



**USER MANUAL
MANUAL DE UTILIZACION
MANUEL D'UTILISATION**

SERIES / SERIE / SÉRIE S4

Models / Modelos / Modèles

S4-6K
S4-15K
S4-30K



INDEX

Specifications	5
Power	5
Before using	5
System power consumption	5
Display description	5
Basic function operation	6
Basic parameter setting	6
- A/D count	6
- High / Low limits setting	7
- Auto-power off	7
- Backlight setting	7
- RS-232 output	8
- RS-232 baud rate	8
- Communication protocol	8
- RS-232 speed setting	10
- Zero average	11
- G Value setting	11
Advanced function setting	11
- Check weighing (span)	11
- Zero Calibration	12
Guarantee	12
EC Declaration of Conformity	30

INDICE

Especificaciones	13
Alimentación	13
Antes de su utilización	13
Consumo	13
Conexión de célula de carga al indicador	13
Descripción del display	14
Operación básica	14
Configuración de parámetros	15
- Cuentas internas (A/D)	15
- Límites de peso (superior e inferior)	15
- Autodesconexión automática	16
- Iluminación del display	16
- Función Hold	16
- Salida de datos RS-232	17
- Velocidad de transmisión	17

- Protocolo de comunicación	17
- Configuración de la velocidad RS-232	19
- Promedio del cero	19
- Configuración de la Gravedad	19
Configuración de funciones avanzadas	20
- Calibración de peso (span)	20
- Calibración del cero	20
Garantía	20
Declaración CE de Conformidad	30

SOMMAIRE

Caractéristiques	21
Alimentation	21
Avant utilisation	21
Consommation	21
Connexion du capteur à l'indicateur	21
Description de l'écran	22
Fonctions de base	22
Configuration de paramètres	23
- Comptes A/D	23
- Limites de poids (supérieure et inférieure)	23
- Auto-déconnexion automatique	24
- Eclairage de l'écran	24
- Fonction Hold	24
- Sortie de données RS-232	25
- Vitesse de transmission RS-232	25
- Protocole de communication	25
- Configuration de la vitesse RS-232	27
- Moyenne du zéro	27
- Configuration de la Gravité	28
Configuration de fonctions avancées	28
- Calibrage de poids (span)	28
- Calibrage du zéro	28
Garantie	29
Declaracion CE de Conformité	30

SPECIFICATIONS

Accuracy: Class III

Nonlinear: $\leq 0.01\%F.S$

System working voltage: DC:5V

Large display connector: Sampling serial output way

Sample rate: 20 times per second (can select)

POWER

Input: 120~240V

Output: 12V/1A

Rechargeable battery: 6V/4AH

BEFORE USING

- 1) Place this product on a firm and smooth place, don't place it in vibration or shaking, use bench for use on four only adjust foot, adjust the balance using the bubble level.
- 2) Use independent source, avoid other electrical disturbance.
- 3) Don't put any object on the platter when turn on the balance.
- 4) Please, turn on 2-3 minutes before using.
- 5) Avoid temperature change too large and air flow strenuous sites.
- 6) Don't overload the balance, don't exceed the maximal capacity.

SYSTEM POWER CONSUMPTION

Main system power consumption: about 12mA

Main system power consumption (with backlight): about 36mA

Main system power consumption (with backlight and RS-232): about 48mA

Battery life: none backlight, about 320 hours.

DISPLAY DESCRIPTION

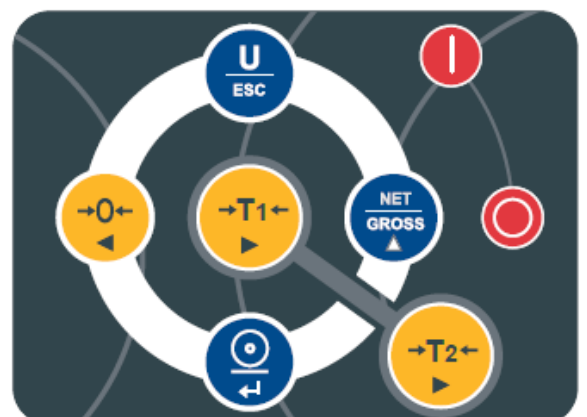
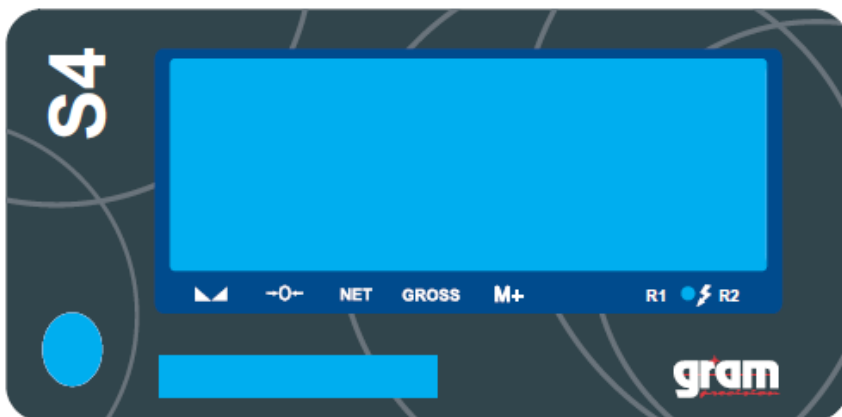

BASIC FUNCTION OPERATION



Press and hold this key for 2 seconds to turn off the balance.



Press this key to turn on the balance



Function 1. To select the desired weight unit.

Function 2. To exit from setup mode.



Function 1. To reset the weight to zero "0", but the display value has to be lesser than $\pm 2\%$ of maximum capacity.

Function 2. To move one space to the left or downward in setup mode.



Function 1. To subtract the container's weight.



Function 2. To move one space to the right or upward in setup mode.



Function 1. To view gross or net weight when the balance is on tare status. All other keys will be disabled when gross weight is activated.

Function 2. To increase values upward in setup mode.



Function 1. Key of confirmation in setup mode.



Function 2. Manually transmitting data through RS232 to computer or printer.

BASIC PARAMETER SETTING









To access to functions setting, press the  and  key at the same time.

Press the  to select the parameter (UF-1 ~ UF-9)

UF-1 A/D count

1. Press the  key to view the A/D count.
2. To move to next parameter press the  key.
3. To exit and return to normal weighing press the  key.





UF-2 High / Low limits setting

1. Press the  key to enter.
2. The display will show the message "000000L"
3. Use the keys  and  to move cursor and press the  to select number.
4. Press the  key to confirm.
5. The display will show "000000H"
6. Use the keys  and  to move cursor and press the  to select number.
7. Press the  key to confirm.
8. Buzzer beep see remark (-)

UF-3 Auto-power off

Modes:



- **AoFF 00** – Auto-turn off disable.
- **AoFF 01** – The balance will automatically turn off after 1 minute of non use.

1. Press the  key to access to auto-power configuration.
2. Use the keys  and  to move from one digit to other and the key  to select the desired mode.
3. Press the  key to confirm.

UF-4 Backlight setting

Modes:

- **A**: Automatic
- **ON**: Backlight on
- **OFF**: Backlight off



1. Press the  to access to backlight configuration.
2. Use the  key to select the desired mode.
3. Press the  key to confirm.

UF-5 HOLD function (keeps the reading fixed on display for few seconds after

removing the load from the platter)

Modes:

- **HOLD 0** : Disable.
- **HOLD 1** : Weighing animals mode.



1. Press the  key to access to HOLD function configuration.
2. Use the  key to select the desired mode.
3. Press the  key to confirm.

UF-6 RS-232 Output

- 232 0 - RS-232 disable
- 232 1 - Stable output – Format 1
- 232 2 - Stream output – Format 1
- 232 3 - Manual output – Format 1
- 232 4 - Stable output – Format 2
- 232 5 - Stream output – Format 2
- 232 6 - Manual output – Format 2

RS232 Baud rate

- b 1200 Baud rate 1200
- b 2400 Baud rate 2400
- b 4800 Baud rate 4800
- b 9600 Baud rate 9600
- b 19200 Baud rate 19200
- b 38400 Baud rate 38400

1. Press the  to enter
2. Press the  to select the baud rate
3. Press the  key to confirm.

Communication Protocol

UART signal of EIA-RS232 C
Format:

1. Serial output: 1200/2400/4800/9600/19200/34800 BPS
2. Data bits: 8 bits
3. Parity bits: None
4. Stop bits: 1 bit

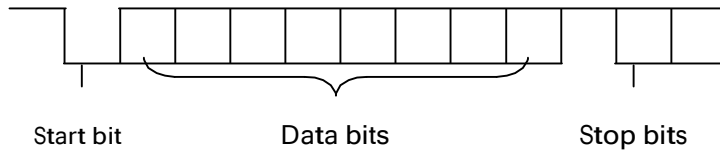

Format 1 (232 1 – 3):

HEAD1 (2 BYTES)	HEAD2 (2 BYTES)
OL – Overload	
ST – Stable	NT – Net weight
US – Unstable	GS – Gross weight

Fixed 18 BYTES ASCII (kg g t lb)

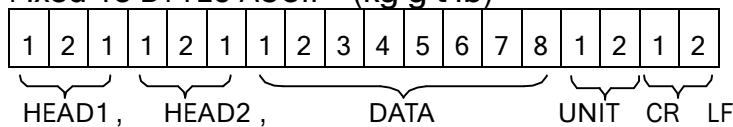

Fixed 21 BYTES ASCII (tl.T lboz)

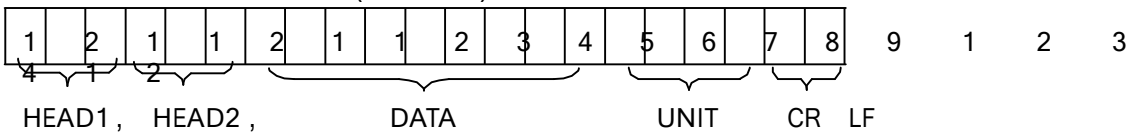

Fixed 19 BYTES ASCII (pcs)

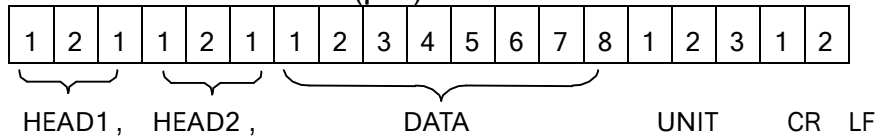

1. Example +0.876 kg Stable net weight :

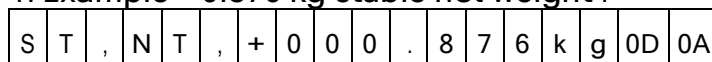

2. Example -1.568 lb unstable gross weight :

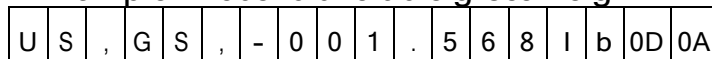

3. Example -20.540 lb oz unstable gross weight :

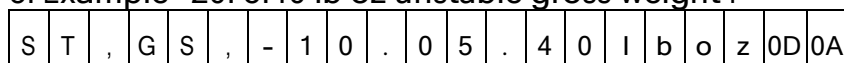

4. Example +1000 pcs stable net weight :

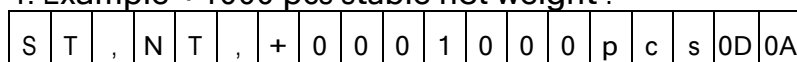

Format 2 (232 4 ~ 6):

Fixed 12 BYTES ASCII (kg g t lb)

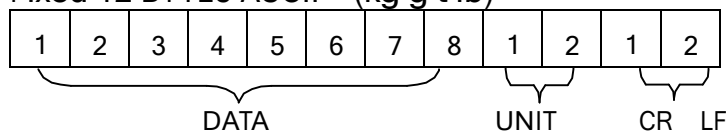

Fixed 15 BYTES ASCII (tl.T lboz)

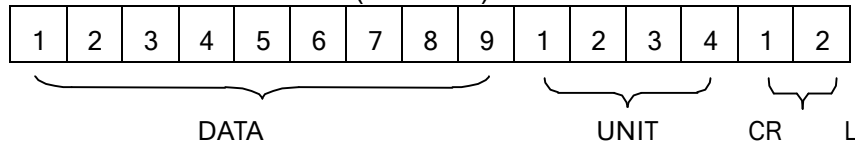

Fixed 13 BYTES ASCII (pcs)

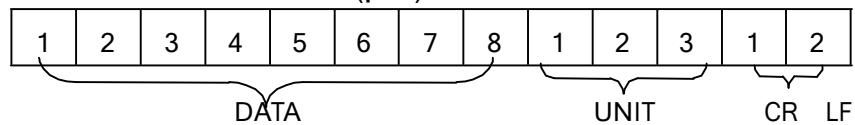

Output examples :

1. Example +0.876 kg stable net weight :

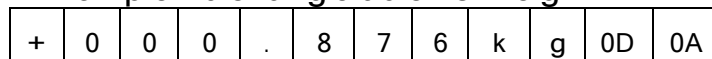

2. Example -1.568 lb unstable gross weight :

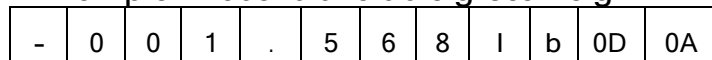

3. Example -20.540 lb oz unstable gross weight :

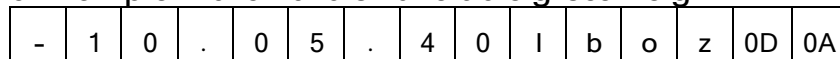

4. Example +1000 pcs stable net weight :

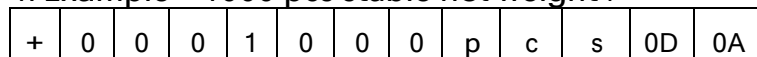

UF-7 RS-232 Speed setting

1. Press the key  to enter.

2. Press the key  to select the desired mode.

Mode 1 : Normal

Mode 2: Fast





Mode 3: Slow

3. Press the key  to confirm.



UF-8 Zero average

1. Press the key  to enter.
2. Press the key  to select.
3. Press the key  to confirm.

UF-9 G Value setting

1. Press the key  to display the G value of manufacture place.
2. If set the G value of local press the  key and then the  or  keys and key  to input the new G value.

ADVANCED FUNCTION SETTING

1. In weight mode, press the  and  keys, the display will show ECF – 1.
2. Press the  or  keys to select ECF-1, ECF-2 or ECF-3

*** ECF-1 Check weighing (SPAN)**

Press the  to enter, display will show CALZ.

Press the  to zero the display.

Use the keys  and  to select the digit.

Press  key to input the weight value.

Put the calibration weight on the platter and press the  key to calibrate.

* ECF-2 Zero Calibration

Press the  key to enter.

The display will show CALZ.

Press the  key to zero.

Press the  key to calibrate.

GUARANTEE

This scale is guaranteed for one year from the delivery date. The guarantee covers any fabrication defect of the material.

During this period GRAM PRECISION, covers the manpower and the spare parts necessary for the reparation of the scale.

This guarantee does not cover the failures caused by an inappropriate use or overcharge.

The guarantee does not cover the freight cost (transport) necessary to repair the scale.

ESPECIFICACIONES

Precisión: Clase III

Rango de sensibilidad de la célula de carga: 1.5 ~ 3.0mV/V

Nonlinear: $\leq 0.01\%F.S$

Voltaje: DC:5V

División: 1/2/5 (seleccionable)

Conector del display : Modo de salida en serie

Frecuencia de muestreo: 20 veces por segundo (seleccionable)

Resolución interna: 300000~600000

ALIMENTACION

Entrada: 120~240V

Salida: 12V/1A

Batería recargable: 6V/4AH

ANTES DE SU UTILIZACION

- 1) Situar la balanza sobre una superficie firme y llana, no exponerla en ambientes con vibraciones, nivelar la plataforma utilizando el nivel de burbuja.
- 2) Utilizar una fuente eléctrica independiente, evitar perturbaciones eléctricas.
- 3) No colocar ningún objeto sobre la plataforma en el momento de poner en marcha el indicador.
- 4) Por favor, permita que la balanza se precaliente durante 2-3 minutos antes de su utilización.
- 5) Evitar cambios de temperatura muy bruscos y corrientes de aire.
- 6) No sobrecargar la balanza, nunca exceder la capacidad máxima.

CONSUMO

Consumo normal: aprox. 12mA

Consumo con la retroiluminación: aprox. 36mA

Consumo con la retroiluminación y salida RS-232: aprox. 48mA

Vida de la batería: sin la retroiluminación, aprox. 320 horas.

CONEXION DE LA CELULA DE CARGA AL INDICADOR

- 1) El conector de la célula de carga es de 5 pins.
- 2) Cuando el indicador está trabajando, no quitar el tapón de la célula de carga, este acto podría dañar el equipo.

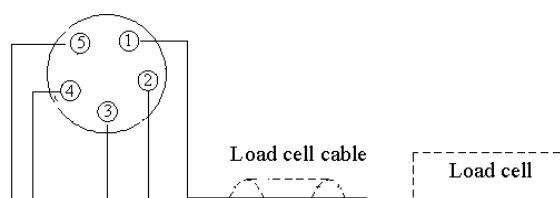

PIN 1:E+

PIN 2:E-

PIN 3:S+

PIN 4:S-

PIN 5:GND

DESCRIPCION DEL DISPLAY

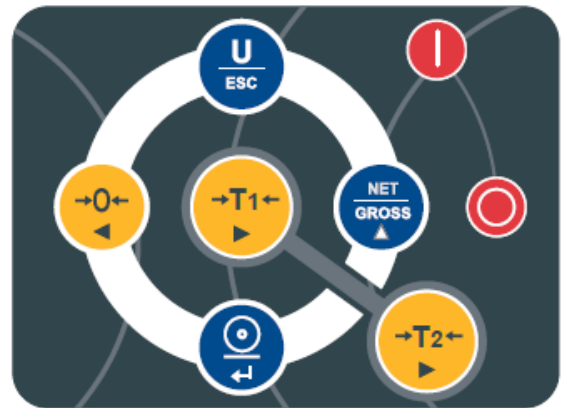
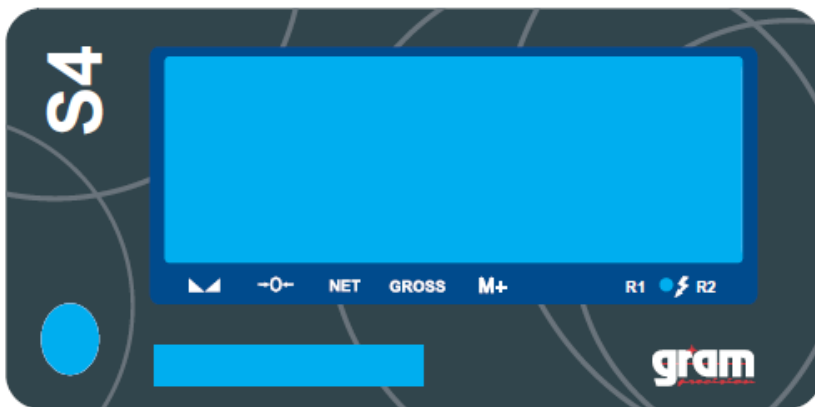

OPERACION BASICA



Mantener pulsada esta tecla durante 2 segundos para apagar el indicador.



Pulsar esta tecla para encender la balanza.



Función 1. Para seleccionar la unidad de pesada deseada.

Función 2. Para salir del modo de programación.



Función 1. Para poner la lectura del display a cero "0", el valor del display tiene que ser menor al $\pm 2\%$ de la capacidad máxima.

Función 2. Para desplazarse un espacio hacía la izquierda o hacía abajo dentro del modo programación.



Función 1. Para sustraer el peso de un contenedor.



Function 2. Para desplazarse un espacio hacia la derecha o hacia arriba dentro del modo programación.



Función 1. Para visualizar el peso neto o bruto de un producto cuando se ha realizado una Tara. Cuando se visualiza el peso bruto del producto las demás teclas quedan deshabilitadas.

Función 2. Para incrementar los valores dentro del modo programación.



Función 1. Tecla de confirmación dentro del modo programación.

Función 2. Transmisión manual de datos a través del puerto RS-232 a un PC o impresora.

CONFIGURACION DE PARAMETROS

Para acceder a la configuración de parámetros, pulsar al mismo tiempo las teclas



y pulsar la tecla



para seleccionar el parámetro deseado (UF-1 ~ UF-9)

UF-1 Cuentas internas (A/D)

1. Pulsar la tecla



para visualizar las cuentas internas de la balanza.

2. Para pasar al siguiente parámetro, pulsar la tecla



3. Para salir y volver al modo normal de pesaje, pulsar la tecla



UF-2 Configuración de los límites de peso (superior e inferior)

1. Pulsar la tecla



para acceder al parámetro.

2. El display mostrará el mensaje "00000L" (Límite inferior)

3. Utilizar las teclas



y para mover el cursor y la tecla



para seleccionar el número deseado.

4. Pulsar la tecla



para confirmar.

5. El display mostrará "00000H" (Límite superior)

6. Utilizar las teclas



y para mover el cursor y la tecla



para seleccionar el número deseado.

7. Pulsar la tecla







para confirmar.

UF-3 Autodesconexión automática

Modos:



- **AoFF 00** – Autodesconexión desactivada.
- **AoFF 01** – Autodesconexión activada, la balanza se apagará automáticamente transcurrido 1 minuto sin ser utilizada.

1. Pulsar la tecla  para acceder al parámetro.
2. Utilizar las teclas  y  para mover el cursor y la tecla  para seleccionar el modo deseado.
3. Pulsar la tecla  para confirmar.

UF-4 Configuración de la iluminación del display

Modos:



- **A**: Automática
- **ON**: Iluminación activada.
- **OFF**: Iluminación desactivada.

1. Pulsar la tecla  para acceder al parámetro.
2. Pulsar la tecla  para seleccionar el modo deseado.
3. Pulsar la tecla  para confirmar.

UF-5 Función HOLD (una vez retirado el objeto del plato, el display mantiene el peso fijado durante unos segundos, función muy útil para el pesaje de animales)

Modos:

- **HOLD 0** : Desactivado.
- **HOLD 1** : Activado



1. Pulsar la tecla  para acceder al parámetro.
2. Pulsar la tecla  para seleccionar el modo deseado.
3. Pulsar la tecla  para confirmar.

UF-6 Salida de datos RS-232

- 232 0 - Salida RS-232 desactivada
- 232 1 - Salida estable – Formato 1
- 232 2 - Salida normal – Formato 1
- 232 3 - Salida manual – Formato 1
- 232 4 - Salida estable – Formato 2
- 232 5 - Salida normal – Formato 2
- 232 6 - Salida manual – Formato 2

RS232 Velocidad de transmisión

- b 1200 1200
- b 2400 2400
- b 4800 4800
- b 9600 9600
- b 19200 19200
- b 38400 38400

1. Pulsar la tecla  para acceder al parámetro
2. Pulsar la tecla  para seleccionar la velocidad de transmisión deseada.
3. Pulsar la tecla  para confirmar.

Protocolo de comunicación

UART signal of EIA-RS232 C

Format:

5. Serial output: 1200/2400/4800/9600/19200/38400 BPS
6. Data bits: 8 bits
7. Parity bits: None
8. Stop bits: 1 bit

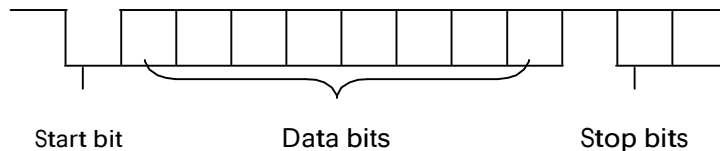

Format 1 (232 1 – 3):

HEAD1 (2 BYTES)	HEAD2 (2 BYTES)
OL – Overload	
ST – Stable	NT – Net weight
US – Unstable	GS – Gross weight

Fixed 18 BYTES ASCII (kg g t lb)

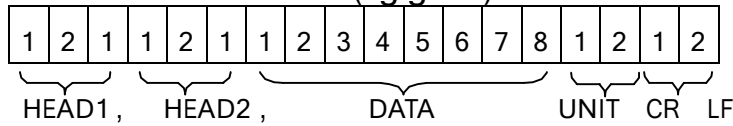

Fixed 21 BYTES ASCII (tl.T lboz)

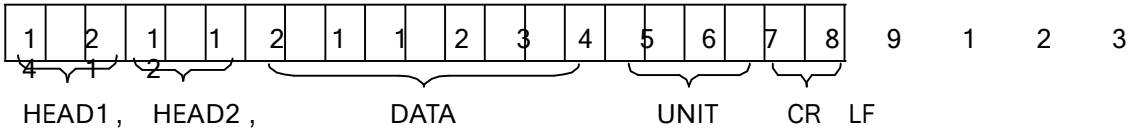

Fixed 19 BYTES ASCII (pcs)

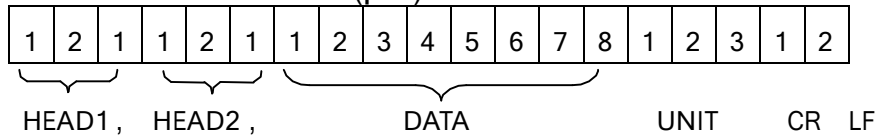

1. Example +0.876 kg Stable net weight :

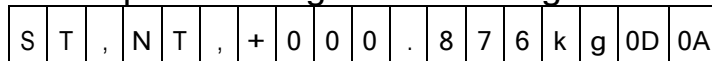

2. Example -1.568 lb unstable gross weight :

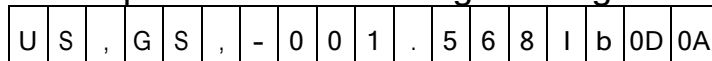

3. Example -20. 5.40 lb oz unstable gross weight :

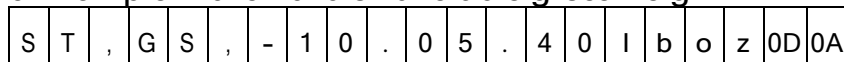

4. Example +1000 pcs stable net weight :

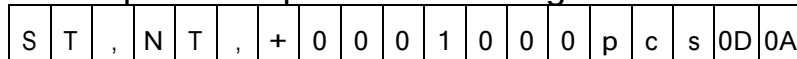

Format 2 (232 4 ~ 6):

Fixed 12 BYTES ASCII (kg g t lb)

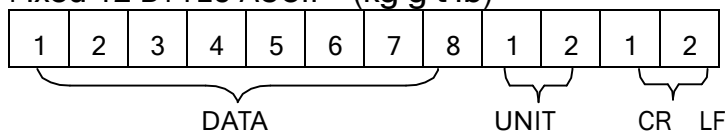

Fixed 15 BYTES ASCII (tl.T lboz)

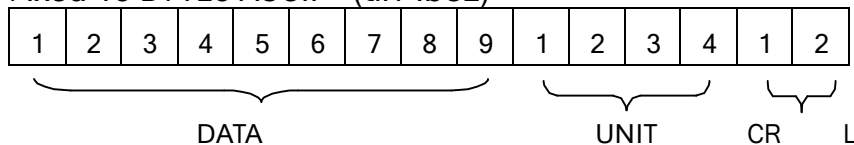

Fixed 13 BYTES ASCII (pcs)

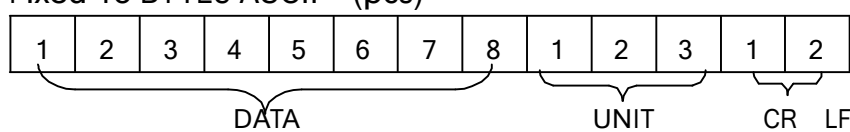

Output examples :

1. Example +0.876 kg stable net weight :

+	0	0	0	.	8	7	6	k	g	0D	0A
---	---	---	---	---	---	---	---	---	---	----	----

2. Example -1.568 lb unstable gross weight :

-	0	0	1	.	5	6	8	l	b	0D	0A
---	---	---	---	---	---	---	---	---	---	----	----



3. Example -20. 5.40 lb oz unstable gross weight :

-	1	0	.	0	5	.	4	0	l	b	o	z	0D	0A
---	---	---	---	---	---	---	---	---	---	---	---	---	----	----

4. Example +1000 pcs stable net weight :

+	0	0	0	1	0	0	0	p	c	s	0D	0A
---	---	---	---	---	---	---	---	---	---	---	----	----





UF-7 Configuración de la velocidad RS-232

1. Pulsar la tecla  para acceder al parámetro.
2. Pulsar la tecla  para seleccionar el modo deseado:
Modo 1 : Normal
Modo 2: Rápido
Modo 3: Lento
3. Pulsar la tecla  para confirmar.



UF-8 Promedio del cero



1. Pulsar la tecla  para acceder al parámetro.
2. Pulsar la tecla  para seleccionar.
3. Pulsar la tecla  para confirmar.

UF-9 Configuración de la gravedad

1. Pulsar la tecla  para visualizar el valor de la Gravedad actual.
2. Para cambiar el valor, pulsar la tecla  , seguidamente utilizar las teclas  y  para mover el cursor y la tecla  para seleccionar el número deseado.

CONFIGURACION DE FUNCIONES AVANZADAS

1. Dentro del modo normal de pesaje, pulsar las teclas  y , el display mostrará el mensaje ECF – 1.

2. Pulsar las teclas  ó  para seleccionar la función deseada: ECF-1, ECF-2 o ECF-3

* ECF-1 Calibración de peso (SPAN)

Pulsar la tecla , el display mostrará CALZ.

Pulsar la tecla  para poner a cero la lectura del display.

Pulsar las teclas  y  para mover el cursor.

Pulsar la tecla  introducir el valor de la pesa de calibración.

Colocar la pesa de calibración sobre la plataforma y pulsar la tecla  para efectuar la calibración

* ECF-2 Calibración de cero

Pulsar la tecla , el display mostrará CALZ .

Pulsar la tecla  para poner la lectura del display a cero.

Pulsar la tecla  para efectuar la calibración.

GARANTIA

Esta balanza está garantizada contra todo defecto de fabricación y de material, por un periodo de 1 año a partir de la fecha de entrega.

Durante este periodo, GRAM PRECISION, se hará cargo de la reparación de la balanza.

Esta garantía no incluye los daños ocasionados por uso indebido o sobrecargas.

La garantía no cubre los gastos de envío (portes) necesarios para la reparación de la balanza.

CARACTÉRISTIQUES

Précision : Classe III

Rang de sensibilité de la cellule de charge: 1.5 ~ 3.0mV/V

Linéarité : $\leq 0.01\%F.S$

Système de voltage: DC:5V

Échelon : 1/2/5 auto-configurable

Connectivité de l'écran LCD: Sortie en série

Vitesse : 20 fois par seconde (sélectionnable)

Résolution interna: 300000~600000

ALIMENTATION

Entrée: 120~240V

Sortie: 12V/1A

Batterie rechargeable: 6V/4AH

AVANT UTILISATION

- 1) Placer la balance sur une surface rigide et plane, ne pas l'utiliser dans un milieu où il y a des vibrations, mettre à niveau la balance grâce à la bulle de niveau.
- 2) Utiliser une source électrique indépendante, éviter les perturbations électriques.
- 3) Ne poser aucun objet sur la plateforme au moment de la mise en marche de la balance.
- 4) Mettre en marche la balance 2-3 minutes avant son utilisation pour permettre un préchauffage.
- 5) Eviter les changements brusques de température et les courants d'air.
- 6) Ne pas surcharger la balance, ne jamais dépasser la capacité maximale.

CONSOMMATION

Consommation normale: approx. 12mA

Consommation avec le rétro éclairage : approx.36mA

Consommation avec le rétro éclairage et la sortie RS-232: approx. 48mA

Autonomie de la batterie: sans le rétro-éclairage, approx. 320 heures.

CONNEXION DU CAPTEUR DE PESÉE A L'INDICATEUR

- 1) Le connecteur de la cellule de charge contient 5 broches (pins).
- 2) Quand l'indicateur fonctionne, ne pas enlever la prise de la cellule de charge, ceci pourrait l'endommager.

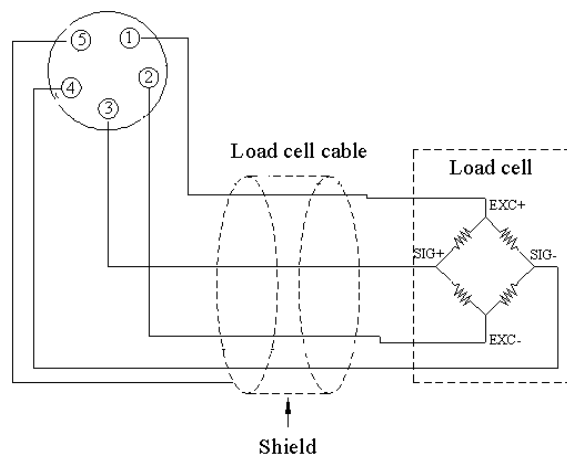

PIN 1:E+

PIN 2:E-

PIN 3:S+

PIN 4:S-

PIN 5:GND

DESCRIPTION DE L'ÉCRAN

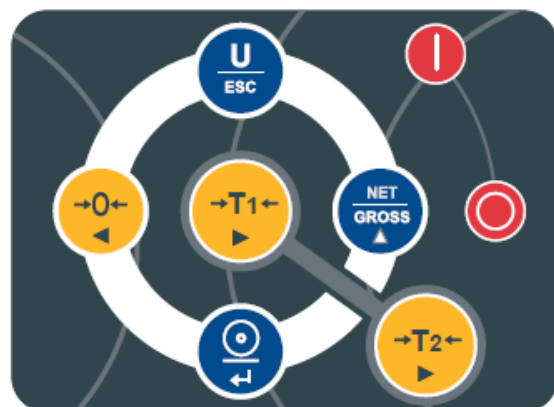
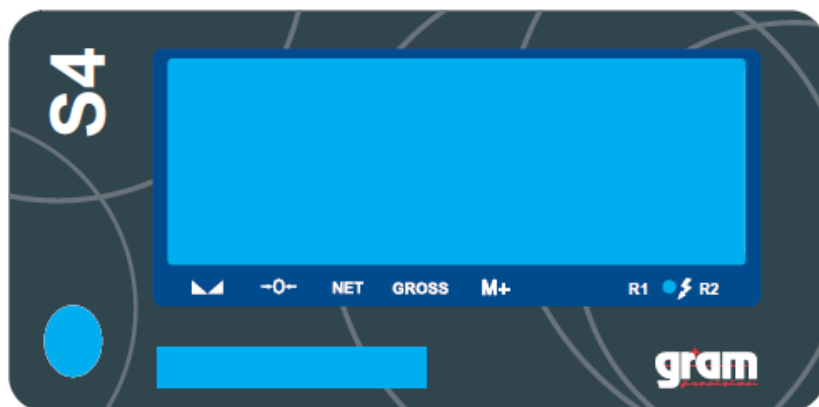

FONCTIONS DE BASE



Maintenir appuyée cette touche pendant 2 secondes pour éteindre l'indicateur.



Appuyer sur cette touche pour allumer la balance.



Fonction 1. Pour sélectionner l'unité de pesée désirée.

Fonction 2. Pour sortir du mode de programmation.



Fonction 1. Pour remettre le poids à zéro "0", mais la valeur affichée sur l'écran doit être inférieure à $\pm 2\%$ de la capacité maximale.

Fonction 2. Pour déplacer un espace vers la gauche ou vers le bas dans le mode de programmation.



Fonction 1. Pour soustraire le poids d'un récipient.



Fonction 2. Pour déplacer un espace vers la droite ou vers le haut dans le mode de programmation.



Fonction 1. Pour visualiser le poids net et brut d'un produit lorsqu'une tare a été réalisée. Quand le poids brut s'affiche les autres touches sont désactivées.



Fonction 2. Pour augmenter les valeurs dans le mode de programmation.



Fonction 1. Touche de confirmation dans le mode de programmation.



Fonction 2. Transmission manuelle de données grâce au port RS-232 à un PC ou une imprimante.

CONFIGURATION DE PARAMÈTRES





Pour accéder à la configuration des paramètres, appuyer en même temps sur les touches  et .





Appuyer sur la touche  pour sélectionner le paramètre choisi (UF-1 ~ UF-9).

UF-1 Compte A/D

1. Appuyer sur la touche  pour voir le compte A/D.
2. Pour passer au paramètre suivant appuyer sur la touche .
3. Pour sortir et revenir au mode normal de pesage, appuyer sur la touche .

UF-2 Configuration des limites de poids (supérieure et inférieure)





1. Appuyer sur la touche  pour accéder au paramètre.
2. L'écran affichera le message "000000L" (Limite inférieure)
3. Utiliser les touches  et  pour déplacer le curseur et la touche  pour sélectionner le nombre voulu.
4. Appuyer sur la touche  pour confirmer.
5. L'écran affichera "000000H" (Limite supérieure)

6. Utiliser les touches  et  pour déplacer le curseur et la touche  pour sélectionner le nombre voulu.
7. Appuyer sur la touche  pour confirmer.

UF-3 Auto-déconnexion automatique

Modes:



- **AoFF 00** – Auto-déconnexion désactivée.
- **AoFF 01** – Auto-déconnexion activée, la balance s'éteindra automatiquement après une minute sans utilisation.

1. Appuyer sur la touche  pour accéder au paramètre.
2. Utiliser les touches  et  pour déplacer le curseur et la touche  pour sélectionner le mode voulu.
3. Appuyer sur la touche  pour confirmer.

UF-4 Configuration de l'éclairage de l'écran

Modes:

- **A** : Automatique
- **ON** : Éclairage actif.
- **OFF** : Éclairage inactif.

1. Appuyer sur la touche  pour accéder au paramètre.
2. Appuyer sur la touche  pour sélectionner le mode voulu.
3. Appuyer sur la touche  pour confirmer.

UF-5 Fonction HOLD (une fois l'objet retiré du plateau, l'écran continue d'afficher le poids pendant quelques secondes, fonction très utile pour le pesage d'animaux).

Modes:

- **HOLD 0** : Désactivé.
- **HOLD 1** : Activé



1. Appuyer sur la touche  pour accéder au paramètre.
2. Appuyer sur la touche  pour sélectionner le mode voulu.
3. Appuyer sur la touche  pour confirmer.

UF-6 Sortie de données RS-232

- 232 0 - Sortie RS-232 désactivée
- 232 1 - Sortie stable – Format 1
- 232 2 - Sortie normale – Format 1
- 232 3 - Sortie manuelle – Format 1
- 232 4 - Sortie stable – Format 2
- 232 5 - Sortie normale – Format 2
- 232 6 - Sortie manuelle – Format 2

Vitesse de transmission RS232

- b 1200 1200
- b 2400 2400
- b 4800 4800
- b 9600 9600
- b 19200 19200
- b 38400 38400

1. Appuyer sur la touche  pour accéder au paramètre.
2. Appuyer sur la touche  pour sélectionner la vitesse de transmission désirée.
3. Appuyer sur la touche  pour confirmer.

Protocole de communication

UART signal of EIA-RS232 C

Format:

- 9. Serial output: 1200/2400/4800/9600/19200/34800 BPS
- 10. Data bits: 8 bits
- 11. Parity bits: None
- 12. Stop bits: 1 bit

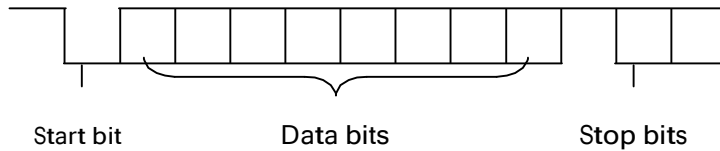

Format 1 (232 1 – 3):

HEAD1 (2 BYTES)	HEAD2 (2 BYTES)
OL – Overload	
ST – Stable	NT – Net weight
US – Unstable	GS – Gross weight

Fixed 18 BYTES ASCII (kg g t lb)

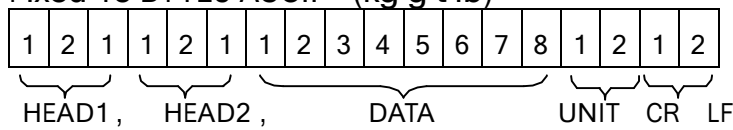

Fixed 21 BYTES ASCII (tl.T lboz)

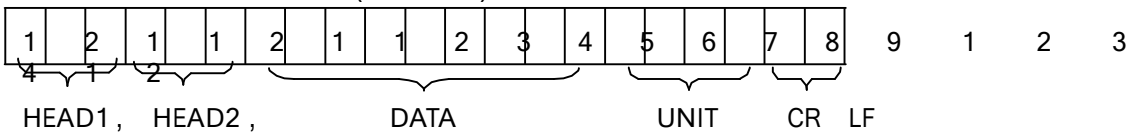

Fixed 19 BYTES ASCII (pcs)

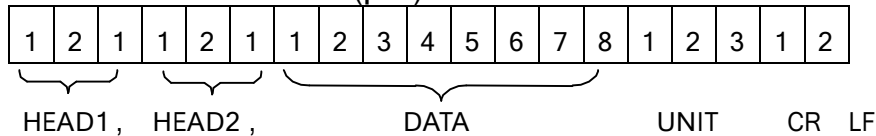

1. Example +0.876 kg Stable net weight :

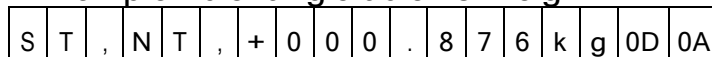

2. Example -1.568 lb unstable gross weight :

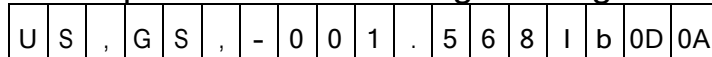

3. Example -20.540 lb oz unstable gross weight :

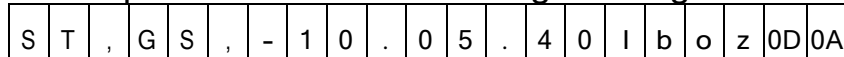

4. Example +1000 pcs stable net weight :

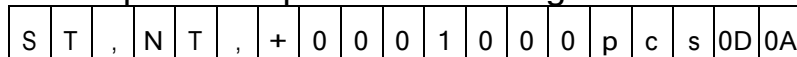

Format 2 (232 4 ~ 6):

Fixed 12 BYTES ASCII (kg g t lb)

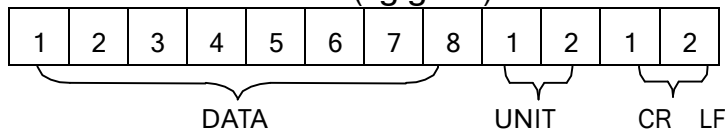

Fixed 15 BYTES ASCII (tl.T lboz)

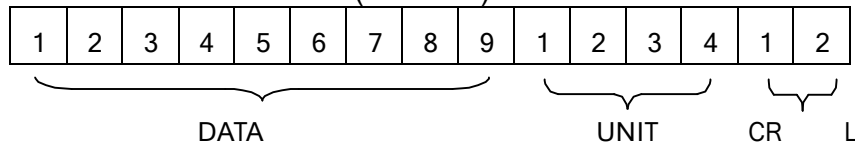

Fixed 13 BYTES ASCII (pcs)

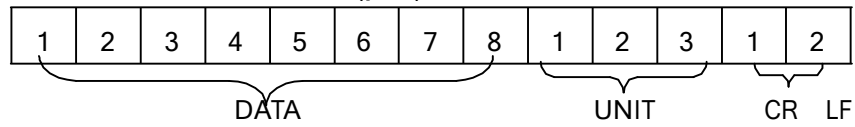

Output examples :

1. Example +0.876 kg stable net weight :

+	0	0	0	.	8	7	6	k	g	0D	0A
---	---	---	---	---	---	---	---	---	---	----	----

2. Example -1.568 lb unstable gross weight :

-	0	0	1	.	5	6	8	l	b	0D	0A
---	---	---	---	---	---	---	---	---	---	----	----

3. Example -20. 5.40 lb oz unstable gross weight :

-	1	0	.	0	5	.	4	0	l	b	o	z	0D	0A
---	---	---	---	---	---	---	---	---	---	---	---	---	----	----

4. Example +1000 pcs stable net weight :

+	0	0	0	1	0	0	0	p	c	s	0D	0A
---	---	---	---	---	---	---	---	---	---	---	----	----

UF-7 Configuration de la vitesse RS-232

1. Appuyer sur la touche  pour accéder au paramètre.

2. Appuyer sur la touche  pour sélectionner le mode voulu :

Mode 1 : Normal

Mode 2: Rapide

Mode 3: Lent

3. Appuyer sur la touche  pour confirmer.





UF-8 Moyenne du zéro

1. Appuyer sur la touche  pour accéder au paramètre.





2. Appuyer sur la touche  pour sélectionner.

3. Appuyer sur la touche  pour confirmer.

UF-9 Configuration de la gravité

1. Appuyer sur la touche  pour visualiser la valeur actuelle de la gravité.
2. Pour changer la valeur, appuyer sur la touche , puis utiliser les touches  et  pour déplacer le curseur et la touche  pour sélectionner le nombre voulu.

CONFIGURATION DE FONCTIONS AVANCÉES

1. Dans le mode normal de pesage, appuyer sur les touches  et , l'écran affichera le message ECF – 1.
2. Appuyer sur les touches  ou  pour sélectionner la fonction voulue : ECF-1, ECF-2 o ECF-3.

* ECF-1 **Calibrage de poids (SPAN)**

Appuyer sur la touche , l'écran affichera CALZ.

Appuyer sur la touche , pour mettre à zéro l'affichage à l'écran.

Appuyer sur les touches  et  pour déplacer le curseur.

Appuyer sur la touche  et introduire la valeur du poids de calibrage.

Placer le poids de calibrage sur la plateforme et appuyer sur la touche  pour effectuer le calibrage.

* ECF-2 **Calibrage du zéro**

Appuyer sur la touche , l'écran affichera CALZ.

Appuyer sur la touche , pour mettre à zéro l'affichage à l'écran.

Appuyer sur la touche  pour effectuer le calibrage.

GARANTIE

Cette balance est garantie contre les défauts de fabrication ou de pièce, pendant une année, à partir de la date de livraison.

Durant cette période, GRAM PRECISION, SL se chargera de la réparation de la balance.

Cette garantie n'inclut pas les dommages causés par une utilisation impropre, surcharge, ou par faute de ne pas avoir suivi les recommandations écrites dans ce manuel (particulièrement de l'aparté CONSEILS POUR L'ENTRETIEN).

La garantie ne couvre pas les frais d'envoi (transport) nécessaires pour la réparation de la balance.

