



pH

table of contents

Introduction..... 2.2

Comparison Guides..... 2.4

Benchtop 2.8

HI6000 Series..... 2.8

HI5000 Series..... 2.18

with Built-in Printer..... 2.24

edge®

edge..... 2.26

edge pH..... 2.30

edge®blu

pH meter with HALO..... 2.34

HALO® Family

HALO2..... 2.40

HALO..... 2.58

Hanna Lab App..... 2.74

Portable..... 2.78

pH/EC/DO..... 2.78

pH/ORP..... 2.82

HACCP Food and Dairy Specific ..2.86, 2.128

Milk Specific..... 2.90, 2.125

HACCP Meat Specific 2.94, 2.129

Yogurt Specific..... 2.98, 2.126

Cheese Specific..... 2.102, 2.127

Beer Analysis..... 2.106, 2.132

Wine Analysis..... 2.110, 2.134

Direct Soil Specific..... 2.114, 2.121

Plating Bath Specific 2.122

Boiler and Cooling Tower Specific 2.123

Leather and Paper Specific 2.124

Drinking Water..... 2.130

Skin and Scalp Specific 2.136

General..... 2.120, 2.137-2.138

pH/mV Simulator 2.139

pH Electrodes 2.140

Introduction..... 2.140

Application Guides..... 2.130

Laboratory Electrodes..... 2.154

Combination 2.154

Special..... 2.158

Rugged..... 2.160

Digital Electrodes..... 2.161

Food Specific Electrodes..... 2.164

Specific Analysis..... 2.168

pH and ORP Half Cells..... 2.171

Reference..... 2.172

Extension Cables..... 2.170

pH and ORP Solutions.... 2.174

Introduction..... 2.174

Calibration..... 2.178

Technical..... 2.178

Millesimal..... 2.180

Quick Cal 2.181

Standard..... 2.182

ORP and Sample Preparation 2.186

Electrode Storage..... 2.187

Electrode Cleaning..... 2.188

Electrode Refilling..... 2.190

Single or Multiparameter Instrumentation

Hanna Instruments offers both single parameter and multiparameter instruments in order to meet a variety of testing requirements.

Using Single Parameter

Hanna single parameter instruments offer simple, accurate and efficient measurement focused on, as the name implies, a single parameter. They are well suited to applications where one parameter must be tested quickly and easily. They are generally simple to operate and can be used by non-technical users.

Using Multiparameter

The advantage of Hanna multiparameter instruments is that a user can choose a single meter with the ability to measure multiple parameters.

Multiparameter instruments offer different operating solutions well suited to meeting multiple requirements and are available in two primary configurations:

1. Multiparameter meters that can measure two or three parameters, but only one parameter at a time.
2. Multiparameter meters that offer two or three parameters measured simultaneously—useful on experimental and research applications where the influence between the parameters is an important factor. Multiple inputs provide the capability for simultaneous measurement.

pH Measurement Input

Hanna meters generally come in two different electrode connection types: BNC or DIN.

BNC Connector: A BNC (Bayonet Neil-Concelman) is a common connector used for coaxial cable devices. A BNC connection is generally used for combined electrodes and half-cell electrodes that require a separate reference probe and separate reference input.

DIN Connector: A DIN (Deutsches Institut für Normung) is a circular connector. It is used to connect amplified pH electrodes. Electrodes utilizing a DIN connector feature a built-in temperature sensor.

Temperature Input

Temperature has an effect on pH measurements. As such, temperature compensation is required for accurate measurements. Temperature compensation can be obtained in three ways:

1. A separate probe specifically for measuring temperature
2. A probe with a temperature sensor built-in
3. Manual adjustment for temperature

If a temperature input is not present, many instruments still offer the ability to manually adjust the temperature according to an external temperature reference.

pH Temperature Compensation

pH readings must be temperature compensated in order to obtain accurate results. The source of temperature measurement can be from a temperature sensor or from a trimmer that is manually adjusted. In either case, the instrument is adjusting the pH reading to compensate for changes in the pH sensor. Compensation in pH provides the actual pH at the temperature of measurement.

mV Reading

Hanna meters with an mV feature offer the ability to read the mV potential from a pH, ORP, or ISE electrode. The relative mV allows the user to offset the mV difference generated from sensors or references.

pH/ISE Calibration

pH calibration should be performed daily or every time a new lot of readings is started. Any errors during calibration will affect all the readings until a new calibration is performed. Errors during the calibration process can be eliminated if standard calibration procedures are followed.

Hanna recommends the following standard calibration procedure:

1. Clean and activate the electrode before the calibration.
2. Use fresh pH buffers and standards.
3. Rinse the electrode with purified water during the calibration process to avoid buffer contamination then rinse in buffer or standard.
4. Wait for a stable reading before the calibration point is confirmed.
5. Compensate the pH reading for temperature.

Calibration is a key component to ensuring accurate readings during pH measurement. With this in mind, Hanna supplies each of our pH instruments with a starter package of calibration solutions.

pH CAL Check™

Many instruments feature Hanna's exclusive pH CAL Check technology. CAL Check is a diagnostics system that ensures accurate pH readings every time. By alerting users to potential problems during the calibration process, the CAL Check system eliminates erroneous readings due to dirty or faulty pH electrodes or contaminated pH buffer solutions during calibration.

During the calibration process, users are prompted with a step-by-step, on-screen tutorial. After calibration, the electrode is evaluated and the condition and response time is provided. Depending upon meter, this may be a graphic of GLP information.

Calibration Errors

Instruments utilizing Hanna's CAL Check technology can evaluate an electrode during calibration and store a history of parameters that describe the quality of electrode to be compared from one calibration to another. During calibration, a very small degradation of these parameters is normal and can be expected. A big change in the parameters signifies an error in the calibration procedure, such as a dirty electrode.

pH Buffer Contamination

pH buffers can be contaminated during the calibration procedure by numerous factors such as introducing a contaminated probe, using old buffers, or by reusing buffers. These factors may cause inaccurate calibration and subsequent measurements.

Hanna's CAL Check can often detect issues during calibration, giving warning messages to inform users about the identified issue.

Response Time of Electrodes

Another parameter that is evaluated during the calibration with certain meters that have CAL Check technology is the response time of an electrode. This is evaluated based on the amount of time necessary to reach stability when the electrode is immersed in a new buffer that has a difference in pH larger than 3 pH units from the old one.

Offset and Slope of pH Electrode

The offset and slope are the most important parameters that can describe the quality of an electrode. With Hanna's CAL Check technology, the offset of the electrode can be evaluated using one point calibration. Offset is generally determined using a 7.01 pH buffer, however, using CAL Check allows the offset to be based on any calibration point. The acceptable range for offset is ± 30 mV although a warning may be displayed.

A minimum of two calibration points is necessary to determine the slope. Slope can be evaluated between two calibration points and normally should fall within a range of 92% to 110%, where 100% is 59.16 mV/pH @ 25°C.

Calibration Points and pH buffers

The calibration of a pH electrode is normally performed using two points: 7 pH, and 4 or 10 pH. This is based on the assumption that the pH electrode is linear from 3 pH up to 10 pH. For the most accurate reading, Hanna recommends using a calibration point closest to the values received during normal measurement.

For a variety of applications and measuring points, many Hanna meters offer the ability to calibrate using more than two points. Many Hanna instruments offer 2, 3, or up to 5 calibration points for enhanced accuracy. pH buffers 1.68, 3.00, 4.01, 6.86, 7.01, 9.18, 10.01, and 12.45 cover the entire pH range.

During calibration, the recognized pH buffers are temperature compensated by the instrument in order to account for pH variation of buffers due to temperature. For example, a 10.01 pH buffer is 10.01 pH only @ 25°C. A table of temperature variation is printed on the label of each pH buffer.

Custom pH Buffers

Hanna has implemented the concept of custom pH buffers into many of its instruments. This permits the user to add an industry specific buffer for calibration. However, temperature compensation during calibration is not implemented because the temperature variation correlation is unknown.

Stability During Calibration

The stability of readings is important in order to avoid incorrect calibration. Based on this, the confirmation of a new calibration point is done only after stability is reached. Users are informed during all processes about the stability conditions, and any instability will restart the stability evaluation. The stability criteria during the calibration is more rigorous than during the measurement. This mode used in Hanna instrumentation avoids errors by confirmation of calibration points during unstable readings. This principle is respected in any type of calibration, manual or automatic.

Out of Calibration Range

This is an important feature during measurement and is considered Good Laboratory Practice (GLP). The measurement is considered more accurate. If the measurement reading is in a range far from the calibration points, the "out of calibration range" message is displayed. The measured value is shown and the user can accept it, but with the warning from the instrument related to possible inaccuracy.

Calibration Reminder

The calibration reminder, like "out of calibration range," is a GLP warning message. Regularly scheduled calibrations are crucial for accurate and repeatable measurements. A warning reminder will be displayed when the sensor needs calibration. Measurements can still be used under the warning reminder.

Step-by-Step Calibration

In order to avoid errors during the calibration procedure, the meters display indicators that can be followed by the user for a successful calibration. If necessary, it is possible for the calibration steps to be performed in a different order by the user.

Additional Features

GLP and ISO standards require the traceability of operations. Hanna's GLP document the quality of calibration, plus information to identify the instrument, operator, and the time at which calibration was performed.

Logging is a common feature for many instruments and can be used to record readings. Two working modes are available: log-on-demand and automatic or interval logging. With log-on-demand, measurements that are considered important can be saved with the press of the log button. With automatic or interval logging, the instrument saves all the readings according to a specified interval. Another logging mode is Auto-End logging or log on stability.

Many Hanna meters include graphic LCD's with features such as tutorials, contextual help, multi-language support, and icons and messages to guide the user through operation and calibration.

Advanced and Research Grade pH Benchtop Meters



	Two Channels	ISE Measurement	0.001 pH Resolution	Five-point pH Calibration	Five Custom pH Buffers	GLP Features	Real Time Graphing	Data Logging	Incremental Methods	User Accounts	Touchscreen Interface	Wireless Connectivity	USB	PC Connectivity	Fully Customizable	Advanced Customization	Page
HI6221			•	•	•	•	•	•	•	•	•	•	A, C	•	•	•	2.8
HI5222	•	•	•	•	•	•	•	•	•				device	•	•		2.18
HI5221			•	•	•	•	•	•					device	•	•		2.22

edge®



	Bluetooth® Wireless Technology	Hanna Lab App Compatible	pH Measurement	EC/TDS Measurement	DO Measurement	pH/CAL Check™	0.001 pH Resolution	Five-point pH Calibration	Two Custom pH Buffers	GLP Features	Capacitive Touch Buttons	Data Logging	8 Hour Battery Life	PC Connectivity	Benchtop, Portable & Wall-Mount	3.5 mm probe input	Page
edge®blu	•	•	•			•	•	•	•	•	•	•	•	•	•	•	2.34
edge			•	•*	•*	•	•	•	•	•	•	•	•	•	•	•	2.26
edge pH			•			•	•	•	•	•	•	•	•	•	•	•	2.30

* with optional compatible edge electrode

HALO 2

and Hanna Lab App



	Dual-level LCD	pH Range	pH/mV conversion*	0.01 pH Resolution	Five-point pH Calibration	Calibration Buffers	GLP features*	Hanna Lab App Compatible	Bluetooth® Wireless Technology	Hanna Lab App Required	Data Logging*	Body material	Recommended Application	Refillable	CPS™ Clogging Prevention	Easy Clean PVDF Sleeve	Battery Life with Bluetooth Enabled (hours)	Page
HI9810402	•	0.00-14.00	•	•	•	up to 5	•	•	•	No	•	glass	Lab	•			500	2.42
HI9810412	•	0.00-12.00	•	•	•	up to 4	•	•	•	No	•	glass	Lab				500	2.43
HI9810422	•	0.00-12.00	•	•	•	up to 4	•	•	•	No	•	PEI	Field				500	2.44
HI9810302	•	0.00-12.00	•	•	•	up to 4	•	•	•	No	•	PVDF	Soil		•		500	2.45
HI9810432	•	0.00-12.00	•	•	•	up to 4	•	•	•	No	•	glass	Cosmetic Creams	•			500	2.46
HI9810372	•	0.00-12.00	•	•	•	up to 4	•	•	•	No	•	glass	Skin & Scalp				500	2.47
HI9810442	•	0.00-12.00	•	•	•	up to 4	•	•	•	No	•	glass	Leather & Paper				500	2.48
HI9810312	•	0.00-12.00	•	•	•	up to 4	•	•	•	No	•	Titanium	Beer				500	2.49
HI9810332	•	0.00-12.00	•	•	•	up to 4	•	•	•	No	•	glass	Wine	•	•		500	2.50
HI9810352	•	0.00-12.00	•	•	•	up to 4	•	•	•	No	•	Titanium	Sushi				500	2.51
HI9810342	•	0.00-12.00	•	•	•	up to 4	•	•	•	No	•	glass	Milk				500	2.52
HI9810322	•	0.00-12.00	•	•	•	up to 4	•	•	•	No	•	PVDF	Cheese				500	2.53
HI9810362 / HI9810452	•	0.00-12.00	•	•	•	up to 4	•	•	•	No	•	PVDF	Meat		•		500	2.54
HI9810392	•	0.00-12.00	•	•	•	up to 4	•	•	•	No	•	PVDF	Chocolate		•		500	2.55
HI9810382	•	0.00-12.00	•	•	•	up to 4	•	•	•	No	•	PVDF	Bread & Dough				500	2.57

*With Hanna Lab App

HALO®

and Hanna Lab App



	pH Range	0.001 pH Resolution	Five-point pH Calibration	Calibration Buffers	GLP features	Hanna Lab App Compatible	Bluetooth® Wireless Technology	Hanna Lab App Required	Data Logging	Body material	Recommended Application	CPS™ Clogging Prevention	Battery Life (hours)	Page
HI11312	0.00-13.00	•	•	up to 7	•	•	•	yes	•	glass	lab		500	2.60
HI11102	0.00-12.00	•	•	up to 7	•	•	•	yes	•	glass	lab		500	2.61
HI13302	0.00-12.00	•	•	up to 7	•	•	•	yes	•	glass	lab, test tube		500	2.62
HI10832	0.00-13.00	•	•	up to 7	•	•	•	yes	•	glass	lab, small sample		500	2.63
HI12302	0.00-12.00	•	•	up to 7	•	•	•	yes	•	PEI	field		500	2.64
FC2022	0.00-12.00	•	•	up to 7	•	•	•	yes	•	PVDF	food		500	2.65
HI10482	0.00-12.00	•	•	up to 7	•	•	•	yes	•	glass	wine, must and juice	•	500	2.67
FC2142	0.00-13.00	•	•	up to 7	•	•	•	yes	•	titanium	brewing		500	2.69
HI12922	0.00-12.00	•	•	up to 7	•	•	•	yes	•	glass	direct soil		500	2.71
HI14142	0.00-12.00	•	•	up to 7	•	•	•	yes	•	glass	flat surfaces		500	2.72
HI10532	0.00-12.00	•	•	up to 7	•	•	•	yes	•	glass	food		500	2.73

Laboratory Grade pH Benchtop Meters



	mV	CAL Check	Temperature Measurement	Automatic Calibration	0.001 pH Resolution	Five-point pH Calibration	Two Custom pH Buffers	GLP Features	Data Logging	PC Connectivity	Magnetic Stirrer	Built-in Printer	Built-in Solution Holders	Analog Output	Page
HI122	•	•	•	•	•	•	•	•	•	•	•	•	•	•	2.24

Waterproof Portable pH Meters



	ISE Measurement	mV Measurement	Temperature Measurement	0.001 pH Resolution	pH Sensor Check™	CAL Check	Automatic Calibration	Automatic Temperature Compensation	Log on Demand (records)	Two-point pH Calibration	Three-point Calibration	Five-point Calibration	Custom Buffers	Backlit LCD	GLP Features	PC Connectivity	Auto-off	Page
HI98199	•	•	•	•	•	•	•	•	45k	•	•	•	•	•	•	•	•	2.78
HI98190	•	•	•	•	•	•	•	•	200	•	•	•	•	•	•	•	•	2.82
HI991003	•	•	•	•	•	•	•	•	•	•	•	•	•	•	•	•	•	2.120
HI991001	•	•	•	•	•	•	•	•	•	•	•	•	•	•	•	•	•	2.120

Application Specific Waterproof Portable Meters



	Temperature Measurement	BEPS	Automatic Temperature Compensation	Two-Point pH Calibration	Waterproof	Soil Measurement	Plating Baths	Boiler & Cooling Towers	Leather & Paper	Foodcare	Milk	Yogurt	Cheese	General Purpose Food	Drinking Water	Beer Analysis	Wine Analysis	Meat Measurement	pH of Skin	Page
HI98161	•		•	•	•					•										2.86
HI98162	•		•	•	•						•									2.90
HI98163	•		•	•	•													•		2.94
HI98164	•		•	•	•							•								2.98
HI98165	•		•	•	•								•							2.102
HI98167	•		•	•	•										•					2.106
HI98169	•		•	•	•												•			2.110
HI98168	•		•	•	•	•														2.114
HI99121	•	•	•	•	•	•														2.121
HI99131	•	•	•	•	•		•													2.122
HI99141	•	•	•	•	•			•												2.123
HI99171	•	•	•	•	•				•											2.124
HI99181	•	•	•	•	•														•	2.136
HI99162	•	•	•	•	•						•									2.125
HI99164	•	•	•	•	•							•								2.126
HI99165	•	•	•	•	•								•							2.127
HI99161	•	•	•	•	•									•						2.128
HI99163	•	•	•	•	•													•		2.129
HI99192	•	•	•	•	•										•					2.130
HI99151	•	•	•	•	•											•				2.132
HI99111	•	•	•	•	•													•		2.134

Other Portable Meters

	mV Measurement	Temperature Measurement	Automatic Calibration	Automatic Temperature Compensation	HOLD Function	Two-Point pH Calibration	Low Battery Indicator	Pre-amplified pH Electrode	Auto-off	Page
HI8424	•	•	•	•	•	•	•		•	2.137
HI8314-1	•	•		•		•	•	•		2.138
HI83141-1	•	•		•		•	•			2.138
HI931001	•									2.139
HI9310014 (Pool Line)	•									2.139



Advanced pH/ORP Meter

pH/ORP and Temperature



HI6221 is a streamlined benchtop meter with a large touch screen display, comprised of a housing and an integrated pH / ORP measurement module.

Compact and easy to operate, the benchtop meter is delivered with Hanna Instruments HI1131B double junction combination pH electrode, together with HI7662-TW temperature probe.

HI1131B is a glass body, double junction, refillable pH electrode with an indicating sensor made of High Temperature (HT) glass. The double junction reference and HT glass design allow the HI1131B to be used in a wide variety of applications including samples with metals and elevated temperatures.

Probe connection to the unit is secured through a galvanically isolated BNC connection.

HI7662-TW stainless steel temperature probe allows the meter to automatically temperature compensate (ATC) pH measurements.

This system responds to a complex range of measurement and monitoring requirements, providing accuracy, reproducibility, and reliability.

HI6221 is supplied with an electrode holder that has a flexible arm. The holder can be mounted quickly and provides secure support for electrodes while taking measurements in sample containers.

User interface

- 7-inch capacitive touch screen with multi-touch support
- Capacitive touch back, home and system menu keys
- User-friendly icons and symbols allow users to easily navigate and interpret the instrument functions.
- The user can select between five different views:
 - Basic measurement configuration
 - Simple GLP with calibration information
 - Full GLP with electrode status and calibration point details
 - Live updated, interactive graph
 - Tabulated data with date, time, and notes

Measurement

- Measure pH/mV (pH) or mV/Rel. mV (ORP) with temperature
- Application-specific profiles allow quick and direct measurement without the need to update the sensor and system settings

- Active log during measurement
- Measurement stability indicator (using the Stability Criteria setting)
- Reading modes: direct and direct/autohold
- Temperature compensation can be Automatic (using temperature probe) or set manually
- Audible and/or alarm messages for measurements outside of predefined limits
- Galvanic isolation for pH/ORP measurement

Calibration

- 5-point pH calibration with automatic recognition for standard buffers (Hanna and NIST buffers)
- Choice of standard or custom buffers for calibration
- Non-volatile memory saves data and settings

Logging

- Data log collection of at least 1,000,000 data points (with time and date stamp)
- Logging types: manual, automatic, autohold
- Sample ID for manual and Autohold data

Connectivity features & services

- Transfer logged data to a USB thumb drive
- Log files that include measurements and calibration data (as .csv file)
- FTP and email for log export via Ethernet and Wi-Fi connection
- USB type A for USB stick, keyboard, and printer
- USB type C for USB stick and PC connection

Help section for meter guidance

- Video support presentation of main functionalities



This system responds to a complex range of measurement and monitoring requirements, providing accuracy, reproducibility, and reliability.



1. Capacitive touch screen with multi-touch support

The benchtop unit has a 7-inch color display with 800 x 480p resolution. The capacitive, multi-touch screen supports video playback and data plotting.

2. Back key

3. Home key

4. System Menu key

This key will enter the system menu where User accounts, System Settings, and Logging can be configured. The Help menu is also accessed on the system menu screen.

5. Stability indicator

6. Current date

7. Current time

8. pH reading

9. mV reading

10. pH electrode icon

11. Calibration information: Electrode condition, Offset, Slope, Date and Time

12. Buffer trays

13. Temp. reading and Temp. compensation status

14. Measurement setup menu

Opens sensor setup parameters.

15. User name (default shown)

16. Direct/Autohold Readings

When Direct/Autohold is selected, measurement reading is held on display when measurement stability is reached. This option removes the subjective nature of stability as a measurement that has not reached equilibrium will not be used.

When not selected, sample measurements are displayed continuously.

17. Logging space availability

18. Logging start

19. USB connection status

20. Peripheral connection status

21. Wireless network connection status

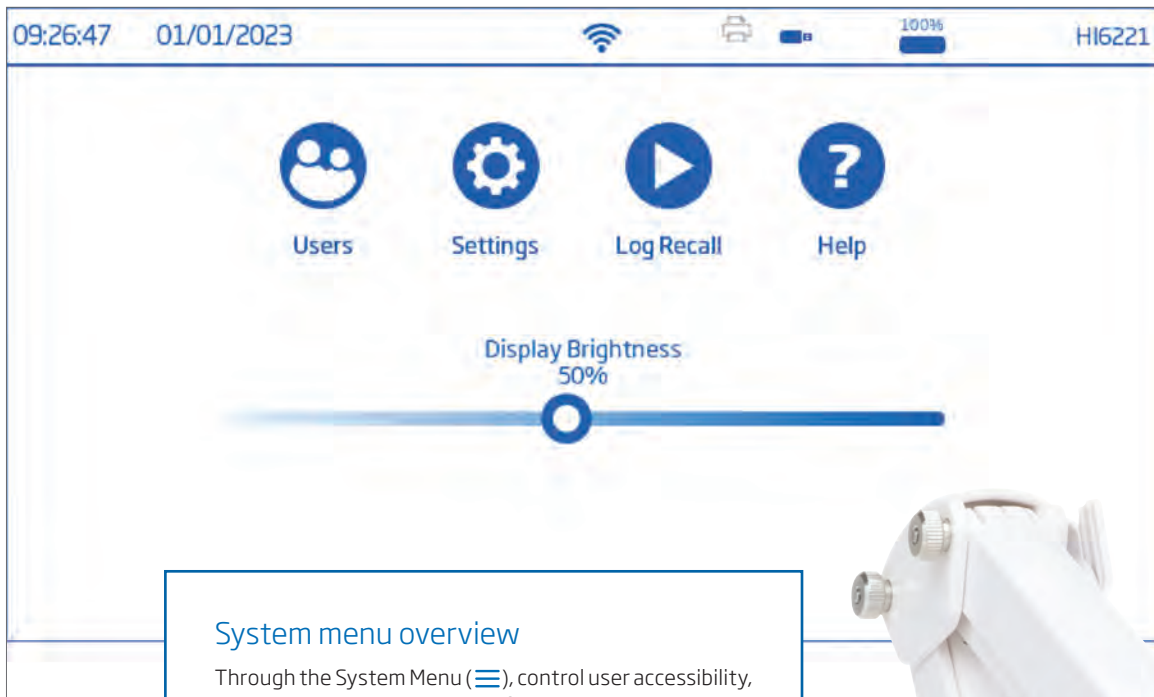

System menu overview

Through the System Menu (☰), control user accessibility, system and connectivity configuration, access logged data and video-supported help.

- Add and delete user accounts through Users (👤).
- Access Network Connectivity, System and Info tabs through Settings (⚙️).
- Log Recall (▶️) recalls stored log sessions (Automatic continuous logging, Manual, or Autohold).
- Help (❓) guides users with video-supported help.



pH

benchtop



Users

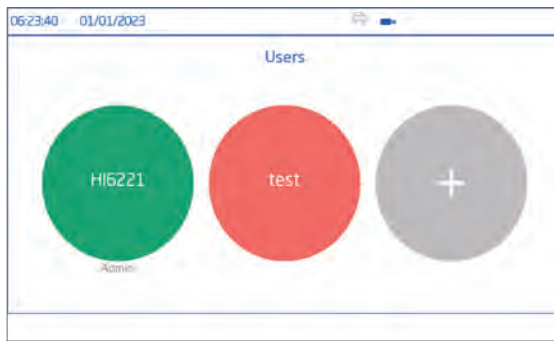

Custom Users

New administrator or standard user accounts can be created. Standard accounts can be configured for specific accessibility.

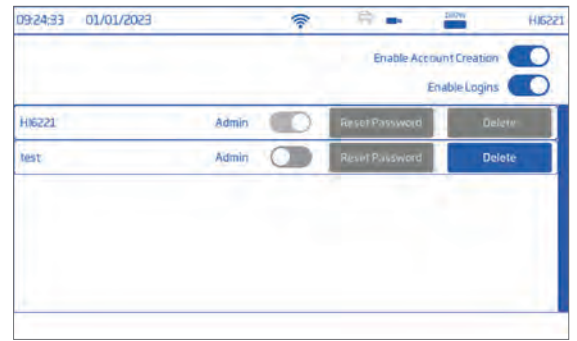

User Account Management

Administrators can create and manage accounts from the Account Management Screen.



Settings

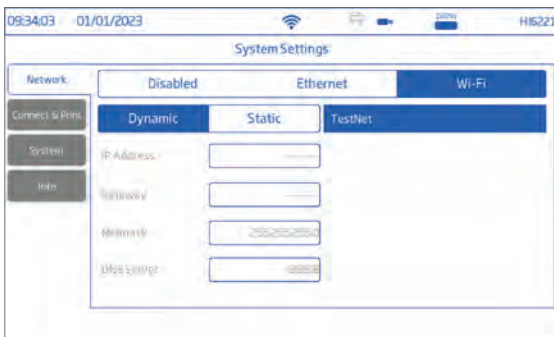

Network Screen

Determine how measurement logs are shared through network settings. Users can select network to be connected via Ethernet or Wi-Fi, or Disabled.

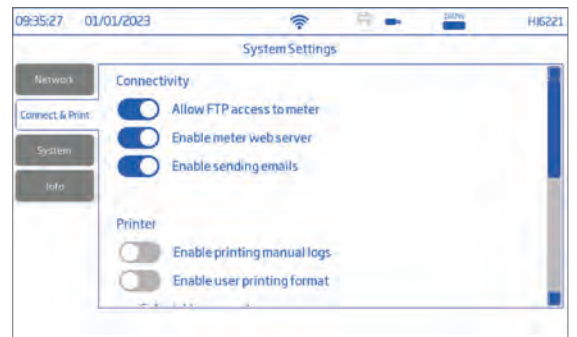

Connect and Print Screen

Activate connectivity options to allow the meter to connect to other devices.

- FTP access to meter, permits log file transfer to a FTP site and to connect the meter FTP server to a client for log download.
- Meter web server, permits log file download to a web client.
- Sending emails, permits log files to be transferred by email.

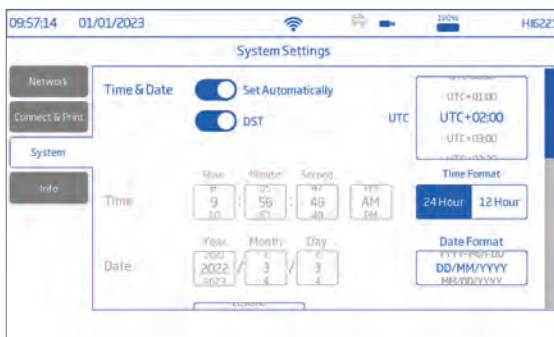

System Screen

The system screen enables users to configure options such as: Time, Date, Language, Meter ID, Decimal Separator, Backlight Saver, Audible signals, Startup Tutorial, and Factory Settings restore.



Info Screen

Displays information on meter, channel serial number, and Wi-Fi firmware version.



Log Recall

Name	Parameter	Start/Stop	#Samples
mV_20220303070237.csv	mV	10:02:37 03/03/2022 10:03:21 03/03/2022	45
pH_20220303070155.csv	pH	10:01:58 03/03/2022 10:02:27 03/03/2022	30
pH_20220303070403.csv	pH	10:04:03 03/03/2022 10:04:32 03/03/2022	10
relmV_20220303070334.csv	Rel. mV	10:03:34 03/03/2022 10:03:53 03/03/2022	20

Log History and Sharing

The item allows users access and management (selection, deletion, and sharing) of measurement data. Only the user who generated the data has access to the logs created by that user.

Data can be viewed tabulated (complete with date, time, and notes), or plotted (as graph).

Log files can be shared via USB, FTP, web server and email.

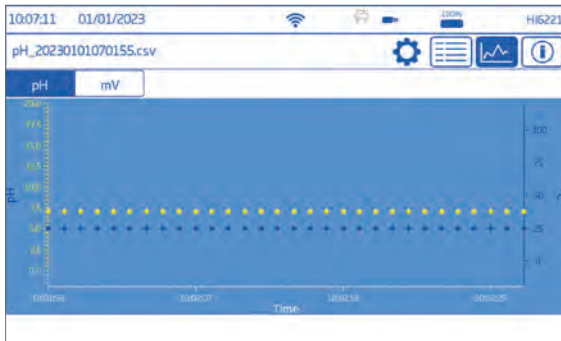

Graph View

pH	mV	T(°C)	Date	Time	Notes
7.044	-2.4	25.0	03/03/2022	10:01:58	"H"
7.044	-2.4	25.0	03/03/2022	10:01:59	"H"
7.044	-2.4	25.0	03/03/2022	10:02:00	"H"
7.044	-2.4	25.0	03/03/2022	10:02:01	"H"
7.044	-2.4	25.0	03/03/2022	10:02:02	"H"
7.044	-2.4	25.0	03/03/2022	10:02:03	"H"
7.044	-2.4	25.0	03/03/2022	10:02:04	"H"
7.044	-2.4	25.0	03/03/2022	10:02:05	"H"
7.044	-2.4	25.0	03/03/2022	10:02:06	"H"
7.044	-2.4	25.0	03/03/2022	10:02:07	"H"

Table View

GENERAL INFORMATION
 Username: HI6221
 Profile: default_pH

INSTRUMENT
 Instrument Name: HI6221-01
 Serial Number: 129456789LMN
 Firmware Version: 01.220825

CHANNEL INFO
 Channel Number: 1
 Module: General

Log Detail

Tapping the information icon displays log details such as user and profile name, instrument name and serial number, channel, lot information, as well as GLP data.



Help

Hanna Tutorial System

- 1. HI6221 First Look
- 2. Getting Started
 - 2.1. Get familiar with functionalities
 - 2.2. Users
 - 2.3. Meter settings
 - 2.4. Setting measurement
- 3. General Operations
- 4. General Operations
- 5. Troubleshooting guide
- 6. Accessories and Warranty

2.1. Get familiar with functionalities
Screens explained
Main View - This screen shows the current measurement according to the measurement settings and give access to the user calibration and measurement settings options.

7.540	25.0
-------	------

Main Menu - This screen gives the user access to the 5 main icons

Hanna Tutorial System

- 1. HI6221 First Look
- 2. Getting Started
 - 2.1. Get familiar with functionalities
 - 2.2. Users
 - 2.3. Meter settings
 - 2.4. Setting measurement
- 3. General Operations
- 4. General Operations
- 5. Troubleshooting guide
- 6. Accessories and Warranty

2.4. Setting up measurement
 Your measurement screen can be configured by pressing **Q**.

Channel Settings

READING

Mode: pH, mV, Rel. mV

On-board Help

The HELP menu supports users with a brief overview of the system's main functionalities through text and video tutorials.



Measurement Setup Configuration



Calibration

Customize calibration options such as Last Calibration, Automatic, semi-automatic or manual calibration, First Calibration Point, daily or periodic Calibration Reminder, and buffer Groups.



Buffer groups

This option allows the user to select Buffers in Use for calibrating a pH electrode when using the Automatic calibration type.

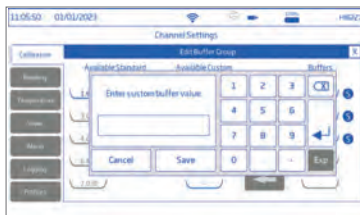

Custom Buffers

Custom buffers can be created.



Reading

Customize measurement options such as Parameter, Resolution, Stability Criteria, Reading Mode



Temperature

Customize temperature options such as Automatic or manual temperature Source, °C, °F, or K temperature Unit, Manual Temperature input, Isopotential Point.

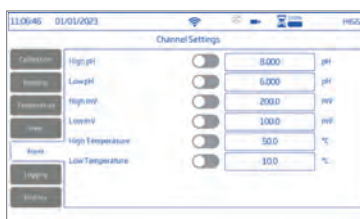

Alarm configuration

Alarm configuration allows users to set the high and low threshold limits for the measured parameters. When the parameter is enabled and the measurement exceeds the high-limit value or drops below the low-limit value, the alarm is triggered and will appear on the message banner along with an audible alarm (if Alarm Beepers is enabled).



Logging

Logging Type (Automatic, Manual or Autohold), Sampling Period (Automatic), File Name (Manual and Autohold), and Sample ID (Manual and Autohold) can be configured under this option menu.

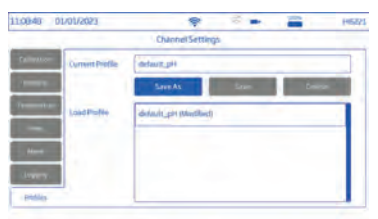

Profiles

A profile is a sensor setup complete with required measurement unit, temperature unit, display preference, and alarm threshold options.

Once saved the profile can be loaded for applications that require similar configurations.

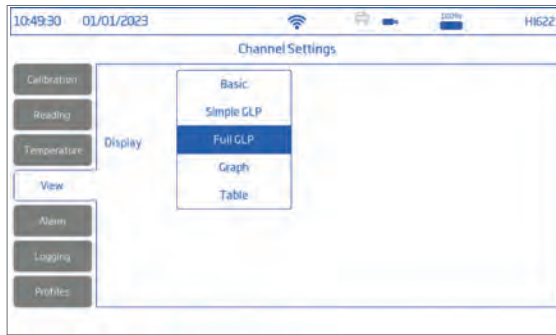

View Configuration

This screen allows users to select the preferred display configuration.

pH options: Basic, Simple GLP, Full GLP, Graph, Table
 mV options: Basic, Graph, Table
 Rel. mV options: Simple GLP, Basic, Graph, Table

Basic View

Basic screen displays the measured value, measurement unit as well as temperature source.



Simple GLP View

In addition to data displayed when Basic option is selected, Simple GLP screen also displays: last calibration date and time, Offset value, average slope (Avg. Slope), and electrode condition (Condition).



Full GLP View

In addition to data displayed when Simple GLP option is selected, Full GLP screen also displays: electrode symbol, used buffers trays together with calibration date, time, and temperature probe status.

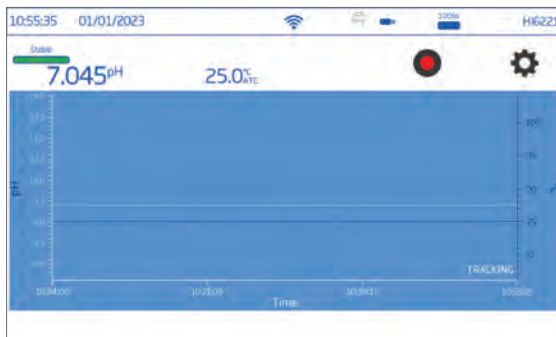

Graph View

When Graph is selected, the measured value is plotted as a graph.



Table

When Table is selected, the measured values are displayed tabulated (complete with date, time, and notes made during logging). The newest data is displayed on the top of the table.

Electrode Holder

HI6221 is supplied with the HI764060 electrode holder featuring a flexible arm. The holder can be mounted on either side quickly and provides secure support for electrodes while taking measurements in sample containers.



Rear Ports

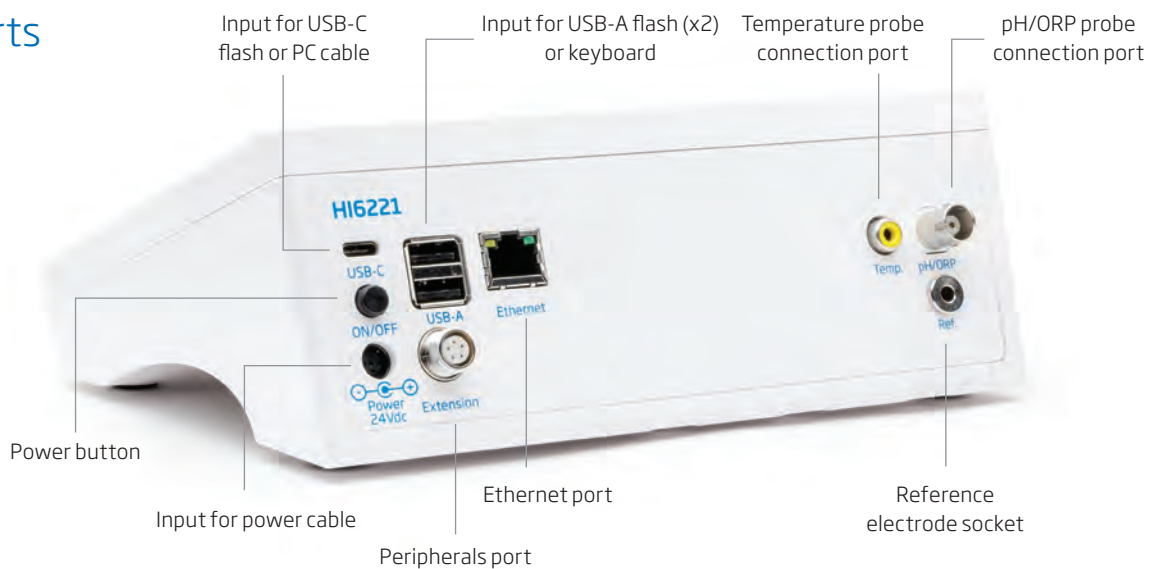

Specifications	HI6221	
pH	Range	-2.0 to 20.0 pH; -2.00 to 20.00 pH; -2.000 to 20.000 pH
	Resolution	0.1 pH; 0.01 pH; 0.001 pH
	Accuracy	±0.1 pH; ±0.01 pH; ±0.002 pH (±1 last significant digit)
mV	Range	±2000.0 mV
	Resolution	1 mV; 0.1 mV
	Accuracy	±0.2 mV ±1 last significant digit
Temperature	Range	-20.0 to 120.0 °C; -4.0 to 248.0 °F; 253.0 to 393.0 K
	Resolution	0.1 °C / 0.1 °F / 0.1 K
	Accuracy	±0.2 °C / ±0.4 °F / ±0.2 K
Relative mV offset range		±2000.0 mV
pH Calibration	Calibration points	Up to 5
	Type	Automatic; Semiautomatic; Manual
	Standard buffers	Hanna and NIST pH 1.68, 3.00, 4.01, 6.86, 7.01, 9.18, 10.01, 12.45
	Custom buffers	Up to 5
	Custom group	Up to 5
	1st calibration point	Offset or Points (user setting)
	Reminder	Disabled Daily: 0 min. to 23 hours and 59 min. Periodic: 1 min. to 500 days, 23 hours and 59 min.
Temperature Compensation		Automatic or Manual
Reading	Modes	Direct; Direct/Autohold
	Stability criteria	Accurate; Medium; Fast
	Isopotential	7.000 or 4.010
	Sampling rate	1000 ms
pH Views	Basic	Measurement (pH, mV, Rel.mV, Abs.mV) Temperature, Stability status
	Simple GLP	Basic view information Last calibration date, electrode offset, average slope, and electrode condition
	Full GLP	Simple GLP information and calibration point details
	Table	Measurements updated every second are displayed in table
	Graph (Plot)	pH (or mV) and temperature versus time graph can be panned or zoomed (pinch-to-zoom technology)
Logging	Type	Automatic, Manual, Autohold
	Number of records	50 000 maximum per file Stores at least 1 000 000 data points per user
	Automatic interval	1, 2, 5, 10, 30 seconds 1, 2, 5, 10, 15, 30, 60, 120, 150, 180 minutes
	Sample ID	Incremental mode
	Export option	.csv file format
Users	Up to 9 users and admin. account (default)	
Connectivity	USB-A	2 ports for keyboard input or USB thumb drive
	USB-C	1 port for PC connectivity and USB-C type thumb drive
	Wi-Fi & Ethernet	FTP Web server Log transfer and download Email
	RS232	Connecting peripherals
Power supply	DC adapter 100-240AC to 24VDC 2.5A	
Environment	0 - 50 °C / 32 - 122 °F / 273 - 323 K maximum 95% RH non-condensing	
Dimensions	205 x 160 x 77 mm (8.0 x 6.2 x 3.0")	
Weight	Approximately 1.2 kg (26.5 lbs.)	
Ordering Information	HI6221 is supplied with HI1131B pH electrode; HI7662-TW temperature probe; pH calibration starter kit consisting of: pH 4.01 buffer solution sachet (2 pcs.); pH 7.01 buffer solution sachet (4 pcs.); pH 10.01 buffer solution sachet (2 pcs.); HI700601 electrode cleaning solution sachet (2 pcs.); HI7082 3.5M KCl electrolyte solution (30 mL); HI764060 electrode holder; capillary pipette; 24 VDC power adapter; USB-C to USB-A cable; quick reference guide with instrument quality certificate.	

Research Grade Meter

pH/ORP/ISE and Temperature



The HI5222 is a research grade benchtop pH/mV/ISE dual channel meter that is completely customizable with a large color LCD, capacitive touch keys, and USB port for computer connectivity.

The HI5222 features two galvanically isolated BNC connections for use with the expansive line of pH, ISE, and ORP electrodes that Hanna Instruments offers. The meter is supplied with the HI1131B glass body, double junction, combination pH electrode that operates over a wide temperature range from 0 to 100°C. All readings are automatically compensated for temperature variations with the separate HI7662-T temperature probe that is included.

As a pH meter the HI5222 can be calibrated up to five points with eight pre-programmed buffers or five custom buffers. The HI5222 features Hanna's exclusive CAL Check™ to alert the user to potential problems during the pH calibration process. Alerts displayed during calibration include "Electrode Dirty/Broken" and "Buffer Contaminated." The overall probe condition based on the offset and slope characteristic of the electrode are displayed as a percentage after calibration is complete.

As an ISE meter the HI5222 can be calibrated up to five points with a choice of five fixed standards or five user standards defined

in any concentration unit. The calibration data including date, time, standards used, and slope can be viewed at any time along with the current measurement by selecting the Good Laboratory Practice (GLP) display option.

Three selectable logging modes are available: automatic, manual, and AutoHold logging. Up to 100,000 data points per channel can be recorded in 100 lots, 50,000 records max/lot and exported to a computer for data review and storage.

Customizable User Interface

The user interface of the HI5222 allows the user to show measurements in various modes: basic measurement with or without GLP information, real-time graphing, and logging data. Calibration stability criteria can be adjusted to fast, moderate, or accurate. Programmable alarm limits can be set to inside or outside allowable limits.

Color Graphic LCD

The HI5222 features a color graphic LCD with on-screen help, graphic, and custom color configurations. The display allows for real-time graphing and the use of virtual keys provide for an intuitive user interface.

Capacitive Touch

The HI5222 features sensitive capacitive touch buttons for accurate keystrokes when navigating menus and screens. There are four dedicated keys that are used for routine operations including calibration and switching measurement modes and four virtual keys that change based upon use. The capacitive touch technology ensures the buttons never get clogged with sample residue.

Two Galvanically Isolated pH/ORP/ISE Channels

The HI5222 has two input channels that can be used for pH, ORP, and ISE electrodes. Each input channel has connectors for BNC probes, reference probes, and a temperature sensor. Each channel is galvanically isolated which means that two measurement probes can be in the same solution at the same time and the voltages produced will not interfere with each other.

Choice of Calibration

Automatic buffer recognition, semi automatic, and direct manual entry pH calibration options are available for calibrating up to five points, from a selection of eight standard buffers and up to five custom buffers.

GLP Data

HI5222 includes a GLP feature that allows users to view calibration data and calibration expiration information at the touch of a key. Calibration data include date, time, buffers used for calibration, and electrode offset and slope characteristics.

CAL Check™

CAL Check alerts users to potential problems during the calibration of the pH electrode. Indicators include "Electrode Dirty/Broken," "Buffer Contaminated," electrode response time, and the overall probe condition as a percentage that is based on the offset and slope characteristics.

ISE Measurement with Choice of Concentration Units

The HI5222 allows for calibration and readings in choice of concentration units. The choices of concentration units include ppt, g/L, mg/mL, ppm, mg/L, µg/mL, ppb, µg/L, mg/mL, M, mol/L, mmol/L, %w/v, and a user-defined unit.

ISE Measurement with Incremental Methods

The known addition, known subtraction,

analyte addition, and analyte subtraction incremental methods are pre-programmed into the HI5222. Simply follow the on screen guided procedure and the meter will perform the calculation automatically allowing for a higher level of accuracy to be obtained as compared to a direct ISE measurement.

Data Logging

Three selectable logging modes are available on the HI5222: automatic, manual, and AutoHold logging. Automatic and manual logs up to 100 lots with 50,000 records max/lot with up to 100,000 total data points per channel. Automatic logging features the option to save data according to sampling period and interval.

Data Transfer

Data can be transferred to a PC with USB cable and HI92000 software (both sold separately).

Contextual Help

Contextual help is always available through a dedicated "HELP" key. Clear tutorial messages and directions are available on-screen to quickly and easily guide users through setup and calibration. The help information displayed is relative to the setting/option being viewed.

CAL Check Screens

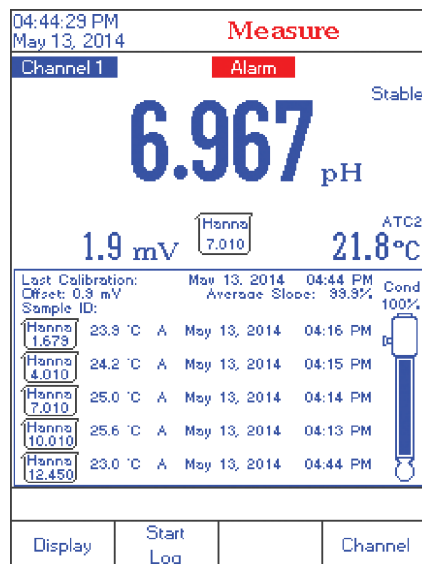
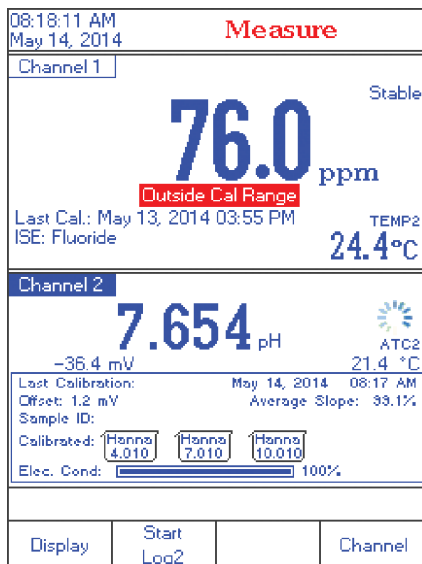
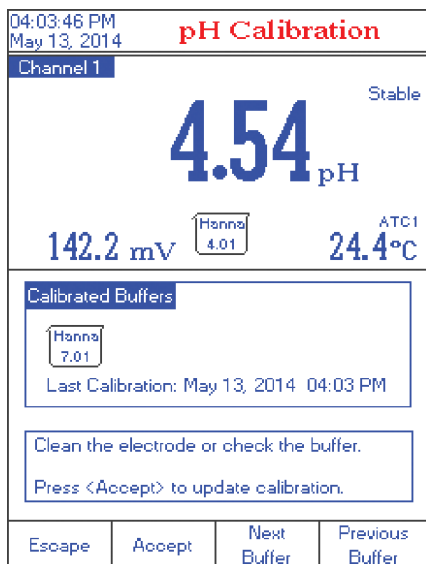

Additional Features by Screen

pH

benchtop

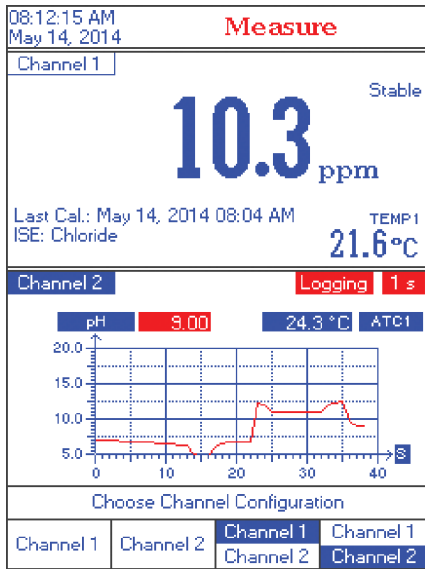

Channel Configuration

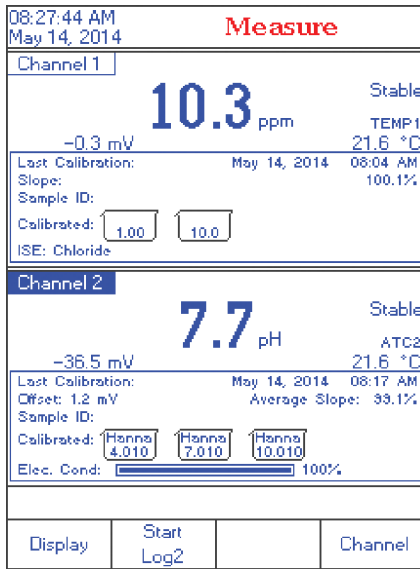

Good Laboratory Practices

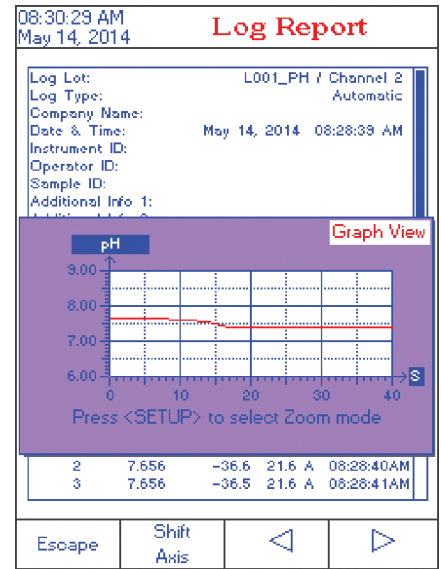

Log Recall

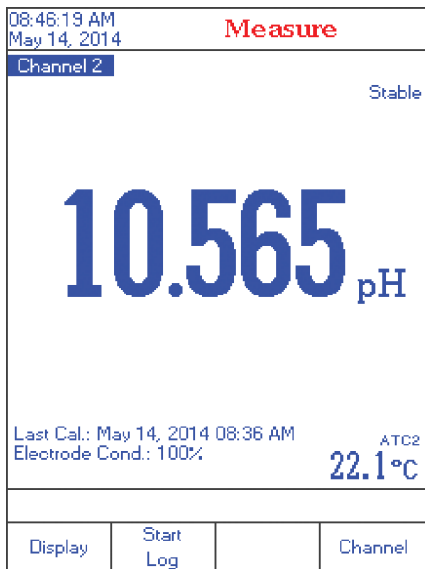

Basic Display

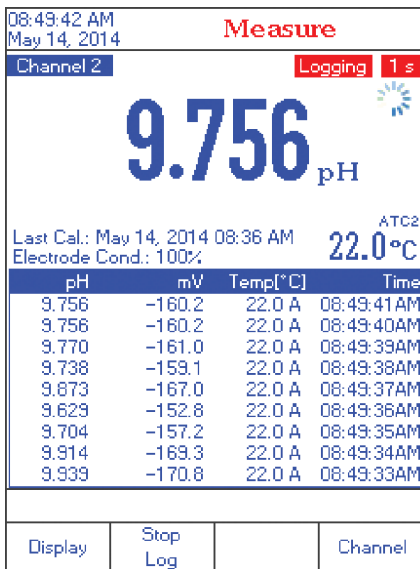

Real-Time Logging

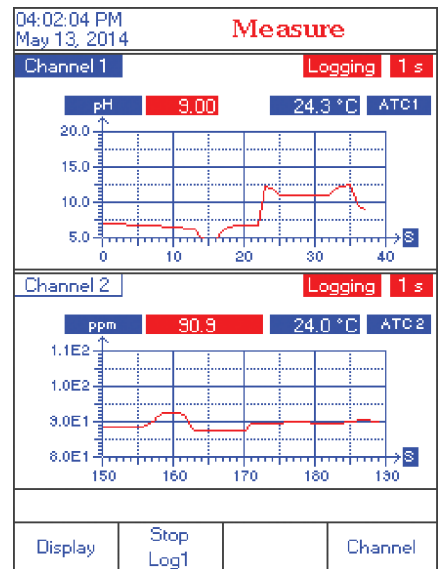

Simultaneous Dual Channel Graphing



Dual Channels

The two measurement channels of the HI5222 are galvanically isolated to eliminate noise and instability.

In ISE mode, this instrument provides a choice of several incremental methods. Communication is via opto-isolated USB.



Specifications

HI5222

pH	Range	-2.0 to 20.0 pH; -2.00 to 20.00; -2.000 to 20.000 pH
	Resolution	0.1 pH; 0.01 pH; 0.001 pH
	Accuracy	±0.1 pH; ±0.01 pH; ±0.002 pH ±1 LSD
	Calibration	automatic, up to five point calibration, eight standard buffers available (1.68, 3.00, 4.01, 6.86, 7.01, 9.18, 10.01, 12.45), and five custom buffers
	Temperature Compensation	automatic or manual from -20.0 to 120.0°C/-4.0 to 248.0°F/253.15 to 393.15K
mV	Range	±2000 mV
	Resolution	0.1 mV
	Accuracy	±0.2 mV ±1 LSD
	Relative mV Offset Range	±2000 mV
ISE	Range	1 x 10 ⁻⁶ to 9.99 x 10 ¹⁰ concentration
	Resolution	1; 0.1; 0.01; 0.001 concentration
	Accuracy	±0.5% (monovalent ions); ±1% (divalent ions)
	Calibration	automatic, up to five-point calibration, seven fixed standard solutions available for each measurement unit, and five user defined standards
Temperature*	Range	-20.0 to 120°C; -4.0 to 248.0°F; 253.15 to 393.15K
	Resolution	0.1°C; 0.1°F; 0.1K
	Accuracy	±0.2°C; ±0.4°F; ±0.2K
Additional Specifications	pH Electrode	HI1131B glass body pH electrode with BNC connector and 1 m (3.3') cable (included)
	Temperature Probe	HI7662-W stainless steel temperature probe with 1 m (3.3') cable (included)
	Input Channel(s)	2 pH/ORP/ISE
	GLP	calibration points, calibration time stamp, probe offset, slope, date, time and buffers/standards used
	Logging	record: Up to 100 lots, 50,000 records max/lot / maximum 100,000 data points/channel; interval: 14 select table between 1 second and 180 minutes; type: automatic, manual, AutoHOLD;
	Display	color graphic LCD 240x340 pixels
	PC Connection	USB
	Power Supply	12 VDC adapter (included)
	Environment	0 to 50°C (32 to 122°F; 273 to 323K) RH max 95% non-condensing
	Dimensions	160 x 231 x 94 mm (6.3 x 9.1 x 3.7")
Weight	1.2 kg (2.64 lbs.)	
Ordering Information	<p>HI5222-01 (115V) and HI5222-02 (230V) are supplied with HI1131B pH electrode, HI7662-W temperature probe, pH 4.01 buffer solution sachet (2), pH 7.01 buffer solution sachet (2), HI700601 electrode cleaning solution sachet (2), HI7082 3.5M KCl electrolyte solution (30 mL), HI76404W electrode holder, 12 VDC adapter, capillary dropper pipette, quality certificate, quick start guide, and instruction manual.</p> <p>HI5222-03 includes the above without electrode.</p>	

(*) Reduced to actual probe limits

Research Grade Meter

pH/ORP and Temperature



The HI5221 is a research grade benchtop pH/mV meter that is customizable with a large color LCD, capacitive touch keys, and USB port for computer connectivity.

The HI5221 features a universal BNC connection for use with the expansive line of pH and ORP electrodes that Hanna Instruments offers. The meter is supplied with the HI1131B glass body, double junction, combination pH electrode that operates over a wide temperature range from 0 to 100°C. All readings are automatically compensated for temperature variations with the separate

HI7662-T temperature probe that is included.

The HI5221 can be calibrated up to five points with a choice of eight pre-programmed buffers or five custom buffers. The HI5221 features Hanna's exclusive CAL Check™ to alert the user of potential problems during the pH calibration process. Alerts displayed during calibration include "Electrode Dirty/Broken" and "Buffer Contaminated." The overall probe condition based on the offset and slope characteristic of the electrode is displayed as a percentage after calibration is complete. The calibration data including

date, time, buffers used, offset, and slope can be accessed at any time along with the current measurement by selecting the Good Laboratory Practice (GLP) display option.

Three selectable logging modes are available: automatic, manual, and AutoHold logging. Up to 100,000 data points can be recorded in 100 lots with 50,000 records max/lot and exported to a computer for data review and storage.

Customizable User Interface

The user interface of the HI5221 allows the user to show measurements in various modes: basic measurement with or without GLP information, real-time graphing, and logging data. Calibration stability criteria can be adjusted to fast, moderate, or accurate. Programmable alarm limits can be set to inside or outside allowable limits.

Color Graphic LCD

The HI5221 features a color graphic LCD with on-screen help, graphic, and custom color configurations. The display allows for real-time graphing and the use of virtual keys provide for an intuitive user interface.

Capacitive Touch

The HI5221 features sensitive capacitive touch buttons for accurate keystrokes when navigating menus and screens. There are four dedicated keys that are used for routine operations including calibration and switching measurement modes and four virtual keys that change based upon use. The capacitive touch technology ensures the buttons never get clogged with sample residue.

Choice of Calibration

Automatic buffer recognition, semiautomatic, and manual pH calibration options are available for calibrating up to five points, from a selection of eight standard buffers and up to five custom buffers.

GLP Data

HI5221 includes a GLP feature that allows users to view calibration data and calibration expiration information at the touch of a key. Calibration data include date, time, buffers/standards used for calibration, and slope characteristics. The offset is also displayed for pH electrodes.

CAL Check™

CAL Check alerts users to potential problems during the calibration of the pH electrode. Alerts include "Electrode Dirty/Broken," "Buffer Contaminated," electrode response time, and the overall probe condition as a percentage that is based on the offset and slope characteristics.

Data Logging

Three selectable logging modes are available on the HI5221: automatic, manual, and AutoHold logging. Automatic and manual logs up to 100 lots with 50,000 records max/lot, with up to 100,000 total data points. Automatic logging features the option to save data according to sampling period and interval.

Data Transfer

Data can be transferred to a PC with USB cable and HI92000 software (both sold separately).

Contextual Help

Contextual help is always available through a dedicated "HELP" key. Clear tutorial messages and directions are available on-screen to quickly and easily guide users through setup and calibration. The help information displayed is relative to the setting/option being viewed.

Specifications	HI5221	
pH	Range	-2.0 to 20.0 pH; -2.00 to 20.00; -2.000 to 20.000 pH
	Resolution	0.1 pH; 0.01 pH; 0.001 pH
	Accuracy	±0.1 pH; ±0.01 pH; ±0.002 pH ±1 LSD
	Calibration	automatic, up to five point calibration, eight standard buffers available (1.68, 3.00, 4.01, 6.86, 7.01, 9.18, 10.01, 12.45), and five custom buffers
	Temperature Compensation	automatic or manual from -20.0 to 120.0°C/-4.0 to 248.0°F/253.15 to 393.15K
mV	Range	±2000 mV
	Resolution	0.1 mV
	Accuracy	±0.2 mV ±1 LSD
	Relative mV Offset Range	±2000 mV
Temperature*	Range	-20.0 to 120°C; -4.0 to 248.0°F; 253.15 to 393.15K
	Resolution	0.1°C; 0.1°F; 0.1K
	Accuracy	±0.2°C; ±0.4°F; ±0.2K
Additional Specifications	pH Electrode	HI1131B glass body pH electrode with BNC connector and 1 m (3.3') cable (included)
	Temperature Probe	HI7662-W stainless steel temperature probe with 1 m (3.3') cable (included)
	Input Channel(s)	1 pH/ORP
	GLP	calibration points, calibration time stamp, probe offset, slope, date, time and buffers/standards used
	Logging	record : Up to 100 lots, 50,000 records max/lot / maximum 100,000 data points/channel; interval : 14 selectable between 1 second and 180 minutes; type : automatic, manual, AutoHOLD;
	Display	color graphic LCD 240x340 pixels
	PC Connection	USB
	Power Supply	12 VDC adapter (included)
	Environment	0 to 50°C (32 to 122°F; 273 to 323K) RH max 95% non-condensing
	Dimensions	160 x 231 x 94 mm (6.3 x 9.1 x 3.7")
	Weight	1.2 kg (2.64 lbs.)
Ordering Information	HI5221-01 (115V) and HI5221-02 (230V) are supplied with HI1131B pH electrode, HI7662-W temperature probe, pH 4.01 buffer solution sachet (2), pH 7.01 buffer solution sachet (2), HI700601 electrode cleaning solution sachet (2), HI7082 3.5M KCl electrolyte solution (30 mL), HI76404W electrode holder, 12 VDC adapter, capillary dropper pipette, quality certificate, quick start guide, and instruction manual. HI5221-03 includes the above without electrode.	

(*) Reduced to actual probe limits

pH Benchtop Meter

with Built-in Printer

The HI122 is a professional pH/mV and temperature benchtop meter with a built-in printer. The built-in impact printer incorporated into the HI122 allows measurement information to be printed while in various modes. The meter comes with Hanna's HI1131P glass pH electrode and the temperature probe HI7662-T to allow for automatic temperature compensation. The HI122 also allows for ORP measurements when used with the HI3131B ORP electrode (supplied separately).

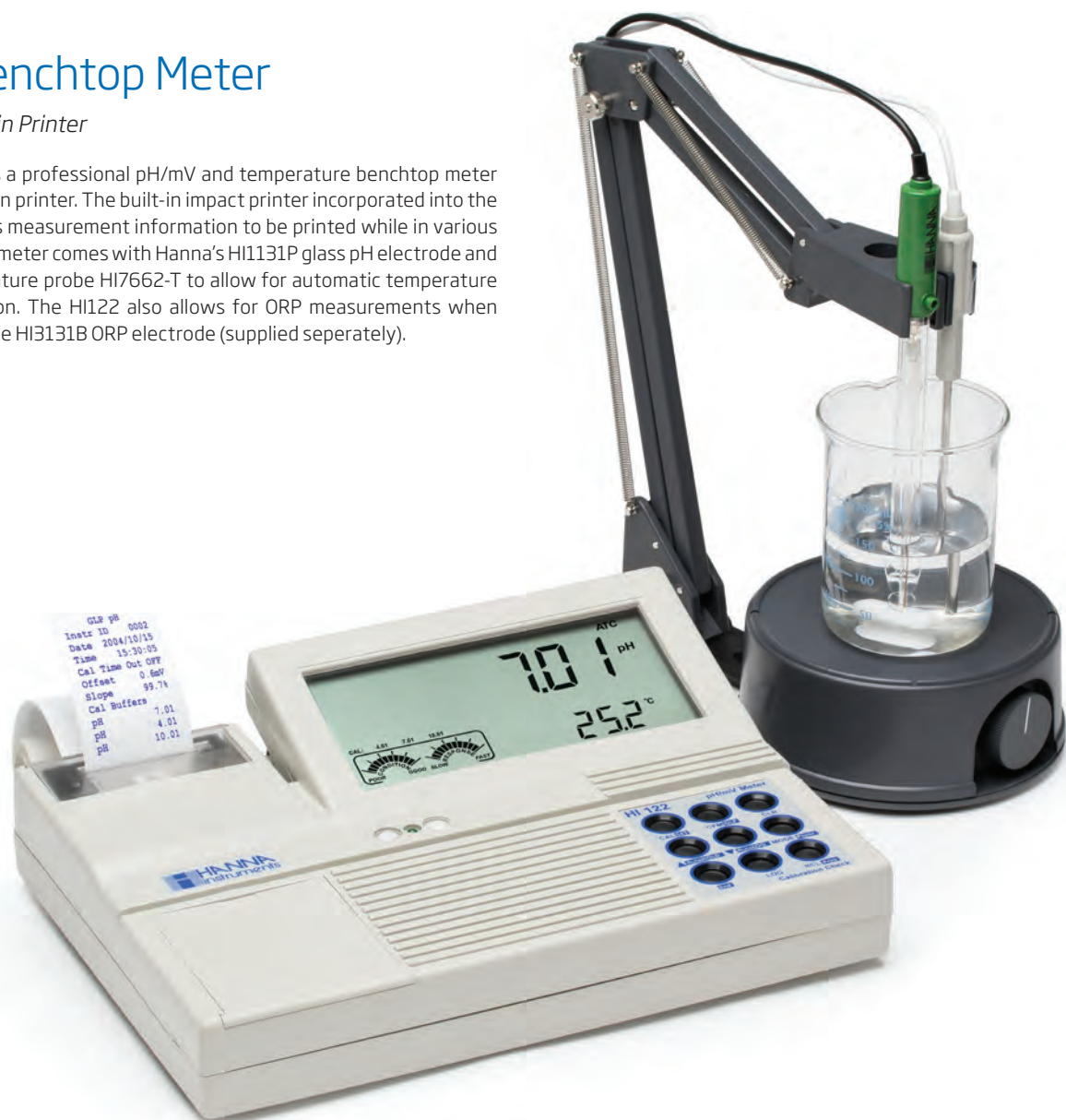

CAL Check™

Hanna's exclusive CAL Check diagnostics system ensures accurate pH readings every time by alerting users to potential problems during the calibration process. The CAL Check system eliminates erroneous readings due to dirty or faulty pH electrodes or contaminated pH buffer solutions during calibration. After the guided calibration process, the probe condition is evaluated and an alert is displayed informing the user of the overall pH electrode status.

Automatic Calibration

pH calibration can be performed with up to five points with seven standard buffers and two custom buffers.

HI1131P pH Electrode

The HI122 is supplied with the HI1131P glass body, double junction, refillable pH electrode with an indicating sensor made of High Temperature (HT) glass. The double junction and HT glass design allows the HI1131P to be used in a wide variety of applications ranging from samples with metals and Tris buffer to samples at elevated temperatures.

Temperature Compensation

Temperature for pH measurements can be compensated for automatically (ATC) or manually (MTC) from -20.0 to 120.0°C with the use of the supplied HI7662-T temperature probe.

GLP Data

The calibration data for each channel including date, time, standards used, offset, and slope can be accessed at any time through the HI122 menu.

Data Logging

The log-on-demand feature accepts the recording of 50 samples. Interval logging allows up to 1000 data points to be recorded and allows the user to specify time intervals from 5 seconds to 180 minutes.

Data Transfer

With a built-in logging function, measurements are stored in non-volatile memory, and can be transferred to a PC through the RS232 port.



Built-in Impact Printer

The built-in impact printer incorporated into the HI122 uses regular paper that does not fade with time. The information related to measurements being taken can be printed while in measurement mode, GLP, or Setup mode. This meter also allows users to print detailed information in four languages for specific help screens and instrument set-up.

Secondary keypad

Specifications	HI122	
pH	Range	-2.00 to 16.00 pH; -2.000 to 16.000 pH
	Resolution	0.01 pH; 0.001 pH
	Accuracy (@25°C)	±0.01 pH; ±0.002 pH
	Calibration	automatic, up to five point calibration standard with seven buffers (1.68, 4.01, 6.86, 7.01, 9.18, 10.01, 12.45) and two custom buffers
Temperature Compensation	automatic or manual from -20.0 to 120°C (-4.0 to 248.0°F)	
mV	Range	±999.9; ±2000 mV
	Resolution	0.1 mV; 1 mV
	Accuracy @25°C	±0.2 mV (±699.9 mV); ±0.5 mV (±999.9 mV); ±1 mV (±2000 mV)
	Relative mV Offset Range	±2000 mV
Temperature	Range	-20.0 to 120.0°C (-4.0 to 248.0°F)
	Resolution	0.1°C (0.1°F)
	Accuracy @25°C	±0.4°C (±0.7°F)
Additional Specifications	pH Electrode	HI1131P glass body pH electrode with BNC + pin connectors and 1 m (3.3') cable (included)
	Temperature Probe	HI7662-T temperature probe with 1 m (3.3') cable (included)
	Log-on-demand	50 samples (25 per channel)
	Interval Logging	5 second to 180 minutes, 1000 samples (500 per channel)
	Input Impedance	10 ¹² Ohm
	PC Connection	RS232 serial port, opto-isolated
	Printer	built-in dot matrix printer, with 44 mm plain paper
	Power Supply	12 VDC adapter (included)
	Environment	0 to 50°C (32 to 122°F); RH max 95% non-condensing
	Dimensions	280 x 203 x 84 mm (11.0 x 8.0 x 3.3")
Weight	1.9 kg (4.2 lbs.)	
Ordering Information	HI122-01 (115V) and HI122-02 (230V) are supplied with HI1131P pH electrode, HI7662-T temperature probe, HI70004 pH 4.01 buffer solution sachet, HI70007 pH 7.01 buffer solution sachet, HI7082 3.5M KCL electrolyte solution (30 mL), (5) paper rolls, 12 VDC adapter, and instructions.	
Accessories	HI710032 Paper rolls (10)	
	HI710033 ink cartridge	



The world's most innovative pH, EC, and DO meter

edge's groundbreaking design is the culmination of Hanna's vision, design capabilities, integrated production, and world class R&D. The edge is rich in features to accommodate the needs of a vast amount of customers. For those that prefer very simplistic operation there is a basic mode operation with simplified menu and options while for those who require advanced features there is the full featured standard operating mode. edge is available as a pH, conductivity, or dissolved oxygen kit and any edge kit can be upgraded with additional probes to measure pH, conductivity, and dissolved oxygen.

edge® technical features

Rechargeable Battery

edge has a built in rechargeable battery that is charged when the meter is plugged in into the benchtop or wall mount cradle. The battery can also be recharged through the micro USB port with either a computer or the power supply.



Two USB ports

edge includes one standard USB for exporting data to a flash drive, and one micro USB port for exporting files to your computer as well as for charging when the cradle is not available.



Clear, full text readout

edge features clear, full text guides displayed on the bottom of the screen. There is no need to decipher scrambled abbreviations or symbols; these helpful messages guide you through every process quickly and easily.



Data logging

edge allows you to store up to 1000 log records of data. Data sets include readings, GLP data, date, and time.



GLP

Data of the last calibration you perform is stored in the sensor including the date, time, and buffers used. When the sensor is connected to edge, GLP data is automatically transferred.

Two Operating Modes

edge can be used in Extended or Basic Operating Modes. Extended Mode enables all edge features while Basic Mode reduces features—ideal for routine measurements by displaying a simplified screen and features.



CAL Check™

Hanna's exclusive CAL Check feature analyzes the pH electrode response in the pH buffers during the calibration process to alert the user of potential problems such as a contaminated buffer or dirty electrode. After calibration, indicators for probe condition are displayed on the measurement screen. The probe condition is based on offset and slope characteristics of the pH electrode.

Sensor Check™ (pH only)

When used with Hanna's electrodes equipped with a matching pin, edge constantly checks the impedance of the pH measuring electrode to notify you in real time in the event of glass breakage. During calibration, Sensor Check checks the state of the junction. The reference junction is also evaluated and reported on the display.

ORP Measurement

edge measures ORP with edge compatible ORP probes.

edge design features



Capacitive touch keypad

edge features sensitive capacitive touch buttons for accurate keystrokes when navigating edge's menus and screens. Since they are part of the screen, the buttons can never get clogged with sample residue.



Easy to read LCD

edge features a 5.5" (14 cm) LCD display that you can clearly view from over 5 m (16.4'). The large display, with its wide 150° viewing angle, provides one of the easiest to read LCDs in the industry.



Zero footprint

Using the wall mount cradle (included), edge can be placed on a wall, leaving zero footprint on the benchtop space. The cradle has a built-in connector to power and charge the batteries.



Hybrid meters that can be used in portable, wall-mount, and benchtop configurations

The versatile design of edge® enables it to be used as a portable, wall-mount, or benchtop meter. edge simplifies measurement, configuration, calibration, diagnostics, logging, and transferring data directly to a computer or USB drive.



Portable field unit

edge is ideal for field use due to its light weight, large screen, and thin design. It can easily be slipped into a backpack or messenger bag. The battery life lasts up to 8 hours when used as a portable device.



Wall-mount cradle

The included wall-mount cradle makes it easy to conserve space on the benchtop while also charging the edge with the AC adapter. The cradle is ideal for continuous monitoring applications.



Electrode holder with built-in cradle

The electrode holder features a swivel, adjustable arm with a built-in cradle to hold the edge securely in place at the optimum viewing angle.



Digital electrodes

edge® measures pH, conductivity and dissolved oxygen through its unique digital electrodes. These digital electrodes are auto-recognized, providing sensor type, calibration data, and a serial number when connected to edge by an easy to plug-in 3.5 mm connector.

- Simply connect each probe via the 3.5 mm jack, Digital Smart Electrodes are automatically recognized

- Resolution selectable from 0.01 and 0.001 pH
- Range -2.000 to 16.000 pH
- Accuracy ± 0.002 pH for 0.001 pH resolution; ± 0.01 for 0.01 resolution
- Data logging
 - Manual log-on-demand
 - Manual log-on-stability
 - Interval logging
- Temperature readout ($^{\circ}\text{C}$ or $^{\circ}\text{F}$)
- Automatic Temperature Compensation (ATC)
- CAL Check™ Indicators:
 - Probe condition
 - Response time
 - Check buffer
 - Clean electrode
- Sensor Check™ Indicators:
 - Broken electrode
 - Clogged junction
- GLP data
 - Records date, time, offset, slope, and buffers used during calibration
- Five-point calibration
 - A choice of seven pre-programmed buffers plus two selectable custom buffers
- Calibration tag on screen
 - Identifies buffers used for current calibration
- Calibration expiration warning



Sleek design

Incredibly thin and lightweight, edge measures just 1/2" (12 mm) thick and weighs just 8.8 ounces (250 g).

All edge compatible pH, EC, and dissolved oxygen digital probes are interchangeable with edge.

Specifications	HI2020	
pH	Range*	-2.00 to 16.00 pH; -2.000 to 16.000 pH [†]
	Resolution	0.01 pH; 0.001 pH [†]
	Accuracy (@25°C/77°F)	± 0.01 pH; ± 0.002 pH [†]
	Calibration	automatic, up to three points (five points [†]) calibration, 5 standard (7 standard [†]) buffers available (1.68 [†] , 4.01 or 3.00, 6.86, 7.01, 9.18, 10.01, 12.45 [†]) and two custom buffers [†]
	Temperature Compensation*	automatic, -5.0 to 100.0°C (23.0 to 212.0°F) (using the built-in temperature sensor)
mV pH	Electrode Diagnostics	standard mode: probe condition, response time and out of calibration range
	Range	± 1000 mV
	Resolution	0.1 mV
Temperature	Accuracy (@25°C/77°F)	± 0.2 mV
	Range*	-20.0 to 120.0°C; -4.0 to 248.0°F
	Resolution	0.1°C; 0.1°F
Additional Specifications	Accuracy	$\pm 0.5^{\circ}\text{C}$; $\pm 0.9^{\circ}\text{F}$
	Probe (included in pH kit)	HI11310 digital glass body pH electrode with 3.5 mm (1/8") connector and 1 m (3.3') cable
	Logging	up to 1000 [†] (400 for basic mode) records organized in: manual log-on-demand (max. 200 logs), manual log-on-stability (max. 200 logs), interval logging [†] (max. 600 samples; 100 lots)
	Connectivity	1 USB port for storage; 1 micro USB port for charging and PC connectivity
	Environment	0 to 50°C (32 to 122°F); RH max 95% non-condensing
Ordering Information	Power Supply	5 VDC adapter (included)
	Dimensions / Weight	202 x 140 x 12 mm (7.9" x 5.5" x 0.5") / 250 g (8.82 oz.)
		HI2020-01 (USA plug) and HI2020-02 (European plug) pH kit includes: HI11310 glass body, refillable pH electrode, pH 4 buffer solution sachets (4), pH 7 buffer solution sachets (2), pH 10 buffer solution sachets (2), and electrode cleaning solution sachets (2), benchtop docking station with electrode holder, wall-mount cradle, USB cable, 5 VDC power adapter, quality certificates, and instruction manual. HI2020-03 includes the above without electrode. All edge compatible pH, EC and DO digital probes are interchangeable with HI2020 and can be ordered separately.

* limits will be reduced to actual probe limits
† standard mode only



edge[®]pH—Innovation dedicated to a single parameter

edge pH's groundbreaking design is the culmination of Hanna's vision, design capabilities, integrated production, and world class R&D. edge pH is a single meter that can measure pH and ORP and is incredibly easy to use.

- Resolution selectable from 0.01 and 0.001 pH
- Range -2.000 to 16.000 pH
- Accuracy ± 0.002 pH for 0.001 pH resolution; ± 0.01 for 0.01 resolution
- Data logging
 - Manual log-on-demand
 - Manual log-on-stability
 - Interval logging
- Temperature readout ($^{\circ}\text{C}$ or $^{\circ}\text{F}$)
- Automatic Temperature Compensation (ATC)
- CAL Check[™] Indicators:
 - Probe condition
 - Response time
 - Check buffer
 - Clean electrode
- Sensor Check[™] Indicators:
 - Broken electrode
 - Clogged junction
- GLP data
 - Records date, time, offset, slope, and buffers used during calibration
- Five-point calibration
 - A choice of seven pre-programmed buffers plus two selectable custom buffers
- Calibration tag on screen
 - Identifies buffers used for current calibration
- Calibration expiration warning

edge®pH technical features

Rechargeable Battery

edge pH has a built in rechargeable battery that is charged when the meter is plugged into benchtop or wall mount cradle. The battery can also be recharged through the micro USB port from a computer or the power supply.



Two USB ports

edge pH includes one standard USB for exporting data to a flash drive, and one micro USB port for exporting files to your computer as well as for charging when the cradle is not available.



Clear, full text readout

edge pH features clear, full text guides displayed on the bottom of the screen. There is no need to decipher scrambled abbreviations or symbols; these helpful messages guide you through every process quickly and easily.



Data logging

edge pH allows you to store up to 1000 log records of data. Data sets include readings, GLP data, date, and time.



GLP

Data of the last calibration you perform is stored in the sensor including the date, time, and buffers used. When the sensor is connected to edge pH, GLP data is automatically transferred.

Two Operating Modes

edge pH can be used in Extended or Basic Operating Modes. Extended Mode enables all edge features while Basic Mode reduces features—ideal for routine measurements by displaying a simplified screen and features.



CAL Check™

Hanna's exclusive CAL Check feature analyzes the pH electrode response in the pH buffers during the calibration process to alert the user of potential problems such as a contaminated buffer or dirty electrode. After calibration, indicators for probe condition are displayed on the measurement screen. The probe condition is based on offset and slope characteristics of the pH electrode.

Sensor Check™

When used with Hanna's electrodes equipped with a matching pin, edge constantly checks the impedance of the pH measuring electrode to notify you in real time in the event of glass breakage. During calibration, Sensor Check checks the state of the junction. The reference junction is also evaluated and reported on the display.

ORP Measurement

edge pH measures ORP with edge compatible ORP probes.

edge pH design features



Capacitive touch keypad

edge pH features sensitive capacitive touch buttons for accurate keystrokes when navigating edge's menus and screens. Since they are part of the screen, the buttons can never get clogged with sample residue.



Easy to read LCD

edge pH features a 5.5" (14 cm) LCD display that you can clearly view from over 5 m (16.4'). The large display, with its wide 150° viewing angle, provides one of the easiest to read LCDs in the industry.



Zero footprint

Using the wall mount cradle (included), edge pH can be placed on a wall, leaving zero footprint on the benchtop space. The cradle has a built-in connector to power and charge the batteries.



A hybrid meter that can be used in portable, wall-mount, and benchtop configurations

The versatile design of edge®pH enables it to be used as a portable, wall-mount, or benchtop meter. edge pH simplifies measurement, configuration, calibration, diagnostics, logging and transferring data directly to a computer or USB drive.



Portable field unit

edge pH is ideal for field use due to its light weight, large screen, and thin design. It can easily be slipped into a backpack or messenger bag. The battery life lasts up to 8 hours when used as a portable device.



Wall-mount cradle

The included wall-mount cradle makes it easy to conserve space on the benchtop while also charging edge pH with the AC adapter. The cradle is ideal for continuous monitoring applications.



Electrode holder with built-in cradle

The electrode holder features a swivel, adjustable arm with a built-in cradle to hold edge pH securely in place at the optimum viewing angle.



3.5 mm probe input

Plugging an electrode in has never been simpler; no alignments or broken pins, simply connect the 3.5 mm plug and begin. Digital electrodes are automatically recognized.

Sleek design

Incredibly thin and lightweight, edge®pH measures just 1/2" (12 mm) thick and weighs just 8.8 ounces (250 g).



Specifications

pH	Range*	-2.00 to 16.00 pH; -2.000 to 16.000 pH†
	Resolution	0.01 pH; 0.001 pH†
	Accuracy (@25°C/77°F)	±0.01 pH; ±0.002 pH†
	Calibration	automatic, up to three points (five points [†]) calibration, 5 standard (7 standard [†]) buffers available (1.68 [†] , 4.01 or 3.00, 6.86, 7.01, 9.18, 10.01, 12.45 [†]) and two custom buffers [†]
	Temperature Compensation*	automatic, -5.0 to 100.0°C (23.0 to 212.0°F) (using built-in temperature sensor)
mV pH	Electrode Diagnostics	standard mode: probe condition, response time and out of calibration range
	Range	±1000 mV
	Resolution	0.1 mV
ORP	Accuracy (@25°C/77°F)	±0.2 mV
	Range	±2000 mV
	Resolution	0.1 mV
	Accuracy (@25°C/77°F)	±0.2 mV (±999.9 mV); ±1 mV (±2000 mV)
Temperature	Calibration	one-point calibration
	Range*	-20.0 to 120.0°C; -4.0 to 248.0°F
	Resolution	0.1°C; 0.1°F
Additional Specifications	Accuracy	±0.5°C; ±0.9°F
	Probe	HI11310 digital glass body pH electrode with 3.5 mm (1/8") connector and 1 m (3.3') cable
	Logging	up to 1000 [†] (400 for basic mode) records organized in: manual log-on-demand (max. 200 logs), manual log-on-stability (max. 200 logs), interval logging [†] (max. 600 samples; 100 lots)
	Connectivity	1 USB port for storage; 1 micro USB port for charging and PC connectivity
	Environment	0 to 50°C (32 to 122°F); RH max 95% non-condensing
	Power Supply	5 VDC adapter (included)
	Dimensions	202 x 140 x 12 mm (7.9" x 5.5" x 0.5")
Weight	250 g (8.82 oz.)	
Ordering Information	<p>HI2002-01 (USA plug) and HI2002-02 (European plug) edge pH includes: HI11310 glass body, refillable pH electrode, pH 4 buffer solution sachets (4), pH 7 buffer solution sachets (2), pH 10 buffer solution sachets (2), electrode cleaning solution sachets (2), benchtop docking station with electrode holder, wall-mount cradle, USB cable, 5 VDC power adapter, quality certificates, and instruction manual.</p> <p>HI2002-03 includes the above without electrode.</p>	

* limits will be reduced to actual probe limits
[†] standard mode only

First pH meter in the world with a Bluetooth® Smart pH electrode

Free yourself from wires when performing pH measurements. Hanna Instruments is proud to introduce edge^{blu}, a pH meter that uses HALO® pH electrodes with Bluetooth® Smart technology (Bluetooth 4.0). Bluetooth® Smart technology is energy efficient, allowing for low power consumption to maximize the life of the replaceable battery used in the pH electrode.

HALO electrodes can also connect to a compatible smart phone or tablet running the Hanna Lab App.

pH

edge^{blu}

edge®blu technical features

Rechargeable Battery

edge blu has a built in rechargeable battery that is charged when the meter plugged into the benchtop or wall mounted cradle. The battery can also be recharged through the micro USB port connected to a computer or directly to a power supply.



Two USB ports

edge blu includes one standard USB for exporting data to a flash drive and one micro USB port for exporting files to your computer as well as for charging when the cradle is not available.



Data logging

Log-on-demand, log-on-stability, and interval logging modes are all available. Up to 200 data points can be logged on demand and an additional 200 data points for samples logged upon a stable reading. The logging interval is adjustable from 5 seconds to 180 minutes. Up to 600 records can be stored in a maximum of 100 interval lots. Logging modes can be started from the meter or by simply pressing the button on the HALO pH probe.

GLP

Data of the last calibration you perform is stored in the sensor including the date, time, and buffers used. When the sensor is connected to edge blu, GLP data is automatically transferred.

The Bluetooth® word mark and logos are registered trademarks owned by Bluetooth SIG, Inc.



CAL Check™

Hanna's exclusive CAL Check feature analyzes the pH electrode response in the pH buffers during the calibration process to alert the user of potential problems such as a contaminated buffer or dirty electrode. After calibration, indicators for probe condition are displayed on the measurement screen. The probe condition is based on offset and slope characteristics of the pH electrode.



Bluetooth Smart Technology

HI11102 HALO® pH electrode use Bluetooth® Smart Technology (Bluetooth 4.0). This technology offers low power consumption allowing for a long 500 hour battery life. The range of the Bluetooth connection is 10 m (33') between the probe and receiving device.



Auto-detection

At a push of the button, the HALO pH electrode enters discovery mode and will be detected by edge blu. Once connected, the serial number, calibration information including date, time and buffers used, and the electrode specifications will be loaded into the meter. Having this information stored in the electrode allows for hot swapping to other pH electrodes without recalibrating. The details of the electrode and calibration information are stored with any logged readings.

edge blu design features



Capacitive touch keypad

edge blu features sensitive capacitive touch buttons for accurate keystrokes when navigating edge's menus and screens. Since they are part of the screen, the buttons can never get clogged with sample residue.



Easy to read LCD

edge blu features a 5.5" (14 cm) LCD display that you can clearly view from over 5 m (16.4') away. The large display, with its wide 150° viewing angle, provides one of the easiest to read LCDs in the industry.



Zero footprint

Using the wall mount cradle (included), edge blu can be placed on a wall, leaving zero footprint on the benchtop space. The cradle has a built-in connector to power the meter and charge the batteries.



A hybrid meter that can be used in portable, wall-mount, and benchtop configurations

The versatile design of edge®blu enables it to be used as a portable, wall-mount, or benchtop meter. edge blu simplifies measurement, wirelessly using compatible HALO® pH electrodes with Bluetooth® Smart technology.



Portable field unit

edge blu is ideal for field use due to its light weight, large screen, and thin design. It can easily be slipped into a backpack or messenger bag. The battery life lasts up to 8 hours when used as a portable device.



Wall-mount cradle

The included wall-mount cradle makes it easy to conserve space on the benchtop while also charging edge blu with the AC adapter. The cradle is ideal for continuous monitoring applications.



Electrode holder with built-in cradle

The electrode holder features a swivel, adjustable arm with a built-in cradle to hold edge blu securely in place at the optimum viewing angle.



HI181 magnetic stirrer and beaker not included.



4,0

Bluetooth®
Smart

0

footprint

0,5

inch thick
(12.7 mm)

8,8

oz. weight
(250 g)

8

hours battery
life

5,5

inch display
(14 cm)

2

USB ports

edge blu additional features

- Resolution selectable from 0.01 and 0.001 pH
- Range -2.000 to 16.000 pH
- Accuracy ± 0.002 pH for 0.001 pH resolution; ± 0.01 for 0.01 resolution
- Data logging
 - Manual log-on-demand
 - Manual log-on-stability
 - Interval logging
- Temperature readout (°C or °F)
- Automatic Temperature Compensation (ATC)
- CAL Check™ Indicators:
 - Probe condition
 - Response time
 - Check buffer
 - Clean electrode
- GLP data
 - Records date, time, offset, slope, and buffers used during calibration
- Five-point calibration
 - A choice of seven pre-programmed buffers plus two custom buffers
- Calibration tag on screen
 - Identifies buffers used for current calibration
- Calibration expiration warning
- Basic mode
 - edge@blu Basic Mode is ideal for routine measurements by displaying a simplified screen and features
- Standby mode
 - HALO® can be switched between standby and measurement mode by edge blu. When measurement is resumed, HALO is automatically recognized. Standby mode is ideal for applications such as aquariums when only periodic measurements are needed in the same sample.

The Bluetooth® word mark and logos are registered trademarks owned by Bluetooth SIG, Inc.



HI11102 HALO pH electrode with Bluetooth® Smart technology

edge blu® is supplied with the HI11102 HALO® professional pH probe with Bluetooth® Smart technology (Bluetooth 4.0). This probe is compatible with the edge blu and the Hanna Lab App¹.

The HI11102 HALO pH electrode is a glass body, gel filled, double junction pH electrode that has an indicating probe made with general purpose glass. The glass body is resistant to many chemicals and easy to clean. Being gel filled reduces maintenance since there are no fill solutions to add. The double junction design is suitable for a variety of solutions that can contain substances such as heavy metals or Tris buffer that will cause the silver chloride (AgCl) found in a single junction probe to precipitate and clog the junction.

- Gel filled glass pH electrode
- Double junction reference design
- Integrated temperature sensor
 - Ensures calibration and measurement is automatically temperature compensated, thus eliminating error
- Wide pH (0 to 12) and temperature (-5 to 80°C) range
- Clear the clutter
 - Data is wirelessly transmitted to the edge blu or compatible smart phone or tablet running the Hanna Lab App via Bluetooth® Smart technology¹. HI11102 HALO provides up to 500 hours of battery life
- Calibration is stored
 - HI11102 HALO stores calibration information; no additional calibration is needed when switching to another edge blu or iPad
- Battery condition
 - The measurement screen of the edge blu and Hanna Lab App displays the name, battery life and condition of the HI11102 HALO probe

Hanna Lab App

pH Meter Application for use with HALO



The Hanna Lab App turns compatible smart phone or tablet into a full-featured pH meter when used with a HALO pH probe via Bluetooth® Smart technology. Functions include calibration, measurement, data logging, graphing, and data sharing. Measurement and logging of pH and temperature at one second intervals start as soon as the probe is connected. Measurements can be displayed alone on the display, with tabulated data or as a graph. The graph can be panned and zoomed with pinch-to-zoom technology for enhanced viewing.

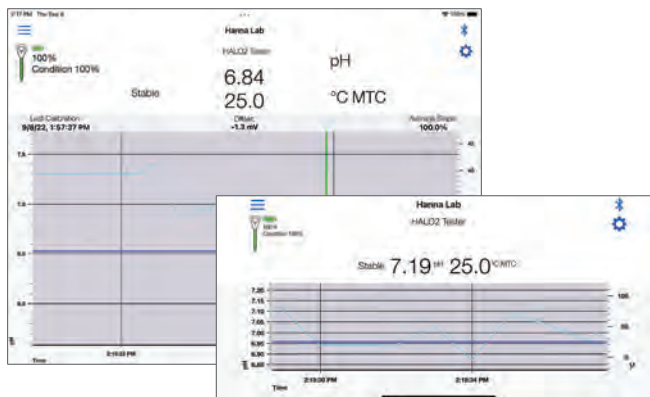

- Connects via Bluetooth® 4.0
- Calibration reminder
- Real-time data
 - Displays updated pH and temperature updated every second
- Measurement alarms
 - Alerts users if the measurement threshold is exceeded
- Basic GLP
 - Displays date and time of current calibration along with probe offset and average slope
- Full GLP
 - Displays date and time of current calibration, probe offset, and average slope along with calibrated buffers, mV values, temperature, and slopes between each buffer
- Fluid, dynamic graphing
 - Measurements can be displayed with tabulated data or as a graph
- One button sample tagging
- Data-logging with custom annotations
 - Data is automatically saved every hour
 - Saved log files may be annotated with measurement specific information
- Four ways to save and share data:
 - All data since last auto save
 - Annotations only
 - All data within a timed interval
 - Annotations within a timed interval
- Share data via email in CSV format
- Help and tutorials

The Bluetooth® word mark and logos are registered trademarks owned by Bluetooth SIG, Inc.

¹ HALO electrodes can only be used with one compatible device at a time.

Specifications	edge®blu*	
pH	Range ²	-2.00 to 16.00 pH; -2.000 to 16.000 pH [†]
	Resolution	0.01 pH; 0.001 pH [†]
	Accuracy (@25°C/77°F)	±0.01 pH; ±0.002 pH [†]
	Calibration	Basic mode: Automatic, up to 3 points calibration 5 standard buffer Standard mode: Automatic up to 5 points calibration 7 standard buffers (1.68, 4.01 or 3.00, 6.86, 7.01, 9.18, 10.01, 12.45) and 2 custom buffers [†]
	Temperature Compensation ²	automatic, -5.0 to 100.0°C (23.0 to 212.0°F) (using built-in temperature sensor)
	Electrode Diagnostics	standard mode: probe condition, response time, and out of calibration range
mV pH	Range	±1000 mV
	Resolution	0.1 mV
	Accuracy (@25°C/77°F)	±0.2 mV
Temperature	Range ²	-20.0 to 120.0°C; -4.0 to 248.0°F
	Resolution	0.1°C; 0.1°F
	Accuracy	±0.5°C; ±0.9°F
Additional Specifications	Probe	HI11102 HALO® glass body pH electrode with Bluetooth® Smart technology
	Logging	up to 1000 [†] (400 for basic mode) records organized in: manual log-on-demand (max. 200 logs), manual log-on-stability (max. 200 logs), interval logging [†] (max. 600 samples; 100 lots)
	Connectivity	1 USB port for storage; 1 micro USB port for charging and PC connectivity
	Environment	0 to 50°C (32 to 122°F); RH max 95% non-condensing
	Power Supply	5 VDC adapter (included)
	Dimensions	202 x 140 x 12 mm (7.9" x 5.5" x 0.5")
	Weight	250 g (8.82 oz.)
Ordering Information	HI2202-01 (USA plug) and HI2202-02 (European plug) edge blu includes: HI11102 HALO pH electrode with Bluetooth® Smart technology, pH 4 buffer solution sachets (4), pH 7 buffer solution sachets (2), pH 10 buffer solution sachets (2), electrode cleaning solution sachets (2), battery for HALO, benchtop docking station with electrode holder, wall-mount cradle, USB cable, 5 VDC power adapter, quality certificates, and instruction manual.	

HALO Specifications	HI11102 HALO (included)
Reference	double, Ag/AgCl
Junction	ceramic
Electrolyte	gel
Range	0.00 to 12.00 pH ±420 mV
Bulb Shape	spheric
Outer Diameter (glass)	12 mm (glass)
Overall Length	183 mm
Solution Temperature	-5.0 to 80.0°C (23.0 to 176.0°F)
Body Material	glass
Environment	0.0 to 50.0°C (32.0 to 122.0°F), electronic module is not waterproof
Temperature Sensor	integrated
Connection	Bluetooth® Smart (Bluetooth® 4.0), 10 m (33') range
Battery Type / Life	CR2032 3V lithium ion / approximately 500 hours

Hanna Lab App Specifications*

Range ²	-2.000 to 16.000 pH ±800 mV -20.0 to 120.0°C (-4.0 to 248.0°F)
Resolution	0.1; 0.01; 0.001 pH 1; 0.1 mV 0.1°C (0.1°F)
Accuracy (@25°C/77°F)	±0.005 pH ±0.3 mV ±0.5°C (±1.0°F)
Calibration Points	up to five-point calibration with seven standard buffers (1.68, 3.00 or 4.01, 6.86, 7.01, 9.18, 10.01, 12.45 pH)
Temperature Compensation ²	automatic from -5.0 to 100.0°C; 23.0 to 212.0°F
Compatibility/System Requirements	see www.hannainst.com for latest compatibility requirements

Download Information



App Store is a service mark of Apple Inc., Google Play and the Google Play logo are trademarks of Google LLC. The Bluetooth® word mark and logos are registered trademarks owned by Bluetooth SIG, Inc.

² Limits will be reduced to actual probe/sensor limits.
* HALO required for measurement use.
[†] Standard mode only

HALO2

Wireless pH Testers

pH

HALO2



Take the complexity out of testing

HALO2 Wireless pH Meter with Bluetooth® Smart technology (Bluetooth® 4.0) is updated with a dual-level LCD and temperature measurement for automatic temperature compensation. HALO2 pH probes can be used virtually anywhere: in the field, laboratory, or classroom. Their versatility and ease of use will revolutionize the way pH is measured.

15 Application Specific Testers

IP65
waterproof

Bluetooth®



Hanna Lab App
Compatible

HI9810402

HALO2

Hanna Lab App
CompatibleThe Hanna Lab App is
available on the App Store®
and on Google Play.

Wireless Refillable pH Tester for Lab

with built-in general purpose electrode

Accurate, and easy to use, HALO2 Wireless pH Tester for lab is ideal for measurements in samples that would be a challenge for standard design pH electrodes. The HI9810402 can be used as a stand-alone pH tester or can be connected to the Hanna Lab App.

- The integrated Bluetooth module allows the tester to be connected to a compatible smart device with the Hanna Lab App
- Compact, waterproof casing, and automatic pH calibration at up to three points, or five points when used with the Hanna Lab App
- Automatically temperature compensated readings

HALO2 Specifications HI9810402

Range	pH	0.00 to 14.00 pH
	mV*	pH/mV conversion
	Temperature	-5.0 to 80.0 °C (23.0 to 176.0 °F)
Resolution	pH	0.01 or 0.1 pH
	mV*	0.1 or 1 mV
	Temperature	0.1 °C; 0.1 °F
Accuracy	pH	±0.02 pH
	Temperature	±0.5 °C; ±0.9 °F
Calibration	Up to three points or five points *	
	Automatic buffer recognition with Standard buffers Hanna (pH 1.68 *, 4.01, 7.01, 10.01, 12.45 *) or NIST (pH 1.68 *, 4.01, 6.86, 9.18, 12.45 *)	
Temperature compensation	Automatic (ATC) or Manual (MTC) *	
Electrode	Body material	Glass
	Glass	High Temperature (HT)
	Junction	Ceramic
	Reference cell	Double, Ag/AgCl
	Electrolyte	3.5M KCl (refillable)
	Tip / Shape	Spheric, Ø 9 mm (Ø 0.35")
	Outer diameter	12 mm (0.5")
Battery type	CR2032 3V Lithium	
Battery life	Approximately 1000 hours (500 hours with Bluetooth enabled)	
Environment	0 to 50 °C (32 to 122 °F)	
IP rating	IP65	
Dimensions / Weight	51 x 206 x 21 mm (2.0 x 8.1 x 0.8") / 60 g (2.1 oz.)	

Ordering Information

HI9810402 (HALO2) is supplied with a starter kit consisting of: pH 4.01 buffer solution sachet (2 pcs.), pH 7.01 buffer solution sachet (2 pcs.), Electrode cleaning solution sachet (2 pcs.), Electrode storage solution (dropper bottle), Electrolyte refill solution (30 mL), Pipette, 3V Lithium battery - CR2032, Instrument quality certificate and Instruction manual.

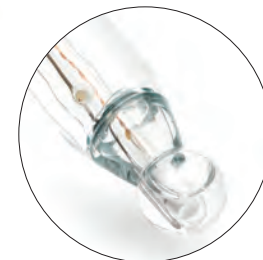
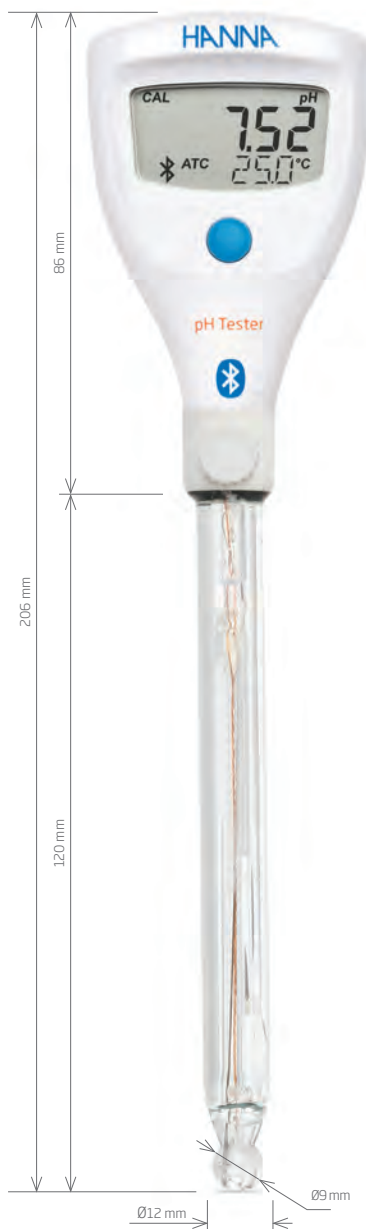

Spherical tip

Provides maximum surface area for accurate measurements.

Electrode Features

Glass body

The HI9810402 features a non-porous glass body that is easy to clean and withstands harsh chemicals.

Refillable

The double junction design presents a silver-free electrolyte solution interacting with the sample, making the electrode less susceptible to clogging and guaranteeing a fast response and stable reading.

Built-in Temperature Sensor

Built-in temperature sensor at the tip of the pH electrode allows for rapid determination of the sample temperature and a high-accuracy temperature reading.

* Available with Hanna Lab App
Note: The tester can display measurements from -2.00 to 16.00 pH. Measurements outside of the pH range will flash.

App Store is a service mark of Apple Inc., Google Play and the Google Play logo are trademarks of Google LLC. The Bluetooth® word mark and logos are registered trademarks owned by Bluetooth SIG, Inc.

pH solutions begin on page 2.174, pH electrode cleaning solutions begin on page 2.188



Spherical tip

Provides maximum surface area for accurate measurements.

HI9810412

HALO2



Hanna Lab App
Compatible

The Hanna Lab App is
available on the App Store®
and on Google Play.

Wireless pH Tester for Lab

with built-in general purpose electrode

Accurate, and easy to use, HALO2 Wireless pH Tester for Lab is ideal for users that prefer a maintenance-free laboratory pH electrode. The HI9810412 can be used as a stand-alone pH tester or can be connected to the Hanna Lab App.

- The integrated Bluetooth module allows the tester to be connected to a compatible smart device with the Hanna Lab App
- Compact, waterproof casing, and automatic pH calibration at up to three points, or four points when used with the Hanna Lab App
- Automatically temperature compensated readings

HALO2 Specifications	HI9810412
Range	pH 0.00 to 12.00 pH
	mV* pH/mV conversion
	Temperature** -5.0 to 80.0 °C (23.0 to 176.0 °F)
Resolution	pH 0.01 or 0.1 pH
	mV* 0.1 or 1 mV
	Temperature 0.1 °C; 0.1 °F
Accuracy	pH ±0.02 pH
	Temperature ±0.5 °C; ±0.9 °F
Calibration	Up to three points or four points * Automatic buffer recognition with Standard buffers Hanna (pH 1.68 *, 4.01, 7.01, 10.01) or NIST (pH 1.68 *, 4.01, 6.86, 9.18)
Temperature compensation	Automatic (ATC) or Manual (MTC) *
Electrode	Body material Glass
	Glass Low Temperature (LT)
	Junction Ceramic
	Reference cell Double, Ag/AgCl
	Electrolyte Gel
	Tip / Shape Spheric
	Outer diameter 12 mm (0.5")
Length 120 mm (4.7")	
Battery type	CR2032 3V Lithium
Battery life	Approximately 1000 hours (500 hours with Bluetooth enabled)
Environment	0 to 50 °C (32 to 122 °F)
IP rating	IP65
Dimensions / Weight	51 x 195 x 21 mm (2.0 x 7.7 x 0.8") / 60 g (2.1 oz.)
Ordering Information	HI9810412 (HALO2) is supplied with a starter kit consisting of: pH 4.01 buffer solution sachet (2 pcs.), pH 7.01 buffer solution sachet (2 pcs.), Electrode cleaning solution sachet (2 pcs.), Electrode storage solution (13 mL dropper bottle), 3V Lithium battery - CR2032, Instrument quality certificate and Instruction manual.

Electrode Features

Glass body

The HI9810412 features a non-porous glass body that is easy to clean and withstands harsh chemicals.

Fast, stable readings

The double junction design presents a silver-free electrolyte solution interacting with the sample, making the electrode less susceptible to clogging and guaranteeing a fast response and stable reading.

Maintenance free

Gel-filled reference with no fill solutions required. Other than routine calibration and cleaning, this probe is maintenance free.

Built-in Temperature Sensor

Built-in temperature sensor at the tip of the pH electrode allows for rapid determination of the sample temperature and a high-accuracy temperature reading.

* Available with Hanna Lab App **Measuring outside the recommended operating temperature range may damage the gel electrolyte and void product warranty. Note: The tester can display measurements from -2.00 to 16.00 pH. Measurements outside of the pH range will flash.

App Store is a service mark of Apple Inc., Google Play and the Google Play logo are trademarks of Google LLC. The Bluetooth® word mark and logos are registered trademarks owned by Bluetooth SIG, Inc.

pH solutions begin on page 2.174, pH electrode cleaning solutions begin on page 2.188

HI9810422

HALO2

Hanna Lab App
CompatibleThe Hanna Lab App is
available on the App Store®
and on Google Play.

Wireless pH Tester for Field

with built-in specialized electrode

Accurate, and easy to use, HALO2 Wireless pH Tester is ideal for field measurements due to its durability. The HI9810422 can be used as a stand-alone pH tester or can be connected to the Hanna Lab App.

- The integrated Bluetooth module allows the tester to be connected to a compatible smart device with the Hanna Lab App
- Compact, waterproof casing, and automatic pH calibration at up to three points, or four points when used with the Hanna Lab App
- Automatically temperature compensated readings

HALO2 Specifications	HI9810422
Range	pH 0.00 to 12.00 pH
	mV* pH/mV conversion
	Temperature** -5.0 to 70.0 °C (23.0 to 158.0 °F)
Resolution	pH 0.01 or 0.1 pH
	mV* 0.1 or 1 mV
	Temperature 0.1 °C; 0.1 °F
Accuracy	pH ±0.05 pH
	Temperature ±0.5 °C; ±0.9 °F
	Up to three points or four points *
Calibration	Automatic buffer recognition with Standard buffers Hanna (pH 1.68 *, 4.01, 7.01, 10.01) or NIST (pH 1.68 *, 4.01, 6.86, 9.18)
	Temperature compensation Automatic (ATC) or Manual (MTC) *
Electrode	Body material Polyetherimide (PEI) resin
	Glass Low Temperature (LT)
	Junction Ceramic
	Reference cell Double, Ag/AgCl
	Electrolyte Gel
	Tip / Shape Dome
	Outer diameter 12 mm (0.5")
	Length 100 mm (3.9")
Battery type CR2032 3V Lithium	
Battery life Approximately 1000 hours (500 hours with Bluetooth enabled)	
Environment 0 to 50 °C (32 to 122 °F)	
IP rating IP65	
Dimensions / Weight 51 x 175 x 21 mm (2.0 x 6.9 x 0.8") / 50 g (1.8 oz.)	

Ordering Information

HI9810422 (HALO2) is supplied with a starter kit consisting of: pH 4.01 buffer solution sachet (2 pcs.), pH 7.01 buffer solution sachet (2 pcs.), Electrode cleaning solution sachet (2 pcs.), Electrode storage solution (dropper bottle), 3V Lithium battery - CR2032, Instrument quality certificate and Instruction manual.

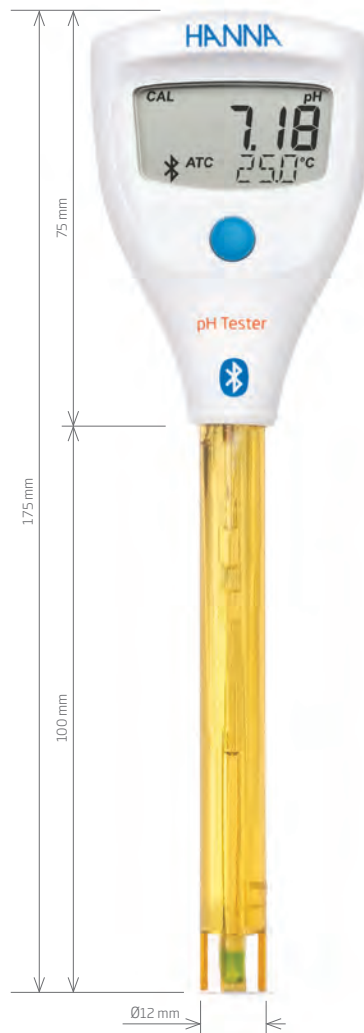

Maintenance free

Gel-filled reference with no fill solutions required. Other than routine calibration and cleaning, this probe is maintenance free.

Electrode Features

PEI Resin body

The HI9810422 features a PEI resin body that is easy to clean and resistant to many aggressive chemicals.

Fast, stable readings

The double junction design presents a silver-free electrolyte solution interacting with the sample, making the electrode less susceptible to clogging and guaranteeing a fast response and stable reading.

Built-in Temperature Sensor

Built-in temperature sensor at the tip of the pH electrode allows for rapid determination of the sample temperature and a high-accuracy temperature reading.

* Available with Hanna Lab App

**Measuring outside the recommended operating temperature range may damage the gel electrolyte and void product warranty. Note: The tester can display measurements from -2.00 to 16.00 pH. Measurements outside of the pH range will flash.

App Store is a service mark of Apple Inc., Google Play and the Google Play logo are trademarks of Google LLC. The Bluetooth® word mark and logos are registered trademarks owned by Bluetooth SIG, Inc.

pH solutions begin on page 2.174, pH electrode cleaning solutions begin on page 2.188



GroLine



Easy pH electrode cleaning

The PVDF outer junction sleeve can be removed and cleaned. Once cleaned, a small amount of supplied gel electrolyte is added and the junction is refreshed, improving the measurement and extending the life of the tester.

HI9810302

HALO2



Hanna Lab App
Compatible

The Hanna Lab App is
available on the App Store®
and on Google Play.

2

Wireless pH Tester for Soil

with built-in specialized electrode

Accurate, and easy to use, the HALO2 Wireless pH Tester for Soil is ideal for agricultural, hydroponics, and greenhouse growers that need to monitor the pH of soil or soil slurries. The HI9810302 can be used as a stand-alone pH tester or can be connected to the Hanna Lab App.

- The integrated Bluetooth module allows the tester to be connected to a compatible smart device with the Hanna Lab App
- Compact, waterproof casing, and automatic pH calibration at up to three points, or four points when used with the Hanna Lab App.
- Automatically temperature compensated readings

HALO2 Specifications HI9810302

Range	pH	0.00 to 12.00 pH
	mV*	pH/mV conversion
	Temperature**	0.0 to 60.0 °C (32.0 to 140.0 °F)
Resolution	pH	0.01 or 0.1 pH
	mV*	0.1 or 1 mV
	Temperature	0.1 °C; 0.1 °F
Accuracy	pH	±0.05 pH
	Temperature	±0.5 °C; ±0.9 °F
Calibration	Up to three points or four points * Automatic buffer recognition with Standard buffers Hanna (pH 1.68 *, 4.01, 7.01, 10.01) or NIST (pH 1.68 *, 4.01, 6.86, 9.18)	
Temperature compensation	Automatic (ATC) or Manual (MTC) *	
Electrode	Body material	Polyvinylidene Fluoride (PVDF)
	Glass	Low Temperature (LT)
	Junction	Open
	Reference cell	Double, Ag/AgCl
	Electrolyte	Gel (refillable)
	Tip / Shape	Conic, Ø 6 x 10 mm (Ø 0.23 x 0.39")
	Outer diameter	8 mm (0.31")
	Length	75 mm (2.95")
Battery type	CR2032 3V Lithium	
Battery life	Approximately 1000 hours (500 hours with Bluetooth enabled)	
Environment	0 to 50 °C (32 to 122 °F)	
IP rating	IP65	
Dimensions / Weight	51 x 150 x 21 mm (2.0 x 5.9 x 0.8") / 45 g (1.6 oz.)	

HI9810302 (HALO2) is supplied with a starter kit consisting of: pH 4.01 buffer solution, (2 pcs.), pH 7.01 buffer solution sachet (2 pcs.), Cleaning solution for soil deposits sachet (1 pc.), Cleaning solution for humus deposits sachet (1 pc.), Electrode storage solution (dropper bottle), Gelled bridge electrolyte (dropper bottle), 3V Lithium battery - CR2032, Instrument quality certificate, and Instruction manual

Ordering Information

Electrode Features

Rugged PVDF body

The rugged PVDF electrode body is easy to clean. Resistant to most chemicals (e.g. solvents, sodium hypochlorite), ultraviolet light, and fungal growth, the PVDF body also has high-abrasion resistance and mechanical strength.

Conical tip

The conical tip allows for easy penetration into soil or soil slurries.

Fast, stable readings

The double junction design presents a silver-free electrolyte solution interacting with the sample, making the electrode less susceptible to clogging and guaranteeing a fast response and stable reading.

Built-in Temperature Sensor

Built-in temperature sensor at the tip of the pH electrode allows for rapid determination of the sample temperature and a high-accuracy temperature reading.

* Available with Hanna Lab App **Measuring outside the recommended operating temperature range may damage the gel electrolyte and void product warranty. Note: The tester can display measurements from -2.00 to 16.00 pH. Measurements outside of the pH range will flash.

App Store is a service mark of Apple Inc., Google Play and the Google Play logo are trademarks of Google LLC. The Bluetooth® word mark and logos are registered trademarks owned by Bluetooth SIG, Inc.

pH solutions begin on page 2.174, pH electrode cleaning solutions begin on page 2.188

HI9810432

HALO2



Hanna Lab App
Compatible

The Hanna Lab App is
available on the App Store®
and on Google Play.

Wireless Refillable pH Tester for Cosmetic Creams

with built-in specialized electrode

Accurate and easy to use, HALO2 Wireless pH Tester for Cosmetic Creams is ideal for measurements in samples that would be a challenge for standard design pH electrodes. The HI9810432 can be used as a stand-alone pH tester or can be connected to the Hanna Lab App.

- The integrated Bluetooth module allows the tester to be connected to a compatible smart device with the Hanna Lab App
- Compact, waterproof casing, and automatic pH calibration at up to three points, or four points when used with the Hanna Lab App
- Automatically temperature compensated readings

HALO2 Specifications	HI9810432	
Range	pH	0.00 to 12.00 pH
	mV*	pH/mV conversion
	Temperature	-5.0 to 70.0 °C (23.0 to 158.0 °F)
Resolution	pH	0.01 or 0.1 pH
	mV*	0.1 or 1 mV
	Temperature	0.1 °C; 0.1 °F
Accuracy	pH	±0.02 pH
	Temperature	±0.5 °C; ±0.9 °F
		Up to three points or four points *
Calibration	Automatic buffer recognition with Standard buffers Hanna (pH 1.68 *, 4.01, 7.01, 10.01) or NIST (pH 1.68 *, 4.01, 6.86, 9.18)	
Temperature compensation	Automatic (ATC) or Manual (MTC) *	
Electrode	Body material	Glass
	Glass	Low Temperature (LT)
	Junction	Triple ceramic
	Reference cell	Double, Ag/AgCl
	Electrolyte	3.5M KCl (refillable)
	Tip / Shape	Conic
	Outer diameter	12 mm (0.5")
Length	120 mm (4.7")	
Battery type	CR2032 3V Lithium	
Battery life	Approximately 1000 hours (500 hours with Bluetooth enabled)	
Environment	0 to 50 °C (32 to 122 °F)	
IP rating	IP65	
Dimensions / Weight	51 x 206 x 21 mm (2.0 x 8.1 x 0.8") / 60 g (2.1 oz.)	

Ordering Information

HI9810432 (HALO2) is supplied with a starter kit consisting of: pH 4.01 buffer solution sachet (2 pcs.), pH 7.01 buffer solution sachet (2 pcs.), Electrode cleaning solution sachet (2 pcs.), Electrode storage solution (dropper bottle), Electrolyte refill solution (30 mL), Pipette, 3V Lithium battery - CR2032, Instrument quality certificate and Instruction manual.

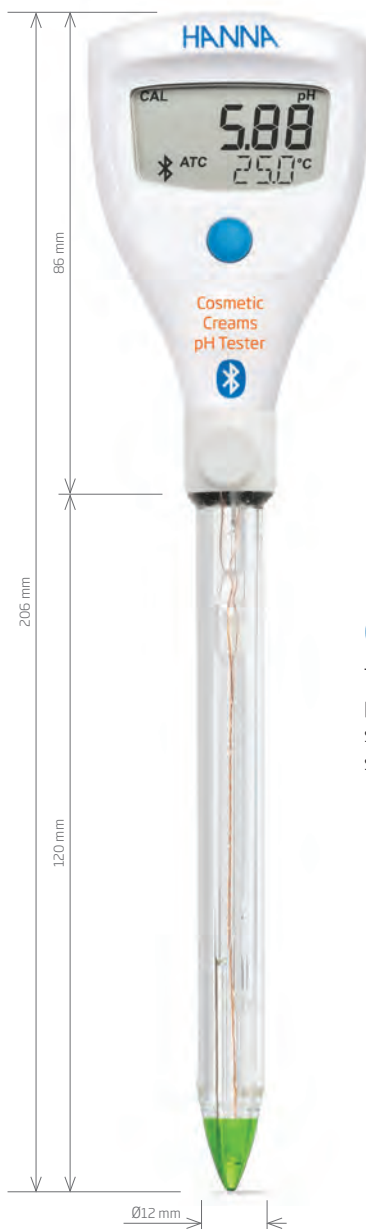

Conical tip

The conical glass tip allows for penetration into emulsions such as lotions and creams, soft solids, and semisolids.

Electrode Features

Glass body

The HI9810432 features a non-porous, glass body that is easy to clean and withstands harsh chemicals.

Refillable electrode

The triple ceramic junction allows a higher flow rate of electrolyte from the reference cell into the solution. This high flow rate provides faster electrode response and a more stable measurement in viscous solutions or samples of low conductivity. The triple junction design prevents both clogging and any potential precipitation of silver at the junction. The fill solution will diffuse through the ceramic junction as it is used.

Built-in Temperature Sensor

Built-in temperature sensor at the tip of the pH electrode allows for rapid determination of the sample temperature and a high-accuracy temperature reading.

* Available with Hanna Lab App
Note: The tester can display measurements from -2.00 to 16.00 pH. Measurements outside of the pH range will flash.

App Store is a service mark of Apple Inc., Google Play and the Google Play logo are trademarks of Google LLC. The Bluetooth® word mark and logos are registered trademarks owned by Bluetooth SIG, Inc.

pH solutions begin on page 2.174, pH electrode cleaning solutions begin on page 2.188



Flat tip sensor

The flat glass tip allows for direct contact with the skin or scalp to ensure a stable measurement.

HI9810372

HALO2



Hanna Lab App
Compatible

The Hanna Lab App is
available on the App Store®
and on Google Play.

2

Wireless pH Tester for Skin & Scalp

with built-in specialized electrode

Accurate and easy to use, this HALO2 Wireless pH Tester is designed to measure the pH of the skin and scalp. The HI9810372 can be used as a stand-alone pH tester or can be connected to the Hanna Lab App.

- The integrated Bluetooth module allows the tester to be connected to a compatible smart device with the Hanna Lab App
- Compact, waterproof casing, and automatic pH calibration at up to three points, or four points when used with the Hanna Lab App
- Automatically temperature compensated readings

HALO2 Specifications HI9810372

Range	pH	0.00 to 12.00 pH
	mV*	pH/mV conversion
	Temperature	0.0 to 50.0 °C (32.0 to 122.0 °F)
Resolution	pH	0.01 or 0.1 pH
	mV*	0.1 or 1 mV
	Temperature	0.1 °C; 0.1 °F
Accuracy	pH	±0.05 pH
	Temperature	±0.5 °C; ±0.9 °F
Calibration	Up to three points or four points *	
	Automatic buffer recognition with Standard buffers Hanna (pH 1.68 *, 4.01, 7.01, 10.01) or NIST (pH 1.68 *, 4.01, 6.86, 9.18)	
Temperature compensation	Automatic (ATC) or Manual (MTC) *	
Electrode	Body material	Glass
	Glass	Low Temperature (LT)
	Junction	Open
	Reference cell	Double, Ag/AgCl
	Electrolyte	Viscolene
	Tip / Shape	Flat
	Outer diameter	12 mm (0.47")
	Length	75 mm (2.95")
Battery type	CR2032 3V Lithium	
Battery life	Approximately 1000 hours (500 hours with Bluetooth enabled)	
Environment	0 to 50 °C (32 to 122 °F)	
IP rating	IP65	
Dimensions / Weight	51 x 150 x 21 mm (2.0 x 5.9 x 0.8") / 50 g (1.8 oz.)	
Ordering Information	HI9810372 (HALO2) is supplied with a starter kit consisting of: pH 4.01 buffer solution sachet (2 pcs.), pH 7.01 buffer solution sachet (2 pcs.), Cleaning and disinfection solution for skin residuals sachet (1 pc.), Electrode cleaning solution for skin grease and sebum sachet (1 pc.), Electrode storage solution (dropper bottle), 3V Lithium battery - CR2032, Instrument quality certificate and Instruction manual	

Electrode Features

Glass body

The HI9810372 features a non-porous glass body that is easy to clean and disinfect.

Fast, stable readings

The open junction reference provides for a direct contact with the skin or scalp, ensuring a stable measurement.

The double junction design presents a silver-free electrolyte solution interacting with the sample, making the electrode less susceptible to clogging and guaranteeing a fast response and stable reading.

Built-in Temperature Sensor

Built-in temperature sensor at the tip of the pH electrode allows for rapid determination of the sample temperature and a high-accuracy temperature reading.

* Available with Hanna Lab App
Note: The tester can display measurements from -2.00 to 16.00 pH. Measurements outside of the pH range will flash.

App Store is a service mark of Apple Inc., Google Play and the Google Play logo are trademarks of Google LLC. The Bluetooth® word mark and logos are registered trademarks owned by Bluetooth SIG, Inc.

HI9810442

HALO2



Hanna Lab App
Compatible

The Hanna Lab App is
available on the App Store®
and on Google Play.

Wireless pH Tester for Leather and Paper

with built-in specialized electrode

Accurate and easy to use, HALO2 Wireless pH Tester for Leather & Paper is ideal for measurements on flat surfaces, or small volume samples, with the specially designed flat sensing tip. The HI9810442 can be used as a stand-alone pH tester or can be connected to the Hanna Lab App.

- The integrated Bluetooth module allows the tester to be connected to a compatible smart device with the Hanna Lab App
- Compact, waterproof casing, and automatic pH calibration at up to three points, or four points when used with the Hanna Lab App
- Automatically temperature compensated readings

HALO2 Specifications HI9810442

Range	pH	0.00 to 12.00 pH
	mV*	pH/mV conversion
	Temperature	0.0 to 50.0 °C (32.0 to 122.0 °F)
Resolution	pH	0.01 or 0.1 pH
	mV*	0.1 or 1 mV
	Temperature	0.1 °C; 0.1 °F
Accuracy	pH	±0.02 pH
	Temperature	±0.5 °C; ±0.9 °F
Calibration	Up to three points or four points *	
	Automatic buffer recognition with Standard buffers Hanna (pH 1.68 *, 4.01, 7.01, 10.01) or NIST (pH 1.68 *, 4.01, 6.86, 9.18)	
Temperature compensation	Automatic (ATC) or Manual (MTC) *	
Electrode	Body material	Glass
	Glass	Low Temperature (LT)
	Junction	Ceramic
	Reference cell	Double, Ag/AgCl
	Electrolyte	Viscolene
	Tip / Shape	Flat
	Outer diameter	12 mm (0.5")
Length	110 mm (4.3")	
Battery type	CR2032 3V Lithium	
Battery life	Approximately 1000 hours (500 hours with Bluetooth enabled)	
Environment	0 to 50 °C (32 to 122 °F)	
IP rating	IP65	
Dimensions / Weight	51 x 185 x 21 mm (2.0 x 7.3 x 0.8") / 60 g (2.1 oz.)	

Ordering Information

HI9810442 (HALO2) is supplied with a starter kit consisting of: pH 4.01 buffer solution sachet (2 pcs.), pH 7.01 buffer solution sachet (2 pcs.), Electrode cleaning solution sachet (2 pcs.), Electrode storage solution (dropper bottle), 3V Lithium battery - CR2032, Instrument quality certificate and instruction manual.

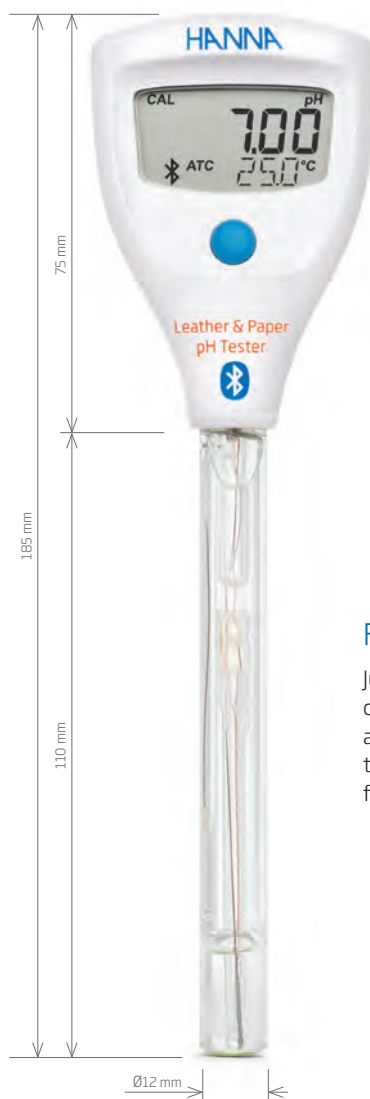

Flat tip

Just one drop of water needed on the sample surface for accurate measurements. Easy to clean electrode with a flat tip for maximum surface contact.

Electrode Features

Glass body

The HI9810442 features a non-porous glass body that is easy to clean and withstands harsh chemicals.

Maintenance free

Gel-filled reference with no fill solutions required. Other than routine calibration and cleaning, this probe is maintenance free.

Fast, stable readings

The double junction design presents a silver-free electrolyte solution interacting with the sample, making the electrode less susceptible to clogging and guaranteeing a fast response and stable reading.

Built-in Temperature Sensor

Built-in temperature sensor at the tip of the pH electrode allows for rapid determination of the sample temperature and a high-accuracy temperature reading.

* Available with Hanna Lab App
Note: The tester can display measurements from -2.00 to 16.00 pH. Measurements outside of the pH range will flash.

App Store is a service mark of Apple Inc., Google Play and the Google Play logo are trademarks of Google LLC. The Bluetooth® word mark and logos are registered trademarks owned by Bluetooth SIG, Inc.

pH solutions begin on page 2.174, pH electrode cleaning solutions begin on page 2.188



Flat tip

The flat glass tip allows for direct pH measurement and prevents mash and cooled wort solids from collecting on the surface.

HI9810312

HALO2



Hanna Lab App
Compatible

The Hanna Lab App is available on the App Store® and on Google Play.

2

Wireless pH Tester for Beer

with built-in specialized electrode

Accurate and easy to use, HALO2 Wireless pH Tester for Beer is ideal for pH measurement of mash, cooled wort, and beer samples. The HI9810312 can be used as a stand-alone pH tester or can be connected to the Hanna Lab App.

- The integrated Bluetooth module allows the tester to be connected to a compatible smart device with the Hanna Lab App
- Compact, waterproof casing, and automatic pH calibration at up to three points, or four points when used with the Hanna Lab App
- Automatically temperature compensated readings

pH

Electrode Features

Titanium body

The titanium body offers protection from accidental breakage. Rugged and resilient, the titanium works as an electronic shield protecting against interferences from electrical noise or humidity.

Extractable cloth junction

The extractable cloth junction allows for clearing any clogging from solids that cause slow response and unstable readings. Pull 3 mm (1/8") to expose a fresh new junction surface for faster response times and reading stability.

Fast, stable readings

The double junction design presents a silver-free electrolyte solution interacting with the sample, making the electrode less susceptible to clogging and guaranteeing a fast response and stable reading.

Built-in Temperature Sensor

Built-in temperature sensor at the tip of the pH electrode allows for rapid determination of the sample temperature and a high-accuracy temperature reading.

HALO2 Specifications

HI9810312

Range	pH	0.00 to 12.00 pH
	mV*	pH/mV conversion
	Temperature**	0.0 to 80.0 °C (32.0 to 176.0 °F)
Resolution	pH	0.01 or 0.1 pH
	mV*	0.1 or 1 mV
Accuracy	Temperature	0.1 °C; 0.1 °F
	pH	±0.05 pH
Calibration	Temperature	±0.5 °C; ±0.9 °F
	Up to three points or four points *	
Temperature compensation	Automatic buffer recognition with Standard buffers Hanna (pH 1.68 *, 4.01, 7.01, 10.01) or NIST (pH 1.68 *, 4.01, 6.86, 9.18)	
	Automatic (ATC) or Manual (MTC) *	
Electrode	Body material	Titanium
	Glass	Low Temperature (LT)
	Junction	Cloth (extractable)
	Reference cell	Double, Ag/AgCl
	Electrolyte	Gel
	Tip / Shape	Flat
	Outer diameter	12 mm (0.47")
	Length	110 mm (4.3")
Battery type	CR2032 3V Lithium	
Battery life	Approximately 1000 hours (500 hours with Bluetooth enabled)	
Environment	0 to 50 °C (32 to 122 °F)	
IP rating	IP65	
Dimensions / Weight	51 x 185 x 21 mm (2 x 7.3 x 0.8") / 60 g (2.1 oz.)	
Ordering Information	<p>HI9810312 (HALO2) is supplied with a starter kit consisting of: pH 4.01 buffer solution sachet (2 pcs.), pH 7.01 buffer solution sachet (2 pcs.), Cleaning solution for brewing deposits sachet (2 pcs.), Electrode storage solution (dropper bottle), 3V Lithium battery - CR2032, Instrument quality certificate and Instruction manual</p>	

HALO2

* Available with Hanna Lab App **Measuring outside the recommended operating temperature range may damage the gel electrolyte and void product warranty. Note: The tester can display measurements from -2.00 to 16.00 pH. Measurements outside of the pH range will flash.

App Store is a service mark of Apple Inc., Google Play and the Google Play logo are trademarks of Google LLC. The Bluetooth® word mark and logos are registered trademarks owned by Bluetooth SIG, Inc.

HI9810332

HALO2

Hanna Lab App
CompatibleThe Hanna Lab App is
available on the App Store®
and on Google Play.

Wireless Refillable pH Tester for Wine

with built-in specialized electrode

Accurate and easy to use, HALO2 Wireless pH Tester for Wine is designed to measure the pH at each step of the winemaking process: from pre-fermentation and fermentation to post-fermentation and bottling. The HI9810332 can be used as a stand-alone pH tester or can be connected to the Hanna Lab App.

- The integrated Bluetooth module allows the tester to be connected to a compatible smart device with the Hanna Lab App
- Compact, waterproof casing, and automatic pH calibration at up to three points, or four points when used with the Hanna Lab App
- Automatically temperature compensated readings

HALO2 Specifications HI9810332

Range	pH	0.00 to 12.00 pH
	mV*	pH/mV conversion
	Temperature	0.0 to 60.0 °C (32.0 to 140.0 °F)
Resolution	pH	0.01 or 0.1 pH
	mV*	0.1 or 1 mV
	Temperature	0.1 °C; 0.1 °F
Accuracy	pH	±0.05 pH
	Temperature	±0.5 °C; ±0.9 °F
Calibration	Up to three points or four points *	
	Automatic buffer recognition with Standard buffers Hanna (pH 1.68 *, 3.00, 7.01, 10.01) or NIST (pH 1.68 *, 3.00, 6.86, 9.18)	
Temperature compensation	Automatic (ATC) or Manual (MTC) *	
Electrode	Body material	Glass
	Glass	Low Temperature (LT)
	Junction	Open (movable)
	Reference cell	Double, Ag/AgCl
Electrode	Electrolyte	3.5M KCl (refillable)
	Tip / Shape	Dome, Ø 8 mm (Ø 0.31")
	Outer diameter	12 mm (0.5")
	Length	120 mm (4.7")
	Battery type	CR2032 3V Lithium
Battery life	Approximately 1000 hours (500 hours with Bluetooth enabled)	
Environment	0 to 50 °C (32 to 122 °F)	
IP rating	IP65	
Dimensions / Weight	51 x 206 x 21 mm (2.0 x 8.1 x 0.8") / 55 g (2.0 oz.)	

HI9810332 (HALO2) is supplied with a starter kit consisting of: pH 3.00 buffer solution sachet (2 pcs.), pH 7.01 buffer solution sachet (2 pcs.), Cleaning solution for wine deposits sachet (1 pc.), Cleaning solution for wine stains sachet (1 pc.), Electrode storage solution (dropper bottle), Electrolyte refill solution, Pipette, 3V Lithium battery - CR2032, Instrument quality certificate and Instruction manual.

Ordering Information

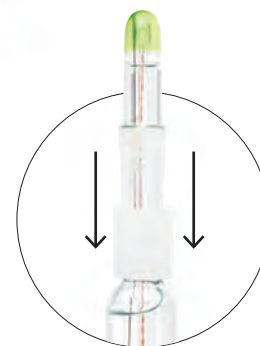

Clogging Prevention System (CPS™) technology

The moveable PE sleeve repels solids and prevents clogging. Additionally, the sleeve can be moved and the ground glass surface cleaned, resulting in faster response times and stable readings.

Domed Tip

The domed tip allows a large surface area to be in contact with the sample.

Electrode Features

Glass body

The HI9810332 features a non-porous glass body that is easy to clean. Specialized low temperature (LT) pH glass ensures fast stabilization and accurate results at lower temperatures.

Refillable electrode

The double junction design presents a silver-free electrolyte solution interacting with the sample, making the electrode less susceptible to clogging and guaranteeing a fast response and stable reading.



Built-in Temperature Sensor

Built-in temperature sensor at the tip of the pH electrode allows for rapid determination of the sample temperature and a high-accuracy temperature reading.

* Available with Hanna Lab App
Note: The tester can display measurements from -2.00 to 16.00 pH. Measurements outside of the pH range will flash.

App Store is a service mark of Apple Inc., Google Play and the Google Play logo are trademarks of Google LLC. The Bluetooth® word mark and logos are registered trademarks owned by Bluetooth SIG, Inc.

pH solutions begin on page 2.174, pH electrode cleaning solutions begin on page 2.188



Flat tip, clog-resistant electrode

The flat glass tip provides optimal surface contact for sushi rice pH measurements and for surfaces that cannot be penetrated. Clog resistant open junction reference due to the hard gel surface (viscolene) that is used for the reference cell. When the junction becomes coated with starch from the rice, clean the probe to expose the hard gel (viscolene) reference.

HI9810352

HALO2



Hanna Lab App
Compatible

The Hanna Lab App is available on the App Store® and on Google Play.

2

Wireless pH Tester for Sushi

with built-in specialized electrode

Accurate and easy to use, HALO2 Wireless pH Tester for Sushi is designed to measure the pH of sushi rice and ensure it meets the food-hygiene and Hazard Analysis Critical Control Point (HACCP) regulations. The HI9810352 can be used as a stand-alone pH tester or can be connected to the Hanna Lab App.

- The integrated Bluetooth module allows the tester to be connected to a compatible smart device with the Hanna Lab App
- Compact, waterproof casing, and automatic pH calibration at up to three points, or four points when used with the Hanna Lab App
- Automatically temperature compensated readings

HALO2 Specifications HI9810352

Range	pH	0.00 to 12.00 pH
	mV*	pH/mV conversion
	Temperature	0.0 to 50.0 °C (32.0 to 122.0 °F)
Resolution	pH	0.01 or 0.1 pH
	mV*	0.1 or 1 mV
	Temperature	0.1 °C; 0.1 °F
Accuracy	pH	±0.05 pH
	Temperature	±0.5 °C; ±0.9 °F
Calibration	Up to three points or four points *	
	Automatic buffer recognition with Standard buffers Hanna (pH 1.68 *, 4.01, 7.01, 10.01) or NIST (pH 1.68 *, 4.01, 6.86, 9.18)	
Temperature compensation	Automatic (ATC) or Manual (MTC) *	
Electrode	Body material	Titanium
	Glass	Low Temperature (LT)
	Junction	Open
	Reference cell	Double, Ag/AgCl
	Electrolyte	Viscolene
	Tip / Shape	Flat
	Outer diameter	12.7 mm (0.5")
Battery type	CR2032 3V Lithium	
Battery life	Approximately 1000 hours (500 hours with Bluetooth enabled)	
Environment	0 to 50 °C (32 to 122 °F)	
IP rating	IP65	
Dimensions / Weight	51 x 160 x 21 mm (2.0 x 6.3 x 0.8") / 60 g (2.1 oz.)	

HI9810352 (HALO2) is supplied with a starter kit consisting of: pH 4.01 buffer solution sachet (2 pcs.), pH 7.01 buffer solution sachet (2 pcs.), Cleaning solution for sushi sachet (2 pcs.), Electrode storage solution (dropper bottle), 3V Lithium battery - CR2032, Instrument quality certificate and Instruction manual

Ordering Information

Electrode Features

Titanium body

The titanium body offers protection from accidental breakage. Rugged and resilient, the titanium works as an electronic shield protecting against interferences from electrical noise or humidity.

Fast, stable readings

The double junction design presents a silver-free electrolyte solution interacting with the sample, making the electrode less susceptible to clogging and guaranteeing a fast response and stable reading.

Built-in Temperature Sensor

Built-in temperature sensor at the tip of the pH electrode allows for rapid determination of the sample temperature and a high-accuracy temperature reading.

* Available with Hanna Lab App
Note: The tester can display measurements from -2.00 to 16.00 pH. Measurements outside of the pH range will flash.

App Store is a service mark of Apple Inc., Google Play and the Google Play logo are trademarks of Google LLC. The Bluetooth® word mark and logos are registered trademarks owned by Bluetooth SIG, Inc.

HI9810342

HALO2



Hanna Lab App
Compatible

The Hanna Lab App is
available on the App Store®
and on Google Play.

Wireless pH Tester for Milk

with built-in specialized electrode

Accurate and easy to use, the HALO2 Wireless pH Tester for Milk is designed to measure the pH during the milk production process. The HI9810342 can be used as a stand-alone pH tester or can be connected to the Hanna Lab App.

- The integrated Bluetooth module allows the tester to be connected to a compatible smart device with the Hanna Lab App
- Compact, waterproof casing, and automatic pH calibration at up to three points, or four points when used with the Hanna Lab App
- Automatically temperature compensated readings

HALO2 Specifications HI9810342

Range	pH	0.00 to 12.00 pH
	mV*	pH/mV conversion
	Temperature**	0.0 to 60.0 °C (32.0 to 140.0 °F)
Resolution	pH	0.01 or 0.1 pH
	mV*	0.1 or 1 mV
	Temperature	0.1 °C; 0.1 °F
Accuracy	pH	±0.05 pH
	Temperature	±0.5 °C; ±0.9 °F
Calibration	Up to three points or four points *	
	Automatic buffer recognition with Standard buffers Hanna (pH 1.68 *, 4.01, 7.01, 10.01) or NIST (pH 1.68 *, 4.01, 6.86, 9.18)	
Temperature compensation	Automatic (ATC) or Manual (MTC) *	
Electrode	Body material	Glass
	Glass	Low Temperature (LT)
	Junction	Open
	Reference cell	Double, Ag/AgCl
	Electrolyte	Gel
	Tip / Shape	Conic, Ø 12 x 12 mm (Ø 0.47 x 0.47")
	Outer diameter	12 mm (0.5")
	Length	85 mm (3.3")
Battery type	CR2032 3V Lithium	
Battery life	Approximately 1000 hours (500 hours with Bluetooth enabled)	
Environment	0 to 50 °C (32 to 122 °F)	
IP rating	IP65	
Dimensions / Weight	51 x 160 x 21 mm (2.0 x 6.3 x 0.8") / 50 g (1.8 oz.)	

Ordering Information

HI9810342 (HALO2) is supplied with a starter kit consisting of: pH 4.01 buffer solution sachet (2 pcs.), pH 7.01 buffer solution sachet (2 pcs.), Cleaning solution for milk deposits sachet (2 pcs.), Electrode storage solution (dropper bottle), 3V Lithium battery - CR2032, Instrument quality certificate and Instruction manual



Conical tip

The conical tip allows for easy penetration into semisolids, ideal for milk and milk products like yogurt.

Electrode Features

Glass body

The HI9810342 features a non-porous glass body that is easy to clean and disinfect.

Maintenance free

Gel-filled reference with no fill solutions required. Other than routine calibration and cleaning, this probe is maintenance free.

Fast, stable readings

The double junction design presents a silver-free electrolyte solution interacting with the sample, making the electrode less susceptible to clogging and guaranteeing a fast response and stable reading.

Low temperature glass

Specialized low temperature (LT) pH glass ensures fast stabilization and accurate results at lower temperatures.

Built-in Temperature Sensor

Built-in temperature sensor at the tip of the pH electrode allows for rapid determination of the sample temperature and a high-accuracy temperature reading.

* Available with Hanna Lab App

**Measuring outside the recommended operating temperature range may damage the gel electrolyte and void product warranty. Note: The tester can display measurements from -2.00 to 16.00 pH. Measurements outside of the pH range will flash.

App Store is a service mark of Apple Inc., Google Play and the Google Play logo are trademarks of Google LLC. The Bluetooth® word mark and logos are registered trademarks owned by Bluetooth SIG, Inc.

pH solutions begin on page 2.174, pH electrode cleaning solutions begin on page 2.188



Conical tip

The conical tip allows for easy penetration into solids and semisolids such as cheese.

HI9810322

HALO2



Hanna Lab App
Compatible

The Hanna Lab App is
available on the App Store®
and on Google Play.

2

Wireless pH Tester for Cheese

with built-in specialized electrode

Accurate and easy to use, HALO2 Wireless pH Tester for Cheese is designed to measure and monitor pH during the main processing steps of cheese manufacturing and ensure it meets the food-hygiene and Hazard Analysis Critical Control Point (HACCP) regulations. The HI9810322 can be used as a stand-alone pH tester or can be connected to the Hanna Lab App.

- The integrated Bluetooth module allows the tester to be connected to a compatible smart device with the Hanna Lab App
- Compact, waterproof casing, and automatic pH calibration at up to three points, or four points when used with the Hanna Lab App
- Automatically temperature compensated readings

HALO2 Specifications HI9810322

Range	pH	0.00 to 12.00 pH
	mV*	pH/mV conversion
	Temperature	0.0 to 60.0 °C (32.0 to 140.0 °F)
Resolution	pH	0.01 or 0.1 pH
	mV*	0.1 or 1 mV
Accuracy	pH	±0.05 pH
	Temperature	±0.5 °C; ±0.9 °F
Calibration	Up to three points or four points *	
	Automatic buffer recognition with Standard buffers Hanna (pH 1.68 *, 4.01, 7.01, 10.01) or NIST (pH 1.68 *, 4.01, 6.86, 9.18)	
Temperature compensation	Automatic (ATC) or Manual (MTC) *	
Electrode	Body material	Polyvinylidene Fluoride (PVDF)
	Glass	Low Temperature (LT)
	Junction	Open
	Reference cell	Double, Ag/AgCl
	Electrolyte	Viscolene
	Tip / Shape	Conic, Ø 6 x 10 mm (Ø 0.23 x 0.39")
	Outer diameter	8 mm (0.31")
Battery type	CR2032 3V Lithium	
Battery life	Approximately 1000 hours (500 hours with Bluetooth enabled)	
Environment	0 to 50 °C (32 to 122 °F)	
IP rating	IP65	
Dimensions / Weight	51 x 146 x 21 mm (2.0 x 5.7 x 0.8") / 45 g (1.6 oz.)	

HI9810322 (HALO2) is supplied with a starter kit consisting of: pH 4.01 buffer solution sachet (2 pcs.), pH 7.01 buffer solution sachet (2 pcs.), Cleaning solution for cheese deposits sachet (2 pcs.), Electrode storage solution (dropper bottle), 3V Lithium battery - CR2032, Instrument quality certificate and Instruction manual.

Ordering Information

Electrode Features

Food grade PVDF body

The food grade PVDF body material is easy to clean and disinfect. Resistant to most chemicals (e.g. solvents, sodium hypochlorite), ultraviolet light, and fungal growth, the PVDF body also has high-abrasion resistance and mechanical strength.

Fast, stable readings

The double junction design presents a silver-free electrolyte solution interacting with the sample, making the electrode less susceptible to clogging and guaranteeing a fast response and stable reading.

Built-in Temperature Sensor

Built-in temperature sensor at the tip of the pH electrode allows for rapid determination of the sample temperature and a high-accuracy temperature reading.

* Available with Hanna Lab App
Note: The tester can display measurements from -2.00 to 16.00 pH. Measurements outside of the pH range will flash.

App Store is a service mark of Apple Inc., Google Play and the Google Play logo are trademarks of Google LLC. The Bluetooth® word mark and logos are registered trademarks owned by Bluetooth SIG, Inc.

pH solutions begin on page 2.174, pH electrode cleaning solutions begin on page 2.188



Wireless pH Tester for Meat

with built-in specialized electrode

Accurate and easy to use, HALO2 Wireless pH Testers for Meat are ideal for pH measurement during meat processing. These testers can be used as a stand-alone pH tester or can be connected to the Hanna Lab App.

- The integrated Bluetooth module allows the tester to be connected to a compatible smart device with the Hanna Lab App
- Compact, waterproof casing, and automatic pH calibration at up to three points, or four points when used with the Hanna Lab App
- Automatically temperature compensated readings
- Removable stainless steel meat blade available (HI9810452)

HALO2 Specifications		HI9810362	HI9810452
Range	pH	0.00 to 12.00 pH	
	mV*	pH/mV conversion	
	Temperature**	0.0 to 60.0 °C (32.0 to 140.0 °F)	
Resolution	pH	0.01 or 0.1 pH	
	mV*	0.1 or 1 mV	
	Temperature	0.1 °C; 0.1 °F	
Accuracy	pH	±0.05 pH	
	Temperature	±0.5 °C; ±0.9 °F	
		Up to three points or four points *	
Calibration		Automatic buffer recognition with Standard buffers Hanna (pH 1.68 *, 4.01, 7.01, 10.01) or NIST (pH 1.68 *, 4.01, 6.86, 9.18)	
	Temperature compensation	Automatic (ATC) or Manual (MTC) *	
Electrode	Body material	Polyvinylidene Fluoride (PVDF)	
	Glass	Low Temperature (LT)	
	Junction	Open	
	Reference cell	Double, Ag/AgCl	
	Electrolyte	Gel (refillable)	
	Tip / Shape	Conic, Ø 6 x 10 mm (Ø 0.23 x 0.39")	
	Outer diameter	8 mm (0.31")	
Length	75 mm (2.95")		
Blade Compatible	no	yes, FC097	
Battery type	CR2032 3V Lithium		
Battery life			
Environment	0 to 50 °C (32 to 122 °F)		
IP rating	IP65		
Dimensions / Weight	51 x 150 x 21 mm (2.0 x 5.9 x 0.8") / 45 g (1.6 oz.)		
Ordering Information	HI9810362 (HALO2) and HI9810452 (HALO2 with thread) is supplied with a starter kit consisting of: pH 4.01 buffer solution sachet (2 pcs.), pH 7.01 buffer solution sachet (2 pcs.), Electrode cleaning solution for Meat, Grease, and Fats (2 pcs.), Electrode storage solution (dropper bottle), Gelled bridge electrolyte (dropper bottle), 3V Lithium battery - CR2032, Instrument quality certificate and instruction manual.		
Accessories	FC097 stainless steel meat blade for HI9810452		

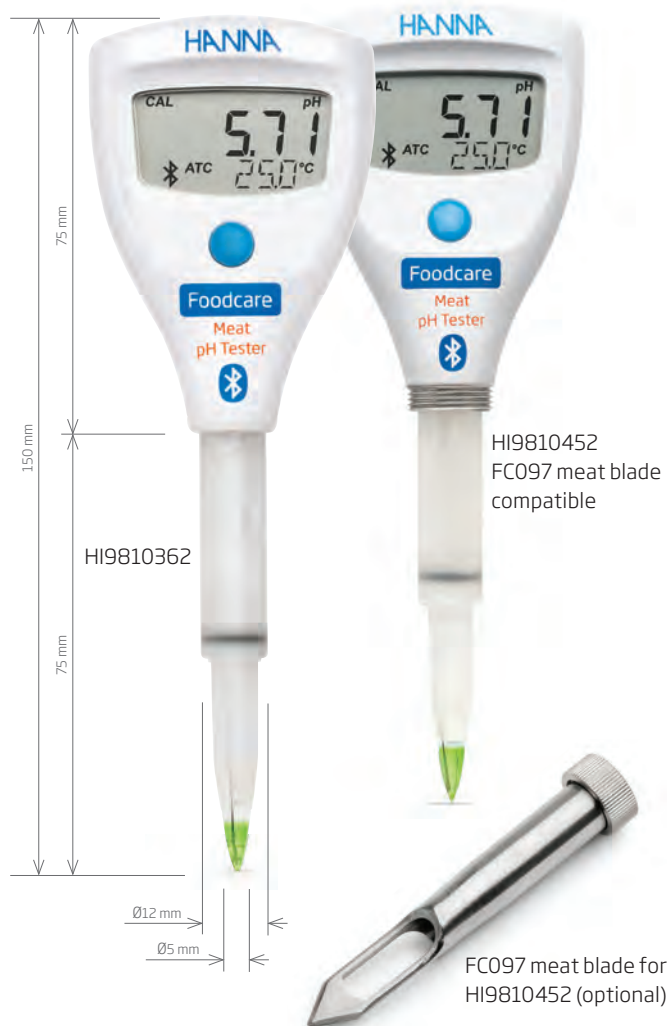

Electrode Features

Food grade PVDF body

The food grade PVDF body material is easy to clean and disinfect. Resistant to most chemicals (e.g. solvents, sodium hypochlorite), ultraviolet light, and fungal growth, the PVDF body also has high-abrasion resistance and mechanical strength.

Conical tip

The conical tip allows for easy penetration into solids and semisolids such as meats and sausages.

Removable stainless steel meat blade available (HI9810452 only)

HI9810452 features threads at the base of the probe for compatibility with the FC097 stainless steel meat blade (optional accessory).

Fast, stable readings

The double junction design presents a silver-free electrolyte solution interacting with the sample, making the electrode less susceptible to clogging and guaranteeing a fast response and stable reading.

Built-in temperature sensor

Built-in temperature sensor at the tip of the pH electrode allows for rapid determination of the sample temperature and a high-accuracy temperature reading.

* Available with Hanna Lab App

**Measuring outside the recommended operating temperature range may damage the gel electrolyte and void product warranty. Note: The tester can display measurements from -2.00 to 16.00 pH. Measurements outside of the pH range will flash.

App Store is a service mark of Apple Inc., Google Play and the Google Play logo are trademarks of Google LLC. The Bluetooth® word mark and logos are registered trademarks owned by Bluetooth SIG, Inc.

pH solutions begin on page 2.174, pH electrode cleaning solutions begin on page 2.188



Easy pH electrode cleaning

The PVDF outer junction sleeve can be removed for cleaning, disinfecting, and refreshing (with supplied gel electrolyte) of the outer reference area. Once cleaned, a small amount of supplied gel electrolyte is added and the junction is refreshed, improving the measurement and extending the life of the tester.

HI9810392

HALO2



Hanna Lab App
Compatible

The Hanna Lab App is available on the App Store® and on Google Play.

2

Wireless pH Tester for Chocolate

with built-in specialized electrode

Accurate and easy to use, HALO2 Wireless pH Tester for Chocolate is ideal for pH measurement during the chocolate making process. The HI9810392 can be used as a stand-alone pH tester or can be connected to the Hanna Lab App.

- The integrated Bluetooth module allows the tester to be connected to a compatible smart device with the Hanna Lab App.
- Compact, waterproof casing, and automatic pH calibration at up to three points, or four points when used with the Hanna Lab App.
- Automatically temperature compensated readings

HALO2 Specifications HI9810392

Range	pH	0.00 to 12.00 pH
	mV*	pH/mV conversion
	Temperature**	0.0 to 60.0 °C (32.0 to 140.0 °F)
Resolution	pH	0.01 or 0.1 pH
	mV*	0.1 or 1 mV
	Temperature	0.1 °C; 0.1 °F
Accuracy	pH	±0.05 pH
	Temperature	±0.5 °C; ±0.9 °F
Calibration	Up to three points or four points *	
	Automatic buffer recognition with Standard buffers Hanna (pH 1.68 *, 4.01, 7.01, 10.01) or NIST (pH 1.68 *, 4.01, 6.86, 9.18)	
Temperature compensation	Automatic (ATC) or Manual (MTC) *	
Electrode	Body material	Polyvinylidene Fluoride (PVDF)
	Glass	Low Temperature (LT)
	Junction	Open
	Reference cell	Double, Ag/AgCl
	Electrolyte	Gel (refillable)
	Tip / Shape	Conic, Ø 6 x 10 mm (Ø 0.23 x 0.39")
	Outer diameter	8 mm (0.31")
Battery type	CR2032 3V Lithium	
Battery life	Approximately 1000 hours (500 hours with Bluetooth enabled)	
Environment	0 to 50 °C (32 to 122 °F)	
IP rating	IP65	
Dimensions / Weight	51 x 150 x 21 mm (2.0 x 5.9 x 0.8") / 45 g (1.6 oz.)	

HI9810392 (HALO2) is supplied with a starter kit consisting of: pH 4.01 buffer solution sachet (2 pcs.), pH 7.01 buffer solution sachet (2 pcs.), Electrode cleaning and disinfection solution for chocolate deposits sachet (2 pcs.), Electrode storage solution, (dropper bottle), Gelled bridge electrolyte (dropper bottle), 3V Lithium battery - CR2032, Instrument quality certificate and Instruction manual.

Ordering Information

Electrode Features

Food grade PVDF body

The food grade PVDF body material is easy to clean and disinfect. Resistant to most chemicals (e.g. solvents, sodium hypochlorite), ultraviolet light, and fungal growth, the PVDF body also has high-abrasion resistance and mechanical strength.

Conical tip

The conical tip allows for easy penetration into solids and semisolids such as chocolate.

Fast, stable readings

The double junction design presents a silver-free electrolyte solution interacting with the sample, making the electrode less susceptible to clogging and guaranteeing a fast response and stable reading.

Built-in Temperature Sensor

Built-in temperature sensor at the tip of the pH electrode allows for rapid determination of the sample temperature and a high-accuracy temperature reading.

* Available with Hanna Lab App **Measuring outside the recommended operating temperature range may damage the gel electrolyte and void product warranty. Note: The tester can display measurements from -2.00 to 16.00 pH. Measurements outside of the pH range will flash.

App Store is a service mark of Apple Inc., Google Play and the Google Play logo are trademarks of Google LLC. The Bluetooth® word mark and logos are registered trademarks owned by Bluetooth SIG, Inc.





Conical tip

The conical tip allows for easy penetration into solids and semisolids such as bread and dough..

HI9810382

HALO2



Hanna Lab App
Compatible

The Hanna Lab App is
available on the App Store®
and on Google Play.

2

Wireless pH Tester for Bread & Dough

with built-in specialized electrode

Accurate and easy to use, HALO2 Wireless pH Tester for Bread & Dough is ideal to measure the pH during baking processes and ensure it meets the food-hygiene and Hazard Analysis Critical Control Point (HACCP) regulations. The HI9810382 can be used as a stand-alone pH tester or can be connected to the Hanna Lab App.

- The integrated Bluetooth module allows the tester to be connected to a compatible smart device with the Hanna Lab App
- Compact, waterproof casing, and automatic pH calibration at up to three points, or four points when used with the Hanna Lab App
- Automatically temperature compensated readings

HALO2 Specifications HI9810382

Range	pH	0.00 to 12.00 pH
	mV*	pH/mV conversion
	Temperature**	0.0 to 60.0 °C (32.0 to 140.0 °F)
Resolution	pH	0.01 or 0.1 pH
	mV*	0.1 or 1 mV
	Temperature	0.1 °C; 0.1 °F
Accuracy	pH	±0.05 pH
	Temperature	±0.5 °C; ±0.9 °F
Calibration	Up to three points or four points *	
	Automatic buffer recognition with Standard buffers Hanna (pH 1.68 *, 4.01, 7.01, 10.01) or NIST (pH 1.68 *, 4.01, 6.86, 9.18)	
Temperature compensation	Automatic (ATC) or Manual (MTC) *	
Electrode	Body material	Polyvinylidene Fluoride (PVDF)
	Glass	Low Temperature (LT)
	Junction	Open
	Reference cell	Double, Ag/AgCl
	Electrolyte	Viscolene
	Tip / Shape	Conic, Ø6 x 10 mm (Ø 0.23 x 0.39")
	Outer diameter	8 mm (0.31")
Battery type	CR2032 3V Lithium	
Battery life	Approximately 1000 hours (500 hours with Bluetooth enabled)	
Environment	0 to 50 °C (32 to 122 °F)	
IP rating	IP65	
Dimensions / Weight	51 x 146 x 21 mm (2.0 x 5.7 x 0.8") / 45 g (1.6 oz.)	

HI9810382 (HALO2) is supplied with a starter kit consisting of: pH 4.01 buffer solution sachet (2 pcs.), pH 7.01 buffer solution sachet (2 pcs.), Electrode cleaning and disinfection solution for bread and dough deposits sachet (2 pcs.), Electrode storage solution (dropper bottle), 3V Lithium battery - CR2032, Instrument quality certificate and Instruction manual.

Ordering Information

Electrode Features

Food grade PVDF body

The food grade PVDF body material is easy to clean and disinfect. Resistant to most chemicals (e.g. solvents, sodium hypochlorite), ultraviolet light, and fungal growth, the PVDF body also has high-abrasion resistance and mechanical strength.

Fast, stable readings

The double junction design presents a silver-free electrolyte solution interacting with the sample, making the electrode less susceptible to clogging and guaranteeing a fast response and stable reading.

Built-in Temperature Sensor

Built-in temperature sensor at the tip of the pH electrode allows rapid determination of the sample temperature and a high-accuracy temperature reading.

* Available with Hanna Lab App **Measuring outside the recommended operating temperature range may damage the gel electrolyte and void product warranty. Note: The tester can display measurements from -2.00 to 16.00 pH. Measurements outside of the pH range will flash.

App Store is a service mark of Apple Inc., Google Play and the Google Play logo are trademarks of Google LLC. The Bluetooth® word mark and logos are registered trademarks owned by Bluetooth SIG, Inc.

pH solutions begin on page 2.174, pH electrode cleaning solutions begin on page 2.188



HALO®

Wireless pH Meters

Take lab grade measurements using a smart phone or tablet

HALO is the world's first professional pH probe with Bluetooth® Smart technology (Bluetooth® 4.0). This technology is energy efficient, allowing for low power consumption to maximize the life of the replaceable battery used in the pH electrode. HALO pH probes can be used virtually anywhere: in the field, laboratory, or classroom. Their versatility and ease of use revolutionizes the way pH is measured.

The Bluetooth® word mark and logos are registered trademarks owned by Bluetooth SIG, Inc.



One Press Connect

Connect to the Hanna Lab App at the press of a button via Bluetooth® wireless technology (10 m (33') range). The LED halo light indicates that the probe is active and transmitting.



One Button Sample Tagging

Pressing the button on the HALO pH probe or the probe icon in the Hanna Lab App will tag sample data for easy reference.



Easy to Replace Battery

The HALO's CR2032 lithium ion battery is easily replaced and lasts for approximately 500 hours.

The Bluetooth® word mark and logos are registered trademarks owned by Bluetooth SIG, Inc.

HI11312

HALO®

Ideal for lab applications



Hanna Lab App
Compatible

The Hanna Lab App is
available on the App Store®
and on Google Play.

Compatible with
edge®blu

HI11312 HALO is an innovative, pH electrode with Bluetooth® Smart technology that allows a compatible Apple or Android smart device to be used as a pH meter. The electrode is a general purpose, glass body pH electrode ideal for routine laboratory measurement.

- **Glass body**
 - Non-porous surface that withstands harsh chemicals
- **Double junction**
 - Silver free outer reference that is compatible with most samples
- **Built-in temperature sensor**
 - High accuracy temperature compensated measurements
- **Refillable**
 - Allows the filling of the reference cell with electrolyte fill solution

Glass Body

The glass body of the HI11312 is resistant to many harsh chemicals and is easy to clean making it ideal for general laboratory use.

Double Junction

HI11312 is a double junction pH electrode in which the Ag/AgCl necessary for the reference cell is located behind an inner ceramic junction. The gel electrolyte between the inner and outer junction is silver free. This is important to prevent the precipitation of silver by Tris buffer, metals, and sulfides that would clog the junction leading to erratic readings.

Built-in Temperature Sensor

HI11312 has a thermistor temperature sensor built into the tip of the pH electrode. A thermistor based temperature sensor provides for a high accuracy temperature reading while being in the tip of the electrode allows for a rapid determination of the temperature as it impacts the effect on the glass membrane potential.

Refillable

HI11312 is a refillable pH electrode. Fill solution from the inside will diffuse through the ceramic junction as it is used and stored in storage solution. Electrolyte fill solution should be added to the probe when the level drops more than 1 cm (1/2") from the fill hole in order to maintain a good flow rate sustained by having adequate head pressure.

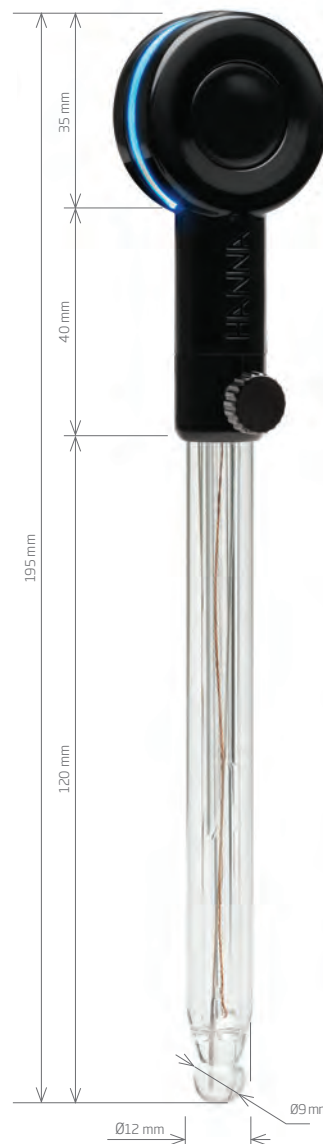

HALO Specifications	HI11312
Measurement Range	0.00 to 13.00 pH
Reference Cell Type	double, Ag/AgCl
Junction Type	ceramic
Electrolyte	3.5M KCl (refillable)
Body Material	glass
Tip / Shape	spheric
Temperature Operating Range	-5 to 80°C (23 to 176°F)
Glass Type	HT (high temperature)
Body Length/Overall Length	120 mm / 195 mm
Temperature Sensor	integrated
Outer Diameter	12 mm (glass)
Connector Type	Bluetooth Smart (Bluetooth 4.0), 10 m (33') range
Battery Type/Life	CR2032 3V lithium ion / approximately 500 hours
Environment	0 to 50°C (32 to 122°F); electronic module is not waterproof
Ordering Information	HI11312 (HALO) is supplied with storage solution, cleaning solution, pH 7.01 buffer solution, pH 4.01 buffer solution, fill solution, battery, quality certificate, and instruction sheet.

App Store is a service mark of Apple Inc., Google Play and the Google Play logo are trademarks of Google LLC. The Bluetooth® word mark and logos are registered trademarks owned by Bluetooth SIG, Inc.

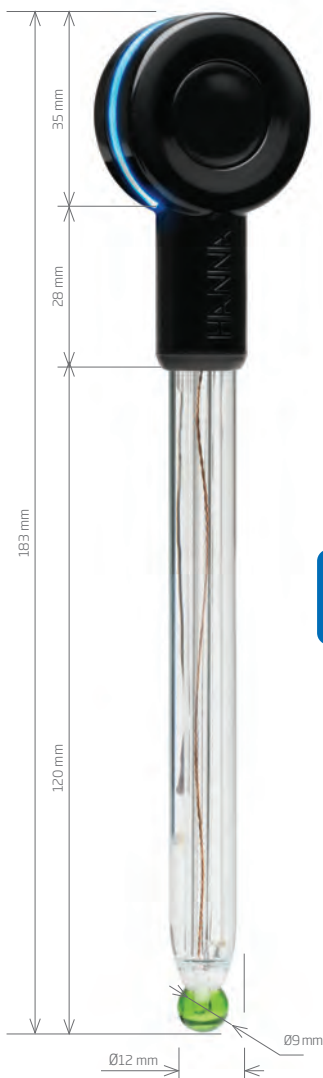

Also included with edge®blu

HI11102

HALO®



Hanna Lab App
Compatible

The Hanna Lab App is available on the App Store® and on Google Play.

Compatible with edge®blu

Ideal for lab applications

HI11102 HALO is an innovative, pH electrode with Bluetooth® Smart technology that allows a compatible Apple or Android smart device to be used as a pH meter. This general purpose, glass body pH electrode is ideal for users that would prefer a laboratory pH electrode without the refill solution maintenance.

- Glass body
 - Non-porous surface that withstands harsh chemicals
- Double junction
 - Silver free outer reference that is compatible with most samples
- Built-in temperature sensor
 - High accuracy temperature compensated measurements
- Gel-filled reference
 - Maintenance free with no fill solutions required

Glass Body

The glass body of the HI11102 is ideal for laboratory use and for users that prefer to have a traditional laboratory pH electrode without having to maintain the proper fill solution level. The glass is resistant to many harsh chemicals and is easy to clean.

Double Junction

HI11102 is a double junction pH electrode in which the Ag/AgCl necessary for the reference cell is located behind an inner ceramic junction. The gel electrolyte between the inner and outer junction is silver free. This is important to prevent the precipitation of silver by Tris buffer, metals, and sulfides that would clog the junction leading to erratic readings.

Built-in Temperature Sensor

HI11102 has a thermistor temperature sensor built into the tip of the pH electrode. A thermistor based temperature sensor provides for a high accuracy temperature reading while being in the tip of the electrode allows for a rapid determination of the temperature as it impacts the effect on the glass membrane potential.

Maintenance Free Gel-filled Reference

HI11102 contains a silver free gel in the outer reference cell. There is no fill solution to replenish as the probe is used. Other than routine calibration and cleaning, this probe is maintenance free.

HALO Specifications	HI11102
Measurement Range	0.00 to 12.00 pH
Reference Cell Type	double, Ag/AgCl
Junction Type	ceramic
Electrolyte	gel
Body Material	glass
Tip / Shape	spheric
Temperature Operating Range	-5 to 80°C (23 to 176°F)
Glass Type	LT (low temperature)
Body Length/Overall Length	120 mm /183 mm
Temperature Sensor	integrated
Outer Diameter	12 mm (glass)
Connector Type	Bluetooth Smart (Bluetooth 4.0), 10 m (33') range
Battery Type/Life	CR2032 3V lithium ion / approximately 500 hours
Environment	0 to 50°C (32 to 122°F); electronic module is not waterproof
Ordering Information	HI11102 (HALO) is supplied with storage solution, cleaning solution, pH 7.01 buffer solution, pH 4.01 buffer solution, battery, quality certificate, and instruction sheet.

App Store is a service mark of Apple Inc., Google Play and the Google Play logo are trademarks of Google LLC. The Bluetooth® word mark and logos are registered trademarks owned by Bluetooth SIG, Inc.

HI13302

HALO®

**Hanna Lab App
Compatible**

 The Hanna Lab App is
available on the App Store®
and on Google Play.

 Compatible with
edge®blu

Ideal for test tube applications

HI13302 HALO is an innovative, application specific, pH electrode with Bluetooth® Smart technology that allows a compatible Apple or Android smart device to be used as a pH meter. This electrode is designed for taking pH measurements in test tubes that are used by university, pharmaceutical, biotechnology, and food laboratories.

- **Small diameter bulb and body**
 - 5 mm diameter bulb fits easily into test tubes
- **Built-in temperature sensor**
 - Provides accurate temperature compensated pH measurements
- **Open junction**
 - Permits a predictable flow rate of reference electrolyte for stability
- **Gel-filled reference**
 - Maintenance free with no fill solutions required

Small 5 mm Diameter Bulb and Body

HI13302 has a small pH-sensing bulb that is only 5 mm in diameter by 80 mm in length. The small diameter of the probe allows for pH measurements in test tubes, vials, and other small containers.

Built-in Temperature Sensor

HI13302 has a thermistor temperature sensor built into the tip of the pH electrode. A thermistor based temperature sensor provides for high accuracy while being in the tip of the electrode allows for a rapid temperature compensated measurement.

Open Junction Design

The reference half-cell has an open junction design in order to accommodate the 5 mm micro bulb and shaft. The open junction design is resistant to clogging from suspended solids and proteins found in biological samples. Any clogging that occurs will impede the measurement circuit between the indicating electrode and the internal reference resulting in slower response time and erratic readings.

Maintenance Free Gel-filled Reference

The open junction design consists of a solid gel (Viscolene) interface between the sample and internal ceramic reference junction. Other than routine calibration and cleaning, this probe is maintenance free.

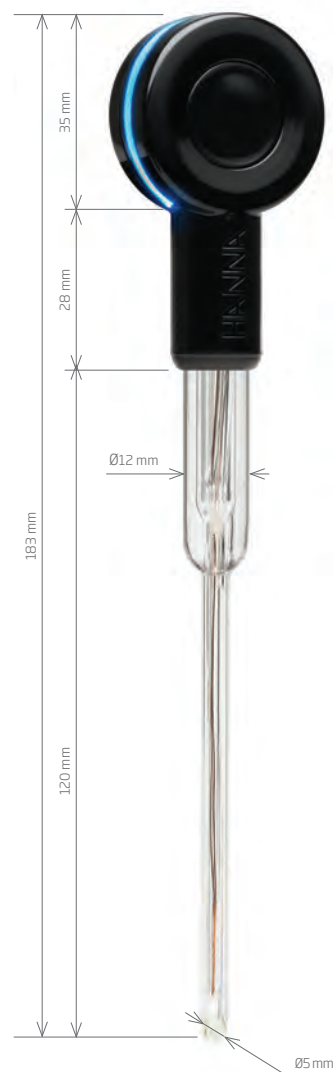

HALO Specifications

HI13302

Measurement Range	0.00 to 12.00 pH
Reference Cell Type	double, Ag/AgCl
Junction Type	open junction
Electrolyte	Viscolene
Body Material	glass
Tip / Shape	spheric
Temperature Operating Range	-5 to 50°C (23 to 122°F)
Glass Type	LT (low temperature)
Body Length/Overall Length	120 mm / 183 mm
Temperature Sensor	integrated
Outer Diameter	5 mm (glass)
Connector Type	Bluetooth Smart (Bluetooth 4.0), 10 m (33') range
Battery Type/Life	CR2032 3V lithium ion / approximately 500 hours
Environment	0 to 50°C (32 to 122°F); electronic module is not waterproof

Ordering Information

HI13302 (HALO) is supplied with storage solution, cleaning solution, pH 7.01 buffer solution, pH 4.01 buffer solution, battery, quality certificate, and instruction sheet.

App Store is a service mark of Apple Inc., Google Play and the Google Play logo are trademarks of Google LLC. The Bluetooth® word mark and logos are registered trademarks owned by Bluetooth SIG, Inc.

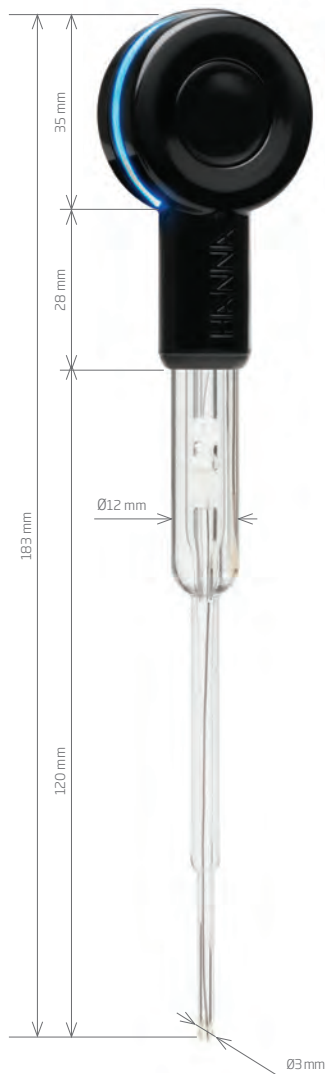

HI10832

HALO®



Hanna Lab App
Compatible

The Hanna Lab App is
available on the App Store®
and on Google Play.

Compatible with
edge@blu

Ideal for small sample
lab applications

HI10832 HALO is an innovative, application specific, pH electrode with Bluetooth® Smart technology that allows a compatible Apple or Android smart device to be used as a pH meter. This pH electrode allows for the wireless measurement of very small sample sizes for laboratory customers in university, pharmaceutical, and biotechnology research.

- **Micro bulb tip**
 - The 3 mm diameter bulb can measure the pH in samples as small as 100 µL.
- **Open junction design**
 - Resists clogging and provides for fast response time
- **Gel-filled reference**
 - Maintenance free with no fill solutions required

Micro Bulb Tip

HI10832 has an extremely small pH-sensing bulb that is only 3 mm in diameter. The small diameter of the probe allows for the measurement of pH in 96 well plates, test tubes, and vials. The HI10832 is ideal for use with expensive samples that offer little volume to work with.

Open Junction Design

The reference half-cell has an open junction design in order to accommodate the 3 mm micro bulb and shaft. The open junction design is resistant to clogging from suspended solids and proteins found in biological samples. Any clogging that occurs will impede the measurement circuit between the indicating electrode and the internal reference resulting in slower response time and erratic readings.

Maintenance Free Gel-filled Reference

The open junction design consists of a solid gel (viscolene) interface between the sample and internal ceramic reference junction. Other than routine calibration and cleaning, this probe is maintenance free.

HALO Specifications	HI10832
Measurement Range	0.00 to 12.00 pH
Reference Cell Type	double, Ag/AgCl
Junction Type	open
Electrolyte	Viscolene
Body Material	glass
Tip / Shape	spheric
Temperature Operating Range	0 to 50°C (32 to 122°F)
Glass Type	GP (general purpose)
Body Length/Overall Length	120 mm /183 mm
Temperature Sensor	none
Outer Diameter	3 mm (glass)
Connector Type	Bluetooth Smart (Bluetooth 4.0), 10 m (33') range
Battery Type/Life	CR2032 3V lithium ion / approximately 500 hours
Environment	0 to 50°C (32 to 122°F); electronic module is not waterproof

Ordering Information

HI10832 (HALO) is supplied with storage solution, cleaning solution, pH 7.01 buffer solution, pH 4.01 buffer solution, battery, quality certificate, and instruction sheet.

App Store is a service mark of Apple Inc., Google Play and the Google Play logo are trademarks of Google LLC. The Bluetooth® word mark and logos are registered trademarks owned by Bluetooth SIG, Inc.

HI12302

HALO®

**Hanna Lab App
Compatible**

The Hanna Lab App is
available on the App Store®
and on Google Play.

Compatible with
edge®blu

Ideal for field applications

HI12302 HALO is an innovative, pH electrode with Bluetooth® Smart technology that allows a compatible Apple or Android smart device to be used as a pH meter. HI12302 is a general purpose, PEI plastic body pH electrode for routine measurements in the field, lab, or at home.

- **PEI plastic body**
 - Durable, chemically resistant plastic
- **Double Junction**
 - Silver free outer reference that is compatible with most samples
- **Built-in temperature sensor**
 - High accuracy temperature compensated measurements
- **Gel-filled reference**
 - Maintenance free with no fill solutions required

PEI Plastic Body

The body of the HI12302 is composed of polyetherimide (PEI) resin. PEI is a high quality plastic that is chemically resistant to many aggressive chemicals making it ideal for a wide range of applications. The PEI body excels in field measurements due to its durability. The shield around the spherical glass tip also helps to minimize breakage due to accidental bumping or dropping of the electrode.

Double Junction

HI12302 is a double junction pH electrode in which the Ag/AgCl necessary for the reference cell is located behind an inner ceramic junction. The electrolyte between the inner and outer junction is silver free. This is important to prevent the precipitation of silver by Tris buffer, metals, and sulfides that would clog the junction leading to erratic readings.

Built-in Temperature Sensor

A thermistor temperature sensor is built into the tip of the pH electrode. A thermistor based temperature sensor provides for a high accuracy temperature reading while being in the tip of the electrode allows for a rapid determination of the temperature as it impacts the effect on the glass membrane potential.

Maintenance Free Gel-filled Reference

HI12302 contains a silver free gel in the outer reference cell. There is no fill solution to replenish as the probe is used. Other than routine calibration and cleaning, this probe is maintenance free.

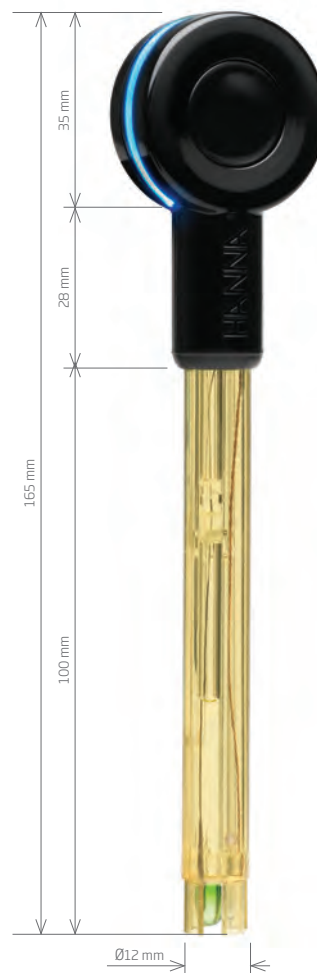

HALO Specifications	HI12302
Measurement Range	0.00 to 12.00 pH
Reference Cell Type	double, Ag/AgCl
Junction Type	ceramic
Electrolyte	gel
Body Material	PEI
Tip / Shape	dome
Temperature Operating Range	-5 to 70°C (23 to 158°F)
Glass Type	LT (low temperature)
Body Length/Overall Length	100 mm / 165 mm
Temperature Sensor	integrated
Outer Diameter	12 mm (plastic)
Connector Type	Bluetooth Smart (Bluetooth 4.0), 10 m (33') range
Battery Type/Life	CR2032 3V lithium ion / approximately 500 hours
Environment	0 to 50°C (32 to 122°F); electronic module is not waterproof
Ordering Information	HI12302 (HALO) is supplied with storage solution, cleaning solution, pH 7.01 buffer solution, pH 4.01 buffer solution, battery, quality certificate, and instruction sheet.

App Store is a service mark of Apple Inc., Google Play and the Google Play logo are trademarks of Google LLC. The Bluetooth® word mark and logos are registered trademarks owned by Bluetooth SIG, Inc.

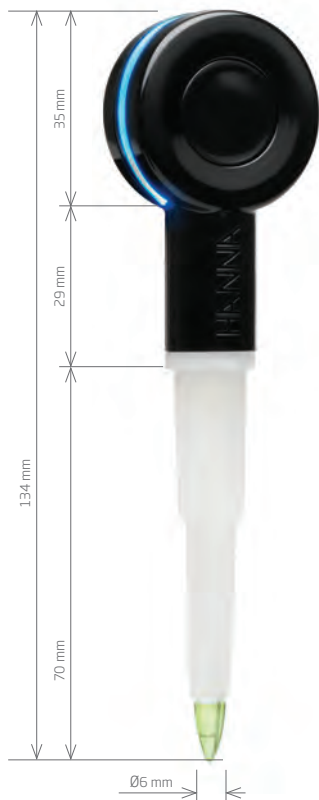

FC2022

HALO®



Hanna Lab App
Compatible

The Hanna Lab App is
available on the App Store®
and on Google Play.

Compatible with
edge@blu

Ideal for food applications

The FC2022 HALO is an innovative, application specific pH electrode with Bluetooth® Smart technology designed for food processing companies that need to monitor the pH of their product for quality and compliance.

- **Conic bulb**
 - Easy penetration into soft solids and semi-solids
- **Low temperature glass**
 - Fast and accurate measurement of refrigerated products
- **Open junction**
 - Resists clogging and provides fast response time
- **Gel-filled reference**
 - Maintenance free with no fill solutions required
- **Built-in temperature sensor**
 - High accuracy temperature compensated measurements

Conic Bulb

The conical shaped tip design allows for the easy penetration of the sensor into soft solids and semi-solids such as cheeses, yogurt, meats, and sauces. It doesn't trap foods and is very easy to wipe clean.

Low Temperature Glass

The glass tip is made with Low Temperature (LT) glass formulation that has a lower resistance than standard glass types used with ordinary pH electrodes. This is beneficial since many food products are stored at low temperatures. FC2022 HALO is suitable to be used for measurements between 0 to 10°C (32 to 50°F).

Open Junction Design

The open junction design consists of a solid gel (viscolene) interface between the sample and internal reference. This interface not only prevents silver from entering the sample, but also makes it impermeable to clogging from food products, maintaining a fast response and stable reading.

Maintenance Free Gel-filled Reference

Because the internal reference is gel, there is no fill solution to replenish as the probe is used. Other than routine calibration and cleaning, this a maintenance free probe.

Built-in Temperature Sensor

The thermistor temperature sensor is built into the tip of the pH electrode. A thermistor based temperature sensor provides for a high accuracy temperature while being in the tip of the electrode allows for a rapid temperature compensated measurement.

HALO Specifications	FC2022
Measurement Range	0.00 to 12.00 pH
Reference Cell Type	double, Ag/AgCl
Junction Type	open
Electrolyte	Viscolene
Body Material	PVDF
Tip / Shape	conic
Temperature Operating Range	0 to 60°C (32 to 140°F)
Glass Type	LT (low temperature)
Body Length/Overall Length	70 mm / 134 mm
Temperature Sensor	integrated
Outer Diameter	12 mm to 8 mm taper (plastic)
Connector Type	Bluetooth Smart (Bluetooth 4.0), 10 m (33') range
Battery Type/Life	CR2032 3V lithium ion / approximately 500 hours
Environment	0 to 50°C (32 to 122°F); electronic module is not waterproof
Ordering Information	FC2022 (HALO) is supplied with storage solution, cleaning solution, pH 7.01 buffer solution, pH 4.01 buffer solution, battery, quality certificate, and instruction sheet.

App Store is a service mark of Apple Inc., Google Play and the Google Play logo are trademarks of Google LLC. The Bluetooth® word mark and logos are registered trademarks owned by Bluetooth SIG, Inc.

The Importance of pH in Wine Making

The pH of wine is important to determine because it will affect the quality of the final product in terms of taste, color, oxidation, chemical stability, and other factors. Generally in winemaking, the higher the pH reading, the lower the amount of acidity in the wine. Three important factors in determining the pH of wine include the ratio of malic acid to tartaric acid, the amount of potassium, and the total amount of acid present.

Most wines optimally have a pH between 2.9 and 4.0, with values differing based on the type of wine. Values above pH 4.0 indicate that the wine may spoil quickly and be chemically unstable. Lower pH values allow the wine to stay fresher for a longer period and retain its original color and flavor. High pH wine is more likely to breed bacteria and become unsuitable to drink. For finished white wines, the ideal pH is between pH 3.00 and pH 3.30, while the final pH for red wine is ideally between pH 3.40 and pH 3.50. The optimal pH before the fermentation process is between pH 2.9 and pH 4.0. The pH of wine therefore not only affects the color of wine, but also the oxidation, yeast fermentation, protein stability, and bacteria growth and fermentation.



HALO Specifications	HI10482
Measurement Range	0.00 to 12.00 pH
Reference Cell Type	double, Ag/AgCl
Junction Type	movable open junction
Electrolyte	3.5M KCl (refillable)
Body Material	glass
Tip / Shape	dome
Temperature Operating Range	0 to 60°C (32 to 140°F)
Glass Type	LT (low temperature)
Body Length/Overall Length	120 mm / 195 mm
Temperature Sensor	integrated
Outer Diameter	12 mm (glass)
Connector Type	Bluetooth Smart (Bluetooth 4.0), 10 m (33') range
Battery Type/Life	CR2032 3V lithium ion / approximately 500 hours
Environment	0 to 50°C (32 to 122°F); electronic module is not waterproof

Ordering Information

HI10482 (HALO) is supplied with storage solution, cleaning solution, pH 7.01 buffer solution, pH 3.00 buffer solution, fill solution, battery, quality certificate, and instruction sheet.

HI10482

HALO®



Hanna Lab App
Compatible

The Hanna Lab App is available on the App Store® and on Google Play.

Compatible with
edge@blu

Ideal for wine, must and juice

HI10482 HALO is an innovative, application specific pH electrode designed for the winemaker that needs to monitor the pH of wine, grape juice, and must.

- **Clogging prevention system (CPS) technology**
 - Anti-clogging PE sleeve that maintains stability and fast response
- **Refillable**
 - Allows the filling of the reference cell with electrolyte fill solution
- **Built-in temperature sensor**
 - High accuracy temperature compensated measurements
- **Customized calibration buffer value**
 - Calibration to pH 3.00 to bracket the expected reading in wine

Clogging Prevention System (CPS) Technology

CPS technology is an innovation for the improvement of pH measurements in wine juice and must samples that have high solids content. Conventional pH electrodes use ceramic junctions that can clog quickly from solids found in juice and must. When the junction is clogged, the electrode does not function properly and erratic readings can result. CPS technology utilizes a ground glass junction coupled with a movable PE sleeve to prevent clogging. The ground glass allows proper flow of the liquid, while the PE sleeve repels solids. As a result, pH electrodes with CPS technology take up to 20 times longer to be fouled as compared to conventional electrodes. When the electrode becomes fouled the PE sleeve can be moved to clean the ground glass surface rejuvenating the junction and extending probe life.

Refillable

HI10482 is a refillable double junction pH electrode. Fill solution from inside the probe will diffuse through the ground glass junction while it is in use and when it is stored in storage solution. Electrolyte fill solution should be added to the probe when the level drops more than 1 cm (.39") from the fill hole in order to maintain a good flow rate sustained by having adequate head pressure.

Built-in Temperature Sensor

HI10482 has a built-in thermistor temperature sensor that is in the tip of the pH electrode. A thermistor temperature sensor provides a high accuracy temperature reading and should be as close as possible to the indicating pH electrode in order to compensate for the effect that temperature has on the membrane potential. Having a built in temperature sensor is important in wine since the measured pH values are more than 3 pH units away from the isopotential point. The further away from the isopotential point the greater the influence that temperature has on the observed reading.

Customized Calibration Buffer Value

The average pH of wine influences the choice of calibration buffers that should be used. Generally, most wines have a finished pH between 3 and 4. To ensure a high accuracy measurement, the HI10482 will prompt for pH 3.00 buffer in place of pH 4.01. This allows the calibration to bracket the expected value to be measured.

pH in Beer

In the brewing process, the enzymes required to convert the starch into sugar are pH-sensitive with an optimal pH range between 5.2 pH and 5.6 pH. Different compounds are used to adjust the pH including phosphoric acid, lactic acid, and gypsum.

Wort clarity and break formation are also affected by pH. Protein coagulation occurs during wort boiling, where the optimum pH is around 4.9, even though a common boil pH is 5.2. A pH that is too high will not only inhibit coagulation but also promote browning due to the interaction of amino acids and reducing sugars.

Hop utilization during the wort boil is also affected by pH. As pH increases, the solubility of hop resins increases. Unfortunately for hop lovers, a high pH also increases the release of tannins resulting in a harsher taste. Higher pH also favors elevated microbial activity.

As a living catalyst, yeast maintains a pH around 6.5 within its cells; however, the preference is to inhabit a more acidic environment. During the fermentation stage, the pH should be lower to accommodate the yeast and also to ensure microbial stability and consistent flavoring of the beer; an optimal pH range during fermentation is between pH 4.1 and 4.3.

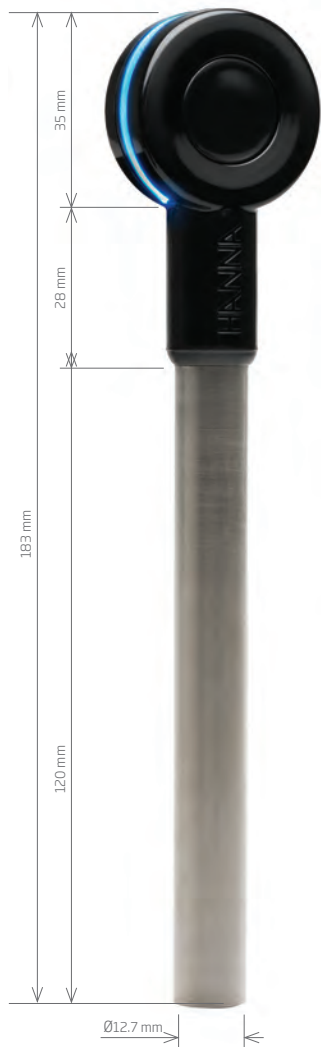

FC2142

HALO®



Hanna Lab App
Compatible

The Hanna Lab App is
available on the App Store®
and on Google Play.

Compatible with
edge@blu

Ideal for brewers

FC2142 HALO is an innovative, application specific pH electrode designed for brewers to help monitor the pH of mash and wort.

- **Built-in temperature sensor**
 - High accuracy temperature compensated measurements
- **Titanium body**
 - Provides protection even at high temperatures as well as stability of measurement

Built-in Temperature Sensor

FC2142 has a thermistor temperature sensor built into the tip of the pH electrode to provide highly accurate temperature readings and temperature compensated pH measurements.

Titanium Body

A pH measurement is a high impedance measurement, and as such is susceptible to interference from electrical noise and humidity. To overcome these issues a titanium body serves as a matching pin. A matching pin is a differential measurement technique used to eliminate electrical noise in the measurement system. The titanium body, being made of metal, is virtually unbreakable and offers additional protection from accidental breakage.



HALO Specifications	FC2142
Measurement Range	0.00 to 13.00 pH
Reference Cell Type	double, Ag/AgCl
Junction Type	cloth
Electrolyte	gel
Body Material	titanium
Tip / Shape	flat
Temperature Operating Range	0 to 80°C (32 to 176°F)
Glass Type	LT (low temperature)
Body Length/Overall Length	120 mm / 183 mm
Temperature Sensor	integrated
Outer Diameter	12.7 mm (titanium)
Connector Type	Bluetooth Smart (Bluetooth 4.0), 10 m (33') range
Battery Type/Life	CR2032 3V lithium ion / approximately 500 hours
Environment	0 to 50°C (32 to 122°F); electronic module is not waterproof
Ordering Information	FC2142 (HALO) is supplied with storage solution, cleaning solution, pH 7.01 buffer solution, pH 4.01 buffer solution, battery, quality certificate, and instruction sheet.

App Store is a service mark of Apple Inc., Google Play and the Google Play logo are trademarks of Google LLC. The Bluetooth® word mark and logos are registered trademarks owned by Bluetooth SIG, Inc.

pH Measurements

pH is the measurement of hydrogen ion concentration (H⁺) in water or soil. A pH of 7 is considered neutral. A pH below 7 is considered more acidic and a pH above 7 is considered more basic or alkaline. Water pH is important for plant management because it affects the solubility of fertilizers and the effectiveness of insecticides and fungicides.

Below is a pH scale that ranges from 0 - 14 pH. Most plants have an optimal pH between 5.8 and 6.4 pH in soil-less media. For direct soil applications, a typical pH range of 6.5 - 7.0 pH is more common.

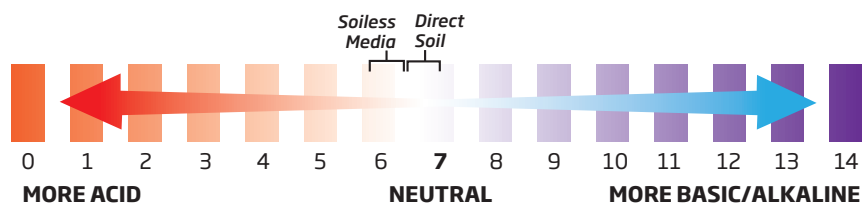

Pounds of Sulfur to Lower the Soil pH per 100 sq. ft.

Present pH	Desired pH				
	6.5	6.0	5.5	5.0	4.5
	lbs. to add				
8.0	3.0	4.0	5.5	7.0	8.0
7.5	2.0	3.5	4.5	6.0	7.0
7.0	1.0	2.0	3.5	5.0	6.0
6.5		1.0	2.5	4.0	4.5
6.0			1.0	2.5	3.5

Increase amount by 1/2 for clay soil, reduce amount by 1/3 for sandy soil, multiply by 6 if aluminum sulfate is used

Pounds of Lime to Raise the Soil pH

pH Value from Soil Test	Amount of Lime to Add/1,000 sq. ft.
Below 5.0	100 lb. agricultural lime
5.0-6.0	50 lb. agricultural lime
Above 6.0	Do not use lime

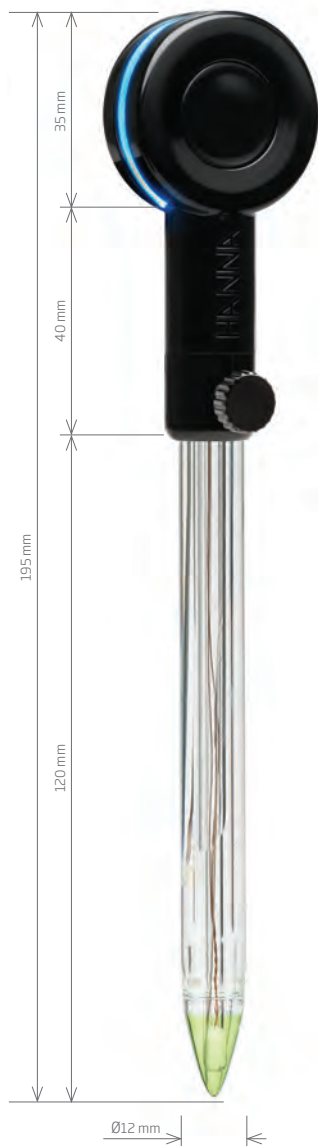

HI12922

HALO®



Hanna Lab App
Compatible

The Hanna Lab App is
available on the App Store®
and on Google Play.

Compatible with
edge@blu

Ideal for direct soil applications

The HI12922 HALO is an innovative, application specific pH electrode with Bluetooth® Smart technology that allows a compatible Apple or Android smart device to be used as a pH meter. This electrode is designed for agricultural, hydroponics, and greenhouse growers that need to monitor the pH of soil and soilless media in order to optimize plant growth.

- **Conic bulb**
 - Easy penetration into soft solids and semi-solids
- **Triple ceramic junction**
 - High flow rate for fast and stable response in slightly hydrated media
- **Refillable**
 - Allows the filling of the reference cell with electrolyte fill solution
- **Built-in temperature sensor**
 - High accuracy temperature compensated measurements

Conic Bulb

The conical shaped tip design allows for the easy penetration of the sensor into soft solids and semi-solids such as soil and soilless media. Soilless media includes hydroponics growing media including rockwool, coconut coir, and perlite.

Triple Ceramic Junction

The refillable HI12922 has three ceramic junctions in the reference cell. All pH electrodes have a reference junction that provides continuity between the internal reference wire and the sample. Utilizing a triple ceramic junction design allows for a higher flow rate of fill solution which helps provide for a fast and stable response in damp soil and soilless media.

Refillable

HI12922 is a refillable pH electrode. Fill solution from the inside will diffuse through the ceramic junctions as it is used and while stored in storage solution. Electrolyte fill solution should be added to the probe when the level drops more than 1 cm (1/2") from the fill hole in order to maintain a good flow rate sustained by having adequate head pressure (optional).

Built-in Temperature Sensor

The HI12922 has a thermistor temperature sensor built into the tip of the pH electrode. A thermistor based temperature sensor provides high accuracy while being in the tip of the electrode allows for a rapid temperature compensated measurement.

HALO Specifications	HI12922
Measurement Range	0.00 to 12.00 pH
Reference Cell Type	double, Ag/AgCl
Junction Type	triple ceramic
Electrolyte	3.5M KCl (refillable)
Body Material	glass
Tip / Shape	conic
Temperature Operating Range	-5 to 70°C (23 to 158°F)
Glass Type	LT (low temperature)
Body Length/Overall Length	120 mm / 195 mm
Temperature Sensor	integrated
Outer Diameter	12 mm (glass)
Connector Type	Bluetooth Smart (Bluetooth 4.0), 10 m (33') range
Battery Type/Life	CR2032 3V lithium ion / approximately 500 hours
Environment	0 to 50°C (32 to 122°F); electronic module is not waterproof

Ordering Information

HI12922 (HALO) is supplied with HI7121319 soil auger, storage solution, cleaning solution, pH 7.01 buffer solution, pH 4.01 buffer solution, fill solution, battery, quality certificate, and instruction sheet.

Includes soil auger



App Store is a service mark of Apple Inc., Google Play and the Google Play logo are trademarks of Google LLC. The Bluetooth® word mark and logos are registered trademarks owned by Bluetooth SIG, Inc.

HI14142

HALO®

Ideal for flat surfaces



Hanna Lab App
Compatible

The Hanna Lab App is
available on the App Store®
and on Google Play.

Compatible with
edge®blu

The HI14142 HALO is an innovative pH electrode with Bluetooth® Smart technology designed for flat surfaces.

- **Flat bulb**
 - Measure pH on flat surfaces or small volume samples
- **Low temperature glass**
 - Fast and accurate measurement at lower temperatures
- **Open junction**
 - Resists clogging and provides fast response time
- **Gel-filled reference**
 - Maintenance free with no fill solutions required
- **Built-in temperature sensor**
 - High accuracy temperature compensated measurements

Flat Tip Bulb

The flat shaped tip design allows for easy measurement on surfaces or samples with a small volume.

Low Temperature Glass

The glass tip is made with Low Temperature (LT) glass formulation that has a lower resistance than standard glass types used with ordinary pH electrodes.

Open Junction Design

The open junction design consists of a solid gel (viscolene) interface between the sample and internal reference. This interface not only prevents silver from entering the sample, but also makes it impermeable to clogging from food products, maintaining a fast response and stable reading.

Maintenance Free Gel-filled Reference

Because the internal reference is gel, there is no fill solution to replenish as the probe is used. Other than routine calibration and cleaning, this a maintenance free probe.

Built-in Temperature Sensor

The thermistor temperature sensor built into the tip of the pH electrode. A thermistor based temperature sensor provides high accuracy while being in the tip of the electrode allows for a rapid temperature compensated measurement.

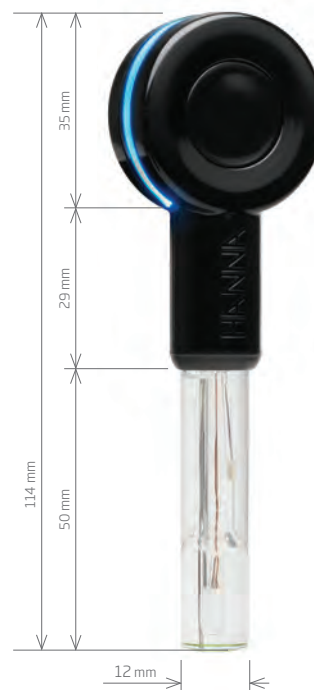

HALO Specifications	HI14142
Measurement Range	0.00 to 12.00 pH
Reference Cell Type	double, Ag/AgCl
Junction Type	open
Electrolyte	Viscolene
Body Material	glass
Tip / Shape	flat
Temperature Operating Range	0 to 50°C (32 to 122°F)
Glass Type	LT (low temperature)
Body Length/Overall Length	50 mm / 114 mm
Temperature Sensor	integrated
Outer Diameter	12 mm (glass)
Connector Type	Bluetooth Smart (Bluetooth 4.0), 10 m (33') range
Battery Type/Life	CR2032 3V lithium ion / approximately 500 hours
Environment	0 to 50°C (32 to 122°F); electronic module is not waterproof
Ordering Information	HI14142 (HALO) is supplied with storage solution, cleaning solution, pH 7.01 buffer solution, pH 4.01 buffer solution, battery, quality certificate, and instruction sheet.

App Store is a service mark of Apple Inc., Google Play and the Google Play logo are trademarks of Google LLC. The Bluetooth® word mark and logos are registered trademarks owned by Bluetooth SIG, Inc.



HI10532

HALO®



Hanna Lab App
Compatible

The Hanna Lab App is
available on the App Store®
and on Google Play.

Compatible with
edge®blu

Ideal for food applications

The HI10532 HALO is a Bluetooth pH electrode that turns a smart device into a fully functional pH meter for measuring the pH of food products. The HI10532 features a conic shaped sensing tip along with a triple ceramic junction in the outer reference for stable and reliable measurements in samples that would be a challenge for standard pH electrode designs.

- **Bluetooth® Smart Connectivity**
 - Connects to smart devices such as phones and tablets
- **Conic bulb**
 - Easy penetration into soft solids and semi-solids
- **Triple ceramic junction**
 - High flow rate for fast and stable response
- **Refillable**
 - Allows the filling of the reference cell with electrolyte fill solution
- **Built-in temperature sensor**
 - High accuracy temperature compensated measurements

Low Temperature Glass

Low Temperature (LT) glass allows the probe to be used from -5 to 70°C (23 to 158°F)

Conical Glass Tip

The conical shaped tip design allows for penetration into solids, semi-solids, and emulsions and is ideal for the direct measurement of pH in food products

Triple Ceramic Junction

The triple ceramic junction allows a higher flow rate of electrolyte from the reference cell into the measurement sample. The increased flow provides greater continuity between the reference electrode and the sample making ideal for slurries and low conductivity samples

Refillable

HI10532 is a refillable pH electrode. Fill solution from the inside will diffuse through the ceramic junctions as it is used and while stored in storage solution. Electrolyte fill solution should be added to the probe when the level drops more than 1 cm (1/2") from the fill hole in order to maintain a good flow rate sustained by having adequate head pressure (optional).

Built-in Temperature Sensor

The temperature reading is necessary in order to compensate for temperature variations that affect the electrode response.

HALO Specifications

HI10532

Measurement Range	0 to 12 pH (resolution displayed by device selectable up to 0.001pH)
Reference Cell Type	double, Ag/AgCl
Junction / Flow Rate	triple ceramic / 40 to 50 µL/h
Electrolyte	3.5M KCl (refillable)
Body Material	glass
Tip / Shape	conic
Temperature Operating Range	-5 to 70°C (23 to 158°F)
Glass Type	LT (low temperature)
Body Length/Overall Length	120 mm / 195 mm
Outer Diameter	12 mm (glass)
Temperature Sensor	yes
Amplifier	yes
Connector Type	Bluetooth Smart (Bluetooth 4.0), 10 m (33') range
Battery Type/Life	CR2032 3V lithium ion / approximately 500 hours
Environment	0 to 50°C (32 to 122°F); electronic module is not waterproof

Ordering Information

HI10532 (HALO) is supplied with pH 7.01 buffer solution sachets (2), pH 4.01 buffer solution sachets (2), electrode cleaning solution sachets (2), storage solution (30 mL), refill electrolyte solution (30 mL), refilling pipette, battery, electrode quality testing certificate, and instruction manual.

App Store is a service mark of Apple Inc., Google Play and the Google Play logo are trademarks of Google LLC. The Bluetooth® word mark and logos are registered trademarks owned by Bluetooth SIG, Inc.

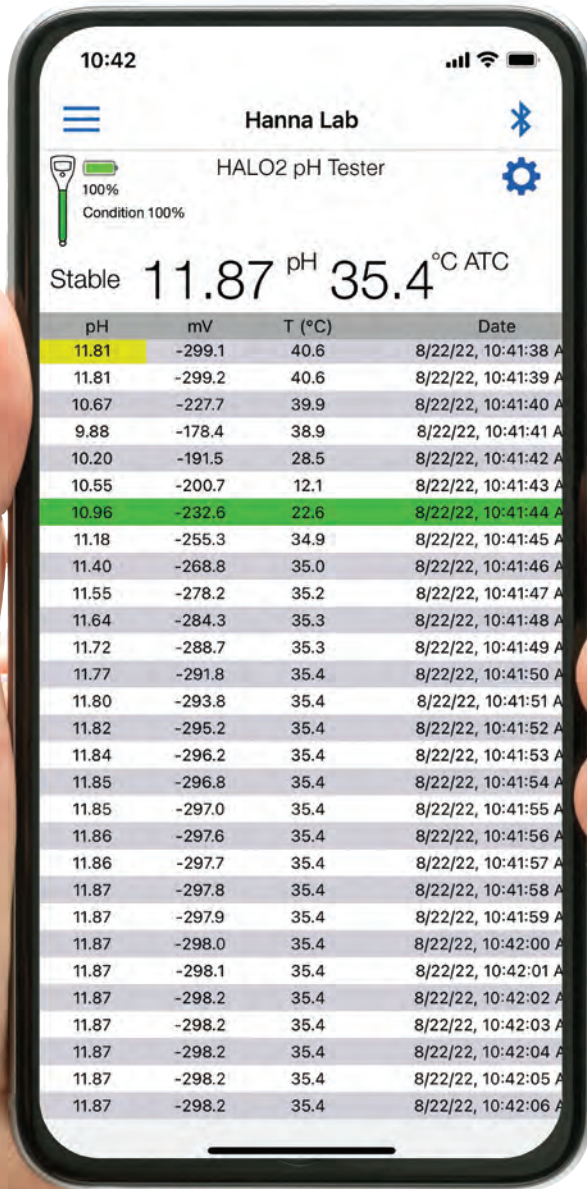

Hanna Lab App

The Hanna Lab App is available on the App Store® and on Google Play.



The first app that turns a smart phone or tablet into a full-featured pH meter.

The Hanna Lab App turns a compatible smart phone or tablet into a full-featured pH meter when used with compatible Hanna electrodes with Bluetooth® wireless technology. Functions include calibration, measurement and data logging (at one second intervals), graphing, and data sharing. Measurements can be displayed alone, with tabulated data, or as a graph. The graph can be panned and zoomed with pinch-to-zoom technology.

Measurement Screen

Name, Battery Status, and Electrode Condition on Display

The measurement screen of the Hanna Lab App displays the name, battery life and condition of the probe.

Real-Time Data

Displays updated pH and temperature every second.



GLP (Good Laboratory Practice)



Basic GLP

Displays date and time of current calibration along with probe offset and average slope. For tablet displays, basic GLP can be also displayed in table and graph views.



Full GLP

Displays date and time of current calibration, probe offset, and average slope along with calibrated buffers, mV values, temperature and slopes between each buffer. For tablet displays, full GLP can be also displayed in table and graph views.

Hanna Lab App Specifications*

Range**	-2.000 to 16.000 pH ±800 mV -20.0 to 120.0°C (-4.0 to 248.0°F)
Resolution	0.1; 0.01; 0.001 pH 1; 0.1 mV; 0.1 °C (0.1°F)
Accuracy (@25°C/77°F)	±0.005 pH ±0.3 mV ±0.5 °C (±1.0°F)
Calibration Points	up to five-point calibration with seven standard buffers (1.68, 3.00 (HI10482, HI981033, HI9810332 only) or 4.01, 6.86, 7.01, 9.18, 10.01, 12.45 pH)
Temperature Compensation**	automatic from -5.0 to 100.0°C – 23.0 to 212.0°F
Compatibility/System Requirements	see www.hannainst.com for latest compatibility requirements

Download Information



* * Limits will be reduced to actual probe/sensor limits.

App Store® is a service mark of Apple Inc., Google Play and the Google Play logo are trademarks of Google LLC. The Bluetooth® word mark and logos are registered trademarks owned by Bluetooth SIG, Inc.

Calibration



Clear and Concise Calibration Screens

The Hanna Lab App allows for calibration of up to five points. The buffer value is automatically detected and temperature corrected to 25.0°C (77°F) during calibration.



Calibration Reminder

Alerts users when calibration is needed.

Additional Features



Measurement Alerts

Readings that exceed user-defined alarm thresholds are highlighted in yellow on the measurement screen, graph, and table. Readings that exceed the probe specifications are highlighted in red.



Settings

Tap the gear icon in the top right corner of the measurement screen to access the Settings menu.



Help and Tutorials

The Hanna Lab App features demo probe mode, general app information, general information, pH tutorial, maintenance tutorial, and contact information.

HI98199

pH • EC • DO Waterproof Meter

Use three professional probes with Hanna's Quick Connect

The HI98199 is a versatile meter that can monitor pH, EC, and dissolved oxygen when paired with the respective probe. Hanna's pH probe is included with the HI98199 and the EC and DO probes can be ordered separately. Each digital probe features Hanna's Quick Connect DIN connector and the included carrying case contains all the accessories necessary to start taking pH measurements.

Backlit Graphic LCD Display

The HI98199 features a backlit graphic LCD with on-screen help and the capability to display multiple parameters simultaneously. The use of virtual keys provides for an intuitive user interface.

Waterproof Protection

HI98199 is enclosed in an IP67 rated waterproof casing and can withstand immersion in water at a depth of 1 m for up to 30 minutes. The probes feature an IP68 rating for continuous immersion in water.

Quick Connect Digital Probe

pH, EC, and DO probes feature a Quick Connect DIN connector that makes a waterproof connection with the meter.

Auto-sensor Recognition

The probe and meter automatically recognize the sensors that are connected.



Data Logging

The HI98199 allows users to store up to 45,000 continuous or log-on-demand samples with logging intervals from one second to three hours.

PC Connectivity

Logged data can be transferred to a Window's compatible PC with the included micro USB cable and Hanna software.

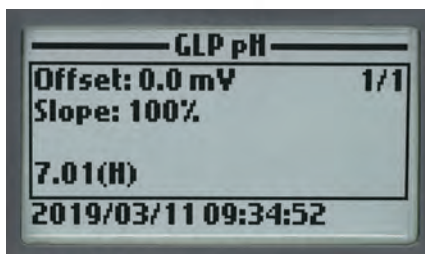

GLP Data

HI98199 includes a GLP feature that allows users to view calibration data and calibration expiration information at the touch of a key. Calibration data includes date, time, buffers/standards used for calibration, and slope characteristics.

Dedicated Help Key

Contextual help is always available through a dedicated "HELP" key. Clear tutorial messages and directions are available on-screen to quickly and easily guide users through setup and calibration. The help information displayed is relative to the setting/option being viewed.

Long Battery Life

The meter displays a battery icon indicator to show the remaining power. The meter uses four 1.5V AA batteries that provide up to 360 hours of battery life.

Versatility when you need it.

Each probe transmits readings digitally to the meter, where data points can be displayed and logged.

2



pH

portable

pH

The HI98199 allows for the measurement of pH and temperature when used with the included HI829113 digital pH probe.

- Up to a three-point calibration with five standard buffers and one custom buffer available
- pH in mV option is useful for diagnostics
- GLP data
 - Offset, slope, date, time and buffers used
- Automatically temperature compensated readings
- pH sensor
 - Gel filled and maintenance free
 - Double junction for reduced contamination of reference cell

Conductivity

The HI98199 allows for the measurement of conductivity, TDS (total dissolved solids), Resistivity, Salinity, seawater σ , and temperature when used with the optional HI763093 digital EC probe.

- Single-point calibration from six standards
- Temperature compensation
 - Automatic Temperature Compensation
 - Configurable temperature coefficient range from 0.00 to 6.00%/°C
 - Choice of reference temperatures at 20 or 25°C
 - Absolute conductivity can be displayed along with the temperature compensated value
- Auto-ranging
- Salinity readings
 - Practical Salinity Scale (PSU) based on conductivity calibration

Dissolved Oxygen

The HI98199 allows for the measurement of dissolved oxygen, atmospheric pressure, and temperature when used with the optional HI764103 digital DO probe.

- Display units in % saturation or ppm (mg/L)
- Salinity compensation for saline waters
 - Manual entry of salinity values
 - Readings compensated for salinity effects
- Built-in barometer
 - Automatic compensation for changes in atmospheric pressure
 - User selectable units
- Temperature compensation
- Automatic polarization of probe at startup
- Ready-to-use HDPE pre-tensioned membrane caps are easy to replace



Specifications	HI98199	
pH / mV (using included HI829113 pH Probe)	Range	0.00 to 14.00 pH / ± 600.0 mV
	Resolution	0.01 pH / 0.1 mV
	Accuracy	± 0.02 pH / ± 0.5 mV
	Calibration	automatic one, two, or three points of five standard buffers (pH 4.01, 6.86, 7.01, 9.18, 10.01) or one custom buffer
EC (using HI763093 EC Probe)	Range	0 to 200 mS/cm
	Resolution	manual: 1 μ S/cm; 0.001 mS/cm; 0.01 mS/cm; 0.1 mS/cm; 1 mS/cm; automatic: 1 μ S/cm from 0 to 9999 μ S/cm; 0.01 mS/cm from 10.00 to 99.99 mS/cm; 0.1 mS/cm from 100.0 to 200.0 mS/cm automatic mS/cm: 0.001 mS/cm from 0.000 to 9.999 mS/cm; 0.01 mS/cm from 10.00 to 99.99 mS/cm; 0.1 mS/cm from 100.0 to 200.0 mS/cm
	Accuracy	$\pm 1.5\%$ of reading or ± 2 μ S/cm whichever is greater
	Calibration	automatic single point, with six standard solutions (84 μ S/cm, 1413 μ S/cm, 5.00 mS/cm, 12.88 mS/cm, 80.0 mS/cm, 111.8 mS/cm) or custom point
TDS (using HI763093 EC Probe)	Range	0.0 to 200.0 ppt (g/L) (the maximum value depends on the TDS factor)
	Resolution	manual: 1 ppm (mg/L); 0.001 ppt (g/L); 0.01 ppt (g/L); 0.1 ppt (g/L); 1 ppt (g/L); automatic: 1 ppm (mg/L) from 0 to 9999 ppm (mg/L); 0.01 ppt (g/L) from 10.00 to 99.99 ppt (g/L); 0.1 ppt (g/L) from 100.0 to 200.0 ppt (g/L) automatic ppt (g/L): 0.001 ppt (g/L) from 0.000 to 9.999 ppt (g/L); 0.01 ppt (g/L) from 10.00 to 99.99 ppt (g/L); 0.1 ppt (g/L) from 100.0 to 200.0 ppt (g/L)
	Accuracy	$\pm 1\%$ of reading or ± 1 ppm (mg/L) whichever is greater
	Calibration	based on conductivity calibration
Resistivity (using HI763093 EC Probe)	Range	0 to 999999 $\Omega \cdot \text{cm}$; 0 to 1000.0 $\text{k}\Omega \cdot \text{cm}$; 0 to 1.0000 $\text{M}\Omega \cdot \text{cm}$
	Resolution	1 $\Omega \cdot \text{cm}$; 0.1 $\text{k}\Omega \cdot \text{cm}$; 0.0001 $\text{M}\Omega \cdot \text{cm}$
	Calibration	based on conductivity calibration
Salinity (using HI763093 EC Probe)	Range	0.00 to 70.00 PSU
	Resolution	0.01 PSU
	Accuracy	$\pm 2\%$ of reading or ± 0.01 PSU whichever is greater
Seawater σ (using HI763093 EC Probe)	Range	0.0 to 50.0 $\sigma_t, \sigma_0, \sigma_{15}$
	Resolution	0.1 $\sigma_t, \sigma_0, \sigma_{15}$
	Accuracy	$\pm 1 \sigma_t, \sigma_0, \sigma_{15}$
Dissolved Oxygen (using HI764103 DO Probe)	Range	0.0 to 500.0%; 0.00 to 50.00 ppm (mg/L)
	Resolution	0.1%; 0.01 ppm (mg/L)
	Accuracy	0.0 to 300.0%: $\pm 1.5\%$ of reading or $\pm 1.0\%$ whichever is greater; 300.0 to 500.0%: $\pm 3\%$ of reading; 0.00 to 30.00 ppm (mg/L): $\pm 1.5\%$ of reading or ± 0.10 ppm (mg/L), whichever is greater; 30.00 ppm (mg/L) to 50.00 ppm (mg/L): $\pm 3\%$ of reading
Atmospheric Pressure (using HI764103 DO Probe)	Range	450 to 850 mm Hg; 17.72 to 33.46 in Hg; 600.0 to 1133.2 mbar; 8.702 to 16.436 psi; 0.5921 to 1.1184 atm; 60.00 to 113.32 kPa
	Resolution	0.1 mm Hg; 0.01 in Hg; 0.1 mbar; 0.001 psi; 0.0001 atm; 0.01 kPa
	Accuracy	± 3 mm Hg within $\pm 15^\circ\text{C}$ from the temperature during calibration
Temperature	Calibration	automatic at one custom point
	Range	-5.00 to 55.00°C ; 23.00 to 131.00°F ; 268.15 to 328.15K
	Resolution	0.01 $^\circ\text{C}$; 0.01 $^\circ\text{F}$; 0.01K
	Accuracy	$\pm 0.15^\circ\text{C}$; $\pm 0.27^\circ\text{F}$; $\pm 0.15\text{K}$
Additional Specifications	Calibration	automatic at one custom point
	Temperature Compensation	automatic from -5 to 55°C (23 to 131 $^\circ\text{F}$)
	Logging Memory	45000 records (continuous logging or log-on-demand)
	Logging Interval	one second to three hours
	PC Connectivity	via USB (with Hanna PC software)
	Environment	0 to 50°C (32 to 122 $^\circ\text{F}$); RH 100% IP67
	Battery Type / Life	1.5V AA batteries (4) / approximately 400 hours of continuous use without backlight (50 hours with backlight)
Dimensions / Weight	185.0 x 93.0 x 35.2 mm (7.3 x 3.6 x 1.4") / 400 g (14.2 oz.)	
Ordering Information	HI98199 is supplied with the HI829113 pH digital probe with 4m (13') cable, pH calibration solution sachets, PC software, micro USB cable, batteries, quality certificate, and instruction manual in a rugged carrying case.	
Probes	HI829113 pH digital probe with 4m (13') cable	
	HI763093 EC digital probe with 4m (13') cable	
	HI764103 DO digital probe with 4m (13') cable	
Accessories	HI710034 orange protective silicone rubber boot	
	HI720199 spare carrying case for HI98199	

HI98190

Professional Waterproof Meter

pH/ORP

- **Waterproof**
 - IP67 rated waterproof, rugged enclosure
- **CAL Check™**
 - Alerts users to problems during calibration including dirty/broken electrode, contaminated buffer, and overall probe condition
- **Automatic or manual temperature compensation**
 - pH sensors incorporate a built-in temperature sensor
- **Calibration**
 - Up to a five-point calibration with seven standard buffers and five custom buffers available
- **Approximately 200 hour battery life**
 - Powered by (4) 1.5V AA batteries
- **Clear display**
 - Dot matrix display with multifunction virtual keys
- **AutoHold**
 - Automatically holds the first stable reading on the display
- **Calibration timeout**
 - Alerts when calibration is due at a specified interval
- **Connectivity**
 - PC connectivity via opto-isolated micro-USB with HI92000 software
- **GLP**
 - GLP data provides data from previous calibration to ensure Good Laboratory Practices are met
- **Intuitive keypad**
 - Most of the available options such as GLP information, help, range, calibration, and backlight have a dedicated button
- **Supplied complete**
 - Each meter is supplied complete with sensor, calibration solution, beakers, PC software and connection cable, instruction manual, quick start guide, and batteries in a rugged, custom carrying case.



Designed for professionals

The HI98190 is a rugged, portable pH meter with the performance and features of a benchtop meter. Exchange out the pH probe for an ORP probe to obtain mV readings in the ± 2000 mV range. This professional, waterproof meter can easily be operated with one hand and complies with IP67 standards. The HI98190 is supplied with all necessary accessories to perform a pH/temperature measurement packaged into a durable carrying case.



Backlit Graphic LCD Display

The HI98190 features a backlit graphic LCD with on-screen help. The graphic display allows for the use of virtual keys to provide for an intuitive user interface.

Waterproof Protection

The meter is enclosed in an IP67 rated waterproof casing and can withstand immersion in water at a depth of 1 m for up to 30 minutes. The probe features an IP68 rating for continuous immersion in water.



Quick Connect Probe

The HI98190 features the HI12963 titanium bodied pH/temperature electrode with a quick connect DIN connector to make attaching and removing the probe simple and easy.

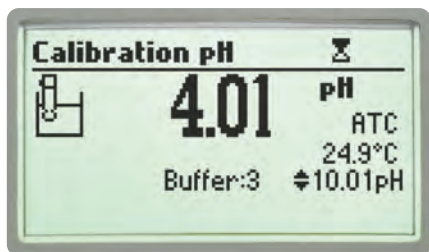

pH Calibration

Choose from seven standard pH buffers and five custom pH buffers to obtain up to five point calibration and achieve high precision readings with a pH accuracy of ± 0.002 and up to ± 0.001 pH resolution.

Enhanced Calibration

An "out of calibration range" warning can be engaged to keep the user informed of the current calibration and help to avoid performing measurements that are out of range.

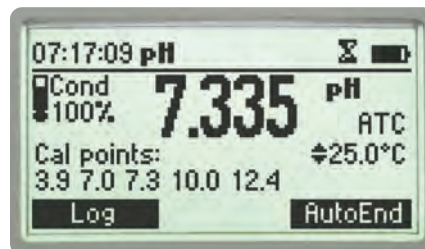

CAL Check™

Hanna's CAL Check maintains a history of past calibrations and monitors the pH electrode and buffers during subsequent calibrations for any signs of wide variances due to a dirty or broken electrode or contaminated pH buffers. During calibration, users are alerted to problems should they occur. After calibration, the electrode's overall condition is displayed as a percentage.

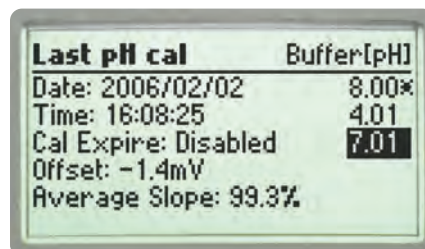

GLP

Comprehensive GLP functions are directly accessible by pressing the GLP key. Calibration data, including date, time, and calibration values are stored for retrieval at a later time.

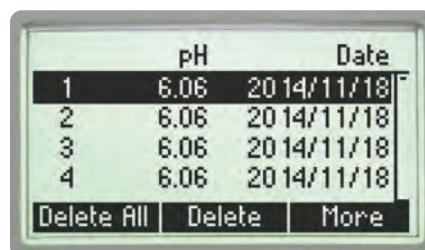

Data Logging

The log-on-demand feature allows users to store up to 200 samples that can be later transferred to a PC with the HI920015 USB cable and HI92000 software.

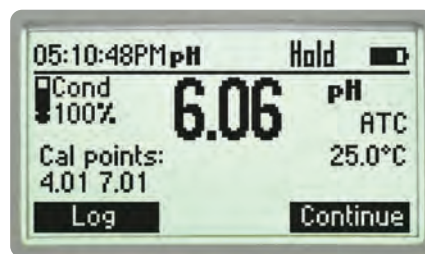

AutoHold

Pressing AutoHold during measurement will automatically hold the first stable reading on the display.

Intuitive Keypad

The fitted rubber keypad has dedicated keys for power, backlight, up/down arrows, help, and alphanumeric characters. The meter also features two virtual soft keys that navigate the user through the configuration of each parameter, meter setup, and logging of data. The interface is intuitive for any user's level of experience.



Dedicated Help Key

Contextual help is always available through a dedicated "HELP" key. Clear tutorial messages and directions are available on-screen to quickly and easily guide users through setup and calibration. The help information displayed is relative to the setting/option being viewed.

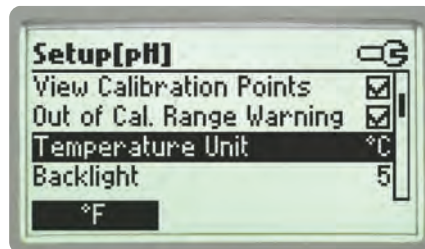

Setup Screen

Our extensive setup screen features a host of configurable options such as time, date, temperature units, and language for help screens and guides.



Supplied Complete in a Rugged Custom Carrying Case

The HI98190 meter, probe, and accessories are supplied in the HI720190 rugged carrying case designed to provide years of use. The inside compartment of the carrying case is thermoformed to securely hold and protect all of the components.



HI12963 pH Electrode

- **Titanium body**
 - Titanium construction provides an unbreakable structure and allows the transfer of heat to the internal temperature sensor for rapid temperature compensation.
- **Maintenance free, gel-filled electrode**
 - No fill solution required



PC Connectivity

Logged data can be transferred to a Windows compatible PC with the included HI920015 micro USB cable and HI92000 software.

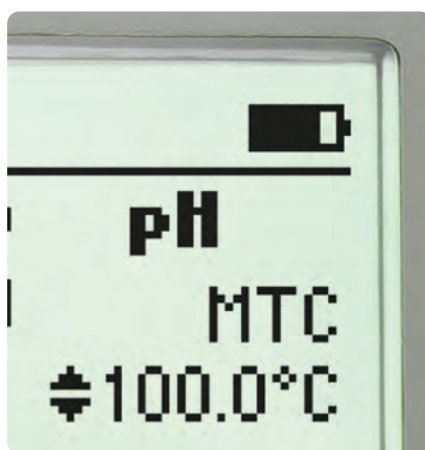

Long Battery Life

The display of the meter has a battery icon to show the remaining power. The meter uses four 1.5V AA batteries that provide up to 200 hours of battery life.

Calibration Error Messages

Calibration is successfully performed if the reading is within certain limits.

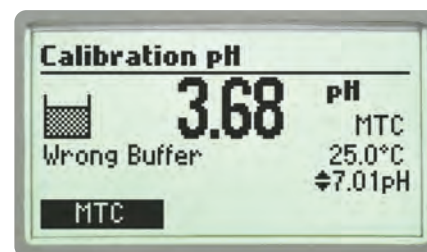

Wrong Buffer – The pH reading is not within range of the selected buffer.

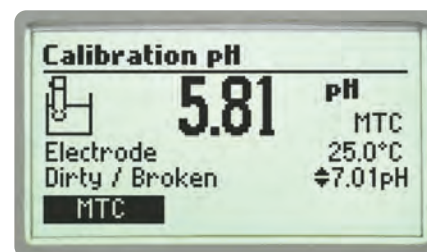

Electrode Dirty/Broken alternatively with Buffer Contaminated –The offset of the electrode is not in the accepted range. Check if the electrode is broken or clean it following the Cleaning Procedure at the end of this section. Check the quality of the buffer. If necessary, change the buffer.

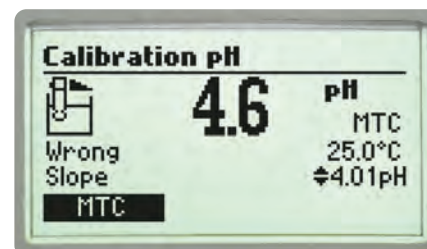

Wrong or Wrong Old Slope – An inconsistency between new and previous (old) calibration is detected.

Calibrate right in the case with custom beaker holders

Our custom carrying case features beaker holders for calibration out in the field.



- Optional shockproof silicon rubber boot
 - Specially designed to protect your instrument from damage or impact

HI710034 Orange

Specifications

HI98190

pH*	Range	-2.0 to 20.0 pH; -2.00 to 20.00 pH; -2.000 to 20.000 pH
	Resolution	0.1 pH; 0.01 pH; 0.001 pH
	Accuracy	±0.1 pH; ±0.01 pH; ±0.002 pH
	Calibration	up to five-point calibration, seven standard buffers available (1.68, 4.01, 6.86, 7.01, 9.18, 10.01, 12.45) and five custom buffers
	Temperature Compensation	automatic or manual from -20.0 to 120.0°C (-4.0 to 248.0°F)
mV*	Range	±2000 mV
	Resolution	0.1 mV
	Accuracy	±0.2 mV
	Relative mV Offset Range	±2000 mV
Temperature*	Range	-20.0 to 120.0 °C (-4.0 to 248.0°F)
	Resolution	0.1°C (0.1°F)
	Accuracy	±0.4°C (±0.8°F) (excluding probe error)
Additional Specifications	pH Probe	HI12963 titanium body, pH electrode with internal temperature sensor, quick DIN connector and 1 m (3.3' cable)
	Slope Calibration	from 80 to 110%
	Log-on-demand	200 samples (100 each pH/mV range)
	PC Connection	opto-isolated USB with HI92000 software and micro USB cable
	Input Impedance	10 ¹² Ω
	Battery Type / Life	1.5V AA batteries (4) / approximately 200 hours of continuous use without backlight (50 hours with backlight)
	Auto-off	user selectable: 5, 10, 30, 60 min, disabled
	Environment	0 to 50°C (32 to 122°F); RH 100% IP67
	Dimensions / Weight	185 x 93 x 35.2 mm (7.3 x 3.6 x 1.4") / 400 g (14.2 oz.)
Ordering Information	<p>HI98190 is supplied with HI12963 pH electrode, HI7004M pH 4.01 buffer solution (230 mL), HI7007M pH 7.01 buffer solution (230 mL), electrode cleaning solution sachet (2), 100 mL plastic beaker (2), HI92000 PC software, HI920015 micro USB cable, 1.5V AA batteries (4), quick start guide, quality certificate, and instruction manual in an HI720190 rugged carrying case with custom insert.</p> <p>HI98190-03 includes the above without electrode.</p>	
Accessories	HI710034 orange protective rubber boot	

* Limits will be reduced to actual sensor limits

Foodcare

HI98161

pH / Temperature Meter for Food

HI98161 is a professional portable pH and temperature meter with a probe designed specifically for pH measurement in the Food sector.

- **Waterproof**
 - IP67 rated waterproof, rugged enclosure
- **CAL Check™**
 - Alerts users to problems during calibration including dirty/broken electrode, contaminated buffer, and overall probe condition
- **Automatic or manual temperature compensation**
 - pH sensors incorporate a built-in temperature sensor
- **Calibration**
 - Up to a five-point calibration with seven standard buffers and five custom buffers
- **Approximately 200 hour battery life**
 - Powered by 4 1.5V AA batteries
- **Clear display**
 - Dot matrix display with multifunction virtual keys
- **Auto hold**
 - Automatically holds the first stable reading on the display
- **Calibration timeout**
 - Alerts when calibration is due at a specified interval
- **Connectivity**
 - PC connectivity via opto-isolated micro-USB with HI92000 software
- **GLP**
 - GLP data provides data from previous calibration to ensure Good Laboratory Practices are met
- **Intuitive keypad**
 - Important and often used functions such as GLP information, help, range, calibration, and backlight have a dedicated button
- **Supplied complete**
 - Each meter is supplied complete with sensor, calibration and cleaning solutions, beakers, PC software and connection cable, instruction manual, quick start guide, and batteries in a rugged, custom carrying case



Foodcare pH Meter

designed for food professionals

Hanna foodcare pH meters are rugged and portable with the performance and features of a benchtop. Eight models are available in this series to measure food, milk, meat, yogurt, cheese, beer, wine, and soil. Each model is supplied with an application specific electrode and cleaning solutions. These waterproof meters comply to IP67 standards and can be easily operated with one hand.



Backlit Graphic LCD Display

These meters feature a backlit graphic LCD with on-screen help. The graphic display allows for the use of virtual keys to provide for an intuitive user interface.

Waterproof Protection

The meter is enclosed in an IP67 rated waterproof casing and can withstand immersion in water at a depth of 1 m for up to 30 minutes.



Quick Connect Probe

Each meter features an application specific pH/temperature probe with a quick connect DIN connector to make attaching and removing the probe simple and easy.

Calibration Timeout

Alerts when calibration is due at a specified interval.

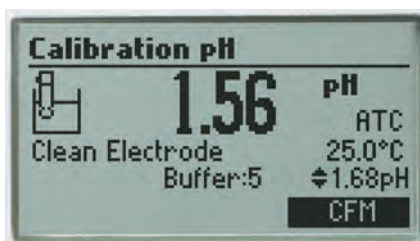

pH Calibration

Choose from seven standard pH buffers and five custom values to obtain up to five point calibration and achieve high precision readings with a 0.001 pH resolution and a pH accuracy of ± 0.002 .

Enhanced Calibration

An "out of calibration range" warning can be engaged to keep the user informed of the current calibration and help to avoid performing measurements that are out of the bracketed range.



CAL Check™

Hanna's CAL Check maintains a history of past calibrations and monitors the pH electrode and buffers during subsequent calibrations for any signs of wide variances due to a dirty or broken electrode or contaminated pH buffers. During calibration, users are alerted to problems should they occur. After calibration, the electrode's overall condition is displayed as a percentage.



GLP

Comprehensive GLP functions are directly accessible by pressing the GLP key. Calibration data including date, time and calibration values are stored with logged data for retrieval at a later time.



Data Logging

The log-on-demand feature allows users to store up to 200 samples that can later be transferred to a PC with the HI920015 USB cable and HI92000 software.

Automatic Temperature Compensation

pH sensors incorporate a built-in temperature sensor in the tip of the electrode for a fast and accurate temperature compensated value.

Intuitive Keypad

The fitted rubber keypad has dedicated keys for many important and often used functions. These meters also feature two virtual soft keys that navigate the user through setup and logging of data. The interface is intuitive for any user's level of experience.

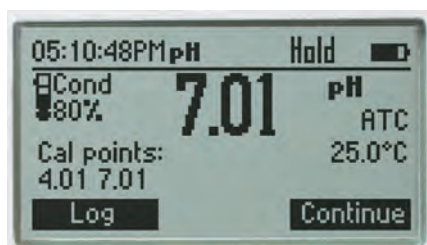

Auto Hold

Pressing AutoEnd during measurement will automatically hold the first stable reading on the display.



Dedicated Help Key

Contextual help is always available through a dedicated "HELP" key. Clear tutorial messages and directions are available on-screen to quickly and easily guide users through setup and calibration. The help information displayed is relative to the setting/option being viewed.



Setup Screen

Our extensive setup screen features a host of configurable options such as time, date, temperature units, and language for help screens and guides.



PC Connectivity

Logged data can be transferred to a Windows compatible PC with the included HI920015 micro USB cable and HI92000 software.

Long Battery Life

The display of the meter has a battery icon indicator to show the remaining power. The meter uses four 1.5V AA batteries that provide up to 200 hours of battery life.



Supplied Complete in a Rugged Custom Carrying Case

Each meter is supplied complete with sensor, calibration and cleaning solutions, beakers, PC software and connection cable, instruction manual, quick start guide, and batteries in a rugged, custom carrying case. The inside compartment of the carrying case is thermoformed to securely hold and protect all of the components.

Specifications	HI98161	
pH*	Range	-2.0 to 20.0 pH; -2.00 to 20.00 pH; -2.000 to 20.000 pH
	Resolution	0.1 pH; 0.01 pH; 0.001 pH
	Accuracy	±0.1 pH; ±0.01 pH; ±0.002 pH
	Calibration	up to five-point calibration, seven standard buffers available (1.68, 4.01, 6.86, 7.01, 9.18, 10.01, 12.45) and five custom buffers
	Temperature Compensation	automatic or manual from -20.0 to 120.0°C (-4.0 to 248.0°F)
mV	Range	±2000 mV
	Resolution	0.1 mV
	Accuracy	±0.2 mV
	Relative mV Offset Range	±2000 mV
Temperature*	Range	-20.0 to 120.0 °C (-4.0 to 248.0°F)
	Resolution	0.1°C (0.1°F)
	Accuracy	±0.4°C (±0.8°F) (excluding probe error)
Additional Specifications	pH Probe	FC2023 PVDF body, pH electrode with internal temperature sensor, quick DIN connector and 1 m (3.3' cable)
	Slope Calibration	from 80 to 110%
	Log-on-demand	Up to 200 samples (100 pH, 100 mV)
	PC Connection	opto-isolated USB with HI92000 software and micro USB cable
	Input Impedance	10 ¹² Ω
	Battery Type / Life	1.5V AA batteries (4) / approximately 200 hours of continuous use without backlight (50 hours with backlight)
	Auto-off	user selectable: 5, 10, 30, 60 min, disabled
	Environment	0 to 50°C (32 to 122°F); RH 100% IP67
	Dimensions / Weight	185 x 93 x 35.2 mm (7.3 x 3.6 x 1.4") / 400 g (14.2 oz.)
	Ordering Information	HI98161 is supplied with FC2023 pH electrode, HI7004M pH 4.01 buffer solution (230 mL), HI7007M pH 7.01 buffer solution (230 mL), HI700641 electrode cleaning solution sachet for dairy deposits (2), 100 mL plastic beaker (2), HI92000 PC software, HI920015 micro USB cable, 1.5V AA batteries (4), quality certificate, and instruction manual in a hard carrying case with custom insert.
Accessories	HI710035 blue protective rubber boot	

* Limits will be reduced to actual probe/sensor limits.



- **Optional shockproof silicon rubber boot**
- Specially designed to protect your instrument from damage or impact

HI710035 Blue

pH / Temperature Probe for Food

When measuring pH, food products can pose a number of challenges. Samples can vary in consistency from solid, semi-solid, to a slurry with a high content of solids. These sample types can coat the sensitive glass membrane surface and/or clog the reference junction. Designed specifically for measuring pH in food, the FC2023 has a conic tip shape for easy penetration, an open junction to resist clogging, and a PVDF food grade plastic body that can be cleaned with sodium hypochlorite. The FC2023 is an ideal general purpose pH electrode for use in food manufacturing.

PVDF body

Polyvinylidene fluoride (PVDF) is a food grade plastic that is resistant to most chemicals and solvents, including sodium hypochlorite. It has high abrasion resistance, mechanical strength, and resistance to ultraviolet and nuclear radiation. PVDF is also resistant to fungal growth.

Low temperature glass

The FC2023 electrode uses Low Temperature (LT) glass for the sensing bulb. The LT glass tip is a lower resistance glass formulation. As the temperature of the sensing glass decreases, the resistance of the LT glass will increase approaching that of standard glass at ambient temperatures. The FC2023 is suitable to use with samples that measure from 0 to 50°C.

Open junction reference

Clogging of the reference junction is a common challenge faced by food producers that measure pH in slurries and semi-solid products. The solids can easily clog the ceramic junction used with standard laboratory pH electrodes. The open junction design of the FC2023 resists clogging and continues to provide accurate, stable readings.

Viscolene electrolyte

The viscolene electrolyte offers a hard gel interface between the inner electrode components and the sample being measured. The electrolyte is silver-free for use in food products and is maintenance-free.

Conic tip shape

This design allows for penetration into semisolids and emulsions for the direct measurement of pH in a variety of food products including sauces, dough, and other semi-solids.

Built-in temperature sensor

A thermistor temperature sensor is in the tip of the indicating pH electrode. A temperature sensor should be as close as possible to the indicating pH bulb in order to compensate for variations in temperature.



Application Importance

One of the most common measurements of food products is pH because of how it affects food characteristics such as shelf stability, texture, and flavor. Foods are generally broken into two groups based on their pH value. These groups include acid foods which have a naturally low pH of 4.6 or below and low-acid foods that have a finished equilibrium pH value greater than pH 4.6 and a water activity greater than 0.85. The low-acid foods can be pH adjusted with the addition of an acid to lower the final pH and become an acidified food.

In food processing, some products require the measurement of pH to meet industry regulations to ensure the quality and safety of goods. A lower pH will help in preventing unwanted bacteria from growing thus extending the shelf life of a product. While food safety is a crucial consideration, understanding the pH of a food product can also help to achieve consistent flavors and textures. Through fermentation and other biological processes, many foodstuffs only achieve their desired qualities at particular pH values or ranges. pH is an essential parameter that requires close observation throughout food production to provide the best possible product.

Specifications	FC2023
Description	pre-amplified pH/temperature probe
Reference	single, Ag/AgCl
Junction	open
Electrolyte	viscolene
Max Pressure	0.1 bar
Range	pH: 0 to 12
Recommended Operating Temperature	0 to 50°C (32 to 122°F)
Glass Type	LT (low temperature)
Tip /Shape	conic (dia: 6 x 10 mm)
Temperature Sensor	yes
Amplifier	yes
Body Material	PVDF
Cable	coaxial; 1 m (3.3')
Connection	quick connect DIN

Foodcare

HI98162

pH / Temperature Meter for Milk

HI98162 is a professional portable pH and temperature meter with a probe designed specifically for pH measurement in milk.

- **Waterproof**
 - IP67 rated waterproof, rugged enclosure
- **CAL Check™**
 - Alerts users to problems during calibration including dirty/broken electrode, contaminated buffer, and overall probe condition
- **Automatic or manual temperature compensation**
 - pH sensors incorporate a built-in temperature sensor
- **Calibration**
 - Up to a five-point calibration with seven standard buffers and five custom buffers
- **Approximately 200 hour battery life**
 - Powered by four 1.5V AA batteries
- **Clear display**
 - Dot matrix display with multifunction virtual keys
- **Auto hold**
 - Automatically holds the first stable reading on the display
- **Calibration timeout**
 - Alerts when calibration is due at a specified interval
- **Connectivity**
 - PC connectivity via opto-isolated micro-USB with HI92000 software
- **GLP**
 - GLP data provides data from previous calibration to ensure Good Laboratory Practices are met
- **Intuitive keypad**
 - Important and often used functions such as GLP information, help, range, calibration, and backlight have a dedicated button
- **Supplied complete**
 - Each meter is supplied complete with sensor, calibration and cleaning solutions, beakers, PC software and connection cable, instruction manual, quick start guide, and batteries in a rugged, custom carrying case



Milk pH Meter

designed for food professionals

Hanna foodcare pH meters are rugged and portable with the performance and features of a benchtop. Eight models are available in this series to measure food, milk, meat, yogurt, cheese, beer, wine, and soil. Each model is supplied with an application specific electrode and cleaning solutions. These waterproof meters comply to IP67 standards and can be easily operated with one hand.



Backlit Graphic LCD Display

These meters feature a backlit graphic LCD with on-screen help. The graphic display allows for the use of virtual keys to provide for an intuitive user interface.

Waterproof Protection

The meter is enclosed in an IP67 rated waterproof casing and can withstand immersion in water at a depth of 1 m for up to 30 minutes.



Quick Connect Probe

Each meter features an application specific pH/temperature probe with a quick connect DIN connector to make attaching and removing the probe simple and easy.

Calibration Timeout

Alerts when calibration is due at a specified interval.

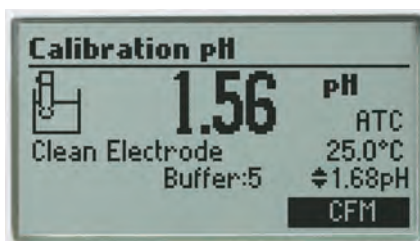

pH Calibration

Choose from seven standard pH buffers and five custom values to obtain up to five point calibration and achieve high precision readings with a 0.001 pH resolution and a pH accuracy of ± 0.002 .

Enhanced Calibration

An "out of calibration range" warning can be engaged to keep the user informed of the current calibration and help to avoid performing measurements that are out of the bracketed range.

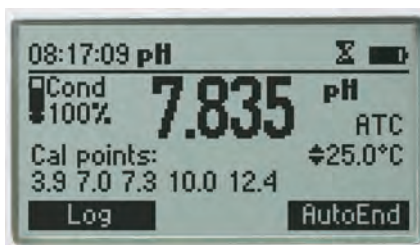

CAL Check™

Hanna's CAL Check maintains a history of past calibrations and monitors the pH electrode and buffers during subsequent calibrations for any signs of wide variances due to a dirty or broken electrode or contaminated pH buffers. During calibration, users are alerted to problems should they occur. After calibration, the electrode's overall condition is displayed as a percentage.



GLP

Comprehensive GLP functions are directly accessible by pressing the GLP key. Calibration data including date, time, and calibration values are stored with logged data for retrieval at a later time.



Data Logging

The log-on-demand feature allows users to store up to 200 samples that can later be transferred to a PC with the HI920015 USB cable and HI92000 software.

Automatic Temperature Compensation

pH sensors incorporate a built-in temperature sensor in the tip of the electrode for a fast and accurate temperature compensated value.

Intuitive Keypad

The fitted rubber keypad has dedicated keys for many important and often used functions. These meters also feature two virtual soft keys that navigate the user through setup and logging of data. The interface is intuitive for any user's level of experience.

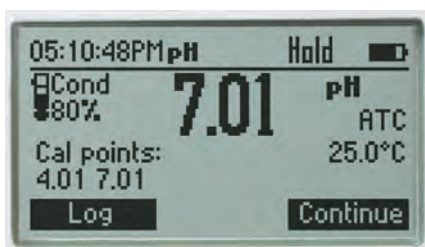

Auto Hold

Pressing AutoEnd during measurement will automatically hold the first stable reading on the display.



Dedicated Help Key

Contextual help is always available through a dedicated "HELP" key. Clear tutorial messages and directions are available on-screen to quickly and easily guide users through setup and calibration. The help information displayed is relative to the setting/option being viewed.



Setup Screen

Our extensive setup screen features a host of configurable options such as time, date, temperature units, and language for help screens and guides.



PC Connectivity

Logged data can be transferred to a Windows compatible PC with the included HI920015 micro USB cable and HI92000 software.

Long Battery Life

The display of the meter has a battery icon indicator to show the remaining power. The meter uses four 1.5V AA batteries that provide up to 200 hours of battery life.



Supplied Complete in a Rugged Custom Carrying Case

Each meter is supplied complete with sensor, calibration and cleaning solutions, beakers, PC software and connection cable, instruction manual, quick start guide, and batteries in a rugged, custom carrying case. The inside compartment of the carrying case is thermoformed to securely hold and protect all of the components.

Specifications	HI98162	
pH*	Range	-2.0 to 20.0 pH; -2.00 to 20.00 pH; -2.000 to 20.000 pH
	Resolution	0.1 pH; 0.01 pH; 0.001 pH
	Accuracy	±0.1 pH; ±0.01 pH; ±0.002 pH
	Calibration	up to five-point calibration, seven standard buffers available (1.68, 4.01, 6.86, 7.01, 9.18, 10.01, 12.45) and five custom buffers
	Temperature Compensation	automatic or manual from -20.0 to 120.0°C (-4.0 to 248.0°F)
mV	Range	±2000 mV
	Resolution	0.1 mV
	Accuracy	±0.2 mV
	Relative mV Offset Range	±2000 mV
Temperature*	Range	-20.0 to 120.0 °C (-4.0 to 248.0°F)
	Resolution	0.1°C (0.1°F)
	Accuracy	±0.4°C (±0.8°F) (excluding probe error)
Additional Specifications	pH Probe	FC1013 PVDF body, pH electrode with internal temperature sensor, quick DIN connector and 1 m (3.3' cable)
	Slope Calibration	from 80 to 110%
	Log-on-demand	Up to 200 samples (100 pH, 100 mV)
	PC Connection	opto-isolated USB with HI92000 software and micro USB cable
	Input Impedance	10 ¹² Ω
	Battery Type / Life	1.5V AA batteries (4) / approximately 200 hours of continuous use without backlight (50 hours with backlight)
	Auto-off	user selectable: 5, 10, 30, 60 min, disabled
	Environment	0 to 50°C (32 to 122°F); RH 100% IP67
	Dimensions / Weight	185 x 93 x 35.2 mm (7.3 x 3.6 x 1.4") / 400 g (14.2 oz.)
	Ordering Information	HI98162 is supplied with FC1013 pH electrode, HI7004M pH 4.01 buffer solution (230 mL), HI7007M pH 7.01 buffer solution (230 mL), HI700640 electrode cleaning solution sachet for milk deposits (2), 100 mL plastic beaker (2), HI92000 PC software, HI920015 micro USB cable, 1.5V AA batteries (4), quality certificate, and instruction manual in a hard carrying case with custom insert.
Accessories	HI710035 blue protective rubber boot	



- Optional shockproof silicon rubber boot
- Specially designed to protect your instrument from damage or impact

HI710035 Blue

* Limits will be reduced to actual probe/sensor limits.

pH / Temperature Probe for Milk

The FC1013 pH electrode has a built-in temperature sensor for simultaneous temperature compensated pH and temperature readings, and also contains a pH sensor preamplifier to provide measurements impervious to noise and electrical interferences.

FC1013 electrode is designed to prevent the typical problems of clogging in viscous and proteinaceous liquids ensuring a fast response and stable reading.

PVDF body

The FC1013 is composed of food grade PVDF plastic. This material is highly durable and chemically resistant.

General purpose glass

The FC1013 uses general purpose (GP) glass. The formulation allows for fast response over a wide range of temperatures. The FC1013 is suitable to use with samples that measure from 0 to 80°C.

Refillable electrolyte

The silver-free electrolyte ensures no silver precipitate can clog the junction. An easy to use fill cap allows for quick refilling of electrolyte solution to maintain adequate head pressure.

Single ceramic junction

A porous ceramic frit allows the silver-free electrolyte to flow slowly into solution, providing accurate readings for aqueous samples.

Spheric tip shape

The shape of the sensing membrane provides a large surface area for contact with milk samples. The highly durable construction provides accurate measurements on the dairy farm as well as the production facility.

Built-in temperature sensor

A thermistor temperature sensor is in the tip of the indicating pH bulb. A temperature sensor should be as close as possible to the indicating pH electrode in order to compensate for variations in temperature.



Specifications	FC1013
Description	pre-amplified pH/temperature probe
Reference	double, Ag/AgCl
Junction	ceramic, single
Electrolyte	KCl 3.5M
Max Pressure	0.1 bar
Range	pH: 0 to 13
Recommended Operating Temperature	0 to 80°C (32 to 176°F)
Glass Type	GP (general purpose)
Tip /Shape	spheric (dia: 7.5 mm)
Temperature Sensor	yes
Amplifier	yes
Body Material	PVDF
Cable	coaxial; 1 m (3.3')
Connection	quick connect DIN

Application Importance

The measurement of pH in milk is important in testing for impurities, spoilage, and signs of mastitis infection. While there are a number of factors that affect the composition of milk, pH measurements can help producers understand what might be causing certain compositional changes. pH measurements are commonly performed at various points in a milk processing plant.

Fresh milk has a pH value of 6.7. When the pH value of the milk falls below pH 6.7, it typically indicates spoilage by bacterial degradation. Bacteria from the family of Lactobacillaceae are lactic acid bacteria (LAB) responsible for the breakdown of the lactose in milk to form lactic acid. Eventually when the milk reaches an acidic enough pH, coagulation or curdling will occur along with the characteristic smell and taste of "sour" milk.

Milk with pH values higher than pH 6.7 potentially indicate that the milk may have come from cows infected with mastitis. Mastitis is an ever-present challenge with dairy milking cows. When infected, the cow's immune system releases histamine and other compounds in response to the infection. There is a resulting increase in permeability of endothelial and epithelial cell layers, allowing blood components to pass through a paracellular pathway. Since blood plasma is slightly alkaline, the resulting pH of milk will be higher than normal. Typically milk producers can perform a somatic cell count to detect a mastitis infection, but a pH measurement offers a quick way to screen for infection.

Understanding the pH of raw milk can also help producers optimize their processing techniques. For example, in operations that use Ultra High Temperature (UHT) processing, even small variations from pH 6.7 can affect the time required for pasteurization and the stability of the milk after treatment.

Foodcare

HI98163

pH / Temperature Meter for Meat

HI98163 is a professional portable pH and temperature meter with a probe designed specifically for pH measurement in meat.

- **Waterproof**
 - IP67 rated waterproof, rugged enclosure
- **CAL Check™**
 - Alerts users to problems during calibration including dirty/broken electrode, contaminated buffer, and overall probe condition
- **Automatic or manual temperature compensation**
 - pH sensors incorporate a built-in temperature sensor
- **Calibration**
 - Up to a five-point calibration with seven standard buffers and five custom buffers
- **Approximately 200 hour battery life**
 - Powered by four 1.5V AA batteries
- **Clear display**
 - Dot matrix display with multifunction virtual keys
- **Auto hold**
 - Automatically holds the first stable reading on the display
- **Calibration timeout**
 - Alerts when calibration is due at a specified interval
- **Connectivity**
 - PC connectivity via opto-isolated micro-USB with HI92000 software
- **GLP**
 - GLP data provides data from previous calibration to ensure Good Laboratory Practices are met
- **Intuitive keypad**
 - Important and often used functions such as GLP information, help, range, calibration, and backlight have a dedicated button
- **Supplied complete**
 - Each meter is supplied complete with sensor, calibration and cleaning solutions, beakers, PC software and connection cable, instruction manual, quick start guide, and batteries in a rugged, custom carrying case



Meat pH Meter

designed for food professionals

Hanna foodcare pH meters are rugged and portable with the performance and features of a benchtop. Eight models are available in this series to measure food, milk, meat, yogurt, cheese, beer, wine, and soil. Each model is supplied with an application specific electrode and cleaning solutions. These waterproof meters comply to IP67 standards and can be easily operated with one hand.



Backlit Graphic LCD Display

These meters feature a backlit graphic LCD with on-screen help. The graphic display allows for the use of virtual keys to provide for an intuitive user interface.

Waterproof Protection

The meter is enclosed in an IP67 rated waterproof casing and can withstand immersion in water at a depth of 1 m for up to 30 minutes.



Quick Connect Probe

Each meter features an application specific pH/temperature probe with a quick connect DIN connector to make attaching and removing the probe simple and easy.

Calibration Timeout

Alerts when calibration is due at a specified interval.

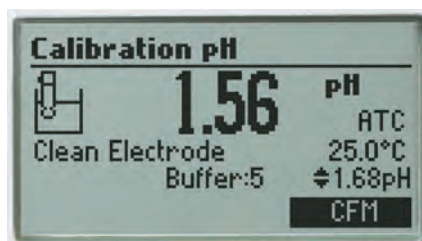

pH Calibration

Choose from seven standard pH buffers and five custom values to obtain up to five point calibration and achieve high precision readings with a 0.001 pH resolution and a pH accuracy of ± 0.002 .

Enhanced Calibration

An "out of calibration range" warning can be engaged to keep the user informed of the current calibration and help to avoid performing measurements that are out of the bracketed range.

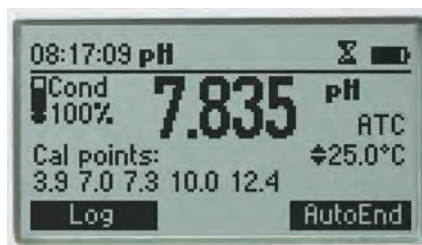

CAL Check™

Hanna's CAL Check maintains a history of past calibrations and monitors the pH electrode and buffers during subsequent calibrations for any signs of wide variances due to a dirty or broken electrode or contaminated pH buffers. During calibration, users are alerted to problems should they occur. After calibration, the electrode's overall condition is displayed as a percentage.



GLP

Comprehensive GLP functions are directly accessible by pressing the GLP key. Calibration data including date, time, and calibration values are stored with logged data for retrieval at a later time.



Data Logging

The log-on-demand feature allows users to store up to 200 samples that can later be transferred to a PC with the HI920015 USB cable and HI92000 software.

Automatic Temperature Compensation

pH sensors incorporate a built-in temperature sensor in the tip of the electrode for a fast and accurate temperature compensated value.

Intuitive Keypad

The fitted rubber keypad has dedicated keys for many important and often used functions. These meters also feature two virtual soft keys that navigate the user through setup and logging of data. The interface is intuitive for any user's level of experience.

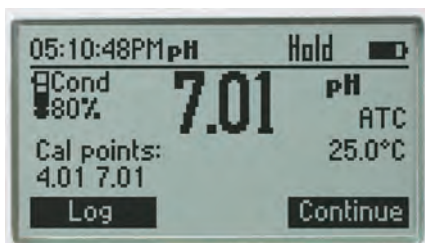

Auto Hold

Pressing AutoEnd during measurement will automatically hold the first stable reading on the display.



Dedicated Help Key

Contextual help is always available through a dedicated "HELP" key. Clear tutorial messages and directions are available on-screen to quickly and easily guide users through setup and calibration. The help information displayed is relative to the setting/option being viewed.



Setup Screen

Our extensive setup screen features a host of configurable options such as time, date, temperature unit, and language for help screens and guides.



PC Connectivity

Logged data can be transferred to a Windows compatible PC with the included HI920015 micro USB cable and HI92000 software.

Long Battery Life

The display of the meter has a battery icon indicator to show the remaining power. The meter uses four 1.5V AA batteries that provide up to 200 hours of battery life.



Supplied Complete in a Rugged Custom Carrying Case

Each meter is supplied complete with sensor, calibration and cleaning solutions, beakers, PC software and connection cable, instruction manual, quick start guide, and batteries in a rugged, custom carrying case. The inside compartment of the carrying case is thermoformed to securely hold and protect all of the components.

Specifications	HI98163	
pH*	Range	-2.0 to 20.0 pH; -2.00 to 20.00 pH; -2.000 to 20.000 pH
	Resolution	0.1 pH; 0.01 pH; 0.001 pH
	Accuracy	±0.1 pH; ±0.01 pH; ±0.002 pH
	Calibration	up to five-point calibration, seven standard buffers available (1.68, 4.01, 6.86, 7.01, 9.18, 10.01, 12.45) and five custom buffers
	Temperature Compensation	automatic or manual from -20.0 to 120.0°C (-4.0 to 248.0°F)
mV	Range	±2000 mV
	Resolution	0.1 mV
	Accuracy	±0.2 mV
	Relative mV Offset Range	±2000 mV
Temperature*	Range	-20.0 to 120.0°C (-4.0 to 248.0°F)
	Resolution	0.1°C (0.1°F)
	Accuracy	±0.4°C (±0.8°F) (excluding probe error)
Additional Specifications	pH Probe	FC2323 PVDF body, pH electrode with internal temperature sensor, quick DIN connector and 1 m (3.3' cable)
	Slope Calibration	from 80 to 110%
	Log-on-demand	Up to 200 samples (100 pH, 100 mV)
	PC Connection	opto-isolated USB with HI92000 software and micro USB cable
	Input Impedance	10 ¹² Ω
	Battery Type / Life	1.5V AA batteries (4) / approximately 200 hours of continuous use without backlight (50 hours with backlight)
	Auto-off	user selectable: 5, 10, 30, 60 min, disabled
	Environment	0 to 50°C (32 to 122°F); RH 100% IP67
	Dimensions / Weight	185 x 93 x 35.2 mm (7.3 x 3.6 x 1.4") / 400 g (14.2 oz.)
	Ordering Information	HI98163 is supplied with FC2323 pH electrode, FC099 meat piercing stainless steel blade, HI7004M pH 4.01 buffer solution (230 mL), HI7007M pH 7.01 buffer solution (230 mL), HI700630 electrode acid cleaning solution sachet for meat grease and fat deposits (2), 100 mL plastic beaker (2), HI92000 PC software, HI920015 micro USB cable, 1.5V AA batteries (4), quality certificate, and instruction manual in a hard carrying case with custom insert.
Accessories	HI710035 blue protective rubber boot	



- Optional shockproof silicon rubber boot
- Specially designed to protect your instrument from damage or impact

HI710035 Blue

* Limits will be reduced to actual probe/sensor limits.

pH / Temperature Probe for Meat

The FC2323 probe has been specially designed with a stainless steel blade tip for meat penetration.

PVDF body

Polyvinylidene fluoride (PVDF) is a food grade plastic that is resistant to most chemicals and solvents, including sodium hypochlorite. It has high abrasion resistance, mechanical strength, and resistance to ultraviolet and nuclear radiation. PVDF is also resistant to fungal growth.

Viscolene electrolyte

The viscolene electrolyte offers a hard gel interface between the inner electrode components and the sample being measured. The electrolyte is silver-free for use in food products and is maintenance-free.

Stainless steel piercing blade

The FC099 (35mm; 1.38") stainless steel blade can be attached to the probe for easy meat penetration. Piercing into the meat will allow for the pH glass and reference junction to be in contact with the sample for a direct pH measurement without extensive sample preparation.

Open junction reference

Clogging of the reference junction is a common challenge faced by food producers that measure pH in semi-solid products such as meat. The solids can easily clog the ceramic junction used with standard laboratory pH electrodes. The open junction design of the FC2323 resists clogging and continues to provide accurate, stable readings.

Low temperature glass

The FC2323 electrode uses Low Temperature (LT) glass for the sensing bulb. The LT glass tip is a lower resistance glass formulation. As the temperature of the sensing glass decreases, the resistance of the LT glass will increase approaching that of standard glass at ambient temperatures. The FC2023 is suitable to use with samples that measure from 0 to 50°C.

Built-in temperature sensor

A thermistor temperature sensor is in the tip of the indicating pH electrode. A temperature sensor should be as close as possible to the indicating pH bulb in order to compensate for variations in temperature.

Conic tip shape

This design along with a piercing blade allows for the easy penetration into semisolids for the direct measurement of pH.



Application Importance

In the meat production industry, the monitoring of pH is considered to be of the utmost importance due to its effect on the meat's quality factors including water binding capacity and shelf life. Upon slaughter, biochemical processes begin to break down the meat. Glycolysis begins post-mortem, converting glycogen to lactic acid, reducing the pH of the carcass. Depending on a number of factors such as type of animal and even breed, this decrease in pH can take anywhere from a single hour to many. It is vital to monitor pH during this phase as once the lowest pH value is reached, the pH will begin to slowly rise, indicating that decomposition has begun.

The pH value of meat influences its' water binding capacity which directly impacts consumer qualities such as tenderness and color. Lower pH values result in a lower water-binding capacity and lighter colors. Factors such as these can be important when considering how to efficiently produce meat products. For example, when producing dry sausages the meat must have a low water binding capacity so that it can dry evenly.

Depending on the type of the final product and the steps required to get there, pH values will vary throughout the meat processing industry. It is imperative, regardless of the final product, that pH be maintained at a low value to prevent bacterial spoilage and comply with food safety regulations. By monitoring pH values throughout the meat production process, you can ensure the creation of consistent and safe meat products.

Specifications	FC2323
Description	pre-amplified pH/temperature probe
Reference	single, Ag/AgCl
Junction	open
Electrolyte	viscolene
Max Pressure	0.1 bar
Range	pH: 0 to 12
Recommended Operating Temperature	0 to 50°C (32 to 122°F)
Glass Type	LT (low temperature)
Tip /Shape	conic (dia: 6 x 10 mm)
Temperature Sensor	yes
Amplifier	yes
Body Material	PVDF
Cable	coaxial; 1 m (3.3')
Connection	quick connect DIN

HI98164

pH / Temperature Meter for Yogurt

HI98164 is a professional portable pH and temperature meter with a probe designed specifically for pH measurement in yogurt.

- **Waterproof**
 - IP67 rated waterproof, rugged enclosure
- **CAL Check™**
 - Alerts users to problems during calibration including dirty/broken electrode, contaminated buffer, and overall probe condition
- **Automatic or manual temperature compensation**
 - pH sensors incorporate a built-in temperature sensor
- **Calibration**
 - Up to a five-point calibration with seven standard buffers and five custom buffers
- **Approximately 200 hour battery life**
 - Powered by four 1.5V AA batteries
- **Clear display**
 - Dot matrix display with multifunction virtual keys
- **Auto hold**
 - Automatically holds the first stable reading on the display
- **Calibration timeout**
 - Alerts when calibration is due at a specified interval
- **Connectivity**
 - PC connectivity via opto-isolated micro-USB with HI92000 software
- **GLP**
 - GLP data provides data from previous calibration to ensure Good Laboratory Practices are met
- **Intuitive keypad**
 - Important and often used functions such as GLP information, help, range, calibration, and backlight have a dedicated button
- **Supplied complete**
 - Each meter is supplied complete with sensor, calibration and cleaning solutions, beakers, PC software and connection cable, instruction manual, quick start guide, and batteries in a rugged, custom carrying case



Yogurt pH Meter

designed for food professionals

Hanna foodcare pH meters are rugged and portable with the performance and features of a benchtop. Eight models are available in this series to measure food, milk, meat, yogurt, cheese, beer, wine, and soil. Each model is supplied with an application specific electrode and cleaning solutions. These waterproof meters comply to IP67 standards and can be easily operated with one hand.



Backlit Graphic LCD Display

These meters feature a backlit graphic LCD with on-screen help. The graphic display allows for the use of virtual keys to provide for an intuitive user interface.

Waterproof Protection

The meter is enclosed in an IP67 rated waterproof casing and can withstand immersion in water at a depth of 1 m for up to 30 minutes.



Quick Connect Probe

Each meter features an application specific pH/temperature probe with a quick connect DIN connector to make attaching and removing the probe simple and easy.

Calibration Timeout

Alerts when calibration is due at a specified interval.

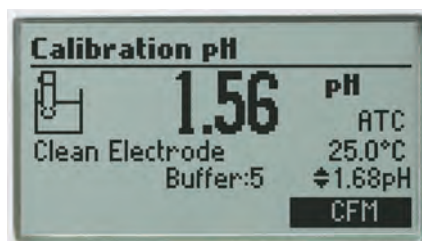

pH Calibration

Choose from seven standard pH buffers and five custom values to obtain up to five point calibration and achieve high precision readings with a 0.001 pH resolution and a pH accuracy of ± 0.002 .

Enhanced Calibration

An "out of calibration range" warning can be engaged to keep the user informed of the current calibration and help to avoid performing measurements that are out of the bracketed range.



CAL Check™

Hanna's CAL Check maintains a history of past calibrations and monitors the pH electrode and buffers during subsequent calibrations for any signs of wide variances due to a dirty or broken electrode or contaminated pH buffers. During calibration, users are alerted to problems should they occur. After calibration, the electrode's overall condition is displayed as a percentage.



GLP

Comprehensive GLP functions are directly accessible by pressing the GLP key. Calibration data, including date, time, and calibration values are stored with logged data for retrieval at a later time.

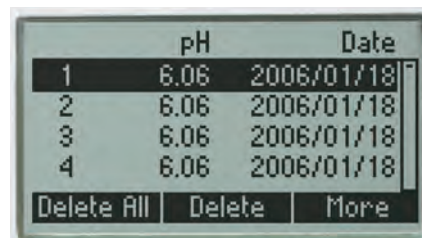

Data Logging

The log-on-demand feature allows users to store up to 200 samples that can later be transferred to a PC with the HI920015 USB cable and HI92000 software.

Automatic Temperature Compensation

pH sensors incorporate a built-in temperature sensor in the tip of the electrode for a fast and accurate temperature compensated value.

Intuitive Keypad

The fitted rubber keypad has dedicated keys for many important and often used functions. These meters also feature two virtual soft keys that navigate the user through setup and logging of data. The interface is intuitive for any user's level of experience.

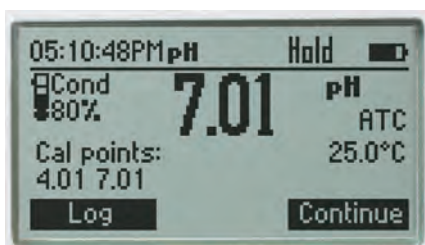

Auto Hold

Pressing AutoEnd during measurement will automatically hold the first stable reading on the display.



Dedicated Help Key

Contextual help is always available through a dedicated "HELP" key. Clear tutorial messages and directions are available on-screen to quickly and easily guide users through setup and calibration. The help information displayed is relative to the setting/option being viewed.



Setup Screen

Our extensive setup screen features a host of configurable options such as time, date, temperature units, and language for help screens and guides.



PC Connectivity

Logged data can be transferred to a Windows compatible PC with the included HI920015 micro USB cable and HI92000 software.

Long Battery Life

The display of the meter has a battery icon indicator to show the remaining power. The meter uses four 1.5V AA batteries that provide up to 200 hours of battery life.



Supplied Complete in a Rugged Custom Carrying Case

Each meter is supplied complete with sensor, calibration and cleaning solutions, beakers, PC software and connection cable, instruction manual, quick start guide, and batteries in a rugged, custom carrying case. The inside compartment of the carrying case is thermoformed to securely hold and protect all of the components.

Specifications	HI98164	
pH*	Range	-2.0 to 20.0 pH; -2.00 to 20.00 pH; -2.000 to 20.000 pH
	Resolution	0.1 pH; 0.01 pH; 0.001 pH
	Accuracy	±0.1 pH; ±0.01 pH; ±0.002 pH
	Calibration	up to five-point calibration, seven standard buffers available (1.68, 4.01, 6.86, 7.01, 9.18, 10.01, 12.45) and five custom buffers
	Temperature Compensation	automatic or manual from -20.0 to 120.0°C (-4.0 to 248.0°F)
mV	Range	±2000 mV
	Resolution	0.1 mV
	Accuracy	±0.2 mV
	Relative mV Offset Range	±2000 mV
Temperature*	Range	-20.0 to 120.0°C (-4.0 to 248.0°F)
	Resolution	0.1°C (0.1°F)
	Accuracy	±0.4°C (±0.8°F) (excluding probe error)
Additional Specifications	pH Probe	FC2133 glass body, pH electrode with internal temperature sensor, quick DIN connector and 1 m (3.3' cable)
	Slope Calibration	from 80 to 110%
	Log-on-demand	Up to 200 samples (100 pH, 100 mV)
	PC Connection	opto-isolated USB with HI92000 software and micro USB cable
	Input Impedance	10 ¹² Ω
	Battery Type / Life	1.5V AA batteries (4) / approximately 200 hours of continuous use without backlight (50 hours with backlight)
	Auto-off	user selectable: 5, 10, 30, 60 min, disabled
	Environment	0 to 50°C (32 to 122°F); RH 100% IP67
	Dimensions / Weight	185 x 93 x 35.2 mm (7.3 x 3.6 x 1.4") / 400 g (14.2 oz.)
	Ordering Information	HI98164 is supplied with FC2133 pH electrode, HI7004M pH 4.01 buffer solution (230 mL), HI7007M pH 7.01 buffer solution (230 mL), HI700643 electrode cleaning and disinfection solution sachet for yogurt products (2), 100 mL plastic beaker (2), HI92000 PC software, HI920015 micro USB cable, 1.5V AA batteries (4), quality certificate, and instruction manual in a hard carrying case with custom insert.
Accessories	HI710035 blue protective rubber boot	



- Optional shockproof silicon rubber boot
- Specially designed to protect your instrument from damage or impact

HI710035 Blue

* Limits will be reduced to actual probe/sensor limits.

pH / Temperature Probe for Yogurt

The FC2133 pH electrode is rugged and easy to clean with a conical tip and built-in temperature sensor. The open junction design consists of a solid gel interface (viscolene) between the sample and internal Ag/AgCl reference. This interface not only prevents silver from entering the sample, but also makes it impermeable to clogging after measurements in semi-solid or viscous samples. The FC2133 electrode is designed to prevent the typical problems of clogging in viscous liquids, ensuring a fast response and stable reading.

Glass body

The glass body of the FC2133 allows standards and samples to more quickly reach thermal equilibrium while also providing chemical resistance.

Low temperature glass

The FC2133 electrode uses Low Temperature (LT) glass for the sensing bulb. The LT glass tip is a lower resistance glass formulation. As the temperature of the sensing glass decreases, the resistance of the LT glass will increase approaching that of standard glass at ambient temperatures. The FC2133 is suitable to use with samples that measure from 0 to 50°C.

Viscolene electrolyte

The viscolene electrolyte offers a hard gel interface between the inner electrode components and the sample being measured. The electrolyte is silver-free for use in yogurt and is maintenance-free.

Open junction reference

Clogging of the reference junction is a common challenge faced by yogurt producers as the milk solids and proteins can easily build up on the electrode. The open junction design of the FC2133 resists clogging and continues to provide accurate, stable readings.

Conic tip shape

This design allows for penetration into semisolids and emulsions for the direct measurement of pH in yogurt products.

Built-in temperature sensor

A thermistor temperature sensor is in the tip of the indicating pH electrode. A temperature sensor should be as close as possible to the indicating pH bulb in order to compensate for variations in temperature.



Specifications	FC2133
Description	pre-amplified pH / temperature probe
Reference	double, Ag/AgCl
Junction	open
Electrolyte	viscolene
Max Pressure	0.1 bar
Range	pH: 0 to 12
Recommended Operating Temperature	0 to 50°C (32 to 122°F)
Glass Type	LT (low temperature)
Tip /Shape	conic
Temperature Sensor	yes
Amplifier	yes
Body Material	glass
Cable	coaxial; 1 m (3.3')
Connection	quick connect DIN

Application Importance

Monitoring pH is crucial in producing consistent, quality yogurt. Yogurt is made by the fermentation of milk with live bacterial cultures. Following pasteurization and compositional adjustment, milk is homogenized for a consistent texture, heated to the desired thickness, and cooled before inoculation. Most yogurt is inoculated with a starter culture consisting of *Lactobacillus bulgaricus* and *Streptococcus thermophilus*. Once the live culture is added, the mixture of milk and bacteria is incubated, allowing for fermentation of lactose to lactic acid. As lactic acid is produced, there is a correlating drop in pH. Due to the more acidic mixture, the casein protein in milk coagulates and precipitates out, thickening the milk into a yogurt-like texture.

Yogurt producers cease incubation once a specific pH level is reached. Most producers have a set point between pH 4.0 and 4.6 in which fermentation is stopped by rapid cooling. The amount of lactic acid present at this pH level is ideal for yogurt, giving it the characteristic tartness, aiding in thickening, and acting as a preservative against undesirable strains of bacteria.

By verifying that fermentation continues to a predetermined pH endpoint, yogurt producers can ensure their products remain consistent in terms of flavor, aroma, and texture. A deviation from the predetermined pH can lead to a reduced shelf life of yogurt or create a product that is too bitter or tart. Syneresis is the separation of liquid, in this case whey, from the milk solids; this can occur if fermentation is stopped too early or too late, resulting in yogurt that is respectively too alkaline or too acidic. Consumers expect yogurt to remain texturally consistent, so ensuring fermentation is stopped at the appropriate pH is vital to consumer perception.

Foodcare

HI98165

pH / Temperature Meter for Cheese

HI98165 is a professional portable pH and temperature meter with a probe designed specifically for pH measurement in cheese.

- **Waterproof**
 - IP67 rated waterproof, rugged enclosure
- **CAL Check™**
 - Alerts users to problems during calibration including dirty/broken electrode, contaminated buffer, and overall probe condition
- **Automatic or manual temperature compensation**
 - pH sensors incorporate a built-in temperature sensor
- **Calibration**
 - Up to a five-point calibration with seven standard buffers and five custom buffers
- **Approximately 200 hour battery life**
 - Powered by four 1.5V AA batteries
- **Clear display**
 - Dot matrix display with multifunction virtual keys
- **Auto hold**
 - Automatically holds the first stable reading on the display
- **Calibration timeout**
 - Alerts when calibration is due at a specified interval
- **Connectivity**
 - PC connectivity via opto-isolated micro-USB with HI92000 software
- **GLP**
 - GLP data provides data from previous calibration to ensure Good Laboratory Practices are met
- **Intuitive keypad**
 - Important and often used functions such as GLP information, help, range, calibration, and backlight have a dedicated button
- **Supplied complete**
 - Each meter is supplied complete with sensor, calibration and cleaning solutions, beakers, PC software and connection cable, instruction manual, quick start guide, and batteries in a rugged, custom carrying case



pH

portable

Cheese pH Meter

designed for food professionals

Hanna foodcare pH meters are rugged and portable with the performance and features of a benchtop. Eight models are available in this series to measure food, milk, meat, yogurt, cheese, beer, wine, and soil. Each model is supplied with an application specific electrode and cleaning solutions. These waterproof meters comply to IP67 standards and can be easily operated with one hand.



Backlit Graphic LCD Display

These meters feature a backlit graphic LCD with on-screen help. The graphic display allows for the use of virtual keys to provide for an intuitive user interface.

Waterproof Protection

The meter is enclosed in an IP67 rated waterproof casing and can withstand immersion in water at a depth of 1 m for up to 30 minutes.



Quick Connect Probe

Each meter features an application specific pH/temperature probe with a quick connect DIN connector to make attaching and removing the probe simple and easy.

Calibration Timeout

Alerts when calibration is due at a specified interval.

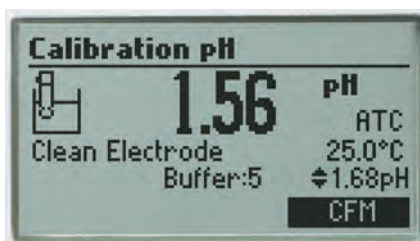

pH Calibration

Choose from seven standard pH buffers and five custom values to obtain up to five point calibration and achieve high precision readings with a 0.001 pH resolution and a pH accuracy of ± 0.002 .

Enhanced Calibration

An "out of calibration range" warning can be engaged to keep the user informed of the current calibration and help to avoid performing measurements that are out of the bracketed range.

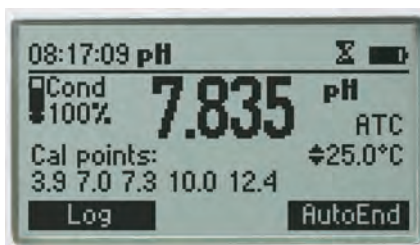

CAL Check™

Hanna's CAL Check maintains a history of past calibrations and monitors the pH electrode and buffers during subsequent calibrations for any signs of wide variances due to a dirty or broken electrode or contaminated pH buffers. During calibration, users are alerted to problems should they occur. After calibration, the electrode's overall condition is displayed as a percentage.



GLP

Comprehensive GLP functions are directly accessible by pressing the GLP key. Calibration data, including date, time, and calibration values are stored with logged data for retrieval at a later time.



Data Logging

The log-on-demand feature allows users to store up to 200 samples that can later be transferred to a PC with the HI920015 USB cable and HI92000 software.

Automatic Temperature Compensation

pH sensors incorporate a built-in temperature sensor in the tip of the electrode for a fast and accurate temperature compensated value.

Intuitive Keypad

The fitted rubber keypad has dedicated keys for many important and often used functions. These meters also feature two virtual soft keys that navigate the user through setup and logging of data. The interface is intuitive for any user's level of experience.

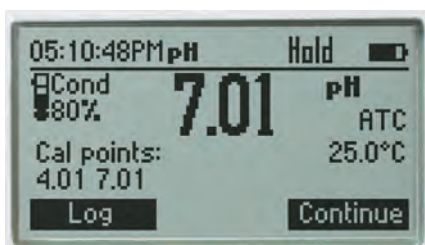

Auto Hold

Pressing AutoEnd during measurement will automatically hold the first stable reading on the display.



Dedicated Help Key

Contextual help is always available through a dedicated "HELP" key. Clear tutorial messages and directions are available on-screen to quickly and easily guide users through setup and calibration. The help information displayed is relative to the setting/opton being viewed.



Setup Screen

Our extensive setup screen features a host of configurable options such as time, date, temperature units, and language for help screens and guides.



PC Connectivity

Logged data can be transferred to a Windows compatible PC with the included HI920015 micro USB cable and HI92000 software.

Long Battery Life

The display of the meter has a battery icon indicator to show the remaining power. The meter uses four 1.5V AA batteries that provide up to 200 hours of battery life.



Supplied Complete in a Rugged Custom Carrying Case

Each meter is supplied complete with sensor, calibration and cleaning solutions, beakers, PC software and connection cable, instruction manual, quick start guide, and batteries in a rugged, custom carrying case. The inside compartment of the carrying case is thermoformed to securely hold and protect all of the components.

Specifications	HI98165	
pH*	Range	-2.0 to 20.0 pH; -2.00 to 20.00 pH; -2.000 to 20.000 pH
	Resolution	0.1 pH; 0.01 pH; 0.001 pH
	Accuracy	±0.1 pH; ±0.01 pH; ±0.002 pH
	Calibration	up to five-point calibration, seven standard buffers available (1.68, 4.01, 6.86, 7.01, 9.18, 10.01, 12.45) and five custom buffers
	Temperature Compensation	automatic or manual from -20.0 to 120.0°C (-4.0 to 248.0°F)
mV	Range	±2000 mV
	Resolution	0.1 mV
	Accuracy	±0.2 mV
	Relative mV Offset Range	±2000 mV
Temperature*	Range	-20.0 to 120.0 °C (-4.0 to 248.0°F)
	Resolution	0.1°C (0.1°F)
	Accuracy	±0.4°C (±0.8°F) (excluding probe error)
Additional Specifications	pH Probe	FC2423 pre-amplified pH and temperature probe with titanium sheath, pH electrode with internal temperature sensor, quick DIN connector and 1 m (3.3' cable)
	Slope Calibration	from 80 to 110%
	Log-on-demand	Up to 200 samples (100 pH, 100 mV)
	PC Connection	opto-isolated USB with HI92000 software and micro USB cable
	Input Impedance	10 ¹² Ω
	Battery Type / Life	1.5V AA batteries (4) / approximately 200 hours of continuous use without backlight (50 hours with backlight)
	Auto-off	user selectable: 5, 10, 30, 60 min, disabled
	Environment	0 to 50°C (32 to 122°F); RH 100% IP67
	Dimensions / Weight	185 x 93 x 35.2 mm (7.3 x 3.6 x 1.4") / 400 g (14.2 oz.)
	Ordering Information	HI98165 is supplied with FC2423 pH electrode, HI7004M pH 4.01 buffer solution (230 mL), HI7007M pH 7.01 buffer solution (230 mL), HI700642 electrode cleaning solution sachet for cheese residues (2), 100 mL plastic beaker (2), HI92000 PC software, HI920015 micro USB cable, 1.5V AA batteries (4), quality certificate, and instruction manual in a hard carrying case with custom insert.
Accessories	HI710035 blue protective rubber boot	
	HI720165 Replacement carrying case for HI98165	



- **Optional shockproof silicon rubber boot**
 - Specially designed to protect your instrument from damage or impact

HI710035 Blue

* Limits will be reduced to actual probe/sensor limits.

pH / Temperature Probe for Cheese

FC2423 electrode has a titanium sheath and conical tip to ensure quick, easy measurements, and fast response. FC2423 pH electrode features a built-in temperature sensor and is ideal for measurements in semi-solid samples such as cheeses.

Low temperature glass

The FC2423 electrode uses Low Temperature (LT) glass for the sensing bulb. The LT glass tip is a lower resistance glass formulation. As the temperature of the sensing glass decreases, the resistance of the LT glass will increase approaching that of standard glass at ambient temperatures. The FC2423 is suitable to use with samples that measure from 0 to 50°C.

Titanium body

The titanium body offers durability in the production facility and can withstand chloride concentrations that cause corrosion in other types of alloys.

Viscolene electrolyte

The viscolene electrolyte offers a hard gel interface between the inner electrode components and the sample being measured. The electrolyte is silver-free for use in cheese products and is maintenance-free.

Built-in temperature sensor

A thermistor temperature sensor is in the tip of the indicating pH electrode. A temperature sensor should be as close as possible to the indicating pH bulb in order to compensate for variations in temperature.

Conic tip shape

This design allows for penetration into solids, semi solids, and emulsions for the direct measurement of pH in cheese products.



Specifications	FC2423
Description	pre-amplified pH / temperature probe
Reference	single, Ag/AgCl
Junction	open
Electrolyte	viscolene
Max Pressure	0.1 bar
Range	pH: 0 to 12
Recommended Operating Temperature	0 to 50°C (32 to 122°F)
Glass Type	LT (low temperature)
Tip / Shape	conic
Temperature Sensor	yes
Amplifier	yes
Body Material	titanium
Cable	coaxial; 1 m (3.3')
Connection	quick connect DIN

Application Importance

pH is an essential measurement throughout the entire cheesemaking process. From the initial measurements of incoming milk to the final measurements of ripened cheese, pH is the most important parameter for cheese quality and safety control.

Acidification of milk begins with the addition of bacterial culture and rennet. The bacteria consume lactose and create lactic acid as a byproduct of fermentation, lowering the pH of the milk. Once the milk reaches a particular pH, the rennet is added. The enzymes in rennet help to speed up curdling and create a firmer substance. For cheesemakers that dilute their rennet, the pH of the dilution water is also critical; water that is near pH 7 or higher can deactivate the rennet, causing problems with coagulation.

Once the curds are cut, stirred, and cooked, the liquid whey must be drained. The pH of whey at draining directly affects the composition and texture of the final cheese product. Whey that has a relatively high pH contributes to higher levels of calcium and phosphate and results in a stronger curd. Typical pH levels at draining can vary depending on the type of cheese; for example, Swiss cheese is drained between pH 6.3 and 6.5 while Cheddar cheese is drained between pH 6.0 and 6.2.

The next stages of milling and salting are affected by pH as well. During milling, curds are cut into smaller pieces to prepare the cheese for salting. Curds with a lower pH at milling result in a harder cheese. A low pH will also result in higher salt absorption during the salting stage.

When curds are pressed into a final, solid form, the pH directly affects how well the curds fuse together. If the pH is too high during pressing, the curds will not bind together as well and the final cheese will have a more open texture.

During brining, the cheese soaks up salt from the brine solution and loses excess moisture. The pH of the brine solution should be close to the pH of the cheese, ensuring equilibrium of ions like calcium and hydrogen. If there is an imbalance during brining, the final product can have rind defects, discoloration, a weakened texture, and a shorter shelf life.

Cheeses must fall within a narrow pH range to provide an optimal environment for microbial and enzymatic processes that occur during ripening. Bacterial cultures used in ripening are responsible for characteristics like the holes in Swiss cheese, the white mold on Brie rinds, and the aroma of Limburger cheese. A deviation from the ideal pH is not only detrimental to the ecology of the bacteria, but also to the cheese structure. Higher pH levels can result in cheeses that are more elastic while lower pH levels can cause brittleness.

HI98167

pH / Temperature Meter for Beer

The HI98167 is a rugged, waterproof, portable pH meter that measures pH and temperature during the brewing process. This meter is supplied with a specialized titanium body pH electrode with a built in temperature sensor that is ideal for measuring the pH of mash, cooled wort, and of the finished product.

- **Waterproof**
 - IP67 rated waterproof, rugged enclosure
- **CAL Check™**
 - Alerts users to problems during calibration including dirty/broken electrode, contaminated buffer, and overall probe condition
- **Automatic or manual temperature compensation**
 - pH sensors incorporate a built-in temperature sensor
- **Calibration**
 - Up to a five-point calibration with seven standard buffers and five custom buffers
- **Approximately 200 hour battery life**
 - Powered by four 1.5V AA batteries
- **Clear display**
 - Dot matrix display with multifunction virtual keys
- **Auto hold**
 - Automatically holds the first stable reading on the display
- **Calibration timeout**
 - Alerts when calibration is due at a specified interval
- **Connectivity**
 - PC connectivity via opto-isolated micro-USB with HI92000 software
- **GLP**
 - GLP data provides data from previous calibration to ensure Good Laboratory Practices are met
- **Intuitive keypad**
 - Important and often used functions such as GLP information, help, range, calibration and backlight have a dedicated button
- **Supplied complete**
 - Each meter is supplied complete with sensor, calibration and cleaning solutions, beakers, PC software and connection cable, instruction manual, quick start guide, and batteries in a rugged, custom carrying case



pH

portable

Beer pH Meter

designed for beer making professionals

Hanna foocare pH meters are rugged and portable with the performance and features of a benchtop. Eight models are available in this series to measure food, milk, meat, yogurt, cheese, beer, wine, and soil. Each model is supplied with an application specific electrode and cleaning solutions. These waterproof meters comply to IP67 standards and can be easily operated with one hand.



Backlit Graphic LCD Display

These meters feature a backlit graphic LCD with on-screen help. The graphic display allows for the use of virtual keys to provide for an intuitive user interface.

Waterproof Protection

The meter is enclosed in an IP67 rated waterproof casing and can withstand immersion in water at a depth of 1 m for up to 30 minutes.



Quick Connect Probe

Each meter features an application specific pH/temperature probe with a quick connect DIN connector to make attaching and removing the probe simple and easy.

Calibration Timeout

Alerts when calibration is due at a specified interval.

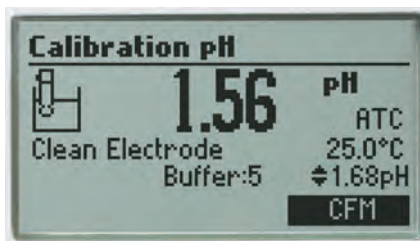

pH Calibration

Choose from seven standard pH buffers and five custom values to obtain up to five point calibration and achieve high precision readings with a 0.001 pH resolution and a pH accuracy of ± 0.002 .

Enhanced Calibration

An "out of calibration range" warning can be engaged to keep the user informed of the current calibration and help to avoid performing measurements that are out of the bracketed range.

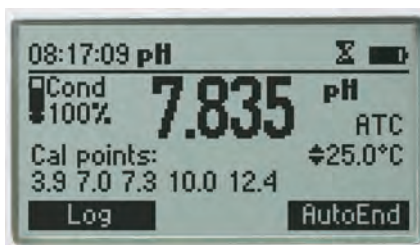

CAL Check™

Hanna's CAL Check maintains a history of past calibrations and monitors the pH electrode and buffers during subsequent calibrations for any signs of wide variances due to a dirty or broken electrode or contaminated pH buffers. During calibration, users are alerted to problems should they occur. After calibration, the electrode's overall condition is displayed as a percentage.

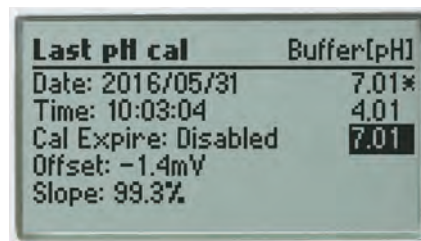

GLP

Comprehensive GLP functions are directly accessible by pressing the GLP key. Calibration data, including date, time, and calibration values are stored with logged data for retrieval at a later time.



Data Logging

The log-on-demand feature allows users to store up to 200 samples that can later be transferred to a PC with the HI920015 USB cable and HI92000 software.

Automatic Temperature Compensation

pH sensors incorporate a built-in temperature sensor in the tip of the electrode for a fast and accurate temperature compensated value.

Intuitive Keypad

The fitted rubber keypad has dedicated keys for many important and often used functions. These meters also feature two virtual soft keys that navigate the user through setup and logging of data. The interface is intuitive for any user's level of experience.

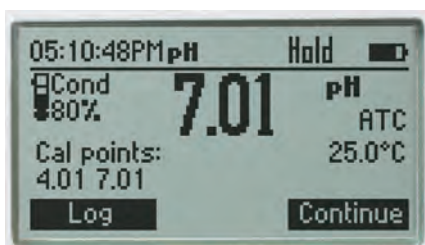

Auto Hold

Pressing AutoEnd during measurement will automatically hold the first stable reading on the display.



Dedicated Help Key

Contextual help is always available through a dedicated "HELP" key. Clear tutorial messages and directions are available on-screen to quickly and easily guide users through setup and calibration. The help information displayed is relative to the setting/option being viewed.



Setup Screen

Our extensive setup screen features a host of configurable options such as time, date, temperature units, and language for help screens and guides.



PC Connectivity

Logged data can be transferred to a Windows compatible PC with the included HI920015 micro USB cable and HI92000 software.

Long Battery Life

The display of the meter has a battery icon indicator to show the remaining power. The meter uses four 1.5V AA batteries that provide up to 200 hours of battery life.



Supplied Complete in a Rugged Custom Carrying Case

Each meter is supplied complete with sensor, calibration and cleaning solutions, beakers, PC software and connection cable, instruction manual, quick start guide, and batteries in a rugged, custom carrying case. The inside compartment of the carrying case is thermoformed to securely hold and protect all of the components.

Specifications	HI98167	
pH*	Range	-2.0 to 20.0 pH; -2.00 to 20.00 pH; -2.000 to 20.000 pH
	Resolution	0.1 pH; 0.01 pH; 0.001 pH
	Accuracy	±0.1 pH; ±0.01 pH; ±0.002 pH
	Calibration	up to five-point calibration, seven standard buffers available (1.68, 4.01, 6.86, 7.01, 9.18, 10.01, 12.45) and five custom buffers
	Temperature Compensation	automatic or manual from -20.0 to 120.0°C (-4.0 to 248.0°F)
mV	Range	±2000 mV
	Resolution	0.1 mV
	Accuracy	±0.2 mV
	Relative mV Offset Range	±2000 mV
Temperature*	Range	-20.0 to 120.0 °C (-4.0 to 248.0°F)
	Resolution	0.1°C (0.1°F)
	Accuracy	±0.4°C (±0.8°F) (excluding probe error)
Additional Specifications	pH Probe	FC2143 Titanium body, flat tip, preamplified pH electrode with internal temperature sensor, quick DIN connector and 1 m (3.3' cable)
	Slope Calibration	from 80 to 110%
	Log-on-demand	Up to 200 samples (100 pH, 100 mV)
	PC Connection	opto-isolated USB with HI92000 software and micro USB cable
	Input Impedance	10 ¹² Ω
	Battery Type / Life	1.5V AA batteries (4) / approximately 200 hours of continuous use without backlight (50 hours with backlight)
	Auto-off	user selectable: 5, 10, 30, 60 min, disabled
	Environment	0 to 50°C (32 to 122°F); RH 100% IP67
	Dimensions / Weight	185 x 93 x 35.2 mm (7.3 x 3.6 x 1.4") / 400 g (14.2 oz.)
	Ordering Information	HI98167 is supplied with FC2143 pH electrode, HI7004M pH 4.01 buffer solution (230 mL), HI7007M pH 7.01 buffer solution (230 mL), HI700682 Electrode cleaning solution sachets for brewing deposits (2), 100 mL plastic beaker (2), HI92000 PC software, HI920015 micro USB cable, 1.5V AA batteries (4), instruction manual, and quality certificate in a HI720161 hard carrying case with custom insert.
Accessories	HI710035 blue protective rubber boot	



- Optional shockproof silicon rubber boot
- Specially designed to protect your instrument from damage or impact

HI710035 Blue

* Limits will be reduced to actual probe/sensor limits.

FC2143

pH / Temperature Probe for Beer

The FC2143 pH electrode is a flat tip pH sensor made with specialized glass to provide a long life when measuring temperatures up to 80°C. A built in temperature sensor compensates for temperature variations. The probe has a built in amplifier and a titanium body that acts as a matching pin to reduce noise as a result from the effect that humidity has on probe connection to the meter. The FC2143 connects to the HI98167 with a quick-connect, waterproof DIN connector, allowing for a secure, non-threaded attachment.

Titanium Body

A pH measurement is a very sensitive voltage measurement that is susceptible to interference. To reduce this susceptibility the titanium body serves as a matching pin. A matching pin is a differential measurement technique used to eliminate electrical noise in the measurement system.

Flat Tip pH Sensor

The flat tip sensor allows for easy cleaning of the pH sensing surface as solids from mash and cooled wort collect on the surface.

Quick Connect DIN Connector

This secure waterproof connector allows for a single cable to be used for both pH and temperature measurements.

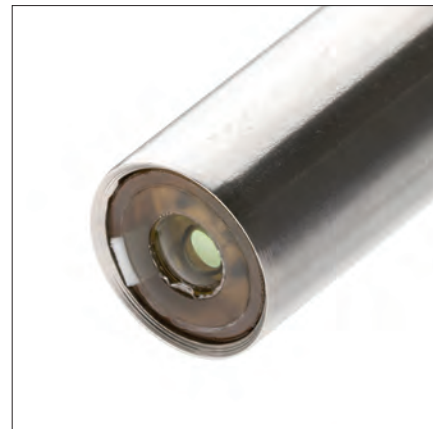

Application Importance

The measurement of pH during the beer making process is important due to the effect it has on enzymatic activity in the mash, yeast activity in fermentation, and the incorporation of flavoring components. Monitoring and controlling the pH allows for a consistent flavor profile and ensures a stable product. The brewer is faced with a number of challenges when measuring pH. The mash has a high content of semi-solids and sugars are formed from the conversion of starch by enzymatic activity. Both can pose problems, including coating the glass and clogging the junction. The mash and cooled wort after boiling are typically above room temperature, which leads to the degradation of the sensitive glass. To overcome these challenges the HI98167 beer pH meter is supplied with a uniquely design titanium body pH electrode.

Specifications	FC2143
Description	pH electrode
Reference	single, Ag/AgCl
Junction	cloth
Electrolyte	gel
Max Pressure	3 bar
Range	pH: 0 to 12
Recommended Operating Temperature	0 to 80°C (32 to 176°F)
Glass Type	LT (low temperature)
Tip /Shape	flat
Temperature Sensor	yes
Amplifier	yes
Body Material	titanium with HT glass sensor
Cable	coaxial; 1 m (3.3')
Connection	quick connect DIN

Foodcare

HI98169

pH / Temperature Meter for Wine

HI98169 is a rugged, waterproof, portable pH meter that measures pH and temperature of must in winemaking. This meter is supplied with a specialized pH probe that features an open junction with Clogging Prevention System (CPS™) technology.

- **Waterproof**
 - IP67 rated waterproof, rugged enclosure
- **CAL Check™**
 - Alerts users to problems during calibration including dirty/broken electrode, contaminated buffer and overall probe condition
- **Automatic or manual temperature compensation**
 - pH sensors incorporate a built-in temperature sensor
- **Calibration**
 - Up to a five-point calibration with seven standard buffers and five custom buffers
- **Approximately 200 hour battery life**
 - Powered by four 1.5V AA batteries
- **Clear display**
 - Dot matrix display with multifunction virtual keys
- **Auto hold**
 - Automatically holds the first stable reading on the display
- **Calibration timeout**
 - Alerts when calibration is due at a specified interval
- **Connectivity**
 - PC connectivity via opto-isolated micro-USB with HI92000 software
- **GLP**
 - GLP data provides data from previous calibration to ensure Good Laboratory Practices are met
- **Intuitive keypad**
 - Important and often used functions such as GLP information, help, range, calibration and backlight have a dedicated button
- **Supplied complete**
 - Each meter is supplied complete with sensor, calibration and cleaning solutions, beakers, PC software and connection cable, instruction manual, quick start guide, and batteries in a rugged, custom carrying case



pH

portable

Wine pH Meter

designed for wine making professionals

Hanna foodcare pH meters are rugged and portable with the performance and features of a benchtop. Eight models are available in this series to measure food, milk, meat, yogurt, cheese, beer, wine, and soil. Each model is supplied with an application specific electrode and cleaning solutions. These waterproof meters comply to IP67 standards and can be easily operated with one hand.



Backlit Graphic LCD Display

These meters feature a backlit graphic LCD with on-screen help. The graphic display allows for the use of virtual keys to provide for an intuitive user interface.

Waterproof Protection

The meter is enclosed in an IP67 rated waterproof casing and can withstand immersion in water at a depth of 1 m for up to 30 minutes.



Quick Connect Probe

Each meter features an application specific pH/temperature probe with a quick connect DIN connector to make attaching and removing the probe simple and easy.

Calibration Timeout

Alerts when calibration is due at a specified interval.

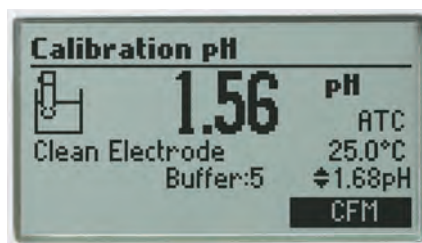

pH Calibration

Choose from seven standard pH buffers and five custom values to obtain up to five point calibration and achieve high precision readings with a 0.001 pH resolution and a pH accuracy of ± 0.002 .

Enhanced Calibration

An "out of calibration range" warning can be engaged to keep the user informed of the current calibration and help to avoid performing measurements that are out of the bracketed range.



CAL Check™

Hanna's CAL Check maintains a history of past calibrations and monitors the pH electrode and buffers during subsequent calibrations for any signs of wide variances due to a dirty or broken electrode or contaminated pH buffers. During calibration, users are alerted to problems should they occur. After calibration, the electrode's overall condition is displayed as a percentage.

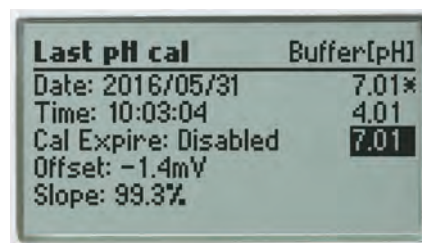

GLP

Comprehensive GLP functions are directly accessible by pressing the GLP key. Calibration data, including date, time, and calibration values are stored with logged data for retrieval at a later time.

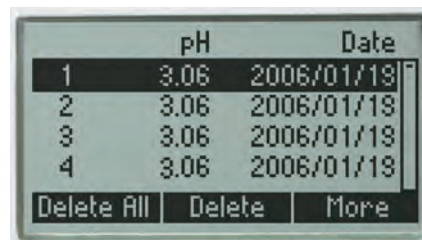

Data Logging

The log-on-demand feature allows users to store up to 200 samples that can later be transferred to a PC with the HI920015 USB cable and HI92000 software.

Automatic Temperature Compensation

pH sensors incorporate a built-in temperature sensor in the tip of the electrode for a fast and accurate temperature compensated value.

Intuitive Keypad

The fitted rubber keypad has dedicated keys for many important and often used functions. These meters also feature two virtual soft keys that navigate the user through setup and logging of data. The interface is intuitive for any user's level of experience.



Auto Hold

Pressing AutoEnd during measurement will automatically hold the first stable reading on the display.



Dedicated Help Key

Contextual help is always available through a dedicated "HELP" key. Clear tutorial messages and directions are available on-screen to quickly and easily guide users through setup and calibration. The help information displayed is relative to the setting/option being viewed.



Setup Screen

Our extensive setup screen features a host of configurable options such as time, date, temperature units, and language for help screens and guides.



PC Connectivity

Logged data can be transferred to a Windows compatible PC with the included HI920015 micro USB cable and HI92000 software.

Long Battery Life

The display of the meter has a battery icon indicator to show the remaining power. The meter uses four 1.5V AA batteries that provide up to 200 hours of battery life.



Supplied Complete in a Rugged Custom Carrying Case

Each meter is supplied complete with sensor, calibration and cleaning solutions, beakers, PC software and connection cable, instruction manual, quick start guide, and batteries in a rugged, custom carrying case. The inside compartment of the carrying case is thermoformed to securely hold and protect all of the components.

Specifications	HI98169	
pH*	Range	-2.0 to 20.0 pH; -2.00 to 20.00 pH; -2.000 to 20.000 pH
	Resolution	0.1 pH; 0.01 pH; 0.001 pH
	Accuracy	±0.1 pH; ±0.01 pH; ±0.002 pH
	Calibration	up to five-point calibration, seven standard buffers available (1.68, 4.01, 6.86, 7.01, 9.18, 10.01, 12.45) and five custom buffers
	Temperature Compensation	automatic or manual from -20.0 to 120.0°C (-4.0 to 248.0°F)
mV	Range	±2000 mV
	Resolution	0.1 mV
	Accuracy	±0.2 mV
	Relative mV Offset Range	±2000 mV
Temperature*	Range	-20.0 to 120.0 °C (-4.0 to 248.0°F)
	Resolution	0.1°C (0.1°F)
	Accuracy	±0.4°C (±0.8°F) (excluding probe error)
Additional Specifications	pH Probe	FC10483 preamplified pH and temperature probe with flat tip, DIN connector and 1 m (3.3') cable
	Slope Calibration	from 80 to 110%
	Log-on-demand	Up to 200 samples (100 pH, 100 mV)
	PC Connection	opto-isolated USB with HI92000 software and micro USB cable
	Input Impedance	10 ¹² Ω
	Battery Type / Life	1.5V AA batteries (4) / approximately 200 hours of continuous use without backlight (50 hours with backlight)
	Auto-off	user selectable: 5, 10, 30, 60 min, disabled
	Environment	0 to 50°C (32 to 122°F); RH 100% IP67
	Dimensions / Weight	185 x 93 x 35.2 mm (7.3 x 3.6 x 1.4") / 400 g (14.2 oz)
	Ordering Information	HI98169 is supplied with FC10483 pH electrode, pH 3.00 buffer solution sachets (2), pH 7.01 buffer solution sachets (2), HI700635 Cleaning solution for wine deposits sachet, HI700636 cleaning solution for wine stains sachet, 100 mL plastic beaker (2), HI920015 micro USB cable, 1.5V AA batteries (4), instruction manual, guidebook for winemakers, and quality certificate in a HI720169 hard carrying case with custom insert.
Accessories	HI710035 blue protective rubber boot	

FC10483 pH electrode

- PE sleeve
- Refillable pH electrode
- Clogging prevention system (CPS™)

The HI98169 portable pH meter for wine uses the glass body FC10483 pH electrode with Hanna's unique Clogging Prevention System (CPS™). This electrode provides a fast stable response and resists clogging. The electrolyte solution in the electrode is refillable.

An integral part of any pH electrode is the reference junction. The reference junction is a part of the electrode that allows for the flow of ions located in the reference cell into the sample being measured. The ions provide for an electrical connection between the reference electrode and the indicating electrode. A standard pH electrode will use a single ceramic junction; however, the CPS™ (Clogging Prevention System) is an innovation in electrode technology. Conventional pH electrodes use ceramic junctions that clog quickly when used in wine. When the junction is clogged, the electrode does not function. CPS™ technology utilizes the porousness of ground glass coupled with a PE sleeve to prevent clogging of the junction. The ground glass allows proper flow of the liquid, while the PE sleeve repels dirt. As a result, pH electrodes with CPS™ stay fresh up to 20 times longer than conventional electrodes.

To optimize the flow from the electrode the refill cap should be unscrewed so that it is open. This allows for positive head pressure to be created allowing for the electrolyte to drain more easily from the reference electrode.



pH

portable

The Importance of pH in Wine Making

The pH of wine is important to determine because it will affect the quality of the final product in terms of taste, color, oxidation, chemical stability and other factors. Generally in winemaking, the higher the pH reading, the lower amount of acidity in the wine. Three important factors in determining the pH of wine include the ratio of malic acid to tartaric acid, the amount of potassium, and the total amount of acid present.

Most wines optimally have a pH between 2.9 and 4.0, with values differing based on the type of wine. Values above pH 4.0 indicate that the wine may spoil quickly and be chemically unstable. Lower pH values allow the wine to stay fresher for a longer period and retain its original color and flavor. High pH wine is more likely to breed bacteria and become unsuitable to drink.

For finished white wines, the ideal pH is between pH 3.00 and pH 3.30, while the final pH for red wine is ideally between pH 3.40 and pH 3.50. The optimal pH before the fermentation process is between pH 2.9 and pH 4.0. The pH of wine therefore not only affects the color of wine, but also the oxidation, yeast fermentation, protein stability, and bacterial growth and fermentation.

Specifications	FC10483
Description	pH electrode
Reference	double, Ag/AgCl
Junction	CPS™
Electrolyte	KCl 3.5M
Max Pressure	0.1 bar
Range	pH: 0 to 12
Recommended Operating Temperature	-5 to 60°C (23 to 140°F)
Glass Type	LT (low temperature)
Tip /Shape	Dome (dia: 8 mm)
Temperature Sensor	yes
Amplifier	yes
Body Material	glass
Cable	coaxial; 1 m (3.3')
Connection	quick connect DIN

HI98168

pH / Temperature Meter for Soil

The HI98168 is a rugged, waterproof, portable pH meter that allows for the direct measure of soil pH. This meter is supplied with a specialized pH electrode that has a rugged conical tip for insertion in soil.

- **Waterproof**
 - IP67 rated waterproof, rugged enclosure
- **CAL Check™**
 - Alerts users to problems during calibration including dirty/broken electrode, contaminated buffer, and overall probe condition
- **Automatic or manual temperature compensation**
 - pH sensors incorporate a built-in temperature sensor
- **Calibration**
 - Up to a five-point calibration with seven standard buffers and five custom buffers
- **Approximately 200 hour battery life**
 - Powered by four 1.5V AA batteries
- **Clear display**
 - Dot matrix display with multifunction virtual keys
- **Auto hold**
 - Automatically holds the first stable reading on the display
- **Calibration timeout**
 - Alerts when calibration is due at a specified interval
- **Connectivity**
 - PC connectivity via opto-isolated micro-USB with HI92000 software
- **GLP**
 - GLP data provides data from previous calibration to ensure Good Laboratory Practices are met
- **Intuitive keypad**
 - Important and often used functions such as GLP information, help, range, calibration, and backlight have a dedicated button
- **Supplied complete**
 - Each meter is supplied complete with sensor, calibration and cleaning solutions, beakers, PC software and connection cable, instruction manual, quick start guide, and batteries in a rugged, custom carrying case



Soil pH Meter

designed for agriculture professionals

Hanna 98 series quality pH meters are rugged and portable with the performance and features of a benchtop. Seven models are available in this series to measure food, milk, meat, yogurt, cheese, beer, wine, and soil. Each model is supplied with an application specific electrode and cleaning solutions. These waterproof meters comply to IP67 standards and can be easily operated with one hand.



Backlit Graphic LCD Display

These meters feature a backlit graphic LCD with on-screen help. The graphic display allows for the use of virtual keys to provide for an intuitive user interface.

Waterproof Protection

The meter is enclosed in an IP67 rated waterproof casing and can withstand immersion in water at a depth of 1 m for up to 30 minutes.



Quick Connect Probe

Each meter features an application specific pH/temperature probe with a quick connect DIN connector to make attaching and removing the probe simple and easy.

Calibration Timeout

Alerts when calibration is due at a specified interval.

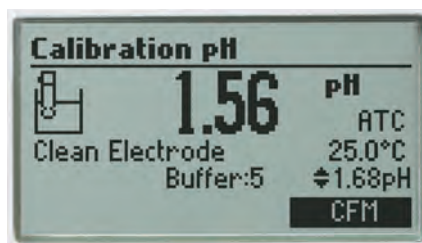

pH Calibration

Choose from seven standard pH buffers and five custom values to obtain up to five point calibration and achieve high precision readings with a 0.001 pH resolution and a pH accuracy of ± 0.002 .

Enhanced Calibration

An "out of calibration range" warning can be engaged to keep the user informed of the current calibration and help to avoid performing measurements that are out of the bracketed range.

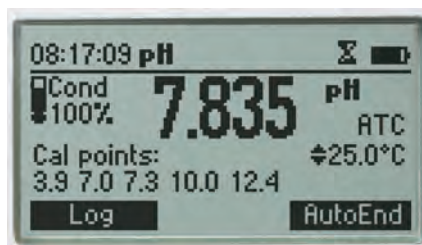

CAL Check™

Hanna's CAL Check maintains a history of past calibrations and monitors the pH electrode and buffers during subsequent calibrations for any signs of wide variances due to a dirty or broken electrode or contaminated pH buffers. During calibration, users are alerted to problems should they occur. After calibration, the electrode's overall condition is displayed as a percentage.

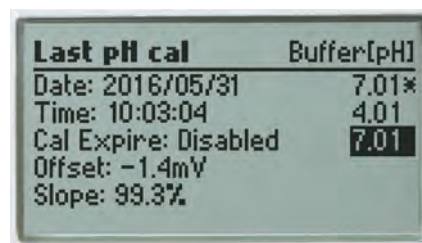

GLP

Comprehensive GLP functions are directly accessible by pressing the GLP key. Calibration data, including date, time, and calibration values are stored with logged data for retrieval at a later time.



Data Logging

The log-on-demand feature allows users to store up to 200 samples that can later be transferred to a PC with the HI920015 USB cable and HI92000 software.

Automatic Temperature Compensation

pH sensors incorporate a built-in temperature sensor in the tip of the electrode for a fast and accurate temperature compensated value.

Intuitive Keypad

The fitted rubber keypad has dedicated keys for many important and often used functions. These meters also feature two virtual soft keys that navigate the user through setup and logging of data. The interface is intuitive for any user's level of experience.

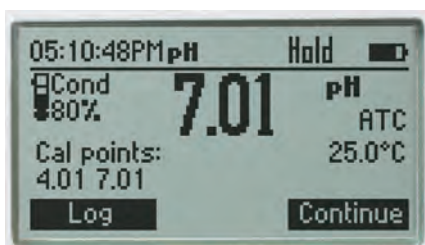

Auto Hold

Pressing AutoEnd during measurement will automatically hold the first stable reading on the display.



Dedicated Help Key

Contextual help is always available through a dedicated "HELP" key. Clear tutorial messages and directions are available on-screen to quickly and easily guide users through setup and calibration. The help information displayed is relative to the setting/option being viewed.



Setup Screen

Our extensive setup screen features a host of configurable options such as time, date, temperature units and language for help screens and guides.



PC Connectivity

Logged data can be transferred to a Windows compatible PC with the included HI920015 micro USB cable and HI92000 software.

Long Battery Life

The display of the meter has a battery icon indicator to show the remaining power. The meter uses four 1.5V AA batteries that provide up to 200 hours of battery life.



Supplied Complete in a Rugged Custom Carrying Case

Each meter is supplied complete with sensor, calibration and cleaning solutions, beakers, PC software and connection cable, instruction manual, quick start guide and batteries in a rugged, custom carrying case. The inside compartment of the carrying case is thermoformed to securely hold and protect all of the components.

Specifications	HI98168	
pH*	Range	-2.0 to 20.0 pH; -2.00 to 20.00 pH; -2.000 to 20.000 pH
	Resolution	0.1 pH; 0.01 pH; 0.001 pH
	Accuracy	±0.1 pH; ±0.01 pH; ±0.002 pH
	Calibration	up to five-point calibration, seven standard buffers available (1.68, 4.01, 6.86, 7.01, 9.18, 10.01, 12.45) and five custom buffers
	Temperature Compensation	automatic or manual from -20.0 to 120.0°C (-4.0 to 248.0°F)
mV	Range	±2000 mV
	Resolution	0.1 mV
	Accuracy	±0.2 mV
	Relative mV Offset Range	±2000 mV
Temperature*	Range	-20.0 to 120.0 °C (-4.0 to 248.0°F)
	Resolution	0.1°C (0.1°F)
	Accuracy	±0.4°C (±0.8°F) (excluding probe error)
Additional Specifications	pH Probe	HI12923 Glass body, conical tip, refillable pH electrode with internal temperature sensor, quick DIN connector and 1 m (3.3' cable)
	Slope Calibration	from 80 to 110%
	Log-on-demand	Up to 200 samples (100 pH, 100 mV)
	PC Connection	opto-isolated USB with HI92000 software and micro USB cable
	Input Impedance	10 ¹² Ω
	Battery Type / Life	1.5V AA batteries (4) / approximately 200 hours of continuous use without backlight (50 hours with backlight)
	Auto-off	user selectable: 5, 10, 30, 60 min, disabled
	Environment	0 to 50°C (32 to 122°F); RH 100% IP67
	Dimensions / Weight	185 x 93 x 35.2 mm (7.3 x 3.6 x 1.4") / 400 g (14.2 oz.)
	Ordering Information	HI98168 is supplied with HI12923 pH electrode, HI721319 ground auger, HI7004M pH 4.01 buffer solution (230 mL), HI7007M pH 7.01 buffer solution (230 mL), HI700663 Cleaning solution sachet for soil deposits, HI700664 Cleaning solution for humus deposits, HI7051M Soil Test Solution (230 mL), 100 mL plastic beaker (2), HI92000 PC software, HI920015 micro USB cable, 1.5V AA batteries (4), instruction manual, and quality certificate in a HI720161 hard carrying case with custom insert.



- Optional shockproof silicon rubber boot
- Specially designed to protect your instrument from damage or impact

HI710035 Blue

HI12923

pH / Temperature Probe for Soil

The HI12923 pH electrode that is supplied with the HI98168 is uniquely designed with a conical tip and a triple ceramic junction for improved performance in soils that have a low moisture content. The probe has a built in amplifier to reduce noise from humidity that can effect the probe connection to the meter. The HI12923 connects to the HI98168 with a quick-connect, waterproof DIN connector, allowing for a secure, non-threaded attachment.

Refillable

As electrolyte is lost over time it can be replenished to extend the life of the electrode.

Triple ceramic junction

The outer reference has three ceramic frits that allow electrolyte to flow at a high rate from the inside of the probe to the outside. A higher flow rate allows for a pH measurement of soil with low moisture.

Conical Tip

The conical tip is made of durable low temperature glass and allows for direct measurement in soils. In the case any rocks are present an auger is provided to make a hole for the probe.

Quick Connect DIN Connector

This secure waterproof connector allows for a single cable to be used for both pH and temperature measurements.



Application Importance

The measurement of pH in agricultural activities is very important due to the influence it has on the growth of the plant. Soil can be acid, neutral or alkaline, according to its pH value. Most plants prefer a pH range from 5.5 to 7.5; but some species prefer more acid or alkaline soils. Nevertheless, every plant requires a particular range of pH for optimum growth.

2

pH

portable

Specifications	HI12923
Description	pH electrode
Reference	single, Ag/AgCl
Junction	ceramic, triple / 40-50 µL/h
Electrolyte	KCl 3.5M + AgCl
Max Pressure	0.1 bar
Range	pH: 0 to 12
Recommended Operating Temperature	-5 to 70°C (23 to 158°F) - LT
Glass Type	LT (low temperature)
Tip /Shape	conic (12 x 12 mm)
Temperature Sensor	yes
Amplifier	yes
Body Material	glass
Cable	coaxial; 1 m (3.3')
Connection	quick connect DIN

99 Series Portable Waterproof Meters

For scientists and professionals who require precision in the field or on the production floor, Hanna's 99 Series meters are durable, water-proof handhelds that deliver accurate results. It's the application-specific design you love with an all-new rugged construction to give you years of flawless measurements.

Features

- **Large LCD**
 - A multilevel display provides at-a-glance readings of your most important numbers from any angle.
- **User-friendly Design**
 - With only two buttons, meter operation could not be simpler. Two buttons allow you to quickly adjust settings, select the measurement range, and choose calibration buffer sets.
- **Application Specific Probe**
 - Your measurements require detailed attention; so should your electrodes. Your probe has been carefully designed to meet the demands of your industry from body materials to junction type. Get top performance with a meter made for you.
- **Probe Condition**
 - An on-screen indicator provides visual confirmation that your probe is working at its best.
- **Durable IP67 waterproof casing**
 - Designed to withstand the knocks, drops, and spills of real life, the new IP67 body ensures top performance in any environment. These meters are protected against dust and water intrusion from any direction.



- **Watertight Connection**
 - A Quick Connect DIN connector makes attaching and removing the probe simple and easy. The rubber coating protects the cable and creates a sealed connection for added reliability.



- **HOLD button**
 - Freezes the reading on the display



- **Selectable temperature unit (°C or °F)**



- **Battery life indication, low battery detection and Auto-off function**
- **Automatic pH calibration at one or two points within two memorized buffer sets (standard or NIST)**
- **On-screen calibration tags**
- **Electrode condition indicator**
- **mV of pH measurement for electrode check**





Shown with: **HI710028**
Silicon rubber boot, orange

Shown with: **HI710029**
Silicon rubber boot, blue

- | | | |
|---|--|--|
| 1 Three level display | 5 Selectable temperature unit, °C or °F | 9 HOLD button to freeze readings on the display |
| 2 Two level display | 6 electrode condition indicator | 10 Quick Connect DIN connector |
| 3 Calibration tags | 7 Stability indicator | 11 HI710028 Silicon rubber boot, orange |
| 4 Automatic temperature compensation indicator | 8 Power and MODE button | 12 HI710029 Silicon rubber boot, blue |

HI991001 · HI991003

pH/pH-mV/ORP and Temperature Meters

- Simultaneous pH, ORP, and temperature measurements on a large three-line LCD display (HI991003)
- Simultaneous pH and temperature measurements on a large dual-line LCD display (HI991001)
- User-friendly two button design
- Application specific probe
- Durable IP67 waterproof casing
- Watertight probe connection
- Probe condition indicator
- Automatic pH calibration at one or two points within two memorized buffer sets (standard or NIST)
- On-screen calibration tags
- mV measurement for electrode check
- Selectable temperature unit (°C or °F)
- Auto-off function
- Battery life indication and low battery detection

The HI991003 is a light weight, portable pH/ORP/temperature meter for pH and ORP measurements encountered in recreational waters (swimming pools and spas), plating baths, water treatment, manufacturing, and environmental testing applications. The meter is supplied with the HI12973 rugged probe protected with a titanium body specially designed for use on this meter.

HI991001 is a durable, portable, pH and temperature meter used for most pH measurements encountered in manufacturing and environmental testing protocols. The meter is provided with the HI12963 rugged titanium bodied electrode with built-in temperature sensor for temperature compensated pH and temperature readings.

- **Optional shockproof silicon rubber boot**
- Specially designed to protect your instrument from damage or impact

HI710028 Orange
HI710029 Blue
HI710030 Green



Specifications	HI991001	HI991003	
pH	Range*	-2.00 to 16.00 pH / -2.0 to 16.0 pH	
	Resolution	0.01 pH / 0.1 pH	
	Accuracy (@25°C/77°F)	±0.02 pH / ±0.1 pH	
	Calibration	Automatic, one or two-point selectable bufferset standard: 4.01; 7.01; 10.01 or NIST: 4.01; 6.86; 9.18	
ORP	Range*	– ±1999 mV	
	Resolution	– 1 mV	
	Accuracy (@25°C/77°F)	– ±2 mV	
pH-mV	Range*	±825 mV ±825 mV	
	Resolution	1 mV 1 mV	
	Accuracy (@25°C/77°F)	±1 mV ±1 mV	
Temperature	Range*	-5.0 to 105.0°C/23.0 to 221.0°F	
	Resolution	0.1°C/0.1°F	
	Accuracy (@25°C/77°F)	±0.5°C up to 60°C; ±1.0°C outside; ±1.0°F up to 140°F; ±2.0°F outside	
Additional Specifications	Temperature Compensation	automatic, from -5.0 to 105.0°C (23.0 to 221.0°F)	
	Probe (included)	HI12963 preamplified pH and temperature probe with titanium body, DIN connector and 1 m (3.3') cable	HI12973 preamplified pH/ORP with internal temperature sensor, DIN connector and 1 m (3.3') cable
	Battery type / life	1.5V AAA (3) approx. 1400 hours of continuous use	
	Auto-Off	user selectable: after 8 min, 60 min, or disabled	
	Environment	0 to 50°C (32 to 122°F); RH max. 100%	
	Meter Dimensions	154 x 63 x 30 mm (6.1 x 2.5 x 1.2")	
	Meter Mass (with batteries)	196 g (6.91 oz.)	
	Case Ingress Protection Rating	IP67	
	Ordering Information	<p>HI991001 is supplied with HI12963 pH/temperature probe with titanium body and Quick Connect DIN connector with 1m (3.3') cable, pH 4.01 and 7.01 Buffer sachets, HI700601 electrode cleaning solution sachet (2), 100 mL beaker, 1.5V AAA batteries (3), calibration certificate of meter, calibration certificate of probe, instruction manual, and rugged carrying case.</p> <p>HI991003 is supplied with HI12973 pH/ORP/temperature probe with titanium body and Quick Connect DIN connector with 1m (3.3') cable, pH 4.01 and 7.01 Buffer sachets, HI700601 electrode cleaning solution sachet (2), 100 mL beaker, 1.5V AAA batteries (3), calibration certificate of meter, calibration certificate of probe, instruction manual, and HI710142 rugged carrying case.</p>	

* HI12963 and HI12973 is limited to be used from 0 to 13 pH and from 0 to 80 °C temperature (32 to 176 °F).



HI99121

Direct Soil pH Meter

with Measurement Kit

- Simultaneous pH and temperature measurements on a large dual-line LCD display
- User-friendly two button design
- Application specific probe
- Durable IP67 waterproof casing
- Watertight probe connection
- Probe condition indicator
- Automatic pH calibration at one or two points within two memorized buffer sets (standard or NIST)
- On-screen calibration tags
- mV measurement for electrode check
- Selectable temperature unit (°C or °F)
- Auto-off function
- Battery life indication and low battery detection
- Soil preparation solution
 - For higher degrees of accuracy, or for stony ground where the electrode may be damaged, use the included HI7051M soil preparation solution

Specifications

HI99121

pH	Range*	-2.00 to 16.00 pH / -2.0 to 16.0 pH
	Resolution	0.01 pH / 0.1 pH
	Accuracy (@25°C/77°F)	±0.02 pH / ±0.1 pH
	Calibration	Automatic, one or two-point selectable bufferset standard: 4.01; 7.01; 10.01 or NIST: 4.01; 6.86; 9.18
pH-mV	Range*	±825 mV
	Resolution	1 mV
	Accuracy (@25°C/77°F)	±1 mV
Temperature	Range*	-5.0 to 105.0°C; 23.0 to 221.0°F
	Resolution	0.1°C; 0.1°F
	Accuracy(@25°C/77°F)	±0.5°C (up to 60°C), ±1.0°C (outside); ±1.0°F (up to 140°F), ±2.0°F (outside)
Additional Specifications	Temperature Compensation	automatic, from -5.0 to 105.0°C (23.0 to 221.0°F)
	Probe (included)	HI12923 glass body, pre-amplified pH electrode for soil measurement with internal temperature sensor, DIN connector and 1 m (3.3') cable
	Battery Type / Life	1.5V AAA (3) approx. 1400 hours of continuous use
	Auto-off	user selectable: after 8 min, 60 min, or disabled
	Environment	0 to 50°C (32 to 122°F); RH max. 100%
	Meter Dimensions	154 x 63 x 30 mm (6.1 x 2.5 x 1.2")
	Meter Mass (with batteries)	196 g (6.91 oz.)
	Case Ingress Protection Rating	IP67
Ordering Information	<p>HI99121 is supplied with HI12923 pH/temperature probe with glass body and Quick Connect DIN connector with 1m (3.3') cable, pH 4.01 and 7.01 Buffer sachets, HI700663 electrode cleaning solution sachet for soil deposits, HI700664 electrode cleaning solution sachet for humus deposits, HI7051M soil preparation solution, HI721319 ground auger, 100 mL beaker, 1.5V AAA batteries (3), calibration certificate of meter, calibration certificate of probe, instruction manual and HI710142 rugged carrying case.</p>	

* the HI12923 is limited to be used from 0-12 pH and from -5 to 70 °C temperature (23 to 158°F).

The HI99121 is the perfect portable pH meter for soil testing. With the HI99121 and HI12923 direct soil pre-amplified pH and temperature probe, users can test both the pH of soil directly or after preparation of a soil slurry with deionized water.

The HI12923 features a conical, rugged tip that can be directly used in soil. A plastic auger is supplied to perforate and loosen the soil prior to sensor measurement. Use this tool to prevent scratching the pH sensitive glass on nutrient crystals or small pebbles.



- Optional shockproof silicon rubber boot
 - Specially designed to protect your instrument from damage or impact

HI710028 Orange
HI710029 Blue
HI710030 Green

Portable pH Meter

for Plating Baths

- Simultaneous pH and temperature measurements on a large dual-line LCD display
- User-friendly two button design
- Application specific probe
- Durable IP67 waterproof casing
- Watertight probe connection
- Probe condition indicator
- Automatic pH calibration at one or two points within two memorized buffer sets (standard or NIST)
- On-screen calibration tags
- mV measurement for electrode check
- Selectable temperature unit (°C or °F)
- Auto-off function
- Battery life indication and low battery detection

Plating Baths can vary from acid to neutral to alkaline with many different chemical formulations used. The common necessity is the fast and accurate measurement of pH to ensure that additives and chemicals are working properly to provide even and consistent plating.

The HI99131 portable pH meter and HI629113 pH electrode are specially designed for pH measurements in plating baths.

The titanium electrode body acts like a Faraday cage, and allows stable readings even in samples where strong electrical fields are involved.

Moreover, a built-in temperature sensor allows simultaneous temperature compensated pH and temperature readings and a pH sensor preamplifier provides measurements impervious to noise and electrical interferences.

- Optional shockproof silicon rubber boot
- Specially designed to protect your instrument from damage or impact

HI710028 Orange
HI710029 Blue
HI710030 Green



Specifications

HI99131

pH	Range*	-2.00 to 16.00 pH / -2.0 to 16.0 pH
	Resolution	0.01 pH / 0.1 pH
	Accuracy (@25°C/77°F)	±0.02 pH / ±0.1 pH
	Calibration	Automatic, one or two-point selectable bufferset standard: 4.01; 7.01; 10.01 or NIST: 4.01; 6.86; 9.18
pH-mV	Range*	±825 mV
	Resolution	1 mV
	Accuracy (@25°C/77°F)	±1 mV
Temperature	Range*	-5.0 to 105.0°C; 23.0 to 221.0°F
	Resolution	0.1°C; 0.1°F
	Accuracy (@25°C/77°F)	±0.5°C (up to 60°C), ±1.0°C (outside); ±1.0°F (up to 140°F), ±2.0°F (outside)
Additional Specifications	Temperature Compensation	automatic, from -5.0 to 105.0°C (23.0 to 221.0°F)
	Probe (included)	HI629113 preamplified pH probe with built-in temperature sensor and titanium cage working as matching pin, DIN connector with 1m (3.3') cable
	Battery Type / Life	1.5V AAA (3) approx. 1400 hours of continuous use
	Auto-off	user selectable: after 8 min, 60 min, or disabled
	Environment	0 to 50°C (32 to 122°F); RH max. 100%
	Meter Dimensions	154 x 63 x 30 mm (6.1 x 2.5 x 1.2")
	Meter Mass (with batteries)	196 g (6.91 oz.)
Case Ingress Protection Rating	IP67	
Ordering Information	HI99131 is supplied with HI629113 preamplified pH probe with built-in temperature sensor and titanium body, Quick Connect DIN connector with 1m (3.3') cable, pH 4.01 and 7.01 Buffer sachets, HI700601 electrode cleaning solution sachets (2), 100 mL beaker, 1.5V AAA batteries (3), calibration certificate of meter, calibration certificate of probe, instruction manual, and HI710142 rugged carrying case.	

* the HI629113 is limited to be used from 0 to 13 pH and from 0 to 80 °C temperature (32 to 176 °F).



HI99141

Portable pH Meter

for Boiler and Cooling Towers

- Simultaneous pH and temperature measurements on a large dual-line LCD display
- User-friendly two button design
- Application specific probe
- Durable IP67 waterproof casing
- Watertight probe connection
- Probe condition indicator
- Automatic pH calibration at one or two points within two memorized buffer sets (standard or NIST)
- On-screen calibration tags
- mV measurement for electrode check
- Selectable temperature unit (°C or °F)
- Auto-off function
- Battery life indication and low battery detection

The HI99141 pH meter is a portable, lightweight meter with two button operation that is simple to use. It is delivered with a rugged pH electrode protected by a titanium body that is perfect for the pH measurement of treated boiler, feed water, and steam condensate.

HI729113 is a rugged double junction pH electrode with a flat pH sensor and titanium body. The electrode has a peripheral Teflon® junction for maximum surface contact and flat pH tip is easy to clean and prevents solids from collecting on the sensor. Chemicals used to minimize scale, corrosion and foaming require an optimum pH. Measuring and controlling water quality helps minimize these effects.

A built-in temperature sensor allows simultaneous temperature compensated pH and temperature readings and a built-in pH sensor preamplifier provides measurements impervious to noise and electrical interferences.

- Optional shockproof silicon rubber boot
- Specially designed to protect your instrument from damage or impact

HI710028 Orange
HI710029 Blue
HI710030 Green



Specifications

HI99141

pH	Range*	-2.00 to 16.00 pH / -2.0 to 16.0 pH
	Resolution	0.01 pH / 0.1 pH
	Accuracy (@25°C/77°F)	±0.02 pH / ±0.1 pH
	Calibration	Automatic, one or two-point selectable bufferset standard: 4.01; 7.01; 10.01 or NIST: 4.01; 6.86; 9.18
pH-mV	Range*	±825 mV
	Resolution	1 mV
	Accuracy (@25°C/77°F)	±1 mV
Temperature	Range*	-5.0 to 105.0°C; 23.0 to 221.0°F
	Resolution	0.1°C; 0.1°F
	Accuracy (@25°C/77°F)	±0.5°C (up to 60°C), ±1.0°C (outside); ±1.0°F (up to 140°F), ±2.0°F (outside)
Additional Specifications	Temperature Compensation	automatic, from -5.0 to 105.0°C (23.0 to 221.0°F)
	Probe (included)	HI729113 preamplified pH probe with built-in temperature sensor and titanium cage working as matching pin, DIN connector with 1m (3.3') cable
	Battery Type / Life	1.5V AAA (3) approx. 1400 hours of continuous use
	Auto-off	user selectable: after 8 min, 60 min or disabled
	Environment	0 to 50°C (32 to 122°F); RH max. 100%
	Meter Dimensions	154 x 63 x 30 mm (6.1 x 2.5 x 1.2")
	Meter Mass (with batteries)	196 g (6.91 oz.)
	Case Ingress Protection Rating	IP67
Ordering Information	<p>HI99141 is supplied with HI729113 preamplified pH probe with built-in temperature sensor and matching pin, Quick Connect DIN connector with 1m (3.3') cable, pH 4.01 and 7.01 buffer sachets, HI700601 electrode cleaning solution sachets (2), 100 mL beaker, 1.5V AAA batteries (3), calibration certificate of meter, calibration certificate of probe, instruction manual, and HI710142 rugged carrying case.</p>	

* the HI729113 is limited to be used from 0 to 13 pH and from 0 to 80°C temperature (32 to 176°F).

Portable pH Meter

for Leather and Paper

- Simultaneous pH and temperature measurements on a large dual-line LCD display
- User-friendly two button design
- Application specific probe
- Durable IP67 waterproof casing
- Watertight probe connection
- Probe condition indicator
- Automatic pH calibration at one or two points within two memorized buffer sets (standard or NIST)
- On-screen calibration tags
- mV measurement for electrode check
- Selectable temperature unit (°C or °F)
- Auto-off function
- Battery life indication and low battery detection



HI99171 is a light weight, portable pH meter supplied with a specially designed pH electrode intended for the direct determination of pH on flat surfaces, such as leather or paper.

The HI99171 portable pH meter together with a HI14143 combination pH electrode (when immersed in a drop of water on the surface of the sample), can determine the pH of the surface with high accuracy and repeatability without the requirement of sample destruction.

During production of cartons and paper used for food packaging, pH measurements provide a useful gauge of product compatibility. pH of a paper is usually considered one of the most reliable indices of the permanence of a paper. Conservators of historical documents (some of which are very valuable or irreplaceable) require a convenient non-destructive method to determine pH.

Leather technicians rely on a pH determination to optimize dyes, coating, and softening agents in order to preserve the fiber structure and prevent damage to leather. Leather is acidic. Its pH is measured at between 4.5 and 5.0. Surface pH measurements provide a non-destructive means to meet specifications and optimize product quality.

Specifications

HI99171

pH	Range*	-2.00 to 16.00 pH / -2.0 to 16.0 pH	
	Resolution	0.01 pH / 0.1 pH	
	Accuracy (@25°C/77°F)	±0.02 pH / ±0.1 pH	
	Calibration	Automatic, one or two-point selectable bufferset standard: 4.01; 7.01; 10.01 or NIST: 4.01; 6.86; 9.18	
pH-mV	Range*	±825 mV	
	Resolution	1 mV	
	Accuracy (@25°C/77°F)	±1 mV	
Temperature	Range*	-5.0 to 105.0°C; 23.0 to 221.0°F	
	Resolution	0.1°C; 0.1°F	
	Accuracy (@25°C/77°F)	±0.5°C (up to 60°C), ±1.0°C (outside); ±1.0°F (up to 140°F), ±2.0°F (outside)	
Additional Specifications	Temperature Compensation	automatic, from -5.0 to 105.0°C (23.0 to 221.0°F)	
	Probe (included)	HI14143 preamplified pH and temperature probe with flat tip, DIN connector, and 1 m (3.3') cable	
	Battery Type / Life	1.5V AAA (3) approx. 1400 hours of continuous use	
	Auto-off	user selectable: after 8 min, 60 min, or disabled	
	Environment	0 to 50°C (32 to 122°F); RH max. 100%	
	Meter Dimensions	154 x 63 x 30 mm (6.1 x 2.5 x 1.2")	
	Meter Mass (with batteries)	196 g (6.91 oz.)	
	Case Ingress Protection Rating	IP67	
	Ordering Information	HI99171 is supplied with HI14143 pH/temperature probe with flat tip and Quick Connect DIN connector with 1m (3.3') cable, pH 4.01 and 7.01 buffer sachets, HI700680 cleaning solution for ink stains sachets (2), HI70960 conductive electrolyte solution for pH measurement (30 mL), 100 mL beaker, 1.5V AAA batteries (3), calibration certificate of meter, calibration certificate of probe, instruction manual, and HI710142 rugged carrying case.	

* the HI14143 is limited to be used from 0 to 12 pH and from 0 to 50 °C temperature (32 to 122 °F).

Foodcare

HI99162

pH / Temperature Meter for Milk

with Application Specific Probe

- Simultaneous pH and temperature measurements on a large dual-line LCD display
- User-friendly two button design
- Application specific probe
- Durable IP67 waterproof casing
- Watertight probe connection
- Probe condition indicator
- Automatic pH calibration at one or two points within two memorized buffer sets (standard or NIST)
- On-screen calibration tags
- mV measurement for electrode check
- Selectable temperature unit (°C or °F)
- Auto-off function
- Battery life indication and low battery detection



Specifications

HI99162

pH	Range*	-2.00 to 16.00 pH / -2.0 to 16.0 pH
	Resolution	0.01 pH / 0.1 pH
	Accuracy (@25°C/77°F)	±0.02 pH / ±0.1 pH
pH-mV	Range*	±825 mV
	Resolution	1 mV
	Accuracy (@25°C/77°F)	±1 mV
Temperature	Range*	-5.0 to 105.0°C; 23.0 to 221.0°F
	Resolution	0.1°C; 0.1°F
	Accuracy (@25°C/77°F)	±0.5°C (up to 60°C), ±1.0°C (outside); ±1.0°F (up to 140°F), ±2.0°F (outside)
Additional Specifications	Temperature Compensation	automatic, from -5.0 to 105.0°C (23.0 to 221.0°F)
	Probe (included)	FC1013 preamplified pH and temperature probe, DIN connector and 1 m (3.3') cable
	Battery Type / Life	1.5V AAA (3) approx. 1400 hours of continuous use
	Auto-off	user selectable: after 8 min, 60 min or disabled
	Environment	0 to 50°C (32 to 122°F); RH max. 100%
	Meter Dimensions	154 x 63 x 30 mm (6.1 x 2.5 x 1.2")
	Meter Mass (with batteries)	196 g (6.91 oz.)
	Case Ingress Protection Rating	IP67
Ordering Information	HI99162 is supplied with FC1013 preamplified pH/temperature probe with Quick Connect DIN connector and 1 m (3.3') cable, pH 4.01 and 7.01 buffer sachets, HI700640 electrode cleaning solution sachet for milk deposits (2), 100 mL beaker, 1.5V AAA batteries (3), calibration certificate of meter, calibration certificate of probe, instruction manual, and HI710142 rugged carrying case.	

* the FC1013 is limited to be used from 0 to 13 pH and from 0 to 80 °C temperature (32 to 176 °F).

HI99162 is a portable pH and temperature meter designed specifically for pH measurement in milk. The measurement of pH in milk is important in testing for impurities, spoilage, and signs of infection. Fresh milk has a pH value close to pH 6.7. When the pH value of milk falls below pH 6.7, it typically indicates spoilage by bacterial degradation. Milk with pH values higher than pH 6.7 potentially indicate that milk may have come from cows with a mastitis infection.

The FC1013 pH electrode has a built-in temperature sensor for simultaneous temperature compensated pH and temperature readings, and also contains a pH sensor preamplifier to provide measurements impervious to noise and electrical interferences.

FC1013 electrode has a PVDF body, double junction reference with refillable bridge electrolyte and ceramic junction.

The HI99162 and FC1013 provide measurements where your milk is processed to optimize operations.

pH

portable

Foodcare

HI99164

pH / Temperature Meter for Yogurt

with Application Specific Probe

- Simultaneous pH and temperature measurements on a large dual-line LCD display
- User-friendly two button design
- Application specific probe
- Durable IP67 waterproof casing
- Watertight probe connection
- Probe condition indicator
- Automatic pH calibration at one or two points within two memorized buffer sets (standard or NIST)
- On-screen calibration tags
- mV measurement for electrode check
- Selectable temperature unit (°C or °F)
- Auto-off function
- Battery life indication and low battery detection

HI99164 is a portable pH and temperature meter designed specifically for pH measurement in yogurt.

Monitoring pH is crucial in producing consistent, quality yogurt. Yogurt is made by fermentation of milk with live bacterial cultures. Once milk is pasteurized, live culture is added and the mixture of milk and bacteria is incubated. Yogurt producers cease incubation once a specific pH level is reached. By verifying that fermentation continues to a predetermined pH endpoint, yogurt producers can ensure their products remain consistent in terms of flavor, aroma, and texture.

The FC2133 pH electrode is rugged and easy to clean with a conical tip and built-in temperature sensor. The open junction design consists of a solid gel interface (viscolene) between the sample and internal Ag/AgCl reference. This interface not only prevents silver from entering the sample, but also makes it impermeable to clogging after measurements in semi-solid or viscous samples. FC2133 electrode is designed to prevent the typical problems of clogging in viscous liquids, ensuring a fast response and stable reading.



- Optional shockproof silicon rubber boot
- Specially designed to protect your instrument from damage or impact

HI710028 Orange
HI710029 Blue
HI710030 Green

Specifications

HI99164

pH	Range*	-2.00 to 16.00 pH / -2.0 to 16.0 pH
	Resolution	0.01 pH / 0.1 pH
	Accuracy (@25°C/77°F)	±0.02 pH / ±0.1 pH
	Calibration	Automatic, one or two-point selectable bufferset standard: 4.01; 7.01; 10.01 or NIST: 4.01; 6.86; 9.18
pH-mV	Range*	±825 mV
	Resolution	1 mV
	Accuracy (@25°C/77°F)	±1 mV
Temperature	Range*	-5.0 to 105.0°C; 23.0 to 221.0°F
	Resolution	0.1°C; 0.1°F
	Accuracy (@25°C/77°F)	±0.5°C (up to 60°C), ±1.0°C (outside); ±1.0°F (up to 140°F), ±2.0°F (outside)
Additional Specifications	Temperature Compensation	automatic, from -5.0 to 105.0°C (23.0 to 221.0°F)
	Probe (included)	FC2133 preamplified pH and temperature probe, DIN connector, and 1 m (3.3') cable
	Battery Type / Life	1.5V AAA (3) approx. 1400 hours of continuous use
	Auto-off	user selectable: after 8 min, 60 min, or disabled
	Environment	0 to 50°C (32 to 122°F); RH max. 100%
	Meter Dimensions	154 x 63 x 30 mm (6.1 x 2.5 x 1.2")
	Meter Mass (with batteries)	196 g (6.91 oz.)
	Case Ingress Protection Rating	IP67
Ordering Information	<p>HI99164 is supplied with FC2133 pH/temperature probe and Quick Connect DIN connector with 1m (3.3') cable, pH 4.01 and 7.01 buffer sachets, HI700643 cleaning solution sachets for yogurt deposits (2), 100 mL beaker, 1.5V AAA batteries (3), calibration certificate of meter, calibration certificate of probe, instruction manual, and HI710142 rugged carrying case.</p>	

* the FC2133 is limited to be used from 0 to 12 pH and from 0 to 50°C temperature (32 to 122°F).

Foodcare

HI99165

pH / Temperature Meter for Cheese

with Application Specific Probe

- Simultaneous pH and temperature measurements on a large dual-line LCD display
- User-friendly two button design
- Application specific probe
- Durable IP67 waterproof casing
- Watertight probe connection
- Probe condition indicator
- Automatic pH calibration at one or two points within two memorized buffer sets (standard or NIST)
- On-screen calibration tags
- mV measurement for electrode check
- Selectable temperature unit (°C or °F)
- Auto-off function
- Battery life indication and low battery detection



Specifications

HI99165

pH	Range*	-2.00 to 16.00 pH / -2.0 to 16.0 pH
	Resolution	0.01 pH / 0.1 pH
	Accuracy (@25°C/77°F)	±0.02 pH / ±0.1 pH
	Calibration	Automatic, one or two-point selectable bufferset standard: 4.01; 7.01; 10.01 or NIST: 4.01; 6.86; 9.18
pH-mV	Range*	±825 mV
	Resolution	1 mV
	Accuracy (@25°C/77°F)	±1 mV
Temperature	Range*	-5.0 to 105.0°C; 23.0 to 221.0°F
	Resolution	0.1°C; 0.1°F
	Accuracy (@25°C/77°F)	±0.5°C (up to 60°C), ±1.0°C (outside); ±1.0°F (up to 140°F), ±2.0°F (outside)
Additional Specifications	Temperature Compensation	automatic, from -5.0 to 105.0°C (23.0 to 221.0°F)
	Probe (included)	FC2423 preamplified pH and temperature probe, DIN connector, and 1 m (3.3') cable
	Battery Type / Life	1.5V AAA (3) approx. 1400 hours of continuous use
	Auto-off	user selectable: after 8 min, 60 min, or disabled
	Environment	0 to 50°C (32 to 122°F); RH max. 100%
	Meter Dimensions	154 x 63 x 30 mm (6.1 x 2.5 x 1.2")
	Meter Mass (with batteries)	196 g (6.91 oz.)
	Case Ingress Protection Rating	IP67
Ordering Information	HI99165 is supplied with FC2423 preamplified pH/temperature probe with Quick Connect DIN connector and 1 m (3.3') cable, pH 4.01 and 7.01 buffer sachets, HI700642 cleaning solution for cheese deposits (2), 100 mL beaker, 1.5V AAA batteries (3), calibration certificate of meter, calibration certificate of probe, instruction manual, and HI710142 rugged carrying case.	

* the FC2423 is limited to be used from 0 to 12 pH and from 0 to 50°C temperature (32 to 122°F).

Throughout the cheese making process, pH measurement is perhaps the most important cheese making management tool. It is an essential parameter in achieving the desired characteristics, quality, and shelf-life of the finished product.

The HI99165 is a waterproof portable pH and temperature meter designed for pH measurement in cheese.

The FC2423 is a penetration style pH electrode with a conical sensing tip and features an easy to clean, stainless steel sheath and single junction gel filled reference with a free diffusion sleeve style reference junction. The electrode is designed for penetration into solids and emulsions for direct measurement of pH in cheese products.

- Optional shockproof silicon rubber boot
- Specially designed to protect your instrument from damage or impact

HI710028 Orange
HI710029 Blue
HI710030 Green



Foodcare

HI99161

Portable pH Meter

for yogurt, cheese, and semi-solids

- Simultaneous pH and temperature measurements on a large dual-line LCD display
- User-friendly two button design
- Application specific probe
- Durable IP67 waterproof casing
- Watertight probe connection
- Probe condition indicator
- Automatic pH calibration at one or two points within two memorized buffer sets (standard or NIST)
- On-screen calibration tags
- mV measurement for electrode check
- Selectable temperature unit (°C or °F)
- Auto-off function
- Battery life indication and low battery detection



The HI99161 is a portable, lightweight meter with two button operation that is simple to use. It is designed specifically for use in yogurt, cheese, and semi-solids.

The meter is supplied with the FC2023 pH electrode specially designed for use in the food sector.

The FC2023 is a penetration style pH electrode with a conical sensing tip and features an easy to clean, PVDF body and double junction gel filled reference with a free diffusion sleeve style reference junction. The electrode is ideal for measurements in semisolid foods such as processed meats, soft cheeses, soups, sauces, condiments, jams, jellies, dough, ice cream and sushi rice.



- **Optional shockproof silicon rubber boot**
 - Specially designed to protect your instrument from damage or impact

HI710028 Orange
HI710029 Blue
HI710030 Green

Specifications

HI99161

pH	Range*	-2.00 to 16.00 pH / -2.0 to 16.0 pH
	Resolution	0.01 pH / 0.1 pH
	Accuracy (@25°C/77°F)	±0.02 pH / ±0.1 pH
pH-mV	Range*	±825 mV
	Resolution	1 mV
	Accuracy (@25°C/77°F)	±1 mV
Temperature	Range*	-5.0 to 105.0°C; 23.0 to 221.0°F
	Resolution	0.1°C; 0.1°F
	Accuracy (@25°C/77°F)	±0.5°C (up to 60°C), ±1.0°C (outside); ±1.0°F (up to 140°F), ±2.0°F (outside)
Additional Specifications	Temperature Compensation	automatic, from -5.0 to 105.0°C (23.0 to 221.0°F)
	Probe (included)	FC2023 preamplified pH/temperature probe with DIN connector, and 1 m (3.3') cable
	Battery Type / Life	1.5V AAA (3) approx. 1400 hours of continuous use
	Auto-off	user selectable: after 8 min, 60 min, or disabled
	Environment	0 to 50°C (32 to 122°F); RH max. 100%
	Meter Dimensions	154 x 63 x 30 mm (6.1 x 2.5 x 1.2")
	Meter Mass (with batteries)	196 g (6.91 oz.)
Case Ingress Protection Rating	IP67	
Ordering Information	<p>HI99161 is supplied with FC2023 preamplified pH/temperature probe with conical tip, Quick Connect DIN connector and 1 m (3.3') cable, pH 4.01 and 7.01 buffer sachets, HI700601 electrode cleaning solution sachets (2), 100 mL beaker, 1.5V AAA batteries (3), calibration certificate of meter, calibration certificate of probe, instruction manual, and HI710142 rugged carrying case.</p>	

* the FC2023 is limited to be used from 0 to 12 pH and from 0 to 50°C temperature (32 to 122°F).

HI99163

Portable pH Meter

and Sensor for Meat

- Simultaneous pH and temperature measurements on a large dual-line LCD display
- User-friendly two button design
- Application specific probe
- Durable IP67 waterproof casing
- Watertight probe connection
- Probe condition indicator
- Automatic pH calibration at one or two points within two memorized buffer sets (standard or NIST)
- On-screen calibration tags
- mV measurement for electrode check
- Selectable temperature unit (°C or °F)
- Auto-off function
- Battery life indication and low battery detection



Specifications

HI99163

pH	Range*	-2.00 to 16.00 pH / -2.0 to 16.0 pH
	Resolution	0.01 pH / 0.1 pH
	Accuracy (@25°C/77°F)	±0.02 pH / ±0.1 pH
	Calibration	Automatic, one or two-point selectable bufferset standard: 4.01; 7.01; 10.01 or NIST: 4.01; 6.86; 9.18
pH-mV	Range*	±825 mV
	Resolution	1 mV
	Accuracy (@25°C/77°F)	±1 mV
Temperature	Range*	-5.0 to 105.0°C; 23.0 to 221.0°F
	Resolution	0.1°C; 0.1°F
	Accuracy (@25°C/77°F)	±0.5°C (up to 60°C), ±1.0°C (outside); ±1.0°F (up to 140°F), ±2.0°F (outside)
Additional Specifications	Temperature Compensation	automatic, from -5.0 to 105.0°C (23.0 to 221.0°F)
	Probe (included)	FC2323 amplified pH/temperature probe with stainless steel blade, DIN connector, and 1 m (3.3') cable
	Battery Type / Life	1.5V AAA (3) approx. 1400 hours of continuous use
	Auto-off	user selectable: after 8 min, 60 min, or disabled
	Environment	0 to 50°C (32 to 122°F); RH max. 100%
	Meter Dimensions	154 x 63 x 30 mm (6.1 x 2.5 x 1.2")
	Meter Mass (with batteries)	196 g (6.91 oz.)
	Case Ingress Protection Rating	IP67

Ordering Information

HI99163 is supplied with FC2323 amplified pH/temperature probe with stainless steel blade, Quick Connect DIN connector and 1 m (3.3') cable, pH 4.01 and 7.01 buffer sachets, HI700630 grease and fats acid cleaning solution sachets (2), 100 mL beaker, 1.5V AAA batteries (3), calibration certificate of meter, calibration certificate of probe, instruction manual, and HI710142 rugged carrying case.

A reliable pH measurement is an important factor in meat processing. pH affects many quality factors including color, grading, tenderness, texture, and process characteristics. A direct measurement of muscle pH, deep in the muscle is the best way to determine pH.

HI99163 is a portable pH and temperature meter with a special probe, dedicated to the measurement of pH in meat processing. The meter works at cold store operating temperatures to 0°C (32°F).

The FC2323 probe has been specially designed for meat processing and comes with a removable stainless steel lance for meat/muscle penetration. The FC2323 is a penetration style pH electrode with a conical sensing tip and features an easy to clean, PVDF body and single junction gel filled reference with a free diffusion sleeve style reference junction.

A pH sensor preamplifier provides measurements impervious to noise and electrical interferences often experienced at cold temperatures with conventional pH equipment.

* the FC2323 is limited to be used from 0 to 12 pH and from 0 to 50°C temperature (32 to 122°F).

Foodcare

HI99192

Portable pH Meter

for Drinking Water

- Simultaneous pH and temperature measurements on a large dual-line LCD display
- User-friendly two button design
- Application specific probe
- Durable IP67 waterproof casing
- Watertight probe connection
- Probe condition indicator
- Automatic pH calibration at one or two points within two memorized buffer sets (standard or NIST)
- On-screen calibration tags
- mV measurement for electrode check
- Selectable temperature unit (°C or °F)
- Auto-off function
- Battery life indication and low battery detection



- Optional shockproof silicon rubber boot
- Specially designed to protect your instrument from damage or impact

HI710028 Orange
HI710029 Blue
HI710030 Green

HI99192 is a portable, lightweight pH meter that is supplied with a FC2153 pH electrode designed specifically for measuring the pH of potable waters.

The pair are ideal for on-site spot checks of drinking water. The pH of potable water is fundamental to ensure safe water quality. If the pH is too low, drinking water will be corrosive to the distribution system and water pipes in homes. If it is too high, it can reduce the effectiveness of disinfectants. The pH of water also influences aesthetic or cosmetic properties including taste, odor, and clarity. Most public water operations maintain pH between 6.5 and 8.5.

The HI99192 together with the FC2153 pH electrode solves all the problems found with standard pH systems. This specialized electrode offers numerous features that improve pH testing in drinking water. The spherical pH bulb features a low resistance pH glass that responds quickly to the sample (even at cold temperatures). It also has a refillable single junction Ag/AgCl reference that is used with a KCl electrolyte and has three ceramic junctions to ensure continuity and provide quick and reproducible measurements (even in low ionic strength waters).

Specifications

HI99192

pH	Range*	-2.00 to 16.00 pH / -2.0 to 16.0 pH
	Resolution	0.01 pH / 0.1 pH
	Accuracy (@25°C/77°F)	±0.02 pH / ±0.1 pH
pH-mV	Range*	±825 mV
	Resolution	1 mV
	Accuracy (@25°C/77°F)	±1 mV
Temperature	Range*	-5.0 to 105.0°C; 23.0 to 221.0°F
	Resolution	0.1°C; 0.1°F
	Accuracy (@25°C/77°F)	±0.5°C (up to 60°C), ±1.0°C (outside); ±1.0°F (up to 140°F), ±2.0°F (outside)
Additional Specifications	Temperature Compensation	automatic, from -5.0 to 105.0°C (23.0 to 221.0°F)
	Probe (included)	FC2153 pH electrode with internal temperature sensor, with DIN connector, and 1 m (3.3') cable
	Battery Type / Life	1.5V AAA (3) approx. 1400 hours of continuous use
	Auto-off	user selectable: after 8 min, 60 min, or disabled
	Environment	0 to 50°C (32 to 122°F); RH max. 100%
	Meter Dimensions	154 x 63 x 30 mm (6.1 x 2.5 x 1.2")
	Meter Mass (with batteries)	196 g (6.91 oz.)
	Case Ingress Protection Rating	IP67
Ordering Information	HI99192 is supplied with FC2153 pH electrode with internal temperature sensor, with Quick Connect DIN connector and 1 m (3.3') cable, pH 4.01 and 7.01 buffer sachets, HI700601 general electrode cleaning solution sachets (2), 100 mL beaker, 1.5V AAA batteries (3), calibration certificate of meter, calibration certificate of probe, instruction manual, and HI710142 rugged carrying case.	

* the FC2153 is limited to be used from 0 to 12 pH and from 0 to 70 °C temperature (32 to 158 °F).



The pH of Drinking Water

The pH of drinking water is a vital measurement. If the pH is too low, or acidic, the water will be corrosive to the distribution system and water pipes in homes. The pH of water also influences other properties including taste, odor, clarity, and efficiency of disinfection. In the United States, the pH of water is determined by a pH meter according to EPA method 150.1 and Standard Methods 4500-H.

Most drinking water plants use surface water (lakes, rivers, and streams) or groundwater as their point source. Surface water is typically lower in mineral content, which results in lower EC/TDS readings. Groundwater that has percolated through limestone, dolomite, or gypsum will have a relatively higher mineral content. Depending on location, there are sources of groundwater that can be very low in mineral content.

Measuring the pH of water that is low in minerals can be difficult. The lower the mineral content the less conductive the water will be. Low conductivity water presents a challenge since the pH meter is an electrochemical system that relies on the solution being measured to be conductive. The HI99192 uses the FC2153 amplified pH electrode. The FC2153 has three ceramic junctions in the outer reference cell that allows for pH measurement in low conductivity solutions.

* Limits will be reduced to actual sensor limits



FC2153 Amplified pH Electrode

- Built-in temperature sensor
 - For automatic compensation of temperature variations
- Refillable pH electrode
- Amplified electrode
 - For fast, stable response that is immune to electrical noise due to humidity
- Triple ceramic junction design

The HI99192 drinking water pH meter uses the glass body FC2153 amplified pH electrode. The amplified electrode provides a fast stable response that is immune to electrical noise due to humidity. The electrode contains an internal temperature probe to allow for automatic compensation for any variances in temperature. The electrolyte solution in the electrode is refillable.

An integral part of any pH electrode is the reference junction. The reference junction allows for the flow of ions located in the reference cell into the sample being measured. The ions provide for an electrical connection between the reference electrode and the indicating electrode. A standard pH electrode will use a single ceramic junction that allows for 15 to 20 $\mu\text{L}/\text{hour}$ of electrolyte to flow. The FC2153 has three ceramic junctions providing for 40 to 50 $\mu\text{L}/\text{hour}$ of electrolyte to flow. This increased flow provides a greater continuity between the reference electrode and the indicating electrode, making it suitable for water with low ionic strength. To optimize the flow from the electrode, the refill cap should be unscrewed; this allows for positive head pressure to be created, allowing for the electrolyte to flow more easily into the sample.

Foodcare

HI99151

Portable pH Meter

for Beer Analysis

- Simultaneous pH and temperature measurements on a large dual-line LCD display
- User-friendly two button design
- Application specific probe
- Durable IP67 waterproof casing
- Watertight probe connection
- Probe condition indicator
- Automatic pH calibration at one or two points within two memorized buffer sets (standard or NIST)
- On-screen calibration tags
- mV measurement for electrode check
- Selectable temperature unit (°C or °F)
- Auto-off function
- Battery life indication and low battery detection



HI99151 is a portable, microprocessor-based pH and temperature meter specifically designed for beer brewing.

It is supplied with the FC2143 rugged double junction pH electrode with a flat pH sensor profile, cloth reference junction, and titanium body perfect for brewing operations.

There are no crevices to collect solids and the pH and temperature specifications are pertinent to most brewing operations.

Together, they are versatile tools for measuring the pH in brewing operations such as mashing and wort separations, measuring the pH of the cooled wort boil, checking the fermentation pH, and checking the finished or conditioned beer.



- Optional shockproof silicon rubber boot
- Specially designed to protect your instrument from damage or impact

HI710028 Orange

HI710029 Blue

HI710030 Green

Specifications

HI99151

pH	Range*	-2.00 to 16.00 pH / -2.0 to 16.0 pH
	Resolution	0.01 pH / 0.1 pH
	Accuracy (@25°C/77°F)	±0.02 pH / ±0.1 pH
pH-mV	Range*	±825 mV
	Resolution	1 mV
	Accuracy (@25°C/77°F)	±1 mV
Temperature	Range*	-5.0 to 105.0°C; 23.0 to 221.0°F
	Resolution	0.1°C; 0.1°F
	Accuracy (@25°C/77°F)	±0.5°C (up to 60°C), ±1.0°C (outside); ±1.0°F (up to 140°F), ±2.0°F (outside)
Additional Specifications	Temperature Compensation	automatic, from -5.0 to 105.0°C (23.0 to 221.0°F)
	Probe (included)	FC2143 preamplified pH/temperature probe with DIN connector, and 1 m (3.3') cable, titanium body
	Battery Type / Life	1.5V AAA (3) approx. 1400 hours of continuous use
	Auto-off	user selectable: after 8 min, 60 min, or disabled
	Environment	0 to 50°C (32 to 122°F); RH max. 100%
	Meter Dimensions	154 x 63 x 30 mm (6.1 x 2.5 x 1.2")
	Meter Mass (with batteries)	196 g (6.91 oz.)
	Case Ingress Protection Rating	IP67
Ordering Information	<p>HI99151 is supplied with FC2143 preamplified pH/temperature probe with Quick Connect DIN connector and 1 m (3.3') cable, pH 4.01 and 7.01 buffer sachets, HI700682 electrode cleaning solution for brewing deposits sachets (2), 100 mL beaker, 1.5V AAA batteries (3), calibration certificate of meter, calibration certificate of probe, instruction manual, and HI710142 rugged carrying case.</p>	

* the FC2143 is limited to be used from 0 to 12 pH and from 0 to 80°C temperature (32 to 176°F)

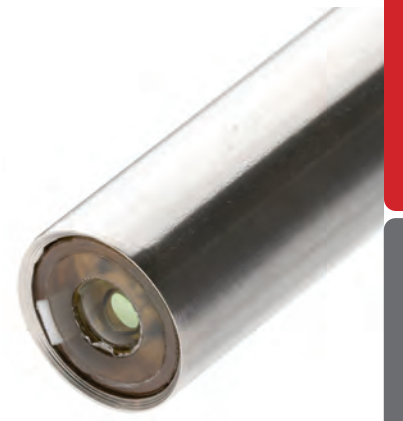

FC2143 Amplified pH Electrode

- **Amplified electrode**
 - Provides a fast, stable response that is immune to electrical noise due to static discharge
- **Maintenance free gel filled electrode**
 - No fill solution required
- **Highly durable titanium body**
- **Low temperature glass**

The HI99151 beer pH meter uses the titanium bodied FC2143 amplified pH electrode with built-in temperature sensor. The amplified electrode provides a fast, stable response that is immune to electrical noise due to static discharge. The body of the electrode is made from titanium, which provides an unbreakable structure.

The Effects of pH in Brewing

In the brewing process, the enzymes required to convert starch into sugar are pH-sensitive, with an optimal pH of 5.2 to 5.6. Different compounds are used to adjust the pH including phosphoric acid, lactic acid, and gypsum.

Wort clarity and break formation are also affected by pH. Protein coagulation occurs during wort boiling, where the optimum pH is around pH 4.9, though a common boil pH is pH 5.2. A pH that is too high will not only inhibit coagulation, but also promote browning due to the interaction of amino acids and reducing sugars.

Hop utilization during the wort boil is also affected by pH; as pH increases, the solubility of hop resins increase. A high pH also increases the release of tannins, resulting in a harsher taste, and tends to favor elevated microbial activity.

Foodcare

HI99111

Portable pH Meter

for Wine Analysis

- Simultaneous pH and temperature measurements on a large dual-line LCD display
- User-friendly two button design
- Application specific probe
- Durable IP67 waterproof casing
- Watertight probe connection
- Probe condition indicator
- Automatic pH calibration at one or two points within two memorized buffer sets (standard or NIST)
- On-screen calibration tags
- mV measurement for electrode check
- Selectable temperature unit (°C or °F)
- Auto-off function
- Battery life indication and low battery detection



HI99111 is a portable, microprocessor-based pH and temperature meter. Main features include: extended pH and temperature ranges; waterproof and compact casing; large dual-line display; low battery detection; automatic pH calibration at one or two points within two memorized buffer sets (standard or NIST); selectable temperature unit (°C or °F).

The FC10483 pH probe features an open junction with Clogging Prevention System (CPSTM) technology, has a built-in temperature sensor for simultaneous temperature compensated pH and temperature readings, and also contains a pH sensor preamplifier to provide measurements impervious to noise and electrical interferences.

- Optional shockproof silicon rubber boot
- Specially designed to protect your instrument from damage or impact

HI710028 Orange
HI710029 Blue
HI710030 Green



Specifications

HI99111

pH	Range*	-2.00 to 16.00 pH / -2.0 to 16.0 pH
	Resolution	0.01 pH / 0.1 pH
	Accuracy (@25°C/77°F)	±0.02 pH / ±0.1 pH
pH-mV	Range*	±825 mV
	Resolution	1 mV
	Accuracy (@25°C/77°F)	±1 mV
Temperature	Range*	-5.0 to 105.0°C; 23.0 to 221.0°F
	Resolution	0.1°C; 0.1°F
	Accuracy (@25°C/77°F)	±0.5°C (up to 60°C), ±1.0°C (outside); ±1.0°F (up to 140°F), ±2.0°F (outside)
Additional Specifications	Temperature Compensation	automatic, from -5.0 to 105.0°C (23.0 to 221.0°F)
	Probe (included)	FC10483 preamplified pH and temperature probe with a flat tip, DIN connector, and 1 m (3.3') cable
	Battery Type / Life	1.5V AAA (3) approx. 1400 hours of continuous use
	Auto-off	user selectable: after 8 min, 60 min, or disabled
	Environment	0 to 50°C (32 to 122°F); RH max. 100%
	Meter Dimensions	154 x 63 x 30 mm (6.1 x 2.5 x 1.2")
	Meter Mass (with batteries)	196 g (6.91 oz.)
Case Ingress Protection Rating	IP67	
Ordering Information	<p>HI99111 is supplied with FC10483 pH/temperature probe with flat tip and Quick Connect DIN connector with 1m (3.3') cable, pH 3.00 and 7.01 buffer sachets, HI700635 Cleaning solution for wine deposits sachets (2), HI700636 Cleaning solution for wine stains (2), 100 mL beaker, 1.5V AAA batteries (3), calibration certificate of meter, calibration certificate of probe, instruction manual, and HI710142 rugged carrying case.</p>	

* the FC10483 is limited to be used from 0 to 12 pH and from 0 to 80°C temperature (32 to 176 °F).



FC10483 pH electrode

- PE sleeve for cleaning
- Refillable pH electrode
- Clogging prevention system (CPS™)

The HI99111 portable pH meter for wine uses the glass body FC10483 pH electrode with Hanna's unique Clogging Prevention System (CPS™). This electrode provides a fast stable response and resists clogging. The electrolyte solution in the electrode is refillable.

An integral part of any pH electrode is the reference junction. The reference junction allows for the flow of ions located in the reference cell into the sample being measured. The ions provide for an electrical connection between the reference electrode and the indicating electrode. A standard pH electrode will use a single ceramic junction; however, the CPS™ (Clogging Prevention System) is an innovation in electrode technology. Conventional pH electrodes use ceramic junctions that clog quickly when used in wine. When the junction is clogged, the electrode does not function. CPS™ technology utilizes the porousness of ground glass coupled with a PE sleeve to prevent clogging of the junction. The ground glass allows proper flow of the liquid, while the PE sleeve repels dirt. As a result, pH electrodes with CPS™ stay fresh up to 20 times longer than conventional electrodes.

To optimize the flow from the electrode the refill cap should be unscrewed so that it is open. This allows for positive head pressure to be created allowing for the electrolyte to drain more easily from the reference electrode.

The Importance of pH in Wine Making

The pH of wine is important to determine because it will affect the quality of the final product in terms of taste, color, oxidation, chemical stability, and other factors. Generally in winemaking, the higher the pH reading, the lower amount of acidity in the wine. Three important factors in determining the pH of wine include the ratio of malic acid to tartaric acid, the amount of potassium, and the total amount of acid present.

Most wines optimally have a pH between 2.9 and 4.0, with values differing based on the type of wine. Values above pH 4.0 indicate that the wine may spoil quickly and be chemically unstable. Lower pH values allow the wine to stay fresher for a longer period and retain its original color and flavor. High pH wine is more likely to breed bacteria and become unsuitable to drink.

For finished white wines, the ideal pH is between pH 3.00 and pH 3.30, while the final pH for red wine is ideally between pH 3.40 and pH 3.50. The optimal pH before the fermentation process is between pH 2.9 and pH 4.0. The pH of wine therefore not only affects the color of wine, but also the oxidation, yeast fermentation, protein stability, and bacterial growth and fermentation.

Portable pH Meter

for Skin and Scalp

- Simultaneous pH and temperature measurements on a large dual-line LCD display
- User-friendly two button design
- Application specific probe
- Durable IP67 waterproof casing
- Watertight probe connection
- Probe condition indicator
- Automatic pH calibration at one or two points within two memorized buffer sets (standard or NIST)
- On-screen calibration tags
- mV measurement for electrode check
- Selectable temperature unit (°C or °F)
- Auto-off function
- Battery life indication and low battery detection



HI99181 is a light weight, portable, pH, and temperature meter supplied with a specially designed pH electrode intended for the direct determination of pH on skin and scalp.

Researchers monitoring the compatibility between skin and cosmetics or pharmaceuticals use pH as essential marker of compatibility. The skin mantle has an acidic pH, ranging from pH 4 to 6. The acidic pH is a deterrent toward harmful microbes, pollution, and toxins. Age, genetics, sweat, and moisture can alter the pH of skin. Products are constantly created to restore the pH balance of skin and a reliable pH measurement of skin provides the scientific metrics.

The HI99181 portable pH meter together with a HI14143/50 combination pH electrode (when immersed in a drop of water on the skin surface), can determine the pH of the skin with high accuracy and repeatability.

The HI14143/50 probe offers numerous features that improve pH testing for skin measurements. The flat tip of the HI14143/50 provides optimal contact between the sample and the sensor.

- **Optional shockproof silicon rubber boot**
 - Specially designed to protect your instrument from damage or impact

HI710028 Orange
HI710029 Blue
HI710030 Green



Specifications

HI99181

pH	Range*	-2.00 to 16.00 pH / -2.0 to 16.0 pH
	Resolution	0.01 pH / 0.1 pH
	Accuracy (@25°C/77°F)	±0.02 pH / ±0.1 pH
pH-mV	Calibration	Automatic, one or two-point selectable bufferset standard: 4.01; 7.01; 10.01 or NIST: 4.01; 6.86; 9.18
	Range*	±825 mV
	Resolution	1 mV
Temperature	Accuracy (@25°C/77°F)	±1 mV
	Range*	-5.0 to 105.0°C; 23.0 to 221.0°F
	Resolution	0.1°C; 0.1°F
Additional Specifications	Accuracy (@25°C/77°F)	±0.5°C (up to 60°C), ±1.0°C (outside); ±1.0°F (up to 140°F), ±2.0°F (outside)
	Temperature Compensation	automatic, from -5.0 to 105.0°C (23.0 to 221.0°F)
	Probe (included)	HI14143/50 preamplified pH and temperature probe with flat tip 50 mm-long body, DIN connector, and 1 m (3.3') cable
Ordering Information	Battery Type / Life	1.5V AAA (3) approx. 1400 hours of continuous use
	Auto-off	user selectable: after 8 min, 60 min, or disabled
	Environment	0 to 50°C (32 to 122°F); RH max. 100%
	Meter Dimensions	154 x 63 x 30 mm (6.1 x 2.5 x 1.2")
	Meter Mass (with batteries)	196 g (6.91 oz.)
	Case Ingress Protection Rating	IP67
Ordering Information		HI99181 is supplied with HI14143/50 pH/temperature probe with flat tip, 50 mm-long body, Quick Connect DIN connector and 1m (3.3') cable, pH 4.01 and 7.01 buffer sachets, HI700620 cleaning and disinfection solution sachet for skin residuals, HI700621 cleaning solution sachet for skin grease and sebum, 100 mL beaker, 1.5V AAA batteries (3), calibration certificate of meter, calibration certificate of probe, instruction manual, and HI710142 rugged carrying case.

* the HI14143/50 is limited to be used from 0 to 12 pH and from 0 to 50 °C temperature (32 to 122 °F).

HI8424

General Purpose pH/mV Meter

- Automatic Temperature Compensation (ATC)
- Waterproof
 - Compact, heavy-duty, and waterproof protected casing
- Two-point calibration
 - Automatic one or two-point calibration
- HOLD function
 - Holds stabilized pH value on LCD
- Battery indicator
 - Low battery indicator

The HI8424 is a highly accurate, portable pH/mV meter. It is one of the most popular pH meters on the market. This instrument is able to perform pH, mV, and temperature measurements with a high degree of accuracy and fast response.

Calibration is automatic at one or two points, with three memorized buffer values (pH 4.01, pH 7.01 and pH 10.01). Once the instrument has been calibrated, the buffer values used during calibration are displayed with tags on the LCD. This feature keeps users informed of the current calibration and helps to avoid taking measurements that are out of range.

Users can exchange the pH probe for an ORP probe to obtain ORP readings in the mV range. The HI8424 also offers measurements in °C and °F and has an auto-off feature to preserve battery life.



Specifications

HI8424

pH*	Range	-2.00 to 16.00 pH
	Resolution	0.01 pH
	Accuracy	±0.01 pH
	Calibration	one or two-point, three standard buffers available (4.01, 7.01, 10.01)
	Temperature Compensation	automatic from -20.0 to 120.0°C (-4.0 to 248.0°F) or manual without temperature probe
mV	Range	±699.9 mV; ±1999 mV
	Resolution	0.1 mV; 1 mV
	Accuracy	±0.2 mV; ±1 mV
Temperature*	Range	-20.0 to 120.0°C; -4.0 to 248.0°F
	Resolution	0.1°C; 0.1°F
	Accuracy	±0.4°C; ±0.8°F
Additional Specifications	pH Electrode	HI1230B PEI body pH electrode with BNC connector and 1 m (3.3') cable (included)
	Temperature Probe	HI7662 stainless steel temperatures probe with 1 m (3.3') cable (included)
	Slope / Offset Calibration	from 75 to 110% / ±1 pH
	Input Impedance	10 ¹² Ohm
	Battery Type / Life	9V / approximately 150 hours of continuous use
	Auto-off	after 20 minutes of non-use (can be disabled)
	Environment	0 to 50°C (32 to 122°F); RH max 100%
	Dimensions / Weight	164 x 76 x 45 mm (6.5 x 3.0 x 1.8") / 180 g (6.3 oz.)
Ordering Information	HI8424 is supplied with HI1230B pH electrode, HI7662 temperature probe, HI70004 pH 4.01 buffer solution sachet, HI70007 pH 7.01 buffer solution sachet, HI700601 electrode cleaning solution sachets (2), battery, protective case, and instructions.	
Accessories	HI710015 blue shockproof rubber boot	

* Limits will be reduced to actual sensor limits

Analog pH/mV Meters

- Automatic Temperature Compensation (ATC)
- Two-point Calibration
- Water-resistant
 - Compact, heavy-duty casing
- Battery indicator
 - Low battery indicator
- Auto shut-off

The HI83141-1 and HI8314-1 are portable pH/mV meters designed to be accurate, reliable and easy to use.

The HI8314-1 uses the HI1217-1 pre-amplified pH electrode with built-in internal temperature sensor.

The HI83141-1 uses the HI1230B pH electrode and HI7669-1 temperature probe using separate connections.

Manual calibration is performed at one or two points by adjusting the trimmers on the front panel. Capable of measuring pH/mV and temperature, these meters are great for field work, providing one meter for multiple uses.

This instrument is ideal for applications that require a custom calibration point. Manual calibration can be extremely useful in order to achieve better accuracy.

These instruments can also be used for ORP measurements with the optional probes below:

HI83141-1: **HI3131B**

HI8314-1: **HI3618D-1**



Specifications	HI83141-1	HI8314-1	
pH*	Range	0.00 to 14.00 pH	0.00 to 14.00 pH
	Resolution	0.01 pH	0.01 pH
	Accuracy	±0.01 pH	±0.01 pH
	Calibration	manual, two-point, via trimmers	
	Temperature Compensation	automatic, 0 to 70°C (32 to 158 °F)	
mV	Range	±1999 mV	±1999 mV
	Resolution	1 mV	1 mV
	Accuracy	±1 mV	±1 mV
Temperature*	Range	0.0 to 100.0°C; 32.0 to 212.0°F	0.1°C; 0.1°F
	Resolution	0.1°C; 0.1°F	0.1°C; 0.1°F
	Accuracy	±0.4°C; ±0.8F (excluding probe error)	
Additional Specifications	pH Electrode	HI1230B PEI body pH electrode with BNC connector and 1 m (3.3') cable (included)	HI1217-1 PEI body, pre-amplified pH electrode with internal temperature sensor, DIN connector, and 1 m cable (included)
	Temperature Probe	HI7669-1 stainless steel temperature probe, BNC connector (included)	-
	Slope / Offset Calibration	from 80 to 110% / ±1 pH	
	Battery Type / Life	9V / approximately 450 hours of continuous use	
	Auto Shut-Off	after 8 minutes of non-use	
	Environment	0 to 50°C (32 to 122°F); RH max 95% non-condensing	
	Dimensions	145 x 80 x 36 mm (5.7 x 3.1 x 1.4")	
	Weight	230 g (8.1 oz.)	
	Ordering Information	<p>HI83141-1 is supplied with HI1230B pH electrode and HI7662 temperature probe, HI70004 pH 4.01 buffer solution sachet, HI70007 pH 7.01 buffer solution sachet, HI700601 electrode cleaning solution sachets (2), calibration screwdriver, battery, protective case, and instructions.</p> <p>HI8314-1 is supplied with HI1217-1 pH electrode, HI70004 pH 4.01 buffer solution sachet, HI70007 pH 7.01 buffer solution sachet, HI700601 electrode cleaning solution sachets (2), calibration screwdriver, battery, protective case, and instructions.</p>	
	Accessories	<p>HI710007 blue shockproof rubber boot</p> <p>HI710008 orange shockproof rubber boot</p>	

* Limits will be reduced to actual sensor limits

HI931001 · HI9310014

pH/mV Precision Simulators

- Simulate pH or ORP sensors to troubleshoot your meter
- Simulate temperature
- Provided with universal BNC connector

Sometimes it is difficult to recognize whether a particular malfunction is due to the meter or the electrode. By simply connecting HI931001 or HI9310014 (Pool Line) to your meter's input socket and turning the dials, pH readings can be simulated from 0 to 14 pH in 0.01 steps. The output signals all correspond to pH values at 25°C.

For the mV range, these meters can simulate output from -1000 to +1000 mV in 1 mV steps.



*Pool
Line*

Specifications	HI931001	HI9310014
pH*	Range	0.00 to 14.00 pH
	Resolution	0.01 pH
	Accuracy	±0.01 pH
mV	Range	-1000 to 1000 mV
	Resolution	1 mV
	Accuracy	±1 mV
Additional Specifications	Impedance Test	-
	Temperature Compensation	all output values are simulated at 25°C
	Battery Type / Life	9V / approximately 500 hours of use
	Weight	320 g (11.3 oz.)
	Environment	0 to 50°C (32 to 122°F); RH max 95%
	Dimensions	185 x 82 x 53 mm (7.3 x 3.2 x 2.1")
Ordering Information	HI931001, and HI9310014 are supplied with HI7858/1 BNC/BNC coaxial cable	
Accessories	HI710009 Blue shockproof rubber boot	

* Limits will be reduced to actual sensor limits