

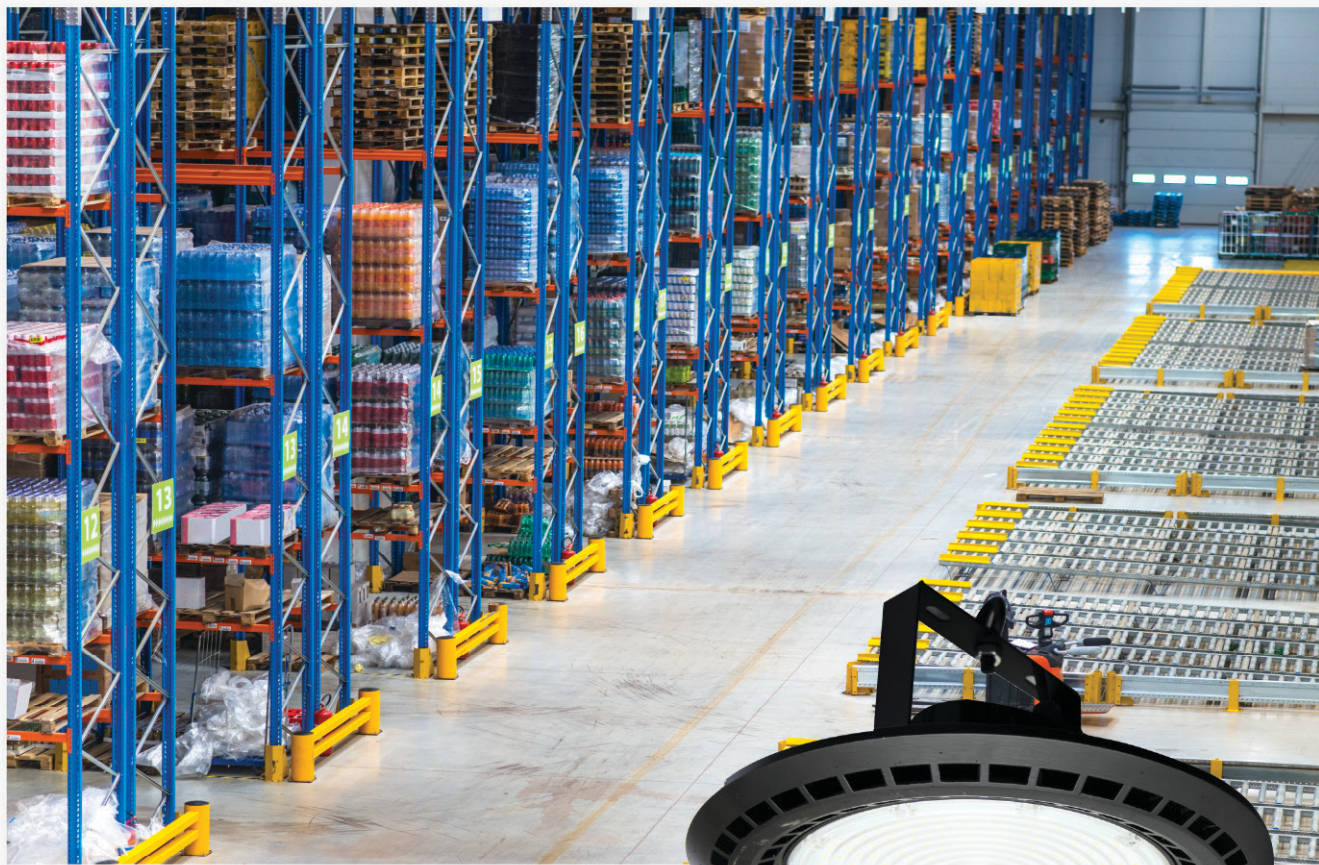

LED Industrial & Outdoor

Highbay
Street Light
Floodlight Slim



LED Highbay

This LED Highbay lighting with superior lumen output extremely endurance with IP65 save on maintenance costs and provide ample illumination for your high ceiling and multiple application : Both indoor and Outdoor use

- Workshop
- Warehouse
- Industrial
- Commercial

DIMENSION

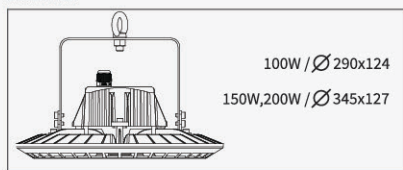

ENERGY SAVING



Non-Dimmable

LED 1955-2551
TTL

Surge Protection
3kV

Product code	Voltage (V)	Rated Wattage (W)	Luminous Flux (lm)	Efficacy (lm/W)	Color Temperature	Color Rendering Index (Ra)	Power Factor	Beam Angle	Lifespan (Hrs.)
S-HB10065C-1	220-240V	100	10000	100	6500K	80	0.9	120°	30,000
S-HB15065C-1	220-240V	150	15000	100	6500K	80	0.9	120°	30,000
S-HB20065C-1	220-240V	200	20000	100	6500K	80	0.9	120°	30,000

Operation temperature : -25°C to 45°C



LED Street Light

LED Street Light maximum light and good light distribution durable material and good ventilation. base on a 50,000 hours



DIMENSION

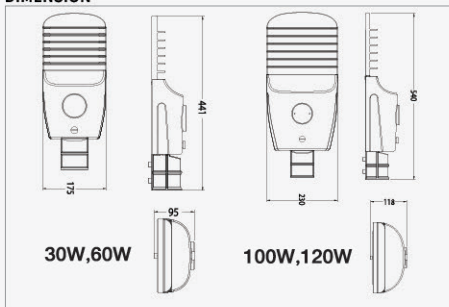

(mm)

EQUIVALENT

70W/100W/150W/250W



30W/60W/100W/120W

ENERGY SAVING



Non-Dimmable



Meanwell 1955-2551 TLLC



Surge Protection 100W,120W



Surge Protection 120W

Product code	Voltage (Vac)	Rated Wattage (W)	Luminous Flux (lm)	Efficacy (lm/W)	Color Temperature	Color Rendering Index (Ra)	Power Factor	Beam Angle	Lifespan (Hrs.)
S-ST03057E-2	180-277	30	3600	120	5700K	80	0.90	70° x 140°	50,000
S-ST06057E-2	180-277	60	7200	120	5700K	80	0.95	70° x 140°	50,000
S-ST10057E-2	180-277	100	12000	120	5700K	80	0.95	70° x 140°	50,000
S-ST12057E-2	180-277	120	14400	120	5700K	80	0.95	70° x 140°	50,000

Operation temperature : -50°C to 45°C

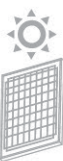



LED Street Light

New LED Street Light come with high efficacy 100 lm/W for 30W and 50W models. The lifespan base on a 30,000 hours life and 3kV surge protection. The light weight is good for convenient installation. Suitable for outdoor use with IP66.

DIMENSION



(mm)

EQUIVALENT

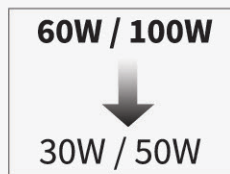

Compare to HPS (high pressure sodium lamp)

ENERGY SAVING



Non-Dimmable

NDP 1955-2551
TTLIC

Surge Protection
3kV

Product code	Voltage (Vac)	Rated Wattage (W)	Luminous Flux (lm)	Efficacy (lm/W)	Color Temperature	Color Rendering Index (Ra)	Power Factor	Beam Angle	Lifespan (Hrs.)
S-ST03065F-1	220-240	30	3000	100	6500K	80	0.95	70° x145°	30,000
S-ST05065F-1	220-240	50	5000	100	6500K	80	0.95	70° x145°	30,000

Operation temperature : -40°C to 50°C



LED Floodlight Slim

Brand new series LED Floodlight has a wider power option from 20W to 100W. Comes with bracket light weight design. Optimal lighting, IP65 rating, suitable for indoor and outdoor lighting fixtures to give you a bright and safe night. Fit for landscape lighting, garden, building lighting, hotels, residential, and other outdoor place for atmosphere decorate.



DIMENSION

	123x88 (20W) 150x110 (30W) 200x160 (50W) 300x205 (100W)
---	--

(mm)

EQUIVALENT

MH30W/MH45W/MH75W/MH160W
↓
20W/30W/50W/100W

Compare to Metal Halide

ENERGY SAVING

ENERGY SAVING
39%/39%/39%/43%
SAVES MONEY



Non-Dimmable



180 1955-2551
TTLT



IP 65



Surge Protection
20W,30W



Surge Protection
50W,100W

Product code	Voltage (Vac)	Rated Wattage (W)	Luminous Flux (lm)	Efficacy (lm/W)	Color Temperature	Color Rendering Index (Ra)	Power Factor	Beam Angle	Lifespan (Hrs.)
S-FD02030C-2	220-240	20	1,800	90	3000K	80	0.9	120°	20,000
S-FD02065C-2	220-240	20	1,900	95	6500K	80	0.9	120°	20,000
S-FD03030C-2	220-240	30	2,700	90	3000K	80	0.9	120°	20,000
S-FD03065C-2	220-240	30	2,850	95	6500K	80	0.9	120°	20,000
S-FD05030C-2	220-240	50	4,500	90	3000K	80	0.9	120°	20,000
S-FD05065C-2	220-240	50	4,750	95	6500K	80	0.9	120°	20,000
S-FD10030C-2	220-240	100	8,500	85	3000K	80	0.9	120°	20,000
S-FD10065C-2	220-240	100	9,000	90	6500K	80	0.9	120°	20,000

Operation temperature : -40°C to 45°C

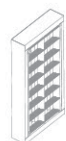



LED Solar Cell

- Street Light
- Floodlight High-Force
- Floodlight 3 Colour Change
- Squid Light
- Garden Light UFO
- Wall Light
- Twin Light
- Dual Light
- Orca Light
- Smart Orca Light



LED Solar Street Light Motion Sensor

LED Solar Street Light come with high energy saving from solar power. The lifespan base on a 20,000 hours life. The light weight is good convenient for installation. Suitable for outdoor use with IP65

DIMENSION

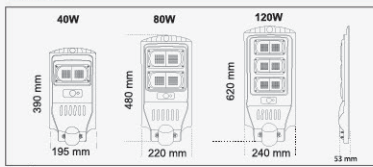

(mm)

ENERGY SAVING



Pipe size
48 mm

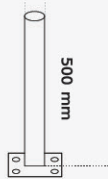

FREE



Motion sensor



IP 65

Product code	Rated Wattage (W)	Luminous Flux (lm)	LiFePO4 3.2V Battery	Solar Panel Power	Color Temperature	Color Rendering Index (Ra)	Beam Angle	Lifespan (Hrs.)
S-ST04065F-1SL	40	1100	5000mAh	8W/6V	6500K	70	150°	20,000
S-ST08065F-1SL	80	1800	10000mAh	12W/6V	6500K	70	150°	20,000
S-ST12065F-1SL	120	2040	15000mAh	15W/6V	6500K	70	150°	20,000





LED Solar Street Light

LED Solar Street Light 100W, 200W (without motion sensor)
The lifespan base on a 25,000 hours life. Working time 12 hrs.
The light weight is good convenient for installation.
Suitable for outdoor use with IP65.

- Waterproof, dustproof, IP65 standard
- High quality LED chips
- Long service life
- Street lighting - Pathway lighting
- On-Off automatically

DIMENSION

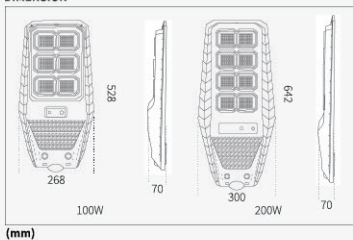

ENERGY SAVING



Polycrystalline Silicon

Pipe size
48 mm



**IP
65**

Product code	Rated Wattage (W)	Luminous Flux (lm)	LiFePO4 3.2V Battery	Solar Panel Power	Color Temperature	Color Rendering Index (Ra)	Beam Angle	Lifespan (Hrs.)
S-ST10065F-2SL	100	2080	10000mAh	10W/5V	6500K	80	150°	25,000
S-ST20065F-2SL	200	2610	15000mAh	15W/5V	6500K	80	150°	25,000



LED Solar Floodlight High-Force

LED Solar Floodlight High-Force combined with solar panel battery. Working time up to 12 hours, Charging time 4-8 hours. Integrated the light by remote control.

Functions

- 3 hours working time.
- 5 hours working time.
- 8 hours working time.
- Auto mode

DIMENSION

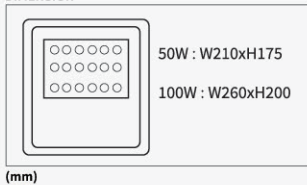

(mm)

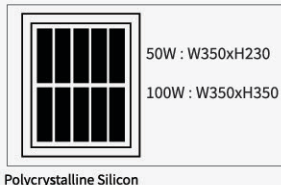

ENERGY SAVING



IP 65

Product code	Rated Wattage (W)	Luminous Flux (lm)	LiFePO4 3.2V Battery	Solar Panel Power	Color Temperature	Color Rendering Index (Ra)	Beam Angle	Lifespan (Hrs.)
S-FD050659-2SL	50	1200	6000mAh	8W/5V	6500K	70	90°	30,000
S-FD100659-2SL	100	1800	12000mAh	15W/5V	6500K	70	90°	30,000

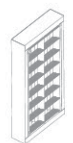

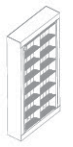

LED Solar Floodlight

3 Colour Change

LED Solar Floodlight 3 colour in one lamp
Warm White , Cool White and Daylight.
No electricity bills with solar energy.
Bright all night come with remote control.
You can set the on-off time, adjust the brightness level.

- Colour change
- Auto mode
- Set time 3 hrs, 5 hrs, 8 hrs

3 Colour Change

Daylight / Cool White / Warm White

DIMENSION

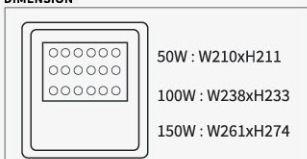

(mm)

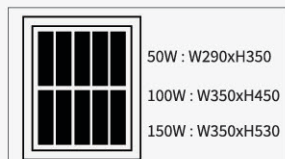

Polycrystalline Silicon

ENERGY SAVING



Product code	Rated Wattage (W)	Luminous Flux (lm)	LiFePO4 3.2V Battery	Solar Panel Power	Color Temperature	Color Rendering Index (Ra)	Beam Angle	Lifespan (Hrs.)
S-FD050009-1SL	50	1680	12000mAh	12W/6V	3000K/4000K/6500K	70	90°	30,000
S-FD100009-1SL	100	2100	18000mAh	20W/6V	3000K/4000K/6500K	70	90°	30,000
S-FD150009-1SL	150	2400	24000mAh	25W/6V	3000K/4000K/6500K	70	90°	30,000



LED Solar Squid Light

Squid Lure Lamp Blue light produces a deeper beam than green light. Makes an excellent lure for squid. Save energy with solar energy and waterproof, dustproof in addition. Can also be used as a decorative light in the garden or buildings as well

Functions

- 3 hours working time.
- 5 hours working time.
- 8 hours working time.
- Auto mode

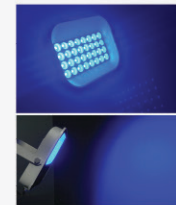
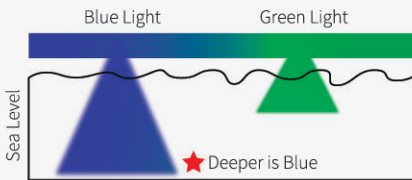

DIMENSION

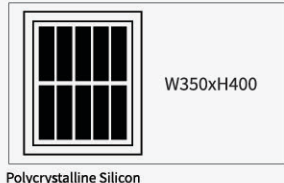
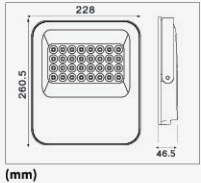

ENERGY SAVING



Product code	Rated Wattage (W)	Luminous Flux (lm)	Battery	Solar Panel Power	Color Temperature	Color Rendering Index (Ra)	Beam Angle	Lifespan (Hrs.)
S-FL100DBC-1SL	100	-	3.2V/24000mAh	20W/6V	Deep Blue	-	120°	30,000

Operation temperature : -20°C to 50°C





Remote Control

LED Solar Garden Light UFO

LED SOLAR GARDEN 450W suitable for garden decoration or as a walkway light is great. Light up all night or use it as a mode the motion sensor illuminates when moving conveniently and comes with a remote can be controlled remotely.

- Waterproof, dustproof, IP65 standard
- High quality LED chips
- Long service life
- Street lighting - Pathway lighting
- On-Off automatically



DIMENSION

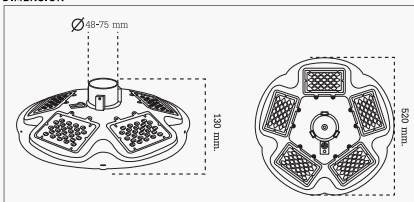

(mm)

Polycrystalline Silicon

Pipe Size

Ø 48-75 mm

**IP
65**

Product code	Rated Wattage (W)	Luminous Flux (lm)	LiFePO4 3.2V Battery	Solar Panel Power	Color Temperature	Color Rendering Index (Ra)	Beam Angle	Lifespan (Hrs.)
S-GDN02B-SL	450	4950	15000mAh	6V/25W	6500K	80	120°	25,000





LED Solar Wall Light

Integrated design of PIR motion sensor and night sensor.
Recharged by sunlight and store power for overnight lighting.
Over 7 hours lighting time after one day charge.
Waterproof IP44 and IP 65 durable and intelligent energy-saving

S-WLL08B-SL (WW)
S-WLL07B-SL (DL)

RLDPG00765CTH2



DIMENSION

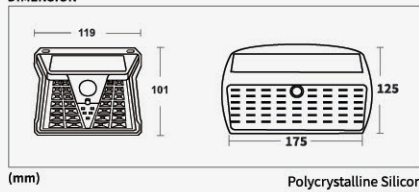

ENERGY SAVING

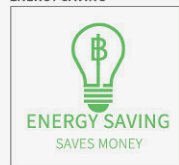

Product code	Rated Wattage (W)	Luminous Flux (lm)	Battery	Color Temperature	Color Rendering Index (Ra)	Beam Angle	IP	Lifespan (Hrs.)
S-WLL08B-SL	2.5	230	3.2V/1200mAh	3000K	70	120°	44	15,000
S-WLL07B-SL	2.5	250	3.2V/1200mAh	6500K	70	120°	44	15,000
RLDPG00765CTH2	7	900	3.2V/3000mAh	6500K	70	120°	65	35,000

Operation temperature : -20°C to 40°C





LED Solar Twin Light

LED Solar Twin Light 7W, Energy saving with solar energy.
Daylight 6500K brightness with twin light
adjustable the angle of light freely. Suitable for outdoor using with IP65.

- Mode 1 : Dim light on automatically,
100% brightness on detect senses motion (30 sec delay time).
Without motion for 30sec back to dim light
- Mode 2 :100% Brightness light on when it senses motion
(30 seconds delay time). Without motion for more than 30 seconds, the light turns off.
- Mode 3 : Always dim light on 4 hours

DIMENSION

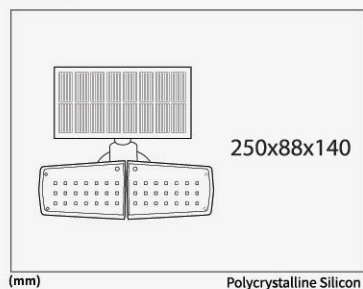

IP
65

Product code	Rated Wattage (W)	Luminous Flux (lm)	LiFePO4 3.7V Battery	Color Temperature	Color Rendering Index (Ra)	Beam Angle	Lifespan (Hrs.)
S-WLL03B-SL	7	450	3000mAh	6500K	70	120°	25,000

Operation temperature : -20°C to 40°C



LED Solar Dual Light

LED Solar Dual Light 4W, Energy saving with solar energy.
2 ways light with daylight 6500K and warm white 3000K brightness.
Suitable for outdoor using with IP65.

- Mode 1: Motion Sensor + Light OFF (back light on)
- Mode 2: Motion Sensor + Dim Light (back light on)

DIMENSION

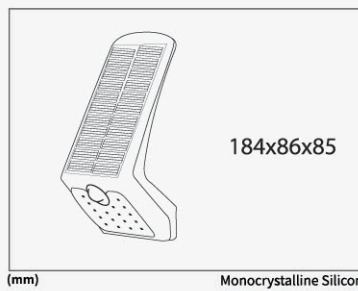

ENERGY SAVING



🔊 Hold press 5 sec.

🔴 A Side installation (DL)

🟢 B Side installation (WW)

🔊 1 Press for change mode



Mode 1



Mode 2



Product code	Rated Wattage (W)	Luminous Flux (lm)	Battery	Color Temperature	Color Rendering Index (Ra)	Beam Angle	Lifespan (Hrs.)
S-WLL04B-SL	4	440	3.7V/1500mAh	3000K/6500K	75	120°	35,000

Operation temperature : -20°C to 40°C



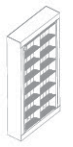

LED Solar Orca Light

LED Solar ORCA Light 7W, Energy saving with solar power.
Daylight 6500K brightness. Suitable for outdoor using with IP65.
Easy installation and using with 4 modes function.

- Mode 1: Full brightness when people passed until walked out last 15S then light off
- Mode 2: Always keep brightness when no people passed all night, when people passed will switch to full brightness, lasts 15S walked out PIR range switch to weak brightness
- Mode 3: Always keep weak brightness all night without PIR sensor
- Mode 4: Emergency mode: Press hold 5sec full brightness until 0% battery.

DIMENSION

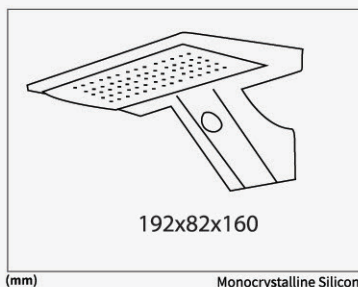

Product code	Rated Wattage (W)	Luminous Flux (lm)	Battery	Color Temperature	Color Rendering Index (Ra)	Beam Angle	Lifespan (Hrs.)
S-WLL05B-SL	7	770	3.7V/2600mAh	6500K	75	120°	35,000

Operation temperature : -20°C to 40°C



LED Smart Orca Light

LED Smart Orca Light convenient with remote control
3 lights in one lamp, Warm White, Cool White and Daylight.
And there are also 4 modes to choose from, will be bright all night or
Light when there is movement, it can be done. Waterproof, dustproof with IP65.

- *Motion sensor + Light OFF
- *Motion sensor + Dim Light
- ⌚ Always Dim Light
- 🔴 * Emergency

3 COLOUR CHANGE

- WARM WHITE
- COOL WHITE
- DAYLIGHT

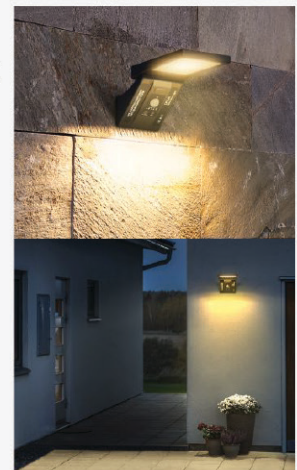

DIMENSION

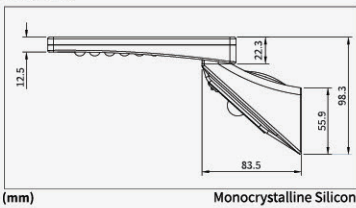

ENERGY SAVING



Press 1 time for mode 1-3
Hold 5 sec. for mode 4



GREEN : Battery Full



RED : Battery Charging

*Only USB Charging

IP 65

Product code	Rated Wattage (W)	Luminous Flux (lm)	Battery	Color Temperature	Color Rendering Index (Ra)	Beam Angle	Lifespan (Hrs.)
S-WLL09B-SL(O)	5	500	3.7V/1500mAh	3000K/4000K/6500K	80	75°x140°	35,000

Operation temperature : -25°C to 40°C



Fluorescent Lamp

Black Light Fluorescent
UV-C Germicidal Lamp



Black Light Fluorescent

This lamp employs photochemical and scintillation action to efficiently radiate near-ultraviolet rays (at a peak wavelength of 252 nm) while emitting only a small amount of visible light. Since near-ultraviolet rays attract most nocturnal flying insects, this lamp can be used as the light source in insect traps.

DIMENSION

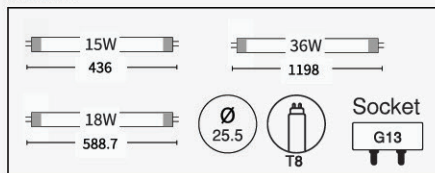

(mm)

Product code	Voltage (Vac)	Rated Wattage (W)	Color Temperature	Average Wavelength Spectrum	Beam Angle	Lifespan (Hrs.)
SHI FL15W/T8/BL TH2	220-240	15	Black light (white)	UVA 365nm	360°	8,000
SHI FL18W/T8/BL TH2	220-240	18	Black light (white)	UVA 365nm	360°	10,000
SHI FL36W/T8/BL TH2	220-240	36	Black light (white)	UVA 365nm	360°	10,000





Black Light Blue Fluorescent

The black light blue use a special glass filter that absorbs almost visible light and passes near ultra-violet energy. There are many industrial applications for these lamps, photo-exposure and chemical reactions, for example. Use is also possible for selecting minerals by their fluorescence. Since near-ultraviolet rays attract most nocturnal flying insects, this lamp can be used as the light source in insect traps.

DIMENSION

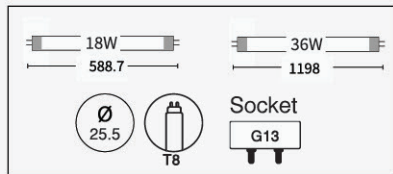

(mm)

Product code	Voltage (Vac)	Rated Wattage (W)	Color Temperature	Beam Angle	Lifespan (Hrs.)
SHI FL18W/T8/BLB TH1	220-240	18	Black light (Blue)	360°	10,000
SHI FL36W/T8/BLB TH1	220-240	36	Black light (Blue)	360°	10,000



UV-C Germicidal Lamp

UV-C Lamp the peak performance of wavelenth is 280 nm. Made from high quality quartz glass. Which is a proven disinfectant against harmful visuses, becteria, molds and spores. Where it needs to be Restaurant, Shopping Malls, Water, Medical, Movie theater, Office, Hospital. Including to food's processing industry.

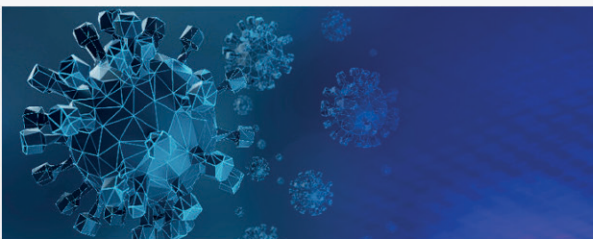

ใช้ได้กับ Magnetic Ballast และ Electronic Ballast*

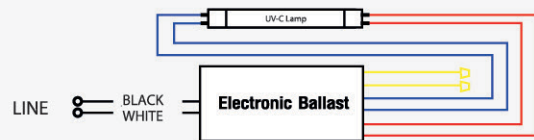
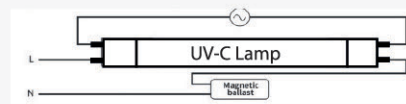

*T5 8W Should use with Electronic Ballast

DIMENSION

G5		G13	
8W = T5/Ø16x302	15W = T8/Ø28x451	18W = T8/Ø28x604	30W = T8/Ø28x908
	36W = T8/Ø28x1213		

(mm)

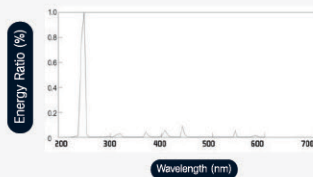

Product Specifications

Product name	Wattage (W)	Wavelength (nm)	UV Irradiance ($\mu\text{W}/\text{cm}^2$)	Life time (Hours)
SHI FL08W/T5/UV-C TH1	8	253.7	22	6,000
SHI FL15W/T8/UV-C TH1	15	253.7	50	8,000
SHI FL18W/T8/UV-C TH1	18	253.7	62	8,000
SHI FL30W/T8/UV-C TH1	30	253.7	100	8,000
SHI FL36W/T8/UV-C TH1	36	253.7	135	8,000

WARNING UV-C emitted from this product. Avoid eye and skin exposure to unshielded product. Follow installation instructions and user manual.

ข้อควรระวัง : การติดตั้งต้องมีการป้องกันการมองเห็น และการแผ่รังสีกระจายสู่ผิวหนังโดยตรง ห้ามนำไปใช้สำหรับ การส่องสว่างทั่วไป

Example Installations

Certified by Intertex

Disinfectant against bacteria ATCC 10348 comparison of fluorescent

Under fluorescence
2 minutes

Under ultraviolet lamp
2 minutes

*Simulation picture

