

2. General Troubleshooting

2.1 Error Display (Indoor Unit)

When the indoor unit encounters a recognized error, the operation lamp will flash in a corresponding series, the timer lamp may turn on or begin flashing, and an error code will be displayed. These error codes are described in the following table:

Operation Lamp	Timer Lamp	LED Display	Error Information	Solution
1 time	OFF	E400	Indoor unit EEPROM parameter error	TS18
2 times	OFF	E401	Indoor / outdoor unit communication error	TS19
3 times	OFF	E402	Zero-crossing signal detection error(for some models)	TS21
4 times	OFF	E403	The indoor fan speed is operating outside of the normal range	TS22
5 times	OFF	E451	Outdoor unit EEPROM parameter error(for some models)	TS18
5 times	OFF	E452	Condenser coil temperature sensor T3 is in open circuit or has short circuited	TS25
5 times	OFF	E453	Outdoor room temperature sensor T4 is in open circuit or has short circuited	TS25
5 times	OFF	E454	Compressor discharge temperature sensor TP is in open circuit or has short circuited	TS25
5 times	OFF	E456	Evaporator coil outlet temperature sensor T2B is in open circuit or has short circuited(for free-match indoor units)	TS25
6 times	OFF	E460	Indoor room temperature sensor T1 is in open circuit or has short circuited	TS25
6 times	OFF	E461	Evaporator coil temperature sensor T2 is in open circuit or has short circuited	TS25
12 times	OFF	E407	The outdoor fan speed is operating outside of the normal range(for some models)	TS22
9 times	OFF	E40b	Indoor PCB / Display board communication error	TS26
8 times	OFF	E40c	Refrigerant leak detected	TS27
7 times	FLASH	P400	IPM malfunction or IGBT over-strong current protection	TS29
2 times	FLASH	P401	Over voltage or over low voltage protection	TS30
3 times	FLASH	P402	High temperature protection of IPM module or High pressure protection(for some models)	TS31
5 times	FLASH	P404	Inverter compressor drive error	TS33
1 time	FLASH	P408	Current overload protection(for some models)	TS28
7 times	FLASH	P403	Low pressure protection(for some models)	TS34
1 times	ON	--	Indoor units mode conflict(match with multi outdoor unit)	--

For other errors:

The display board may show a garbled code or a code undefined by the service manual. Ensure that this code is not a temperature reading.

Troubleshooting:

Test the unit using the remote control. If the unit does not respond to the remote, the indoor PCB requires replacement. If the unit responds, the display board requires replacement.

LED flash frequency:

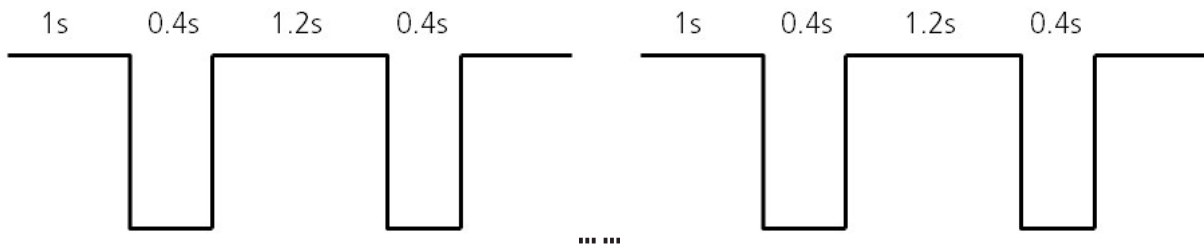

2.2 Error Display (For Some Outdoor Units)

There are 2 LED lights (RED color and GREEN color) welded in outdoor main board. After power on, LED show different actions when encounter different problems.

No.	Problem	LED(GREEN)	LED(RED)	Solution
1	Standby normally	ON	OFF	-
2	Operate normally	OFF	ON	-
3	Compressor driven chip EEPROM parameter error	ON	FLASH	TS19
4	IPM malfunction or IGBT over-strong current protection	FLASH	OFF	TS30
5	Over voltage or too low voltage protection	ON	ON	TS31
6	Inverter compressor drive error	OFF	FLASH	TS34
7	Inverter compressor drive error	FLASH	LIGHT	TS34
8	Communication error between outdoor main chip and compressor driven chip	FLASH	FLASH	TS19

3. Complain Record Form

Complain Record Form

Request No.:

Date:

Installation Date:

Service Date:

Customer Information			
Name		Telephone No.	
Home Address			
Email			
Product Information			
Indoor Unit Model		Outdoor Unit Model	
Serial No. of indoor unit			
Serial No. of outdoor unit			
Working Mode	<input type="checkbox"/> Cooling <input type="checkbox"/> Heating <input type="checkbox"/> Fan only <input type="checkbox"/> Dry		
Setting temperature	_____°C / °F	Fan speed	<input type="checkbox"/> Turbo <input type="checkbox"/> High <input type="checkbox"/> Medium <input type="checkbox"/> Low <input type="checkbox"/> Auto
Temperature of air inlet	_____°C / °F	Temperature of air outlet	_____°C / °F
Installation / Condition Information			
Indoor temperature	_____°C / °F	Indoor humidity	_____ %RH
Outdoor temperature	_____°C / °F	Outdoor humidity	_____ %RH
Length of Connecting pipe		Pipe diameter	Gas pipe: Liquid pipe:
Length of Wiring		wire diameter	
System Running Pressure	_____MPa or _____Bar or _____PSI		
Room size (L*W*H)			
Photo of Installation of Indoor unit (Photo #1)		Photo of Installation of Outdoor unit (Photo #2)	
Failure Description			
Error Code of Indoor unit		Code of Outdoor PCB	
Unit does not start			
Remote control does not work			
Indoor display shows nothing			
No cooling or heating at all			
Less cooling or heating			
Unit starts but stops shortly			
High noise			
High vibration			

Parameter Checking information by Remote controller			
Displaying code	Displaying code meaning	Display value	Display value meaning
T1	Room temperature		
T2	Indoor coil temperature		
T3	Outdoor coil temperature		
T4	Ambient temperature		
Tb	Outlet temperature of indoor coil		
TP	Discharge temperature		
TH	Suction temperature		
FT	Targeted Frequency		
Fr	Actual Frequency		
IF	Indoor fan speed		
OF	Outdoor fan speed		
LA	EXV opening steps		
CT	Compressor continuous running time		
ST	Causes of compressor stop.		
A0, A1, b0, b1, b2, b3, b4, b5, b6, dL, Ac, Uo, Td, dA, dS, dT	Reserved		

Approval from Manufacturer	
<input type="checkbox"/> Approved	
<input type="checkbox"/> More Proof needed	
<input type="checkbox"/> Rejected	

4. Information Inquiry

- To enter information inquiry status, complete the following procedure within ten seconds:
 - Press LED(or DO NOT DISTURB) 3 times.
 - Press SWING(or AIR DIRECTION) 3 times.
- Finish 1 and 2 within 10 seconds, you will hear beeps for two seconds, which means the unit goes into parameter checking mode.
- Use the LED(or DO NOT DISTURB) and SWING(or AIR DIRECTION) buttons to cycle through information displayed.
- Pressing LED(or DO NOT DISTURB) will display the next code in the sequence. Pressing SWING(or AIR DIRECTION) will show the previous.
- The following table shows information codes. The screen will display this code for two seconds, then the information for 25 seconds.

Displayed code	Explanation	Displayed value	Meaning	Additional Notes
T1	Room temperature	-1F,-1E,-1d,-1c,-1b,-1A -19—99 A0,A1,...A9 b0,b1,...b9 c0,c1,...c9 d0,d1,...d9 E0,E1,...E9 F0,F1,...F9	-25,-24,-23,-22,-21,-20 -19—99 100,101,...109 110,111,...119 120,121,...129 130,131,...139 140,141,...149 150,151,...159	<ol style="list-style-type: none"> All displayed temperatures use actual values. All temperatures are displayed in °C regardless of remote used. T1, T2, T3, T4, and T2B display ranges from -25 to 70 °C. TP display ranges from -20 to 130 °C. The frequency display ranges from 0 to 159HZ. If the actual values exceed or fall short of the defined range, the values closest to the maximum and minimum values will be displayed.
T2	Indoor coil temperature			
T3	Outdoor coil temperature			
T4	Ambient temperature			
TB	Outlet temperature of indoor coil			
TP	Discharge temperature			
TH	Suction temperature			
FT	Targeted frequency			
FR	Actual frequency			
F	Indoor fan speed	0 1,2,3,4	OFF Low speed, Medium speed, High speed, Turbo.	N/A Used for some large capacity motors.
OF	Outdoor fan speed	14-FF	Actual fan speed is equal to the display value converted to decimal value and multiplied by 10. This is measured in RPM.	Used for some small capacity motors. The display value is 14-FF (hexadecimal). The corresponding fan speed ranges from 200 to 2550RPM.
LR	EXV opening angle	0-FF	Actual EXV opening value is equal to the display value converted to decimal value and then multiplied by 2.	-
CT	Compressor continuous running time	0-FF	0-255 minutes	If the actual value exceeds or falls short of the defined range, the value closest to the maximum and minimum will be displayed.
ST	Causes of compressor stop	0-99	For a detailed explanation, contact technical support.	-

Displayed code	Explanation	Displayed value	Meaning	Additional Notes	
R0	Reserved				
R1					
b0					
b1					
b2					
b3					
b4			0-FF		
b5			2-28		
b6			5-20	-	-
dL			5-25		
Rc					
Uo					
Td					
dR					
dS					
dT					

5. Error Diagnosis and Troubleshooting Without Error Code

WARNING

Be sure to turn off unit before any maintenance to prevent damage or injury.

5.1 Remote maintenance

SUGGESTION: When troubles occur, please check the following points with customers before field maintenance.

No.	Problem	Solution
1	Unit will not start	TS13 - TS14
2	The power switch is on but fans will not start	TS13 - TS14
3	The temperature on the display board cannot be set	TS13 - TS14
4	Unit is on but the wind is not cold(hot)	TS13 - TS14
5	Unit runs, but shortly stops	TS13 - TS14
6	The unit starts up and stops frequently	TS13 - TS14
7	Unit runs continuously but insufficient cooling(heating)	TS13 - TS14
8	Cool can not change to heat	TS13 - TS14
9	Unit is noisy	TS13 - TS14

5.2 Field maintenance

	Problem	Solution
1	Unit will not start	TS15 - TS16
2	Compressor will not start but fans run	TS15 - TS16
3	Compressor and condenser (outdoor) fan will not start	TS15 - TS16
4	Evaporator (indoor) fan will not start	TS15 - TS16
5	Condenser (Outdoor) fan will not start	TS15 - TS16
6	Unit runs, but shortly stops	TS15 - TS16
7	Compressor short-cycles due to overload	TS15 - TS16
8	High discharge pressure	TS15 - TS16
9	Low discharge pressure	TS15 - TS16
10	High suction pressure	TS15 - TS16
11	Low suction pressure	TS15 - TS16
12	Unit runs continuously but insufficient cooling	TS15 - TS16
13	Too cool	TS15 - TS16
14	Compressor is noisy	TS15 - TS16
15	Horizontal louver can not revolve	TS15 - TS16

1.Remote Maintenance	Electrical Circuit				Refrigerant Circuit									
Possible causes of trouble	Power failure	The main power tripped	Loose connections	Faulty transformer	The voltage is too high or too low	The remote control is powered off	Broken remote control	Dirty air filter	Dirty condenser fins	The setting temperature is higher/lower than the room's(cooling/heating)	The ambient temperature is too high/low when the mode is cooling/heating	Fan mode	SILENCE function is activated(optional function)	Frosting and defrosting frequently
Unit will not start	☆	☆	☆	☆										
The power switch is on but fans will not start			☆	☆	☆									
The temperature on the display board cannot be set						☆	☆							
Unit is on but the wind is not cold(hot)										☆	☆	☆		
Unit runs, but shortly stops					☆					☆	☆			
The unit starts up and stops frequently					☆						☆			☆
Unit runs continuously but insufficient cooling/heating)								☆	☆	☆	☆		☆	
Cool can not change to heat														
Unit is noisy														
Test method / remedy	Test voltage	Close the power switch	Inspect connections - tighten	Change the transformer	Test voltage	Replace the battery of the remote control	Replace the remote control	Clean or replace	Clean	Adjust the setting temperature	Turn the AC later	Adjust to cool mode	Turn off SILENCE function.	Turn the AC later

1.Remote Maintenance	Others				
Possible causes of trouble	Heavy load condition				
	Loosen hold down bolts and / or screws				
	Bad airproof				
	The air inlet or outlet of either unit is blocked				
	Interference from cell phone towers and remote boosters				
	Shipping plates remain attached				
Unit will not start					
The power switch is on but fans will not start				☆	
The temperature on the display board cannot be set					
Unit is on but the wind is not cold(hot)					
Unit runs, but shortly stops					
The unit starts up and stops frequently				☆	
Unit runs continuously but insufficient cooling(heating)	☆		☆	☆	
Cool can not change to heat					
Unit is noisy		☆			☆
Test method / remedy	Check heat load				
	Tighten bolts or screws				
	Close all the windows and doors				
	Remove the obstacles				
	Reconnect the power or press ON/OFF button on remote control to restart operation				
	Remove them				

2.Field Maintenance	Electrical Circuit														
Possible causes of trouble	Power failure	Blown fuse or varistor	Loose connections	Shorted or broken wires	Safety device opens	Faulty thermostat / room temperature sensor	Wrong setting place of temperature sensor	Faulty transformer	Shorted or open capacitor	Faulty magnetic contactor for compressor	Faulty magnetic contactor for fan	Low voltage	Faulty stepping motor	Shorted or grounded compressor	Shorted or grounded fan motor
	Unit will not start	☆	☆	☆	☆	☆			☆						
Compressor will not start but fans run				☆	☆			☆	☆					☆	
Compressor and condenser (outdoor) fan will not start				☆	☆					☆					
Evaporator (indoor) fan will not start				☆				☆		☆					☆
Condenser (Outdoor) fan will not start				☆	☆			☆		☆					☆
Unit runs, but shortly stops										☆		☆			
Compressor short-cycles due to overload										☆		☆			
High discharge pressure															
Low discharge pressure															
High suction pressure															
Low suction pressure															
Unit runs continuously but insufficient cooling															
Too cool						☆	☆								
Compressor is noisy															
Horizontal louver can not revolve			☆	☆									☆		
Test method / remedy	Test voltage	Inspect fuse type & size	Inspect connections - tighten	Test circuits with tester	Test continuity of safety device	Test continuity of thermostat / sensor & wiring	Place the temperature sensor at the central of the air inlet grille	Check control circuit with tester	Check capacitor with tester	Test continuity of coil & contacts	Test continuity of coil & contacts	Test voltage	Replace the stepping motor	Check resistance with multimeter	Check resistance with multimeter

2.Field Maintenance	Refrigerant Circuit														Others								
Possible causes of trouble	Compressor stuck	Shortage of refrigerant	Restricted liquid line	Dirty air filter	Dirty evaporator coil	Insufficient air through evaporator coil	Overcharge of refrigerant	Dirty or partially blocked condenser	Air or incompressible gas in refrigerant cycle	Short cycling of condensing air	High temperature condensing medium	Insufficient condensing medium	Broken compressor internal parts	Inefficient compressor	Expansion valve obstructed	Expansion valve or capillary tube closed completely	Leaking power element on expansion valve	Poor installation of feeler bulb	Heavy load condition	Loosen hold down bolts and / or screws	Shipping plates remain attached	Poor choices of capacity	Contact of piping with other piping or external plate
Unit will not start																							
Compressor will not start but fans run	☆																						
Compressor and condenser (outdoor) fan will not start																							
Evaporator (indoor) fan will not start																							
Condenser (Outdoor) fan will not start																							
Unit runs, but shortly stops		☆	☆				☆	☆								☆	☆						
Compressor short-cycles due to overload		☆					☆	☆															
High discharge pressure							☆	☆	☆	☆	☆												
Low discharge pressure		☆													☆								
High suction pressure							☆							☆				☆	☆				
Low suction pressure		☆	☆	☆	☆	☆								☆	☆	☆							
Unit runs continuously but insufficient cooling		☆	☆	☆	☆	☆		☆	☆	☆				☆					☆			☆	
Too cool																							
Compressor is noisy							☆						☆							☆	☆		☆
Horizontal louver can not revolve																							
Test method / remedy	Replace the compressor	Leak test	Replace restricted part	Clean or replace	Clean coil	Check fan	Change charged refrigerant volume	Clean condenser or remove obstacle	Purge, evacuate and recharge	Remove obstruction to air flow	Remove obstruction in air or water flow	Remove obstruction in air or water flow	Replace compressor	Test compressor efficiency	Replace valve	Replace valve	Replace valve	Fix feeler bulb	Check heat load	Tighten bolts or screws	Remove them	Choose AC of larger capacity or add the number of AC	Rectify piping so as not to contact each other or with external plate

6. Quick Maintenance by Error Code

If you do not have the time to test which specific parts are faulty, you can directly change the required parts according to the error code.

You can find the parts to replace by error code in the following table.

Part requiring replacement	Error Code								
	EH00	EL01	EH02	EH03	EH60	EH61	EH0b	EL0C	PC08
Indoor PCB	✓	✓	✓	✓	✓	✓	✓	✓	x
Outdoor PCB	x	✓	x	x	x	x	x	x	✓
Display board	x	x	x	x	x	x	✓	x	x
Indoor fan motor	x	x	x	✓	x	x	x	x	x
T1 sensor	x	x	x	x	✓	x	x	x	x
T2 Sensor	x	x	x	x	x	✓	x	✓	x
Reactor	x	✓	x	x	x	x	x	x	x
Compressor	x	x	x	x	x	x	x	x	✓
Additional refrigerant	x	x	x	x	x	x	x	✓	x

Part requiring replacement	EC53	EC52	EC54	EC56	EC51	EC07	PC00	PC01	PC02	PC03	PC04
Indoor PCB	x	x	x	x	x	x	x	x	x	x	x
Outdoor PCB	✓	✓	✓	✓	✓	✓	✓	✓	✓	✓	✓
Indoor fan motor	x	x	x	x	x	x	x	x	x	x	x
Outdoor fan motor	x	x	x	x	x	✓	✓	x	✓	x	✓
T3 Sensor	x	✓	x	x	x	x	x	x	x	x	x
T4 Sensor	✓	x	x	x	x	x	x	x	x	x	x
TP Sensor	x	x	✓	x	x	x	x	x	x	x	x
T2B Sensor	x	x	x	✓	x	x	x	x	x	x	x
Reactor	x	x	x	x	x	x	x	✓	x	x	x
Compressor	x	x	x	x	x	x	✓	x	x	x	✓
IPM module board	x	x	x	x	x	x	✓	✓	✓	x	✓
High pressure protector	x	x	x	x	x	x	x	x	✓	x	x
Low pressure protector	x	x	x	x	x	x	x	x	x	✓	x
Additional refrigerant	x	x	x	x	x	x	x	x	x	✓	x

Note: For certain models, outdoor PCB could not be removed separately. In this case, the outdoor electric control box should be replaced as a whole.

7. Troubleshooting by Error Code

7.1 EH 00 / EC 51 (EEPROM parameter error diagnosis and solution)

Description: Indoor or outdoor PCB main chip does not receive feedback from EEPROM chip.

Recommended parts to prepare:

- Indoor PCB
- Outdoor PCB

Troubleshooting and repair:

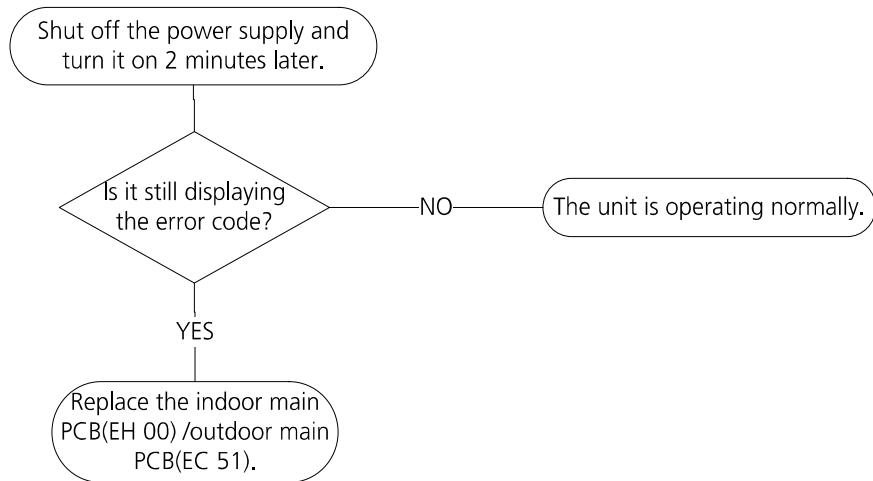

Remarks:

EEPROM: A read-only memory whose contents can be erased and reprogrammed using a pulsed voltage.

The location of the EEPROM chip on the indoor and outdoor PCB is shown in the following two images:

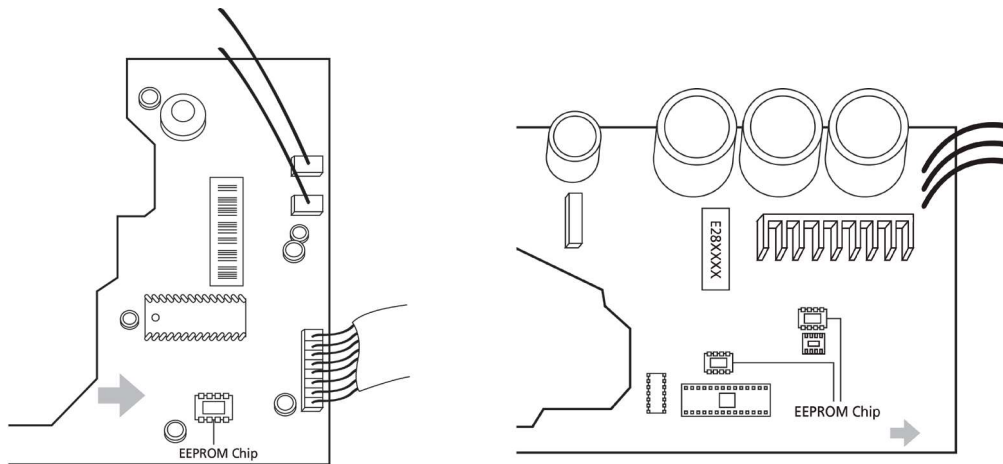

Note: For certain models, outdoor PCB could not be removed separately. In this case, the outdoor electric control box should be replaced as a whole. This pictures are only for reference, actual appearance may vary.

Troubleshooting and repair of compressor driven chip EEPROM parameter error and communication error between outdoor main chip and compressor driven chip are same as EC 51.

7.2 EL 01 (Indoor and outdoor unit communication error diagnosis and solution)

Description: Indoor unit can not communicate with outdoor unit

Recommended parts to prepare:

- Indoor PCB
- Outdoor PCB
- Short-circuited component

Troubleshooting and repair:

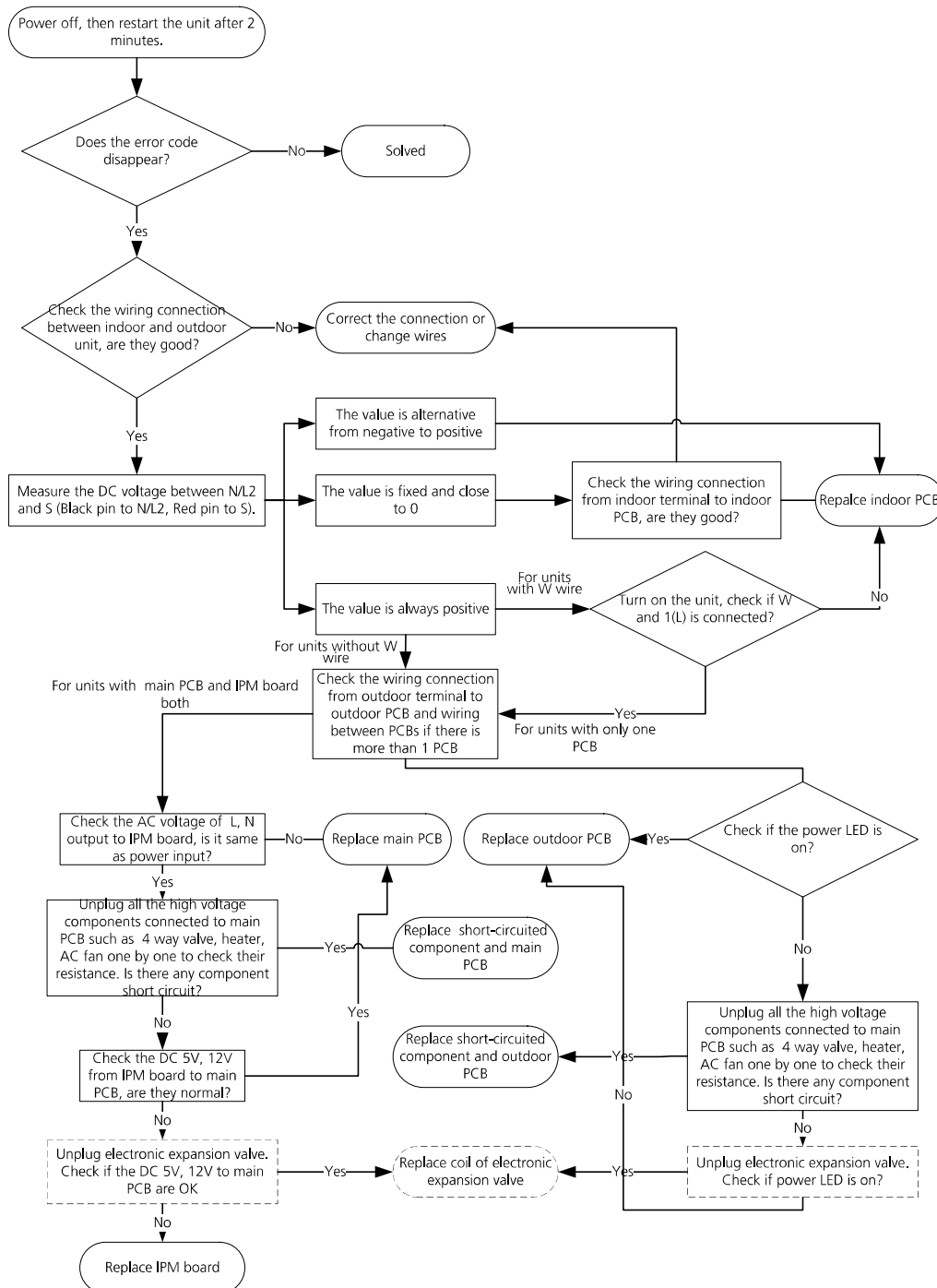

Note: For certain models, outdoor PCB could not be removed separately. In this case, the outdoor electric control box should be replaced as a whole.

Remarks:

- Use a multimeter to test the DC voltage between 2 port(or S or L2 port) and 3 port(or N or S port) of outdoor unit. The red pin of multimeter connects with 2 port(or S or L2 port) while the black pin is for 3 port(or N or S port).
- When AC is normal running, the voltage is moving alternately as positive values and negative values
- If the outdoor unit has malfunction, the voltage has always been the positive value.
- While if the indoor unit has malfunction, the voltage has always been a certain value.

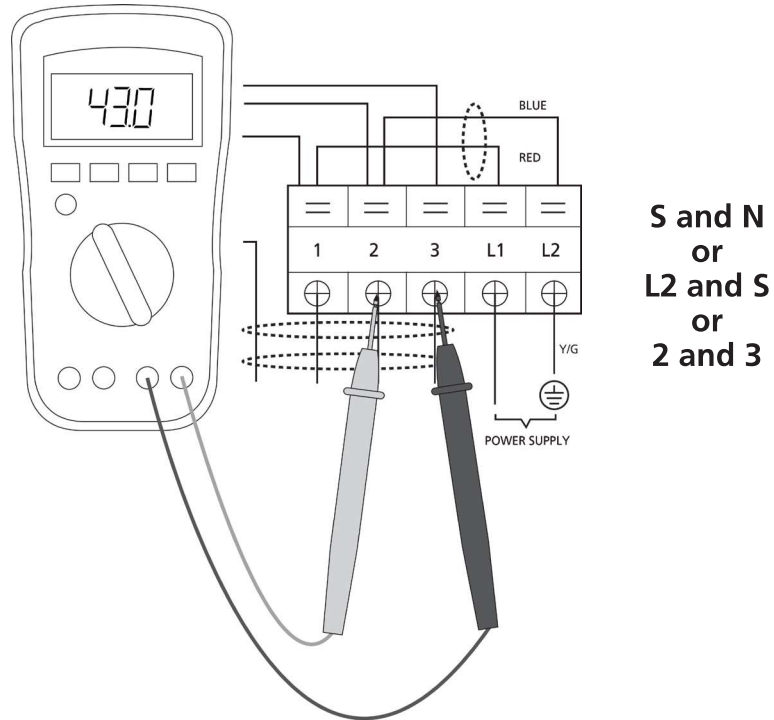

- Use a multimeter to test the resistance of the reactor which does not connect with capacitor.
- The normal value should be around zero ohm. Otherwise, the reactor must have malfunction.

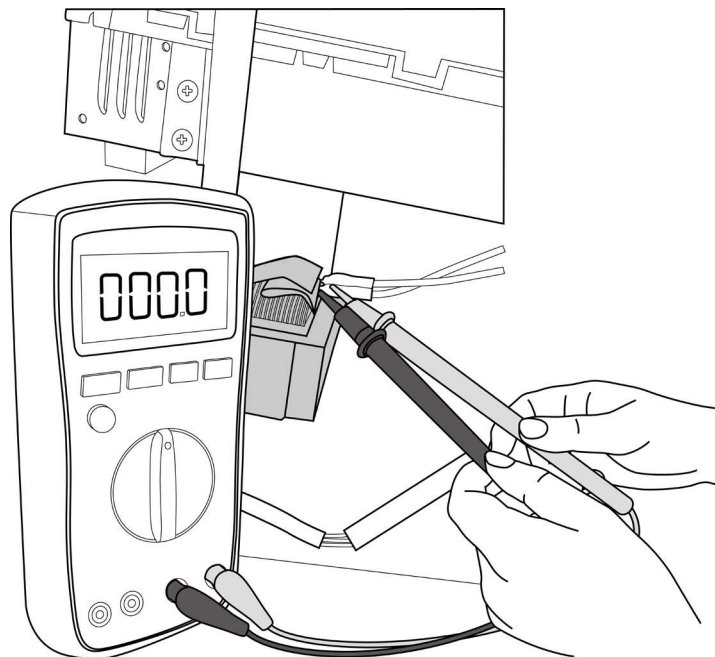

Note: The picture and the value are only for reference, actual condition and specific value may vary.

7.3 EH 02 (Zero crossing detection error diagnosis and solution)

Description: When PCB does not receive zero crossing signal feedback for 4 minutes or the zero crossing signal time interval is abnormal.

Recommended parts to prepare:

- Connection wires
- PCB

Troubleshooting and repair:

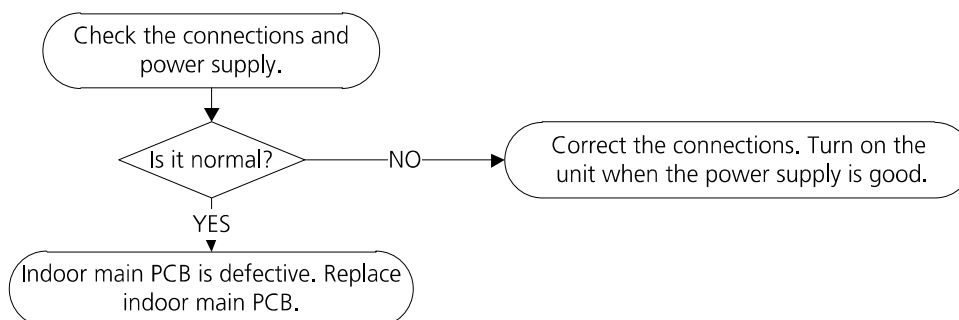

Note: EH 02 zero crossing detection error is only valid for the unit with AC fan motor, for other models, this error is invalid.

7.4 EH 03 / EC 07 (Fan speed is operating outside of normal range diagnosis and solution)

Description: When indoor / outdoor fan speed keeps too low or too high for a certain time, the LED displays the failure code and the AC turns off.

Recommended parts to prepare:

- Connection wires
- Fan assembly
- Fan motor
- PCB

Troubleshooting and repair:

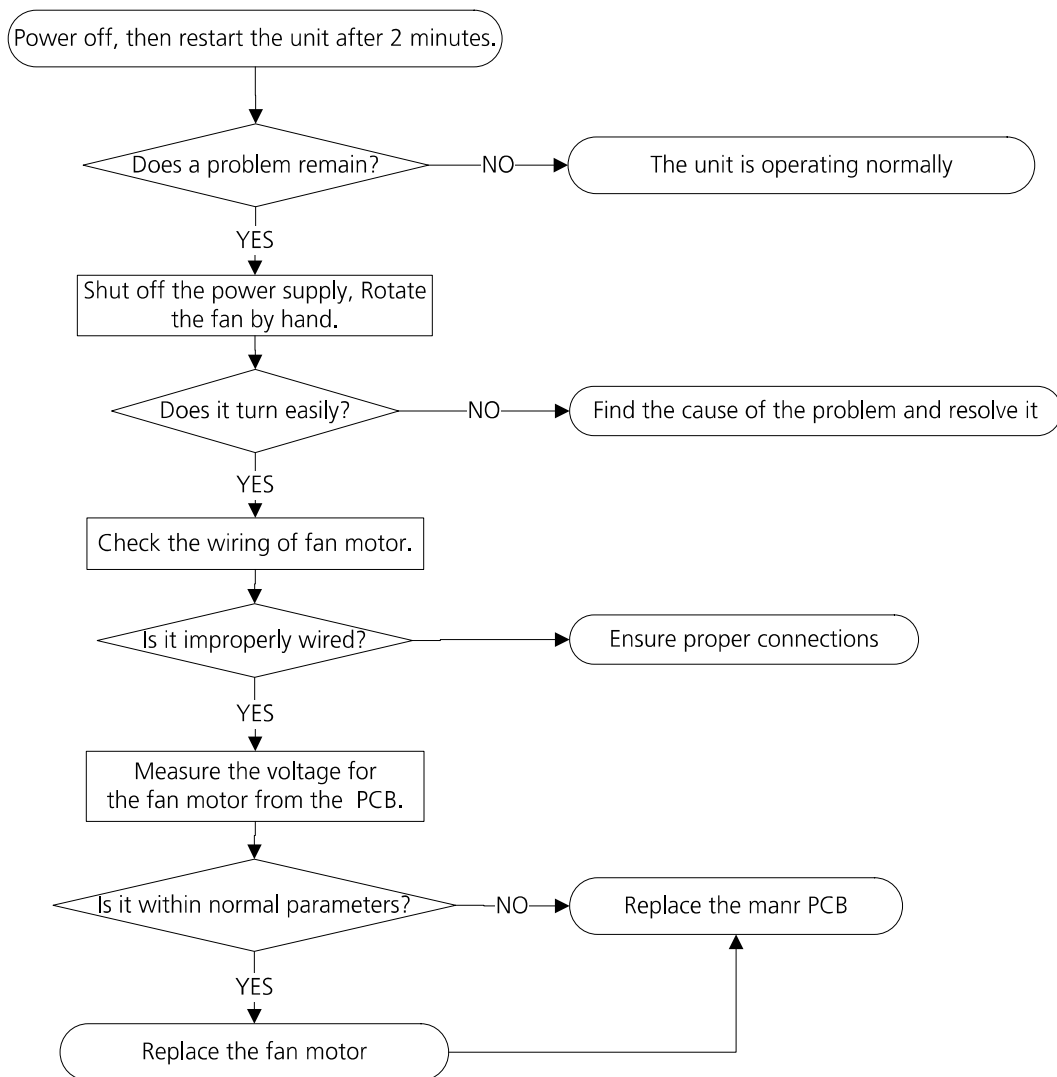

Note: For certain models, outdoor PCB could not be removed separately. In this case, the outdoor electric control box should be replaced as a whole.

Index:**1. Indoor or Outdoor DC Fan Motor(control chip is in fan motor)**

Power on and when the unit is in standby, measure the voltage of pin1-pin3, pin4-pin3 in fan motor connector. If the value of the voltage is not in the range showing in below table, the PCB must has problems and need to be replaced.

- DC motor voltage input and output (voltage: 220-240V~):

No.	Color	Signal	Voltage
1	Red	Vs/Vm	280V~380V
2	---	---	---
3	Black	GND	0V
4	White	Vcc	14-17.5V
5	Yellow	Vsp	0~5.6V
6	Blue	FG	14-17.5V

- DC motor voltage input and output (voltage: 115V~):

No.	Color	Signal	Voltage
1	Red	Vs/Vm	140V~190V
2	---	---	---
3	Black	GND	0V
4	White	Vcc	14-17.5V
5	Yellow	Vsp	0~5.6V
6	Blue	FG	14-17.5V

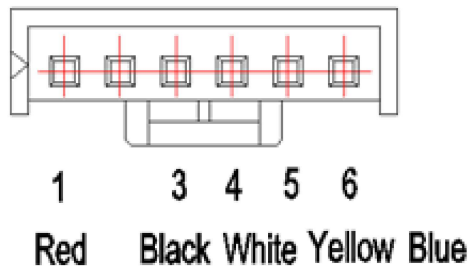
**2. Outdoor DC Fan Motor (control chip is in outdoor PCB)**

Release the UVW connector. Measure the resistance of U-V, U-W, V-W. If the resistance is not equal to each other, the fan motor must has problems and need to be replaced. otherwise the PCB must has problems and need to be replaced.

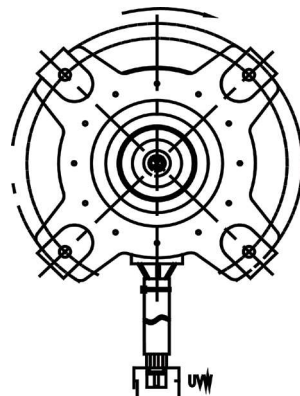

3. Indoor AC Fan Motor

Power on and set the unit running in fan mode at high fan speed. After running for 15 seconds, measure the voltage of pin1 and pin2. If the value of the voltage is less than 100V(208~240V power supply) or 50V (115V power supply), the PCB must has problems and need to be replaced.

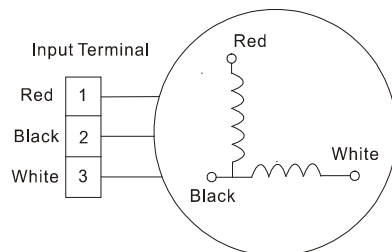

7.5 EH 60/EH 61/EC 53/EC 52/EC 54/EC 56 (Open circuit or short circuit of temperature sensor diagnosis and solution)

Description: If the sampling voltage is lower than 0.06V or higher than 4.94V, the LED displays the failure code.

Recommended parts to prepare:

- Connection wires
- Sensors
- PCB

Troubleshooting and repair:

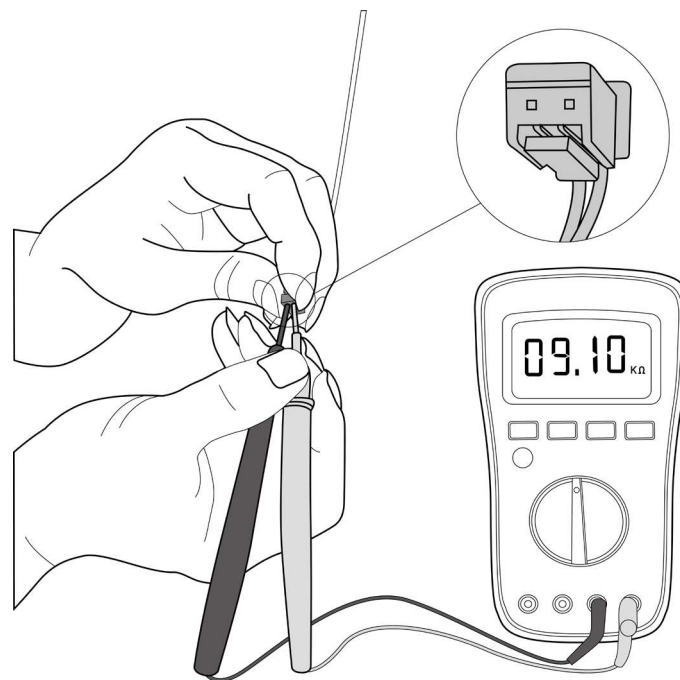
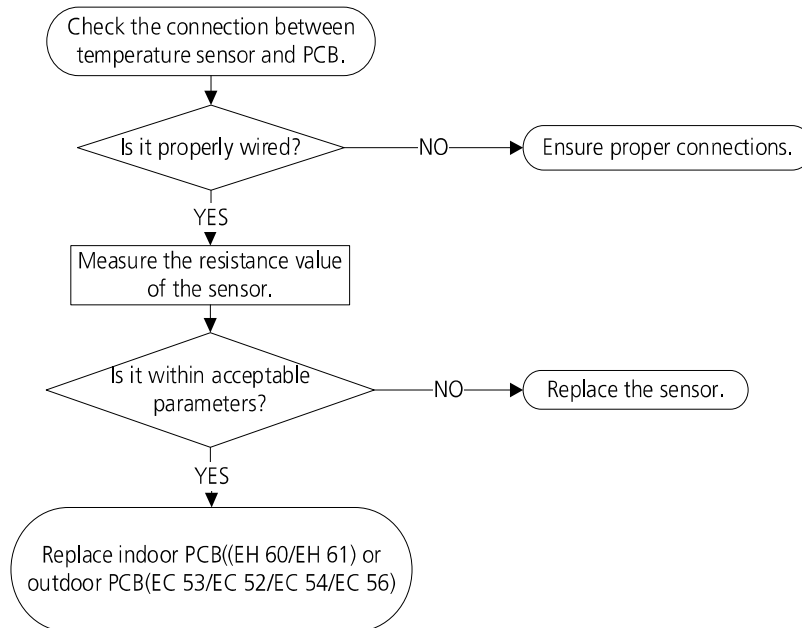

Note: For certain models, outdoor PCB could not be removed separately. In this case, the outdoor electric control box should be replaced as a whole. This picture and the value are only for reference, actual appearance and value may vary

7.6 EH 0b (Indoor PCB / Display board communication error diagnosis and solution)

Description: Indoor PCB does not receive feedback from the display board.

Recommended parts to prepare:

- Communication wire
- Indoor PCB
- Display board

Troubleshooting and repair:

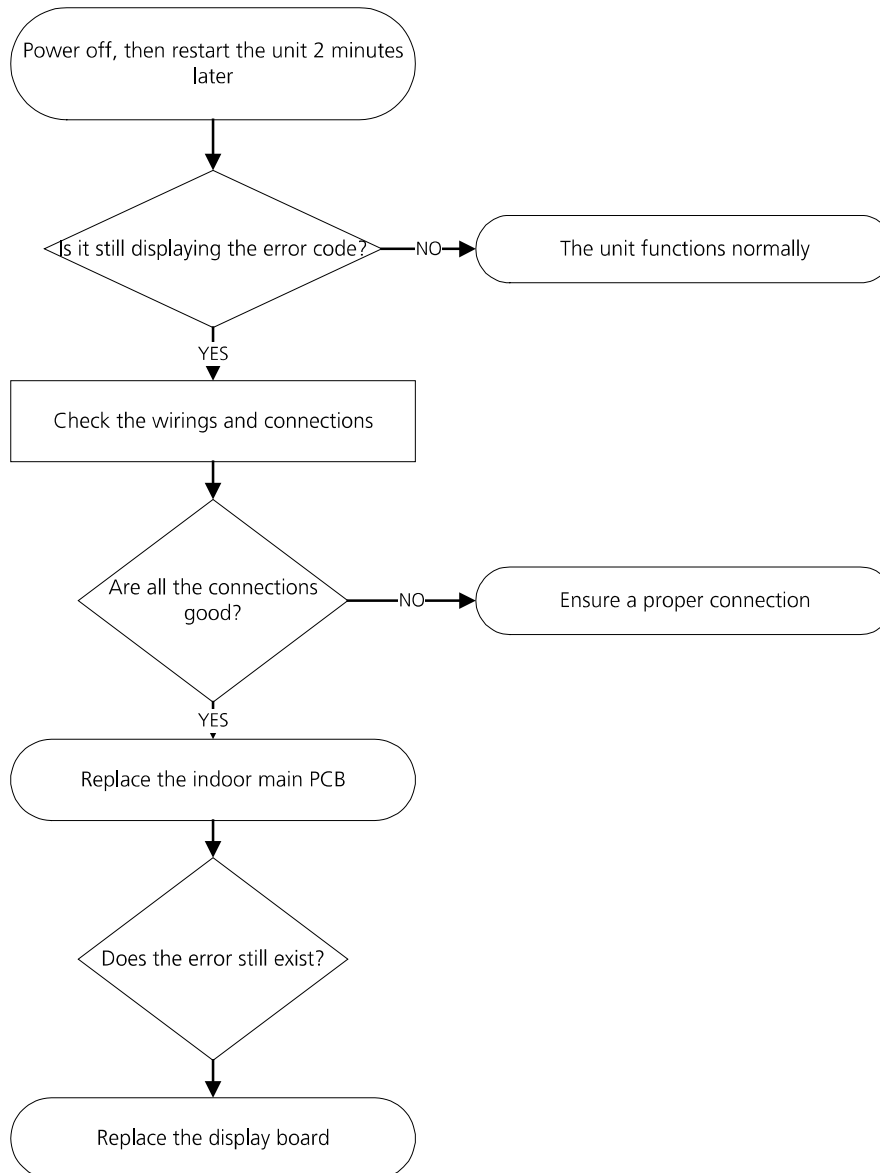

7.7 EL 0C (Refrigerant Leakage Detection diagnosis and solution)

Description: Define the evaporator coil temperature T2 of the compressor just starts running as Tcool.

In the beginning 5 minutes after the compressor starts up, if $T2 < T_{cool} - 1^{\circ}\text{C}$ (1.8°F) does not keep continuous 4 seconds and compressor running frequency higher than 50Hz does not keep for 3 minutes, and this situation happens 3 times, the LED displays the failure code and AC turns off.

Recommended parts to prepare:

- T2 sensor
- Indoor PCB
- Additional refrigerant

Troubleshooting and repair:

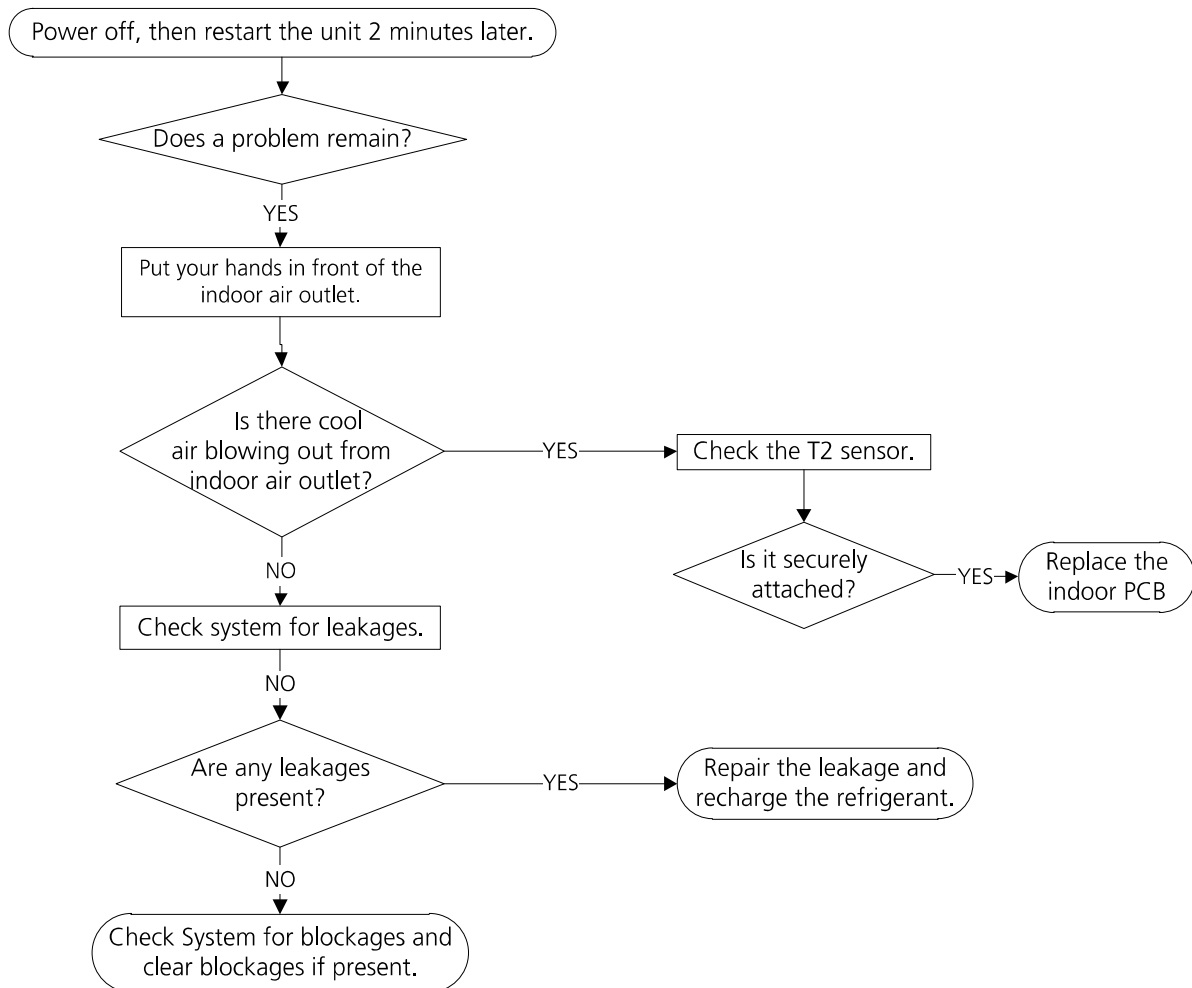

7.8 PC 08 (Overload current protection diagnosis and solution)

Description: An abnormal current rise is detected by checking the specified current detection circuit.

Recommended parts to prepare:

- Outdoor PCB
- Connection wires
- Compressor

Troubleshooting and repair:

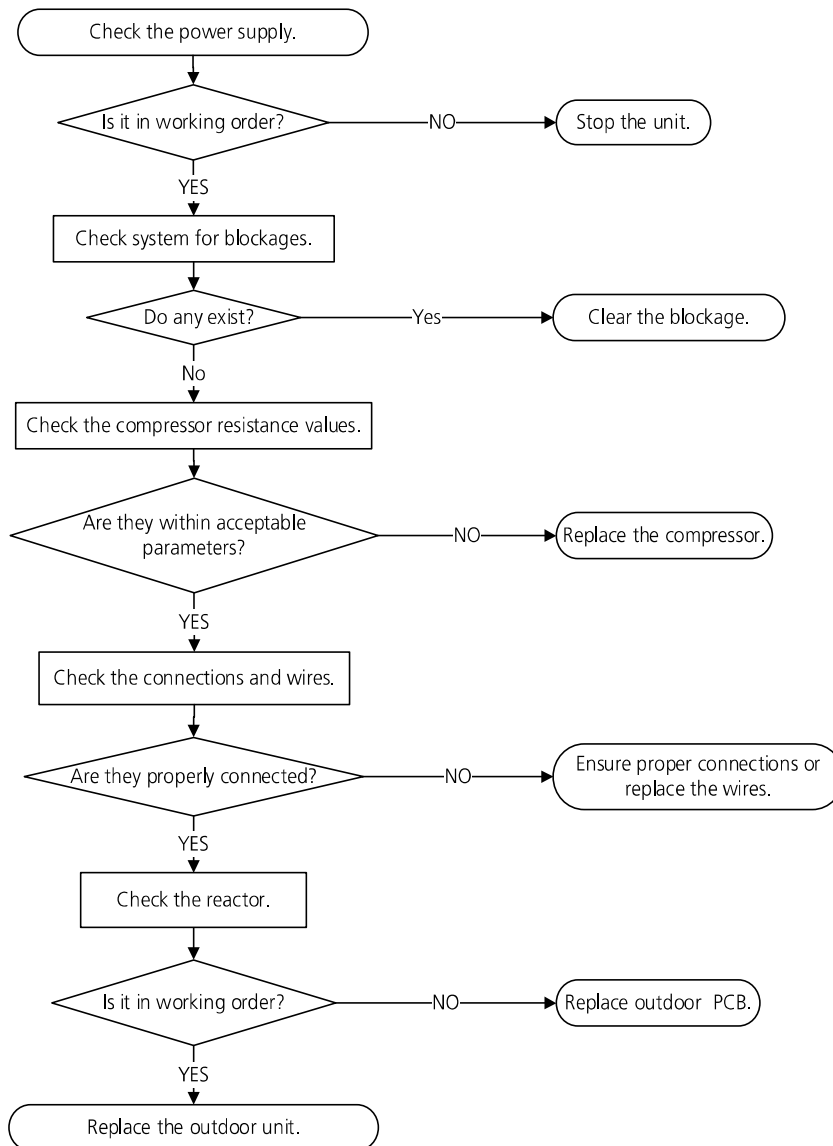

Note: For certain models, outdoor PCB could not be removed separately. In this case, the outdoor electric control box should be replaced as a whole.

7.9 PC 00(IPM malfunction or IGBT over-strong current protection diagnosis and solution)

Description: When the voltage signal the IPM sends to the compressor drive chip is abnormal, the LED displays the failure code and the AC turns off.

Recommended parts to prepare:

- Connection wires
- IPM module board
- Outdoor fan assembly
- Compressor
- Outdoor PCB

Troubleshooting and repair:

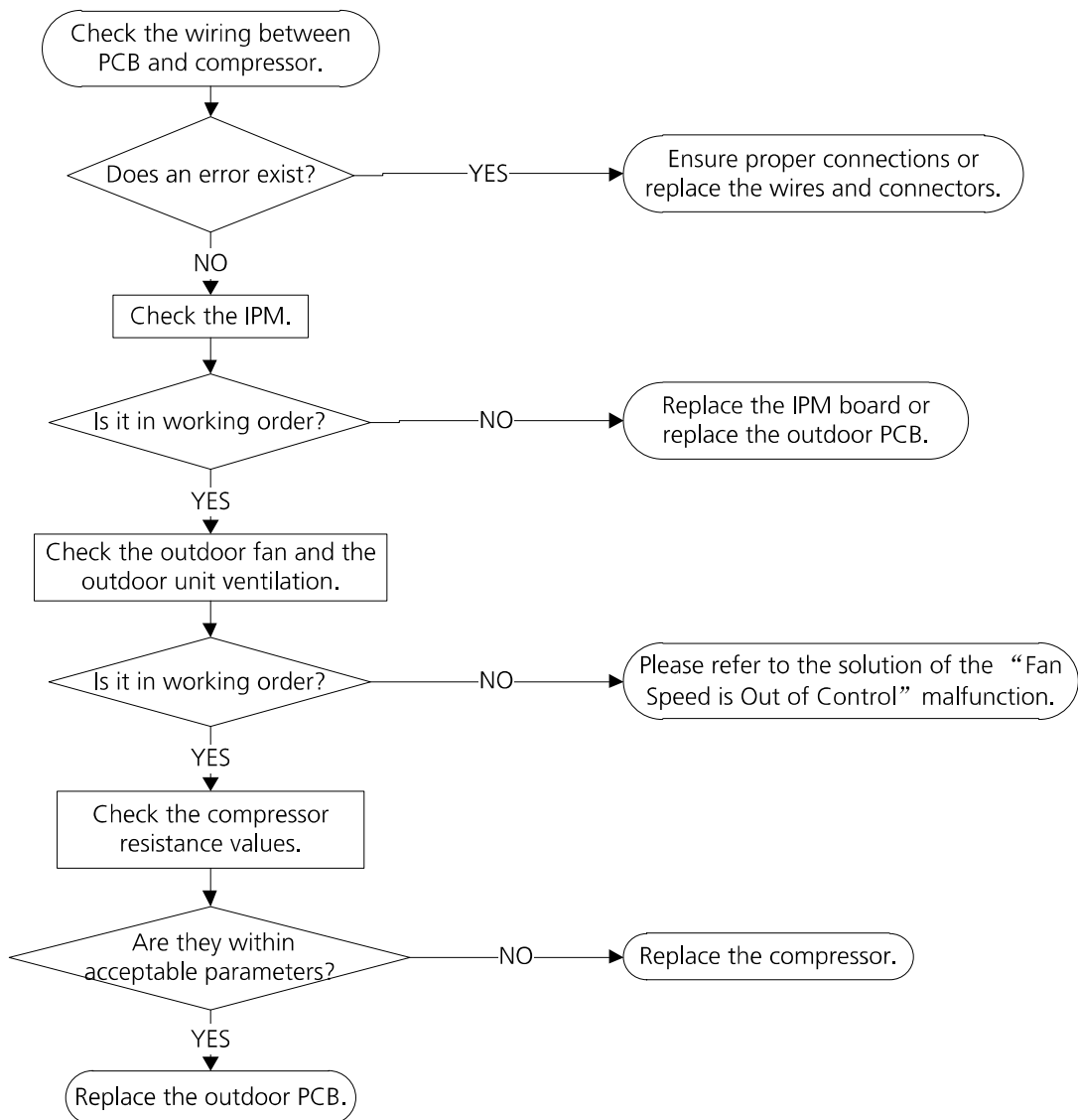

Note: For certain models, outdoor PCB could not be removed separately. In this case, the outdoor electric control box should be replaced as a whole.

7.10 PC 01(Over voltage or too low voltage protection diagnosis and solution)

Description: Abnormal increases or decreases in voltage are detected by checking the specified voltage detection circuit.

Recommended parts to prepare:

- Power supply wires
- IPM module board
- PCB
- Reactor

Troubleshooting and repair:

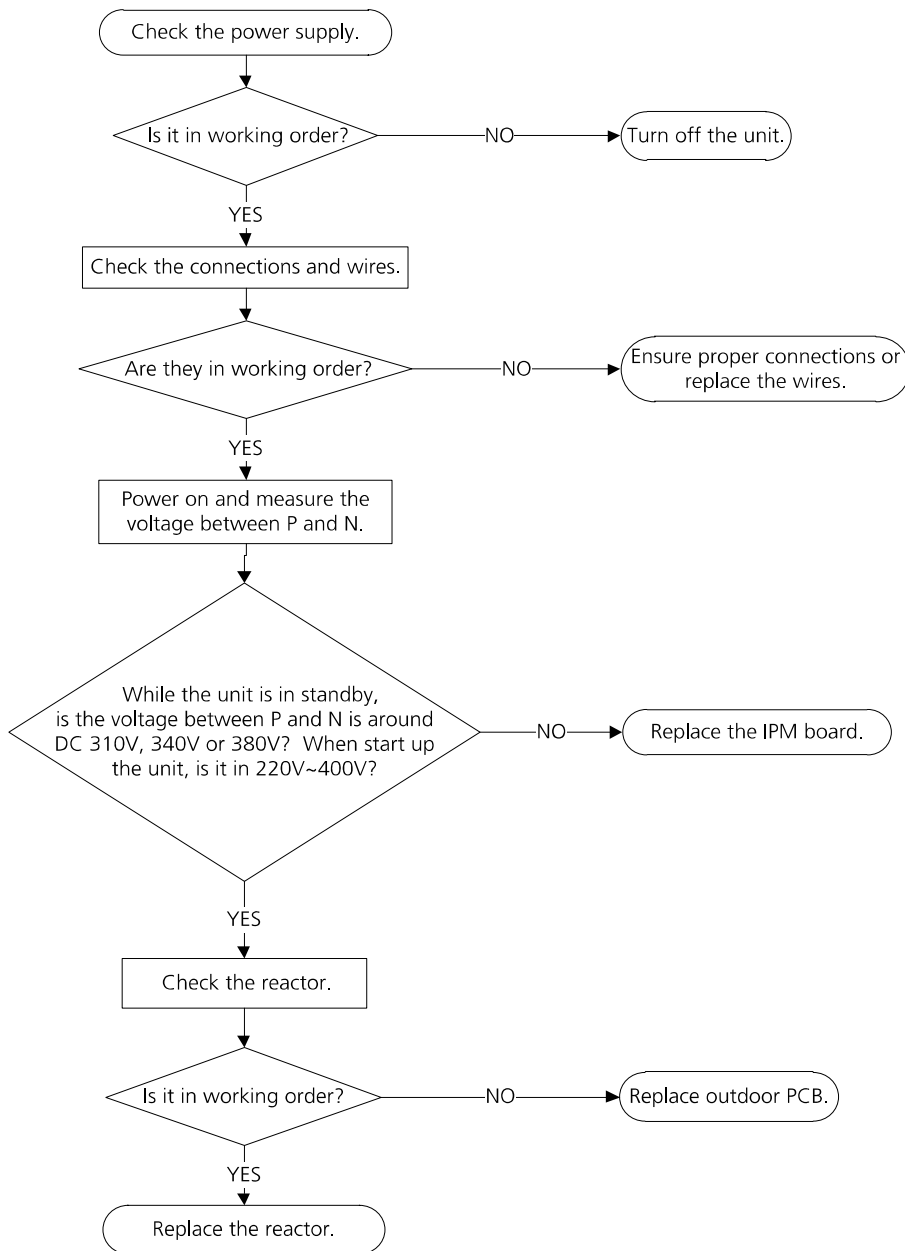

Note: For certain models, outdoor PCB could not be removed separately. In this case, the outdoor electric control box should be replaced as a whole.

7.11 PC 02(High temperature protection of IPM module or High pressure protection diagnosis and solution)

Description: If the temperature of IPM module is higher than a certain value, the LED displays the failure code.

For some models with high pressure switch, outdoor pressure switch cut off the system because high pressure is higher than 4.4 MPa, the LED displays the failure code.

Recommended parts to prepare:

- Connection wires
- Outdoor PCB
- IPM module board
- High pressure protector
- System blockages

Troubleshooting and repair:

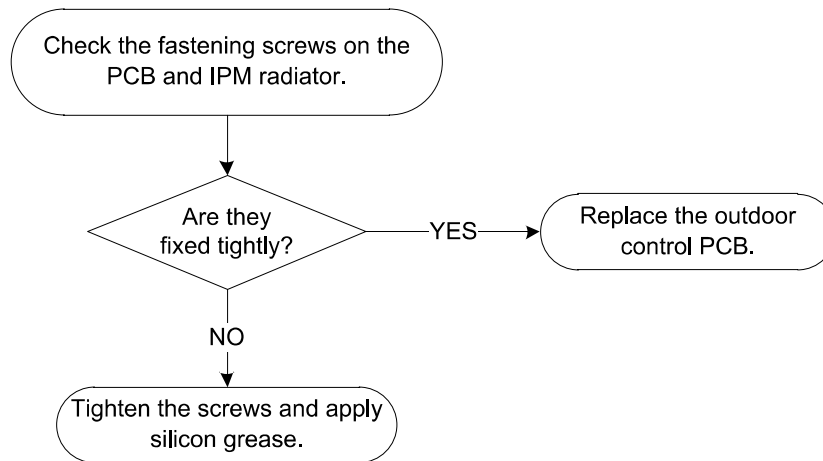

Note: For certain models, outdoor PCB could not be removed separately. In this case, the outdoor electric control box should be replaced as a whole.

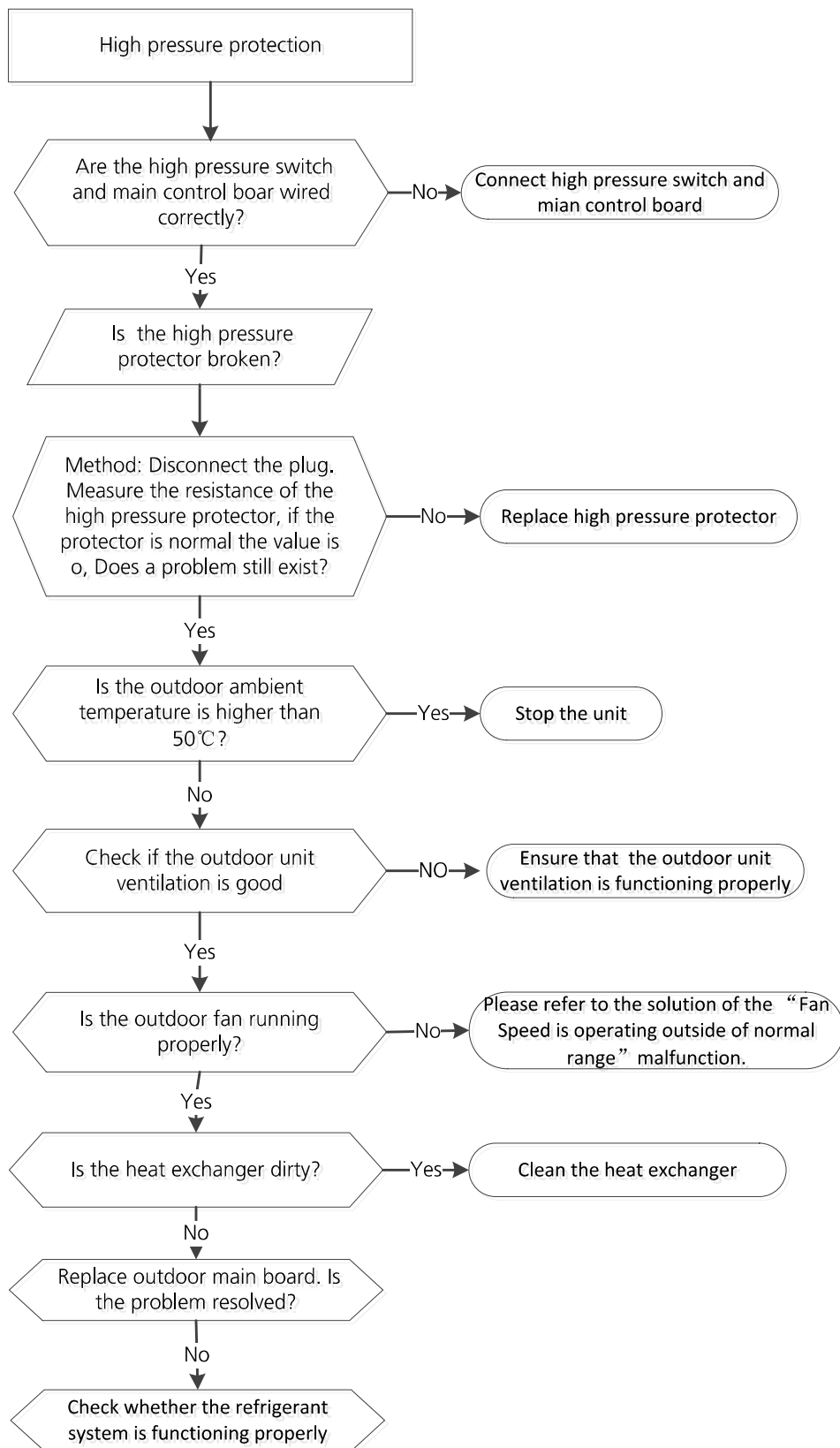

7.12 PC 04(Inverter compressor drive error diagnosis and solution)

Description: An abnormal inverter compressor drive is detected by a special detection circuit, including communication signal detection, voltage detection, compressor rotation speed signal detection and so on.

Recommended parts to prepare:

- Connection wires
- IPM module board
- Outdoor fan assembly
- Compressor
- Outdoor PCB

Troubleshooting and repair:

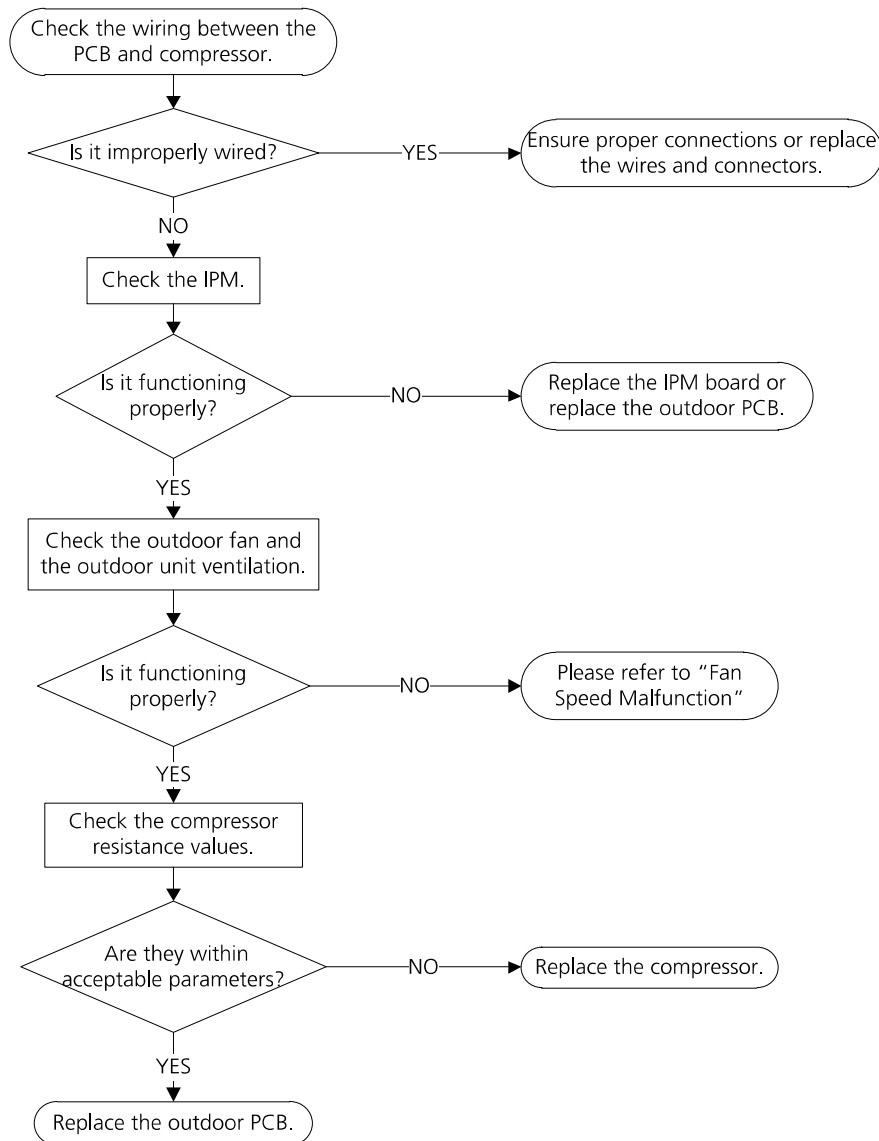

Note: For certain models, outdoor PCB could not be removed separately. In this case, the outdoor electric control box should be replaced as a whole.

7.13 PC 03(Low pressure protection diagnosis and solution)

Description: Outdoor pressure switch cut off the system because low pressure is lower than 0.13 MPa, the LED displays the failure code.

Recommended parts to prepare:

- Connection wires
- Outdoor PCB
- Low pressure protector
- Refrigerant

Troubleshooting and repair:

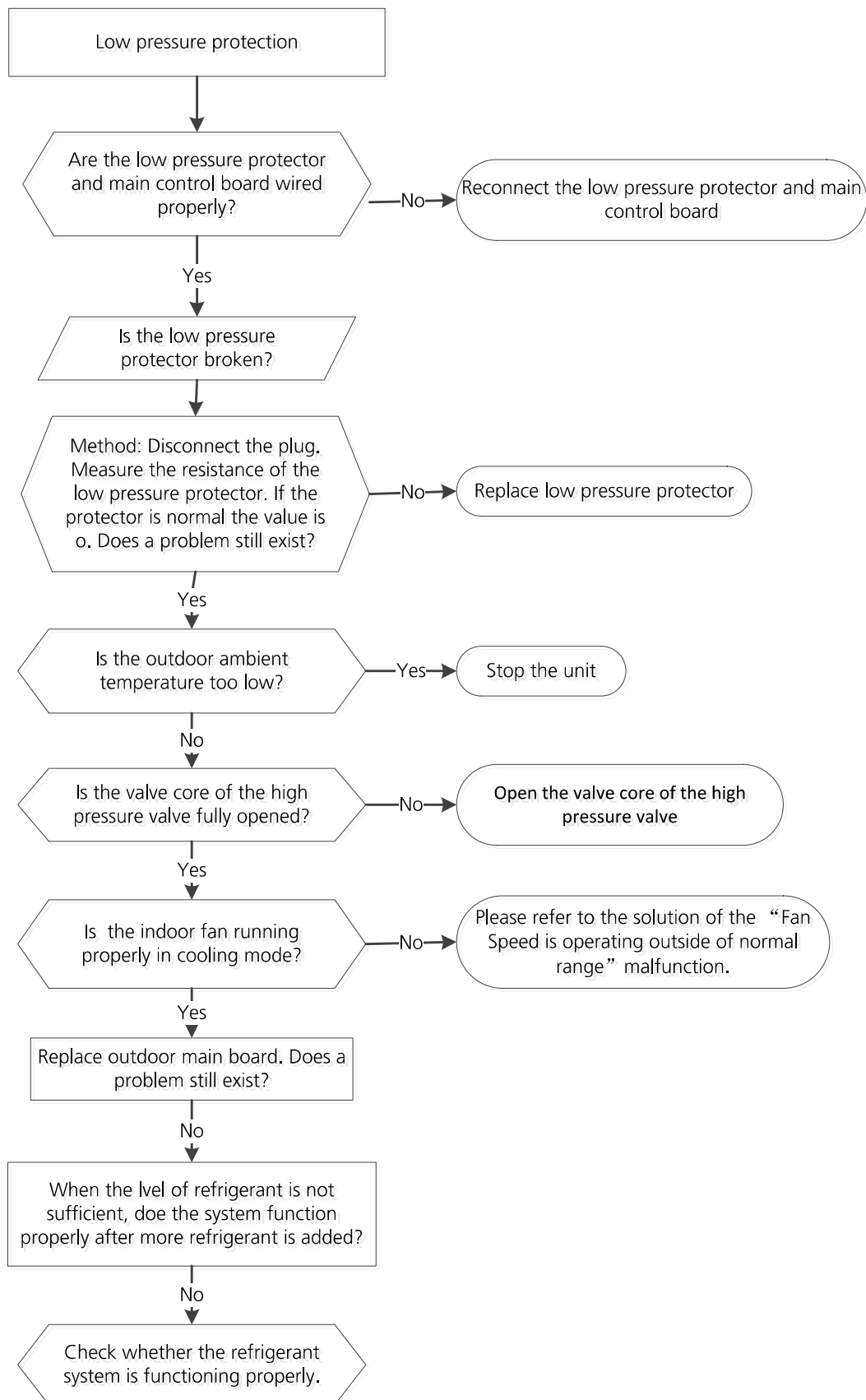

8. Check Procedures

8.1 Temperature Sensor Check

WARNING

Be sure to turn off all power supplies or disconnect all wires to avoid electric shock. Operate after compressor and coil have returned to normal temperature in case of injury.

1. Disconnect the temperature sensor from PCB (Refer to Chapter 5&6. Indoor&Outdoor Unit Disassembly).
2. Measure the resistance value of the sensor using a multi-meter.
3. Check corresponding temperature sensor resistance value table (Refer to Chapter 8. Appendix).

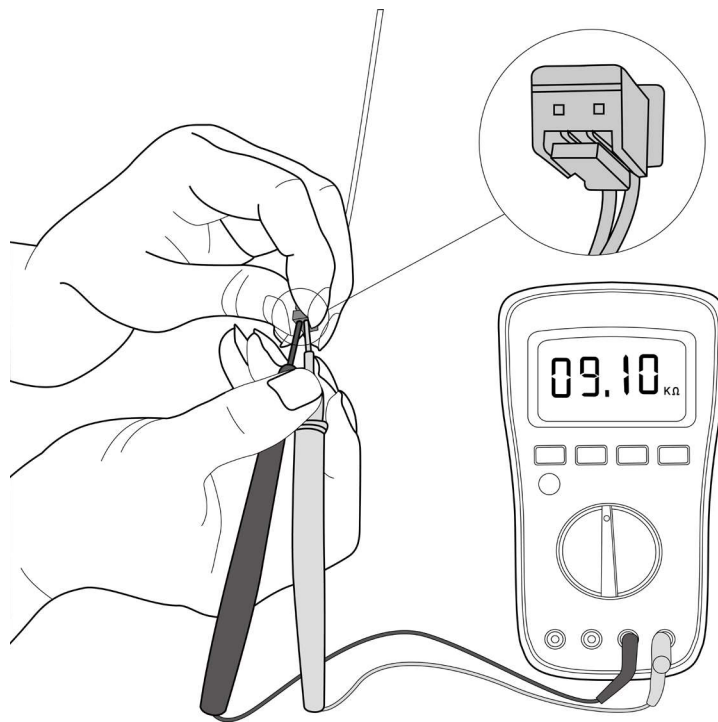

Note: The picture and the value are only for reference, actual condition and specific value may vary.

8.2 Compressor Check

1. Disconnect the compressor power cord from outdoor PCB (Refer to Chapter 6. Outdoor Unit Disassembly)).
2. Measure the resistance value of each winding using a multi-meter.
3. Check the resistance value of each winding in the following table.

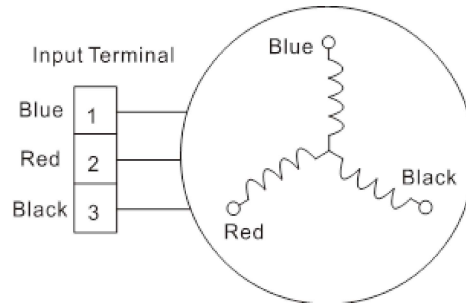

Resistance Value	KSK89D53UEZ	KSK103D33UEZ3	KSM135D23UFZ	KSN140D21UFZ	KTF235D22UMT
Blue-Red	2.35Ω	2.02Ω	1.72Ω	1.28Ω	0.75Ω
Blue-Black					
Red-Black					

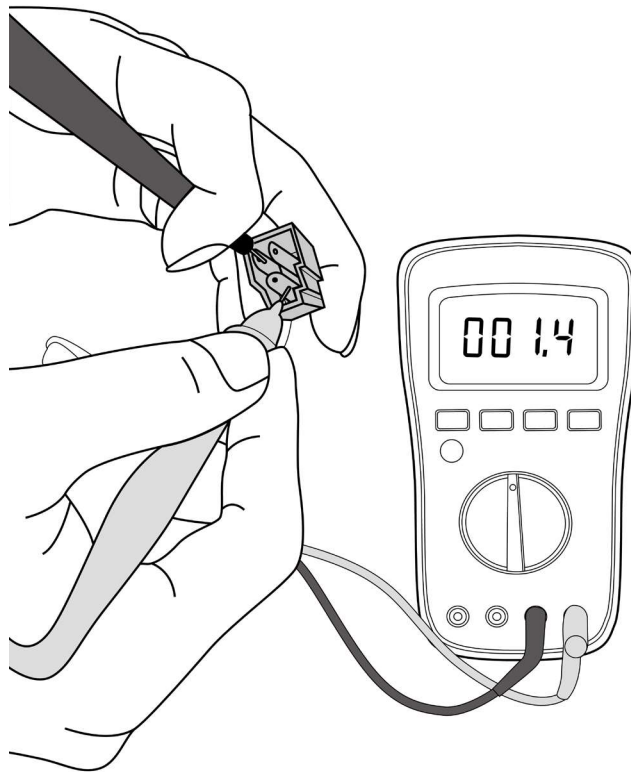

Note: The picture and the value are only for reference, actual condition and specific value may vary.

8.3 IPM Continuity Check

⚠ WARNING

Electricity remains in capacitors even when the power supply is off. Ensure the capacitors are fully discharged before troubleshooting.

1. Turn off outdoor unit and disconnect power supply.
2. Discharge electrolytic capacitors and ensure all energy-storage unit has been discharged.
3. Disassemble outdoor PCB or disassemble IPM board.
4. Measure the resistance value between P and U(V, W, N); U(V, W) and N.

Digital tester		Resistance value	Digital tester		Resistance value
(+)Red	(-)Black		(+)Red	(-)Black	
P	N	∞ (Several MΩ)	U	N	∞ (Several MΩ)
	U		V		
	V		W		
	W		-		

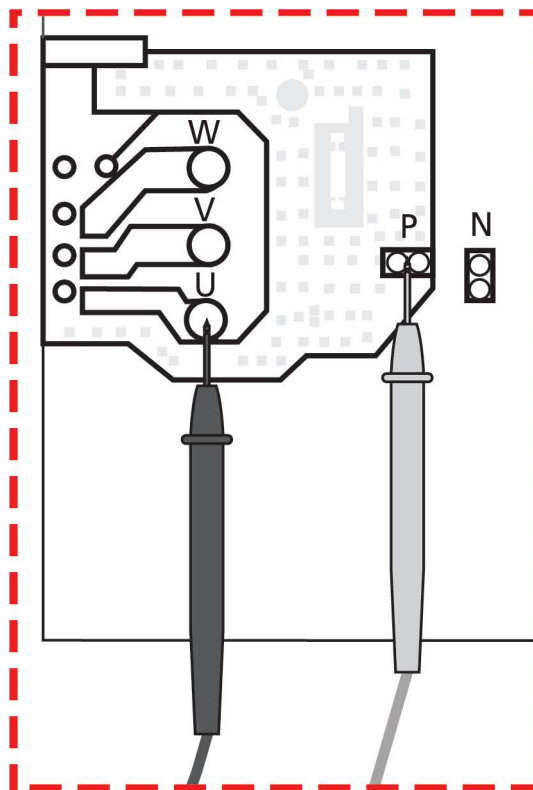

Note: The picture and the value are only for reference, actual condition and specific value may vary.

8.4 Fan Motor Check

1. Turn off outdoor unit and disconnect power supply
2. Disconnect outdoor fan motor power cord from outdoor PCB
3. Measure the resistance value between each windings.

The normal value of different motor show as follows:

Model	YKFG-13-4-38L YKFG-13-4-38L-4	YKFG-15-4-28-1	YKFG-20-4-10L	YKFG-20-4-5-11
Brand	Welling	Welling	Welling	Welling
Black – Red Main	345Ω	75Ω	269Ω	388Ω
Blue – Black AUX	348Ω	150Ω	224Ω	360Ω

Model	YKFG-20-4-5-19	YKFG-25-4-6-14	YKFG-28-4-3-7 YKFG-28-4-3-14	YKFG-28-4-6-5
Brand	Welling	Welling	Welling	Welling
Black – Red Main	444Ω	287Ω	231Ω	183.6Ω
Blue – Black AUX	470Ω	409Ω	414Ω	206Ω

Model	YKFG-45-4-13	YKFG-45-4-22 YKFG-45-4-22-13	YKFG-60-4-2-6
Brand	Dongfang	Welling	Welling
Black – Red Main	125.2Ω	168Ω	96Ω
Blue – Black AUX	83.8Ω	141Ω	96Ω