

Field test device Y-2005

INSTRUCTION MANUAL

<Contents>

1. Specification	2
2. Part names and functions (for AE-SW)	3
3. Connection (for AE-SW)	5
4. Initial setting and operation (for AE-SW)	6
5. Tests (for AE-SW)	8
6. Settings and accuracy (for AE-SW)	15
7. Inspection form (for AE-SW)	20
8. Part names and functions (for AE-SS/SH)	23
9. Connection (for AE-SS/SH)	25
10. Initial setting and operation (for AE-SS/SH)	26
11. Tests (for AE-SS/SH)	28
12. Settings and accuracy (for AE-SS/SH)	33
13. Inspection form (for AE-SS/SH)	36

<Models>

AE630-SW AE1000-SW AE1250-SW AE1600-SW

AE2000-SWA

AE2000-SW AE2500-SW AE3200-SW

AE4000-SWA

AE4000-SW AE5000-SW AE6300-SW

AE630-SH AE1000-SH AE1250-SH AE1600-SH AE2000-SH AE2500-SH AE3200-SH

AE630-SS AE1000-SS AE1250-SS AE1600-SS

AE2000-SS AE2500-SS AE3200-SS

AE4000-SSC

AE4000-SSA

AE4000-SS AE5000-SS AE6300-SS

**IMPORTANT NOTE: Before using this device, please read this instruction manual carefully,
and make sure that final user receives this manual.**



OBSERVE THE FOLLOWING FOR SAFETY:



- Before using this device, make sure to read this Instruction manual thoroughly. The cautionary items noted herein are of the utmost importance for the safe use of this device, and should always be strictly followed.
- Store this instruction manual together with the device so that it can be read anytime during use.
- Also read the instruction manual for AE–SW to be tested, and take care not to damage the air circuit breaker.
- These safety precautions and Instruction manual is prepared for an electrical expert.

The following symbols have been used:

 DANGER	Failure to follow these instructions may result in dangerous conditions, which in turn could lead to severe personal injury or even death.
---	--

 CAUTION	Failure to follow these instructions may result in dangerous conditions, which could result in moderate to slight personal injury or damage to equipment and facilities
--	---

	Warning for possible electrification under certain conditions.
	Warning for possible outbreak of a fire under certain conditions.

	This means prohibition. Never ignore this indication.
	Be sure to follow these instructions without fail.

 DANGER	
<ul style="list-style-type: none"> ● Do not use this device on the conditions over ratings. Otherwise ground–fault, short circuit fault or fire may occur due to dielectric breakdown. ● Do not touch the terminals of Breaker and Y–2005. There is a risk of electrical shock. 	

 CAUTION	
<ul style="list-style-type: none"> ● Test should be performed by an electrical expert. ● Test should be performed only after shutting off the electric power and verifying that there is no voltage present. Failure to do so may result in an electrical shock. ● Connect for tests in accordance with the description given in this instruction manual. Otherwise, electric shocks or malfunction may occur. ● Do not install in areas subject to high temperatures, high humidity, dust, corrosive gas, vibrations, shocks, etc. To do so may result in malfunction or fire. ● This tester is for 100–240VAC 50/60Hz. Using it at other specifications may cause fires or malfunction. ● After testing, remove the wiring used for testing and restore the circuit breaker to its original condition. Any other conditions may cause fires or malfunction. ● When discard products, dispose of as industrial waste. 	

1. Specification

The Y-2005 breaker tester is a light-weight portable tester for MITSUBISHI Low-Voltage Air Circuit Breakers series AE-SW, AE-SS and AE-SH. The characteristics of electronic trip relay can be checked in the field without applying a current to circuit breaker.

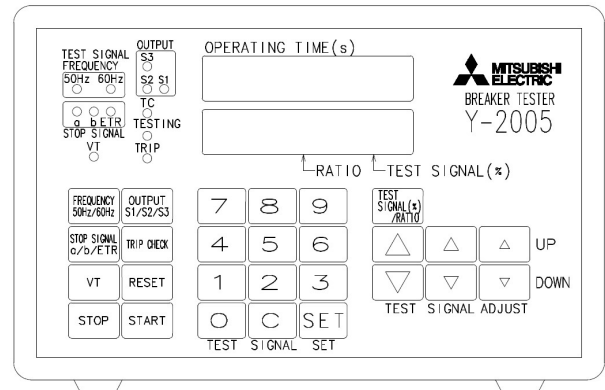

Input voltage	100-240V AC 50/60Hz (available voltage range: AC85-264V)
Power consumption VA	100VA or less
Range of signal output	Voltage signal equivalent to 1%~2500% of Rated current I_n (CT rating) (continuously adjustable). *The output at 100% of CT rating is 141mV at 50Hz or 170mV at 60Hz.
Test power output and trip check power output	DC30V 5W
Terminal for checking the signal output	The same signal as the signal output is output to the terminal on the back side (load impedance: 100k Ω or more).
Stop signal input	"a" contact, "b" contact or test terminal (ETR)
Test items	LTD, STD, INST/MCR, GFR, PAL, PAL2 and Trip check *ER check is not available.
Signal level	Max. 2500% of Rated current setting (I_r) (accuracy: $\pm 2.5\%$ at CT rating)
Time counter	0.000s $\pm 2ms$ ~ 999.999s $\pm 1\%$
Working temperature range	0~40°C (humidity: 85%Rh or less)
Storage temperature range	-10°C~50°C(humidity: 85%Rh or less)
Dimensions	220mm (width) X 150mm (height) X 340mm (depth)
Weight	4.8kg
Attachments	AC power cord, test cable, carry case

 Earth leakage protection (ER) check is not available with this tester. Please make a reference separately about the ER operating check method.

 When carrying out ETR check of Type WD, Please make inquiries.

 Power plug of AC power cord is equipped with grounding pin. Please use the outlet with grounding for the electric shock prevention.

2. Part names and functions (for AE-SW)



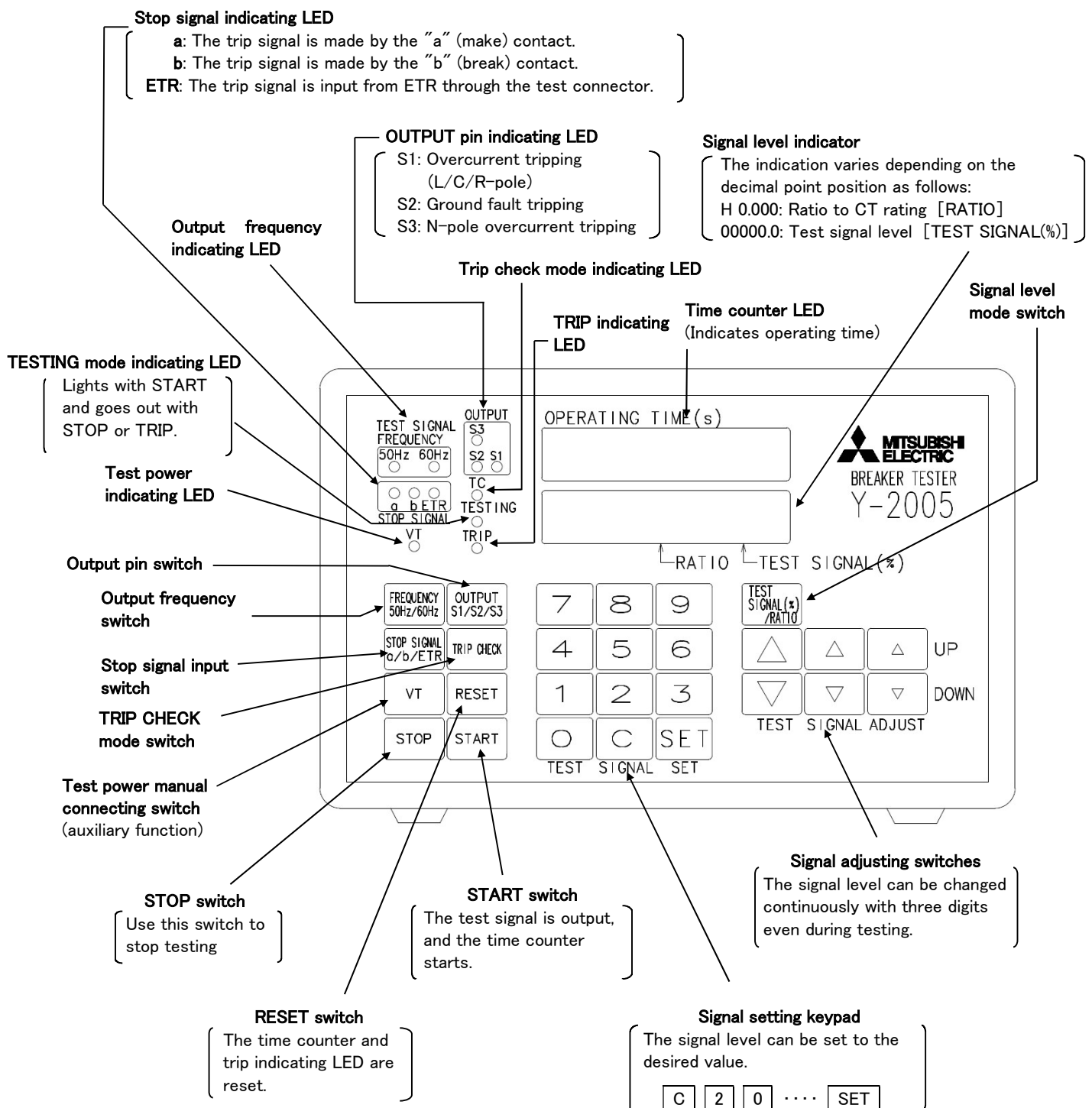

The ratio to CT rating "RATIO" indicated on the front face of Y-2005 is a ratio of Current setting I_r at AE-SW Electronic trip relay (ETR) to Rated current I_n (CT rating). Be careful in testing or operating.

● Front view



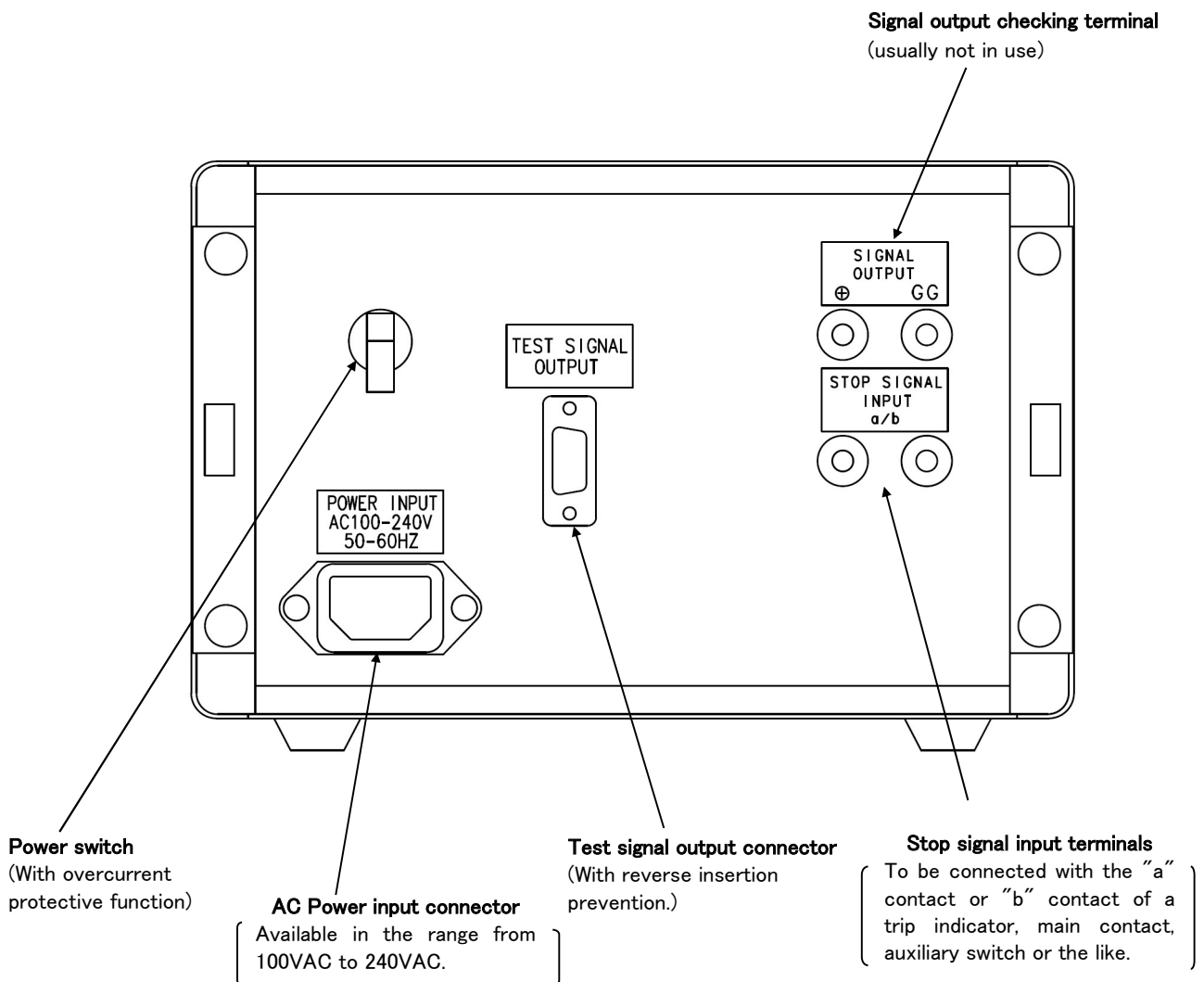

● Back view

	For calibration, inquire at any of our branch offices or service centers.
	The test signal output can be checked by connecting an AC voltmeter.



 DANGER	When using the "Stop signal input terminals", check that no power is supplied and that there is no interference with other wiring in the panelboard. Otherwise, electric shocks or short circuits may occur.
---	--

3. Connection (for AE-SW)

 DANGER	Do not touch the terminals. Otherwise, electric shocks may occur.
	When checking a dielectric voltage test or insulation resistance measurement of the circuit breaker and panelboard, remove all wiring for Y-2005. Otherwise, trouble may occur.

Electronic trip relay (ETR)

Note) This figure includes Display (*option) and MCR switch (*option).

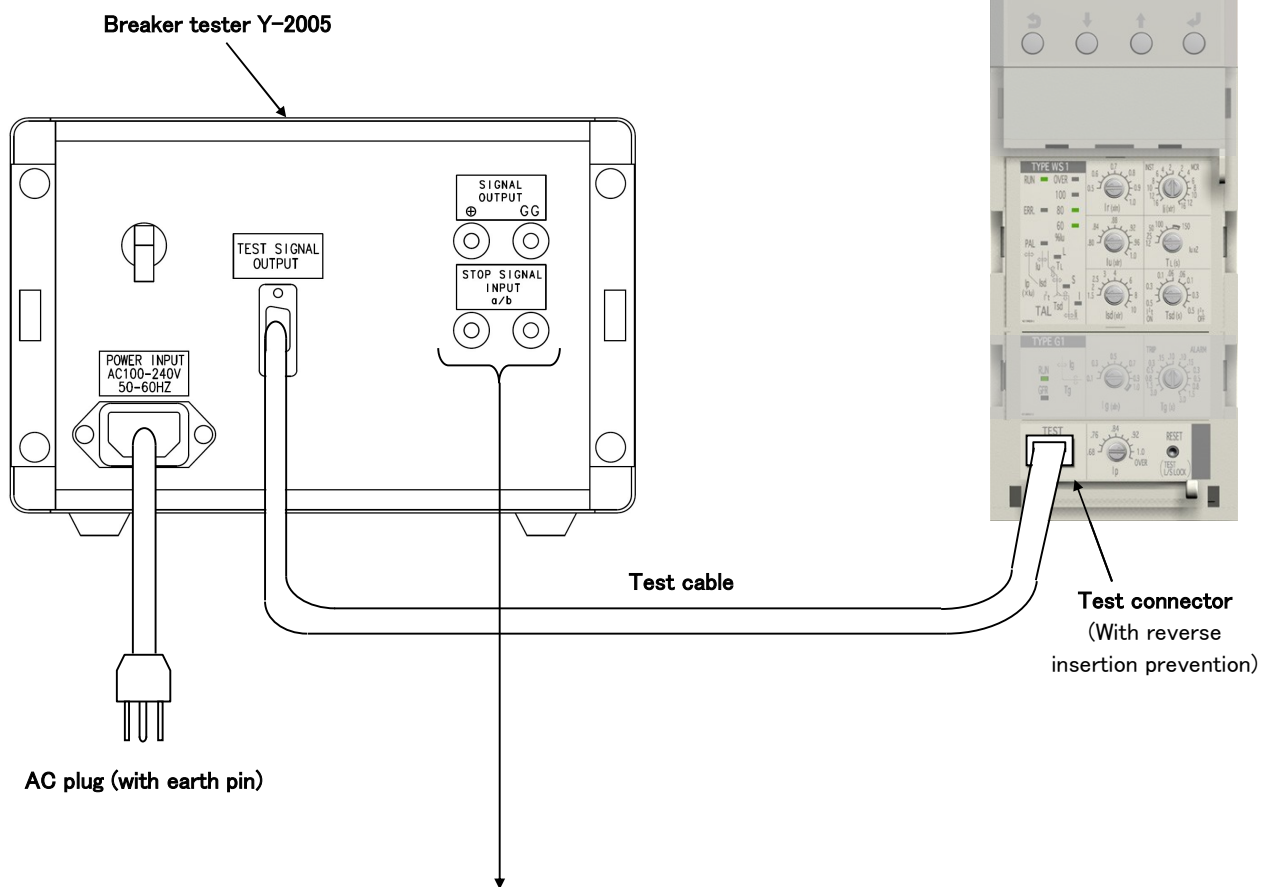

These are used when the stop signal is input from other than the test cable (test connector of ETR).

- ①When using the main contact of breaker. ... Set the "Stop signal input switch" on the front face to [b].
- ②When using the "a" contact of auxiliary switch (AX). ... Set the "Stop signal input switch" to [b].
- ③When using the "b" contact of auxiliary switch (AX). ... Set the "Stop signal input switch" to [a].
- ④When using the OCR alarm switch (AL). ... Set the "Stop signal input switch" to [a].

*Connect to the circuit breaker's control circuit terminal block (97 and 98).

- ⑤When using the alarm contacts. ... Set the "Stop signal input switch" to [a].

*Connect to the circuit breaker's control circuit terminal block (524 ~ 564 and 513).

*For using these alarm contacts, the Power supply module with alarm contact (type: P3, P4 OR P5) is required.

4. Initial setting and operation (for AE-SW)



Start the setting and operation after carefully reading an instruction manual for AE-SW (IB63366) and 6. *Settings and accuracy* in this instruction manual to understand the characteristics of ETR.

4.1 Setting of rated current

- (1) Open the front cover of ETR.
- (2) Connect a test cable to ETR as described in *Chapter 3*.
- (3) Turn on the “Power switch” on the back panel.
- (4) Set a mode with the corresponding switches described below. The settings are changed in turn by pushing the switches. As for function of each setting, see *chapter 2*.

- Output frequency 50Hz / 60Hz
- Stop signal a / b / ETR
- Output pin S1 / S2 / S3
- Test mode usual test / TRIP CHECK

*When power is turned on, each item is set to the marked position.

(5) Setting of Rated current

This tester outputs a signal at the ratio of Current setting I_r at ETR to Rated current I_n (CT rating). Therefore, at the beginning, the ratio to CT rating should be set in % of Rated current I_n (CT rating).

- ① Set a mode to H 0.000 with “Signal level mode switch TEST SIGNAL(%)/RATIO “.
(When power is turned on, the rated current is set to H 1.000).
- ② Input a value of the rated current to H 0.000 with “Signal adjusting switches” or “Signal setting keypad”.

● When testing the Overcurrent tripping or pre-alarm characteristics.

(i) In case of WS or WB type relay;

Input a value of I_r setting dial of ETR.

Example) In case that I_r is set to 0.8: Input H 0.800 .

(ii) In case of WM type relay;



Input a value calculated by $(I_r [A] \div I_n [A])$.

Example) In case that $I_n=1600A$ and $I_r=1283A$: $1283A \div 1600A=0.802$, therefore input H 0.802 .

● When testing the ground fault characteristics.

Set to H 1.000 even if I_r setting dial of ETR is not set to 1.0.

4.2 How to operate

 DANGER	<p>Test should be performed only after shutting off the electric power and verifying that there is no voltage present. Failure to do so may result in an electrical shock.</p>
	<p>When current is flowing in the main circuit of breaker, it is combined with the test signal of Y-2005, consequently does not become correct characteristic. The operating test should be performed in the state that load current does not flow in the main circuit.</p>

(1) Set the “Signal level indicator” to by pushing the “Signal level mode switch” “.

(2) Set a signal level in % of I_r by using the “Signal adjusting switches” or “Signal setting keypad”.

● When using the “Signal adjusting switches”:

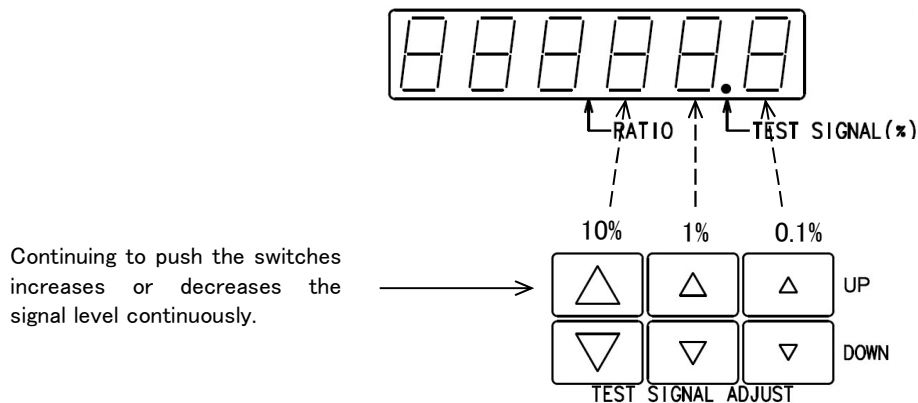

● When using the “Signal setting keypad”:

- ① Push a clear key .
- ② Since figures are shifted to left every time you push numerical keys, enter the desired values.
- ③ Push a set key .

⇒ To set to 200% I_r , push , and is set.

(3) Push switch, and the test signal is output. Then the time counter starts from , and also the “TESTING mode indicating LED” lights.

(4) Push switch, and the test signal is stopped. Then the time counter stops, and the “TESTING mode indicating LED” goes off.

In case of tripping, the “TRIP indicating LED” lights and the time counter stops automatically.

(5) Push switch to reset the “TRIP indicating LED” and the time counter. This switch is used for retesting.

5. Test (for AE-SW)



It is possible to display a trip current value on LCD by supplying control power to ETR, if Display (DP1 or DP2) (*option) is equipped. However, this value may become somewhat larger than the value displayed by Y-2005, especially in case of STD and INST trip. Furthermore, since the test signal from Y-2005 is not input into the Extension module (EX1), even if it supplies the test current to ETR, the measuring current value displayed on LCD will be as “0”.

5.1 LTD Pick-up current test

- (1) Set the signal level to approximately 90% of LTD pick-up current.
- (2) Push **START** switch.
- (3) Increase the signal level with “Signal adjusting switch”, and take a reading of pick-up value.
 - (i) In case of WS type relay
The pick-up value is calculated by;
(Pick-up level at a point where ETR turns a [OVER] LED on) ÷ I_u.
Example) When the [OVER] LED lights at 94% with I_u=0.8, the pick-up value is 94% ÷ 0.8=117.5%.
 - (ii) In case of WM type relay
The LTD pick-up level can be taken at a point where ETR turns a [100%] LED on.
- (4) Push **STOP** switch.
- (5) Push **RESET** switch and start at (1), if testing again.

Increase the signal level with this 1% step key.

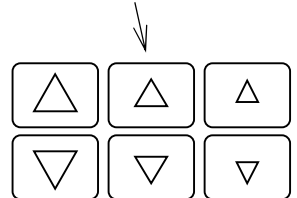

Signal adjusting switches

5.2 LTD operating time test

- (1) Set a desired signal level.
 - (i) In case of WS type relay
The operating time is to be taken at 200%I_u, therefore, if I_u is set to 1.0, set the signal level to **00200.0** .
In case that I_u is not set to 1.0, for example, if I_u is 0.9, since 0.9 × 200%=180%, set the signal level to **00180.0** .
 - (ii) In case of WM type relay
The operating time is to be taken at 120%I_L, therefore, if I_L is set to 1.05, since 1.05 × 120%=126%, set the signal level to **00126.0** .
- (2) The I_{sd} (short-time-delay pick-up current) and I_i (instantaneous pick-up current) setting dial of ETR should be set to 1.2 times or more the above-mentioned signal level.
- (3) Push **START** switch.
- (4) After tripping, the operating time is indicated.
- (5) Push **RESET** switch and start at (3), if testing again.



Since ETR has a memory effect for overcurrent state, when the operating time test is interrupted on the way, the operating time at the next test becomes short. This memory effect can be reset by tripping. Therefore, if operating time test is interrupted on the way, perform the next test after tripping ETR one-time. To trip, perform the trip check in accordance with 5.12.

<Hint> In section 5.1 and 5.2, if I_u of WS type relay is not set to 1.0, the reading value of the signal level can be regarded as the LTD pick-up current (%) by setting the value of **H 0.000** to I_r × I_u. Also, when measuring the LTD operating time, test can be performed with the signal level **00200.0**. However, when checking the STD or INST characteristics, return the setting of **H 0.000** to a former value.

5.3 STD Pick-up current test

- (1) Set I_i (instantaneous pick-up current) setting dial of ETR to the maximum, and set T_{sd} (short-time-delay operating time) to the minimum (0.06s).
 * If the setting value of T_g is large, exact measurement cannot be performed in the following (5).

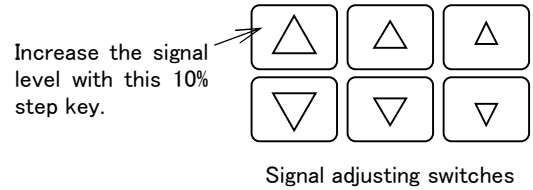

- (2) Set the signal level to approximately 80% of I_{sd} .
- (3) Push **START** switch, and immediately increase the signal level with a 10% signal adjusting switch until ETR trips and Time counter LED stops.

	Increase the signal level by using 10% step key. Since it takes a long time to test in case of 1% or 0.1% step, the LTD pick-up may operate before STD. If LTD pick-up operates even the 10% step, start again at approximately 95% of I_{sd} .
--	---

- (4) Read the signal level indicated at the time.
- (5) Furthermore, measure the operating time near the pick-up current measured in (3) by using 1% step key. The point where the operating time becomes short suddenly serves as accurate measured value of I_{sd} .
- (6) Push **RESET** switch and start at (2), if testing again.

5.4 STD operating time test

- (1) Set I_i setting dial of ETR to the maximum.
- (2) Set a desired signal level.
 For example, if I_{sd} setting dial is set to 4, since $400\% \times 1.5 = 600\%$, set the signal level to **00600.0**.
 *Where, 1.5 is a value that the operating time becomes flat.

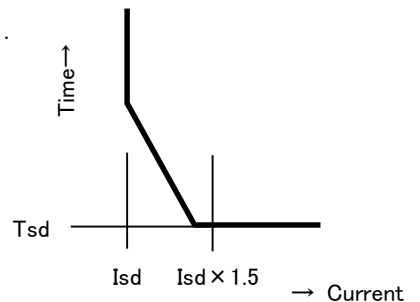

- (3) Push **START** switch.
- (4) After tripping, the operating time is indicated.

When the stop signal is made by the main contact, auxiliary switch (AX) or OCR alarm switch (AL).	Take the reading of the counter as it is.
When the stop signal is made through the test connector of ETR or alarm contacts of Power supply module (type: P3, P4 or P5).	Add 20ms (mechanical operating time) to the reading of the counter.

- (5) Push **RESET** switch and start at (3), if testing again.

	If ETR operates as LTD or INST in checking STD pick-up current, change the set value of INST/LTD, or change the test current. Moreover, ETR may operate as INST when checking STD operating time at $I_{sd}=10$. In this case, lower the test current to near 140% I_{sd} , or lower the test current after setting T_{sd} to "I ² t OFF" temporarily.
--	--

5.5 INST Pick-up current test

- (1) When the MCR switch (*option) is equipped, set Ii setting dial to "INST" side (See right figure).
- (2) Set the signal level to approximately 90% of Ii.
- (3) Push switch while continuing to push a [L/S LOCK] button of ETR, then increase the signal level by using the "Signal adjusting switch" until ETR trips and Time counter LED stops.
- (4) Read the signal level indicated at the time.
- (5) Push switch and start at (2), if testing again.
- (6) For models with MCR, if you change the dial to the INST side and test, return the dial to its original position.

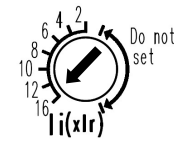

●INST (standard)

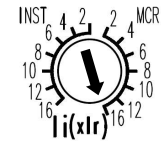

●MCR (*option)
(INST/MCR selectable)

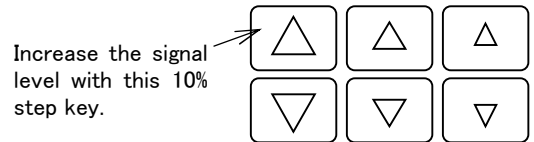

Signal adjusting switches

5.6 INST operating time test

- (1) Set a desired signal level.
For example, if Ii setting dial is set to 10, since $1000\% \times 1.5 = 1500\%$, set the signal level to .
*Where, 1.5 is a value that the operating time becomes flat.
- (2) Push switch while continuing to push the [L/S LOCK] button of ETR.
- (3) After tripping, the operating time is indicated.

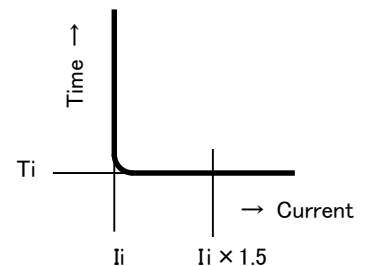

When the stop signal is made by the main contact, auxiliary switch (AX) or OCR alarm switch (AL).	Take the reading of the counter as it is.
When the stop signal is made through the test connector of ETR or alarm contacts of Power supply module (type: P3, P4 or P5).	Add 20ms (mechanical operating time) to the reading of the counter.

- (4) Push switch and start at (2), if testing again.

5.7 MCR function check (*Only when MCR switch is equipped)

- (1) Set Ii setting dial of ETR to "MCR" side.
- (2) When the state of circuit breaker is off, ETR operates as INST.
Check the INST operation in accordance with *section 5.5 and 5.6*.
*** This test is checking that instantaneous characteristics is effective during breaker closing operation (from open to close) .**

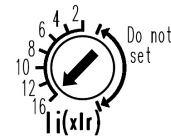

●INST (standard)

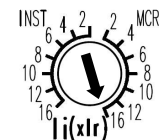

●MCR (*option)
(INST/MCR selectable)

- (3) Confirms that the breaker does not operate as INST even when the same test as *section 5.5 and 5.6* is carried out. In this case, it operates as STD in case of WS or WM type relay. In case of WB type relay, it does not trip.

5.8 GFR Pick-up current test (TRIP mode) (*Only when G1 module is equipped)

- (1) Set T_g (ground fault operating time) setting dial of ETR to the minimum (0.10s) of “TRIP” side.
 * If the setting value of T_g is large, exact measurement cannot be performed in the following (4).

(2) Set the “Signal output pin” to [S2] and the rated current to in accordance with section 4.1(5).

(3) Set the signal level to approximately 80% of I_g (ground fault pick-up current).

(4) Push switch, and immediately increase the signal level with the “Signal adjusting switch” until ETR trips and Time counter LED stops.

(5) Read the signal level indicated at the time.

(6) Push switch and start at (3), if testing again.

Increase the signal level with this 1% step key.

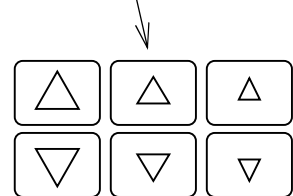

Signal adjusting switches

5.9 GFR operating time test (TRIP mode) (*Only when G1 module is equipped)

(1) Set T_g setting dial of ETR to “TRIP” side.

(2) Set the “Signal output pin” to [S2] and the rated current to in accordance with section 4.1(5).

(3) Set the “Signal level indicator” to by pushing the “Signal level mode switch ”.

(4) Set a desired signal level.

For example, if I_g setting dial is set to 0.3, since $30\% \times 1.5 = 45\%$, set the signal level to .

* Where, 1.5 is a value that the operating time becomes flat.

(5) Push switch.

(6) After tripping, the operating time is indicated.

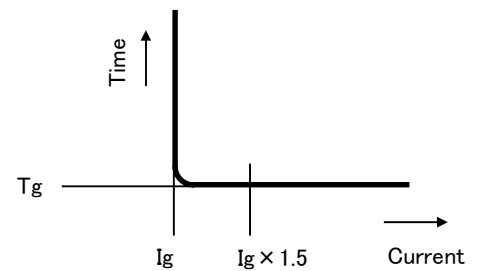

When the stop signal is made by the main contact, auxiliary switch (AX) or OCR alarm switch (AL).	Take the reading of the counter as it is.
When the stop signal is made through the test connector of ETR or alarm contacts of Power supply module (type: P3, P4 or P5).	Add 20ms (mechanical operating time) to the reading of the counter.

(8) Push switch and start at (5), if testing again.

	<p>When checking the short time operation such as GFR operating time test, in order to measure the operating time with accuracy, push the “Test power manual connecting switch <input type="text" value="VT"/>”, and push the <input type="text" value="START"/> switch after the “Test power indicating LED” lighting. If do not pushing the “Test power manual connecting switch <input type="text" value="VT"/>”, exact measurement cannot be performed.</p>
--	---

5.10 GFR Pick-up current test (ALARM mode) (*Only when G1 module is equipped)

- (1) Set T_g (ground fault operating time) setting dial of ETR to the minimum (0.10s) of “ALARM” side.
* If the setting value of T_g is large, exact measurement cannot be performed in the following (5).

(2) Set the “Signal output pin” to [S2] and the rated current to **H 1.000** in accordance with *section 4.1(5)*.

(3) Set the signal level to approximately 80% of I_g (ground fault pick-up current).

(4) Push **START** switch.

(5) Increase the signal level using the “Signal adjusting switch”,
and take a reading of the counter at a point where ETR turns a [GFR] LED on.

(6) Push **RESET** switch and start at (3), if testing again.

Increase the signal level with this 1% step key.

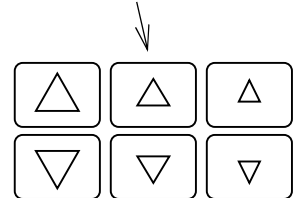

Signal adjusting switches

5.11 GFR operating time test (ALARM mode) (*Only when type P3, P4 or P5 module and G1 module are equipped)

(1) Set T_g setting dial of ETR to “ALARM” side.

(2) Supply power to ETR (between **P1** and **P2** of the circuit breaker’s control circuit terminal block).

(3) Connect the “Stop signal input” on the back of tester and the contact terminal for GFR (between **544** and **513** of the circuit breaker’s control circuit terminal block). Then set the “Stop signal input switch” to [a].

***The terminal allocation for GFR (**544** and **513**) described in above is the assignment at the factory shipments. If this allocation is changed by using the display (DP1 or DP2), it differs from the above allocation.**

(4) Set a desired signal level (See *section 5.9*).

(5) Push **START** switch.

(6) After operation, the operating time is indicated.

(7) Push **RESET** switch and start at (4), if testing again.

5.12 Trip check

This function enables the circuit breaker to operate instantaneously. It is effective when checking panel sequence, resetting the memory effect for overcurrent and the like.

- (1) Set a test mode to [TC] (trip check).
- (2) In case of WM type relay, if MCR switch (*option) is equipped, set Ii setting dial to "INST" side.
***In case of WB type relay, unless Ii setting dial is set to "INST" side, ETR does not trip.**
- (3) Push switch.
- (4) Confirms that the circuit breaker trips instantaneously.
- (5) Push switch and start at (3), if testing again.



When checking the circuit breaker operating time, push the "Test power manual connecting switch " , and push switch after the "Test power indicating LED" lighting. If do not pushing the "Test power manual connecting switch " , exact measurement cannot be performed.

5.13 PAL pick-up current test

- (1) Set the signal level to approximately 80% of I_p .
- (2) Push switch.
- (3) Increase the signal level using the "Signal adjusting switch", and take a reading of the counter at a point where [PAL] LED of ETR blinks.
- (4) Push switch.
- (5) Push switch and start at (1), if testing again.

Increase the signal level with this 1% step key.

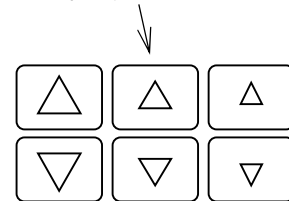

Signal adjusting switches

5.14 PAL operating time test (*Only when type P3, P4 or P5 of Power supply module is equipped)

- (1) Supply power to ETR (between and of the circuit breaker's control circuit terminal block).
- (2) Connect the "Stop signal input" on the back of tester and the contact terminal for PAL OUT (between and of the circuit breaker's control circuit terminal block). Then set the "Stop signal input switch" to [a].
***The terminal allocation for PAL OUT (and) described in above is the assignment at the factory shipments. If this allocation is changed by using the display (DP1 or DP2), it differs from the above allocation.**
- (3) Set a desired signal level (See *section 5.2*).
- (4) Push switch.
- (5) After operation, the operating time is indicated.
- (6) Push switch and start at (3), if testing again.



Since ETR has a memory effect for overcurrent state, when the operating time test is interrupted on the way, the operating time at the next test becomes short. This memory effect can be reset by tripping. Therefore, if operating time test is interrupted on the way, perform the next test after tripping ETR one-time. To trip, perform the trip check in accordance with 5.12.

5.15 PAL2 pick-up current test (*Only when AP module is equipped)

- (1) Set the signal level to approximately 80% of I_p2 .
- (2) Push **START** switch.
- (3) Increase the signal level using the "Signal adjusting switch", and take a reading of the counter at a point where [PAL2] LED of ETR blinks.
- (4) Push **STOP** switch.
- (5) Push **RESET** switch and start at (1), if testing again.

Increase the signal level with this 1% step key.

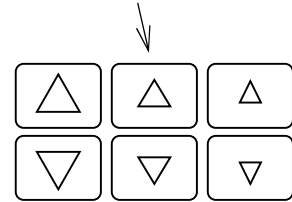

Signal adjusting switches

5.16 PAL2 operating time test (*Only when P3, P4 or P5 module and AP module are equipped)

- (1) Supply power to ETR (between **P1** and **P2** of the circuit breaker's control circuit terminal block).
- (2) Connect the "Stop signal input" on the back of tester and the contact terminal for PAL2 OUT (between **544** and **513** of the circuit breaker's control circuit terminal block). Then set the "Stop signal input switch" to [a].
***The terminal allocation for PAL2 OUT (**544** and **513**) described in above is the assignment at the factory shipments. If this allocation is changed by using the display (DP1 or DP2), it differs from the above allocation.**
- (3) Set a desired signal level (See *section 5.2*).
- (4) Push **START** switch.
- (5) After operation, the operating time is indicated.
- (6) Push **RESET** switch and start at (3), if testing again.



Since ETR has a memory effect for overcurrent state, when the operating time test is interrupted on the way, the operating time at the next test becomes short. This memory effect can be reset by tripping. Therefore, if operating time test is interrupted on the way, perform the next test after tripping ETR one-time. To trip, perform the trip check in accordance with *5.12*.

5.17 OCR alarm switch (AL) check

The OCR alarm switch (AL) is a contact ("a" contact) of short time operation (30–50ms)^{Note}. This time can be measured with the oscilloscope, the millisecond counter or the like.

Note): In case of the manual reset type (MRE) (*option), AL is output continuously. This contact output is not reset until pushing the manual reset button of breaker.



Y-2005 enables a check of operation even if breaker is in the state of OFF. However, as for AL checking, since AL is included in the trip mechanism, AL is output only when tripping from ON state. (AL cannot be output unless tripping actually).

6. Settings and accuracy (for AE-SW)

6.1 Settings and accuracy of type WS relay

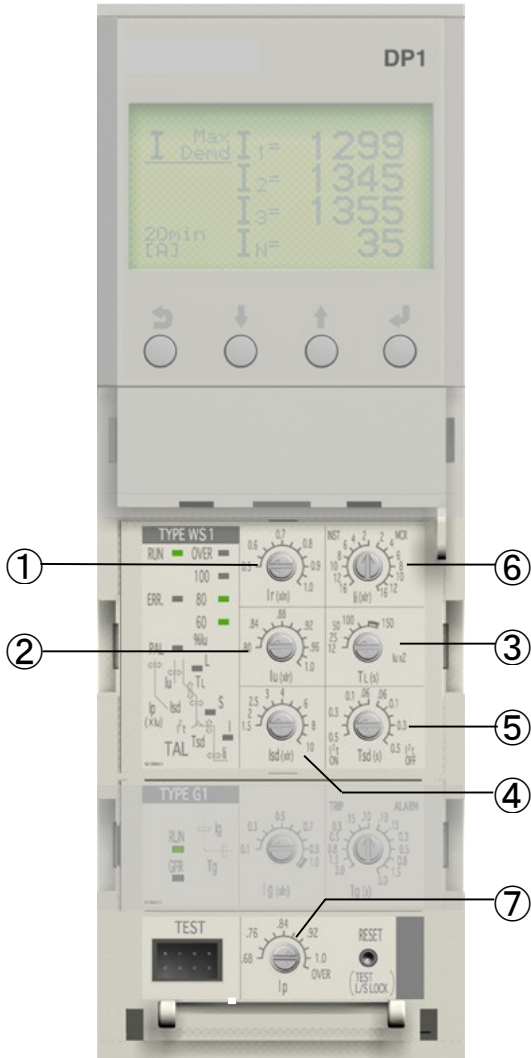

■ The figure includes optional G1 setting module, Display and MCR.

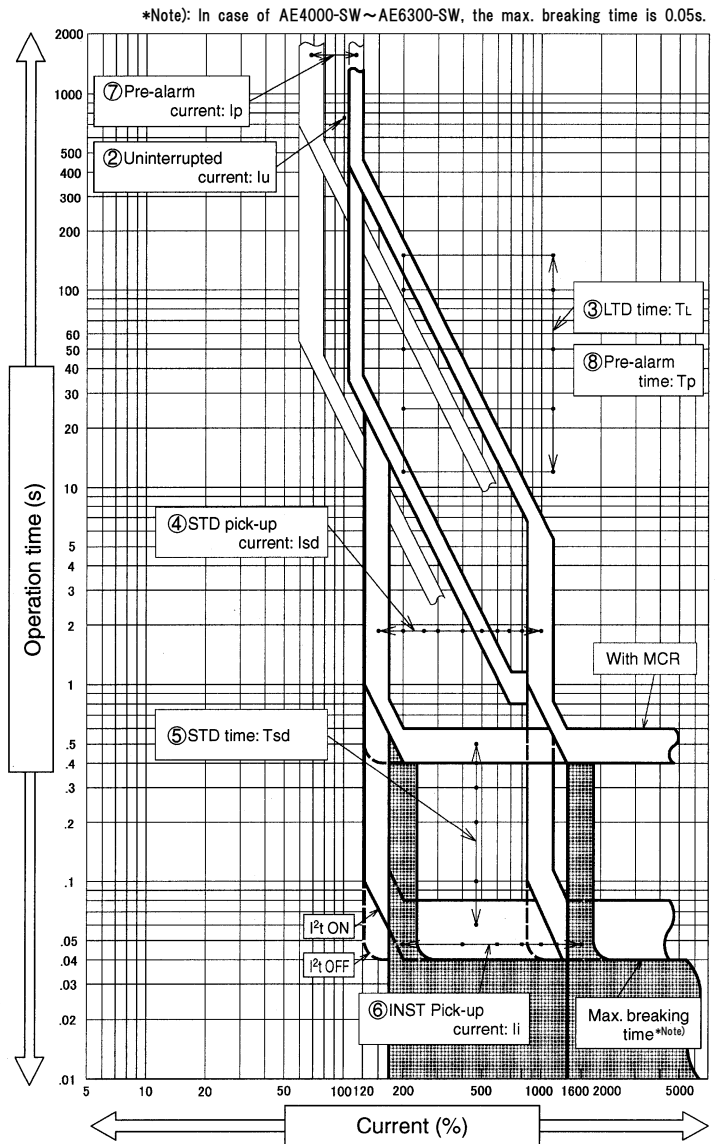

*Note: In case of AE4000-SW~AE6300-SW, the max. breaking time is 0.05s.

No.	Setting item	Mark	Adjustable setting range			Accuracy
			AE630-SW~AE1600-SW AE2000-SW~AE3200-SW AE4000-SW	AE2000-SWA AE4000-SWA AE5000-SW	AE6300-SW	
①	Rated current setting	I _r	0.5~1.0(0.05step) × I _n (CT rating)			—
②	Uninterrupted current	I _u	0.8~1.0 × I _r (0.02step), Pick-up current: 1.15xI _u			1.05 × I _u ...Non pick-up 1.25 × I _u ...Pick-up
③	LTD time	T _L	12-25-50-100-150s at I _u × 2			± 20%
④	STD Pick-up current	I _{sd}	1.5-2-2.5-3-4-5-6-7-8-9-10 × I _r			± 15%
⑤	STD time	T _{sd}	0.5-0.4-0.3-0.2-0.1-0.06 (I ² t ON) 0.06-0.1-0.2-0.3-0.4-0.5s (I ² t OFF)			± 20% (0.06...±0.02s)
⑥	INST. Pick-up current	I _i	16~2 - 2~16 × I _r (INST) (MCR) WS1	12~2 - 2~12 × I _r (INST) (MCR) WS2	10~2 - 2~10 × I _r (INST) (MCR) WS3	± 15%
⑦	Pre-alarm current	I _p	I _u × 0.68~1.0(0.04step)-OVER			± 10%
⑧	Pre-alarm time	T _p	1/2 TL (after 1/2TL, PAL output contact turns on)			± 20%

*Note: The table shows data obtained on the breakers provided with MCR (*option). For breakers without MCR, the setting position for MCR is not provided.

Relation of setting dial

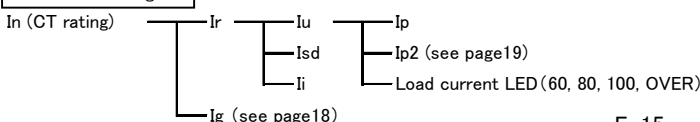

6.2 Settings and accuracy of type WM relay

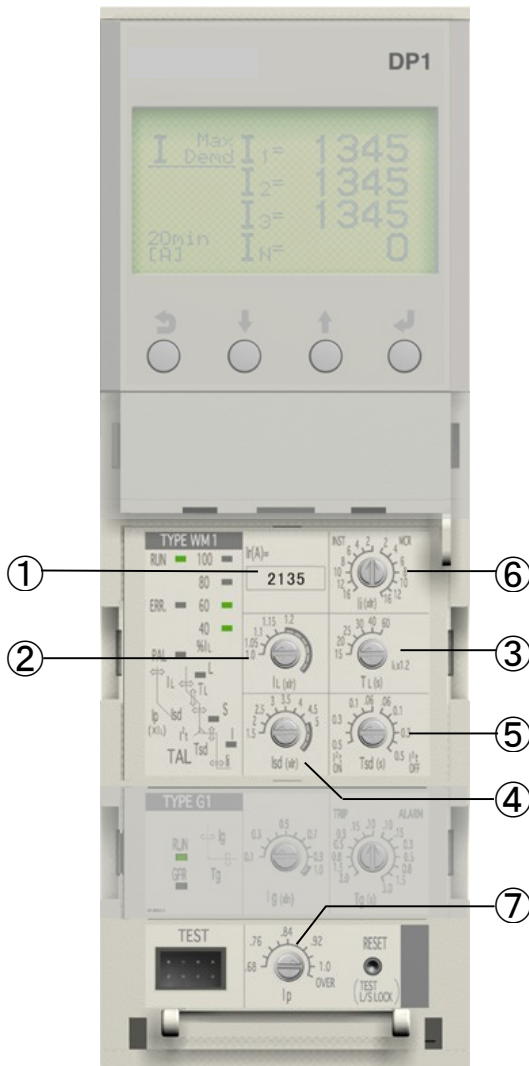

■ The figure includes optional G1 setting module, Display and MCR.

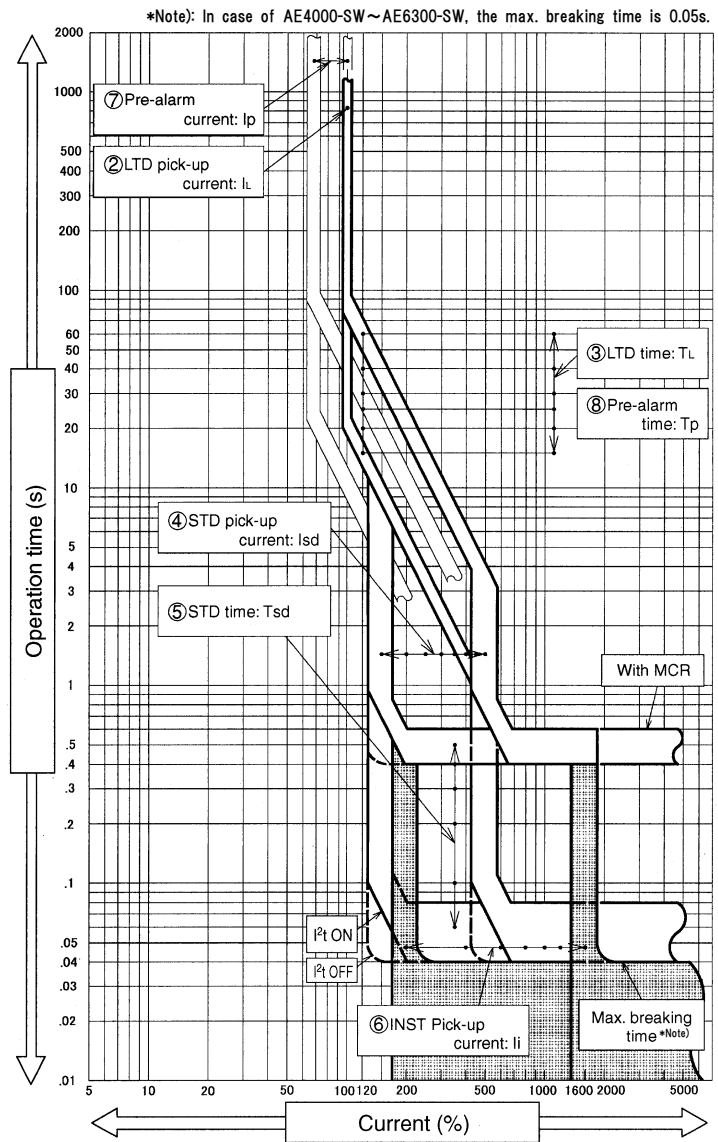

*Note): In case of AE4000-SW~AE6300-SW, the max. breaking time is 0.05s.

No.	Setting item	Mark	Adjustable setting range			Accuracy
			AE630-SW~AE1600-SW AE2000-SW~AE3200-SW AE4000-SW	AE2000-SWA AE4000-SWA AE5000-SW	AE6300-SW	
①	Rated current setting	I_r	0.63 ~ 1.0 × I_n (*Set to specified current value before shipment (fixed))			—
②	LTD pick-up current	I_L	1.0-1.05-1.1-1.15-1.2 × I_r			± 5%
③	LTD time	T_L	15-20-25-30-40-60s at $I_L \times 1.2$			± 20%
④	STD pick-up current	I_{sd}	1.5-2-2.5-3-3.5-4-4.5-5 × I_r			± 15%
⑤	STD time	T_{sd}	0.5-0.4-0.3-0.2-0.1-0.06 (I ² t ON) / 0.06-0.1-0.2-0.3-0.4-0.5s (I ² t OFF)			± 20% ³⁾ (0.06...±0.02s)
⑥	INST. pick-up current	I_i	16~2-2~16 × I_r (INST) (MCR) WM1	12~2-2~12 × I_r (INST) (MCR) WM2	10~2-2~10 × I_r (INST) (MCR) WM3	± 15% ³⁾
⑦	Pre-alarm current	I_p	$I_L \times 0.68 \sim 1.0(0.04\text{step})\text{-OVER}$			± 5%
⑧	Pre-alarm time	T_p	1/2 T_L (after 1/2 T_L , PAL output contact turns on)			± 20%

*Note1): The table shows data obtained on the breakers provided with MCR (*option). For breakers without MCR, the setting position for MCR is not provided.

*Note2): When the WM type relay is used, the pre-alarm current at the setting, OVER, is the same as that at 1.0.

*Note3): When used without voltage applied to the control power supply(ETR power supply module), Tsd, Ii operation on time may increase max. 20ms.

Relation of setting dial

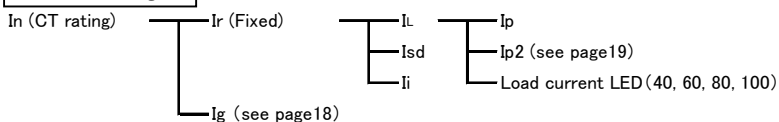

6.3 Settings and accuracy of type WB relay

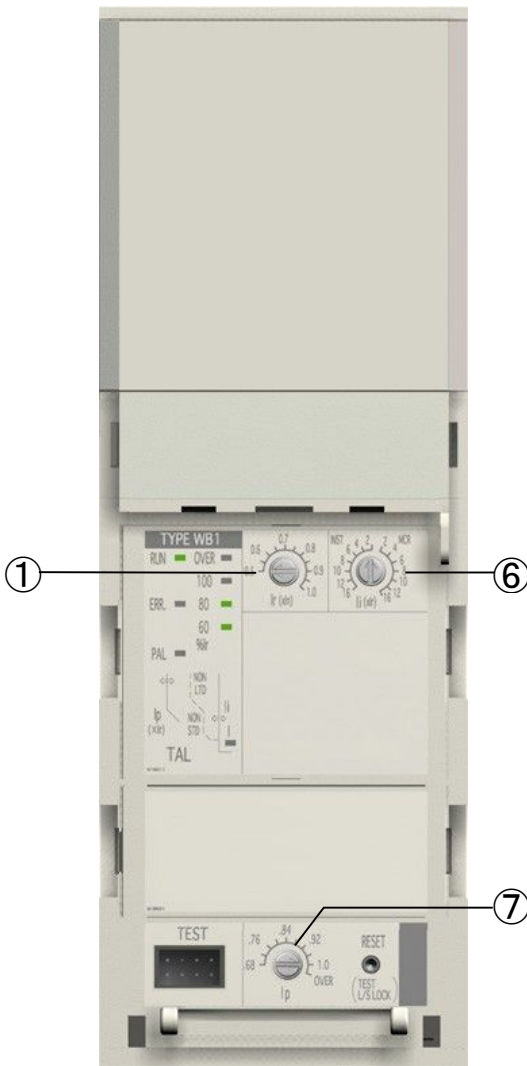

■ The figure includes MCR function.

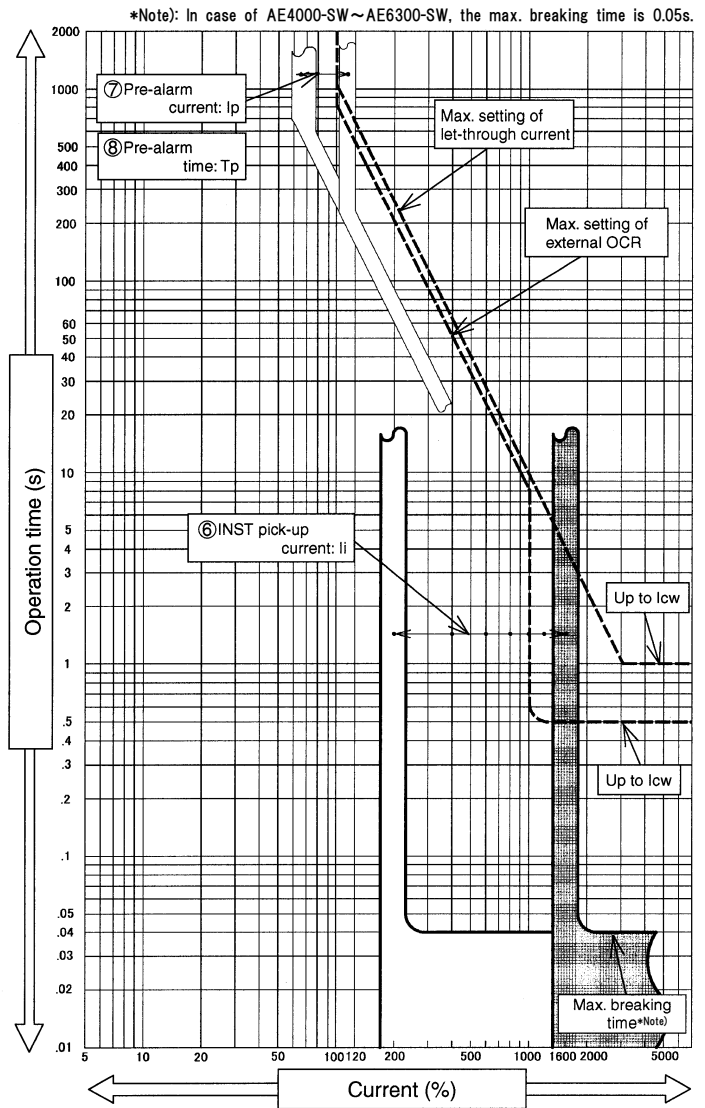

No.	Setting item	Mark	Adjustable setting range			Accuracy
			AE630-SW~AE1600-SW AE2000-SW~AE3200-SW AE4000-SW	AE2000-SWA AE4000-SWA AE5000-SW	AE6300-SW	
①	Rated current setting	Ir	0.5 ~ 1.0(0.05step) × In (CT rating)			—
⑥	INST. pick-up current	Ii	16~2 - 2~16 × Ir (INST) (MCR) WB1	12~2 - 2~12 × Ir (INST) (MCR) WB2	10~2 - 2~10 × Ir (INST) (MCR) WB3	±15%
⑦	Pre-alarm current	Ip	Ir × 0.68~1.0(0.04step)-OVER			±5%
⑧	Pre-alarm time	Tp	75s at Ir × 2 (after 1/2TL, PAL output contact turns on)			±20%

*Note): The table shows data obtained on the breakers provided with MCR (*option). For breakers without MCR, the setting position for MCR is not provided.

Relation of setting dial

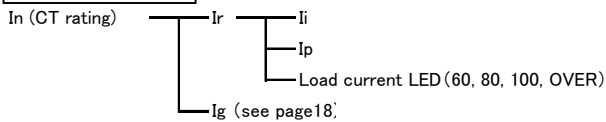

6.4 Settings and accuracy of G1 module

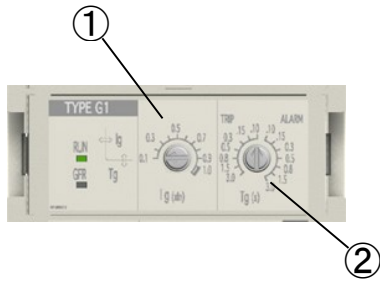

Ground fault protection characteristics

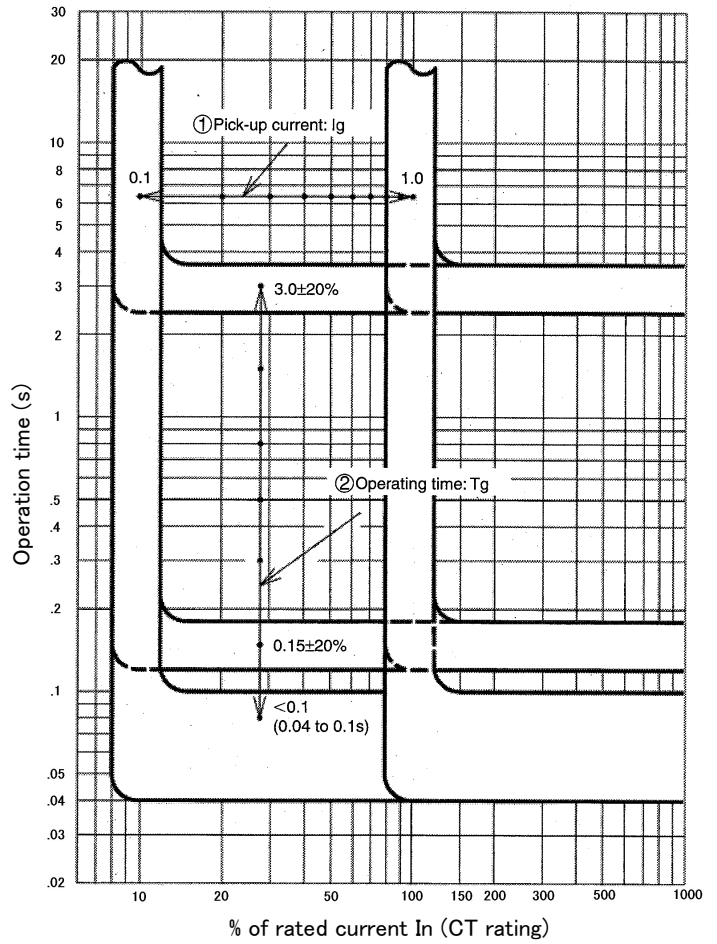

No.	Setting item	Mark	Adjustable setting range	Accuracy
①	Ground fault Pick-up	I_g	$0.1 \sim 1.0 \times I_n$ (0.1step)	$\pm 20\%$
②	Ground fault time	T_g	$\frac{3.0-1.5-0.8-0.5-0.3-0.15- <0.1}{\text{(Trip)}} - \frac{<0.1-0.15-0.3-0.5-0.8-1.5-3.0}{\text{(Alarm)}}$	$\pm 20\%$

6.5 Settings and accuracy of AP module

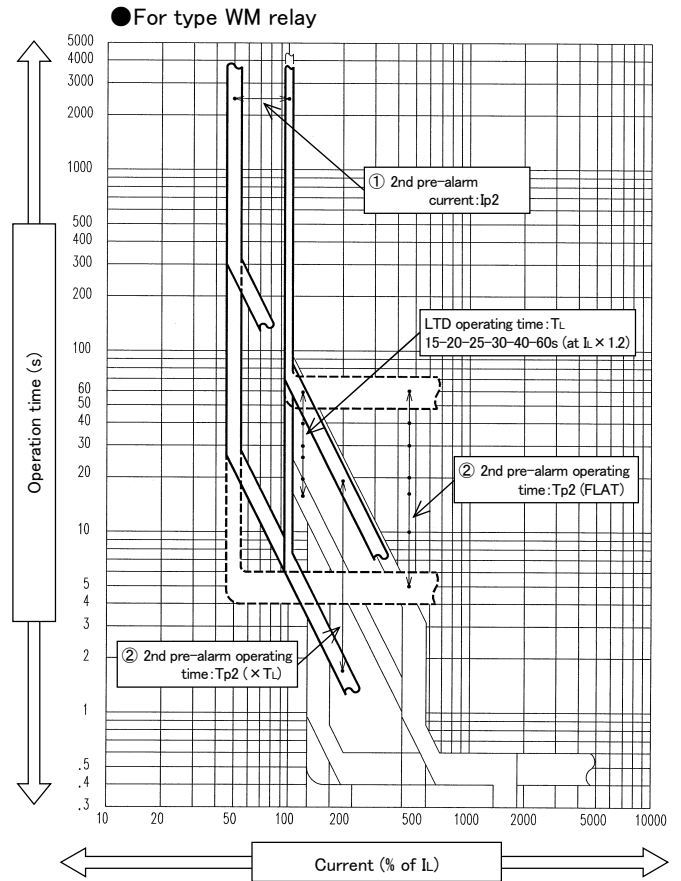
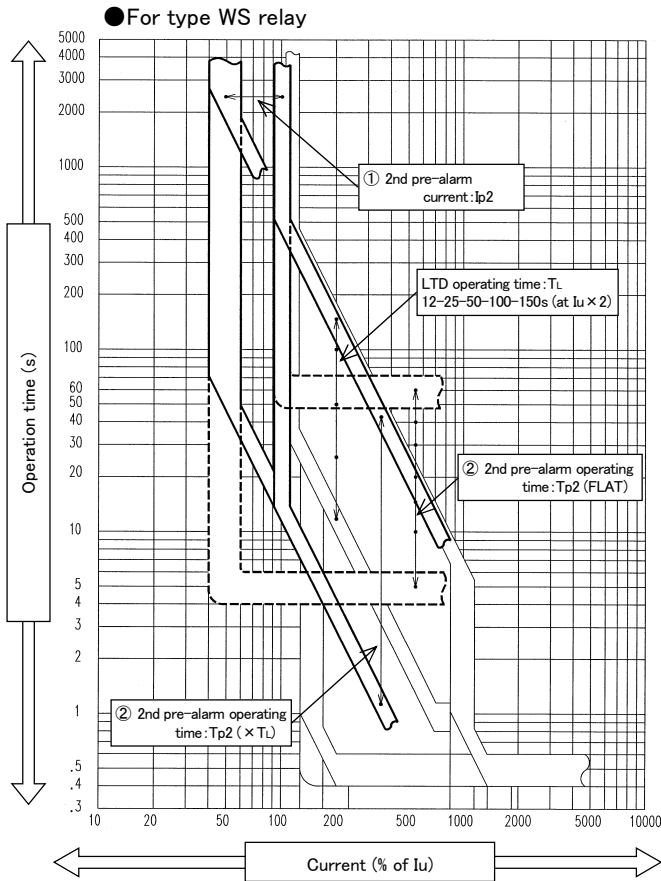
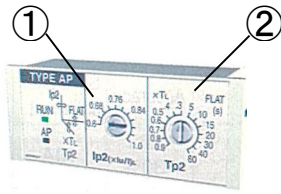

No.	Setting items	Mark	Adjustable setting range	Accuracy
①	2nd pre-alarm current	Ip2	0.5-0.6-0.7-0.8-0.84-0.88-0.92-0.96-1.0 × I _u	± 10%
			0.5-0.6-0.7-0.8-0.84-0.88-0.92-0.96-1.0 × I _L	± 5%
②	2nd pre-alarm operating time	Tp2	0.9-0.8-0.7-0.6-0.5-0.4-0.3 × T _L - 5-10-15-20-30-40-60s (× T _L) (FLAT)	± 20%

7. Inspection form (for AE-SW)

Inspection report form for WS type relay

Date:

Checked person:

Name of Panel/Distribution system:					
ACB Type					
CT rating (In)					
Serial number					
ETR type					
ETR serial number					
External appearance	There must be no breakage of ETR.				There must be no breakage.
	There must be no loosening of terminal screws of Control circuit terminal block.				There must be connected securely.
Confirmation of settings	Rated current setting (Ir)				Fill in the setting values. If setting was changed during check, reset the value to the previous settings at the completion of check.
	LTD	Uninterrupted current (Iu)			
		Operating time (TL)			
	STD	Pickup current (Isd)			
		Operating time (Tsd)			
	I ² t ON/OFF settings				
	INST	Pickup current (Ii)			
		INST/MCR settings			
	PAL	Pickup current (Ip)			
		Operating time (Tp)			
	GFR ³⁾	Pickup current (Ig)			
		Operating time (Tg)			
	TRIP/ALARM settings				
	ER ³⁾	Pickup current (IΔn)			
Operating time (Te)					
TRIP/ALARM settings					
PAL2 ³⁾	Pickup current (Ip2)				
	Operating time (Tp2)				
Pickup/ Operating time	LTD	Pickup current (%)		105% - 125%Iu	
		Operating time (s)		TL±20% at 200%Iu	
	STD ²⁾	Pickup current (%)		Isd±15%	
		Operating time (s)		Tsd±20% at 150%Isd	
	INST ¹⁾	Pickup current (%)		Ii±15%	
		Operating time (s)		≤ Max. breaking time at 150%Ii	
	PAL	Pickup current (%)		Ip±10%	
		Operating time (s)		TL/2±20% at 200%Iu	
	GFR ³⁾	Pickup current (%)		Ig±20%	
		Operating time (s)		Tg±20% at 150%Ig	
ER ^{3),4)}	Pickup current (%)		IΔn+0%-30%		
	Operating time (s)		Te±20% at 150%IΔn		
PAL2 ³⁾	Pickup current (%)		Ip2±10%		
	Operating time (s)		Tp2±20% at 200%Iu		
Outputs	Trip indicator LED (L, S, I, PAL, GFR ³⁾ , ER ^{3),4)} , PAL2 ³⁾)				
	Trip indicator contact output (L, S/I, PAL, GFR ³⁾ /ER ^{3),4)} /PAL2 ³⁾)			Only if Power supply with alarm contact (type: P3/P4/P5) is equipped.	
	OCR alarm switch (AL) output ⁵⁾			AL (*standard): 30ms (1pulse) MRE (*option): continuously	
Result					
Other items to be checked.					

Note1): If ETR operates as LTD or STD in checking INST pick-up current, use the L/S LOCK (LTD/STD LOCK) button of ETR.

Note2): If ETR operates as LTD or INST in checking STD pick-up current, change the set value of INST/LTD, or change the test current.

Moreover, ETR may operate as INST when checking STD operating time at Isd=10. In this case, lower the test current to near 140%Isd, or lower the test current after setting Tsd to "I²t OFF" temporarily.

Note3): Check and fill in the blanks only if any Optional setting module (G1/E1/AP) is equipped.

Note4): Please make a reference separately about the ER operating check method.

Note5): Since AL is included in the trip mechanism, AL is output only when tripping from ON state. (AL cannot be output unless tripping actually).

Inspection report form for WM type relay

Date:

Checked person:

Name of Panel/Distribution system:					
ACB Type					
CT rating (In)					
Serial number					
ETR type					
ETR serial number					
External appearance	There must be no breakage of ETR.				There must be no breakage.
	There must be no loosening of terminal screws of Control circuit terminal block.				There must be connected securely.
Confirmation of settings	Rated current setting (Ir)				Fill in the setting values. If setting was changed during check, reset the value to the previous settings at the completion of check.
	LTD	Pickup current (IL)			
		Operating time (TL)			
	STD	Pickup current (Isd)			
		Operating time (Tsd)			
	I ² t ON/OFF settings				
	INST	Pickup current (Ii)			
		INST/MCR settings			
	PAL	Pickup current (Ip)			
		Operating time (Tp)			
	GFR ³⁾	Pickup current (Ig)			
		Operating time (Tg)			
	TRIP/ALARM settings				
	ER ³⁾	Pickup current (IΔn)			
Operating time (Te)					
TRIP/ALARM settings					
PAL2 ³⁾	Pickup current (Ip2)				
	Operating time (Tp2)				
Pickup/ Operating time	LTD	Pickup current (%)			IL ± 5%
		Operating time (s)			TL ± 20% at 120%IL
	STD ^{2), 6)}	Pickup current (%)			Isd ± 15%
		Operating time (s)			Tsd ± 20% at 150%Isd
	INST ^{1), 6)}	Pickup current (%)			Ii ± 15%
		Operating time (s)			≤ Max. breaking time at 150%Ii
	PAL	Pickup current (%)			Ip ± 5%
		Operating time (s)			TL/2 ± 20% at 120%IL
	GFR ³⁾	Pickup current (%)			Ig ± 20%
		Operating time (s)			Tg ± 20% at 150%Ig
	ER ^{3), 4)}	Pickup current (%)			IΔn +0% -30%
		Operating time (s)			Te ± 20% at 150%IΔn
PAL2 ³⁾	Pickup current (%)			Ip2 ± 5%	
	Operating time (s)			Tp2 ± 20% at 120%IL	
Outputs	Trip indicator LED (L, S, I, PAL, GFR ³⁾ , ER ^{3), 4)} , PAL2 ³⁾)				
	Trip indicator contact output (L, S/I, PAL, GFR ³⁾ /ER ^{3), 4)} /PAL2 ³⁾)				Only if Power supply with alarm contact (type: P3/P4/P5) is equipped.
	OCR alarm switch (AL) output ⁵⁾				AL (*standard): 30ms (1pulse) MRE (*option): continuously
Result					
Other items to be checked.					

Note1): If ETR operates as LTD or STD in checking INST pick-up current, use the L/S LOCK (LTD/STD LOCK) button of ETR.

Note2): If ETR operates as LTD or INST in checking STD pick-up current, change the set value of INST/LTD, or change the test current.

Moreover, ETR may operate as INST when checking STD operating time at Isd=10. In this case, lower the test current to near 140%Isd, or lower the test current after setting Tsd to "I²t OFF" temporarily.

Note3): Check and fill in the blanks only if any Optional setting module (G1/E1/AP) is equipped.

Note4): Please make a reference separately about the ER operating check method.

Note5): Since AL is included in the trip mechanism, AL is output only when tripping from ON state. (AL cannot be output unless tripping actually).

Note6): When used without voltage applied to the control power supply(ETR power supply module), Tsd, Ii operation on time may increase max. 20ms.

Inspection report form for WB type relay

Date:

Checked person:

Name of Panel/Distribution system:						
ACB Type						
CT rating (In)						
Serial number						
ETR type						
ETR serial number						
External appearance	There must be no breakage of ETR.				There must be no breakage.	
	There must be no loosening of terminal screws of Control circuit terminal block.				There must be connected securely.	
Confirmation of settings	Rated current setting (Ir)				Fill in the setting values. If setting was changed during check, reset the value to the previous settings at the completion of check.	
	INST	Pickup current (Ii)				
		INST/MCR settings				
	PAL	Pickup current (Ip)				
		Operating time (Tp)				
	GFR ¹⁾	Pickup current (Ig)				
		Operating time (Tg)				
		TRIP/ALARM settings				
	ER ¹⁾	Pickup current (IΔn)				
		Operating time (Te)				
TRIP/ALARM settings						
PAL2 ¹⁾	Pickup current (Ip2)					
	Operating time (Tp2)					
Pickup/ Operating time	INST	Pickup current (%)			Ii ± 15%	
		Operating time (s)			≤ Max. breaking time at 150%Ii	
	PAL	Pickup current (%)			Ip ± 10%	
		Operating time (s)			75s ± 20% at 200%Ir	
	GFR ¹⁾	Pickup current (%)			Ig ± 20%	
		Operating time (s)			Tg ± 20% at 150%Ig	
	ER ^{1), 2)}	Pickup current (%)			IΔn + 0% - 30%	
		Operating time (s)			Te ± 20% at 150%IΔn	
PAL2 ¹⁾	Pickup current (%)			Ip2 ± 10%		
	Operating time (s)			Tp2 ± 20% at 200%Ir		
Outputs	Trip indicator LED (I, PAL, GFR ¹⁾ , ER ^{1), 2)} , PAL2 ¹⁾)					
	Trip indicator contact output (I, PAL, GFR ¹⁾ /ER ^{1), 2)} /PAL2 ¹⁾)				Only if Power supply with alarm contact (type: P3/P4/P5) is equipped.	
	OCR alarm switch (AL) output ³⁾				AL (*standard): 30ms (1pulse) MRE (*option): continuously	
Result						
Other items to be checked.						

Note1): Check and fill in the blanks only if any Optional setting module (G1/E1/AP) is equipped.

Note2): Please make a reference separately about the ER operating check method.

Note3): Since AL is included in the trip mechanism, AL is output only when tripping from ON state. (AL cannot be output unless tripping actually).

8. Part names and functions (for AE-SS/SH)



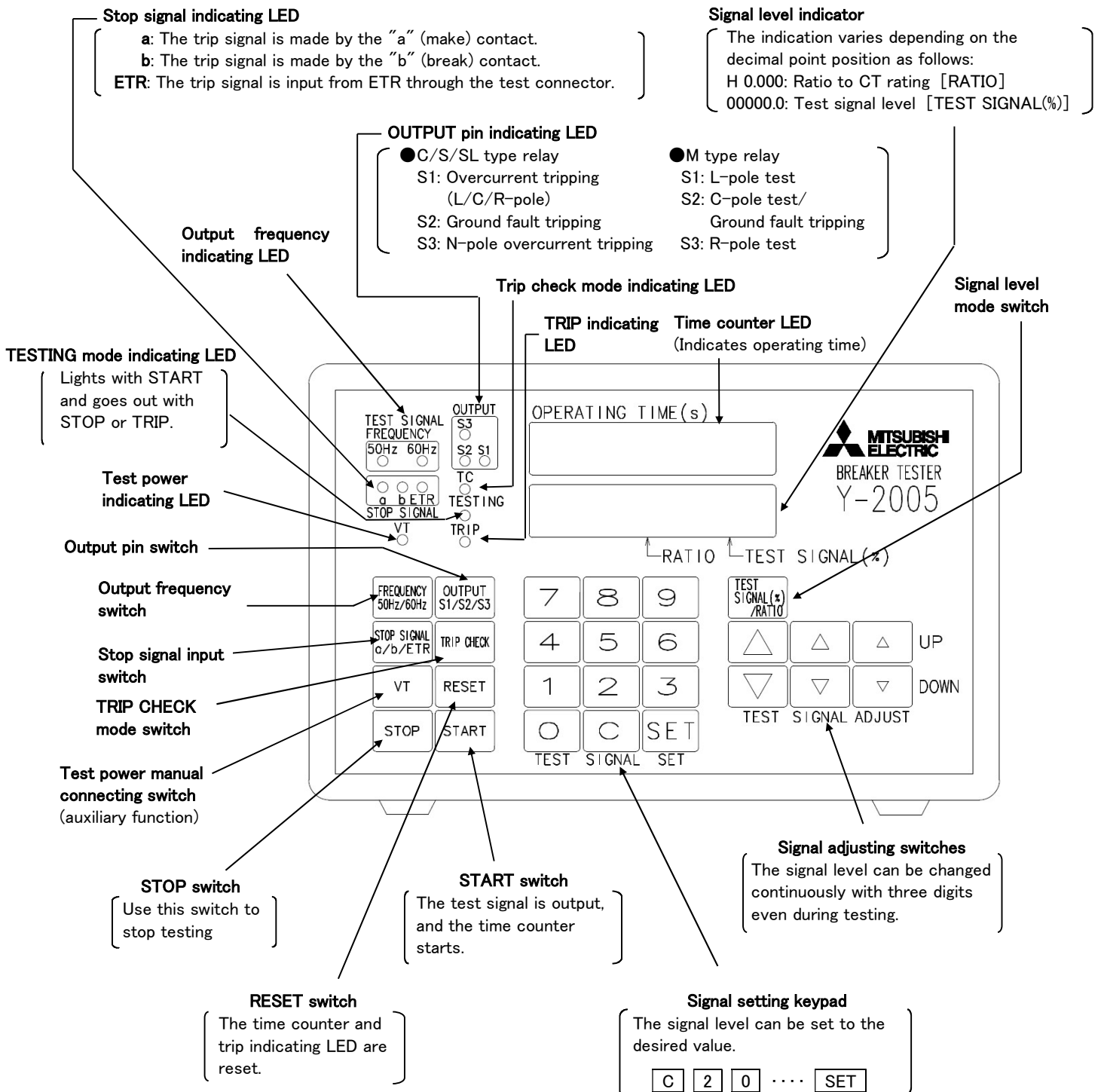

The ratio to CT rating "RATIO" indicated on the front face of Y-2005 is a ratio of RATED CURRENT In at AE-SS Electronic trip relay to RATED CURRENT MAX In max(CT rating). Be careful in testing or operating.

● Front view



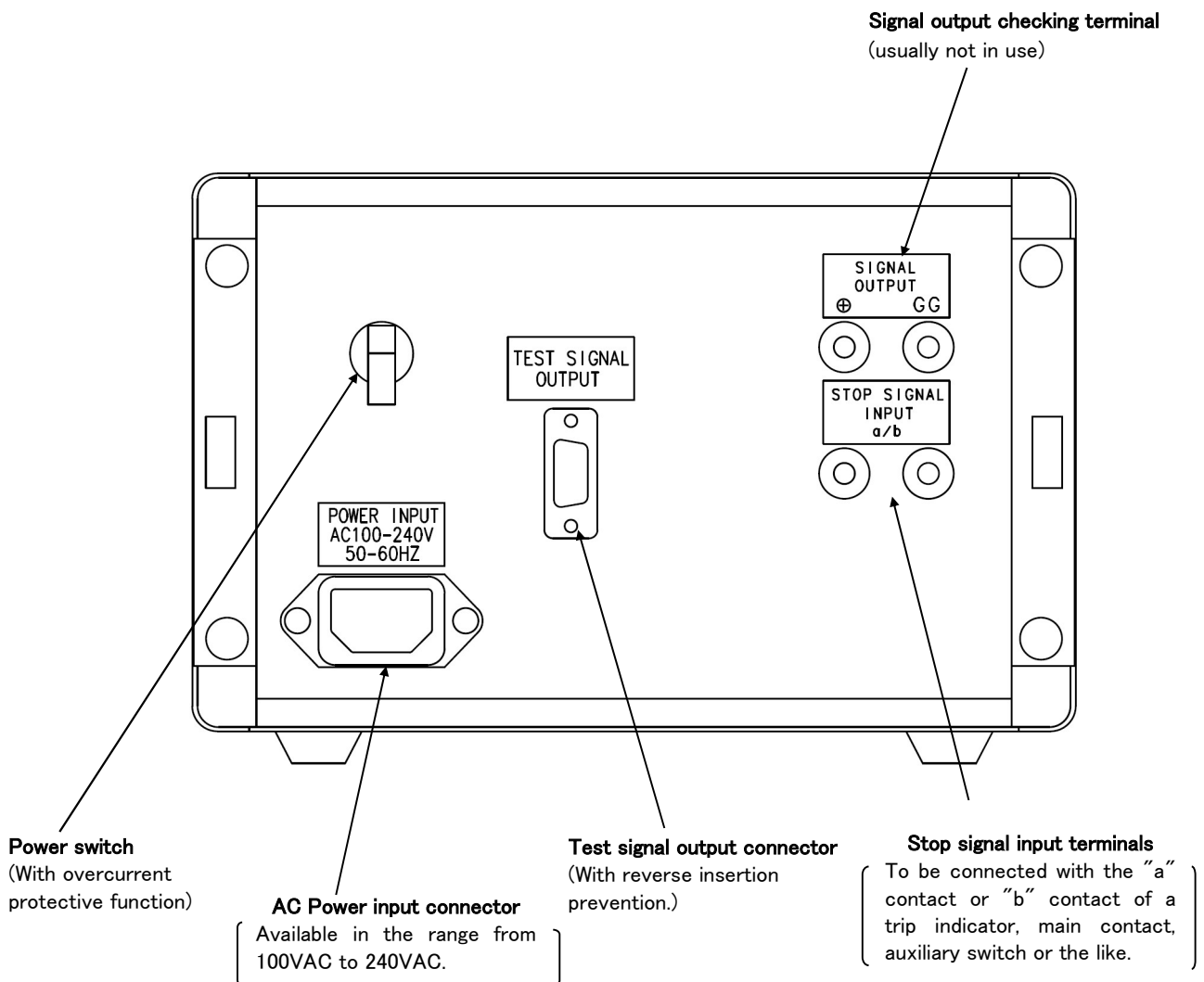

● Back view

	For calibration, inquire at any of our branch offices or service centers.
	The test signal output can be checked by connecting an AC voltmeter.



 DANGER	When using the "Stop signal input terminals", check that no power is supplied and that there is no interference with other wiring in the panelboard. Otherwise, electric shocks or short circuits may occur.
---	--

9. Connection (for AE-SS/SH)

 DANGER	Do not touch the terminals. Otherwise, electric shocks may occur.
	When conducting a withstand voltage test or insulation resistance measurement of the circuit breaker, remove the wiring of Y-2005. Otherwise, trouble may occur.

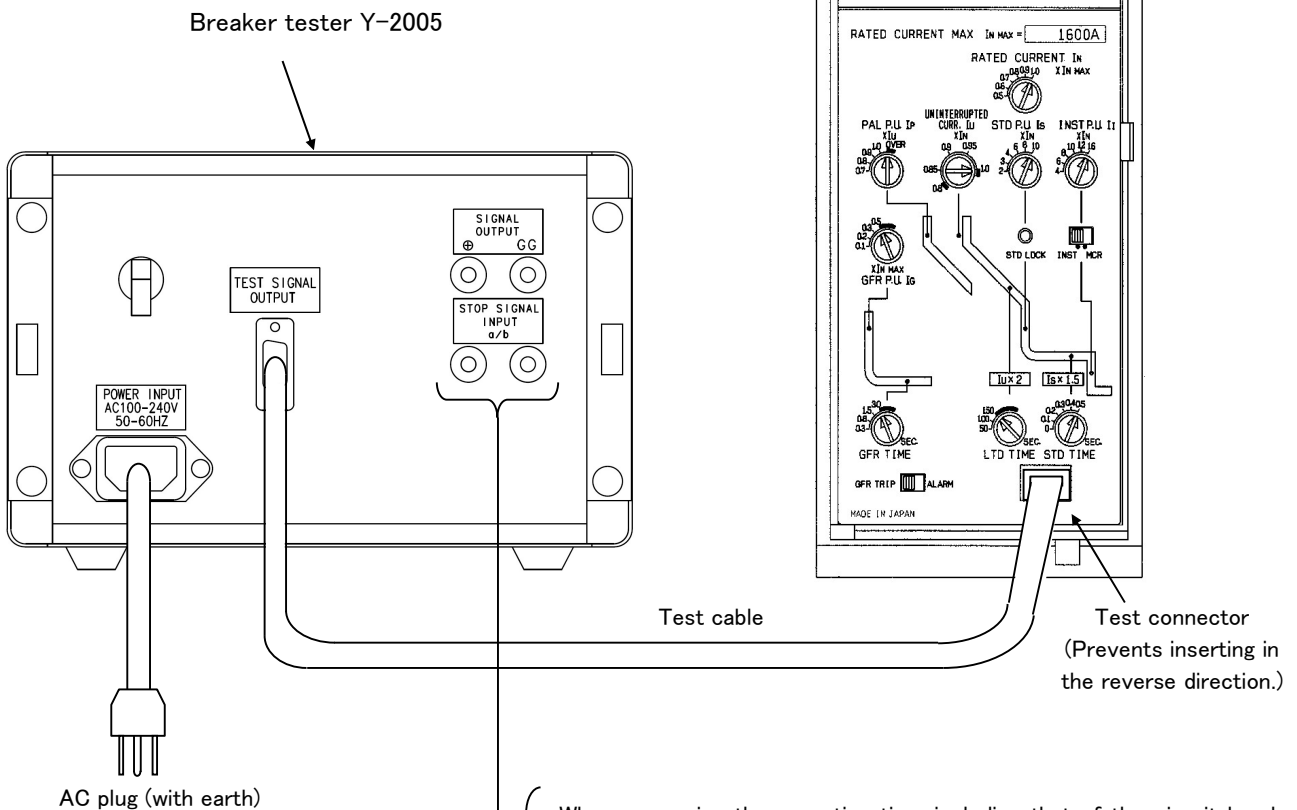

- When measuring the operating time including that of the circuit breaker, connect with the "a" contact or "b" contact of the auxiliary switch (AX).
- "a" contact of the auxiliary switch (AX) ... Set the stop signal to [b].
- "b" contact of the auxiliary switch (AX) ... Set the stop signal to [a].
- When measuring the pre-alarm operating time, connect with the PAL OUT contact.
- "a" contact between PAL OUT $T0+$ and $T4-$... Set the stop signal to [a].
- ※ To operate the PAL OUT contact, control power is required for the trip relay.

10. Initial setting and operation (for AE-SS/SH)



Start the setting and operation after carefully reading an instruction manual for AE-SS/SH and 12. *Settings and accuracy* in this instruction manual to understand the characteristics of Electronic trip relay.

10.1 Setting of rated current

- (1) Open the front cover of Electronic trip relay.
- (2) Connect as described in paragraph 9.
- (3) Turn on the power switch on the back panel, and the time counter and other indicator lights at the front.
- (4) Set the following with the corresponding switches. The settings are changed in turn by pushing the switches.
(The function of each setting, see paragraph 8).

- Output frequency , 60Hz
- Stop signal , b, ETR
- Output pin , S2, S3
- Test mode , TRIP CHECK

When the power is turned on, each item is set to the marked position.

- (5) Setting of the rated current

First, set the ratio to CT rating because this tester is designed so that signals are output in percentages (%) of RATED CURRENT I_N at Electronic trip relay to RATED CURRENT MAX I_{NMAX} (CT rating).

When the power is turned on, the rated current is set to ($I_N=1.000 \times I_{NMAX}$).

- ① In the case of a C type or S type relay, set the mode to with the signal level mode switch.

Set to the value of the rated current setting dial of the trip relay with the signal adjusting switches or signal setting switches.



Example: In the case where the rated current (I_N) is set to 0.8,
set to .

- ② In the case of an M type relay, set as follows:

Example: In the case where $I_{NMAX}=1600A$ and $I_N=1283A$,
 $1283A \div 1600A=0.802$, therefore set to .

- ③ In the case of measuring the ground fault tripping characteristics, set to (even if the rated current is not set to 1.0).

10.2 How to operate

 DANGER	<p>Test should be performed only after shutting off the electric power and verifying that there is no voltage present. Failure to do so may result in an electrical shock.</p>
	<p>When current is flowing in the main circuit of breaker, it is combined with the test signal of Y-2005, consequently does not become correct characteristic. The operating test should be performed in the state that load current does not flow in the main circuit.</p>

- (1) Set the signal level indicator to ○○○○○.○ by pushing the TEST SIGNAL(%) / RATIO signal level mode switch.
- (2) Set the signal level with the signal adjusting switches or signal setting switches in % of I_N set in 10.1 (5).

When using the signal adjusting switches

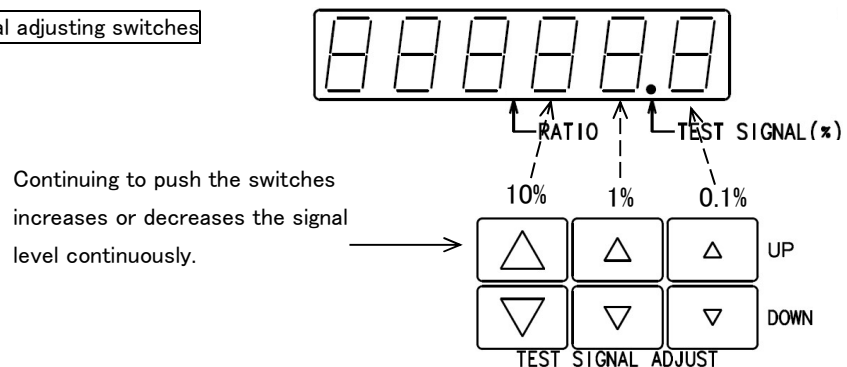

When using the signal setting switches

- ① Push the C (clear) key.
- ② Since figures are shifted to the left every time you push the numeral keys, indicate the desired value.
- ③ Push the SET key.

⇒ To set 200%, push C 2 0 0 0 SET, and 0200.0 is set.

- (3) START Push the [START] switch, and the test signal is output, the time counter starts from 000.000, and also the [TESTING] mode indicating LED lights.
- (4) STOP To stop testing, push the [STOP] switch, and the test signal is stopped, the time counter stops, and also the [TESTING] mode indicating LED goes out.
- (5) With tripping, the TRIP indicating LED lights, and the time counter stops. Read the operating time at the time counter.
- (6) RESET Push the [RESET] switch to reset the TRIP indicating LED and the time counter, so that testing can be restarted.

11. Test (for AE-SS/SH)

11.1 LTD Pick-up current test

- (1) If the trip relay has the ground fault function (GFR), set the ground fault alarm switch to "ALARM".
- (2) Set the signal level to approximately 90% of the pick-up current.
- (3) Push the **START** switch.
- (4) Increase the signal with the signal adjusting switch, and measure the pick-up value.
 - ① In the case of a C type or S type relay, the long-time-delay pick-up current is to be taken when the [OVER] LED of the trip relay lights.
In the case where I_U of the S relay is not set to 1.0,
for example, if I_U is 0.8 and the [OVER] LED lights are at 94%,
the pick-up value is $94\% \div 0.8 = 117.5\%$.
 - ② In the case of an M type relay, the long-time-delay pick-up current is to be taken when the [100%] LED lights.
- (5) Push the **STOP** switch.
- (6) Return the trip relay setting changed in (1) to the initial condition.

11.2 LTD operating time test

- (1) Set the signal level to be tested.
 - ① In the case of a C type or S type relay, the operating time is to be taken at 200%, therefore set the signal level to **00200.0**.
In the case where I_U of the S relay is not set to "1.0",
for example, if I_U is 0.9,
 $0.9 \times 200\% = 180\%$, therefore set the signal level to **00180.0**.
 - ② In the case of an M relay,
for example, if the long-time-delay pick-up current (I_L) is set to "1.05",
 $1.05 \times 120\% = 126\%$, therefore set the signal level to **00126.0**.
- (2) Set the short-time-delay pick-up current (I_S) setting dial and the instantaneous pick-up current (I_I) setting dial of the trip relay to 1.2 times the above-mentioned signal level or more.
If the trip relay has the ground fault function (GFR), set the ground fault alarm switch to "ALARM".
- (3) Push the **START** switch.
- (4) After tripping, the operating time is indicated.
- (5) Push the **RESET** switch.
- (6) Return the trip relay settings changed in (2) to the initial conditions.



Since Electronic trip relay has a memory effect for overcurrent state, when the operating time test is interrupted on the way, the operating time at the next test becomes short. This memory effect can be reset by tripping. Therefore, if operating time test is interrupted on the way, perform the next test after tripping Electronic trip relay one-time. To trip, perform the trip check in accordance with 11.10.

- <Hint>** In 11.1 and 11.2, if I_U of the S relay is not set to "1.0", the reading of the signal level is regarded as the long-time-delay pick-up current (%) by setting the value of **HO.000** to $I_N \times I_U$.
When measuring the long-time-delay operating time, measurement can be performed with the signal level **00200.0**.
When performing the short-time-delay or instantaneous tests, return the setting of **HO.000** to the initial value.

11.3 STD Pick-up current test

- (1) Set the instantaneous pick-up current (I_i) setting dial of the trip relay to the maximum.
Set the short-time-delay operating time (T_s) to 0s. (minimum).
If the trip relay has the ground fault function (GFR), set the ground fault alarm switch to "ALARM."
- (2) Set the signal level to approximately 80% of the short-time-delay pick-up current.
- (3) Push the **START** switch, immediately increase the signal with the signal adjusting switch until Electronic trip relay trips and Time counter LED stops.

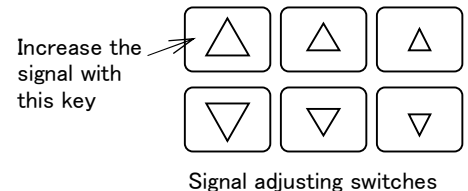

- (4) Read the signal level indicated at the time.
- (5) In addition, measure the operating times before and after the short-time-delay pick-up current measured above, and take the point where the operating time shortens suddenly as the measured value of the short-time-delay pick-up current (I_s).
- (6) Return the trip relay settings changed in (1) to the initial conditions.
 - * If there is a long delay in increasing the signal, long-time-delay operation may be performed before reaching the short-time-delay pick-up current. In this case, start again from approximately 95% of the short-time-delay pick-up current.

11.4 STD operating time test

- (1) Set the instantaneous pick-up current (I_i) of the trip relay to the maximum. If the trip relay has the ground fault function (GFR), set the ground fault alarm switch to "ALARM."
- (2) Set the signal level to be tested.
For example, if the short-time-delay pick-up current (I_s) setting dial is set to 4.5, $450\% \times 1.5 = 675\%$, therefore set the signal level to 00675.0.
* Here, 1.5 is the value with which the operating time becomes flat.

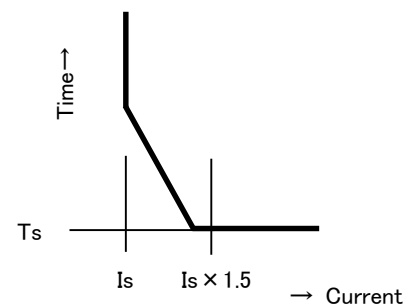

- (3) Push the **START** switch.
- (4) After tripping, the operating time is indicated.

When the stop signal is made by the main contact or auxiliary switch (AX)	Take the reading of the counter as it is.
When the stop signal is made through the test connector of Electronic trip relay	Add 20ms. (mechanical operating time) to the reading of the counter.

- (5) Push the **RESET** switch.
- (6) Return the trip relay settings changed in (1) to the initial conditions.
- (7) Be aware that instantaneous operation may be performed near the instantaneous pick-up current (I_i) due to the influence of the signal making phase.

11.5 INST Pick-up current test

- (1) Set the long-time-delay operating time (T_L) setting dial of the trip relay to the maximum.
If the INST/MCR switch is provided, set the switch to "INST."
If the trip relay has the ground fault function (GFR), set the ground fault alarm switch to "ALARM."
 - (2) Set the signal level to approximately 80% of the instantaneous pick-up current (I).
 - (3) Push the **START** switch with the [STD LOCK] switch of the trip relay pushed, immediately increase the signal with the signal adjusting switch until Electronic trip relay trips and Time counter LED stops.
 - (4) Read the signal level.
 - (5) Push the **RESET** switch.
 - (6) Return the trip relay settings changed in (1) to the initial conditions.
- * If there is a long delay in increasing the signal, long-time-delay operation may be performed before reaching the instantaneous pick-up current. In this case, start again from approximately 95% of the instantaneous pick-up current.
- * If the MCR/INST switch of the trip relay is set to MCR when the circuit breaker is on, instantaneous operation is not performed but short-time-delay or long-time-delay operation is performed.

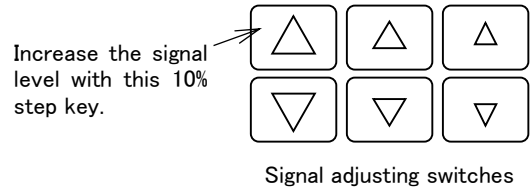

11.6 INST operating time test

- (1) Set the signal level to be tested.
For example, if the instantaneous pick-up current (I_i) setting dial is set to "10",
 $1000\% \times 1.5 = 1500\%$, therefore set the signal level to 01500.0.
* Here, 1.5 is the value with which the operating time becomes flat.

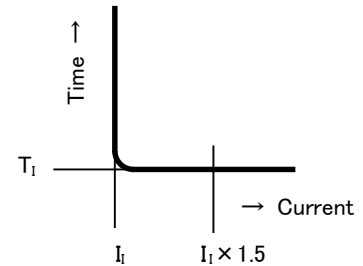

- (2) Push the **START** switch with the [STD LOCK] switch of the trip relay pushed.
- (3) After tripping, the operating time is indicated.

When the stop signal is made by the main contact or auxiliary switch (AX)	Take the reading of the counter as it is.
When the stop signal is made through the test connector of Electronic trip relay	Add 20ms. (mechanical operating time) to the reading of the counter.

- (4) Push the [RESET] switch.

	<p>When checking the short time operation such as INST operating time test, in order to measure the operating time with accuracy, push the "Test power manual connecting switch VT", and push START switch after the "Test power indicating LED" lighting. If do not pushing the "Test power manual connecting switch VT", exact measurement cannot be performed.</p>
--	--

11.7 MCR function check

- (1) Set the INST/MCR switch of the trip relay to MCR.
Set the stop signal of Y-2005 to ETR.
- (2) Instantaneous operation is performed with the circuit breaker off.
Check the instantaneous operation in accordance with 11.5 and 11.6.
* **This test is checking that instantaneous characteristics is effective during breaker closing operation (from open to close).**
- (3) Instantaneous tripping characteristics disappear with the circuit breaker on.
Set the signal level exceeding the instantaneous pick-up current (I_i), and check that instantaneous operation is not performed.

11.8 GFR Pick-up current test

- (1) Set the ground fault alarm switch of the trip relay to "TRIP," and set the ground fault operating time (T_G) to "0.3"s. (minimum).
- (2) Set the signal output pin to [S2], and set the rated current to **H1.000** in accordance with paragraph 10.
- (3) Set the rated current of the tester to $I_N=1 \times I_{NMAX}$. (See 10.1 (5) ③).
- (4) Set the signal level to approximately 80% of the ground fault pick-up current (I_G).
- (5) Push the **START** switch, immediately increase the signal with the signal adjusting switch until Electronic trip relay trips and Time counter LED stops.
- (6) Read the signal level indicated at the time.
- (7) In addition, push the **START** switch at several points before and after the ground fault pick-up current measured in (6), and take the minimum value with which the trip relay trips as the measured value of the ground fault pick-up current (I_G).
- (8) Return the trip relay settings changed in (1) to the initial conditions.

11.9 GFR operating time test

- (1) Set the signal level to be tested.
- (2) Set the ground fault alarm switch of the trip relay to "TRIP."
- (3) Set the signal output pin to [S2], and set the rated current to **H1.000** in accordance with paragraph 10.
For example, if the ground fault pick-up current (I_G) is set to "0.3",
 $30\% \times 1.5=45\%$, therefore set the signal level to 00045.0.
* Here, 1.5 is the value with which the operating time becomes flat.

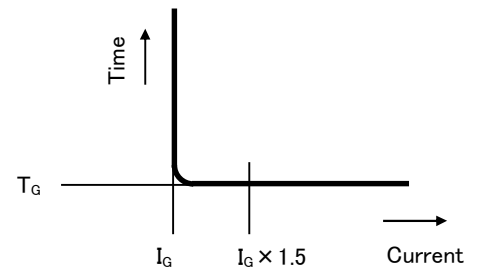

- (4) Push the **START** switch.
- (5) After tripping, the operating time is indicated.

When the stop signal is made by the main contact or auxiliary switch (AX)	Take the reading of the counter as it is.
When the stop signal is made through the test connector of Electronic trip relay	Add 20ms. (mechanical operating time) to the reading of the counter.

- (6) Push the **RESET** switch.
- (7) Return the trip relay setting changed in (2) to the initial condition.



When checking the short time operation such as GFR operating time test, in order to measure the operating time with accuracy, push the "Test power manual connecting switch **VT**", and push the **START** switch after the "Test power indicating LED" lighting. If do not pushing the "Test power manual connecting switch **VT**", exact measurement cannot be performed.

11.10 Trip check

The circuit breaker can be tripped instantaneously with this trip check, which is effective when checking the panel sequence and resetting the memory effect in 11.2 (7).

- (1) Set the test mode to "TC" (trip check).
- (2) If the INST/MCR switch is provided for the trip relay, set the switch to "INST."
- (3) Push the **START** switch.
- (4) Check that the circuit breaker is tripped instantaneously.
- (5) Push the **RESET** switch.
- (6) Return the trip relay setting changed in (2) to the initial condition.



When checking the circuit breaker operating time, push the "Test power manual connecting switch **VT**", and push **START** switch after the "Test power indicating LED" lighting. If do not pushing the "Test power manual connecting switch **VT**", exact measurement cannot be performed.

11.11 PAL pick-up current test

- (1) If the trip relay has the ground fault function (GFR), set the ground fault alarm switch to "ALARM."
- (2) Set the signal level to approximately 80% of the pre-alarm pick-up current (I_p).
- (3) Push the **START** switch.
- (4) Increase the signal with the signal adjusting switch, and take the value with which the [PAL] LED of the trip relay lights as the measured value of the pre-alarm pick-up current.
- (5) Push the **STOP** switch.
- (6) Return the trip relay setting to the initial condition.

11.12 PAL operating time test

- (1) Input control power to the trip relay (between **R+** and **R1-** or between **R+** and **R2-** of the circuit breaker's control circuit terminal block).
- (2) If the trip relay has the ground fault function (GFR), set the ground fault alarm switch to "ALARM."
- (3) Set the stop signal input of the tester to [a], and connect the PAL OUT contacts (**T0+** and **T4-**) of the circuit breaker with the input terminals on the back of the tester.
- (4) Set the signal level to be tested. (See 11.2 LTD operating time test).
- (5) Push the **START** switch.
- (6) After operation, the operating time is indicated.
- (7) Push the **RESET** switch.
- (8) Return the trip relay setting to the initial condition.

11.13 OCR alarm switch (AL) check

Measure the AL operating time with an oscilloscope, millisecond counter or the like.

The minimum AL operating time is 30 ms., however, when measured with Y-2005, the operating time is approximately 5 ms. shorter than that taken when tripping at the actual current.

12. Settings and accuracy (for AE-SS/SH)

12.1 Settings and accuracy of type C relay

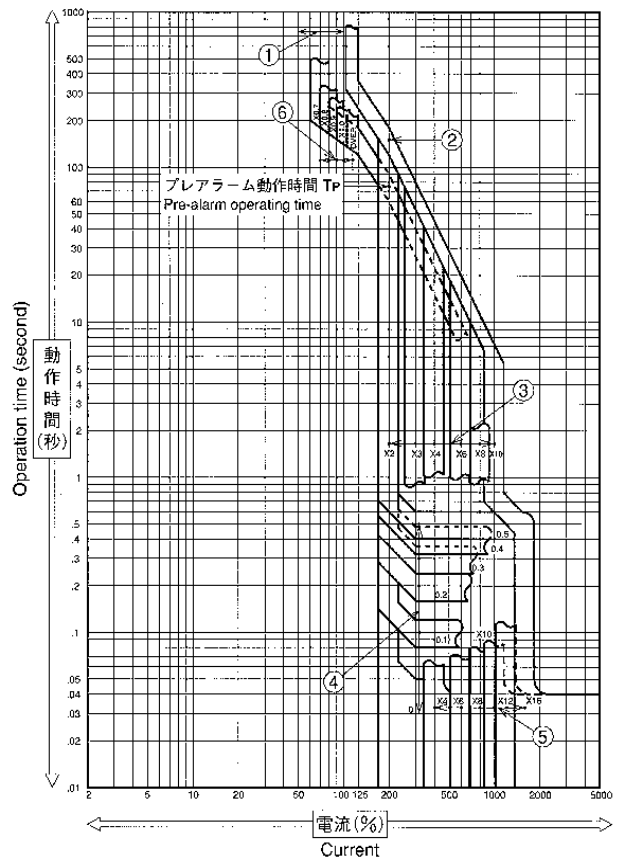
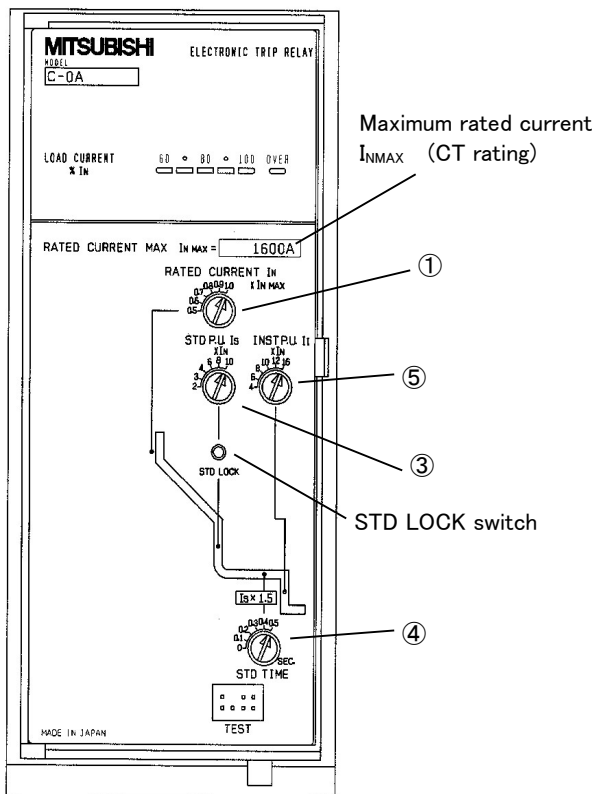

No.	Item	Mark	Setting range [tolerance]		
			AE630~4000-SS /AE-SH	AE5000-SS	AE6300-SS
①	Rated current	I_N	$0.5-0.6-0.7-0.8-0.9-1.0 \times I_{NMAX}$ [The LTD pick-up current ranges from 105% to 125% of the rated current.]		
②	LTD time	T_L	150 s. at $2 \times I_N$ (fixed)	[±20%]	
③	STD Pick-up current	I_s	$2-3-4-6-8-10 \times I_N$		[±15%]
④	STD time	T_s	$0-0.1-0.2-0.3-0.4-0.5$ s. at $1.5 \times I_s$		[±20%]
⑤	INST pick-up current	I_i	$4-6-8-10-12-16 \times I_N$ [±15%]	$4-6-8-10-12 \times I_N$ [±15%]	$4-6-8-10 \times I_N$ [±15%]
⑥	Pre-alarm pick-up current	I_p	$0.7-0.8-0.9-1.0-OVER \times I_N$		[±10%]

12.2 Settings and accuracy of type S/SL relay

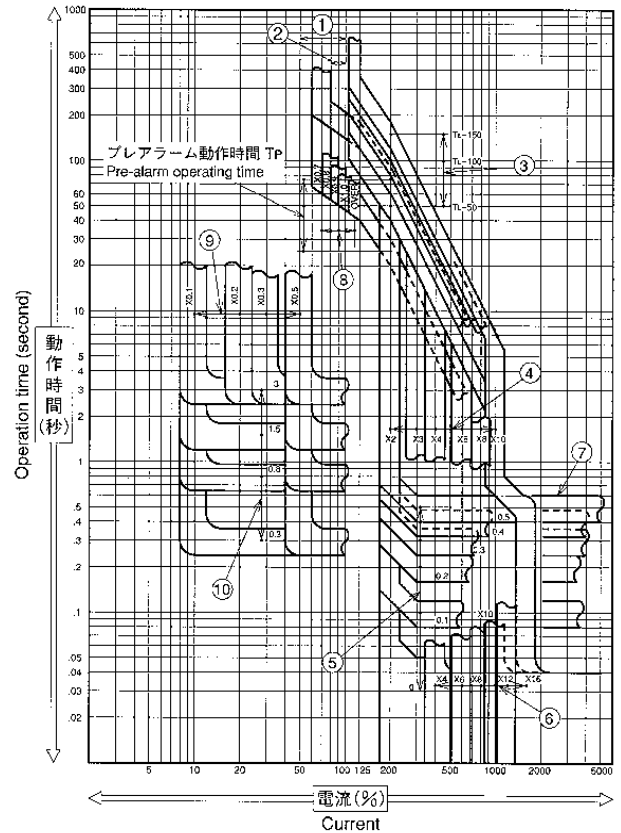
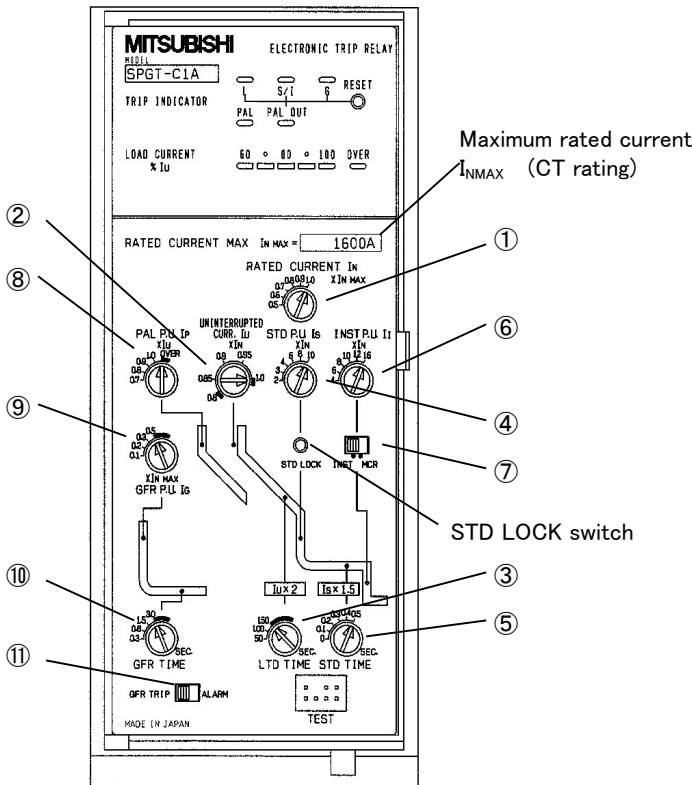

No.	Item	Mark	Setting range [tolerance]		
			AE630~4000-SS /AE-SH	AE5000-SS	AE6300-SS
①	Rated current	I_N	0.5~0.6~0.7~0.8~0.9~1.0 $\times I_{NMAX}$		
②	Uninterrupted current	I_U	0.8~1.0 $\times I_N$ [The LTD pick-up current ranges from 105% to 125% of the uninterrupted current.]		
③	LTD time	T_L	S series: 50~100~150s. at 2 $\times I_U$	[$\pm 20\%$]	
			SL series: 10~15~20~25~30s. at 5 $\times I_U$	[$\pm 20\%$]	
④	STD Pick-up current	I_S	2~3~4~6~8~10 $\times I_N$ [$\pm 15\%$]		
⑤	STD time	T_S	0~0.1~0.2~0.3~0.4~0.5s. at 1.5 $\times I_S$ [$\pm 20\%$]		
⑥	INST pick-up current	I_I	4~6~8~10~12~16 $\times I_N$ [$\pm 15\%$]	4~6~8~10~12 $\times I_N$ [$\pm 15\%$]	4~6~8~10 $\times I_N$ [$\pm 15\%$]
⑦	(INST/MCR) switch (Note 2)	-	Switch to select <u>instantaneous tripping characteristics</u> or <u>MCR</u> .		
⑧	Pre-alarm pick-up current	I_P	0.7~0.8~0.9~1.0~OVER $\times I_U$ [$\pm 10\%$]		
⑨	Ground fault pick-up current (Note 1)	I_G	0.1~0.2~0.3~0.5 $\times I_{NMAX}$ [$\pm 20\%$]	0.2~0.3~0.5 $\times I_{NMAX}$	[$\pm 20\%$]
⑩	Ground fault operating time	T_G	0.3~0.8~1.5~3 s. at 1.5 $\times I_G$ [$\pm 20\%$]		
⑪	Ground fault alarm switch	-	Switch to select <u>tripping</u> or <u>only alarm</u> with a ground fault.		

(Note 1) The setting for AE4000-SS is the same as that for AE5000-SS and AE6000-SS.

(Note 2) "MCR" is an abbreviation for "making current release", which has INST characteristics only when the circuit breaker is turned on (make). After the circuit breaker is turned on (make), the INST characteristics disappear.

12.3 Settings and accuracy of type M relay

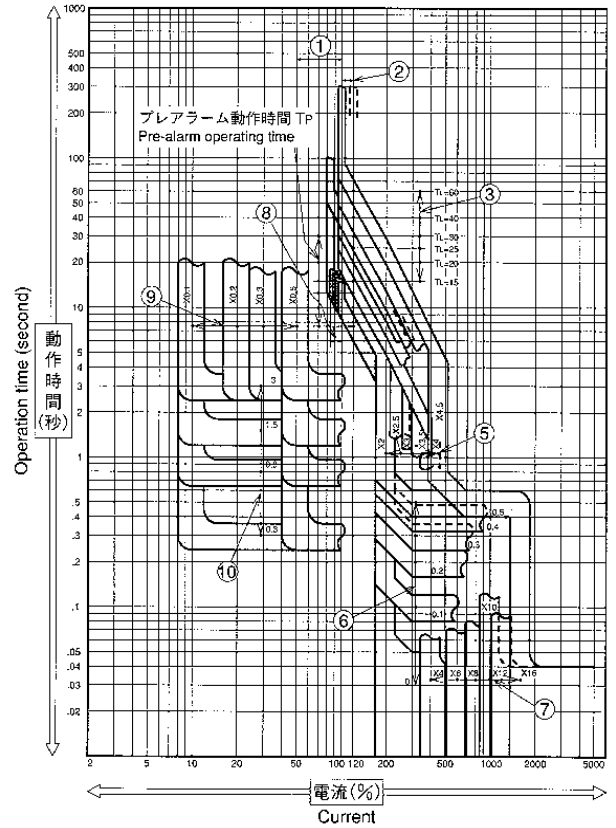
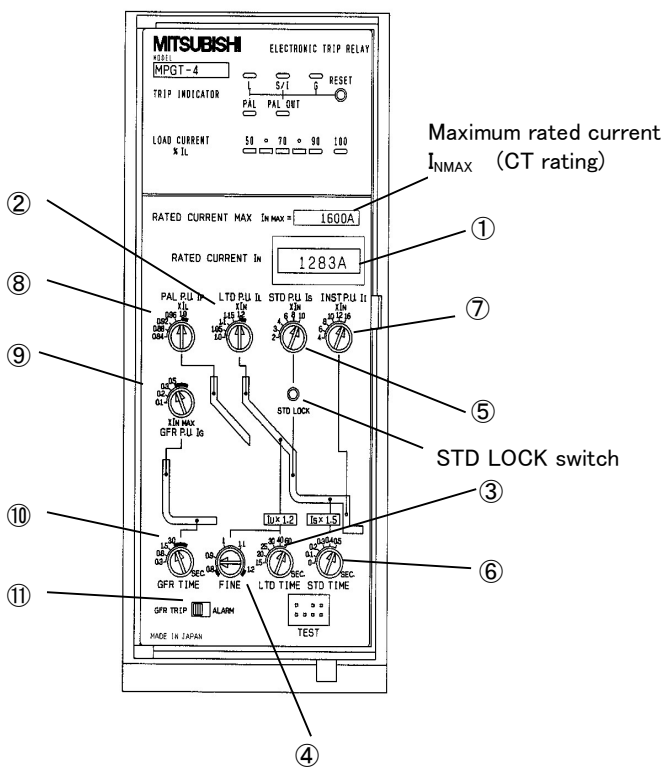

No.	Item	Symbol	Setting range [tolerance]		
			AE630~4000-SS /AE-SH	AE5000-SS	AE6300-SS
①	Rated current	I_N	Set at the factory within the range of $0.5 \sim 1.0 \times I_{NMAX}$		
②	LTD Pick-up current	I_L	$1.0-1.05-1.1-1.15-1.2 \times I_N$		$[\pm 5\%]$
③	LTD time	T_L	$15-20-25-30-40-60s. \text{ at } 1.2 \times I_L$		$[\pm 20\%]$
④	LTD Pick-up time fine adjustment	-	$0.8 \sim 1.0 \sim 1.2 \times T_L$		
⑤	STD Pick-up current	I_S	$2-2.5-3-3.5-4-4.5 \times I_N$		$[\pm 15\%]$
⑥	STD time	T_S	$0-0.1-0.2-0.3-0.4-0.5s. \text{ at } 1.5 \times I_S$		$[\pm 20\%]$
⑦	INST pick-up current	I_I	$4-6-8-10-12-16 \times I_N$ $[\pm 15\%]$	$4-6-8-10-12 \times I_N$ $[\pm 15\%]$	$4-6-8-10 \times I_N$ $[\pm 15\%]$
⑧	Pre-alarm pick-up current	I_P	$0.84-0.88-0.92-0.96-1.0 \times I_L$		$[\pm 5\%]$
⑨	Ground fault pick-up current (Note)	I_G	$0.1-0.2-0.3-0.5$ $\times I_{NMAX} \quad [\pm 20\%]$	$0.2-0.3-0.5 \times I_{NMAX}$	$[\pm 20\%]$
⑩	Ground fault operating time	T_G	$0.3-0.8-1.5-3s. \text{ at } 1.5 \times I_G$		$[\pm 20\%]$
⑪	Ground fault alarm switch	-	Switch to select tripping or only alarm with a ground fault.		

(Note) The setting for AE4000-SS is the same as that for AE5000-SS and AE6300-SS.

13. Inspection form (for AE-SS/SH)

Inspection report form for S type relay

Date:

Checked person:

Usage									
Type									Standard value
Rated current									(Pickup current or test current Operating time)
Serial number									
Date of manufacture									
OCR relay type									
OCR relay type serial number									
Inspection Item		Inspector							
External appearance	(1) There must be no breakage of the OCR unit.								There must be no breakage.
	(2) The connection condition of the CT connector to the OCR unit.								Musat be connected securely.
	(3) The connection condition of the output connector from the OCR unit.								
	(4) There must be no loosening of the terminal screws of the control circuit terminal block.								
Confirmation of settings	(1) Long time delay	① Rated current (I_n)							Write settings value
		② Uninterrupted current (I_u)							
		③ Operating time (T_L)							
	(2) Short time delay	① Pickup current (I_{sd})							
		② Operating time (T_{sd})							
	(3) Instantaneous	Pickup current (I_i)							
	(4) Pre-alarm	① Pick up current (I_p)							
		② Operating time (T_p)							
	(5) Grand fault protection	① Pick up current (I_g)							
		② Operating time (T_g)							
(6) Earth-leakage protection	① Pick up current ($I_{\Delta n}$)								
	② Operating time (T_e)								
(7) INST and MCR settings									
(8) TRIP and ALARM settings of the GFR									
Pickup, Operating Time	(1) Long time delay (Note 1)	① Pickup current (%)							$105 \sim 125\% \times I_u$
		② Operating time (s)							$T_L \pm 20\% \text{ at } 200\% \times I_u$
	(2) Short time delay (Note 2)	① Pickup current (%)							$I_{sd} \pm 15\%$
		② Operating time (s)							$T_{sd} \pm 20\% \text{ at } 150\% \times I_{sd}$
	(3) Instantaneous (Note 1)	① Pickup current (%)							$I_i \pm 15\%$
		② Operating time (s)							$\geq 40\text{ms at } 150\% \times I_i$
	(4) Pre-alarm	① Pickup current (%)							$I_p \pm 10\%$
		② Operating time (s)							$T_L/2 \pm 20\% \text{ at } 200\% \times I_u$
	(5) Grand fault protection	① Pick up current (%)							$I_g \pm 20\%$
		② Operating time (s)							$T_g \pm 20\% \text{ at } 150\% \times I_g$
	(6) Earth-leakage protection	① Pick up current (%)							$I_{\Delta n} \pm 20\%$
		② Operating time (s)							$T_e \pm 20\% \text{ at } 150\% \times I_{\Delta n}$
Outputs	(1) Trip indicator contact output (L, S/I, G, P)								Output in each mode respectively.
	(2) Trip indicator output LED (L, S/I, G, P)								Lights up in each mode respectively.
Others, remarks									
General remarks									

Note 1) If short-time operation is performed during measurement of long-time or instantaneous operation, use the STD LOCK button.

Note 2) If long-time or instantaneous operation is performed during measurement of STD, change the set value (long-time or instantaneous operation value), or change the test current. If you change a set value, be sure to reset the value to the previous value at the completion of test.

三菱低圧気中遮断器 AE形

Low-Voltage Air Circuit Breakers type AE

フィールドテスト装置Y-2005

Field test device Y-2005

mitsubishi electric corporation

東京都千代田区丸の内 2-7-3 (東京ビル) 〒100-8310
HEAD OFFICE: TOKYO BLDG., MARUNOUCHI, 2-7-3, CHIYODAKU, TOKYO 100-8310



当社管理用コードです。
This is our administrative code.

LN338A475H04 IB63C07-E2403