

PHASE CONTROL THYRISTORS

Hockey Puk Version

Features

- Center amplifying gate
- Metal case with ceramic insulator
- International standard case TO-200AC (B-PUK)

Typical Applications

- DC motor control
- Controlled DC power supplies
- AC controllers

Major Ratings and Characteristics

Parameters	ST700C..L	Units
$I_{T(AV)}$	910	A
@ T_{hs}	55	°C
$I_{T(RMS)}$	1857	A
@ T_{hs}	25	°C
I_{TSM}	@ 50Hz 15700	A
	@ 60Hz 16400	A
I^2t	@ 50Hz 1232	KA ² s
	@ 60Hz 1125	KA ² s
V_{DRM}/V_{RRM}	1200 to 2000	V
t_q	typical 150	μs
T_J	- 40 to 125	°C

910A

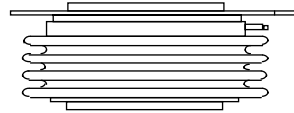

case style TO-200AC (B-PUK)

ST700C..L Series

Bulletin I25190 rev.D 04/00

International
 Rectifier

ELECTRICAL SPECIFICATIONS

Voltage Ratings

Type number	Voltage Code	V_{DRM}/V_{RRM} , max. repetitive peak and off-state voltage V	V_{RSM} , maximum non-repetitive peak voltage V	I_{DRM}/I_{RRM} max. @ $T_J = T_J$ max mA
ST700C..L	12	1200	1300	80
	16	1600	1700	
	18	1800	1900	
	20	2000	2100	

On-state Conduction

Parameter	ST700C..L	Units	Conditions		
$I_{T(AV)}$ Max. average on-state current @ Heatsink temperature	910 (355)	A	180° conduction, half sine wave double side (single side) cooled		
	55 (85)	°C			
$I_{T(RMS)}$ Max. RMS on-state current	1857	A	DC @ 25°C heatsink temperature double side cooled		
I_{TSM} Max. peak, one-cycle non-repetitive surge current	15700		t = 10ms	No voltage reappplied	
	16400		t = 8.3ms	reappplied	
	13200		t = 10ms	100% V_{RRM}	
	13800		t = 8.3ms	reappplied	
I^2t Maximum I^2t for fusing	1232	KA ² s	t = 10ms	No voltage reappplied	Sinusoidal half wave, Initial $T_J = T_J$ max.
	1125		t = 8.3ms	reappplied	
	871		t = 10ms	100% V_{RRM}	
	795		t = 8.3ms	reappplied	
$I^2\sqrt{t}$ Maximum $I^2\sqrt{t}$ for fusing	12321	KA ² √s	t = 0.1 to 10ms, no voltage reappplied		
$V_{T(TO)1}$ Low level value of threshold voltage	1.00	V	(16.7% x π x $I_{T(AV)}$) < I < π x $I_{T(AV)}$, $T_J = T_J$ max.		
$V_{T(TO)2}$ High level value of threshold voltage	1.13		(I > π x $I_{T(AV)}$), $T_J = T_J$ max.		
r_{t1} Low level value of on-state slope resistance	0.40	mΩ	(16.7% x π x $I_{T(AV)}$) < I < π x $I_{T(AV)}$, $T_J = T_J$ max.		
r_{t2} High level value of on-state slope resistance	0.35		(I > π x $I_{T(AV)}$), $T_J = T_J$ max.		
V_{TM} Max. on-state voltage	1.80	V	$I_{pk} = 2000A$, $T_J = T_J$ max, $t_p = 10ms$ sine pulse		
I_H Maximum holding current	600	mA	$T_J = 25^\circ C$, anode supply 12V resistive load		
I_L Typical latching current	1000				

Switching

Parameter	ST700C..L	Units	Conditions
di/dt Max. non-repetitive rate of rise of turned-on current	1000	A/μs	Gate drive 20V, 20Ω, $t_r \leq 1\mu s$ $T_J = T_J \text{ max}$, anode voltage $\leq 80\% V_{DRM}$
t_d Typical delay time	1.0	μs	Gate current 1A, $di_g/dt = 1A/\mu s$ $V_d = 0.67\% V_{DRM}$, $T_J = 25^\circ C$
t_q Typical turn-off time	150		$I_{TM} = 750A$, $T_J = T_J \text{ max}$, $di/dt = 60A/\mu s$, $V_R = 50V$ $dv/dt = 20V/\mu s$, Gate 0V 100Ω, $t_p = 500\mu s$

Blocking

Parameter	ST700C..L	Units	Conditions
dv/dt Maximum critical rate of rise of off-state voltage	500	V/μs	$T_J = T_J \text{ max}$. linear to 80% rated V_{DRM}
I_{DRM} I_{RRM} Max. peak reverse and off-state leakage current	80	mA	$T_J = T_J \text{ max}$, rated V_{DRM}/V_{RRM} applied

Triggering

Parameter	ST700C..L		Units	Conditions
P_{GM} Maximum peak gate power	10.0		W	$T_J = T_J \text{ max}$, $t_p \leq 5ms$
$P_{G(AV)}$ Maximum average gate power	2.0			$T_J = T_J \text{ max}$, $f = 50Hz$, $d\% = 50$
I_{GM} Max. peak positive gate current	3.0		A	$T_J = T_J \text{ max}$, $t_p \leq 5ms$
$+V_{GM}$ Maximum peak positive gate voltage	20		V	$T_J = T_J \text{ max}$, $t_p \leq 5ms$
$-V_{GM}$ Maximum peak negative gate voltage	5.0			
I_{GT} DC gate current required to trigger	TYP.	MAX.	mA	$T_J = -40^\circ C$ $T_J = 25^\circ C$ $T_J = 125^\circ C$ Max. required gate trigger/ current/ voltage are the lowest value which will trigger all units 12V anode-to-cathode applied
	200	-		
	100	200		
V_{GT} DC gate voltage required to trigger	2.5	-	V	$T_J = -40^\circ C$ $T_J = 25^\circ C$ $T_J = 125^\circ C$
	1.8	3.0		
	1.1	-		
I_{GD} DC gate current not to trigger	10		mA	Max. gate current/voltage not to trigger is the max. value which will not trigger any unit with rated V_{DRM} anode-to-cathode applied
V_{GD} DC gate voltage not to trigger	0.25		V	

ST700C..L Series

Bulletin I25190 rev. D 04/00

International
IRF Rectifier

Thermal and Mechanical Specification

Parameter	ST700C..L	Units	Conditions
T_J Max. operating temperature range	-40 to 125	°C	
T_{stg} Max. storage temperature range	-40 to 150		
R_{thJ-hs} Max. thermal resistance, junction to heatsink	0.073 0.031	K/W	DC operation single side cooled DC operation double side cooled
R_{thC-hs} Max. thermal resistance, case to heatsink	0.011 0.006		K/W
F Mounting force, $\pm 10\%$	14700 (1500)	N (Kg)	
wt Approximate weight	255	g	
Case style	TO-200AC (B-PUK)		See Outline Table

ΔR_{thJ-hs} Conduction

(The following table shows the increment of thermal resistance R_{thJ-hs} when devices operate at different conduction angles than DC)

Conduction angle	Sinusoidal conduction		Rectangular conduction		Units	Conditions
	Single Side	Double Side	Single Side	Double Side		
180°	0.009	0.009	0.006	0.006	K/W	$T_J = T_J \text{ max.}$
120°	0.011	0.011	0.011	0.011		
90°	0.014	0.014	0.015	0.015		
60°	0.020	0.020	0.021	0.021		
30°	0.036	0.036	0.036	0.036		

Ordering Information Table

Device Code							
ST	70	0	C	20	L	1	
①	②	③	④	⑤	⑥	⑦	⑧
1	- Thyristor	2	- Essential part number	3	- 0 = Converter grade	4	- C = Ceramic Puk
5	- Voltage code: Code x 100 = V_{RRM} (See Voltage Rating Table)	6	- L = Puk Case TO-200AC (B-PUK)	7	- 0 = Eyelet terminals (Gate and Auxiliary Cathode Unsoldered Leads) 1 = Fast-on terminals (Gate and Auxiliary Cathode Unsoldered Leads) 2 = Eyelet terminals (Gate and Auxiliary Cathode Soldered Leads) 3 = Fast-on terminals (Gate and Auxiliary Cathode Soldered Leads)	8	- Critical dv/dt: None = 500V/ μ sec (Standard selection) L = 1000V/ μ sec (Special selection)

Outline Table

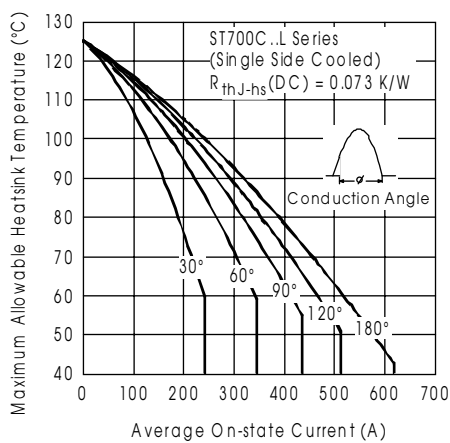
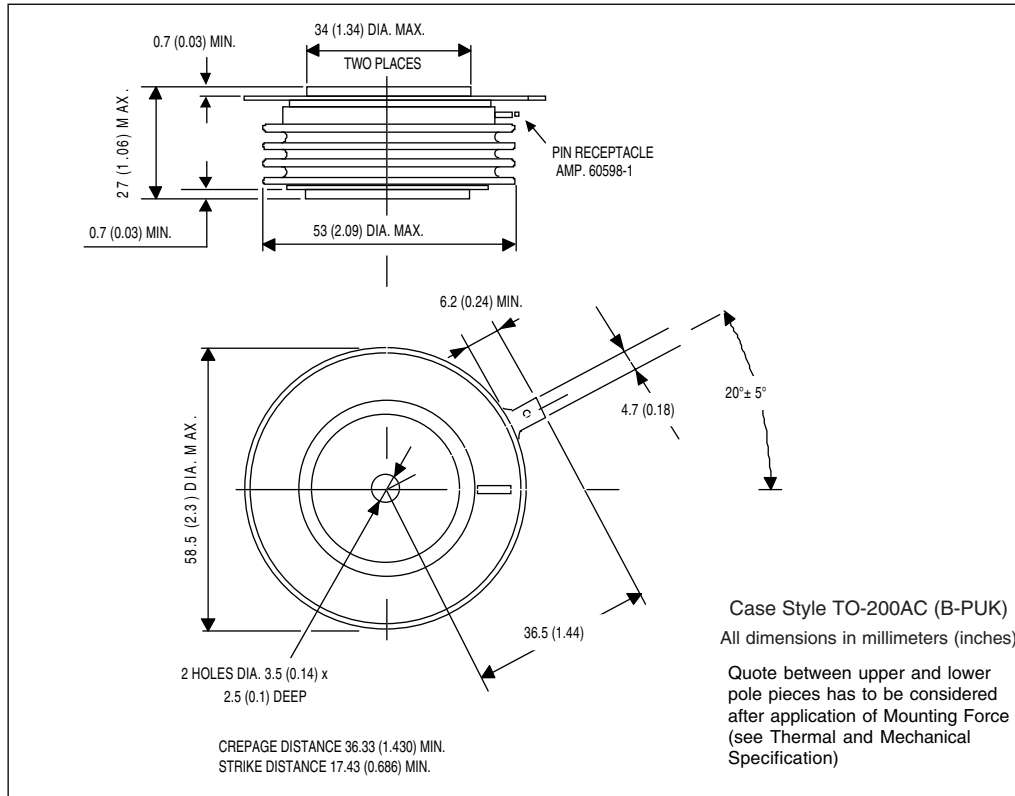

Fig. 1 - Current Ratings Characteristics

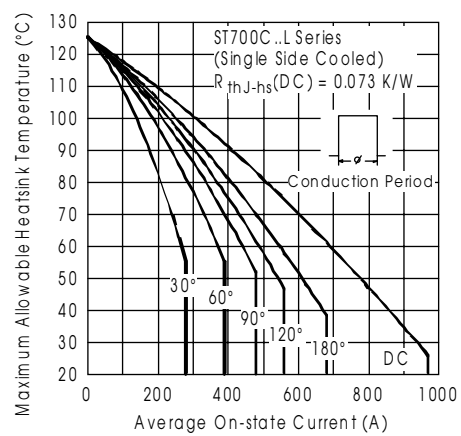

Fig. 2 - Current Ratings Characteristics

ST700C..L Series

Bulletin I25190 rev.D 04/00

International
IRF Rectifier

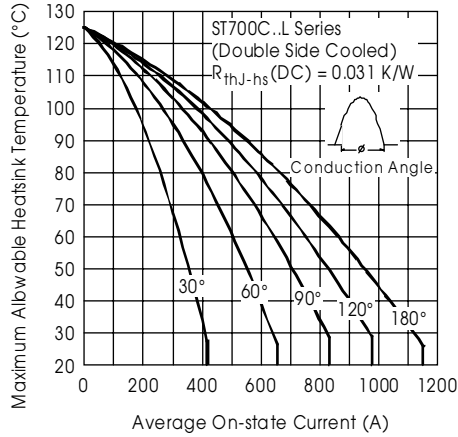

Fig. 3 - Current Ratings Characteristics

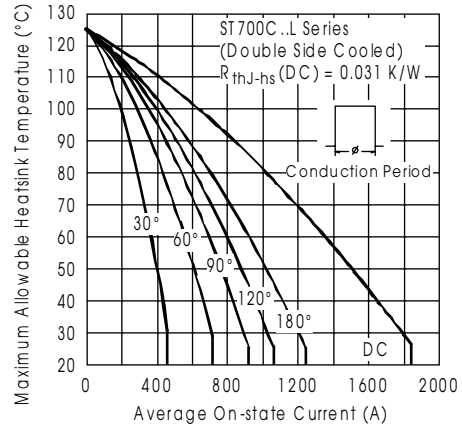

Fig. 4 - Current Ratings Characteristics

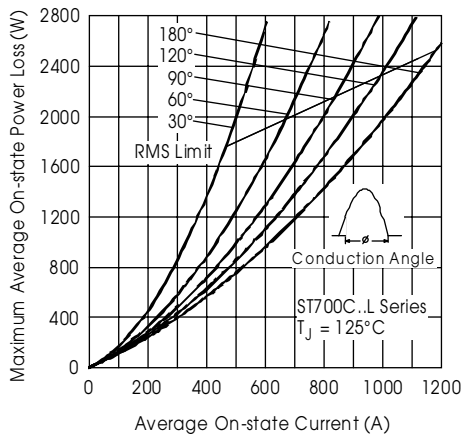

Fig. 5 - On-state Power Loss Characteristics

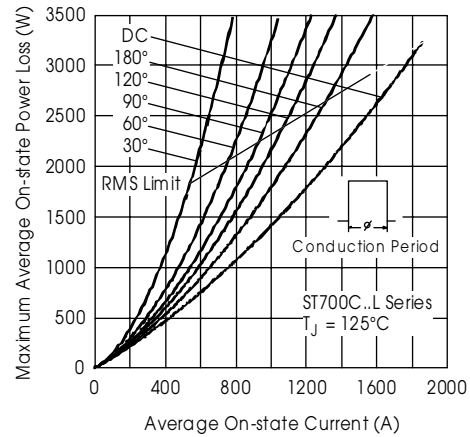

Fig. 6 - On-state Power Loss Characteristics

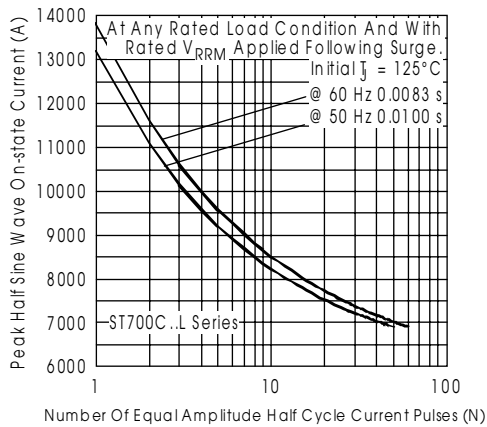

Fig. 7 - Maximum Non-Repetitive Surge Current Single and Double Side Cooled

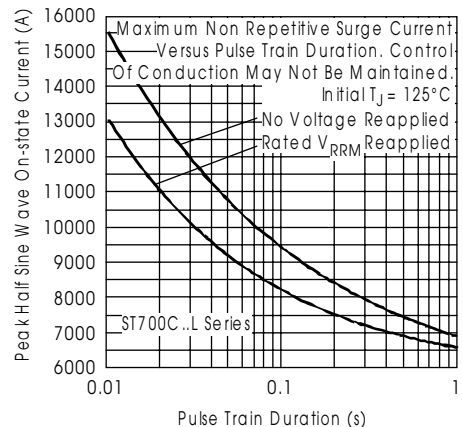

Fig. 8 - Maximum Non-Repetitive Surge Current Single and Double Side Cooled

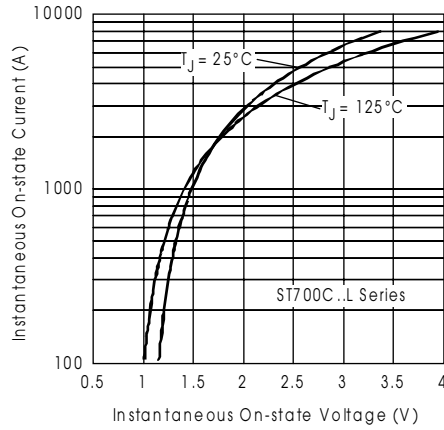

Fig. 9 - On-state Voltage Drop Characteristics

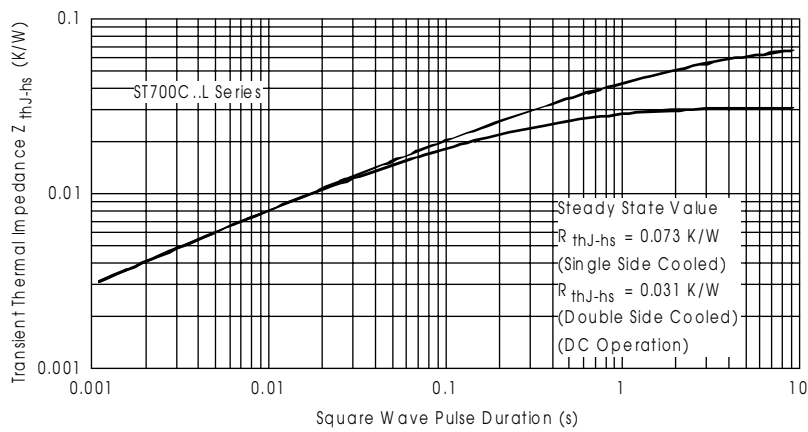

Fig. 10 - Thermal Impedance Z_{thJ-hs} Characteristics

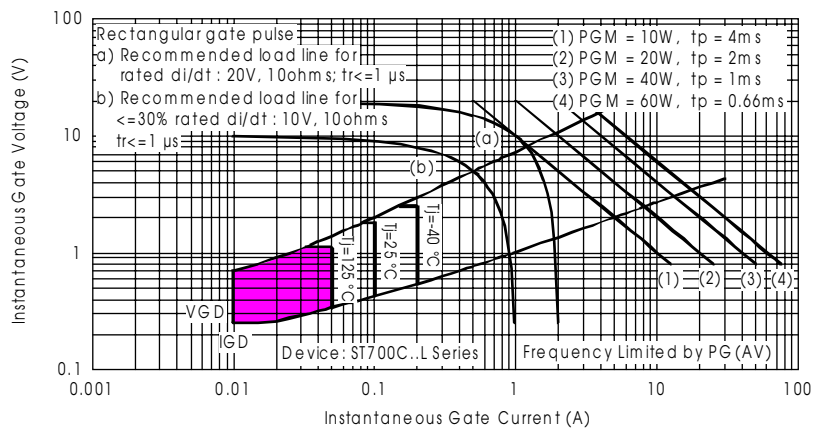

Fig. 11 - Gate Characteristics