

LABSELECT®



**PRODUCT
CATALOG**

Company Profile

Labgic technology is an innovative enterprise engaged in developing and sales of laboratory products. Since established, we are dedicated to provide premium products and service, consistent to the finest standards in this field.

For nearly two decades, we have gained enormous amount of knowledge and experiences in life science area. Especially after the integration of excellent resources such as technology, products, storage and marketing channels, we had established good reputation in China. Biosharp, Labelect and Labgic are three brands under Labgic company, which belong to different categories in laboratory products. Diverse products and services make our products acknowledged and accepted by more and more users. We, Labgic, will continue to adhere to customer demand as the core to provide one-stop service for different types of customers and deliver high-quality service and strong support for our partners.



Infrastructure

Main Port: Shanghai/Beijing/Guangzhou



Warehouse Space
70000+ m²

Product Range
Reagents Consumables Instruments
Biosharp Labelect Labgic

Invoices per day
10000+
Daily order quantity

Staff
400+

 Our Brands

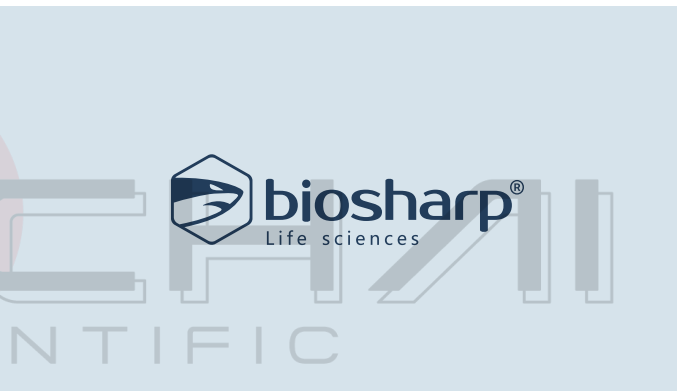



LABSELECT®

甄选·为你而选

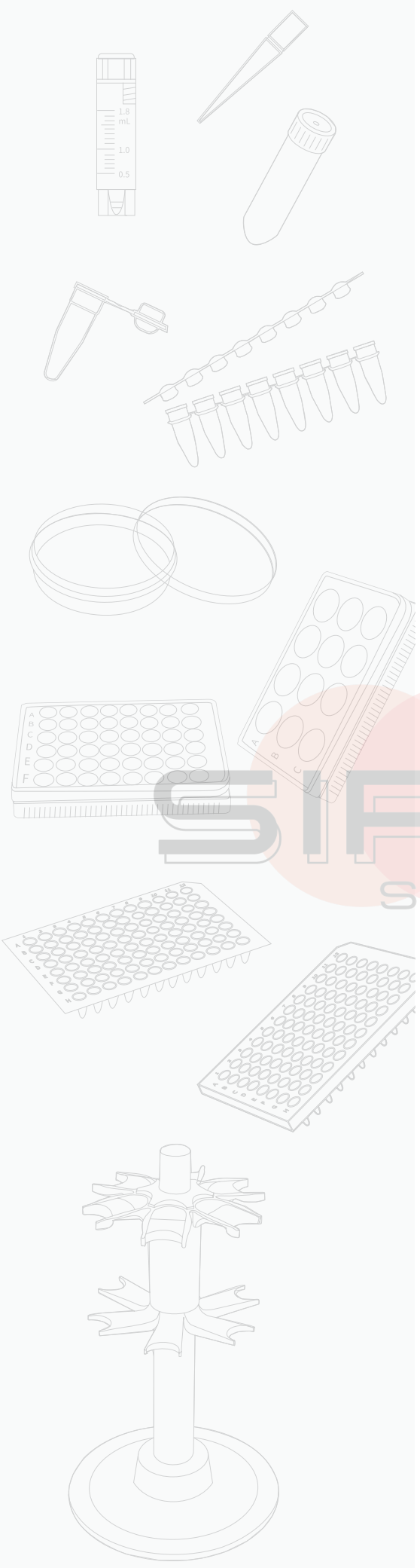

INTRODUCTION

Welcome to the latest LABSELECT product catalog.

This catalog demonstrates all laboratory consumables under LABSELECT brand. These products are designed to solve problems, improve productivity, save space and deliver value.

Labselect is one of the brands of Labgic company. Labselect primarily provides premium consumables for higher ends, products covering molecular biology, cell biology, microbiology, and other fields. Because of diversity products and good service, we enjoy much more popularity among dealers and end users.

We, Labgic, will continue to adhere to customer demand as the core to provide one-stop service for different types of customers and deliver high-quality service and strong support for our partners.

LIST OF CONTENTS

Pipette Tips

■ Universal Pipette Tip	5
■ Pipette Tip 5mL 10mL	6
■ Filter Pipette Tip	7
■ Low Retention Tip	9
■ Low Retention Filter Tip	11
■ LTS Compatible Pipette Tip	13
■ Automation Tip	14
■ Pipette Carousel Stand	16

PCR Consumables

■ PCR Tube	18
■ PCR Strip Tube & Strip Cap	19
■ PCR Plate	22
■ Sealing Film	30

Cell Culture Consumables

■ Cell Culture Dish	35
■ Cell Culture Flask	37
■ Erlenmeyer Flask	39
■ Cell Culture Plate	40
■ Cell Culture Insert	47
■ Bio-reaction Tubes	50
■ Cell Scraper & Lifter	51
■ Glass Coverslip	52
■ Confocal Dish	53
■ Chamber Slide	54
■ Cryogenic Vial	55

Tubes

■ Micro-centrifuge Tube	60
■ Low Retention Centrifuge Tube	61
■ Centrifuge Tube 15 mL 50 mL	62
■ Large Volume Centrifuge Tube	64
■ Screw Cap Tube	65

Liquid Handling

■ Serological Pipet	67
■ Assay Microplate	68
■ Disposable Bottle Top Vacuum Filter	72
■ Storage Bottle	73
■ Reagent Reservoir	74
■ Deep Well Plate	76
■ Magnetic Rod Tip & Silicone Mat	78
■ Centrifuge Tube Filters	79
■ 96-Well Filter Plates	82

Microbiology

■ Petri Dish	87
--------------	----

Transfer Membranes

■ Nylon Transfer Membrane	89
■ PVDF Transfer Membrane	90

Pipette Tips

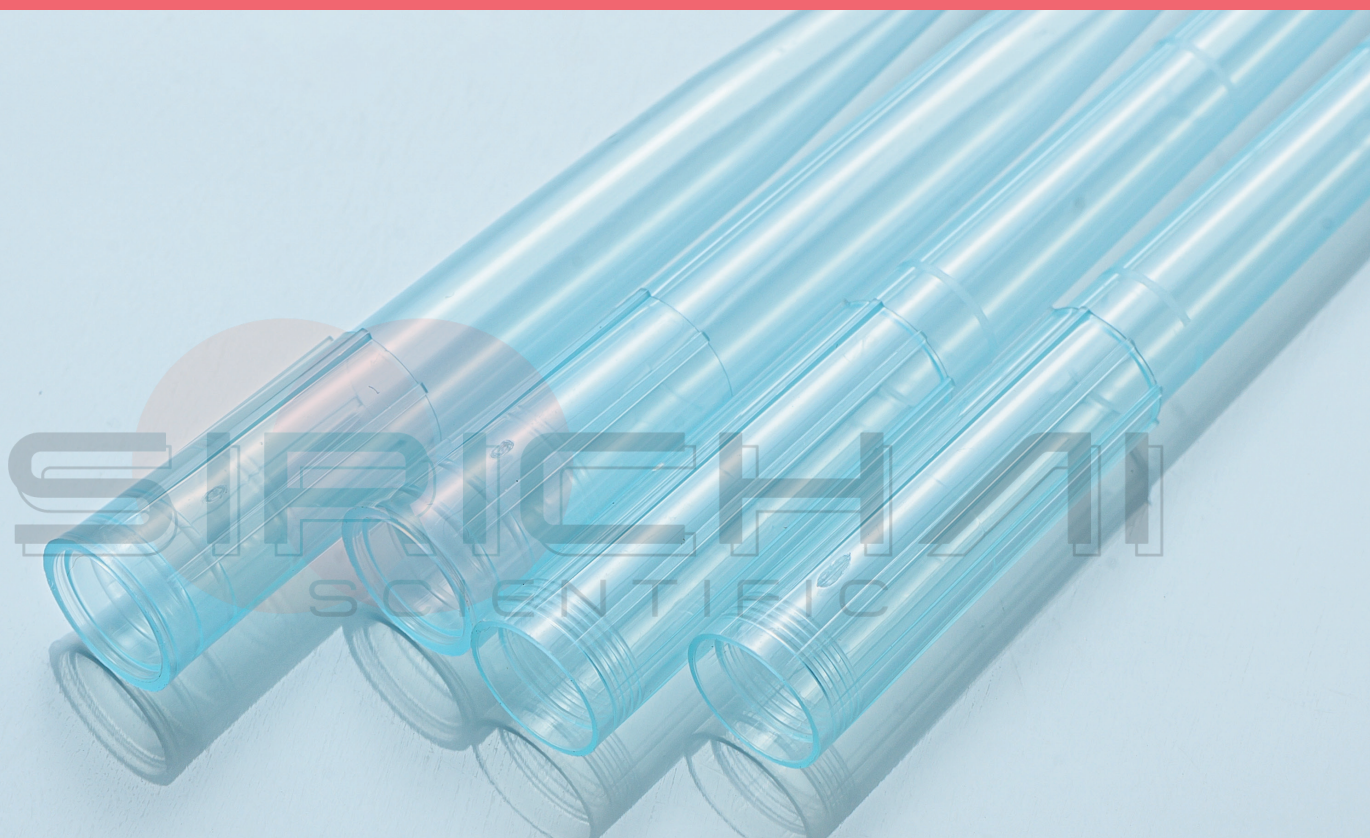

- Universal Pipette Tip
- Pipette Tip 5mL | 10mL
- Filter Pipette Tip
- Low Retention Tip
- Low Retention Filter Tip
- LTS Compatible Pipette Tip
- Automation Tip
- Pipette Carousel Stand

Universal Pipette Tip

Labselect Universal Pipette Tips are designed to fit a wide variety of single and multi-channel pipettes. They are compatible with most research grade pipettes. They are classified by sample volume and types. Sterile racked design is especially suitable for cell culture and microbial culture experiments.

- Manufactured from high-quality polypropylene material
- Diverse product range
- Excellent compatibility
- Easily distinguished by color
- Autoclavable
- Nonpyrogenic
- DNase-/RNase-free

Ordering information

Cat.No.	Volume	Description	Packaging
T-001-10	10µL	Bulk	
T-010-R-S		Racked, sterile	
T-001-10L	10µL Long	Bulk	
T-010L-R-S		Racked, sterile	
T-001-10XL	10µL Super Long	Bulk	
T-001-200	200µL	Bulk, yellow	Bulk Packed: 1000pcs/bag, 20bags/case
T-001-200-YG		Bulk, yellow, with graduation	
T-001-200-C		Bulk, clear	Racked Packed: 96pcs/rack, 50racks/case
T-0200-R-S		Racked, sterile, yellow	
T-0200-C-R-S		Racked, sterile, clear	
T-001-200W		Bulk, wide-bore	
T-001-200XL	200µL Extra Long	Bulk	
T-0200XL-R-S		Racked, sterile	
T-001-300	300µL	Bulk	
T-0300-R-S		Racked, sterile	
T-001-1000	1000µL	Bulk, blue	1000pcs/bag, 5bags/case
T-001-1000-C		Bulk, clear	
T-001-1000W		Bulk, wide-bore	
T-01000-R-S		Racked, sterile, clear	100pcs/rack, 50racks/case
T-01000-B-R-S		Racked, sterile, blue	
T-001-1250	1250µL	Bulk, blue	1000pcs/bag, 5bags/case
T-001-1250-C		Bulk, clear	
T-01250-R-S		Racked, sterile, blue	96pcs/rack, 50racks/case
T-01250-C-R-S		Racked, sterile, clear	

10µL Tips 10µL Long tips 200µL Tips



200µL Tips 300µL Tips 200µL Extra long tips



1000µL Tips 1000µL Tips 1250µL Tips 1250µL Tips

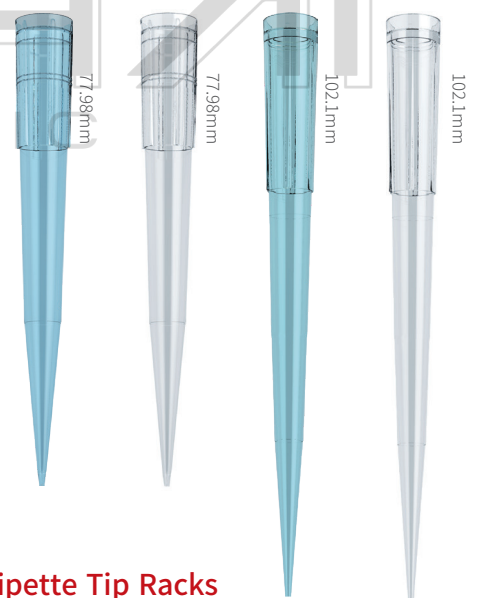

Pipette Tip Racks

Cat.No.	Tip Compatibility	Packaging
TK-001-10	10µL Tips	50pcs/case
TK-001-10L	10µL Long Tips	
TK-001-200	200µL Tips	
TK-001-300	300µL Tips	
TK-001-1000	1000µL Tips	
TK-001-1250	1250µL Tips	

Pipette Tip 5mL | 10mL

Pipette Tips 5mL and 10mL are made of high-quality polypropylene material. They are compatible with most research grade pipettes. It is widely used in the transfer of various liquids in laboratories. 5mL and 10mL pipette tips are suitable for large volume pipettes. They are ideal for molecular microbiology and microbiology applications. They are packaged in sealed-bottom racks with lids to prevent contamination and in sterilized form.

- Manufactured from polypropylene material
- Excellent compatibility
- Nonpyrogenic
- DNase-/RNase-free

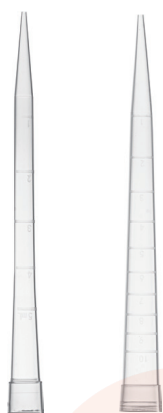

T-001-5ML T-001-10ML



Ordering information

Cat.No.	Volume	Type	Compatibility	Packaging
T-011-5ML-W	5mL	Rack, sterile	Eppendorf, Gilson, Sartorius, Dragonlab	24pcs/rack, 6racks/unit, 5units/case
T-011-5ML-N	5mL	Rack, sterile	Thermo	40pcs/rack, 6racks/unit, 5units/case
T-001-5ML	5mL	Bulk	Eppendorf, Dragonlab	100pcs/bag, 10bags/case
T-001-5ML-W	5mL	Bulk	Eppendorf, Dragonlab, Watson	100pcs/bag, 10bags/case
T-001-5ML-N	5mL	Bulk	Thermo	100pcs/bag, 10bags/case
T-011-10ML-E	10mL	Rack, sterile	Eppendorf, Gilson, Sartorius, Dragonlab	24pcs/rack, 6racks/unit, 5units/case
T-011-10ML-F	10mL	Rack, sterile	Thermo	24pcs/rack, 6racks/unit, 5units/case
T-001-10ML-E	10mL	Bulk	Eppendorf, Gilson, Sartorius, Dragonlab	100pcs/bag, 10bags/case
T-001-10ML-F	10mL	Bulk	Thermo	100pcs/bag, 10bags/case
T-001-10ML	10mL	Bulk	Eppendorf, Dragonlab	100pcs/bag, 10bags/case

Pipette Tip Racks

Cat.No.	Tip Compatibility	Packaging
TK-001-5mL	5mL Tips, compatible with T-001-5ML	36pcs/case
TK-001-10mL	10mL Tips, compatible with T-001-10ML	

Labelcet Filter Pipette Tips are designed to fit a wide variety of single and multi-channel pipettes. They are compatible with most research grade pipettes. Technologically advanced filter material allows free passage of air while blocking aerosol contamination. They are ideal for molecular microbiology and microbiology applications where trace contamination can completely invalidate results. Racked packed filter tips are packaged in sealed-bottom racks with lids to prevent contamination and in sterilized form.

- Manufactured from polypropylene for tip and high-quality hydrophobic polyethylene for filter
- Excellent compatibility
- Extended length is available
- Nonpyrogenic
- DNase-/RNase-free



- Filter serves as a barrier against aerosols and protects the pipette shafts from any contamination
- Ideal for PCR, genetic research, sequencing and working with infectious samples

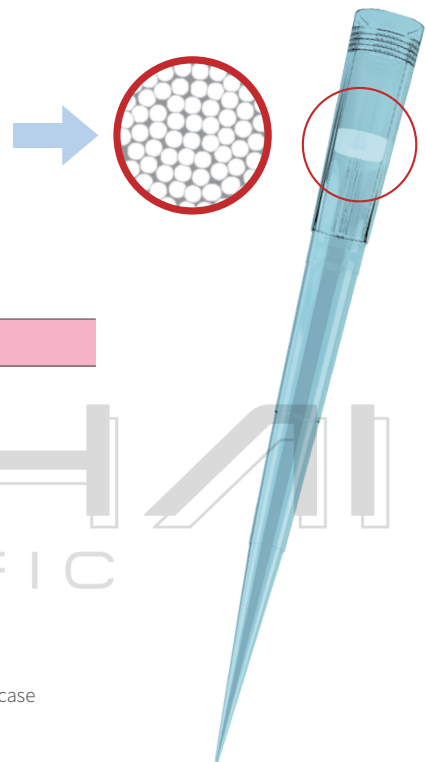

Ordering information

Cat.No.	Volume	Description	Packaging
FT-10	10µL	Bulk, Filtered	Bulk Packed: 1000pcs/bag, 10bags/case Racked Packed: 96pcs/rack, 50racks/case
FT-10-R-S		Racked, Sterile, Filtered	
FT-10L	10µL Long	Bulk, Filtered	
FT-10L-R-S		Racked, Sterile, Filtered	
FT-20	20µL	Bulk, Filtered	
FT-20-R-S		Racked, Sterile, Filtered	
FT-50	50µL	Bulk, Filtered	
FT-50-R-S		Racked, Sterile, Filtered	
FT-100	100µL	Bulk, Filtered	
FT-100-R-S		Racked, Sterile, Filtered	
FT-200	200µL	Bulk, Filtered	
FT-200-R-S		Racked, Sterile, Filtered	
FT-200L-R-S	200µL Long	Racked, Sterile, Filtered	
FT-200XL	200µL Extra Long	Bulk, Filtered	
FT-200XL-R-S		Racked, Sterile, Filtered	
FT-300	300µL	Bulk, Filtered	
FT-1000	1000µL	Bulk, Filtered	1000pcs/bag, 5bags/case
FT-1000-R-S		Racked, Sterile, Filtered	100pcs/rack, 50racks/case
FT-1250	1250µL	Bulk, Filtered	1000pcs/bag, 5bags/case
FT-1250-R-S		Racked, Sterile, Filtered	96pcs/rack, 50racks/case

Filter Pipette Tip

FT-10
10µL



31.56mm

FT-10-R-S
10µL



31.56mm

FT-10L
10µL



45.7mm

FT-10L-R-S
10µL



45.7mm

FT-20
20µL



50.55mm

FT-20-R-S
20µL



50.55mm

FT-50
50µL



50.55mm

FT-50-R-S
50µL



50.55mm

FT-100
100µL



50.55mm

FT-100-R-S
100µL



50.55mm

FT-300
300µL



59mm

FT-200XL
200µL



89mm

FT-200L-R-S
200µL



59mm

FT-200XL-R-S
200µL



89mm

FT-1000
1000µL



77.98mm

FT-1000-R-S
1000µL



77.98mm

FT-200
200µL



50.55mm

FT-200-R-S
200µL



50.55mm

FT-1250
1250µL



102.1mm

FT-1250-R-S
1250µL



102.1mm



Labselect Low Retention Tips are designed to be compatible with most popular brands of pipettes. These polypropylene tips are nonpyrogenic and DNase-/RNase-free. Low retention surface ensures maximum sample recovery and high-precision pipetting.

- Maximum recovery technology for ultra-low retention and high yield
- Available in bulk pack and rack pack
- Diverse product range
- Excellent compatibility
- Nonpyrogenic
- DNase-/RNase-free

Ordering information

Cat.No.	Volume	Description	Packaging
T-001-LR-10	10µL	Bulk	Bulk Packed: 1000pcs/bag, 20bags/case Racked Packed: 96pcs/rack, 50racks/case
T-010-LR-R-S		Racked, Sterile	
T-001-LR-10L	10µL Long	Bulk	
T-010L-LR-R-S		Racked, Sterile	
T-001-LR-200	200µL	Bulk	
T-0200-LR-R-S		Racked, Sterile	
T-001-LR-200XL	200µL Extra Long	Bulk	
T-0200XL-LR-R-S		Racked, Sterile	
T-001-LR-300	300µL	Bulk	
T-0300-LR-R-S		Racked, Sterile	
T-001-LR-1000	1000µL	Bulk	1000pcs/bag, 5bags/case
T-01000-LR-R-S		Racked, Sterile	100pcs/rack, 50racks/case
T-001-LR-1250	1250µL	Bulk	1000pcs/bag, 5bags/case
T-01250-LR-R-S		Racked, Sterile	96pcs/rack, 50racks/case



Low Retention Tip

T-001-LR-10
10µL



31.65mm

T-010-LR-R-S
10µL



31.65mm

T-001-LR-10L
10µL



45.7mm

T-010L-LR-R-S
10µL



45.7mm

T-001-LR-200
200µL



50.55mm

T-0200-LR-R-S
200µL



50.55mm

T-001-LR-200XL
200µL



89mm

T-0200XL-LR-R-S
200µL



89mm

T-001-LR-300
300µL



59.3mm

T-0300-LR-R-S
300µL



59.3mm

T-001-LR-1000
1000µL



77.98mm

T-01000-LR-R-S
1000µL



77.98mm

T-001-LR-1250
1250µL



102.1mm

T-01250-LR-R-S
1250µL



102.1mm

Low Retention

Our low-binding technology creates an ultra-hydrophobic surface, preventing liquid retention and ensuring maximum sample retrieval.

Tips leave no residue, ultra-low retention and high yield



Standard pipette tips leave residue after dispensing sample, especially for viscous liquid.

- Maximum recovery technology for ultra-low retention and high yield
- Technologically advanced filter material allows free passage of air while blocking aerosol contamination
- Suitable for precious samples
- Filters are made of virgin high-quality hydrophobic polyethylene without additives
- Available in bulk pack and rack pack
- Nonpyrogenic
- DNase-/RNase-free

Ordering information

Cat.No.	Volume	Description	Packaging
FT-10-LR	10µL	Bulk, Filtered	Bulk Packed: 1000pcs/bag, 10bags/case Racked Packed: 96pcs/rack, 50racks/case
FT-10-LR-R-S		Racked, Sterile, Filtered	
FT-10L-LR	10µL Long	Bulk, Filtered	
FT-10L-LR-R-S		Racked, Sterile, Filtered	
FT-20-LR	20µL	Bulk, Filtered	
FT-20-LR-R-S		Racked, Sterile, Filtered	
FT-50-LR	50µL	Bulk, Filtered	
FT-50-LR-R-S		Racked, Sterile, Filtered	
FT-100-LR	100µL	Bulk, Filtered	
FT-100-LR-R-S		Racked, Sterile, Filtered	
FT-200-LR	200µL	Bulk, Filtered	
FT-200-LR-R-S		Racked, Sterile, Filtered	
FT-200L-LR-R-S	200µL Long	Racked, Sterile, Filtered	
FT-200XL-LR	200µL Extra Long	Bulk, Filtered	
FT-200XL-LR-R-S		Racked, Sterile, Filtered	
FT-300-LR	300µL	Bulk, Filtered	
FT-1000-LR	1000µL	Bulk, Filtered	1000pcs/bag, 5bags/case
FT-1000-LR-R-S		Racked, Sterile, Filtered	100pcs/rack, 50racks/case
FT-1250-LR	1250µL	Bulk, Filtered	1000pcs/bag, 5bags/case
FT-1250-LR-R-S		Racked, Sterile, Filtered	96pcs/rack, 50racks/case



Low Retention Filter Tip

FT-10-LR 10µL FT-10-LR-R-S 10µL



FT-10L-LR 10µL FT-10L-LR-R-S 10µL



FT-20-LR 20µL FT-20-LR-R-S 20µL



FT-50-LR 50µL FT-50-LR-R-S 50µL



FT-100-LR 100µL FT-100-LR-R-S 100µL



FT-200-LR 200µL FT-200-LR-R-S 200µL



FT-300-LR 300µL



FT-200L-LR-R-S 200µL



FT-200XL-LR 200µL FT-200XL-LR-R-S 200µL

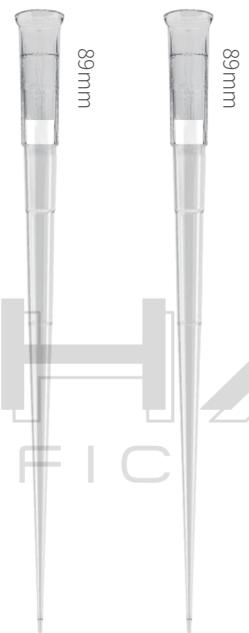

FT-1250-LR 1250µL FT-1250-LR-R-S 1250µL



FT-1000-LR 1000µL



FT-1000-LR-R-S 1000µL

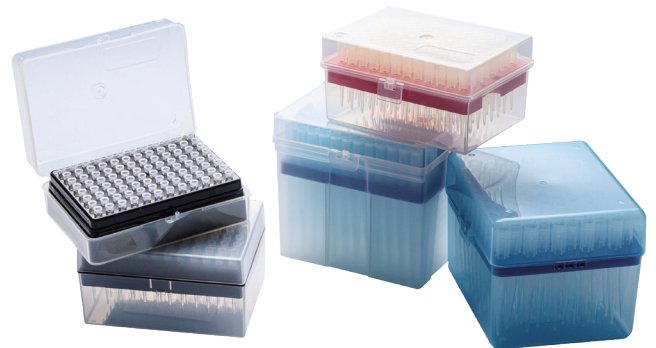

- Manufactured from high-quantity polypropylene material
- Diverse product range
- Compatible with the Rainin LTS style pipettors
- Maximizes sample recovery with low binding resin and a fine point design
- Nonpyrogenic, Noncytotoxic
- DNase-/RNase-free

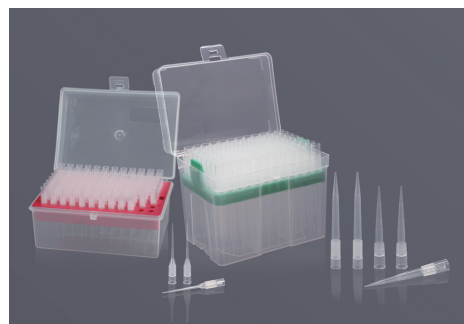

Ordering information

Cat.No.	Description	Packaging
T-R001-20	20µL Pipette tips, bulk pack, compatible with LTS style pipettors	1000pcs/bag, 10bags/case
T-R001-200	200µL Pipette tips, bulk pack, compatible with LTS style pipettors	1000pcs/bag, 10bags/case
T-R001-300	300µL Pipette tips, bulk pack, compatible with LTS style pipettors	1000pcs/bag, 10bags/case
T-R001-1000	1000µL Pipette tips, bulk pack, compatible with LTS style pipettors	1000pcs/bag, 10bags/case
T-R001-LR-20	20µL Low retention pipette tips, bulk pack, compatible with LTS style pipettors	1000pcs/bag, 10bags/case
T-R001-LR-200	200µL Low retention pipette tips, bulk pack, compatible with LTS style pipettors	1000pcs/bag, 10bags/case
T-R001-LR-300	300µL Low retention pipette tips, bulk pack, compatible with LTS style pipettors	1000pcs/bag, 10bags/case
T-R001-LR-1000	1000µL Low retention pipette tips, bulk pack, compatible with LTS style pipettors	1000pcs/bag, 10bags/case
T-R20-R-S	20µL Pipette tips, rack pack, compatible with LTS style pipettors	96pcs/rack, 10racks/unit, 5units/case
T-R200-R-S	200µL Pipette tips, rack pack, compatible with LTS style pipettors	96pcs/rack, 10racks/unit, 5units/case
T-R300-R-S	300µL Pipette tips, rack pack, compatible with LTS style pipettors	96pcs/rack, 10racks/unit, 5units/case
T-R1000-R-S	1000µL Pipette tips, rack pack, compatible with LTS style pipettors	96pcs/rack, 10racks/unit, 5units/case
T-R20-LR-R-S	20µL Low retention pipette tips, rack pack, compatible with LTS style pipettors	96pcs/rack, 10racks/unit, 5units/case
T-R200-LR-R-S	200µL Low retention pipette tips, rack pack, compatible with LTS style pipettors	96pcs/rack, 10racks/unit, 5units/case
T-R300-LR-R-S	300µL Low retention pipette tips, rack pack, compatible with LTS style pipettors	96pcs/rack, 10racks/unit, 5units/case
T-R1000-LR-R-S	1000µL Low retention pipette tips, rack pack, compatible with LTS style pipettors	96pcs/rack, 10racks/unit, 5units/case
FT-R20-R-S	20µL Filter pipette tips, rack pack, compatible with LTS style pipettors	96pcs/rack, 10racks/unit, 5units/case
FT-R200-R-S	200µL Filter pipette tips, rack pack, compatible with LTS style pipettors	96pcs/rack, 10racks/unit, 5units/case
FT-R300-R-S	300µL Filter pipette tips, rack pack, compatible with LTS style pipettors	96pcs/rack, 10racks/unit, 5units/case
FT-R1000-R-S	1000µL Filter pipette tips, rack pack, compatible with LTS style pipettors	96pcs/rack, 10racks/unit, 5units/case
FT-R20-LR-R-S	20µL Filter low retention pipette tips, rack pack, compatible with LTS style pipettors	96pcs/rack, 10racks/unit, 5units/case
FT-R200-LR-R-S	200µL Filter low retention pipette tips, rack pack, compatible with LTS style pipettors	96pcs/rack, 10racks/unit, 5units/case
FT-R300-LR-R-S	300µL Filter low retention pipette tips, rack pack, compatible with LTS style pipettors	96pcs/rack, 10racks/unit, 5units/case
FT-R1000-LR-R-S	1000µL Filter low retention pipette tips, rack pack, compatible with LTS style pipettors	96pcs/rack, 10racks/unit, 5units/case

Note: LTS™ is a registered trademarks of Rainin Instrument, LLC.

Automation Tip

Labselect Automation Tips are manufactured from high-quality polypropylene material. High quality, flexible polypropylene to ensure proper fit for accuracy and precision. These tips are engineered to the exact specifications to ensure compatibility and consistent fit. Filtered version available to prevent aerosol and liquid contamination.

These tips are manufactured to stringent specifications under strict process controls and assembled via automation to ensure consistent performance and quality.

- Manufactured from high-quality polypropylene material
- Compatible with variety of Automation Workstation
- Standard size, excellent compatibility
- Available in variety volume sizes
- Product quality is stable from batch to batch
- Nonpyrogenic
- DNase-/RNase-free
- Sterile



Ordering information

TECAN

Cat.No.	Description	Packaging
TFT-50-B-R-S	50µL Filtered conductive automation tips, black, 58mm	96pcs/rack, 10racks/unit, 5units/case
TFT-200-B-R-S	200µL Filtered conductive automation tips, black, 58mm	96pcs/rack, 10racks/unit, 5units/case
TFT-1000-B-R-S	1000µL Filtered conductive automation tips, black, 95mm	96pcs/rack, 10racks/unit, 5units/case
TFT-50-C-R-S	50µL Filtered automation tips, clear, 58mm	96pcs/rack, 10racks/unit, 5units/case
TFT-200-C-R-S	200µL Filtered automation tips, clear, 58mm	96pcs/rack, 10racks/unit, 5units/case
TFT-1000-C-R-S	1000µL Filtered automation tips, clear, 95mm	96pcs/rack, 10racks/unit, 5units/case

Agilent

Cat.No.	Description	Packaging
AUT-30-C-R-S	30µL Automation tips, clear	384pcs/rack, 10racks/unit, 5units/case
AUT-50-C-R-S	50µL Automation tips, clear	384pcs/rack, 10racks/unit, 5units/case
AUT-70-C-R-S	70µL Automation tips, clear	384pcs/rack, 10racks/unit, 5units/case
AUT-250-C-R-S	250µL Automation tips, clear	96pcs/rack, 10racks/unit, 3units/case
AFT-30-C-R-S	30µL Filtered automation tips, clear	384pcs/rack, 10racks/unit, 5units/case
AFT-50-C-R-S	50µL Filtered automation tips, clear	384pcs/rack, 10racks/unit, 5units/case
AFT-70-C-R-S	70µL Filtered automation tips, clear	384pcs/rack, 10racks/unit, 5units/case
AFT-250-C-R-S	250µL Filtered automation tips, clear	96pcs/rack, 10racks/unit, 3units/case

Hamilton

Cat.No.	Description	Packaging
HFT-300-B-R-S	300µL Filtered conductive automation tips, black, 60.05mm	96pcs/rack, 10racks/unit, 5units/case
HFT-1000-B-R-S	1000µL Filtered conductive automation tips, black, 95mm	96pcs/rack, 10racks/unit, 5units/case
HFT-300-C-R-S	300µL Filtered automation tips, clear, 60.05mm	96pcs/rack, 10racks/unit, 5units/case
HFT-1000-C-R-S	1000µL Filtered automation tips, clear, 95mm	96pcs/rack, 10racks/unit, 5units/case

Beckman

Cat.No.	Description	Packaging
BUT-50-C-R-S	50µL Automation tips, clear	96pcs/rack, 10racks/unit, 5units/case
BUT-250-C-R-S	250µL Automation tips, clear	96pcs/rack, 10racks/unit, 5units/case
BUT-1025-C-R-S	1025µL Automation tips, clear	96pcs/rack, 10racks/unit, 3units/case
BFT-50-C-R-S	50µL Filtered automation tips, clear	96pcs/rack, 10racks/unit, 5units/case
BFT-250-C-R-S	250µL Filtered automation tips, clear	96pcs/rack, 10racks/unit, 5units/case
BFT-1025-C-R-S	1025µL Filtered automation tips, clear	96pcs/rack, 10racks/unit, 3units/case

Integra

Cat.No.	Description	Packaging
IFT-12.5-C-R-S	12.5µL Filtered automation tips, clear	384pcs/rack, 10racks/unit, 5units/case
IFT-125-C-R-S	125µL Filtered automation tips, clear	384pcs/rack, 10racks/unit, 5units/case
IFT-300-C-R-S	300µL Filtered automation tips, clear	96pcs/rack, 10racks/unit, 5units/case
IFT-1250-C-R-S	1250µL Filtered automation tips, clear	96pcs/rack, 10racks/unit, 5units/case

Perkin Elmer

Cat.No.	Description	Packaging
PFT-25-C-R-S	25µL Filtered automation tips, clear	96pcs/rack, 10racks/unit, 5units/case
PFT-30-C-R-S	30µL Filtered automation tips, clear	384pcs/rack, 10racks/unit, 5units/case
PFT-50-C-R-S	50µL Filtered automation tips, clear	96pcs/rack, 10racks/unit, 5units/case
PFT-175-C-R-S	175µL Filtered automation tips, clear	96pcs/rack, 10racks/unit, 5units/case
PFT-235-C-R-S	235µL Filtered automation tips, clear	96pcs/rack, 10racks/unit, 5units/case
PFT-1000-C-R-S	1000µL Filtered automation tips, clear	96pcs/rack, 10racks/unit, 5units/case
PUT-1000-B-R	1000µL Conductive automation tips, black	96pcs/rack, 10racks/unit, 5units/case
PFT-1000-B-R	1000µL Filtered conductive automation tips, black	96pcs/rack, 10racks/unit, 5units/case

Pipette Carousel Stand

Labselect Pipette Carousel Stands provides safe and convenient storage of pipette. Compatible with most popular brands of pipettes: Eppendorf, Thermo Finn pipette, Brand, Sartorius, Dragonlab. Suitable for single and multi-channel pipettes, stable and convenient, accommodates six single pipettes.

Hold and store pipettes in style with the new universal pipette carousel stand. The sleek and modern design enables this stand to securely hold virtually every known brand of pipette in the marketplace, while adding a pop of color to the benchtop. One-handed removal or replacement is made easy with a rotating head and stable, weighted base. A quick grip handle allows users to move the stand while keeping pipettes in place.

- Provides safe and convenient storage of pipette
- Compatible with most popular brands of pipettes
- Pipettes are held in a vertical position to help prevent contamination
- Conveniently rotate stand head to select or store pipettes
- Accommodates six single channel pipettes
- The unit is not autoclavable but can be cleaned with common laboratory disinfectants
- Robust design that securely holds and protects pipettes

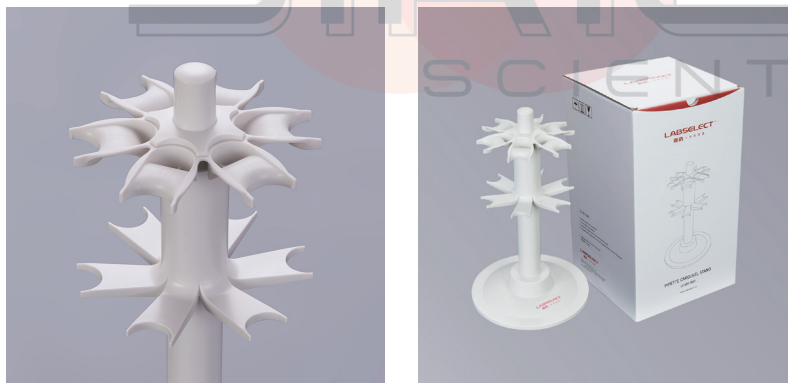

Ordering information

Cat.No.	Description	Packaging
LC-001-0601	Pipette carousel stand, compatible with Eppendorf, Thermo Finn pipette, Brand, Sartorius, DLAB pipettes	1pc/box, 6boxes/case

PCR Consumables

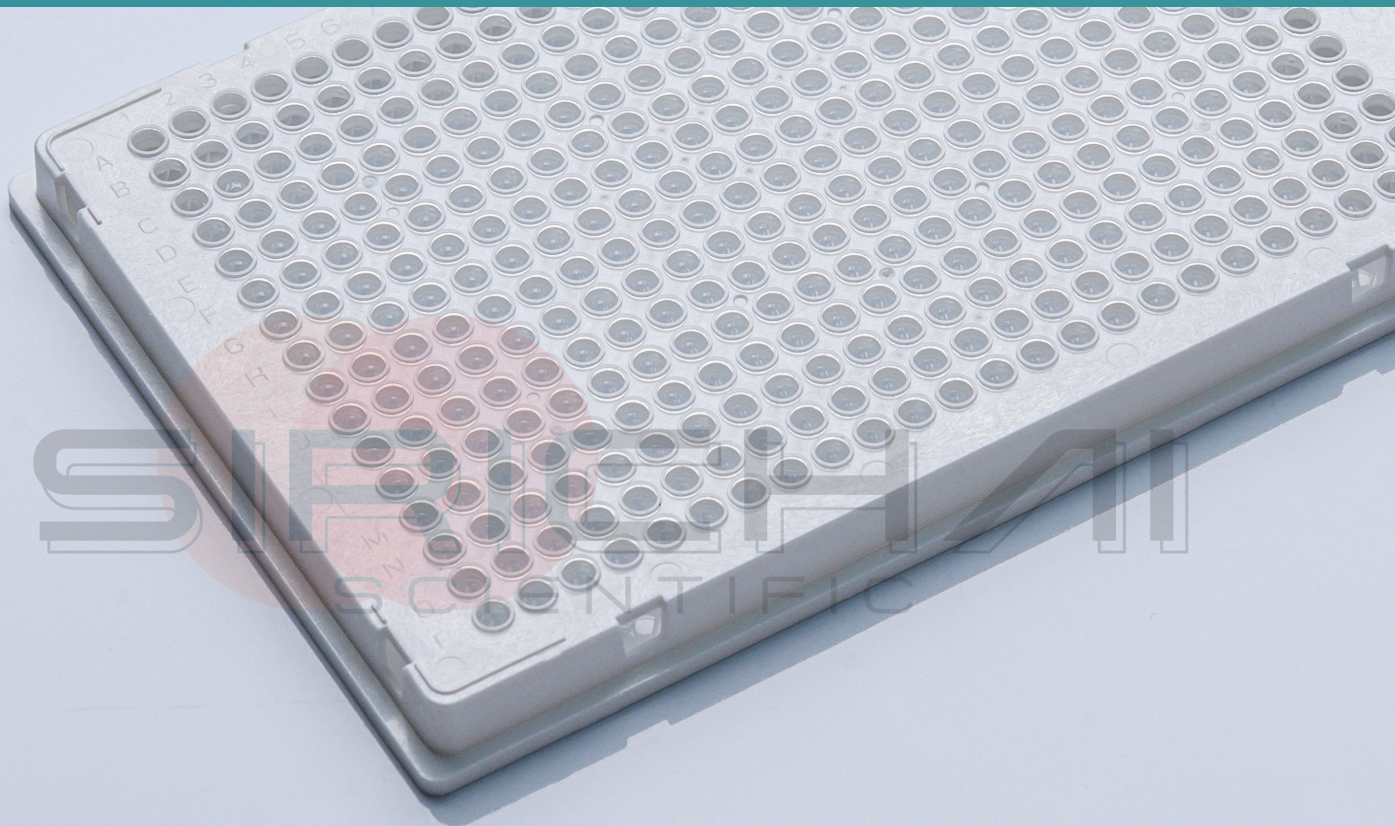

PCR Tube

PCR Strip Tube & Strip Cap

PCR Plate

Sealing Film

Labselect PCR Tubes are suitable for real time PCR, ultra-clear, thin walled and uniformly thick tubes, provide efficient and homogeneous heat transfer ensuring consistently reliable amplification.

- Manufactured from polypropylene material
- Individual PCR tubes feature evaporation-resistant, easy-to-open-and-close lids that prevent sample loss
- Ultra-thin, uniform walls ensure optimal heat transfer and reaction efficiency
- Conveniently packaged in bags to minimize risk of contamination
- Nonpyrogenic
- DNase-/RNase-free

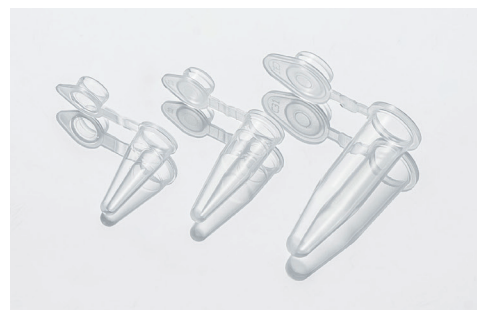

Ordering information

Cat.No.	Description	Packaging
PT-01-CB	0.1mL PCR tube, flat cap	1000pcs/box, 10boxes/case
PT-02-C	0.2mL PCR tube, flat cap	1000pcs/box, 10boxes/case
PT-05-C	0.5mL PCR tube, flat cap	1000pcs/box, 10boxes/case



V-shaped bottom



Flat cap design



Volume: 0.1mL

Volume: 0.2mL

Volume: 0.5mL

Labselect PCR Strip Tubes & Strip Caps are manufactured from pure polypropylene materials and are designed to fit a variety of thermal cyclers for PCR and Real-time PCR. The consistent and ultra-thin wall allows precise thermal transfer and optimally conduct heat to the reaction solution. PCR tubes in a standardized form, applicable to almost all laboratory PCR equipment, such as APPLIED BIOSYSTEMS, EPPENDORF, BIO RAD, Roche etc.



PST-0108-FT-C



PST-0108-FT-W



PST-0208-FT-C



PST-0208-D-C



PSC-08-RT-CA



PST-0208-C



PSC-08-RT-CB



STP100



PST-0208-FT-CB



PST-0108-FT-CB



PST-0108-FT-WB



PST-0208-FT-AB

Traditional Strip Tube

- Available as 0.1 and 0.2 mL PCR strip tubes
- Two tube colors: clear, white
- Manufactured from virgin polypropylene material
- High transparency of PCR strips allows the use for applications where the optical qPCR signal comes from the bottom of the tubes
- Nonpyrogenic
- DNase-/RNase-free

Ordering information

Cat.No.	Description	Packaging
PST-0108-FT-C	0.1mL 8-strip tubes (with strip caps), clear	125strips/box, 10boxes/case
PST-0108-FT-W	0.1mL 8-strip tubes (with strip caps), white	125strips/box, 10boxes/case
PST-0208-FT-C	0.2mL 8-strip tubes (with strip caps), clear	125strips/box, 10boxes/case
PST-0208-D-C	0.2mL 8-strip tubes (with domed strip caps), clear	125strips/box, 10boxes/case
PST-0208-C	0.2mL 8 Strip tubes, without cap	125strips/box, 10 boxes/case
PSC-08-RT-CA	0.1/0.2mL 8-strip caps, flat cap, clear	125strips/box, 10boxes/case
PSC-08-RT-CB	0.1/0.2mL 8-strip caps, domed cap, clear	125strips/box, 10boxes/case
STP100	Strip caps installing tool, 118*78 mm	1pc/bag

Hard Strip Tube

- Available as 0.1 and 0.2 mL PCR strip tubes
- Three tube colors: clear, white, frosted
- Manufactured from virgin polypropylene material
- Robust interwell linkages make the strips rigid and easy to handle, preventing spills
- Ultra-thin walls ensure efficient thermal transfer and maximum yield
- Nonpyrogenic
- DNase-/RNase-free

Ordering information

Cat.No.	Volume	Tube Type	Tube Color	Packaging
PST-0108-FT-CB	0.1mL	8-strip tubes (with strip caps)	Clear	125strips/box, 10boxes/case
PST-0108-FT-WB	0.1mL	8-strip tubes (with strip caps)	White	125strips/box, 10boxes/case
PST-0208-FT-CB	0.2mL	8-strip tubes (with strip caps)	Clear	125strips/box, 10boxes/case
PST-0208-FT-AB	0.2mL	8-strip tubes (with strip caps)	Frosted	125strips/box, 10boxes/case

PCR Strip Tube & Strip Cap

Attached Strip Tube

- Available as 0.1 and 0.2 mL PCR strip tubes
- Manufactured from polypropylene material
- Clear tubes provide high clarity for visualizing contents
- Ultra-thin walls ensure efficient thermal transfer and maximum yield
- Attached caps prevent cap lids and hinges from interfering with each other
- Nonpyrogenic
- DNase-/RNase-free

Optically-clear caps

Optically-clear caps ensure the fluorescence signal passed through uninhibited



Clear Tubes

Provide high clarity to visualize contents

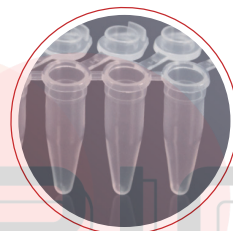

Ultra-thin walls

Ultra-thin walls ensure efficient thermal transfer and maximum yield

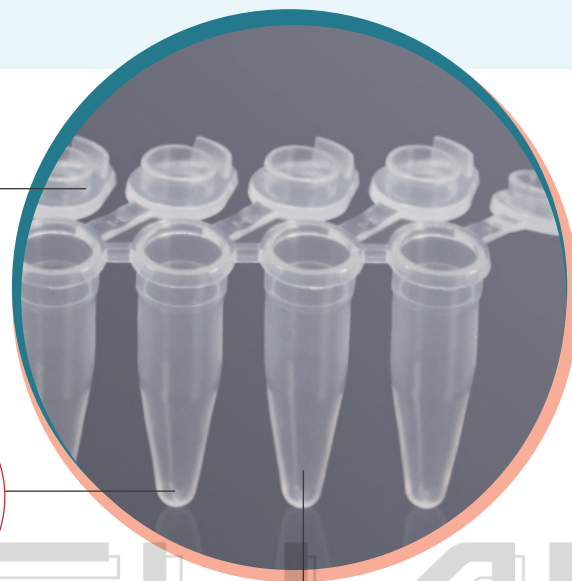
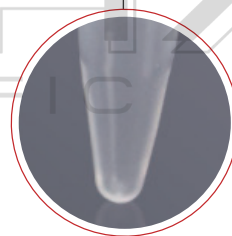

Ordering information

Cat.No.	Volume	Tube Type	Tube Color	Packaging
PST-0108-AFT-CB	0.1mL	8-strip tubes (with attached caps)	Clear	120strips/box, 10boxes/case
PST-0208-AFT-C	0.2mL	8-strip tubes (with attached caps)	Clear	120strips/box, 10boxes/case
PST-0208-AFT-CB	0.2mL	8-strip tubes (with attached caps)	Clear	120strips/box, 10boxes/case

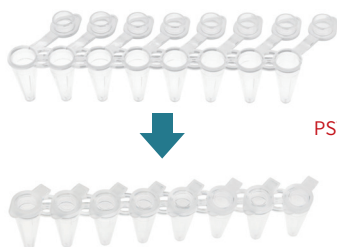

PST-0108-AFT-CB

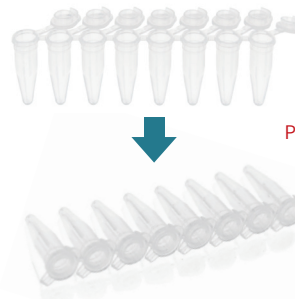

PST-0208-AFT-C/PST-0208-AFT-CB

PCR 4-Strip Tubes and Caps

Labselect 0.1mL PCR 4-Strip Tubes are specifically designed for use with the Qiagen/Corbett Rotor-gene system. There are 4 tubes per strip and 4 caps per strip. The consistent and ultra-thin wall allows precise thermal transfer, better signal to noise ratio than other competitors. Easy lock caps provide leak-free seals for reduced evaporation.

- Manufactured from high-quality polypropylene material
- Thin wall design for efficient heat transfer
- Optically clear tubes ideally suited for qPCR
- Frosted cap extensions allow for easy handling and labeling
- Designed for Qiagen/Corbett Rotor-Gene instruments
- Nonpyrogenic
- DNase-/RNase-free



Manufactured from high-quality polypropylene material

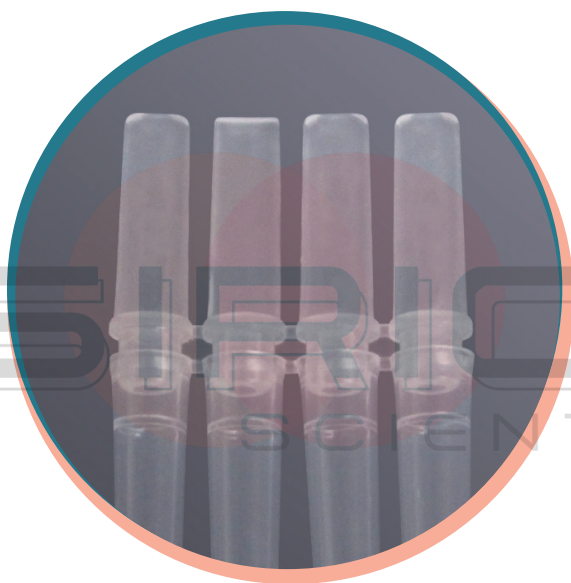

Thin wall design for efficient heat transfer

Ordering information

Cat.No.	Description	Packaging
PST-0104-C	0.1 mL PCR 4-strip tubes and caps	250strips/box, 10boxes/case

PCR Plate

Labselect 96-well and 384-well PCR Plates are designed to fit almost all laboratory PCR equipment. The consistent and ultra-thin wall allows precise thermal transfer for optimum results. Non-Skirted, semi-skirted and full-skirted plates are available. To minimize evaporation with small sample volumes and to prevent contamination, seal the plates with the appropriate sealing film.

96-well PCR Plate Non-skirted & Semi-skirted & Full-skirted Plate

- Available as 0.1 and 0.2 mL PCR plates
- 3 skirt types: Non-skirted, Semi-skirted, Full-skirted
- Designed to fit standard 96-well blocks, fit most popular thermal cyclers
- Ultra-thin, uniform wells ensure optimal heat transfer for high reaction efficiency
- Can be sealed with sealing film
- Nonpyrogenic
- DNase-/RNase-free

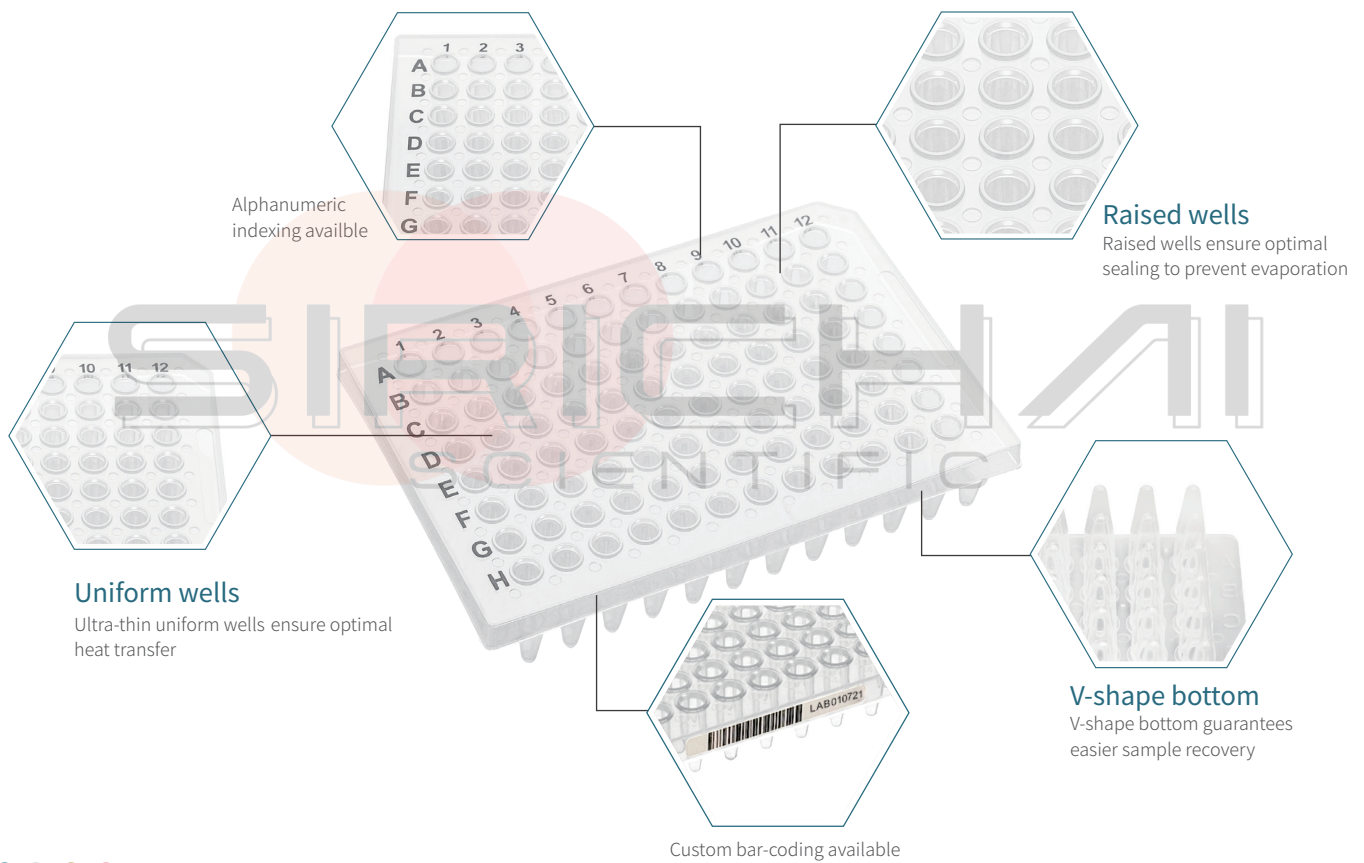

Can be customized, various colors can be chosen

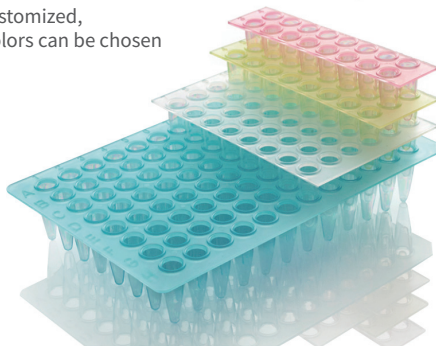

Non-skirted



Semi-skirted



Full-skirted

Non-skirted Plate

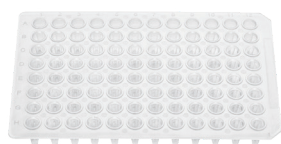

PP-96-NS-0100

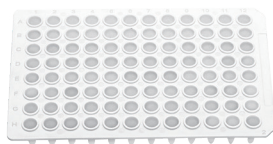

PP-96-NS-0100-W

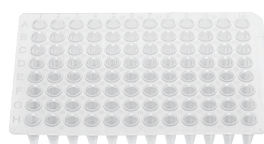

PP-96-NS-0200

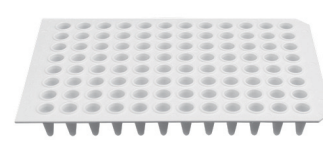

PP-96-NS-0200-W

Ordering information

Cat.No.	Material	Color	Skirt	Notch corner	Volume	Packaging
PP-96-NS-0100	PP	Clear	Non-skirted	A12/H12	0.1mL	10pcs/bag, 5bags/case
PP-96-NS-0100-W	PP	White	Non-skirted	A12/H12	0.1mL	10pcs/bag, 5bags/case
PP-96-NS-0200	PP	Clear	Non-skirted	A12/H12	0.2mL	10pcs/bag, 5bags/case
PP-96-NS-0200-W	PP	White	Non-skirted	A12/H12	0.2mL	10pcs/bag, 5bags/case

Semi-skirted Plate

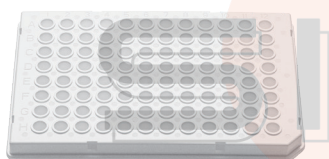

PP-96-HS-LC480-W

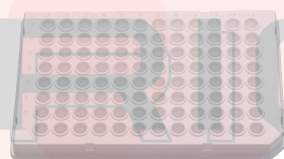

PP-96-HS-LC480-WB

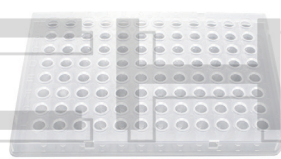

PP-96-HS-LC480-C

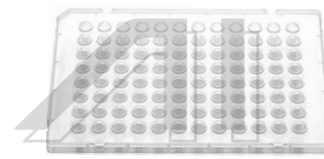

PP-96-HS-0100

Ordering information

Cat.No.	Material	Color	Skirt	Notch corner	Volume	Packaging
PP-96-HS-0100B	PP	Clear	Semi-skirted	A1	0.1mL	10pcs/bag, 5bags/case
PP-96-HS-LC480-W	PP	White	Semi-skirted	H12	0.1mL	10pcs/bag, 5bags/case
PP-96-HS-LC480-WB	PP	White	Semi-skirted	H12	0.1mL	10pcs/bag, 5bags/case
PP-96-HS-LC480-C	PP	Clear	Semi-skirted	H12	0.1mL	10pcs/bag, 5bags/case
PP-96-HS-0100	PP	Clear	Semi-skirted, raised deck	A1	0.1mL	10pcs/bag, 5bags/case
MP-96-HS-0200	PP	Clear	Semi-skirted	A12	0.2mL	10pcs/bag, 5bags/case
PP-96-AB-0200	PP	Clear	Semi-skirted, raised deck	A12	0.2mL	10pcs/bag, 5bags/case
MP-96-HS-0200-W	PP	White	Semi-skirted	A12	0.2mL	10pcs/bag, 5bags/case
PC-96-HS-0100-BF	PC frame, PP tube	Black plate, frosted tubes	Semi-skirted	H12	0.1mL	10pcs/bag, 5bags/case
PC-96-HS-0100-BW	PC frame, PP tube	Black plate, white tubes	Semi-skirted	H12	0.1mL	10pcs/bag, 5bags/case

Cat.No.	Material	Color	Skirt	Notch corner	Volume	Packaging
PC-96-HS-0100-CF	PC frame,PP tube	Clear plate, frosted tubes	Semi-skirted	A12	0.1mL	10pcs/bag, 5bags/case
PC-96-HS-0100-CW	PC frame,PP tube	Clear plate, white tubes	Semi-skirted	H12	0.1mL	10pcs/bag, 5bags/case
PC-96-HS-0100-GF	PC frame,PP tube	Green plate, frosted tubes	Semi-skirted	H12	0.1mL	10pcs/bag, 5bags/case
PC-96-HS-0100-GW	PC frame,PP tube	Green plate, white tubes	Semi-skirted	H12	0.1mL	10pcs/bag, 5bags/case
PC-96-HS-0100-LF	PC frame,PP tube	Blue plate, frosted tubes	Semi-skirted	H12	0.1mL	10pcs/bag, 5bags/case
PC-96-HS-0100-LW	PC frame,PP tube	Blue plate, white tubes	Semi-skirted	H12	0.1mL	10pcs/bag, 5bags/case
PC-96-HS-0100-OF	PC frame,PP tube	Orange plate, frosted tubes	Semi-skirted	H12	0.1mL	10pcs/bag, 5bags/case
PC-96-HS-0100-OW	PC frame,PP tube	Orange plate, white tubes	Semi-skirted	H12	0.1mL	10pcs/bag, 5bags/case
PC-96-HS-0100-RF	PC frame,PP tube	Red plate, frosted tubes	Semi-skirted	H12	0.1mL	10pcs/bag, 5bags/case
PC-96-HS-0100-RW	PC frame,PP tube	Red plate, white tubes	Semi-skirted	H12	0.1mL	10pcs/bag, 5bags/case
PC-96-HS-0100-WF	PC frame,PP tube	White plate, frosted tubes	Semi-skirted	H12	0.1mL	10pcs/bag, 5bags/case
PC-96-HS-0100-WW	PC frame,PP tube	White plate, white tubes	Semi-skirted	H12	0.1mL	10pcs/bag, 5bags/case
PC-96-HS-0100-YF	PC frame,PP tube	Yellow plate, frosted tubes	Semi-skirted	H12	0.1mL	10pcs/bag, 5bags/case
PC-96-HS-0100-YW	PC frame,PP tube	Yellow plate, white tubes	Semi-skirted	H12	0.1mL	10pcs/bag, 5bags/case
PC-96-HS-0200-CF	PC frame,PP tube	Clear plate, frosted tubes	Semi-skirted	A12	0.2mL	10pcs/bag, 5bags/case
PC-96-HS-0200-CW	PC frame,PP tube	Clear plate, white tubes	Semi-skirted	A12	0.2mL	10pcs/bag, 5bags/case
PC-96-HS-0200-WF	PC frame,PP tube	White plate, frosted tubes	Semi-skirted	A12	0.2mL	10pcs/bag, 5bags/case
PC-96-HS-0200-WW	PC frame,PP tube	White plate, white tubes	Semi-skirted	A12	0.2mL	10pcs/bag, 5bags/case



Full-skirted Plate



Full-skirted

- Two tube colors: clear, white
- Thin-wall polypropylene for excellent mechanical fit and heat transfer
- Polycarbonate (hard shell) for mechanical stability and flatness
- Designed to reduce cross-contamination with raised well rims for effective sealing
- Nonpyrogenic
- DNase-/RNase-free

Alphanumeric indexing

High-contrast, black alphanumeric indexing

Polycarbonate (hard shell)

Polycarbonate (hard shell) for mechanical stability and flatness

Thin-wall polypropylene

Thin-wall polypropylene for excellent mechanical fit and heat transfer

Two tube colors

clear, white



PC-96-FS-0100-WW

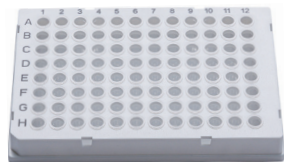

PC-96-FS-0100-WC



PC-96-FS-0100-CC

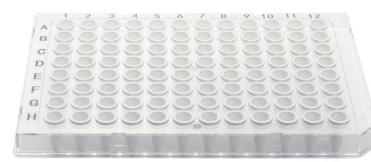

PC-96-HS-0100-CW

Ordering information

Cat.No.	Color	Skirt	Notch corner	Volume	Packaging
PC-96-FS-0100-CC	Clear plate, clear tubes	Full-skirted	H1	0.1mL	10pcs/bag, 5bags/case
PC-96-FS-0100-CW	Clear plate, white tubes	Full-skirted	H1	0.1mL	10pcs/bag, 5bags/case
PC-96-FS-0100-WC	White plate, clear tubes	Full-skirted	H1	0.1mL	10pcs/bag, 5bags/case
PC-96-FS-0100-WW	White plate, white tubes	Full-skirted	H1	0.1mL	10pcs/bag, 5bags/case
PC-96-FS-0100-BC	Black plate, clear tubes	Full-skirted	H1	0.1mL	10pcs/bag, 5bags/case
PC-96-FS-0100-BW	Black plate, white tubes	Full-skirted	H1	0.1mL	10pcs/bag, 5bags/case
PC-96-FS-0100-GC	Green plate, clear tubes	Full-skirted	H1	0.1mL	10pcs/bag, 5bags/case
PC-96-FS-0100-GW	Green plate, white tubes	Full-skirted	H1	0.1mL	10pcs/bag, 5bags/case
PC-96-FS-0100-LC	Blue plate, clear tubes	Full-skirted	H1	0.1mL	10pcs/bag, 5bags/case
PC-96-FS-0100-LW	Blue plate, white tubes	Full-skirted	H1	0.1mL	10pcs/bag, 5bags/case
PC-96-FS-0100-OC	Orange plate, clear tubes	Full-skirted	H1	0.1mL	10pcs/bag, 5bags/case
PC-96-FS-0100-OW	Orange plate, white tubes	Full-skirted	H1	0.1mL	10pcs/bag, 5bags/case
PC-96-FS-0100-RC	Red plate, clear tubes	Full-skirted	H1	0.1mL	10pcs/bag, 5bags/case
PC-96-FS-0100-RW	Red plate, white tubes	Full-skirted	H1	0.1mL	10pcs/bag, 5bags/case
PC-96-FS-0100-YC	Yellow plate, clear tubes	Full-skirted	H1	0.1mL	10pcs/bag, 5bags/case
PC-96-FS-0100-YW	Yellow plate, white tubes	Full-skirted	H1	0.1mL	10pcs/bag, 5bags/case

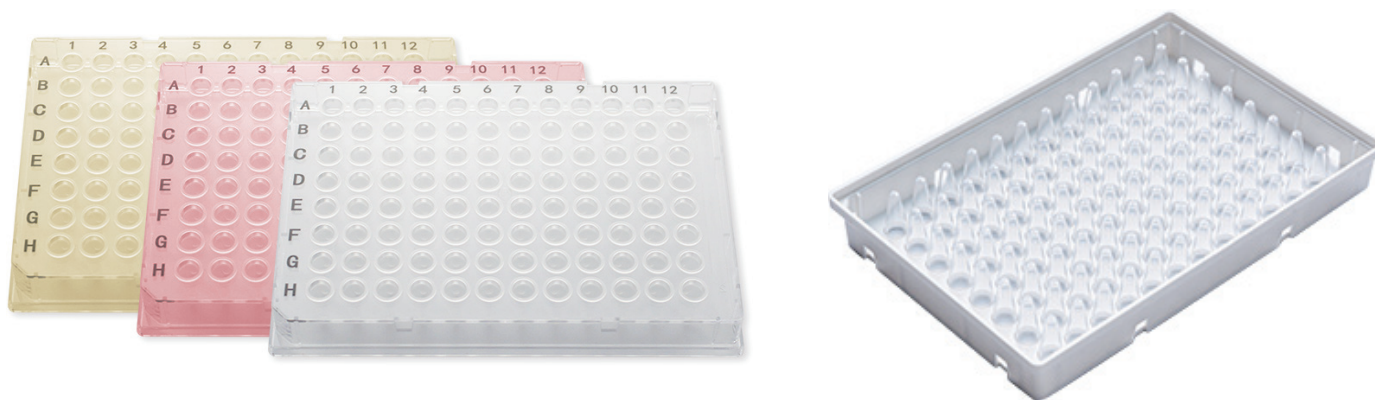

96-Well Segmented Plate

96-Well segmented plates maintain all benefits of 96 well semi-skirted PCR plate, also add extra flexibility. This kind of plates allow for the most flexible, efficient and cost-effective use of a PCR plate, which can be quickly and easily divided along the perforations between the rows. They also avoid the costly use of half-empty plates or the fiddly separation of plates with scissors. Segmented plate can be sealed with strip caps or sealing film.

- PC frame, PP tube
- Conveniently pre-cut into 8 well sections, tears easily into strips or part plates
- Semi-skirted adds rigidity
- Universal cycler and sequencer compatibility
- Uniform, thin well walls deliver maximum and consistent heat transfer
- Raised rim around each well enables secure sealing and safeguards against evaporation
- Can be sealed with strip caps or sealing film
- Nonpyrogenic
- DNase-/RNase-free

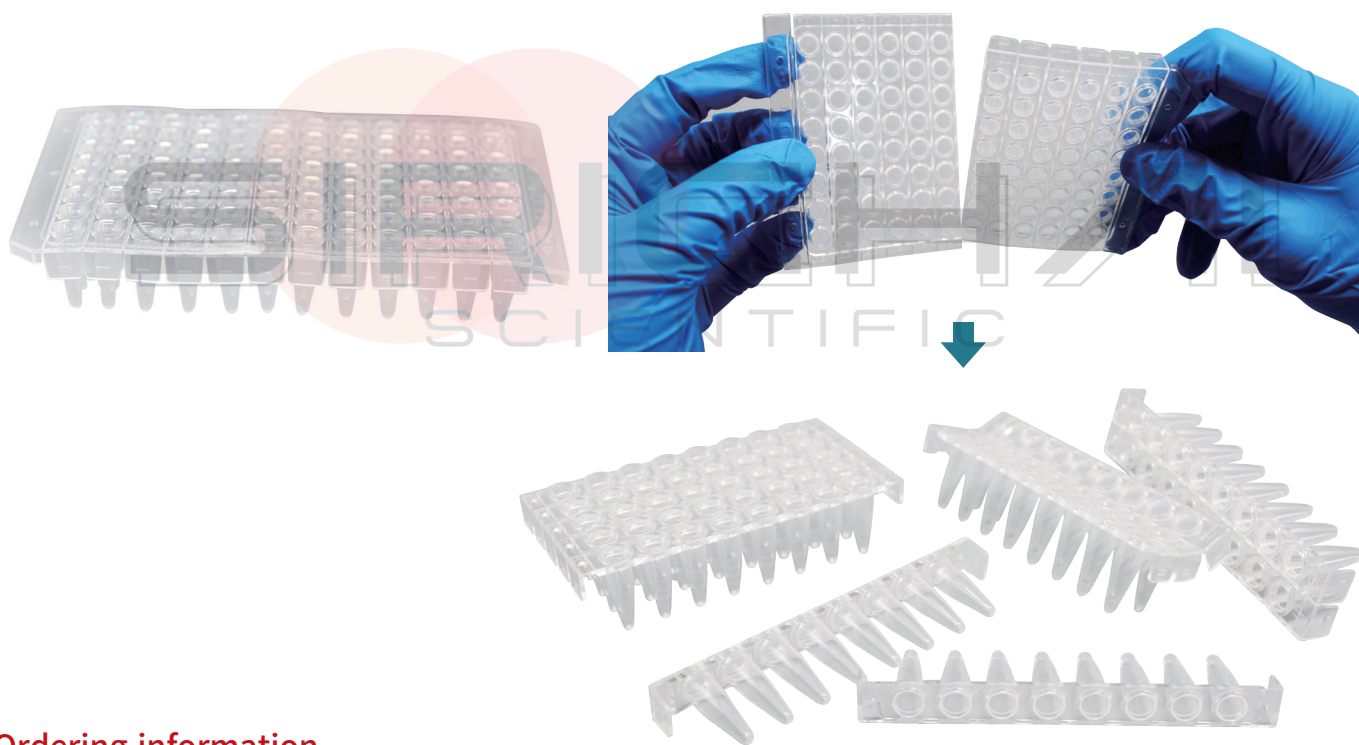

Ordering information

Cat.No.	Material	Color	Skirt	Notch corner	Volume	Packaging
PC-96-HS-0100-CC-SG	PC frame, PP tube	Clear	Semi-skirted, segmented	A12	0.1mL	10pcs/bag, 5bags/case
PC-96-HS-0200-CC-SG	PC frame, PP tube	Clear	Semi-skirted, segmented	A12	0.2mL	10pcs/bag, 5bags/case

384-Well PCR Plate



Full-skirted

- Two tube colors: clear, white
- Made of high-quality polypropylene (PP) and polycarbonate (PC) material
- Ultra-thin, uniform wells ensure optimal heat transfer
- Alphanumeric marking for easy identification
- Excellent thermal conductivity leads efficient PCR
- Nonpyrogenic
- DNase-/RNase-free

Thin-wall polypropylene

Thin-wall polypropylene ensure rapid temperature transfer for short cycle times

Polycarbonate (hard shell)

Polycarbonate (hard shell) for mechanical stability and flatness

Applications

For applications in automation and high-throughput analysis

Three plate colors

clear, white, black



Can be customized, various colors available.





PP-384-FS-0040-CC



PP-384-FS-ABI-C

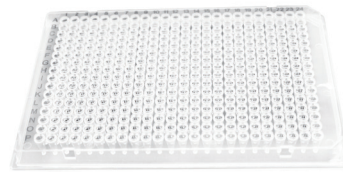

PP-384-FS-C



PP-384-FS-W

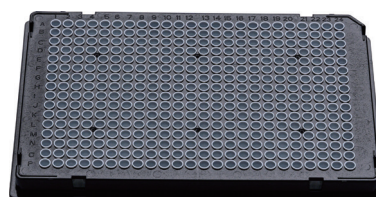

PC-384-FS-0040-BW

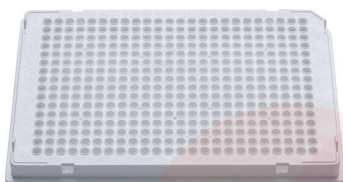

PC-384-FS-0040-WC

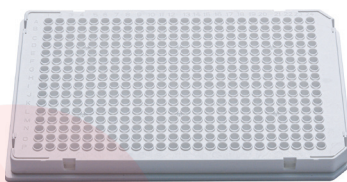

PC-384-FS-0040-WW

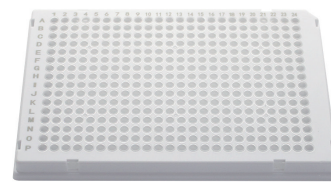

PC-384-FS-0040-CF



Ordering information

Cat.No.	Color	Material	Skirt	Notch corner	Volume	Packaging
PP-384-FS-0040-CC	Clear	PP	Full- skirted	A24/P24	40µL	10pcs/bag, 5bags/case
PP-384-FS-ABI-C	Clear			A24		
PP-384-FS-C	Clear			A24/P24		
PP-384-FS-W	White			A24/P24		
PC-384-FS-0040-BW	Black plate, white tubes	PC frame PP tube		A24		
PC-384-FS-0040-WC	White plate, clear tubes			A24		
PC-384-FS-0040-WW	White plate, white tubes			A24/P24		
PC-384-FS-0040-RC	Clear plate, clear tubes			A24/P24		
PC-384-FS-0040-CW	Clear plate, white tubes			A24		
PC-384-FS-0040-CC	Clear plate, clear tubes			A24		
PC-384-FS-0040-CF	Clear plate, frosted tubes		A24			

Sealing Film

Labselect Sealing Films provides a highly effective seal, preventing evaporation and eliminating contamination between wells and are designed for applications ranging from PCR, Real-Time PCR, ELISA and storage. Create an evaporation-resistant seal to minimize sample loss. They can be used in wide temperature ranges making them suitable for many applications.

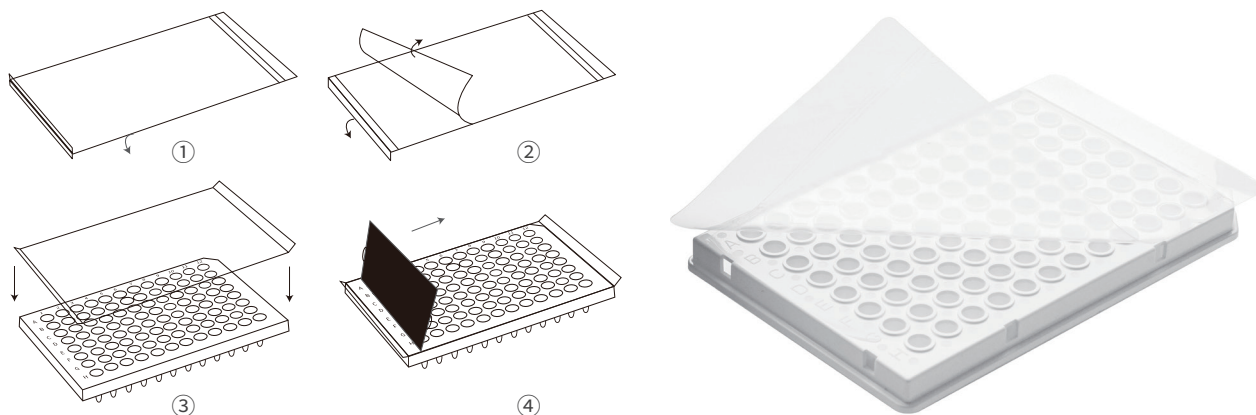

Sealing Film, for Standard PCR/storage

- Pre-cut, plate-sized sheets
- Standard film is used for short-term storage and transportation of samples to ensure tightness and reduce evaporation of samples
- Not react with experimental samples ensure reliable results
- DNase-/RNase-free
- Non-sterile

Ordering information

Cat.No.	Material	Application	Color	Size (mm)	Temperature range	Packaging
SF-SP-25	PP	PCR/Storage, adhesive	Clear	138*83	-40°C~102°C	25sheets/box
SF-SP-100	PP	PCR/Storage, adhesive	Clear	138*83	-40°C~102°C	100sheets/box
SF-SP-100A	PP	PCR/Storage, adhesive	Clear	124*83	-40°C~102°C	100sheets/box
SF-WS-100	PET	PCR/Storage, adhesive	White	135*85	-80°C~120°C	100sheets/ box
SF-BS-100	PET	PCR/Storage, adhesive	Black	135*85	-80°C~120°C	100sheets/ box



Aluminum Foil Sealing Film, for Standard PCR/storage

- Pre-cut, plate-sized sheets
- Foil sealing film are ideal for light-sensitive samples
- Not react with experimental samples ensure reliable results
- DNase-/RNase-free
- Non-sterile



Ordering information

Cat.No.	Material	Application	Color	Size (mm)	Temperature range	Packaging
ASF-TS-100	Aluminum foil	PCR/Storage, adhesive	Silvery	146*79.2	-80°C~104°C	100sheets/ box
ASF-SS-100	Aluminum foil	PCR/Storage, adhesive	Silvery	129.1*80	-60°C~90°C	100sheets/ box
ASF-001-TH-100	Aluminum foil	PCR/Storage, glossy	Silvery	125*83	-20°C~120°C	100sheets/ box
ASF-002-SH-100	Aluminum foil	PCR/Storage, embossing	Silvery	125*83	-20°C~120°C	100sheets/ box

Sealing Film, for qPCR

- Pre-cut, plate-sized sheets
- Optical clear sealing film (no auto-fluorescence, high transparency) allows for optical analysis during qPCR
- Not react with experimental samples ensure reliable results
- Secure sealing of all wells minimizes evaporation
- DNase-/RNase-free
- Non-sterile



Ordering information

Cat.No.	Material	Application	Color	Size (mm)	Temperature range	Packaging
SF-001-UC-25	PP	qPCR, pressure-sensitive	Clear	141*78	-70°C~100°C	25sheets/box
SF-001-UC-100	PP	qPCR, pressure-sensitive	Clear	141*78	-70°C~100°C	100sheets/box
SF-001-UC-100B	PP	qPCR, pressure-sensitive	Clear	142*80	-70°C~100°C	100sheets/box
SF-024-UC-100	PP	qPCR, pressure-sensitive	Clear	100*55	-70°C~100°C	100sheets/box
SF-001-UH-25	PET	qPCR, heat-sensitive	Clear	125*80	-20°C~120°C	25sheets/box
SF-001-UH-100	PET	qPCR, heat-sensitive	Clear	125*80	-20°C~120°C	100sheets/ box
SF-001-US-25	PET	qPCR, adhesive	Clear	141.5*80	-20°C~120°C	25sheets/box
SF-001-US-100	PET	qPCR, adhesive	Clear	141.5*80	-20°C~120°C	100sheets/box

Film Strip, for qPCR

- Strips can be easily peeled for sealing of 8-tubes or partial plates
- For qPCR applications
- Not react with experimental samples ensure reliable results
- Seal selectively, an economical and more user-friendly alternative to strip-caps
- Strips can be used to selectively cover one row of a plate to prevent accidental pipetting or to re-seal rows that have been pierced
- Specially formulated adhesive provides an excellent seal to minimize evaporation, reduce cross-contamination and prevent spillage
- DNase-/RNase-free
- Non-sterile

Ordering information

Cat.No.	Material	Application	Color	Size (mm)	Temperature range	Packaging
SF-008-US-25	PET	qPCR, adhesive	Clear	128*99	-20°C~120°C	25sheets/box
SF-008-US-100	PET	qPCR, adhesive	Clear	128*99	-20°C~120°C	100sheets/box



Sealing Film Scraper

- Manufactured from LDPE material
- Size: 100*72mm
- Using for making the sealing film fit better with PCR plate



Ordering information

Cat.No.	Material	Size (mm)	Packaging
LSF100	LDPE	100*72	1pc/bag

Breathable Sealing Film

Labelect Breathable Sealing Films are designed for cellular and bacterial culture applications. Labelect's sealing films are the easiest and most cost-effective method for sealing plates. Breathable sealing film provides for adequate gas exchange while maintaining a sterile barrier. Breathable sealing tape fits all 96- and 384-well microplates and polypropylene blocks. They can be used in wide temperature ranges, making them suitable for many applications.

- Rayon non-woven material
- Pre-cut, plate-sized sheets
- Breathable film that allows effective gas exchange for cellular/bacterial cultivation while preventing contamination
- Seal polypropylene and polystyrene culture plates, 96 well and 384 microplates, and other assay plates
- Moisture vapor transmission rate: 4,200g/m²/24hrs
- Size: 153mm*82mm
- Temperature range: -20°C to 80°C
- DNase-/RNase-free

Ordering information

Cat.No.	Description	Packaging
BSF-HF-50-S	Breathable sealing film, adhesive, sterile	50sheets/box
BSF-HF-100	Breathable sealing film, adhesive, non-sterile	100sheets/box



Cell Culture Consumables

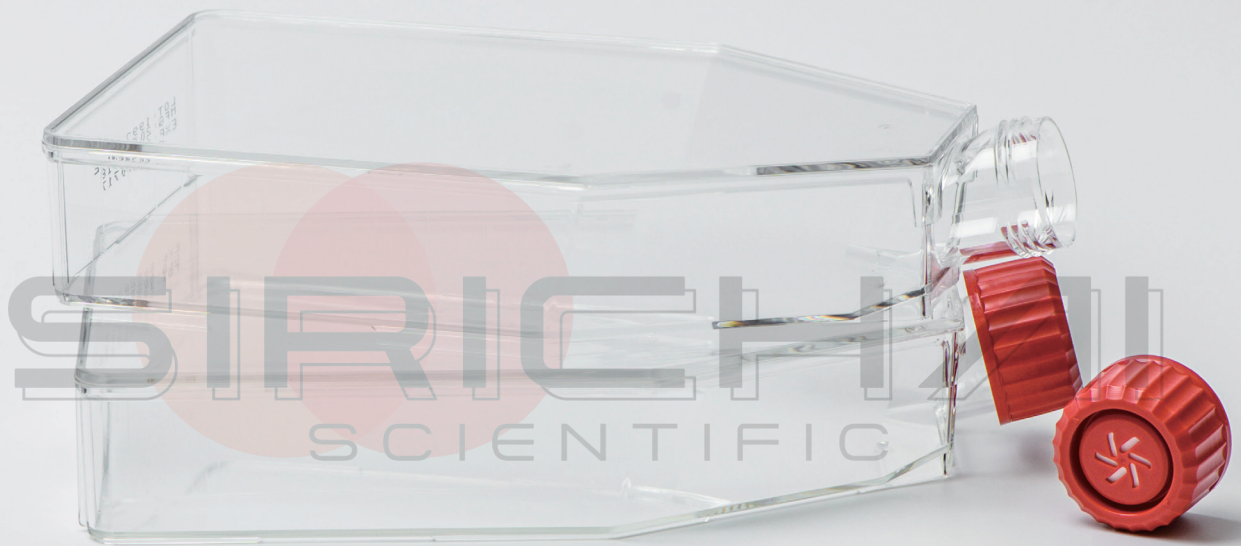

Cell Culture Dish
Cell Culture Flask
Erlenmeyer Flask
Cell Culture Plate
Cell Culture Insert
Bio-reaction Tubes

Cell Scraper&Lifter
Glass Coverslip
Confocal Dish
Chamber Slide
Cryogenic Vial

Labselect Easy-grip Cell Culture Dishes are uniquely designed to simplify lifting one dish or a small stack of dishes. The grip ring is easy to hold and stays secure in your gloved hand. The raised lip on the outer edge of the lid facilitates stable stacking of multiple dishes for secure transportation. Labselect Easy-grip cell culture dishes come in four sizes 35 mm, 60 mm, 100 mm, 150 mm. TC-treated and non-treated cell culture dishes are available.

- TC-treated for optimal cell attachment
- Non-treated surface suitable for suspension cell culture
- Features flat, optically clear polystyrene surfaces for distortion-free microscopic visualization of cells
- Uniquely designed to simplify lifting one dish or a small stack of dishes
- Grip ring is easy to hold and stays secure during handling
- Nonpyrogenic
- DNase-/RNase-free
- Sterile



Grip ring



Raised outer edge for secure stacking



Orientation marks help you easily locate cells

Easy-grip Cell Culture Dish **Ordering information**



Cat.No.	Description	Packaging
12111	35mm Cell culture dish, TC-treated, Easy-grip	10pcs/bag, 50bags/case
12211	60mm Cell culture dish, TC-treated, Easy-grip	10pcs/bag, 50bags/case
12311	100mm Cell culture dish, TC-treated, Easy-grip	10pcs/bag, 30bags/case
12411	150mm Cell culture dish, TC-treated, Easy-grip	5pcs/bag, 12bags/case
12121	35mm Cell culture dish, non-treated, Easy-grip	10pcs/bag, 50bags/case
12221	60mm Cell culture dish, non-treated, Easy-grip	10pcs/bag, 50bags/case
12321	100mm Cell culture dish, non-treated, Easy-grip	10pcs/bag, 30bags/case
12421	150mm Cell culture dish, non-treated, Easy-grip	5pcs/bag, 12bags/case

Recommended Medium Volumes

Cell Culture Dish	Approximate Growth Area (cm ²)	Average Cell Yield	Recommended Medium Volume(mL)
35mm	9	9.0 × 10 ⁵	1.8-2.7
60mm	21	2.1 × 10 ⁶	4.2-6.3
100mm	55	5.5 × 10 ⁶	11-16.5
150mm	152	1.52 × 10 ⁷	30.4-45.6

Ultra-low Attachment Dish

- Manufactured from polystyrene material
- Ultra-Low Attachment surface plates minimizes cell attachment, protein absorption, and cellular activation
- Cell culture dish lids are designed for optimal gas exchange
- Nonpyrogenic
- DNase-/RNase-free
- Sterile



Ordering information

Cat.No.	Description	Packaging
12231	60mm ultra-low attachment dish, sterile, Easy-grip	10pcs/bag, 4bags/case
12331	100mm ultra-low attachment dish, sterile, Easy-grip	10pcs/bag, 4bags/case

Poly-D-Lysine Surface Treatment

- Manufactured from high-quality polystyrene material
- Poly-D-Lysine surface treatment enhance cell adhesion and protein absorption by altering surface charges on the culture substrate
- Attachment and spreading of a variety of cell types
- Nonpyrogenic
- DNase-/RNase-free
- Sterile



Ordering information

Cat.No.	Description	Packaging
12140	35mm Cell culture dish, Poly-D-Lysine surface treatment	10pcs/bag, 50bags/case
12240	60mm Cell culture dish, Poly-D-Lysine surface treatment	10pcs/bag, 50bags/case
12340	100mm Cell culture dish, Poly-D-Lysine surface treatment	10pcs/bag, 30bags/case
12440	150mm Cell culture dish, Poly-D-Lysine surface treatment	5pcs/bag, 12bags/case

Labelect Cell Culture Flasks are designed widely used in the culture of animal and plant cells, bacteria, and viruses. Choose from culture areas 25 cm² , 75 cm², 175cm² or 225cm² to suit your specific applications and cell types. Secure stacking provides stability from accidental tips or spills. Canted neck flasks allow easier pouring and improved access to the flask for pipetting or scraping. Vent caps contain a 0.2 µm pore, hydrophobic membrane sealed to the cap, providing consistent, sterile gas exchange while minimizing the risk of contamination. TC-treated and non-treated cell culture flasks are available.

- Manufactured from optically clear polystyrene
- 25cm² , 75cm², 175cm² and 225cm² cell culture flask are available
- TC-treated for optimal cell attachment
- Non-treated surface suitable for suspension cell culture
- Canted neck flasks allow easier pouring and improved access to the flask for pipetting or scraping
- Nonpyrogenic
- DNase-/RNase-free
- Sterile



25cm²/75cm²
Cell Culture Flask

175cm²
Cell Culture Flask

225cm²
Cell Culture Flask



Volume graduations
Volume graduations molded on both sides



Canted neck
Canted neck design offers good pipet and cell scraper access



Vent caps
Vent caps contain a 0.2 µm pore, hydrophobic membrane sealed to the cap

Ordering information

Cat.No.	Description	Packaging
13112A	25cm ² Cell culture flask, TC-treated, vent cap	10pcs/bag, 20bags/case
13212A	75cm ² Cell culture flask, TC-treated, vent cap	5pcs/bag, 20bags/case
13313	175cm ² Cell culture flask, TC-treated, vent cap	5pcs/bag, 10bags/case
13412	225cm ² Cell culture flask, TC-treated, vent cap	5pcs/bag, 5bags/case
13111	25cm ² Cell culture flask, TC-treated, plug seal cap	10pcs/bag, 20bags/case
13211	75cm ² Cell culture flask, TC-treated, plug seal cap	5pcs/bag, 20bags/case
13311	175cm ² Cell culture flask, TC-treated, plug seal cap	5pcs/bag, 10bags/case
13411	225cm ² Cell culture flask, TC-treated, plug seal cap	5pcs/bag, 5bags/case
13122	25cm ² Cell culture flask, non-treated, vent cap	10pcs/bag, 20bags/case
13222	75cm ² Cell culture flask, non-treated, vent cap	5pcs/bag, 20bags/case
13322	175cm ² Cell culture flask, non-treated, vent cap	5pcs/bag, 10bags/case
13422	225cm ² Cell culture flask, non-treated, vent cap	5pcs/bag, 5bags/case

Recommended Medium Volumes

Cell Culture Flask	Approximate Growth Area (cm ²)	Average Cell Yield	Recommended Medium Volume(mL)
25 cm ²	25	2.5 × 10 ⁵	5-7.5
75 cm ²	75	7.5 × 10 ⁶	15-22.5
175 cm ²	175	1.75 × 10 ⁷	35-52.5
225 cm ²	225	2.25 × 10 ⁷	45-67.5

Ultra-low Attachment Flask

- Manufactured from optically clear polystyrene
- Ultra-low attachment surface is a covalently bound hydrogel layer that effectively inhibits cellular attachment
- The surface minimizes cell attachment, protein absorption, and enzyme activation
- Surface is non-cytotoxic, biologically inert, and nondegradable
- Nonpyrogenic
- DNase-/RNase-free
- Sterile



Ordering information

Cat.No.	Description	Packaging
13132	25cm ² Cell culture flask, ultra-low attachment, vent cap	10pcs/bag, 5bags/case
13232	75cm ² Cell culture flask, ultra-low attachment, vent cap	5pcs/bag, 5bags/case

Poly-D-Lysine Surface Treatment

- Manufactured from high-quality polystyrene material
- Poly-D-Lysine surface treatment enhance cell adhesion and protein absorption by altering surface charges on the culture substrate
- Attachment and spreading of a variety of cell types
- Nonpyrogenic
- DNase-/RNase-free
- Sterile



Ordering information

Cat.No.	Description	Packaging
13142	25cm ² Cell culture flask, Poly-D-Lysine surface treatment, vent cap	10pcs/bag, 20bags/case
13242	75cm ² Cell culture flask, Poly-D-Lysine surface treatment, vent cap	5pcs/bag, 20bags/case
13342	175cm ² Cell culture flask, Poly-D-Lysine surface treatment, vent cap	5pcs/bag, 10bags/case
13442	225cm ² Cell culture flask, Poly-D-Lysine surface treatment, vent cap	5pcs/bag, 5bags/case

Labselect Erlenmeyer Flasks are manufactured from high-quality polycarbonate material. Erlenmeyer flasks are conical flasks with wide plain & baffled bottoms and tapered necks. The flasks are designed for a variety of laboratory liquid handling applications, including pouring, mixing, storage, and suspension cell culture. Ideal for shaker culture applications and storage. These flasks are nonpyrogenic and sterile.

- Manufactured from polycarbonate material
- Uniform thickness
- With graduation
- Ideal for shaker culture applications
- Flat cap used for a closed liquid tight seal
- DNase-/RNase-free
- Nonpyrogenic
- Sterile



Plain Bottom Erlenmeyer Flask

Cat.No.	Description	Packaging
17111	125mL Polycarbonate erlenmeyer flask with vent cap	1pc/bag, 24bags/case
17211	250mL Polycarbonate erlenmeyer flask with vent cap	1pc/bag, 12bags/case
17311	500mL Polycarbonate erlenmeyer flask with vent cap	1pc/bag, 12bags/case
17411	1000mL Polycarbonate erlenmeyer flask with vent cap	1pc/bag, 24bags/case
17711	5000mL Polycarbonate erlenmeyer flask with vent cap	1pc/bag, 4bags/case
17121	125mL Polycarbonate erlenmeyer flask with flat cap	1pc/bag, 24bags/case
17221	250mL Polycarbonate erlenmeyer flask with flat cap	1pc/bag, 12bags/case
17321	500mL Polycarbonate erlenmeyer flask with flat cap	1pc/bag, 12bags/case
17421	1000mL Polycarbonate erlenmeyer flask with flat cap	1pc/bag, 24bags/case



Baffled Bottom Erlenmeyer Flask

Cat.No.	Description	Packaging
17112	125mL Baffled polycarbonate erlenmeyer flask with vent cap	1pc/bag, 24bags/case
17212	250mL Baffled polycarbonate erlenmeyer flask with vent cap	1pc/bag, 12bags/case
17312	500mL Baffled polycarbonate erlenmeyer flask with vent cap	1pc/bag, 12bags/case
17412	1000mL Baffled polycarbonate erlenmeyer flask with vent cap	1pc/bag, 24bags/case
17512	2000mL Baffled polycarbonate erlenmeyer flask with vent cap	1pc/bag, 6bags/case
17612	3000mL Baffled polycarbonate erlenmeyer flask with vent cap	1pc/bag, 4bags/case
17122	125mL Baffled polycarbonate erlenmeyer flask with flat cap	1pc/bag, 24bags/case
17222	250mL Baffled polycarbonate erlenmeyer flask with flat cap	1pc/bag, 12bags/case
17322	500mL Baffled polycarbonate erlenmeyer flask with flat cap	1pc/bag, 12bags/case
17422	1000mL Baffled polycarbonate erlenmeyer flask with flat cap	1pc/bag, 24bags/case



Plain bottom



Vent cap for continuous gas exchange

Baffled bottom

Cell Culture Plate

Labselect Cell Culture Plates are made of high-quality polystyrene materials, with strict process control, and ergonomic design. These plates are with flat bottom or U-bottom, lid with sealing ring, reducing evaporation and cross contamination. Individual alphanumeric codes for well identification. Safe and easy handling through pronounced corrugation of the plate and smaller lid. TC-treated and non-treated cell culture plates are available.

Clear Plate

- Manufactured from polystyrene material
- Lid with sealing ring, reducing evaporation and cross contamination
- TC-treated for optimal cell attachment
- Non-treated plates surface suitable for suspension cell culture
- Alphanumeric labeling
- Individually Packaged
- Nonpyrogenic
- DNase-/RNase-free
- Sterile



TC-treated

TC-treated for optimal cell attachment

Uniform well volume

Uniform well volume ensures an equal growth surface area

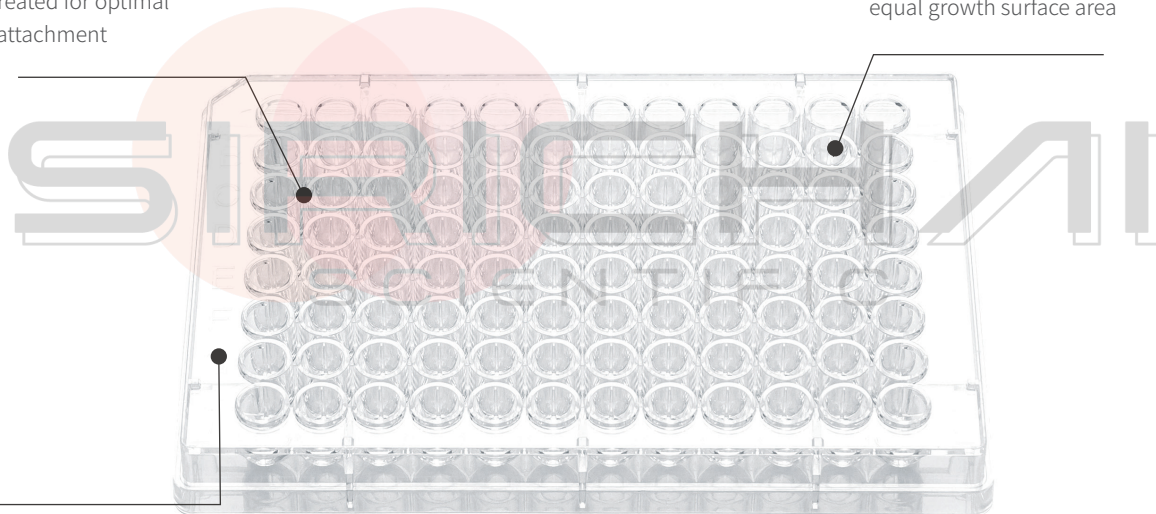

Wells are labeled

Wells are labeled with alphanumeric code for easy identification



skin packing



paper/plastic wrap

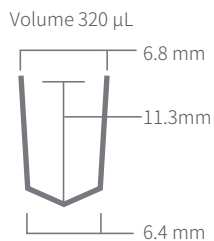

V-Bottom

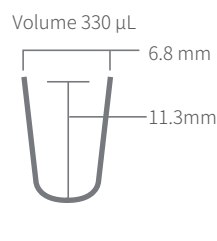

U-Bottom

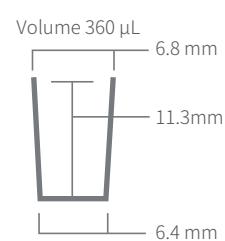

Flat Bottom

Ordering information

Cat.No.	Description	Packaging
11110	6-well cell culture plate, skin packing, TC-treated	1pc/bag, 50bags/case
11210	12-well cell culture plate, skin packing, TC-treated	1pc/bag, 50bags/case
11310	24-well cell culture plate, skin packing, TC-treated	1pc/bag, 50bags/case
11410	48-well cell culture plate, skin packing, TC-treated	1pc/bag, 50bags/case
11510	96-well cell culture plate, skin packing, TC-treated	1pc/bag, 50bags/case
11710	96-well cell culture plate, skin packing, TC-treated, low evaporation	1pc/bag, 50bags/case
11511	96-well cell culture plate, skin packing, TC-treated, U-shaped bottom	1pc/bag, 50bags/case
11538	96-well cell culture plate, skin packing, TC-treated, V-shaped bottom	1pc/bag, 50bags/case
11112	6-well cell culture plate, paper/plastic wrap, TC-treated	1pc/bag, 50bags/case
11212	12-well cell culture plate, paper/plastic wrap, TC-treated	1pc/bag, 50bags/case
11312	24-well cell culture plate, paper/plastic wrap, TC-treated	1pc/bag, 50bags/case
11412	48-well cell culture plate, paper/plastic wrap, TC-treated	1pc/bag, 50bags/case
11512	96-well cell culture plate, paper/plastic wrap, TC-treated	1pc/bag, 50bags/case
11513	96-well cell culture plate, paper/plastic wrap, U-shaped bottom, TC-treated	1pc/bag, 50bags/case
11120	6-well cell culture plate, skin packing, non-treated	1pc/bag, 50bags/case
11220	12-well cell culture plate, skin packing, non-treated	1pc/bag, 50bags/case
11320	24-well cell culture plate, skin packing, non-treated	1pc/bag, 50bags/case
11420	48-well cell culture plate, skin packing, non-treated	1pc/bag, 50bags/case
11520	96-well cell culture plate, skin packing, non-treated	1pc/bag, 50bags/case
11521	96-well cell culture plate, skin packing, non-treated, U-shaped bottom	1pc/bag, 50bags/case
11568	96-well cell culture plate, skin packing, non-treated, V-shaped bottom	1pc/bag, 50bags/case

Recommended Medium Volumes

Cell Culture Plates	Well Bottom Diameter (mm)	Single Well Only			
		Approx. Growth Area (cm ²)	Average Cell Yield	Total Well Volume(mL)	Working Volume(mL)
6-well	34.8	9.5	9.5 x 10 ⁵	16.8	1.9-2.9
12-well	22.1	3.8	3.8 x 10 ⁵	6.9	0.760-1.14
24-well	15.6	1.9	1.9 x 10 ⁵	3.4	0.380-0.570
48-well	11	0.95	9.5 x 10 ⁴	1.6	0.19-0.285
96-well flat bottom	6.4	0.32	3.2 x 10 ⁴	0.36	0.100 - 0.200
96-well U-bottom	6.4	NA	NA	0.33	0.100 - 0.200
96-well V-bottom	6.4	0.38	3.8 x 10 ⁴	0.29	0.100 - 0.200

NA: these wells are round, the surface area available for cell attachment is dependent on the medium volume used.

Cell Culture Plate

96-Well Cell Culture Plate, Detachable

- Manufactured from polystyrene material
- TC-treated for optimal cell attachment
- Flat bottom
- Uniform well volume ensures an equal growth surface area
- Alphanumeric labeling
- Individually Packaged
- Nonpyrogenic
- DNase-/RNase-free
- Sterile

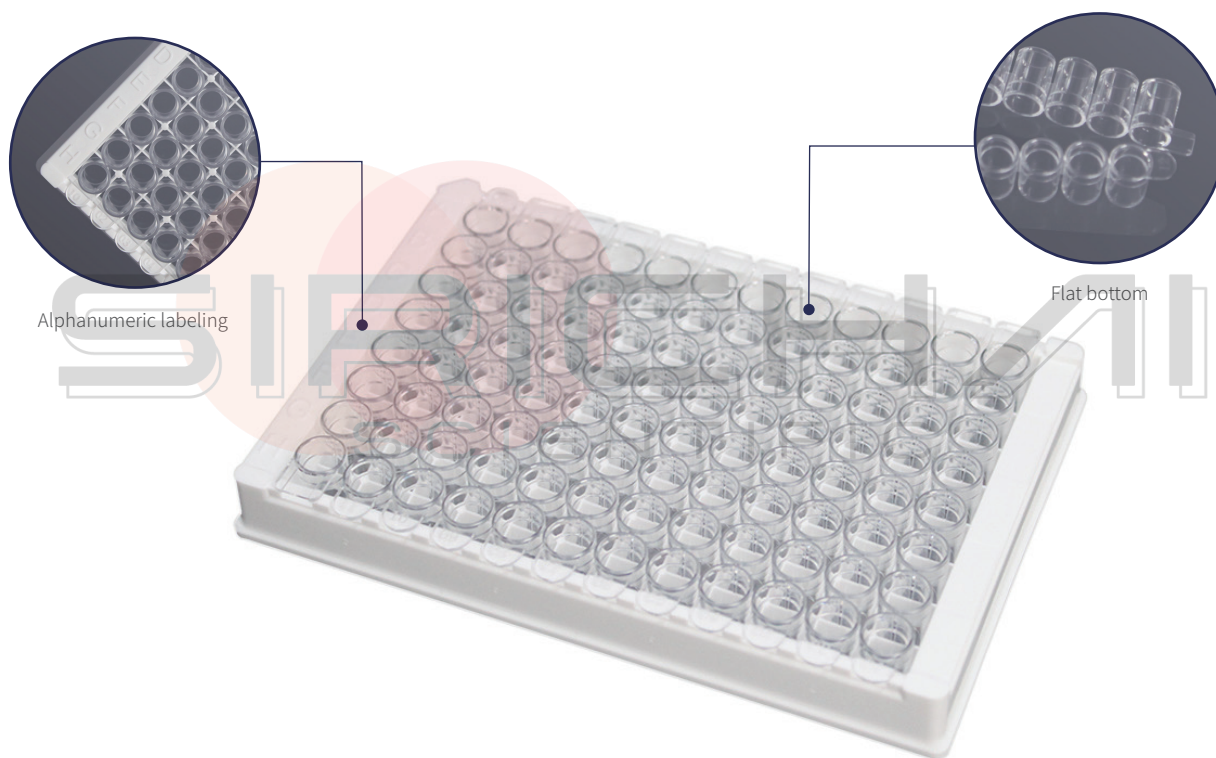
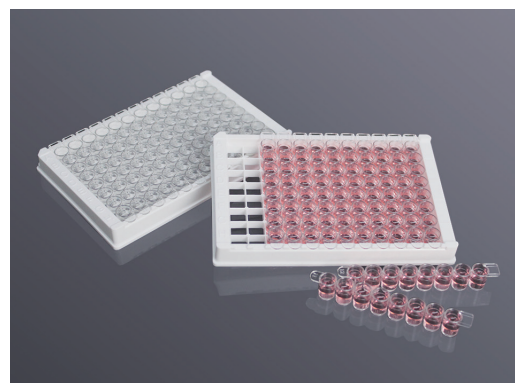

Ordering information

Cat.No.	Description	Packaging
11810	96-Well cell culture plate, detachable	1pc/bag, 50bags/case

Ultra-low Attachment Plate

- Manufactured from polystyrene material
- Ultra-Low Attachment surface plates minimizes cell attachment, protein absorption, and cellular activation
- Ultra-Low Attachment Plates feature a covalently bound hydrogel layer that effectively inhibits cellular attachment
- Individually wrapped
- DNase-/RNase-free
- Sterile

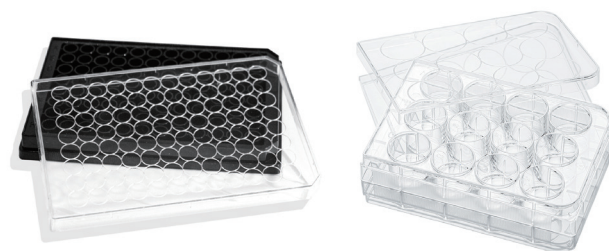

Ordering information

Cat.No.	Description	Packaging
11118	6-well clear flat bottom ultra-low attachment plate	1pc/bag, 20bags/case
11218	12-well clear flat bottom ultra-low attachment plate	1pc/bag, 20bags/case
11318	24-well clear flat bottom ultra-low attachment plate	1pc/bag, 20bags/case
11418	48-well clear flat bottom ultra-low attachment plate	1pc/bag, 20bags/case
11518	96-well clear flat bottom ultra-low attachment plate	1pc/bag, 24bags/case
11548	96-well clear U-bottom ultra-low attachment plate	1pc/bag, 24bags/case
11534	96-well clear flat bottom ultra-low attachment plate, black frame	1pc/bag, 24bags/case

Poly-D-Lysine Surface Treatment

- Manufactured from high-quality polystyrene material
- Poly-D-Lysine surface treatment enhance cell adhesion and protein absorption by altering surface charges on the culture substrate
- Attachment and spreading of a variety of cell types
- Flat bottom with lid
- Nonpyrogenic
- DNase-/RNase-free
- Sterile

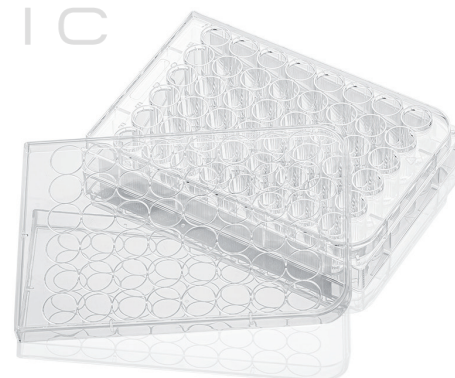

Ordering information

Cat.No.	Description	Packaging
11130	6-Well cell culture plate, Poly-D-Lysine surface treatment	1pc/bag, 50bags/case
11230	12-Well cell culture plate, Poly-D-Lysine surface treatment	1pc/bag, 50bags/case
11330	24-Well cell culture plate, Poly-D-Lysine surface treatment	1pc/bag, 50bags/case
11430	48-Well cell culture plate, Poly-D-Lysine surface treatment	1pc/bag, 50bags/case
11530	96-Well cell culture plate, Poly-D-Lysine surface treatment	1pc/bag, 50bags/case

Cell Culture Plate

96-Well Clear Bottom Black and White Plate

- Manufactured from polystyrene material
- TC-treated for optimal cell attachment
- Non-treated surface suitable for suspension cell culture
- Optically clear flat well bottom permits direct microscopic viewing
- Opaque walls prevent well-to-well cross-talk
- Can be used for both top and bottom reading instruments
- Flat bottoms with 360 μL total volume
- Recommended working volumes of 75 to 200 μL
- Individually package
- Nonpyrogenic
- DNase-/RNase-free
- Sterile

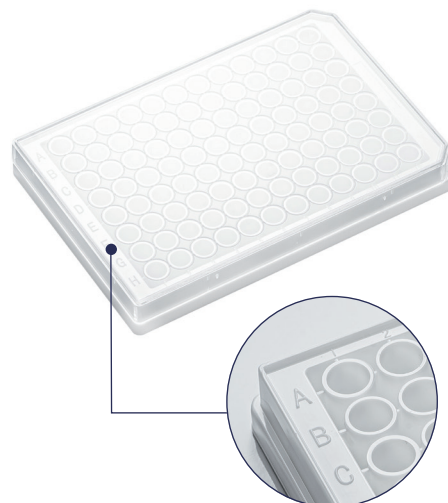

Clear flat well bottom permits direct microscopic viewing

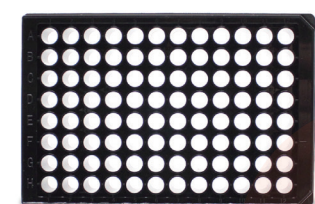

11514

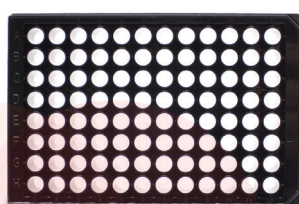

11544

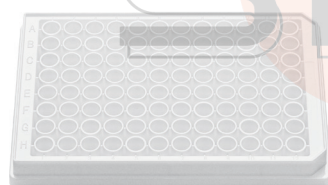

11515



11545

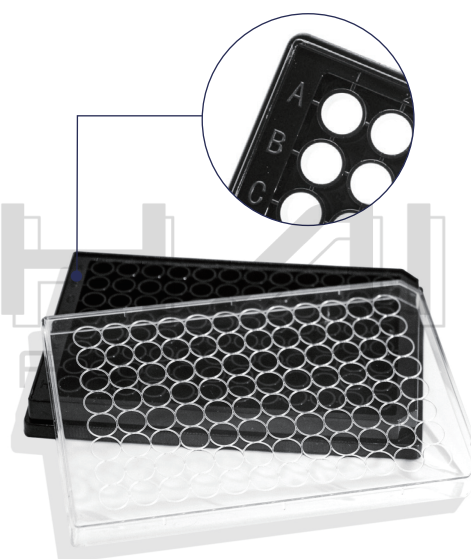

Ordering information

Cat.No.	Description	Packaging
11514	96-well cell culture plate, clear flat bottom, black plate, clear lid, TC-treated	1pc/bag, 48bags/case
11515	96-well cell culture plate, clear flat bottom, white plate, clear lid, TC-treated	1pc/bag, 48bags/case
11544	96-well cell culture plate, clear flat bottom, black plate, clear lid, non-treated	1pc/bag, 48bags/case
11545	96-well cell culture plate, clear flat bottom, white plate, clear lid, non-treated	1pc/bag, 48bags/case

96-Well Solid Black and White Plate

- Manufactured from polystyrene material
- TC-Treated for optimal cell attachment
- Non-treated surface suitable for suspension cell culture
- Black well plates have low background fluorescence
- White well plates enhance luminescent signals
- Flat bottoms with 360 μL total volume
- Recommended working volumes of 75 to 200 μL
- Individually package
- Nonpyrogenic
- DNase-/RNase-free
- Sterile

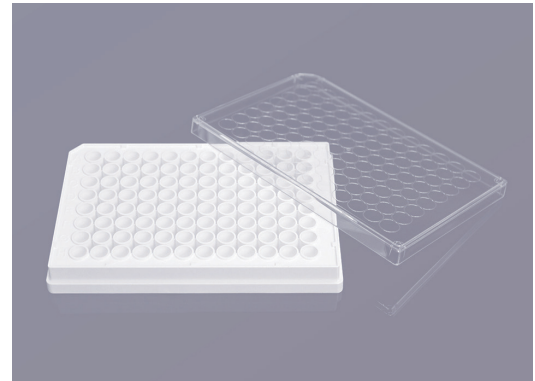

11517/11547



11516-BL

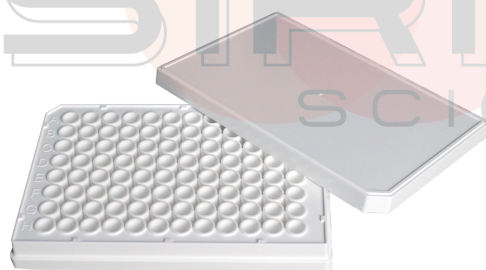

11517-WL

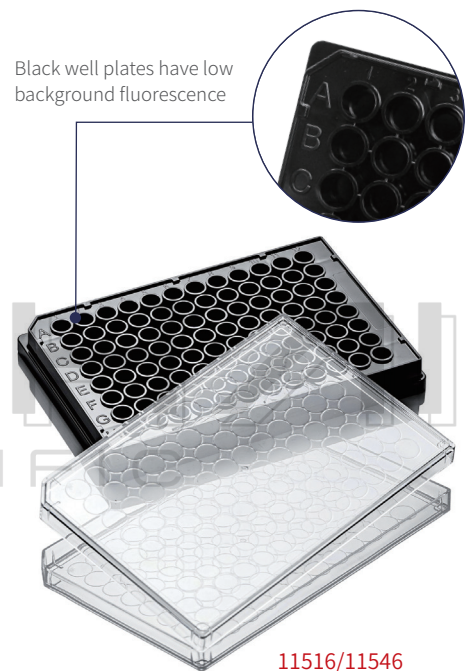

Black well plates have low background fluorescence

11516/11546

Ordering information

Cat.No.	Description	Packaging
11516	96-well cell culture plate, black bottom, black plate, clear lid, TC-treated	1pc/bag, 100bags/case
11517	96-well cell culture plate, white bottom, white plate, clear lid, TC-treated	1pc/bag, 100bags/case
11516-BL	96-well cell culture plate, solid black, TC-treated	1pc/bag, 100bags/case
11517-WL	96-well cell culture plate, solid white, TC-treated	1pc/bag, 100bags/case
11546	96-well cell culture plate, black bottom, black plate, clear lid, non-treated	1pc/bag, 100bags/case
11547	96-well cell culture plate, white bottom, white plate, clear lid, non-treated	1pc/bag, 100bags/case

Cell Culture Plate

384-Well Cell Culture Plate

- Manufactured from polystyrene material
- TC-Treated for optimal cell attachment
- Non-treated surface suitable for suspension cell culture
- Opaque wells to prevent well-to-well crosstalk
- Flat bottoms with 120 μ L total volume
- Recommended working volumes of 20 to 80 μ L
- Individually package
- Nonpyrogenic
- DNase-/RNase-free
- Sterile

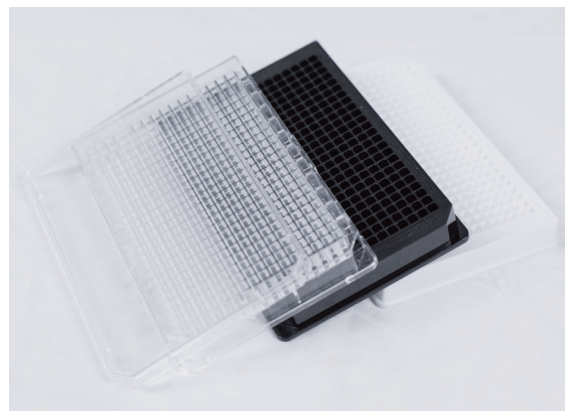

Ordering information

Cat.No.	Description	Packaging
11614	384-well cell culture plates, TC-treated, black plate, clear bottom, clear lid	1pc/bag, 100bags/case
11615	384-well cell culture plates, TC-treated, white plate, clear bottom, clear lid	1pc/bag, 100bags/case
11610	384-well cell culture plates, TC-treated, clear plate, clear bottom, clear lid	1pc/bag, 50pcs/case
11660	384-Well cell culture plates, non-treated, clear plate, clear bottom, clear lid	1pc/bag, 50bags/case
11616	384-well cell culture plates, TC-treated, solid black, clear lid	1pc/bag, 50pcs/case
11617	384-well cell culture plates, TC-treated, solid white, clear lid	1pc/bag, 50pcs/case

Labselect Cell Culture Inserts are convenient, ready-to-use permeable support devices pre-packaged in standard multiple well plates. Allowing the access of media from both their apical and basolateral sides. The unique, self-centered hanging design prevents medium wicking between the insert and outer well. Cell growth, structure, and function more closely mimic what occurs in vivo. TC-Treated for optimal cell attachment. Smooth-walled inserts, suitable for differentiation, transportation, co-cultivation, transmigration and cell polarity assays. Cell culture inserts are available in a wide variety of sizes and two membrane types.

Transparent PET inserts permit sufficient optical transparency for visualization of cell outlines by phase contrast microscopy and easy to observe. The PC membrane is not easy to be torn or curled, and it is easy to operate when taking out of the chamber.

- Pore sizes ranging from 0.1 µm to 12 µm diameters
- Produce a cell culture environment that closely resembles an in vivo state
- Available in a wide variety of sizes and two membrane types
- Cell culture treated PC or PET membranes for optimal cell attachment
- The well and insert are perfectly coordinated
- Cell culture insert carrier plates are equipped with alphanumeric
- Supplied in multiple well plates
- Nonpyrogenic
- DNase-/RNase-free
- Sterile

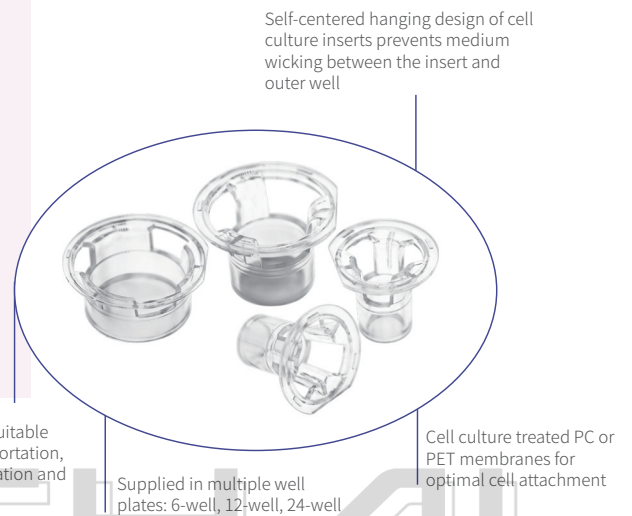

Application	Cell Type	Pore Size (µm)
Angiogenesis	Endothelial, hmvec, huvec	3.0
Co-culture	Stem, neuronal, and various others	0.4
Epithelial Cell Polarity	Epithelial cells	0.4
Migration	Endothelial, hmvec, huvec	3.0
	Neutrophils, PMNs	3.0
	Neuronal cells	3.0
	Dendritic cells	3.0, 5.0, 8.0
	Epithelial fibroblasts	8.0
Invasion	Smooth muscle	8.0
	Endothelial	3.0, 5.0, 8.0
	Osteoblasts	8.0
Tissue Engineering	Lymphoma, Jurkat	5.0, 8.0
	Human skin model	0.4, 3.0
Transport and Permeability Studies	Caco-2	0.4
	MDCK	0.4

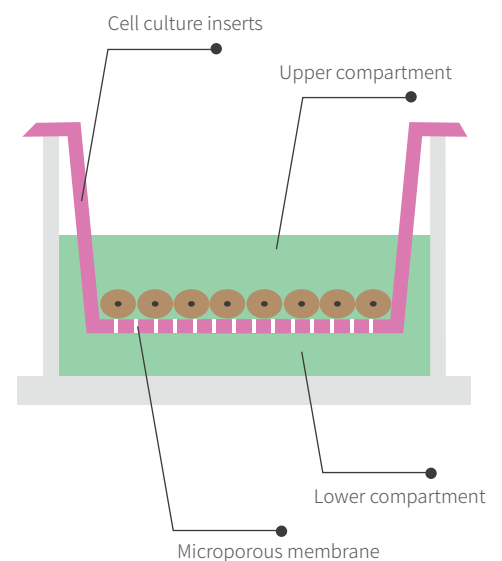

Ordering information

PC Membrane

Cat.No.	Description	Membrane Diameter (mm)	Membrane Pore Size (µm)	Packaging
14301	Inserts in 24-well plates	6.5	0.1	12 pcs/pk, 48 pcs/case
14311	Inserts in 24-well plates	6.5	0.4	12 pcs/pk, 48 pcs/case
14351	Inserts in 24-well plates	6.5	1.0	12 pcs/pk, 48 pcs/case
14321	Inserts in 24-well plates	6.5	3.0	12 pcs/pk, 48 pcs/case
14331	Inserts in 24-well plates	6.5	5.0	12 pcs/pk, 48 pcs/case
14341	Inserts in 24-well plates	6.5	8.0	12 pcs/pk, 48 pcs/case
14361	Inserts in 24-well plates	6.5	12.0	12 pcs/pk, 48 pcs/case
14201	Inserts in 12-well plates	12	0.1	12 pcs/pk, 48 pcs/case
14211	Inserts in 12-well plates	12	0.4	12 pcs/pk, 48 pcs/case
14251	Inserts in 12-well plates	12	1.0	12 pcs/pk, 48 pcs/case
14221	Inserts in 12-well plates	12	3.0	12 pcs/pk, 48 pcs/case
14241	Inserts in 12-well plates	12	8.0	12 pcs/pk, 48 pcs/case
14261	Inserts in 12-well plates	12	12.0	12 pcs/pk, 48 pcs/case
14101	Inserts in 6-well plates	24	0.1	6 pcs/pk, 24 pcs/case
14111	Inserts in 6-well plates	24	0.4	6 pcs/pk, 24 pcs/case
14151	Inserts in 6-well plates	24	1.0	6 pcs/pk, 24 pcs/case
14121	Inserts in 6-well plates	24	3.0	6 pcs/pk, 24 pcs/case
14141	Inserts in 6-well plates	24	8.0	6 pcs/pk, 24 pcs/case
14161	Inserts in 6-well plates	24	12.0	6 pcs/pk, 24 pcs/case

PET Membrane (Opaque)

Cat.No.	Description	Membrane Diameter (mm)	Membrane Pore Size (µm)	Packaging
14314	Inserts in 24-well plates	6.5	0.4	12 pcs/pk, 48 pcs/case
14324	Inserts in 24-well plates	6.5	3.0	12 pcs/pk, 48 pcs/case
14214	Inserts in 12-well plates	12	0.4	12 pcs/pk, 48 pcs/case
14224	Inserts in 12-well plates	12	3.0	12 pcs/pk, 48 pcs/case
14114	Inserts in 6-well plates	24	0.4	6 pcs/pk, 24 pcs/case
14124	Inserts in 6-well plates	24	3.0	6 pcs/pk, 24 pcs/case

PET Membrane (Translucent)

Cat.No.	Description	Membrane Diameter (mm)	Membrane Pore Size (µm)	Packaging
14302	Inserts in 24-well plates	6.5	0.1	12 pcs/pk, 48 pcs/case
14312	Inserts in 24-well plates	6.5	0.4	12 pcs/pk, 48 pcs/case
14352	Inserts in 24-well plates	6.5	1.0	12 pcs/pk, 48 pcs/case
14322	Inserts in 24-well plates	6.5	3.0	12 pcs/pk, 48 pcs/case
14332	Inserts in 24-well plates	6.5	5.0	12 pcs/pk, 48 pcs/case
14342	Inserts in 24-well plates	6.5	8.0	12 pcs/pk, 48 pcs/case
14202	Inserts in 12-well plates	12	0.1	12 pcs/pk, 48 pcs/case
14212	Inserts in 12-well plates	12	0.4	12 pcs/pk, 48 pcs/case
14252	Inserts in 12-well plates	12	1.0	12 pcs/pk, 48 pcs/case
14222	Inserts in 12-well plates	12	3.0	12 pcs/pk, 48 pcs/case
14242	Inserts in 12-well plates	12	8.0	12 pcs/pk, 48 pcs/case
14102	Inserts in 6-well plates	24	0.1	6 pcs/pk, 24 pcs/case
14112	Inserts in 6-well plates	24	0.4	6 pcs/pk, 24 pcs/case
14152	Inserts in 6-well plates	24	1.0	6 pcs/pk, 24 pcs/case
14122	Inserts in 6-well plates	24	3.0	6 pcs/pk, 24 pcs/case
14142	Inserts in 6-well plates	24	8.0	6 pcs/pk, 24 pcs/case

Cell Culture Insert, Individual Package

Cat.No.	Description	Membrane Diameter (mm)	Membrane Pore Size (µm)	Packaging
14331-D	Cell culture insert, PC membrane	6.5	5.0	1 pc/pk, 48 pcs/case
14342-D	Cell culture insert, PET membrane	6.5	8.0	1 pc/pk, 48 pcs/case
14231-D	Cell culture insert, PC membrane	12	5.0	1 pc/pk, 48 pcs/case
14242-D	Cell culture insert, PET membrane	12	8.0	1 pc/pk, 48 pcs/case
14131-D	Cell culture insert, PC membrane	24	5.0	1 pc/pk, 48 pcs/case
14142-D	Cell culture insert, PET membrane	24	8.0	1 pc/pk, 48 pcs/case



Individual package

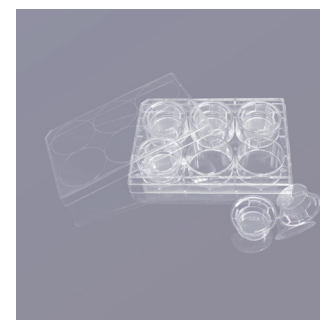
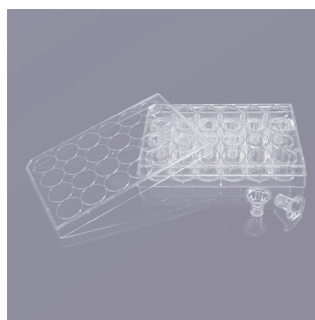

Inserts in plates

Bio-reaction Tubes

Bio-reaction Tubes

- Manufactured from high-quality polypropylene material
- Hydrophobic vent cap for continuous gas exchange
- RCF Rating (xg): 12,000
- DNase-/RNase-free
- Nonpyrogenic
- Noncytotoxic
- Sterile

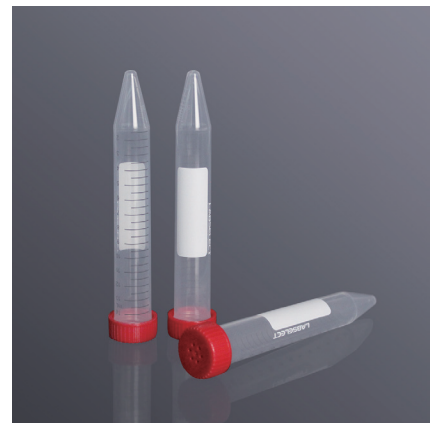

Manufactured from high-quality polypropylene material



Hydrophobic vent cap ensures continuous gas exchange

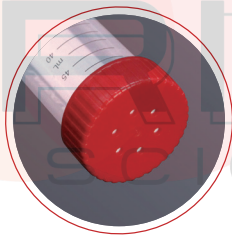

Large writing area on tube for easy sample identification

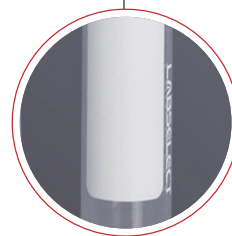

Ordering information

Cat.No.	Description	Packaging
15111	15mL Bio-reaction tube	25pcs/bag, 20bags/case
15211	50mL Bio-reaction tube	25pcs/bag, 8bags/case

Labselect Cell Scrapers features a wide beveled edge for use in cell culture dishes or flasks, specifically designed to make collecting of cells easier and more effective. Cell scrapers feature an angled swivel blade for easy access to growth surfaces of flasks and dishes.

Designed to gently remove cells, scrapers maximize sample recovery. Cell scraper models feature a flexible swivel blade design for multiple angle options and greatest accessibility to all growth areas.

- Useful for the harvesting of cells
- Blade design minimizes cell damage and ensures even contact with the growth surface
- Designed for used with cell cuture flasks, as well as cell cuture dishes
- Individually wrapped
- DNase-/RNase-free
- Nonpyrogenic
- Sterile

Long-handled devices with angled, beveled heads designed to harvest cells from a variety of tissue and cell culture vessels.

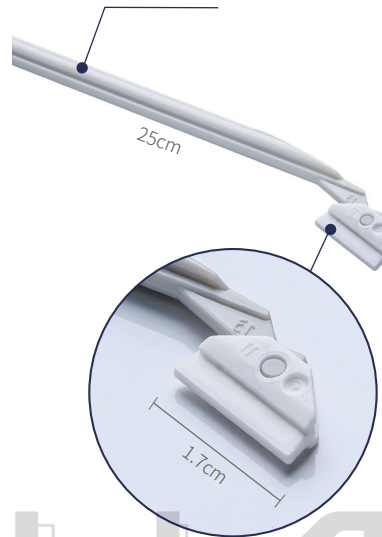

Labselect cell scrapers provide superior scraping ability with dishes, plates, and flasks. Easily harvest cells from tissue culture flasks.

Angled swivel blade minimizes cell damage and ensures even contact with growth area

Labselect Cell Lifters are an ideal tool for harvesting stem cells and colonies while maintaining high viability. Flat blade cell lifters are manufactured with high-quality polyethylene, blade design minimizes cell damage and ensures even contact with the growth surface. Individual packing eliminates possible chances of contamination during cell culture.

- Manufactured from high-quality PE
- One-piece design for better control
- Individually wrapped
- Nonpyrogenic
- DNase-/RNase-free
- Sterile
- Disposable

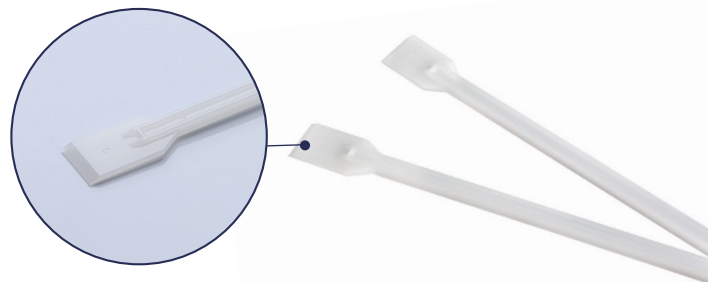

Ordering information

Cat.No.	Description	Packaging
1601	1.7cm Cell scraper, individually wrapped	1pc/bag, 100pcs/case
1602	3.0cm Cell scraper, individually wrapped	1pc/bag, 100pcs/case
1900	1.8cm Cell lifter, individually wrapped	1pc/bag, 100pcs/case



Glass Coverslip

Labselect Glass Coverslips are free of bubbles and scratches, with poly-D-lysine coating, mainly used for cell culture and confocal fluorescence microscopy. These cover glasses offer maximum clarity, and uniform thickness and size.

- Manufactured from borosilicate glass material
- Poly-D-Lysine surface treatment enhanced cell adhesion and growth of a variety of cells
- A variety of specifications are available, suitable for different cell culture plates
- Good chemical stability and tolerance to common solutions used in laboratory
- Nonpyrogenic
- DNase-/RNase-free
- Sterile

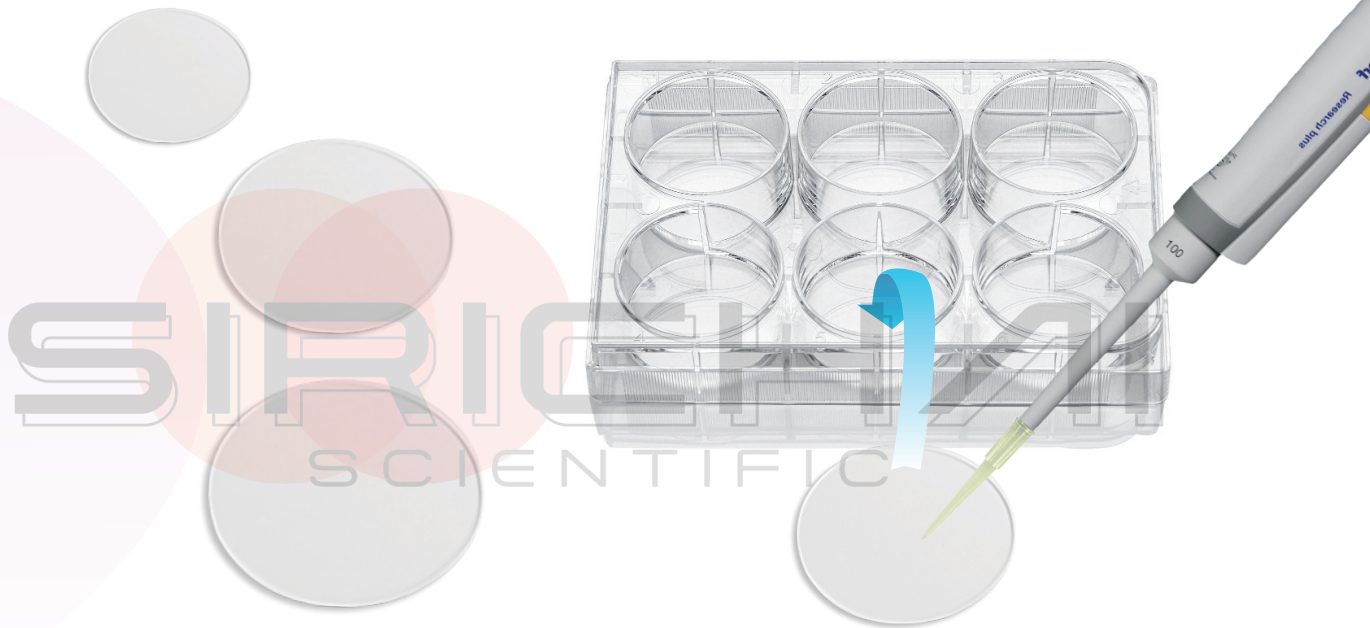

Poly-D-Lysine surface treatment enhanced cell adhesion

Ordering information

Cat.No.	Description	Diameter (mm)	Packaging
18122	Glass coverslip, Poly-D-Lysine surface treatment, for 24-well plate	14	100pcs/box
18125	Glass coverslip, Poly-D-Lysine surface treatment, for 12-well plate	20	100pcs/box
18127	Glass coverslip, Poly-D-Lysine surface treatment, for 6-well plate	25	100pcs/box

Confocal Dish

- Manufactured from high-quality polystyrene material
- Available with 2 different glass bottom sizes of 15mm or 20mm
- Glass thickness is 0.16-0.19mm
- Poly-D-Lysine surface treatment enhance cell adhesion and protein absorption by altering surface charges on the culture substrate
- Can be used for live cells observation
- Borosilicate glass construction, with high homogeneity, low bubble, and low inclusion content
- Nonpyrogenic
- Noncytotoxic
- Sterile

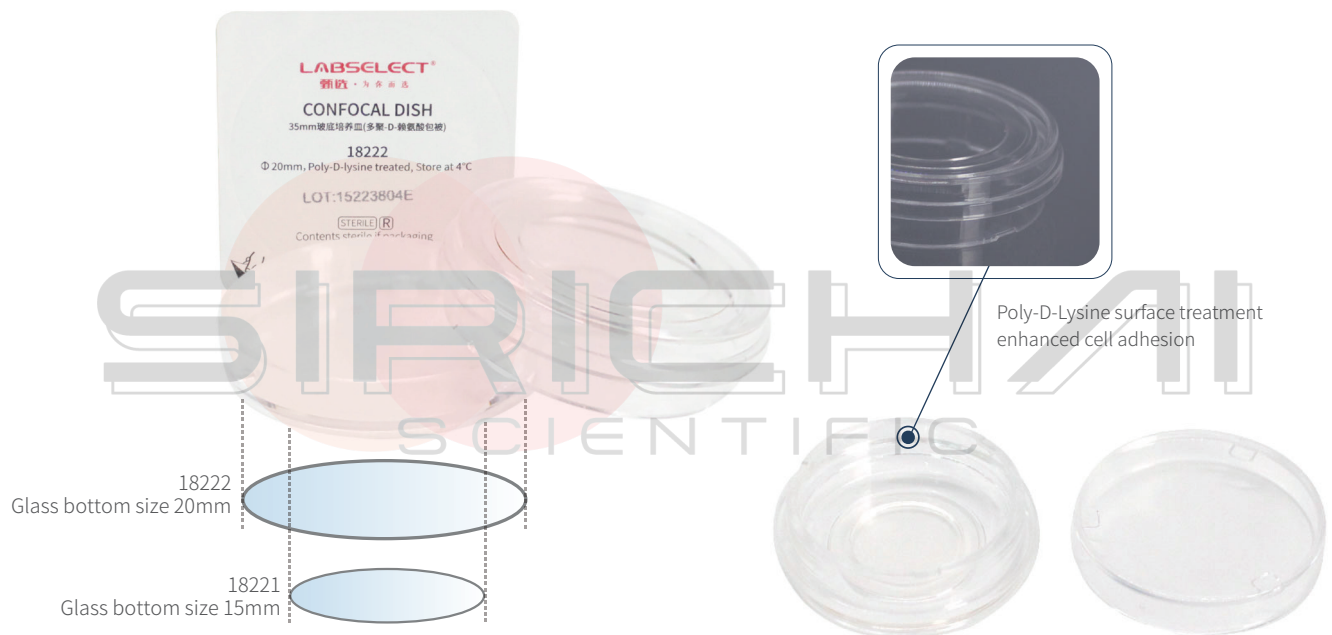

Ordering information

Cat.No.	Description	Packaging
18221	Confocal dish, Poly-D-Lysine surface treatment, diameter 35mm, hole size 15mm	1pc/bag, 20bags/case
18222	Confocal dish, Poly-D-Lysine surface treatment, diameter 35mm, hole size 20mm	1pc/bag, 20bags/case

Chamber Slide

Labselect Chamber Slides are designed for various cell-based experiments, excellent optical quality suitable for fluorescence microscopy. Cell Culture Slides provide removable chamber that enables cell growth directly on the microscopic slide, convenient for staining and microscopic examination without cell transfer. Chambers with various well numbers are available for different applications.

Ideal for live cell imaging applications like cell cultivation and microscopy, transfection, protein localization and high-content microscopy. The chamber slide is provided sterile and ready to use.

- Material: cover and chamber - polystyrene, slide - glass, slide holder - polypropylene
- Alphanumeric labeling
- No autofluorescence
- Tissue culture treated
- Nonpyrogenic
- DNase-/RNase-free
- Sterile
- Disposable



Cat.No.	CS-01-TC	CS-02-TC	CS-04-TC	CS-08-TC
Number of chambers	1	2	4	8
Culture area (cm ²)	9.4	4.55	2.13	0.98
Recommended working volume (mL)	2.5-5.5	1.2-2.5	0.5-1.3	0.2-0.6

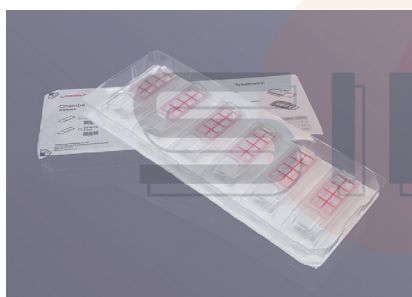

Disassembly sketch map

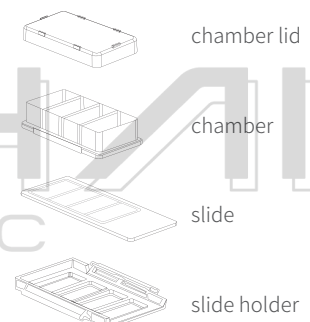
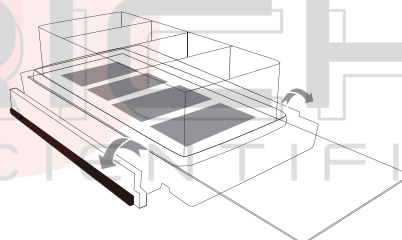

Ordering information

Cat.No.	Description	Packaging
CS-01-TC	1-Well chamber slide, TC-treated	6pcs/plate, 2plates/box, 4boxes/case
CS-02-TC	2-Well chamber slide, TC-treated	6pcs/plate, 2plates/box, 4boxes/case
CS-04-TC	4-Well chamber slide, TC-treated	6pcs/plate, 2plates/box, 4boxes/case
CS-08-TC	8-Well chamber slide, TC-treated	6pcs/plate, 2plates/box, 4boxes/case
CS-01S-TC	1-Well chamber slide, TC-treated	2pcs/plate, 24plates/case
CS-02S-TC	2-Well chamber slide, TC-treated	2pcs/plate, 24plates/case
CS-04S-TC	4-Well chamber slide, TC-treated	2pcs/plate, 24plates/case
CS-08S-TC	8-Well chamber slide, TC-treated	2pcs/plate, 24plates/case
CS-CM-TC	chamber slide, TC-treated	6pcs/plate, 2plates/box, 4boxes/case

CS-CM-TC: include one 1-well chamber slide, one 2-well chamber slide, two 4-well chamber slides, two 8-well chamber slide.

Labselect Cryogenic Vials are manufactured from high-quality polypropylene for storing cells, tissues, microbiological samples, nucleic acid and protein samples in extreme temperatures ranging from -196 to +121°C. Do not use cryogenic vials for storage in the liquid phase of liquid nitrogen. Only store vials in the vapor phase above the liquified gas. Cryopreservation is an essential process for halting almost all chemical reactions during long-term storage and for preventing sample degradation. Cryogenic vial closures and tubes are made of polypropylene with the same coefficient of expansion, which further enhances the leakproof qualities of these vials at various temperatures.



► Can be customized, various cap colors can be chosen

Features

- High-purity polypropylene with excellent chemical resistance
- Tight-sealing and easy opening
- Safe long-term storage down to -196 °C
- Nonpyrogenic
- DNase-/RNase-free
- Sterile

Applications

- Sample storage
- Aliquoting and sample preparation
- Extracting nucleic acids and proteins
- Screening tests

Perfect seal



► Polypropylene cryogenic vial cap inserts are available

Good stability due to thick-walled design

Foot rim with notches for locking into a cryo rack



Resealable, stand-up packaging is clean and convenient

Cryogenic Vial



Comparison of thread types



Advantages of internal thread

- Space-saving compared to cryogenic tubes with external thread
- Uniform exterior diameter improves fit with centrifuge rotors

- White graduations and large marking area for easier filling and sample identification
- Self-standing design for easy operation
- Special base design for locking into cryogenic rack with single-handed manipulation
- Vials have a silicone washer for a secure seal
- Nonpyrogenic
- DNase-/RNase-free
- Sterile



Advantages of external thread

- Simplifies single-handed operation in comparison to cryogenic tubes with internal thread
- Reduces the danger of contamination

Ordering information

Cat.No.	Capacity	Cap Type	Packaging
CV-002-120-EX	1.2mL	External thread	50pcs/bag, 10bags/case
CV-002-120-IN	1.2mL	Internal thread	50pcs/bag, 10bags/case
CV-002-200-EX	2.0mL	External thread	50pcs/bag, 10bags/case
CV-002-200-IN	2.0mL	Internal thread	50pcs/bag, 10bags/case
CV-002-500-EX	5.0mL	External thread	50pcs/bag, 10bags/case
CV-002-500-IN	5.0mL	Internal thread	50pcs/bag, 10bags/case



Cryogenic Vial Safety Tip

Appropriate safety equipment (gloves, face shields, biological safety cabinets, hoods, etc.) should always be used to protect personnel when removing vials or ampules from cryogenic.

Warning

Do not use cryogenic vials for storage in the liquid phase of liquid nitrogen. Only store vials in the vapor phase above the liquified gas. Always use appropriate safety equipment when removing vials from cryogenic storage systems.



2D Cryogenic Vial

- Medical grade PP material
- Available in 0.5mL, 1.5mL, 2mL and 5mL for options
- Suitable for 10*10 cryovial boxes to increase storage capacity
- Cap Color for options: Red, Yellow, Blue, Green, White, Purple, Orange
- E-Beam Sterile, RNase & DNase Free, Endotoxin Free, Exogenous DNA Free
- Bottom QR code, Side barcode and digital code (3-in-1), all tubes coded message is unique
- Temperature range: stable from -196°C to 121°C



Ordering information

Cat.No.	Description	Packaging
22151	0.5mL 2D Cryogenic vials,white cap,external thread,3 code	50pcs/bag,20bags/case
22152	0.5mL 2D Cryogenic vials,red cap,external thread,3 code	50pcs/bag,20bags/case
22153	0.5mL 2D Cryogenic vials,green cap,external thread,3 code	50pcs/bag,20bags/case
22154	0.5mL 2D Cryogenic vials,blue cap,external thread,3 code	50pcs/bag,20bags/case
22155	0.5mL 2D Cryogenic vials,yellow cap,external thread,3 code	50pcs/bag,20bags/case
22156	0.5mL 2D Cryogenic vials,purple cap,external thread,3 code	50pcs/bag,20bags/case
22157	0.5mL 2D Cryogenic vials,orange cap,external thread,3 code	50pcs/bag,20bags/case
22251	1.5mL 2D Cryogenic vials,white cap,external thread,3 code	50pcs/bag,20bags/case
22252	1.5mL 2D Cryogenic vials,red cap,external thread,3 code	50pcs/bag,20bags/case
22253	1.5mL 2D Cryogenic vials,green cap,external thread,3 code	50pcs/bag,20bags/case
22254	1.5mL 2D Cryogenic vials,blue cap,external thread,3 code	50pcs/bag,20bags/case
22255	1.5mL 2D Cryogenic vials,yellow cap,external thread,3 code	50pcs/bag,20bags/case
22256	1.5mL 2D Cryogenic vials,purple cap,external thread,3 code	50pcs/bag,20bags/case
22257	1.5mL 2D Cryogenic vials,orange cap,external thread,3 code	50pcs/bag,20bags/case
22351	2.0mL 2D Cryogenic vials,white cap,external thread,3 code	50pcs/bag,20bags/case
22352	2.0mL 2D Cryogenic vials,red cap,external thread,3 code	50pcs/bag,20bags/case
22353	2.0mL 2D Cryogenic vials,green cap,external thread,3 code	50pcs/bag,20bags/case
22354	2.0mL 2D Cryogenic vials,blue cap,external thread,3 code	50pcs/bag,20bags/case
22355	2.0mL 2D Cryogenic vials,yellow cap,external thread,3 code	50pcs/bag,20bags/case
22356	2.0mL 2D Cryogenic vials,purple cap,external thread,3 code	50pcs/bag,20bags/case
22357	2.0mL 2D Cryogenic vials,orange cap,external thread,3 code	50pcs/bag,20bags/case
22341	2.0mL 2D Cryogenic vials,white cap,internal thread,3 code	50pcs/bag,20bags/case
22342	2.0mL 2D Cryogenic vials,red cap,internal thread,3 code	50pcs/bag,20bags/case

Cryogenic Vial

Cat.No.	Description	Packaging
22343	2.0mL 2D Cryogenic vials,green cap,internal thread,3 code	50pcs/bag,20bags/case
22344	2.0mL 2D Cryogenic vials,blue cap,internal thread,3 code	50pcs/bag,20bags/case
22345	2.0mL 2D Cryogenic vials,yellow cap,internal thread,3 code	50pcs/bag,20bags/case
22346	2.0mL 2D Cryogenic vials,purple cap,internal thread,3 code	50pcs/bag,20bags/case
22347	2.0mL 2D Cryogenic vials,orange cap,internal thread,3 code	50pcs/bag,20bags/case
23151	0.5mL 2D Cryogenic vials,white cap,external thread,4 code	100pcs/box,5boxes/unit,10units/case
23152	0.5mL 2D Cryogenic vials,red cap,external thread,4 code	100pcs/box,5boxes/unit,10units/case
23153	0.5mL 2D Cryogenic vials,green cap,external thread,4 code	100pcs/box,5boxes/unit,10units/case
23154	0.5mL 2D Cryogenic vials,blue cap,external thread,4 code	100pcs/box,5boxes/unit,10units/case
23155	0.5mL 2D Cryogenic vials,yellow cap,external thread,4 code	100pcs/box,5boxes/unit,10units/case
23156	0.5mL 2D Cryogenic vials,purple cap,external thread,4 code	100pcs/box,5boxes/unit,10units/case
23157	0.5mL 2D Cryogenic vials,orange cap,external thread,4 code	100pcs/box,5boxes/unit,10units/case
23251	1.5mL 2D Cryogenic vials,white cap,external thread,4 code	100pcs/box,5boxes/unit,10units/case
23252	1.5mL 2D Cryogenic vials,red cap,external thread,4 code	100pcs/box,5boxes/unit,10units/case
23253	1.5mL 2D Cryogenic vials,green cap,external thread,4 code	100pcs/box,5boxes/unit,10units/case
23254	1.5mL 2D Cryogenic vials,blue cap,external thread,4 code	100pcs/box,5boxes/unit,10units/case
23255	1.5mL 2D Cryogenic vials,yellow cap,external thread,4 code	100pcs/box,5boxes/unit,10units/case
23256	1.5mL 2D Cryogenic vials,purple cap,external thread,4 code	100pcs/box,5boxes/unit,10units/case
23257	1.5mL 2D Cryogenic vials,orange cap,external thread,4 code	100pcs/box,5boxes/unit,10units/case
23341	2.0mL 2D Cryogenic vials,white cap,internal thread,4 code	100pcs/box,5boxes/unit,10units/case
23342	2.0mL 2D Cryogenic vials,red cap,internal thread,4 code	100pcs/box,5boxes/unit,10units/case
23343	2.0mL 2D Cryogenic vials,green cap,internal thread,4 code	100pcs/box,5boxes/unit,10units/case
23344	2.0mL 2D Cryogenic vials,blue cap,internal thread,4 code	100pcs/box,5boxes/unit,10units/case
23345	2.0mL 2D Cryogenic vials,yellow cap,internal thread,4 code	100pcs/box,5boxes/unit,10units/case
23346	2.0mL 2D Cryogenic vials,purple cap,internal thread,4 code	100pcs/box,5boxes/unit,10units/case
23347	2.0mL 2D Cryogenic vials,orange cap,internal thread,4 code	100pcs/box,5boxes/unit,10units/case
23351	2.0mL 2D Cryogenic vials,white cap,external thread,4 code	100pcs/box,5boxes/unit,10units/case
23352	2.0mL 2D Cryogenic vials,red cap,external thread,4 code	100pcs/box,5boxes/unit,10units/case
23353	2.0mL 2D Cryogenic vials,green cap,external thread,4 code	100pcs/box,5boxes/unit,10units/case
23354	2.0mL 2D Cryogenic vials,blue cap,external thread,4 code	100pcs/box,5boxes/unit,10units/case
23355	2.0mL 2D Cryogenic vials,yellow cap,external thread,4 code	100pcs/box,5boxes/unit,10units/case
23356	2.0mL 2D Cryogenic vials,purple cap,external thread,4 code	100pcs/box,5boxes/unit,10units/case
23357	2.0mL 2D Cryogenic vials,orange cap,external thread,4 code	100pcs/box,5boxes/unit,10units/case

Tubes



Micro-centrifuge Tube

Low Retention Centrifuge Tube

Centrifuge Tube 15 mL | 50 mL

Large Volume Centrifuge Tube

Screw Cap Tube

Micro-centrifuge Tube

Labselect Micro-centrifuge Tubes are ideal for sample preparation, centrifugation and storage. Versatile tubes manufactured from transparent polypropylene material, autoclavable and with graduations. Tight-fitting lid provides a leak proof seal and offer exceptional strength and chemical resistance. Flat top for easy sample identification.

- Ideal for sample preparation, centrifugation and storage
- Versatile tubes manufactured from transparent polypropylene material
- With graduations
- Frosted writing spot for easy sample identification
- Tight-fitting lid provides a leak proof seal
- Offer exceptional strength and chemical resistance
- RNase-/DNase-free
- Nonpyrogenic
- Autoclavable
- Disposables



Friendly hinge for finger, rounded cap-edge reduces irritation to the finger, and makes it easier to close the cap



Virgin polypropylene delivers crystal clarity and improves visibility

Ordering information

Cat.No.	Description	RCF Rating (xg)	Packaging
a MCT-001-060	0.6mL Micro-centrifuge tube	12,000	1000pcs/box, 10boxes/case
b MCT-001-060-SC	0.6mL Centrifuge tube, non-sterile, locking Lid	12,000	1000pcs/box, 10boxes/case
c MCT-001-060-S	0.6mL Micro-Centrifuge tube, sterile	12,000	500pcs/box, 10boxes/case
d MCT-001-150	1.5mL Micro-centrifuge tube	12,000	500pcs/box, 10boxes/case
e MCT-001-150-SC	1.5mL Centrifuge tube, non-sterile, locking lid	12,000	500pcs/box, 10boxes/case
f MCT-001-150-S	1.5mL Micro-centrifuge tube, sterile	12,000	5x50pcs/box, 10boxes/case
g MCT-001-150X	1.5mL Micro-centrifuge tube, amber	12,000	500pcs/box, 10boxes/case
h MCT-001-150X-S	1.5mL Micro-centrifuge tube, amber, sterile	12,000	5x50pcs/box, 10boxes/case
i MCT-001-175	1.7mL Micro-centrifuge tube	12,000	500pcs/box, 10boxes/case
j MCT-001-200	2.0mL Micro-centrifuge tube	12,000	500pcs/box, 10boxes/case
k MCT-001-200-SC	2.0mL Centrifuge tube, non-sterile, locking Lid	12,000	500pcs/box, 10boxes/case
l MCT-001-200-S	2.0mL Micro-centrifuge tube, sterile	12,000	5x50bags/box, 10boxes/case
m MCT-001-500	5.0mL Centrifuge tube, non-sterile, locking Lid	12,000	100pcs/bag, 10bags/case



High-contrast graduations facilitate more accurate volume estimation



Large writing area on tube for easy sample identification

Low Retention Centrifuge Tube

Labselect Low Retention Centrifuge Tubes are manufactured from high-quality polypropylene material. Snap-cap lid provides a secure seal even over extended periods. You can use these tubes in procedures that require smaller sample volumes.

These tubes interior surfaces are ultra-smooth with low retention characteristics. Tubes are with snap flat caps and writing surface and packed in resealable bags. Critical applications where minute sample recovery is important.

- Manufactured from high-quality polypropylene material
- With flat snap caps, side graduations, and frosted writing surface
- Ultra low fluid retention, designed for use in critical applications
- Easy to open, easy to close
- Max RCF : 12000xg
- Autoclavable
- Capacity: 0.6mL,1.5mL, 2.0mL
- DNase/RNase free

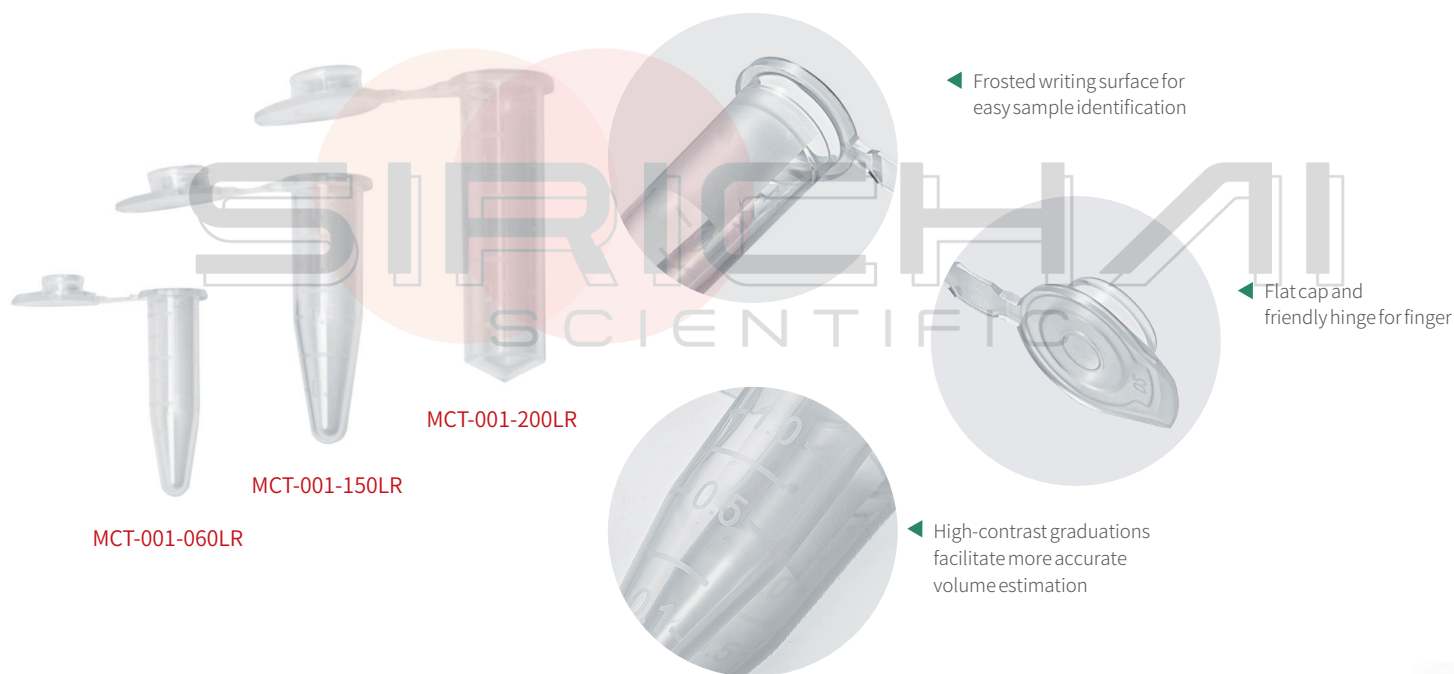

Ordering information

Cat.No.	Description	Packaging
MCT-001-060LR	0.6mL Low retention centrifuge tubes	1000pcs/bag, 10bags/case
MCT-001-150LR	1.5mL Low retention centrifuge tubes	500pcs/bag, 10bags/case
MCT-001-200LR	2.0mL Low retention centrifuge tubes	500pcs/bag, 10bags/case



Centrifuge Tube 15 mL | 50 mL

Labselect Centrifuge Tubes 15mL | 50mL are made of high-quality polypropylene (PP) and are designed for your everyday centrifugation and storage needs. These tubes include large white marking area and black easy-to-read graduations. Smooth inner walls for easy filling and sample preparation. These leak-proof conical-bottom centrifuge tubes prevent breakage and leakage during high-speed centrifugation. They are available with a flat cap that is easy to label for horizontal applications. Centrifuge tubes feature labeling areas that help reduce smearing of lab markers and also help protect sample labeling from damage during procedures.

Pure, additive-free flat caps for easy labeling

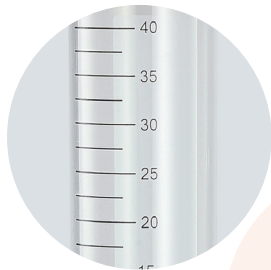

Large writing area on tube for easy sample identification

Prevents breakage & leakage during high-speed centrifugation

Thick, durable, high-quality polypropylene withstands breakage

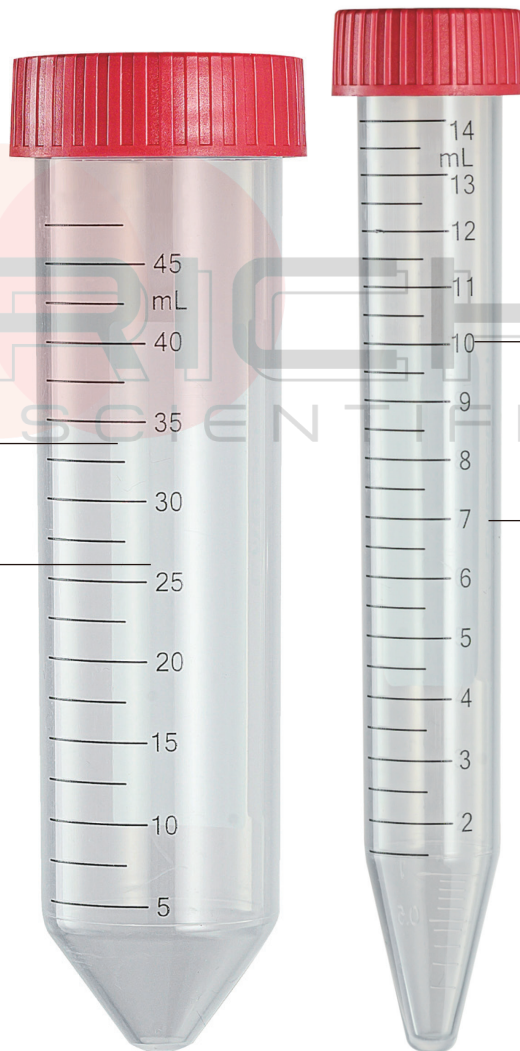

Precise graduation marks for quick and simple volume check

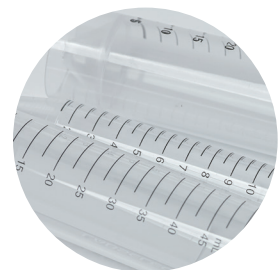

Nonpyrogenic, Noncytotoxic
DNase-/RNase-free
Sterile

Centrifuge Tube 15 mL | 50 mL



- High-clarity polypropylene (PP) material
- Tight sealing screw cap
- Clear graduations and smooth inner walls for easy filling and sample preparation
- Graduations every 0.5mL (15 mL tube) or 2.5 mL (50 mL tube) increments
- Large writing area on tube for easy sample identification
- Nonpyrogenic, Noncytotoxic
- DNase-/RNase-free
- Sterile



Bulk Packed

Supplied in sterile form
Bags have validated secure seal for purity
Great value and economical choice



Racked Packed

Supplied in sterile form
Stable standing racked form

Ordering information

Cat.No.	Description	RCF Rating (xg)	Packaging
CT-002-15A	15mL Centrifuge tubes, bulk packed	12,000	25pcs/bag, 20bags/case
CT-012-15A	15mL Centrifuge tubes, racked packed	12,000	50pcs/rack, 10racks/case
CT-002-50-SS	50mL Centrifuge tube, conical bottom, self-standing, screw-cap	4,500	25pcs/bag, 20bags/case
CT-002-50A	50mL Centrifuge tubes, bulk packed	12,000	25pcs/bag, 20bags/case
CT-012-50A	50mL Centrifuge tubes, racked packed	12,000	25pcs/rack, 20racks/case
CT-022-15A	15mL Centrifuge tubes, individually packaged	12,000	50pcs/bag, 10bags/case
CT-022-50A	50mL Centrifuge tubes, individually packaged	12,000	25pcs/bag, 20bags/case
CT-102-15A	15mL Centrifuge tubes, bulk packed, with molded-in graduations	12,000	50pcs/bag, 10bags/case
CT-102-50A	50mL Centrifuge tubes, bulk packed, with molded-in graduations	12,000	25pcs/bag, 20bags/case
CT-103-15A	15mL Centrifuge tubes, bulk packed, amber	12,000	50pcs/bag, 10bags/case
CT-103-50A	50mL Centrifuge tubes, bulk packed, amber	12,000	25pcs/bag, 20bags/case
CT-202-15	15mL Centrifuge tubes, bulk packed, high RCF	20,000	25pcs/bag, 20bags/case
CT-202-50	50mL Centrifuge tubes, bulk packed, high RCF	20,000	25pcs/bag, 20bags/case

Large Volume Centrifuge Tube

Labselect Large Volume Centrifuge Tubes are manufactured from high-quality polypropylene (PP) material. Ideal for applications requiring large volume centrifugation. It provides open, easy access for pipetting, decanting, and removal of the pellet following centrifugation. These polypropylene centrifuge tubes are sterile and disposable.

- Manufactured from polypropylene material
- Ideal for large volume centrifugation
- Easy to use
- With graduations
- Nonpyrogenic, noncytotoxic
- DNase-/RNase-free
- Sterile
- Disposable



CT-302-175

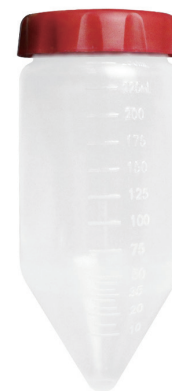

CT-302-225



CT-002-500

CT-002-250

CT-002-225

Ordering information

Cat.No.	Description	RCF Rating (xg)	Packaging
CT-002-225	225 mL PP centrifuge tubes	8,000	8pcs/bag, 6bags/case
CT-002-250	250 mL PP centrifuge tubes	8,000	6pcs/bag, 17bags/case
CT-002-500	500 mL PP centrifuge tubes	8,000	6pcs/bag, 6bags/case
CT-302-175	175mL PP centrifuge tubes, wide caliber	7,000	4pcs/bag, 6bags/case
CT-302-225	225mL PP centrifuge tubes, wide caliber	7,000	4pcs/bag, 6bags/case

Labselect Screw Cap Tubes feature a cap that provides a tight secure seal, with a conical bottom and self-standing design. All caps include an O-Ring to ensure a leak-tight seal at most temperatures, coupled with the low binding quality of polypropylene tube, make these screw cap tubes perfect for almost every long term storage application. Screw caps are available in a variety of colors.

- Polypropylene material
- Self-standing design, easy to use
- Conical bottom
- Withstand temperature -80°C~121°C
- DNase/RNase-free
- Nonpyrogenic
- Disposable



Ordering information

Cat.No.	Description	RCF Rating (xg)	Packaging
ST-001-050-A	0.5mL screw cap tube, amber	20,000	500pcs/bag, 5bags/case
ST-001-050-C	0.5mL screw cap tube, clear	20,000	500pcs/bag, 5bags/case
ST-001-150-A	1.5mL screw cap tube, amber	20,000	500pcs/bag, 5bags/case
ST-001-150-C	1.5mL screw cap tube, clear	20,000	500pcs/bag, 5bags/case
ST-001-200-A	2.0mL screw cap tube, amber	20,000	500pcs/bag, 5bags/case
ST-001-200-C	2.0mL screw cap tube, clear	20,000	500pcs/bag, 5bags/case
SCT-012-050-C-S	0.5mL screw cap tube, sterile, with cap, clear	20,000	50pcs/bag, 10bags/case
SCT-012-050-A-S	0.5mL screw cap tube, sterile, with cap, amber	20,000	50pcs/bag, 10bags/case
SCT-012-150-C-S	1.5mL screw cap tube, sterile, with cap, clear	20,000	50pcs/bag, 10bags/case
SCT-012-150-A-S	1.5mL screw cap tube, sterile, with cap, amber	20,000	50pcs/bag, 10bags/case
SCT-012-200-C-S	2.0mL screw cap tube, sterile, with cap, clear	20,000	50pcs/bag, 10bags/case
SCT-012-200-A-S	2.0mL screw cap tube, sterile, with cap, amber	20,000	50pcs/bag, 10bags/case

Cat.No.	Description	Packaging
SCO-001-C	Screw caps with O-ring, clear	500pcs/bag, 5bags/case
SCO-001-R	Screw caps with O-ring, red	500pcs/bag, 5bags/case
SCO-001-P	Screw caps with O-ring, pink	500pcs/bag, 5bags/case
SCO-001-Y	Screw caps with O-ring, yellow	500pcs/bag, 5bags/case
SCO-001-G	Screw caps with O-ring, green	500pcs/bag, 5bags/case
SCO-001-B	Screw caps with O-ring, blue	500pcs/bag, 5bags/case
SCO-001-O	Screw caps with O-ring, orange	500pcs/bag, 5bags/case
SCO-001-V	Screw caps with O-ring, violet	500pcs/bag, 5bags/case
SCO-001-BR	Screw caps with O-ring, brown	500pcs/bag, 5bags/case



SCT-012-050-C-S



ST-001-050-C



SCO-001-R

Liquid Handling

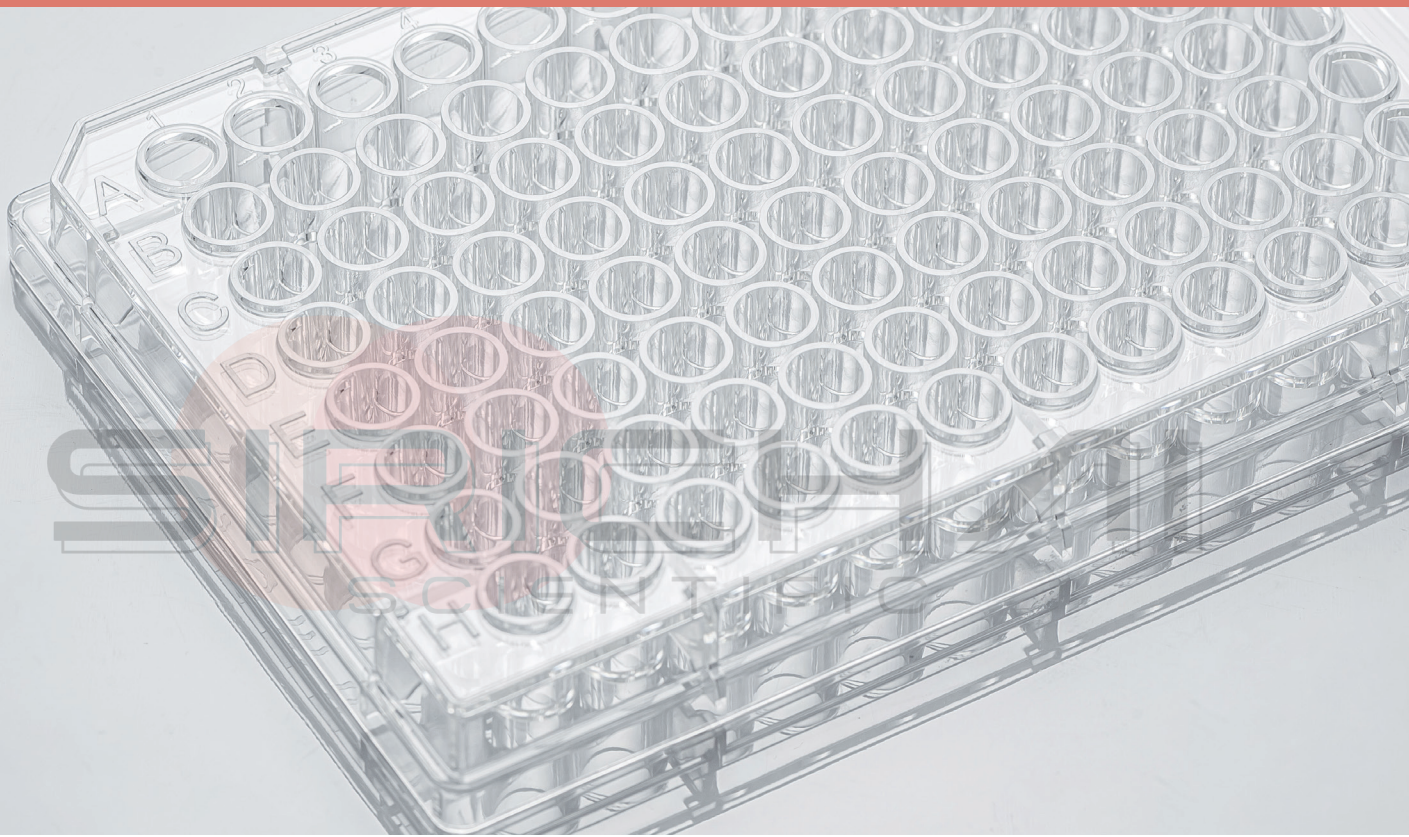

Serological Pipet
Assay Microplate
Disposable Bottle Top Vacuum Filter
Storage Bottle
Reagent Reservoir
Deep Well Plate
Magnetic Rod Tip&Silicone Mat
Centrifuge Tube Filters
96-Well Filter Plates

Labelect Serological Pipets are manufactured from high-quality virgin polystyrene materials and are suitable for cell culture and microbial culture experiments. The anti-drip tip assures accurate delivery, magnifier stripes and bidirectional graduations make volume reading and size selection easier.



- 7 different volumes
- Bidirectional graduations provide choice of ascending and descending scales
- Plastic wrap can reduce paper scraps when tearing
- Negative graduations for extra working volume
- Polyolefin plug to help prevent overflow
- Color-coded for quick identification
- Accuracy within $\pm 3\%$ at full volume
- Individually wrapped
- Nonpyrogenic, Noncytotoxic
- DNase-/RNase-free
- Sterile

Serological Pipets, Paper/plastic Wrapped



Printing is crisp, dark, and easy-to-read. Graduation alignment mark allows graduations to be brought into the line of sight quickly. Individually wrapped pipets feature thermoformed paper/plastic wrap to ensure against contamination.

Cat.No.	Color Code	Vol. (mL)	Graduations. (mL)	Packaging
SP-013-1	Yellow	1	0.01	50pcs/bag, 10bags/case
SP-013-2	Green	2	0.02	50pcs/bag, 10bags/case
SP-013-5	Blue	5	0.1	50 pcs/bag, 4bags/case
SP-013-10	Orange	10	0.1	50 pcs/bag, 4bags/case
SP-013-25	Red	25	0.2	25 pcs/bag, 8bags/case
SP-013-50	Purple	50	0.5	25 pcs/bag, 4bags/case
SP-013-100	Black	100	1	25 pcs/bag, 2bags/case



Serological Pipets, Plastic Wrapped

Cat.No.	Color Code	Vol. (mL)	Graduations. (mL)	Packaging
SP-033-001	Yellow	1	0.01	50pcs/bag, 10bags/case
SP-033-002	Green	2	0.02	50pcs/bag, 10bags/case
SP-033-005	Blue	5	0.1	50 pcs/bag, 4bags/case
SP-033-010	Orange	10	0.1	50 pcs/bag, 4bags/case
SP-033-025	Red	25	0.2	25 pcs/bag, 8bags/case
SP-033-050	Purple	50	0.5	25 pcs/bag, 4bags/case
SP-033-100	Black	100	1	25 pcs/bag, 2bags/case

Assay Microplate

Labselect Assay Microplates are manufactured from high-quality polystyrene material. Commonly assay microplates are generally used to inspect enzyme-linked immunosorbent. These plates undergone strict process control and are ergonomically designed. They are mainly used in chemiluminescence analyzers, microplate readers and other instruments for fluorescence analysis and chemical analysis.

96-Well & 384-Well UV Plate

- Manufactured from polystyrene material
- UV-transparent well bottom, ideal for determining protein and/or nucleic acid concentrations
- Low background and consistent performance at 260 and 280nm
- 96-Well plate recommended working volume 25 to 340 μ L
- 384-Well plate recommended working volume 20 to 80 μ L
- Individual package
- DNase-/RNase-free
- Non-sterile

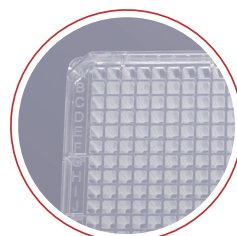

12699

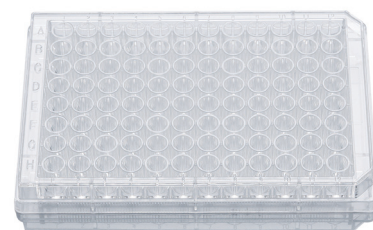

12599

Ordering information

Cat.No.	Description	Packaging
12599	96-Well clear flat bottom UV-transparent microplate, non-sterile	1pc/bag, 50bags/case
12699	384-well clear flat bottom UV-transparent microplate, non-sterile	1pc/bag, 50bags/case

96-Well Microplate, High-binding Surface

- Manufactured from polystyrene material
- High binding surface
- Ideal for immunoassays
- Recommended working volume 75 to 200 μ L
- Conforms to standard microplate footprint and dimensions
- Flat bottom
- Non-sterile

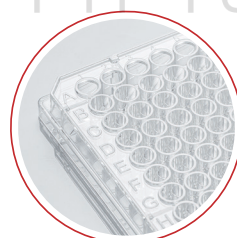

31111/3111B

96-Well assay microplate, clear

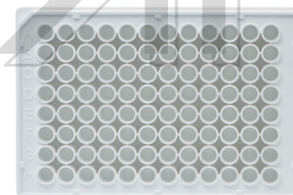

31113 96-Well assay microplate, white



31112 96-Well assay microplate, black

Ordering information

Cat.No.	Description	Packaging
31111	96-Well assay microplate, clear	10pcs/bag, 10bags/case
31111B	96-Well assay microplate, clear	1pc/bag, 100bags/case
31112	96-Well assay microplate, black	1pc/bag, 50bags/case
31113	96-Well assay microplate, white	1pc/bag, 50bags/case

96-Well Microplate, Non-treated

- Manufactured from polystyrene or polypropylene material
- Non-treated
- Optically clear flat well bottom permits direct microscopic viewing
- Black well plates have low background fluorescence
- White well plates enhance luminescent signals
- V-shaped bottom can reduce liquid sample residue
- Nonpyrogenic
- DNase-/RNase-free
- Non-sterile

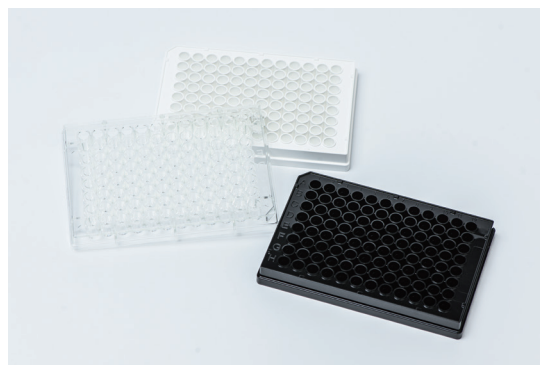

11554



11555



11556



11557

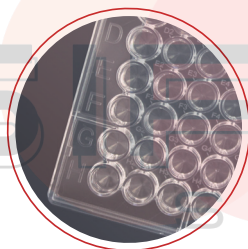

11558

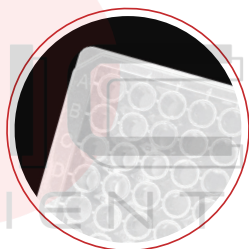

33112

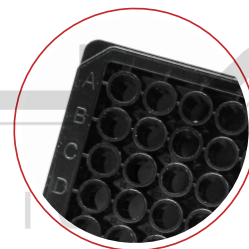

33113

Ordering information

Cat.No.	Description	Material	Packaging
11554	96-Well assay microplate, black frame, clear flat bottom	PS	25pcs/bag, 4bags/case
11555	96-Well assay microplate, white frame, clear flat bottom	PS	25pcs/bag, 4bags/case
11556	96-Well assay microplate, solid black, flat bottom	PS	25pcs/bag, 4bags/case
11557	96-Well assay microplate, solid white, flat bottom	PS	25pcs/bag, 4bags/case
31131	96-Well assay microplate, clear, flat bottom	PS	10pcs/bag, 10bags/case
11558	96-Well assay microplate, clear, V-shaped bottom	PS	25pcs/bag, 4bags/case
11551	96-Well assay microplate, clear, U-shaped bottom	PS	1pc/bag, 50bags/case
33111	96-Well assay microplate, clear	PP	25pcs/bag, 4bags/case
33112	96-Well assay microplate, solid white	PP	25pcs/bag, 4bags/case
33113	96-Well assay microplate, solid black	PP	25pcs/bag, 4bags/case

Assay Microplate

Assay Microplate, Detachable

- Manufactured from polystyrene material
- High binding and non-treated surface are available, suitable for ELISA and other detection experiments
- Flat bottom, clear tube
- Frames have alphabetic mark to provide quick sample location
- Recommended working volume 75 to 200 μ L
- DNase-/RNase-free
- Non-sterile

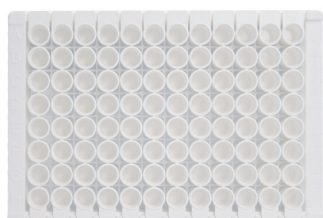
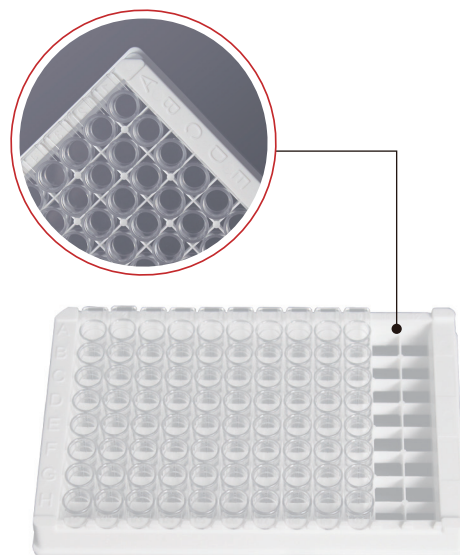

31122/31142

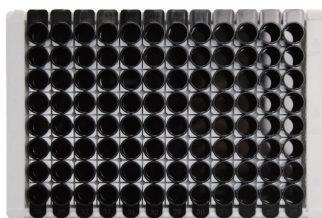

31123/31143

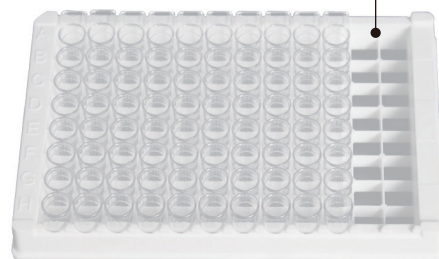

31121/31141

Ordering information

Cat.No.	Description	Packaging
31121	96-Well assay microplate, detachable, high binding, clear strips	25pcs/bag, 4bags/case
31122	96-Well assay microplate, detachable, high binding, white strips	1pc/bag, 50bags/case
31123	96-Well assay microplate, detachable, high binding, black strips	1pc/bag, 50bags/case
31141	96-Well assay microplate, detachable, non-treated, clear strips	25pcs/bag, 4bags/case
31142	96-Well assay microplate, detachable, non-treated, white strips	1pc/bag, 50bags/case
31143	96-Well assay microplate, detachable, non-treated, black strips	1pc/bag, 50bags/case

8-Well Plate Strips

- Manufactured from polystyrene material
- High binding surface, suitable for ELISA and other detection experiments
- Flat bottom, clear tube
- Recommended working volume 75 to 200 μ L
- DNase-/RNase-free
- Non-sterile

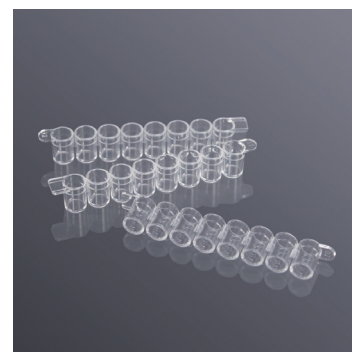

Ordering information

Cat.No.	Description	Packaging
32221	8-Well plate strips, non-sterile	100pcs/bag, 10bags/case

384-Well Microplate

- Manufactured from polystyrene material
- High binding surface is capable of binding medium and large biomolecules that possess ionic groups and/or hydrophobic regions
- Ideal for immunoassays
- Black microplates have low background fluorescence and minimize light scattering
- White well plates enhance luminescent signals
- Nonpyrogenic
- DNase-/RNase-free
- Non-sterile

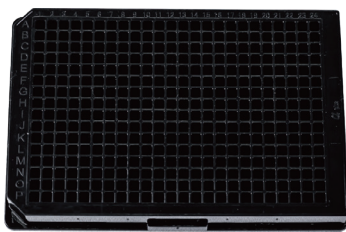

31413/31433

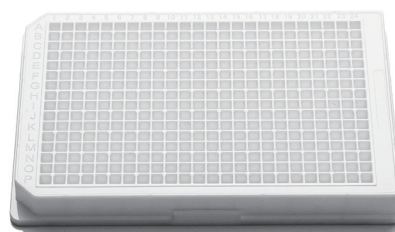

31412/31432

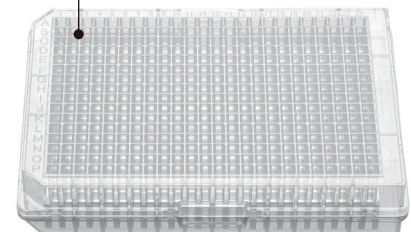

31411/31431

Ordering information

Cat.No.	Description	Packaging
31411	384-Well assay microplate, clear, high binding surface	10pcs/bag, 10bags/case
31412	384-Well assay microplate, solid white, high binding surface	10pcs/bag, 10bags/case
31413	384-Well assay microplate, solid black, high binding surface	10pcs/bag, 10bags/case
31431	384-Well assay microplate, clear, non-treated	10pcs/bag, 10bags/case
31432	384-Well assay microplate, solid white, non-treated	10pcs/bag, 10bags/case
31433	384-Well assay microplate, solid black, non-treated	10pcs/bag, 10bags/case

Assay Microplate Lid

- Manufactured from polystyrene material
- Suitable for assay microplate
- Nonpyrogenic
- DNase-/RNase-free
- Non-sterile

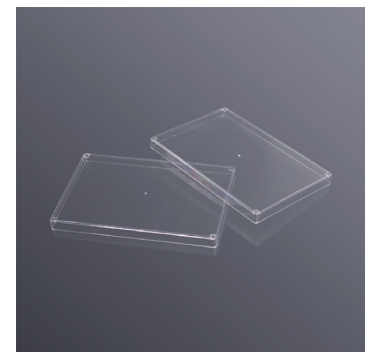

Ordering information

Cat.No.	Description	Packaging
35311	Assay Microplate Lid	10pcs/bag, 20bags/case

Disposable Bottle Top Vacuum Filter

Labselect Disposable Bottle Top Vacuum Filter for vacuum filtration of aqueous solutions including cell culture media, buffers, or other biological fluids. Four sizes are available, 150 mL, 250 mL, 500 mL, and 1000mL. Low liquid retention funnel design and hose connector simplifies vacuum line attachment. Storage bottles need ordered separately.

- Polystyrene funnel
- PES membrane (-GL45 bottle thread)
- With graduations
- Individually packaged in easy to peel bags
- Nonpyrogenic
- DNase-/RNase-free
- Sterile



GL45 bottle thread



Ordering information

Cat.No.	Description	Packaging
42111	Disposable bottle top vacuum filter, 150mL	1pc/bag, 24bags/case
42211	Disposable bottle top vacuum filter, 250mL	1pc/bag, 24bags/case
42311	Disposable bottle top vacuum filter, 500mL	1pc/bag, 24bags/case
42411	Disposable bottle top vacuum filter, 1000mL	1pc/bag, 24bags/case

Labselect Storage Bottles are safe for solution storage. Disposable polystyrene bottles are ideal for storage of media, buffers and other aqueous solutions. Media bottle used to hold samples and for storage, mixing, and sampling applications. Polystyrene body for durability and dimensional stability, it is transparent to allow visual fluid monitoring. Used for a wide variety of common applications that require fluid or substance containment.

- Manufactured from high-quality polystyrene
- Available with 4 different volumes of 150, 250, 500, 1000mL
- Disposable bottles for storage of media, buffers, and other aqueous solutions
- Heavy wall construction and edge knurls on the cap for easy screw
- Designed wide and easy access mouth for efficiently and stably pour out
- With graduation
- Easy grip sides facilitate handling
- Individually wrapped
- Nonpyrogenic, Noncytotoxic
- DNase-/RNase-free
- Sterile
- Disposable



Ordering information

Cat.No.	Description	Packaging
43111	150mL Disposable storage bottle	1pc/bag, 24bags/case
43211	250mL Disposable storage bottle	1pc/bag, 24bags/case
43311	500mL Disposable storage bottle	1pc/bag, 24bags/case
43411	1000mL Disposable storage bottle	1pc/bag, 24bags/case

Reagent Reservoir

Labselect Reagent Reservoirs are ideal for all liquid handling applications. The rigid design of this product assures consistency in an automated environment. These reservoirs are compatible with most robotic arms and platform configurations.

- Manufactured from high-quality polypropylene material
- Easy-to-use loading of multichannel pipettes
- Good chemical resistant
- Nonpyrogenic
- DNase-/RNase-free

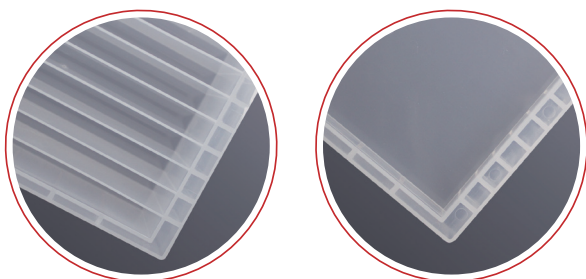

Ordering information

Cat.No.	Description	Packaging
RES-01-SL	1-Well reagent reservoir, low profile	10pcs/bag, 5bags/case
RES-01-SM	1-Well reagent reservoir, medium profile	5pcs/bag, 10bags/case
RES-04-FH	4-Well reagent reservoir, high profile	5pcs/bag, 10bags/case
RES-08-FL	8-Well reagent reservoir, low profile	10pcs/bag, 5bags/case
RES-08-FH	8-Well reagent reservoir, high profile	5pcs/bag, 10bags/case
RES-12-FL	12-Well reagent reservoir, low profile	10pcs/bag, 5bags/case
RES-12-FH	12-Well reagent reservoir, high profile	5pcs/bag, 10bags/case
RES-08-SH	Single well reagent reservoir with 8-bottom troughs, high profile	5pcs/bag, 10bags/case
RES-12-SH	Single well reagent reservoir with 12-bottom troughs, high profile	5pcs/bag, 10bags/case
RES-96-SL	Single well reagent reservoir with 96-bottom troughs, low profile	10pcs/bag, 5bags/case
RES-96-SM	Single well reagent reservoir with 96-bottom troughs, medium profile	5pcs/bag, 10bags/case
RES-96-SH	Single well reagent reservoir with 96-bottom troughs, high profile	5pcs/bag, 10bags/case
RES-384-SL	Single well reagent reservoir with 384-bottom troughs, low profile	10pcs/bag, 5bags/case

Reagent Reservoir

Cat.No.	Description	Packaging
RES-384-SM	Single well reagent reservoir with 384-bottom troughs, medium profile	5pcs/bag, 10bags/case
RES-384-SH	Single well reagent reservoir with 384-bottom troughs, high profile	5pcs/bag, 10bags/case
RES-01-SL-S	1-Well reagent reservoir, low profile, sterile	10pcs/bag, 5bags/case
RES-01-SM-S	1-Well reagent reservoir, medium profile, sterile	5pcs/bag, 10bags/case
RES-04-FH-S	4-Well reagent reservoir, high profile, sterile	5pcs/bag, 10bags/case
RES-08-FL-S	8-Well reagent reservoir, low profile, sterile	10pcs/bag, 5bags/case
RES-08-FH-S	8-Well reagent reservoir, high profile, sterile	5pcs/bag, 10bags/case
RES-12-FL-S	12-Well reagent reservoir, low profile, sterile	10pcs/bag, 5bags/case
RES-12-FH-S	12-Well reagent reservoir, high profile, sterile	5pcs/bag, 10bags/case
RES-08-SH-S	Single well reagent reservoir with 8-bottom troughs, high profile, sterile	5pcs/bag, 10bags/case
RES-12-SH-S	Single well reagent reservoir with 12-bottom troughs, high profile, sterile	5pcs/bag, 10bags/case
RES-96-SL-S	Single well reagent reservoir with 96-bottom troughs, low profile, sterile	10pcs/bag, 5bags/case
RES-96-SM-S	Single well reagent reservoir with 96-bottom troughs, medium profile, sterile	5pcs/bag, 10bags/case
RES-96-SH-S	Single well reagent reservoir with 96-bottom troughs, high profile, sterile	5pcs/bag, 10bags/case
RES-384-SL-S	Single well reagent reservoir with 384-bottom troughs, low profile, sterile	10pcs/bag, 5bags/case
RES-384-SM-S	Single well reagent reservoir with 384-bottom troughs, medium profile, sterile	5pcs/bag, 10bags/case
RES-384-SH-S	Single well reagent reservoir with 384-bottom troughs, high profile, sterile	5pcs/bag, 10bags/case
RES-04-FM	4-Well reagent reservoir, 190mL	5pcs/bag, 10bags/case
RES-08-FM	8-Well reagent reservoir, 180mL	5pcs/bag, 10bags/case
RES-12-FM	12-Well reagent reservoir, 180mL	5pcs/bag, 10bags/case
RES-96-FM	96-Well reagent reservoir, 195mL	5pcs/bag, 10bags/case
RES-384-FM	384-Well reagent reservoir, 185mL	5pcs/bag, 10bags/case
RES-01-60-S	reagent reservoir, 60mL, sterile	5pcs/bag, 20bags/case
RES-04-FM-S	4-Well reagent reservoir, 190mL, sterile	5pcs/bag, 10bags/case
RES-08-FM-S	8-Well reagent reservoir, 180mL, sterile	5pcs/bag, 10bags/case
RES-12-FM-S	12-Well reagent reservoir, 180mL, sterile	5pcs/bag, 10bags/case
RES-96-FM-S	96-Well reagent reservoir, 195mL, sterile	5pcs/bag, 10bags/case
RES-384-FM-S	384-Well reagent reservoir, 185mL, sterile	5pcs/bag, 10bags/case

Labselect Deep Well Plates are made of high-quality polypropylene material. These plates are ideal for sample storage, sample re-suspension and diluting. Using with multi-channel pipettes or automation systems and are widely used in laboratories. Different sealing options are available, including cap seals or film seals, which can be applied independently to avoid cross-contamination.

- Manufactured from polypropylene material
- Ultra-flat surface ensures proper sealing with heat sealing film
- Offer excellent chemical resistance and can withstand temperatures down to -80°C
- DNase-/RNase-free
- Autoclavable
- Nonpyrogenic

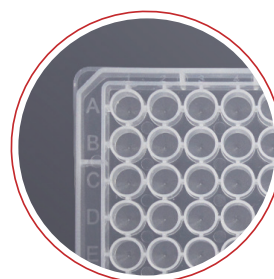
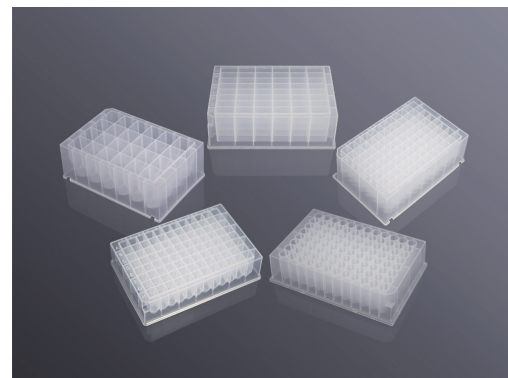

Ordering information

Cat.No.	Description	Type of well	Packaging
DWR-96-VC-0360A	0.36mL 96-well deep well plates, V-bottom, clear	Round	10pcs/bag, 10bags/case
DWR-96-UC-0400A	0.4mL 96-well deep well plates, U-bottom, clear	Round	10pcs/bag, 10bags/case
DWR-96-FC-0400A	0.4mL 96-well deep well plates, Flat-bottom, clear	Round	10pcs/bag, 10bags/case
DWR-96-VC-0450	0.45mL 96-well deep well plates, V-bottom, clear	Round	10pcs/bag, 10bags/case
DWR-96-UC-0500	0.5mL 96-well deep well plates, U-bottom, clear	Round	10pcs/bag, 10bags/case
DWS-96-VC-0500	0.5mL 96-well deep well plates, V-bottom, clear	Square	5pcs/bag, 10bags/case
DWS-96-VC-1000	1.0mL 96-well deep well plates, V-bottom, clear	Square	10pcs/bag, 10bags/case
DWR-96-UC-1000A	1.0mL 96-well deep well plates, U-bottom, clear	Round	5pcs/bag, 10bags/case
DWR-96-VC-1000A	1.0mL 96-well deep well plates, V-bottom, clear	Round	5pcs/bag, 10bags/case
DWR-96-UC-1100	1.1mL 96-well deep well plates, U-bottom, clear	Round	5pcs/bag, 10bags/case
DWR-96-VC-1100	1.1mL 96-well deep well plates, V-bottom, clear	Round	5pcs/bag, 10bags/case
DWS-96-UC-1200	1.2mL 96-well deep well plates, round-bottom, clear	Square	5pcs/bag, 10bags/case
DWR-96-UC-1300	1.3mL 96-well deep well plates, U-bottom, clear	Round	5pcs/bag, 10bags/case
DWS-96-UC-1600	1.6mL 96-well deep well plates, round-bottom, clear	Square	5pcs/bag, 10bags/case

Cat.No.	Description	Type of well	Packaging
DWS-96-UM-1600	1.6mL 96-well deep well plates, round-bottom, frosted	Square	5pcs/bag, 10bags/case
DWS-96-SC-1600	1.6mL 96-well deep well plates, Sharp-bottom, clear	Square	5pcs/bag, 10bags/case
DWR-96-VC-2000	2.0mL 96-well deep well plates, V-bottom, clear	Round	5pcs/bag, 10bags/case
DWR-96-UC-2000	2.0mL 96-well deep well plates, U-bottom, clear	Round	5pcs/bag, 10bags/case
DWS-96-UC-2200	2.2mL 96-well deep well plates, round-bottom, clear	Square	5pcs/bag, 10bags/case
DWS-96-UM-2200	2.2mL 96-well deep well plates, round-bottom, frosted	Square	5pcs/bag, 10bags/case
DWS-96-VC-2200	2.2mL 96-well deep well plates, V-bottom, clear	Square	5pcs/bag, 10bags/case
DWS-96-UC-2200G	2.2mL 96-well deep well plates, U-bottom, clear	Square	5pcs/bag, 10bags/case
DWS-96-VM-2200	2.2mL 96-well deep well plates, V-bottom, frosted	Square	5pcs/bag, 10bags/case
DWS-96-SM-2300	2.3mL 96-well deep well plates, Sharp-bottom, frosted	Square	5pcs/bag, 10bags/case
DWR-48-UC-3500	3.5mL 48-well deep well plates, U-bottom, clear	Round	5pcs/bag, 10bags/case
DWR-48-UC-3500M	3.5mL 48-well deep well plates, U-bottom, clear	Round	5pcs/bag, 10bags/case
DWS-48-VC-4600	4.6mL 48-well deep well plates, V-bottom, clear	Square	5pcs/bag, 10bags/case
DWS-24-VC-8000	8.0mL 24-well deep well plates, V-bottom, clear	Square	5pcs/bag, 10bags/case
DWS-24-VC-15000	15mL 24-well deep well plates, V-bottom, clear	Square	2pcs/bag, 25bags/case
DWS-384-SC-0120	120 μ L 384-well deep well plates, V-bottom, clear	Square	10pcs/bag, 10bags/case
DWS-384-SC-0240	240 μ L 384-well deep well plates, V-bottom, clear	Square	5pcs/bag, 10bags/case
DWS-96-VC-0500-S	0.5mL 96-well deep well plates, V-bottom, clear, sterile	Square	5pcs/bag, 10bags/case
DWS-96-UC-1200-S	1.2mL 96-well deep well plates, round-bottom, clear, sterile	Square	5pcs/bag, 10bags/case
DWR-96-UC-1300-S	1.3mL 96-well deep well plates, U-bottom, clear, sterile	Round	5pcs/bag, 10bags/case
DWS-96-UC-1600-S	1.6mL 96-well deep well plates, round-bottom, clear, sterile	Square	5pcs/bag, 10bags/case
DWS-96-UM-1600-S	1.6mL 96-well deep well plates, round-bottom, frosted, sterile	Square	5pcs/bag, 10bags/case
DWR-96-UC-2000-S	2.0mL 96-well deep well plates, U-bottom, clear, sterile	Round	5pcs/bag, 10bags/case
DWS-96-UC-2200-S	2.2mL 96-well deep well plates, round-bottom, clear, sterile	Square	5pcs/bag, 10bags/case
DWS-96-UM-2200-S	2.2mL 96-well deep well plates, round-bottom, frosted, sterile	Square	5pcs/bag, 10bags/case
DWS-96-VC-2200-S	2.2mL 96-well deep well plates, V-bottom, clear, sterile	Square	5pcs/bag, 10bags/case
DWS-48-VC-4600-S	4.6mL 48-well deep well plates, V-bottom, clear, sterile	Square	5pcs/bag, 10bags/case
DWS-24-VC-8000-S	8.0mL 24-well deep well plates, V-bottom, clear, sterile	Square	5pcs/bag, 10bags/case

Magnetic Rod Tip & Silicone Mat

Magnetic Rod Tip

- Manufactured from polypropylene material
- Good chemical and physical resistance
- RNase-/DNase-free
- Nonpyrogenic
- Non-sterile

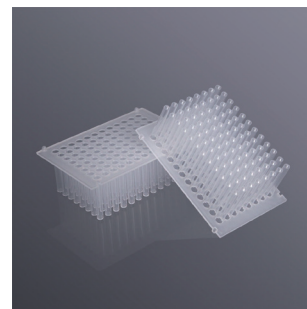

Ordering information

Cat.No.	Description	Packaging
DWT-96-V-01	96-Well magnetic rod tip, V-bottom	2pcs/bag, 50bags/case
DWT-08-V-01	Magnetic rod tip, 8-strip, V-bottom, with locking Snap	2pcs/bag, 125bags/case
DWT-08-U-01	Magnetic rod tip, 8-strip, U-bottom	2pcs/bag, 125bags/case
DWT-08-U-02	Magnetic rod tip, 8-strip, U-bottom, with locking Snap	2pcs/bag, 125bags/case
DWT-08-U-03	Magnetic rod tip, 8-strip, U-bottom, with locking Snap	2pcs/bag, 125bags/case

Silicone Mat

- Silicone material
- Eliminates cross-contamination between wells
- RNase-/DNase-free
- Autoclavable

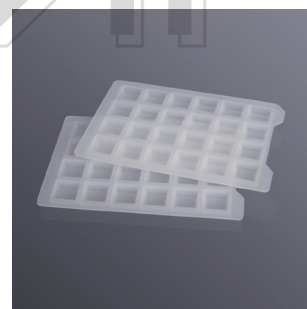
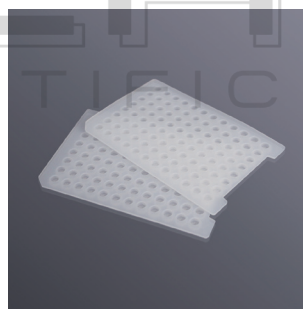

Ordering information

Cat.No.	Description	Packaging
MTD-96R-001A	96-Well silicone mat, round well, 8.3mm	5pcs/bag, 10bags/case
MTD-96R-002A	96-Well silicone mat, round well, 8.5mm	5pcs/bag, 10bags/case
MTD-96R-003A	96-Well silicone mat, round well, 7.2mm	5pcs/bag, 10bags/case
MTD-96S-001A	96-Well silicone mat, square well	5pcs/bag, 10bags/case
MTD-48S-001C	48-Well silicone mat, square well	4pcs/bag, 10bags/case
MTD-24S-001C	24-Well silicone mat, square well	5pcs/bag, 10bags/case

Centrifuge Tube Filters

Labselect Centrifuge Tube Filters consist of a membrane-containing insert and a polypropylene centrifuge tube. The filter removes bacteria and particles, cells from media and DNA from agarose or acrylamide gels. All membranes are available in 0.22 and 0.45 μm pore sizes.

- Available pore sizes: 0.22 μm and 0.45 μm
- Ease of handling
- Ideal for removing bacteria, particles, or cells from liquids, HPLC sample preparation and DNA removal from agarose or acrylamide gels
- Fast sample preparation
- Biologically inert material of construction
- Fast filtration and highly reproducible performance
- Parallel filtration of multiple samples
- Ideal for use with protein and nucleic acid solutions
- Nonpyrogenic
- DNase-/RNase-free



Non-sterile Centrifuge Tube Filters

Membrane Type	Cat. No.	Volume (mL)	Pore Size (μm)	Max Funnel Capacity (mL)	RCF Rating (xg)	Package
CA	CTF-02-CA-22	2mL	0.22 μm	0.6	20,000	25pcs/box, 5boxes/case
	CTF-02-CA-45	2mL	0.45 μm	0.6	20,000	25pcs/box, 5boxes/case
	CTF-15-CA-22	15mL	0.22 μm	3	12,000	25pcs/box, 10boxes/case
	CTF-15-CA-45	15mL	0.45 μm	3	12,000	25pcs/box, 10boxes/case
	CTF-50-CA-22	50mL	0.22 μm	8	10,000	25pcs/box, 10boxes/case
	CTF-50-CA-45	50mL	0.45 μm	8	10,000	25pcs/box, 10boxes/case
MCE	CTF-02-MCE-22	2mL	0.22 μm	0.6	20,000	25pcs/box, 5boxes/case
	CTF-02-MCE-45	2mL	0.45 μm	0.6	20,000	25pcs/box, 5boxes/case
	CTF-15-MCE-22	15mL	0.22 μm	3	12,000	25pcs/box, 10boxes/case
	CTF-15-MCE-45	15mL	0.45 μm	3	12,000	25pcs/box, 10boxes/case
	CTF-50-MCE-22	50mL	0.22 μm	8	10,000	25pcs/box, 10boxes/case
	CTF-50-MCE-45	50mL	0.45 μm	8	10,000	25pcs/box, 10boxes/case

Centrifuge Tube Filters

Membrane Type	Cat. No.	Volume (mL)	Pore Size (µm)	Max Funnel Capacity (mL)	RCF Rating (xg)	Package
Nylon	CTF-02-NY-22	2mL	0.22µm	0.6	20,000	25pcs/box, 5boxes/case
	CTF-02-NY-45	2mL	0.45µm	0.6	20,000	25pcs/box, 5boxes/case
	CTF-15-NY-22	15mL	0.22µm	3	12,000	25pcs/box, 10boxes/case
	CTF-15-NY-45	15mL	0.45µm	3	12,000	25pcs/box, 10boxes/case
	CTF-50-NY-22	50mL	0.22µm	8	10,000	25pcs/box, 10boxes/case
	CTF-50-NY-45	50mL	0.45µm	8	10,000	25pcs/box, 10boxes/case
PVDF hydrophilic	CTF-02-PVDFL-22	2mL	0.22µm	0.6	20,000	25pcs/box, 5boxes/case
	CTF-02-PVDFL-45	2mL	0.45µm	0.6	20,000	25pcs/box, 5boxes/case
	CTF-15-PVDFL-22	15mL	0.22µm	3	12,000	25pcs/box, 10boxes/case
	CTF-15-PVDFL-45	15mL	0.45µm	3	12,000	25pcs/box, 10boxes/case
	CTF-50-PVDFL-22	50mL	0.22µm	8	10,000	25pcs/box, 10boxes/case
	CTF-50-PVDFL-45	50mL	0.45µm	8	10,000	25pcs/box, 10boxes/case
PVDF hydrophobic	CTF-02-PVDFB-22	2mL	0.22µm	0.6	20,000	25pcs/box, 5boxes/case
	CTF-02-PVDFB-45	2mL	0.45µm	0.6	20,000	25pcs/box, 5boxes/case
	CTF-15-PVDFB-22	15mL	0.22µm	3	12,000	25pcs/box, 10boxes/case
	CTF-15-PVDFB-45	15mL	0.45µm	3	12,000	25pcs/box, 10boxes/case
	CTF-50-PVDFB-22	50mL	0.22µm	8	10,000	25pcs/box, 10boxes/case
	CTF-50-PVDFB-45	50mL	0.45µm	8	10,000	25pcs/box, 10boxes/case
PTFE hydrophilic	CTF-02-PTFEL-22	2mL	0.22µm	0.6	20,000	25pcs/box, 5boxes/case
	CTF-02-PTFEL-45	2mL	0.45µm	0.6	20,000	25pcs/box, 5boxes/case
	CTF-15-PTFEL-22	15mL	0.22µm	3	12,000	25pcs/box, 10boxes/case
	CTF-15-PTFEL-45	15mL	0.45µm	3	12,000	25pcs/box, 10boxes/case
	CTF-50-PTFEL-22	50mL	0.22µm	8	10,000	25pcs/box, 10boxes/case
	CTF-50-PTFEL-45	50mL	0.45µm	8	10,000	25pcs/box, 10boxes/case
PTFE hydrophobic	CTF-02-PTFEB-22	2mL	0.22µm	0.6	20,000	25pcs/box, 5boxes/case
	CTF-02-PTFEB-45	2mL	0.45µm	0.6	20,000	25pcs/box, 5boxes/case
	CTF-15-PTFEB-22	15mL	0.22µm	3	12,000	25pcs/box, 10boxes/case
	CTF-15-PTFEB-45	15mL	0.45µm	3	12,000	25pcs/box, 10boxes/case
	CTF-50-PTFEB-22	50mL	0.22µm	8	10,000	25pcs/box, 10boxes/case
	CTF-50-PTFEB-45	50mL	0.45µm	8	10,000	25pcs/box, 10boxes/case

Sterile Centrifuge Tube Filters

Membrane Type	Cat. No.	Volume (mL)	Pore Size (µm)	Max Funnel Capacity (mL)	RCF Rating (xg)	Package
CA	CTF-02-CA-22-S	2mL	0.22µm	0.6	20,000	25pcs/box, 5boxes/case
	CTF-02-CA-45-S	2mL	0.45µm	0.6	20,000	25pcs/box, 5boxes/case
	CTF-15-CA-22-S	15mL	0.22µm	3	12,000	25pcs/box, 10boxes/case
	CTF-15-CA-45-S	15mL	0.45µm	3	12,000	25pcs/box, 10boxes/case
	CTF-50-CA-22-S	50mL	0.22µm	8	10,000	25pcs/box, 10boxes/case
	CTF-50-CA-45-S	50mL	0.45µm	8	10,000	25pcs/box, 10boxes/case
MCE	CTF-02-MCE-22-S	2mL	0.22µm	0.6	20,000	25pcs/box, 5boxes/case
	CTF-02-MCE-45-S	2mL	0.45µm	0.6	20,000	25pcs/box, 5boxes/case
	CTF-15-MCE-22-S	15mL	0.22µm	3	12,000	25pcs/box, 10boxes/case
	CTF-15-MCE-45-S	15mL	0.45µm	3	12,000	25pcs/box, 10boxes/case
	CTF-50-MCE-22-S	50mL	0.22µm	8	10,000	25pcs/box, 10boxes/case
	CTF-50-MCE-45-S	50mL	0.45µm	8	10,000	25pcs/box, 10boxes/case
Nylon	CTF-02-NY-22-S	2mL	0.22µm	0.6	20,000	25pcs/box, 5boxes/case
	CTF-02-NY-45-S	2mL	0.45µm	0.6	20,000	25pcs/box, 5boxes/case
	CTF-15-NY-22-S	15mL	0.22µm	3	12,000	25pcs/box, 10boxes/case
	CTF-15-NY-45-S	15mL	0.45µm	3	12,000	25pcs/box, 10boxes/case
	CTF-50-NY-22-S	50mL	0.22µm	8	10,000	25pcs/box, 10boxes/case
	CTF-50-NY-45-S	50mL	0.45µm	8	10,000	25pcs/box, 10boxes/case
PVDF hydrophilic	CTF-02-PVDFL-22-S	2mL	0.22µm	0.6	20,000	25pcs/box, 5boxes/case
	CTF-02-PVDFL-45-S	2mL	0.45µm	0.6	20,000	25pcs/box, 5boxes/case
	CTF-15-PVDFL-22-S	15mL	0.22µm	3	12,000	25pcs/box, 10boxes/case
	CTF-15-PVDFL-45-S	15mL	0.45µm	3	12,000	25pcs/box, 10boxes/case
	CTF-50-PVDFL-22-S	50mL	0.22µm	8	10,000	25pcs/box, 10boxes/case
	CTF-50-PVDFL-45-S	50mL	0.45µm	8	10,000	25pcs/box, 10boxes/case
PVDF hydrophobic	CTF-02-PVDFB-22-S	2mL	0.22µm	0.6	20,000	25pcs/box, 5boxes/case
	CTF-02-PVDFB-45-S	2mL	0.45µm	0.6	20,000	25pcs/box, 5boxes/case
	CTF-15-PVDFB-22-S	15mL	0.22µm	3	12,000	25pcs/box, 10boxes/case
	CTF-15-PVDFB-45-S	15mL	0.45µm	3	12,000	25pcs/box, 10boxes/case
	CTF-50-PVDFB-22-S	50mL	0.22µm	8	10,000	25pcs/box, 10boxes/case
	CTF-50-PVDFB-45-S	50mL	0.45µm	8	10,000	25pcs/box, 10boxes/case

96-Well Filter Plates

Membrane Type	Cat. No.	Volume (mL)	Pore Size (μm)	Max Funnel Capacity (mL)	RCF Rating (xg)	Package
PTFE hydrophilic	CTF-02-PTFEL-22-S	2mL	0.22 μm	0.6	20,000	25pcs/box, 5boxes/case
	CTF-02-PTFEL-45-S	2mL	0.45 μm	0.6	20,000	25pcs/box, 5boxes/case
	CTF-15-PTFEL-22-S	15mL	0.22 μm	3	12,000	25pcs/box, 10boxes/case
	CTF-15-PTFEL-45-S	15mL	0.45 μm	3	12,000	25pcs/box, 10boxes/case
	CTF-50-PTFEL-22-S	50mL	0.22 μm	8	10,000	25pcs/box, 10boxes/case
	CTF-50-PTFEL-45-S	50mL	0.45 μm	8	10,000	25pcs/box, 10boxes/case
PTFE hydrophobic	CTF-02-PTFEB-22-S	2mL	0.22 μm	0.6	20,000	25pcs/box, 5boxes/case
	CTF-02-PTFEB-45-S	2mL	0.45 μm	0.6	20,000	25pcs/box, 5boxes/case
	CTF-15-PTFEB-22-S	15mL	0.22 μm	3	12,000	25pcs/box, 10boxes/case
	CTF-15-PTFEB-45-S	15mL	0.45 μm	3	12,000	25pcs/box, 10boxes/case
	CTF-50-PTFEB-22-S	50mL	0.22 μm	8	10,000	25pcs/box, 10boxes/case
	CTF-50-PTFEB-45-S	50mL	0.45 μm	8	10,000	25pcs/box, 10boxes/case

Filter Plates

Labselect Filter Plates are designed to ensure reliable results free of cross-contamination. Made of chemical resistant polypropylene material with superior mechanical strength, these plates conform to standard 96 well footprint compatible with high throughput sample processing. Labselect plates meet standard ANSI/SBS footprint dimensions for microplates.

- Manufactured from polystyrene
- Available pore sizes: 0.22 μm and 0.45 μm
- Ease of handling
- Max funnel capacity (mL): 0.3mL
- Max RCF rating: 2,800xg
- Compatible with automation
- Fast filtration and highly reproducible performance
- Parallel filtration of multiple samples
- Nonpyrogenic
- DNase-/RNase-free

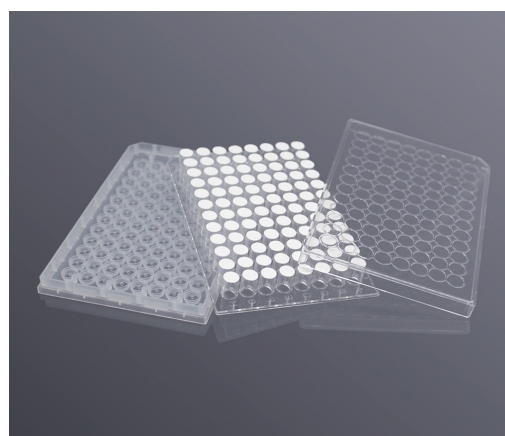

Ordering information

Cat.No.	Description	Packaging
CTF-24-CA-22	24-Well plate filters, CA membrane, 0.22µm	2units/box, 10boxes/case
CTF-24-CA-45	24-Well plate filters, CA membrane, 0.45µm	2units/box, 10boxes/case
CTF-96-CA-22	96-Well plate filters, CA membrane, 0.22µm	5pcs/box, 5boxes/case
CTF-96-CA-45	96-Well plate filters, CA membrane, 0.45µm	5pcs/box, 5boxes/case
CTF-24-NY-22	24-Well plate filters, Nylon membrane, 0.22µm	2units/box, 10boxes/case
CTF-24-NY-45	24-Well plate filters, Nylon membrane, 0.45µm	2units/box, 10boxes/case
CTF-96-NY-22	96-Well plate filters, Nylon membrane, 0.22µm	5pcs/box, 5boxes/case
CTF-96-NY-45	96-Well plate filters, Nylon membrane, 0.45µm	5pcs/box, 5boxes/case
CTF-96-PVDFL-22	96-Well plate filters, hydrophilic PVDF membrane, 0.22µm	5pcs/box, 5boxes/case
CTF-96-PVDFL-45	96-Well plate filters, hydrophilic PVDF membrane, 0.45µm	5pcs/box, 5boxes/case
CTF-24-PVDFB-22	24-Well plate filters, hydrophobic PVDF membrane, 0.22µm	2units/box, 10boxes/case
CTF-24-PVDFB-45	24-Well plate filters, hydrophobic PVDF membrane, 0.45µm	2units/box, 10boxes/case
CTF-96-PVDFB-22	96-Well plate filters, hydrophobic PVDF membrane, 0.22µm	5pcs/box, 5boxes/case
CTF-96-PVDFB-45	96-Well plate filters, hydrophobic PVDF membrane, 0.45µm	5pcs/box, 5boxes/case
CTF-24-MCE-22	24-Well plate filters, MCE membrane, 0.22µm	2units/box, 10boxes/case
CTF-24-MCE-45	24-Well plate filters, MCE membrane, 0.45µm	2units/box, 10boxes/case
CTF-96-MCE-22	96-Well plate filters, MCE membrane, 0.22µm	5pcs/box, 5boxes/case
CTF-96-MCE-45	96-Well plate filters, MCE membrane, 0.45µm	5pcs/box, 5boxes/case
CTF-24-PTFEL-22	24-Well plate filters, hydrophilic PTFE membrane, 0.22µm	2units/box, 10boxes/case
CTF-24-PTFEL-45	24-Well plate filters, hydrophilic PTFE membrane, 0.45µm	2units/box, 10boxes/case
CTF-96-PTFEL-22	96-Well plate filters, hydrophilic PTFE membrane, 0.22µm	5pcs/box, 5boxes/case
CTF-96-PTFEL-45	96-Well plate filters, hydrophilic PTFE membrane, 0.45µm	5pcs/box, 5boxes/case
CTF-24-PTFEB-22	24-Well plate filters, hydrophobic PTFE membrane, 0.22µm	2units/box, 10boxes/case
CTF-24-PTFEB-45	24-Well plate filters, hydrophobic PTFE membrane, 0.45µm	2units/box, 10boxes/case
CTF-96-PTFEB-22	96-Well plate filters, hydrophobic PTFE membrane, 0.22µm	5pcs/box, 5boxes/case
CTF-96-PTFEB-45	96-Well plate filters, hydrophobic PTFE membrane, 0.45µm	5pcs/box, 5boxes/case
CTF-24-CA-22-S	24-Well plate filters, CA membrane, 0.22µm, sterile	2units/box, 10boxes/case
CTF-24-CA-45-S	24-Well plate filters, CA membrane, 0.45µm, sterile	2units/box, 10boxes/case
CTF-96-CA-22-S	96-Well plate filters, CA membrane, 0.22µm, sterile	5pcs/box, 5boxes/case

Cat.No.	Description	Packaging
CTF-96-CA-45-S	96-Well plate filters, CA membrane, 0.45µm, sterile	5pcs/box, 5boxes/case
CTF-24-NY-22-S	24-Well plate filters, Nylon membrane, 0.22µm, sterile	2units/box, 10boxes/case
CTF-24-NY-45-S	24-Well plate filters, Nylon membrane, 0.45µm, sterile	2units/box, 10boxes/case
CTF-96-NY-22-S	96-Well plate filters, Nylon membrane, 0.22µm, sterile	5pcs/box, 5boxes/case
CTF-96-NY-45-S	96-Well plate filters, Nylon membrane, 0.45µm, sterile	5pcs/box, 5boxes/case
CTF-96-PVDFL-22-S	96-Well plate filters, hydrophilic PVDF membrane, 0.22µm, sterile	5pcs/box, 5boxes/case
CTF-96-PVDFL-45-S	96-Well plate filters, hydrophilic PVDF membrane, 0.45µm, sterile	5pcs/box, 5boxes/case
CTF-24-PVDFB-22-S	24-Well plate filters, hydrophobic PVDF membrane, 0.22µm, sterile	2units/box, 10boxes/case
CTF-24-PVDFB-45-S	24-Well plate filters, hydrophobic PVDF membrane, 0.45µm, sterile	2units/box, 10boxes/case
CTF-96-PVDFB-22-S	96-Well plate filters, hydrophobic PVDF membrane, 0.22µm, sterile	5pcs/box, 5boxes/case
CTF-96-PVDFB-45-S	96-Well plate filters, hydrophobic PVDF membrane, 0.45µm, sterile	5pcs/box, 5boxes/case
CTF-24-MCE-22-S	24-Well plate filters, MCE membrane, 0.22µm, sterile	2units/box, 10boxes/case
CTF-24-MCE-45-S	24-Well plate filters, MCE membrane, 0.45µm, sterile	2units/box, 10boxes/case
CTF-96-MCE-22-S	96-Well plate filters, MCE membrane, 0.22µm, sterile	5pcs/box, 5boxes/case
CTF-96-MCE-45-S	96-Well plate filters, MCE membrane, 0.45µm, sterile	5pcs/box, 5boxes/case
CTF-24-PTFEL-22-S	24-Well plate filters, hydrophilic PTFE membrane, 0.22µm, sterile	2units/box, 10boxes/case
CTF-24-PTFEL-45-S	24-Well plate filters, hydrophilic PTFE membrane, 0.45µm, sterile	2units/box, 10boxes/case
CTF-96-PTFEL-22-S	96-Well plate filters, hydrophilic PTFE membrane, 0.22µm, sterile	5pcs/box, 5boxes/case
CTF-96-PTFEL-45-S	96-Well plate filters, hydrophilic PTFE membrane, 0.45µm, sterile	5pcs/box, 5boxes/case
CTF-24-PTFEB-22-S	24-Well plate filters, hydrophobic PTFE membrane, 0.22µm, sterile	2units/box, 10boxes/case
CTF-24-PTFEB-45-S	24-Well plate filters, hydrophobic PTFE membrane, 0.45µm, sterile	2units/box, 10boxes/case
CTF-96-PTFEB-22-S	96-Well plate filters, hydrophobic PTFE membrane, 0.22µm, sterile	5pcs/box, 5boxes/case
CTF-96-PTFEB-45-S	96-Well plate filters, hydrophobic PTFE membrane, 0.45µm, sterile	5pcs/box, 5boxes/case
CTF-24-PESL-22	24-Well plate filters, hydrophilic PES membrane, 0.22µm	2units/box, 10boxes/case
CTF-24-PESL-45	24-Well plate filters, hydrophilic PES membrane, 0.45µm	2units/box, 10boxes/case
CTF-24-PESB-22	24-Well plate filters, hydrophobic PES membrane, 0.22µm	2units/box, 10boxes/case
CTF-24-PESB-45	24-Well plate filters, hydrophobic PES membrane, 0.45µm	2units/box, 10boxes/case
CTF-24-PESL-22-S	24-Well plate filters, hydrophilic PES membrane, 0.22µm, sterile	2units/box, 10boxes/case
CTF-24-PESL-45-S	24-Well plate filters, hydrophilic PES membrane, 0.45µm, sterile	2units/box, 10boxes/case
CTF-24-PESB-22-S	24-Well plate filters, hydrophobic PES membrane, 0.22µm, sterile	2units/box, 10boxes/case

96-Well Filter Plates

Cat.No.	Description	Packaging
CTF-24-PESB-45-S	24-Well plate filters, hydrophobic PES membrane, 0.45µm, sterile	2units/box, 10boxes/case
CTF-96-CA-22-N	96-Well plate filters, CA membrane, 0.22µm, non-detachable	5pcs/box, 5boxes/case
CTF-96-CA-45-N	96-Well plate filters, CA membrane, 0.45µm, non-detachable	5pcs/box, 5boxes/case
CTF-96-NY-22-N	96-Well plate filters, Nylon membrane, 0.22µm, non-detachable	5pcs/box, 5boxes/case
CTF-96-NY-45-N	96-Well plate filters, Nylon membrane, 0.45µm, non-detachable	5pcs/box, 5boxes/case
CTF-96-PVDFL-22-N	96-Well plate filters, hydrophilic PVDF membrane, 0.22µm, non-detachable	5pcs/box, 5boxes/case
CTF-96-PVDFL-45-N	96-Well plate filters, hydrophilic PVDF membrane, 0.45µm, non-detachable	5pcs/box, 5boxes/case
CTF-96-PVDFB-22-N	96-Well plate filters, hydrophobic PVDF membrane, 0.22µm, non-detachable	5pcs/box, 5boxes/case
CTF-96-PVDFB-45-N	96-Well plate filters, hydrophobic PVDF membrane, 0.45µm, non-detachable	5pcs/box, 5boxes/case
CTF-96-MCE-22-N	96-Well plate filters, MCE membrane, 0.22µm, non-detachable	5pcs/box, 5boxes/case
CTF-96-MCE-45-N	96-Well plate filters, MCE membrane, 0.45µm, non-detachable	5pcs/box, 5boxes/case
CTF-96-PTFEL-22-N	96-Well plate filters, hydrophilic PTFE membrane, 0.22µm, non-detachable	5pcs/box, 5boxes/case
CTF-96-PTFEL-45-N	96-Well plate filters, hydrophilic PTFE membrane, 0.45µm, non-detachable	5pcs/box, 5boxes/case
CTF-96-PTFEB-22-N	96-Well plate filters, hydrophobic PTFE membrane, 0.22µm, non-detachable	5pcs/box, 5boxes/case
CTF-96-PTFEB-45-N	96-Well plate filters, hydrophobic PTFE membrane, 0.45µm, non-detachable	5pcs/box, 5boxes/case
CTF-96-CA-22-N-S	96-Well plate filters, CA membrane, 0.22µm, non-detachable, sterile	5pcs/box, 5boxes/case
CTF-96-CA-45-N-S	96-Well plate filters, CA membrane, 0.45µm, non-detachable, sterile	5pcs/box, 5boxes/case
CTF-96-NY-22-N-S	96-Well plate filters, Nylon membrane, 0.22µm, non-detachable, sterile	5pcs/box, 5boxes/case
CTF-96-NY-45-N-S	96-Well plate filters, Nylon membrane, 0.45µm, non-detachable, sterile	5pcs/box, 5boxes/case
CTF-96-PVDFL-22-N-S	96-Well plate filters, hydrophilic PVDF membrane, 0.22µm, non-detachable, sterile	5pcs/box, 5boxes/case
CTF-96-PVDFL-45-N-S	96-Well plate filters, hydrophilic PVDF membrane, 0.45µm, non-detachable, sterile	5pcs/box, 5boxes/case
CTF-96-PVDFB-22-N-S	96-Well plate filters, hydrophobic PTFE membrane, 0.22µm, non-detachable, sterile	5pcs/box, 5boxes/case
CTF-96-PVDFB-45-N-S	96-Well plate filters, hydrophobic PTFE membrane, 0.45µm, non-detachable, sterile	5pcs/box, 5boxes/case
CTF-96-MCE-22-N-S	96-Well plate filters, MCE membrane, 0.22µm, non-detachable, sterile	5pcs/box, 5boxes/case
CTF-96-MCE-45-N-S	96-Well plate filters, MCE membrane, 0.45µm, non-detachable, sterile	5pcs/box, 5boxes/case
CTF-96-PTFEL-22-N-S	96-Well plate filters, hydrophilic PTFE membrane, 0.22µm, non-detachable, sterile	5pcs/box, 5boxes/case
CTF-96-PTFEL-45-N-S	96-Well plate filters, hydrophilic PTFE membrane, 0.45µm, non-detachable, sterile	5pcs/box, 5boxes/case
CTF-96-PTFEB-22-N-S	96-Well plate filters, hydrophobic PTFE membrane, 0.22µm, non-detachable, sterile	5pcs/box, 5boxes/case
CTF-96-PTFEB-45-N-S	96-Well plate filters, hydrophobic PTFE membrane, 0.45µm, non-detachable, sterile	5pcs/box, 5boxes/case

Microbiology



Petri Dish

Labselect Petri Dishes are made from high-quality polystyrene material. Durable construction assures stable dish manipulation. Dishes are sterilized by E-beam. These clear, polystyrene dishes feature a large growth area and are suitable for performing agar diffusion assays, screening large numbers of colonies in cloning experiments and for culturing of bacteria.

- Manufactured from high-quality polystyrene material
- Size: 90*15mm
- Card slot design lids ensures stable gas exchange
- Non-treated surface
- Ideal for colony formation
- Nonpyrogenic
- DNase-/RNase-free
- E-Beam sterilization
- Disposables



Ordering information

Cat.No.	Description	Packaging
12520	90mm Petri dish, 90*15mm	10pcs/bag, 50bags/case

Transfer Membranes



SIRICH **SCIENTIFIC**

Nylon Transfer Membrane

PVDF Transfer Membrane

Labselect Transfer Membranes are used in blotting techniques as the solid phase support upon which proteins or nucleic acids are transferred from gel matrices so that detection and analysis may be performed. After size separation by electrophoresis in a polyacrylamide, proteins or nucleic acids are immobilized on a solid matrix membrane, facilitating the detection of specific proteins or nucleic acids using antibodies directed against the target of interest. These transfer membranes can be used for western blotting, northern blotting, southern blotting, dot/slot and immunoblotting.

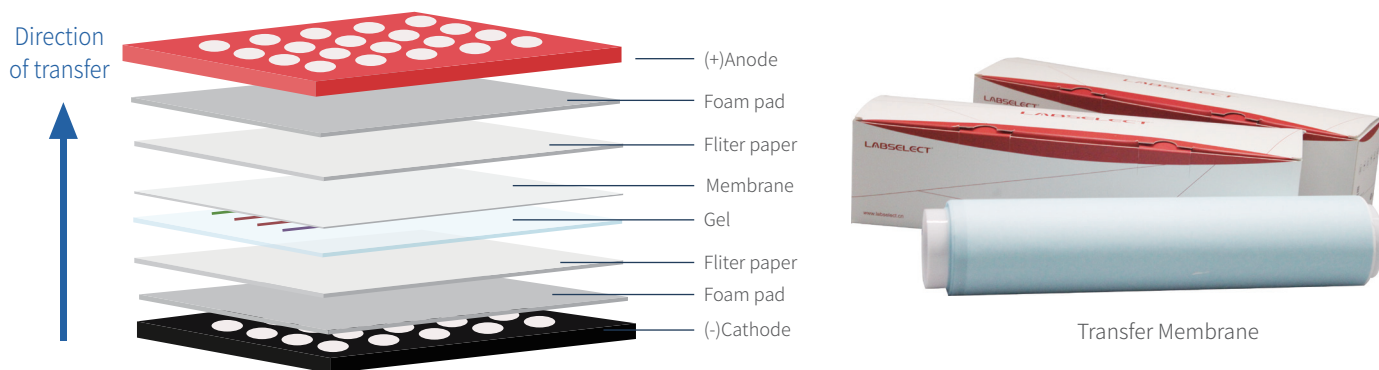

Nylon Transfer Membrane

Positively charged Nylon transfer membrane are intrinsically hydrophilic for easy wetting, will not crack, shrink, or tear when subjected to multiple cycles of hybridization, stripping. Positively charged Nylon transfer membrane for western blotting with Chemiluminescence, Radioactive & Fluorescent detection methods.

- Nylon transfer membrane are designed for multiple repeat hybridization detection
- Strengthen and durability preventing distortion or contamination in multiple reprobings
- Suited for all probes both radioactive and non-radioactive, including chemiluminescent and biotinylated detection systems

Ordering information

Cat.No.	Description	Size	Packaging
TM-NY-XS-45	Nylon transfer membrane, positively charged, 0.45µm	7.4cm*8.5cm	10pcs/unit
TM-NY-S-45	Nylon transfer membrane, positively charged, 0.45µm	10cm*15cm	1pc/unit
TM-NY-R-45	Nylon transfer membrane, positively charged, 0.45µm	30cm*3m	1roll/unit

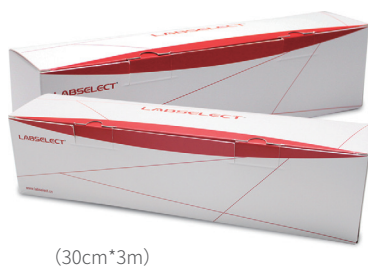

(30cm*3m)



(7.4cm*8.5cm)



(10cm*15cm)

PVDF Transfer Membrane

The higher mechanical strength and superior chemical resistance of PVDF membranes make polyvinylidene fluoride transfer membrane ideal for a variety of staining applications and reprobing in immunodetection. PVDF membranes offer better protein retention, physical strength and broad chemical compatibility. Naturally polyvinylidene fluoride is ideal for a wide variety of protein-analysis applications.

- PVDF membranes provide durability and high tensile strength for ease of handling
- Exceptional sensitivity detects low-level components
- Low extractables ensures tests will be clean with consistent results
- 0.22 μm pore size recommended for blotting proteins less than 20 kDa
- 0.45 μm pore size recommended for most western blotting, especially proteins greater than 20 kDa



Ordering information

Cat.No.	Description	Size	Packaging
TM-PVDF-XS-22	PVDF transfer membrane, 0.22 μm	7.4cm*8.5cm	10pcs/unit
TM-PVDF-XS-45	PVDF transfer membrane, 0.45 μm	7.4cm*8.5cm	10pcs/unit
TM-PVDF-S-22	PVDF transfer membrane, 0.22 μm	10cm*15cm	1pc/unit
TM-PVDF-S-45	PVDF transfer membrane, 0.45 μm	10cm*15cm	1pc/unit
TM-PVDF-R-22	PVDF transfer membrane, 0.22 μm	30cm*3m	1roll/unit
TM-PVDF-R-45	PVDF transfer membrane, 0.45 μm	30cm*3m	1roll/unit



LABSELECT®

Beijing Labgic Technology Co., Ltd.

Add: No.9 Yumin Street, Area B of the Airport Industrial Zone, Shunyi District, Beijing 101318 China

Toll Free: 400-600-4213

Website: www.labselect.cn



June, 2024