



HÄFELE

ER4800

# DIGITAL DOOR LOCK



USER MANUAL

# Before Using

---

## Product features

---



### Two way solution

Available to use secret code as well as card key.

---



### Random security coding function

When you enter your home with friends or other people, you don't want to show secret code to them. In this case, you may press any number randomly without limitation and then enter your secret code at final. Then, you can open the door without revealing your secret code.

---



### Individual management for card

Individual registration or delete of card is available.

---



### Auto lock / Auto re-lock function



When the door is closed, to be locked status automatically. And if users do not open the door after unlocking with password, etc, it is to be locked automatically for higher security.

---



### Double lock function

When double lock system is activated, the door can not be opened from outside even with the registered card key or secret code.

---



### Trespass alarm function

With 5 times of abnormal try with wrong number, function of door lock is suspended with alarm sound.

---



### Prevent mischief and hacking

The mortise lock of this product facilitates easy adjusting to left or right handle direction

---



### Low battery indicator and alarm for battery replacement time.

Low battery indicator with alarm sound shows battery replacement time.

---

## Safety precautions



Do not disassemble or alter the lock. Assembling or disassembling the door lock may damage the product. Damages to the product caused by unauthorized persons may result in damages to your property. Please contact our Customer Service.



If the product generates harmful gased or smoke, please remove the batteries immediately from the product. If you do not take this step immediately, the product may suffer severe damage.



Please keep the product away from water or any liquids. If the product is exposed to salty water or liquids, please wipe off the moisture with a soft cloth. If moisture or foreign material penetrate the product, remove the batteries immediately and contact the Service Agency or Customer Service Center for advice. Using a product contaminated with foreign materials may cause problems.



Please check the batteries every 6 months to see if the batteries are leaking and to check the cleanliness of battery terminals. If leakage is discovered, please wipe out with a dry cloth and replace the new batteries. In case of exposure to leakage, wash with soap and water immediately.



Do not clean the product with flammable materials such as alcohol, benzene or thinners. Such materials may damage the surface or cause a fire.



Batteries should not be exposed directly to heat sources or flames, or submerged in water, because they may leak or explode, resulting in severe damage. Please do not use damaged batteries.



Do not allow the battery electrodes to make contact with metals such as keys, as the battery may overheat, causing explosion or severe damage.



Please do not close the door with the deadbolt on the locked position. It may damage the product cause a malfunction.



Do not force to pull the front cover. It may damage the product or cause a malfunction.



Please do not mix old with new batteries or use different types. Always use new alkaline batteries. Please make sure the batteries are inserted correctly (+/-) as indicated in the battery compartment. Otherwise, it may cause a leaks or explosions.

# Before Using

---

## Before using

Product features .....	1
Safety precautions .....	2
Contents .....	3
Product composition and components .....	4
Name and function of each part – Front ass'y	5
Name and function of each part – Back ass'y	6
How to replace battery .....	7
How to apply external power in the emergency .....	7
How to use touch-pad and random security .....	8
How to change mode .....	9
(Normal mode > Safety mode)	
How to change mode .....	9
(Safety mode > Normal mode)	

## Basic function

Normal Mode .....	10	How to open from outdoor (secret code, card, mute function) .....	17
How to register secret code in normal mode .....	10	How to lock the door from outdoor .....	18
How to register card key in normal mode .....	10	How to lock the door from indoor .....	18
How to delete all card key in normal mode .....	11	How to set auto/manual locking system .....	18
Safety mode .....	12	How to open or close with thumb-turn from indoor .....	19
How to register secret code in safety mode .....	12	How to open or close with [Open/Close] button from indoor .....	19
How to register card key in safety mode .....	13	How to hold or release the user's secret code or card .....	19
How to delete all card data in safety mode .....	14		
How to delete individual card data in safety mode .....	14		
Guest secret mode (Temporary use) .....	15		
How to set manager in safety mode .....	16		
Change manager code in safety mode .....	16		
Changer manager card in safety mode .....	16		

## How to Install

How to Install .....	24-25
----------------------	-------

## Applications

How to set double locking function .....	20
Auto-locking system .....	20
Auto-relocking system .....	20
How to control volume level .....	21
Warning function against mischief or hacking .....	22
Warning alarm function against trespassing by force .....	22
System reset .....	23



## ✓ Product composition and components

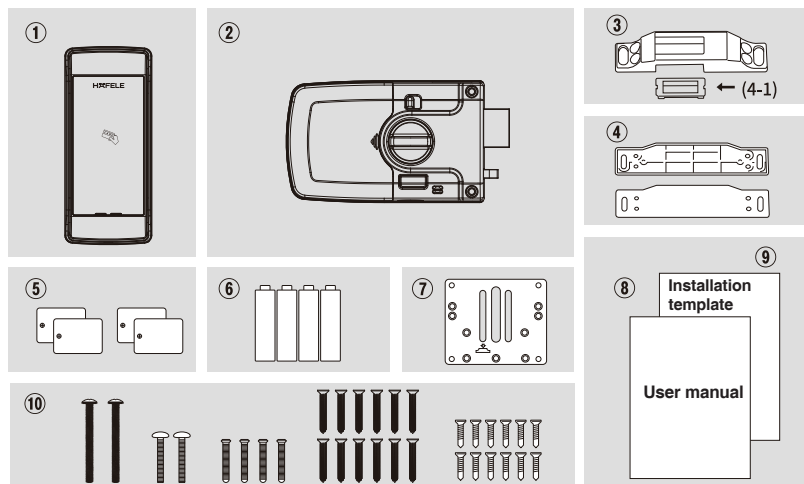

Name	Product specification	Remark
1. Front Ass'y	71.8mm (W) x 163.6mm (H) x 18.4mm (D)	Including rubber pad
2. Back Ass'y	154mm (W) x 93mm (H) x 37mm (D)	Including rubber pad
3. Strike	76mm (W) x 140mm (H) x 28mm (D)	
4. Strike spacer	31mm (W) x 140mm (H) x 2mm (D) 1EA 31mm (W) x 140mm (H) x 4.5mm (D) 3EA	Using for Height of strike
5. Card key	4EA	
6. Battery	4 pcs (1.5V, "AA" size, LR6 Alkaline)	
7. Mounting Plate	77mm (W) x 87mm (H) x 3mm (D)	
8. User manual	Main user manual	Including warranty form
9. Installation template e	Use for making hole at the door	
10. Screw	5 x 60mm 2EA : For back cover 5 x 30mm 2EA : For back cover 5 x 29mm 4EA : For inner upper part 4 x 30mm 12EA : For front/Back plate 4 x 19mm 12EA : For front/Back plate	TH M5 x 60mm TH M5 x 30mm OH M5 x 29mm FH T4 x 30mm FH T4 x 19mm
11. Door thickness	For 40~50mm	

(4-1) Dead Bolt Guider : Should remove after finishing installation.

## Before Using

### ✓ Name and function of each part - Front ass'y

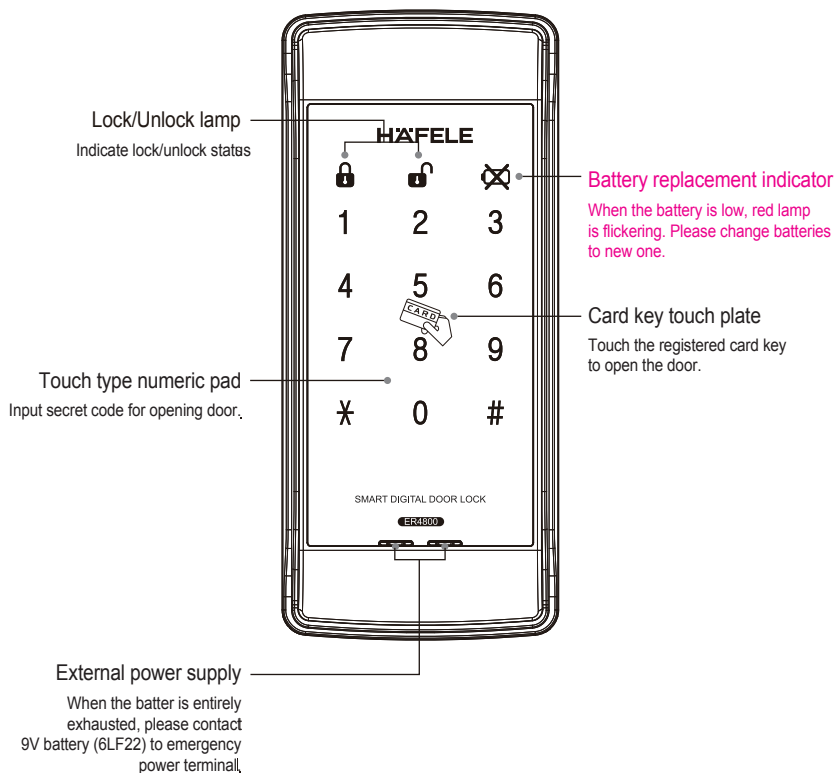



## Name and function of each part - Back ass'y

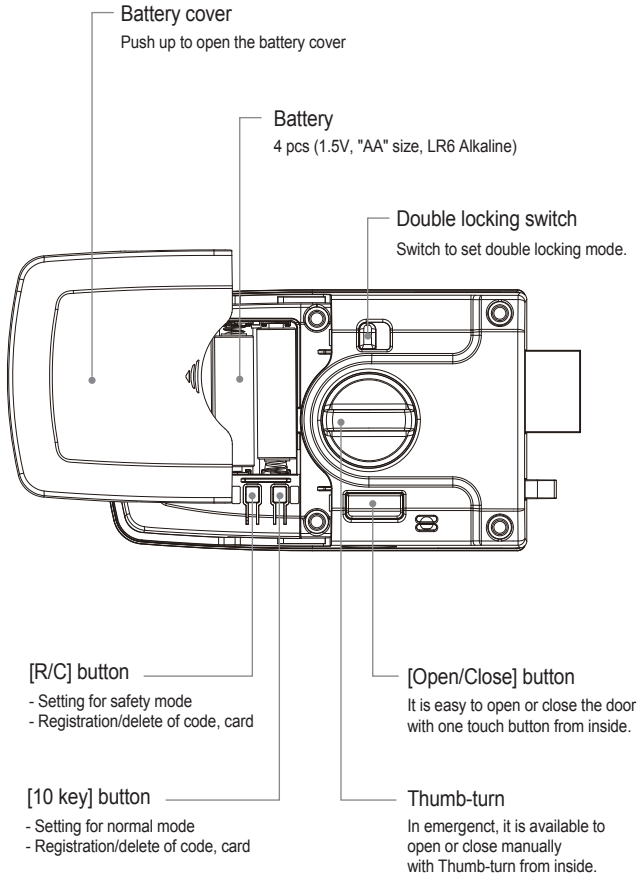

## Before Using

### ✓ How to replace battery

If battery lamp in RED is flickering with sound, Replace all 4 batteries to new one. (1.5V, "AA" size, LR6 Alkaline)

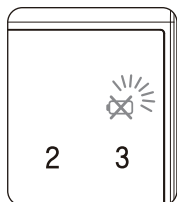

If battery lamp is flickering with sound

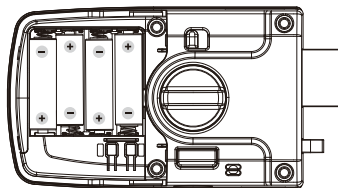

Replace batteries in same position as like above picture.

### ① Note

- Life of battery is around one year based on 10 times of uses a day.
- Battery life can be vary depending on battery's manufacturer, production date, installed environment and usage frequency.
- Do not use rechargeable battery.
- Leakage on battery can be caused and it is very harmful for door lock's operation. Please check batteries periodically (at least every 6 months) and if there is any of leakage on battery, replace all to new batteries.

### ✓ How to apply external power in the emergency

When the battery is entirely exhausted and door lock is not activated, please contact 9V (6LF22) battery to external power supply.

Once the door lock is activated, open the door by secret code and replace the batteries in back ass'y.

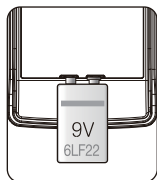

Contact 9V battery to electrode



Input secret code  
(Ex:123456)

OR



Touch the card

### ① Note

- Position of polarity is in regardless.
- Please use 9V battery only in case the batteries are exhausted entirely.

## ✓ How to use touch-pad and random security coding function

Random security coding function - Press any number randomly without limitation and then enter your secret code at final. With this function, you can open the door without revealing your secret code to others.

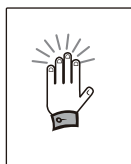

Touch the front pad

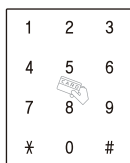

Numeric buttons are displayed

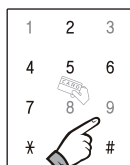

Press random code (Ex : 1389)  
Press secret code (Ex : 123456) and [\*].  
Pull down the handle, then door is opened.

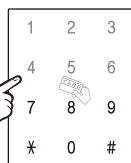

### ⓘ Note

- Do not wear gloves during operation for touch pad.
- When you use random security coding function, actual secret code shall be entered at final.
- Please use soft cloth when you clean touch pad

# Before Using

## ✓ How to change mode (Normal mode → Safety mode)

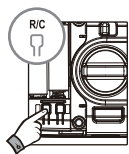

Open battery cover.  
Press [R/C] button  
for 5 sec. (Bik~Bik~)

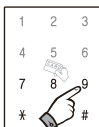

Enter Secret Code.  
(Ex : 123456)



Press [#]  
(Brik~)

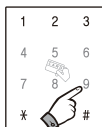

Enter  
New Manager Code.  
(Ex : 456789)



Press [#]  
(Brik~Brik~)

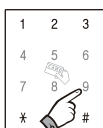

Enter New Manager  
Code again.  
(Ex : 456789)



Press [#]  
(Briirik~)

## ✓ How to change mode (Safety mode → Normal mode)

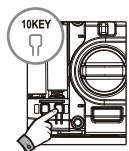

Open battery cover.  
Press [10Key] button  
for 5 sec. (Bik~Bik~)

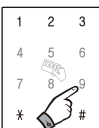

Enter Manager Code.  
(Ex : 456789)



Press [#]  
(Brik~)

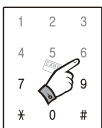

Enter  
New Secret Code.  
(Ex : 123456)



Press [#]  
(Brik~Brik~)



Enter New Secret  
Code again.  
(Ex : 123456)



Press [#]  
(Briirik~)

## ⓘ Note

- Manager code & manager card shall be controlled by authorized person for security.
- Existing secret code, card are deleted automatically after registration of new manager code.
- Only one of manager code can be registered with 6 ~ 12 digits.
- After input manager code which was used at safety mode and press [#], all code/card which were registered at safety mode shall be deleted. Newly registered code is for usage at normal mode.
- Max. 10EA of Secret code can be registered with 6 to 12 digits.
- To register multiple code, input new secret code and press successively.
- Previous code is deleted automatically with registration of new code.
- Please do the change / registration of new code at door opened status to prevent unintentional locking.
- After changing secret code, please verify it by unlocking with new secret code.

## Normal Mode

### How to register secret code in normal mode

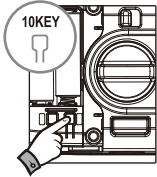

Open battery cover and press [10key] button shortly. (Bik)

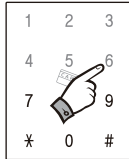

Press new secret code. (Ex : 123456)

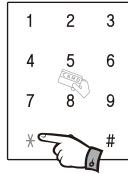

Press [\*] (BrikBrik)

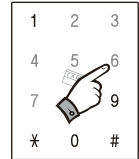

Press new secret code. (Ex : 234567)

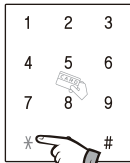

Press [\*] (BrikBrik)

...  
To register more secret code (Max.10EA of secret code can be registerd)



Complete registration by [\*]

### Note

- Factory setting (Mode : Normal mode, Secret code : 123456)
- Max. 10EA of Secret code can be registered with 6 to 12 digits.
- To register multiple code, input new secret code and press [ ] successively.
- Previous code is deleted automatically with registration of new code.
- Please do the change/registration of new code at door opened status to prevent unintentional locking.
- After changing secret code, please verify it by unlocking with new secret code.

### How to register card key in normal mode

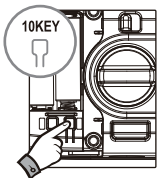

Open battery cover and press [10key] button shortly. (Bik)

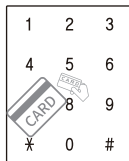

Touch the card key one by one.



Max.50EA of User card key can be registerd.

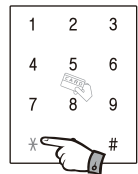

Complete registration by [\*]

## Basic function

### How to delete all card key in normal mode

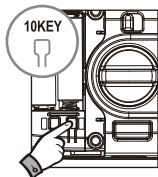

Open the battery cover and press [10KEY] button shortly. (Bik~)

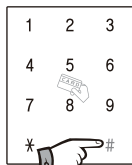

Press [\*]

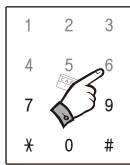

Input registered secret code. (Ex : 123456)

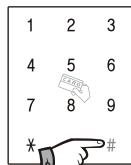

Press [#]

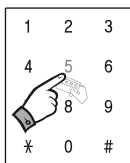

Press [5]

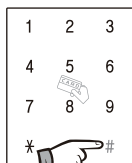

Press [\*]

Delete confirm (Biririk~)

#### ! Note

- Previous card key memory is deleted automatically after registration of new card key.
- To register multiple secret code, press new secret code successively and press [\*].
- To finish registration, please press [\*] one more time.
- Max. 50 card keys can be registered.
- For high security, please use cards which are supplied by HÄFELE.



## Safety Mode

### ✓ How to register secret code in safety mode

⚠ Manager code & manager card shall be controlled by authorized person for security.

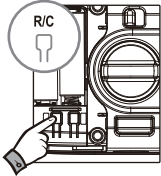

Open the battery cover and press [R/C] button shortly. (Bik~)

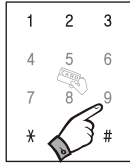

Registered manager code (Ex : 456789) or manager card

or

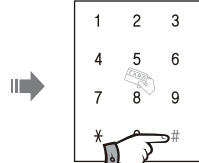
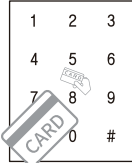

Press [#]

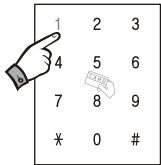

Press [1]

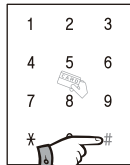

Press [#]

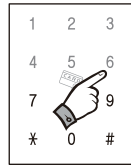

Input new secret code. (Ex : 123456)

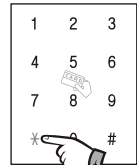

Press [\*] (BirikBirik)

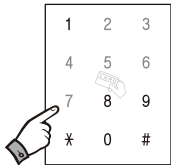

Input new secret code. (Ex : 234567)

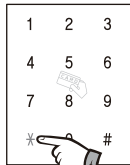

Press [\*] (BirikBirik)

...  
To register more secret code (Max.10EA of secret code can be registerd)

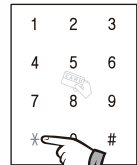

Press [\*]  
Complete with sound (BirikBirik)

#### ① Note

- Max. 10EA of Secret code can be registered with 6 to 12 digits.
- To register multiple code, input new secret code and press [\*] successively.
- To finish registration, please press [\*] one more time.
- Previous code is deleted automatically with registration of new code.
- Please do the change/registration of new code at door opened status to prevent unintentional locking.
- After changing secret code, please verify it by unlocking with new secret code.

# Basic function

## How to register card key in safety mode

**!** Even though new card is registered, previous card data is not deleted.  
If same registration number is applied, hold registration mode with warning sound.

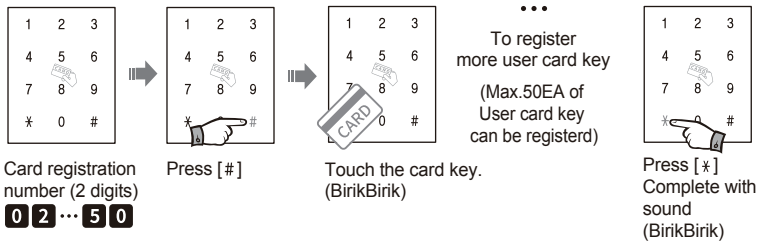
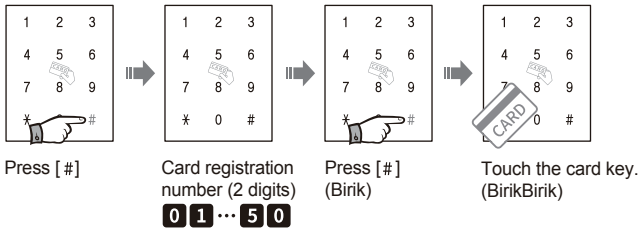
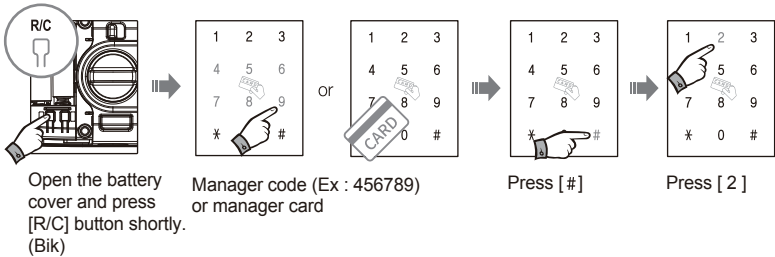

### Note

- To register multiple card, repeat to input new registration number and touch the another card key successively.
- To finish registration, please press [\*] one more time.
- Registration number shall be two digits. (01 ~ 50)  
(Ex : 1 => 01, 2 => 02, etc.)

## ✓ How to delete all card data in safety mode

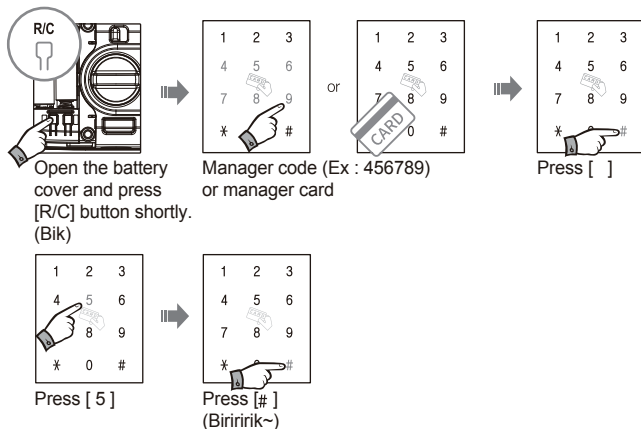

## ✓ How to delete individual card data in safety mode

**i** It is not available to delete multiple individual card data in one time.

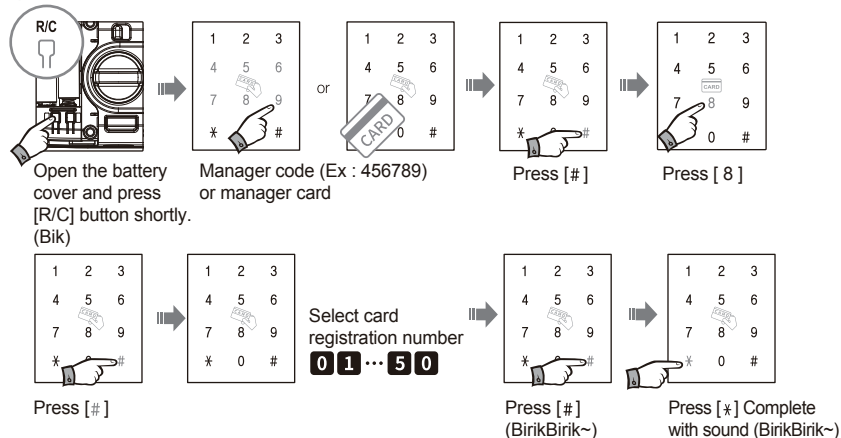

### ⚠ Note

- To use this function, manager has to remember the exact registration number of each user card.
- If there is no card data on certain registration number, warning sound will be caused. (Bik~Bik~)

## Basic function

### ✔ Guest secret code (Temporary use)

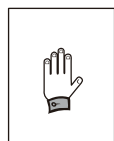

Touch the front pad

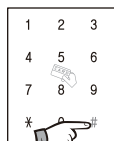

Press [#]

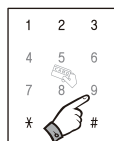

Input manager code (Ex : 456789)  
or touch the manager card

or

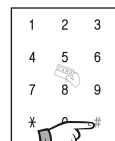
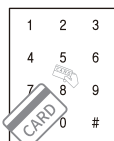

Press [#]

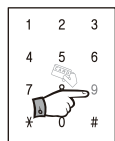

Press [9]

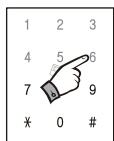

Input guest  
secret code

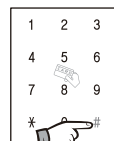

Press [#]

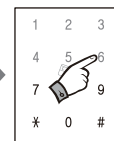

Input guest  
secret code

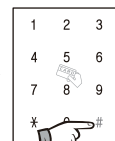

Press [#]

#### ① Note

- Guest secret code is for temporary use. Once a guest opens the door, this code is deleted.
- Guest secret code function is only available in safety mode.
- Only one code can be registered with 6 ~ 12 digits.
- For guest secret code, random security coding function is not available.

## How to set manager in safety mode

### ✓ Change manager code in safety mode

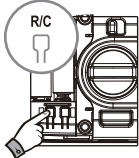

Open the battery cover and press [R/C] button shortly. (Bik)

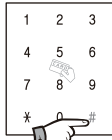

Press [#]  
(Bik)

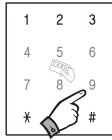

Manager code  
(Ex : 456789)



Press [#]  
(Brik~)

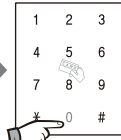

Press [0]



Press [#]  
(Bik)



Input new manager  
code (Ex : 567890)



Press [#]  
(Brik~Brik~)



Input new manager  
code (Ex : 567890)

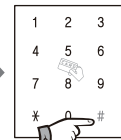

Press [#]  
(Briirik~)

### ✓ Change manager card in safety mode

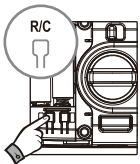

Open the battery cover and press [R/C] button shortly. (Bik~)

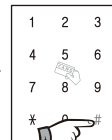

Press [#]  
(Bik)

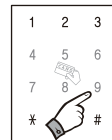

Manager code  
(Ex : 456789)

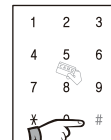

Press [#]  
(Bik)

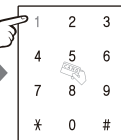

Press [1]

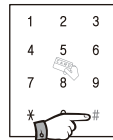

Press [#]  
(Bik)



Touch new manager  
card (BirikBirik~)



Max. 3EA of Master  
Cards can be registered.

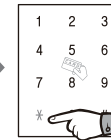

Press [\*]  
(Bik)

#### ⓘ Note

- Only one manager code available.
- Manager code can be registered with 6 to 12 digits.
- Max. 3EA of manager cards can be registered.
- Previous manager cards are deleted automatically with registration of new manager card.
- To register multiple manager card, register Max. 3EA successively and press [ ].

# Basic function

## How to open from outdoor (Secret code, card, Mute function)

### 1. Open the door using secret code

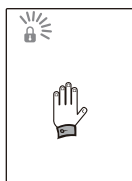

Touch the front pad

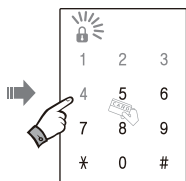

Enter secret code  
(Ex : 123456)

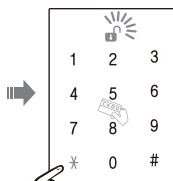

Press [\*] and door  
is unlocked  
(Biriririk~)

### 2. Open the door using card key

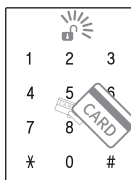

Touch the registered  
card key to card  
contact point

### 3. Open the door with mute function (No sound)

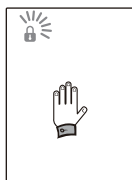

Touch the numeric pad  
for about 3 second.  
Numeric pad is flickering  
two times.

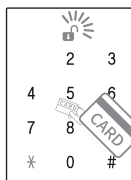

Touch the registered  
card key to card  
point

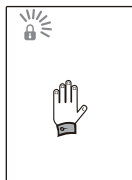

Touch the numeric pad  
for about 3 second.  
Numeric pad is flickering  
two times.

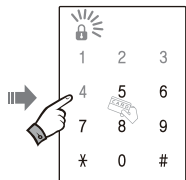

Enter secret code  
(Ex : 123456)

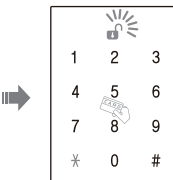

Press [\*] and door  
is unlocked  
(Biriririk~)

## ✓ How to lock the door from outdoor

### 1. Lock the door at auto-locking mode

When the door is closed, it is locked automatically with beeping sound.



※ If the door is not closed correctly, warning sound can be caused. Please check and confirm the door closing status.

### 2. Lock door at manual-locking mode

At manual-locking mode, door is not locked automatically even though the door is closed.

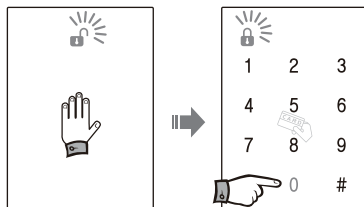

Close door and touch the front pad

Press [ 0 ] button, then door will be locked

## ✓ How to lock the door from indoor

### 1. In auto-locking mode

When the door is closed, door is locked with beep sound automatically

### 2. In manual-locking mode

After closing door, press [Open/Close] button, then door is locked with beep sound. (Biririk- )

## ✓ How to set auto/manual locking system

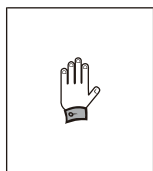

Touch the front pad

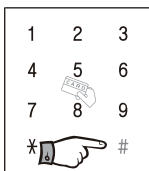

Press [#]

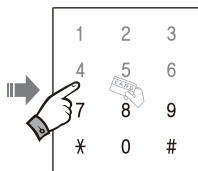

Input secret code (Ex : 123456)  
or Touch the card key

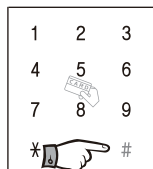
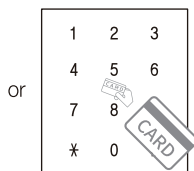

Press [#]

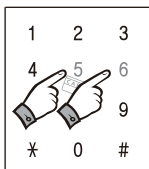

5 : [Auto-locking] mode  
6 : [Manual-locking] mode

※ In Auto-locking mode, door will be locked automatically after closing.  
In Manual-locking mode, door will be locked with pressing manual lock button after closing.

# Basic function

## How to open or close with thumb-turn from indoor

The lock can be locked or unlocked by turning the thumb-turn.

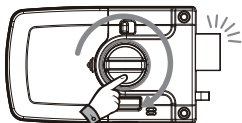

Turn to clockwise, it will be unlocked

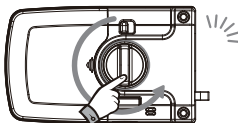

Turn to counterclockwise, it will be locked.

## How to open or close with [Open/Close] button from indoor

If you press [Open/Close] button, it is locked or unlocked automatically

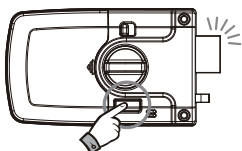

Press in locked status, it will be unlocked.

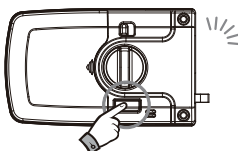

Press in unlocked status, it will be locked.

## How to hold or release the user's secret code or card

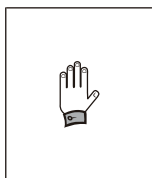

Touch the front pad

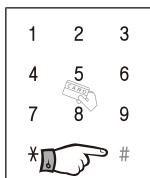

Press [#]

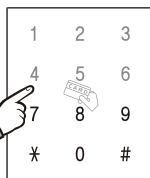

Input secret code (Ex : 123456)  
or Touch the card key

or

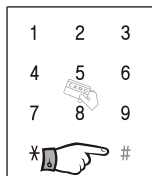
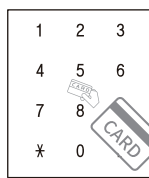

Press [#]

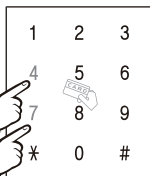

4 : [Hold] mode  
7 : [Release] mode



## ✓ How to set double locking function

In [Double lock] mode, function of door lock is suspended and can't open the door from outside.

※ Please set this function after the door is closed.

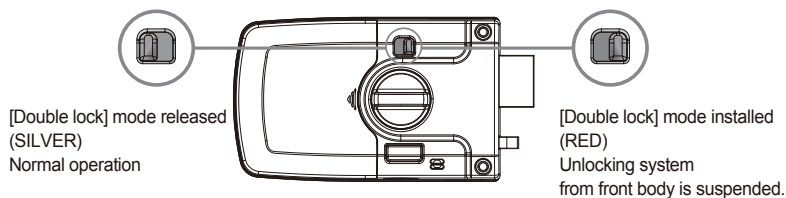

### ① Note

- In [Double Locking] mode, from indoor, you can release lock by the use of thumb-turn.
- Intrusion alarm function still activating while [Double Locking] mode.
- When volume is set to "mute", only the indicating lamp of [Double Locking] mode is flickering without sound.
- Even in door is opened status, [Double locking] mode can be installed.

## ✓ Auto-locking system / Auto-relocking system

### 1. Auto-locking system

When the door is closed,  
it will be locked automatically  
(Please refer to page 00 for setting method.)

### 2. Auto-relocking system

If the door is not opened within 7 seconds  
after input secret code, it will be relocked  
automatically to protect user's property.

### ① Note

- Auto-relocking system is different from "Auto-locking".
- This is fixed function and can't be released.

# Application

## ✓ How to control volume level

Sound volume can be controlled by 8 levels. (Mute to maximum level)

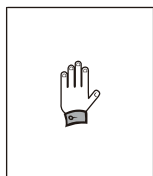

Touch the front pad

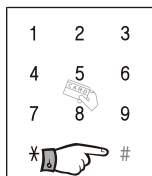

Press [#]

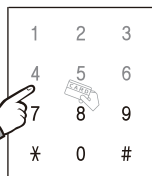

Input secret code (Ex : 123456)  
or Touch the card key

or

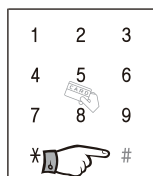
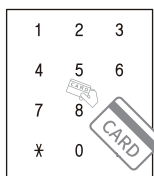

Press [#]

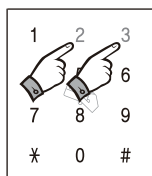

2 : Volume down  
3 : Volume up

※ Press 1 to make maximum level and press 0 to make mute in one time.

### ! Note

· In mute status, numeric lamp is flickering with entering secret code.

## Warning function against mischief or hacking

If wrong secret code or unregistered card is applied over 3 times, alarm system is activated with warning sound and all the function of door lock is suspended for one minute.

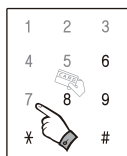

Applying wrong secret code over 3 times

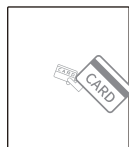

Applying unregistered card key over 3 times

♪Biyooong~ Biyoong~

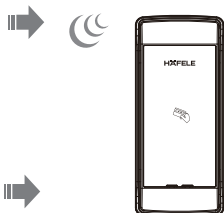

After warning sound, function of door lock is suspended.

How to release the suspended lock function

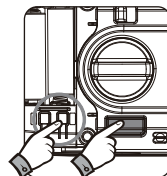

Press [Open/Close] button or [10Key] button, then suspended function is released.

## Warning alarm function against trespassing by force

Once the door is locked, alarm system is activated in 5 seconds.

If there is any trying of trespassing by force, it is warning with strong alarm sound for 3 minutes.

♪Biyooong~ Biyoong~

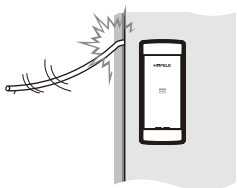

How to release warning sound

1. Touch the card key
2. Input secret code

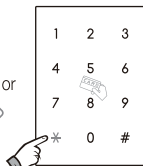
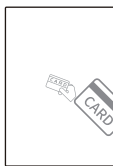

Touch the card key Or press [\*]



Input secret code (Ex : 123456)

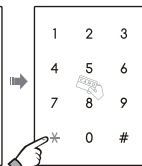

Press [\*] again. Warning sound will be stop

### Note

- With applying wrong code for 3 times or unregistered card for 3 times, alarm system is activated with warning sound and all the function of door lock is suspended for 3 minutes.
- In case warning function against mischief/hacking is activated, it will be released after 3 minutes.
- Warning status can be released by [Manual lock] button.
- Trespass warning alarm continues for 3 minutes.
- If the trespass warning alarm is released by secret code or card key, system return to normal status.

# Application

## System reset

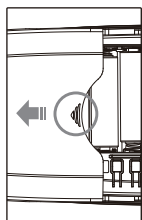

Open battery cover

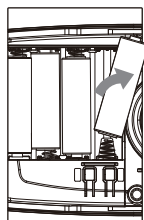

Remove battery ①&②

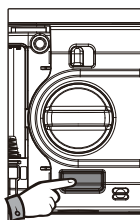

Press open button to make it discharged entirely.

### Safety mode

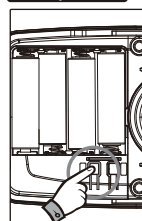

Pressing [R/C] button,

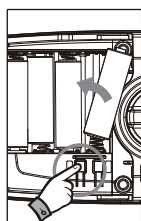

Insert batterie,

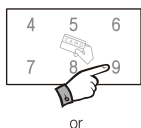

Input manager code  
or touch manager card.

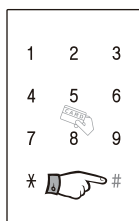

Press [#] button  
for 3 seconds.  
System reset is completed.

### Normal mode

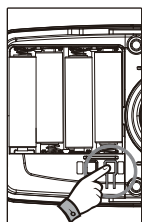

Pressing [10Key] button,

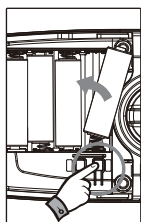

Insert batterie.

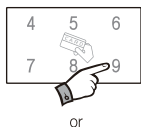

Input user code  
or touch user card.

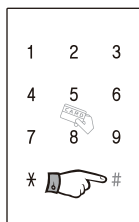

Press [#] button  
for 3 seconds.  
System reset is completed.

No.	Item	Setting
1	Master code	Deleted
2	Master card	Deleted
3	User secret code	Deleted
4	User card	Deleted
5	Sound volume	Level 8
6	Auto/Manual locking	Manual locking
7	Suspend user code/card	Released

※ After reset, all secret code, card are deleted.  
So, new secret code, card shall be registered for proper operation.