

INDUSTRIAL SOLUTION  
**BKvalve**

## MOTORIZED VALVE operation manual

หัวขับเคลื่อน/ปิด วาล์วทำงานด้วยระบบไฟฟ้า on/off ISO5211



## CONTENTS

Product Introduction	2
Dimension of 02/05/10/20/40/60 Series	3-4
Performance Parameter of 02/05 Series	5-6
Performance Parameter of 10/20/40/60 Series	7-8
Performance Parameter of 100/200 Series	8
Performance Parameter of Modulating Type	9
Wiring Diagram	10-12
Power, Voltage and Installation	12
Adjustment of On-off Type	14
Adjustment of Potentiometer and Modulating Type	16-19
Model Selection	20
Failure and Countermeasure	23
Dimension product CAD drawing	26-28
Electronic circuit control Wiring Diagram CAD drawing	29-37

## Product Introduction

The Electric Actuator is distinguished by its special design, beautiful appearance, great performance and long-time operation. The rotary valve electric actuator will win customers' hearts by its supreme performance.

**Powerful function:** Modulating, proportional, on-off, and various output signally

**Small Size:** 35% smaller than other of the same kind;

**Lightweight:** 35% lighter than other of the same kind:

**Beautiful Appearance:** Die-casting aluminum alloy cover can prevent disturbance of electromagnetic;

**Precision and Wear-resistance:** Integration of worm wheel and output axle avoids the separation among keys and the forged brass alloy material is featured by high strength and good wear-resistance;

**Safety Guarantee:** Tested by AC 1500V and can withstand it; F-grade insulation motor guarantees safe operation;

**Easy to Form Complete Set:** 110 v, 220V, 380V alternate current and direct current are all available for simple connection;

**Easy Application:** No oil or point inspection is needed; waterproof, antirust and optional installation angle;

**Protection Appliance:** Double limits, over-hot protection, Overload protection;

**Various Motion Time:** 9s, 13s, 15s, 30s, 50s, 100s (Set Before Delivery);

**Antirust and Anti-corrosion:** Whole machine support, coupler and screws are made of stainless steel;

**Intelligent Numerical Control:** Intelligently control module is built in the actuator body so that there is no need to mount positioner. Digit setting and adjusting, highly accusation and self-diagnosis can be realized.

### Appearance and Parts Name

1	Case Body
2	Opening Mete
3	Inlet Wire Lock
4	Rubber Cover of Handle Shaft
5	No-Bracket Installation
6	Gear Box Cover
7	Electric Cover
8	Wiring Cover
9	Handle Shaft Cover
10	Output Shaft
11	Adapter

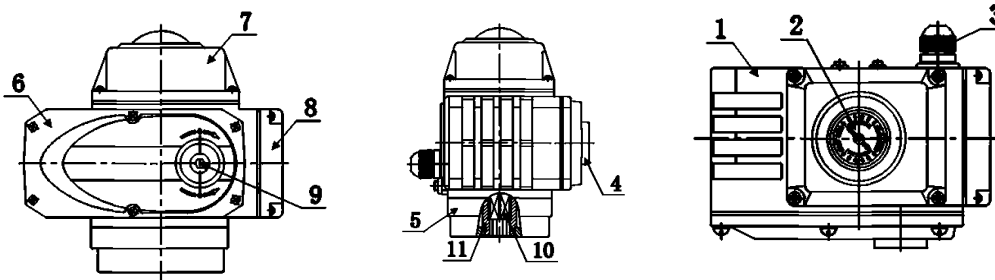

### Overall Dimension

<p>KL-02</p>				
<p>KL-05</p>				
<p>KL-10</p>				

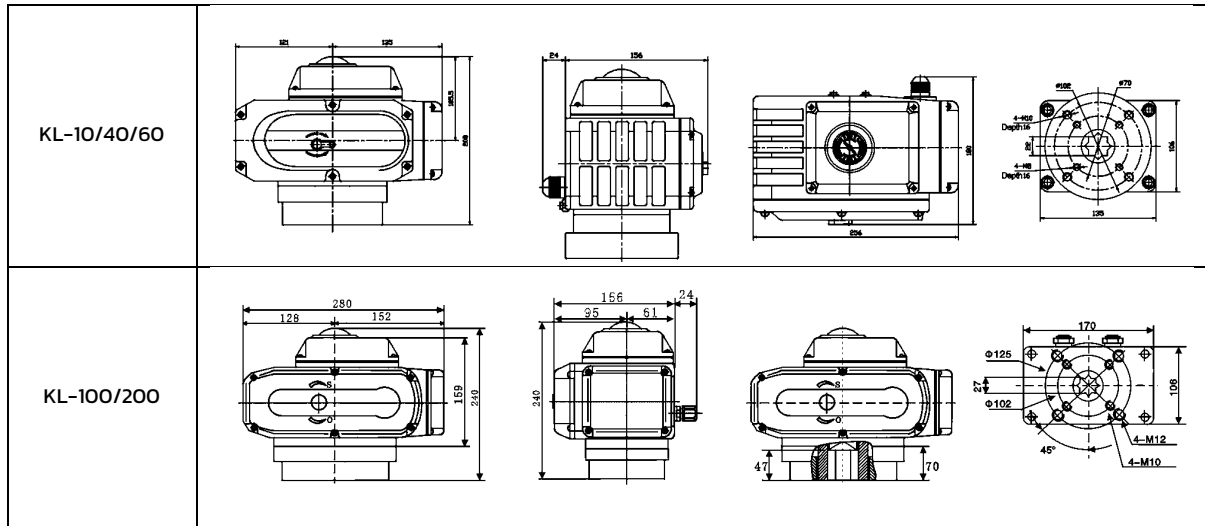

หัวขับ KL-05  
24VDC แรงบิด 50  
นิวตัน/เมตร  
ประกอบกับ บอล  
วาล์วบอลวาล์ว  
สแตนเลส 3 ชั้น

Electric motor actuator [KL-05 24VDC](#) Install ball valve 3pc stainless steel iso 5211

**KL-O2 Performance Parameter**

<b>Model</b>	<b>KL-O2</b>
Power Supply(V)	AC85-260
Output Torque(N.m.)	6
Motion Scope( ° )	0-90
Motion Time(S)	7 (second)
Rated Current(A)	0.2
Drive Motor(W)	4.6
Protection Device	Motor Protection Thermistor, Mechanical Limit Block at Both Open and Close Side
Opening Detection	Position Detection Components for Full Open and Close: a. Full Open: Red(LED) b. Full Close: Green(LED)
Output Signal	Output Signals for Full Open and Close (NPN Transistor, Collector Current, Emission stage) (Connection Capacity: DC50V,20mA)
Application Environment	Tempest) --+55°C Humidity: 10-90%RH
Output Shaft	SUS303, (t>:12, Pit:5, Depth:5)
Handle Shaft	Hexagon Hole Opposite Angle: 4mm (With Lid)
Waterproof	JIS C0920 Grade 6 (IP 65)
Install direction	360-Degree Optional Direction
Distribution Cable	0.3 X 6 Core Cable 30cm
Body Material	Die-Casting Aluminum Alloy
Color of Coating	Gray and White
Weight(kg)	0.5



**KL-05 Performance Parameter**

<b>Model</b>	<b>KL-05</b>				
Power Supply(V)	DC24	AC24	AC110	AC220	AC380
Output Toque(Nm)	50				
Motion Times(S)	7	20			
Rotary Angle ( ° )	0-360				
Motor Power(W)	10	15			
Rated Current(A)	0.5	2.2	0.48	0.24	0.15
Weight(kg)	2.3	2.7			
Insulation Resistance (MO)	DC24V: 100/250VDC AC110/220V/380V: 100/500VDC				
Voltage Resistance Class	DC24V: 500VAC, AC110/220V: 1500VAC, AC380V: 1800VAC. (1 Min.)				
Protection Class	IP68				
Installation Position	Optional Direction: 360°				
Electrical Connection	M18 X 1.5 Water-proof Cable Connectors, Electric Power Wire, Signal Wire				
Ambient Temp.	-3013--6013				
Circuit Control	B, S, K, R, A, D, H, T				
Optional Function	I. Over Torque Protectors II. Dehumidify Heater				



**KL-10 Performance Parameter**

<b>Model</b>	<b>KL-10</b>				
Power Supply(V)	DC24	AC24	AC110	AC220	AC380
Output Toque(Nm)	100				
Motion Time(S)	10	30			
Rotary Angle (°)	0-360				
Motor Power(W)	20	25			
Rated Current(A)	0.85	3	0.7	0.32	0.2
Weight(kg)	4	4.3			
Insulation Resistance (MQ)	DC24V: 100/250VDC AC110/220V/380V: 100/500VDC				
Voltage Resistance	DC24V: 500VAC, AC110/220V: 1500VAC, AC380V: 1800VAC.(1Min.)				
Protection Level	IP68				
Installation Position	360-Degree Optional Direction				
Electrode connection	M1815 Water-proof Cable Connector, Electric Power Wire, Signal Wire				
Ambient Temp.	-30t; - +60°C				
Circuit Control	B, S, K, R, TA, D, H				
Optional Function	I. Over Torque Protectors II. Dehumidify Heater				





**KL-20/40/60 Performance Parameter**

Model	KL-20					KL-40					KL-60				
	DC24	AC24	AC110	AC220	AC380	DC24	AC24	AC110	AC220	AC380	DC24	AC24	AC110	AC220	AC380
Power Supply(V)	DC24	AC24	AC110	AC220	AC380	DC24	AC24	AC110	AC220	AC380	DC24	AC24	AC110	AC220	AC380
Output Toque(Nm)	200					400					600				
Motion Time(S)	12	30/60				15	30/60				20	45/60			
Rotary Angle (°)	0-90					0-90					0-90				
Motor Power(W)	40					70	90				90				
Rated Current(A)	1.2	7.5	1.6	0.88	0.4	2.5	9	2.2	1	0.48	2.5	9	2.2	1	0.5
Weight(kg)	8.7	9.3				8.8	10				8.8	10			
Insulation Resistance (MQ)	DC24V: 100/250VDC AC110/220V/380V: 100/500VDC														
Voltage Resistance	DC24V: 500VAC AC110/220V: 1500VAC AC380V: 1800VAC. ( 1 Minute)														
Protection Class	IP68														
Installation Position	360-Degree Optional Direction														
Electrical Connection	M1815 Water-proof Cable Connectors, Electric Power Wire, Signal Wire														
Ambient Temp.	-30tI - +60t														
Circuit Control	B, S, K, R, A, D, H, T														
Optional Function	I. Over Torque Protectors II. Dehumidify Heater														

**KL-100/200 Series Performance Parameter**

Model	KL-100				KL-200			
	AC24	AC110	AC220	AC380	AC24	AC110	AC220	AC380
Motor Power(W)	100				100			
Rated Current(A)	9	2.2	1.2	0.48	9	2.2	1.2	0.48
Output Torque(Nm)	800/1000				2000			
Motion Time (S)	30/50				100			
Circuit Control	B, S, K, R, A, D, H, T							
Rotary Angle (°)	0-90							
Weight(kg)	11.2				11.8			
Voltage Resistance	AC110V/AC220V:1500VAC, AC380V:1800VAC(Minute)							
Insulation Resistance(MQ)	100MD/500VDC							
Protection Class	IP-68							
Ambient Temp.	-30t~+60°C							
Installation Angle	360-Degree Optional Direction							
Case Body Material	Die-Casting Aluminum Alloy							
Optional Function	I. Over Torque Protectors II. Dehumidify Heater							

Performance Parameter of Modulating Type

	05A	10A	20A	40A	60A	100A	200A
	DC24V/AC24V, AC 110V, AC220V, AC380V, 50/60HZ						
Motor Power (w)	15W	25W	40W	90W	90W	100W	100W
Rated Current (A)	0.24A (AC220V)	0.32A (AC220V)	0.88A (AC220V)	(AC220V)	(AC220V)	(AC220V)	(AC220V)
Output Torque (N.m.)	50Nm	100 Nm	200 Nm	400 Nm	600 Nm	1000 Nm	2000 Nm
Motion Time (S)	20S	30S	30S	30S	45S	50S	100S
Rotary Angle (°)	0-360°			0-90°			
Input Signal	4~20mA.DC 1~5V.DC 0-10V.DC ( others could be set before delivery)						
Output Signal	4~20mA.DC ( Others could be set before delivery)						
Precision Grade	1%						
Weight	2.7kg	4.3kg	9.3kg	10kg	10kg	11.2kg	11.8kg
Voltage Resistance	DC24V:500VAC/1 min			1500VAC/1min			
Insulation Resistance	DC24V: 100M Q/300VDC			100M D/500VDC			
Protection Class	IP-68						
Ambient Temp.	-30°C~+60°C						
Installation Angle	360-Degree Optional Direction						
Case Body Material	Die-Casting Aluminum Alloy						
Optional Function	I. Over Torque Protectors II. Dehumidify Heater						

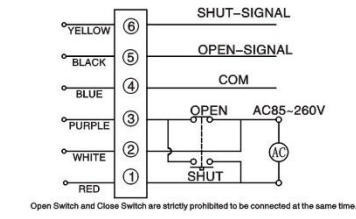
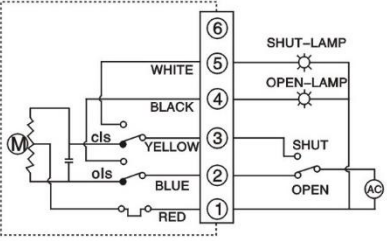
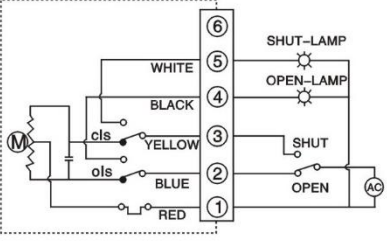
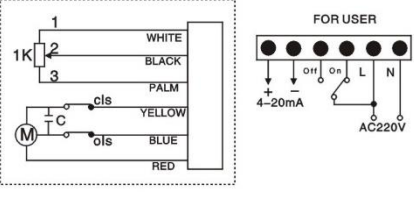

## Wiring Diagram

 <p>Open Switch and Close Switch are strictly prohibited to be connected at the same time.</p>	<p><b>Z: O2 On-Off Type</b></p> <p>The actuator is equipped with dedicated cable (30cm) to distribute wiring for power and full closed &amp; full open output signal (NPN Transistor&amp; Collector Current).</p> <p><b>Wiring Instructions:</b></p> <ol style="list-style-type: none"> <li>1. Wiling distribution shall be conducted by qualified electrical engineer in accordance with electrical equipment technical standard.</li> <li>2. It's prohibited to conduct wiring distribution when it's raining or the air is highly humid.</li> <li>3. Make sure the wiring diagram IS correctly connected.</li> <li>4. Dedicated cable is built in the actuator so that internal wiring is not needed.</li> <li>5. Top cover is strictly forbidden. (Cable is already available)</li> <li>6. It's strictly forbidden to connect open Switch and Close Switch simultaneously when the power is on.</li> </ol>
	<p><b>B: On-Off Type (Standard)</b></p> <p>Valve can be controlled to open and close by the on-off circuit and the circuit will output a group of active position signal to indicate the valve is in full close or full open position.</p> <p><b>Wiring Instruction:</b></p> <ol style="list-style-type: none"> <li>1. Connect terminal 1 with null line.</li> <li>2. When terminal 2 connects with phase line, it indicates "Opening*" is in operation.</li> <li>3. When terminal 3 connects with phase line, it indicates "Closing" is in operation.</li> <li>4. When "Opening finishes its operation, the signal lamp connected with terminal 4 will be on.</li> <li>5. When "Closing finishes its operation, the signal lamp connected with terminal 5 will be on.</li> </ol>
	<p><b>S: Passive Contact Type</b></p> <p>Valve can be controlled to open and close by the on-off circuit and the circuit will output a group of passive position signal to Indicate the valve is in full close or full open position.</p> <p><b>Wiring Instruction:</b></p> <ol style="list-style-type: none"> <li>1. Connect terminal 1 with null line.</li> <li>2. When terminal 2 connects with phase line, it indicates "Opening" is in operation.</li> <li>3. When terminal 3 connects with phase line. It Indicates "Closing" is in operation.</li> <li>4. Terminal 4 is the passive contact common port.</li> <li>5. When "Opening finishes its operation, terminal 5 will output Fully Open Signal.</li> <li>6. When "Closing finishes its operation, terminal 5 will output Fully Close Signal.</li> </ol>
	<p><b>K: With Position Generator Type</b></p> <p>Valve can be controlled to open and close by the on-off circuit and the circuit will output current signal corresponding to the openness angle of valve.</p> <p><b>Wiring Instruction:</b></p> <ol style="list-style-type: none"> <li>1. "N" IS null line and "L" is phase line.</li> <li>2. When "L" is connected with "On", valve is in open operation.</li> <li>3. When "L" is connected with "Off", Valve is in close operation.</li> <li>4. Connect "+" of output terminal with the positive pole of output signal and with negative pole of output signal.</li> </ol>

	<p><b>R: Opening Signal Type</b></p> <p>Valve can be controlled to open and close by the on-off circuit and the circuit will output resistant signal corresponding to the openness angle of valve.</p> <p><b>Wiring Instruction:</b></p> <ol style="list-style-type: none"> <li>Terminal 1 connect with null line. Terminal 5 is the lift arm of potentiometer.</li> <li>When terminal 2 connects with phase line, valve will open; when terminal 3 connects with phase line, valve will close.</li> <li>Terminal 4 is the low side of potentiometer. When valve opens, the resistance between terminal 4 and 5 will increase with the opening degree.</li> <li>Terminal 6 is the high side of potentiometer. When valve close, the resistance between terminal 4 and 5 will increase with the closing degree.</li> </ol>
	<p><b>A: Modulating Type</b></p> <p>The opening or closing is realized by the standard signal through external computer or industry meter. Meanwhile, the corresponding standard signals will be output.</p> <p><b>Wiring Instrument:</b></p> <ol style="list-style-type: none"> <li>Connect "N" of input terminal with null line and "L" with phase line.</li> <li>Connect the "+" of external control terminal with positive pole of input signal, with negative pole of input signal.</li> <li>Connect the "+" of feedback terminal with positive pole of input signal, "-" with negative pole of input signal.</li> </ol>
	<p><b>D: Direct Current On-Off Type</b></p> <p>Opening or closing operation of valve can realized by switching the positive and negative pole of external direct current. Meanwhile, a group of passive contact signal will be output to indicate fully openness or close of valve.</p> <p><b>Wiring Instrument:</b></p> <ol style="list-style-type: none"> <li>Valve will open when terminal 1 is connected with positive pole and terminal 2 with negative pole.</li> <li>Valve will close when terminal 1 is connected with negative pole and terminal 2 with positive pole.</li> <li>Terminal 4 is the passive contact common end.</li> <li>When "Opening finishes its operation, terminal 5 will output Fully Open Signal.</li> <li>When "Closing finishes its operation, terminal 6 will output Fully Close Signal</li> </ol>
	<p><b>H: Three-Phase On-Off Type</b></p> <p>Valve can be controlled to open and close by the on-off circuit and the circuit will output a group of active position signal to indicate the valve is in full close or full open position.</p> <p><b>Wiring Instruction:</b></p> <ol style="list-style-type: none"> <li>Connect terminal 1,2,3 with 3-phase alternate current. The motor will be operated to rotate close wise and anticlockwise through external phase inverter circuit.</li> <li>Terminal 4 is the common port of external control circuit.</li> <li>Terminal 5 is "open operation control.</li> <li>Terminal 6 is "close" operation control.</li> <li>When "Opening finishes its operation, terminal 7 will output Fully Open Signal.</li> <li>When "Closing finishes its operation, terminal 8 will output Fully Close Signal.</li> </ol>

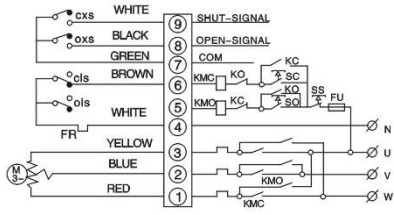

**T: Three-Phase Passive Contact Type**

Valve can be controlled to open and close by the on-off circuit and the circuit will output a group of active position signal to indicate the valve is in full close or full open position.

**Wiring Instruction:**

1. Terminal 1,2,3 connected with 3-phase power. By means of the external phase reversing! circuit, running normally or reversibly of motor.
2. Terminal 4 is the common port of external control circuit.
3. Terminal 5 is "open operation control."
4. Terminal 6 is "close" operation control.
5. Terminal 7 is passive contact common port.
6. When "Opening finishes its operation, terminal 8 will output Fully Open Signal."
7. When "Closing finishes its operation, terminal 9 will output Fully Close Signal."

### Power, Voltage

Please choose power voltage according to product nameplate or wiring diagram. Available voltages are listed as followings: AC380V ± 10% 50/60HZ; AC220V ± 10% 50/60HZ; DC24V

Notes: When choosing AC380V, pay attention to the sequence of phase line during wiring and make sure travel switch can correctly control openness and close of valve, otherwise, the actuator would be damaged.

Selection of Fuse and Circuit Breaker:

In order to protect the actuator, avoid short circuit and reduce injuries, A circuit breaker can be connected at the power input terminal of each actuator. Choose the appropriate fuse protection based on the following table.

motorized valve	AC380V	AC220V	AC110V	AC24V	DC24V
05	2A	2A	3A	5A	5A
10	2A	3A	5A	7A	7A
20/40/60	3A/5A	5A/7A	7A/10A	10A/11A	15A
100/200	5A	7A	10A	20A	

Power lines of two or several electric devices can't be connected in parallel;

Several electric devices can't be controlled by the same connection point; otherwise, you will lose control or the motor will be overheating.

### Installation

Cautions for Indoor Installation

- ◆ Products can't be installed in the room with explosive air unless they are of anti-explosive;
- ◆ Please install a shield to cover the product for safety if the product is installed in a place with water or raw material;
- ◆ Space is needed for inlet wiring or manual operation

### Adjustment of On-Off Type

Adjustment of Limit Position Switch(Drawing2)

- ◆ Close the valve to fully closed position.
- ◆ Loosen the fastening screw of stroke blocker, turn the blocker below to activate the stroke switch. "Click" sound will be heard when the switch moves. Then fasten the screw. Adjustment way of full open position is the same as above.

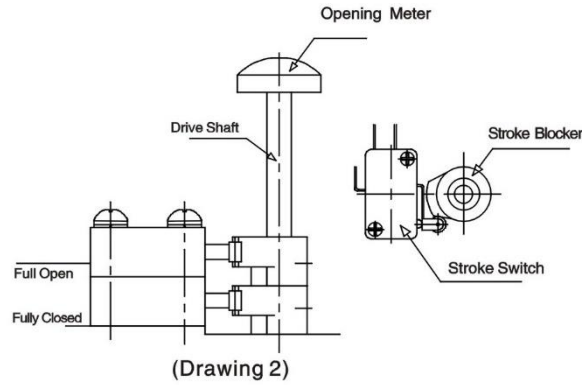

**Adjustment of Middle Position Switch (Drawing 3)**

- ◆ Operate the valve manually to desired position.
- ◆ Loosen the fastening screw of stroke blocker, turn the blocker below to activate the stroke switch. "Click" sound will be heard when the switch moves. Then fasten the screw. Adjustment way of full open position is the same as above.
- ◆ Motion position of two middle position switch can be adjusted in accordance with requirement

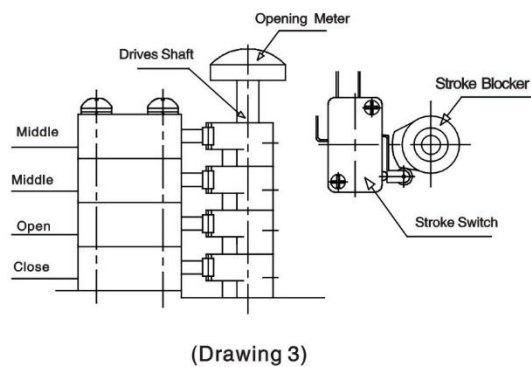

**Regulation of Mechanical Position-limiting (Drawing 4)**

- ◆ Rotate the handle to fully open position.
- ◆ Loosen tightening nut and rotate to adjust screw in order to make it contact the mechanical blocker. Then, rotate screw semi-circle and fasten the nut. In anticlockwise direction for tightening nut.
- ◆ Using same method, operator could regulate mechanical link-stopper at wholly-closed position.

\* Notes: Mechanical position limit must lag behind the electric position limit. Or the motor will be too hot.

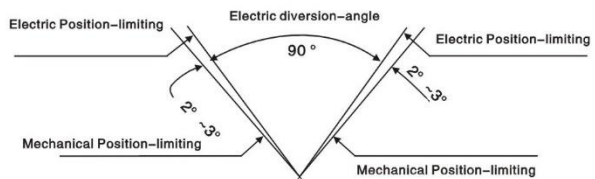
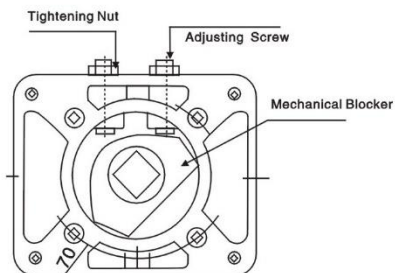

( Drawing 4 )

**Potentiometer Adjustment (Opening Type R, Modulating Type A) (Drawing 5)**

- ◆ The resistance value of potentiometer is 1 K, 5K8
- ◆ Rotary valve to fully closed position with handle;
- ◆ Loosen screw of opening-gear and rotate opening gear for regulating potentiometer.

Measure resistance value between 4 and 5 wiring terminals by universal meter, and make the resistance value achieve 10G, tighten opening gear, fixing screw. (if it is modulating type, resistance between RV and RS jacks shall be measured when connecting the seven-line connector).

\*Notes: Potentiometer can be loosen for adjustment.

When fixing, pay attention to the mesh between potentiometer gear and opening gear, which can't be too large or small, or else, it would directly affect the precision of actuator.

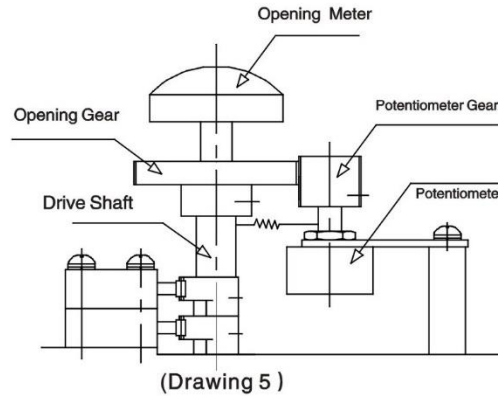

### Adjustment of Modulating Type

#### Actuator Adjustment

◆ Before adjustment, you should understand the adjustment method of open and close angle. Adjust electric position-limiting, potentiometer and mechanical position-limiting of actuator in accordance with the fully openness and close of valve.

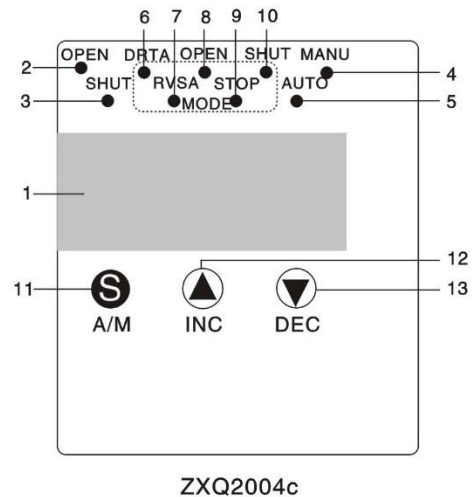
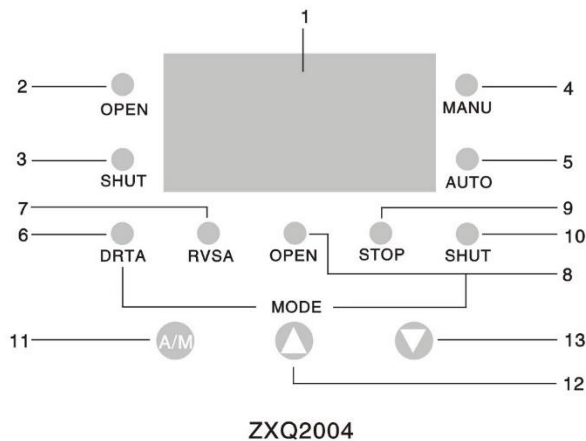

## Positioner Panel

Data Display	1	LED Window	Actual opening value, setting opening value, temperature inside positioner and setting parameter can be indicated by switching the buttons.
Status Indication	2	OPEN	Output control 'open', relay will shut
	3	SHUT	Output control 'closed', relay will shut
	4	MANU	Manual Status
	5	AUTO	Automation Status
Mode Indication	6	DRTA	Obverse-action mode, corresponding output of input signal is stated as following: 4mA-full (Normally set as fully open); 20mA-zero (Normally set as fully closed)
	7	RVSA	Reverse-action mode, corresponding output of input signal is stated as following: 4mA-zero (Normally set as fully closed); 20mA-full (Normally set as fully open)
	8	OPEN	Input signal suspension indicates "open", actuator opens to the largest position limit.
	9	STOP	Input signal suspension indicates "stop", actuator remains in the current position.
	10	SHUT	Input signal suspension indicates "closed", actuator closes to the largest position limit.
Button	11	A/M	Manual/Automatic switching button, button for parameter input, modification and switch
	12	▲	Value Increasing Button. It can be used to switch and indicate the set openness value in automatic status. It shows "open" in manual status.
	13	▼	Value Decreasing Button. It can be used to switch and indicate the inside temperature of positioner in automatic status. It shows "closed" in manual status.

## Wiring Introduction

ZXQ2004 intelligent positioner can be connected with electric actuator through one seven-line connector:

There is a group wiring tightened by six-line spring pressure on positioner(as shown in drawing 6), of which the N, L lines is connected with mid-line and phase-line of 220VAC single-phase circuit, two 4~20mA(or 1~5V) IN terminals is connected with control current (voltage), two 4~20mA terminals are to give feedback of current signal output, which can be connected with ammeter so as to display actual opening value of valve, it also can be not connected. <math>\phi 1\sim 2\text{mm}</math> single-core or multi-core infrared insulated line (shown in diagram 7) can be adopted as connection line. It is suggested to fasten tightly and plate tin onto multi-core line if this line is adopted. It is suggested to insert single-core line or tin-plated multi-core line into the holler there is spring resistance, insert another 4-5 mm. If the wire is soft, insert the wire into the hole and press the spring locking switch with straight screwdriver, insert another 4-5mm and loosen the switch, then the wire is locked. The wire can't be pulled out under normal circumstance. If it's needed to pull out the wire, press the switch beside the corresponding hole with screwdriver and then pull out the wire.

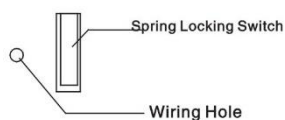

( Drawing 6 )

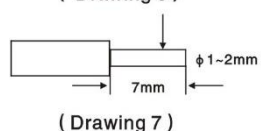

( Drawing 7 )

## Setting Operation Intelligent Positioner

Connect the lines between given signal source, output signal measure meter (Disconnection is also allowed) and power supply according to wiring drawing.

◆ When the power is on, the actual opening value of valve would be displayed, and the positioner is under auto test status at this time.



◆ Press A/M button to switch to manual state, press ▲ and ▼ buttons separately to manually control the 'open' and 'close' of actuator.

◆ Under automatic status, press ▲ to check the set openness value of valve and the varying trend & stability of input signal.

◆ Under automatic status, press? to observe the inside temperature of positioner. When it exceeds 70 centigrade, the positioner will cease the open and close control of actuator;

◆ Under automatic status, press A/M button for 4S to enter the setting parameter shown in the table below, the parameter value could be revised by pressing ▲ and ▼ see the operation progress diagram for details.

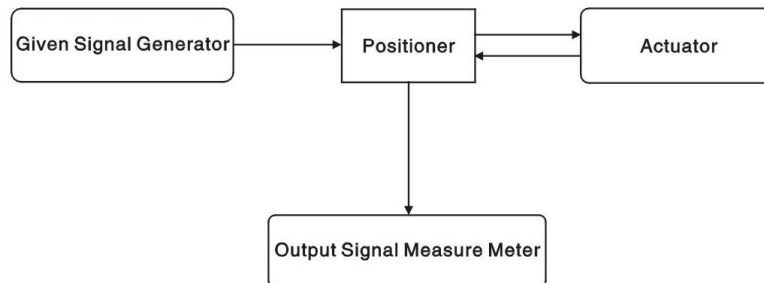

### Setting Operation Intelligent Positioner

#### Parameter List

Parameter	Indicated Value	Meaning	Set Value
U0	00x.0	X=1 Electronic braking is allowed, x=0 Electronic braking is not allowed	1
	000.x	x=0 Positioning accuracy is not allowed but time readjustment is allowed. X=1,2,3 Time readjustment is not allowed but positioning accuracy is allowed	0
U1	00x.0	Set positive and active action. x=0 is positive, X=1 is negative.	1
	000.x	Signal Suspension Mode, x=0(neglection) X=1 (open) x=2(stop) x=3(shut)	2
U2	XXX. X	Control output lower limit value is OSU2< 100, manual zero and full setting will not be limited by the parameter	<b>0.0</b>
U3	XXX.X	Control output upper limit value is OSU2< 100, manual zero and full setting will not be limited by the parameter	100.0
U4	00x.x	The precision is adjustable, it equals x.x/100	0.4
U7	XXX.X	Operation password, (U5=003.1 is opening setting of entering the actuator)	
U5	XXX.X	Actuator zero position confirmation, press ▲ and ▼ button. When it reaches full position, press A/M button for zero position confirmation, then enter U5.	
U6	XXX.X	Actuator zero confirmation. Press ▲ and ▼ button. When it reaches full position, press A/M button for full position confirmation.	

Notes: other parameters are reserved by manufacturer, Appendix will be taken for reference if needed.

The parameters of actuator have been set before delivery. It can be applied by directly connecting power supply, signal source and output signal measure meter (Disconnection is also allowed) without any resetting. If it's needed to set, the following procedure could be followed.

◆Set the zero and full position of actuator. This setting will exert no effect on input, outputting signal of positioner. After the resetting, rotary angle shall be reset, then the actuator could work normally. The setting falls into the following two methods:

**Method 1 (Manual Setting)** (According to the operating process):

◆ Enter into U5 and modify U5= 003.11 then press A/M button again and enter into U6 parameter (set zero position). Press ▲ and ▼ button, the actuator will operate towards "open" and "close" direction accordingly. The actual opening value of valve displayed will increase and decrease accordingly. When expected zero position (usually set at full close position) is reached, press A/M button for zero position confirmation and enter into U7 parameter.

◆ Enter into U7 parameter (set full position), press ▲ and ▼ button to expected full-position (normally y at full open position), and press A/M button for full position conformation, The actuator will be back to 90% position automatically and return to U5, then return to U5.

◆ Revise I15=000.5 to return to test control status.

**Method 2 (Automatic Setting)**

◆ Enter into U5 and revise U5 to be 003.11 then press A/M button and ▼ button and then release them at the same time. Automatic setting will be started. The zero position will first be set in positioner and then the full position. The positioner will be in manual status after setting. ★ Re-enter parameter U5 and modify U5=000.5 (default value) and then press A/M button, the set result Will be saved.

◆ During test control process of positioner, the actuator will vibrate and be heated because of input signal quality, external electromagnetism disturbance. To avoid the vibration, the U0 (000.X) can be modified: 1. Set x=0, the position precision will remain the set precision during the vibration of actuator, the readjustment time of actuator will increase to 7 S to meet the requirement of precise positioning and interval operation of actuator; 2. X=1,2,3, the readjustment time will remain unchanged (about 2s) during vibration of actuator. The precision of actuator will decrease so as to work under the most appropriate precision. ^ If there is 10s interval during parameter modification, test control status will be restored.

**Operation Process**

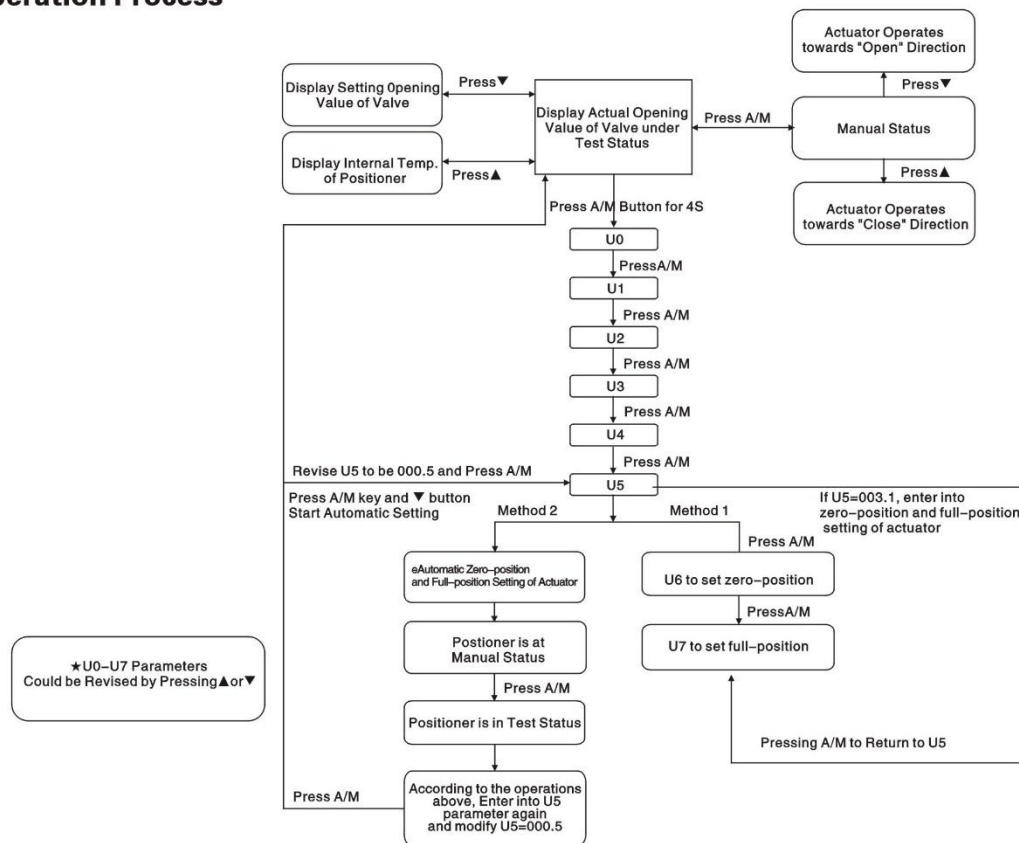

## Setting Operation of Intelligent Positioner

### Error Code List

Error Code	Meanings
E-01	controlling signal Suspension or below 0.3mA
E-03	Signal Feedback line or open-close line between positioner and actuator are connected wrongly
E-05	Actuator vibrates heavily, maybe because of the instability of input signal or feedback signal, high precision, etc.
E-06	Actuator is blocked during operating towards close direction.
E-07	Actuator is blocked during operating towards open direction.
E-08	Inside temperature of positioner exceeds 70°C

### Cautions for Outdoor Installation

- ◆ Please install a shield to cover the product to avoid rain or direct sunlight;
- ◆ Space is needed for inlet wiring or manual operation.

Notes: The sunlight outdoor would lead to high-temperature which can accelerate aging of components and even losing effectiveness;

The rain would accelerate aging of rubber-pad. Moreover, failure to avoid rain will lead to damage to product.

### Ambient Temperature and Fluid Temperature Condition

- ◆ Ambient temperature shall be between -30 °C and +60°C.

Note: Actuator with damp heater shall be chosen when it is applied in place with temperature below zero centigrade or with large temperature gap.

- ◆ High-temperature connector shall be used to mount the actuator on valve if the fluid temperature is high.

### Wring Cable and Wiring

- ◆ 8 cable shall be applied for 05 PG11 wire-in line lock.
- ◆ 8 cable shall be applied for 10 PG11 wire-in line lock.
- ◆ 8 cable shall be applied for 20/40/60/100/200 PG11 wire-in line lock.
- ◆ 8 cable can be applied according to dimension of wire-in line lock so as to guarantee safety and reliability of wiring;

- ◆ Pass the cable through line-lock and fasten line end onto terminal stand;

- ◆ Tighten cover of wire-lock for fastening the cable.

### Wiring Line Pipe

- ◆ When using line-pipe, it must be waterproof;

◆ As shown in drawing 11 the actuator shall be higher than line pipe to prevent actuator damage resulted from water drop flowing into the actuator by walking along the wire.

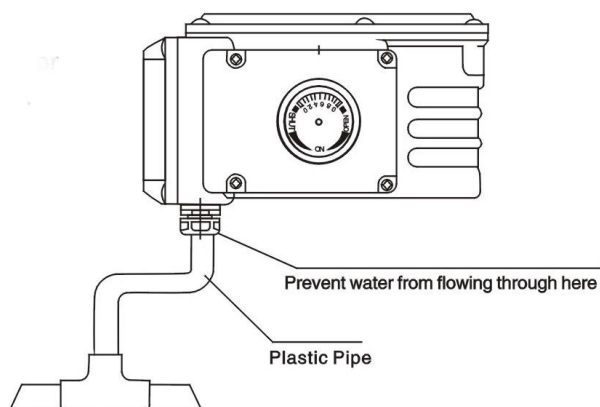

( Drawing1 )

**Model Selection**

Model KL	Output Torque	Motion Time (0-90°)	Power Supply	Hard - Sealing Butterfly Valve	Soft-Sealing Butterfly Valve	Ball Valve	Ventilating Butterfly Valve	
					<PN1.6MPa	<PN1.6MPa	<PN1.0MPa	
02	6N.M	7S	AC11CK AC220V. 50/60HZ. DC24V		DN25	S=DN20		
05	15N.M	10S	AC110V, AC220V, AC380V, 50/60HZ; DC24V		SSDN65	S: DN40	DN50-DN80	
	30N.M	20S						
	50N.M	30S						
10	50N.M	13S			DN40 - DN65	DN80-DN125	DN40-DN50	DN100 - DN200
		15S						
	60N.M	20S						
20	100N.M	30S						
	80N.M	9S						
	100N.M	15S			DN80-DN125	DN150- DN200	DN65 - DN80	DN250 - DN300
	150N.M	20S						
40/60	200N.M	30S						
	60S							
	150N.M	9S			DN150 - DN200	DN250	DN100-DN125	DN350 - DN500
	250N.M	15S						
100	400N.M	20S						
	600N.M	30S						
100	800N.M	30S		DN250	DN300 ~ DN350	DN150-DN200	DN600 - DN800	
	1000N.M	50S						
200	2000N.M	100S		DN300 - DN400	DN400 - DN500	DN250- DN300	DN800- DN1000	
400	4000N.M	100S		DN400 - DN500	DN500 - DN600	DN300 - DN400	DN1000- DN1200	
600	6000N.M	150S		DN500 - DN600	DN800 - DN600	DN400 - DN500	DN1400- DN1600	

Actual torque of valves vary a lot because of different manufacturer and different application even for valves of the same dimension and same model. It is therefore suggested to choose the actuator model by taking 60%-80% of rated output torque of actuator as the working torque of valve.

**Appendix: other setting —see the drawing below for input signal, output signal setting**

**Appendix:** Other setting ---see the drawing below for input signal, output signal setting

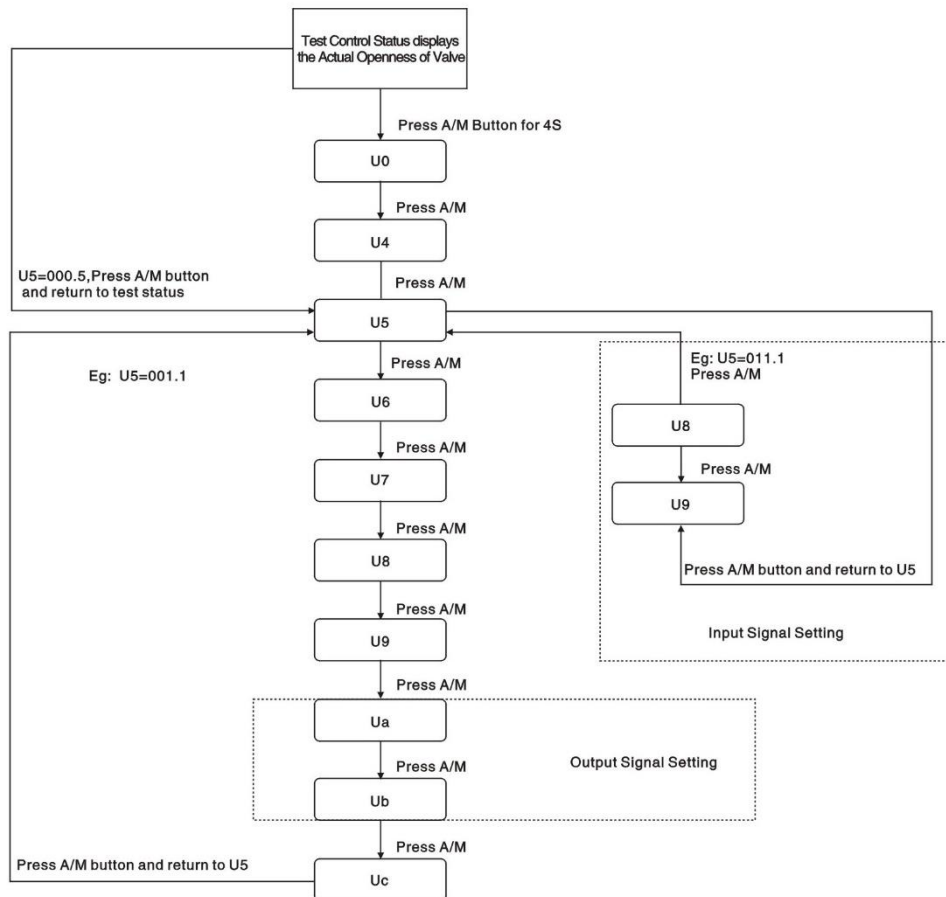

**Updating Version Introduction of ZXQ2004 Model**

1. A Simplified automatic setting method is added. Press A/M button and button under automatic status and then release at the same time, the automatic setting will be activated (The function is the same as the automatic setting in method 2)
2. According to the setting method in the instruction manual, set full position(U7), press confirmation button (A/M), it will not return to U5 immediately. However, the electric valve will go to 10% position of setting measurement, then return to U5.
3. Another function of anti-blocking is added to the module. When the electric valve is blocked (10% of the full range time), the module will stop controlling output. It will check the blocking again after one minute. If the malfunction does not solve, it will check the valve again three times in one minute. Fault code and valve position value will be shown alternately on the display screen. If the fault still exists, the module ceases checking and displays fault module, then stops working.

The module will be back to normal by pressing the panel button or charging with electricity.

**Input Signal Setting**

◆ Under normal test status of positioner, press A/M button for 4s to enter into parameter setting status; the "U0" data value will be displayed. Select U5, parameter by pressing A/M button, Press ▲ or ▼ button to modify value of U5 to be 011.1. (See the No. Meaning in the following table for reference)

◆ Enter into "U8" parameter value to adjust zero position of input current; When setting, input the zero position through external instrument (4mA usually), then press A/M button for confirmation, then enter into "U9"

**Parameter.**

Parameter	Display Value	Meanings
U5	0xx.x	Enter into password setting. U5=011.1, enter into input current setting; U5=001.1; enter into output current setting; U5=003.1; enter into zero, full position setting of actuators.
U6	XXX.X	Zero-Position Confirmation Parameter of Actuator
U7	XXX.X	Full-Position Confirmation Parameter of Actuator
U8	XXX.X	Zero-Position Parameter Adjustment of Input Current
U9	XXX.X	Full Range Parameter Adjustment of Input Current
Ua	XXX.X	Zero-Position Parameter Setting of Output Current
Ub	XXX.X	Full Range Parameter Setting of Output Current
Uc	XXX.X	Inside Temp. Adjustment

◆"U9" parameter is the full-range adjustment of input current: During adjustment, input the full-range signal (usually 20mA) through external instrument, press A/M button for confirmation, then enter into "U5" parameter to modify U5=000.5, press A/M button for confirmation and exit. The setting will be finished.

**Output Signal Setting**

- ◆ Make sure the cleanness and stability of input signal during the operations above.
- ◆ Enter into U5 parameter, correct U5=001.1; press A/M button to enter U5 parameter.
- ◆ Skip parameter U5, U5, U5 to enter into Ua.
- ◆ "Ua" is the zero-position setting of output current: During setting, press ▲ and ▼ to set output 4mA or other value. The value will be corresponding to the zero-position output signal value of actuator"press A/M button to confirm and then enter into Ub parameter.
- ◆ "Ub" parameter output current range setting: Press ▲ and ▼ to set the output 20mA or other value. The value will be corresponding to the full-position output signal value of actuator, press A/M button to confirm and then enter into Uc parameter.
- ◆ "Uc" parameter is to modify the temperature inside the cover. Press ▲ and ▼ for adjustment.
- ◆ Press A/M button for confirmation. Then return to "U5" parameter. Modify "U5" value, make U5=000.5. Press A/M button to confirm and back to test status.



**Failure and Countermeasure**

<b>Failure Status</b>	<b>Reason</b>	<b>Countermeasure</b>	
Motor doesn't rotate	The power supply and voltage is low, or no power supply	Check power and voltage	
	Input signal suspends or the value is not enough	Check input signal	
	Break line is separated from terminal stand	Connect wire and replace terminal stand	
	Temperature protector works	Lower the ambient temperature	
		Reduce use frequency	
		Load is too heavy	
	Limit switch actions at the middle openness	Adjust stroke blocker	
	Capacity used for motor enter-phase is damaged	Replace the capacity	
Motor is disconnected	Replace the motor		
Control box is damaged	Replace the control box		
The openness varies continuously	There is interruption signal in signal source	Check input signal	
	The interruption is produced from potentiometer	Replace potentiometer	
	The gear of potentiometer or opening are loosened	Check screw of tightening gear	
The input signal doesn't conform with opening	Input signal is wrong	Check Input signal	
	Adjustment of zeroing, multiplying-power has problem	Readjust multiplying-power to zero position	
	Position of potentiometer gear is changed	Readjust the potentiometer gear	
No opening signal	Opening signal line is disconnected or connection has problem	Check wiring	

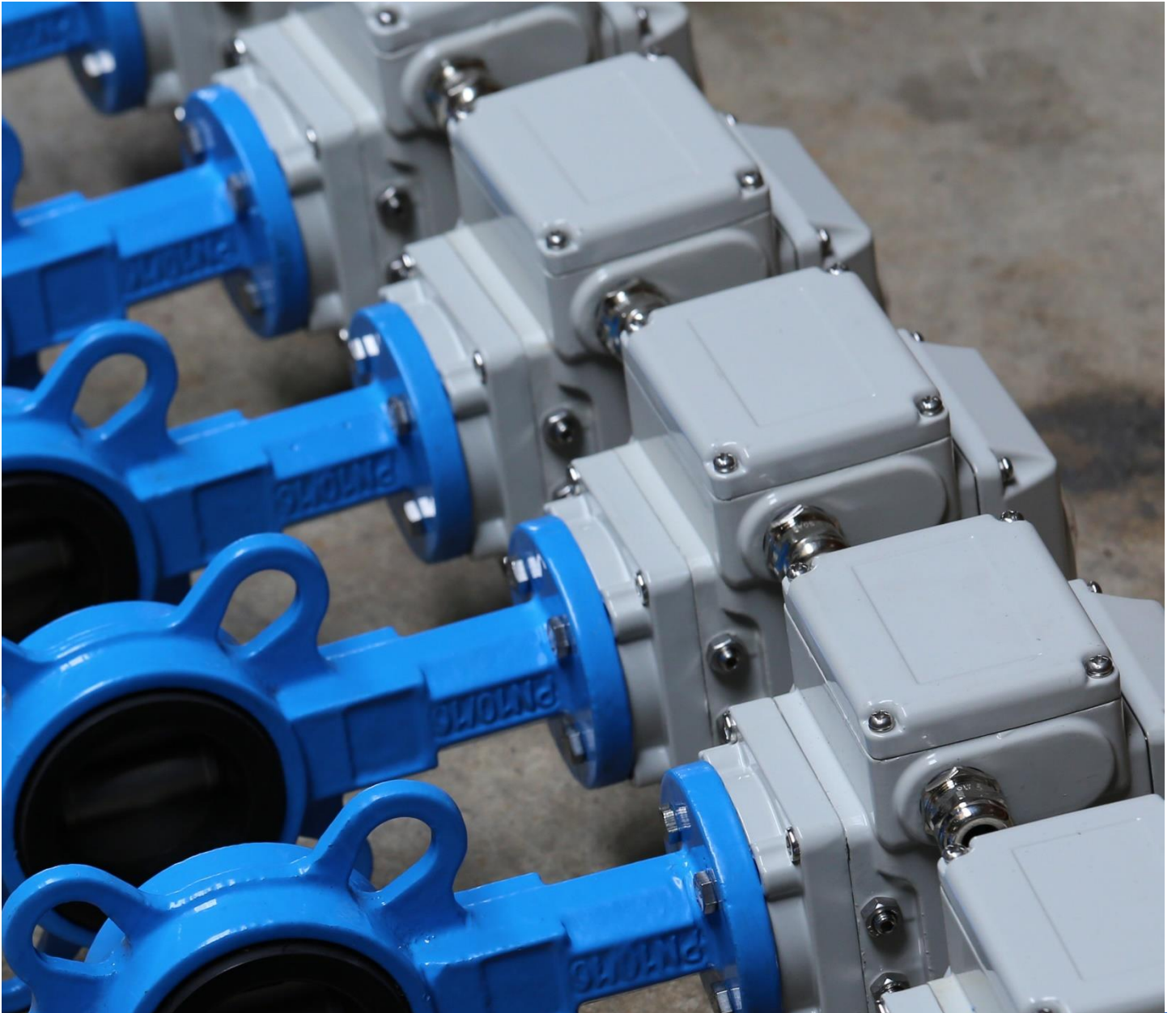

INDUSTRIAL SOLUTION  
**BK**valve