

Tapped stud M6
 (Behind the door)

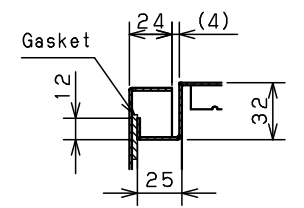

CROSS SECTION A-A
 1:3

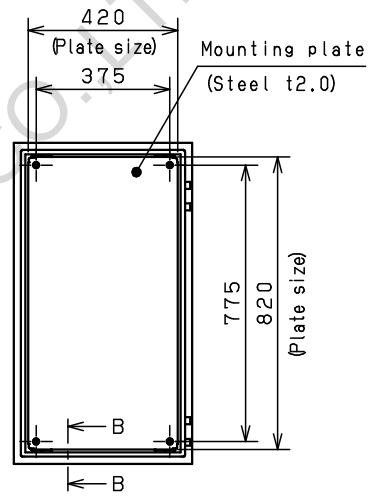
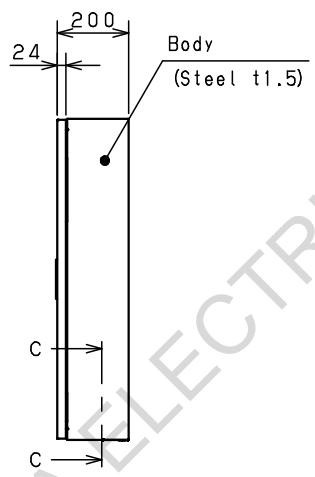
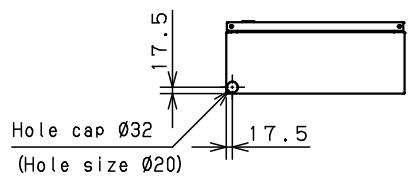
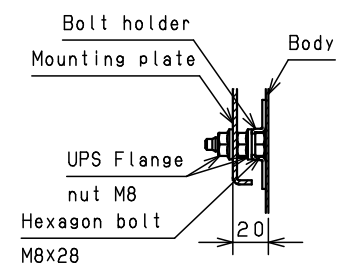

CROSS SECTION B-B
 1:3

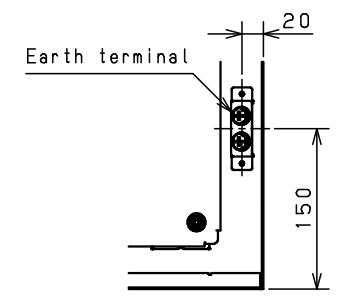

CROSS SECTION C-C
 1:5

Model	Wall-mounting, indoor/outdoor-use, RA20-59TH			Name/Type	RA20-59TH			
Body	Steel sheet, t1.5							
Door	Steel sheet, t1.5			Drawing number	- / 1/1			
Mounting plate	Steel sheet, t2.0							
Base	-			A3 scale	Scale	Design	Drawing	Check
Color	Outside	Light beige (5Y7/1) (Smooth)			1:15	SUPAKIT	SUPAKIT	KONISHI
IP	IP55			Date	13 / Oct. / 2021			
Weight	26.7 Kg							