

Tapped stud M6
(Behind the door)

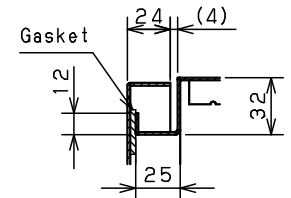

CROSS SECTION A-A
1:3

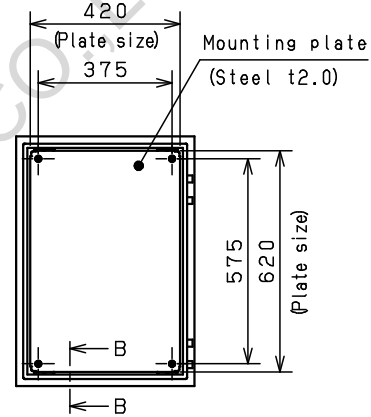
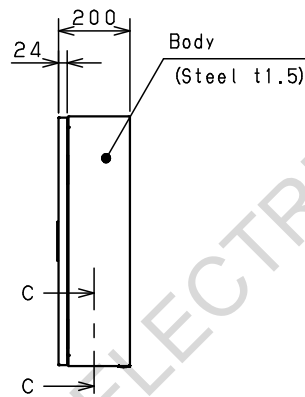
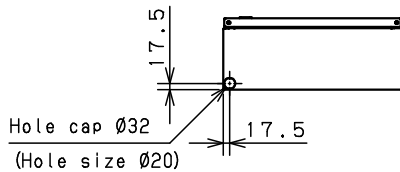
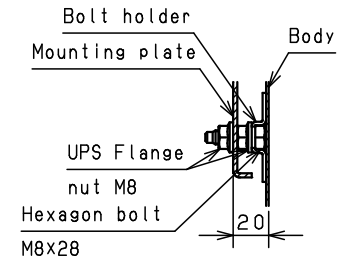

CROSS SECTION B-B
1:3

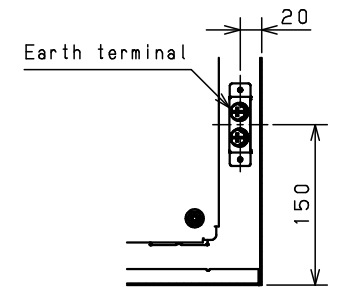

CROSS SECTION C-C
1:5

Model	Wall-mounting, indoor/outdoor-use, RA20-57TH		Name/Type	RA20-57TH			
Body	Steel sheet, t1.5						
Door	Steel sheet, t1.5						
Mounting plate	Steel sheet, t2.0						
Base	-		Drawing number	- / 1/1			
Color	Outside	Light beige (5Y7/1) (Smooth)					
	Inside	Light beige (5Y7/1) (Smooth)	A3 scale	Scale	Design	Drawing	Check
IP	IP55			1:15	SUPAKIT	SUPAKIT	KONISHI
Weight	21.0 Kg		Date	13 / Oct. / 2021			