

AURA ELECTRIC CO., LTD.

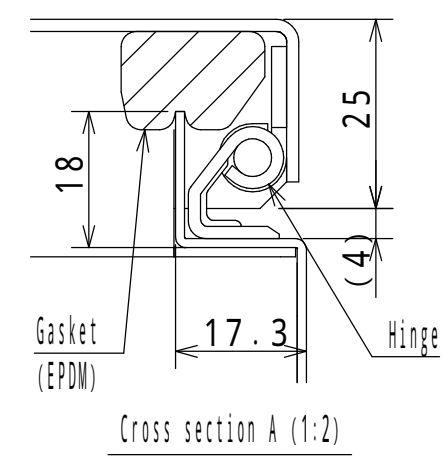

NOTE

1. The door opening angle is approximately 115°.

Enclosure specification		Model	CH25-45A						
Type	Indoor use, CH25-45A	Door	1/2						
Body	Steel t 1.2	Mounting plate							
Door	Steel t 1.6	Scale	1:10	Design	MIZUNO	Draw	NGUYEN	Check	SUZUKI
Mounting plate	Steel t 1.6	IP	IP4X						
Color	Standard / Light beige (5Y7/1)	Weight	11.6 kg						
Date:	25 / Mar. / 2021								