

AURA ELECTRIC CO., LTD.

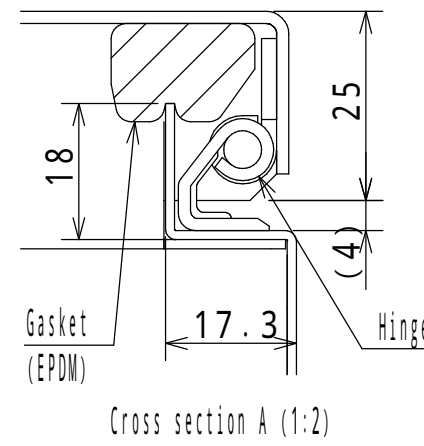

NOTE

1. The door opening angle is approximately 115°.

Enclosure specification		Model	CH20-34A						
Type	Indoor use, CH20-34A	Mounting plate	1/2						
Body	Steel t 1.2	Scale	1:10	Design	MIZUNO	Draw	NGUYEN	Check	SUZUKI
Door	Steel t 1.6	Date:	25 / Mar. / 2021						
Mounting plate	Steel t 1.6	Weight	7.2 kg						
Color	Standard / Light beige (5Y7/1)								
IP	IP4X								