

CROSS SECTION A-A
1:2

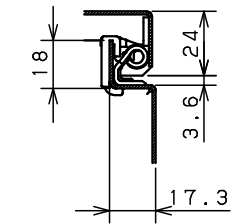

CROSS SECTION B-B
1:2

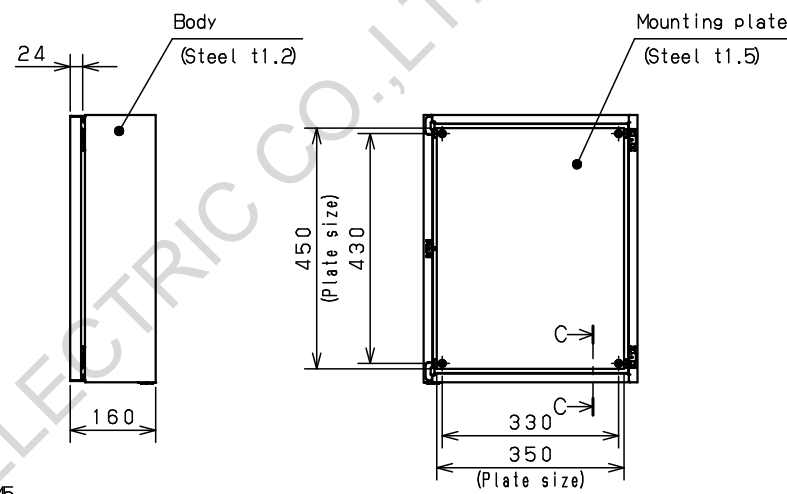
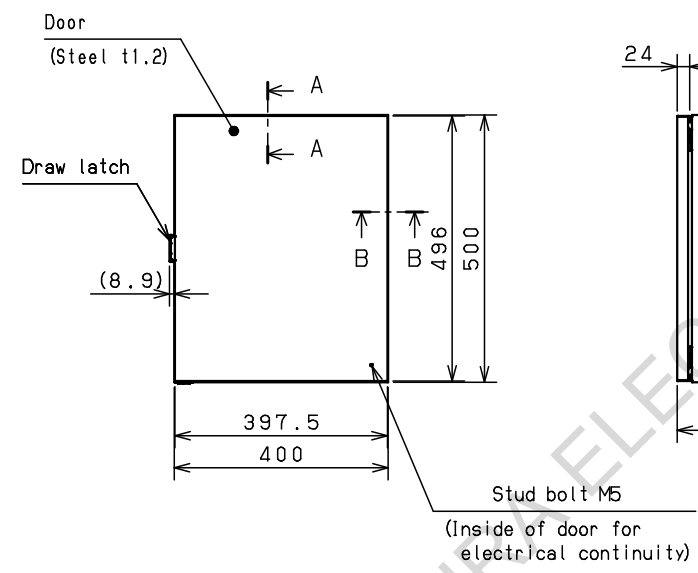
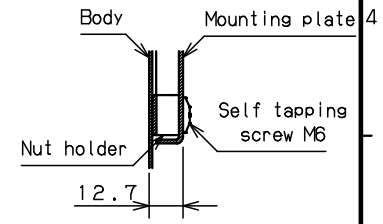
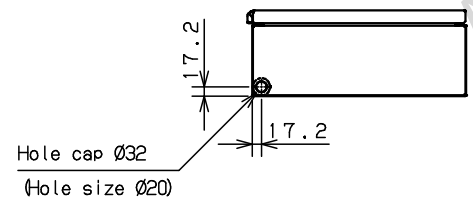

CROSS SECTION C-C
1:2

Model	Wall-mounting, indoor-use, CH16-45TH			Name/ Type	CH16-45TH			
Body	Steel sheet, t1.2							
Door	Steel sheet, t1.2							
Mounting plate	Steel sheet, t1.5							
Base	-			Drawing number	- / 1 1			
Color	Outside	Light beige (5Y7/1) (Smooth)						
	Inside	Light beige (5Y7/1) (Smooth)		A3 scale	Scale	Design	Drawing	Check
IP	IP4X				1:10	SUPAKIT	SUPAKIT	KONISHI
Weight	9.4 Kg			Date	13 / Oct. / 2021			