

CROSS SECTION A-A  
1:2

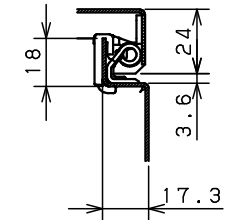

CROSS SECTION B-B  
1:2

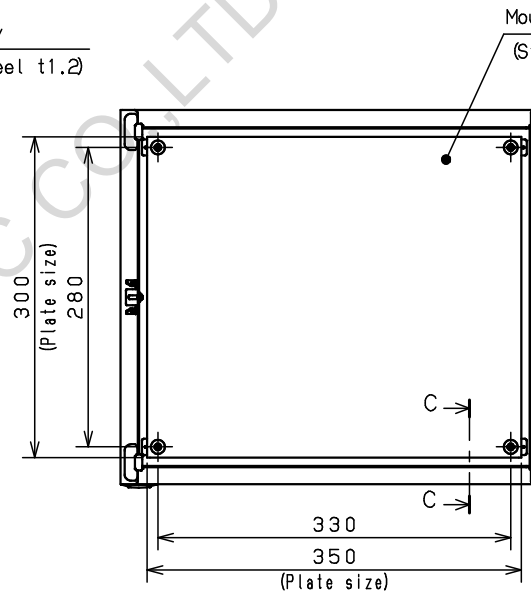
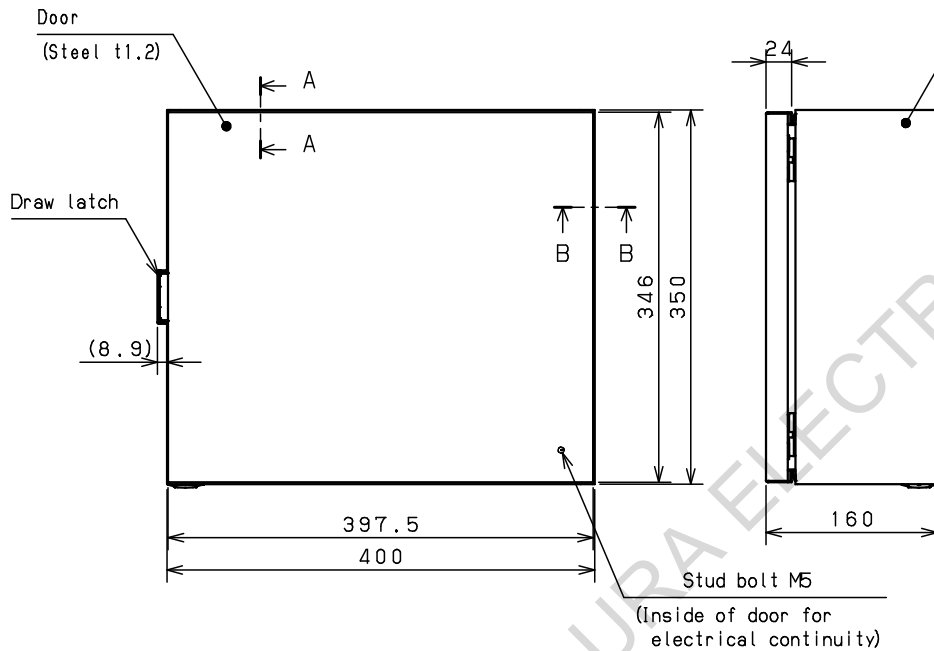
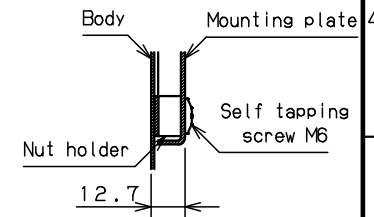

CROSS SECTION C-C  
1:2

Model	Wall-mounting, indoor-use, CH16-435TH			Name/ Type	CH16-435TH			
Body	Steel sheet, t1.2							
Door	Steel sheet, t1.2			Drawing number	- / 1 1			
Mounting plate	Steel sheet, t1.5							
Base	-			A3 scale	Scale	Design	Drawing	Check
Color	Outside	Light beige (5Y7/1) (Smooth)			1:5	SUPAKIT	SUPAKIT	KONISHI
IP	IP4X			Date	13 / Oct. / 2021			
Weight	7.0 Kg							