

AURA ELECTRIC CO., LTD.

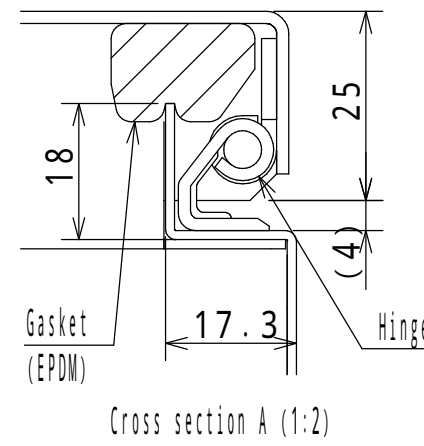

NOTE

1. The door opening angle is approximately 115°.

Enclosure specification		Model	CH12-32A						
Type	Indoor use, CH12-32A	Drawing A3 scale	1/2						
Body	Steel t 1.2								
Door	Steel t 1.6								
Mounting plate	Steel t 1.6	Scale	1:5	Design	MIZUNO	Draw	NGUYEN	Check	SUZUKI
Color	Standard / Light beige (5Y7/1)								
IP	IP4X								
Weight	3.5 kg	Date: 25 / Mar. / 2021							