



# SUPER POWER

**VARIABLE SPEED PUMP**

**With Wi-Fi AND MODBUS OPTIONS**

\*NSF only apply for NSF version

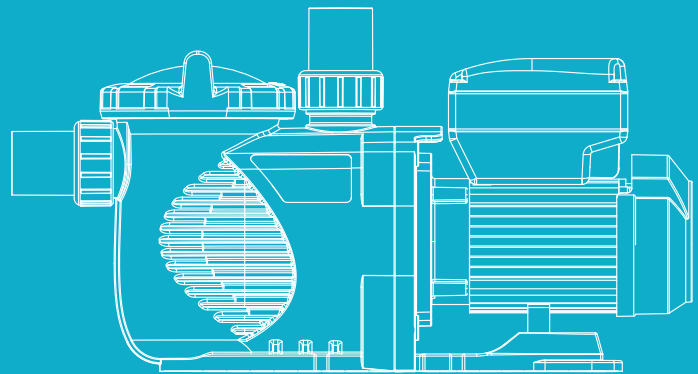

## USER MANUAL

***SUPERPOWER***



**RoHS  
COMPLIANT  
2002/95/EC**



**SAA**



**Model: SPV Series**

# TABLE OF CONTENT

PAGE	2	... WARNINGS AND SAFETY INSTRUCTIONS
	4	... 1. IMPORTANT SAFETY INSTRUCTIONS
	4	... 2. INSTALLATION
	5	... 3. CONTROL AND DISPLAY PANEL
	7	... 4. OPERATION PROCEDURE
	11	... 5. PRIMING SETTING
	12	... 6. RS485 SETTING
	13	... 7. SYSTEM RESET TO FACTORY DEFAULT SETTING
	13	... 8. AUTO-RECOVERY
	14	... 9. ERROR MENU
	14	... 10. ERRORS DESCRIPTION
	15	... 11. WI-FI SETTING
	18	... 12. ROUTINE MAINTENANCE
	18	... 13. AFTER-SALES SERVICE
	18	... 14. DIMENSIONS
	19	... 15. REPLACEMENT PARTS
	20	... 16. SPECIFICATION AND PUMP CURVE
	20	... 17. TROUBLE SHOOTING
	21	... 18. WARRANTY POLICY

## WARNINGS AND SAFETY INSTRUCTIONS

### GENERAL WARNING

This instruction contain general caution information for use in Pool and SPA pump installation application. Specified Pump model function should be refer to particular manual. Components such as the filtration system, pumps and heater must be positioned so as to prevent their being used as means of access to the pool by young children.



### RISK OF ELECTRICAL SHOCK

This appliance should be installed by qualified electrical personnel in accordance with National Electrical Code and all applicable local codes and ordinances. Hazardous voltage can shock, burn, and cause death or serious property damage. DO NOT use an extension cord to connect unit to electric supply to reduce the risk of electric shock.

1. The pump should be permanently connected to an individual circuit breaker.
2. Pump must be connected to a residual current device (RCD) having a rated residual operating current not exceeding 30 mA or receptacle with ground fault circuit interrupt (GCFI).
3. Electrical grounding must be connected before connecting to electrical power. Failure to ground all electrical equipment can cause serious or fatal electrical shock hazard.
4. Bonding: Use at least #8 AWG (#6 AWG for Canada) a solid copper conductor, run a continuous wire from external bonding lug (if available) to the pressure wire connector provided on the electrical equipment and to all metal parts of swimming pool, spa, or hot tub, and metal piping (except gas piping), and conduit within 1.5 m (5 ft) of inside walls of swimming pool, spa, or hot tub.
5. Never open the inside of the drive motor enclosure. There is a capacitor bank that holds a mains supply voltage charge even when there is no power to the unit. The voltage should be referred to the individual pump operation voltage.
6. The pump is capable of high flow rates; use caution when installing and programming to limit pumps performance only.
7. Switch OFF pump power before servicing and disconnecting the main circuit to the pump.
8. Never change the filter control valve position while the pump is running.



### COMPRESS AIR HAZARDOUS

This system enclosed pre-filter / filter and become pressurized. Pressurized air can cause the Lid to separate which can result in serious injury or death.

Pool and spa circulation systems operate under high pressure. When any part of the circulating system (i.e. lock ring, pump, filter, valves, etc.) is serviced, air can enter the system and become pressurized. Filter tank Lid and pre-filter cover must be properly secured to prevent violent separation. Place pre-filter / filter air relief valve in the open position and wait for all pressure in the system to be relieved before remove the lib to access the basket for cleaning.



### HYPERTHERMIA

SPA water temperature excess 38°C (104°F) may be injurious to health. Measure water temperature before entering SPA.

Hyperthermia occurs when the internal temperature of the body reaches a level several degrees above the normal body temperature of 98.6 °F (37 °C). The symptoms of hyperthermia include drowsiness, lethargy, and an

increase in the internal temperature of the body.



## SUCTION ENTRAPMENT HAZARD

This pump produces high levels of suction and creates a strong vacuum at the main drain at the bottom of your pool and spa. This suction is so strong that it can trap adults or children under water if they come in close proximity to a pool or spa drain or a loose or broken drain cover or grate.

The Virginia Graeme Baker (VGB) Pool and Spa Safety Act creates new requirements for owners and operators of commercial swimming Pools and spas.

Commercial pools or spas constructed on or after December 19, 2008, shall utilize:

1. A multiple main drain system without isolation capability with suction outlet covers that meet ASME/ANSI A112.19.8a Suction Fittings for Use in Swimming Pools, Wading Pools, Spas, and Hot Tubs and either:
  - 1.1 A safety vacuum release system (SVRS) meeting ASME/ANSI A112.19.17 Manufactured Safety Vacuum Release systems (SVRS)  
For Residential and Commercial Swimming Pool, Spa, Hot Tub, and Wading Pool Suction Systems and/or ASTM F2387 Standard  
Specification for Manufactured Safety Vacuum Release Systems (SVRS) for Swimming pools, Spas and Hot Tubs or
  - 1.2 A properly designed and tested suction-limiting vent system or
  - 1.3 An automatic pump shut-off system.

Commercial pools and spas constructed prior to December 19, 2008, with a single submerged suction outlet shall use a suction outlet cover that meets ASME/ANSI A112.19.8a and either:

1. A SVRS meeting ASME / ANSI A112.19.17 and/or ASTM F2387, or
2. A properly designed and tested suction-limiting vent system, or
3. An automatic pump shut-off system, or
4. Disabled submerged outlets, or
5. Suction outlets shall be reconfigured into return inlets.

There are five types of suction entrapment according to The Virginia Graeme Baker (VGB) Pool and Spa Safety Act

1. **Body Entrapment** a section of the torso becomes entrapped
2. **Limb Entrapment** an arm or leg is caught by or pulled into an open drainpipe
3. **Hair Entrapment** or entanglement hair is pulled into and/or wrapped around the grate of the drain cover
4. **Mechanical Entrapment** the bather's jewelry or clothing gets caught in the drain or the grate
5. **Evisceration** the victim's buttocks come into contact with the pool suction outlet and he or she is disemboweled



## TO REDUCE ENTRAPMENT HAZARD RISK



**WARNING:**

Two function suction outlets per pump must be installed to prevent entrapment. The minimum separate of suction on the same plate must be at least point to point measurement 1 meter (3ft) apart. It is used to avoid "dual blockage" by bather.

If suction is found damage, broken, cracked, missing or not securely attached during regular checking, shunt down the pool and replace it immediately.



A vacuum release or vent system is recommended to install for suction entrapment release.

# 1. IMPORTANT SAFETY INSTRUCTIONS

The user guide you are holding includes essential information on the safety measures to be implemented for installation and start-up. Therefore, the installer as well as the user must read the instructions before beginning installation and start-up. Keep this manual for future reference.

The pump should be installed according to your local electrical installation ordinances and regulations. Only qualified, licensed personnel should install the pump and the wiring.

This appliance cannot be used by persons (including children) with reduced physical, sensory or mental capabilities or lack of experience and knowledge unless they have been given supervision or instruction concerning use of the appliance in a safe way and understand the hazards involved. Children must not play with the appliance.

<p><b>CAUTION</b></p>  <p><b>Hazardous suction.</b> Can trap hair or body part, causing severe injury or death. Do not block suction.</p>	<p style="text-align: center;">Correct disposal of this product</p>  <p>This symbol on the product, or in its packaging, indicates that this product may not be treated as household waste. Instead, it should be taken to the appropriate waste collection point for the recycling of electrical and electronic equipment. By ensuring this product is disposed of correctly, you will help prevent potential negative consequences for the environment and human health, which could otherwise be caused by the inappropriate waste handling of this product. For more detailed information about the recycling of this product, please contact your local council, your household waste disposal service, or the shop where you purchased the product.</p>
--	---

# 2. INSTALLATION

1. Install the pump as close to the pool as possible, preferably in a dry, well ventilated area away from direct sun light. Protect the pump from excessive moisture.
2. Place the pump as close to the water source as possible, so that the suction pipe is short, straight and direct to reduce the friction loss. Don't install the pump at more than 10ft (3 meters) of geometrical height from water level.
3. Before installing the pump, make sure that the surface is solid, elevated, rigid and vibration free.
4. Secure the pump to the base with screws or bolts to limit the vibration and the stress on the pipe or the joints.
5. Leave enough space for gate valves in suction and discharge piping, if required.
6. Connect the suction and discharge pipe to the outlet and inlet of the swimming pool.
7. Make sure that floor drainage is adequate to prevent flooding.
8. This pump must be equipped with an isolating transformer or through a residual current device (RCD) having a rated residual operating current not exceeding 30 mA.
9. Make sure that the pump and piping are accessible for servicing.

Note: The pump suction and discharge connections are mounded in thread stops, DO NOT try to screw the pipe beyond these stops.

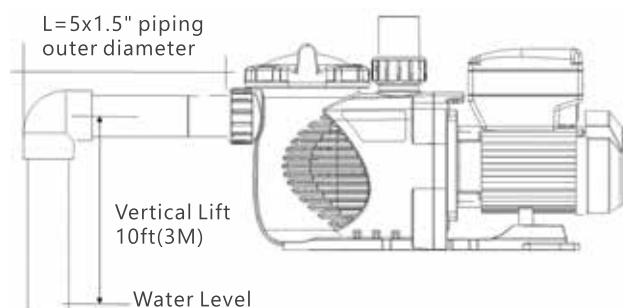

## 2.1 MAIN POWER WIRING

This is an alternative wire connection for those owners who would like to wire the pump directly to the main power. SPV Pump is supplied with a power cord that can be plugged into the power source. There are two terminals labelled as AC-L and AC-N. Attach the power leads to these terminals. Either wire may be attached to either terminal (see Figure 1).

For 230Vac 2 phase connection, connect L1 to L, L2 to N and Earth to Ground.

### START UP

The wide range of pump settings makes it suitable for multiple purposes. The pump controller is used to program motor speeds and schedules as described in Chapter "Operation" of this manual.

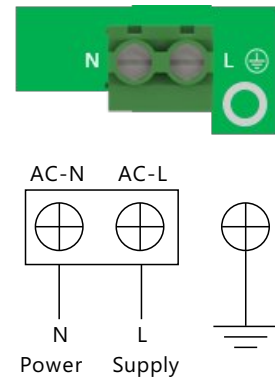

Figure 1

### WARNING:

1. NEVER run the pump dry! Running the pump dry will damage seals, causing leakage and flooding. Fill the pump with water before starting.
2. Always STOP THE PUMP before and RELEASE ALL PRESSURE from the pump and the piping system before proceeding.
3. NEVER tighten or loosen screws while the pump is operating.
4. Do not block the pump suction.

## 2.2 PRIMING PUMP

1. Release all air from filter and piping system (consult your filter user manual).
2. In a flooded suction system (water source higher than pump), the pump will prime itself when suction and discharge valves are opened.
3. If pump is not installed in a flooded suction system, unscrew and remove pump lid and fill it with water.
4. Turn on power wait for pump to prime, which can take up to fourteen (14) minutes at 10ft (3m) vertical lift of 1.5" inlet piping. Priming will depend on vertical length of suction lift and horizontal length of suction pipe. If pump does not prime within 14 minutes, stop the motor and determine cause.

**WARNING: Tighten / untighten the pump lid by hand only.**

---

## 3. CONTROL AND DISPLAY PANEL

---

### 3.1 OVERVIEW

The panel include the below display or control function to monitor and control the pump running status.

1. **Clock:** Real Time Clock display
2. **Running Status:** Running speed and power rating display
3. **Pre-set Speed:** 3 pre-set running speeds.
4. **Function settings:** Real time clock, 3 pre-set speeds, 2 schedule settings, NO flow self- priming settings.
5. **Error display:** Overcurrent, Overvoltage, Under-voltage, Overheating fault code.
6. **Auto-recovery:** After an overcurrent, Overvoltage, Under-voltage, Overheating or Power failure, the settings will be restored as before the error.
7. **Power failure recovery:** When there is a power is interrupt, the pump will be restored as before when power resume.
8. **Wi-Fi:** Wi-Fi ready indication after start up.
9. **RS485 Connection:** external automation control over MODBUS

### 3.2 CONTROLLER

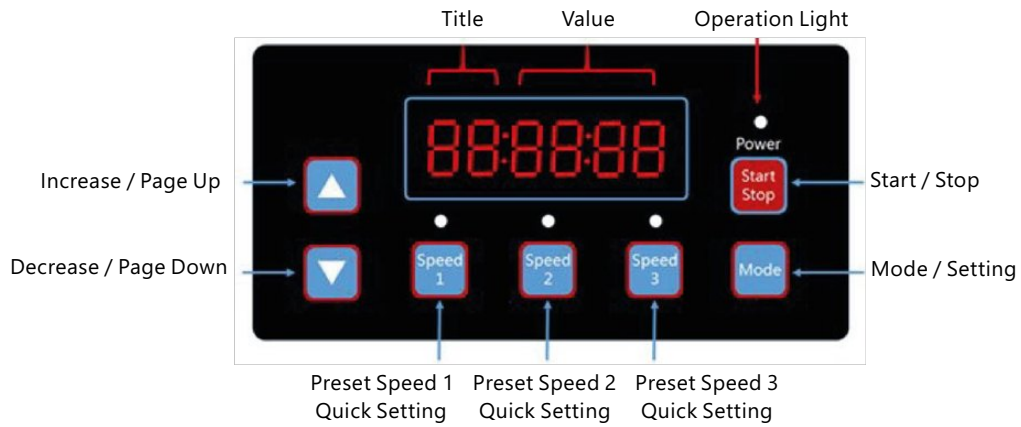

### 3.3 PROGRAM FLOW CHART

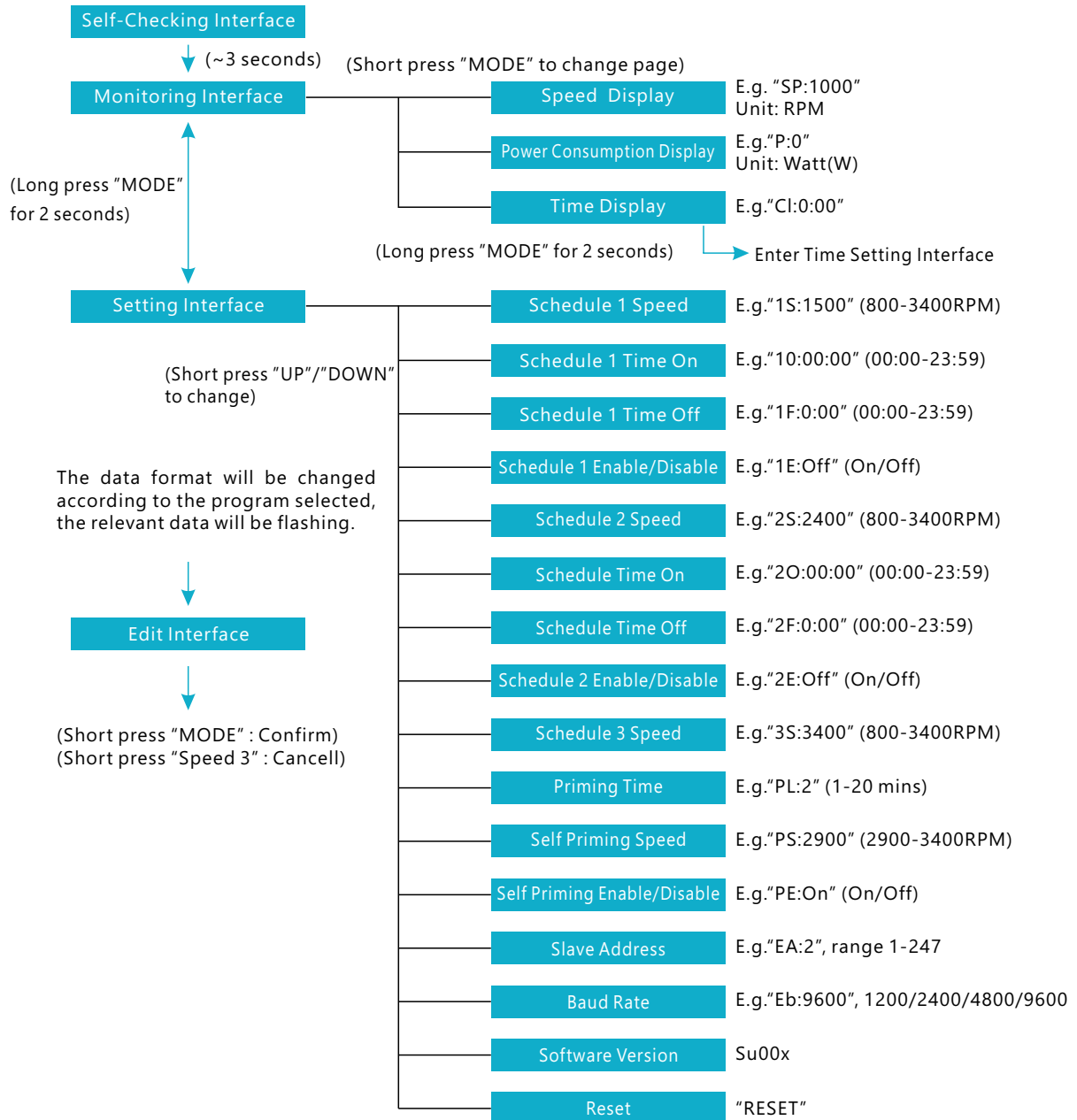

---

## 4. OPERATION PROCEDURE

---

### 4.1 POWER UP

Plug in power and the pump will do self-diagnostic checking.

1. If there is error, it will display as below, call you installer or dealer to fix the problem.

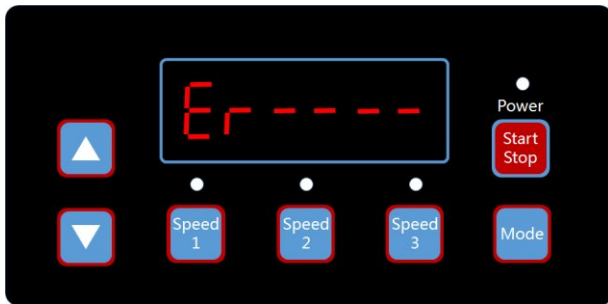

2. Normal display is as below and use "▲" "▼" buttons to adjust the speed (SP) in RPM.

3. Short press "Mode" again will display the power consumption (P) in Watt.

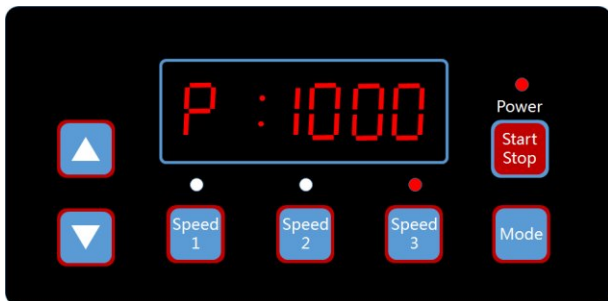

4. Short press "Mode" again to display the clock (CL)



### 4.2 CLOCK SETTING

1. Long Press "Mode" to access clock setting.
2. Short press "Speed 1" and "Speed 2" to shift between Hour and Minute. The adjustable value digital is flashing.
3. Press "▲" or "▼" to adjust the value.
4. Short press "Mode" to save setting or press "Speed 3" for cancel.
5. Then it exist clock setting.



### 4.3 PRESET SPEED 1-3

1. There are three preset speed, press Speed 1, Speed 2 and Speed 3 to change the pump speed.

Speed 1 = 1500 RPM

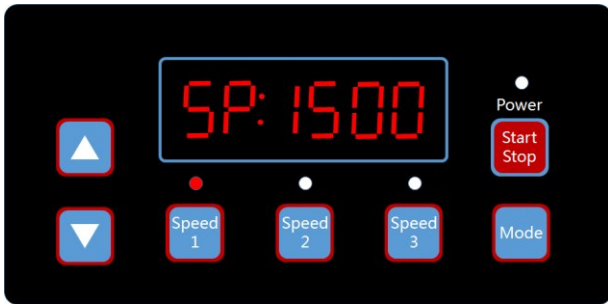

Speed 2 = 2400 RPM

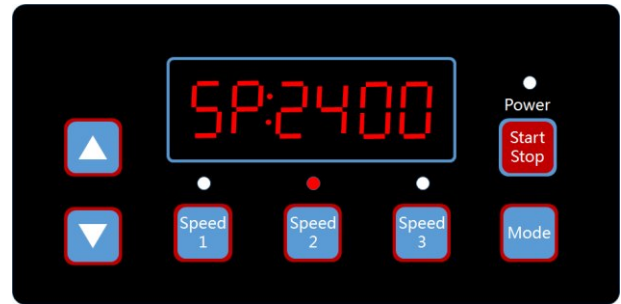

Speed 3 = 3400 RPM

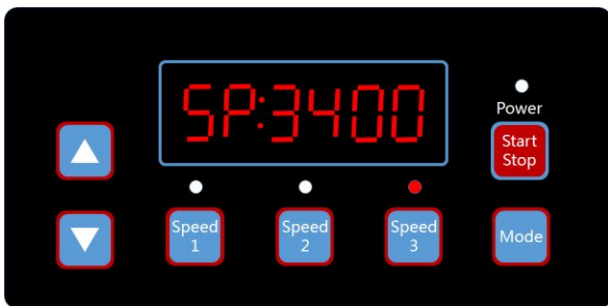

### 4.4 CHANGE PRESET SPEED 1-3

1. Press "Speed 1" and long press "Mode". The four digital speed value will flash.
2. Press "▲" or "▼" to adjust the speed.
3. Short press "Mode" to save setting or press "Speed 3" for cancel.
4. Repeat above for Speed 2 and Speed 3 setting.

### 4.5 SETTING SCHEDULE

When the display back to SP:1000. (Current speed display)

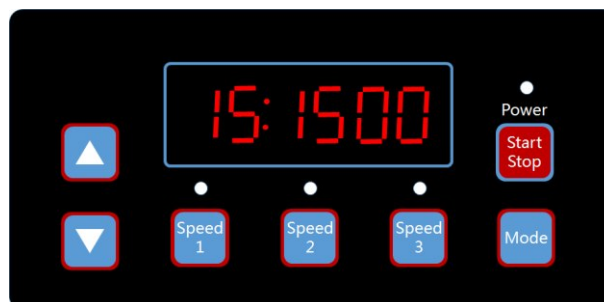

1. Long Press "Mode" to access **schedule 1** setting. Default speed is 1500RPM.
2. The corresponding speed is "Speed 1" and it can't be changed from this point. It needs to change from Speed 1-3 setting procedure as above.
3. Short press "▲" or "▼" to set **START TIME** (10:00:00). Default is 00:00

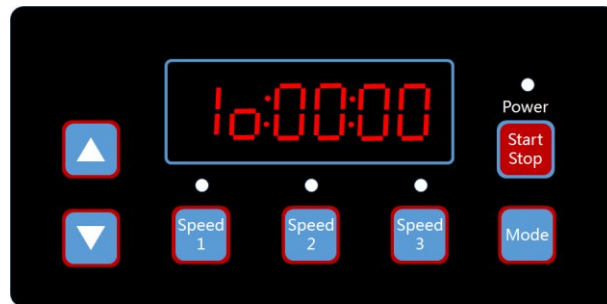

1. Short press "Speed 1" and "Speed 2" to shift between Hour and Minute. The adjustable value digital is flashing.
2. Press "▲" or "▼" to adjust the value.
3. Short press "Mode" to save setting or press "Speed 3" for cancel

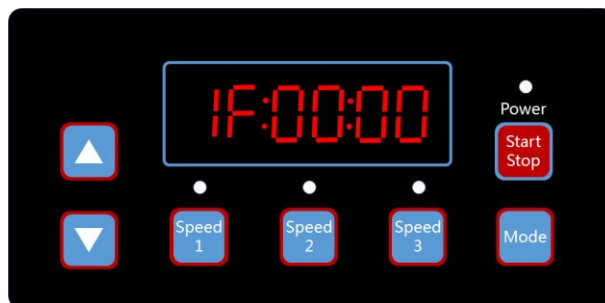

1. Short press "▲" or "▼" to set the **END TIME** (11:00:00) . Default is 00:00
2. Short press "Speed 1" and "Speed 2" to shift between Hour and Minute. The adjustable value digital is flashing.
3. Press "▲" or "▼" to adjust the value.
4. Short press "Mode" to save setting or press "Speed 3" for cancel
5. Short press "▲" or "▼" to access ON or OFF setting. Default is OFF

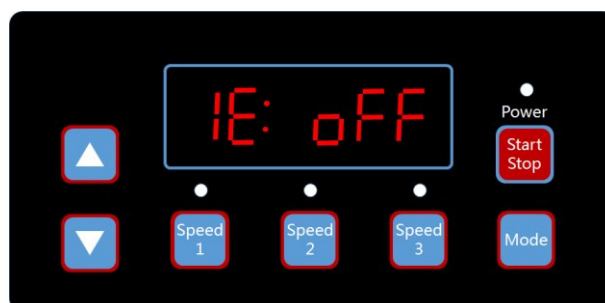

1. Press "▲" or "▼" to turn it ON or OFF
2. Short press "Mode" to save setting or press "Speed 3" for cancel
3. Short press "▲" or "▼" to **schedule 2** setting. Default speed is 2400 RPM

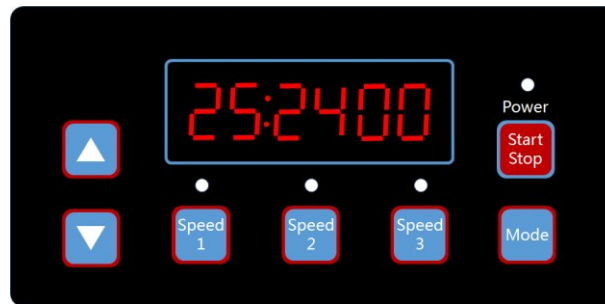

1. Repeat the above procedure for schedule 2 setting
2. Short press "▲" or "▼" to schedule 3 speed setting display only. Default is 3400 RPM



### 4.5.1 SCHEDULE POLICY

1. Programmed Schedule Priority Schedule 1 > Schedule 2
2. If more than 1 schedule is enables within the same time period, the controller will operate only with the highest priority schedule and speed. The corresponding indication light will turn on.
3. If all schedules are completed according to their pre-set times, the controller will return to the condition before setting the schedule.
4. When one of programmed schedules is running and before schedule end. Any operation such as Start / Stop, speed adjust by ▲ or ▼, Speed 1-3 and any change by external RS485 MODUS. The schedule timer and speed will be resumed when it is start over by pressing the Start / Stop to run again.
5. The scheduled settings and auto-recovery cannot contradict each other. When there is an error, the variable speed driver will restore the settings to those before the error. (The priority setting is still applicable).

---

## 5. PRIMING SETTING

---

### 5.1 PRIMING TIME

1. Short press "▼" to access PRIME TIME setting. Default is 2 minute
2. Press "▲" or "▼" to adjust the value.
3. Short press "Mode" to save setting or press "Speed 3" to cancel.

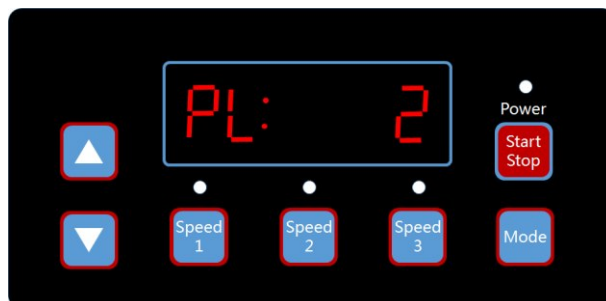

### 5.2 PRIME SPEED

1. Short press "▼" to access **PRIME SPEED** setting
2. Press "▲" or "▼" to adjust the value
3. Short press "Mode" to save setting or press "Speed 3" for cancel



### 5.3 PRIMING ENABLE / DISABLE

1. Short press "▼" to access enable and disable setting. Default is ON
2. Press "▲" "▼" to set ON or OFF.
3. Short press "Mode" to save setting or press "Speed 3" for cancel



---

## 6. RS485 SETTING

---

The pump equipped with RS485 communication interface for external automation controller. It is not for domestic user access purpose. It is an always ready to interface for external automation control.

The pin assignment is 1 = A and 2=B. The waterproof connector type is SP1310 4pins. SPV's RS485 is a pure data communication without 5V power supply output.

Contact your dealer for MODBUS programing manual, if you are a system integrator

### 6.1 SLAVE ADDRESS

There are two parameter can be change.

1. Short press "▼" to access Slave Address setting. Default Is 2
  - (1.1) Press ▲▼ to adjust the value.
  - (1.2) Short press "Mode" to save setting or press "Speed 3" for cancel



### 6.2 BAUD RATE

1. Short press "▼" to access Baud rate Setting. Default is 9600 bp
  - (1.1) Press ▲▼ to adjust the value.
  - (1.2) Short press "Mode" to save setting or press "Speed 3" for cancel
2. Short press "" to check the firmware version



---

## 7. SYSTEM RESET TO FACTORY DEFAULT SETTING

---

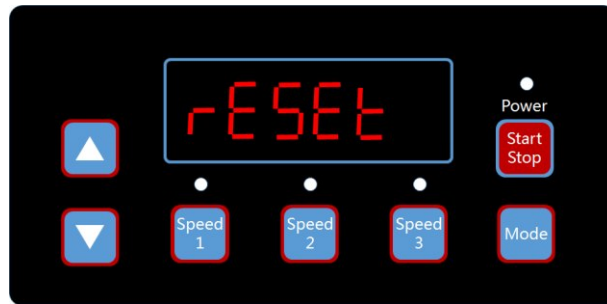

1. Short press "▼" to access system "RESET" function
2. Press "Mode" to confirm reset to factory default setting

---

## 8. AUTO-RECOVERY

---

When there is an Overcurrent, Overvoltage, Under-voltage or Overheating error, the system will recover itself automatically. If two errors happen in less than a 60 seconds interval, the auto-recovery time will increase once. If the auto-recovery increases by 3 times, the system will direct you to the Error menu, and will not execute the auto-recovery. The Auto-recovery page will display the error details during the first 5 seconds and the countdown details during the following 5 seconds.

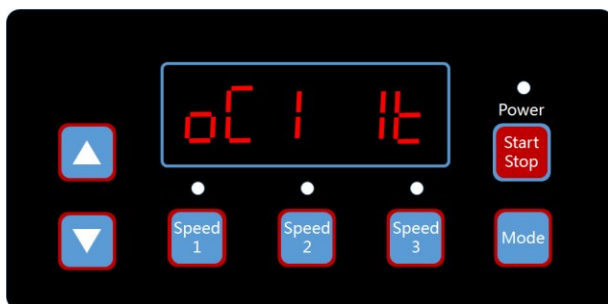

Press "Start/Stop" button to cancel the countdown during the auto-recovery process or to activate the auto-recovery immediately. (Without activating the auto-run. If there is an error and the variable speed driver is in operation, then after the auto-recovery the system will display the auto-start page. The auto-start page will show the error details (same as auto-recovery, which will last for 5 seconds) and the countdown details)

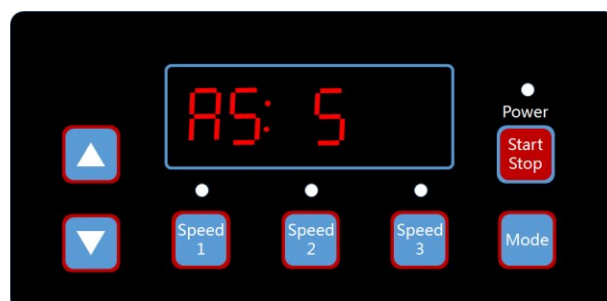

Press "Run" to cancel the procedures and to auto-recover immediately (the default settings of the variable speed driver will appear).

## 9. ERROR MENU

The Error Menu display will show all error details and all lights will start flashing. Press "Run" shortly at the error menu, to auto-recover the variable speed driver (keep the driver Off).

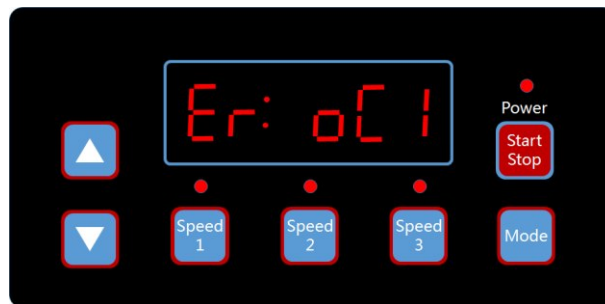

## 10. ERRORS DESCRIPTION

### 10.1 COMMUNICATION ERROR

If the communication error ("ER ---") appears, make sure that the plug has a good contact with the current and reset the system by unplugging the equipment from the power supply, wait at least 60 seconds before reconnecting.

If the error continues, contact your Emaux technical service.

### 10.2 OPERATION ERRORS

When the controller is not working, an error code will be shown on the controller display. E.g. "Er: OV". Press the "Start/Stop" button to restore the controller.

The common error codes are the following:

Error	Description	Reason
OC	Overcurrent: driver current output exceeds the threshold (200% of rated)	- Driver output failure - Driver IPM module is damaged
OV	Overvoltage: the main circuit DC voltage exceeds the threshold.	- Exceeded power from the power supply - Power supply voltage exceeds the control settings
UV	Under-voltage: the main electric current is too low.	- Ambient temperature is too high - Supply voltage fluctuation is too large
OH	Overheating: the motor heat sink is overheated.	- Ambient temperature is too high - Motor Cooling Fan does not work

---

# 11. WI-FI SETTING

---

EPV series VS pump Wi-Fi version with control interface build in to control the pump over Wi-Fi in Wi-Fi Direct ONE to ONE and Home Network.

## 11.1 ENABLE WI-FI CONNECTION

1. Connect to AC power and Power on EPV variable speed pump by "Run" button after proper piping installation.
2. The pump will start self-pumping and Wi-Fi icon should display next to the clock in few minutes.
3. If there is no Wi-Fi icon display, press the "MENU" button and roll down to items 10 by "▼" , press "ENTER" to access Wi-Fi setting.
4. Press "FUNCTION" to display the selection.
5. Press "Enabled" by pressing "ENTER" and "ESC" to go back to home display.

## 11.2 Wi-Fi Direct CONNECTION

EPV Wi-Fi Direct connection is a ONE To ONE connection without access Home Network. It is just like a private controller. It can be connected and control by mobile phone, tablet PC, laptop top or any Wi-Fi enable devices directly without computer operation system concern. The user interface support most of the popular web browser.



1. Go to Wi-Fi setting of mobile phone and find "EPV SPV-WiFi" and enter password "VS\_\_PUMP" for connection. This is the factory default SSID name and password.
2. Scan the QR code label on the side of the controller unit, it will access the EPV user interface and the browser show "EPV PUMP.com" which is a virtual domain name without internet connection.
3. Or, by typing IP address 192.168.8.1 to access.

## 11.3 APPLICATION INTERFACE

The user interface can do all the EPV setting and programming as the control panel on the pump, along with status display. It easy and comprehensive to use.

1. Touch the "Run/Stop" button to switch the pump ON/OFF.
2. Touch the speed "number, 2500", enter the speed and touch any location of screen for enter. The pump will run at new speed.
3. Press S1-S4 to select the preprogram speed.
4. Pump running status, schedule status and error code display at the bottom.
5. Touch the SETTING icon to enter setting page
6. Touch "English" next to Emaux logo to select language. The control page support languages in English, French, German, Italian, Spanish, Russian and Chinese.



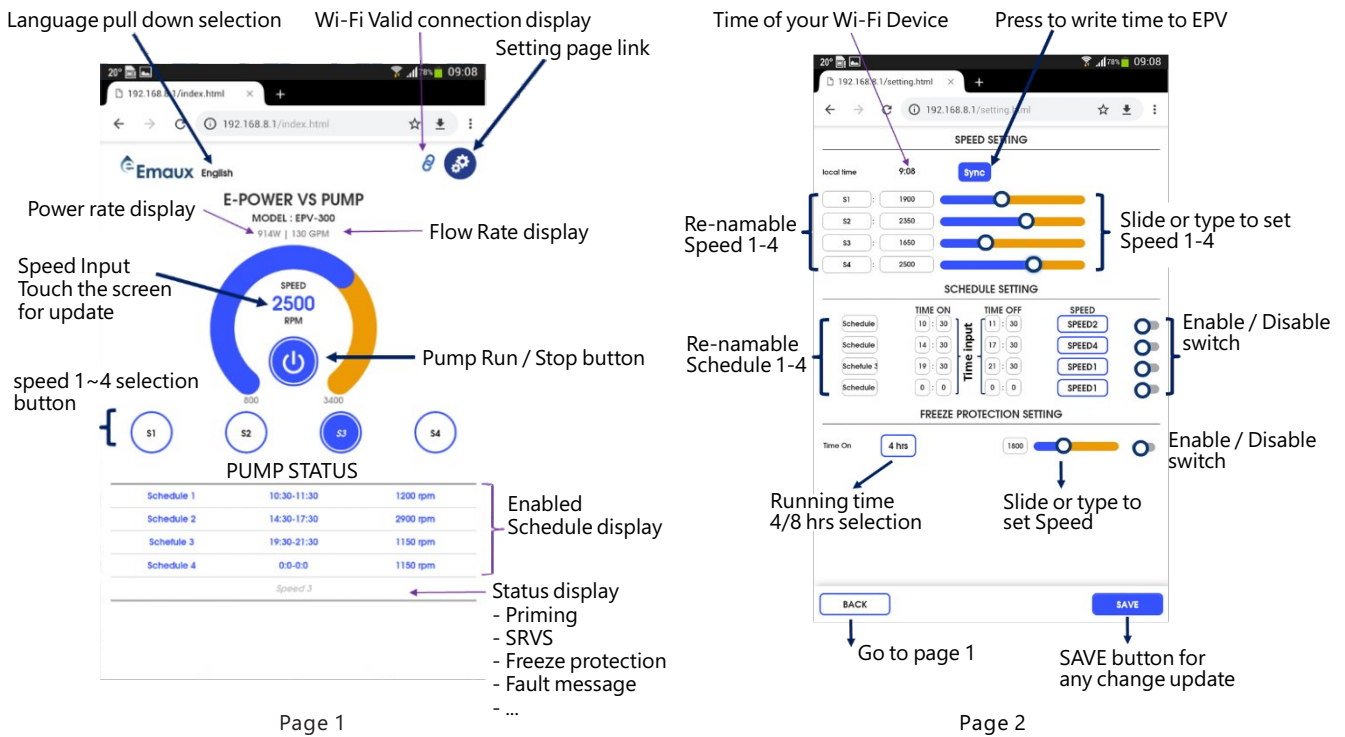

1. Touch the "SYNC" to set the pump clock, the pump will follow the clock of your Wi-Fi device.
2. Speed 1-4 speed setting is done by slider or direct enter the speed box.
3. Speed 1-4 can be renamed as user prefer in less than 10 characters.
4. Schedule 1-4 can set Time On and OFF duration and among Speed 1-4. Schedule can be renamed as user prefer in less than 10 characters. There is enable and disable switch at the end of each setting to turn it ON or OFF.
5. Freeze protection default temperature is 4 degree C in 4 or 8 hours running in setting speed.
6. To do any change, touch save to store the change before back to home page.

## 11.4 CHANGE SSID AND PASSWORD

The SSID and Password can be changed by typing the IP address 192.168.8.1:88 to access the Wi-Fi Network setting page. It is similar to what people do for their home router.

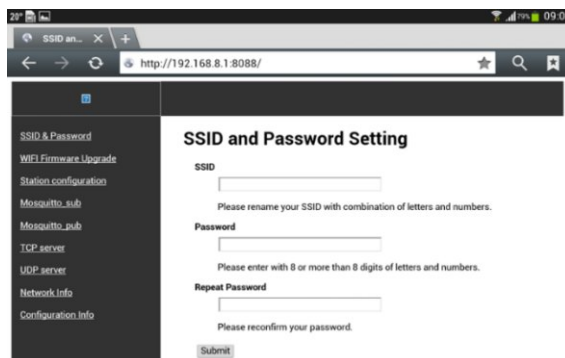

- Type SSID name and password, repeat the same password, then press "Submit".
- The EPV Wi-Fi SSID and password is changed and you need to re-connect the EVP Variable speed pump Wi-Fi by new assigned SSID and Password.
- Scan QR code or type IP address 192.168.8.1 to access the web server page again.

## 11.5 CONNECT TO HOME NETWORK

(Caution) User has to know how to do "Home Network Router" Setting and it is preferred to do it by desktop or laptop PC. Refer to your router manual if necessary.



The EPV variable speed pump Wi-Fi can be set to connect to Home Network to extend the control distance and easy access.

1. Access Emaux-WiFi Type IP address 192.168.8.1:8 to access the Wi-Fi network setting. Select Station configuration.

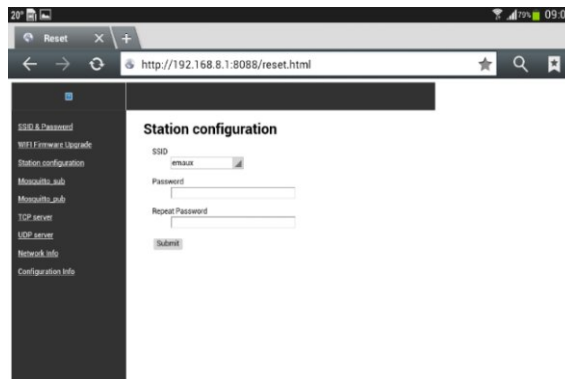

2. Type your Home Network SSID and password, repeat password and then press submit. It will show success when it is done. The EPV will connect to Home Router automatically. The Direct-Wi-Fi connection SSID will be erased and can't be found and used again.
3. Access your router and go to DHCP Client list to find EPV new IP address. The location and display format will not be the same for different router bands, user must have the knowledge to get the new IP address from the router's DHCP clients list.
4. Connect mobile phone / tablet to assigned Home Network type the new assigned IP address on the web browser for user interface access.

The screenshot shows a router's web interface with a sidebar menu on the left containing "Status", "Quick Setup", "Network", "Dual Band Selection", "Wireless 2.4GHz", "Wireless 5GHz", "Guest Network", "DHCP", "DHCP Settings", "DHCP Clients List", "Address Reservation", and "USB Settings". The main content area is titled "DHCP Clients List" and contains a table with the following data:

ID	Client Name	MAC Address	Assigned IP	Lease Time
1	win8	F8-BC-12-9B-92-3F	192.168.0.100	01:59:24
2	EPV	14-CC-20-42-B8-E5	192.168.0.101	01:56:24
3	test-3-PC	16-CC-20-CE-14-93	192.168.0.102	01:54:42
4	iPhone-6	16-CC-20-D7-FD-E4	192.168.0.103	01:57:29

A red box highlights the row for the EPV client (ID 2). Below the table is a "Refresh" button.

5. The same User Interface will be displayed and operation functions remain the same.

---

## 12. ROUTINE MAINTENANCE

---

The only routine maintenance needed is the inspection/cleaning of the trap basket. Debris or trash collected in the basket will choke off the water flow through the pump. Follow the instructions below in order to clean the trap:

1. Stop the pump, close the gate valve in suction and discharge, and release all pressure from the system before proceeding.
2. Unscrew the trap lid (turn counter clockwise).
3. Remove the strainer basket and clean. Make sure all the holes in the basket are clear, flush the basket with water and replace it in the trap with large opening at the pipe connection port (between ribs provided). If the basket is replaced backwards, the cover will not fit on the trap body.
4. Clean and inspect the lid ring; reinstall on the trap cover.
5. Clean the ring groove on the trap body and replace the lid. To help keep the lid from sticking, tighten it by hand only.
6. Prime the pump (see priming instructions above).

---

## 13. AFTER-SALES SERVICE

---

Refer all service needs to your local agent or dealer as his knowledge of your equipment makes him the best qualified source of information. Order all the repair parts through your dealer. Give the following information when ordering repair parts.

1. Unit name on the plate data or serial number on the label.
2. Description of the part.

---

## 14. DIMENSIONS

---

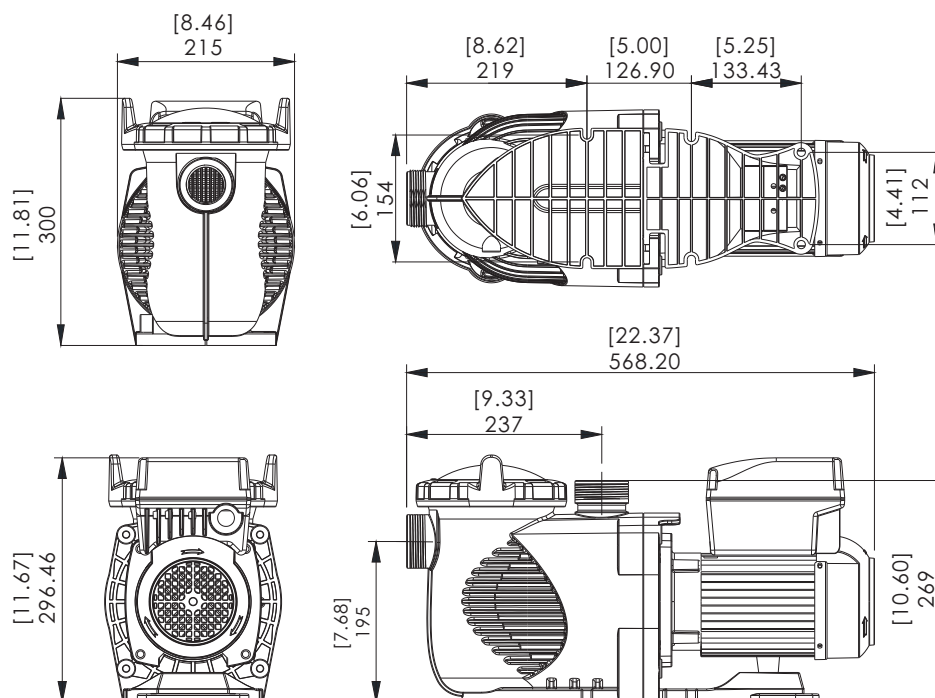

## 15. REPLACEMENT PARTS

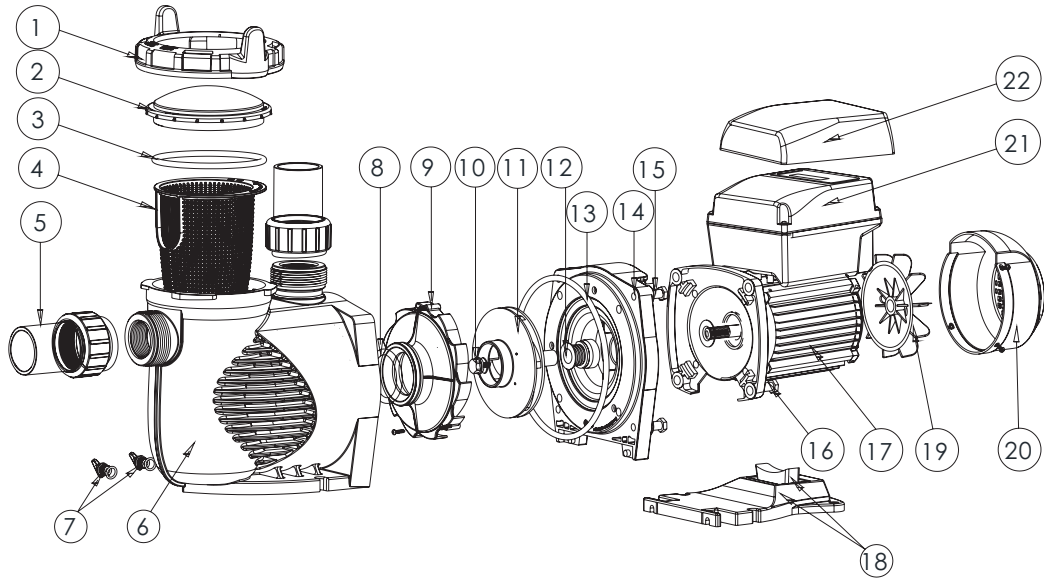

Key No.	Part No.	Description	QTY
1	01021143	Nut for lid	1
2	01041057	Transparent Lid	1
3	02010253	O-Ring for Lid	1
4	01112080	Basket	1
5	89023801	1.5" Union	2
6	01021144	Pump Body	1
7	89021307	Drain Plug with O-ring	2
8	02010245	O-Ring for Diffuser	1
9	01112081	Diffuser	1
10	89020719	Screw for impeller with O-Ring	1
11	01311058	Impeller For SPV150 & EPV150	1
12	04015065	3/4" Mechanical seal (EPH/EPV/SPH/SPV)	1
13	02010246	O-Ring for Flange	1
14	01021145	Flange	1
15	89020720	M8 x 35 Screw with Washer for Motor	4
16	03011075	M8 x 30 Screw	4
17	04020140	SPV150 TYC-71L Motor	1
18	01112082	Base	1
18	02010211	Arch Cushion for Base	1
19	01031027	Fan	1
20	01321032	Fan Cover	1
21	89023901	Programmable Controller for SPV150	1
22	01041061	Transparent Lid for Programmable Controller	1

## 16. SPECIFICATION AND PUMP CURVE

Code	Model		Voltage/ Frequency	Max Load Current	Connection ID/OD	Input Power	Horse power	RPM
9023302	SPV150	RS485	220-240V 50Hz/60 Hz	5.9-5.4A	1.5"/2" 50mm/63mm	1.30 (kW)	1.5 hp	800-3400 RPM
9023303	SPV150WR	WIFI + RS485						

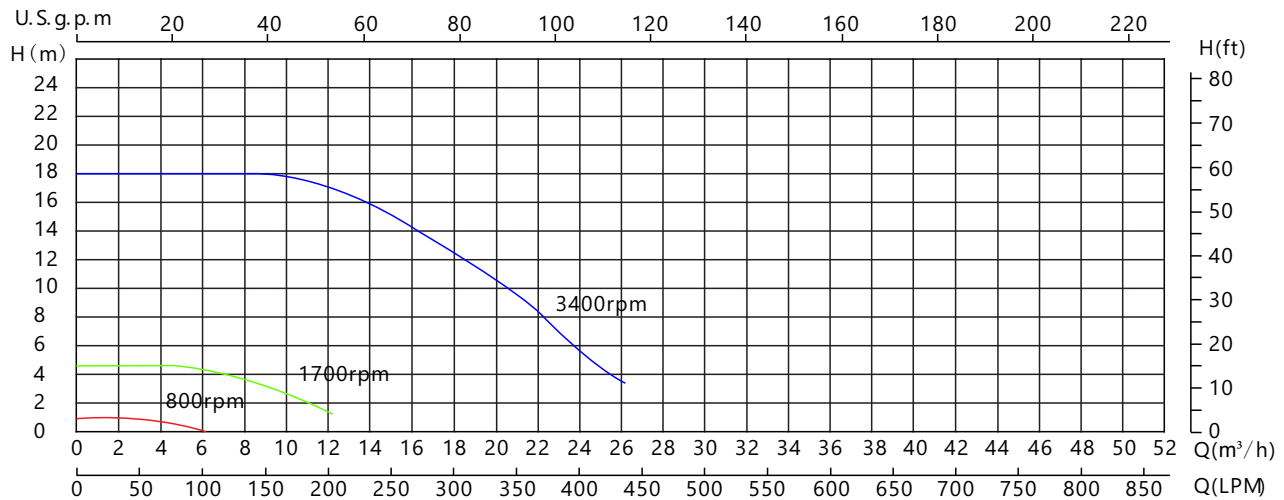

## 17. TROUBLE SHOOTING

Problem description	Possible causes
Motor does not start	<ol style="list-style-type: none"> <li>1. Disconnect switch or circuit breaker in off position</li> <li>2. Fuses blow nor thermal over load open</li> <li>3. Locked motor shaft</li> <li>4. Motor windings burned out</li> <li>5. Defective starting switch inside single phase motor</li> <li>6. Disconnected or defective wiring</li> <li>7. Low voltage</li> </ol>
Pump does not reach full speed	<ol style="list-style-type: none"> <li>1. Low voltage</li> <li>2. Pump connected to the wrong voltage</li> </ol>
Motor over heats (protect or trips)	<ol style="list-style-type: none"> <li>1. Low voltage</li> <li>2. Motor windings connected to the wrong voltage on dual voltage model</li> </ol>
Pump delivers no water	<ol style="list-style-type: none"> <li>1. Pump is not primed</li> <li>2. Closed valve in suction or discharge line</li> <li>3. Leakage or air into suction system</li> <li>4. Impeller clogged</li> </ol>

<b>Problem description</b>	<b>Possible causes</b>
Leakage of water at the shaft	Shaft seal requires replacement
Low pump capacity	<ol style="list-style-type: none"> <li>1. Valve in the suction or discharge line partly closed</li> <li>2. Suction or discharge line partly plugged</li> <li>3. Suction or discharge line too small</li> <li>4. Plugged basket in skimmer or hair and lint strainer</li> <li>5. Dirty filter</li> <li>6. Impeller clogged</li> </ol>
High pump pressure	<ol style="list-style-type: none"> <li>1. Discharge valve or inlet fittings closed too much</li> <li>2. Return lines too small</li> <li>3. Dirty filters</li> </ol>
Noisy pump and motor	<ol style="list-style-type: none"> <li>1. Plugged basket in skimmer or hair in lint strainer</li> <li>2. Worn motor bearings</li> <li>3. Valve in suction line partly closed</li> <li>4. Suction line partly plugged</li> <li>5. Vacuum hose plugged or too small</li> <li>6. Pump not supported properly</li> </ol>
Air bubbles at inlet fittings	<ol style="list-style-type: none"> <li>1. Leakage of air into the suction line in connections or valve stem</li> <li>2. Cover gasket of hair and lint strainer needs cleaning</li> <li>3. Low water level in the pool</li> </ol>

Note: If the above recommendations of this manual do not solve your particular problem(s), please contact your local service agent for further assistance.

## 18. WARRANTY POLICY

Emaux manufactures its products with the highest standard of workman ship, using the best materials available through state of the art process. Emaux proudly warrants its products as follows:

<b>EXTENDED WARRANTY FOR SPECIFIC PRODUCTS (OFFERED FROM DATE OF INVOICE).</b>	
<b>Product</b>	<b>Warranty Period</b>
Filters & Filter Systems	2 years
Pumps	1 year
Underwater Lights	1 year (bulbs 90 days)
Ladders	1 year
Control devices	1 year
Heat Pumps & Heat Exchangers	1 year
Salt Chlorinators & UV Systems	1 year (2 years for cell material)
Pool Fittings	1 year
Cleaning Equipment & All others	1 year

## 18.1 EXCEPTIONS THAT MAY RESULT IN DENIAL OF A WARRANTY CLAIM:

1. Damage caused by careless handling, improper repackaging or shipping.
2. Damage due to misapplication, misuse, abuse or failure to operate and install the equipment as specified in this manual.
3. Damage caused by a misuse, abuse or failure to operate and install the equipment out of the scope of a professional level demanded in similar equipment or installation type.
4. Damage due to unauthorized product modifications or failure to use Emaux original replacement parts.
5. Damaged caused by negligence or failure to properly maintain products as specified in this manual.
6. Damage caused by failure to maintain water chemistry in conformity with the standards of the swimming pool industry for any length of time.
7. Damage caused by water freezing inside the product.
8. Accident damage, fire or other circumstances outside the control of Emaux.
9. Items had been repaired or altered in any way by any person that is not authorized by Emaux.
10. Wear & tear parts.

## 18.2 CLAIM PROCESS

Summary of Emaux Claim Process in 3 steps:

1. Claim: Customer contacts Emaux salesperson and provides completed details of the claim which includes:
  - (1) Information about the failed product such as the part number(s) and serial number(s).
  - (2) Description of the complaint/failure.
  - (3) Pictures
2. Once the complaint is received, the product quality incident will then be reviewed by Emaux's Quality Control Department following the "Emaux Warranty Policy".
3. Conclusion: After the investigation is completed, Emaux will inform the distributor accordingly.

## 18.3 WARRANTY OBLIGATION

Emaux warrants any of above items from workmanship and/or material(s).

Should a defect become evident during the term of warranty, Emaux will, at its option, repair or replace such item or part at its own cost and expense. Customer will need to follow the warranty claim procedures from Emaux in order to obtain the benefit on this warranty.

Emaux is not, however, responsible under this warranty for any cost of shipping or transportation of the equipment or parts thereof "to" or "from" our technical operations.

Emaux is not able to liable for any loss of time, inconvenience, incidental expenses such as labor cost, phone calls, legal cost or material cost incurred in connection with the replacement or removal of the equipment, or any other consequential or incidental damage on persons or assets. Emaux will be not responsible for any business profit loss operation stop due to the non-conformity product equipment. No indemnity or damages can be claimed on any account whatever.

## 18.4 WARRANTY OR REPRESENTATIONS BY OTHERS

No dealer or other person has authority to make any warranty or representation concerning Emaux or its products. Accordingly, Emaux is not responsible for any such warranty or representation.

**EMAUX WATER TECHNOLOGY CO., LTD**

ADDRESS FLAT A-D, 20/F., KAI BO 22, 22 WING KIN ROAD,  
KWAI CHUNG, HONG KONG

PHONE +852 2832 9880

 **YOUR PREMIER SUPPLIER**

[www.emauxgroup.com](http://www.emauxgroup.com)