



E-POWER VARIABLE SPEED PUMP

WITH WI-FI AND MODBUS OPTIONS

For large residential pools and water features

*NSF only apply for NSF version

EMAUX WATER TECHNOLOGY CO., LTD

ADDRESS FLAT A-D, 20/F., KAI BO 22, 22 WING KIN ROAD,
KWAI CHUNG, HONG KONG

PHONE +852 2832 9880

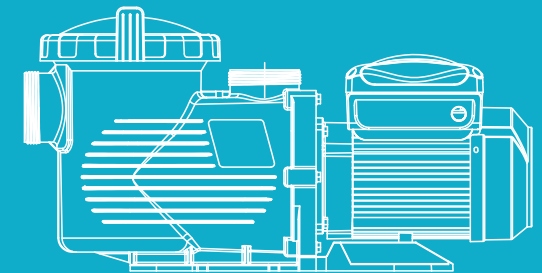

USER MANUAL

◆ STRIVE FOR CLEAR WATER



RoHS
COMPLIANT
2002/95/EC



SAA



www.emauxgroup.com

Model: EPV Series

TABLE OF CONTENT

PAGE	
2 WARNINGS AND SAFETY INSTRUCTIONS
41. EPV SERIES VARIABLE SPEED PUMP OVERVIEW
42. PRODUCT INFORMATION @ 220-240Vac 50/60 Hz
53. IMPORTANT SAFETY INSTRUCTIONS
64. INSTALLATION
	4.1 PIPING
	4.2 ELECTRICAL WIRING
75. START UP
86. ROUTINE MAINTENANCE
97. WINTERIZING
98. CONTROL AND DISPLAY PANEL
	8.1 CONTROLLER OVERVIEW
	8.2 DISPLAY INTERFACES
	8.3 CONTROL BUTTONS
	8.4 PROGRAMMING FLOW CHART
129. OPERATION INSTRUCTIONS
	9.1 INTERNAL SYSTEM CLOCK
	9.2 SPEED SET UP
	9.3 SCHEDULE SET UP
	9.4 SCHEDULE 1 SET UP
	9.5 VARIABLE SPEED SET UP
	9.6 LANGUAGE SET UP
	9.7 SVRS (SAFETY VACUUM RELEASE SYSTEMS) SETTING
	9.8 "NO FLOW" SET UP
	9.9 PUMP PRIMING SET UP
	9.10 FREEZE PROTECTION SET UP
	9.11 WI-FI
	9.12 RS485
	9.13 RESET
1510. ERRORS DESCRIPTION
	10.1 COMMUNICATION ERROR (COMM ERROR)
	10.2 ERROR DISPLAY
1511. WI-FI CONNECTION (FOR WIFI VERSION)
	11.1 ENABLE WI-FI CONNECTION
	11.2 WI-FI DIRECT CONNECTION
	11.3 APPLICATION INTERFACE
	11.4 CHANGE SSID AND PASSWORD
	11.5 CONNECT TO HOME NETWORK
	11.6 CONNECTIVITY SPECIFICATION
1912. RS-485 CONNECTION (FOR RS-485 VERSION)
2013. AFTER-SALES SERVICE
2114. REPLACEMENT PARTS
2215. TROUBLE SHOOTING

15. TERMS OF THE WARRANTY

As original purchaser of this equipment have purchased from Emaux Water Technology Co., Ltd, through Authorized International Distributor or Dealer, warrants its products free from defects in materials and workmanship under normal use during warranty period. The warranty period begins on the day of purchase and extends only to the original purchaser. It is not transferable to anyone who subsequently purchases the product from you. It excludes all expendable parts.

During the warranty period, Emaux authorized reseller will repair or replace defective parts with new parts or, at the option of Emaux, serviceable used parts that are equivalent or superior to new parts in performance.

This Limited Warranty extends only to products purchased from Emaux authorized reseller. This Limited Warranty does not extend to any product that has been damaged or rendered defective

1. As a result of accident, misuse or abuse;
2. As a result of an act of God;
3. By operation outside the usage parameters stated herein;
4. By the use of parts not manufactured or sold by Emaux;
5. By modification of the product;
6. As a result of war or terrorist attack; or
7. As a result of service by anyone other than Emaux authorized reseller or authorized agent.

Except as expressly set forth in this warranty, emaux makes no other warranties expressed or implied, including any implied warranties or merchantability and fitness for a particular Purpose. Emaux expressly disclaims all warranties not stated in this limited warranty. Any Implied warranties that may be imposed by law are limited to the terms of this express limited Warranty.

14. TROUBLE SHOOTING

Problem description	Possible causes
Motor does not start	<ol style="list-style-type: none"> 1. Disconnect switch or circuit breaker in off position 2. Fuses blown or thermal overload open 3. Locked motor shaft 4. Motor windings burned out 5. Defective starting switch inside single phase motor 6. Disconnected or defective wiring 7. Low voltage
Pump does not reachfull speed	<ol style="list-style-type: none"> 1. Low voltage 2. Pump connected to the wrong voltage
Motor overheats(protect or trips)	<ol style="list-style-type: none"> 1. Low voltage 2. Motor windings connected to the wrong voltage on dual voltage model
Pump delivers no water	<ol style="list-style-type: none"> 1. Pump is not primed 2. Closed valve in suction or discharge line 3. Leakage of air into suction system 4. Impeller clogged
Leakage of water at the shaft	Shaft seal requires replacement
Low pump capacity	<ol style="list-style-type: none"> 1. Valve in the suction or discharge line partly closed 2. Suction or discharge line partly plugged 3. Suction or discharge line too small 4. Plugged basket in skimmer or hair and lint strainer 5. Dirty filter 6. Impeller clogged
High pump pressure	<ol style="list-style-type: none"> 1. Discharge valve or inlet fittings closed too much 2. Return lines too small 3. Dirtyfilters
Noisy pump and motor	<ol style="list-style-type: none"> 1. Blocked skinner basket or hair in lint strainer 2. Worn motor bearings 3. Valve in suction line partly closed 4. Suction line partly plugged 5. Vacuum hose plugged or too small 6. Pump not supported properly
Air bubbles at in let fittings	<ol style="list-style-type: none"> 1. Leakage of air into the suction line in connections or valve stem 2. Cover gasket of hair and lint strainer needs cleaning 3. Low water level in the pool
Pump Running not as Schedule	Clock setting is not the local time

Note: If the above suggestion do not solve your particular problem(s), please contact your local service agent for further assistance.

WARNINGS AND SAFETY INSTRUCTIONS GENERAL WARNING

These instructions contain general safety information for the use of pumps in Pool and SPA installations. For specific pump models, refer to the respective manual. Components such as the filtration system, pumps and heaters should not be located in an area used by young children for access to the pool.



RISK OF ELECTRICAL SHOCK

This appliance should be installed by qualified electrician in accordance with National Electrical Code and all applicable local codes and ordinances. Hazardous voltage can shock, burn, and cause death or serious property damage. In order to reduce the risk of electric shock, "DO NOT" use an extension cord to connect the unit to an electricity supply.

1. The pump should be permanently connected to an individual circuit breaker.
2. Pump must be connected to a residual current device (RCD) having a rated residual operating current not exceeding 30 mA or receptacle with ground fault circuit interrupt (GCFI).
3. Electrical grounding must be connected before connecting to electrical power. Failure to ground all electrical equipment can cause serious or fatal electrical shock hazard.
4. Bonding: Use at least #8 AWG (#6 AWG for Canada) a solid copper conductor, run a continuous wire from external bonding lug (if available) to the pressure wire connector provided on the electrical equipment and to all metal parts of swimming pool, spa, or hot tub, and metal piping (except gas piping), and conduit within 1.5m(5 ft) of inside walls of swimming pool, spa, or hot tub.
5. Never open the inside of the drive motor enclosure. There is a capacitor bank that holds a mains supply voltage charge even when there is no power to the unit. The voltage should be referred to the individual pump operation voltage.
6. The pump is capable of high flow rates; use caution when installing and programming to limit pumps performance only.
7. Switch OFF pump power before servicing and disconnecting the main circuit to the pump.
8. Never change the filter control valve position while the pump is running

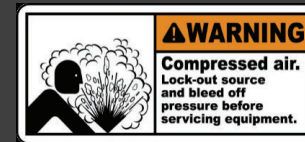

COMPRESS AIR HAZARDOUS

Enclosed pre-filter / filter system will become pressurized. Compressed air can cause the lid to separate which can result in serious injury or death.

STAND CLEAR OF PUMP DURING START-UP

Pool and spa circulation systems operate under high pressure. When any part of the circulating system (i.e. lock ring, pump, filter, valves, etc.) is serviced, air can enter the system and become pressurized. Filter tank lid and pre-filter cover must be properly secured to prevent violent separation. Set the pre-filter / filter air relief valve in the open position and wait for all pressure in the system to be relieved before remove the lib to access the basket for cleaning.



HYPERTHE

SPA water temperature excess 38°C (104°F) may be hazardous to health. Test water temperature before entering spa water. Hyperthermia occurs when the internal temperature of the body reaches a level several

degrees above the normal body temperature of 98.6°F (37°C). The symptoms of hyperthermia include drowsiness, lethargy, and an increase in the internal temperature of the body.

SUCTION ENTRAPMENT HAZARD



WARNING:

This pump produces high levels of suction and creates a strong vacuum at the main drain in the pool and spa floor. This suction is so strong that it can trap adults or children under water if they come close to the drain or to be a loose or broken draincover or grating.

The Virginia Graeme Baker (VGB) Pool and Spa Safety Act creates new requirements for owners and operators of commercial swimming Pools and spas.

Commercial pools or spas constructed on or after December 19, 2008, shall utilize:

multiple main drain system without isolation capability with suction outlet covers that meet ASME/ANSI A112.19.8a Suction Fittings for Use in Swimming Pools, Wading Pools, Spas, and Hot Tubs and either:

1. A safety vacuum release system (SVRS) meeting ASME / ANSI A112.19.17 Manufactured Safety Vacuum Release systems (SVRS), or Residential and Commercial Swimming Pool, Spa, Hot Tub, and Wading Pool Suction Systems and/or ASTM F2387 Standard. Specification for Manufactured Safety Vacuum Release Systems (SVRS) for Swimming pools, Spas and Hot Tubs or
2. A properly designed and tested suction-limiting vent system or
3. An automatic pump shut-off system.

Commercial pools and spas constructed prior to December 19, 2008, with a single submerged suction outlet shall use a suction outlet cover that meets ASME / ANSI A112.19.8a and either:

1. A SVRS meeting ASME / ANSI A112.19.17 and / or ASTM F2387, or
2. A properly designed and tested suction-limiting vent system, or
3. An automatic pump shut-off system, or
4. Disabled submerged outlets, or
5. Suction outlets shall be reconfigured into return inlets.

There are five types of suction entrapment according to The Virginia Graeme Baker (VGB) Pool and Spa Safety Act:

1. Body Entrapment a section of the torso becomes entrapped
2. Limb Entrapment an arm or leg is caught by or pulled into an open drainpipe
3. Hair Entrapment or entanglement hair is pulled into and / or wrapped around the grate of the drain cover
4. Mechanical Entrapment the bather's jewelry or clothing gets caught in the drain or the grate
5. Evisceration the victim's buttocks come into contact with the pool suction outlet and he or she is disemboeled



WARNING: WARNING: TO REDUCE ENTRAPMENT HAZARD RISK

To prevent entrapment, two functioning suction outlets per pump must be installed. The minimum separation of suction on the same floor or wall must be at least 1 meter (3ft). This will avoid "dual blockage" by bather.

If the drain or its cover is damaged, broken, cracked, missing or not securely attached, shut down the pool and replace it immediately.

A vacuum safety release or vent system is recommended to be installed for suction entrapment release.

13. REPLACEMENT PARTS

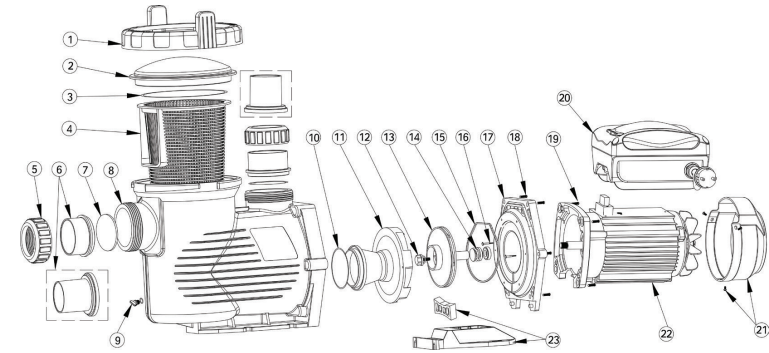

Key No.	Part No.	Description	QTY
1	01020016	Ring-lock for Lid	1
2	01041049	Transparent Lid	1
3	02010042	O-Ring for Lid	1
4	01110024	Basket	1
5	01013147	2.5" Nut for Connector	2
6	01171160	2.0" Union Adaptor	2
6	01171158	2.5" Union Adaptor	2
7	111040024	O-ring D80.5*5.3 * Replace 02010043	2
8	01112087	Pump Body	1
9	89021307	Drain Plug With O-Ring	2
10	02010213	O-Ring	1
11	01110025	Diffuser	1
12	89020719	Screw for Impeller with O-Ring	1
13	01311058	Impeller for EPV150 (50Hz)	1
13	01311047	Impeller for EPV200 & SPH100(50Hz)	1
13	01400103	Impeller for EPV300 & SPH150(50Hz)	1
14	E020001	3/4" Mechanical seal (EPH/EPV/SPH/SPV)	1
15	02010212	O-Ring for Flange	1
16	03011402	M3.5 x 35 Screw	2
17	01020017	Flange	1
18	89020720	M8 x 35 Screw with Washer for Motor	6
19	03011075	M8 x 30 Screw	4
20	89023702	Programmable Controller for EPV150 (without plug)	1
20	E023728	Programmable Controller for EPV150-RS485 (without plug)	1
20	E023725	Programmable Controller for EPV150-RS485 (Europe plug)	1
20	E023727	Programmable Controller for EPV150-RS485-WiFi (without plug)	1
20	E023726	Programmable Controller for EPV150-RS485-WiFi (Europe plug)	1
20	89023703	Programmable Controller for EPV200 (without plug)	1
20	E023729	Programmable Controller for EPV200-RS485 (without plug)	1
20	E023724	Programmable Controller for EPV200-RS485 (Europe plug)	1
20	E023730	Programmable Controller for EPV200-RS485-WiFi (without plug)	1
20	E023723	Programmable Controller for EPV200-RS485-WiFi (Europe plug)	1
20	89023704	Programmable Controller for EPV300 (without plug)	1
20	E023732	Programmable Controller for EPV300-RS485 (without plug)	1
20	E023722	Programmable Controller for EPV300-RS485 (Europe plug)	1
20	E023731	Programmable Controller for EPV300-RS485-WiFi (without plug)	1
20	E023721	Programmable Controller for EPV300-RS485-WiFi (Europe plug)	1
21	01321024	Fan Cover	1
22	04020113	EPV150 TYC-80M Motor	1
22	04020114	EPV200 TYC-80L Motor	1
22	04020115	EPV300 TYC-80XL Motor	1
23	01110026	Base	1
23	02010211	Arch Cushion for Base	1

11.6 Connectivity Specification

- Wi-Fi : Compliant to IEEE 802.11b / g / n
 1T1R 2.4GHz with support for a 150Mbps PHY data rate
 Security: WEP64 / 128, TKIP, AES, WPA, WPA2, WAPI
 AP and STA mode
 25m distance transmission
 Build-in antenna
- RS485: Max baud rate 9600bps
 MODBUS Protocol, support function code 3, 4, 6 and 16
 1-247 slave address
 Isolated A / B data bus, without 120 ohm terminal resistor

12. RS-485 CONNECTION (FOR RS-485 VERSION)

The RS-485 connection point is located on the side of the variable speed drive and should be connected to the MODBUS controller by a cable connector assembly (only the connector without cable is provided) as in the figure below.

Making the RS-485 cable connector assembly:

Disassemble the female connector and locate the pin numbers on the base.

Prepare one Pair 22 unshielded twisted Paired Cable RS 485. The length depends on the PUMP distance from the MODBUS controller which should not be more than 100m. Solder pin 1 for A and pin 2 for B respectively which corresponds to the Pump MOSBUS controller RS485 output pin configuration. Reassemble the connector and plug into the RS485 socket on the variable speed pump



For long distance wiring, pin 4 is needed for grounding and 120 ohm terminal resistor across A / B signal line.

1. EPV SERIES VARIABLE SPEED PUMP OVERVIEW

E-Power Series Variable Speed Pump provides the best energy saving solution from over-usage while increasing efficiency and reduce maintenance cost. Traditional single speed pump runs at maximum load continuously. They are inefficient and lead to higher running costs compared to Emaux E-Power Variable Speed Pump. Reduced speeds (rpm) provide a slower water circulation rate that put less strain on the complete installation such as filtration, sanitization, and plumbing. It reduces the wear and tear factor and resulting in significant cost saving to the pool owner.



Wireless Wi-Fi connectivity capability in Wi-Fi Direct AP Mode and Home network STA mode to access menu and control the pump over any Wi-Fi device with web browser. Wired RS485 MODBUS protocol for automation connectivity.

ENHANCED FEATURES:

Freeze Protection to prevent damage to piping by frozen water, and Safety Vacuum Release Systems (SVRS) detected by the pump to stop the circulation if entrapment occur in the pool.

2. PRODUCT INFORMATION @ 220-240Vac 50/60 Hz

DIMENSIONS: (unit in mm)

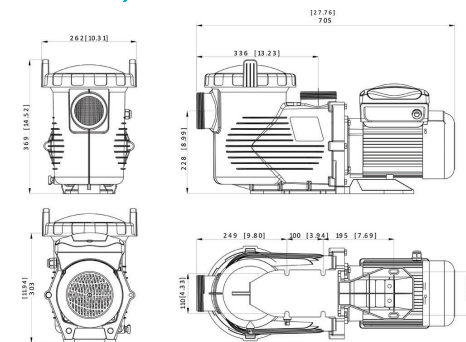

Code	Model	Connection Size (inch/mm)	Maximum Loading Current (Amp)	Maximum Input Power (kW)	Horse Power (hp)	Weight (kg)
88021107	EPV150	2" / 2.5" 63 / 75	6.8-6.25	1.50	1.5	23
88021108	EPV200		8.2-7.5	1.80	2.0	24
88021109	EPV300		10.0-9.2	2.20	3.0	25
9021605	EPV150-RS485		6.8-6.25	1.50	1.5	23
9021606	EPV200-RS485		8.2-7.5	1.80	2.0	24
9021607	EPV300-RS485		10.0-9.2	2.20	3.0	25
9021611	EPV150-WIFI+RS485		6.8-6.25	1.50	1.5	23
9021612	EPV200-WIFI+RS485		8.2-7.5	1.80	2.0	24
9021613	EPV300-WIFI+RS485		10.0-9.2	2.20	3.0	25

EPV300 PUMP CURVE

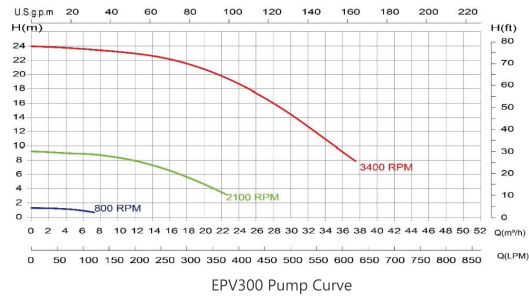

PERFORMANCE DATA

The Performance advantages of the E-Power Variable Speed Pump go beyond simple energy saving. It is much quieter, requires less maintenance, has longer equipment life, and increase the effectiveness of the filter by slower water filtration rates.

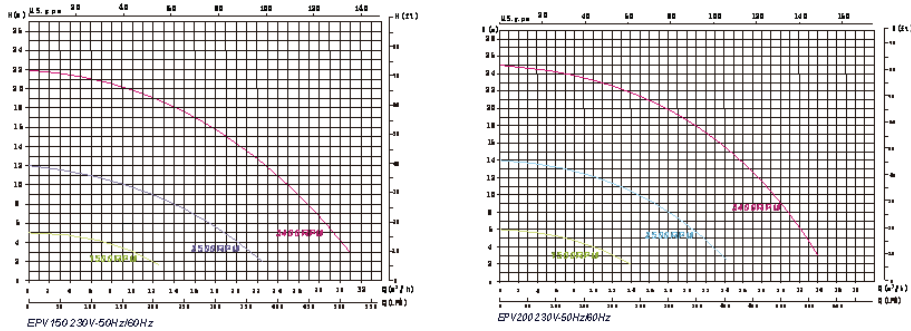

3. IMPORTANT SAFETY INSTRUCTIONS



IMPORTANT: The instruction manual you are holding includes essential information on the safety measures for installation and start-up of this equipment. Therefore, the installer as well as the user must read the instructions before beginning installation and start-up. Keep this manual for future reference.

1. A protective device is to be installed in the fixed wiring
2. This appliance can only be used by children aged from 8 years and above and persons with reduced physical, sensory or mental capabilities or lack of experience and knowledge if they have been given supervision or instruction concerning use of the appliance in a safe way and understand the hazards involved. Children shall not play with the appliance. Cleaning and user maintenance shall not be made by children without supervision.
3. The appliance shall be installed in accordance with national wiring regulations and a means of disconnection must be incorporated in the fixed wiring in accordance with the wiring rules. A disconnected system must be incorporated in the fixed.
4. The pump is to be supplied through a residual current device (RCD) or Ground Fault Circuit Interrupt (GFCI) having a rated residual operation current not exceeding 30mA.

Type SSID name and password repeat the same password, then press “Submit”. The EPV Wi-Fi SSID and password is changed, and you need to re-connect the EVP Variable speed pump Wi-Fi by new assigned SSID and Password. Scan QR code or type IP address 192.168.8.1 to access the web server page again.

11.5 CONNECT TO HOME NETWORK



WARNING:

User needs to be familiar with “Home Network Router” settings and the settings should preferably be done from a desktop or laptop computer. Refer to your router manual if necessary.

The EPV variable speed pump Wi-Fi can be set to connect to Home Network to extend the control distance and easy access.

Access Emaux-WIFI, Type IP address 192.168.8.1:8088 to access the Wi-Fi network setting. Select Station configuration.

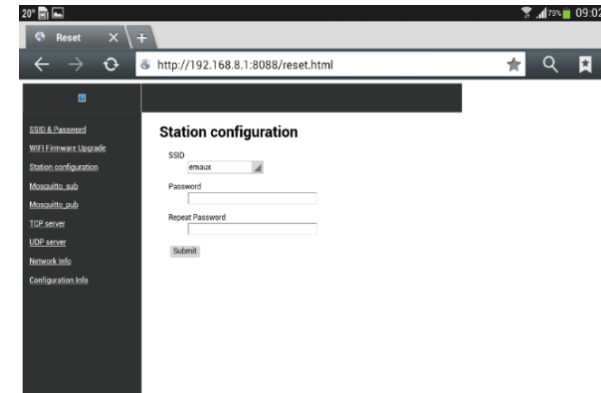

1. Type your Home Network SSID and password, repeat password and then press “Submit”. It will show “success” when it is done. The EPV will connect to Home Router automatically. The Direct-Wi-Fi connection SSID will be erased and can't be found and used again.
2. Access the router and go to DHCP Client list to find EPV new IP address. The location and display format will not be same for different router band, user must know how to obtain the new IP address from router from the DHCP clients list.
3. Connect mobile phone / tablet to assigned “Home Network”, type the new assigned IP address on the web browser for user interface access.

ID	Client Name	MAC Address	Assigned IP	Lease Time
1	win8	F8-BC-12-9B-92-3F	192.168.0.100	01:59:24
2	EPV	14-CC-20-42-88-E5	192.168.0.101	01:56:24
3	test-3-PC	16-CC-20-CE-14-93	192.168.0.102	01:54:42
4	iPhone-6	16-CC-20-07-FD-E4	192.168.0.103	01:57:29

The same user interface will be displayed, and the operation and function remain the same.

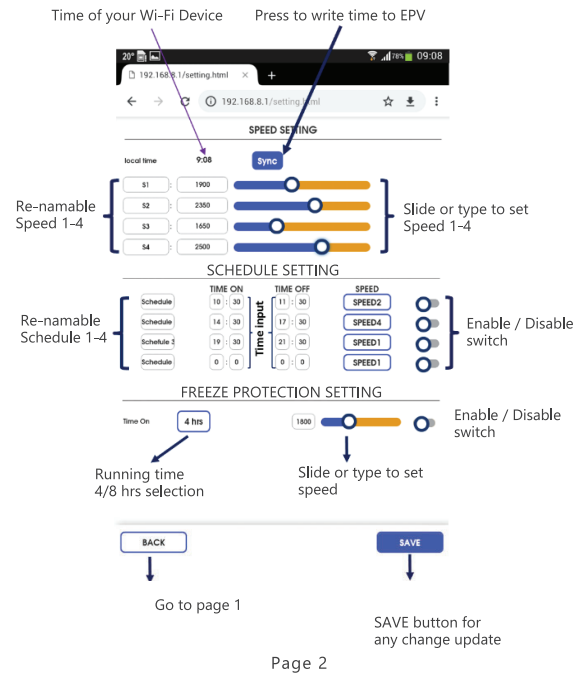

1. Touch the "SYNC" to set the pump clock, the pump will follow the clock of your Wi-Fi device.
2. Speed 1-4 speed setting is done by slider or direct enter the speed box.
3. Speed 1-4 can be renamed as user prefer in less than 10 characters.
4. Schedule 1-4 can set Time On and OFF duration and among Speed 1-4. Schedule can be renamed as user prefers in less than 10 characters. There is enable and disable switch at the end of each setting to turn it ON or OFF.
5. The freeze protection default temperature is 4 degree C in 4 or 8 hours running in setting speed.
6. To make any change, touch save to store the change before returning to home page.

11.4 CHANGE SSID AND PASSWORD

The SSID and Password can be changed by typing the IP address 192.168.8.1:8088 to access the Wi-Fi Network setting page. It is similar to resetting a home router.

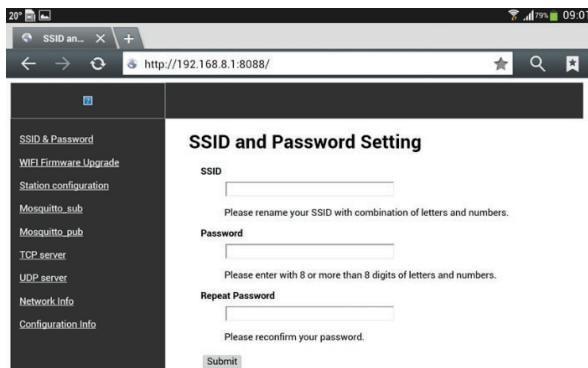

	<p style="text-align: center;">Correct disposal of this product</p> <p>This symbol on the product, or in its packaging, indicates that this product may not be treated as household waste. Instead, it should be taken to the appropriate waste collection point for the recycling of electrical and electronic equipment. By ensuring this product is disposed of correctly, you will help prevent potential negative consequences for the environment and human health, which could otherwise be caused by the inappropriate waste handling of this product. For more detailed information about the recycling of this product, please contact your local council, your household waste disposal service, or the shop where you purchased the product.</p>
--	--

4. INSTALLATION

4.1 PIPING:

1. Install the pump as close to the pool as possible, preferably in a dry, well ventilated area away from direct sun light. Protect the pump from excessive moisture.
2. Place the pump as close to the water source as possible, so that the suction pipe is short, straight and direct to reduce the friction loss. Don't install the pump at more than 10ft (3meters) of geo metric al height from water level. Pump priming time for 3m (10ft) should be at least 7 minutes at 2900 RPM.
3. Before installing the pump, make sure that the surface is solid, elevated, rigid and vibration free.
4. Secure the pump to the base with screws or bolts to limit the vibration and the stress on the pipe or the joints.
5. Leave enough space for gate valves in suction and discharge piping, if required.
6. Connect the suction and discharge pipe to the outlet and inlet of the swimming pool.
7. Make sure that floor drainage is adequate to prevent flooding.

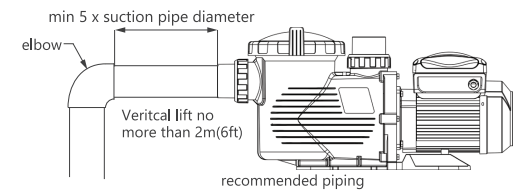

Note: The pump suction and discharge connection shave thread stops, DO NOT try to screw the pipe beyond these stops.

The two sets of 2" union adaptors with 2.5" nut are universally designed for both metric and imperial PVC pipe connection.

4.2 ELECTRICAL WIRING:



This power pump requires a certified electrician or qualified pool installer to ensure there is adequate protection between the pump motor and mains power supply according to individual country's safely code.

The pump has a power cord with plug attached. Plug it to a power socket with circuit breaker to isolate the motor from the mains power for overload protection.

The circuit breaker rating should comply with the electrical specification of the pump's working voltage and power. The power supply must be equipment with a Residual Current Device (RCD) or Ground Fault Circuit Interrupt (GFCI) with a rated residual operating current not exceeding 30mA.



If the RCD / GFCI device trips, it means there is fault on the power line or motor. Do not use this pump. Disconnect the pump and have the problem corrected by a qualified service representative before using. Press the reset button to reset the RCD / GFCI devices after fixing. If the power line problem is not fixed it will keep the circuit shut off and will not reset. It is recommended to test the RCD / GFCI at least once a month.

RCD

















NEMA GFCI Receptacle



NEMA GFCI Breaker



Pumps should be shipped with Power cord with plug for corresponding countries. If there is not power cord attached to the pump, it is necessary to follow the local electricity power line color code to connect the power according to the wiring for individual pump diagram.

   Australia Plug UK Plug European Plug 200-240Vac Single Phase	 NEMA Plug 115Vac Single Phase	NEMA 230Vac 3 phase Wire Color Code
L  N  Ground 	L  Black N  White or Silver  Green / Yellow or Green	 L1 = Black  L2 = Red  L3 = Blue  White  Green / Yellow or Green

This is a 220-240V ac 50/60Hz electric variable speed pump. Unscrew the four corner screws of the variable speed driver box. There are three terminals labelled as AC-L, AC-N and GROUND. Connect the power wires to these terminals according to the electrical code. For single phase 220-240Vac 50Hz, the pump ships with a power cord and there is no need to wire the power cord. Simply plug the cord into a RCD / GFCI protected socket.

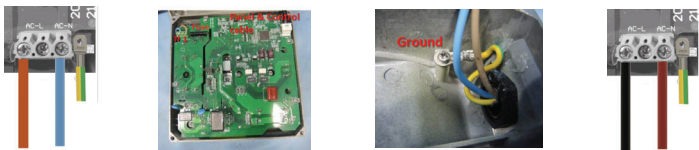

MENA Hardwired

For a 230Vac 60Hz two phase hardwired connection, open the cover of the drive. Follow NEC color code, connect L1 to AC-L, L2 to AC-N and Earth to Ground on metal case.

5. START UP



1. Verify the pump shaft turns freely.
2. Check that the mains voltage, current and frequency correspond with the name plate.
3. Never let the pump run dry! Running a pump dry will damage the mechanical seal causing leakage and flooding.
4. Fill the pre-filter with water before starting the motor.



Wi-Fi Direct

1. Go to Wi-Fi setting of mobile phone and find "EPVSPV-WiFi" and enter password "VS __ PUMP" for connection. This is the factory default SSID name and password.
2. Scan the QR code label on the side of the controller unit, it will access the EPV user interface and the browser show "EPVPUMP.com" which is a virtual domain name without internet connection.
3. Or, by typing IP address 192.168.8.1 to access.

11.3 APPLICATION INTERFACE

The user interface can do all the EPV setting and programming as the control panel on the pump, along with status display. It is easy and comprehensive to use.

1. Touch the "Run / Stop" button to switch the pump ON / OFF.
2. Touch the speed "number, 2500", enter the speed and touch any location of screen for enter. The pump will run at new speed.
3. Press S1-S4 to select the preprogram speed.
4. Pump running status, schedule status and error code display at the bottom.
5. Touch the SETTING icon to enter setting page
6. Touch "English" next to the Emaux logo to select language. The control page supports English, French, German, Italian, Spanish, Russian and Chinese.

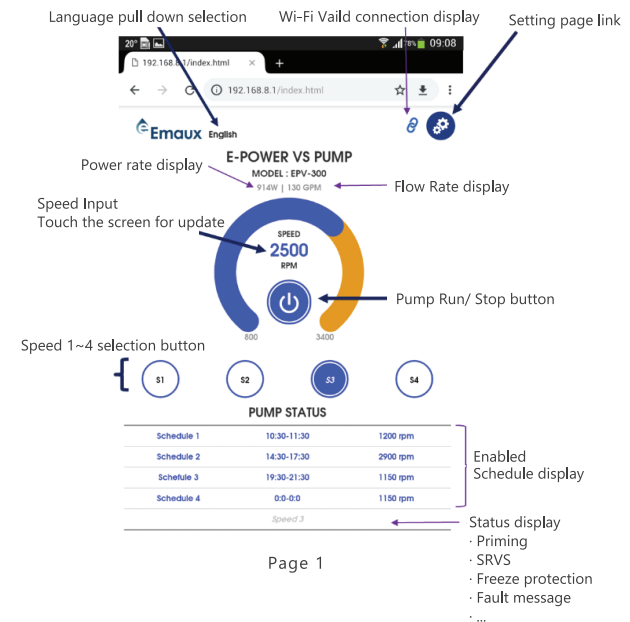

10. ERRORS DESCRIPTION

10.1 COMMUNICATION ERROR (COMM ERROR)

If the communication error appears, check the following:

1. Ensure the 3-pin plug has good contact with the power point.
2. Reset the system by turning off the power supply, leaving it for 30 seconds and then switching the pump on again.
3. If problem persists, contact your Emaux service agent.

10.2 ERROR DISPLAY

When the programmable controller is not working properly, a fault code will be shown on the controller display.

Error	Description	Possible causes
OC	Over current Driver's output current exceeds the threshold (200% of rated current)	1. Driver output failure 2. Drive of IPM module is damaged
OV	Over voltage Main circuit DC voltage exceeds the threshold	1. Excessive power of power supply 2. Power supply voltage exceeds settings
UV	Under voltage The main electric current is too low	3. Supply voltage fluctuation is too large
OH	Over heating Heat sink on motor is over heating	Environment temperature is too high
NF	No water flow No water in the circuit	1. Water level in the pool is too low 2. Not enough water in the basket when starting

11. WI-FI CONNECTION (FOR WIFI VERSION)

EPV series vs pump Wi-Fi version with build-in interface to control the pump over Wi-Fi in Wi-Fi direct one to one and home network.

11.1 ENABLE WI-FI CONNECTION

1. Connect to AC power and Power on EPV variable speed pump by "Run" button after proper piping installation.
2. The pump will start self-pumping and Wi-Fi icon should display next to the clock in few minutes.
3. If there is no Wi-Fi icon display, press the "MENU" button and scroll down to items 10 by "▼", press "ENTER" to access Wi-Fi setting.
4. Press "FUNCTION" to display the selection.
5. Press "Enabled" by pressing "ENTER" and "ESC" to go back to home display.

11.2 Wi-Fi Direct CONNECTION

EPV Wi-Fi Direct connection is a ONE to ONE connection without access Home Network. It is just like a private controller. It can be connected and control by a mobile phone, tablet PC, laptop top or any Wi-Fi enable devices directly without computer operation system. The user interface supports most popular web browsers.

5. Before removing the pre-filter lid, stop pump, close gate valves in suction and discharge pipes.
6. Always stop the pump before when releasing all pressure from the pump and the piping system.
7. Never tighten or loosen screw while the pump is in operation.
8. The suction pipe and the suction inlet in the pool must be free from obstruction.



Tighten / untighten the pump Lid by hand only

Before start-up, check the alignment of the pump. The pipes should be inspected to ensure that they are properly fitted and tightened and that they do not exert pressure or tension on the pump's suction or discharge connection.

1. Clear all piping of construction debris and verify that the piping has passed a proper pressure test.
2. Check the filter and other equipment for proper installation, verifying all clamps and connections are properly installed as per the manufacturer's instructions.
3. Open any shut off valves on the suction and discharge lines.
4. Open the filter pressure relief valve and release all pressure from the system.
5. If the pump is located below the water level of the pool, opening the pressure relief valve will fill the pump with water.
6. If the pump is located above the pool water level, remove the Lid from the pre-filter and fill with water before starting the pump.
7. Check to see that the Lid O-ring and seat areas are clean and lubricated. Debris in the sealing area can cause air to leak into the system and make it difficult to prime the pump.
8. Close/tighten the Lid to make an airtight seal.
9. Turn on power wait for pump to prime. Pump priming time for 3m (10ft) should be at least 7minutes. Priming will depend on vertical length of suction lift and horizontal length of suction pipe. If the pump does not prime within priming time, stop the motor and determine cause.
10. If the pump does not prime within 10 minutes. If the pump does not prime within 10 minutes. Ensure all instructions to this point have been followed. Stop the pump! Check for suction leaks and repeat steps (I) through (VIII). Ensure all instructions to this point have been followed. Stop the pump! Check for suction leaks and repeat steps (I) through (VIII).

6. ROUTINE MAINTENANCE

The mechanical seal does not require lubrication or service.

The only routine maintenance needed is the inspection and cleaning of the pre-filter basket. Debris or trash collected in the basket will choke off the water flow through the pump. Follow the instructions below in order to clean the pre-filter basket:

1. Turn off the pump, close the suction and discharge valves, and release all pressure from the system before proceeding.
2. Loosen the suction inlet hose or piping.
3. Turn the ring-lock by hand to open it and release the transparent Lid.
4. Remove the pre-filter basket and clean it. Make sure all the holes in the basket are clear, flush the basket with water. Replace the basket with the guideline on the edge of the basket. If the basket is not placed correctly, the transparent lid and its ring-lock will not fit well and will cause air leakage.
5. Clean and inspect the lid O-ring ring and replace it if it is damaged. Reinstall it on the transparent lid.
6. Clean the ringgroove on the pre-filter body and replace the Lid. To help keep the Lid from sticking, tighten by hand only.
7. Connect back the suction hose or pipe. Water should flood the pump body and restart the pump.
8. Restart the pump and check that it is priming correctly.

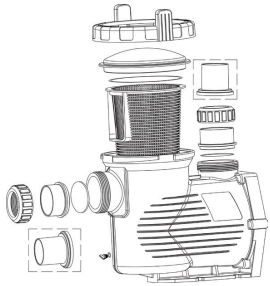

7. WINTERIZING

If the air temperature drops below 0°C (35°F), the water in the system can freeze and cause damage. Damage due to freezing is not covered by warranty.

Prevention of damage from freezing:

1. Shut off electrical power for the pump at the house circuit breaker.
2. Drain the water out of the pump case by removing the two drain plugs from the case.
3. Store the plugs in the pump basket.
4. Cover the motor to protect it from severe rain, snow and ice.
5. If it is possible, store the pump in a dry location during this time.
6. Do not wrap the motor in plastic. It will cause condensation and rust on the inside of the motor.

8. CONTROL AND DISPLAY PANEL

8.1 CONTROLLER OVERVIEW

The controller display shows current time, operation speed, input power, speed and schedule settings, Wi-Fi connected and fault codes.

CONTROLLER DISPLAY

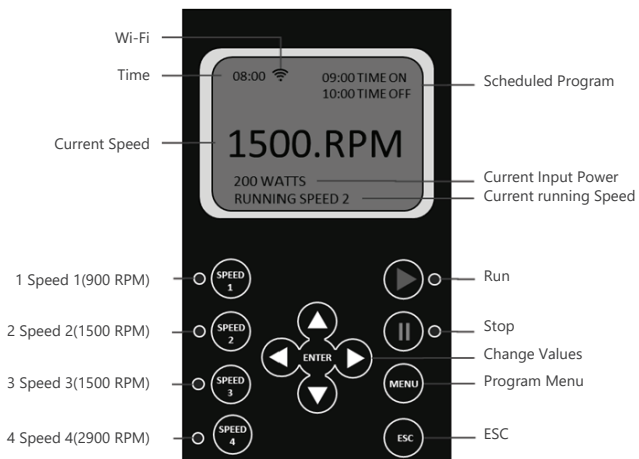

9.9 PUMP PRIMING SET UP

This function is set up through the following parameters: "Function": Enable / Disable "Pump Priming" function
 "Priming time": Set the prime time before switching to the other program
 "Priming speed": Set the speed during the priming cycle
 To set up these parameters use the same method as for Schedule 1.
 Pump Priming Time for 3m (10ft) lift should be at least 7 minutes.

Pump Priming Time:

1. Minimum time: 1 minute.
2. Maximum time: 20 minutes.
3. Default time: 2 minutes.

Pump Priming Speed:

1. Minimum speed: 2900 RPM
2. Maximum speed: 3400 RPM
3. Default speed: 2900 RPM

9.10 FREEZE PROTECTION SET UP

This function is to turn on the pump when outside temp is below 4 degree C for water circulation to prevent water frozen.

"Function": Enable / Disable Freeze Protection

"Run Duration Time": set running period in 4 or 8 hours

"Run Speed": set the running speed from 900-3400 rpm

"Temperature" set trigger temp from 0-10 degree C.

9.11 Wi-Fi

This function is available in Wi-Fi version to turn Wi-Fi function on / off.

"Function": Enable / Disable Wi-Fi

"WIFI RESET": reset WiFi SSID & Password to factory default

9.12 RS485

This function is for external MODBUS automation control system connection. It is not for domestic user access purpose.

"Function": Enable / Disable RS485

"Baud Rate": set the data rate from 1200 / 2400 / 4800 / 9600 bps

"Slave address": set the EPV pump address location in the MODBUS network form 1-247.

Contact your dealer for MODBUS programming manual, if you are a system integrator

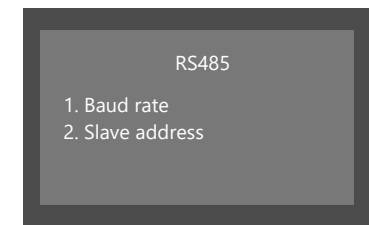
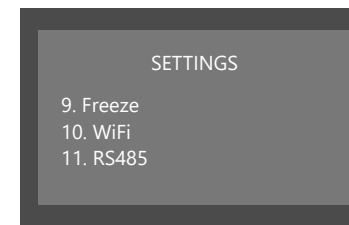

9.13 RESET

This function will reset all the user setting to the factory default settings.

9.5 VARIABLE SPEED SET UP

This function is set up through the following parameters:

"Function": Enable / Disable the speed.

"Time On": Set the start time.

"Time off": Set the off time.

"Min Speed": Set the minimum speed (RPM).

"Max Speed": Set the maximum speed (RPM).

"Step": Set the speed for different time frames.

"Rhythm": Set the time frame for water flow to change.

The "Step" & "Rhythm" options are particularly useful for water features like a water descent, making water flow change and creating a visual effect.

1. Make sure the pump is in off position before changing the settings.
 2. Press "Menu" to highlight the settings.
 3. Use "Up" / "Down" buttons to go to "Variable Speed" and press "Enter".
- To set up the parameters above use the same method as for Schedule 1.

9.6 LANGUAGE SET UP

Make sure the pump is in off position before changing the program.

1. Use "Up" / "Down" buttons to go to "Language" option and press "Enter".
2. The symbol ">" indicates the language in use.
3. Press "Enter" again to enter in editing mode, use "Up" / "Down" buttons to select the required language among English, French, German, Spain, Italy and Chinese.
4. Press "Enter" to save the setting. The interface will be shown in the selected language immediately. Otherwise, press "ESC" to exit the editing mode.
5. Press "ESC" to exit.

9.7 SVRS (SAFETY VACUUM RELEASE SYSTEMS) SETTING

The SVRS system prevents a person's body being trapped by suction over a main drain. It will slow down the pump speed in order to reduce the suction pressure, then release the entrapment.

There are five settings: "SVRS enable", "SVRS alarm time", "SVRS sensitivity", "SVRS reset time" and "SVRS reset speed" for the installer to do setting according to the pool draining system.

1. SVRS Enable / Disable. The default position is 'disable'. It needs the installer's attention to enable it and choose the best setting for the piping system.
2. SVRS Alarm time. The default setting is 1 second means the pump response time to a drain entrapment is 1second. It can be adjusted form 1~999 second.
3. SVRS sensitivity sets the suction pressure alarm level. It can be set from 1 to 100%
4. SVRS Restart Time is the time during which the speed and suction pressure are reduced. It can be adjusted form 30-999 seconds.
5. SVRS Reset Speed is the pump rotation speed for the SVRS is function. The adjustable range is from 800-3400rpm, but it is not recommended to change the default setting of 800rpm.

9.8 "NO FLOW" SET UP

This function is only available for motor speeds of 1800 RPM or more, it is set up through the following parameters:

"Function": Enable / Disable "No-Flow" function.

"Alarm time": Set the time frame for "No-Flow" function. Minimum setting is 5 minutes.

"Sensitivity": Sensitivity of protection system, expressed in %. Minimum setting is 0.01%.

To set up these parameters use the same method as for Schedule 1.

Fault Code "NF" will be shown if "No Flow" protection is activated.

Time: Built-in time clock.

Wi-Fi: Connected or disconnected

Current Speed: Shows operating speed.

Expressed in RPM.

Scheduled Program: Shows current operating schedule.

Current Running Speed: Shows current operating speed. Four pre-set speeds available.

LCD Display backlight will switch off after 60 seconds if no button is pressed. It can be turned on again by pressing any button.

8.2 DISPLAY INTERFACES



Starting screen

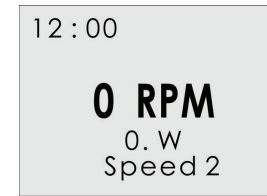

Static interface



Normal operating interface



Communication error interface

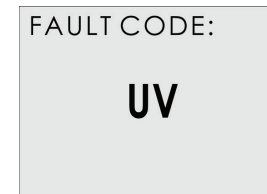

Fault code interface

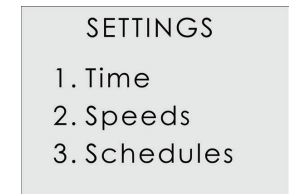

Parameter setting interface

8.3 CONTROL BUTTONS



Up
Increase value



Down
Decrease value



Left
Move cursor left



Right
Move cursor left



Enter
Enter sub-menus or save setting



Speed 1
Select Speed 1. LED next to the button turns on.



Speed 2
Select Speed 2. LED next to the button turns on.



Speed 3
Select Speed 3. LED next to the button turns on.



Speed 4
Select Speed 4. LED next to the button turns on.



Start
Start the motor. LED next to the button turns on.



Stop
Stop the Motor, LED next to the button turns red.
Drive fault reset key.



Menu
Enter adjustment menu, only when the motor is not operating.



ESC
Back / Cancel

8.4 PROGRAMMING FLOW CHART

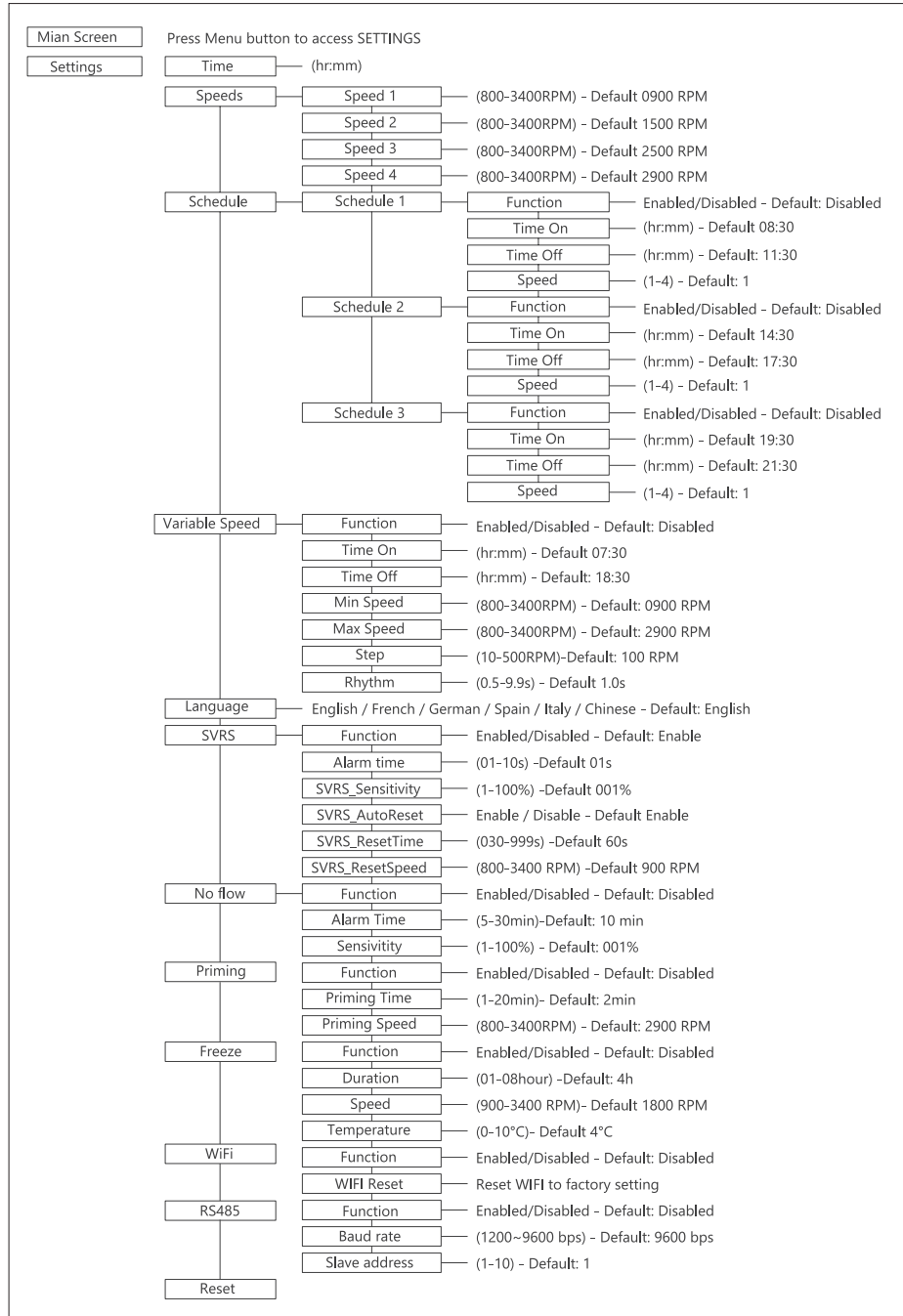

9. OPERATION INSTRUCTIONS

9.1 INTERNAL SYSTEM CLOCK

The internal system clock is used to program operating schedules. If the power supply is disconnected, the controller memory and programmed settings will be maintained for approximately 7 days. The clock set up will be required after this time.

9.2 SPEED SET UP

There are 4 speed settings available. To set up the speed:

1. Press "Menu" button.
2. Use buttons "Up" and "Down" to highlight "Speeds" option.
3. Press "Enter" to show 1 to 4 speeds.
4. Use buttons "Up" and "Down" to highlight a one of 4 pre-set speeds.
5. Press "Enter" to show the set speed. Adjust the speed using "Up" and "Down" buttons.
6. Press "Enter" to save settings or press "ESC" to cancel.

Make sure the pump is in off position before modifying the settings.

9.3 SCHEDULE SET UP

The pump is supplied with the pre-set schedules for an easier start-up. If necessary, these parameters could be changed (see chapter "2.6.4 Programming Flow Chart" for further details). To modify the schedules, use the following menu parameters (the same method of programming applies to 4 schedules):

"Function": Enable / Disable the schedule "Time on": Set the start time

"Time off": Set the off time "Speed": Set the speed (RPM)

Make sure the pump is in off position before modifying the settings.

9.4 SCHEDULE 1 SET UP

To revise / update "Function" settings:

1. Press "Menu" to highlight the settings.
2. Use "Up" / "Down" buttons to go to "Schedules" and press "Enter".
3. Choose one of four Schedules 1 to 4 by use of buttons "Up" / "Down" and press "Enter". "Function" title will be highlighted.
4. Press "Enter" to Disable / Enable the schedule using the "Up" / "Down" buttons. Press "Enter" to save settings or "ESC" to cancel.
5. Press "ESC" to exit.

To revise / update "Time On" settings within "Schedules 1" menu:

1. Use "Up" / "Down" buttons to go to "Time on" option and press "Enter".
2. Choose hours / minutes using "Left" / "Right" buttons.
3. Change hours / minutes using "Up" / "Down" buttons.
4. Press "Enter" to save settings or "ESC" to cancel.
5. Press "ESC" to exit.

To revise / update "Time Off" settings within "Schedules 1" menu:

1. Use "Up" / "Down" buttons to go to "Time off" option and press "Enter".
2. Choose hours / minutes using "Left" / "Right" buttons.
3. Change hours / minutes using "Up" / "Down" buttons.
4. Press "Enter" to save settings or "ESC" to cancel.
5. Press "ESC" to exit.

To set up the Schedules 2, 3 & 4 use the same method as for Schedule 1.