

ABB MEASUREMENT & ANALYTICS | DATA SHEET | DS/100GPD-EN REV. F

## **100 GP-D**

Digital pH/ORP sensor



---

## Measurement made easy

The ¾ in digital pH/ORP sensor for use in general purpose applications

### Increased efficiency

- ABB's glass formulation provides fast process response without compromising durability and robustness
- Close-coupled temperature measurement ensures high accuracy even with rapid temperature changes

### EZLink™ connectivity

- Plug-and-play technology makes sensor integration fast and easy
- Advanced diagnostics providing end-of-life indication and fault analysis
- Improved measurement accuracy with digital communication

### Dependable performance

- Enhanced double junction with ion trap delays poisoning effects ensuring the sensor operates longer in your process
- Large PTFE junction promotes fouling resistance and is easy to clean
- Durable Kynar® body provides high chemical- and abrasion-resistance

### Modular design

- Common ¾ in sensor design paired with intelligent accessories provides mounting flexibility with safety and convenience in mind

## Introduction

Making the right sensor selection for your application should be simple and easy. To help you make the right choice, we've divided our new family of pH/ORP sensors into three distinct ranges based on the applications they have been designed for; the 100, 500 and 700 ranges.

The 100 range are entry-level sensors designed for light duty use, while the 500 range offer a robust design for industrial applications. The 700 range are a specialty range for target applications.

Each electrode is clearly named and is also color-coded for ease of identification. This enables you to easily select the best sensor to meet your needs, ensuring optimal plant efficiency, performance and lifetime; every time.

## The 100 GP-D digital pH/ORP sensor

Part of the next generation of ABB's pH/ORP sensors, the digital 100 GP-D combines exceptional performance and durability in one efficient, maintenance-free design.

Highly accurate with fast response times, the versatile 100 GP-D provides complete confidence in a wide range of general process applications that include:

- drinking water
- municipal wastewater
- cooling water
- food & beverage

## Performance you can trust

The 100 GP-D features ABB's enhanced diffusion path double junction design with a polymerized gel electrolyte and chemical inhibitor, both slowing down the ion-diffusion rate and extending the length of the diffusion path. This design ensures that poisoning substances take longer to reach the encapsulated reference while the large, porous, chemically-resistant PTFE junction incorporating Viton™ seals protects against sensor fouling.



## Improved process efficiency

Varying sample temperature is one of the most common causes of pH measurement error due to its impact on sensor output. The 100 GP-D is equipped with a close-coupled temperature element capable of rapid response to quickly changing process conditions, ensuring a high level of accuracy and confidence in your measurement.

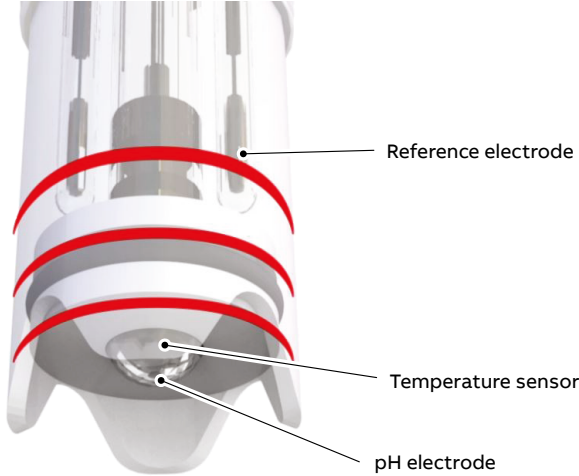

Temperature element location

## EZLink connectivity

Convenient EZLink technology enables seamless plug-and-play integration when using the 100 GP-D. Automatically recognized, the sensor uploads calibration, diagnostic and manufacturing information to any of ABB's EZLink-capable transmitters within seconds; significantly reducing commissioning and product maintenance.

### Sensor healthcheck

The 100 GP-D provides advanced sensor diagnostics such as the unique perpetual impedance monitoring (patent-pending) that detects electrode faults such as **Broken Glass** or **Out-of-Sample** in real-time without the need for a solution earth.

In addition, ABB's SMART reference electrode monitoring (REM) system provides early warning notification of electrolyte loss enabling the sensor to be replenished when required, saving money without risking process control.

### Enhanced accuracy

Instantaneous signal conditioning from analog to digital ensures minimal electrical interference and strengthens signal strength, greatly improving measurement accuracy even with longer cable distances.

EZLink plug-and-play connection simplifies user set-up with automatic sensor recognition and guidance

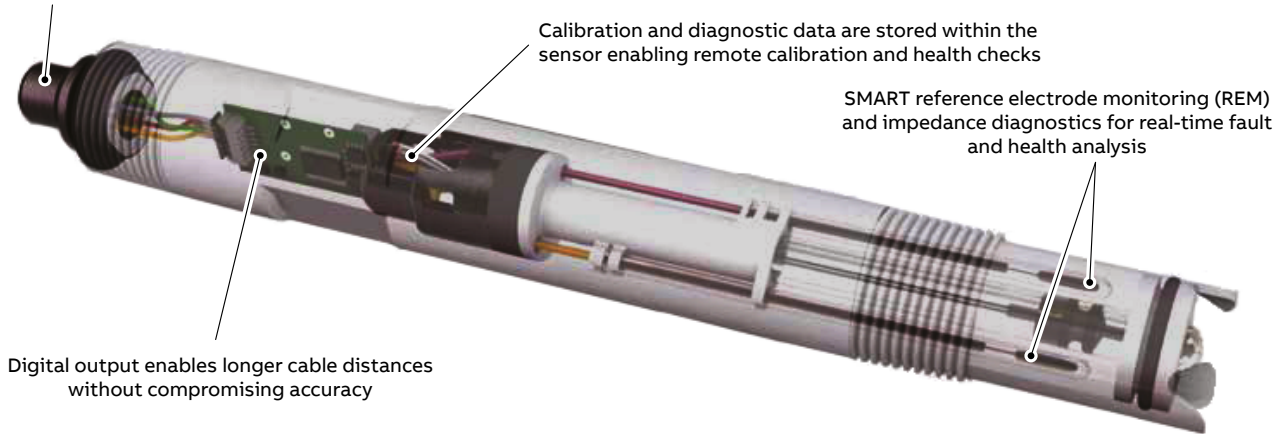

Key features

---

## Robust glassware

Utilizing ABB's experience in glass manufacturing dating back to the 1950s, the proprietary glass formulations used with the 100 GP-D offer fast response without sacrificing durability. Selectable in several configurations, the robust glassware is made suitable for wide range of general-purpose applications.

### Low temperature (LT) glass

For measurement below 15 °C (59 °F), our low temperature blue glass provides ultrafast response in applications such as municipal and industrial wastewater treatment. Available in bullet-style.

### High-performance (S) glass

Our high-performance yellow glass provides fast response and accurate measurement over the entire pH range. With an extremely low sodium error, the glass can maintain its accuracy even at very high pH levels. Available in flat or bullet style.

### ORP platinum electrode

Chemically inert, our platinum electrode is design for conventional ORP/Redox measurement with an RTD element providing process temperature information.



High performance (S) glass -  
flat with flush body



Low temperature (LT) glass with  
notched body



ORP electrode with notched body

---

## Product adaptability

The 100 GP-D is available in flush- or notched-body design helping extend sensor operation and maintainability in challenging applications.

### Flush-body design

The flush-body design, when paired with a flat-shaped glass electrode, helps promote self-cleaning when installed perpendicular to sample flow. In addition, the minimal protrusion prevents unwanted buildup, especially in fouling applications.

### Notched-body design

The notched-body design provides additional protection for bullet-style glass electrodes; especially from abrasive applications that can damage the glass electrode rendering it unresponsive.

### Intelligent accessories

The 100 GP-D is offered with mounting accessories designed to improve adaptability into your process while providing safe and convenient operation. Available with flow-cell, quick-connect bayonet and dip pole assemblies, the 100 GP-D utilizes modular accessories that are compatible with all ABB's next generation  $\frac{3}{4}$  in threaded sensor bodies.

Optional auto-cleaning functionality is available as an added feature, ensuring extended operation with minimal intervention.

### Extended storage

We understand most customers maintain stock of pH/ORP sensors in case of unexpected demand. Ensuring peak performance, even after extended storage, is critical in maintaining product availability and keeping your process running.

The 100 GP-D is stored in a specially-formulated solution with added antimicrobial agent keeping the sensor active for up to 2 years when stored as recommended.



## Dimensions

Dimensions in mm (in)

### Flush sensor body

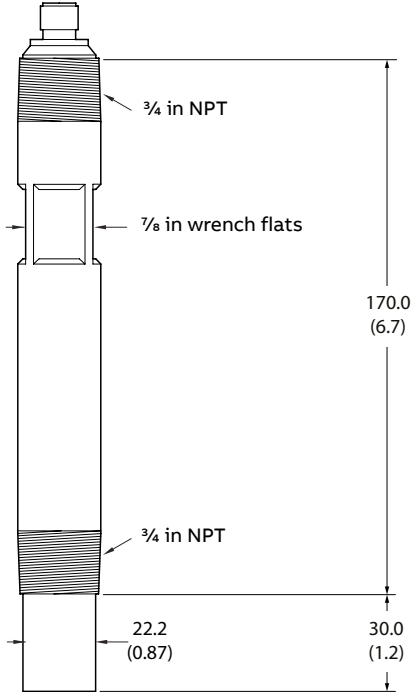

### Notched sensor body

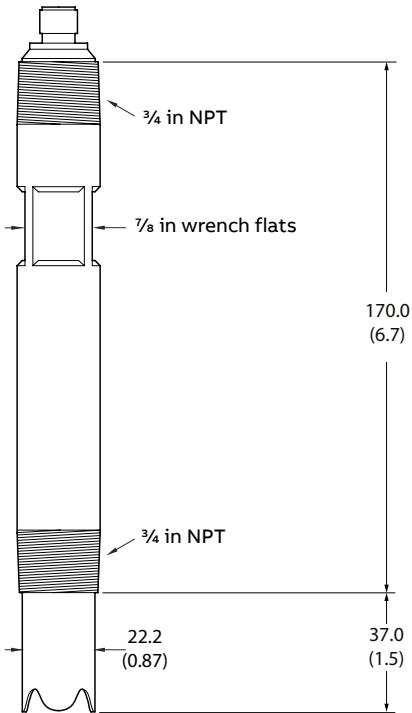

## Electrical connections

All digital sensors come with EZLink connectivity.

ASME B1.20.1  $\frac{3}{4}$  in NPT thread is compatible with ASME B16.11  $\frac{3}{4}$  in NPT threaded fittings including: couplings, half couplings, bosses, couplets.

## Specifications

### Measurements

- pH/ORP (platinum)
- Temperature

### Measurement range

High performance (S) glass

0 to 14 pH

Low temperature (LT) glass

0 to 10 pH

ORP

-2,000 to 2,000 mV

### Temperature range

High performance (S) glass (bullet)

0 to 60 °C (32 to 140 °F)

(typical glass impedance at 25 °C [77 °F] = 250 MΩ)

High performance (S) glass (flat)

5 to 60 °C (41 to 140 °F)

(typical glass impedance at 25 °C [77 °F] = 600 MΩ)

Low temperature (LT) glass

-5 to 50 °C (23 to 122 °F)

(typical glass impedance at 25 °C [77 °F] = 25 MΩ)

ORP platinum electrode

0 to 60 °C (32 to 140 °F)

### Temperature sensor

Pt1000 (Class B, IEC 60751)

### Maximum pressure

6 bar (90 psi)

### Recommended minimum sample conductivity

50 μS/cm

### Recommended sensor storage

Between 15 and 35 °C (59 and 95 °F)

### Isothermal point at 25 °C (77 °F)

pH 7

### Reference system

Ag/AgCl with KCl gel electrolyte, double junction plus ion trap

### Process connections

¾ in NPT

### Wetted materials

Electrode body

PVDF (Kynar)

Reference junction system

Porous PTFE and Viton O-rings

Measure system

pH: Glass

ORP: Platinum

### Approvals, certification and safety

#### CE Mark

Covers EMC+LV directives

(including latest version of EN61010)

#### Regulation 31

Drinking water approval: Complies to DWI Regulation 31(4)(b)

Additional tests: BS6920 parts 2.2 and 2.4 on all wetted parts

#### EMC

Meets requirements of IEC61326 for an industrial environment

#### CRN approval

Maximum allowable working pressure (MAWP): 5.58 bar (81 psi)

Design temperature: -5 to 105 (23 °F to 221 °F)

CRN number: 0F22557

#### MCERTS

Certificate no: Sira MC220375/00



## Ordering information

100 GP-D ¾ in pH/ORP electrode (EZLink digital)	APS122/	XX	XX	X	XX	Option
<b>Sensor type</b>						
pH – bullet glass for standard applications: high performance (S) glass		P2				
pH – flat glass for in-line, fouling applications: high performance (S) glass		P3				
pH – low temperature (LT) glass		P4				
ORP (Redox) – platinum		R2				
<b>Body style</b>						
¾ in threaded insertion/immersion – no sensor guard (flush)				K1		
¾ in threaded insertion/immersion – notched sensor guard				K2		
<b>Connection type</b>						
EZLink digital					D	
<b>Integral cable length</b>						
None						00
1 m (3.3 ft)						01
3 m (10 ft)						03
5 m (16 ft)						05
10 m (33 ft)						10



### Optional ordering code



Add one or more of the following codes after the standard ordering information to select any additional options if required

### Operating instructions

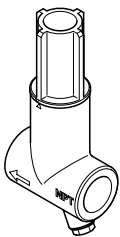
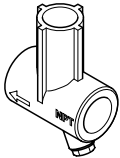
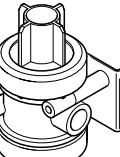
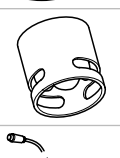
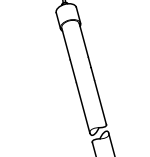
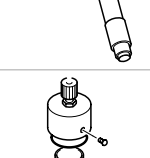
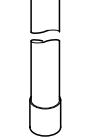
English						M5
<b>EZLink digital extension cable</b>						
1 m (3.3 ft)						E01
5 m (16.4 ft)						E05
10 m (32.8 ft)						E10
15 m (49.2 ft)						E15
25 m (82 ft)						E25
50 m (164 ft)						E50

## Accessories

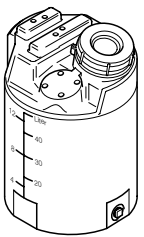
Part number	Description	
3KXA163000L0002	1 in BSP bayonet polycarbonate T-piece	
3KXA163000L0004	1 in NPT bayonet polycarbonate T-piece	
3KXA163000L0006	1 in BSP screw polycarbonate T-piece	
3KXA163000L0008	1 in NPT screw polycarbonate T-piece	
3KXA163000L0012	½ in NPT polycarbonate flowcell and ¾ in adapter	
3KXA163000L0011	½ in NPT stainless steel flowcell and ¾ in adapter	
3KXA163000L0024	Protective shroud for ¾ in body	
3KXA163000L0021	1¼ in NB dip pole assembly	
3KXA163000L0022	2.5 m (8.2 ft)	
3KXA163000L0023	Dip pole kit (customer-supplied 1¼ in NB tube)	

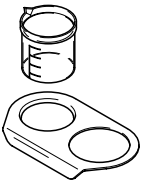
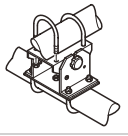
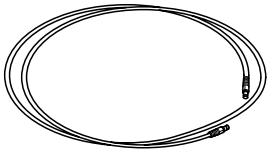
Part number	Description	
3KXA163000L0025	Automatic cleaning system (liquid)	
3KXA163000L0026	T-piece cleaning adapter	
3KXA163000L0120	Calibration kit (includes calibration beaker and holder)	
ATS4000760	Rail mounting kit (tilt only)	
	EZLink cable	
AWT4009010	1 m (3.3 ft)	
AWT4009050	5 m (16.4 ft)	
AWT4009100	10 m (32.8 ft)	
AWT4009150	15 m (49.2 ft)	
AWT4009250	25 m (82 ft)	
AWT4009500	50 m (164 ft)	

For a complete list of spares and accessories refer to Operating Instruction [OI/100/500](#).

---

## Notes

Sales



Service



### Acknowledgements

Kynar is a registered trademark of Arkema Inc.

Viton is a registered trademark of the Chemours Company

---

### **ABB Measurement & Analytics**

For your local ABB contact, visit:  
**[www.abb.com/contacts](http://www.abb.com/contacts)**

For more product information, visit:  
**[www.abb.com/measurement](http://www.abb.com/measurement)**

We reserve the right to make technical changes or modify the contents of this document without prior notice. With regard to purchase orders, the agreed particulars shall prevail. ABB does not accept any responsibility whatsoever for potential errors or possible lack of information in this document.

We reserve all rights in this document and in the subject matter and illustrations contained therein. Any reproduction, disclosure to third parties or utilization of its contents – in whole or in parts – is forbidden without prior written consent of ABB.