



**MITSUBISHI  
ELECTRIC**

*Changes for the Better*

INVERTER

Model

**FR-A800**

for a greener tomorrow



Oct., 2013

**New Product RELEASE**

No.13-3



# Unparalleled Performance. Uncompromising Quality.

*Channeling inherited techniques to deliver  
the ultimate in inverter technology.*

Released in December 2013

# A800



**WARNING** Risk of injury and electric shock  
 △ Read the manual and follow the safety instructions before use.  
 △ Isolate from supply and wait 10 minutes before restoring this cover.  
 △ Ensure proper earth connection.

**CAUTION** Risk of fire  
 △ Mount the inverter on a non-combustible surface.

**WARNING** Il y a un risque de se faire mal et de recevoir une décharge électrique  
 △ Avant de l'utiliser il faut lire le manuel et il faut suivre les instructions de sécurité.  
 △ L'isoler les matériaux électriques et attendre dix minutes avant d'enlever la couverture.  
 △ Assurer la propre connexion mise à la terre.

**AVERTISSEMENT** Il y a un risque d'un feu.  
 △ Montez le variateur de vitesse sur une surface non combustible.

**注意**: 怪我、感電の恐れあり  
 △ 使用前に必ず取扱説明書をお読みください。安全動作にご注意ください。  
 △ 電源からの電源を切り、10分程度電源をOFFにしてからカバーを取り外してください。  
 △ 確実に接地を確保してください。

**注意**: 火災の恐れあり  
 △ 必ず非燃焼性の面に設置してください。

**注意**: 発熱、感電の恐れあり  
 △ 必ず取扱説明書をお読みください。安全動作にご注意ください。  
 △ 発熱防止のため、必ず取扱説明書をお読みください。  
 △ 必ず接地を確保してください。

**注意**: 最大入力超過  
 △ 必ず取扱説明書をお読みください。

三菱電機株式会社  
 製品部 製造課  
 〒100-8555 東京都千代田区千代田1-4-1  
 三菱電機ビルヂング5F  
 TEL: 03-3242-1111  
 FAX: 03-3242-1112  
 E-MAIL: a800@mc.a.mitsubishielectric.com



# LEADING DRIVE PERFORMANCE

The new series is equipped with the new state-of-the-art high-speed processor developed by Mitsubishi. With better control performance and response level, safe and accurate operation is assured in a diverse range of applications.

## Swift, Smooth, yet Robust

The enhanced Real sensorless vector control and vector control serve the needs of all machinery types.

Vector control is also valid when equipped with optional FR-A8AP.

### (1) For high-quality products

#### High response

**[Response speed]** Real sensorless vector control **50 Hz**\*1 [A700: 20 Hz] Vector control **130 Hz** [A700: 50 Hz]

\*1: At 3.7 kW with no load. Differs depending on the load conditions and motor capacity.

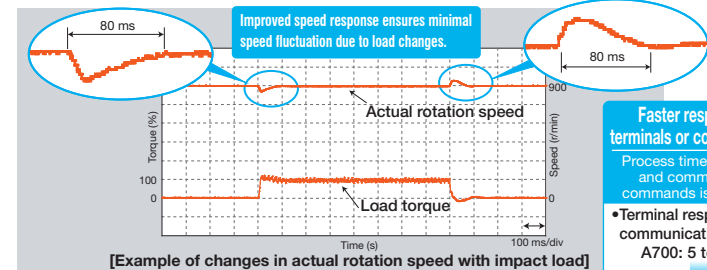

#### Line control

Line control is necessary for the machining of elongated products such as paper, thread, wires, all kinds of sheet, and tape. This will respond rapidly to changes in line speed and suppress the occurrences of winding unevenness. This contributes to a steady supply of high-quality products.



**Faster response via terminals or communication**  
Process time for terminal and communication commands is minimized.  
• Terminal response, communication response  
A700: 5 to 20 ms  
A800: 2 to 3 ms\*2

### (2) Perform ultra-fine processing

#### High-speed rotation

**[Operating frequency]** Real sensorless vector control and vector control **400 Hz** [A700: 120 Hz]

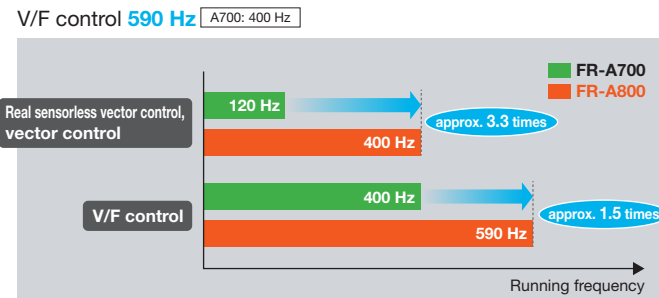

#### Machine tool

Cutting-edge machine tools are harder and thinner than ever before to be applicable to diverse new materials. High-speed rotation is required more than ever before in order to be applicable for fine and precise cutting on hard and difficult-to-grind materials.

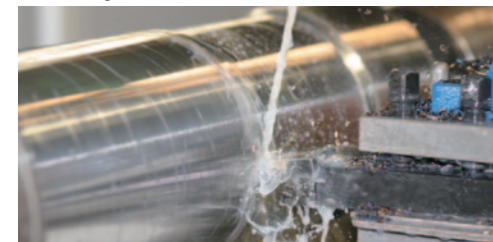

### (3) Swiftly move heavy weights

#### High torque at low speed

**[Starting torque]** Real sensorless vector control **200%** (ND rating) (When at 0.3 Hz) Vector control **200%** (ND rating) (150% of initial setting for 5.5K and higher)

**[Zero-speed torque]** Vector control **200%**. (Select HD rating.)

**[Speed control range]** V/F control **1:10** (6 to 60 Hz: Driving) Advanced magnetic flux vector control **1:120** (0.5 to 60 Hz: Driving) Real sensorless vector control **1:200** (0.3 to 60 Hz: Driving) Vector control **1:1500** (1 to 1500 r/min: Both driving/regeneration)

#### Cranes

Cranes are in operation daily at ports carrying fully-laden containers in response to strong demand from all over the world. Our new inverter realizes smooth cargo handling work at low speed and high torque for the slow and stable movements required for heavy objects.

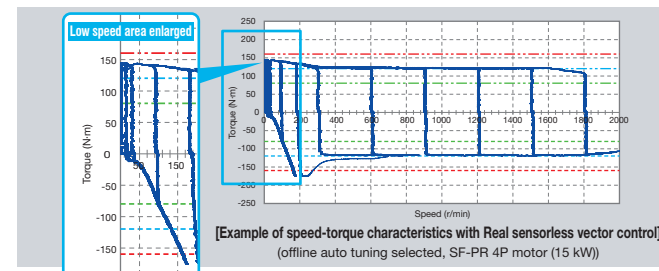

### (4) For accurate and stable transport between machines

#### PM sensorless vector control

##### • What is a permanent magnet (PM) motor?

A PM motor is a synchronous motor with strong permanent magnets embedded in its rotor.

The two major PM motor types are: the interior permanent magnet (IPM) motor with its magnets embedded inside the rotor, and the surface permanent magnet (SPM) motor with its permanent magnets attached on the rotor surface.

##### • What is PM sensorless vector control?

The speed and magnetic pole positions, the two essential bits of information to control a PM motor, are detected without a sensor (encoder). The speed detection internally-performed in an inverter enables highly accurate control of a PM motor, almost as accurate as an AC servo system, without the need of a sensor (encoder)<sup>3</sup>.

Combining with Mitsubishi MM-CF series IPM motors facilitates aspects of high-level control with no encoder such as "simple positioning"<sup>4</sup> and "zero speed torque".

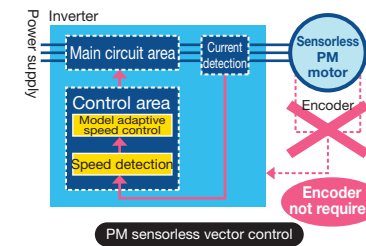

\*3: Speed fluctuation ratio:  $\pm 0.05\%$  (digital input)

\*4: Positional accuracy (with no load) of 1.5K and lower:  $\pm 1.8^\circ$ , 2K and higher:  $\pm 3.6^\circ$

##### • Easy maintenance for sensor (encoder)-less motor

- No additional cables means less wiring space required.
- Improved reliability is obtained in unfavorable operating environments. (e.g. high vibration)
- PM motors are usually smaller and lighter than induction motors.

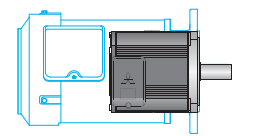

Comparison of SF-PRF 1.5 kW 4P and MM-CF152

#### Transfer of circuit boards

The Simple positioning control delivers a precision workpiece, such as a printed substrate, to a precise position. Transfer of fragile glass substrates can be performed with a highly accurate driving system.



### (5) Taking motor performance to the max

#### Induction motors and magnet motors can be combined freely

##### • The cutting-edge auto tuning function

The PM motor auto tuning function, which has been newly developed, enables operation of other manufacturers' permanent magnet (PM) motors. Operation with all Mitsubishi induction motors and PM motors, in addition to induction motors and PM motors from other manufacturers<sup>5</sup>, is possible. That means you need less motors for spare and stocks.

(With IPM motors other than MM-CF and PM motors manufactured by other companies, starting torque is limited to 50%, and simple positioning control and zero speed torque cannot be used even if tuned.)

\*5: Tuning may not be available depending on its motor characteristics.

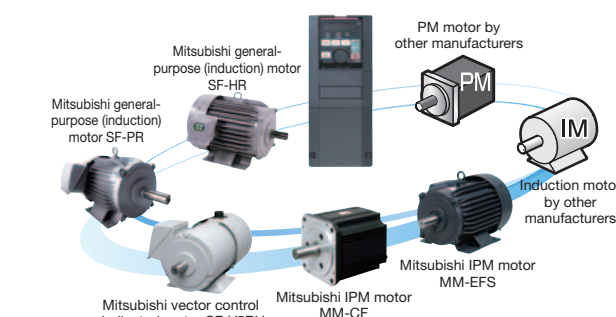

##### • Low speed, high torque realized with SF-PR motor

By combining with Mitsubishi's high-performance, energy-saving motor SF-PR, 100% continuous operation is possible from a low speed of 0.3 Hz for inverters of any capacity. (when using Real sensorless vector control)

##### • Sharing the spare inverter

One spare inverter is enough for the two types of motors (IM and PM).

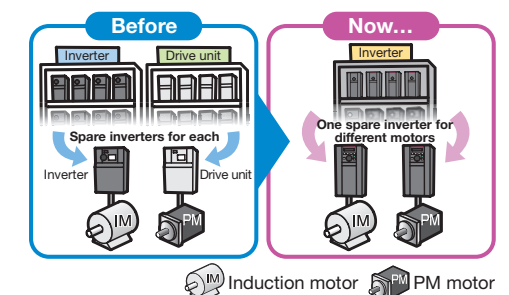

IM Induction motor PM motor



# SECURITY & SAFETY

Swift recovery ensured by preventing trouble beforehand. The FR-A800 has been developed with reliability and safety foremost in mind.

## For Improved Equipment Reliability

Rapid response is obtained when an unexpected trouble occurs.

### (1) Improved system safety

#### Safety standards compliance **NEW**

Controls with safety functions can be easily performed.

- PLd and SIL2 are supported as standard. (STO)
  - EN ISO 13849-1 PLd / Cat.3
  - EN 61508, EN 61800-5-2 SIL2
- Compatible with PLe and SIL3 using a built-in option.
  - EN ISO 13849-1 PLe / Cat.4 (to be supported soon)
  - EN 61508, EN 61800-5-2 SIL3

In addition to STO, also compatible with SS1, SS2, SLS, and SOS by using an option (to be released soon).

Functions for IEC/EN 61800-5-2:2007
STO (Safe Torque Off)
SS1 (Safe Stop 1)
SS2 (Safe Stop 2)
SOS (Safe Operating Stop)
SLS (Safely-Limited Speed)

- Safety communication networks will be also supported by using an option (to be released soon).
  - CC-Link IE Safty communication function
  - PROFIsafe

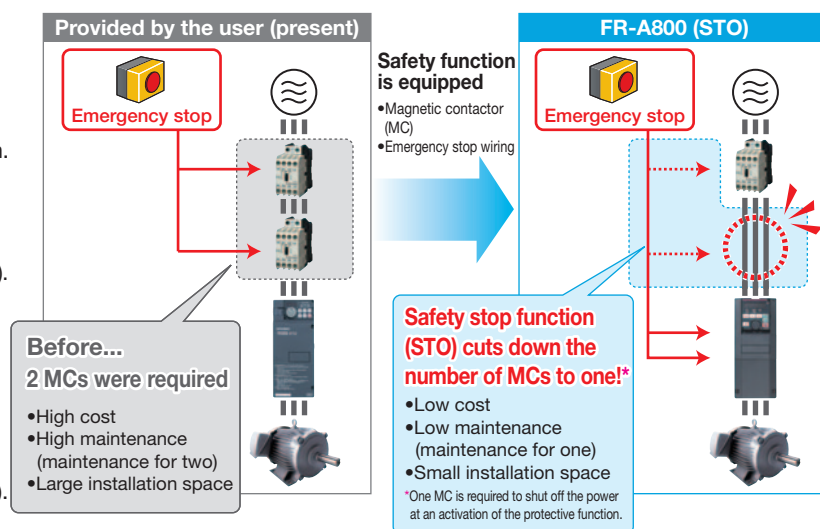

### (2) Reliable and secure maintenance

#### Standard 24 VDC power supply for the control circuit **NEW**

With the existing control power supply to R1 and S1 (AC), 24 VDC input is equipped as standard.

The 24 VDC power supplied from outside can be fed to the control circuit locally, enabling the parameter settings, communication operation and safety maintenance without turning ON the main power.

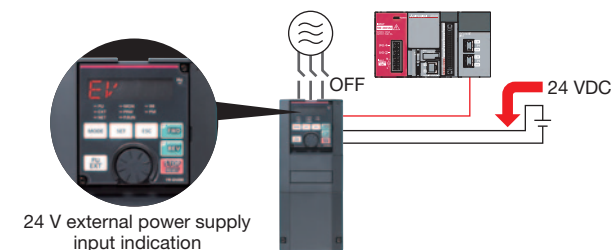

#### Prevention of trouble with temperature monitoring **NEW**

The inverter is equipped with an internal temperature sensor, which outputs a signal when the ambient temperature is high. This facilitates the detection of rises in temperature inside the inverter following cooling fan malfunction, or rises in ambient temperature due to inverter operating conditions.

### (3) Quick reaction to troubles

#### Easy fault diagnosis **NEW**

- The operating status (output frequency, etc.) immediately before the protection function activates can be stored in the inverter built-in RAM with the trace function. Stored data (trace data) can be copied to a USB memory device, facilitating easy trouble analysis at a separate location by reading into FR Configurator2.

Trace data stored in the built-in RAM is deleted when the power is turned OFF or the inverter is reset.



- Clock setting is now available in addition to the already-available cumulative energization time. The time and date at a protective function activation are easily identified. (The clock is reset at power-OFF.) The date and time are also saved with the trace data, making the fault analysis easier. By using the real-time clock function with the optional FR-LU08 (when using battery), the time is not reset even when the power supply is turned OFF.

### (4) Long life components and life check function

#### Long life components

- The service life of the cooling fans is now 10 years<sup>\*1</sup>. The service life can be further extended by ON/OFF control of the cooling fan.
- Capacitors with a design life of 10 years<sup>\*\*2</sup> are adapted. With these capacitors, the service of the inverter is further extended.
- Life indication of life components

Components	Estimated lifespan of the FR-A800	Guideline of JEMA <sup>*3</sup>
Cooling fan	10 years <sup>*1</sup>	2 to 3 years
Main circuit smoothing capacitor	10 years <sup>**2</sup>	5 years
Printed board smoothing capacitor	10 years <sup>**2</sup>	5 years

\*1: Surrounding air temperature: Annual average of 40°C (free from corrosive gas, flammable gas, oil mist, dust and dirt). The design life is a calculated value and is not a guaranteed product life.

\*\*2: Output current: 80% of the inverter rating.

\*3: Excerpts from "Periodic check of the transistorized inverter" of JEMA (Japan Electrical Manufacturer's Association).

#### Enhanced life diagnosis function

- An internal thermal sensor is equipped to all inverters as standard. This improves the accuracy in life diagnosis for the control circuit capacitors. **NEW**
- Maintenance timers are available for up to three peripheral devices, such as motor and bearing.



"Maintenance 1 output" warning

### (5) Renewal assurance

#### Intercompatibility with existing models

- The inverter installation method is the same as that for the FR-A700 series, eliminating any concerns over replacement.

Furthermore, FR-A700 series control circuit terminal blocks can be installed with the use of an option (to be released soon).



- The terminal response adjustment function allows a user to adjust the response speed in accordance with the existing facility. **NEW**
- The conversion function of FR Configurator2 enables parameter copy from an FR-A700 and even from an FR-A500 (to be supported soon).

### (6) Reasons for high quality

#### Design considering the hazardous environment

3D-vibration analysis is performed to confirm the vibration resistance. The analysis is also useful to find the best layout position and to further improve the product's rigidity. Assuming a hazardous service condition, the product reliability is thoroughly assessed in the design stage. Every effort is made to ensure the best quality of the Mitsubishi inverter.<sup>\*4</sup>

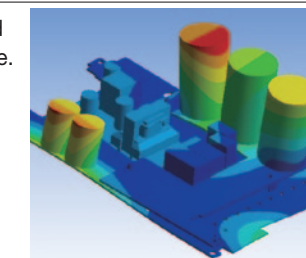

3D-vibration analysis

#### Heat control for high quality

Resistance against heat is what makes an inverter reliable. A well-designed heat-resistant power module is essential in a reliable inverter. From the power module's design stage, its heat resistance is carefully considered.<sup>\*4</sup>

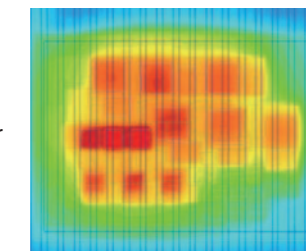

Hydraulic analysis and heat simulation

#### Acknowledging the limits for quality control

Assessments are made to acknowledge the product's limits and to simulate the product condition beyond the limits. These assessments are important to know the quality level of the product and to secure the safety in case of a failure.<sup>\*4</sup>



HALT  
Highly accelerated life test (HALT):  
Test to confirm the thermal and vibration limits.

#### In-house production for high quality

The best-matching module for the Mitsubishi inverter (7.5K or lower) is being made by in-house manufacturing, having the most suitable shape and the leading edge power element.



In-house produced transistor module

\*4 The usage beyond the product's specified service condition is not guaranteed.



## EASY SETUP & EASY TO USE

A range of equipment and functions are prepared allowing work to be performed anywhere to suit product life cycles.

### From Startup to Maintenance

Fully equipped with a variety of simple functions and equipment to improve work efficiency.

#### (1) Streamlining the startup process

##### Parameter copying with USB memory **NEW**

- A USB host connector (A type), which allows external device connections, has been added. Parameters can be copied to commercial USB memory devices.

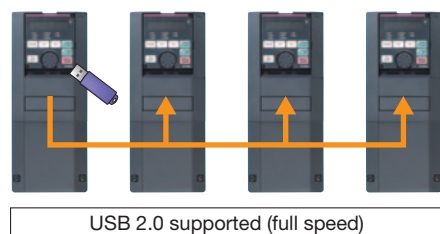

##### Easy setup with FR Configurator2

- Sense of unity with other Mitsubishi FA products with common MELSOFT design and operability
- Easy plug-and-play connection to USB terminal equipped as standard

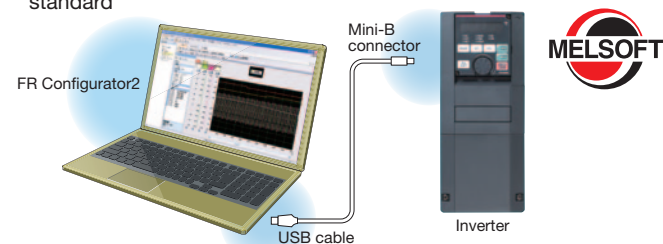

- A trial version, which contains start-up functions, is available. It can be downloaded at Mitsubishi Electric FA Global Website.

##### Easy wiring to the control circuit **NEW**

Highly reliable and easily wired spring clamp terminals have been adopted for control circuit terminals. Round crimping terminals can also be used by employing a control terminal option (to be released soon).

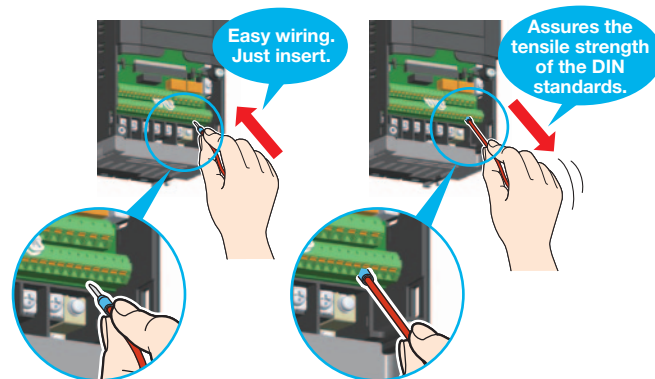

#### (2) Easy-to-follow display improves the operability

##### Easy operation with GOT (to be released soon) **NEW**

- Automatic communication is possible without specifying any parameter settings simply by connecting to the GOT2000 series.
- The PLC function device monitor can be displayed at the GOT2000 series. Batch control of multiple inverter device monitors is possible with a single GOT unit.
- The sample screen data for the A800 can be found in the screen design software of the GOT2000 series. The newest version of the screen design software can be downloaded from the Mitsubishi Electric FA Global Website.



##### Easy-to-follow parameter configuration **NEW**

One of the selectable mode by the operation panel is the Group parameter mode, which provides intuitive and simple parameter settings. (The conventional parameter setting mode is selected by default.)

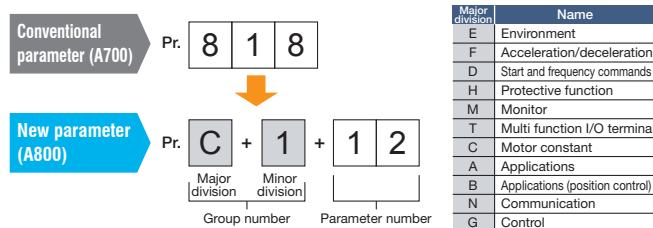

##### Easy-to-read operation panel **NEW**

A 5-digit, 12-seg display has been adopted for the operation panel (FR-DU08) for a more natural character display. Furthermore, an optional operation panel (FR-LU08) adopting an LCD panel capable of displaying Kanji characters and menus is also available.

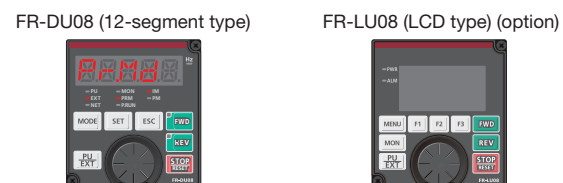

#### (3) To aid with maintenance

##### Reduced wiring check time

Split-type covers are adapted for all capacity models. Maintenance is now easy because all an operator has to do is to remove the cover for the target wiring area.



##### Maintenance and control of multiple inverters (Option) **NEW**

Serial number reading is possible using the optional FR-LU08 or FR Configurator2. Administration of different inverters has become much more simple.



## ECO-FRIENDLY FACTORIES

The power consumption by motors is said to amount about the half of all power consumption made by the Japanese manufacturing industry. Factories can save more energy without dropping their production. Less energy and more production—the FR-A800 series will help you to get the both.

### The Next Step — Go Green

Save energy while increasing factory production.

#### (1) Energy-saving function tailored to system, application

##### Variety of functions

- **Check the energy saving effect at a glance**
  - You can check the energy saving effect on the energy saving monitor.
  - The measured output power amount can be output in pulses.
- **Reduce power consumption during standby**
  - Control circuits other than those for power-related parts can be operated with 24 VDC power supplied from an external power source. **NEW**
  - Since the control circuit can use the external 24 VDC, other power control circuits can stay OFF while no driving is required, and that saves the standby energy.
  - By turning the cooling fan ON/OFF based on the inverter status, wasteful power consumption during stoppages can be reduced.

- **Save energy with Optimum excitation control **NEW****

The excitation current is constantly adjusted to drive the motor in the most efficient method which leads to energy saving. For example, with optimum excitation control with motor load torque of 10% when using the SF-JR, motor efficiency has increased by approximately 15% over the previous V/F control method.

- **Effective use of regenerative energy (option)**

Multiple inverters can be connected to the FR-CV/FR-HC2 via a common PN bus. Regenerative power is used at other inverters, and surplus energy is returned to the power supply, resulting in energy saving. The 315K or higher models are inverter-converter separated types, which are suitable for power regeneration. **NEW**

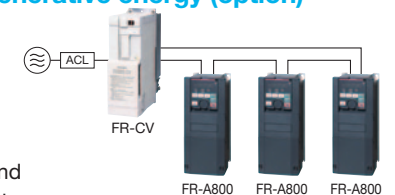

#### (2) PM motor contributes to the energy saving in factories

##### PM motor

If the inverter is being used for an application requiring constant-torque, such as a conveyor, factory energy savings can be achieved by replacing your current induction motors with permanent magnet motors (PM motors). (Tuning is required for an IPM motor other than MM-CF, and for the PM motors of other manufacturers. Please contact your sales representative.)

- **Why is a PM motor so efficient?**

- The current does not flow to the rotor (secondary side), so there is no secondary copper loss.
- Magnetic flux is generated by permanent magnets, so less current is required to drive a motor.

##### Conveyor

A conveyor transports different goods and products according to its application. A PM motor can keep the carrying speed constant while saving energy.

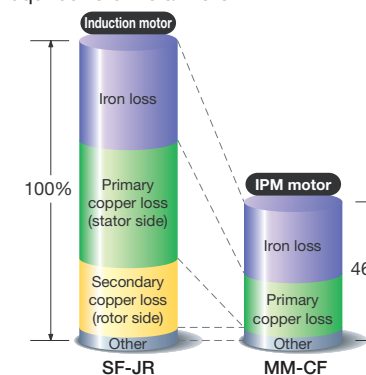

[ Comparison of motor losses ]  
(Example of 1.5 kW motors)



# SYSTEM SUPPORT

## High Equipment Functionality

Numerous functions and the extensive lineup of models are ready to support various systems.

### (1) Various network compatibility brings all the control in your hand

#### Compatibility to various open networks

- A controller can control and monitor an inverter via networks. RS-485 communication (Mitsubishi inverter protocol, Modbus-RTU protocol), which is supported as standard, conveys data up to 115200 bps.
- A function block (FB) programming for CC-Link communication is available for the MELSEC-Q/L series. Inverter control sequence programs can be created easily. (An FB library (FB part library) can be downloaded from the Mitsubishi Electric FA Global Website.)

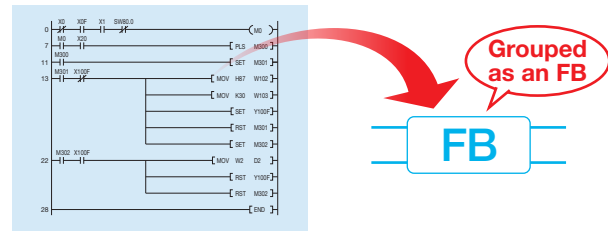

- Communication options are also available for the major network protocols such as CC-Link and SSCNET III/H (to be released soon) as well as DeviceNet™, PROFIBUS-DP V0, and LonWorks® (to be released soon). Other Ethernet networks are also supported.
- CC-Link IE Field • FL-net remote I/O (to be released soon)

LonWorks® is a registered trademark of Echelon Corporation, DeviceNet™ is a trademark of ODVA, and PROFIBUS® is a registered trademark of the PROFIBUS User Organization. Other company and product names herein are the trademarks and registered trademarks of their respective owners.

### (2) Selection of optimum capacity to suit the application

#### Multi-rating NEW

Rated current and four different overload capacity ratings (SLD rating (super light duty), LD rating (light duty), ND rating (normal duty), HD rating (heavy duty)) can be selected with parameters. The optimum inverter can be selected to suit the application, and by selecting an inverter with SLD or LD rating, equipment size can be reduced when compared with the FR-A700 series. The HD rating is best suited for applications requiring low speed and high torque.

If using an inverter with capacity of 75K or higher, or motor with capacity of 75 kW or higher, always select and install the inverter based on the capacity of the motor with DC reactor.

#### With FR-A700

#### With FR-A800

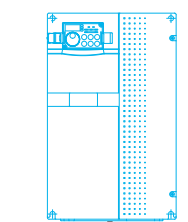

Space saving

Rating	SLD	LD	ND	HD
	Super light duty	Light duty	Normal duty	Heavy duty
Application		Fan and Pump Shield Machines, Winding and Unwinding, Printing Machines	Cranes, Press	Conveyor
Pr.570 (E301) setting	0	1	2 (Initial value)	3
Overload current rating (inverse-time characteristics)	110% 60 s, 120% 3 s	120% 60 s, 150% 3 s	150% 60 s, 200% 3 s	200% 60 s, 250% 3 s
Surrounding air temperature	40°C	50°C	50°C	50°C

Refer to page 10 for the inverter rating selection.

### (3) Wire saving, space saving

#### Built-in brake transistor NEW

In addition to the 22K and lower, 400 V class 30 to 55K models have also been equipped with a built-in brake transistor. In an application where the motor is hardly decelerated, connecting a brake resistor can shorten the deceleration time; no brake unit or power regeneration converter is required. Wiring, space, and ultimately the cost will be all saved.

### (4) PLC control with an inverter

#### PLC function NEW

- Parameters and setting frequency can be changed at the program.
- Inverter control such as inverter operations triggered by input signals, signal output based on inverter operation status, and monitor output can be freely customized based on the machine specifications.
- All machines can be controlled by the inverter alone, and control can also be dispersed.
- Time-based operation is possible by using in combination with the real-time clock function (when using optional FR-LU08).

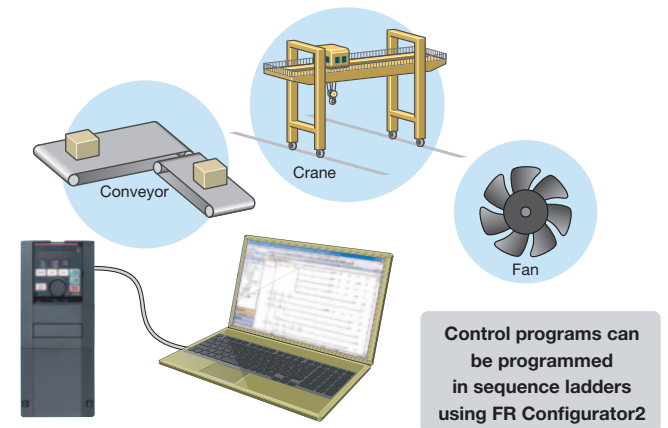

Control programs can be programmed in sequence ladders using FR Configurator2

### (5) Direct installation by the machine

#### IP55 compatible NEW

A lineup of IP55 compatible model in the 400 V 0.4 to 160K range is available as a separate series (to be released soon).

- Inverters can be installed nearby the machine, minimizing cable length between the inverter and motor.
- Support is available for use even in high-humidity or dusty environments, facilitating a more flexible choice of installation locations.
- By enclosing a DC reactor, it requires less wiring and less space.

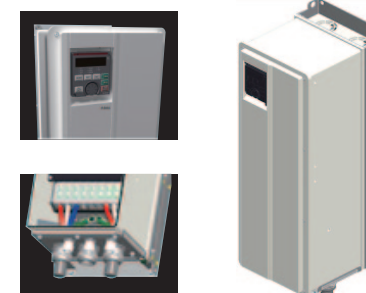

### (6) Flexible configuration to meet the needs

#### Separate inverter and converter modules NEW

The inverter module and the converter module are physically separated for the 315K or higher capacity models (to be released soon).

Inverter module: FR-A842

Converter module: diode converter unit

This facilitates flexible support for a variety of systems such as parallel drive and common bus line, allowing installation space to be minimized and costs reduced.

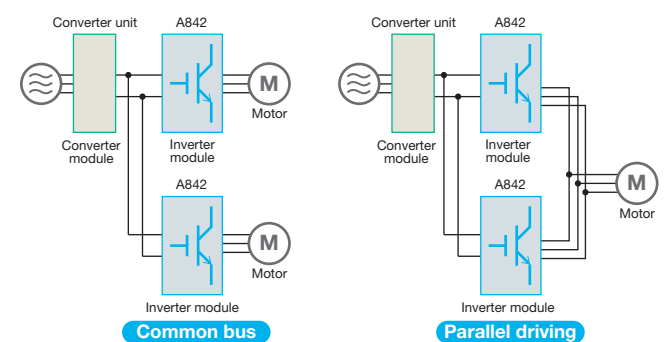

Restrictions apply to parallel drive depending on the specifications. Please contact your sales representative beforehand.

### (7) Reduced tact time with functionality suited to the application

#### Vibration control NEW

Vibrations applied to conveyed objects that occur at the crane travel axis when cranes stop can be suppressed.

#### Increased magnetic excitation deceleration NEW

Deceleration time can be reduced without a brake resistor. Tact time can be eliminated at conveyor lines, etc.



# Standard Specifications

## Rating

### ◆ 200 V class (Standard model)

Model FR-A820-□		00046 (0.4K)	00077 (0.75K)	00105 (1.5K)	00167 (2.2K)	00250 (3.7K)	00340 (5.5K)	00490 (7.5K)	00630 (11K)	00770 (15K)	00930 (18.5K)	01250 (22K)	01540 (30K)	01870 (37K)	02330 (45K)	03160 (55K)	03800 (75K)	04750 (90K)	
Applicable motor capacity (kW) *1	SLD	0.75	1.5	2.2	3.7	5.5	7.5	11	15	18.5	22	30	37	45	55	75	90/110	132	
	LD	0.75	1.5	2.2	3.7	5.5	7.5	11	15	18.5	22	30	37	45	55	75	90	110	
	ND (initial setting)	0.4	0.75	1.5	2.2	3.7	5.5	7.5	11	15	18.5	22	30	37	45	55	75	90	
	HD	0.2	0.4	0.75	1.5	2.2	3.7	5.5	7.5	11	15	18.5	22	30	37	45	55	75	
Rated capacity (kVA) *2	SLD	1.8	2.9	4	6.4	10	13	19	24	29	35	48	59	71	89	120	145	181	
	LD	1.6	2.7	3.7	5.8	8.8	12	17	22	27	32	43	53	65	81	110	132	165	
	ND (initial setting)	1.1	1.9	3	4.2	6.7	9.1	13	18	23	29	34	44	55	67	82	110	132	
	HD	0.6	1.1	1.9	3	4.2	6.7	9.1	13	18	23	29	34	44	55	67	82	110	
Rated current (A) *3	SLD	4.6 (3.9)	7.7 (6.5)	10.5 (8.9)	16.7 (14.2)	25 (21.3)	34 (28.9)	49 (41.7)	63 (53.6)	77 (65.5)	93 (79.1)	125 (106)	154 (131)	187 (159)	233 (198)	316 (269)	380 (323)	475 (404)	
	LD	4.2 (3.6)	7 (6)	9.6 (8.2)	15.2 (12.9)	23 (19.6)	31 (26.4)	45 (38.3)	58 (49.3)	70.5 (59.9)	85 (72.3)	114 (96.9)	140 (119)	170 (145)	212 (180)	288 (245)	346 (294)	432 (367)	
	ND (initial setting)	3 (4.5)	5 (7.5)	8 (12)	11 (16.5)	17.5 (26.3)	24 (36)	33 (49.5)	46 (69)	61 (91.5)	76 (114)	90 (135)	115 (173)	145 (218)	175 (263)	215 (323)	288 (432)	346 (519)	
	HD	1.5 (4.5)	3 (7.5)	5 (12)	8 (16.5)	11 (26.3)	17.5 (36)	24 (49.5)	33 (69)	46 (91.5)	61 (114)	76 (135)	90 (173)	115 (218)	145 (263)	175 (323)	215 (432)	288 (519)	
Overload current rating *4	SLD	110% 60s, 120% 3s (inverse-time characteristics) at surrounding air temperature 40°C																	
	LD	120% 60s, 150% 3s (inverse-time characteristics) at surrounding air temperature 50°C																	
	ND (initial setting)	150% 60s, 200% 3s (inverse-time characteristics) at surrounding air temperature 50°C																	
	HD	200% 60s, 250% 3s (inverse-time characteristics) at surrounding air temperature 50°C																	
Rated voltage *5		Three-phase 200 to 240V																	
Regenerative braking	Brake transistor	Built-in															FR-BU2 (Option)		
	Maximum brake torque	When the built-in brake resistor is used 150% torque/3%ED		100% torque/3%ED		100% torque/2%ED		—		—		—		—		—		—	
	FR-ABR (when the option is used)	150% torque/10%ED			100% torque/10%ED			100% torque/6%ED			—		—		—		—		
Power supply	Rated input AC voltage/frequency	Three-phase 200 to 240V 50Hz/60Hz																	
	Permissible AC voltage fluctuation	170 to 264V 50Hz/60Hz																	
	Permissible frequency fluctuation	±5%																	
Protective structure (IEC 60529) *6		Enclose type (IP20)												Open type (IP00)					
Cooling system		Self-cooling					Forced air cooling												
Approx. mass (kg)		2.0	2.2	3.3	3.3	3.3	6.7	6.7	8.3	15	15	15	22	42	42	54	74	74	

### ◆ 400 V class (Standard model)

Model FR-A840-□		00023 (0.4K)	00038 (0.75K)	00052 (1.5K)	00083 (2.2K)	00126 (3.7K)	00170 (5.5K)	00250 (7.5K)	00310 (11K)	00380 (15K)	00470 (18.5K)	00620 (22K)	00770 (30K)	00930 (37K)	01160 (45K)	01800 (55K)	02160 (75K)	02600 (90K)	
Applicable motor capacity (kW) *1	SLD	0.75	1.5	2.2	3.7	5.5	7.5	11	15	18.5	22	30	37	45	55	75/90	110	132	
	LD	0.75	1.5	2.2	3.7	5.5	7.5	11	15	18.5	22	30	37	45	55	75	90	110	
	ND (initial setting)	0.4	0.75	1.5	2.2	3.7	5.5	7.5	11	15	18.5	22	30	37	45	55	75	90	
	HD	0.2	0.4	0.75	1.5	2.2	3.7	5.5	7.5	11	15	18.5	22	30	37	45	55	75	
Rated capacity (kVA) *2	SLD	1.8	2.9	4	6.3	10	13	19	24	29	36	47	59	71	88	137	165	198	
	LD	1.6	2.7	3.7	5.8	8.8	12	18	22	27	33	43	53	65	81	110	137	165	
	ND (initial setting)	1.1	1.9	3	4.6	6.9	9.1	13	18	24	29	34	43	54	66	84	110	137	
	HD	0.6	1.1	1.9	3	4.6	6.9	9.1	13	18	24	29	34	43	54	66	84	110	
Rated current (A) *3	SLD	2.3 (2)	3.8 (3.2)	5.2 (4.4)	8.3 (7.1)	12.6 (10.7)	17 (14.5)	25 (21.3)	31 (26.4)	38 (32.3)	47 (40)	62 (52.7)	77 (65.5)	93 (79.1)	116 (98.6)	180 (153)	216 (184)	260 (221)	
	LD	2.1 (1.8)	3.5 (3)	4.8 (4.1)	7.6 (6.5)	11.5 (9.8)	16 (13.6)	23 (19.6)	29 (24.7)	35 (29.8)	43 (36.6)	57 (48.5)	70 (59.5)	85 (72.3)	106 (90.1)	144 (122)	180 (153)	216 (184)	
	ND (initial setting)	1.5 (2.3)	2.5 (3.8)	4 (6)	6 (9)	9 (13.5)	12 (18)	17 (25.5)	23 (34.5)	31 (46.5)	38 (57)	44 (66)	57 (85.5)	71 (107)	86 (129)	110 (165)	144 (216)	180 (270)	
	HD	0.8 (2.3)	1.5 (3.8)	2.5 (6)	4 (9)	6 (13.5)	9 (18)	12 (25.5)	17 (34.5)	23 (46.5)	31 (57)	38 (66)	44 (85.5)	57 (107)	71 (129)	86 (165)	110 (216)	144 (270)	
Overload current rating *4	SLD	110% 60s, 120% 3s (inverse-time characteristics) at surrounding air temperature 40°C																	
	LD	120% 60s, 150% 3s (inverse-time characteristics) at surrounding air temperature 50°C																	
	ND (initial setting)	150% 60s, 200% 3s (inverse-time characteristics) at surrounding air temperature 50°C																	
	HD	200% 60s, 250% 3s (inverse-time characteristics) at surrounding air temperature 50°C																	
Rated voltage *5		Three-phase 380 to 500V																	
Regenerative braking	Brake transistor	Built-in															FR-BU2(Option)		
	Maximum brake torque	When the built-in brake resistor is used 100% torque/2%ED		—		—		—		—		—		—		—		—	
	FR-ABR (when the option is used)	100% torque/10%ED			100% torque/6%ED			—		—		—		—		—			
Power supply	Rated input AC voltage/frequency	Three-phase 380 to 500V 50Hz/60Hz *7																	
	Permissible AC voltage fluctuation	323 to 550V 50Hz/60Hz																	
	Permissible frequency fluctuation	±5%																	
Protective structure (IEC 60529) *6		Enclose type (IP20)												Open type (IP00)					
Cooling system		Self-cooling					Forced air cooling												
Approx. mass (kg)		2.8	2.8	2.8	3.3	3.3	6.7	6.7	8.3	8.3	15	15	23	41	41	43	52	55	



### ◆ 400 V class (Standard model)

Model FR-A840-[]		03250 (110K)	03610 (130K)	04320 (160K)	04810 (185K)	05470 (220K)	06100 (250K)	06830 (280K)	
Applicable motor capacity (kW) *1	SLD	160	185	220	250	280	315	355	
	LD	132	160	185	220	250	280	315	
	ND (initial setting)	110	132	160	185	220	250	280	
	HD	90	110	132	160	185	220	250	
Output	Rated capacity (kVA) *2	SLD	248	275	329	367	417	465	521
		LD	198	248	275	329	367	417	465
		ND (initial setting)	165	198	248	275	329	367	417
		HD	137	165	198	248	275	329	367
	Rated current (A) *3	SLD	325 (276)	361 (307)	432 (367)	481 (409)	547 (465)	610 (519)	683 (581)
		LD	260 (221)	325 (276)	361 (307)	432 (367)	481 (409)	547 (465)	610 (519)
		ND (initial setting)	216 (324)	260 (390)	325 (488)	361 (542)	432 (648)	481 (722)	547 (821)
		HD	180 (324)	216 (390)	260 (488)	325 (542)	361 (648)	432 (722)	481 (821)
	Overload current rating *4	SLD	110% 60s, 120% 3s (inverse-time characteristics) at surrounding air temperature 40°C						
		LD	120% 60s, 150% 3s (inverse-time characteristics) at surrounding air temperature 50°C						
		ND (initial setting)	150% 60s, 200% 3s (inverse-time characteristics) at surrounding air temperature 50°C						
		HD	200% 60s, 250% 3s (inverse-time characteristics) at surrounding air temperature 50°C						
Rated voltage *5		Three-phase 380 to 500V							
Regenerative braking torque	Maximum value/permissible duty		10% torque/continuous						
Power supply	Rated input AC voltage/frequency		Three-phase 380 to 500V 50Hz/60Hz *7						
	Permissible AC voltage fluctuation		323 to 550V 50Hz/60Hz						
	Permissible frequency fluctuation		±5%						
Protective structure (IEC 60529) *6		Open type (IP00)							
Cooling system		Forced air cooling							
Approx. mass (kg)		71	78	117	117	166	166	166	

### ◆ 400 V class (IP55 compatible model)

Model FR-A846-[]		00250 (7.5K)	00310 (11K)	00380 (15K)	00470 (18.5K)	
Applicable motor capacity (kW) *1	LD	11	15	18.5	22	
	ND (initial setting)	7.5	11	15	18.5	
Output	Rated capacity (kVA) *2	LD	18	22	27	33
		ND (initial setting)	13	18	24	29
	Rated current (A) *3	LD	23 (19.6)	29 (24.7)	35 (29.8)	43 (36.6)
		ND (initial setting)	17 (25.5)	23 (34.5)	31 (46.5)	38 (57)
	Overload current rating *4	LD	120% 60s, 150% 3s (inverse-time characteristics) at surrounding air temperature 40°C			
		ND (initial setting)	150% 60s, 200% 3s (inverse-time characteristics) at surrounding air temperature 40°C			
	Rated voltage *5		Three-phase 380 to 500V			
	Regenerative braking torque	Maximum value/permissible duty		10% torque/continuous		
	Power supply	Rated input AC voltage/frequency		Three-phase 380 to 500V 50Hz/60Hz *7		
		Permissible AC voltage fluctuation		323 to 550V 50Hz/60Hz		
		Permissible frequency fluctuation		±5%		
Protective structure		IP55 (IEC 60529), UL Type 12				
Cooling system		Forced-air-cooling + internal fan				
Approx. mass (kg)		26	26	27	27	

\*1 The applicable motor capacity indicated is the maximum capacity applicable for use of the Mitsubishi 4-pole standard motor.

\*2 The rated output capacity indicated assumes that the output voltage is 220 V for 200 V class and 440 V for 400 V class.

\*3 When an operation is performed with the carrier frequency set to 3 kHz or more, and the inverter output current reaches the value indicated in the parenthesis of the rated current, the carrier frequency is automatically lowered. The motor noise becomes louder accordingly.

\*4 The % value of the overload current rating indicated is the ratio of the overload current to the inverter's rated output current. For repeated duty, allow time for the inverter and motor to return to or below the temperatures under 100% load.

\*5 The maximum output voltage does not exceed the power supply voltage. The maximum output voltage can be changed within the setting range. However, the maximum point of the voltage waveform at the inverter output side is the power supply voltage multiplied by about  $\sqrt{2}$ .

\*6 FR-DU08: IP40 (except for the PU connector section)

\*7 For the power voltage exceeding 480 V, set **Pr.977 Input voltage mode selection.**





## Common specifications

Control specifications	Control method		Soft-PWM control, high carrier frequency PWM control (selectable among V/F control, Advanced magnetic flux vector control, Real sensorless vector control), vector control <sup>*1</sup> , and PM sensorless vector control	
	Output frequency range		0.2 to 590 Hz (400 Hz or less under Advanced magnetic flux vector control <sup>*1</sup> , Real sensorless vector control, and vector control. 200 Hz or less under PM sensorless vector control.)	
	Frequency setting resolution	Analog input	0.015 Hz/60 Hz (0 to 10 V/12 bits for terminals 2 and 4) 0.03 Hz/60 Hz (0 to 5 V/11 bits or 0 to 20 mA/approx. 11 bits for terminals 2 and 4, 0 to ±10 V/12 bits for terminal 1) 0.06 Hz/60 Hz (0 to ±5 V/11 bits for terminal 1)	
		Digital input	0.01 Hz	
	Frequency accuracy	Analog input	Within ±0.2% of the max. output frequency (25°C ± 10°C)	
		Digital input	Within 0.01% of the set output frequency	
	Voltage/frequency characteristics		Base frequency can be set from 0 to 590 Hz. Constant-torque/variable-torque pattern or adjustable 5 points V/F can be selected.	
	Starting torque		SLD Rating:120% 0.3 Hz, LD Rating:150% 0.3 Hz, ND Rating:200% 0.3 Hz <sup>*6</sup> , HD Rating:250% 0.3 Hz (Real sensorless vector control, vector control <sup>*1</sup> )	
	Torque boost		Manual torque boost	
	Acceleration/deceleration time setting		0 to 3600 s (acceleration and deceleration can be set individually), linear or S-pattern acceleration/deceleration mode, backlash countermeasures acceleration/deceleration can be selected.	
DC injection brake (induction motor)		Operation frequency (0 to 120 Hz), operation time (0 to 10 s), operation voltage (0 to 30%) variable		
Stall prevention operation level		Operation current level can be set (0 to 220% variable), whether to use the function or not can be set. SLD Rating:0 to 120%, LD Rating:0 to 150%, ND Rating:0 to 220%, HD Rating:0 to 280%		
Torque limit level		Torque limit value can be set (0 to 400% variable).		
Operation specifications	Frequency setting signal	Analog input	Terminals 2 and 4: 0 to 10 V, 0 to 5 V, 4 to 20 mA (0 to 20 mA) are available. Terminal 1: -10 to +10 V, -5 to +5 V are available.	
		Digital input	Input using the setting dial of the operation panel or parameter unit Four-digit BCD or 16-bit binary (when used with option FR-A8AX)	
	Start signal		Forward and reverse rotation or start signal automatic self-holding input (3-wire input) can be selected.	
	Input signals (twelve terminals)		Low-speed operation command, Middle-speed operation command, High-speed operation command, Second function selection, Terminal 4 input selection, Jog operation selection, Electronic bypass function, Output stop, Start self-holding selection, Forward rotation command, Reverse rotation command, Inverter reset	
	Pulse train input		100 kpps	
	Operational functions		Maximum and minimum frequency settings, multi-speed operation, acceleration/deceleration pattern, thermal protection, DC injection brake, starting frequency, JOG operation, output stop (MRS), stall prevention, regeneration avoidance, increased magnetic excitation deceleration, DC feeding, frequency jump, rotation display, automatic restart after instantaneous power failure, electronic bypass sequence, remote setting, automatic acceleration/deceleration, intelligent mode, retry function, carrier frequency selection, fast-response current limit, forward/reverse rotation prevention, operation mode selection, slip compensation, droop control, load torque high-speed frequency control, speed smoothing control, traverse, auto tuning, applied motor selection, gain tuning, RS-485 communication, PID control, PID pre-charge function, easy dancer control, cooling fan operation selection, stop selection (deceleration stop/coasting), power-failure deceleration stop function, stop-on-contact control, PLC function, life diagnosis, maintenance timer, current average monitor, multiple rating, orientation control <sup>*</sup> , speed control, torque control, position control, pre-excitation, torque limit, test run, 24 V power supply input for control circuit, safety stop function	
	Output signal Open collector output (five terminals) Relay output (two terminals)		Inverter running, Up to frequency, Instantaneous power failure/undervoltage, Overload warning, Output frequency detection, Fault Fault codes of the inverter can be output (4 bits) from the open collector.	
	Pulse train output		50 kpps	
	Indication	For meter	Pulse train output (FM type)	Max. 2.4 kHz: one terminal (output frequency) The monitored item can be changed using <b>Pr.54 FM/CA terminal function selection</b> .
			Current output (CA type)	Max. 20 mADC: one terminal (output current) The monitored item can be changed using <b>Pr.54 FM/CA terminal function selection</b> .
Voltage output			Max. 10 VDC: one terminal (output voltage) The monitored item can be changed using <b>Pr.158 AM terminal function selection</b> .	
Operation panel (FR-DU08)		Operating status	Output frequency, Output current, Output voltage, Frequency setting value The monitored item can be changed using <b>Pr.52 Operation panel main monitor selection</b> .	
	Fault record	A fault record is displayed when a fault occurs. Past 8 fault records and the conditions immediately before the fault (output voltage/current/frequency/cumulative energization time/year/month/date/time) are saved.		
Protective/warning function	Protective function		Overcurrent trip during acceleration, Overcurrent trip during constant speed, Overcurrent trip during deceleration or stop, Regenerative overvoltage trip during acceleration, Regenerative overvoltage trip during constant speed, Regenerative overvoltage trip during deceleration or stop, Inverter overload trip, Motor overload trip, Heatsink overheat, Instantaneous power failure, Undervoltage, Input phase loss <sup>*5</sup> , Stall prevention stop, Loss of synchronism detection <sup>*5</sup> , Brake transistor alarm detection, Output side earth (ground) fault overcurrent, Output phase loss, External thermal relay operation <sup>*5</sup> , PTC thermistor operation <sup>*5</sup> , Option fault, Communication option fault, Parameter storage device fault, PU disconnection, Retry count excess <sup>*5</sup> , Parameter storage device fault, CPU fault, Operation panel power supply short circuit RS-485 terminals power supply short circuit, 24 VDC power fault, Abnormal output current detection <sup>*5</sup> , Inrush current limit circuit fault, Communication fault (inverter), Analog input fault, USB communication fault, Safety circuit fault, Overspeed occurrence <sup>*5</sup> , Speed deviation excess detection <sup>*1+5</sup> , Signal loss detection <sup>*1+5</sup> , Excessive position fault <sup>*1+5</sup> , Brake sequence fault <sup>*5</sup> , Encoder phase fault <sup>*1+5</sup> , 4 mA input fault <sup>*5</sup> , Pre-charge fault <sup>*5</sup> , PID signal fault <sup>*5</sup> , Option fault, Opposite rotation deceleration fault <sup>*5</sup> , Internal circuit fault, Abnormal internal temperature <sup>*7</sup>	
	Warning function		Fan alarm, Stall prevention (overcurrent), Stall prevention (overvoltage), Regenerative brake pre-alarm <sup>*5</sup> , Electronic thermal relay function pre-alarm, PU stop, Speed limit indication <sup>*5</sup> , Parameter copy, Safety stop, Maintenance signal output <sup>*5</sup> , USB host error, Home position return setting error <sup>*5</sup> , Home position return uncompleted <sup>*5</sup> , Home position return parameter setting error <sup>*5</sup> , Operation panel lock <sup>*5</sup> , Password locked <sup>*5</sup> , Parameter write error, Copy operation error, 24 V external power supply operation, Internal fun alarm <sup>*7</sup>	
Environment	Surrounding air temperature		-10°C to +50°C (non-freezing) (LD, ND, HD ratings) -10°C to +40°C (non-freezing) (SLD rating, IP55 compatible model)	
	Surrounding air humidity		95% RH or less (non-condensing) (With circuit board coating, IP55 compatible model) 90% RH or less (non-condensing) (Without circuit board coating)	
	Storage temperature <sup>*2</sup>		-20°C to +65°C	
	Atmosphere		Indoors (without corrosive gas, flammable gas, oil mist, dust and dirt, etc.)	
Altitude/vibration		Maximum 1000 m above sea level <sup>*3</sup> , 5.9 m/s <sup>2</sup> <sup>*4</sup> or less at 10 to 55 Hz (directions of X, Y, Z axes)		

\*1 Available only when the option (FR-A8AP) is mounted.

\*2 Temperature applicable for a short time, e.g. in transit.

\*3 For the installation at an altitude above 1,000 m up to 2,500 m, derate the rated current 3% per 500 m.

\*4 2.9m/s<sup>2</sup> or less for the FR-A840-04320(160K) or higher.

\*5 This protective function is not available in the initial status.

\*6 The initial value is 150% for the FR-A820-00340(5.5K) or higher and the FR-A840-00170(5.5K) or higher.

\*7 Available for the IP55 compatible model only.

# Outline Dimension Drawings

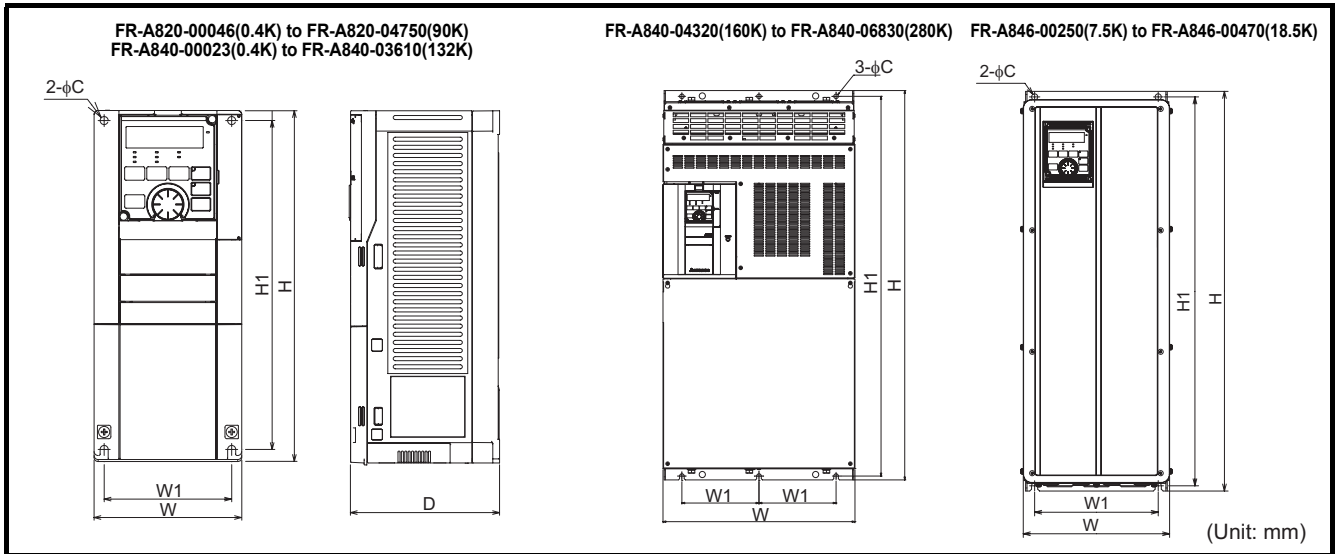

This is a sample outline dimension drawing. The shape differs by the model.

## ◆ 200 V class (Standard model)

Inverter Model	W	W1	H	H1	D	C
FR-A820-00046(0.4K)	110	95	260	245	110	6
FR-A820-00077(0.75K)					125	
FR-A820-00105(1.5K)	150	125			140	
FR-A820-00167(2.2K)					170	
FR-A820-00250(3.7K)						
FR-A820-00340(5.5K)	220	195			300	
FR-A820-00490(7.5K)						
FR-A820-00630(11K)	250	230	400	380	195	
FR-A820-00930(18.5K)						
FR-A820-01250(22K)						
FR-A820-01540(30K)	325	270	550	530	195	12
FR-A820-01870(37K)	435	380				
FR-A820-02330(45K)						
FR-A820-03160(55K)	465	410	700	675	360	
FR-A820-03800(75K)						
FR-A820-04750(90K)						

## ◆ 400 V class (Standard model)

Inverter Model	W	W1	H	H1	D	C
FR-A840-00023(0.4K)	150	125	260	245	140	6
FR-A840-00038(0.75K)						
FR-A840-00052(1.5K)						
FR-A840-00083(2.2K)						
FR-A840-00126(3.7K)						
FR-A840-00170(5.5K)						
FR-A840-00250(7.5K)	220	195	300	285	190	10
FR-A840-00310(11K)						
FR-A840-00380(15K)						
FR-A840-00470(18.5K)	250	230	400	380	195	
FR-A840-00620(22K)						
FR-A840-00770(30K)	325	270	550	530	195	
FR-A840-00930(37K)						
FR-A840-01160(45K)	435	380	620	595	300	
FR-A840-01800(55K)						
FR-A840-02160(75K)	465	400	740	715	360	
FR-A840-02600(90K)						
FR-A840-03250(110K)						
FR-A840-03610(132K)	498	200	1010	985	380	
FR-A840-04320(160K)						
FR-A840-04810(185K)	680	300	984	380	380	
FR-A840-05470(220K)						
FR-A840-06100(250K)						
FR-A840-06830(280K)						

## ◆ 400 V class (IP55 compatible model)

Inverter Model	W	W1	H	H1	D	C
FR-A846-00250(7.5K)	238	201	650	632.5	285	10
FR-A846-00310(11K)						
FR-A846-00380(15K)						
FR-A846-00470(18.5K)						

# **mitsubishi electric corporation**

HEAD OFFICE: TOKYO BLDG., 2-7-3, MARUNOUCHI, CHIYODA-KU, TOKYO 100-8310, JAPAN

---