

# EX - TERMINAL ENCLOSURES

Stainless steel version for Zone 1, 2, 21 and 22

2

The new explosion-protected terminal enclosures made of stainless steel (AISI 316 L) with ground surfaces was developed for instrumentation and control installations using the Ex-e and Ex-i technologies.

They act as a link between the main cable to the control room and the branch cables into the field. In addition to this, they may also be used for the direct connection of actuators and sensors. Here the metal cable glands also allow electromagnetically compatible connection methods.

The robust design of the stainless steel terminal boxes provides a high degree of safety for offshore applications and in places where particularly adverse chemical, mechanical and climatic operating conditions prevail within the hazardous area.

Three series of terminal enclosures are available in various sizes accommodating up to 7 x 128 terminals. The choice between screw and tension-spring (screwless) terminals for single and multi-wire conductors makes it possible for the installation engineers to select the type of connection that is most suitable for the respective application.

Two separate PE rails are available for the separate connection of PE/PA and screened cables. Due to the optimized design, there is a large drilling area for fitting a large number of metal glands. Unused entry holes must be sealed safely with certified blanking plugs. As an alternative, a screw-on metal flange can be used for a wide variety of applications.

- **Stainless steel AISI 316 L, electro-polished surface**
- **Highly resistant silicone seals**
- **Metal flanges available on request**
- **Safety standard IP66**
- **PE/PA rails**

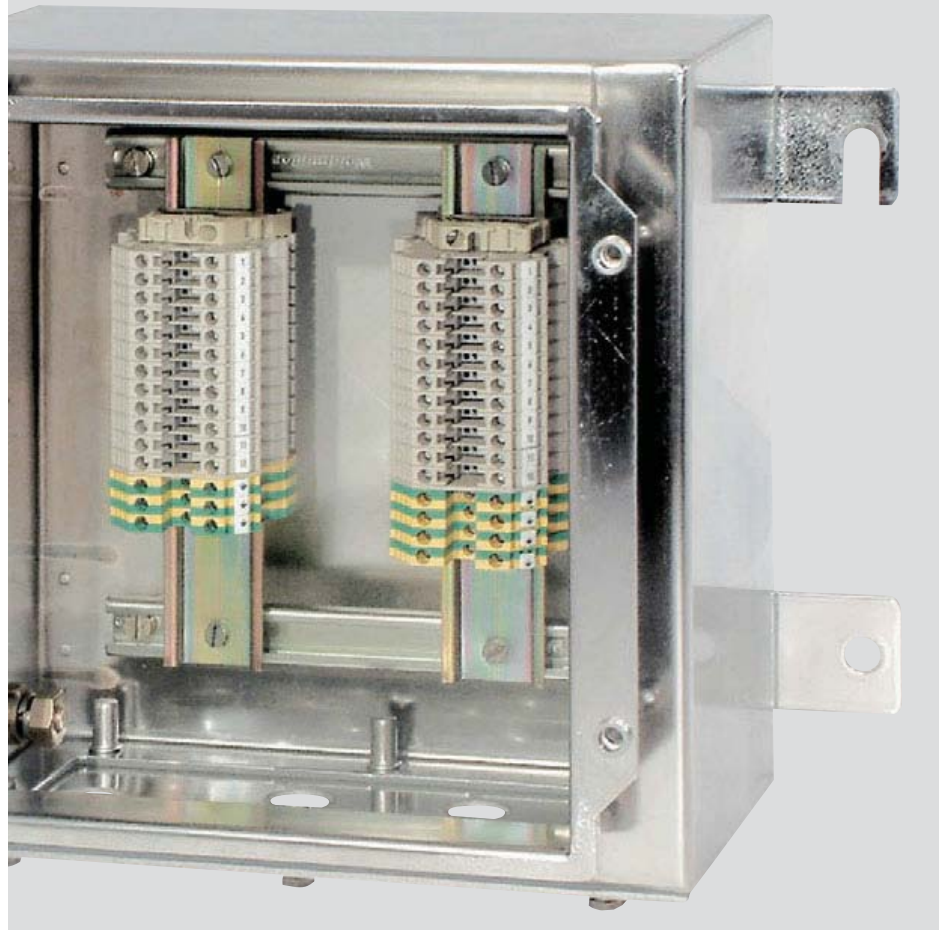
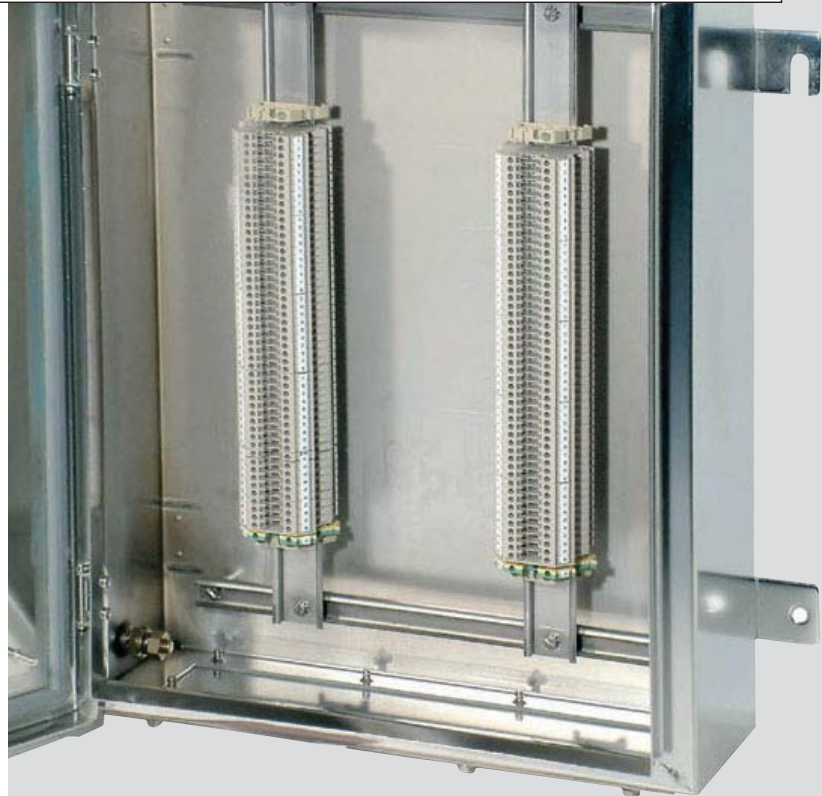

This external & internal brass earth/ground stud assembly enables rapid and reliable protective earth/ground connection, which is mounted on the side of the enclosure for ease of access.



The enclosure is mounted by four heavy-duty 3 mm thick surface welded and stainless steel lugs, with slotted bottom lugs for ease of mounting. These provide a secure, reliable means of mounting the enclosure.



2

To make the choice of the right terminal boxes or branching boxes for your application, the tables on this page contain the basic data. You can use these tables to identify and configure your terminal boxes.

The “max. terminal capacity” in the tables is based on the mechanical conditions of the terminal enclosure such as length of mounting rail and height the terminals. It is based on common terminal types such as Phoenix® or Wago®. The permissible number of terminals in terms of the type exam-

ination certificate must be checked in each individual case based on the current load tables in the operating instructions.

On the basis of the maximum drilled and the interference diameter of the cable and line duct, you can select the relevant terminal box by means of the number of ducts that you need.

**N-TB Range**

Size	Max. terminal capacity (2.5 mm <sup>2</sup> )	Max. entry guide (M16) Top-Bottom/ Left/Right
22/15/13	1 x 21	6/6/6
26/26/16	2 x 27	20/9/9
26/26/20	2 x 27	28/18/18
30/30/16	2 x 36	26/20/26
30/30/20	2 x 36	34/28/34
38/26/16	2 x 51	20/20/20
38/26/20	2 x 51	28/28/28
45/38/16	2 x 67	29/29/29
45/38/20	2 x 67	46/46/46
48/48/20	3 x 71	53/46/53
50/35/20	3 x 75	40/40/40
62/45/20	4 x 99	53/53/53
74/55/20	5 x 124	60/60/60
76/50/20	3 x 128	53/82/82
86/64/20	6 x 147	82/80/80
91/61/20	5 x 158	72/72/72
98/74/20	6 x 171	80/106/106
30/35/20	landscape 3 x 36	40/28/34
38/45/20	landscape 4 x 36	53/28/28
45/55/20	landscape 5 x 67	60/44/44
50/64/20	landscape 6 x 75	82/53/53

**Ex-Cell Range**

Size	Max. terminal capacity (2.5 mm <sup>2</sup> )	Max. entry guide (M16) Top-Bottom/ Left/Right
23/15/13	1 x 21	6/6/6
26/26/15	1 x 27	21/11/11
30/20/15	1 x 36	15/15/15
30/30/15	2 x 36	26/15/15
30/30/20	2 x 36	34/28/34
40/30/15	2 x 56	26/26/26
40/30/20	2 x 56	34/34/34
40/40/15	3 x 56	35/26/26
40/40/20	3 x 56	44/34/34
40/50/15	4 x 56	48/26/26
40/50/20	4 x 56	62/34/34
50/40/15	3 x 77	35/35/35
50/40/20	3 x 77	44/44/44
50/50/15	4 x 77	48/35/35
50/50/20	4 x 77	62/44/44
50/60/20	6 x 77	78/44/44
60/40/15	3 x 97	35/48/48
60/40/20	3 x 97	44/62/62
60/50/15	4 x 97	48/48/48
60/50/20	4 x 97	62/62/62
60/60/15	6 x 97	59/48/48
60/60/20	6 x 97	78/62/62
60/76/20	7 x 97	100/62/62
76/50/20	4 x 128	62/78/78
76/60/20	6 x 128	78/78/78
76/76/20	7 x 128	100/78/78

**S-TB Range**

Size	Max. terminal capacity (2.5 mm <sup>2</sup> )	Max. entry guide (M16) Top-Bottom/ Left/Right
12/12/08	1 x 8	7/7/4
15/12/08	1 x 13	7/9/6
15/15/09	1 x 13	9/9/6
19/15/09	1 x 21	9/12/8
19/19/10	1 x 21	18/18/14
25/25/12	2 x 31	32/32/26
16/38/12	1 x 55	50/20/44
25/40/13	3 x 31	54/32/48
38/38/22	3 x 42	100/100/88
40/60/22	3 x 46	164/108/92
60/40/22	5 x 79	108/164/152

**GHG 74.2 Range**

Size	Max. terminal capacity (2.5 mm <sup>2</sup> )
744 21	40
745 22	82
746 23	188
749 24	296

# EX - TERMINAL ENCLOSURES

## Stainless Steel Version for Zone 1, 2, 21 and 22

2

The N-TB enclosure has been specifically designed for installation in locations with aggressively hostile environmental conditions. These include such locations as petrochemical hazardous areas, pharmaceutical, food process and utility applications.

Manufactured from high quality stainless steel that is electro-polished for a highly corrosion resistant "Chromium enriched" surface.

This multi certified enclosure is available in different sizes and depths, each with the facility for many configuration possibilities for a multitude of applications.

Using the highest quality materials, unique design benefits and precision manufacturing the N-TB range is the benchmark in heavy-duty gauge enclosures of its class.

An integral drainage channel prevents liquids or other solids contaminants from running in or falling into the enclosure when the door is opened, and to minimise gasket path contamination.

The high integrity „one piece“ sealing gasket for superior ingress protection (IP) of 66 and excellent recovery and re-sealing properties for continuous environmental protection.

There is an option for the mounting of up to four 3 mm thick gland-plates on each side in 4 possible combinations of 1, 2, 3 or 4 gland-plates. All units are sealed to IP66 by a high integrity Silicon gasket and secured by stainless steel bolts into blind inserts.

- **316L Stainless Steel (1.4404 to EN 10088)**  
Superior "corrosion resistant" electro chemically polished
- high integrity „one piece“ silicon gasket
- Detachable hinged door, stainless steel hinges with captive stainless steel hex screws
- 4 x external welded lugs,  
11 mm Ø holes / slots
- Optional Gland Plate / Entries 3 mm thick
- Extended ambient temperatures  
-40 °C to + 55 °C as option
- Certification TR-CU, AEx, cULus and Germanischer Lloyd on request

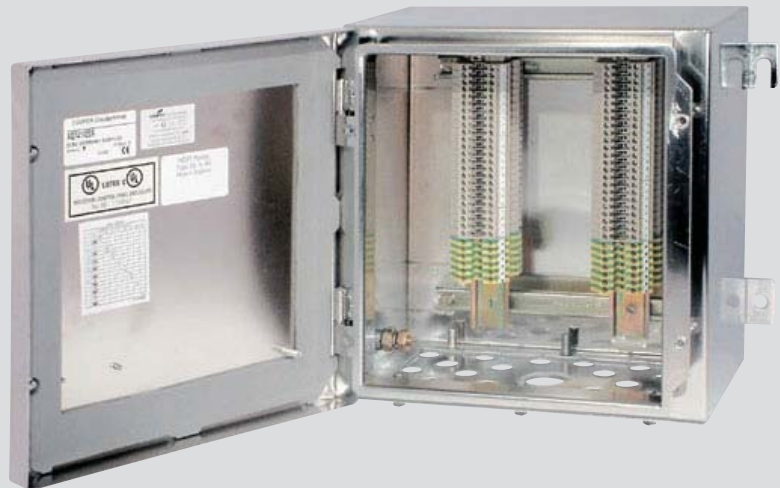



**Technical data**

**Ex-e terminal enclosures N-TB**

Marking accd. to 94/9/EC	⊕ II 2 G Ex e IIC Gb / ⊕ II 2 D Ex tb IIIC Db
Temperature class	T6 up to +40 °C / T5 up to +55 °C
EC-Type Examination Certificate	BVS 13 ATEX E 014U
Application temperature	-40 °C to +55 °C <sup>1)</sup>
IECEX Certificate of Conformity	IECEX BVS 13.0026U
Marking accd. to IECEx	Ex e II Gb Ex tb IIIC Db
Rated voltage	up to 1100 V <sup>1)</sup>
Rated current	up to 500 A <sup>1)</sup>
Connecting terminals	up to 240 mm <sup>2</sup> <sup>1)</sup>
Protection class	I
Degree of protection accd. to EN 60529	IP66
Cable glands/gland plates/enclosure drilling	up to 4 side optional gland plate (3 mm) combination with entries to meet requirements
Type of mounting	4 x 3 mm welded lugs with Ø 11 mm holes/slots horizontal
Enclosure material	Stainless steel 316 L electro chemically polished or sheet steel polyester powder coated (RAL 7032)
Material thickness	1.5 mm, 2 mm (- 62/45/20 and over)
Components mounting	4 x stand of pillars Ø 9 mm, 25 mm height, thread M6 x 10, for rail or mounting plate
Enclosure earth	M10 external/internal stainless steel earth stud assembly M6 internal stud on lid & painted gland plates
Gasket material	Silicone gasket

<sup>1)</sup> depending on type of terminal and Ex-components used

Additional Approvals:

cULUs Type 3S, 4, 4 x approval suitable for

Class I, Div 2 applications, Class I Zone 1, AExe II T6 (limited range available),

TR-CU, Germanischer Lloyd

**Dimension drawing**

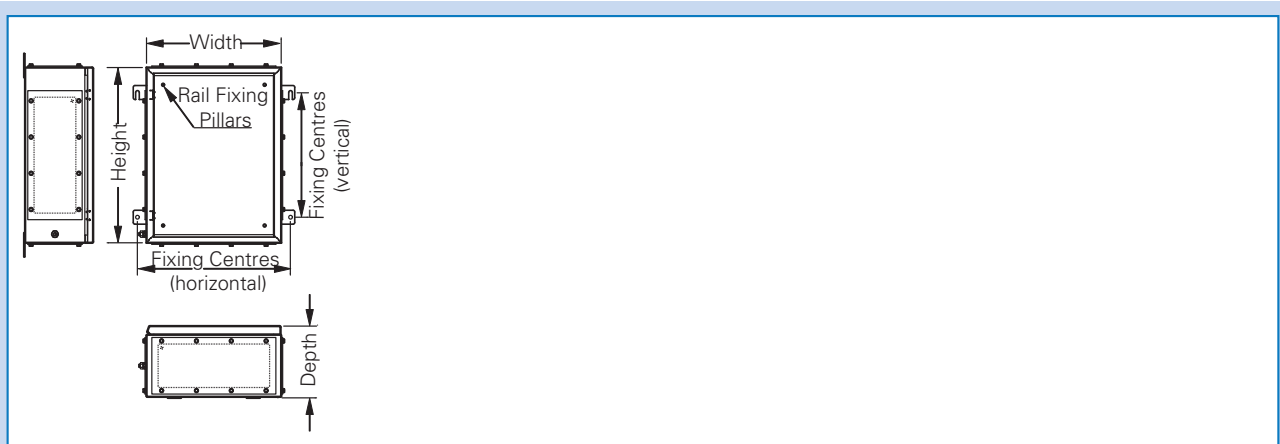

Dimensions in mm

## Ex-e terminal enclosures



N-TB

2

### Ordering details N-TB up to 2 x 51 terminals

N-TB	Dimensions <sup>2)</sup> H x W x D in mm	Fixing Centres <sup>2)</sup> B <sub>vertical</sub> x B <sub>horizontal</sub>	Weight in kg (empty enclosure)	Terminal mounting rail				Terminal content			
				Rail fixing centres		Rail length		Row orientation vertical (thickness in mm)			
Type				vert.	horiz.	vert.	horiz.	2.5 (5)	4 (6)	6 (8)	10 (10)
<b>Enclosure dimensions and terminal content</b>											
N-TB 1	229x152x130	152x208 <sup>3)</sup>	3.25	129	52	149	72	1x21	1x17	1x13	1x10
N-TB 2	260x260x160	170x316	5.50	160	160	180	180	2x27	2x23	1x17	1x13
N-TB 3	260x260x205	170x316	5.50	160	160	180	180	2x27	2x23	1x17	1x13
N-TB 4	306x306x160	203x361 <sup>3)</sup>	7.00	206	260	226	226	2x36	2x30	2x23	2x18
N-TB 5	306x306x205	203x361 <sup>3)</sup>	7.00	206	206	226	226	2x36	2x30	2x23	2x18
N-TB 6	380x260x205	250x316	7.00	280	180	300	160	2x51	2x43	1x32	1x25
N-TB 7	458x382x160	305x437 <sup>3)</sup>	9.75	358	282	378	302	2x67	2x56	2x42	2x33

N-TB	Available glanding area			Max. entry guide (metric)						Order No. <sup>4)</sup>	
	Top & bottom	left	right	Top & bottom / left / right							
Size	(with gland plates fitted) in mm			M16	M20	M25	M32	M40	M50	M63	
<b>Gland entry detail</b>											
N-TB 1	58x108	58x108	58x108	6/6/6	3/3/3	2/2/2	1/1/1	-	-	-	NXTS12215130
N-TB 2	214x 80	114x 80	114x 80	20/9/9	10/6/6	6/3/2	3/2/3	3/1/1	2/1/1	-	NXTS12626160
N-TB 3	214x124	114x124	114x124	28/18/18	15/9/9	12/5/5	6/4/4	5/2/2	2/1/1	2/1/1	NXTS12626200
N-TB 4	261x 80	214x 80	261x 80	26/20/26	14/10/14	8/6/8	4/3/4	3/3/3	3/2/3	-	NXTS13030160
N-TB 5	261x124	214x124	261x124	34/28/34	20/15/20	15/12/15	8/6/8	6/5/6	3/2/3	2/2/2	NXTS13030200
N-TB 6	214x124	214x124	214x124	28/28/28	15/15/15	12/12/12	6/6/6	5/5/5	2/2/2	2/2/2	NXTS13826200
N-TB 7	337x 80	337x 80	337x 80	29/29/29	18/18/18	10/10/10	6/6/6	5/5/5	4/4/4	-	NXTS14538160

#### Options

with 1 gland plate	NXT S1 XXYYZZ 1	with 2 gland plate	NXT S1 XXYYZZ 2
with 3 gland plate	NXT S1 XXYYZZ 3	with 4 gland plate	NXT S1 XXYYZZ 4
		Permanent Padlock HASP Facility (Factory Fitted ONLY)	NXT NN XXYYZZ0-HASP

Type	Order No.
<b>Example</b>	
N-TB 4 with 3 gland plates, painted and padlock HASP facility	NXTS13030163-HASP

**Note:** 1. The information provided is based on the physical constraints of the enclosure. Please refer to the certificate for hazardous area applications.

2. Dimension drawing see page 2.2.41

3. <sup>3)</sup> Subtract 30 mm when no side gland plates

4. Refer to „OPTIONS“ for ordering key





N-TB

Ordering details N-TB up to 6 x 171 terminals

N-TB	Dimensions <sup>2)</sup> H x W x D in mm	Fixing Centres <sup>2)</sup> B <sub>vertical</sub> x B <sub>horizontal</sub>	Weight in kg (empty enclosure)	Terminal rail				Terminal content			
				Rail fixing centres		Rail length		Row orientation vertical (thickness in mm)			
Size				vert.	horiz.	vert.	horiz.	2.5 (5)	4 (6)	6 (8)	10 (10)
<b>Enclosure dimensions and terminal content</b>											
N-TB 8	380x380x230	250x435	8.10	280	280	300	300	2x 51	2x 43	2x32	2x25
N-TB 9	458x382x205	305x437 <sup>3)</sup>	9.75	358	282	378	302	2x 67	2x 56	2x42	2x33
N-TB 10	480x480x205	327x535 <sup>3)</sup>	10.40	380	380	400	400	3x 71	3x 59	3x44	3x35
N-TB 11	620x450x205	450x506	17.00	520	350	540	370	4x 99	3x 83	3x62	3x49
N-TB 12	762x508x205	508x564 <sup>3)</sup>	23.50	662	408	682	428	3x128	3x106	3x80	3x64
N-TB 13	740x550x205	540x606	30.40	640	450	660	470	5x124	4x103	4x77	4x61
N-TB 14	860x640x205	570x696	29.00	760	540	780	560	6x147	5x123	5x 92	4x73
N-TB 15	980x740x205	700x796	38.00	880	640	900	660	6x171	6x143	5x107	5x85

N-TB	Available glanding area			Max. entry guide (metric)						Order No. <sup>4)</sup>	
	Top & bottom	left	right	Top & bottom / left / right							
Type	(with gland plates fitted) in mm			M16	M20	M25	M32	M40	M50	M63	
<b>Gland entry detail</b>											
N-TB 8	324x150	335x150	335x150	35/35/35	23/23/23	15/15/15	9/9/9/	7/7/7	5/5/5/	2/2/2	NXTS13838230
N-TB 9	337x124	337x124	337x124	46/46/46	26/26/26	21/21/21	11/11/11	9/9/9	4/4/4	3/3/3	NXTS14538200
N-TB 10	404x124	337x124	404x124	53/46/53	30/26/30	24/21/24	14/11/14	11/9/11	5/4/5	4/3/4	NXTS14848200
N-TB 11	404x124	404x124	404x124	53/53/53	30/30/30	24/24/24	14/14/14	11/11/11	5/5/5	4/4/4	NXTS16245200
N-TB 12	404x124	594x124	594x124	53/82/82	30/47/47	24/39/39	14/20/20	11/17/17	5/7/7	4/6/6	NXTS17650200
N-TB 13	504x124	504x124	504x124	60/60/60	39/39/39	30/30/30	18/18/18	13/13/13	6/6/6	5/5/5	NXTS17455200
N-TB 14	594x124	2x (304x124)	2x (304x124)	82/80/80	47/48/48	39/36/36	20/20/20	17/14/14	7/8/8	6/6/6	NXTS18664200
N-TB 15	2x (304x124)	2x (404x124)	2x (404x124)	80/106/106	48/60/60	36/48/48	20/28/28	14/22/22	8/10/10	6/8/8	NXTS19874200

Options

with 1 gland plate	NXT S1 XXYZZ 1	with 2 gland plate	NXT S1 XXYZZ 2
with 3 gland plate	NXT S1 XXYZZ 3	with 4 gland plate	NXT S1 XXYZZ 4
		Permanent Padlock HASP Facility (Factory Fitted ONLY)	NXT NN XXYZZ0-HASP

Type	Order No.
Example	
N-TB 11 with 3 gland plate, 316L SS and Padlock HASP Facility	NXTS162445203-HASP

- Note:** 1. The information provided is based on the physical constraints of the enclosure. Please refer to the certificate for hazardous area applications.  
 2. Dimension drawing see page 2.2.41  
 3. <sup>3)</sup> Subtract 30 mm when no side gland plates  
 4. Refer to „OPTIONS“ for ordering key

# EX - TERMINAL ENCLOSURES

**Ex-Cell**      **Stainless Steel Version for Zone 1, 2, 21 and 22**

2 The Ex-Cell enclosure range is an ATEX certified enclosure / termination solution for category 2 (Zone1) application with an ingress protection of IP66. Ex-Cell is available in a comprehensive range of sizes, each with the facility for various configuration possibilities for a multitude of applications. Using the highest quality materials, some unique design benefits and precision manufacturing, the Ex-Cell range is the benchmark in enclosure for both instrumentation and electrical applications.

The Ex-Cell product line is designed and ATEX certified for hazardous areas, UL-approved for heavy industrial applications and are predominantly used in the petrochemical, pharmaceutical, food process and utilities market sectors. As a result of this, our enclosures have the inherent benefits of a high degree of ingress protection (IP) to environmental characteristics such as ingress of water and dust. The ingress protection (IP) of the complete product line is IP66 (water & dust) along with an impact resistance of a minimum of 7 Nm, making them ideal for wash-down and heavy duty applications.

The Ex-Cell-I series is made for instrumentation with easy access central locking system and hinged cover.

The 1/4 turn embossed latch or bolt down fastening provides rapid means of achieving high integrity ingress protection (IP) of 66 environmental seal for reliable, rapid environmental protection.

There is an option for up to 3 gland plates (3 mm thick) on each side with possible combinations of 0, 1, 3 gland plates available. All units are sealed to IP66 by a high integrity chloroprene gasket and secured by rapid fixing "Hytork" fixing bolts.

An integral drainage channel prevents liquids or other solids contaminates from running in or falling into the enclosure when the door is opened, and to minimise gasket path contamination.

- **Stainless steel 316 L options and 304**
- **Safety standard IP66**
- **Hinges and central locking device for easy access**
- **Extended ambient temperatures up to +60 °C on request**
- **External and internal earthing bolts**



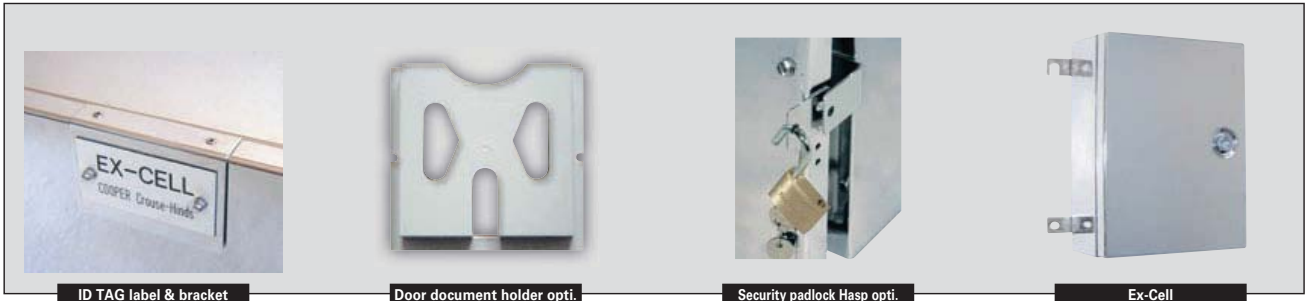

2

Technical data

Type Ex-Cell

Marking accd. to 94/9/EC	⊕ II 2 G Ex e II / ⊕ II 2 D Ex tD A21 IP66
Temperature class	T6 up to +40 °C / T5 up to +55 °C
EC-Type Examination Certificate	PTB 02 ATEX 1021 U
Application temperature	-20 °C to +40 °C -55 °C to +55 °C (option: closed cell expanded Silicone gasket)
Rated voltage	up to 750 V <sup>1)</sup>
Rated current	up to 500 A <sup>1)</sup>
Connecting terminals	up to 240 mm <sup>2</sup> <sup>1)</sup>
Protection class	I
Degree of protection accd. to EN 60529	IP66
Cable glands/gland plates/enclosure drilling	up to 4 side optional gland plate combination with entries to meet requirements
Type of mounting	4 x 3 mm welded lugs with Ø 11 mm holes/slots, vertical or horizontal
Enclosure material	Stainless steel 316 L or 304 electro chemically polished or sheet steel polyester powder coated (RAL 7032)
Material thickness	1.2 mm (body), 1.5 mm (door)
Components mounting	4 x stand of pillars Ø 9 mm, 25 mm height, thread M6 x 10, for rail or mounting plate
Enclosure earth	M10 external and internal brass earth stud assembly
Gasket material	PUR, Chloroprene gasket (option), closed cell expanded Silicone gasket (option)

<sup>1)</sup> depending on type of terminal and Ex-components used

cUL<sub>us</sub> Typen 3S, 4, 4 x approval, Germanischer Lloyd available on request.

Dimension drawing

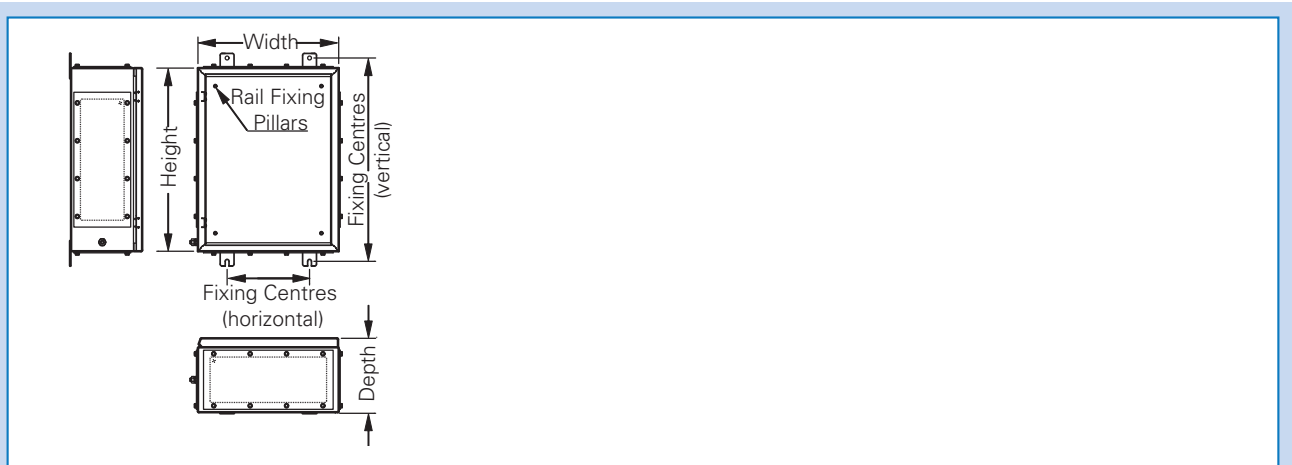

Dimensions in mm



## Ex-e/Ex-i terminal box



Fastening



Bolt fastening

2

### Ordering details Ex-Cell up to 2 x 56 terminals

316L SS- 90° Fastening Size	Dimensions <sup>2)</sup> H x W x D in mm	Fixing Centres <sup>2)</sup> vertical x horizontal	Weight in kg (empty enclosure)	Terminal rail				Terminal content				
				Rail fixing		Rail length		Row orientation vertical				
				centres		centres		2.5 mm <sup>2</sup>	4 mm <sup>2</sup>	6 mm <sup>2</sup>	10 mm <sup>2</sup>	16 mm <sup>2</sup>

#### Enclosure dimensions and terminal content

Size	Dimensions	Fixing Centres	Weight	Terminal rail				Terminal content				
				Rail fixing		Rail length		Row orientation vertical				
				vert.	horiz.	vert.	horiz.	2.5 mm <sup>2</sup>	4 mm <sup>2</sup>	6 mm <sup>2</sup>	10 mm <sup>2</sup>	16 mm <sup>2</sup>
23/15/13	229x152x127	152x208	2.35	129	52	149	72	1x21	1x17	1x13	1x10	1x 9
26/26/15	260x260x152	170x316	2.8	160	160	180	180	2x27	2x23	1x17	1x13	1x11
30/20/15	305x203x152	203x259	3.4	205	103	225	123	1x36	1x30	1x23	1x18	1x15
30/30/15	305x305x152	203x361	4.6	205	205	225	225	2x36	2x30	2x23	2x18	2x15
30/30/20	305x305x203	203x361	5.8	205	205	225	225	2x36	2x30	2x23	2x18	2x15
40/30/15	406x305x152	267x361	5.7	306	205	326	225	2x56	2x47	2x35	2x28	2x23
40/30/20	406x305x203	267x361	6.6	306	205	326	225	2x56	2x47	2x35	2x28	2x23

316L SS - 90° Fastening Size	Available glanding area			Max. entry guide (metric)						Order No. <sup>3)</sup>	
	Top & bottom	left	right	Top & bottom / left / right							
	(with gland plates fitted) in mm			M16	M20	M25	M32	M40	M50	M63	

#### Gland entry detail

Size	Top & bottom	left	right	M16	M20	M25	M32	M40	M50	M63	Order No.
23/15/13	108x 58	108x 58	108x 58	6/6/6	2/2/2	2/2/2	1/1/1	-	-	-	XLHS12315130
26/26/15	214x 80	114x 80	114x 80	21/11/11	10/5/5	4/2/2	3/2/2	3/1/1	2/1/1	-	XLHS12626150
30/20/15	156x 80	156x 80	156x 80	15/15/15	7/7/7	3/3/3	2/2/2	2/2/2	2/2/2	-	XLHS13020150
30/30/15	261x 80	156x 80	156x 80	26/15/15	13/7/7	5/3/3	4/2/2	3/2/2	3/2/2	-	XLHS13030150
30/30/20	261x124	214x124	261x124	34/28/34	18/15/18	15/12/15	8/6/8	6/5/6	3/2/3	2/2/2	XLHS13030200
40/30/15	261x 80	261x 80	261x 80	26/26/26	13/13/13	5/5/5	4/4/4	3/3/3	3/3/3	-	XLHS14030150
40/30/20	261x124	261x124	261x124	34/34/34	18/18/18	15/15/15	8/8/8	6/6/6	3/3/3	2/2/2	XLHS14030200

#### Options

with 1 gland plate	XLH <b>S1</b> XXYZZ <b>1</b>	with 3 gland plate	XLH <b>S1</b> XXYZZ <b>3</b>
Ex-Cell 316L SS - bolt fastening	XLH <b>S1</b> XXYZZ0- <b>B</b>	Ex-Cell 304 SS - 1/4 Fastening	XLH <b>S2</b> XXYZZ <b>0</b>
Ex-Cell 304 SS - bolt fastening	XLH <b>S2</b> XXYZZ0- <b>B</b>	Ex-Cell Painted - 1/4 Fastening	XLH <b>PS</b> XXYZZ <b>0</b>
Ex-Cell Painted - bolt fastening	XLH <b>PS</b> XXYZZ0- <b>B</b>	Permanent Padlock HASP Facility (Factory Fitted ONLY)	XLH NN XXYZZ0- <b>HASP</b>

Type	Order No.
Example	
30/20/15 with 3 gland plate, painted with bolt fastening and Permanent Padlock HASP Facility	<b>XLHPS 3020153-B-HASP</b>

**Note:** 1. The information provided is based on the physical constraints of the enclosure. Please refer to the certificate for hazardous area applications.

2. Dimension drawing see page 2.2.45

3. Refer to „OPTIONS“ for ordering key



Ex-Cell 40/50/15

2

Ordering details Ex-Cell up to 3 x 77 terminals

316L SS- 90° Fastening Size	Dimensions <sup>2)</sup> H x W x D in mm	Rail fixing centres <sup>2)</sup> vertical x horizontal	Weight in kg (empty enclosure)	Terminal rail				Terminal content				
				Rail fixing centres		Rail length		Row orientation vertical				
				vert.	horiz.	vert.	horiz.	2.5 mm <sup>2</sup>	4 mm <sup>2</sup>	6 mm <sup>2</sup>	10 mm <sup>2</sup>	16 mm <sup>2</sup>
<b>Enclosure dimensions and terminal content</b>												
40/40/15	406x406x152	267x462	7.1	306	306	326	326	3x56	3x47	3x35	3x28	3x23
40/40/20	406x406x203	267x462	8.1	306	306	326	326	3x56	3x47	3x35	3x28	3x23
40/50/15	406x508x152	267x564	8.5	306	408	326	428	4x56	4x47	4x35	4x28	4x23
40/50/20	406x508x203	267x564	9.7	306	408	326	428	4x56	4x47	4x35	4x28	4x23
50/40/15	508x406x152	354x462	8.5	408	306	428	326	3x77	3x64	3x48	3x38	3x32
50/40/20	508x406x203	354x462	9.7	408	306	428	326	3x77	3x64	3x48	3x38	3x32

316L SS - 90° Fastening Size	Available glanding area			Max. entry guide (metric)						Order No. <sup>3)</sup>	
	Top & bottom	left	right	Top & bottom / left / right							
	(with gland plates fitted) in mm			M16	M20	M25	M32	M40	M50	M63	
<b>Gland entry detail</b>											
40/40/15	337x 80	261x 80	261x 80	35/26/26	17/13/13	7/5/5	6/4/4	5/3/3	4/3/3	-	XLHS14040150
40/40/20	334x124	261x124	261x124	44/34/34	26/18/18	21/15/15	11/8/8	9/6/6	4/3/3	3/2/2	XLHS14040200
40/50/15	464x 80	261x 80	261x 80	48/26/26	24/13/13	10/5/5	8/4/4	7/3/3	6/3/3	-	XLHS14050150
40/50/20	460x124	261x124	261x124	62/34/34	35/18/18	29/15/15	15/8/8	13/6/6	5/3/3	4/2/2	XLHS14050200
50/40/15	337x 80	337x 80	337x 80	35/35/35	17/17/17	7/7/7	6/6/6	5/5/5	4/4/4	-	XLHS15040150
50/40/20	334x124	334x124	334x124	44/44/44	26/26/26	21/21/21	11/11/11	9/9/9	4/4/4	3/3/3	XLHS15040200

Options			
with 1 gland plate	XLH <b>S1</b> XXYYZZ <b>1</b>	with 3 gland plate	XLH <b>S1</b> XXYYZZ <b>3</b>
Ex-Cell 316L SS - bolt fastening	XLH <b>S1</b> XXYYZZ0- <b>B</b>	Ex-Cell 304 SS - 1/4 Fastening	XLH <b>S2</b> XXYYZZ <b>0</b>
Ex-Cell 304 SS - bolt fastening	XLH <b>S2</b> XXYYZZ0- <b>B</b>	Ex-Cell Painted - 1/4 Fastening	XLH <b>PS</b> XXYYZZ <b>0</b>
Ex-Cell Painted - bolt fastening	XLH <b>PS</b> XXYYZZ0- <b>B</b>	Permanent Padlock HASP Facility (Factory Fitted ONLY)	XLH <b>NN</b> XXYYZZ0- <b>HASP</b>

Type	Order No.
Example	
40/50/20 with 1 gland plates, 316L SS with bolt fastening and Permanent Padlock HASP Facility	XLHS14050201-B-HASP

- Note:** 1. The information provided is based on the physical constraints of the enclosure. Please refer to the certificate for hazardous area applications.  
 2. Dimension drawing see page 2.2.45  
 3. Refer to „OPTIONS“ for ordering key

## Ex-e/Ex-i terminal box



Ex-Cell

2

### Ordering details Ex-Cell up to 4 x 97 terminals

316L SS- 90° Fastening Size	Dimensions <sup>2)</sup> H x W x D in mm	Rail fixing centres <sup>2)</sup>		Weight in kg (empty enclosure)	Terminal rail				Terminal content				
		vertical x horizontal			Rail fixing centres		Rail length		Row orientation vertical				
					vert.	horiz.	vert.	horiz.	2.5 mm <sup>2</sup>	4 mm <sup>2</sup>	6 mm <sup>2</sup>	10 mm <sup>2</sup>	16 mm <sup>2</sup>
<b>Enclosure dimensions and terminal content</b>													
50/50/15	508x508x152	354x564		10.2	408	408	428	428	4x77	4x64	4x 48	4x38	4x32
50/50/20	508x508x203	354x564		11.4	408	408	428	428	4x77	4x64	4x 48	4x38	4x32
50/60/20	508x610x203	354x666		13.2	408	510	428	530	6x77	6x64	6x 48	6x38	6x32
60/40/15	610x406x152	445x462		9.9	510	306	530	326	3x97	3x81	3x61	3x49	3x40
60/40/20	610x406x203	445x462		11.2	510	306	530	326	3x97	3x81	3x61	3x49	3x40
60/50/15	610x508x152	445x564		11.8	510	408	530	428	4x97	4x81	4x61	4x49	4x40
60/50/20	610x508x203	445x564		13.2	510	408	530	428	4x97	4x81	4x61	4x49	4x40

316L SS - 90° Fastening Size	Available glanding area			Max. entry guide (metric)						Order No. <sup>3)</sup>	
	Top & bottom	left	right	Top & bottom / left / right							
	(with gland plates fitted) in mm			M16	M20	M25	M32	M40	M50	M63	
<b>Gland entry detail</b>											
50/50/15	464x 80	337x 80	337x 80	48/35/35	24/17/17	10/7/7	8/6/6	7/5/5	6/4/4	-	<b>XLHS15050150</b>
50/50/20	460x124	334x124	334x124	62/44/44	35/26/26	29/21/21	15/11/11	13/9/9	5/4/4	4/3/3	<b>XLHS15050200</b>
50/60/20	562x124	334x124	334x124	78/44/44	44/26/26	36/21/21	19/11/11	16/9/9	7/4/4	5/3/3	<b>XLHS15060200</b>
60/40/15	337x 80	464x 80	464x 80	35/48/48	17/24/24	7/10/10	6/8/8	5/7/7	4/6/6	-	<b>XLHS16040150</b>
60/40/20	334x124	460x124	460x124	44/62/62	26/35/35	21/29/29	11/15/15	9/13/13	4/5/5	3/4/4	<b>XLHS16040200</b>
60/50/15	464x 80	464x 80	464x 80	48/48/48	24/24/24	10/10/10	8/8/8	7/7/7	6/6/6	-	<b>XLHS16050150</b>
60/50/20	460x124	460x124	460x124	62/62/62	35/35/35	29/29/29	15/15/15	13/13/13	5/5/5	4/4/4	<b>XLHS16050200</b>

Options			
with 1 gland plate	XLH <b>S1</b> XXYZZ <b>1</b>	with 3 gland plate	XLH <b>S1</b> XXYZZ <b>3</b>
Ex-Cell 316L SS - bolt fastening	XLH <b>S1</b> XXYZZ0- <b>B</b>	Ex-Cell 304 SS - 1/4 Fastening	XLH <b>S2</b> XXYZZ <b>0</b>
Ex-Cell 304 SS - bolt fastening	XLH <b>S2</b> XXYZZ0- <b>B</b>	Ex-Cell Painted - 1/4 Fastening	XLH <b>PS</b> XXYZZ <b>0</b>
Ex-Cell Painted - bolt fastening	XLH <b>PS</b> XXYZZ0- <b>B</b>	Permanent Padlock HASP Facility (Factory Fitted ONLY)	XLH NN XXYZZ0- <b>HASP</b>

Type	Order No.
Example	
60/50/20 with 3 gland plate, painted 1/4 turn lock and Permanent Padlock HASP Facility	<b>XLHPS6050203-HASP</b>

- Note:** 1. The information provided is based on the physical constraints of the enclosure. Please refer to the certificate for hazardous area applications.  
 2. Dimension drawing see page 2.2.45  
 3. Refer to „OPTIONS“ for ordering key



2

Ex-Cell

Ordering details Ex-Cell up to 7 x 128 terminals

316L SS- 90° Fastening Size	Dimensions <sup>2)</sup> H x W x D in mm	Rail fixing centres <sup>2)</sup> vertical x horizontal	Weight in kg (empty enclosure)	Terminal rail				Terminal content							
				Rail fixing centres		Rail length		Row orientation vertical							
				vert.	horiz.	vert.	horiz.	2.5 mm <sup>2</sup>	4 mm <sup>2</sup>	6 mm <sup>2</sup>	10 mm <sup>2</sup>	16 mm <sup>2</sup>			
<b>Enclosure dimensions and terminal content</b>															
60/60/15	610x610x152	445x666	13.7	510	510	530	530	6x	97	6x	81	6x61	6x49	6x40	
60/60/20	610x610x203	445x666	15.3	510	510	530	530	6x	97	6x	81	6x61	6x49	6x40	
60/76/20	610x762x203	445x818	18.3	510	662	530	682	7x	97	7x	81	7x61	7x49	7x40	
76/50/20	762x508x203	508x564	15.9	662	408	682	428	4x	128	4x	106	4x80	4x64	4x53	
76/60/20	762x610x203	508x666	18.3	662	510	682	530	6x	128	6x	106	6x80	6x64	6x53	
76/76/20	762x762x203	508x818	21.9	662	662	682	682	7x	128	7x	106	7x80	7x64	7x53	

316L SS - 90° Fastening Size	Available glanding area			Max. entry guide (metric)								Order No. <sup>3)</sup>
	Top & bottom	left	right	Top & bottom / left / right								
	(with gland plates fitted) in mm			M16	M20	M25	M32	M40	M50	M63		
<b>Gland entry detail</b>												
60/60/15	562x 80	464x 80	464x 80	59/48/48	29/24/24	12/10/10	10/8/8	8/7/7	7/6/6	-	XLHS16060150	
60/60/20	562x124	460x124	460x124	78/62/62	44/35/35	36/29/29	19/15/15	16/13/13	7/5/5	5/4/4	XLHS16060200	
60/76/20	714x124	460x124	460x124	100/62/62	56/35/35	47/29/29	24/15/15	20/13/13	9/5/5	7/4/4	XLHS16076200	
76/50/20	460x124	562x124	562x124	62/78/78	35/44/44	29/36/36	15/19/19	13/16/16	5/7/7	4/5/5	XLHS17650200	
76/60/20	562x124	562x124	562x124	78/78/78	44/44/44	36/36/36	19/19/19	16/16/16	7/7/7	5/5/5	XLHS17660200	
76/76/20	714x124	562x124	562x124	100/78/78	56/44/44	47/36/36	24/19/19	20/16/16	9/7/7	7/5/5	XLHS17676200	

Options			
with 1 gland plate	XLH <b>S1</b> XXYYZZ <b>1</b>	with 3 gland plate	XLH <b>S1</b> XXYYZZ <b>3</b>
Ex-Cell 316L SS - bolt fastening	XLH <b>S1</b> XXYYZZ0- <b>B</b>	Ex-Cell 304 SS - 1/4 Fastening	XLH <b>S2</b> XXYYZZ <b>0</b>
Ex-Cell 304 SS - bolt fastening	XLH <b>S2</b> XXYYZZ0- <b>B</b>	Ex-Cell Painted - 1/4 Fastening	XLH <b>PS</b> XXYYZZ <b>0</b>
Ex-Cell Painted - bolt fastening	XLH <b>PS</b> XXYYZZ0- <b>B</b>	Permanent Padlock HASP Facility (Factory Fitted ONLY)	XLH <b>PS</b> XXYYZZ0- <b>HASP</b>

Type	Order No.
Example	
60/76/20 with 3 gland plate, 316 SS with bolt fastening and Permanent Padlock HASP Facility	XLHS16076203-B-HASP

- Note:** 1. The information provided is based on the physical constraints of the enclosure. Please refer to the certificate for hazardous area applications.  
 2. Dimension drawing see page 2.2.45  
 3. Refer to „OPTIONS“ for ordering key

# EX - TERMINAL ENCLOSURES

**Stainless Steel Version for Zone 1, 2, 21 and 22**

**S-TB**

2

The **ST-B** range is an “ATEX certified” terminal box solution available in various options of materials and finishes fully compliant with the impact, thermal and ingress requirements of EN 60079-0 ff. and EN 6124-0 ff. and is available in a comprehensive range of 12 different sizes. With for the possibilities many configuration for a multitude of applications. Using the highest quality materials, unique design benefits and precision manufacturing the **S-TB** range is the benchmark in heavy-duty gauge enclosures of its class.

**ST-B** has unique wrap-round lid cover design that wraps around the body of the enclosures eliminate ingress of both liquids and dusts such as sand. This design provides a significant advantage as the gasket sealing area is not exposed to the external environment, preventing contamination from ice formations and abrasion of sand storms. The lid cover is secured and sealed to IP66 by the retained stainless steel bolts around the outside of the enclosure, whilst being supported a floppy hinge that allow the lid cover to be removed.

The superior quality-one piece Chloroprene closed cell gasket material that maintains the enclosures high ingress protection integrity providing IP66. This material has a wide operating temperature range for the most hostile environments.

The body of the **ST-B** enclosure has a superior wide surface area gasket sealing area 10 mm wide compared to conventional enclosures that use a knife-edge seal, that is only the thickness of the material, typically only 1.5 mm.

- **316L Stainless Steel (1.4404 to EN 10088)**  
Superior “corrosion resistant” electro chemically polished.
- **Sheet Steel - Polyester powder coated to RAL 7032**
- **Foamed silicone gasket**
- **Safety standard IP66**
- **Extended ambient temperatures**  
-40 °C to +55 °C as option
- **Certification TR-CU, AEx, cULus and Germanischer Lloyd on request**

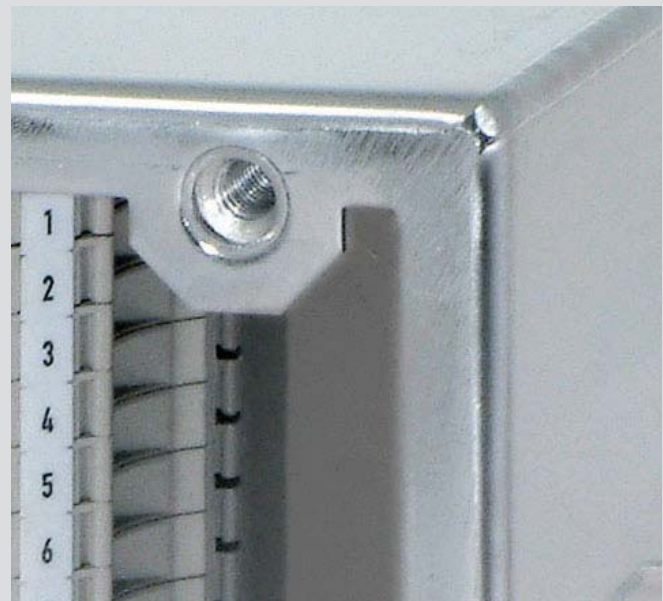
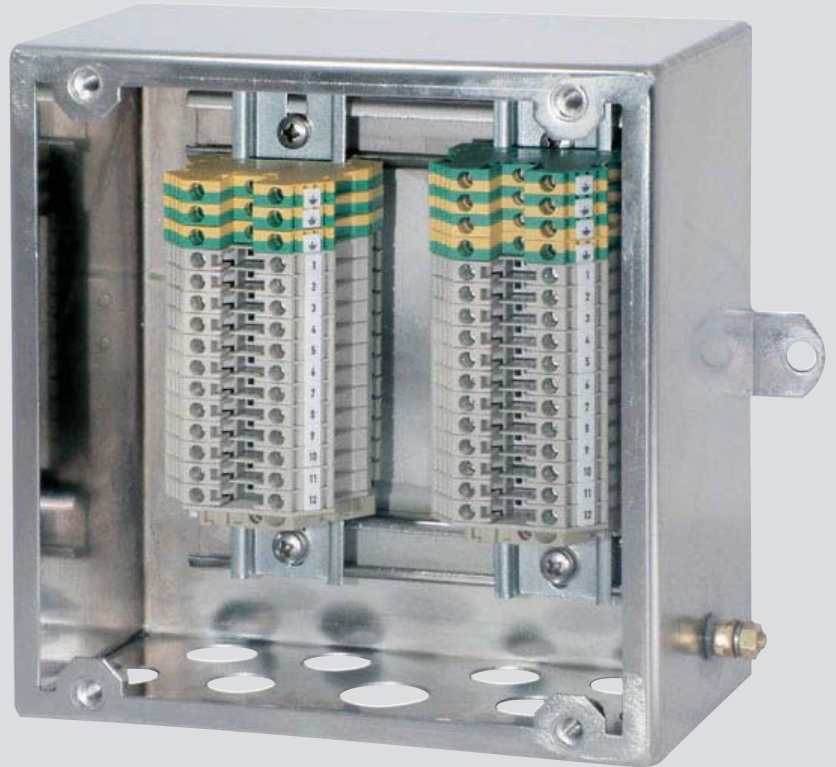





Technical data

Type S-TB terminal boxes

Marking accd. to 94/9/EC	II 2 G Ex e IIC Gb II 2 D Ex tb IIIC Db
Temperature class	T6 up to +40 °C / T5 up to +55 °C
EC-Type Examination Certificate	BVS 13 ATEX E 015 U
Application temperature	-30 °C to +40 °C -40 °C to +55 °C (option)
IECEX Certificate of Conformity	IECEX BVS 13.0025U
Marking accd. to IECEx	Ex e IIC Gb Ex tb IIIC Db
Rated voltage	up to 690 V*
Rated current	up to 500 A*
Connecting terminals	up to 240 mm <sup>2</sup> *
Protection class	I
Degree of protection accd. to EN 60529	IP66
Cable glands/gland plates/enclosure drilling	up to 4 side optional gland plate combination with entries to meet requirements (38/38/20 - 60/40/20) combination with entries to meet requirements
Type of mounting	S-TB 12/12/08 - 25/25/12 2 welded lugs with Ø 8 mm holes S-TB 16/38/12 - 25/40/13 4 welded lugs with Ø 8 mm holes S-TB 38/38/22 - 60/40/20 4 welded lugs with Ø 11 mm holes
Enclosure material	Stainless steel 316 L or 304
Material thickness	1.5 mm
Components mounting	12/12/08 - 25/40/13 internally welded TAS 20 rail for terminals mounting 38/38/20 - 60/40/20 4 x stand of pillars Ø 9 mm, 25 mm height, thread M6 x 10, for rail or mounting plate
Enclosure earth	12/12/08 - 25/40/13 M6 external/internal earth stud assembly 38/38/20 - 60/40/20 M10 external/internal earth stud assembly
Gasket material	Silikon-gasket

\* depending on type of terminal and Ex-components used

Additional certifications:

TR-CU and cUL<sub>US</sub> types 3S, 4, 4 x on request.

Dimension drawing

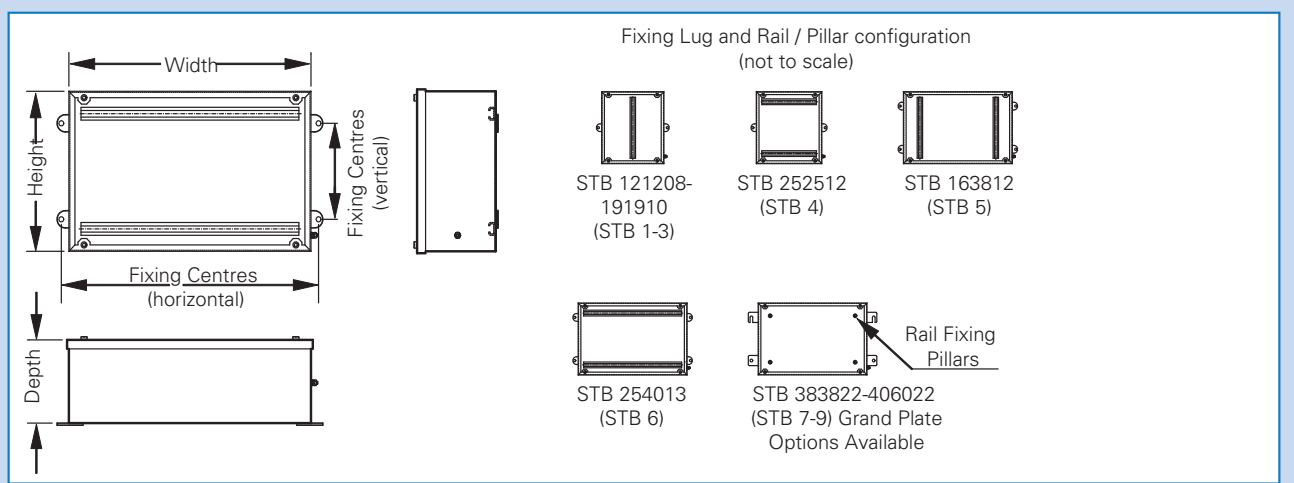

Dimensions in mm

## Ex-e terminal enclosures



S-TB



S-TB

2

### Ordering details S-TB up to 3 x 51 terminals

S-TB	Dimensions <sup>1)</sup> H x W x D in mm	Rail fixing centres <sup>1)</sup> vertical x horizontal	Weight in kg (empty enclosure)	Terminal rail				Terminal content			
				Rail fixing centres		Rail length		Row orientation vertical			
Size				vert.	horiz.	vert.	horiz.	2.5 (6)	4 (6.5)	6 (8)	10 (10)

#### Enclosure dimensions and terminal content

S-TB	Dimensions	Rail fixing centres	Weight	Terminal rail Rail fixing	Terminal rail Rail length	Terminal content
S-TB 1	120x120x 80	145x145	1.4	62	82	1x 8 1x 6 1x 5 1x 4
S-TB 2	150x150x 90	175x175	1.9	90	110	1x13 1x11 1x 8 1x 7
S-TB 3	190x190x100	215x215	3.0	130	150	1x21 1x18 1x13 1x10
S-TB 4	250x250x120	275x275	3.7	180	200	2x31 2x26 2x19 2x15
S-TB 5	160x380x130	80x405	3.7	300	320	1x55 1x46 1x34 1x28

S-TB	Available glanding area			Max. entry guide (metric)						Order No. <sup>4)</sup>
	Top & bottom	left	right	Top & bottom / left / right						
Size	(with gland plates fitted) in mm			M16	M20	M25	M32	M40	M50	M63

#### Gland entry detail

S-TB	114x 63	114x 63	70x 63	7/7/4	3/3/1	2/2/1	2/2/1	-	-	-	Order No.
S-TB 1	114x 63	114x 63	70x 63	7/7/4	3/3/1	2/2/1	2/2/1	-	-	-	STBS1121208
S-TB 2	144x 73	144x 73	100x 73	9/9/6	6/6/4	3/3/2	2/2/1	2/2/1	-	-	STBS1151509
S-TB 3	184x 83	184x 83	140x 83	18/18/14	8/8/6	7/7/5	3/3/2	2/2/2	2/2/1	-	STBS1191910
S-TB 4	244x103	244x103	200x103	32/32/26	18/18/14	10/10/8	7/7/6	3/3/3	3/3/2	2/2/2	STBS1252512
S-TB 5	372x103	154x103	330x103	50/20/44	29/11/24	15/6/14	12/4/10	5/2/5	4/1/4	3/1/3	STBS1254013

#### Options

S-TB with gland 1 plate <sup>3)</sup>	STB <u>S</u> 1XXYYZZ <u>1</u>	S-TB with additional UL CERT	STB <u>S</u> 1XXYYZZ <u>UL</u>
S-TB with gland 3 plate <sup>3)</sup>	STB <u>S</u> 1XXYYZZ <u>3</u>		

Type	Order No.
Example	
S-TB 2 with 3 gland plate and UL-certification	STBS1151509-UL

The information provided is based on the physical constraints of the enclosure. Please refer to the certificate for hazardous area applications.

**Note:** 1. Dimension drawing see page 2.2.51

3. Only this types includes UL-Certification and can be ordered with 1 or 3 gland plates

4. Refer to „OPTIONS“ for ordering key



S-TB

2

Ordering details S-TB up to 5 x 79 terminals

S-TB	Dimensions <sup>1)</sup> H x W x D in mm	Rail fixing centres <sup>1)</sup> vertical x horizontal	Weight in kg (empty enclosure)	Terminal rail				Terminal content			
				Rail fixing centres		Rail length		Row orientation vertical			
Size				vert.	horiz.	vert.	horiz.	2.5 (6)	4 (6.5)	6 (8)	10 (10)
<b>Enclosure dimensions and terminal content</b>											
S-TB 6	250x400x130	150x425	5.4	180	200	3x31	3x26	3x19	3x15		
S-TB 7 <sup>2)</sup>	380x380x220	250x435	8.5	280	300	3x42	3x39	3x32	3x25		
S-TB 8	480x480x200	340x535	10.5	380	400	4x61	4x56	4x46	4x36		
S-TB 9 <sup>2)</sup>	600x400x220	464x456	13.0	500	520	5x79	5x73	5x59	5x47		

S-TB	Available glanding area			Max. entry guide (metric)							Order No. <sup>3)</sup>
	Top & bottom	left	right	Top & bottom / left / right							
Type	(with gland plates fitted) in mm			M16	M20	M25	M32	M40	M50	M63	
<b>Gland entry detail</b>											
S-TB 6	394x113	244x113	350x113	54/32/48	30/18/26	16/10/14	13/7/11	6/3/5	5/3/4	4/2/3	STBS12540200
S-TB 7 <sup>2)</sup>	374x203	374x203	324x203	100/100/88	57/57/48	40/40/33	24/24/20	15/15/12	8/8/7	6/6/5	STBS13838220
S-TB 8	474x183	474x183	474x183	124/124/118	78/78/74	54/54/50	30/30/28	20/20/18	11/11/9	10/10/8	STBS14848200
S-TB 9 <sup>2)</sup>	337x124	337x124	337x124	108/164/152	60/93/84	40/65/60	26/40/38	17/26/23	9/14/13	7/11/10	STBS16040220

Options	
S-TB with gland 1 plate <sup>2)</sup>	STB <u>S</u> 1XXYYZZ <u>1</u>
S-TB with gland 3 plate <sup>2)</sup>	STB <u>S</u> 1XXYYZZ <u>3</u>
S-TB with additional UL CERT	STB <u>S</u> 1XXYYZZ <u>UL</u>
Type	Order No.
<b>Example</b>	
S-TB 7 316L SS with 3 gland plate incl. UL-certification	STBS13838223

The information provided is based on the physical constraints of the enclosure. Please refer to the certificate for hazardous area applications.

- Note:**
1. Dimension drawing see page 2.2.51
  2. Only this types includes UL-Certification and can be ordered with 1 or 3 gland plates
  3. Refer to „OPTIONS“ for ordering key