

GboX junction and terminal enclosures

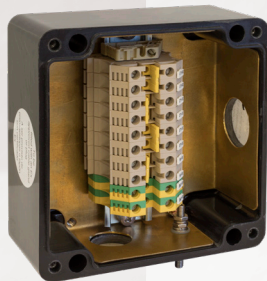

EATON

Powering Business Worldwide

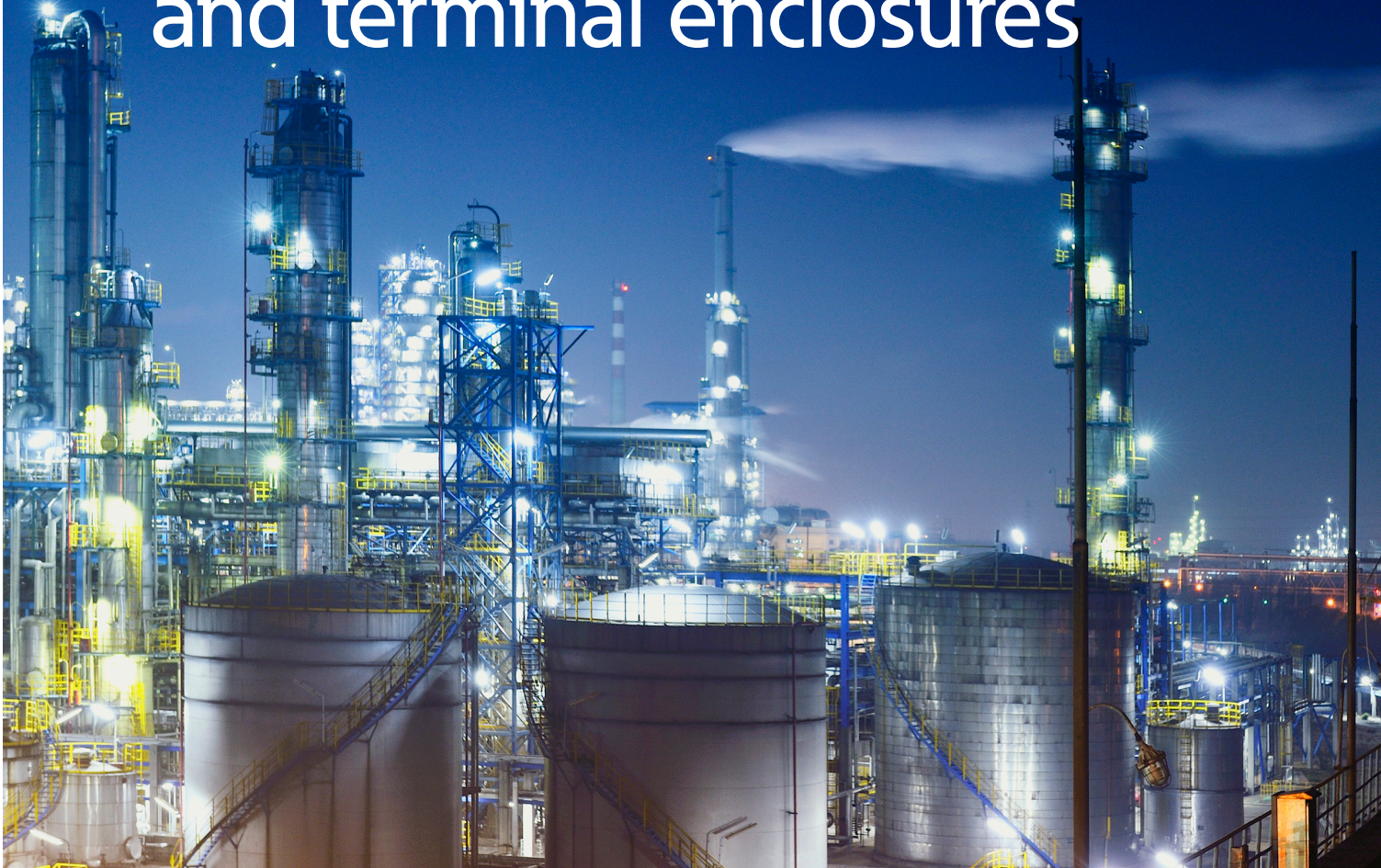

GboX enclosures for hazardous rated areas

High quality. Maintenance free. Robust construction.

Eaton's Crouse-Hinds series GboX junction and terminal enclosures are a glass-reinforced polyester (GRP) terminal box solution designed for use with metallic cable glands, cable entries on multiple sides/faces, and with industry standard sizes to match common end-user specifications.

In the oil and gas industry, GboX enclosure solutions provide corrosion resistance, impact strength and ingress protection in harsh and hazardous areas.

GboX junction enclosures

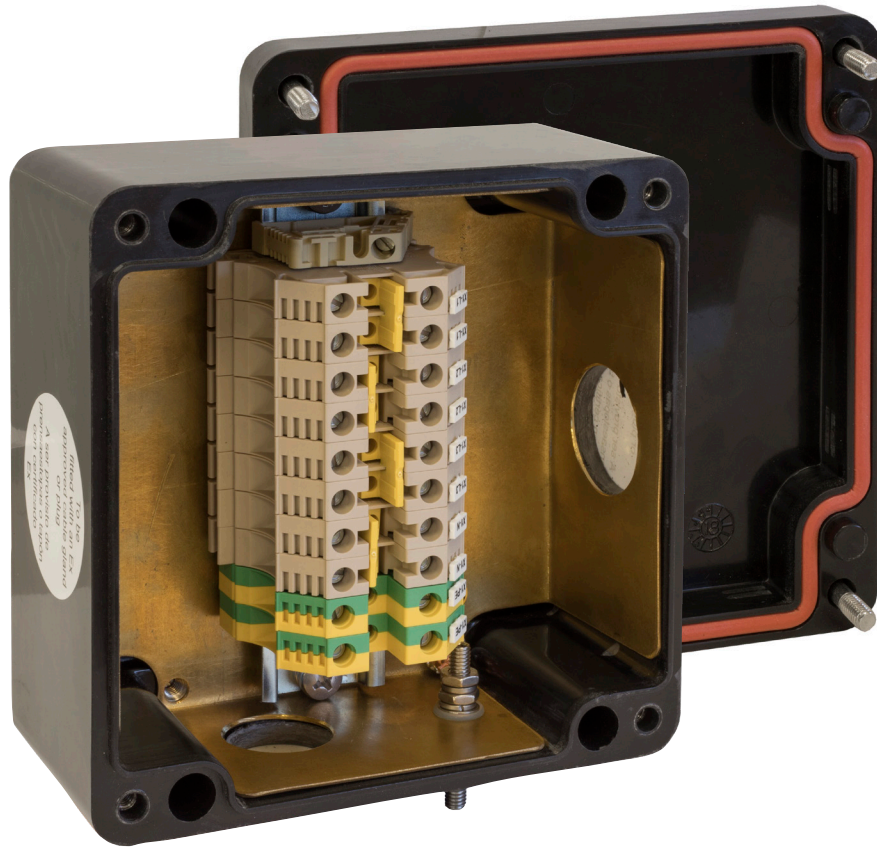

Heavy duty glass-reinforced polyester (GRP) construction:

- Corrosion resistant, anti-static surface



Built for harsh environments:

- IP 66 protection and superior impact resistance
- Stainless steel captive lid screws

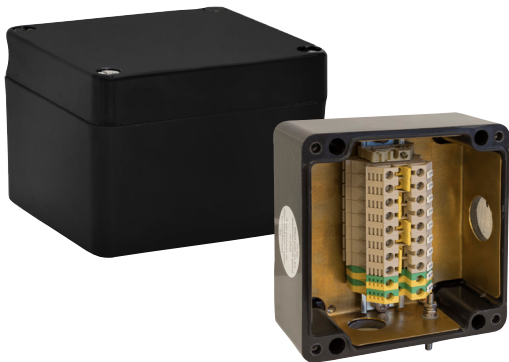

Approved to the latest international standards:

- Certified as an empty enclosure and as factory assembled terminal boxes to ATEX, IECEx and EAC standards

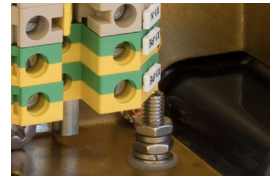

Flexible earthing and built-in component options:

- Brass or galvanized steel earth plates, internal / external earth studs and wiring options



Rated for extreme temperatures:

- Silicone sealing for service temperatures from -60°C to +110°C

GboX empty enclosures



Applications:

- Manufactured to meet the most demanding harsh and hazardous area environmental applications
- A globally certified enclosure for Zones 1, 2, 21 and 22
- Certified to meet requirements for impact, thermal and IP66 ingress protection

Standards:

- IEC 60079- 0:2017 / EN IEC 60079 - 0:2018 general requirements
- IEC 60079- 7:2017 / EN IEC 60079 - 7:2015 + A1:2018 increased safety requirements "e"
- IEC 60079- 31:2013 / EN 60079 - 31:2014 protection by enclosure "t"

Certificates and markings (empty enclosure):

- TÜV 19 ATEX 8392U; IECEx TUR 19.0040U
- ATEX marking:
 ⓈII 2G Ex eb IIC Gb
 ⓈII 2D Ex tb IIIC Db
- IECEx marking:
 Ex eb IIC Gb
 Ex tb IIIC Db
- IP66 accd. IEC60529

Standard materials & finishes:

- Enclosure – GRP (glass reinforced polyester)
- Enclosure finish – AL9011/ black
- Gasket – silicone
- Lid screws – M4 / M6 captive screws (304 stainless steel)

Technical specifications:

- Service temperature: -60°C to +110°C
- UL94 flammability rating: self-extinguishing accd. UL94 V0
- Impact resistance: 7J accd. IEC 60079- 0
- Enclosure mounting: 4 holes for M4 to M6 screw
- Surface resistance: $<10^9 \Omega$
- Halogen free (REACH and ROHS compliant)
- Fixing holes located outside of the lid sealing area
- Threaded internal holes for earth plate or rail mounting

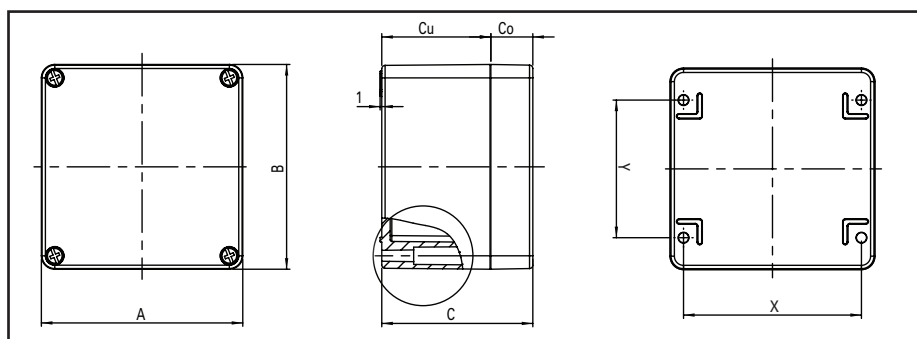

Dimensions

Dimensions (mm)

Cat. #	A	B	C	Cu	Co	X	Y	Weight (g)
GBXE080707	80	75	75	60	15	68	45	319
GBXE121209	122	120	90	65	25	106	82	762
GBXE221209	220	120	90	65	25	204	82	1099
GBXE161609	160	160	90	70	20	140	110	1286
GBXE261609	260	160	90	70	20	240	110	1769
GBXE361609	360	160	90	70	20	340	110	2263
GBXE252512	255	250	120	95	25	235	200	2387
GBXE252516	255	250	160	95	65	235	200	3086
GBXE402512	400	250	120	95	25	380	200	3845
GBXE402516	400	250	160	95	65	380	200	4736
GBXE404012	400	405	120	95	25	380	355	5456
GBXE602512	600	250	120	95	25	580	200	5377
GBXE602516	600	250	160	95	65	580	200	6561
GBXE404020	400	405	200	175	25	380	355	6946

GboX terminal enclosures



Applications:

- Meets international standards for Zones 1, 2, 21 and 22
- Engineered to order with custom terminal and entry configuration
- Assembled at multiple Eaton's Crouse-Hinds Division global manufacturing facilities
- Certified with a wide variety of rail mount, wiring terminals, earth plate and earth stud options

Standards:

- IEC 60079- 0:2017 / EN IEC 60079 - 0:2018 general requirements
- IEC 60079- 7:2017 / EN IEC 60079 - 7:2015 + A1:2018 increased safety requirements "e"
- IEC 60079- 31:2013 / EN 60079 - 31:2014 protection by enclosure "t"

Certificates and markings:

- IECEx BVS 18.0065X; BVS 18 ATEX E 077X
- ATEX marking:
 ⓂII 2G Ex eb IIC T6/T5/T4+ Gb
 ⓂII 2D Ex tb IIIC T80°C/T95°C/T110°C+ Db
- IECEx marking:
 Ex eb IIC T6/T5/T4+ Gb
 Ex tb IIIC T80°C /T95°C/T110°C+ Db
- EAC certificate - in process
- IP66 accd.IEC60529

Standard materials & finishes:

- Enclosure – GRP (glass reinforced polyester)
- Enclosure finish – AL9011/ black
- Gasket – silicone
- Lid screws – M4 / M6 captive screws (304 stainless steel)
- Enclosure mounting – 4 holes for M4 to M6 screw
- Surface resistance – $10^9 \Omega$

Technical specifications:

- Ambient temperatures:
 -60°C up to +40°C T6/+55°C T5/+70°C T4
- Internal/external earth stud: M4, M6, M8, M10 in brass or stainless steel
- Internal continuity plate: 1.2mm thick brass
- Built-in terminal options including the UK series, UT series, WDU/WPE series and others†
- Intrinsically safe circuits according to IEC/EN 60079-11

Electrical ratings:

- Rated operating voltage (Ue): 690V - 50/60Hz
- Rated operating current (Ie): max 315A
- Max cross section for terminals: up to 240mm²

Terminal capacity

Maximum physical terminal capacity (qty)

Cat. #	Usable rail length (mm)	Cross section (mm ²)														
		1.5	2.5	4	6	10	16	25	35	50	70	95	120	150	185	240
GBX080707	50	8	8	-	-	-	-	-	-	-	-	-	-	-	-	-
GBX121209	80	15	15	13	10	-	-	-	-	-	-	-	-	-	-	-
GBX221209	178 (82)	34	34	28	21	8*	6*	-	-	-	-	-	-	-	-	-
GBX161609	114	22	22	18	14	11	9	-	-	-	-	-	-	-	-	-
GBX261609	214 (118)	41	41	34	26	21	17	7*	7*	-	-	-	-	-	-	-
GBX361609	314 (118)	60	60	50	38	31	25	7*	7*	-	-	-	-	-	-	-
GBX252512	2 x 208	2 x 40	2 x 40	2 x 33	2 x 25	20	17	13	13	-	-	-	-	-	-	-
GBX252516	2 x 208	2 x 40	2 x 40	2 x 33	2 x 25	20	17	13	13	-	-	-	-	-	-	-
GBX402512	2 x 354 (208)	2 x 68	2 x 68	2 x 57	2 x 43	34	29	22	22	10*	10*	-	-	-	-	-
GBX402516	2 x 354 (208)	2 x 68	2 x 68	2 x 57	2 x 43	34	29	22	22	10*	10*	8*	-	-	-	-
GBX404012	3 x 354	3 x 68	3 x 68	3 x 57	3 x 43	3 x 34	29	22	22	17	17	14	-	-	-	-
GBX602512	553 (185)	2 x 106	2 x 106	2 x 89	2 x 67	54	45	34	34	9*	9*	7*	6*	6*	5*	5*
GBX602516	553 (185)	2 x 106	2 x 106	2 x 89	2 x 67	54	45	34	34	9*	9*	7*	-	-	-	-
GBX404020	3 x 354	2 x 68	3 x 68	3 x 57	3 x 43	3 x 34	29	22	22	17	17	14	-	-	-	-

*Cross sections use 90° rotated DIN rails.

†Values of temperature class and surface temperature dependant on ambient temperature and built-in components.

‡Consult Eaton's Crouse-Hinds for details.

Note: Reference load tables for maximum number of wires and continuous current ratings.

GboX terminal enclosures technical data

GBX 080807

Dimensions: 80 x 75 x 75mm

Usable rail length (mm)	50						
Conductor Size (mm ²)	1.5	2.5	4	6	10	16	25
Max. terminal fit (qty/rail)	8	8					
Qty of rails	1	1					
Maximum number of wires [Ⓐ] according to Current (A)	3						
	6	26					
	10	9	18				
	16	3	10				
	20		3				
	25						
	35						
	50						
	63						

Maximum number of cable glands

Size	Metal gland [Ⓓ]		Plastic gland [Ⓔ]	
	W/Y side	X/Z side	W/Y side	X/Z side
12	4	2	5	2
16	2	1	3	2
20	1	1	2	1
25	1		1	1
32	1		1	
40				
50				
63				

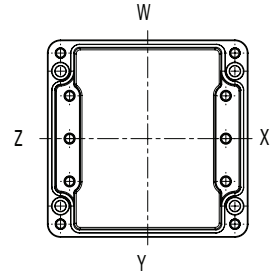

[Ⓓ] For metallic cable glands Capri Type ADE for Ex-e, through-hole with locknut and earth plate.
[Ⓔ] For plastic cable glands CEAG Type GHG96 with threaded hole and no earth plate.

GBX 121209

Dimensions: 122 x 120 x 90mm

Usable rail length (mm)	80						
Conductor Size (mm ²)	1.5	2.5	4	6	10	16	25
Max. terminal fit (qty/rail)	15	15	13	10			
Qty of rails	1	1	1	1			
Maximum number of wires [Ⓐ] according to Current (A)	3						
	6	43					
	10	14	28				
	16	6	16	32			
	20		7	18	35		
	25			5	13		
	35				2		
	50						
	63						

Maximum number of cable glands

Size	Metal gland [Ⓓ]		Plastic gland [Ⓔ]	
	W/Y side	X/Z side	W/Y side	X/Z side
12	6	5	10	8
16	5	3	6	4
20	3	2	4	3
25	2	1	2	1
32	1	1	2	1
40			1	
50				
63				

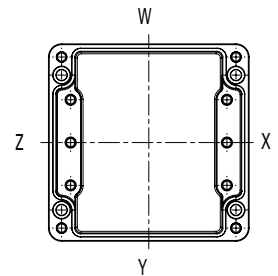

[Ⓓ] For metallic cable glands Capri Type ADE for Ex-e, through-hole with locknut and earth plate.
[Ⓔ] For plastic cable glands CEAG Type GHG96 with threaded hole and no earth plate.

GBX 221209

Dimensions: 220 x 120 x 90mm

Usable rail length (mm)	178 (82 [Ⓓ])						
Conductor Size (mm ²)	1.5	2.5	4	6	10	16	25
Max. terminal fit (qty/rail)	34	34	28	21	8 [Ⓒ]	6 [Ⓒ]	
Qty of rails	1	1	1	1			
Maximum number of wires [Ⓐ] according to Current (A)	3						
	6	45					
	10	15	30				
	16	6	17	34			
	20		8	19	37		
	25			5	14	36	
	35				2	11	30
	50					4	14
	63						5

Maximum number of cable glands

Size	Metal gland [Ⓓ]		Plastic gland [Ⓔ]	
	W/Y side	X/Z side	W/Y side	X/Z side
12	14	5	26	8
16	12	4	14	4
20	7	2	10	2
25	5	1	6	1
32	3	1	4	1
40			3	1
50				
63				

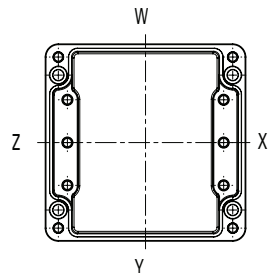

[Ⓓ] For metallic cable glands Capri Type ADE for Ex-e, through-hole with locknut and earth plate.
[Ⓔ] For plastic cable glands CEAG Type GHG96 with threaded hole and no earth plate.

[Ⓐ] Number of conductors/wires is the sum of all internal conductors and internal wire connections, bridge lines and earth excluded.

[Ⓒ] = Up to max terminal fit quantity

[Ⓓ] = Engineer-to-order only by Eaton (with heat rise calculation)

[Ⓔ] DIN rail length in case of 90° rotation.

[Ⓕ] Use 90° rotated DIN rail.

GboX terminal enclosures technical data

GBX 161609

Dimensions: 160 x 160 x 90mm

Usable rail length (mm)	114						
Conductor Size (mm ²)	1.5	2.5	4	6	10	16	25
Max. terminal fit (qty/rail)	22	22	18	14	11	9	
Qty of rails	1	1	1	1	1	1	
Maximum number of wires ^A according to Current (A)	3						
	6	48					
	10	16	32				
	16	6	18	36			
	20		9	20	39		
	25			6	15	38	
	35				2	12	31
	50					4	14
	63						5

Maximum number of cable glands

Size	Metal gland ^D		Plastic gland ^E	
	W/Y side	X/Z side	W/Y side	X/Z side
12	9	7	18	13
16	8	6	9	6
20	4	3	6	5
25	2	2	3	3
32	2	1	2	2
40			2	1
50				
63				

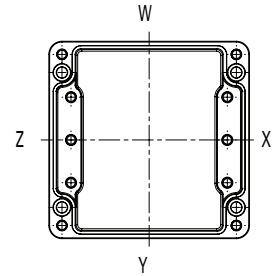

^D For metallic cable glands Capri Type ADE for Ex-e, through-hole with locknut and earth plate.
^E For plastic cable glands CEAG Type GHG96 with threaded hole and no earth plate.

GBX 261609

Dimensions: 260 x 160 x 90mm

Usable rail length (mm)	214 (118 ^B)								
Conductor Size (mm ²)	1.5	2.5	4	6	10	16	25	35	
Max. terminal fit (qty/rail)	41	41	34	26	21	17	7 ^C	7 ^C	
Qty of rails	1	1	1	1	1	1	1	1	
Maximum number of wires ^A according to Current (A)	3								
	6	52							
	10	18	34						
	16	7	20	39					
	20		9	22	42				
	25			6	16	41			
	35				2	13	34		
	50					4	16	56	
	63						6	17	63
	80							7	16
	100								6

Maximum number of cable glands

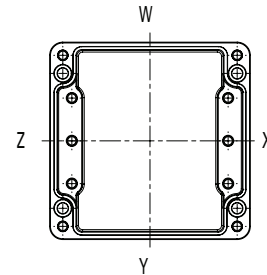

Size	Metal gland ^D		Plastic gland ^E	
	W/Y side	X/Z side	W/Y side	X/Z side
12	18	7	33	13
16	14	6	17	6
20	9	3	14	5
25	5	2	8	3
32	4	1	4	2
40			3	1
50				
63				

^D For metallic cable glands Capri Type ADE for Ex-e, through-hole with locknut and earth plate.
^E For plastic cable glands CEAG Type GHG96 with threaded hole and no earth plate.

^A Number of conductors/wires is the sum of all internal conductors and internal wire connections, bridge lines and earth excluded.

^B = Up to max terminal fit quantity

^C = Engineer-to-order only by Eaton (with heat rise calculation)

^D DIN rail length in case of 90° rotation.

^E Use 90° rotated DIN rail.

GboX terminal enclosures technical data

GBX 361609

Dimensions: 360 x 160 x 90mm

Usable rail length (mm)	314 (118 [Ⓟ])							
Conductor Size (mm ²)	1.5	2.5	4	6	10	16	25	35
Max. terminal fit (qty/rail)	60	60	50	38	31	25	7 [Ⓢ]	7 [Ⓢ]
Qty of rails	1	1	1	1	1	1	1	1
Maximum number of wires [Ⓐ] according to Current (A)	3							
	6	53						
	10	18	35					
	16	7	20	40				
	20	9	22	43				
	25		6	17	42			
	35			2	13	35		
	50				4	16	58	
	63					6	18	64
	80						7	17
100							6	

Maximum number of cable glands

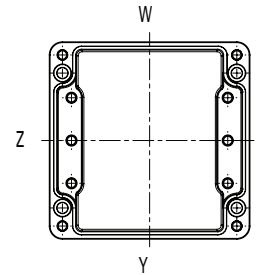

Size	Metal gland [Ⓣ]		Plastic gland [Ⓤ]	
	W/Y side	X/Z side	W/Y side	X/Z side
12	27	7	48	13
16	22	6	24	6
20	14	3	20	5
25	8	2	10	3
32	6	1	7	2
40			5	1
50				
63				

[Ⓣ] For metallic cable glands Capri Type ADE for Ex-e, through-hole with locknut and earth plate.

[Ⓤ] For plastic cable glands CEAG Type GHG96 with threaded hole and no earth plate.

GBX 252512

Dimensions: 255 x 250 x 120mm

Usable rail length (mm)	208								
Conductor Size (mm ²)	1.5	2.5	4	6	10	16	25	35	50
Max. terminal fit (qty/rail)	40	40	33	25	20	17	13	13	
Qty of rails	2	2	2	2	1	1	1	1	
Maximum number of wires [Ⓐ] according to Current (A)	3								
	6	70							
	10	24	46						
	16	10	27	52					
	20	13	29	57					
	25	8	22	55					
	35	3	18	46					
	50	6	21	76					
	63	8	23	85					
	80	10	22						
100		9							
125									

Maximum number of cable glands

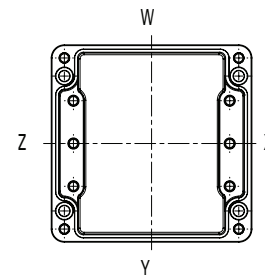

Size	Metal gland [Ⓣ]		Plastic gland [Ⓤ]	
	W/Y side	X/Z side	W/Y side	X/Z side
12	26	23	48	27
16	21	18	25	20
20	14	11	18	14
25	10	8	11	10
32	5	4	8	6
40	3	3	4	3
50	2	2	3	2
63			2	2

[Ⓣ] For metallic cable glands Capri Type ADE for Ex-e, through-hole with locknut and earth plate.

[Ⓤ] For plastic cable glands CEAG Type GHG96 with threaded hole and no earth plate.

[Ⓐ] Number of conductors/wires is the sum of all internal conductors and internal wire connections, bridge lines and earth excluded.

□ = Up to max terminal fit quantity

■ = Engineer-to-order only by Eaton (with heat rise calculation)

Ⓟ = DIN rail length in case of 90° rotation.

Ⓢ = Use 90° rotated DIN rail.

GboX terminal enclosures technical data

GBX 252516

Dimensions: 255 x 250 x 160mm

Usable rail length (mm)	208								
Conductor Size (mm ²)	1.5	2.5	4	6	10	16	25	35	
Max. terminal fit (qty/rail)	40	40	33	25	20	17	13	13	
Qty of rails	2	2	2	2	1	1	1	1	
Maximum number of wires ^A according to Current (A)	3								
	6	81							
	10	28	54						
	16	11	31	61					
	20		15	34	66				
	25			10	26	65			
	35				3	21	53		
	50					7	25	88	
	63						9	27	99
	80							12	26
	100								10
	125								

Maximum number of cable glands

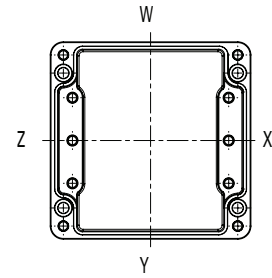

Size	Metal gland ^D		Plastic gland ^E	
	W/Y side	X/Z side	W/Y side	X/Z side
12	26	23	48	27
16	21	18	25	20
20	14	11	18	14
25	10	8	11	10
32	5	4	8	6
40	3	3	4	3
50	2	2	3	2
63			2	2

^D For metallic cable glands Capri Type ADE for Ex-e, through-hole with locknut and earth plate.

^E For plastic cable glands CEAG Type GHG96 with threaded hole and no earth plate.

GBX 402512

Dimensions: 400 x 250 x 120mm

Usable rail length (mm)	354 (208 ^B)										
Conductor Size (mm ²)	1.5	2.5	4	6	10	16	25	35	50	70	95
Max. terminal fit (qty/rail)	68	68	57	43	34	29	22	22	10 ^C	10 ^C	
Qty of rails	2	2	2	2	1	1	1	1	1	1	
Maximum number of wires ^A according to Current (A)	3										
	6	76									
	10	26	50								
	16	10	29	57							
	20		15	32	62						
	25			9	24	60					
	35				3	19	50				
	50					6	23	82			
	63						9	25	92		
	80							11	24		
	100								9	24	
	125									8	21
	160										7
	200										3
225											

Maximum number of cable glands

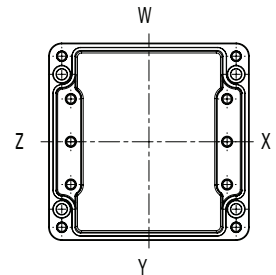

Size	Metal gland ^D		Plastic gland ^E	
	W/Y side	X/Z side	W/Y side	X/Z side
12	47	23	72	39
16	39	18	42	21
20	23	11	33	15
25	17	8	18	10
32	9	4	14	6
40	6	3	8	3
50	4	2	5	2
63			4	2

^D For metallic cable glands Capri Type ADE for Ex-e, through-hole with locknut and earth plate.

^E For plastic cable glands CEAG Type GHG96 with threaded hole and no earth plate.

^A Number of conductors/wires is the sum of all internal conductors and internal wire connections, bridge lines and earth excluded.

Light blue = Up to max terminal fit quantity

Orange = Engineer-to-order only by Eaton (with heat rise calculation)

^B DIN rail length in case of 90° rotation.

^C Use 90° rotated DIN rail.

GboX terminal enclosures technical data

GBX 402516

Dimensions: 400 x 250 x 160mm

Usable rail length (mm)	354 (208ⓐ)											
Conductor Size (mm ²)	1.5	2.5	4	6	10	16	25	35	50	70	95	
Max. terminal fit (qty/rail)	68	68	57	43	34	29	22	22	10ⓐ	10ⓐ	8ⓐ	
Qty of rails	3	3	3	3	3	1	1	1	1	1	1	
Maximum number of wires [Ⓐ] according to Current (A)	3											
	6	87										
	10	30	58	225								
	16	12	34	65								
	20		16	37	71							
	25			11	28	69						
	35				4	22	57					
	50					7	26	94				
	63						10	29	105			
	80							12	28			
	100								11	28		
	125									9	25	
	160										9	21
	200										3	12
	225											6
	250											

Maximum number of cable glands

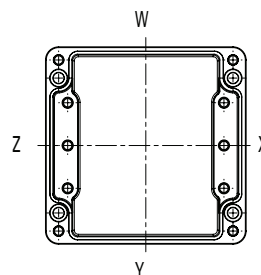

Size	Metal gland [ⓐ]		Plastic gland [ⓑ]	
	W/Y side	X/Z side	W/Y side	X/Z side
12	47	23	72	39
16	39	18	42	21
20	23	11	33	15
25	17	8	18	10
32	9	4	14	6
40	6	3	8	3
50	4	2	5	2
63			4	2

ⓐ For metallic cable glands Capri Type ADE for Ex-e, through-hole with locknut and earth plate.
 ⓑ For plastic cable glands CEAG Type GHG96 with threaded hole and no earth plate.

GBX 404012

Dimensions: 400 x 405 x 120mm

Usable rail length (mm)	354											
Conductor Size (mm ²)	1.5	2.5	4	6	10	16	25	35	50	70	95	
Max. terminal fit (qty/rail)	68	68	57	43	34	29	22	22	17	17	14	
Qty of rails	3	3	3	3	3	1	1	1	1	1	1	
Maximum number of wires [Ⓐ] according to Current (A)	3											
	6	91										
	10	31	61	236								
	16	13	35	68								
	20		17	39	75							
	25			11	29	72						
	35				4	23	60					
	50					8	28	99				
	63						10	31	111			
	80							13	29			
	100								11	29		
	125									10	26	
	160										9	22
	200										3	13
	225											7
	250											

Maximum number of cable glands

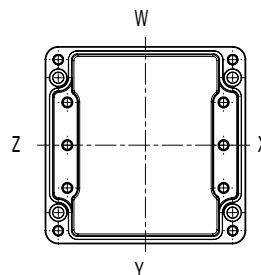

Size	Metal gland [ⓐ]		Plastic gland [ⓑ]	
	W/Y side	X/Z side	W/Y side	X/Z side
12	47	42	72	68
16	39	35	42	39
20	23	20	33	30
25	17	15	18	18
32	9	8	14	13
40	6	5	8	6
50	4	3	5	5
63			4	4

ⓐ For metallic cable glands Capri Type ADE for Ex-e, through-hole with locknut and earth plate.
 ⓑ For plastic cable glands CEAG Type GHG96 with threaded hole and no earth plate.

Ⓐ Number of conductors/wires is the sum of all internal conductors and internal wire connections, bridge lines and earth excluded.

ⓐ = Up to max terminal fit quantity

ⓑ = Engineer-to-order only by Eaton (with heat rise calculation)

ⓐ = DIN rail length in case of 90° rotation.

ⓐ = Use 90° rotated DIN rail.

GboX terminal enclosures technical data

GBX 404020

Dimensions: 400 x 405 x 200mm

Usable rail length (mm)	354											
Conductor Size (mm ²)	1.5	2.5	4	6	10	16	25	35	50	70	95	
Max. terminal fit (qty/rail)	68	68	57	43	34	29	22	22	17	17	14	
Qty of rails	3	3	3	3	3	1	1	1	1	1	1	
Maximum number of wires* according to Current (A)	3											
	6	114										
	10	39	76	296								
	16	16	44	86								
	20		21	48	93							
	25			14	36	91						
	35				5	29	75					
	50					10	35	124				
	63						13	39	139			
	80							16	36			
	100								15	37		
	125									12	32	
	160										11	28
	200										4	16
225											8	

Maximum number of cable glands

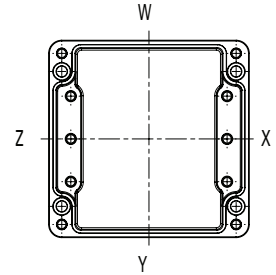

Size	Metal gland [Ⓓ]		Plastic gland [Ⓔ]	
	W/Y side	X/Z side	W/Y side	X/Z side
12	90	84	114	135
16	77	71	84	78
20	54	49	55	50
25	34	31	39	36
32	21	18	23	21
40	12	11	18	15
50	7	5	11	11
63	4	3	8	7

Ⓓ For metallic cable glands Capri Type ADE for Ex-e, through-hole with locknut and earth plate.
 Ⓔ For plastic cable glands CEAG Type GHG96 with threaded hole and no earth plate.

GBX 602512

Dimensions: 600 x 250 x 120mm

Usable rail length (mm)	553 (185 [Ⓓ])											
Conductor Size (mm ²)	1.5	2.5	4	6	10	16	25	35	50	70	95	
Max. terminal fit (qty/rail)	106	106	89	67	54	45	34	34	9 [Ⓒ]	9 [Ⓒ]	7 [Ⓒ]	
Qty of rails	3	3	3	3	3	1	1	1	1	1	1	
Maximum number of wires* according to Current (A)	3											
	6	78										
	10	26	52	201								
	16	11	30	58								
	20		14	33	64							
	25			9	25	62						
	35				3	20	51					
	50					6	24	84				
	63						9	26	95			
	80							11	25			
	100								10	25		
	125									8	22	
	160										8	19
	200										3	11
225											6	
250												

Maximum number of cable glands

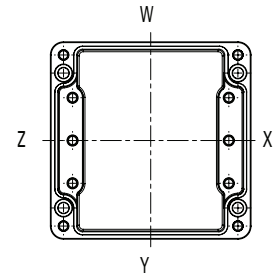

Size	Metal gland [Ⓓ]		Plastic gland [Ⓔ]	
	W/Y side	X/Z side	W/Y side	X/Z side
12	66	21	112	36
16	54	18	60	21
20	32	10	42	15
25	24	7	28	8
32	12	4	16	6
40	8	3	8	3
50	6	2	6	2
63			6	2

Ⓓ For metallic cable glands Capri Type ADE for Ex-e, through-hole with locknut and earth plate.
 Ⓔ For plastic cable glands CEAG Type GHG96 with threaded hole and no earth plate.

- Ⓐ Number of conductors/wires is the sum of all internal conductors and internal wire connections, bridge lines and earth excluded.
- Ⓑ = Up to max terminal fit quantity
- Ⓒ = Engineer-to-order only by Eaton (with heat rise calculation)
- Ⓓ DIN rail length in case of 90° rotation.
- Ⓔ Use 90° rotated DIN rail.

GboX terminal enclosures technical data

GBX 602516

Dimensions: 600 x 250 x 160mm

Usable rail length (mm)	553 (185 [ⓐ])															
Conductor Size (mm ²)	1.5	2.5	4	6	10	16	25	35	50	70	95	120	150	185	240	
Max. terminal fit (qty/rail)	106	106	89	67	54	45	34	34	9 [ⓐ]	9 [ⓐ]	7 [ⓐ]	6 [ⓐ]	6 [ⓐ]	5 [ⓐ]	5 [ⓐ]	
Qty of rails	3	3	3	3	3	1	1	1	1	1	1	1	1	1	1	
Maximum number of wires [Ⓐ] according to Current (A)	3															
	6	88														
	10	30	59	229												
	16	12	34	66												
	20		16	37	72											
	25			11	28	70										
	35				4	23	58									
	50					7	27	96								
	63						10	30	107							
	80							13	28							
	100								11	28						
	125									10	25					
	160										9	22	67			
	200										3	12	26			
	225											6	16	33		
	250												3	9	20	
315														4	14	
400															2	
500																

Maximum number of cable glands

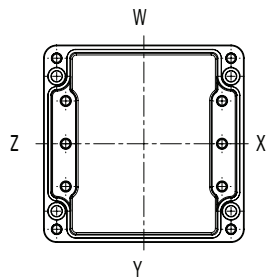

Size	Metal gland [ⓐ]		Plastic gland [ⓑ]	
	W/Y side	X/Z side	W/Y side	X/Z side
12	66	21	112	36
16	54	18	60	21
20	32	10	42	15
25	24	7	28	8
32	12	4	16	6
40	8	3	8	3
50	6	2	6	2
63			6	2

[ⓐ] For metallic cable glands Capri Type ADE for Ex-e, through-hole with locknut and earth plate.

[ⓑ] For plastic cable glands CEAG Type GHG96 with threaded hole and no earth plate.

[Ⓐ] Number of conductors/wires is the sum of all internal conductors and internal wire connections, bridge lines and earth excluded.

☐ = Up to max terminal fit quantity

■ = Engineer-to-order only by Eaton (with heat rise calculation)

[ⓐ] DIN rail length in case of 90° rotation.

[ⓐ] Use 90° rotated DIN rail.

GboX terminal enclosures technical data

Maximum permissible power loss depending on temperature class and ambient temperature

Perm. ambient temperature	Power dissipation at temperature class								
	T6			T5			T4		
	40°C	55°C	70°C	40°C	55°C	70°C	40°C	55°C	70°C
GBX080707	3.4 W	2.1 W	0.9 W	4.7 W	3.4 W	2.1 W	6.0 W	4.7 W	3.4 W
GBX121209	6.8 W	4.2 W	1.7 W	9.3 W	6.8 W	4.2 W	11.9 W	9.3 W	6.8 W
GBX221209	10.2 W	6.4 W	2.6 W	14.1 W	10.2 W	6.4 W	17.9 W	14.1 W	10.2 W
GBX161609	9.7 W	6.1 W	2.4 W	13.3 W	9.7 W	6.1 W	17.0 W	13.3 W	9.7 W
GBX261609	13.7 W	8.5 W	3.4 W	18.8 W	13.7 W	8.5 W	23.9 W	18.8 W	13.7 W
GBX361609	17.6 W	11.0 W	4.4 W	24.3 W	17.6 W	11.0 W	30.9 W	24.3 W	17.6 W
GBX252512	21.6 W	13.5 W	5.4 W	29.7 W	21.6 W	13.5 W	37.8 W	29.7 W	21.6 W
GBX252516	26.3 W	16.4 W	6.6 W	36.1 W	26.3 W	16.4 W	46.0 W	36.1 W	26.3 W
GBX402512	29.9 W	18.7 W	7.5 W	41.1 W	29.9 W	18.7 W	52.3 W	41.1 W	29.9 W
GBX402516	35.9 W	22.5 W	9.0 W	49.4 W	35.9 W	22.5 W	62.9 W	49.4 W	35.9 W
GBX404012	41.4 W	25.9 W	10.4 W	57.0 W	41.4 W	25.9 W	72.5 W	57.0 W	41.4 W
GBX602512	43.6 W	27.2 W	10.9 W	59.9 W	43.6 W	27.2 W	76.3 W	59.9 W	43.6 W
GBX602516	49.6 W	31.0 W	12.4 W	68.2 W	49.6 W	31.0 W	86.7 W	68.2 W	49.6 W
GBX404020	56.7 W	35.4 W	14.2 W	77.9 W	56.7 W	35.4 W	99.1 W	77.9 W	56.7 W

The values apply to wall mounting as a single unit (radiating surface = 4 side walls plus cover).



If the radiating surfaces are reduced due to obstacles, the maximum power dissipation should also be reduced.

Cable Glands

ADE-1F2

ADE-1F2 cable glands are designed to provide a flameproof and weatherproof seal on the outer sheath of non-armored, tray, marine shipboard or Type P cable. ADE glands are available in a wide range of corrosion-resistant materials to suit any harsh, industrial application.

Cable types:

- Non-armoured cable 
- Marine shipboard cable; Type P cable 
- Tray cable (armoured) cable 

Standard materials:

- Nickel-plated brass for superior corrosion resistance
- 316L stainless steel, bronze and aluminum (optional); it is recommended that a suitable lubricant be used on all threads of stainless steel and aluminum versions



NPT thread size	Cat. # NPT	Metric thread size	Cat. # Metric	Cable sealing range		
				Min.	Max.	NPT max.
1/2"	ADE1N0500NPN	M20	ADE1M200NPN	2.8	5.5	
1/2"	ADE1N0501NPN	M20	ADE1M201NPN	4.5	8.5	
1/2"	ADE1N0502NPN	M20	ADE1M202NPN	7.0	12.0	
1/2"	ADE1N0503NPN	M20	ADE1M203NPN	10.0	16.0	15.5
3/4"	ADE1N0751NPN	M25	ADE1M251NPN	7.0	12.0	
3/4"	ADE1N0752NPN	M25	ADE1M252NPN	10.0	16.0	
3/4"	ADE1N0753NPN	M25	ADE1M253NPN	13.5	20.5	
1"	ADE1N1003NPN	M32	ADE1M323NPN	18.0	27.5	26.0

Catalog numbers are for nickel-plated brass; refer to the cable glands catalog online for other material options.
Dimensions shown in millimeters.

Certifications and compliances:



Ingress protection (IP):





- IP66/IP68 according to the method of attachment and the condition of the equipment area. IP66 protection is achieved through thread-to-thread engagement. Additional protection up to IP68 can be achieved through the addition of sealing washer or thread sealant.
- NEMA 4X

Operating temperature:

- -60°C to +140°C

ADE-4F

Cable types:

- Steel wire armored cable (SWA) 
- Steel wire braided cable (SWB) 
- Steel tape armored cable (STA) 
- Braided marine shipboard cable; Type P cable 
- Lead sheathed cable (with addition of earthing washer) 

Standard materials:

- Nickel-plated brass for superior corrosion resistance
- 316L stainless steel, bronze and aluminum (optional); it is recommended that a suitable lubricant be used on all threads of stainless steel and aluminum versions



NPT thread size	Cat. # NPT	Metric thread size	Cat. # Metric	Cable sealing range inner sheath		Cable sealing range outer sheath		Armor	
				Min.	Max.	Min.	Max.	Min.	Max.
1/2"	ADE4N0500NPN	M20	ADE4M200NPN	2.8	5.5	4.5	8.5	0.2	0.9
1/2"	ADE4N0501NPN	M20	ADE4M201NPN	4.5	8.0	7.0	12.0	0.2	0.9
1/2"	ADE4N0502NPN	M20	ADE4M202NPN	7.0	12.0	10.0	16.0	0.2	1.3
1/2"	ADE4N0503NPN	M20	ADE4M203NPN	10.0	15.5	13.5	21.0	0.2	1.3
3/4"	ADE4N0751NPN	M25	ADE4M251NPN	7.0	12.0	10.0	16.0	0.2	1.3
3/4"	ADE4N0752NPN	M25	ADE4M252NPN	10.0	15.5	13.5	21.0	0.2	1.3
3/4"	ADE4N0753NPN	M25	ADE4M253NPN	13.5	20.5	18.0	27.5	0.2	1.6
1"	ADE4N1002NPN	M32	ADE4M322NPN	13.5	21.0	18.0	27.5	0.2	1.6
1"	ADE4N1003NPN	M32	ADE4M323NPN	18.0	26.0	23.0	34.0	0.2	1.6

Catalog numbers are for nickel-plated brass; refer to the cable glands catalog online for other material options.
Dimensions shown in millimeters.

Certifications and compliances:



Ingress protection (IP):

- IP66/IP68 according to the method of attachment and the condition of the equipment area

Operating temperature:

- -60°C to +140°C

Accessories

Breather/drains

Cat. #	Type
DPE1004S3	M20 Ex e IP66 Brass Breather drain
DPE1005S3	M25 Ex e IP66 Brass Breather drain
DPE1104S3	M20 Ex e IP66 Nickel Plated Brass Breather drain
DPE1105S3	M25 Ex e IP66 Nickel Plated Brass Breather drain
DPE3004S3	M20 Ex e IP66 316 Stainless Steel Breather drain
DPE3005S3	M25 Ex e IP66 316 Stainless Steel Breather drain



Breather/drains



**U.S. (global headquarters):
Eaton's Crouse-Hinds Division**

1201 Wolf Street
Syracuse, NY 13208

(866) 764-5454
FAX: (315) 477-5179
FAX Orders Only:
(866) 653-0640

crousecustomerctr@eaton.com

For more information:

If further assistance is required, please contact an authorized Eaton Distributor, Sales Office, or Customer Service Department.

Canada

Toll Free: 800-265-0502
FAX: (800) 263-9504
FAX Orders only: (866) 653-0645

Mexico/Latin America/Caribbean

52-555-804-4000
FAX: 52-555-804-4020
ventascentromex@eaton.com

Germany

49 (0) 6271 806-500
49 (0) 6271 806-476
info-ex@eaton.com

Great Britain

44 247 630 89 30
FAX: 44 247 630 10 27
sales5@eaton.com

The Netherlands

31 10 2452145
FAX: 31 10 2452121
chr_mail@eaton.com

Eaton Middle East (Dubai)

9714-8066100
FAX: 9714-8894813
chmesales@eaton.com

Singapore

65-6645-9888
FAX: 65-6297-4819
chsi-sales@eaton.com

China

86-21-2899-3600
FAX: 86-21-2899-4055
ECHsales@eaton.com

Norway

47 32 244 600
FAX: 47 32 244 646
chlioffice@eaton.com

Russia

7-495 510 2427
FAX: 7-495 510 2428
info@cooper.ru.com

Korea

82-2-3484-6783
82-2-3484-6778
ECHKsales@eaton.com

Australia

61-2-8787-2777
FAX: 61-2-9609-2342
crousehindsanz@eaton.com

India

91-124-4683888
FAX: 91-124-4683899
cchindia@eaton.com

Spain

34 937 362 710
FAX: 34 937 835 055
Sales.cch.es@cooperindustries.com

Eaton
1000 Eaton Boulevard
Cleveland, OH 44122
United States
Eaton.com

© 2019 Eaton
All Rights Reserved
Printed in USA
Publication No. 5409-1219
December 2019

Eaton is a registered trademark.

All other trademarks are property of their respective owners.