



(1) **EC-TYPE EXAMINATION CERTIFICATE**

(2) Equipment or protective system intended for use in potentially explosive atmospheres Directive 94/9/EC

(3) EC-Type Examination Certificate number: **LOM 02ATEX2035**

(4) Equipment or Protection System   Luminaires  
Type KFL...

(5) Applicant:                           Cooper, Crouse-Hinds Division, CEAG  
CEAG Nortem, S.A.

(6) Address:                            Avda. Santa Eulalia, 290  
08223 TARRASA (BARCELONA)  
SPAIN

(7) This equipment or protective system and any acceptable variation thereto is specified in the schedule to this certificate and the documents therein referred to.

(8) Laboratorio Oficial J.M. Madariaga (LOM), notified body number 0163 in accordance with Article 9 of the Directive 94/9/EC of the European Parliament of 23 March 1994, certifies that this equipment or protective system has been found to comply with the Essential Health and Safety Requirements relating to the design and construction of equipment and protective systems intended for use in potentially explosive atmospheres, given in Annex II to the Directive.  
The examination and test results are recorded in confidential report nr. **LOM 01.291 RP**

(9) Compliance with the Essential Health and Safety Requirements has been assured by compliance with:  
- Standards           **EN 50014:1997 + A1:1999 + A2:1999**  
                              **EN 50018:2000**  
                              **EN 50019:2000**

(10) If the sign X is placed after the certificate number, it indicates that the equipment or protective system is subject to special conditions for safe use specified in this certificate schedule.

(11) This EC-Type Examination Certificate relates only to the design and construction of this specified equipment or protective system in accordance with the Directive 94/9/EC. Further requirements of the Directive applies to the manufacture and supply of this equipment or protective system. These are not covered by this certificate.

(12) The marking of the equipment or protective system shall include the following:

 II 2 G    EEx de IIC T3..T4  
Ta: -20 °C / +55 °C

  
Carlos Fernández Ramón  
DIRECTOR OF THE LABORATORY



Madrid, 10 July 2002  
  
Angel Vega Remesal  
Head of ATEX area

*(This document may only be reproduced in its entirety)*

This Certificate is a translation from the original in Spanish. The LOM liability applies only on the Spanish text





# LABORATORIO OFICIAL J. M. MADARIAGA

(A1) **SCHEDULE**

(A2) EC-Type Examination Certificate: **LOM 02ATEX2035**

(A3) Description of equipment or protective system

Projection luminaires with 20 ó 50 W halogen lamps and power supply by transformer or directly. Terminal box is increased safety type of protection.

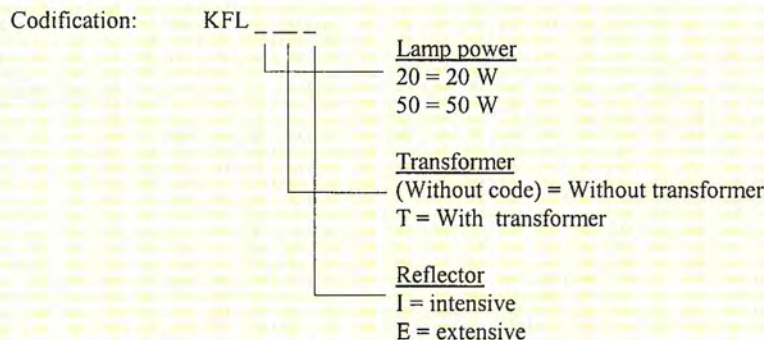

Temperature class:

Lamp power (W)	Temperature class	
	Ta: -20 °C / +40 °C	Ta: -20 °C / +55 °C
20	T4	T4
50	T4	T3

Rated voltage

Without transformer: 12 y 24 Vcc, Vca

With transformer: 42-240 Vca

(A4) Test report: n° **LOM 01.291 RP**

(A5) Individual test

Each manufactured unit must be submitted to a static overpressure test at 1125 kPa in both compartments according 15.1.3.1 of EN 50018:2000.

(A6) Essential Health and Safety Requirements

Explosion safe requirements are covered by application of the standards indicated in page 1/2 of this certificate.

(A7) Descriptive documents:

	<u>Rev.</u>	<u>Date</u>
Description nr. KFL.doc (5 pp)	-	2001-08-01
Partlist nr.:	B	2001-07-19
	A	2001-07-19
Drawings n°:	B	2001-07-19
	A	2001-07-19
	A	2001-08-01
	B	2001-08-01



*(This document may only be reproduced in its entirety)*

This Certificate is a translation from the original in Spanish. The LOM liability applies only on the Spanish text



## (1) EC-TYPE EXAMINATION CERTIFICATE SUPPLEMENT

- (2) Equipment or protective system intended for use in potentially explosive atmospheres.  
Directive 94/9/EC
- (3) Supplement nr. 1 to EC-Type Examination Certificate number: **LOM 02ATEX2035**
- (4) Equipment or Protection System                      Luminaries  
Type KFL...
- (5) Applicant                                                      Cooper, Crouse-Hinds Division, CEAG  
CEAG Nortem, S.A.
- (6) Address                                                        Avda. Santa Eulalia, 290  
08223 TARRASA (BARCELONA)  
SPAIN
- (7) This certificate supplement increases the scope of certificate LOM 03ATEX2035 to include variants as specified in the annex to this certificate supplement and listed documents.
- (8) The examination and test results are recorded in confidential report nr. **LOM 03.060 SP**

This supplement must be an inseparable part together with base certificate.

Madrid, 6 May 2003

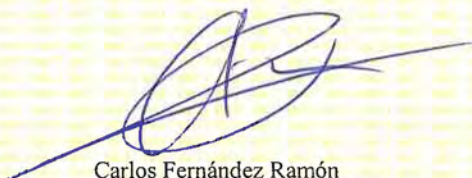

Carlos Fernández Ramón  
DIRECTOR OF THE LABORATORY



Angel Vega Remesal  
Head of ATEX area

*(This document may only be reproduced in its entirety)*

This Certificate is a translation from the original in Spanish. The LOM liability applies only on the Spanish text

Page 1/2



# LABORATORIO OFICIAL J. M. MADARIAGA

(A1) **ANNEX**

(A2) Supplement nr. 1 to EC-Type Examination Certificate number: **LOM 02ATEX2035**

(A3) Variations included in this supplement

To extend the application of the luminaries type KFL... to combustible dust atmospheres by assessment of the standard EN 50281-1-1:1998 + A1:2002

Lamp power (W)	Temperature class		Surface temperature	
	Ta: -20 °C / +40 °C	Ta: -20 °C / +55 °C	Ta: -20 °C / +40 °C	Ta: -20 °C / +55 °C
20	T4	T4	T105 °C	T120 °C
50	T4	T3	T125 °C	T140 °C

(A4) Marking variations

 II 2 GD EEx de IIC T\* IP66 T\* (\* = according type)

(A5) Test report nr. **LOM 03.060 SP**

(A6) Essential Health and Safety Requirements

No change

(A7) Descriptive documents

Drawing nr. N514114B0003 

<u>Rev.</u>	<u>Date</u>
B	2002-10-07





(1) **EC-TYPE EXAMINATION CERTIFICATE SUPPLEMENT**

(2) Equipment or protective system intended for use in potentially explosive atmospheres.  
Directive 94/9/EC

(3) Supplement nr. **2** of EC-Type Examination Certificate: **LOM 02ATEX2035**

(4) Equipment or protective system: Luminaries  
Type KFL...

(5) Applicant: Cooper Crouse-Hinds, S.A.

(6) Address: Avda. Santa Eulalia, 290  
08223 TARRASA (BARCELONA)  
SPAIN

(7) Test report: **LOM 04.655 BP**

(8) Variations included in this certificate

- To increase the use for an ambient temperature Ta: -50 °C /+55 °C

(9) Marking changes

Change to the marking: Ta: -50 °C /+55 °C

(10) Change in individual tests

Each compartment of each manufactured unit must be submitted to overpressure test of 1720 kPa according paragraph 15.1.3 of EN 50018:2000.

(11) Descriptive documents

	<u>Rev.</u>	<u>Date</u>
-Description nr. Low temperature KFL.doc	-	2004-12-21

Madrid, 28th February 2005

  
Carlos Fernández Ramón  
DIRECTOR OF THE LABORATORY

OFICIAL  
LABORATORIO  
LOM  
J.M. MADARIAGA

  
Angel Vega Remosal  
Head of ATEX area

This supplement must be an inseparable part together with the base certificate **LOM 02ATEX2035**  
(This document may only be reproduced in its entirety and without any change)  
This Certificate is a translation from the original in Spanish. The LOM liability applies only on the Spanish text



(1) **EC-TYPE EXAMINATION CERTIFICATE SUPPLEMENT**

(2) Equipment or protective system intended for use in potentially explosive atmospheres.  
Directive 94/9/EC

(3) Supplement nr. 3 of EC-Type Examination Certificate: **LOM 02ATEX2035**

(4) Equipment or protective system: Luminaries  
Type KFL...

(5) Applicant: Cooper Crouse-Hinds, S.A.

(6) Address: Avda. Santa Eulalia, 290  
08223 TARRASA (BARCELONA)  
SPAIN

(7) Test report: **LOM 05.243 RP**

(8) Variations included in this certificate

To include a variant that use a halogen lamp of 50 W directly connected to mains supply at 230 V and without transformer.

Class temperature for this variant is T3

(9) Marking changes

Those that affect to electrical an thermal characteristics

(10) Change in individual tests

None

(11) Descriptive documents

	<u>Rev.</u>	<u>Date</u>
- Description nr. Ext. Nr. 3 KFL	-	2005-04-14
- Drawing nr. N514112-0006	-	2005-02-24

Madrid, 24th June 2005



Carlos Fernández Ramón  
DIRECTOR OF THE LABORATORY

Angel Vega Remesal  
Head of ATEX area

This supplement must be an inseparable part together with the base certificate **LOM 02ATEX2035**  
(This document may only be reproduced in its entirety and without any change)  
This Certificate is a translation from the original in Spanish. The LOM liability applies only on the Spanish text





(1) **EC-TYPE EXAMINATION CERTIFICATE SUPPLEMENT**

(2) Equipment or protective system intended for use in potentially explosive atmospheres.  
Directive 94/9/EC

(3) Supplement nr. **4** of EC-Type Examination Certificate: **LOM 02ATEX2035**

(4) Equipment or protective system  
Luminaries  
Type KFL...

(5) Applicant  
COOPER Crouse-Hinds

(6) Address  
Avda. Santa Eulalia, 290  
08223-TERRASSA (BARCELONA)  
SPAIN

(7) Test report nr.: **LOM 08.234 SP**

(8) Variations included in this certificate

- 1 Assessment update to the standards 60079-0:2006, EN 60079-1:2007, EN 60079-7:2007, EN 61241-0:2006 and EN 61241-1:2004
- 2 Update of the manufacturer/applicant name

(9) Changes in marking

 II 2 GD Ex de IIC T3..T4  
Ex tD A21 IP66 T... °C

Temperature classes, surface temperatures and ambient temperature ranges are indicated in the base certificate, previous supplements, and this supplement.

(10) Descriptive documents

		Rev.	Date
- Description nr.	Ext varios	-	2008-05-19
- Drawings nr.:	CCH-0805005	0	2008-05-19

Madrid, 3<sup>rd</sup> March, 2009



Carlos Fernández Ramón  
DIRECTOR OF THE LABORATORY

Angel Vega Remesal  
Head of ATEX area

This supplement must be an inseparable part together with the base certificate **LOM 02ATEX2035**

This Certificate is a translation from the original in Spanish. The LOM liability applies only on the Spanish text

*(This document may only be reproduced in its entirety and without any change)*





(1) EC-TYPE EXAMINATION CERTIFICATE SUPPLEMENT

(2) Equipment or protective system intended for use in potentially explosive atmospheres. Directive 94/9/EC

(3) Supplement nr. 5 of EC-Type Examination Certificate: LOM 02ATEX2035

(4) Equipment or protective system Luminaries Type KFL...

(5) Applicant COOPER Crouse-Hinds

(6) Address Avda. Santa Eulalia, 290 08223-TERRASSA (BARCELONA) SPAIN

(7) Test report nr.: LOM 09.424 MP

(8) Variations included in this certificate

To include a variant named KFL 7LED witch includes a LED lamp of 7 W. Power supply is 230-240 V and the equipment has direct entry. Temperature class is T6 for an ambient temperature up to 55 °C.

(9) Changes in making Marking for this variant

II 2 GD Ex de IIC T6 Ex tD A21 IP66 T80 °C

(11) Descriptive documents

Table with 3 columns: Description, Rev., Date. Rows include KFL 7 LD, CCH-0908001, and N514112-007.



Carlos Fernández Ramón DIRECTOR OF THE LABORATORY

Madrid, 2009-10-07

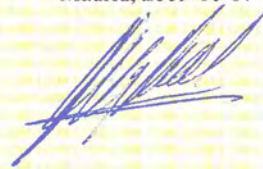

Angel Vega Remesal Head of ATEX area

This supplement must be an inseparable part together with the base certificate LOM 02ATEX2035

This Certificate is a translation from the original in Spanish. The LOM liability applies only on the Spanish text

(This document may only be reproduced in its entirety and without any change)







Los certificados del LOM son emitidos con firma digital para asegurar la autenticidad del firmante. Es posible comprobar su validez pulsando sobre la firma digital. Los certificados emitidos con firma digital para asegurar la autenticidad del firmante. Es posible comprobar su validez pulsando sobre la firma digital. Los certificados emitidos con firma digital para asegurar la autenticidad del firmante. Es posible comprobar su validez pulsando sobre la firma digital.

(1) EC-TYPE EXAMINATION CERTIFICATE SUPPLEMENT

(2) Equipment or protective system intended for use in potentially explosive atmospheres... Directive 94/9/EC

(3) Supplement nr. 6 of EC-Type Examination Certificate: LOM 02ATEX2035

(4) Equipment or protective system Luminaries Type KFL...

(5) Manufacturer COOPER Crouse-Hinds

(6) Address Avda. Santa Eulalia, 290 08223-TERRASSA (BARCELONA) SPAIN

(7) Test report nr.: LOM 14.598 MP

(8) Variations included in this certificate

- Assessment update to the standards EN 60079-0:2012, EN 60079-1:2007, EN 60079-7:2007 and EN 60079-31:2009

To allow for the KFL 7 LED variant the use of LED lamps up to 10W, with Gu10 or Gu5.3 socket, and direct mains voltage up to 277 V. The temperature class is T6 and surface temperature is T85°C for this variant

To allow the use of 20W lamps in KFL 50 variants ... with direct mains connection or via transformer

Table with 3 columns: Temperature class, Surface temperature, and sub-headers Ta ≤ 55 °C, Ta ≤ 40 °C, Ta ≤ 55 °C. Rows: T4, T105 °C, T120 °C

Ambient temperature range is maintained: -50 °C ≤ Ta ≤ +55 °C

(9) Changes in marking

KFL 50...

KFL 7LED



II 2G Ex d e IIC T4 .. T3 Gb



II 2G Ex d e IIC T6 Gb

II 2D Ex tb IIIC T105 °C... T140 °C Db

II 2D Ex tb IIIC T85 °C Db

(10) Changes in the special conditions for a safe use

Without changes

(11) Descriptive documents

Technical description nr.: KFL Extensión nr.6 0

Drawings nr.: N601114-0197 2014-11-19

Rev. Date

Getafe, 2015-04-09

Handwritten signature of Carlos Fernández Ramón

Carlos Fernández Ramón Head of Certification Committee

This supplement must be an inseparable part together with the base certificate LOM 02ATEX2035 This Certificate is a translation from the original in Spanish. The LOM liability applies only on the Spanish text

(This document may only be reproduced in its entirety and without any change)

