



**BELDEN**  
SENDING ALL THE RIGHT SIGNALS

Signal Transmission Products and Systems

# EMEA Master Catalog

**COPPER CABLE & CONNECTIVITY**

**FIBER OPTIC CABLE & CONNECTIVITY**

**CABLE MANAGEMENT SOLUTIONS**

**POWER OVER ETHERNET PRODUCTS**





Belden is an innovative company, leading where others follow. Many new products are unique and have been singled out for recognition in the trade press and by customers. Here are a few examples which are simply typical of Belden:

#### **Transforming Composite Cable Installation...**

##### **Banana Peel®**

This new idea is an installer's dream. Banana Peel® is very easy to install. It is a fully integrated version of the composite cable construction where the various cables are fixed to a centre spline for easy pulling rather than being bundled together.

A revolutionary step is the elimination of an outer jacket. This means labour saving because individual cables are instantly identifiable and ready for termination.

Simply, Belden.

## The Future is Changing and Belden is Changing the Future



#### **Big Performance From a Small Cable...**

##### **Digitruck™**

This is a revolutionary and award-winning cable. It is a miniature coaxial, weighing about 60% less than a standard Mini RG 59/U coax; that means it requires 40% less space. With superior return loss characteristics, it is designed specifically for analog, SDI, HD video and AES/EBU digital audio transmission in broadcast production trucks where space and weight are critical.

Simply, Belden.

#### **Problem Solving with Enhanced Ability...**

##### **IBDN System 10GX**

This flagship system is revolutionary in Belden's family of structured cabling systems. The fully integrated 10 Gigabit solution is designed around a series of dynamic enabling technologies. These overcome problems which other manufacturers cannot solve – namely, the ability to reduce significantly alien crosstalk and the ability to control key electrical characteristics during high frequency operation.

Simply, Belden.

## **BELDEN ... Sending All the Right Signals Around Europe, Middle East and Africa**

We focus on being the brand that is trusted...the brand that can be depended upon to give the right signals... the brand that provides the most cost effective solutions.

Belden customers enjoy working with Belden. Repeatedly, they tell us that Belden is the brand they can trust and rely on for dependable signal transmission. This is because the Belden brand has become synonymous with high quality, high performance and reliability. All that means peace of mind, all the time and in any market – broadcast, commercial networking, security, industrial, residential and many other applications.

We have earned our worldwide reputation as an expert solution provider. You are our number one priority. We care for you and we make it our job to supply you with high performance, quality products and innovative solutions on which you can rely.

Belden offers the very widest range of signal transmission products. We provide all the data and backup support necessary to help you to make the right decision to meet your requirements and to solve your problems.

The company is continually growing, evolving and developing. That means ongoing research and development to bring to market the very best in signal transmission technology – copper, optical fiber, wireless and so on. Consequently, the product range has expanded to include complete system solutions including, for example: connectivity equipment, enclosures, cable raceways and racks.



## The Future is Changing and Belden is Changing the Future

### **Your Starting Point**

This EMEA Master Catalog is your single source solution – the easy to read and comprehensive reference to thousands of cabling and signal transmission products and related products.

The Catalog is designed to be the essential tool which will provide the answer and solve the problem – whatever the application and wherever you are in Europe, the Middle East, Africa or elsewhere.

In addition, all the information in these pages, together with easy-to-access tools and helpful advice, can be found on [www.belden-emea.com](http://www.belden-emea.com)



# 1 Table of Contents

## Visit our Website

Our website is a valuable online resource for Belden wire and cable products, services, support, solutions, and purchasing information. Point your browser to [www.belden-emea.com](http://www.belden-emea.com) to find out more.

## Contact One of Our Sales Representatives for Assistance

Call +31-77-3878-555 or email us at [venlo.salesinfo@belden.com](mailto:venlo.salesinfo@belden.com).

## To Place an Order

For many of the products in the catalog, you will find everything you need in this catalog to place an order. Should you need assistance, please contact your Belden sales representative. A complete list of all of our sales offices can be found on the back cover of this catalog or at [www.belden-emea.com](http://www.belden-emea.com).

## How to Use the Belden Master Catalog

### If You're Not Sure of What You Need...

#### Select by Cable Type or Application

Use the section index below or look at the more detailed Table of Contents pages found at the beginning of each section to find your cable type or application.

#### Select by Keyword

Reference the Table of Contents section on the following pages for an alphabetical listing of product keywords.

#### Consult the Cable Finder Guide

If you know the gage size, shielding type, and/or number of conductors needed for your application, you can locate a part number and corresponding catalog page number for all matching multi-conductor and paired cable products in the Cable Finder Guide (section 2).

### If You Know the Belden Part Number..

#### Consult the Index in the Back of the Catalog

In the Part Number Index (section 24), you'll find a numerical listing of Belden part numbers. This comprehensive index lists every product featured in the Belden Master Catalog.

## Section Index

Section Name	Section No.
Table of Contents	1
Cable Finder Guide	2
Hook-Up and Lead Wire	3
Multi-Conductor Cables	4
Paired Cables	5
MIL-C-17 Coaxes	6
Shipboard and Offshore Cables	7
Cable Assembly	8
Broadband Coax Cables	9
Enclosures and Accessories	11
Open Frame Racks and Accessories	12
Surface Raceway Systems	13
Commercial Networking – Copper	15
Commercial Networking – Optical Fiber	16
Commercial Networking – Training	17
Industrial Automation and Control Cables	18
Brilliance® Broadcast Cables	19
New Generation® Sound, Security and Alarm Cables	20
Residential Cables	21
Glossary of Terms	22
Technical Information	23
Part Number Index	24

# Table of Contents

## Alphabetical Index

Products	
<b>10GX®</b> , Belden IBDN® System	15.6 – 15.8
<b>110 Cross-Connect System</b>	15.21 – 15.23
<b>Access Control Cable</b>	20.45
<b>AES/EBU Digital Audio Cable</b> 19.16 – 19.18	
<b>AES-3id Cable</b>	19.27 – 19.34
<b>Alarm &amp; Security Cable</b>	4.13 – 4.14 20.46 – 20.55
<b>Analog Audio Cable</b>	19.11 – 19.15 18.34
<b>Antenna Coax</b>	6.3 – 6.4 9.27 – 9.32
<b>Armored Cable</b>	4.21 15.56 18.9, 18.11 18.13 – 18.15 18.18 18.20 – 18.21 18.31 – 18.35
<b>Armoring Capabilities</b>	18.2, 23.12
<b>Assemblies</b>	
Brilliance® (Broadcast)	8.3 – 8.6
Copper Cable (Networking)	15.7, 15.9 – 15.13
Optical Fiber	16.6 – 16.9
SMPT311	8.6
<b>Audio, Communication &amp; Instrumentation Cables</b> 19.21	
<b>Audio Wire &amp; Cable</b>	
Brilliance® Broadcast	19.9 – 19.22
Coaxial	19.23 – 19.34
Multi-Conductor	4.4
New Generation® Commercial Audio	20.10
Paired	5.4 – 5.5 5.10 – 5.11 5.22 – 5.23
Residential	21.10 – 21.11
<b>Augmented Category 6</b>	15.6 – 15.8
<b>Automation</b>	
Factory	(see Industrial Section)
Home	(see Residential Section)
<b>Backbone Cable</b>	
Copper	15.44 – 15.63
Optical Fiber	16.25 – 16.64
<b>Banana Peel®</b>	
Brilliance® Assemblies	8.4
Composite Data, Audio, Video, Security & Control Cables	21.4 – 21.5
DataTwist® 350	15.55
New Generation®	20.44 – 20.45
Video Multicore	19.33 – 19.34, 21.13
<b>Belden IBDN® System 10GX® Structured Cabling</b>	15.6 – 15.8

Products (continued)	
<b>Belden Infinity® Cable</b>	18.37 – 18.38
<b>BIX Cross-Connect System</b>	15.16 – 15.20
<b>Blue Hose® Cable</b>	18.13 – 18.14
<b>Bonded Pairs</b>	
Broadcast	19.22
Copper	15.44, 15.46, 15.48 – 15.49 15.55, 15.61 15.64 – 15.65 15.69 – 15.70
Industrial	18.7 – 18.11
Residential	21.9
<b>Breakout-Kit Optical Cable</b>	16.32
<b>Breakout Optical Cable</b>	16.28
<b>Breakout Style Optical Cable</b>	16.62
<b>Brilliance® Audio Cable</b>	19.9 – 19.22 21.9 – 21.11
<b>Brilliance® Cable</b>	(see Broadcast Cable)
<b>Brilliance® VideoFLEX® Cable</b>	19.31 – 19.32
<b>Brilliance® VideoTwist® UTP Cable</b>	21.9
<b>Broadband Cable</b>	9.9 – 9.26
Commercial Networking	15.69 – 15.71
<b>Broadcast Cable</b>	19.8 – 19.34
75 Ohm Standard Analog Video Coax	19.25
AES/EBU Digital Audio Cable	19.16 – 19.18
Analog Multi-Pair Snake Cable	19.12 – 19.15
Audio/Video & Composite Cable	19.21
Banana Peel® Cable	19.33 – 19.34
Bundled Analog/Digital Coax	19.26 19.31 – 19.34
Connector Cross	19.7
DigiTruck™ Mini Coax	19.27
Line-Level Analog Audio Cable	19.11
Low Loss Serial Digital Coax	19.27 – 19.34
Microphone & Musical Instrument Cable	19.9 – 19.10, 19.21
Precision Video Coax for Analog & Digital	19.27 – 19.34
RGB Component Video Cable	19.26 19.31 – 19.34
Residential	21.12 – 21.13
RJ-45 Cable for A/V Applications	19.22
S-Video Cable	21.12
Shipboard Audio/Video Cable	7.3 – 7.4
Snake Cable analog	19.12 – 19.15
Snake Cable digital	19.17 – 19.18
Speaker Wire and Cable	19.19 – 19.20
Special Audio, Communication & Instrumentation Cable	19.21
Standard Analog Video Coax	19.25
Tactical Mobile Optical Fiber Cable	19.8

Products (continued)	
<b>Broadcast Cable (continued)</b>	
Technical Information	19.3 – 19.6
Video Triax Cable	19.23 – 19.24
<b>Burglar Alarm Cable</b>	20.11 – 20.33
<b>Burial Cable</b>	(see Direct Burial Cable)
<b>Cabinets, Enclosures &amp; Accessories</b>	11.1 – 11.29
<b>Cable Management Products</b>	
Cable Ties	12.8 – 12.10
Modular Enclosures & Accessories	11.3 – 11.27
Open Frame Racks & Accessories	12.3 – 12.7
Surface Raceway Systems	13.3 – 13.4
Wall Mount Enclosures & Accessories	11.28 – 11.29
<b>Cable Raceways</b>	13.2 – 13.4
<b>Cable Ties</b>	12.8 – 12.10
<b>California Proposition 65 Regulations</b>	23.21
<b>Camera Cable</b>	19.8
<b>CANopen Cable</b>	18.28
<b>Category 3 Cables</b>	15.58 – 15.59
<b>Category 5 Cables</b>	15.56 – 15.57
<b>Category 5e Cables</b>	15.49 – 15.55
<b>Category 5e Connectivity</b>	15.11
<b>Category 5e Patch Cables</b>	15.62 – 15.63 15.65 – 15.66
<b>Category 6 Cables</b>	15.44 – 15.48, 15.51
<b>Category 6 Connectivity</b>	15.7 15.9 – 15.10
<b>Category 6 Patch Cables</b>	15.61, 15.64
<b>Category 7 Cables</b>	15.60
<b>CatSnake™ Cat 5e Audio/Video Cable</b>	19.22
<b>CCTV Cable</b>	19.25 20.34 – 20.38 20.39 – 20.45
<b>Central Loose Tube Optical Cable</b>	16.33 – 16.40 16.64
<b>Class A, Broadband (CATV) Cable</b>	9.8
<b>Class D, Category 5e</b>	15.62 – 15.63
<b>Class E, Category 6</b>	15.61
<b>Class F, Category 7</b>	15.60
<b>Closed Circuit TV (CCTV)</b>	19.25 20.34 – 20.38 20.39 – 20.45
<b>Coaxial Cable</b>	
50 Ohm Transmission Cable	9.27 – 9.32
Analog Video Cable	19.25
Brilliance® Assemblies	8.3 – 8.6
Brilliance® VideoFLEX® Cable	19.31 – 19.32
Broadband: CATV	9.9 – 9.26
Broadband: Class A Cable	9.8
Broadband: Coaxial Cable	9.9 – 9.26

# Table of Contents

## Alphabetical Index

<b>Products (continued)</b>	
<b>Coaxial Cable (continued)</b>	
Broadband: Headend/Video Cable	9.26 19.25, 19.28
Broadband: MATV	9.24, 19.25
Broadcast Coaxial Cable	19.25 – 19.34
Bundled RGB	19.26, 19.31 – 19.34
Burial Coaxial Cable	7.4, 9.18
CATV Coaxial Cable	9.9 – 9.26
Coaxial Cable Finder	2.24 – 2.33
Computer & Instrumentation Cable	15.69, 15.71
Conformable® Coax	9.32
Digital Video Cable	19.27 – 19.34
HDTV Coax	19.27 – 19.34
HDTV/SDI Digital Video	19.27 – 19.34
Headend/Video Cables	9.26 19.25, 19.28
High-Flex Coax	19.28 – 19.29 21.12
High-Flex S-Video (Y/C)	21.12
Industrial	18.18 – 18.19
Industrial Coax	18.12 18.18 – 18.19
Industrial Twinax	18.13 – 18.17
Local Area Network (LAN) Coax	15.69, 15.71 18.12
Low Loss 50 Ohm Wireless	9.27 – 9.29
LSZH and ABS Type Approved	7.4
MIL-C-17G QPL Cable	6.3 – 6.6
Microwave Cable	9.32
Miniature Coaxial Cable	19.31, 19.33
Plenum-Rated Coax	4.4, 4.12 5.5, 5.8, 5.10, 5.22 15.67 – 15.70 15.77 – 15.78 18.14, 18.16 18.31, 18.34
Precision Video Coax for Analog & Digital	19.27 – 19.34
RF Transmission Cable	9.30 – 9.31
RF & Wireless Coax	9.27 – 9.32
RGB Coax	19.26, 19.31 – 19.34
RG-Types	23.15
Security	20.34 – 20.38
Siamese Cable	(see ShotGun)
Snake Cable	19.12 – 19.15 19.17 – 19.18
Standard Analog Video Coax	19.25
SVHS	21.12
S-Video	21.12
Technical Information	9.3

<b>Products (continued)</b>	
<b>Coaxial Cable (continued)</b>	
Thicknet	15.69, 18.12
Transmission Cable	9.27 – 9.32
Triax Cable	19.23 – 19.24
Twinax Cable	18.13 – 18.17 19.16
Video Triax Cable	19.23 – 19.24
Wireless RF Transmission Cable	9.27 – 9.32
<b>Color Code Charts</b>	23.17 – 23.19
<b>Commercial Networking – Copper</b>	15.2 – 15.72
<b>Cables</b>	15.44 – 15.72
Armored U/UTP Cable	15.56
Certified System Cables	15.44 – 15.50
DataTwist® Cable	15.44, 15.49 15.51 – 15.53, 15.55 15.57 – 15.58
D-Series Cable	15.59
F/UTP Shielded Twisted Pair Cable	15.61 – 15.62 15.66
GigaFlex® Cable	15.9 – 15.11
MediaTwist® Cable	15.48, 15.64
S/FTP Shielded Twisted Pair Cable	15.60
SF/UTP Shielded Twisted Pair Cable	15.63
U/UTP Unshielded Twisted Pair Cable	15.44 – 15.59 15.64 – 15.66
VideoTwist® Cable	15.67 – 15.68
<b>Connectivity</b>	15.6 – 15.42
110 Cross-Connect System	15.21 – 15.23
Belden IBDN® System 10GX®	15.6 – 15.8
BIX Cross-Connect System	15.16 – 15.20
GigaBIX® Multi System	15.12 – 15.15
Introduction	15.2 – 15.5
Labels	15.24
Line Protection and Bonding & Grounding	15.43
Modular Cords	15.38 – 15.41
Network Connectivity Products	15.42
Patch Panels	15.25 – 15.26
Workstation Outlets	15.27 – 15.37
<b>Commercial Networking – Optical Fiber</b>	16.2 – 16.64
<b>Cables</b>	16.25 – 16.58
Breakout Kit	16.32
Breakout Cables	16.28
Breakout Style Cable	16.62
Cable Selection Guide	16.22
Cable Selection Guide Plenum	16.24
Cable Quality Selection Guide	16.21
Central Loose Tube Cable	16.33 – 16.40 16.64

<b>Products (continued)</b>	
<b>Commercial Networking – Optical Fiber (continued)</b>	
Color Code Charts	16.23
CST, Armored	16.36, 16.39, 16.45 – 16.46 16.55 – 16.56
Distribution Cable	16.29 – 16.32 16.60 – 16.61
FRP, Armored	16.35
Industrial Armored	18.36
Interconnect – Simplex & Duplex	16.25 – 16.27 16.59
Mini Breakout Optical Cable (Distribution)	16.29 – 16.32
Multi Loose Tube Cable	16.41 – 16.58
Plenum Cable	16.59 – 16.64
SWA, Armored	16.40, 16.47 – 16.48 16.57 – 16.58
Tactical Cable	19.8
<b>Connectivity</b>	16.4 – 16.17
FiberExpress Connectors	16.4 – 16.5
FiberExpress Manager	16.11
FiberExpress Outlets	16.15 – 16.16
FiberExpress Patch Panel Accessories	16.14
FiberExpress Patch Panels	16.12 – 16.13
FiberExpress Secure/Keyed LC System	16.9 – 16.10
Introduction	16.2 – 16.3
Network Connectivity Products	16.17
Pre-Connectorized Assemblies	16.6 – 16.8
<b>Commercial Networking – Training</b>	17.2 – 17.6
Copper Products	17.5
Design and Concept	17.4
End-to-End Installation/Testing – Copper	17.6
End-to-End Installation/Testing – Optical Fiber	17.6
Intro to Belden	17.3
Installation	17.4
Optical Fiber Products	17.5
Overview	17.2
Project Management	17.3
<b>Composite Cable</b>	15.72 18.22, 18.26 – 18.27, 18.29 19.19 20.39 – 20.45 21.4 – 21.6
<b>Computer Cable</b>	
EIA RS-232	4.2, 4.6 – 4.7 4.9 – 4.11 5.13 – 5.18 5.25 – 5.26
EIA RS-422	5.9, 5.13, 5.17 5.20, 5.25
EIA RS-423	4.11

## Table of Contents

### Alphabetical Index

<b>Products (continued)</b>	
<b>Computer Cable (continued)</b>	
EIA RS-485	5.14
Ethernet/IP™ Compliant	18.7 – 18.9
IBM Cabling System	15.71 – 15.72
IEEE 802.3 Trunk and Transceiver Cables	15.70
IEEE 802.4 (MAP)	15.71
IEEE 802.5	15.71
Industrial Data	18.7 – 18.36
Industrial Ethernet	18.7 – 18.11
Local Area Network (LAN)	15.44 – 15.72
Low-Capacitance	4.11 5.9, 5.13 – 5.18 5.20, 5.25 19.11
Multi-Conductor	4.2 4.6 – 4.7 4.9 – 4.11
Optical Fiber	16.25 – 16.58
Paired	5.3, 5.7 – 5.9 5.13 – 5.18 5.20, 5.25
Residential	21.4 – 21.6
Thicknet	15.71, 18.12
Thinnet	15.69
Transceiver	15.70
Trunk	15.69, 18.12
<b>Conductors</b>	23.2 – 23.5
<b>Conformable® Coaxial Cable</b>	9.32
<b>Connectivity – Copper</b>	15.2 – 15.72
<b>Connectivity – Optical Fiber</b>	16.4 – 16.17
<b>Connectors</b>	
Copper	15.6, 15.9 – 15.11
Optical Fiber	16.4 – 16.5
<b>Control Cable</b>	
High-Temperature	4.15 – 4.34
Industrial – Belden Infinity®	18.37 – 18.38
Multi-Conductor (also see Industrial section)	4.4 – 4.12
Paired	5.10 – 5.11 5.22 – 5.23
Residential	21.7 – 21.8
<b>ControlBus™ Cable</b>	18.19
<b>ControlNet™ Cable</b>	18.18
<b>Cross-Connect Systems</b>	15.16 – 15.23
<b>D-Series Cable</b>	15.59
<b>DataBus® Cable</b>	18.20 – 18.21
<b>Data Cable</b>	
Broadcast	19.22
Commercial Networking – Copper	15.44 – 15.72
Commercial Networking – Optical Fiber	16.25 – 16.58

<b>Products (continued)</b>	
<b>Data Cable (continued)</b>	
Industrial	18.7 – 18.11
Residential	21.4 – 21.6, 21.9
<b>Datalene® Cable</b>	
	4.11 5.9, 5.14, 5.17 5.20, 5.25 15.70, 15.72 18.16, 18.29, 18.33 19.16 – 19.17
<b>DataTray® Cable</b>	
	18.17
<b>DataTuff® Cable</b>	
	18.7 – 18.11
<b>DataTwist® Cable</b>	
	15.44, 15.49 15.51 – 15.53 15.55, 15.57 – 15.58
<b>DeviceBus® Cable</b>	
	18.22 – 18.27
<b>DeviceNet™ Cable</b>	
	18.22 – 18.24
<b>Digital Audio Cable</b>	
	5.25 19.16 – 19.18
<b>Digital Video Cable</b>	
	19.27 – 19.34 21.12
<b>Digital Video Time Code</b>	
	19.16
<b>DigiTruck® Mini Coax</b>	
	19.27, 21.12
<b>Direct Burial Cable</b>	
	4.8 9.9 – 9.11 15.69, 18.12 19.23 – 19.24
<b>Distribution Optical Cable</b>	
	16.29 – 16.32 16.60 – 16.61
<b>Distribution Broadband Cable</b>	
	9.12 – 9.15
<b>DMX512</b>	18.28, 18.32, 19.21
<b>Drop Broadband Cable</b>	
	9.16 – 9.25
<b>DT-12 Audio Snake Cable</b>	
	19.14
<b>Duplex Optical Cable</b>	
	16.26 – 16.27
<b>Duplex Primary Wire</b>	
	4.5
<b>EIA RS-232</b>	4.2, 4.6 – 4.7 4.9 – 4.11 5.13 – 5.18 5.25 – 5.26
<b>EIA RS-422</b>	5.9, 5.13, 5.17 5.20, 5.25
<b>EIA RS-423</b>	4.11
<b>EIA RS-485</b>	5.14
<b>EIB/KNX Cables</b>	21.8
<b>Enclosures &amp; Accessories</b>	
Cable Management Accessories	11.24
Climate Monitor	11.27
Cooling Devices & Fans	11.5, 11.8, 11.11 11.14, 11.17, 11.27
Fan Controllers	11.27
Introduction	11.2
Modular Enclosures	11.3 – 11.19
Modular Enclosure Options & Accessories	11.20 – 11.27

<b>Products (continued)</b>	
<b>Enclosures &amp; Accessories (continued)</b>	
Power Strips & Power Accessories	11.25 – 11.26
Swing Racks	11.29
Wall Mount Enclosures & Accessories	11.28 – 11.29
<b>Enhanced Category 5e Cables</b>	15.49 – 15.50
<b>Enhanced Category 6 Cables</b>	15.44 15.47 – 15.48
<b>Environmental Regulations and Compliance</b>	
	23.21
<b>Ethernet Hubs</b>	15.42
<b>European Union Restrictions</b>	23.21
<b>Faceplates</b>	
	15.31, 15.33
Copper System	15.6 – 15.23
Optical Fiber Guide to installation	16.20
<b>FEP Cable</b>	
Industrial	18.12, 18.14, 18.16 18.31, 18.34
Multi-Conductor	4.4, 4.12
Networking	15.44 – 15.45, 15.47 – 15.48 15.50, 15.53, 15.55, 15.69
Paired	5.8, 5.10, 5.22
<b>Fiber Optic Cable</b>	
Breakout Kit	16.32
Breakout Cable	16.28
Breakout Style Cable	16.62
Cable Quality Selection Guide	16.21
Cable Selection Guide	16.22
Cable Selection Guide Plenum	16.24
Central Loose Tube Cable	16.33 – 16.40 16.64
Color Code Charts	16.23
CST, Armored	16.36, 16.39 16.45 – 16.46 16.55 – 16.56
Distribution Cable	16.29 – 16.32 16.60 – 16.61
FRP, Armored	16.35
Industrial Armored	18.36
Interconnect – Simplex & Duplex	16.25 – 16.27 16.59
Mini Breakout Optical Cable (Distribution)	16.29 – 16.32
Multi Loose Tube Cable	16.41 – 16.58
Plenum Cable	16.59 – 16.64
SWA, Armored	16.40, 16.47 – 16.48 16.57 – 16.58
Tactical Cable	19.8
<b>FiberExpress Connectivity &amp; Systems</b>	
	16.4 – 16.17
<b>Field Installable Fiber Connectors</b>	16.4 – 16.5

# Table of Contents

## Alphabetical Index

<b>Products (continued)</b>	
<b>Fire Alarm Cable</b>	20.46 – 20.55
<b>Flexible Automation Cable</b>	18.37 – 18.38
<b>FlexSnake® Snake Cable</b>	19.13
<b>F/UTP Shielded Twisted Pair Cable</b>	15.61 – 15.62 15.66
<b>GigaBIX Multi System</b>	15.12 – 15.15
<b>GigaFlex Cable</b>	15.9 – 15.11
<b>Glossary of Terms</b>	22.2 – 22.13
<b>Halogen-Free Cable</b>	
Broadband	9.9, 9.12 9.14 – 9.16 9.19 – 9.26
Broadcast	19.14, 19.17 – 19.18
Hook-Up Wire	3.16 – 3.20
Industrial	18.7, 18.13 18.15 – 18.16 18.20 – 18.21 18.30 – 18.35
Multi-Conductor	4.17 – 4.28
Networking	15.45 – 15.47, 15.49 – 15.54 15.59, 15.61 – 15.63, 15.66
New Generation®	20.12 – 20.13 20.15 – 20.17, 20.19 20.21 – 20.22 20.24, 20.26 – 20.27 20.29 – 20.39 20.47 – 20.51, 20.56
Optical Fiber	16.25 – 16.31, 16.37 – 16.40 16.51 – 16.58
Residential	21.7 – 21.8
Shipboard & Offshore	7.3 – 7.7
<b>Halogen-Free Standards</b>	23.20
<b>Hart Cable</b>	18.28
<b>Heavy Metal Free Compliance</b>	23.21
<b>High Definition (HD) Coaxes</b>	19.27 – 19.34
<b>High-Temperature Cable</b>	3.21 – 3.22 4.31 – 4.34
<b>Home Automation (see Residential Cable)</b>	
<b>Hook-Up Wire</b>	
EFLAS	3.23
ETFE	3.10 – 3.11
FEP	3.6 – 3.9
Glass Braid	3.21
Kapton®	3.21
Mica	3.22
PFA	3.12
PTFE	3.5
PTFE/Kapton®/PTFE	3.4
Silicone Rubber FRNC	3.16 – 3.20
Technical Information	3.3
Trakrad100	3.13
Zyrad®	3.14 – 3.15

<b>Products (continued)</b>	
<b>Horizontal Cable – Copper</b>	15.44 – 15.63
<b>Hubs, Ethernet</b>	
	15.42 16.17
<b>Hubs, Midspan – Power over Ethernet</b>	14.2 – 14.6
<b>IBM Cable</b>	15.71 – 15.72
<b>IDC Systems</b>	15.6 – 15.23
<b>Industrial Armored Optical Cable</b>	18.36
<b>Industrial Automation &amp; Control Cables</b>	
Armored Cable	18.9, 18.11 18.13 – 18.15 18.20 – 18.21 18.32 – 18.35
Belden Infinity® Flexible Automation Cable	18.37 – 18.38
Blue Hose® Cable	18.13 – 18.14
Burial Cable	18.7 – 18.11
CANopen Cable	18.28
Coaxial	18.18 – 18.19
ControlBus™ Coax	18.19
Control Cable	18.30 – 18.31
ControlNet™ Coax	18.18
Cross Reference Guide	18.3 – 18.4
DataBus® FieldBus or Profibus	18.20 – 18.21
Data Cables	18.7 – 18.12
Datalene®	18.16, 18.28, 18.33
DataTray® 600V Twinaxial Cable	18.17
DataTuff® Cable	18.7 – 18.11
DeviceBus®	18.22 – 18.27
DeviceNet™, ODVA	18.22 – 18.24
EIA Industrial RS-485	18.28
Ethernet/IP™ Compliant	18.7 – 18.9
FEP	18.8, 18.10 18.12, 18.14 18.16, 18.19 18.22, 18.34
Fiber Optic Cable	18.36
Flat Cable	18.28
Foundation FieldBus	18.20 – 18.21
Hart Cable	18.28
High-Flex Cable	18.13 18.22 – 18.24 18.37 – 18.38
Honeywell Smart Distributed System Cables	18.25
Industrial Coax	18.12, 18.18 – 18.19
Industrial Communications Protocol	18.5
Industrial Data Solutions®	18.7 – 18.36
Industrial Ethernet	18.7 – 18.11
Industrial Twinax	18.13 – 18.17
Infinity, Belden – Flex Data Cable	18.37 – 18.38

<b>Products (continued)</b>	
<b>Industrial Automation &amp; Control Cables (continued)</b>	
Infinity, Belden Flexible Automation Cable	18.37 – 18.38
Instrumentation 300V, PLTC	18.28
Interconnect Cable	18.35
Low-Smoke, Zero-Halogen (LSZH) Cable	18.7, 18.13 18.15 – 18.16, 18.18 18.20 – 18.21, 18.30 – 18.35
MAP and Mini-MAP Cable	18.15 – 18.16
ODVA DeviceNet™ Cables	18.22 – 18.24
Optical Fiber Cable	18.36
Phoenix Contact Interbus®-S Cables	18.27
PLC/DCS Cables	18.7 – 18.35
PLC/DCS Cable Cross Reference Guide	18.3 – 18.4
Plenum	18.8, 18.10 18.12, 18.14 18.16, 18.18 – 18.19 18.33 – 18.35
PLTC Cables	18.10, 18.14, 18.17 18.20 – 18.24 18.28 – 18.29
Profibus Cables	18.20 – 18.21
Square D/Seriplex® Cables	18.26
Tactical Optical Fiber	18.36
TC Cable	(see Tray Cable)
Teflon®	18.12, 18.14, 18.16
Tray (TC) Cable	18.17
Twinaxial	18.15 – 18.16
<b>Infinity®, Belden – Flexible Automation Cable</b>	18.37 – 18.38
<b>Instrumentation Cable</b>	
Coaxial	6.3 – 6.6
Flat Cable	18.28
High-Temperature	3.3 – 3.22
Multi-Conductor	4.4 – 4.38
<b>Interconnect Optical Cable</b>	16.25 – 16.27, 16.59
<b>Jacks</b>	15.25 – 15.37
<b>Keypad Cable (Residential)</b>	21.6
<b>KNX</b>	(see EIB)
<b>Land Mobile Radio Coax</b>	9.27 – 9.29
<b>Lead Wire</b>	(see Hook-Up Wire)
<b>Line-Level Audio Cable</b>	19.11
<b>LonWorks</b>	21.7 – 21.8
<b>Low-Capacitance Cable</b>	(see Computer, Low-Capacitance Cable)
<b>Low-Smoke, Zero-Halogen Cables</b>	3.16 – 3.20 4.17 – 4.28 7.3 – 7.7 9.9, 9.12, 9.14 – 9.16 9.19 – 9.26 15.45 – 15.54 15.61 – 15.63, 15.66



## Table of Contents

### Alphabetical Index

<b>Products (continued)</b>		<b>Products (continued)</b>		<b>Products (continued)</b>	
<b>Low-Smoke, Zero-Halogen Cables</b>	16.25 – 16.31	<b>Musical Instrument Cable</b>	19.21	<b>Plenum Cable (continued)</b>	
<i>(continued)</i>	16.37 – 16.40	<b>NanoSkew® UTP Cables</b>	21.9	Local Area Network (LAN)	15.44 – 15.70
	16.51 – 16.58	<b>New Generation® Cable</b>	20.2 – 20.56	Multi-Conductor	4.4, 4.12
	18.7, 18.13	Access Control Banana Peel® Cable	20.45	Optical Fiber	16.58 – 16.64
	18.15 – 18.16	Cable Finder Guide	20.3 – 20.9	Paired	5.5, 5.8, 5.10, 5.22
	18.20 – 18.21	CATV Cable	20.34 – 20.38	<b>PoE Products</b>	14.3 – 14.6
	18.30 – 18.35	CCTV Surveillance Cable	20.34 – 20.45	<b>Power-Limited Tray Cable, PLTC</b>	18.10
19.14, 19.17 – 19.18	20.12 – 20.13	Composite Cable	20.39 – 20.45		18.14, 18.17
20.15 – 20.17, 20.19	20.21 – 20.22	Fire Alarm Cable	20.46 – 20.55		18.20 – 18.24
20.24, 20.26 – 20.27	20.29 – 20.39	MATV Cable	20.38		18.28 – 18.29
20.47 – 20.51, 20.56	21.7 – 21.8	Pan/Tilt/Zoom (PTZ) Banana Peel®	20.44	<b>Power over Ethernet (PoE) Products</b>	14.2 – 14.6
		Pan/Tilt/Zoom (PTZ) Camera Cable	20.39	<b>PowerSense® PoE Products</b>	14.2 – 14.6
<b>MAP &amp; Mini-MAP Cables</b>		Security and Alarm Cable	20.11 – 20.33	Accessories	14.6
<b>(IEEE 802.4 &amp; 802.7)</b>	15.71	Security and Surveillance		Introduction	14.2
<b>MATV Cable</b>	19.25	CCTV Cable	20.34 – 20.45	Midspan Hubs	14.3 – 14.5
<b>Media Converters</b>	15.42	Security Coaxial Cable	20.34 – 20.38	<b>Power Strips &amp; Power Accessories</b>	11.25 – 11.26
<b>MediaTwist® Cable</b>	15.48, 15.64	UTP CCTV Surveillance Cable	20.41 – 20.42	<b>Preterminated Fiber Assemblies</b>	16.6 – 16.8
	21.9	<b>Networking Cable</b>	(see Commercial	<b>Process Control Cable</b>	18.7 – 18.38
<b>Messenger Cable</b>	9.9 – 9.11, 9.13, 9.17		Networking: Copper and	<b>Professional Music Cable</b>	19.9 – 19.10, 19.21
	16.49 – 16.50		Commercial Networking: Optical Fiber)	<b>Profibus Cable</b>	18.20 – 18.21
<b>Metric Conversions</b>	23.15 – 23.16	<b>Network Connectivity Products</b>	15.42	<b>PTZ (Pan/Tilt/Zoom) Camera Cable</b>	20.39 – 20.45
<b>Microphone &amp; Musical</b>		<b>Network Tester</b>	15.42	<b>Quad, Mini-Star</b>	19.10
<b>Instrument Cable</b>	19.9 – 19.10	<b>ODVA DeviceNet™ Cable</b>	18.22 – 18.24	<b>Raceways</b>	13.2 – 13.4
<b>Microwave Cable</b>	9.32	<b>Open Frame Racks &amp; Accessories</b>	12.2 – 12.10	<b>Racks</b>	12.3 – 12.7
<b>Midspan Hubs for Power</b>		Cable Ties	12.8 – 12.10	<b>Residential Cable</b>	21.2 – 21.14
<b>over Ethernet</b>	14.2 – 14.6	Introduction	12.2	Alarm, Security and Speaker Cable	21.4 – 21.6
<b>Military Specifications</b>		<b>Optimax® Connectors</b>	16.4	Banana Peel® Cable	21.4 – 21.5
MIL-C-17	6.3 – 6.6	<b>Outlets, Optical Fiber</b>	16.15 – 16.16	Coaxial Cable	21.12
<b>Mini Breakout Optical Cable</b>	16.29 – 16.32	<b>Packaging, Cable</b>	23.22	Composite Cable	21.4 – 21.7
<b>Mini-MAP Cables</b>	18.19	<b>Paired Cables</b>	5.4 – 5.26	Compression Tool	21.14
<b>Modular Cords</b>	15.38 – 15.41	Individually Shielded	5.19 – 5.23	Connectors	21.14
<b>Modular Enclosures &amp; Accessories</b>	11.2 – 11.29	Individually Shielded Pairs		Data & Voice Cable	21.6
<b>Modules</b>	15.6, 15.9 – 15.11	with Overall Foil/Braid Shield	5.24 – 5.25	EIB/KNX Cables	21.8
<b>Multi-Conductor Cable</b>	4.4 – 4.38	Overall Beldfoil® Shield	5.6 – 5.11	Fiber Optic Cable	21.4
FEP	4.29	Overall Braid Shield	5.26	HDTV Cable	21.12 – 21.13
FEP-Overall Braid	4.30	Overall Foil/Braid Shield	5.12 – 5.18	Keypad Cable	21.7
Fire Alarm Cable	4.13 – 4.14	Selection Guide	5.3	LonWorks	21.7
Glass Fiber-Glass Braid	4.31 – 4.32	Unshielded	5.4 – 5.5	Security & Alarm Cable	21.2 – 21.3
High-Temperature Control	4.29 – 4.34	<b>Patch Cords</b>		Speaker Cable OFHC	21.10 – 21.11
Mica-Ceramic Braid	4.33	Copper	15.7, 15.9 – 15.11	Stripping Tool	21.14
Micaflame® Glass Braid	4.34	Optical Fiber	16.6 – 16.8	Tools and Accessories	21.14
Overall Beldfoil® Shield	4.6 – 4.8	<b>Patch Panels</b>		Video Cable	21.12 – 21.13
Overall Foil/Braid Shield	4.9 – 4.12	Copper	15.25 – 15.26	<b>Restriction on Hazardous Substances</b>	
PVC	4.35 – 4.38	Optical Fiber	16.12 – 16.14	<b>(RoHS) Regulations</b>	23.21
RS-232 and RS-423	4.11	<b>PLC/DCS Cable</b>	18.7 – 18.35	<b>RF Coaxial</b>	9.27 – 9.29
Silicone Rubber	4.17 – 4.28	<b>PLC/DCS Cross Reference Guide</b>	18.3 – 18.4	<b>RGB Coaxial</b>	19.26, 19.31 – 19.34
TPE	4.15 – 4.16	<b>Plenum Cable</b>			21.13
Unshielded	4.4 – 4.5	Industrial	18.8, 18.10	<b>RJ-45 Cable for A/V Applications</b>	19.22
<b>Multi Loose Tube Optical Cable</b>	16.41 – 16.58		18.12, 18.14	<b>Robotic Cable</b>	18.37 – 18.38
<b>Multi-Pair Cable</b>	(see Snake Cables)		18.16, 18.18 – 18.19	<b>RoHS Regulations</b>	23.21
			18.31		
			18.33 – 18.35		

## Table of Contents

### Alphabetical Index

<b>Products (continued)</b>	
<b>Satellite, Direct Broadcast Cable</b>	9.16 – 9.25
<b>Secure Fiber Connectivity</b>	16.9 – 16.10
<b>Security &amp; Alarm Cable</b>	20.11 – 20.33 21.4
<b>Serial Digital (SDI) Coaxes</b>	19.27 – 19.34
<b>S/FTP Shielded Twisted Pair Cable</b>	15.60
<b>SF/UTP Shielded Twisted Pair Cable</b>	15.63
<b>Shielding, Technical Information</b>	23.14 – 23.15
<b>Shipboard Audio/Video Cables</b>	7.3
<b>ShotGun</b>	9.21 – 9.22, 9.25
<b>Simplex Optical Cable</b>	16.25
<b>SMPT 311 HD Camera Cable</b>	19.8
<b>Snake Cable</b>	19.12 – 19.15 19.17 – 19.18
<b>Sound Cables, Commercial</b>	21.10 – 21.11
<b>Speaker Cable</b>	
Brilliance® Broadcast	19.19 – 19.20
Residential	21.10 – 21.11
<b>Special Application Audio</b>	19.21
<b>Star Quad Cables</b>	19.10, 19.12
<b>Stereo Connecting Cable</b>	19.11, 19.16, 21.10
<b>Structured Cable</b>	21.4 – 21.6
(also see Commercial Networking – Copper & Optical Fiber)	
<b>Structured Cabling Systems</b>	
Copper	15.2 – 15.72
Optical Fiber	16.2 – 16.64
Training	17.2 – 17.6
<b>Surface Raceway Systems</b>	13.2 – 13.3
<b>Surveillance Cable</b>	20.34 – 20.36
<b>SVHS (S-Video) Cable</b>	21.12
<b>Tactical Mobile Optical Fiber Cable</b>	18.36, 19.8

<b>Products (continued)</b>	
<b>Teflon® Cable</b>	15.44 – 15.70 18.12, 18.14, 18.16
<b>Tefzel® Cable</b>	18.31
<b>Terms of Use of Master Catalog</b>	23.22
<b>Test Unit, Ethernet Network</b>	15.42
<b>Thicknet</b>	15.69, 18.12
<b>Thinnet</b>	15.69, 18.12
<b>Tools – Cable Prep, Connecting, Terminating</b>	15.37 16.4 21.14
<b>Transceiver Cable</b>	15.70
<b>Transceivers</b>	15.42
<b>Tray Cable (TC)</b>	
PLTC	18.10, 18.14, 18.17 18.20 – 18.24 18.28 – 18.29
<b>Triax Cable</b>	19.23 – 19.24
<b>Trunk Broadband Cable</b>	9.9 – 9.11
<b>TV Camera Cable</b>	19.8
<b>Twinaxial Cable</b>	18.13 – 18.17
<b>U/UTP Unshielded Twisted Pair Cable</b>	15.44 – 15.59 15.64 – 15.66
<b>Video Cable</b>	19.25 – 19.34 21.12 – 21.13
<b>Video Snake Cable</b>	19.26, 19.33 – 19.34, 21.13
<b>VideoTwist® UTP Cable</b>	15.67 – 15.68 21.9
<b>Wall Mount Enclosures &amp; Accessories</b>	11.28 – 11.29
<b>Wireless 50 Ohm Coax</b>	9.27 – 9.32
<b>Workstation Outlets</b>	15.27 – 15.37
<b>Zip Cord</b>	21.10

ControlNet™ is a ControlNet International trademark.  
 DeviceNet™ is an Open DeviceNet Vendor Association Inc. trademark.  
 Interbus® is a Phoenix Contact trademark.  
 Seriplex® is a Square D/Schneider AEG registered trademark.  
 Kapton®, Tefzel® and Teflon® are DuPont trademarks.

## Table of Contents

### Alphabetical Index

Tech Info, Charts & Graphs	
<b>AES/EBU Digital Audio Cable</b>	
Max. Recommended Transmission Distances	19.3
<b>Armoring</b>	18.2, 23.13
<b>Attenuation</b>	
Paired Cable, Individually Shielded	5.19, 5.21
Paired Cable, Individually Shielded & Overall Foil/Braid Shield	5.24
Paired Cable, Overall Beldfoil® Shield	5.6
Paired Cable, Overall Foil/Braid Shield	5.12
<b>Belden IBDN® Networking Products</b>	
Copper Systems Selection Guide	15.4 – 15.5
System 10GX®	15.2 – 15.8
Tools	15.37
<b>Bit Rate</b>	
Paired Cable, Individually Shielded	5.19, 5.21
Paired Cable, Individually Shielded & Overall Foil/Braid Shield	5.24
Paired Cable, Overall Beldfoil® Shield	5.6
Paired Cable, Overall Foil/Braid Shield	5.12
<b>Cable Finder Reference Guide</b>	2.2 – 2.33
<b>Cable Ties Selection Guide</b>	12.2
<b>Class A Cables</b>	9.3, 9.8
<b>Color Code Charts</b> (also refer to respective cable section)	23.17 – 23.19
<b>Conductors</b>	23.2 – 23.5
<b>Connector, Audio/Video – Specifications (Residential)</b>	21.14
<b>Connector Cross Broadband Cables</b>	9.6 – 9.8
<b>Connector Cross Broadcast Cables</b>	19.7
<b>Crush Resistance</b>	19.6
<b>Current Ratings</b>	23.4
<b>DataTuff® Industrial Ethernet Cable Selection Guide</b>	18.6
<b>Enclosures (Freestanding) Selection Guide</b>	11.2
<b>Environmental Regulations &amp; Compliance (RoHS)</b>	23.21
<b>Fiber Optics</b>	(see Optical Fiber)
<b>Glossary of Terms</b>	22.2 – 22.13
<b>Halogen-Free, Low-Smoke</b>	23.20

Tech Info, Charts & Graphs	
<b>Hook-Up and Lead Wire</b>	
Temperature Ranges	3.2
<b>Index</b>	24.2 – 24.16
<b>Industrial Ethernet Cable Selection Guide</b>	18.6
<b>Insulations</b>	23.6 – 23.11
<b>Jackets</b>	23.6 – 23.11
<b>Metric Conversions</b>	23.15 – 23.16
<b>New Generation® Cable Finder Guide</b>	20.3 – 20.9
<b>Optical Fiber</b>	
Cable Finder Reference Guide	16.22
Color Code Charts	16.23
Fiber Channel Topology	16.3
FiberExpress Systems	16.2
Fiber Selection Guide Plenum	16.24
Optical Specifications	16.21
<b>Phase Stability (Coax)</b>	9.4
<b>PLC/DCS Cable Cross Reference Guide</b>	18.3 – 18.4
<b>Power over Ethernet, Information</b>	14.2
<b>Power Rating, Coaxial</b>	9.4
Rise Time	
Paired Cable, Individually Shielded	5.19, 5.21
Paired Cable, Individually Shielded & Overall Foil/Braid Shield	5.24
Paired Cable, Overall Beldfoil® Shield	5.6
Paired Cable, Overall Foil/Braid Shield	5.12
<b>Racks (Open Frame) Selection Guide</b>	12.2
<b>Serial Digital Data Rates – Maximum Transmission Distances</b>	19.6
<b>Serial Digital Video (SDI) Specifications</b>	19.5
<b>Shielded Multi-Conductor Computer Cable for RS-232 Applications</b>	4.2
<b>Shielded Multi-Pair Computer Cable for RS-232, RS-422, &amp; RS-485 Applications</b>	5.3
<b>Shielding &amp; Armoring</b>	18.2, 23.13
<b>Skew – Video Transmission Distance</b>	21.3
<b>Speaker Cable Selection Guide</b>	19.4
<b>VSWR Limits</b>	9.4
<b>Wireless 50 Ohm Coax</b>	9.5



# Cable Finder Guide

# 2



The Belden Cable Finder Guide is a tool for the user of the Belden Master Catalog. It is designed to give quick access and page reference to current Belden product offerings by AWG size, shielding type and number of conductors. Use the Cable Finder to locate where the specific cable you seek is detailed in the body of the catalog.

The cross reference lists shows equivalent nominal values. Actual cross sections may vary. The AWG values are approximate, if the cables are made to European standards (mm<sup>2</sup>) and vice versa. In critical applications, where the current reaches upper limits, the deviating operation conditions for installation and laying according to standards are to be taken into consideration.

### Table of Contents

<b>Cable Finder Guide</b>	<b>Page No.</b>
<b>Multi-Conductor and Paired Cables</b>	<b>2.2 – 2.22</b>
<b>Combination Cables</b>	<b>2.23</b>
<b>Coax Cables</b>	<b>2.24 – 2.33</b>

## Multi-Conductor and Paired Cables

No. of Cond.	No. of Pairs	Stranded (mm/AWG*)	Solid (mm)	Drain Wire	Unshielded		Overall Spiral		Overall Braid		Overall Foil		Overall Foil/Braid		Individual Foil		Individual Braid		
					Part No.	Page	Part No.	Page	Part No.	Page	Part No.	Page	Part No.	Page	Part No.	Page	Part No.	Page	Part No.
<b>28 AWG 0.07 mm² 0.40 0.30</b>																			
4	none	19x40							1804A	19.10									
	2	7x36		x									8132	5.14					
	2	7x36		x									9804	5.13					
6	3	7x36		x									8133	5.14					
	3	7x36		x									9805	5.13					
8	4	7x36		x									8134	5.14					
	4	7x36		x									9806	5.13					
10	5	7x36		x									8135	5.14					
	5	7x36		x									9807	5.13					
14	7	7x36		x									9808	5.13					
16	8	7x36		x									8138	5.14					
18	9	7x36		x									9809	5.13					
24	12	7x36		x									9812	5.13					
25	12+1/C	7x36		x									8142	5.14					
26	13	7x36		x									9813	5.13					
36	18	7x36		x									8148	5.14					
	18	7x36		x									9819	5.13					
50	25	7x36		x									8155	5.14					
	25	7x36		x									9825	5.13					
62	31	7x36		x									9814	5.13					
<b>26 AWG 0.14 mm² 0.50 0.40</b>																			
2	1	7x34		x								9180	19.16						
	1	7x0.16																BE46273*	19.18
	1	7x0.16																BE46202*	19.18
	1	18x0.1		x														BE46959*	19.17
	none	19x0.107						HMC0016	4.16										
	none	19x0.107						HMC0331	4.30										
	1	18x0.1		x														YE00193*	19.17
3	none	19x0.107						HMC0017	4.16										
	none	19x0.107						HMC0332	4.30										
4	none	30x40		x				1172A	19.10										
	2	7x34												1215A*	15.72				
	2	19x38		x														7884A	19.12
	2	7x34		x										7891A*	19.17				
	2	7x0.16																BE46203*	19.18
	2	18x0.1		x														BE46923*	19.17
	none	19x0.107						HMC0018	4.16										
	none	19x0.107						HMC0333	4.30										
5	none	19x0.107						HMC0019	4.16										
	none	19x0.107						HMC0334	4.30										
6	none	19x0.107						HMC0020	4.16										
	none	19x0.107						HMC0335	4.30										
7	none	19x0.107						HMC0021	4.16										
	none	19x0.107						HMC0336	4.30										
8	4	7x34		x								1868E	15.66						
	4	7x34		x								1868ENH	15.66						
	4	19x38		x														7885A	19.12
	4	7x34		x										7890A*	19.17				
	4	7x0.16																BE46204*	19.18
	4	18x0.1																BE46312*	19.12
	4	18x0.1		x														BE46925*	19.17

\* Individually shielded pairs or triads, plus overall foil, overall braid or overall foil and braid.  
 # Measures without a decimal point are in AWG sizes.

### Multi-Conductor and Paired Cables

No. of Cond.	No. of Pairs	Stranded (mm/AWG#)	Solid (mm)	Drain Wire	Unshielded		Overall Spiral		Overall Braid		Overall Foil		Overall Foil/Braid		Individual Foil		Individual Braid		
					Part No.	Page	Part No.	Page	Part No.	Page	Part No.	Page	Part No.	Page	Part No.	Page	Part No.	Page	Part No.
<b>26 AWG 0.14 mm<sup>2</sup> 0.50 0.40 (continued)</b>																			
16	8	7x34		x											7880A*	19.17			
	8	19x38		x													7886A	19.12	
	8	7x0.16															BE46266*	19.18	
	8	18x0.1															BE46313*	19.12	
	8	18x0.1		x													BE46935*	19.17	
20	10	7x0.16																BE46208*	19.18
	10	18x0.1		x														BE46936*	19.17
24	12	19x38		x														7887A	19.12
	12	7x34		x										7892A*	19.17				
	12	7x0.16																BE46205*	19.18
	12	18x0.1																BE46315*	19.12
	12	18x0.1		x														BE46937*	19.17
32	16	19x38		x														7888A	19.12
	16	7x34		x										7893A*	19.17				
	16	7x0.16																BE46207*	19.18
	16	18x0.1																BE46305*	19.12
	16	18x0.1		x														BE46938*	19.17
48	24	19x38		x														7889A	19.12
	24	18x0.1																BE46306*	19.12
80	40	18x0.1																BE46948*	19.12
<b>25 AWG 0.16 mm<sup>2</sup> 0.50 0.45</b>																			
1	none	7x33							8410	19.21									
<b>24 AWG 0.22 mm<sup>2</sup> 0.60 0.50</b>																			
1	none	8x0.193							HMC0486	4.37									
2	1	7x32		x							1508A	19.14							
	1	7x32		x							1508ENH	19.14							
	1	7x32		x							1800B	19.16							
	1	41x40		x					1800F	19.16									
	1	7x32		x							1883A	19.11							
	1	41x40		x									7200A	18.37					
	1	41x40		x									7205A	18.37					
	1	41x40		x									7206A	18.37					
	none	105x44					9397	19.9											
	1	19x36		x							9452	19.11							
	1	7x32		x							9501	5.7							
	1	7x32		x									9841	18.32					
	1	7x32		x									9841LS	18.32					
	1	7x32		x									9841NH	18.32					
	none	32x0.1					BE46349	19.9											
	1	7x32		x							82641	5.8							
	none	19x0.127							HMC0022	4.16									
	none	19x0.127							HMC0337	4.30									
	none	7x0.20							HMC0355	4.31									
none	7x0.20							HMC0379	4.32										
none	8x0.193							HMC0487	4.37										
3	none	105x44					9398	19.9											
	none	7x32		x							9533	4.6							
	none	7x32											9608	4.9					
	none	7x32		x									9925	4.11					
	none	7x32											83503	4.12					
	none	19x0.127							HMC0023	4.16									
	none	19x0.127							HMC0338	4.30									
	none	7x0.20							HMC0356	4.31									
	none	7x0.20							HMC0380	4.32									
	none	8x0.193							HMC0488	4.37									

\* Individually shielded pairs or triads, plus overall foil, overall braid or overall foil and braid.  
 # Measures without a decimal point are in AWG sizes.

### Multi-Conductor and Paired Cables

No. of Cond.	No. of Pairs	Stranded (mm/AWG*)	Solid (mm)	Drain Wire	Unshielded		Overall Spiral		Overall Braid		Overall Foil		Overall Foil/Braid		Individual Foil		Individual Braid	
					Part No.	Page	Part No.	Page	Part No.	Page	Part No.	Page	Part No.	Page	Part No.	Page	Part No.	Page
<b>24 AWG 0.22 mm² 0.60 0.50 (continued)</b>																		
4	none	41x40							1192A	19.10								
	2		solid		1227A1	15.58												
	2		solid		1243A2	15.58												
	2	7x32		x							1419A	5.9						
	2	7x32		x												1509C*	19.14	
	2	7x32		x											1509ENH*	19.14		
	2	7x32		x											1802B	19.16		
	2	41x40		x													1902A	19.13
	2	41x40		x									7201A	18.37				
	2		solid	x							7933A	18.8						
	2	7x32		x									8102	5.17				
	2	7x32		x											8162*	5.25		
	2	7x32		x									8332	5.15				
	2	7x32		x							9502†	5.7						
	none	7x32		x							9534	4.6						
	none	7x32											9609	4.9				
	2	7x32		x												9729	5.20	
	2	7x32		x													18.33	
	2	7x32		x												9729LS**	18.33	
	2	7x32		x												9729NH	18.33	
	2	7x32		x									9829	5.16				
	2	7x32		x									9842	18.32				
	2	7x32		x									9842LS**	18.32				
	2	7x32		x									9842NH	18.32				
	none	7x32		x									9927	4.11				
	2	7x32		x							82502	5.8						
	none	7x32											83504	4.12				
	none	19x0.127								HMC0024	4.16							
	none	19x0.127								HMC0339	4.30							
	none	7x0.20								HMC0357	4.31							
none	7x0.20								HMC0381	4.32								
none	8x0.193								HMC0489	4.37								
2	8x0.193								HMC0630	5.26								
5	none	7x32		x							9535	4.6						
	none	7x32											9610	4.9				
	none	7x32		x									9929	4.11				
	none	19x0.127																
	none	19x0.127																
	none	8x0.193																
6	3	7x32		x							1420A	5.9						
	3	7x32											3120A	18.27				
	3	41x40		x									7202A	18.37				
	3	7x32		x									8103	5.17				
	3	7x32		x											8163*	5.25		
	3	7x32											8333	5.15				
	3	7x32		x							9503	5.7						
	none	7x32		x							9536	4.6						
	none	7x32											9611	4.9				
	3	7x32		x							9680	5.9						
	3	7x32		x											9730	5.20		
	3	7x32		x									9830	5.16				
	3	7x32		x									9843	18.32				
	3	7x32		x									9843NH	18.32				
	none	7x32		x									9931	4.11				
	3	7x32		x							82503	5.8						
	none	7x32											83506	4.12				
	none	19x0.127																
	none	19x0.127																
	none	8x0.193																
3	8x0.193																	

\* Individually shielded pairs or triads, plus overall foil, overall braid or overall foil and braid. • \*\* Armored • # Measures without a decimal point are in AWG sizes.

† Pennsylvania Department of Environmental Resources and United States Mine Safety and Health Administration certification. Request quotations of RG/U cables not listed.





### Multi-Conductor and Paired Cables

No. of Cond.	No. of Pairs	Stranded (mm/AWG*)	Solid (mm)	Drain Wire	Unshielded		Overall Spiral		Overall Braid		Overall Foil		Overall Foil/Braid		Individual Foil		Individual Braid	
					Part No.	Page	Part No.	Page	Part No.	Page	Part No.	Page	Part No.	Page	Part No.	Page	Part No.	Page
<b>24 AWG 0.22 mm² 0.60 0.50 (continued)</b>																		
8	4		solid		24566945	15.47												
	4		solid		24567315	15.47												
	4		solid		24567345	15.47												
	4		solid		24567915	15.47												
	4		solid		24567945	15.47												
	4		solid		24568005	15.47												
	4		solid		24568015	15.47												
	4		solid		24568315	15.47												
	4		solid		24568331	15.47												
	4		solid		24570157	15.50												
	4		solid		24570161	15.50												
	4		solid		24570166	15.50												
	4		solid		24570452	15.50												
	4		solid		24570460	15.50												
	4		solid		24570800	15.50												
	4		solid		24570808	15.50												
	4		solid		24570810	15.50												
	4		solid		24570812	15.50												
	4		solid		24598301	15.50												
	4		solid		24598331	15.50												
4		solid		BEB1212	18.7													
	4		solid	x								BEB3212	18.7					
	none	8x0.193						HMC0493	4.37									
	4	8x0.193						HMC0632	5.26									
9	none	7x32		x						9539	4.6							
	none	7x32										9614	4.9					
	none	7x32		x								9934	4.11					
10	5	7x32		x						1422A	5.9							
	5	7x32		x								8105	5.17					
	5	7x32		x										8165*	5.25			
	5	7x32										8335	5.15					
	5	7x32		x					9505	5.7								
	none	7x32		x					9540	4.6								
	none	7x32										9615	4.9					
	5	7x32		x								9832	5.16					
	none	7x32		x								9935	4.11					
	5	7x32		x						82505	5.8							
5	8x0.193							HMC0633	5.26									
12	6	7x32		x						1423A	5.9							
	6	7x32		x										1511C*	19.14			
	6	41x40		x												1906A	19.13	
	6	7x32		x								8106	5.17					
	6	7x32		x										8166*	5.25			
	6	7x32										8336	5.15					
	6	7x32		x					9506	5.7								
	6	7x32		x					9682	5.9								
	6	7x32		x										9731	5.20			
	6	7x32		x						82506	5.8							
6	8x0.193							HMC0634	5.26									
14	7	7x32		x								8107	5.17					
	7	7x32		x										8167*	5.25			
	7	7x32										8337	5.15					
	7	7x32		x					9507	5.7								
15	none	7x32		x						9541	4.7							
	none	7x32										9616	4.9					
	none	7x32		x								9936	4.11					
16	8	7x32		x										1512C*	19.14			
	8	7x32		x										1512ENH*	19.14			
	8		solid		1667E	15.53												
	8	8x0.193							HMC0635	5.26								

\* Individually shielded pairs or triads, plus overall foil, overall braid or overall foil and braid.  
 # Measures without a decimal point are in AWG sizes.

### Multi-Conductor and Paired Cables

No. of Cond.	No. of Pairs	Stranded (mm/AWG#)	Solid (mm)	Drain Wire	Unshielded		Overall Spiral		Overall Braid		Overall Foil		Overall Foil/Braid		Individual Foil		Individual Braid			
					Part No.	Page	Part No.	Page	Part No.	Page	Part No.	Page	Part No.	Page	Part No.	Page	Part No.	Page	Part No.	Page
<b>24 AWG 0.22 mm<sup>2</sup> 0.60 0.50 (continued)</b>																				
16	8		solid		1667ENH	15.53														
	8		solid	x							1668E	15.62								
	8		solid	x							1668ENH	15.62								
	8		solid	x									1668ES	15.63						
	8		solid	x									1668ENS	15.63						
	8	7x32		x													1805F*	19.18		
	8	7x32		x															1908A	19.13
	8	7x32		x									8108	5.17						
	8	7x32		x													8168*	5.25		
18	9	7x32		x																
	9	7x32		x																
	9	7x32		x																
	9	7x32		x																
20	10	7x32		x									8110	5.17						
	10	7x32		x																
	10	7x32		x									8340	5.15						
	10	7x32		x																
	none	7x32		x								9510	5.7							
10	8x0.193								HMC0636	5.26										
22	11	7x32		x																
24	12	7x32		x																
	12	7x32		x																
	12	41x40		x																
	12	7x32		x																
	12	8x0.193								HMC0637	5.26									
25	12+1/C	7x32		x																
	12+1/C	7x32		x																
	12+1/C	7x32		x																
	none	7x32		x																
	none	7x32		x																
	12+1/C	7x32		x																
30	15	7x32		x																
	15	7x32		x																
	15	7x32		x																
	15	7x32		x																
	15	7x32		x																
	none	7x32		x																
	15	7x32		x																
32	16	7x32		x																
	16	7x32		x																
	16	41x40		x																
34	17	7x32		x																
	36	18	7x32		x															
		18	7x32		x															
37	18	7x32		x																
	18	7x32		x																
38	none	7x32																		
	none	7x32		x																
40	19	7x32		x																
	19	7x32		x																
48	20	7x32		x																
	20	7x32		x																
48	24	7x32		x																
	24	7x32		x																
	24		solid		1700S6	15.55 21.5														

\* Individually shielded pairs or triads, plus overall foil, overall braid or overall foil and braid.  
# Measures without a decimal point are in AWG sizes.



### Multi-Conductor and Paired Cables

No. of Cond.	No. of Pairs	Stranded (mm/AWG#)	Solid (mm)	Drain Wire	Unshielded		Overall Spiral		Overall Braid		Overall Foil		Overall Foil/Braid		Individual Foil		Individual Braid	
					Part No.	Page	Part No.	Page	Part No.	Page	Part No.	Page	Part No.	Page	Part No.	Page	Part No.	Page
<b>24 AWG 0.22 mm² 0.60 0.50 (continued)</b>																		
48	24		solid		1701S6	15.55												
	24	41x40		x												1924A	19.13	
50	25		solid		1232A1	15.58												
	25		solid		1864A	15.57												
	25		solid		1871A	15.57												
	25	7x32		x								8125	5.17					
	25	7x32		x										8185*	5.25			
	25	7x32												8355	5.15			
	25	7x32		x							9525	5.8						
	none	7x32		x							9546	4.7						
	none	7x32											9619	4.9				
	25		solid			24576125	15.54											
	25		solid			24577125	15.54											
	25		solid			25500027	15.56											
25		solid			25500028	15.56												
25		solid			NN00097	15.59												
52	26	7x32		x											1517C*	19.14		
54	27	7x32		x											9738	5.20		
64	32	7x32		x											1518C*	19.14		
	32	7x32		x											1854F*	19.18		
	32	41x40		x												1932A	19.13	
100	50	7x32		x							9550	5.8						
	50		solid		NN00099	15.59												
104	52	7x32		x											1519C*	19.14		
200	100		solid	x	NN00101	15.59												
<b>23 AWG 0.26 mm² 0.65 0.57</b>																		
8	4		solid		1872A	15.48												
	4		solid		1874A	15.48												
	4		solid													1885ENH*	15.60	
	4		solid		7812E	15.46												
	4		solid		7812ENH	15.46												
	4		solid		7851A	15.44												
	4		solid		7851NH	15.44												
	4		solid		7852A	15.44												
	4		solid	x								7860ENH	15.61					
	4		solid	x										7860ENS	15.61			
	4		solid			7927A	18.11											
	4		solid			7931A	18.10											
	4		solid			7965E	15.51											
	4		solid			7965ENH	15.51											
	4		solid			7989P	15.67											
	4		solid			7989R	15.67											
							21.9											
	4		solid			11872A	18.11											
	4		solid			121872A**	18.11											
	4		solid			24586385	15.45											
4		solid			24586985	15.45												
4		solid			24587385	15.45												
4		solid			24587985	15.45												
4		solid			24588085	15.45												
16	8		solid												1887ENH*	15.60		
<b>22 AWG 0.34 mm² 0.80 0.64</b>																		
1	none	11x0.193							HMC0494	4.37								
2	1	7x30		x									1696A	19.16				
	1	7x30		x							3077ELS**	18.20						
	1	7x30		x							3077ENH	18.20						

\* Individually shielded pairs or triads, plus overall foil, overall braid or overall foil and braid. • \*\* Armored  
 # Measures without a decimal point are in AWG sizes.

### Multi-Conductor and Paired Cables

No. of Cond.	No. of Pairs	Stranded (mm/AWG#)	Solid (mm)	Drain Wire	Unshielded		Overall Spiral		Overall Braid		Overall Foil		Overall Foil/Braid		Individual Foil		Individual Braid		
					Part No.	Page	Part No.	Page	Part No.	Page	Part No.	Page	Part No.	Page	Part No.	Page	Part No.	Page	Part No.
<b>22 AWG 0.34 mm<sup>2</sup> 0.80 0.64 (continued)</b>																			
2	1	7x30		x							3077F	18.20							
	1	7x30		x							3078F	18.21							
	1		solid										3079A	18.21					
	1		solid										3079ALS**	18.21					
	1		solid										3079ANH	18.21					
	1	7x30											3079E	18.21					
	1	7x30			x								3105A	18.28					
	1		solid			7701NH	18.30												
	1		solid		x								7703NH	18.30					
	none	7x30				8442	4.4												
	1	7x30			x								8451	19.11					
	1		solid		x								8761	5.10					
	1	19x34			x								9182	18.16					
	1	19x34			x								9182NH	18.16					
	1	7x30			x								9451	19.11					
	1	7x30			x								9451SB	7.3					
	none	7x30													83552	4.12			
	1	19x34			x								89182	18.16					
	none	19x0.160								HMC0028	4.16								
	none	19x0.160								HMC0343	4.30								
	none	7x0.25								HMC0358	4.31								
	none	7x0.25								HMC0382	4.32								
	none	11x01.93												HMC0444	4.35				
none	11x01.93								HMC0495	4.37									
3	1+1/C	7x30		x										3106A	18.28				
	none	7x30			8443	4.4													
	none	7x30												9939	4.10				
	none	7x30												83553	4.12				
	none	19x0.160								HMC0029	4.16								
	none	19x0.160								HMC0344	4.30								
	none	7x0.25								HMC0359	4.31								
	none	7x0.25								HMC0383	4.32								
	none	11x01.93												HMC0445	4.35				
	none	11x01.93								HMC0496	4.37								
4	2	19x34		x												1504A	21.10		
	2		solid													1634A*	15.71		
	2	7x30		x												1814R*	19.15		
	2	7x30		x										3107A	18.28				
	2		solid		7702NH	18.30													
	2		solid		x								7704NH	18.30					
	2	7x30												8302	5.18				
	none	7x30			8444	4.4													
	2	7x30			x											8723	5.22	18.34	
	2	7x30			x											8723LS**	18.34		
	2	7x30			x											8723NH	18.34		
	2	7x30			x											8723SB	7.3		
	2	7x30			x											8728	19.11		
	none	7x30												9940	4.10				
	2		solid													9688*	15.71		
	none	7x30														88723	18.34		
	2	7x30			x											83554	4.12		
	2	7x0.25			x														
	BE43906																		
	none	19x0.160									HMC0030	4.16							
	none	19x0.160									HMC0345	4.30							
	none	7x0.25									HMC0360	4.31							
	none	7x0.25									HMC0384	4.32							
none	11x0.193																		
none	11x01.93													HMC0446	4.35				
none	11x01.93									HMC0497	4.37								

\* Individually shielded pairs or triads, plus overall foil, overall braid or overall foil and braid. • \*\* Armored  
 # Measures without a decimal point are in AWG sizes.

### Multi-Conductor and Paired Cables

No. of Cond.	No. of Pairs	Stranded (mm/AWG*)	Solid (mm)	Drain Wire	Unshielded		Overall Spiral		Overall Braid		Overall Foil		Overall Foil/Braid		Individual Foil		Individual Braid		
					Part No.	Page	Part No.	Page	Part No.	Page	Part No.	Page	Part No.	Page	Part No.	Page	Part No.	Page	
<b>22 AWG 0.34 mm² 0.80 0.64 (continued)</b>																			
5	none	7x30			8445	4.4													
	none	7x30											9941	4.10					
	none	19x0.160							HMC0031	4.16									
	none	19x0.160							HMC0346	4.30									
	none	11x01.93											HMC0447	4.35					
	none	11x01.93								HMC0498	4.37								
6	3	7x30		x									3108A	18.28					
	3	7x30											8303	5.18					
	3	7x30		x											8777	5.22	18.33		
	3	7x30		x											8777LS**	18.34			
	3	7x30		x											8777NH	18.33			
	3	7x30		x											8777SB	7.3			
	none	7x30											9942	4.10					
	3	7x30		x											82777	5.22			
	none	7x30											83556	4.12					
	none	19x0.160							HMC0032	4.16									
	none	19x0.160							HMC0347	4.30									
	none	11x01.93											HMC0448	4.35					
none	11x01.93								HMC0499	4.37									
7	none	7x30			9430	4.4													
	none	7x30											9943	4.10					
	none	19x0.160							HMC0033	4.16									
	none	19x0.160							HMC0348	4.30									
	none	11x01.93											HMC0449	4.35					
	none	11x01.93								HMC0500	4.37								
8	4	7x30		x											1815R*	19.15			
	4	7x30		x									3109A	18.28					
	4		solid		7922A	18.10							8304	5.18					
	4	7x30											9421	4.4					
	none	7x30											9944	4.10					
	none	11x01.93								HMC0501	4.37								
9	none	7x30			9423	4.4													
	none	7x30											9945	4.10					
	none	7x30											83559	4.12					
10	5	7x30											8305	5.18					
	none	7x30			8456	4.4													
	none	7x30											9946	4.10					
12	6	7x30		x											1816R*	19.15			
	6	7x30											8306	5.18					
	6	7x30		x											8778	5.22			
	none	7x30											83562	4.12					
14	7	7x30										8307	5.18						
15	none	7x30										9947	4.10						
16	8	7x30		x											1817R*	19.15			
	8	7x30											8308	5.18					
18	9	7x30		x											8774	5.22			
19	none	7x30											83569	4.12					
20	10	7x30											8310	5.18					
24	12	7x30		x											1818R*	19.15			
25	12+1/C	7x30		x									8312	5.18					
	none	7x30											9948	4.10					
30	15	7x30		x									8315	5.18					

\* Individually shielded pairs or triads, plus overall foil, overall braid or overall foil and braid. • \*\* Armored  
# Measures without a decimal point are in AWG sizes.

**Multi-Conductor and Paired Cables**

No. of Cond.	No. of Pairs	Stranded (mm/ AWG#)	Solid (mm)	Drain Wire	Unshielded		Overall Spiral		Overall Braid		Overall Foil		Overall Foil/Braid		Individual Foil		Individual Braid	
					Part No.	Page	Part No.	Page	Part No.	Page	Part No.	Page	Part No.	Page	Part No.	Page	Part No.	Page
<b>22 AWG 0.34 mm² 0.80 0.64 (continued)</b>																		
32	16	7x30		x										1819R*	19.15			
36	18	7x30										8318	5.18					
37	none	7x30										9949	4.10					
40	20	7x30		x										1820R*	19.15			
48	24	7x30		x										1821R*	19.15			
50	25	7x30										8325	5.18					
	none	7x30										9950	4.10					
52	26	7x30		x										1822R*	19.15			
64	32	7x30		x										1823R*	19.15			
<b>20 AWG 0.50 mm² 0.90 0.81</b>																		
1	none	16x0.193						HMC0502	4.37									
2	1	7x28			8205	5.4												
	none	26x34						8412	19.9									
	1	7x28		x						8762	5.10							
	1	7x28		x						9154	5.10							
	1	7x28										9207	18.15					
	1	7x28										9207NH	18.15					
	1	7x28		x								9463	18.13					
	1	7x28		x								9463DB	18.13					
	1	42x36										9463F	18.13					
	1	7x28		x								9463LS**	18.13					
	1	7x28		x								9463NH	18.13					
	1	7x28		x						9464	5.10							
	1	7x28		x								89463	18.14					
	1	7x28		x								129463**	18.14					
1	7x28		x								139463**	18.14						
1	7x28		x								189463**	18.14						
none	19x0.203							HMC0034	4.16									
none	19x0.203							HMC0349	4.30									
none	16x0.20							HMC0361	4.31									
none	16x0.20							HMC0385	4.32									
none	16x0.193											HMC0451	4.35					
none	16x0.193							HMC0503	4.37									
3	none	7x28		x						8772	4.8							
	none	19x0.203						HMC0035	4.16									
	none	19x0.203						HMC0350	4.30									
	none	7x28		x								1348A	18.29					
	none	16x0.20						HMC0362	4.31									
	none	16x0.20						HMC0386	4.32									
	none	16x0.193										HMC0452	4.35					
	none	16x0.193						HMC0504	4.37									
4	none	26x34						8424	19.10									
	2	7x28		x										9402	5.23			
	none	19x0.203						HMC0036	4.16									
	none	19x0.203						HMC0351	4.30									
	none	16x0.20						HMC0363	4.31									
	none	16x0.20						HMC0387	4.32									
	none	16x0.193										HMC0453	4.35					
	none	16x0.193						HMC0505	4.37									
5	2		solid	x						YE00820	21.8							
	2		solid	x						YE00906	21.8							
	2	16x0.193						HMC0638	5.26									
	none	19x0.203						HMC0037	4.16									
5	none	19x0.203						HMC0352	4.30									
	none	16x0.193										HMC0454	4.35					
	none	16x0.193						HMC0506	4.37									
	none	16x0.193																

\* Individually shielded pairs or triads, plus overall foil, overall braid or overall foil and braid. • \*\* Armored # Measures without a decimal point are in AWG sizes.

**Multi-Conductor and Paired Cables**

No. of Cond.	No. of Pairs	Stranded (mm / AWG*)	Solid (mm)	Drain Wire	Unshielded		Overall Spiral		Overall Braid		Overall Foil		Overall Foil/Braid		Individual Foil		Individual Braid		
					Part No.	Page	Part No.	Page	Part No.	Page	Part No.	Page	Part No.	Page	Part No.	Page	Part No.	Page	Part No.
<b>20 AWG 0.50 mm² 0.90 0.81 (continued)</b>																			
6	3	7x28			9750	5.4													
	3	7x28		x												9873	5.23		
	none	19x0.203							HMC0038	4.16									
	none	19x0.203							HMC0353	4.30									
	none	16x0.193										HMC0455	4.35						
	none	16x0.193							HMC0507	4.37									
7	3	16x0.193							HMC0639	5.26									
	none	19x0.203							HMC0039	4.16									
	none	19x0.203							HMC0354	4.30									
	none	16x0.193										HMC0456	4.35						
8	none	16x0.193							HMC0508	4.37									
	4	7x28		x											9901*	15.70			
	4	7x28		x										89901*	15.70				
	none	16x0.193										HMC0457	4.35						
10	none	16x0.193												HMC0458	4.35				
	none	16x0.193							HMC0510	4.37									
12	6	7x28			9751	5.4													
	6	7x28		x															
	none	16x0.193										HMC0459	4.35						
18	9	7x28			9752	5.4													
	9	7x28		x											9875	5.23			
30	15	7x28			9755	5.4													
<b>18 AWG 0.75 mm² 1.20 1.02</b>																			
2	1	7x26		x							3076ELS**	18.20							
	1	7x26		x							3076ENH	18.20							
	1	7x26		x							3076F	18.20							
	1	7x26		x									3072F	18.17					
	1	7x26		x									3073F	18.17					
	1	7x26		x									3074F	18.17					
	1	7x26				8461	5.4												
	1	16x30		x							8760	18.35							
	1	16x30		x							8760LS**	18.35							
	1	16x30		x							8760NH	18.35							
	none		solid			9571	4.13												
	none		solid	x							9574	4.13							
	1	16x30				9740	5.4												
	1	19x30				82740	5.5												
	1	19x30		x							82760	5.10							
	none	24x0.20				HMC0001	4.15												
	none	24x0.20				HMC0040	4.17												
	none	24x0.20				HMC0100	4.20												
	none	24x0.20									HMC0120	4.21							
	none	24x0.20									HMC0190	4.24							
	none	24x0.20				HMC0215	4.25												
	none	24x0.20									HMC0263	4.27							
	none	24x0.20				HMC0311	4.29												
	none	24x0.20									HMC0364	4.31							
	none	24x0.20									HMC0388	4.32							
	none	22x0.193													HMC0461	4.35			
	none	22x0.193									HMC0511	4.37							
	none	24x0.20				SHO 0001**	7.8												
	none	24x0.20				SHO 0028**	7.9												
1	7x0.36									SHO 0055	7.10								
none	7x0.36									SHO 0088	7.13								
3	none	16x30		x								8770	4.8						
	none	24x0.20																	
	none	24x0.20																	
	none	24x0.20																	

\* Individually shielded pairs or triads, plus overall foil, overall braid or overall foil and braid. • \*\* Armored  
# Measures without a decimal point are in AWG sizes.

### Multi-Conductor and Paired Cables

No. of Cond.	No. of Pairs	Stranded (mm/AWG#)	Solid (mm)	Drain Wire	Unshielded		Overall Spiral		Overall Braid		Overall Foil		Overall Foil/Braid		Individual Foil		Individual Braid		
					Part No.	Page	Part No.	Page	Part No.	Page	Part No.	Page	Part No.	Page	Part No.	Page	Part No.	Page	Part No.
<b>18 AWG 0.75 mm<sup>2</sup> 1.20 1.02 (continued)</b>																			
3	none	16x30		x							8770	4.8							
	none	24x0.20			HMC0002	4.15													
	none	24x0.20			HMC0041	4.17													
	none	24x0.20			HMC0101	4.20													
	none	24x0.20									HMC0121	4.21							
	none	24x0.20							HMC0191	4.24									
	none	24x0.20			HMC0216	4.25													
	none	24x0.20							HMC0264	4.27									
	none	24x0.20			HMC0312	4.29													
	none	24x0.20							HMC0365	4.31									
	none	24x0.20							HMC0389	4.32									
	none	22x0.193										HMC0462	4.35						
	none	24x0.20			SHO0002**	7.8													
	none	24x0.20			SHO0029**	7.9													
	none	7x0.36								SHO0089	7.13								
4	2	16x30			9156	5.4													
	none	19x30									9418	4.8							
	none	19x30	solid	x							9578	4.13							
	none	19x30			82489	4.4													
	none	24x0.20			HMC0003	4.15													
	none	24x0.20			HMC0042	4.17													
	none	24x0.20			HMC0102	4.20													
	none	24x0.20									HMC0122	4.21							
	none	24x0.20							HMC0192	4.24									
	none	24x0.20			HMC0217	4.25													
	none	24x0.20							HMC0265	4.27									
	none	24x0.20			HMC0313	4.29													
	none	24x0.20							HMC0366	4.31									
	none	24x0.20							HMC0390	4.32									
	none	22x0.193										HMC0463	4.35						
	2	7x0.36								SHO0056	7.10								
5	none	24x0.20			HMC0004	4.15													
	none	24x0.20			HMC0043	4.17													
	none	24x0.20			HMC0103	4.20													
	none	24x0.20									HMC0123	4.21							
	none	24x0.20							HMC0193	4.24									
	none	24x0.20			HMC0218	4.25													
	none	24x0.20							HMC0266	4.27									
	none	24x0.20			HMC0314	4.29													
	none	22x0.193										HMC0464	4.35						
	none	24x0.20			SHO0003**	7.8													
	none	24x0.20			SHO0030**	7.9													
	none	7x0.36								SHO0090	7.13								
6	3	16x30			8690	5.5													
	3	19x30		x										9773	5.23				
	none	24x0.20			HMC0056	4.18													
	none	24x0.20									HMC0124	4.21							
	none	24x0.20			HMC0219	4.25													
	none	24x0.20							HMC0267	4.27									
	none	22x0.193										HMC0465	4.35						
	3	22x0.193								HMC0640	5.26								
7	3	24x0.20			HMC0005	4.15													
	3	24x0.20			HMC0057	4.18													
	none	24x0.20									HMC0125	4.21							
	none	24x0.20							HMC0194	4.24									
	none	24x0.20			HMC0220	4.25													
	none	24x0.20							HMC0268	4.27									

\*\* Armored  
# Measures without a decimal point are in AWG sizes.



### Multi-Conductor and Paired Cables

No. of Cond.	No. of Pairs	Stranded (mm/ AWG#)	Solid (mm)	Drain Wire	Unshielded		Overall Spiral		Overall Braid		Overall Foil		Overall Foil/Braid		Individual Foil		Individual Braid	
					Part No.	Page	Part No.	Page	Part No.	Page	Part No.	Page	Part No.	Page	Part No.	Page	Part No.	Page
<b>18 AWG 0.75 mm<sup>2</sup> 1.20 1.02 (continued)</b>																		
7	none	22x0.193											HMC0466	4.35				
	none	7x0.36																
8	4	16x30				9157	5.5											
	none	24x0.20				HMC0058	4.18											
	none	22x0.193											HMC0467	4.35				
	4	7x0.36																
10	5	16x30				9159	5.5											
	none	24x0.20				HMC0059	4.18											
	none	22x0.193											HMC0468	4.35				
	none	7x0.36																
12	6	19x30		x												9774	5.23	
	none	24x0.20				HMC0060	4.18											
	none	22x0.193											HMC0469	4.35				
	none	7x0.36																
14	none	24x0.20				HMC0061	4.18											
	7	7x0.36																
	none	7x0.36																
16	none	24x0.20				HMC0062	4.18											
	none	7x0.36																
18	9	19x30		x												9775	5.23	
	none	24x0.20				HMC0063	4.18											
19	none	7x0.36																
20	none	24x0.20				HMC0064	4.18											
	10	7x0.36																
24	none	24x0.20				HMC0065	4.18											
	none	7x0.36																
25	none	24x0.20				HMC0066	4.18											
28	14	7x0.36																
38	19	7x0.36																
48	24	7x0.36																
<b>17 AWG 1.00 mm<sup>2</sup> 1.40 1.15</b>																		
2	none	32x0.20				HMC0006	4.15											
	none	32x0.20				HMC0044	4.17											
	none	32x0.20				HMC0104	4.20											
	none	32x0.20											HMC0126	4.21				
	none	32x0.20																
	none	32x0.20				HMC0221	4.25											
	none	32x0.20																
	none	32x0.20				HMC0316	4.29											
	none	32x0.20																
	none	32x0.20																
	none	32x0.20																
	none	32x0.20																
	none	32x0.20																
	none	20x0.243																
	none	20x0.243																
	none	20x0.243					HMC0524	4.38										
none	32x0.20					SHO 0004**	7.8											
none	32x0.20					SHO 0031**	7.9											
3	none	32x0.20				HMC0007	4.15											
	none	32x0.20				HMC0045	4.17											
	none	32x0.20				HMC0105	4.20											
	none	32x0.20																
	none	32x0.20																
	none	32x0.20																
	none	32x0.20				HMC0222	4.25											

\*\* Armored  
# Measures without a decimal point are in AWG sizes.

### Multi-Conductor and Paired Cables

No. of Cond.	No. of Pairs	Stranded (mm/AWG#)	Solid (mm)	Drain Wire	Unshielded		Overall Spiral		Overall Braid		Overall Foil		Overall Foil/Braid		Individual Foil		Individual Braid		
					Part No.	Page	Part No.	Page	Part No.	Page	Part No.	Page	Part No.	Page	Part No.	Page	Part No.	Page	Part No.
<b>17 AWG 1.00 mm<sup>2</sup> 1.40 1.15 (continued)</b>																			
3	none	32x0.20			HMC0317	4.29													
	none	32x0.20							HMC0368	4.31									
	none	32x0.20							HMC0392	4.32									
	none	32x0.20							HMC0404	4.33									
	none	32x0.20							HMC0424	4.34									
	none	20x0.243											HMC0472	4.35					
	none	20x0.243							HMC0515	4.37									
	none	20x0.243				HMC0525	4.38												
	none	32x0.20				SHO0005**	7.8												
none	32x0.20				SHO0032**	7.9													
4	none	32x0.20			HMC0008	4.15													
	none	32x0.20			HMC0046	4.17													
	none	32x0.20			HMC0106	4.20													
	none	32x0.20									HMC0128	4.21							
	none	32x0.20							HMC0197	4.24									
	none	32x0.20			HMC0223	4.25													
	none	32x0.20							HMC0271	4.27									
	none	32x0.20			HMC0318	4.29													
	none	32x0.20							HMC0369	4.31									
	none	32x0.20							HMC0393	4.32									
	none	32x0.20							HMC0405	4.33									
	none	32x0.20							HMC0425	4.34									
	none	20x0.243											HMC0473	4.35					
	none	20x0.243							HMC0516	4.37									
none	20x0.243				HMC0526	4.38													
none	32x0.20				SHO0006**	7.8													
none	32x0.20				SHO0033**	7.9													
5	none	32x0.20			HMC0009	4.15													
	none	32x0.20			HMC0047	4.17													
	none	32x0.20			HMC0107	4.20													
	none	32x0.20									HMC0129	4.21							
	none	32x0.20							HMC0198	4.24									
	none	32x0.20			HMC0224	4.25													
	none	32x0.20							HMC0272	4.27									
	none	32x0.20			HMC0319	4.29													
	none	32x0.20							HMC0406	4.33									
	none	32x0.20							HMC0426	4.34									
none	20x0.243											HMC0474	4.35						
none	20x0.243							HMC0517	4.37										
6	none	32x0.20			HMC0067	4.18													
	none	32x0.20									HMC0130	4.21							
	none	32x0.20			HMC0225	4.25													
	none	32x0.20							HMC0273	4.27									
none	20x0.243											HMC0475	4.35						
7	none	32x0.20			HMC0010	4.15													
	none	32x0.20			HMC0068	4.18													
	none	32x0.20									HMC0131	4.21							
	none	32x0.20							HMC0199	4.24									
	none	32x0.20			HMC0226	4.25													
	none	32x0.20							HMC0274	4.27									
	none	32x0.20			HMC0320	4.29													
none	20x0.243											HMC0476	4.35						
8	none	32x0.20			HMC0069	4.18													
	none	20x0.243											HMC0477	4.35					
10	none	32x0.20			HMC0070	4.18													
12	none	32x0.20			HMC0071	4.18													
14	none	32x0.20			HMC0072	4.18													
16	none	32x0.20			HMC0073	4.18													

\*\* Armored  
# Measures without a decimal point are in AWG sizes.

### Multi-Conductor and Paired Cables

No. of Cond.	No. of Pairs	Stranded (mm/AWG#)	Solid (mm)	Drain Wire	Unshielded		Overall Spiral		Overall Braid		Overall Foil		Overall Foil/Braid		Individual Foil		Individual Braid		
					Part No.	Page	Part No.	Page	Part No.	Page	Part No.	Page	Part No.	Page	Part No.	Page	Part No.	Page	Part No.
<b>17 AWG 1.00 mm<sup>2</sup> 1.40 1.15 (continued)</b>																			
18	none	32x0.20			HMC0074	4.18													
20	none	32x0.20			HMC0075	4.18													
24	none	32x0.20			HMC0076	4.18													
25	none	32x0.20			HMC0077	4.18													
<b>16 AWG 1.50 mm<sup>2</sup> 1.50 1.30</b>																			
2	none	65x34			1307A	21.10													
	none	84x0.15			3999E	18.28													
	1	19x29			8471	5.5 18.30 21.8													
	1	19x29			8471LS**	18.31													
	1	19x29			8471NH	18.31													
	none	19x29			8677	4.5													
	1	19x29		x							8719	5.11 18.31							
	none		solid		9572	4.13													
	none		solid	x							9575	4.13							
	none	26x30			9716	21.10													
	1		solid										9860	18.15					
	1		solid										9860LS**	18.15					
	1		solid										9860NH	18.15					
	1	19x29			85102	18.31													
	none	25x0.23			BE46382	19.19													
	none	30x0.25			HMC0011	4.15													
	none	30x0.25			HMC0048	4.17													
	none	30x0.25			HMC0108	4.20													
	none	30x0.25									HMC0132	4.21							
	none	30x0.25								HMC0200	4.24								
	none	30x0.25			HMC0227	4.25													
	none	30x0.25								HMC0275	4.27								
	none	30x0.25			HMC0321	4.29													
	none	30x0.25								HMC0370	4.31								
	none	30x0.25								HMC0394	4.32								
	none	30x0.25								HMC0407	4.33								
	none	30x0.25								HMC0427	4.34								
	none	28x0.245											HMC0479	4.36					
	none	28x0.245								HMC0518	4.38								
	none	28x0.245			HMC0527	4.38													
	none	30x0.25			SHO 0007**	7.8													
	none	30x0.25			SHO 0034**	7.9													
none	7x0.52			SHO 0063	7.11														
none	7x0.52								SHO 0098	7.12									
3	none	30x0.25			HMC0012	4.15													
	none	30x0.25			HMC0049	4.17													
	none	30x0.25			HMC0109	4.20													
	none	30x0.25									HMC0133	4.21							
	none	30x0.25							HMC0201	4.24									
	none	30x0.25			HMC0228	4.25													
	none	30x0.25							HMC0276	4.27									
	none	30x0.25			HMC0322	4.29													
	none	30x0.25							HMC0371	4.31									
	none	30x0.25							HMC0395	4.32									
	none	30x0.25							HMC0408	4.33									
	none	30x0.25							HMC0428	4.34									
	none	28x0.245										HMC0480	4.36						
	none	28x0.245							HMC0519	4.38									
	none	28x0.245			HMC0528	4.38													
	none	30x0.25			SHO 0008**	7.8													
	none	30x0.25			SHO 0035**	7.9													

\*\* Armored  
# Measures without a decimal point are in AWG sizes.

### Multi-Conductor and Paired Cables

No. of Cond.	No. of Pairs	Stranded (mm/AWG#)	Solid (mm)	Drain Wire	Unshielded		Overall Spiral		Overall Braid		Overall Foil		Overall Foil/Braid		Individual Foil		Individual Braid	
					Part No.	Page	Part No.	Page	Part No.	Page	Part No.	Page	Part No.	Page	Part No.	Page	Part No.	Page
<b>16 AWG 1.50 mm<sup>2</sup> 1.50 1.30 (continued)</b>																		
3	none	7x0.52			SHO0064	7.11												
	none	7x0.52							SHO0099	7.12								
4	none	65x34			1308A	21.10												
	none		solid	x							9579	4.13						
	none	30x0.25			HMC0013	4.15												
	none	30x0.25			HMC0050	4.17												
	none	30x0.25			HMC0110	4.20												
	none	30x0.25									HMC0134	4.21						
	none	30x0.25							HMC0202	4.24								
	none	30x0.25			HMC0229	4.25												
	none	30x0.25							HMC0277	4.27								
	none	32x0.25			HMC0323	4.29												
	none	30x0.25							HMC0372	4.31								
	none	30x0.25							HMC0396	4.32								
	none	30x0.25							HMC0409	4.33								
	none	30x0.25							HMC0429	4.34								
	none	28x0.245											HMC0481	4.36				
	none	28x0.245							HMC0520	4.38								
none	28x0.245			HMC0529	4.38													
none	30x0.25			SHO0009**	7.8													
none	30x0.25			SHO0036**	7.9													
none	7x0.52			SHO0065	7.11													
none	7x0.52							SHO0100	7.12									
5	none	30x0.25			HMC0014	4.15												
	none	30x0.25			HMC0051	4.17												
	none	30x0.25			HMC0111	4.20												
	none	30x0.25									HMC0135	4.21						
	none	30x0.25							HMC0203	4.24								
	none	30x0.25			HMC0230	4.25												
	none	30x0.25							HMC0278	4.27								
	none	30x0.25							HMC0410	4.33								
	none	32x0.25			HMC0324	4.29												
	none	30x0.25							HMC0430	4.34								
	none	28x0.245											HMC0482	4.36				
	none	28x0.245							HMC0521	4.38								
	none	30x0.25			SHO0010**	7.8												
none	30x0.25			SHO0037**	7.9													
none	7x0.52			SHO0066	7.11													
none	7x0.52							SHO0101	7.12									
6	none	30x0.25			HMC0078	4.18												
	none	30x0.25									HMC0136	4.21						
	none	30x0.25			HMC0231	4.25												
	none	30x0.25							HMC0279	4.27								
	none	28x0.245											HMC0483	4.36				
7	none	30x0.25			HMC0015	4.15												
	none	30x0.25			HMC0079	4.18												
	none	30x0.25									HMC0137	4.21						
	none	30x0.25							HMC0204	4.24								
	none	30x0.25			HMC0232	4.25												
	none	30x0.25							HMC0280	4.27								
	none	32x0.25			HMC0325	4.29												
	none	30x0.25			SHO0011**	7.8												
	none	30x0.25			SHO0038**	7.9												
	none	7x0.52			SHO0067	7.11												
none	7x0.52							SHO0102	7.12									
8	none	30x0.25			HMC0080	4.18												
	none	30x0.25									HMC0138	4.21						
	none	30x0.25			HMC0233	4.25												
	none	30x0.25							HMC0281	4.27								

\*\* Armored  
# Measures without a decimal point are in AWG sizes.

### Multi-Conductor and Paired Cables

No. of Cond.	No. of Pairs	Stranded (mm/AWG*)	Solid (mm)	Drain Wire	Unshielded		Overall Spiral		Overall Braid		Overall Foil		Overall Foil/Braid		Individual Foil		Individual Braid	
					Part No.	Page	Part No.	Page	Part No.	Page	Part No.	Page	Part No.	Page	Part No.	Page	Part No.	Page
<b>16 AWG 1.50 mm<sup>2</sup> 1.50 1.30 (continued)</b>																		
10	none	30x0.25			HMC0081	4.18												
	none	30x0.25									HMC0139	4.21						
	none	30x0.25			HMC0234	4.25												
	none	30x0.25							HMC0282	4.27								
	none	7x0.52			SHO0068	7.11												
	none	7x0.52							SHO0103	7.12								
12	none	30x0.25			HMC0082	4.18												
	none	30x0.25									HMC0140	4.21						
	none	30x0.25			HMC0235	4.25												
	none	30x0.25							HMC0283	4.27								
	none	30x0.25			SHO0012**	7.8												
	none	30x0.25			SHO0039**	7.9												
14	none	30x0.25																
	none	30x0.25			HMC0083	4.18												
	none	30x0.25									HMC0141	4.21						
	none	30x0.25			HMC0236	4.25												
	none	30x0.25							HMC0284	4.27								
	none	7x0.52			SHO0069	7.11												
16	none	30x0.25																
	none	30x0.25			HMC0084	4.18												
	none	30x0.25									HMC0142	4.21						
	none	30x0.25			HMC0237	4.25												
	none	30x0.25							HMC0285	4.27								
	none	7x0.52							SHO0106	7.12								
18	none	30x0.25			HMC0085	4.18												
	none	30x0.25									HMC0143	4.21						
	none	30x0.25			HMC0238	4.25												
	none	30x0.25							HMC0286	4.27								
19	none	7x0.52			SHO0070	7.11												
	none	7x0.52									SHO0107	7.12						
20	none	30x0.25			HMC0086	4.19												
	none	30x0.25									HMC0144	4.21						
	none	30x0.25			HMC0239	4.25												
	none	30x0.25							HMC0287	4.27								
24	none	30x0.25			HMC0087	4.19												
	none	30x0.25									HMC0145	4.21						
	none	30x0.25			HMC0240	4.25												
	none	30x0.25							HMC0288	4.27								
	none	7x0.52			SHO0071	7.11												
	none	7x0.52							SHO0108	7.12								
30	none	30x0.25			HMC0241	4.25												
	none	30x0.25									HMC0289	4.27						
<b>14 AWG 2.50 mm<sup>2</sup> 1.85 1.63</b>																		
2	none	105x34			1309A	21.11												
	1	41x30			8473	5.5												
	none	19x27			8675	4.5												
	1	19x27		x							8720	5.11						
	none		solid		9580	4.14												
	none		solid	x							9581	4.14						
	none	50x0.25			HMC0052	4.17												
	none	50x0.25			HMC0112	4.20												
	none	50x0.25									HMC0146	4.21						
	none	50x0.25							HMC0205	4.24								
	none	50x0.25			HMC0242	4.25												
	none	50x0.25							HMC0290	4.27								
	none	50x0.25			HMC0326	4.29												

\* Individually shielded pairs or triads, plus overall foil, overall braid or overall foil and braid. • \*\* Armored  
 # Measures without a decimal point are in AWG sizes.

### Multi-Conductor and Paired Cables

No. of Cond.	No. of Pairs	Stranded (mm/AWG#)	Solid (mm)	Drain Wire	Unshielded		Overall Spiral		Overall Braid		Overall Foil		Overall Foil/Braid		Individual Foil		Individual Braid	
					Part No.	Page	Part No.	Page	Part No.	Page	Part No.	Page	Part No.	Page	Part No.	Page	Part No.	Page
<b>14 AWG 2.50 mm<sup>2</sup> 1.85 1.63 (continued)</b>																		
2	none	50x0.25							HMC0373	4.31								
	none	50x0.25							HMC0397	4.32								
	none	50x0.25							HMC0411	4.33								
	none	50x0.25							HMC0431	4.34								
	none	48x0.243							HMC0522	4.38								
	none	50x0.25			SHO0013**	7.8												
	none	50x0.25			SHO0040**	7.9												
	none	7x0.68			SHO0072	7.11												
3	none	50x0.25																
	none	50x0.25			HMC0053	4.17												
	none	50x0.25			HMC0113	4.20												
	none	50x0.25									HMC0147	4.21						
	none	50x0.25							HHMC0206	4.24								
	none	50x0.25			HMC0243	4.25												
	none	50x0.25							HMC0291	4.27								
	none	50x0.25			HMC0327	4.29												
	none	50x0.25							HMC0374	4.31								
	none	50x0.25							HMC0398	4.32								
	none	50x0.25							HMC0412	4.33								
	none	50x0.25							HMC0432	4.34								
	none	48x0.243											HMC0484	4.36				
	none	48x0.243							HMC0523	4.38								
	none	48x0.243			HMC0530	4.38												
	none	50x0.25			SHO0014**	7.8												
none	50x0.25			SHO0041**	7.9													
none	7x0.68			SHO0073	7.11													
4	none	105x34																
	none	104x34			1310A	21.11												
	none	50x0.25			1810A	19.19												
	none	50x0.25			HMC0054	4.17												
	none	50x0.25			HMC0114	4.20												
	none	50x0.25									HMC0148	4.21						
	none	50x0.25							HMC0207	4.24								
	none	50x0.25			HMC0244	4.26												
	none	50x0.25							HMC0292	4.27								
	none	50x0.25			HMC0328	4.29												
	none	50x0.25							HMC0375	4.31								
	none	50x0.25							HMC0399	4.32								
	none	50x0.25							HMC0413	4.33								
	none	50x0.25							HMC0433	4.34								
	none	48x0.243											HMC0485	4.36				
	none	50x0.25			SHO0015**	7.8												
none	50x0.25			SHO0042**	7.9													
none	7x0.68			SHO0074	7.11													
5	none	50x0.25																
	none	50x0.25			HMC0055	4.17												
	none	50x0.25			HMC0115	4.20												
	none	50x0.25									HMC0149	4.22						
	none	50x0.25							HMC0208	4.24								
	none	50x0.25			HMC0245	4.26												
	none	50x0.25							HMC0293	4.27								
	none	50x0.25			HMC0329	4.29												
	none	50x0.25							HMC0414	4.33								
	none	50x0.25							HMC0434	4.34								
6	none	50x0.25																
	none	50x0.25			HMC0089	4.19												
	none	50x0.25									HMC0150	4.22						
	none	50x0.25			HMC0246	4.26												
										HMC0294	4.28							

\*\* Armored  
# Measures without a decimal point are in AWG sizes.

### Multi-Conductor and Paired Cables

No. of Cond.	No. of Pairs	Stranded (mm/AWG#)	Solid (mm)	Drain Wire	Unshielded		Overall Spiral		Overall Braid		Overall Foil		Overall Foil/Braid		Individual Foil		Individual Braid	
					Part No.	Page	Part No.	Page	Part No.	Page	Part No.	Page	Part No.	Page	Part No.	Page	Part No.	Page
<b>12 AWG 4.00 mm<sup>2</sup> 2.40 2.05</b>																		
2	none	165x34			1311A	21.11												
	1	65x30			8477	5.5												
	none	19x25			8673	5.4												
	1	19x25		x							8718	5.11						
	none		solid		9582	4.14												
	none		solid	x							9583	4.14						
	none	56x0.30									HMC0153	4.22						
	none	56x0.30							HMC0210	4.24								
	none	56x0.30			HMC0251	4.26												
	none	56x0.30							HMC0299	4.28								
	none	56x0.30							HMC0376	4.31								
	none	56x0.30							HMC0400	4.32								
	none	56x0.30							HMC0415	4.33								
	none	56x0.30							HMC0435	4.34								
	none	56x0.30			SHO0018*	7.8												
	none	56x0.30			SHO0045*	7.9												
none	56x0.30			SHO0076	7.11													
none	56x0.30							SHO0112	7.12									
3	none	56x0.30			HMC0116	4.20												
	none	56x0.30									HMC0154	4.22						
	none	56x0.30							HMC0211	4.24								
	none	56x0.30			HMC0252	4.26												
	none	56x0.30							HMC0300	4.28								
	none	56x0.30							HMC0377	4.31								
	none	56x0.30							HMC0401	4.32								
	none	56x0.30							HMC0416	4.33								
	none	56x0.30							HMC0436	4.34								
	none	56x0.30			SHO0019**	7.8												
	none	56x0.30			SHO0046**	7.9												
	none	56x0.30			SHO0077	7.11												
	none	56x0.30							SHO0113	7.12								
4	none	165x34			1312A	21.11												
	none	56x0.30			HMC0117	4.20												
	none	56x0.30									HMC0155	4.22						
	none	56x0.30							HMC0212	4.24								
	none	56x0.30			HMC0253	4.26												
	none	56x0.30							HMC0301	4.28								
	none	56x0.30							HMC0378	4.31								
	none	56x0.30							HMC0402	4.32								
	none	56x0.30			SHO0020**	7.8												
	none	56x0.30							HMC0417	4.33								
	none	56x0.30							HMC0437	4.34								
	none	56x0.30			SHO0047**	7.9												
	none	56x0.30			SHO0078	7.11												
none	56x0.30							SHO0114	7.12									
5	none	56x0.30									HMC0156	4.22						
	none	56x0.30							HMC0213	4.24								
	none	56x0.30			HMC0254	4.26												
	none	56x0.30							HMC0302	4.28								
	none	56x0.30							HMC0418	4.33								
	none	56x0.30			SHO0021**	7.8												
	none	56x0.30			SHO0048**	7.9												
none	56x0.30							HMC0438	4.34									
6	none	56x0.30									HMC0157	4.22						
	none	56x0.30			HMC0255	4.26												
	none	56x0.30							HMC0303	4.28								
7	none	56x0.30									HMC0158	4.22						
	none	56x0.30							HMC0214	4.24								
	none	56x0.30			HMC0256	4.26												
none	56x0.30							HMC0304	4.28									

\*\* Armored

# Measures without a decimal point are in AWG sizes.

### Multi-Conductor and Paired Cables

No. of Cond.	No. of Pairs	Stranded (mm/AWG#)	Solid (mm)	Drain Wire	Unshielded		Overall Spiral		Overall Braid		Overall Foil		Overall Foil/Braid		Individual Foil		Individual Braid	
					Part No.	Page	Part No.	Page	Part No.	Page	Part No.	Page	Part No.	Page	Part No.	Page	Part No.	Page
<b>11 AWG 4.20 mm<sup>2</sup> 2.60 2.30</b>																		
3	none	56x0.30			BE46380	19.20												
<b>10 AWG 6.00 mm<sup>2</sup> 2.95 2.60</b>																		
2	none	259x34			1313A	21.11												
	none	19x23			8678	4.5												
	none	84x0.30								HMC0159	4.22							
	none	84x0.30			HMC0257	4.26												
	none	84x0.30							HMC0305	4.28								
	none	84x0.30							HMC0419	4.33								
	none	84x0.30							HMC0439	4.34								
	none	84x0.30			SHO0022**	7.8												
	none	84x0.30			SHO0049**	7.9												
3	none	84x0.30																
	none	84x0.30			HMC0118	4.20												
	none	84x0.30									HMC0160	4.22						
	none	84x0.30			HMC0258	4.26												
	none	84x0.30								HMC0306	4.28							
	none	84x0.30								HMC0420	4.33							
	none	84x0.30								HMC0440	4.34							
	none	84x0.30			SHO0023**	7.8												
	none	84x0.30			SHO0050**	7.9												
4	none	84x0.30																
	none	84x0.30			HMC0119	4.20												
	none	84x0.30									HMC0161	4.22						
	none	84x0.30			HMC0259	4.26												
	none	84x0.30								HMC0307	4.28							
	none	84x0.30								HMC0421	4.33							
	none	84x0.30								HMC0441	4.34							
	none	84x0.30			SHO0024**	7.8												
	none	84x0.30			SHO0051**	7.9												
5	none	84x0.30																
	none	84x0.30									HMC0162	4.22						
	none	84x0.30			HMC0260	4.26												
	none	84x0.30								HMC0308	4.28							
	none	84x0.30								HMC0422	4.33							
6	none	84x0.30																
	none	84x0.30									HMC0163	4.22						
	none	84x0.30			HMC0261	4.26												
7	none	84x0.30																
	none	84x0.30									HMC0164	4.22						
	none	84x0.30			HMC0262	4.26												
<b>8 AWG 10.00 mm<sup>2</sup> 3.26</b>																		
2	none	80x0.40																
	none	80x0.40																
	none	80x0.40			SHO0025**	7.8												
	none	80x0.40			SHO0052**	7.9												
	none	80x0.40			SHO0082	7.11												
3	none	80x0.40																
	none	80x0.40																
	none	80x0.40			SHO0026**	7.8												
	none	80x0.40			SHO0053**	7.9												
4	none	80x0.40																
	none	80x0.40																
	none	80x0.40			SHO0083	7.11												
	none	80x0.40																
4	none	80x0.40																
	none	80x0.40																
	none	80x0.40			SHO0027**	7.8												
	none	80x0.40			SHO0054**	7.9												
	none	80x0.40			SHO0084	7.11												
none	80x0.40									SHO0146	7.12							

\*\* Armored

# Measures without a decimal point are in AWG sizes.





## Multi-Conductor and Paired Cables

No. of Cond.	No. of Pairs	Stranded (mm/AWG#)	Solid (mm)	Drain Wire	Unshielded		Overall Spiral		Overall Braid		Overall Foil		Overall Foil/Braid		Individual Foil		Individual Braid	
					Part No.	Page	Part No.	Page	Part No.	Page	Part No.	Page	Part No.	Page	Part No.	Page	Part No.	Page
<b>8 AWG</b> 10.00 mm <sup>2</sup> <b>3.26</b> (continued)																		
5	none	80x0.40									HMC0168	4.22						
<b>6 AWG</b> 16.00 mm <sup>2</sup> <b>4.12</b>																		
2	none	128x0.40									HMC0169	4.22						
3	none	128x0.40									HMC0170	4.22						
	none	126x0.40			SH00085	7.11												
4	none	128x0.40									HMC0171	4.22						
5	none	128x0.40									HMC0172	4.22						
<b>4 AWG</b> 25.00 mm <sup>2</sup> <b>5.19</b>																		
2	none	200x0.40									HMC0173	4.22						
3	none	200x0.40									HMC0174	4.22						
	none	196x0.40			SH00086	7.11												
4	none	200x0.40									HMC0175	4.22						
<b>2 AWG</b> 35.00 mm <sup>2</sup> <b>6.54</b>																		
2	none	280x0.40									HMC0176	4.22						
3	none	280x0.40									HMC0177	4.22						
	none	276x0.40			SH00087	7.11												
4	none	280x0.40									HMC0178	4.23						
<b>1 AWG</b> 50 mm <sup>2</sup> <b>7.35</b>																		
2	none	400x0.40									HMC0179	4.23						
3	none	400x0.40									HMC0180	4.23						
4	none	400x0.40									HMC0181	4.23						
<b>2/0 AWG</b> 70 mm <sup>2</sup> <b>9.26</b>																		
2	none	356x0.50									HMC0182	4.23						
3	none	356x0.50									HMC0183	4.23						
4	none	356x0.50									HMC0184	4.23						
<b>3/0 AWG</b> 95 mm <sup>2</sup> <b>10.4</b>																		
2	none	485x0.50									HMC0185	4.23						
3	none	485x0.50									HMC0186	4.23						
4	none	485x0.50									HMC0187	4.23						
<b>4/0 AWG</b> 120 mm <sup>2</sup> <b>11.7</b>																		
2	none	614x0.50									HMC0188	4.23						
3	none	614x0.50									HMC0189	4.23						

# Measures without a decimal point are in AWG sizes.

## Combination Cables

### Unshielded, Shielded and Partially Shielded

No. of Cond.	Part No.	Description		Shielding	Component	Page
		Conductor / Gage	mm			
<b>Combination Gages</b>						
3	1306SB	1 co - 18 AWG 1 pr - 18 AWG	1.00 1.20	95% BC Braid Unshielded	CCTV Audio	7.5
4	1502R	1 pr - 22 AWG 2 cdr - 18 AWG	0.80 1.20	Beldfoil® Unshielded	Data Power	21.7
	3082A	2 cdr - 15 AWG 2 cdr - 18 AWG	1.70 1.24	Beldfoil® each pair plus overall braid	Power Data	18.22
	3082F	2 cdr - 15 AWG 2 cdr - 18 AWG	1.70 1.20	Beldfoil® each pair plus overall braid	Power Data	18.23
	3082K	2 cdr - 16 AWG 2 cdr - 16 AWG	1.47 1.47	Unshielded	Power Data	18.24
	3082KP	2 cdr - 16 AWG 2 cdr - 16 AWG	1.47 1.47	Unshielded	Power Data	18.24
	3083A	2 cdr - 15 AWG 2 cdr - 18 AWG	1.70 1.24	Beldfoil® each pair plus overall braid	Power Data	18.23
	3084A	2 cdr - 22 AWG 2 cdr - 24 AWG	0.78 0.61	Beldfoil® each pair plus overall braid	Power Data	18.23
	3084F	2 cdr - 22 AWG 2 cdr - 24 AWG	0.76 0.58	Beldfoil® each pair plus overall braid	Power Data	18.23
	3085A	2 cdr - 22 AWG 2 cdr - 24 AWG	0.78 0.61	Beldfoil® each pair plus overall braid	Power Data	18.24
	3086A	2 cdr - 16 AWG 2 cdr - 20 AWG	1.47 0.94	Beldfoil® each pair	Power Data	18.25
	3087A	2 cdr - 22 AWG 2 cdr - 22 AWG	0.78 0.78	Beldfoil® each pair	Power Data	18.25
	3124A	2 cdr - 18 AWG 2 cdr - 22 AWG	1.20 0.76	Overall Beldfoil®	Power Data	18.26
	3125A	2 cdr - 16 AWG 2 cdr - 22 AWG	1.50 0.76	Overall Beldfoil®	Power Data	18.26
	7895A	2 cdr - 20 AWG 2 cdr - 18 AWG	0.94 1.24	Beldfoil® each pair plus overall braid	Power Data	18.24
	7896A	2 cdr - 16 AWG 2 cdr - 18 AWG	1.47 1.24	Beldfoil® each pair plus overall braid	Power Data	18.22
	7897A	2 cdr - 15 AWG 2 cdr - 18 AWG	1.70 1.24	Beldfoil® each pair plus overall braid	Power Data	18.22
7900A	2 cdr - 16 AWG 2 cdr - 18 AWG	1.47 1.24	Unshielded	Power Data	18.22	

No. of Cond.	Part No.	Description		Shielding	Component	Page
		Conductor / Gage	mm			
<b>Combination Gages</b>						
5	1349A	2 cdr - 18 AWG 3 cdr - 20 AWG	1.22 0.96	Overall Beldfoil®	Power Data	18.29
	BE43908	1 pr - 26 AWG 3 cdr - 18 AWG	0.48 1.15	90% BC Braid Unshielded	Audio Power	19.19
6	3126A	2 cdr - 16 AWG 2 cdr - 22 AWG 2 cdr - 12 AWG	1.50 0.76 2.41	Overall Beldfoil®	Control Data Power	18.26
8	9891	3 pr - 22 AWG 1 pr - 20 AWG	0.76 0.96	Beldfoil® each pair plus foil/braid overall	- -	15.70
	9903	3 pr - 28 AWG 1 pr - 24 AWG	0.38 0.61	Beldfoil® each pair plus foil/braid overall	- -	15.70
9	3119A	3 cdr - 18 AWG 3 pr - 24 AWG	1.22 0.61	Overall Beldfoil® plus overall braid	Control Power	18.27
	7911A	4 pr - 24 AWG 1 co - 18 AWG	0.50 1.00	Unshielded Duobond+/-Braid	Data Coax	21.6
10	1347A	2 co - 20 AWG 4 pr - 22 AWG	0.80 0.80	Duofoil®/Braid Beldfoil®	2xVideo 4xAudio	19.21
12	7952A	4 pr - 24 AWG 4 cdr - 14 AWG	0.50 1.85	Unshielded	Data 4xCDR	21.6
	9689	2 pr - 22 AWG 4 pr - 22 AWG	0.64 0.64	Beldfoil® each pair + Braid Unshielded	- -	15.72
13	YR48902	4 pr - 24 AWG 1 co - 20 AWG 1 pr/2 cdr - 1502R	0.50 0.80 -	Unshielded Duofoil®/Braid Unshielded	Data Coax Control	21.5
18	7876S	8 pr - 24 AWG 2 co - 18 AWG	0.50 1.00	Unshielded Duobond+/-Braid	2xData 2xCoax	21.4
20	7878S	8 pr - 24 AWG 2 co - 18 AWG 2 fi - 62.5/ 125/900	0.50 1.00 -	Unshielded Duobond+/-Braid	2xData 2xCoax 2xFiber	21.4

co = Coax • cdr = Conductor(s) • pr = Pair • fi = Fiber

# Coaxial Cables

No. of Cond.	Material	Stranded (mm)	Solid (mm)	Nom. Imp. Ohm	CDR Diameter (mm)	Braid			Double Braid			Cu-foil/Braid		
						Part No.		Page	Part No.		Page	Part No.		Page
<b>30 AWG</b>		<b>0.30</b>	<b>0.25</b>											
1	TCB	7x38		75	0.31	7500A	95% TC	18.38						
	SPCSW	7x0.10		50	0.30	MRG178	96% SPC	6.3						
	SPCSW	7x0.10		75	0.30	MRG179	95% SPC	6.5						
	SPCSW	7x0.10		95	0.30	MRG180	91% SPC	6.6						
	SPCSW	7x0.10		75	0.30	MRG187	95% SPC	6.5						
	SPCSW	7x0.10		95	0.30	MRG195	91% SPC	6.6						
	SPCSW	7x0.10		50	0.30	MRG196	96% SPC	6.3						
2	TC	7x38		75	0.31	1808A	90% TC	21.12						
3	TC	7x38		75	0.30									
4	TC	7x38		75	0.30									
5	TC	7x38		75	0.30									
<b>29 AWG</b>			<b>0.28</b>											
1	SPCCS		solid	50	0.28	1674A•	100% CT	9.32						
<b>28.5 AWG</b>			<b>0.30</b>											
1	BC		solid	75	0.31									
<b>26 AWG</b>		<b>0.50</b>	<b>0.40</b>											
1	CCS		solid	75	0.40									
	SPCSW	7x0.17		50	0.51	MRG188	96% SPC	6.3						
	SPCSW	7x0.17		50	0.51	MRG316	95% SPC	6.3						
3	BC	7x34		75	0.48									
4	BC	7x34		75	0.48									
5	BC	7x34		75	0.48									
<b>25 AWG</b>		<b>0.55</b>	<b>0.45</b>											
1	BC	19x37		75	0.53									
	BC	19x38		75	0.48	7501A	95% TC	18.38						
	BC		solid	50	0.46									
3	TC		solid	75	0.46									
	TC		solid	75	0.46									
4	TC		solid	75	0.46									
	TC		solid	75	0.46									
5	TC		solid	75	0.46									
	TC		solid	75	0.46									
6	TC		solid	75	0.46									
	TC		solid	75	0.46									
<b>24 AWG</b>			<b>0.50</b>											
1	BC		solid	50	0.50									
	SPCCS		solid	50	0.50	1671A•	100% CT	9.32						
<b>23 AWG</b>			<b>0.58</b>											
1	BC		solid	75	0.58									
	CCS		solid	75	0.58	8241	95% BC	19.25						
	BC		solid	75	0.58				BE43187	90% TC + 85% TC	19.28			
	BC		solid	75	0.58				H106T00	92% TC	9.26			
	BC		solid	75	0.58				H106T01	92% TC	9.26			
	CCS		solid	75	0.58	MRG5900	95% BC	9.26						

• Composite Braid

# Coaxial Cables

Duobond®/Braid			Duobond® II/Braid			Duobond® IV			Duobond Plus®/Braid			Duofoil®/Braid			Beldfoil®/Braid			
Part No.		Page	Part No.		Page	Part No.		Page	Part No.		Page	Part No.		Page	Part No.		Page	
<b>30 AWG</b>																		
												1520A	90% TC	19.26				
												1521A	90% TC	19.26				
												1522A	90% TC	19.26				
<b>29 AWG</b>																		
<b>28.5 AWG</b>																		
	179DT	95% TC	19.27 21.12															
<b>26 AWG</b>																		
												H122A00	60% TC	9.25				
												1406B	93% TC	19.26				
												1407B	93% TC	19.26				
												1417B	93% TC	19.26				
<b>25 AWG</b>																		
												1865A	95% TC	19.27				
															7805	90% TC	9.27	
	1277R	95% TC	19.31 21.13															
	1281S3	95% TC	19.33 21.13															
	1278R	95% TC	19.31 21.13															
	1281S4	95% TC	19.33 21.13															
	1279R	95% TC	19.31 21.13															
	1281S5	95% TC	19.33 21.13															
	1280R	95% TC	19.31 21.13															
	1281S6	95% TC	19.33 21.13															
<b>24 AWG</b>																		
																7805R	93% TC	9.27
<b>23 AWG</b>																		
																1855A	95% TC	19.27

See page 2.33 for key to abbreviations used in this table.



### Coaxial Cables

No. of Cond.	Material	Stranded (mm)	Solid (mm)	Nom. Imp. Ohm	CDR Diameter (mm)	Braid			Double Braid			Cu-foil/Braid		
						Part No.		Page	Part No.		Page	Part No.		Page
<b>23 AWG</b>		<b>0.58</b>		<i>(continued)</i>										
3	BC		solid	75	0.58									
	TC		solid	75	0.58									
4	TC		solid	75	0.58									
5	BC		solid	75	0.58									
	TC		solid	75	0.58									
6	BC		solid	75	0.58									
	TC		solid	75	0.58									
10	TC		solid	75	0.58									
12	TC		solid	75	0.58									
<b>22 AWG</b>		<b>0.80</b>		<b>0.60</b>										
1	BCC	7x29		75	0.76				1505F	98% TC	19.28 21.12			
	TC		solid	75	0.64									
	BC	19x34		75	0.79	7502A	95% TC	18.38						
	BC	7x30		75	0.76	9259	95% BC	19.25						
	BC		solid	75	0.65									
	BC		solid	75	0.65									
	BC		solid	75	0.65									
	SPCSW		solid	75	0.64	MRG140	95% SPC	6.5						
	SPCSW		solid	75	0.64	MRG302	95% SPC	6.5						
<b>20 AWG</b>		<b>0.90</b>		<b>0.80</b>										
1	BC		solid	75	0.81									
	BC		solid	75	0.81									
	SPC	19x0.36		75	0.99				7783AF*	90% SPC + 80% BC	19.23			
	BC		solid	75	0.81				8281	98% TC	19.25			
	SPCCS		solid	75	0.81									
	TC	19x32		50	0.94									
	TC	19x32		50	0.94									
	TC	19x32		50	0.94									
	BC		solid	75	0.80									
	BC		solid	75	0.80									
	BC		solid	75	0.80									
	BC		solid	75	0.80									
	BC		solid	75	0.80							H121C00	45% BC	9.24
	2	BC		solid	75	0.80								
3	BC		solid	75	0.81									
	BC		solid	75	0.81									
4	BC		solid	75	0.81									
5	BC		solid	75	0.81									
	BC		solid	75	0.81									
6	BC		solid	75	0.81									
10	BC		solid	75	0.81									
<b>19 AWG</b>		<b>1.00</b>		<b>0.90</b>										
1	SPCCS		solid	50	0.90	1673A•	100% CT	9.32						
	BC	7x27		75	1.00				1694F	99% TC	19.29			
	BC		solid	50	0.90									
	SPCSW		solid	50	0.94	MRG303	95% SPC	6.3						
	SPCSW		solid	50	0.94				MRG142	96% SPC	6.3			
	TC	19x0.18		50	0.91	MRG5800	93% TC	9.31						

• Composite Braid  
\* Triax

# Coaxial Cables

Duobond®/Braid			Duobond® II/Braid			Duobond® IV			Duobond Plus®/Braid			Duofoil®/Braid			Beldfoil®/Braid		
Part No.		Page	Part No.		Page	Part No.		Page	Part No.		Page	Part No.		Page	Part No.		Page
<b>23 AWG</b>																	
												1855S3	95% TC	19.33			
												7787A	95% TC	19.31			
												7788A	95% TC	19.31			
												1855S5	95% TC	19.33			
												7789A	95% TC	19.31			
												1855S6	95% TC	19.33			
												7790A	95% TC	19.31			
												7791A	95% TC	19.31			
												7792A	95% TC	19.31			
<b>22 AWG</b>																	
												1855ENH	90% TC	19.27			
												H123A00	44% TC	9.25			
												H123A01	88% TC	9.25			
												H123A02	88% TC	9.25			
<b>20 AWG</b>																	
												1505A	95% TC	19.28			
												1505ANH	95% TC	19.28			
									9167	95% AL	9.26						
			9907	93% TC	15.69 18.12												
			82907	93% TC	15.69												
			89907	93% TC	18.12 15.69												
												H121A00	40% TC	9.24			
												H121A01	40% TC	9.24			
												H121A03	75% TC	9.24			
												H121A04	75% TC	9.24			
												H121A02	40% TC	9.25			
												1505S3	95% TC	19.34			
												7794A	95% TC	19.32			
												7795A	95% TC	19.32			
												1505S5	95% TC	19.34			
												7796A	95% TC	19.32			
												1505S6	95% TC	19.34			
												7798A	95% TC	19.32			
<b>19 AWG</b>																	
												7806A	90% TC	9.27			

See page 2.33 for key to abbreviations used in this table.



## Coaxial Cables

No. of Cond.	Material	Stranded (mm)	Solid (mm)	Nom. Imp. Ohm	CDR Diameter (mm)	Braid			Double Braid			Cu-foil/Braid		
						Part No.		Page	Part No.		Page	Part No.		Page
<b>18 AWG</b>														
		<b>1.00</b>												
1	BC		solid	75	1.02									
	BC		solid	75	1.02									
	BC		solid	75	1.02									
	BC	7x15x40		75	1.02	7503A	95% TC	18.38						
	CCS		solid	75	1.02									
	BC	105x40		75	1.02									
	CCS		solid	75	1.02									
	CCS		solid	75	1.02									
	CCS		solid	75	1.02									
	CCS		solid	75	1.02									
	BC		solid	75	1.00									
	BC		solid	75	1.00							CT100C0	53% BC	9.23
	BC		solid	75	1.00							CT100C1	53% BC	9.23
	BC		solid	75	1.00							CT100C3	53% BC	9.23
	BC		solid	75	1.00							H109C00	55% BC	9.20
	BC		solid	75	1.00							H109C02	55% BC	9.20
	BC		solid	75	1.00									
	BC		solid	75	1.00									
	BC		solid	75	1.00									
	BC		solid	75	1.00									
	BC		solid	75	1.00									
	BC		solid	75	1.00									
	BC		solid	75	1.00									
	BC		solid	75	1.00									
	BC		solid	75	1.00									
	BC		solid	75	1.00									
	BC		solid	75	1.00									
	BC		solid	75	1.00									
	BC		solid	75	1.00									
	BC		solid	75	1.00									
	BC		solid	75	1.00									
	BC		solid	75	1.00									
	BC		solid	75	1.00									
BC		solid	75	1.00										
BC		solid	75	1.00										
BC		solid	75	1.00										
BC		solid	75	1.00										
BC		solid	75	1.00										
BC		solid	75	1.00										
CCS		solid	75	1.00										
CCS		solid	75	1.00										
CCS		solid	75	1.00										
2	BC		solid	75	1.00									
	BC		solid	75	1.00							H125C03	40% BC	9.21
3	BC		solid	75	1.02									
4	BC		solid	75	1.02									
5	BC		solid	75	1.02									
10	BC		solid	75	1.02									
<b>17 AWG</b>														
		<b>1.40</b>		<b>1.15</b>										
1	BC		solid	50	1.15									
	TC	19x0.28		50	1.41									
	TC	19x0.28		50	1.41									
	SPC	19x0.28		75	1.40				7784AF*	90% SPC + 85% BC	19.23			
<b>16 AWG</b>														
		<b>1.50</b>		<b>1.20</b>										
1	BC	7x37x40		75	1.65	7504A	95% TC	18.38						
	SPC		solid	75	1.40				7784ANH*	90% SPC + 85% BC	19.23			
	SPC		solid	75	1.40				7784AS*	90% SPC + 85% BC	19.23			

\* Triax





# Coaxial Cables

No. of Cond.	Material	Stranded (mm)	Solid (mm)	Nom. Imp. Ohm	CDR Diameter (mm)	Braid			Double Braid			Cu-foil/Braid					
						Part No.		Page	Part No.		Page	Part No.		Page			
<b>16 AWG</b>														<b>1.50</b>		<b>1.20 (continued)</b>	
1	BC		solid	75	1.40				7784E*	85% BC + 80% BC	19.23						
	TC		solid	75	1.20												
	BC		solid	75	1.20												
	BC		solid	75	1.20							PRG7C00	40% BC	9.17			
	BC		solid	75	1.20							PRG7C01	40% BC	9.17			
	BC		solid	75	1.25							CT125C0	51% BC	9.16			
	BC		solid	75	1.25							CT125C1	51% BC	9.16			
	BC		solid	75	1.25							CT125C3	51% BC	9.16			
	BC		solid	75	1.25							RG7C00	50% BC	9.17			
	BC		solid	75	1.25							RG7C01	50% BC	9.16			
	BC		solid	75	1.25							RG7C02	50% BC	9.16			
<b>15 AWG</b>														<b>1.45</b>			
1	BC		solid	50	1.45												
	SPCSW		solid	50	1.50	MRG304	95% SPC	6.4									
<b>14.5 AWG</b>														<b>1.55</b>			
1	BC		solid	75	1.55												
	BC		solid	75	1.55												
	BC		solid	75	1.55							PRG11C0	50% BC	9.13			
	BC		solid	75	1.55							PRG11C2	50% BC	9.14			
	BC		solid	75	1.55							PRG11C4	50% BC	9.14			
	BC		solid	75	1.55							PRG11C6#	50% BC	9.13			
	BC		solid	75	1.55												
	BC		solid	75	1.55												
	BC		solid	75	1.55												
<b>14 AWG</b>														<b>1.60</b>			
1	CCS		solid	75	1.63												
	CCS		solid	75	1.63												
	BC		solid	75	1.63												
	BC		solid	75	1.63												
	BC		solid	75	1.63												
	CCS		solid	75	1.63												
	CCS		solid	75	1.63												
	CCS		solid	75	1.63												
	SPC		solid	50	1.65	1675A*	100% CT	9.32									
	BC		solid	75	1.67							CT167C0	55% BC	9.12			
	BC		solid	75	1.67							CT167C1	55% BC	9.12			
	BC		solid	75	1.67							CT167C2	55% BC	9.12			
	BC		solid	75	1.67							CT167C3	55% BC	9.12			
	<b>13 AWG</b>														<b>1.83</b>		
1	BC		solid	50	1.83												
<b>12 AWG</b>														<b>2.40</b>		<b>2.05</b>	
1	SPC	7x0.75		75	2.21				7785A*	80% SPC + 80% BC	19.24						
	SPC	7x0.75		75	2.21				7785ANH*	80% SPC + 80% BC	19.24						
	BC		solid	50	2.05												
	BC		solid	50	2.05												
	BC		solid	75	2.23							CX4C0	60% BC	9.11			
	BC		solid	75	2.23							CX4C1***		9.11			
	BC		solid	75	2.23							CX4C2	60% BC	9.11			
	BC		solid	75	2.23							CX4C3#	60% BC	9.11			
	SPC	7x0.80		50	2.40	MRG165	96% SPC	6.4									
	SPC	7x0.79		50	2.30				MRG225	95% SPC	6.4						
	BC	7x0.75		50	2.25	MRG2130	92% BC	9.31									

• Composite Braid  
 \* Triax, \*\*\* without Braid  
 # Messenger

# Coaxial Cables

Duobond®/Braid			Duobond® II/Braid			Duobond® IV			Duobond Plus®/Braid			Duofoil®/Braid			Beldfoil®/Braid		
Part No.		Page	Part No.		Page	Part No.		Page	Part No.		Page	Part No.		Page	Part No.		Page
<b>16 AWG</b>																	
												PRG7A00	40% TC	9.17			
												PRG7A01#	40% TC	9.17			
<b>15 AWG</b>																	
			7808A	95% TC	9.28												
<b>14.5 AWG</b>																	
												PRG11A2	50% TC	9.14			
												PRG11A3	50% TC	9.14			
												PRG11D0	50% TC	9.15			
												PRG11D1	70% TC	9.15			
												PRG11D3	50% TC	9.15			
<b>14 AWG</b>																	
						3094A		15.71									
								18.19									
						3095A		18.19									
												7731A	95% TC	19.30			
												7731ANH	95% TC	19.30			
												9292	60% TC	19.25			
			1523A	60% AL	9.13												
			1524AM#	60% AL	9.13												
			1525A**	60% AL	9.13												
<b>13 AWG</b>																	
			7809A	95% TC	9.28												
<b>12 AWG</b>																	
						9880		15.69									
								18.12									
						89880		15.69									
								18.12									

# Messenger  
 \*\* CoreGuard®  
 See page 2.33 for key to abbreviations used in this table.

## Coaxial Cables

No. of Cond.	Material	Stranded (mm)	Solid (mm)	Nom. Imp. Ohm	CDR Diameter (mm)	Braid			Double Braid			Cu-foil/Braid		
						Part No.		Page	Part No.		Page	Part No.		Page
<b>11 AWG</b>			<b>2.50</b>											
1	BC		solid	50	2.50							H500C00	50% BC	9.30
<b>10 AWG</b>			<b>2.70</b>		<b>2.60</b>									
1	BCCA		solid	50	2.60									
	BC		solid	50	2.62							H1000C0	50% BC	9.30
	BC		solid	50	2.62							H1000C1	50% BC	9.30
	BC		solid	50	2.62							H1000C3	85% BC	9.30
	BC	19x0.54		solid	50	2.70						H1001C1	50% BC	9.30
<b>9 AWG</b>					<b>3.15</b>									
1	CCA		solid	75	3.15									
	CCA		solid	75	3.15									
<b>8 AWG</b>					<b>3.38</b>									
1	BC		solid	75	3.38							CX3C0	60% BC	9.9
	BC		solid	75	3.38							CX3C1***		9.9
	BC		solid	75	3.38							CX3C2	60% BC	9.9
	BC		solid	75	3.38							CX3C3#	60% BC	9.9
<b>7 AWG</b>					<b>3.60</b>									
1	BCCA		solid	50	3.60									
<b>5.5 AWG</b>					<b>4.47</b>									
1	BCCA		solid	50	4.47									

\*\*\* without Braid  
# Messenger

# Coaxial Cables

Duobond®/Braid		Duobond® II/Braid			Duobond® IV			Duobond Plus®/Braid			Duofoil®/Braid			Beldfoil®/Braid			
Part No.		Page	Part No.		Page	Part No.		Page	Part No.		Page	Part No.		Page	Part No.		Page
<b>11 AWG</b>																	
<b>10 AWG</b>																	
			7810A	95% TC	9.28												
<b>9 AWG</b>																	
	YE00131◆		9.10														
	YE00132#◆		9.10														
<b>8 AWG</b>																	
<b>7 AWG</b>																	
			7976A	90% TC	9.29												
<b>5.5 AWG</b>																	
			7977A	85% TC	9.29												

# Messenger  
 ◆ Welded Aluminum Tube

**Conductor abbreviations:**  
 BC = Bare Copper  
 BCC = Bare Compacted Copper  
 BCCA = Bare Copper-Covered Aluminum  
 CCA = Copper-Cladded Aluminum  
 CCS = Copper-Covered Steel  
 SPC = Silver-Plated Copper  
 SPCCS = Silver-Plated Copper-Covered Steel  
 SPCSW = Silver-Plated Copperweld-Steel-Wire  
 TC = Tinned Copper  
 TCB = Tinned Cadmium Bronze

2 • Cable Finder Guide

---

## Notes

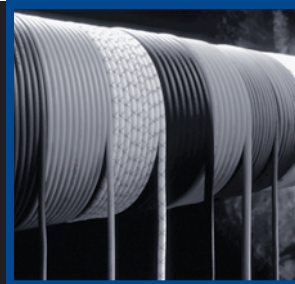

# Hook-Up and Lead Wire

## Table of Contents

Hook-Up & Lead Wire Cables	Page No.
<b>Introduction</b>	<b>3.2</b>
<b>Technical Information</b>	<b>3.3</b>
<b>PTFE/Kapton®/PTFE</b>	<b>3.4</b>
600V, 260°C	3.4
<b>PTFE</b>	<b>3.5</b>
600V, 260°C, peak temp 300°C	3.5
<b>FEP</b>	<b>3.6 – 3.9</b>
(VDE approved): 300/500V, 180°C	3.6
(VDE approved) double insulated: 300/500V, 180°C	3.7
600V, 200°C, peak temp 230°C	3.8
(VDE 0881): 900V, 180°C, peak temp 200°C	3.9
<b>ETFE</b>	<b>3.10 – 3.11</b>
450/750V, 135°C	3.10
600V, 135°C	3.11
<b>PFA</b>	<b>3.12</b>
600V, 260°C, peak temp 280°C	3.12
<b>Trakrad 100</b>	<b>3.13</b>
1900/3300V, 125°C	3.13
<b>Zyrad®</b>	<b>3.14 – 3.15</b>
Zyrad® 500 UL/CSA: 600V, 150°C	3.14
Zyrad® 555: 600V, 155°C	3.15
<b>Silicone Rubber FRNC</b>	<b>3.16 – 3.20</b>
Braidless: 300/500V, 180°C, peak temp 250°C	3.16
Braidless (H05S): 300/500V, 180°C, peak temp 250°C	3.17
Braidless (VDE approved): 300/300V, 180°C, peak temp 250°C	3.18
Braidless (Superflex): 300/500V, 180°C, peak temp 250°C	3.19
Glass Braid (H05SJ-K): 300/500V, 180°C	3.20
<b>Glass Braid</b>	<b>3.21</b>
250V, 350°C	3.21
<b>Kapton®</b>	<b>3.21</b>
Glass Braid: 300/300V, 220°C, month 300°C, peak temp 500°C	3.21
<b>Mica</b>	<b>3.22</b>
Glass Braid: 300/500V, 350°C, peak temp 500°C	3.22
Ceramic Braid: 300/500V, 1550°C (short term)	3.22
<b>EFGLAS</b>	<b>3.23</b>
Glass Braid/PTFE: 600V, 260°C	3.23

Kapton® is a DuPont trademark.

## Introduction

### Hook-Up With Belden and Lead The Way

Consistency is vital wherever cables are used. From data processing to lighting, from services to HVAC – cable quality delivers a performance that makes life easier, more efficient and problem free.

Off-the-shelf or tailor-made, Belden hook-up and lead wire products are manufactured in a variety of materials, sizes and designs to meet rigid industry specifications. By manufacturing in-house, Belden has full control from start to finish – from the initial copper rod through rubber formulation and plastic mixing to the finished product. The way Belden manufactures cables is the guarantee of durable quality, perfect performance and top specifications which will meet or exceed industry standards.

### Key Applications

- Inter-connection circuits
- Wiring of computers
- Wiring of data processing equipment
- Appliances
- Lighting
- Motor leads
- Heating and cooling equipment
- Harness fabrication
- Automotive
- Aerospace/defense
- Nuclear environment/radiation resistance

### Special Features

- Extended temperature and chemical resistant cables: these cables are suitable for applications in the temperature range from -190°C up to +1250°C.

### Availability

Most of our hook-up and lead wire constructions are available from stock in a wide variety of colors and packages. Many of these are available off the shelf from distributors. If you have a new or unusual application or you cannot find a hook up wire cable in this catalog section that meets your technical requirements, see our U.S. Master Catalog or contact technical support at +31-77-3875-414 or techsupport.venlo@belden.com.

### Index by Voltage and Temperature Rating

Hook-Up & Lead Wire Section		Page No.
<b>300V, 180°C</b>	Silicone Rubber Braidless FRNC	3.16
	Silicone Rubber Braidless FRNC (H05S)	3.17
	Silicone Rubber Braidless FRNC (VDE approved)	3.18
	Silicone Rubber Braidless FRNC (Superflex)	3.19
	Silicone Rubber Glass Braid FRNC (H05SJ-K)	3.20
	FEP (VDE approved)	3.6
	FEP double insulated (VDE approved)	3.7
<b>300V, 350°C</b>	Glass Braid	3.21
	Kapton® Glass Braid	3.21
	Mica Glass Braid	3.22
<b>300V, 1550°C</b>	Mica Ceramic Braid	3.22
<b>450V, 135°C</b>	ETFE	3.10
<b>600V, 150°C</b>	ETFE	3.11
	Zyrad® 500	3.14
<b>600V, 155°C</b>	Zyrad® 555	3.15
<b>600V, 200°C</b>	FEP	3.8
	EFGLAS Glass Braid/PTFE	3.23
<b>600V, 260°C</b>	PFA	3.12
	PTFE/Kapton®/PTFE	3.4
	PTFE	3.5
	FEP (VDE 0881)	3.9
<b>1900V, 125°C</b>	Trakrad 100 FR and oil resistant	3.13

\*peak voltage

### Nominal Temperature Operating Ranges (°C)

-100°	-80°	-60°	-40°	-20°	0	20°	40°	60°	80°	100°	120°	140°	160°	180°	200°	220°	240°																						
-190°																		PTFE		260°C																			
-190°																		-100°				ETFE				150°C													
-190°																		PFA																		260°C			
-190°																		-25°				Trakrad100				125°C													
-190°																		-65°				Zyrad®				150°C													
-190°																		-50°				Silicone				180°C													
-190°																		-100°																		FEP		205°C	
-190°																		-50°				Glass Braid				350°C													
-190°																		-50°				S-Glass Fiber				400°C													
-190°																		-50°				Kapton®				500°C													
-190°																		-50°				Mica				1250°C													

Kapton® is a DuPont trademark.

## Technical Information

### Conductor and Insulation Materials

#### Conductors

##### Uni-Strand®

Uni-Strand tinned copper conductor. In this type of construction, the bare copper wires are stranded and then tinned to coat the strands and also fill the interstices between the strands. This allows for easier wire stripping with no re-twisting operation.

##### Plated Copper Conductor

There are a number of plating materials used to enhance the characteristics of the copper conductor. Tin plating is mainly used to improve the soldering characteristics of the conductor. Silver is used to increase the temperature and conductivity of the conductor as well as its soldering characteristics. Nickel-plating increases the temperature rating of the conductor even higher as well as offering excellent anti-oxidation characteristics.

#### Insulation Materials

##### Silicone Rubber

Braidless silicone lead wire features easy and clean stripping without the problems associated with glass braid lead wire. It has excellent physical and mechanical strength properties.

Recommended for high temperature applications in motors, lighting fixtures, clothes dryers, stoves, therapeutic and electronic devices. It is recommended that varnish compatibility be checked before production. Some rigid varnishes may cause cracking when the wire is severely bent.

##### Silicone Rubber – Glass Braid

The silicone insulation strips clean and easy. The glass braid provides additional abrasion resistance and is treated to prevent fraying. Recommended for high-temperature applications in motors, lighting fixtures, clothes dryers, stoves, therapeutic and electronic devices.

##### FEP Teflon®

Teflon® is a fluorinated thermoplastic with outstanding thermal, physical, and electrical properties. Teflon® is generally restricted to applications requiring its special characteristics because its basic resin and processing costs are relatively high.

Belden Teflon® wire products are highly recommended for miniature cable applications because of their superior thermal and electrical properties. Teflon® is especially suitable for internal wiring soldering applications where insulation melt back is a specific problem.

Belden wiring products insulated with Teflon® are outstanding in their resistance to oil, oxidation, heat, sunlight and flame; and also in their ability to remain flexible at low temperatures. They have excellent resistance to ozone, water, alcohol, gasoline, acids, alkalis, aromatic hydrocarbons and solvents.

##### PTFE

Best chemical resistance and very good electrical and mechanical properties are characteristic for this material. Belden processes PTFE in the form of wrapped tapes and extrusion.

##### PFA

Same material properties as PTFE. Applied by extrusion.

##### ETFE

Chemical and mechanical properties comparable to PTFE. Applied by extrusion.

##### Trakrad 100

Trakrad is a cross-linked polyolefin insulated cable designed for traction and rolling stock, and is suitable for fixed installations within vehicles and between motor and underframe. These cables are also designed for use in connections to coil windings, wiring of motor vehicles, control panels and switchgear. They are designed to provide enhanced oil resistance to meet British Rail spec. TDE 76/P/16.

##### Zyrad®

Zyrad® 500 and 555 are a modified cross-linked polyolefin having a 600V 155°C rating for commercial applications, in particular class F motor lead wires.

Zyrad® 500 is approved to UL3289 and CSA CL 1503. Both Zyrad® 500 and Zyrad® 555 have excellent abrasion resistance, coupled with good flexibility, and will withstand varnish bake temperatures of 190°C and short term exposure at 250°C.

##### EFGLAS

EFGLAS cable range is designed to meet the specification BSG222, a specification for aircraft wiring cables at high (+260°C) and low (-70°C) temperature. These cables are popular throughout many industries and applications because of their temperature rating and improved abrasion resistance.

##### Ceramic Material Insulated Cables

Belden offers special insulation and sheath materials based on ceramic and mica. These material allow service at a constant ambient temperature of +800°C and peak temperatures up to +1550°C even under extreme conditions, e.g. application in glass, iron- and steel fabrication.

In order to extend the fields of application, glass fiber materials can be combined with other high performance materials e.g. PTFE, FEP, Kapton®, silicone or mica. These combinations ensure application in humid areas at an excellent dielectric strength.

##### Kapton®

Kapton® film is a compact, lightweight mechanically tough cable insulation system offering both space and weight saving characteristics. Kapton® equipment wires have excellent electrical properties as well as generating low smoke and being classed as low toxic.

Kapton® and Teflon® are DuPont trademarks.



**PTFE / Kapton® / PTFE**

600V, 260°C

De- scription	Part No.	UL NEC/ C(UL)CEC Type IEC	Standard Lengths		Standard Unit Weight		Conductor (Stranding) Diameter Nom. DCR	Nominal Conductor OD		Shielding Material Nom. DCR	Nominal OD		Application
			ft.	m	lbs.	kg		AWG	Section mm <sup>2</sup>		inch	mm	

**260°C • 20 - 4/0 AWG • Stranded Nickel-Plated Copper Wire**

**PTFE / Kapton® / White PTFE Insulation • according to VG 95218 part 20 B**

ASTM-D 4895

Unshielded

For wiring at high ambient temperatures and increased mechanical stress e.g.  
- Aerospace  
- Lead wires for engines and gearboxes

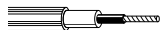

<b>HMC4000</b>	1000	305	6.7	3.0	37 wires NPC	20	0.50	0.083	2.10
<b>HMC4001</b>	1000	305	8.7	4.0	37 wires NPC	18	0.75	0.091	2.30
<b>HMC4002</b>	1000	305	10.8	4.9	37 wires NPC	17	1.00	0.098	2.50
<b>HMC4003</b>	1000	305	15.5	7.0	37 wires NPC	16	1.50	0.110	2.80
<b>HMC4004</b>	1000	305	23.5	10.7	37 wires NPC	14	2.50	0.138	3.50
<b>HMC4005</b>	1000	305	37.6	17.1	7 legs NPC	12	4	0.173	4.40
<b>HMC4006</b>	1000	305	51.8	23.5	7 legs NPC	10	6	0.209	5.30
<b>HMC4007</b>	500	152	41.3	18.8	19 legs NPC	8	10	0.256	6.50
<b>HMC4008</b>	500	152	66.5	30.2	19 legs NPC	6	16	0.303	7.70
<b>HMC4009</b>	500	152	100.5	45.6	37 legs NPC	4	25	0.378	9.60
<b>HMC4010</b>	500	152	137.8	62.5	37 legs NPC	2	35	0.429	10.90
<b>HMC4011</b>	500	152	184.8	83.8	37 legs NPC	1	50	0.504	12.80
<b>HMC4012</b>	500	152	252.7	114.6	37 legs NPC	2/0	70	0.587	14.90
<b>HMC4013</b>	500	152	335.1	152.0	37 legs NPC	3/0	95	0.685	17.40
<b>HMC4014</b>	500	152	407.3	184.8	37 legs NPC	4/0	120	0.756	19.20

NPC = Nickel-Plated Copper • DCR = DC resistance

Kapton® is a DuPont trademark.

**PTFE**

600V, 260°C, peak temp 300°C

De- scription	Part No.	UL NEC / C(UL)/CEC Type IEC	Standard lengths		Standard Unit Weight		Conductor (Stranding) Diameter Nom. DCR	Nominal Conductor OD		Shielding Material Nom. DCR	Nominal OD		Application
			ft.	m	lbs.	kg		AWG	Section mm <sup>2</sup>		inch	mm	

**260°C • 20 - 2 AWG • Stranded Nickel-Plated Copper Wire**

**PTFE Insulation** (Brown, Red, Orange, Yellow, Green, Violet, Grey, White, Black and Blue) • **According to MIL-W-16878**  
 ASTM-D 4895 Unshielded For internal wiring at low and high ambient temperatures and/or corrosive environments.



Bi-color and tri-color combinations are available on request.

<b>HMC4015</b>	328	100	1.6	0.7	(7x0.30) NPC	20	0.50	0.059	1.51
<b>HMC4016</b>	328	100	2.4	1.1	(19x0.228) NPC	18	0.75	0.067	1.69
<b>HMC4017</b>	328	100	2.9	1.3	(29x0.203) NPC	17	1.00	0.074	1.88
<b>HMC4018</b>	328	100	4.0	1.8	(27x0.254) NPC	16	1.50	0.088	2.24
<b>HMC4019</b>	328	100	6.6	3.0	(45x0.254) NPC	14	2.50	0.104	2.65
<b>HMC4020</b>	328	100	9.9	4.5	(50x0.30) NPC	12	4	0.124	3.15
<b>HMC4021</b>	328	100	14.6	6.6	(75x0.30) NPC	10	6	0.152	3.85
<b>HMC4022</b>	328	100	25.6	11.6	(80x0.404) NPC	8	10	0.224	5.70
<b>HMC4023</b>	328	100	38.8	17.6	(126x0.404) NPC	6	16	0.268	6.80
<b>HMC4024</b>	328	100	60.0	27.2	(196x0.404) NPC	4	25	0.339	8.60
<b>HMC4025</b>	328	100	82.7	37.5	(276x0.404) NPC	2	35	0.390	9.90

**260°C • 30 - 20 AWG • Solid Nickel-Plated Copper Wire**

**PTFE Insulation** (Brown, Red, Orange, Yellow, Green, Violet, Grey, White, Black and Blue) • **According to MIL-W-16878**  
 ASTM-D 4895 Unshielded



Bi-color and tri-color combinations are available on request.

<b>HMC4026</b>	328	100	0.3	0.1	(1x0.254) NPC	30	0.051	0.034	0.86
<b>HMC4027</b>	328	100	0.4	0.2	(1x0.32) NPC	28	0.080	0.036	0.92
<b>HMC4028</b>	328	100	0.6	0.3	(1x0.40) NPC	26	0.126	0.039	1.00
<b>HMC4029</b>	328	100	0.8	0.4	(1x0.50) NPC	24	0.197	0.043	1.10
<b>HMC4030</b>	328	100	1.1	0.5	(1x0.64) NPC	22	0.32	0.049	1.24
<b>HMC4031</b>	328	100	1.5	0.7	(1x0.80) NPC	20	0.50	0.055	1.40

NPC = Nickel-Plated Copper • DCR = DC resistance

- Also available on request:
- BS3G 210 Type A (300V)
  - BS3G 210 Type B (600V)
  - BS3G 210 Type C (1000V)

**FEP (VDE approved)**

300/500V, 180°C

De- scription	Part No.	UL NEC/ C(UL)CEC Type IEC	Standard Lengths		Standard Unit Weight		Conductor (Stranding) Diameter Nom. DCR	Nominal Conductor OD		Shielding Material Nom. DCR	Nominal OD		Application
			ft.	m	lbs.	kg		AWG	Section mm <sup>2</sup>		inch	mm	

**180°C • 20 - 14 AWG • Stranded Tin-Plated Copper Wire**

**FEP Insulation** (Brown, Red, Orange, Yellow, Green, Violet, Grey, White, Black and Blue) • **VDE reg. no. 6574 5519**  
 VDE 0207 Part 6 Unshielded For wiring in electrical appliances and lighting up to a maximum operating temperature of 180°C.



<b>HMC4032</b>	328	100	1.0	0.5	(16x0.20) TPC	20	0.50	0.059	1.50
<b>HMC4033</b>	328	100	1.6	0.7	(24x0.20) TPC	18	0.75	0.067	1.70
<b>HMC4034</b>	328	100	2.2	1.0	(32x0.20) TPC	17	1.00	0.075	1.90
<b>HMC4035</b>	328	100	2.9	1.3	(30x0.25) TPC	16	1.50	0.083	2.10
<b>HMC4036</b>	328	100	4.2	1.9	(50x0.25) TPC	14	2.50	0.106	2.70

**180°C • 20 - 14 AWG • Solid Tin-Plated Copper Wire**

**FEP Insulation** (Brown, Red, Orange, Yellow, Green, Violet, Grey, White, Black and Blue) • **VDE reg. no. 6574 5519**  
 VDE 0207 Part 6 Unshielded



<b>HMC4037</b>	328	100	1.5	0.7	(1x0.80) TPC	20	0.50	0.055	1.40
<b>HMC4038</b>	328	100	2.1	1.0	(1x0.98) TPC	18	0.75	0.063	1.60
<b>HMC4039</b>	328	100	2.6	1.2	(1x1.13) TPC	17	1.00	0.065	1.65
<b>HMC4040</b>	328	100	3.7	1.7	(1x1.38) TPC	16	1.50	0.079	2.00
<b>HMC4041</b>	328	100	6.2	2.8	(1x1.78) TPC	14	2.50	0.098	2.50

TPC = Tin-Plated Copper • DCR = DC resistance

### FEP (VDE approved) double insulated

300/500V, 180°C

De- scription	Part No.	UL NEC/ C(UL)/CEC Type IEC	Standard Lengths		Standard Unit Weight		Conductor (Stranding) Diameter Nom. DCR	Nominal Conductor OD		Shielding Material Nom. DCR	Nominal OD		Application
			ft.	m	lbs.	kg		AWG	Section mm <sup>2</sup>		inch	mm	

**180°C • 20 - 14 AWG • Stranded Tin-Plated Copper Wire**

**FEP Double Insulation** (Brown, Red, Orange, Yellow, Green, Violet, Grey, White, Black and Blue) • **VDE reg. no. 6574 9410**

VDE 0207  
Part 6

Unshielded

For wiring in electrical appliances and lighting appropriate for protection class II up to an operating temperature of 180°C.

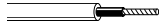

HMC4042	328	100	2.6	1.2	(16x0.20) TPC	20	0.50	0.083	2.10
HMC4043	328	100	3.3	1.5	(24x0.20) TPC	18	0.75	0.091	2.30
HMC4044	328	100	4.0	1.8	(32x0.20) TPC	17	1.00	0.098	2.50
HMC4045	328	100	5.3	2.4	(30x0.25) TPC	16	1.50	0.106	2.70
HMC4046	328	100	8.2	3.7	(50x0.25) TPC	14	2.50	0.134	3.40

**180°C • 20 - 14 AWG • Solid Tin-Plated Copper Wire**

**FEP Double Insulation** (Brown, Red, Orange, Yellow, Green, Violet, Grey, White, Black and Blue) • **VDE reg. no. 6574 9410**

VDE 0207  
Part 6

Unshielded



HMC4047	328	100	2.4	1.1	(1x0.80) TPC	20	0.50	0.079	2.00
HMC4048	328	100	3.1	1.4	(1x0.98) TPC	18	0.75	0.087	2.20
HMC4049	328	100	3.7	1.7	(1x1.13) TPC	17	1.00	0.091	2.30
HMC4050	328	100	5.1	2.3	(1x1.38) TPC	16	1.50	0.102	2.60
HMC4051	328	100	7.9	3.6	(1x1.78) TPC	14	2.50	0.126	3.20

TPC = Tin-Plated Copper • DCR = DC resistance

**FEP**

600V, 200°C, peak temp 230°C

De- scription	Part No.	UL NEC/ C(UL)CEC Type IEC	Standard Lengths		Standard Unit Weight		Conductor (Stranding) Diameter Nom. DCR	Nominal Conductor OD		Shielding Material Nom. DCR	Nominal OD		Application
			ft.	m	lbs.	kg		AWG	Section mm <sup>2</sup>		inch	mm	

**200°C • 20 - 2 AWG • Stranded Silver-Plated Copper Wire**

**FEP Insulation** (Brown, Red, Orange, Yellow, Green, Violet, Grey, White, Black and Blue)

VDE 0207  
Part 6  
ASTM-D 2116

Unshielded

For wiring at low and high ambient temperatures and/or corrosive environments.



HMC4052	1000	305	5.0	2.3	(7x0.30) SPC	20	0.50	0.059	1.51
HMC4053	1000	305	7.4	3.4	(19x0.228) SPC	18	0.75	0.067	1.69
HMC4054	1000	305	8.7	4.0	(29x0.203) SPC	17	1.00	0.074	1.88
HMC4055	1000	305	12.1	5.5	(27x0.254) SPC	16	1.50	0.088	2.24
HMC4056	1000	305	20.2	9.1	(45x0.254) SPC	14	2.50	0.104	2.65
HMC4057	1000	305	30.2	13.7	(50x0.30) SPC	12	4	0.124	3.15
HMC4058	500	152	22.2	10.1	(75x0.30) SPC	10	6	0.152	3.85
HMC4059	500	152	39.0	17.7	(80x0.404) SPC	8	10	0.224	5.70
HMC4060	500	152	59.1	26.8	(126x0.404) SPC	6	16	0.268	6.80
HMC4061	500	152	91.4	41.5	(196x0.404) SPC	4	25	0.339	8.60
HMC4062	500	152	126.0	57.2	(276x0.404) SPC	2	35	0.390	9.90

**200°C • 30 - 22 AWG • Solid Silver-Plated Copper Wire**

**FEP Insulation** (Brown, Red, Orange, Yellow, Green, Violet, Grey, White, Black and Blue)

VDE 0207  
Part 6  
ASTM-D 2116

Unshielded



HMC4063	1000	305	0.9	0.4	(1x0.254) SPC	30	0.051	0.034	0.86
HMC4064	1000	305	1.3	0.6	(1x0.32) SPC	28	0.080	0.036	0.92
HMC4065	1000	305	1.8	0.8	(1x0.40) SPC	26	0.126	0.039	1.00
HMC4066	1000	305	2.5	1.1	(1x0.50) SPC	24	0.197	0.043	1.10
HMC4067	1000	305	3.2	1.5	(1x0.64) SPC	22	0.32	0.049	1.24

SPC = Silver-Plated Copper • DCR = DC resistance

### FEP (VDE 0881)

900V\*, 180°C, peak temp 200°C

De- scription	Part No.	UL NEC/ C(UL)/CEC Type IEC	Standard Lengths		Standard Unit Weight		Conductor (Stranding) Diameter Nom. DCR	Nominal Conductor OD		Shielding Material Nom. DCR	Nominal OD		Application
			ft.	m	lbs.	kg		AWG	Section mm <sup>2</sup>		inch	mm	

**180°C • 31 - 12 AWG • Stranded Silver-Plated Copper Wire**

**FEP Insulation** (Brown, Red, Orange, Yellow, Green, Violet, Grey, White, Black and Blue)

VDE 0207  
Part 6

Unshielded

For internal wiring of telecommunication devices, electronic modules in appliances and for wiring of telecommunication and data processing systems.



HMC4068	1640	500	1.3	0.6	(7x0.08) SPC	31	0.035	0.034	0.87
HMC4069	1640	500	1.7	0.8	(7x0.10) SPC	30	0.055	0.037	0.93
HMC4070	1640	500	2.0	0.9	(7x0.12) SPC	28	0.079	0.039	0.99
HMC4071	1640	500	2.6	1.2	(7x0.15) SPC	26	0.12	0.043	1.08
HMC4072	1640	500	3.9	1.8	(7x0.20) SPC	24	0.22	0.048	1.23
HMC4073	1640	500	5.4	2.5	(7x0.25) SPC	22	0.34	0.054	1.38
HMC4074	1640	500	8.0	3.7	(7x0.32) SPC	20	0.56	0.063	1.59
HMC4075	1640	500	12.1	5.5	(19x0.25) SPC	18	0.93	0.075	1.90
HMC4076	1640	500	16.5	7.5	(19x0.29) SPC	16	1.30	0.083	2.10
HMC4077	1640	500	23.1	10.5	(19x0.36) SPC	14	1.90	0.096	2.45
HMC4078	1640	500	37.5	17.0	(19x0.46) SPC	12	3.20	0.116	2.95

**180°C • 31 - 12 AWG • Solid Silver-Plated Copper Wire**

**FEP Insulation** (Brown, Red, Orange, Yellow, Green, Violet, Grey, White, Black and Blue)

VDE 0207  
Part 6

Unshielded



HMC4079	1640	500	1.4	0.7	(7x0.08) SPC	31	0.25	0.033	0.85
HMC4080	1640	500	1.9	0.9	(7x0.10) SPC	30	0.32	0.036	0.92
HMC4081	1640	500	2.4	1.1	(7x0.12) SPC	28	0.40	0.039	1.00
HMC4082	1640	500	3.3	1.5	(7x0.15) SPC	26	0.50	0.043	1.10
HMC4083	1640	500	4.7	2.2	(7x0.20) SPC	24	0.63	0.048	1.23
HMC4084	1640	500	6.9	3.2	(7x0.25) SPC	22	0.80	0.055	1.40
HMC4085	1640	500	10.0	4.6	(7x0.32) SPC	20	1.00	0.063	1.60
HMC4086	1640	500	16.5	7.5	(19x0.25) SPC	18	1.30	0.075	1.90
HMC4087	1640	500	23.1	10.5	(19x0.29) SPC	16	1.60	0.088	2.23
HMC4088	1640	500	38.6	17.5	(19x0.36) SPC	14	2.10	0.106	2.70

\* = peak voltage

SPC = Silver-Plated Copper • DCR = DC resistance

**ETFE**

450/750V, 135°C

De- scription	Part No.	UL NEC/ C(UL)CEC Type IEC	Standard Lengths		Standard Unit Weight		Conductor (Stranding) Diameter Nom. DCR	Nominal Conductor OD		Shielding Material Nom. DCR	Nominal OD		Application
			ft.	m	lbs.	kg		AWG	Section mm <sup>2</sup>		inch	mm	

**135°C • 24 - 10 AWG • Stranded Tin-Plated Copper Wire**

**ETFE Insulation** (Brown, Red, Orange, Yellow, Green, Violet, Grey, White, Black and Blue)

VDE 0250  
Part 106

Unshielded

For internal wiring of power electronics, heating appliances and lighting at an ambient temperature exceeding 55°C.



<b>HMC4089</b>	1640	500	5.0	2.3	(14x0.15) TPC	24	0.25	0.061	1.55
<b>HMC4090</b>	1640	500	8.0	3.7	(16x0.20) TPC	20	0.50	0.073	1.85
<b>HMC4091</b>	1640	500	11.0	5.0	(24x0.20) TPC	18	0.75	0.079	2.00
<b>HMC4092</b>	1640	500	14.3	6.5	(32x0.20) TPC	17	1.00	0.087	2.20
<b>HMC4093</b>	1640	500	20.9	9.5	(30x0.25) TPC	16	1.50	0.104	2.65
<b>HMC4094</b>	1640	500	34.2	15.5	(50x0.25) TPC	14	2.50	0.132	3.35
<b>HMC4095</b>	1640	500	50.7	23.0	(56x0.30) TPC	12	4	0.150	3.80
<b>HMC4096</b>	1640	500	70.5	32.0	(84x0.30) TPC	10	6	0.173	4.40

**135°C • 24 - 10 AWG • Solid Tin-Plated Copper Wire**

**ETFE Insulation** (Brown, Red, Orange, Yellow, Green, Violet, Grey, White, Black and Blue)

VDE 0250  
Part 106

Unshielded

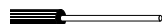

<b>HMC4097</b>	1640	500	4.9	2.2	(1x0.56) TPC	24	0.25	0.057	1.45
<b>HMC4098</b>	1640	500	7.9	3.6	(1x0.80) TPC	20	0.50	0.067	1.70
<b>HMC4099</b>	1640	500	10.8	4.9	(1x0.98) TPC	18	0.75	0.075	1.90
<b>HMC4100</b>	1640	500	13.2	6.0	(1x1.13) TPC	17	1.00	0.081	2.05
<b>HMC4101</b>	1640	500	19.8	9.0	(1x1.38) TPC	16	1.50	0.098	2.50
<b>HMC4102</b>	1640	500	33.1	15.0	(1x1.78) TPC	14	2.50	0.122	3.10
<b>HMC4103</b>	1640	500	48.5	22.0	(1x2.26) TPC	12	4	0.142	3.60
<b>HMC4104</b>	1640	500	70.5	32.0	(1x2.76) TPC	10	6	0.161	4.10

TPC = Tin-Plated Copper • DCR = DC resistance

**ETFE**  
600V, 135°C

De- scription	Part No.	UL NEC/ C(UL)/CEC Type IEC	Standard Lengths		Standard Unit Weight		Conductor (Stranding) Diameter Nom. DCR	Nominal Conductor OD		Shielding Material Nom. DCR	Nominal OD		Application
			ft.	m	lbs.	kg		AWG	Section mm <sup>2</sup>		inch	mm	

**135°C • 20 - 2 AWG • Stranded Tin-Plated Copper Wire**

<b>ETFE Insulation</b> (Brown, Red, Orange, Yellow, Green, Violet, Grey, White, Black and Blue)												
VDE 0207 Part 6 ASTM-D 3159							Unshielded			For wiring at low and high ambient temperatures and/or corrosive environments.		



Bi color combinations are available on request.

HMC4105	1640	500	7.5	3.4	(7x0.30) TPC	20	0.50	0.059	1.51
HMC4106	1640	500	7.6	3.5	(15x0.203) TPC	20	0.50	0.060	1.52
HMC4107	1640	500	11.0	5.0	(19x0.228) TPC	18	0.75	0.067	1.69
HMC4108	1640	500	10.4	4.7	(22x0.203) TPC	18	0.75	0.067	1.70
HMC4109	1640	500	13.2	6.0	(29x0.203) TPC	17	1.00	0.074	1.88
HMC4110	1640	500	18.7	8.5	(27x0.254) TPC	16	1.50	0.088	2.24
HMC4111	1640	500	30.9	14.0	(45x0.254) TPC	14	2.50	0.104	2.65
HMC4112	1640	500	47.4	21.5	(50x0.30) TPC	12	4	0.124	3.15
HMC4113	328	100	13.9	6.3	(75x0.30) TPC	10	6	0.152	3.85
HMC4114	328	100	24.3	11.0	(80x0.404) TPC	8	10	0.224	5.70
HMC4115	328	100	37.0	16.8	(126x0.404) TPC	6	16	0.268	6.80
HMC4116	328	100	56.4	25.6	(196x0.404) TPC	4	25	0.339	8.60
HMC4117	328	100	79.1	35.9	(276x0.404) TPC	2	35	0.390	9.90

**135°C • 30 - 20 AWG • Solid Tin-Plated Copper Wire**

<b>ETFE Insulation</b> (Brown, Red, Orange, Yellow, Green, Violet, Grey, White, Black and Blue)												
VDE 0207 Part 6 ASTM-D 3159							Unshielded					



Bi color combinations are available on request.

HMC4118	1640	500	1.3	0.6	(1x0.254) TPC	30	0.051	0.034	0.86
HMC4119	1640	500	1.8	0.8	(1x0.32) TPC	28	0.080	0.036	0.92
HMC4120	1640	500	2.3	1.1	(1x0.40) TPC	26	0.126	0.039	1.00
HMC4121	1640	500	3.3	1.5	(1x0.50) TPC	24	0.197	0.043	1.10
HMC4122	1640	500	4.6	2.1	(1x0.64) TPC	22	0.32	0.049	1.24
HMC4123	1640	500	7.1	3.2	(1x0.80) TPC	20	0.50	0.055	1.40

TPC = Tin-Plated Copper • DCR = DC resistance

Also available on request:  
DEF STAN 61-12 Part 29 ETFE wires Type 1 to Type 6.



**PFA**

600V, 260°C, peak temp 280°C

De- scription	Part No.	UL NEC/ C(UL)CEC Type IEC	Standard Lengths		Standard Unit Weight		Conductor (Stranding) Diameter Nom. DCR	Nominal Conductor OD		Shielding Material Nom. DCR	Nominal OD		Application
			ft.	m	lbs.	kg		AWG	Section mm <sup>2</sup>		inch	mm	

**260°C • 20 - 2 AWG • Stranded Nickel-Plated Copper Wire**

<b>PFA Insulation</b> (Brown, Red, Orange, Yellow, Green, Violet, Grey, White, Black and Blue)													
ASTM-D 3307							Unshielded				For internal wiring at low and high ambient temperatures and/or corrosive environments.		



<b>HMC4124</b>	1640	500	8.2	3.7	(7x0.30) NPC	20	0.50	0.059	1.51
<b>HMC4125</b>	1640	500	12.1	5.5	(19x0.228) NPC	18	0.75	0.067	1.69
<b>HMC4126</b>	1640	500	14.3	6.5	(29x0.203) NPC	17	1.00	0.074	1.88
<b>HMC4127</b>	1640	500	19.8	9.0	(27x0.254) NPC	16	1.50	0.088	2.24
<b>HMC4128</b>	1640	500	33.1	15.0	(45x0.254) NPC	14	2.50	0.104	2.65
<b>HMC4129</b>	1640	500	49.6	22.5	(50x0.30) NPC	12	4	0.124	3.15
<b>HMC4130</b>	328	100	14.6	6.6	(75x0.30) NPC	10	6	0.152	3.85
<b>HMC4131</b>	328	100	25.6	11.6	(80x0.404) NPC	8	10	0.224	5.70
<b>HMC4132</b>	328	100	38.8	17.6	(126x0.404) NPC	6	16	0.268	6.80
<b>HMC4133</b>	328	100	60.0	27.2	(196x0.404) NPC	4	25	0.339	8.60
<b>HMC4134</b>	328	100	82.7	37.5	(276x0.404) NPC	2	35	0.390	9.90

**260°C • 30 - 20 AWG • Solid Nickel-Plated Copper Wire**

<b>PFA Insulation</b> (Brown, Red, Orange, Yellow, Green, Violet, Grey, White, Black and Blue)													
ASTM-D 3307							Unshielded						

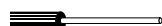

<b>HMC4135</b>	1640	500	1.5	0.7	(1x0.254) NPC	30	0.051	0.034	0.86
<b>HMC4136</b>	1640	500	2.2	1.0	(1x0.32) NPC	28	0.080	0.036	0.92
<b>HMC4137</b>	1640	500	3.0	1.4	(1x0.40) NPC	26	0.126	0.039	1.00
<b>HMC4138</b>	1640	500	4.1	1.9	(1x0.50) NPC	24	0.197	0.043	1.10
<b>HMC4139</b>	1640	500	5.3	2.4	(1x0.64) NPC	22	0.32	0.049	1.24
<b>HMC4140</b>	1640	500	7.7	3.5	(1x0.80) NPC	20	0.50	0.055	1.40

NPC = Nickel-Plated Copper • DCR = DC resistance

# Trakrad 100

1900/3300V, 125°C

De- scription	Part No.	UL NEC / C(UL)/CEC Type IEC	Standard Lengths		Standard Unit Weight		Conductor (Stranding) Diameter Nom. DCR	Nominal Conductor OD		Shielding Material Nom. DCR	Nominal OD		Application
			ft.	m	lbs.	kg		AWG	Section mm <sup>2</sup>		inch	mm	

**125°C • 20 AWG - 750 MCM • Stranded Tin-Plated Copper Wire**

**Trakrad 100 Grey Insulation • Oil-Resistance • Flame-Retardant**

BS 4066-1  
IEC 60332-3(A)

Unshielded

Suitable for fixed installations within trains and between motor and underframe e.g.  
- Connections to coil windings  
- Wiring of motor trains  
- Control panels and switchgear

Designed to provide enhanced oil resistance to meet British Rail spec. TDE 76/P/16.



HMC4141	1640	500	13.3	6.0	(16x0.20) TPC	20	0.50	0.102	2.59
HMC4142	1640	500	16.9	7.7	(24x0.20) TPC	18	0.75	0.111	2.82
HMC4143	1640	500	19.8	9.0	(32x0.20) TPC	17	1.00	0.115	2.92
HMC4144	1640	500	21.4	9.7	(37x0.20) TPC	16.5	1.16	0.118	3.00
HMC4145	1640	500	26.9	12.2	(30x0.25) TPC	16	1.50	0.131	3.32
HMC4146	1640	500	30.9	14.0	(37x0.25) TPC	15	1.80	0.138	3.50
HMC4147	1640	500	38.9	17.7	(50x0.25) TPC	14	2.50	0.148	3.76
HMC4148	1640	500	41.1	18.6	(37x0.30) TPC	13	2.60	0.154	3.90
HMC4149	1640	500	56.6	25.7	(56x0.30) TPC	12	4	0.169	4.29
HMC4150	328	100	13.5	6.1	(37x0.40) TPC	11	4.70	0.189	4.80
HMC4151	328	100	18.4	8.3	(84x0.30) TPC	10	6	0.223	5.67
HMC4152	328	100	21.7	9.8	(61x0.40) TPC	9	7.70	0.236	6.00
HMC4153	328	100	28.2	12.8	(80x0.40) TPC	8	10	0.276	7.00
HMC4154	328	100	41.4	18.8	(126x0.40) TPC	6	16	0.319	8.10
HMC4155	328	100	65.6	29.8	(196x0.40) TPC	4	25	0.406	10.30
HMC4156	on request		891.1	404.2	(276x0.40) TPC	2	35	0.461	11.70
HMC4157	on request		1240.3	562.6	(396x0.40) TPC	1	50	0.539	13.70
HMC4158	on request		1728.0	783.8	(360x0.50) TPC	2/0	70	0.630	16.00
HMC4159	on request		2266.3	1028.0	(475x0.50) TPC	3/0	95	0.728	18.50
HMC4160	on request		2877.0	1305.0	(608x0.50) TPC	4/0	120	0.803	20.40
HMC4161	on request		3542.8	1607.0	(756x0.50) TPC	300 MCM	150	0.890	22.60
HMC4162	on request		4296.8	1949.0	(925x0.50) TPC	350 MCM	185	0.976	24.80
HMC4163	on request		5562.2	2523.0	(1221x0.50) TPC	500 MCM	240	1.094	27.80
HMC4164	on request		7067.9	3206.0	(1525x0.50) TPC	600 MCM	300	1.260	32.00
HMC4165	on request		9153.5	4152.0	(2013x0.50) TPC	750 MCM	400	1.417	36.00

Weights for "on request" are for 1 km

TPC = Tin-Plated Copper • DCR = DC resistance

**Zyrad® 500 UL/CSA**

600V, 150°C

De- scription	Part No.	UL NEC/ C(UL)CEC Type IEC	Standard Lengths		Standard Unit Weight		Conductor (Stranding) Diameter Nom. DCR	Nominal Conductor OD		Shielding Material Nom. DCR	Nominal OD		Application
			ft.	m	lbs.	kg		AWG	Section mm <sup>2</sup>		inch	mm	

**150°C • 24 - 4/0 AWG • Stranded Tin-Plated Copper Wire**

**Zyrad® 500 Insulation** (Brown, Red, Orange, Yellow, Green, Violet, Grey, White, Black, Blue, Pink and Green/Yellow)

UL3289  
CSA CL 1503

Unshielded

- For wiring at high ambient temperatures, e.g.
- Class F electric motors
  - Transformers
  - Domestic appliances
  - Inductive loop
  - Lighting
  - General hostile environments



HMC4166	3280	1000	7.8	3.5	(19x0.13) TPC	24	0.25	0.089	2.25
HMC4167	3280	1000	11.3	5.1	(16x0.20) TPC	22	0.50	0.100	2.53
HMC4168	3280	1000	14.6	6.6	(24x0.20) TPC	20	0.75	0.108	2.74
HMC4169	3280	1000	17.7	8.1	(32x0.20) TPC	18	1.00	0.115	2.92
HMC4170	3280	1000	23.3	10.6	(30x0.25) TPC	16	1.50	0.126	3.20
HMC4171	1640	500	34.7	15.8	(50x0.25) TPC	14	2.50	0.144	3.67
HMC4172	1640	500	51.9	23.5	(56x0.30) TPC	12	4	0.165	4.20
HMC4173	328	100	14.6	6.6	(84x0.30) TPC	10	6	0.189	4.79
HMC4174	328	100	26.6	12.1	(80x0.40) TPC	8	10	0.260	6.60
HMC4175	328	100	42.3	19.2	(126x0.40) TPC	6	16	0.350	8.90
HMC4176	328	100	62.0	28.1	(196x0.40) TPC	4	25	0.406	10.30
HMC4177	164	50	42.3	19.2	(278x0.40) TPC	2	35	0.461	11.70
HMC4178	164	50	61.6	27.9	(399x0.40) TPC	1	50	0.563	14.30
HMC4179	164	50	84.7	38.4	(361x0.50) TPC	0	70	0.646	16.40
HMC4180	164	50	110.6	50.2	(475x0.50) TPC	3/0	95	0.728	18.50
HMC4181	164	50	141.1	64.0	(608x0.50) TPC	4/0	120	0.787	20.00

TPC = Tin-Plated Copper • DCR = DC resistance

# Zyrad® 555

600V, 155°C

De- scription	Part No.	UL NEC/ C(UL)/CEC Type IEC	Standard Lengths		Standard Unit Weight		Conductor (Stranding) Diameter Nom. DCR	Nominal Conductor OD		Shielding Material Nom. DCR	Nominal OD		Application
			ft.	m	lbs.	kg		AWG	Section mm <sup>2</sup>		inch	mm	

**155°C • 24 - 4/0 AWG • Stranded Tin-Plated Copper Wire**

**Zyrad® 555 Insulation** (Brown, Red, Orange, Yellow, Green, Violet, Grey, White, Black, Blue, Pink and Green/Yellow)

Unshielded

- For wiring at high ambient temperatures, e.g.
- Class F electric motors
  - Transformers
  - Domestic appliances
  - Inductive loop
  - Lighting
  - General hostile environments



HMC4182	3280	1000	4.4	2.0	(19x0.13) TPC	24	0.25	0.057	1.45
HMC4183	3280	1000	7.4	3.4	(19x0.18) TPC	20	0.50	0.069	1.75
HMC4184	3280	1000	11.8	5.3	(24x0.20) TPC	18	0.75	0.088	2.24
HMC4185	3280	1000	15.4	7.0	(32x0.20) TPC	17	1.00	0.099	2.52
HMC4186	3280	1000	20.7	9.4	(30x0.25) TPC	16	1.50	0.110	2.80
HMC4187	1640	500	31.6	14.3	(50x0.25) TPC	14	2.50	0.126	3.20
HMC4188	1640	500	49.2	22.3	(56x0.30) TPC	12	4	0.154	3.90
HMC4189	328	100	14.2	6.5	(84x0.30) TPC	10	6	0.181	4.59
HMC4190	328	100	24.8	11.3	(80x0.40) TPC	8	10	0.244	6.20
HMC4191	328	100	38.4	17.4	(126x0.40) TPC	6	16	0.311	7.90
HMC4192	328	100	58.3	26.4	(196x0.40) TPC	4	25	0.374	9.50
HMC4193	164	50	40.7	18.5	(278x0.40) TPC	2	35	0.437	11.10
HMC4194	164	50	58.1	26.4	(399x0.40) TPC	1	50	0.524	13.30
HMC4195	164	50	81.0	36.7	(361x0.50) TPC	2/0	70	0.614	15.60
HMC4196	164	50	108.1	49.1	(475x0.50) TPC	3/0	95	0.713	18.10
HMC4197	164	50	136.4	61.9	(608x0.50) TPC	4/0	120	0.772	19.60

TPC = Tin-Plated Copper • DCR = DC resistance

# Silicone Rubber

Braidless

300/500V, 180°C, peak temp 250°C

De- scription	Part No.	UL NEC/ C(UL)CEC Type IEC	Standard Lengths		Standard Unit Weight		Conductor (Stranding) Diameter Nom. DCR	Nominal Conductor OD		Shielding Material Nom. DCR	Nominal OD		Application
			ft.	m	lbs.	kg		AWG	Section mm <sup>2</sup>		inch	mm	

**180°C • 24 AWG - 500 MCM • Stranded Tin-Plated Copper Wire**

**Silicone Halogen-Free Insulation** (Brown, Red, Orange, Yellow, Green, Violet, Grey, White, Black and Blue)

IEC 60754-1  
VDE 0282  
Part 1

Unshielded

For wiring at high ambient temperatures, e.g.  
- Lighting  
- Domestic appliances  
- Instrumentation engineering  
- Mechanical engineering



HMC4198	328	100	1.3	0.6	(14x0.15) TPC	24	0.25	0.071	1.80
HMC4199	328	100	2.0	0.9	(16x0.20) TPC	20	0.50	0.083	2.10
HMC4200	328	100	2.4	1.1	(24x0.20) TPC	18	0.75	0.091	2.30
HMC4201	328	100	3.1	1.4	(32x0.20) TPC	17	1.00	0.094	2.40
HMC4202	328	100	4.2	1.9	(30x0.25) TPC	16	1.50	0.106	2.70
HMC4203	328	100	6.4	2.9	(50x0.30) TPC	14	2.50	0.126	3.20
HMC4204	328	100	9.7	4.4	(56x0.30) TPC	12	4	0.157	4.00
HMC4205	328	100	13.7	6.2	(84x0.30) TPC	10	6	0.181	4.60
HMC4206	328	100	27.3	12.4	(80x0.40) TPC	8	10	0.256	6.50
HMC4207	328	100	40.8	18.5	(128x0.40) TPC	6	16	0.303	7.70
HMC4208	328	100	61.9	28.1	(200x0.40) TPC	4	25	0.374	9.50
HMC4209	on request		840.0	381.0	(280x0.40) TPC	2	35	0.429	10.90
HMC4210	on request		1181.7	536.0	(400x0.40) TPC	1	50	0.500	12.70
HMC4211	on request		1640.2	744.0	(356x0.50) TPC	2/0	70	0.575	14.60
HMC4212	on request		2180.3	989.0	(485x0.50) TPC	3/0	95	0.685	17.40
HMC4213	on request		2691.8	1221.0	(614x0.50) TPC	4/0	120	0.744	18.90
HMC4214	on request		3353.2	1521.0	(765x0.50) TPC	300 MCM	150	0.815	20.70
HMC4215	on request		4186.5	1899.0	(944x0.50) TPC	350 MCM	185	0.925	23.50
HMC4216	on request		5732.0	2600.0	(1225x0.50) TPC	500 MCM	240	1.047	26.60

Weights for "on request" are for 1 km

**180°C • 20 - 12 AWG • Solid Tin-Plated Copper Wire**

**Silicone Halogen-Free Insulation** (Brown, Red, Orange, Yellow, Green, Violet, Grey, White, Black and Blue)

IEC 60754-1  
VDE 0282  
Part 1

Unshielded

For wiring at high ambient temperatures, e.g.  
- Lighting  
- Domestic appliances  
- Instrumentation engineering  
- Mechanical engineering



HMC4217	328	100	1.8	0.8	(1x0.80) TPC	20	0.50	0.079	2.00
HMC4218	328	100	2.4	1.1	(1x0.98) TPC	18	0.75	0.083	2.10
HMC4219	328	100	2.9	1.3	(1x1.13) TPC	17	1.00	0.091	2.30
HMC4220	328	100	4.0	1.8	(1x1.38) TPC	16	1.50	0.098	2.50
HMC4221	328	100	6.4	2.9	(1x1.78) TPC	14	2.50	0.122	3.10
HMC4222	328	100	9.9	4.5	(1x2.26) TPC	12	4	0.150	3.80

Weights for "on request" are for 1 km

TPC = Tin-Plated Copper • DCR = DC resistance

### Silicone Rubber (H05S)

Braidless

300/500V, 180°C, peak temp 250°C

De- scription	Part No.	UL NEC / C(UL)/CEC Type IEC	Standard Lengths		Standard Unit Weight		Conductor (Stranding) Diameter Nom. DCR	Nominal Conductor OD		Shielding Material Nom. DCR	Nominal OD		Application
			ft.	m	lbs.	kg		AWG	Section mm <sup>2</sup>		inch	mm	

**180°C • 20 - 14 AWG • Stranded Tin-Plated Copper Wire**

**Silicone Halogen-Free Insulation** (Brown, Red, Orange, Yellow, Green, Violet, Grey, White, Black and Blue)

IEC 60754-1  
VDE 0282  
Part 3

Unshielded

For wiring in electrical appliances and lighting up to a maximum operating temperature of 180°C.



H05S-K

<b>HMC4223</b>	328	100	2.6	1.2	(16x0.20) TPC	20	0.50	0.098	2.50
<b>HMC4224</b>	328	100	3.3	1.5	(24x0.20) TPC	18	0.75	0.106	2.70
<b>HMC4225</b>	328	100	3.7	1.7	(32x0.20) TPC	17	1.00	0.110	2.80
<b>HMC4226</b>	328	100	5.5	2.5	(30x0.25) TPC	16	1.50	0.130	3.30
<b>HMC4227</b>	328	100	8.2	3.7	(50x0.25) TPC	14	2.50	0.154	3.90

**180°C • 20 - 14 AWG • Solid Tin-Plated Copper Wire**

**Silicone Halogen-Free Insulation** (Brown, Red, Orange, Yellow, Green, Violet, Grey, White, Black and Blue)

IEC 60754-1  
VDE 0282  
Part 3

Unshielded



H05S-U

<b>HMC4228</b>	328	100	2.4	1.1	(1x0.80) TPC	20	0.50	0.094	2.40
<b>HMC4229</b>	328	100	3.1	1.4	(1x0.98) TPC	18	0.75	0.098	2.50
<b>HMC4230</b>	328	100	3.7	1.7	(1x1.13) TPC	17	1.00	0.106	2.70
<b>HMC4231</b>	328	100	5.3	2.4	(1x1.38) TPC	16	1.50	0.122	3.10
<b>HMC4232</b>	328	100	7.9	3.6	(1x1.78) TPC	14	2.50	0.146	3.70

TPC = Tin-Plated Copper • DCR = DC resistance

### Silicone Rubber (VDE approved)

Braidless

300/300V, 180°C, peak temp 250°C

De- scription	Part No.	UL NEC/ C(UL)CEC Type IEC	Standard Lengths		Standard Unit Weight		Conductor (Stranding) Diameter Nom. DCR	Nominal Conductor OD		Shielding Material Nom. DCR	Nominal OD		Application
			ft.	m	lbs.	kg		AWG	Section mm <sup>2</sup>		inch	mm	

**180°C • 20 - 14 AWG • Stranded Tin-Plated Copper Wire**

**Silicone Halogen-Free Insulation** (Brown, Red, Orange, Yellow, Green, Violet, Grey, White, Black and Blue) • **VDE reg. no. N2GFA resp. (N)2GFA**

IEC 60754-1  
VDE 0282  
Part 1

Unshielded

For wiring in electrical appliances and lighting  
up to a maximum operating temperature of 180°C.



<b>HMC4233</b>	1000	305	6.0	2.7	(16x0.20) TPC	20	0.50	0.083	2.10
<b>HMC4234</b>	1000	305	7.4	3.4	(24x0.20) TPC	18	0.75	0.091	2.30
<b>HMC4235</b>	1000	305	9.4	4.3	(32x0.20) TPC	17	1.00	0.094	2.40
<b>HMC4236</b>	1000	305	13.4	6.1	(30x0.25) TPC	16	1.50	0.114	2.90
<b>HMC4237</b>	1000	305	21.5	9.8	(50x0.25) TPC	14	2.50	0.138	3.50

**180°C • 20 - 14 AWG • Solid Tin-Plated Copper Wire**

**Silicone Halogen-Free Insulation** (Brown, Red, Orange, Yellow, Green, Violet, Grey, White, Black and Blue) • **VDE reg. no. N2GFA resp. (N)2GFA**

IEC 60754-1  
VDE 0282  
Part 1

Unshielded



N2GFA

<b>HMC4238</b>	1000	305	5.4	2.4	(1x0.80) TPC	20	0.50	0.079	2.00
<b>HMC4239</b>	1000	305	7.4	3.4	(1x0.98) TPC	18	0.75	0.083	2.10
<b>HMC4240</b>	1000	305	8.7	4.0	(1x1.13) TPC	17	1.00	0.091	2.30
<b>HMC4241</b>	1000	305	12.1	5.5	(1x1.38) TPC	16	1.50	0.106	2.70
<b>HMC4242</b>	1000	305	19.5	8.8	(1x1.78) TPC	14	2.50	0.130	3.30

TPC = Tin-Plated Copper • DCR = DC resistance

### Silicone Rubber (Superflex)

Braidless

300/500V, 180°C, peak temp 250°C

De- scription	Part No.	UL NEC/ C(UL)/CEC Type IEC	Standard Lengths		Standard Unit Weight		Conductor (Stranding) Diameter Nom. DCR	Nominal Conductor OD		Shielding Material Nom. DCR	Nominal OD		Application
			ft.	m	lbs.	kg		AWG	Section mm <sup>2</sup>		inch	mm	

**180°C • 24 - 2 AWG • Stranded Tin-Plated Copper Wire**

**Silicone Halogen-Free Insulation** (Brown, Red, Orange, Yellow, Green, Violet, Grey, White, Black and Blue)

IEC 60754-1  
VDE 0282  
Part 1

Unshielded

For wiring at high ambient temperatures, e.g.  
- Lighting  
- Domestic appliances  
- Instrumentation engineering  
- Mechanical engineering



HMC4243	1640	500	6.6	3.0	(128x0.05) TPC	24	0.25	0.071	1.80
HMC4244	1640	500	11.0	5.0	(256x0.05) TPC	20	0.50	0.087	2.20
HMC4245	1640	500	13.2	6.0	(384x0.05) TPC	18	0.75	0.094	2.40
HMC4246	1640	500	17.6	8.0	(512x0.05) TPC	17	1.00	0.106	2.70
HMC4247	1640	500	24.3	11.0	(392x0.07) TPC	16	1.50	0.122	3.10
HMC4248	1640	500	38.6	17.5	(651x0.07) TPC	14	2.50	0.150	3.80
HMC4249	1640	500	58.4	26.5	(1040x0.07) TPC	12	4	0.185	4.70
HMC4250	1640	500	83.8	38.0	(1560x0.07) TPC	10	6	0.205	5.20
HMC4251	1640	500	135.6	61.5	(2600x0.07) TPC	8	10	0.276	7.00
HMC4252	1640	500	208.3	94.5	(2048x0.10) TPC	6	16	0.335	8.50
HMC4253	1640	500	320.8	145.5	(3200x0.10) TPC	4	25	0.402	10.20
HMC4254	1640	500	445.3	202.0	(1120x0.20) TPC	2	35	0.465	11.80

TPC = Tin-Plated Copper • DCR = DC resistance



### Silicone Rubber (H05SJ-K)

Glass Braid

300/500V, 180°C

De- scription	Part No.	UL NEC/ C(UL)CEC Type IEC	Standard Lengths		Standard Unit Weight		Conductor (Stranding) Diameter Nom. DCR	Nominal Conductor OD		Shielding Material Nom. DCR	Nominal OD		Application
			ft.	m	lbs.	kg		AWG	Section mm <sup>2</sup>		inch	mm	

**180°C • 20 AWG - 350 MCM • Stranded Tin-Plated Copper Wire**

**White Halogen-Free Silicone Insulation • Silicone-impregnated Glass-Fiber Braid**

IEC 60754-1  
VDE 0282  
Part 1

Overall  
Glass-Fiber Braid

For internal wiring at high ambient  
temperatures, e.g.  
- Lighting  
- Domestic appliances  
- Mechanical engineering



Identification tracer

HMC4255	328	100	2.6	1.2	(16x0.20) TPC	20	0.50	0.106	2.70
HMC4256	328	100	3.3	1.5	(24x0.20) TPC	18	0.75	0.114	2.90
HMC4257	328	100	4.0	1.8	(32x0.20) TPC	17	1.00	0.118	3.00
HMC4258	328	100	4.9	2.2	(30x0.25) TPC	16	1.50	0.138	3.50
HMC4259	328	100	7.7	3.5	(50x0.25) TPC	14	2.50	0.161	4.10
HMC4260	328	100	10.8	4.9	(56x0.30) TPC	12	4	0.181	4.60
HMC4261	328	100	15.0	6.8	(84x0.30) TPC	10	6	0.205	5.20
HMC4262	328	100	28.9	13.1	(80x0.40) TPC	8	10	0.283	7.20
HMC4263	328	100	43.4	19.7	(128x0.40) TPC	6	16	0.331	8.40
HMC4264	164	50	32.5	14.8	(200x0.40) TPC	4	25	0.402	10.20
HMC4265	164	50	43.4	19.7	(280x0.40) TPC	2	35	0.457	11.60
HMC4266	164	50	60.6	27.5	(400x0.40) TPC	1	50	0.528	13.40
HMC4267	164	50	83.9	38.1	(356x0.50) TPC	2/0	70	0.602	15.30
HMC4268	on request		2211.2	1003.0	(485x0.50) TPC	3/0	95	0.713	18.10
HMC4269	on request		2731.5	1239.0	(614x0.50) TPC	4/0	120	0.772	19.60
HMC4270	on request		3386.3	1536.0	(765x0.50) TPC	300 MCM	150	0.843	21.40
HMC4271	on request		4241.7	1924.0	(944x0.50) TPC	350 MCM	185	0.953	24.20

Weights for "on request" are for 1 km

**180°C • 20 - 8 AWG • Solid Tin-Plated Copper Wire**

**White Halogen-Free Silicone Insulation • Silicone-impregnated Glass-Fiber Braid**

IEC 60754-1  
VDE 0282  
Part 1

Overall  
Glass-Fiber Braid



Identification tracer

HMC4272	328	100	2.4	1.1	(1x0.80) TPC	20	0.50*	0.102	2.60
HMC4273	328	100	3.1	1.4	(1x0.98) TPC	18	0.75*	0.106	2.70
HMC4274	328	100	4.0	1.8	(1x1.13) TPC	17	1.00	0.114	2.90
HMC4275	328	100	5.3	2.4	(1x1.38) TPC	16	1.50	0.150	3.80
HMC4276	328	100	7.7	3.5	(1x1.78) TPC	14	2.50	0.154	3.90
HMC4277	328	100	11.5	5.2	(1x2.26) TPC	12	4	0.173	4.40
HMC4278	328	100	16.3	7.4	(1x2.78) TPC	10	6	0.193	4.90
HMC4279	328	100	26.7	12.1	(1x3.60) TPC	8	10	0.248	6.30

\* = according to VDE 0282 part 3

TPC = Tin-Plated Copper • DCR = DC resistance

### Glass Braid

250V, 350°C

De- scription	Part No.	UL NEC/ C(UL)/CEC Type IEC	Standard Lengths		Standard Unit Weight		Conductor (Stranding) Diameter Nom. DCR	Nominal Conductor OD		Shielding Material Nom. DCR	Nominal OD		Application
			ft.	m	lbs.	kg		AWG	Section mm <sup>2</sup>		inch	mm	

**350°C • 24 - 10 AWG • Stranded Nickel-Plated Copper Wire**

**Glass Braid Insulation • Impregnated Glass-Fiber Braid**



Separator foil

Overall  
Glass-Fiber Braid

For wiring at high ambient temperatures and increased mechanical stress e.g.  
 - Domestic appliances (stoves, heating plates, ovens)  
 - Extrusion and drying installations  
 - Electric heating systems  
 - Steel and iron fabrication  
 - Glass and ceramic fabrication

HMC4280	328	100	0.8	0.4	(7x0.20) NPC	24	0.22	0.043	1.10
HMC4281	328	100	1.2	0.6	(14x0.15) NPC	23	0.25	0.075	1.90
HMC4282	328	100	2.4	1.1	(7x0.254) NPC	22	0.34	0.075	1.90
HMC4283	328	100	2.9	1.3	(16x0.203) NPC	20	0.50	0.083	2.10
HMC4284	328	100	3.7	1.7	(24x0.203) NPC	18	0.75	0.091	2.30
HMC4285	328	100	4.9	2.2	(32x0.203) NPC	17	1.00	0.098	2.50
HMC4286	328	100	6.0	2.7	(30x0.254) NPC	16	1.50	0.110	2.80
HMC4287	328	100	11.0	5.0	(50x0.254) NPC	14	2.50	0.169	4.30
HMC4288	328	100	14.6	6.6	(56x0.30) NPC	12	4	0.197	5.00
HMC4289	328	100	17.9	8.1	(84x0.30) NPC	10	6	0.224	5.70

### Kapton®

Glass Braid

300/300V, 220°C, Month 300°C, Peak Temp 500°C

De- Description	Part No.	UL NEC/ C(UL)/CEC Type IEC	Standard Lengths		Standard Unit Weight		Conductor (Stranding) Diameter Nom. DCR	Nominal Conductor OD		Shielding Material Nom. DCR	Nominal OD		Application
			ft.	m	lbs.	kg		AWG	Section mm <sup>2</sup>		inch	mm	

**350°C • 24 - 10 AWG • Stranded Nickel-Plated Copper Wire**

**Kapton® Insulation • Impregnated Glass-Fiber Braid**



Overall  
Glass-Fiber Braid

For wiring at high ambient temperatures and increased mechanical stress e.g.  
 - Domestic appliances (stoves, heating plates, ovens)  
 - Extrusion and drying installations  
 - Traffic technology

HMC4290	328	100	1.5	0.7	(7x0.20) NPC	24	0.22	0.047	1.20
HMC4291	328	100	1.0	0.5	(14x0.15) NPC	23	0.25	0.051	1.30
HMC4292	328	100	1.7	0.8	(7x0.254) NPC	22	0.34	0.055	1.40
HMC4293	328	100	1.8	0.8	(16x0.203) NPC	20	0.50	0.067	1.70
HMC4294	328	100	2.4	1.1	(24x0.203) NPC	18	0.75	0.075	1.90
HMC4295	328	100	2.9	1.3	(32x0.203) NPC	17	1.00	0.079	2.00
HMC4296	328	100	4.0	1.8	(30x0.254) NPC	16	1.50	0.098	2.50
HMC4297	328	100	6.6	3.0	(50x0.254) NPC	14	2.50	0.110	2.80
HMC4298	328	100	11.0	5.0	(56x0.30) NPC	12	4	0.138	3.50
HMC4299	328	100	14.3	6.5	(84x0.30) NPC	10	6	0.161	4.10

NPC = Nickel-Plated Copper • DCR = DC resistance • Kapton® is a DuPont trademark.



### Mica

#### Glass and Ceramic Braid 300/500V

De- scription	Part No.	UL NEC/ C(UL)/CEC Type IEC	Standard Lengths		Standard Unit Weight		Conductor (Stranding) Diameter Nom. DCR	Nominal Conductor OD		Shielding Material Nom. DCR	Nominal OD		Application
			ft.	m	lbs.	kg		AWG	Section mm <sup>2</sup>		inch	mm	

**350°C (peak temp 500°C) • 20 - 10 AWG • Stranded Nickel-Plated Copper Wire**

**Mica Insulation • Impregnated Glass-Fiber Braid**



Overall  
Glass-Fiber Braid

For wiring at high ambient temperatures and increased operating voltage e.g.  
- Industrial furnaces  
- Extrusion and drying installations  
- Electric heating systems

HMC4300	328	100	2.9	1.3	(16x0.203) NPC	20	0.50	0.094	2.40
HMC4301	328	100	4.0	1.8	(24x0.203) NPC	18	0.75	0.102	2.60
HMC4302	328	100	4.9	2.2	(32x0.203) NPC	17	1.00	0.122	3.10
HMC4303	328	100	6.6	3.0	(30x0.254) NPC	16	1.50	0.134	3.40
HMC4304	328	100	8.6	3.9	(50x0.254) NPC	14	2.50	0.154	3.90
HMC4305	328	100	13.0	5.9	(56x0.30) NPC	12	4	0.185	4.70
HMC4306	328	100	17.9	8.1	(84x0.30) NPC	10	6	0.213	5.40

**1550°C (short term) • 20 - 8 AWG • Stranded Nickel-Plated Copper Wire**

**Mica Insulation • Impregnated Ceramic Braid**



Overall  
Ceramic Braid

For wiring at high ambient temperatures and increased mechanical stress e.g.  
- Glass, steel and iron fabrication  
- Industrial furnaces  
- Electric heating systems

UL approval and other conductor materials (e.g. special alloys) available on request.

HMC4307	328	100	2.4	1.1	(16x0.203) NPC	20	0.50	0.094	2.40
HMC4308	328	100	4.0	1.8	(24x0.203) NPC	18	0.75	0.098	2.50
HMC4309	328	100	5.1	2.3	(32x0.203) NPC	17	1.00	0.126	3.20
HMC4310	328	100	6.2	2.8	(30x0.254) NPC	16	1.50	0.142	3.60
HMC4311	328	100	10.1	4.6	(50x0.254) NPC	14	2.50	0.154	3.90
HMC4312	328	100	15.4	7.0	(56x0.30) NPC	12	4	0.205	5.20
HMC4313	328	100	22.9	10.4	(84x0.30) NPC	10	6	0.236	6.00
HMC4314	328	100	32.4	14.7	(80x0.40) NPC	8	10	0.291	7.40

NPC = Nickel-Plated Copper • DCR = DC resistance

**EFGLAS**

Glass Braid/PTFE  
600V, 260°C

De- scription	Part No.	UL NEC/ C(UL)/CEC Type IEC	Standard Lengths		Standard Unit Weight		Conductor (Stranding) Diameter Nom. DCR	Nominal Conductor OD		Shielding Material Nom. DCR	Nominal OD		Application
			ft.	m	lbs.	kg		AWG	Section mm <sup>2</sup>		inch	mm	

**260°C • 22 - 0000 AWG • Stranded Nickel-Plated Copper Wire**

**EFGLAS Insulation • PTFE-Impregnated Glass Yarn Braid**

BSG 222 : 1976  
acc. MIL-W-22759/3

Unshielded

For wiring at high ambient temperatures and improved abrasion resistance e.g.  
- Aircraft wiring



HMC4315	1000	305	5.8	2.6	(19x0.15) NPC	22	0.336	0.081	2.05
HMC4316	1000	305	8.2	3.7	(19x0.20) NPC	20	0.597	0.091	2.30
HMC4317	1000	305	10.8	4.9	(19x0.25) NPC	18	0.933	0.100	2.55
HMC4318	1000	305	13.8	6.3	(19x0.30) NPC	16	1.340	0.110	2.80
HMC4319	1000	305	18.1	8.2	(37x0.25) NPC	14	1.820	0.122	3.10
HMC4320	1000	305	26.2	11.9	(37x0.32) NPC	12	2.890	0.148	3.75
HMC4321	1000	305	44.4	20.1	(37x0.40) NPC	10	4.650	0.187	4.75
HMC4322	1000	305	71.2	32.3	(17/7x0.30) NPC	8	8.410	0.246	6.25
HMC4323	500	152	58.5	26.5	(26/7x0.30) NPC	6	12.85	0.287	7.30
HMC4324	500	152	93.4	42.4	(42/7x0.30) NPC	4	20.75	0.360	9.15
HMC4325	500	152	142.5	64.6	(703x0.25) NPC	2	34.49	0.427	10.85
HMC4326	500	152	168.0	76.2	(851x0.25) NPC	1	41.75	0.469	11.90
HMC4327	500	152	212.4	96.3	(1073x0.25) NPC	0	52.64	0.518	13.15
HMC4328	500	152	270.5	122.7	(1369x0.25) NPC	2/0	67.16	0.569	14.45
HMC4329	500	152	339.4	154.0	(1728x0.25) NPC	3/0	84.78	0.632	16.05
HMC4330	500	152	426.8	193.6	(2196x0.25) NPC	4/0	107.74	0.691	17.55

NPC = Nickel-Plated Copper • DCR = DC resistance

**Notes**



## 4 Multi-Conductor Cables

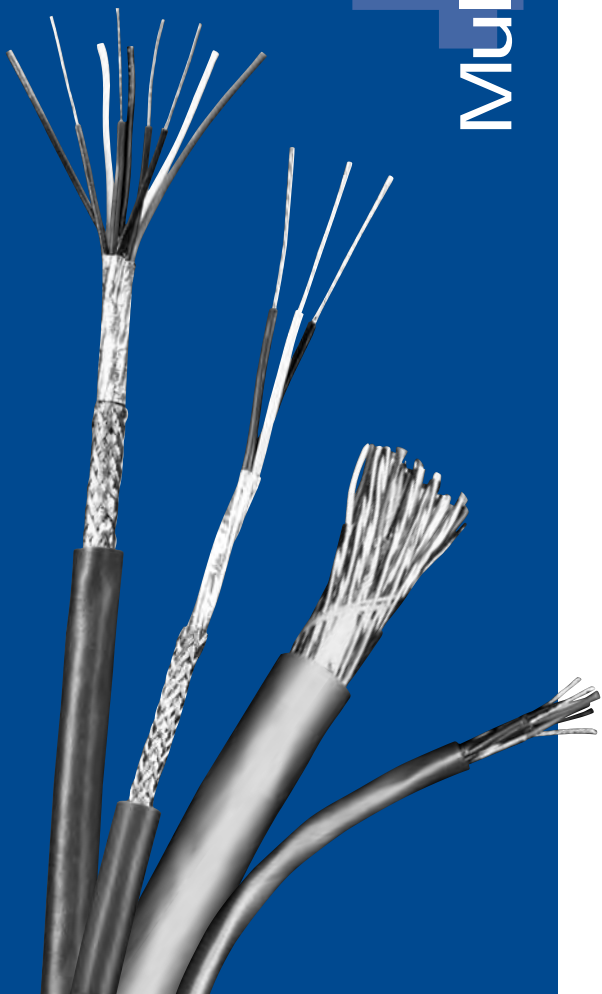

### Table of Contents

Multi-Conductor Cables	Page No.
<b>Introduction</b>	<b>4.2 – 4.3</b>
<b>Selection Guide:</b>	
Shielded Computer Cables for RS-232 Applications	<b>4.2</b>
<b>Unshielded</b>	<b>4.4 – 4.5</b>
Audio, Control and Instrumentation Cables	4.4
Duplex Primary Wire	4.5
<b>Overall Beldfoil® Shield</b>	<b>4.6 – 4.8</b>
Computer Cables for EIA RS-232 Applications	4.6 – 4.7
Audio, Control and Instrumentation Cables	4.8
<b>Overall Foil/Braid Shield</b>	<b>4.9 – 4.12</b>
Computer Cables for EIA RS-232 Applications	4.9 – 4.10
Low-Capacitance Computer Cables for EIA RS-232 and EIA RS-423 Applications	4.11
Audio, Control and Instrumentation Cables	4.12
<b>Fire Alarm</b>	<b>4.13 – 4.14</b>
Power-Limited Fire Protective Signaling Circuit Cables Subject 1424	4.13 – 4.14
<b>TPE</b>	<b>4.15 – 4.16</b>
Multicore Cable: 300V, 150°C	4.15 – 4.16
<b>Silicone Rubber</b>	<b>4.17 – 4.28</b>
Multicore Cable: 300/500V, 180°C, peak temp 250°C	4.17 – 4.19
Multicore Cable (H05SS-F): 300/500V, 180°C, peak temp 250°C	4.20
Multicore Cable (SWB): 300/500V, 180°C, peak temp 250°C	4.21 – 4.23
Multicore Cable (Overall Braid): 300/500V, 180°C, peak temp 250°C	4.24
Multicore Cable (Heavy Duty): 300/500V, 180°C	4.25 – 4.26
Multicore Cable (Heavy Duty, Overall Braid): 300/500V, 180°C	4.27 – 4.28
<b>FEP</b>	<b>4.29</b>
Multicore Cable: 600V, 200°C, peak temp 230°C	4.29
<b>FEP-Overall Braid</b>	<b>4.30</b>
Multicore Cable: 600V, 200°C, peak temp 230°C	4.30
<b>Glass Fiber-Glass Braid</b>	<b>4.31 – 4.32</b>
Multicore Cable: 300/300V, 350°C	4.31
Multicore Cable (SWB): 300/300V, 350°C	4.32
<b>Mica-Ceramic Braid</b>	<b>4.33</b>
Multicore Cable (SWB): 380V, 1250°C	4.33
<b>Micaflame® – Glass Braid</b>	<b>4.34</b>
Multicore Cable: 300/500V, 1550°C short term, 300°C permanent	4.34
<b>PVC</b>	<b>4.35 – 4.38</b>
500V, 80°C, LiY(St)CY	4.35 – 4.36
750V, 80°C, LiY CY	4.37 – 4.38
450/750V, 75°C, 07BQ-F	4.38

## Introduction

### Multi Applications Demand Multiple Choice

When the applications are many and the systems different, cable flexibility is vital. Choice means the ability to meet every requirement and every contingency, because every system has different requirements.

Belden's multi-conductor cables meet the technical requirements of many different types of systems. In fact, Belden offers one of the broadest lines of UL-Listed, NEC and CEC multi-conductor cables available from any single source.

### Key Applications

- Computers
- Communications
- Instrumentation
- Sound
- Control
- Audio
- Data transmission

### Special Features

- Belden multi-conductor cables are offered in many variations including plenum and high-temperature versions. Variations include:
  - Gage sizes
  - Dimensions
  - Insulation materials
  - Shielding configurations
  - Jacketing materials
- Each cable is designed to protect signal integrity under critical conditions by reducing hum, noise, and crosstalk.
- Belden's unique UnReel® cable dispenser is available for many of the multi-conductor products listed in this section. The letter "U" before the specified put-up length denotes UnReel® packaging.
- Extended temperature and chemical resistant cable range: a broad range of cables suitable for application in the temperature range from -100°C up to +1550°C.

### Availability

Most of our multi-conductor cables are available from stock. Many of these are available off the shelf from distributors. If you have a new or unusual application or you cannot find a multi-conductor cable in this catalog section that meets your technical requirements, see our U.S. Master Catalog or contact technical support at +31-77-3875-414 or [techsupport.venlo@belden.com](mailto:techsupport.venlo@belden.com).

### Selection Guide: Shielded Multi-Conductor Computer Cables for RS-232 Applications

Specifications		Cable Series*			
		9925	9608	9533	9939
Conductor Size: (AWG)	28				
	24	✓	✓	✓	
	22				✓
	20				
	18				
Page No.		4.11	4.9	4.6	4.10
Insulation:	S-R PVC		✓	✓	✓
	Polyethylene				
	Polypropylene				
	Datalene®†	✓			
Shield:	Overall Foil			✓	
	Drain Wire	✓		✓	
	Overall Foil/Braid	✓	✓		✓
	Braid Coverage	65%	65%		65%
Drain Wire Overall:		Yes	No	Yes	No
No. of Cond. Available:	1				
	2				
	3	✓	✓	✓	✓
	4	✓	✓	✓	✓
	5	✓	✓	✓	✓
	6	✓	✓	✓	✓
	7	✓	✓	✓	✓
	8	✓	✓	✓	✓
	9	✓	✓	✓	✓
	10	✓	✓	✓	✓
	11				
	12				
	13				
	15	✓	✓	✓	✓
	17				
	18				
	19				
	20			✓	
	25	✓	✓	✓	✓
	27				
30			✓		
31					
37	✓	✓		✓	
40			✓		
50		✓	✓	✓	
Capacitance** (pF/m)		39.4	98.4	98.4	114.8

\* All cables are UL-Listed.

\*\*Capacitance may vary on some cables.

† Foam high density polyethylene.

## Introduction

To assist you in selecting the proper cable for your application, both the suggested working voltages and the maximum temperature ratings are indicated for each applicable product in this section.

### Extended Temperature and Chemical Resistant Cable Range Nominal Temperature Operating Ranges (°C)

-100°	-80°	-60°	-40°	-20°	0	20°	40°	60°	80°	100°	120°	140°	160°	180°	200°	220°	240°	
			-40°	TPE										150°C				
			-50°	Silicone										180°C				
			-100°	FEP										205°C				
			-50°	Glass Fiber										350°C				
			-50°	S-Glass Fiber										400°C				
			-50°	Mica										1250°C				
			-50°	Micaflame										1550°C				

### Index by Voltage and Temperature Rating

Multicore Section		Page No.
<b>300V, 150°C</b>	TPE 2-7 Conductors	4.15
	TPE 2-7 Conductors Overall Braid	4.16
<b>300V, 180°C</b>	Silicone Rubber FRNC 2-5 Conductors	4.17
	Silicone Rubber FRNC 6-25 Conductors	4.18 – 4.19
	Silicone Rubber FRNC 2-5 Conductors (H05SS-F)	4.20
	Silicone Rubber FRNC 2-24 Conductors	4.21 – 4.23
	Steel Wire Braid (SWB)	
	Silicone Rubber FRNC 2-7 Conductors Overall Braid	4.24
	Silicone Rubber FRNC 2-30 Conductors Heavy Duty	4.25 – 4.26
Silicone Rubber FRNC 2-30 Conductors Heavy Duty Overall Braid		
<b>300V, 205°C</b>	FEP 2-7 Conductors	4.29
<b>300V, 350°C</b>	Glass Fiber Serving 2-4 Conductors Glass Braid	4.31
	Glass Fiber Serving 2-4 Conductors Glass Braid Steel Wire Braid (SWB)	4.32
	Micaflame® 2-5 Conductors Glass Braid	4.34
<b>380V, 1250°C</b>	Mica 2-5 Conductors Ceramic Braid	4.33
	Steel Wire Braid (SWB)	
<b>450V, 75°C</b>	PVC 07BQ-F 2-4 Conductors	4.38
<b>500V, 80°C</b>	PVC LiY(St)CY 2-12 Conductors	4.35 – 4.36
<b>600V, 205°C</b>	FEP 2-7 Conductors Overall Braid	4.30
<b>750V, 80°C</b>	PVC LiY CY 1-10 Conductors	4.37 – 4.38



### Unshielded

### Audio, Control and Instrumentation Cables Plenum-Rated and Non-Plenum

De- scription	Part No.	UL NEC/ C(UL)CEC Type IEC	Standard Lengths		Standard Unit Weight		Conductor (Stranding) Diameter Nom. DCR	Nominal Insulation OD		Shielding Material Nom. DCR	Nominal OD		Color Code
			ft.	m	lbs.	kg		inch	mm		inch	mm	

**22 AWG • Stranded (7x30) 0.8 mm Tinned Copper • Conductors Cabled**

**PVC Insulation • Chrome PVC Jacket**

150V 80°C  
UL AWM Style 2576  
NEC:  
CMG  
CEC:  
CMG FT4  
0.76 mm  
22 AWG  
(7x30) TC  
0.060 1.52 Unshielded



<b>8442</b>	2 CDR*	100	31	2.4	1.1	0.170	4.32	Black, Red
		U-500	U-152	8.2	3.7			
		500	152	7.5	3.4			
		U-1000	U-305	15.0	6.8			
		1000	305	15.0	6.8			
		† 10000	3048	150.4	68.2			

For Plenum version of 8442, see 88442 or 82442.

<b>8443</b>	3 CDR	100	31	2.6	1.2	0.172	4.37	Black, Red, Green
		U-500	U-152	9.5	4.3			
		500	152	9.5	4.3			
		U-1000	U-305	18.1	8.2			
		1000	305	18.1	8.2			

<b>8444</b>	4 CDR	100	31	3.1	1.4	0.185	4.70	see chart 1 (Tech Info Section)
		U-500	U-152	11.5	5.2			
		500	152	11.5	5.2			
		U-1000	U-305	22.0	10.0			
		1000	305	23.1	10.5			

For Plenum version of 8444, see 88444 or 82444.

<b>8445</b>	5 CDR	100	31	3.5	1.6	0.194	4.93	see chart 1 (Tech Info Section)
		U-500	U-152	13.4	6.1			
		500	152	13.4	6.1			
		U-1000	U-305	25.1	11.4			
		1000	305	26.0	11.8			

<b>9430</b>	7 CDR	U-500	U-152	17.0	7.7	0.214	5.44	see chart 1 (Tech Info Section)
		500	152	17.0	7.7			
		U-1000	U-305	32.0	14.5			
		1000	305	35.1	15.9			

<b>9421</b>	8 CDR	100	31	4.2	1.9	0.229	5.82	see chart 1 (Tech Info Section)
		U-500	U-152	19.2	8.7			
		500	152	18.5	8.4			
		U-1000	U-305	35.9	16.3			
		1000	305	37.9	17.2			

<b>9423</b>	9 CDR	100	31	4.6	2.1	0.244	6.20	see chart 1 (Tech Info Section)
		U-500	U-152	21.2	9.6			
		500	152	21.6	9.8			
		U-1000	U-305	41.0	18.6			
		1000	305	43.0	19.5			

<b>8456</b>	10 CDR	100	31	5.1	2.3	0.264	6.71	see chart 1 (Tech Info Section)
		U-500	U-152	22.5	10.2			
		500	152	23.1	10.5			
		U-1000	U-305	44.1	20.0			
		1000	305	46.1	20.9			

**18 AWG • Stranded (19x30) 1.2 mm Tinned Copper • Conductors Cabled**

**Plenum • FEP Insulation • Natural Flamarrest® Jacket**

Non-conduit **82489** NEC: † U-1000 U-305 31.1 14.1 1.24 mm 0.063 1.60 Unshielded 0.170 4.32 Black, White, Red, Green  
CMP † 1000 305 29.1 13.2 18 AWG  
CEC: (19x30) TC  
CMP FT6



4-Conductor

TC = Tinned Copper • DCR = DC resistance

† Spools and/or UnReel® cartons are one piece, but length may vary ±10% for spools and ±5% for UnReel® from length shown.

\* Twisted Pair

# Unshielded

## Duplex Primary Wire

De- scription	Part No.	UL NEC / C(UL)/CEC Type IEC	Standard Lengths		Standard Unit Weight		Conductor (Stranding) Diameter Nom. DCR	Nominal Insulation OD		Shielding Material Nom. DCR	Nominal OD		Color Code
			ft.	m	lbs.	kg		inch	mm		inch	mm	

**Duplex Primary Wire** Stranded Bare Copper • Conductors Parallel

**PVC Insulation • Chrome PVC Jacket**

300V RMS 75°C  
VW-1

Unshielded

Brown, Red



<b>8677</b>	2 CDR	500	152	18.5	8.4	1.47 mm 16 AWG (19x29) BC	0.106	2.69	0.149	3.78	x	x	0.254	6.45
<b>8675</b>	2 CDR	500	152	23.6	10.7	1.85 mm 14 AWG (19x27) BC	0.119	3.01	0.168	4.27	x	x	0.290	7.37
<b>8673</b>	2 CDR	500	152	32.6	14.8	2.36 mm 12 AWG (19x25) BC	0.145	3.68	0.186	4.72	x	x	0.328	8.33
<b>8678</b>	2 CDR	500	152	50.9	23.1	2.9 mm 10 AWG (19x23) BC	0.176	4.48	0.225	5.72	x	x	0.400	10.16

BC = Bare Copper • DCR = DC resistance

# Overall Beldfoil® Shield

## Computer Cables for EIA RS-232 Applications

De- scription	Part No.	UL NEC/ C(UL)/CEC Type IEC	Standard Lengths		Standard Unit Weight		Conductor (Stranding) Diameter Nom. DCR	Nominal Insulation OD		Shielding Material Nom. DCR	Nominal OD		Nom. Vel. of Prop.	Nominal Capacitance		Color Code
			ft.	m	lbs.	kg		inch	mm		inch	mm		pF/ft.	pF/m	

**24 AWG • Stranded (7x32) 0.6 mm Tinned Copper • Conductors Cabled • Overall Beldfoil® Shield • 24 AWG Tinned Copper Drain Wire**

**Semi-Rigid PVC Insulation • Chrome PVC Jacket**

300V 80°C UL AWM Style 2464	NEC: CMG CEC: CMG FT4		0.61 mm 24 AWG (7x32) TC	0.044	1.11	Overall Beldfoil® + Drain Wire (24 AWG TC)	-									see chart 1 (Tech Info Section)
--------------------------------	--------------------------------	--	--------------------------------	-------	------	---	---	--	--	--	--	--	--	--	--	------------------------------------

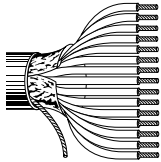

<b>9533</b>	3 CDR	100	31	2.6	1.2		0.162	4.11			CDR/CDR	33	108	
		U-500	U-152	9.5	4.3							CDR/SCR	65	213
		500	152	9.0	4.1									
		U-1000	U-305	18.1	8.2									
		1000	305	18.1	8.2									
<b>9534</b>	4 CDR	100	31	3.1	1.4		0.184	4.67			CDR/CDR	33	108	
		U-500	U-152	11.0	5.0							CDR/SCR	65	213
		500	152	11.5	5.2									
		U-1000	U-305	20.9	9.5									
		1000	305	22.0	10.0									
<b>9535</b>	5 CDR	100	31	3.3	1.5		0.189	4.80			CDR/CDR	33	108	
		U-500	U-152	11.9	5.4							CDR/SCR	65	213
		500	152	11.0	5.0									
		U-1000	U-305	22.9	10.4									
		1000	305	22.0	10.0									
<b>9536</b>	6 CDR	100	31	3.5	1.6		0.209	5.31			CDR/CDR	33	108	
		U-500	U-152	14.6	6.6							CDR/SCR	65	213
		500	152	12.6	5.7									
		U-1000	U-305	27.1	12.3									
		1000	305	29.1	13.2									
<b>9537</b>	7 CDR	100	31	3.7	1.7		0.209	5.31			CDR/CDR	33	108	
		U-500	U-152	15.0	6.8							CDR/SCR	65	213
		500	152	13.7	6.2									
		U-1000	U-305	29.1	13.2									
		1000	305	30.2	13.7									
<b>9538</b>	8 CDR	100	31	3.7	1.7		0.224	5.69			CDR/CDR	33	108	
		U-500	U-152	17.0	7.7							CDR/SCR	65	213
		500	152	15.0	6.8									
		U-1000	U-305	32.2	14.6									
		1000	305	34.0	15.4									
<b>9539</b>	9 CDR	100	31	4.2	1.9		0.244	6.20			CDR/CDR	30	98	
		U-500	U-152	20.1	9.1							CDR/SCR	55	180
		500	152	17.2	7.8									
		U-1000	U-305	37.3	16.9									
		1000	305	38.1	17.3									
<b>9540</b>	10 CDR	100	31	4.4	2.0		0.244	6.20			CDR/CDR	30	98	
		U-500	U-152	19.6	8.9							CDR/SCR	55	180
		500	152	18.1	8.2									
		U-1000	U-305	37.9	17.2									
		1000	305	36.2	16.4									

TC = Tinned Copper • DCR = DC resistance • SCR = Capacitance between one conductor and other conductors connected to shield. • CDR = Capacitance between conductors

# Overall Beldfoil® Shield

## Computer Cables for EIA RS-232 Applications

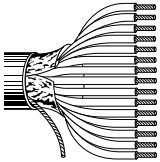
De- scription	Part No.	UL NEC/ C(UL)/CEC Type IEC	Standard Lengths		Standard Unit Weight		Conductor (Stranding) Diameter Nom. DCR	Nominal Insulation OD		Shielding Material Nom. DCR	Nominal OD		Nom. Vel. of Prop.	Nominal Capacitance		Color Code
			ft.	m	lbs.	kg		inch	mm		inch	mm		pF/ft.	pF/m	
<b>24 AWG • Stranded (7x32) 0.6 mm TC • Conductors Cabled • Overall Beldfoil® Shield • 24 AWG Tinned Copper Drain Wire (continued)</b>																
<b>Semi-Rigid PVC Insulation • Chrome PVC Jacket</b>																
300V 80°C UL AWM Style 2464		NEC: CMG CEC: CMG FT4					0.61 mm 24 AWG (7x32) TC	0.044	1.11	Overall Beldfoil® + Drain Wire (24 AWG TC)			-			see chart 2R (Tech Info Section)
																
<b>9541</b>	15 CDR		100	31	6.0	2.7					0.284	7.21		CDR/CDR	30	98
			U-500	U-152	27.6	12.5								CDR/SCR	55	180
			500	152	28.0	12.7										
			U-1000	U-305	54.0	24.5										
			1000	305	56.0	25.4										
<b>9542</b>	20 CDR		100	31	7.3	3.3					0.314	7.98		CDR/CDR	30	98
			U-500	U-152	34.0	15.4								CDR/SCR	55	180
			500	152	35.5	16.1										
			1000	305	69.0	31.3										
<b>9543</b>	25 CDR		100	31	8.8	4.0					0.339	8.61		CDR/CDR	30	98
			500	152	44.1	20.0								CDR/SCR	55	180
			1000	305	86.0	39.0										
<b>9544</b>	30 CDR		100	31	10.4	4.7					0.380	9.65		CDR/CDR	30	98
			500	152	51.6	23.4								CDR/SCR	55	180
			1000	305	102.1	46.3										
<b>9545</b>	40 CDR		100	31	13.4	6.1					0.430	10.92		CDR/CDR	30	98
			500	152	65.0	29.5								CDR/SCR	55	180
			1000	305	130.1	59.0										
<b>9546</b>	50 CDR		100	31	16.3	7.4					0.490	12.45		CDR/CDR	30	98
			500	152	81.6	37.0								CDR/SCR	55	180
			1000	305	168.2	76.3										

TC = Tinned Copper • DCR = DC resistance • SCR = Capacitance between one conductor and other conductors connected to shield. • CDR = Capacitance between conductors

# Overall Beldfoil® Shield

## Audio, Control and Instrumentation Cables

De- scription	Part No.	UL NEC/ C(UL)CEC Type IEC	Standard Lengths		Standard Unit Weight		Conductor (Stranding) Diameter Nom. DCR	Nominal Insulation OD		Shielding Material Nom. DCR	Nominal OD		Nom. Vel. of Prop.	Nominal Capacitance		Color Code
			ft.	m	lbs.	kg		inch	mm		inch	mm		pF/ft.	pF/m	

**20 AWG** • Stranded (7x28) 1.0 mm Tinned Copper • Conductors Cabled • Overall **Beldfoil®** Shield • 20 AWG Tinned Copper Drain Wire

Polyethylene Insulation • Chrome PVC Jacket																	
300V 60°C	<b>8772</b>	NEC:	U-500	U-152	16.1	7.3	0.96 mm	0.070	1.78	Overall Beldfoil® + Drain Wire (20 AWG TC)	0.218	5.54	-	CDR/CDR	27	89	Black, Red, Clear
UL AWM Style	2093	CM	500	152	16.1	7.3	20 AWG							CDR/SCR	51	167	
		CEC:	U-1000	U-305	31.1	14.1	(7x28) TC										
		CM	1000	305	32.0	14.5											

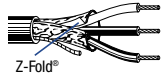

Z-Fold®

3 CDR

**18 AWG** • Stranded (16x30) 1.2 mm Tinned Copper • Conductors Cabled • Overall **Beldfoil®** Shield • 20 AWG Tinned Copper Drain Wire

Polyethylene Insulation • Chrome PVC Jacket																	
300V 60°C	<b>8770</b>	NEC:	U-500	U-152	20.1	9.1	1.20 mm	0.083	2.12	Overall Beldfoil® + Drain Wire (20 AWG TC)	0.246	6.25	-	CDR/CDR	24	79	Black, Red, Clear
UL AWM Style	2093	CM	500	152	20.5	9.3	18 AWG							CDR/SCR	48	157	
		CEC:	U-1000	U-305	37.9	17.2	(16x30) TC										
		CM	1000	305	40.1	18.2											
			†† 10000	3048	431.0	195.5											

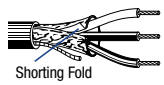

Shorting Fold

For Plenum version of 8770, see 88770.

3 CDR

**18 AWG** • Stranded (19x30) 1.2 mm Tinned Copper • Conductors Cabled • Overall **Beldfoil®** Shield • 20 AWG Tinned Copper Drain Wire

Semi-Rigid PVC Insulation • Chrome PVC Jacket																	
300V 80°C	<b>9418</b>	NEC:	100	31	5.7	2.6	1.24 mm	0.069	1.74	Overall Beldfoil® + Drain Wire (20 AWG TC)	0.245	6.22	-	CDR/CDR	70	230	Red, Green, Black, White
UL AWM Style	2464	CMG	U-500	U-152	18.1	8.2	18 AWG							CDR/SCR	120	394	
		CEC:	500	152	24.5	11.1	(19x30) TC										
		CMG FT4	U-1000	U-305	35.3	16.0											
			1000	305	52.2	23.7											
			†† 10000	3048	509.9	231.3											

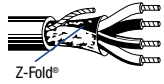

Z-Fold®

For Plenum versions of 9418, see 89418 or 82418.

4 CDR

TC = Tinned Copper • DCR = DC resistance • SCR = Capacitance between one conductor and other conductors connected to shield. • CDR = Capacitance between conductors  
 †† Final put-up may vary -10% to +20%. May contain 2 pieces. Min. length 460 m.

### Overall Foil/Braid Shield

### Computer Cables for EIA RS-232 Applications

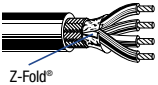
De- scription	Part No.	UL NEC/ C(UL)/CEC Type IEC	Standard Lengths		Standard Unit Weight		Conductor (Stranding) Diameter Nom. DCR	Nominal Insulation OD		Shielding Material Nom. DCR	Nominal OD		Nom. Vel. of Prop.	Nominal Capacitance		Color Code
			ft.	m	lbs.	kg		inch	mm		inch	mm		pF/ft.	pF/m	
<b>24 AWG • Stranded Conductors (7x32) 0.6 mm Tinned Copper • Overall Beldfoil® Shield + 65% Tinned Copper Braid</b> <b>Semi-Rigid PVC Insulation • Chrome PVC Jacket</b>																
300V 80°C UL AWM Style 2464		NEC: CMG CEC: CMG FT4					0.61 mm 24 AWG (7x32) TC	0.044	1.12	Overall Beldfoil® + Overall 65% TC Braid			-			
																
<b>9608</b>	3 CDR		100 500 1000	31 152 305	3.1 11.9 22.9	1.4 5.4 10.4					0.190	4.83	CDR/CDR CDR/SCR	35 65	115 213	see chart 1 (Tech Info Section)
<b>9609</b>	4 CDR		100 500 1000	31 152 305	3.5 13.4 26.0	1.6 6.1 11.8					0.200	5.08	CDR/CDR CDR/SCR	35 65	115 213	see chart 1 (Tech Info Section)
<b>9610</b>	5 CDR		100 500 1000	31 152 305	4.0 16.1 32.0	1.8 7.3 14.5					0.215	5.46	CDR/CDR CDR/SCR	35 65	115 213	see chart 1 (Tech Info Section)
<b>9611</b>	6 CDR		100 500 1000	31 152 305	4.2 17.0 34.0	1.9 7.7 15.4					0.225	5.72	CDR/CDR CDR/SCR	30 55	98 180	see chart 1 (Tech Info Section)
<b>9612</b>	7 CDR		100 500 1000	31 152 305	4.2 18.5 38.1	1.9 8.4 17.3					0.225	5.72	CDR/CDR CDR/SCR	30 55	98 180	see chart 1 (Tech Info Section)
<b>9613</b>	8 CDR		100 500 1000	31 152 305	4.4 20.9 41.0	2.0 9.5 18.6					0.240	6.10	CDR/CDR CDR/SCR	30 55	88 180	see chart 1 (Tech Info Section)
<b>9614</b>	9 CDR		100 500 1000	31 152 305	4.9 22.0 44.1	2.2 10.0 20.0					0.253	6.43	CDR/CDR CDR/SCR	30 55	98 180	see chart 1 (Tech Info Section)
<b>9615</b>	10 CDR		100 500 1000	31 152 305	5.5 25.1 50.0	2.5 11.4 22.7					0.270	6.86	CDR/CDR CDR/SCR	30 55	98 180	see chart 1 (Tech Info Section)
<b>9616</b>	15 CDR		100 500 1000	31 152 305	6.6 31.5 63.1	3.0 14.3 28.6					0.300	7.62	CDR/CDR CDR/SCR	30 55	98 180	see chart 2R (Tech Info Section)
<b>9617</b>	25 CDR		100 500 1000	31 152 305	10.1 49.6 100.1	4.6 22.5 45.4					0.370	9.40	CDR/CDR CDR/SCR	30 55	98 180	see chart 2R (Tech Info Section)
<b>9618</b>	37 CDR		100 500 1000	31 152 305	13.2 66.6 135.1	6.0 30.2 61.3					0.411	10.43	CDR/CDR CDR/SCR	30 55	98 180	see chart 2R (Tech Info Section)
<b>9619</b>	50 CDR		100 500 1000	31 152 305	17.2 93.0 182.1	7.8 42.2 82.6					0.485	12.32	CDR/CDR CDR/SCR	30 55	98 180	see chart 2R (Tech Info Section)

TC = Tinned Copper • DCR = DC resistance • SCR = Capacitance between one conductor and other conductors connected to shield. • CDR = Capacitance between conductors

4 • Multi-Conductor Cables

## Overall Foil/Braid Shield

### Computer Cables for EIA RS-232 Applications

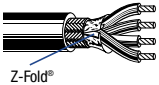
De- scription	Part No.	UL NEC/ C(UL)CEC Type IEC	Standard Lengths		Standard Unit Weight		Conductor (Stranding) Diameter Nom. DCR	Nominal Insulation OD		Shielding Material Nom. DCR	Nominal OD		Nom. Vel. of Prop.	Nominal Capacitance		Color Code
			ft.	m	lbs.	kg		inch	mm		inch	mm		pF/ft.	pF/m	
<b>22 AWG • Stranded Conductors (7x30) 0.8 mm Tinned Copper • Overall Beldfoil® Shield + 65 % Tinned Copper Braid</b>																
<b>Semi-Rigid PVC Insulation • Chrome PVC Jacket</b>																
300V 80°C UL AWM Style 2464		NEC: CMG CEC: CMG FT4					0.76 mm 22 AWG (7x30) TC	0.051	1.30	Overall Beldfoil® + Overall 65% TC Braid			-			
																
<b>9939</b>	3 CDR		100 500 1000	31 152 305	3.5 12.1 24.0	1.6 5.5 10.9					0.202	5.13	CDR/CDR CDR/SCR	37 67	121 220	see chart 1 (Tech Info Section)
<b>9940</b>	4 CDR		100 500 1000	31 152 305	4.0 14.6 32.0	1.8 6.6 14.5					0.215	5.46	CDR/CDR CDR/SCR	37 67	121 220	see chart 1 (Tech Info Section)
<b>9941</b>	5 CDR		100 500 1000	31 152 305	4.0 16.1 38.1	1.8 7.3 17.3					0.230	5.84	CDR/CDR CDR/SCR	37 67	121 220	see chart 1 (Tech Info Section)
<b>9942</b>	6 CDR		100 500 1000	31 152 305	4.6 22.0 43.0	2.1 10.0 19.5					0.245	6.22	CDR/CDR CDR/SCR	35 63	115 207	see chart 1 (Tech Info Section)
<b>9943</b>	7 CDR		100 500 1000	31 152 305	5.1 23.8 46.1	2.3 10.8 20.9					0.245	6.22	CDR/CDR CDR/SCR	35 63	115 207	see chart 1 (Tech Info Section)
<b>9944</b>	8 CDR		100 500 1000	31 152 305	5.5 26.0 52.0	2.5 11.8 23.6					0.260	6.60	CDR/CDR CDR/SCR	35 63	115 207	see chart 1 (Tech Info Section)
<b>9945</b>	9 CDR		100 500 1000	31 152 305	6.2 28.4 57.1	2.8 12.9 25.9					0.280	7.11	CDR/CDR CDR/SCR	35 63	115 207	see chart 1 (Tech Info Section)
<b>9946</b>	10 CDR		100 500 1000	31 152 305	6.6 31.5 61.9	3.0 14.3 28.1					0.300	7.62	CDR/CDR CDR/SCR	35 63	115 207	see chart 1 (Tech Info Section)
<b>9947</b>	15 CDR		100 500 1000	31 152 305	8.8 42.5 83.1	4.0 19.3 37.7					0.340	8.64	CDR/CDR CDR/SCR	35 63	115 207	see chart 2R (Tech Info Section)
<b>9948</b>	25 CDR		100 500 1000	31 152 305	13.3 66.6 132.1	6.0 30.2 59.9					0.410	10.41	CDR/CDR CDR/SCR	35 63	115 207	see chart 2R (Tech Info Section)
<b>9949</b>	37 CDR		100 500 1000	31 152 305	16.1 87.5 180.1	7.3 39.7 81.7					0.460	11.68	CDR/CDR CDR/SCR	35 63	115 207	see chart 2R (Tech Info Section)
<b>9950</b>	50 CDR		100 500 1000	31 152 305	25.1 118.2 238.3	11.4 53.6 108.1					0.555	14.10	CDR/CDR CDR/SCR	35 63	115 207	see chart 2R (Tech Info Section)

TC = Tinned Copper • DCR = DC resistance • SCR = Capacitance between one conductor and other conductors connected to shield. • CDR = Capacitance between conductors

### Overall Foil/Braid Shield

Low-Capacitance Computer Cables for EIA RS-232 and EIA RS-423 Applications

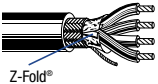
De- scription	Part No.	UL NEC/ C(UL)/CEC Type IEC	Standard Lengths		Standard Unit Weight		Conductor (Stranding) Diameter Nom. DCR	Nominal Insulation OD		Shielding Material Nom. DCR	Nominal OD		Nom. Vel. of Prop.	Nominal Capacitance		Color Code
			ft.	m	lbs.	kg		inch	mm		inch	mm		pF/ft.	pF/m	
<b>24 AWG • Stranded Conductors (7x32) 0.6 mm Tinned Copper • Overall Beldfoil® Shield + 65% Tinned Copper Braid • 24 AWG TC Drain Wire</b> <b>Datalene® Insulation • Chrome PVC Jacket</b>																
30V 80°C UL AWM Style 2919		NEC: CM CEC: CM					0.61 mm 24 AWG (7x32) TC	0.053	1.35	Overall Beldfoil® + Overall 65% TC Braid + Drain Wire (24 AWG TC)			78%			
																
	<b>9925</b>	3 CDR	100 500 1000	31 152 305	3.5 12.1 24.0	1.6 5.5 10.9					0.215	5.46	CDR/CDR CDR/SCR	12 22	39 72	see chart 1 (Tech Info Section)
	<b>9927</b>	4 CDR	100 500 1000	31 152 305	3.5 14.6 32.0	1.6 6.6 14.5					0.230	5.84	CDR/CDR CDR/SCR	12 22	39 72	see chart 1 (Tech Info Section)
	<b>9929</b>	5 CDR	100 500 1000	31 152 305	4.0 16.1 35.9	1.8 7.3 16.3					0.246	6.25	CDR/CDR CDR/SCR	12 22	39 72	see chart 1 (Tech Info Section)
	<b>9931</b>	6 CDR	100 500 1000 10000	31 152 305 3048	4.2 17.6 39.0 410.3	1.9 8.0 17.7 186.1					0.265	6.73	CDR/CDR CDR/SCR	12 22	39 72	see chart 1 (Tech Info Section)
	<b>9932</b>	7 CDR	100 500 1000	31 152 305	4.4 18.5 41.0	2.0 8.4 18.6					0.265	6.73	CDR/CDR CDR/SCR	12 22	39 72	see chart 1 (Tech Info Section)
	<b>9633</b>	8 CDR	100 500 1000 10000	31 152 305 3048	4.9 21.2 46.1 480.4	2.2 9.6 20.9 217.9					0.280	7.11	CDR/CDR CDR/SCR	12 22	39 72	see chart 1 (Tech Info Section)
	<b>9934</b>	9 CDR	100 500 1000	31 152 305	5.3 22.0 48.1	2.4 10.0 21.8					0.300	7.62	CDR/CDR CDR/SCR	12 22	39 72	see chart 1 (Tech Info Section)
	<b>9935</b>	10 CDR	100 500 1000	31 152 305	5.7 28.0 53.1	2.6 12.7 24.1					0.306	7.77	CDR/CDR CDR/SCR	12 22	39 72	see chart 1 (Tech Info Section)
	<b>9636</b>	15 CDR	100 500 1000	31 152 305	7.3 35.1 68.1	3.3 15.9 30.9					0.350	8.89	CDR/CDR CDR/SCR	12 22	39 72	see chart 2R (Tech Info Section)
	<b>9937</b>	25 CDR	100 500 1000	31 152 305	9.9 54.7 108.0	4.5 24.8 49.0					0.445	11.30	CDR/CDR CDR/SCR	12 22	39 72	see chart 2R (Tech Info Section)
	<b>9938</b>	37 CDR	100 500 1000	31 152 305	13.0 71.6 139.1	5.9 32.5 63.1					0.500	12.70	CDR/CDR CDR/SCR	12 22	39 72	see chart 2R (Tech Info Section)

TC = Tinned Copper • DCR = DC resistance • SCR = Capacitance between one conductor and other conductors connected to shield. • CDR = Capacitance between conductors



## Overall Foil/Braid Shield

### Audio, Control and Instrumentation Cables

De-scription	Part No.	UL NEC/ C(UL)CEC Type IEC	Standard Lengths		Standard Unit Weight		Conductor (Stranding) Diameter Nom. DCR	Nominal Insulation OD		Shielding Material Nom. DCR	Nominal OD		Nom. Vel. of Prop.	Nominal Capacitance		Color Code
			ft.	m	lbs.	kg		inch	mm		inch	mm		pF/ft.	pF/m	

**24 AWG** • Stranded Conductors (7x32) 0.6 mm Tinned Copper • Conductors Cabled • Overall **Beldfoil®** Shield + 85% Tinned Copper Braid

**Plenum • FEP Insulation • Red FEP Jacket**

300V RMS Non-conduit	NEC: CMP CEC: CMP FT6						0.61 mm 24 AWG (7x32) TC	0.036	0.91	Overall Beldfoil® + Overall 85% TC Braid	-					see chart 2 (Tech Info Section)
-------------------------	--------------------------------	--	--	--	--	--	--------------------------------	-------	------	---	---	--	--	--	--	------------------------------------



Part No.	Conductors	Length (ft.)	Length (m)	Weight (lbs.)	Weight (kg)	Nom. OD (inch)	Nom. OD (mm)	Capacitance (pF/ft.)	Capacitance (pF/m)
83503	3 CDR	† 500	152	9.5	4.3	0.135	3.43	CDR/CDR CDR/SCR	20 66 36 118
		† 1000	305	16.1	7.3				
83504	4 CDR	100	31	3.5	1.6	0.144	3.66	CDR/CDR CDR/SCR	20 66 36 118
		† 500	152	10.1	4.6				
		† 1000	305	20.1	9.1				
83506	6 CDR	† 500	152	13.2	6.0	0.165	4.19	CDR/CDR CDR/SCR	20 66 36 118
		† 1000	305	26.2	11.9				

**22 AWG** • Stranded Conductors (7x30) 0.8 mm Tinned Copper • Conductors Cabled • Overall **Beldfoil®** Shield + 85% Tinned Copper Braid

**Plenum • FEP Insulation • Red FEP Jacket**

300V RMS Non-conduit	NEC: CMP CEC: CMP FT6						0.76 mm 22 AWG (7x30) TC	0.042	1.06	Overall Beldfoil® + Overall 85% TC Braid	-					see chart 2 (Tech Info Section)
-------------------------	--------------------------------	--	--	--	--	--	--------------------------------	-------	------	---	---	--	--	--	--	------------------------------------



Part No.	Conductors	Length (ft.)	Length (m)	Weight (lbs.)	Weight (kg)	Nom. OD (inch)	Nom. OD (mm)	Capacitance (pF/ft.)	Capacitance (pF/m)
83552	2 CDR	† 500	152	8.2	3.7	0.141	3.58	CDR/CDR CDR/SCR	23 75 40 131
		† 1000	305	16.1	7.3				
83553	3 CDR	100	31	3.5	1.6	0.148	3.76	CDR/CDR CDR/SCR	23 75 40 131
		† 500	152	11.5	5.2				
		† 1000	305	20.1	9.1				
83554	4 CDR	100	31	4.0	1.8	0.159	4.04	CDR/CDR CDR/SCR	23 75 40 131
		† 500	152	12.6	5.7				
		† 1000	305	25.1	11.4				
83556	6 CDR	100	31	5.3	2.4	0.183	4.65	CDR/CDR CDR/SCR	23 75 40 131
		† 500	152	16.5	7.5				
		† 1000	305	35.9	16.3				
83559	9 CDR	100	31	6.8	3.1	0.209	5.31	CDR/CDR CDR/SCR	23 75 40 131
		† 500	152	23.1	10.5				
		† 1000	305	50.0	22.7				
83562	12 CDR	† 500	152	28.7	13.0	0.234	5.94	CDR/CDR CDR/SCR	23 75 40 131
		† 1000	305	60.0	27.2				
83569	19 CDR	100	31	9.7	4.4	0.269	6.83	CDR/CDR CDR/SCR	23 75 40 131
		† 500	152	44.1	20.0				
		† 1000	305	85.1	38.6				

TC = Tinned Copper • DCR = DC resistance • SCR = Capacitance between one conductor and other conductors connected to shield. • CDR = Capacitance between conductors  
 † Spools are one piece, but length may vary ± 10% from length shown.

### Fire Alarm

#### Power-Limited Fire Protective Signaling Circuit Cables Subject 1424 (NEC Article 760, Type FPLR)

De- scription	Part No.	UL NEC/ C(UL)/CEC Type IEC	Standard Lengths		Standard Unit Weight		Conductor (Stranding) Diameter Nom. DCR	Nominal Insulation OD		Shielding Material Nom. DCR	Nominal OD		Color Code
			ft.	m	lbs.	kg		inch	mm		inch	mm	

**18 AWG • Solid 1.0 mm Bare Copper • Conductors Cabled**

**PVC Insulation • Red PVC Jacket**

300V 105°C UL AWM Style 2464 & 1424	<b>9571</b>	NEC: MPR, FPLR CEC: FAS 105 FT4	U-500	U-152	14.6	6.6	1.02 mm	0.074	1.88	Unshielded	0.228	5.79	Black, Red
			U-1000	U-305	28.0	12.7	18 AWG Solid BC						



2 CDR

**18 AWG • Solid 1.0 mm Bare Copper • Conductors Cabled • Overall Beldfoil® Shield • 22 AWG Tinned Copper Drain Wire**

**PVC Insulation • Red PVC Jacket**

300V 105°C UL AWM Style 2464 & 1424		NEC: MPR, FPLR CEC: FAS 105 FT4					1.02 mm	0.074	1.88	Overall Beldfoil® + Drain Wire (22 AWG TC)			
							18 AWG Solid BC						



Z-Fold®

<b>9574</b>	2 CDR	U-500	U-152	16.1	7.3						0.231	5.87	Black, Red
		U-1000	U-305	31.1	14.1								
<b>9578</b>	4 CDR	U-500	U-152	25.6	11.6						0.263	6.68	Black, Red, Yellow, Light Blue
		1000	305	51.1	23.2								

**16 AWG • Solid 1.3 mm Bare Copper • Conductors Cabled**

**PVC Insulation • Red PVC Jacket**

300V 105°C UL AWM Style 2464 & 1424	<b>9572</b>	NEC: MPR, FPLR CEC: FAS 105 FT4	U-500	U-152	18.1	8.2	1.29 mm	0.087	2.21	Unshielded	0.250	6.35	Black, Red
			U-1000	U-305	35.1	15.9	16 AWG Solid BC						



2 CDR

**16 AWG • Solid 1.3 mm Bare Copper • Conductors Cabled • Overall Beldfoil® Shield • 22 AWG Tinned Copper Drain Wire**

**PVC Insulation • Red PVC Jacket**

300V 105°C UL AWM Style 2464 & 1424		NEC: MPR, FPLR CEC: FAS 105 FT4					1.29 mm	0.087	2.21	Overall Beldfoil® + Drain Wire (22 AWG TC)			
							16 AWG Solid BC						

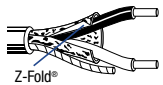

Z-Fold®

<b>9575</b>	2 CDR	U-500	U-152	20.1	9.1						0.253	6.43	Black, Red
		U-1000	U-305	39.0	17.7								
<b>9579</b>	4 CDR	U-500	U-152	35.5	16.1						0.301	7.65	Black, Red, Yellow, Light Blue
		1000	305	72.1	32.7								

TC = Tinned Copper • BC = Bare Copper • DCR = DC resistance

### Fire Alarm

#### Power-Limited Fire Protective Signaling Circuit Cables Subject 1424 (NEC Article 760, Type FPLR)

De- scription	Part No.	UL NEC/ C(UL)CEC Type IEC	Standard Lengths		Standard Unit Weight		Conductor (Stranding) Diameter Nom. DCR	Nominal Insulation OD		Shielding Material Nom. DCR	Nominal OD		Color Code
			ft.	m	lbs.	kg		inch	mm		inch	mm	

**14 AWG • Solid 1.6 mm Bare Copper • Conductors Cabled**

**PVC Insulation • Red PVC Jacket**

300V 105°C UL Style 1424	<b>9580</b>	NEC: FPLR CEC: FAS 105 FT4	U-500 1000	U-152 305	27.1 54.0	12.3 24.5	1.63 mm 14 AWG Solid BC	0.108	2.75	Unshielded	0.306	7.77	Black, Red
-----------------------------	-------------	-------------------------------------	---------------	--------------	--------------	--------------	-------------------------------	-------	------	------------	-------	------	------------



2 CDR

**14 AWG • Solid 1.6 mm Bare Copper • Conductors Cabled • Overall Beldfoil® Shield • 16 AWG Tinned Copper Drain Wire**

**PVC Insulation • Red PVC Jacket**

300V 105°C UL Style 1424	<b>9581</b>	NEC: FPLR CEC: FAS 105 FT4	U-500 1000	U-152 305	32.4 65.0	14.7 29.5	1.63 mm 14 AWG Solid BC	0.108	2.75	Overall Beldfoil® + Drain Wire (16 AWG TC)	0.306	7.77	Black, Red
-----------------------------	-------------	-------------------------------------	---------------	--------------	--------------	--------------	-------------------------------	-------	------	---	-------	------	------------



2 CDR

**12 AWG • Solid 2.1 mm Bare Copper • Conductors Cabled**

**PVC Insulation • Red PVC Jacket**

300V 105°C UL Style 1424	<b>9582</b>	NEC: FPLR CEC: FAS 105 FT4	1000	305	75.2	34.1	2.05 mm 12 AWG Solid BC	0.125	3.17	Unshielded	0.340	8.64	Black, Red
-----------------------------	-------------	-------------------------------------	------	-----	------	------	-------------------------------	-------	------	------------	-------	------	------------



2 CDR

**12 AWG • Solid 2.1 mm Bare Copper • Conductors Cabled • Overall Beldfoil® Shield • 16 AWG Tinned Copper Drain Wire**

**PVC Insulation • Red PVC Jacket**

300V 105°C UL Style 1424	<b>9583</b>	NEC: FPLR CEC: FAS 105 FT4	1000	305	85.1	38.6	2.05 mm 12 AWG Solid BC	0.125	3.17	Overall Beldfoil® + Drain Wire (16 AWG TC)	0.343	8.71	Black, Red
-----------------------------	-------------	-------------------------------------	------	-----	------	------	-------------------------------	-------	------	---	-------	------	------------

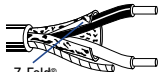

2 CDR

TC = Tinned Copper • BC = Bare Copper • DCR = DC resistance

**TPE**

Multicore Cables

300V, 150°C

De- scription	Part No.	No. of Cond. (CDR)	Standard Lengths		Standard Unit Weight		Conductor (Stranding) Diameter Nom. DCR	Nominal Conductor OD		Shielding Material Nom. DCR	Nominal OD		Application
			ft.	m	lbs.	kg		AWG	Section mm <sup>2</sup>		inch	mm	

**150°C • 18 - 16 AWG • Stranded Tinned Copper**

**TPE Insulation** (Color Code: see chart 11, Tech Info Section) • **Overall Black TPE Jacket**

Unshielded

- Traffic and automotive
- Installations in buildings
- Instrumentation engineering
- Robotics
- Tool and mechanical engineering

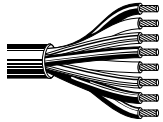

Also available on request with Bare Copper conductor for 135°C.

<b>HMC0001</b>	2	1640	500	32.0	14.5	(24x0.20) TC	18	0.75	0.165	4.20
<b>HMC0002</b>	3	1640	500	39.7	18.0	(24x0.20) TC	18	0.75	0.177	4.50
<b>HMC0003</b>	4	1640	500	51.8	23.5	(24x0.20) TC	18	0.75	0.201	5.10
<b>HMC0004</b>	5	1640	500	65.0	29.5	(24x0.20) TC	18	0.75	0.220	5.60
<b>HMC0005</b>	7	1640	500	82.7	37.5	(24x0.20) TC	18	0.75	0.240	6.10
<b>HMC0006</b>	2	1640	500	40.8	18.5	(32x0.20) TC	17	1.00	0.189	4.80
<b>HMC0007</b>	3	1640	500	51.8	23.5	(32x0.20) TC	17	1.00	0.201	5.10
<b>HMC0008</b>	4	1640	500	63.9	29.0	(32x0.20) TC	17	1.00	0.217	5.50
<b>HMC0009</b>	5	1640	500	77.2	35.0	(32x0.20) TC	17	1.00	0.240	6.10
<b>HMC0010</b>	7	1640	500	105.8	48.0	(32x0.20) TC	17	1.00	0.268	6.80
<b>HMC0011</b>	2	1640	500	52.9	24.0	(30x0.25) TC	16	1.50	0.209	5.30
<b>HMC0012</b>	3	1640	500	68.3	31.0	(30x0.25) TC	16	1.50	0.220	5.60
<b>HMC0013</b>	4	1640	500	86.0	39.0	(30x0.25) TC	16	1.50	0.244	6.20
<b>HMC0014</b>	5	1640	500	110.2	50.0	(30x0.25) TC	16	1.50	0.276	7.00
<b>HMC0015</b>	7	1640	500	142.2	64.5	(30x0.25) TC	16	1.50	0.299	7.60

TC = Tinned Copper • DCR = DC resistance

**TPE**

Multicore Cables

300V, 150°C

De-scription	Part No.	No. of Cond. (CDR)	Standard Lengths		Standard Unit Weight		Conductor (Stranding) Diameter Nom. DCR	Nominal Conductor OD		Shielding Material Nom. DCR	Nominal OD		Application
			ft.	m	lbs.	kg		AWG	Section mm <sup>2</sup>		inch	mm	

**150°C • 26 - 20 AWG • Stranded Tinned Copper • Separator Foil • Overall Tinned Copper Braid**

**TPE Insulation** (Color Code: see chart 11, Tech Info Section) • **Overall Black TPE Jacket**



Overall TC Braid

- Traffic and automotive
- Installations in buildings
- Instrumentation engineering
- Robotics
- Tool and mechanical engineering

Also available on request with Bare Copper conductor for 135°C.

HMC0016	2	1640	500	19.3	8.8	(19x0.107) TC	26	0.14		0.138	3.50	
HMC0017	3	1640	500	23.5	10.7	(19x0.107) TC	26	0.14		0.146	3.70	
HMC0018	4	1640	500	27.0	12.3	(19x0.107) TC	26	0.14		0.157	4.00	
HMC0019	5	1640	500	36.6	16.6	(19x0.107) TC	26	0.14		0.169	4.30	
HMC0020	6	1640	500	40.8	18.5	(19x0.107) TC	26	0.14		0.189	4.80	
HMC0021	7	1640	500	50.7	23.0	(19x0.107) TC	26	0.14		0.189	4.80	
HMC0022	2	1640	500	23.1	10.5	(19x0.127) TC	24	0.25		0.150	3.80	
HMC0023	3	1640	500	27.6	12.5	(19x0.127) TC	24	0.25		0.157	4.00	
HMC0024	4	1640	500	33.1	15.0	(19x0.127) TC	24	0.25		0.169	4.30	
HMC0025	5	1640	500	45.2	20.5	(19x0.127) TC	24	0.25		0.193	4.90	
HMC0026	6	1640	500	48.5	22.0	(19x0.127) TC	24	0.25		0.205	5.20	
HMC0027	7	1640	500	51.8	23.5	(19x0.127) TC	24	0.25		0.205	5.20	
HMC0028	2	1640	500	28.7	13.0	(19x0.160) TC	22	0.34		0.161	4.10	
HMC0029	3	1640	500	34.2	15.5	(19x0.160) TC	22	0.34		0.169	4.30	
HMC0030	4	1640	500	41.9	19.0	(19x0.160) TC	22	0.34		0.189	4.80	
HMC0031	5	1640	500	56.2	25.5	(19x0.160) TC	22	0.34		0.209	5.30	
HMC0032	6	1640	500	63.9	29.0	(19x0.160) TC	22	0.34		0.220	5.60	
HMC0033	7	1640	500	66.1	30.0	(19x0.160) TC	22	0.34		0.220	5.60	
HMC0034	2	1640	500	37.5	17.0	(19x0.203) TC	20	0.50		0.177	4.50	
HMC0035	3	1640	500	48.5	22.0	(19x0.203) TC	20	0.50		0.193	4.90	
HMC0036	4	1640	500	59.5	27.0	(19x0.203) TC	20	0.50		0.209	5.30	
HMC0037	5	1640	500	73.9	33.5	(19x0.203) TC	20	0.50		0.228	5.80	
HMC0038	6	1640	500	88.2	40.0	(19x0.203) TC	20	0.50		0.248	6.30	
HMC0039	7	1640	500	93.7	42.5	(19x0.203) TC	20	0.50		0.248	6.30	

TC = Tinned Copper • DCR = DC resistance

### Silicone Rubber

#### Multicore Cables

300/500V, 180°C, peak temp 250°C

De- scription	Part No.	No. of Cond. (CDR)	Standard Lengths		Standard Unit Weight		Conductor (Stranding) Diameter Nom. DCR	Nominal Conductor OD		Shielding Material Nom. DCR	Nominal OD		Application
			ft.	m	lbs.	kg		AWG	Section mm <sup>2</sup>		inch	mm	

**180°C • 18 - 14 AWG • Stranded Tinned Copper Wire**

**Silicone Halogen-Free Insulation** (Color Code: see chart 11, Tech Info Section) • **Overall Red-Brown FRNC/LSNH Jacket**

IEC 60754-1  
VDE 0282  
Part 1

Unshielded

Industrial areas with increased temperature requirements, e.g.  
 - Mechanical engineering  
 - Traffic technology  
 - Lighting industry  
 - Sauna and solarium  
 - Glass and ceramic fabrication  
 - Steel and iron fabrication

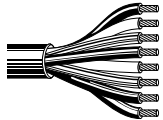

Also available on request with Bare Copper conductor for 135°C.

<b>HMC0040</b>	2	1640	500	55.1	25.0	(24x0.20) TC	18	0.75	0.240	6.10
<b>HMC0041</b>	3	1640	500	68.3	31.0	(24x0.20) TC	18	0.75	0.260	6.60
<b>HMC0042</b>	4	1640	500	79.4	36.0	(24x0.20) TC	18	0.75	0.283	7.20
<b>HMC0043</b>	5	1640	500	108.0	49.0	(24x0.20) TC	18	0.75	0.319	8.10
<b>HMC0044</b>	2	1640	500	70.5	32.0	(32x0.20) TC	17	1.00	0.260	6.60
<b>HMC0045</b>	3	1640	500	80.5	36.5	(32x0.20) TC	17	1.00	0.276	7.00
<b>HMC0046</b>	4	1640	500	97.0	44.0	(32x0.20) TC	17	1.00	0.299	7.60
<b>HMC0047</b>	5	1640	500	115.7	52.5	(32x0.20) TC	17	1.00	0.335	8.50
<b>HMC0048</b>	2	1640	500	92.6	42.0	(30x0.25) TC	16	1.50	0.307	7.80
<b>HMC0049</b>	3	1640	500	111.3	50.5	(30x0.25) TC	16	1.50	0.323	8.20
<b>HMC0050</b>	4	1640	500	138.9	63.0	(30x0.25) TC	16	1.50	0.358	9.10
<b>HMC0051</b>	5	1640	500	173.1	78.5	(30x0.25) TC	16	1.50	0.394	10.00
<b>HMC0052</b>	2	1640	500	136.7	62.0	(50x0.25) TC	14	2.50	0.362	9.20
<b>HMC0053</b>	3	1640	500	173.1	78.5	(50x0.25) TC	14	2.50	0.382	9.70
<b>HMC0054</b>	4	1640	500	216.1	98.0	(50x0.25) TC	14	2.50	0.425	10.80
<b>HMC0055</b>	5	1640	500	262.3	119.0	(50x0.25) TC	14	2.50	0.472	12.0

TC = Tinned Copper • DCR = DC resistance

# Silicone Rubber

## Multicore Cables

300/500V, 180°C, peak temp 250°C

De- scription	Part No.	No. of Cond. (CDR)	Standard Lengths		Standard Unit Weight		Conductor (Stranding) Diameter Nom. DCR	Nominal Conductor OD		Shielding Material Nom. DCR	Nominal OD		Application
			ft.	m	lbs.	kg		AWG	Section mm <sup>2</sup>		inch	mm	

**180°C • 18 - 14 AWG • Stranded Tinned Copper Wire**

**Silicone Halogen-Free Insulation** (Color Code: see chart 11, Tech Info Section) • **Overall Red-Brown FRNC/LSNH Jacket**

IEC 60754-1  
VDE 0282  
Part 1

Unshielded

Industrial areas with increased temperature requirements and VDE-approval, e.g.  
 - Mechanical engineering  
 - Traffic technology  
 - Lighting industry  
 - Sauna and solarium  
 - Glass and ceramic fabrication  
 - Steel and iron fabrication

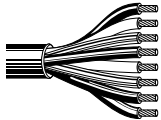

HMC0056	6	1640	500	122.4	55.5	(24x0.20) TC	18	0.75	0.343	8.70
HMC0057	7	1640	500	124.6	56.5	(24x0.20) TC	18	0.75	0.343	8.70
HMC0058	8	1640	500	145.5	66.0	(24x0.20) TC	18	0.75	0.378	9.60
HMC0059	10	1640	500	178.6	81.0	(24x0.20) TC	18	0.75	0.429	10.90
HMC0060	12	1640	500	203.9	92.5	(24x0.20) TC	18	0.75	0.449	11.40
HMC0061	14	1640	500	239.2	108.5	(24x0.20) TC	18	0.75	0.492	12.50
HMC0062	16	1640	500	273.4	124.0	(24x0.20) TC	18	0.75	0.520	13.20
HMC0063	18	1640	500	309.7	140.5	(24x0.20) TC	18	0.75	0.555	14.10
HMC0064	20	1640	500	325.2	147.5	(24x0.20) TC	18	0.75	0.571	14.50
HMC0065	24	1640	500	390.2	177.0	(24x0.20) TC	18	0.75	0.634	16.10
HMC0066	25	1640	500	425.5	193.0	(24x0.20) TC	18	0.75	0.673	17.10
HMC0067	6	1640	500	143.3	65.0	(32x0.20) TC	17	1.00	0.374	9.50
HMC0068	7	1640	500	157.6	71.5	(32x0.20) TC	17	1.00	0.374	9.50
HMC0069	8	1640	500	176.4	80.0	(32x0.20) TC	17	1.00	0.402	10.20
HMC0070	10	1640	500	216.1	98.0	(32x0.20) TC	17	1.00	0.457	11.60
HMC0071	12	1640	500	246.9	112.0	(32x0.20) TC	17	1.00	0.484	12.30
HMC0072	14	1640	500	288.8	131.0	(32x0.20) TC	17	1.00	0.531	13.50
HMC0073	16	1640	500	329.6	149.5	(32x0.20) TC	17	1.00	0.559	14.20
HMC0074	18	1640	500	374.8	170.0	(32x0.20) TC	17	1.00	0.598	15.20
HMC0075	20	1640	500	396.8	180.0	(32x0.20) TC	17	1.00	0.614	15.60
HMC0076	24	1640	500	472.9	214.5	(32x0.20) TC	17	1.00	0.681	17.30
HMC0077	25	1640	500	503.8	228.5	(32x0.20) TC	17	1.00	0.724	18.40
HMC0078	6	1640	500	201.7	91.5	(30x0.25) TC	16	1.50	0.437	11.10
HMC0079	7	1640	500	211.6	96.0	(30x0.25) TC	16	1.50	0.437	11.10
HMC0080	8	1640	500	251.3	114.0	(30x0.25) TC	16	1.50	0.480	12.20
HMC0081	10	1640	500	307.5	139.5	(30x0.25) TC	16	1.50	0.543	13.80
HMC0082	12	1640	500	354.9	161.0	(30x0.25) TC	16	1.50	0.567	14.40
HMC0083	14	1640	500	407.9	185.0	(30x0.25) TC	16	1.50	0.618	15.70
HMC0084	16	1640	500	466.3	211.5	(30x0.25) TC	16	1.50	0.661	16.80
HMC0085	18	1640	500	511.5	232.0	(30x0.25) TC	16	1.50	0.697	17.70

TC = Tinned Copper • DCR = DC resistance

### Silicone Rubber

#### Multicore Cables

300/500V, 180°C, peak temp 250°C

De- scription	Part No.	No. of Cond. (CDR)	Standard Lengths		Standard Unit Weight		Conductor (Stranding) Diameter Nom. DCR	Nominal Conductor OD		Shielding Material Nom. DCR	Nominal OD		Application
			ft.	m	lbs.	kg		AWG	Section mm <sup>2</sup>		inch	mm	

**180°C • 18 - 14 AWG • Stranded Tinned Copper Wire (continued)**

**Silicone Halogen-Free Insulation (Color Code: see chart 11, Tech Info Section) • Overall Red-Brown FRNC/LSNH Jacket**

IEC 60754-1  
VDE 0282  
Part 1

Unshielded

Industrial areas with increased temperature requirements and VDE-approval, e.g.  
 - Mechanical engineering  
 - Traffic technology  
 - Lighting industry  
 - Sauna and solarium  
 - Glass and ceramic fabrication  
 - Steel and iron fabrication

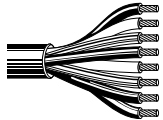

HMC0086	20	1640	500	565.5	256.5	(30x0.25) TC	16	1.50	0.724	18.40
HMC0087	24	1640	500	677.9	307.5	(30x0.25) TC	16	1.50	0.803	20.40
HMC0088	25	1640	500	720.9	327.0	(30x0.25) TC	16	1.50	0.850	21.60
HMC0089	6	1640	500	307.5	139.5	(50x0.25) TC	14	2.50	0.516	13.10
HMC0090	7	1640	500	319.7	145.0	(50x0.25) TC	14	2.50	0.516	13.10
HMC0091	8	1640	500	375.9	170.5	(50x0.25) TC	14	2.50	0.567	14.40
HMC0092	10	1640	500	458.6	208.0	(50x0.25) TC	14	2.50	0.642	16.30
HMC0093	12	1640	500	544.5	247.0	(50x0.25) TC	14	2.50	0.677	17.20
HMC0094	14	1640	500	621.7	282.0	(50x0.25) TC	14	2.50	0.740	18.80
HMC0095	16	1640	500	703.3	319.0	(50x0.25) TC	14	2.50	0.791	20.10
HMC0096	18	1640	500	736.3	334.0	(50x0.25) TC	14	2.50	0.831	21.10
HMC0097	20	1640	500	867.5	393.5	(50x0.25) TC	14	2.50	0.862	21.90
HMC0098	24	1640	500	1031.8	468.0	(50x0.25) TC	14	2.50	0.957	24.30
HMC0099	25	1640	500	1069.2	485.0	(50x0.25) TC	14	2.50	1.016	25.80

TC = Tinned Copper • DCR = DC resistance



### Silicone Rubber (H05SS-F)

Multicore Cables

300/500V, 180°C, peak temp 250°C

De- scription	Part No.	No. of Cond. (CDR)	Standard Lengths		Standard Unit Weight		Conductor (Stranding) Diameter Nom. DCR	Nominal Conductor OD		Shielding Material Nom. DCR	Nominal OD		Application
			ft.	m	lbs.	kg		AWG	Section mm <sup>2</sup>		inch	mm	

**180°C • 18 - 10 AWG • Stranded Tinned Copper Wire**

**Silicone Halogen-Free Insulation** (Color Code: see chart 11, Tech Info Section) • **Overall Red-Brown FRNC/LSNH Jacket**

IEC 60754-1  
VDE 0282  
Part 15

Unshielded

Industrial areas with increased temperature requirements and VDE-approval, e.g.  
 - Mechanical engineering  
 - Traffic technology  
 - Lighting industry  
 - Sauna and solarium  
 - Glass and ceramic fabrication  
 - Steel and iron fabrication

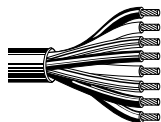

HMC0100	2	1640	500	55.1	25.0	(24x0.20) TC	18	0.75	0.240	6.10
HMC0101	3	1640	500	68.3	31.0	(24x0.20) TC	18	0.75	0.260	6.60
HMC0102	4	1640	500	79.4	36.0	(24x0.20) TC	18	0.75	0.283	7.20
HMC0103	5	1640	500	108.0	49.0	(24x0.20) TC	18	0.75	0.319	8.10
HMC0104	2	1640	500	70.5	32.0	(32x0.20) TC	17	1.00	0.260	6.60
HMC0105	3	1640	500	80.5	36.5	(32x0.20) TC	17	1.00	0.276	7.00
HMC0106	4	1640	500	97.0	44.0	(32x0.20) TC	17	1.00	0.299	7.60
HMC0107	5	1640	500	115.7	52.5	(32x0.20) TC	17	1.00	0.335	8.50
HMC0108	2	1640	500	92.6	42.0	(30x0.25) TC	16	1.50	0.323	8.20
HMC0109	3	1640	500	111.3	50.5	(30x0.25) TC	16	1.50	0.343	8.70
HMC0110	4	1640	500	138.9	63.0	(30x0.25) TC	16	1.50	0.378	9.60
HMC0111	5	1640	500	173.1	78.5	(30x0.25) TC	16	1.50	0.413	10.50
HMC0112	2	1640	500	136.7	62.0	(50x0.25) TC	14	2.50	0.378	9.60
HMC0113	3	1640	500	173.1	78.5	(50x0.25) TC	14	2.50	0.402	10.20
HMC0114	4	1640	500	216.1	98.0	(50x0.25) TC	14	2.50	0.445	11.30
HMC0115	5	1640	500	262.3	119.0	(50x0.25) TC	14	2.50	0.496	12.60
HMC0116	3	1640	500	248.0	112.5	(56x0.30) TC	12	4	0.469	11.90
HMC0117	4	1640	500	319.7	145.0	(56x0.30) TC	12	4	0.520	13.20
HMC0118	3	1640	500	336.2	152.5	(84x0.30) TC	10	6	0.535	13.60
HMC0119	4	1640	500	418.9	190.0	(84x0.30) TC	10	6	0.591	15.00

TC = Tinned Copper • DCR = DC resistance

### Silicone Rubber – Steel Wire Braid (SWB)

Multicore Cables

300/500V, 180°C, peak temp 250°C

De- scription	Part No.	No. of Cond. (CDR)	Standard Lengths		Standard Unit Weight		Conductor (Stranding) Diameter Nom. DCR	Nominal Conductor OD		Shielding Material Nom. DCR	Nominal OD		Application
			ft.	m	lbs.	kg		AWG	Section mm <sup>2</sup>		inch	mm	

**180°C • 18 - 4/0 AWG • Stranded Tinned Copper Wire**

**Silicone Halogen-Free Insulation (Color Code: see chart 11, Tech Info Section) • Glass Fiber Tape • Overall Red-Brown FRNC/LSNH Jacket • SWB**

IEC 60754-1  
VDE 0282  
Part 1

Overall  
Glass Fiber Foil

Industrial areas with increased temperature and mechanical requirements, e.g.  
- Mechanical engineering  
- Glass and ceramic fabrication  
- Steel and iron fabrication

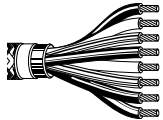

HMC0120	2	1640	500	97.0	44.0	(24x0.20) TC	18	0.75	0.283	7.20
HMC0121	3	1640	500	109.1	49.5	(24x0.20) TC	18	0.75	0.299	7.60
HMC0122	4	1640	500	133.4	60.5	(24x0.20) TC	18	0.75	0.319	8.10
HMC0123	5	1640	500	162.0	73.5	(24x0.20) TC	18	0.75	0.362	9.20
HMC0124	6	1640	500	186.3	84.5	(24x0.20) TC	18	0.75	0.390	9.90
HMC0125	7	1640	500	196.2	89.0	(24x0.20) TC	18	0.75	0.390	9.90
HMC0126	2	1640	500	108.0	49.0	(32x0.20) TC	17	1.00	0.299	7.60
HMC0127	3	1640	500	131.2	59.5	(32x0.20) TC	17	1.00	0.315	8.00
HMC0128	4	1640	500	153.2	69.5	(32x0.20) TC	17	1.00	0.346	8.80
HMC0129	5	1640	500	184.1	83.5	(32x0.20) TC	17	1.00	0.382	9.70
HMC0130	6	1640	500	203.9	92.5	(32x0.20) TC	17	1.00	0.409	10.40
HMC0131	7	1640	500	213.8	97.0	(32x0.20) TC	17	1.00	0.409	10.40
HMC0132	2	1640	500	138.9	63.0	(30x0.25) TC	16	1.50	0.327	8.30
HMC0133	3	1640	500	157.6	71.5	(30x0.25) TC	16	1.50	0.343	8.70
HMC0134	4	1640	500	187.4	85.0	(30x0.25) TC	16	1.50	0.378	9.60
HMC0135	5	1640	500	218.3	99.0	(30x0.25) TC	16	1.50	0.409	10.40
HMC0136	6	1640	500	270.1	122.5	(30x0.25) TC	16	1.50	0.449	11.40
HMC0137	7	1640	500	282.2	128.0	(30x0.25) TC	16	1.50	0.449	11.40
HMC0138	8	1640	500	347.2	157.5	(30x0.25) TC	16	1.50	0.500	12.70
HMC0139	10	1640	500	407.9	185.0	(30x0.25) TC	16	1.50	0.551	14.00
HMC0140	12	1640	500	449.7	204.0	(30x0.25) TC	16	1.50	0.571	14.50
HMC0141	14	1640	500	519.2	235.5	(30x0.25) TC	16	1.50	0.614	15.60
HMC0142	16	1640	500	596.3	270.5	(30x0.25) TC	16	1.50	0.669	17.00
HMC0143	18	1640	500	660.3	299.5	(30x0.25) TC	16	1.50	0.701	17.80
HMC0144	20	1640	500	694.4	315.0	(30x0.25) TC	16	1.50	0.720	18.30
HMC0145	24	1640	500	837.7	380.0	(30x0.25) TC	16	1.50	0.803	20.40
HMC0146	2	1640	500	181.9	82.5	(50x0.25) TC	14	2.50	0.382	9.70
HMC0147	3	1640	500	262.3	119.0	(50x0.25) TC	14	2.50	0.402	10.20
HMC0148	4	1640	500	295.4	134.0	(50x0.25) TC	14	2.50	0.453	11.50

TC = Tinned Copper • DCR = DC resistance

### Silicone Rubber – Steel Wire Braid (SWB)

Multicore Cables

300/500V, 180°C, peak temp 250°C

De- scription	Part No.	No. of Cond. (CDR)	Standard Lengths		Standard Unit Weight		Conductor (Stranding) Diameter Nom. DCR	Nominal Conductor OD		Shielding Material Nom. DCR	Nominal OD		Application
			ft.	m	lbs.	kg		AWG	Section mm <sup>2</sup>		inch	mm	

**180°C • 18 - 4/0 AWG • Stranded Tinned Copper Wire (continued)**

**Silicone Halogen-Free Insulation** (Color Code: see chart 11, Tech Info Section) • **Glass Fiber Tape** • **Overall Red-Brown FRNC/LSNH Jacket** • **SWB**

IEC 60754-1  
VDE 0282  
Part 1

Overall  
Glass Fiber Foil

Industrial areas with increased temperature and mechanical requirements, e.g.  
- Mechanical engineering  
- Glass and ceramic fabrication  
- Steel and iron fabrication

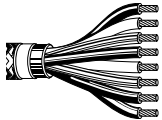

HMC0149	5	1640	500	347.2	157.5	(50x0.25) TC	14	2.50	0.500	12.70
HMC0150	6	1640	500	407.9	185.0	(50x0.25) TC	14	2.50	0.539	13.70
HMC0151	7	1640	500	424.4	192.5	(50x0.25) TC	14	2.50	0.539	13.70
HMC0152	12	1640	500	670.2	304.0	(50x0.25) TC	14	2.50	0.693	17.60
HMC0153	2	1640	500	281.1	127.5	(56x0.30) TC	12	4	0.453	11.50
HMC0154	3	1640	500	329.6	149.5	(56x0.30) TC	12	4	0.480	12.20
HMC0155	4	1640	500	402.3	182.5	(56x0.30) TC	12	4	0.528	13.40
HMC0156	5	1640	500	501.5	227.5	(56x0.30) TC	12	4	0.594	15.10
HMC0157	6	1640	500	578.7	262.5	(56x0.30) TC	12	4	0.646	16.40
HMC0158	7	1640	500	612.9	278.0	(56x0.30) TC	12	4	0.646	16.40
HMC0159	2	1640	500	359.3	163.0	(84x0.30) TC	10	6	0.508	12.90
HMC0160	3	1640	500	442.0	200.5	(84x0.30) TC	10	6	0.539	13.70
HMC0161	4	1640	500	534.6	242.5	(84x0.30) TC	10	6	0.583	14.80
HMC0162	5	1640	500	663.6	301.0	(84x0.30) TC	10	6	0.661	16.80
HMC0163	6	1640	500	772.7	350.5	(84x0.30) TC	10	6	0.717	18.20
HMC0164	7	1640	500	811.3	368.0	(84x0.30) TC	10	6	0.717	18.20
HMC0165	2	1640	500	598.5	271.5	(80x0.40) TC	8	10	0.681	17.30
HMC0166	3	1640	500	718.7	326.0	(80x0.40) TC	8	10	0.724	18.40
HMC0167	4	1640	500	909.4	412.5	(80x0.40) TC	8	10	0.811	20.60
HMC0168	5	1640	500	1088.0	493.5	(80x0.40) TC	8	10	0.886	22.50
HMC0169	2	1640	500	824.5	374.0	(128x0.40) TC	6	16	0.795	20.20
HMC0170	3	1640	500	1002.0	454.5	(128x0.40) TC	6	16	0.846	21.50
HMC0171	4	1640	500	1304.0	591.5	(128x0.40) TC	6	16	0.921	23.40
HMC0172	5	1640	500	1535.5	696.5	(128x0.40) TC	6	16	1.031	26.20
HMC0173	2	1640	500	1153.0	523.0	(200x0.40) TC	4	25	0.937	23.80
HMC0174	3	1640	500	1484.8	673.5	(200x0.40) TC	4	25	1.024	26.00
HMC0175	4	1640	500	1849.7	839.0	(200x0.40) TC	4	25	1.114	28.30
HMC0176	2	1640	500	1519.0	689.0	(280x0.40) TC	2	35	1.071	27.20
HMC0177	3	1640	500	2034.8	923.0	(280x0.40) TC	2	35	1.142	29.00

TC = Tinned Copper • DCR = DC resistance

### Silicone Rubber – Steel Wire Braid (SWB)

Multicore Cables

300/500V, 180°C, peak temp 250°C

De- scription	Part No.	No. of Cond. (CDR)	Standard Lengths		Standard Unit Weight		Conductor (Stranding) Diameter Nom. DCR	Nominal Conductor OD		Shielding Material Nom. DCR	Nominal OD		Application
			ft.	m	lbs.	kg		AWG	Section mm <sup>2</sup>		inch	mm	

**180°C • 18 - 4/0 AWG • Stranded Tinned Copper Wire (continued)**

**Silicone Halogen-Free Insulation (Color Code: see chart 11, Tech Info Section) • Glass Fiber Tape • Overall Red-Brown FRNC/LSNH Jacket • SWB**

IEC 60754-1  
VDE 0282  
Part 1

Overall  
Glass Fiber Foil

Industrial areas with increased temperature and mechanical requirements, e.g.  
- Mechanical engineering  
- Glass and ceramic fabrication  
- Steel and iron fabrication

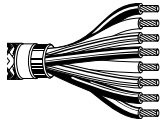

HMC0178	4	1640	500	2469.2	1120.0	(280x0.40) TC	2	35	1.272	32.30
HMC0179	2	1640	500	2060.2	934.5	(400x0.40) TC	1	50	1.236	31.40
HMC0180	3	1640	500	2627.9	1192.0	(400x0.40) TC	1	50	1.319	33.50
HMC0181	4	1640	500	2978.4	1351.0	(400x0.40) TC	1	50	1.465	37.20
HMC0182	2	1640	500	2735.9	1241.0	(356x0.50) TC	2/0	70	1.390	35.30
HMC0183	3	1640	500	3653.0	1657.0	(356x0.50) TC	2/0	70	1.508	38.30
HMC0184	4	1640	500	4490.8	2037.0	(356x0.50) TC	2/0	70	1.673	42.50
HMC0185	2	1640	500	3725.8	1690.0	(485x0.50) TC	3/0	95	1.630	41.40
HMC0186	3	1640	500	4738.8	2149.5	(485x0.50) TC	3/0	95	1.764	44.80
HMC0187	4	1640	500	5885.2	2669.5	(485x0.50) TC	3/0	95	1.961	49.80
HMC0188	3	1640	500	5816.8	2638.5	(614x0.50) TC	4/0	120	1.921	48.80
HMC0189	4	1640	500	7243.2	3285.5	(614x0.50) TC	4/0	120	2.130	54.10

TC = Tinned Copper • DCR = DC resistance

### Silicone Rubber – Overall Braid

Multicore Cables

300/500V, 180°C, peak temp 250°C

De- scription	Part No.	No. of Cond. (CDR)	Standard Lengths		Standard Unit Weight		Conductor (Stranding) Diameter Nom. DCR	Nominal Conductor OD		Shielding Material Nom. DCR	Nominal OD		Application
			ft.	m	lbs.	kg		AWG	Section mm <sup>2</sup>		inch	mm	

**180°C • 18 - 14 AWG • Stranded Tinned Copper Wire • Separator Foil • Overall Tinned Copper Braid**

**Silicone Halogen-Free Insulation** (Color Code: see chart 11, Tech Info Section) • **Overall Red-Brown FRNC/LSNH Jacket**

IEC 60754-1  
VDE 0282  
Part 1

Overall  
> 85% TC  
Braid

Industrial areas with increased temperature and mechanical requirements, e.g.  
- Mechanical engineering  
- Traffic technology  
- Lighting industry  
- Glass and ceramic fabrication  
- Steel and iron fabrication



HMC0190	2	1640	500	100.3	45.5	(24x0.20) TC	18	0.75	0.287	7.30
HMC0191	3	1640	500	120.2	54.5	(24x0.20) TC	18	0.75	0.299	7.60
HMC0192	4	1640	500	141.1	64.0	(24x0.20) TC	18	0.75	0.323	8.20
HMC0193	5	1640	500	170.9	77.5	(24x0.20) TC	18	0.75	0.350	8.90
HMC0194	7	1640	500	209.4	95.0	(24x0.20) TC	18	0.75	0.386	9.80
HMC0195	2	1640	500	114.6	52.0	(32x0.20) TC	17	1.00	0.315	8.00
HMC0196	3	1640	500	136.7	62.0	(32x0.20) TC	17	1.00	0.331	8.40
HMC0197	4	1640	500	157.6	71.5	(32x0.20) TC	17	1.00	0.354	9.00
HMC0198	5	1640	500	201.7	91.5	(32x0.20) TC	17	1.00	0.382	9.70
HMC0199	7	1640	500	264.6	120.0	(32x0.20) TC	17	1.00	0.421	10.70
HMC0200	2	1640	500	132.3	60.0	(30x0.25) TC	16	1.50	0.339	8.60
HMC0201	3	1640	500	159.8	72.5	(30x0.25) TC	16	1.50	0.354	9.00
HMC0202	4	1640	500	210.5	95.5	(30x0.25) TC	16	1.50	0.390	9.90
HMC0203	5	1640	500	246.9	112.0	(30x0.25) TC	16	1.50	0.421	10.70
HMC0204	7	1640	500	297.6	135.0	(30x0.25) TC	16	1.50	0.453	11.50
HMC0205	2	1640	500	192.9	87.5	(50x0.25) TC	14	2.50	0.394	10.00
HMC0206	3	1640	500	233.7	106.0	(50x0.25) TC	14	2.50	0.413	10.50
HMC0207	4	1640	500	288.8	131.0	(50x0.25) TC	14	2.50	0.445	11.30
HMC0208	5	1640	500	337.3	153.0	(50x0.25) TC	14	2.50	0.484	12.30
HMC0209	7	1640	500	451.9	205.0	(50x0.25) TC	14	2.50	0.547	13.90
HMC0210	2	1640	500	251.3	114.0	(56x0.30) TC	12	4	0.449	11.40
HMC0211	3	1640	500	318.6	144.5	(56x0.30) TC	12	4	0.472	12.00
HMC0212	4	1640	500	414.5	188.0	(56x0.30) TC	12	4	0.535	13.60
HMC0213	5	1640	500	482.8	219.0	(56x0.30) TC	12	4	0.583	14.80
HMC0214	7	1640	500	612.9	278.0	(56x0.30) TC	12	4	0.630	16.00

TC = Tinned Copper • DCR = DC resistance

# Silicone Rubber - Heavy Duty

Multicore Cables  
300/500V, 180°C

De- scription	Part No.	No. of Cond. (CDR)	Standard Lengths		Standard Unit Weight		Conductor (Stranding) Diameter Nom. DCR	Nominal Conductor OD		Shielding Material Nom. DCR	Nominal OD		Application
			ft.	m	lbs.	kg		AWG	Section mm <sup>2</sup>		inch	mm	

**180°C • 18 - 10 AWG • Stranded Tinned Copper Wire**

**Silicone Halogen-Free Insulation** (Color Code: see chart 11, Tech Info Section) • **Overall Black FRNC/LSNH Jacket**

IEC 60754-1  
VDE 0282  
Part 1

Unshielded

Industrial areas with increased temperature requirements, e.g.  
- Traffic technology  
- Power plant technology  
- Mechanical engineering  
- Steel and iron fabrication

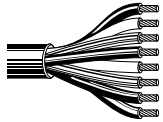

HMC0215	2	1640	500	115.7	52.5	(24x0.20) TC	18	0.75	0.374	9.50
HMC0216	3	1640	500	130.1	59.0	(24x0.20) TC	18	0.75	0.386	9.80
HMC0217	4	1640	500	148.8	67.5	(24x0.20) TC	18	0.75	0.409	10.40
HMC0218	5	1640	500	173.1	78.5	(24x0.20) TC	18	0.75	0.437	11.10
HMC0219	6	1640	500	198.4	90.0	(24x0.20) TC	18	0.75	0.461	11.70
HMC0220	7	1640	500	202.8	92.0	(24x0.20) TC	18	0.75	0.461	11.70
HMC0221	2	1640	500	127.9	58.0	(32x0.20) TC	17	1.00	0.386	9.80
HMC0222	3	1640	500	145.5	66.0	(32x0.20) TC	17	1.00	0.402	10.20
HMC0223	4	1640	500	167.5	76.0	(32x0.20) TC	17	1.00	0.425	10.80
HMC0224	5	1640	500	197.3	89.5	(32x0.20) TC	17	1.00	0.453	11.50
HMC0225	6	1640	500	224.9	102.0	(32x0.20) TC	17	1.00	0.484	12.30
HMC0226	7	1640	500	232.6	105.0	(32x0.20) TC	17	1.00	0.484	12.30
HMC0227	2	1640	500	157.6	71.5	(30x0.25) TC	16	1.50	0.425	10.80
HMC0228	3	1640	500	181.9	82.5	(30x0.25) TC	16	1.50	0.441	11.20
HMC0229	4	1640	500	211.6	96.0	(30x0.25) TC	16	1.50	0.469	11.90
HMC0230	5	1640	500	252.4	114.5	(30x0.25) TC	16	1.50	0.504	12.80
HMC0231	6	1640	500	276.7	125.5	(30x0.25) TC	16	1.50	0.539	13.70
HMC0232	7	1640	500	299.8	136.0	(30x0.25) TC	16	1.50	0.539	13.70
HMC0233	8	1640	500	340.6	154.5	(30x0.25) TC	16	1.50	0.575	14.60
HMC0234	10	1640	500	403.4	183.0	(30x0.25) TC	16	1.50	0.630	16.00
HMC0235	12	1640	500	453.0	205.5	(30x0.25) TC	16	1.50	0.654	16.60
HMC0236	14	1640	500	513.7	233.0	(30x0.25) TC	16	1.50	0.697	17.70
HMC0237	16	1640	500	573.2	260.0	(30x0.25) TC	16	1.50	0.732	18.60
HMC0238	18	1640	500	636.0	288.5	(30x0.25) TC	16	1.50	0.768	19.50
HMC0239	20	1640	500	679.0	308.0	(30x0.25) TC	16	1.50	0.787	20.00
HMC0240	24	1640	500	794.8	360.5	(30x0.25) TC	16	1.50	0.858	21.80
HMC0241	30	1640	500	951.3	431.5	(30x0.25) TC	16	1.50	0.925	23.50
HMC0242	2	1640	500	206.1	93.5	(50x0.25) TC	14	2.50	0.472	12.00
HMC0243	3	1640	500	243.6	110.5	(50x0.25) TC	14	2.50	0.492	12.50

TC = Tinned Copper • DCR = DC resistance

### Silicone Rubber – Heavy Duty

Multicore Cables  
300/500V, 180°C

De- scription	Part No.	No. of Cond. (CDR)	Standard Lengths		Standard Unit Weight		Conductor (Stranding) Diameter Nom. DCR	Nominal Conductor OD		Shielding Material Nom. DCR	Nominal OD		Application
			ft.	m	lbs.	kg		AWG	Section mm <sup>2</sup>		inch	mm	

**180°C • 18 - 10 AWG • Stranded Tinned Copper Wire (continued)**

**Silicone Halogen-Free Insulation** (Color Code: see chart 11, Tech Info Section) • **Overall Black FRNC/LSNH Jacket**

IEC 60754-1  
VDE 0282  
Part 1

Unshielded

Industrial areas with increased temperature requirements, e.g.  
- Traffic technology  
- Power plant technology  
- Mechanical engineering  
- Steel and iron fabrication

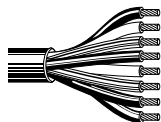

HMC0244	4	1640	500	287.7	130.5	(50x0.25) TC	14	2.50	0.528	13.40		
HMC0245	5	1640	500	343.9	156.0	(50x0.25) TC	14	2.50	0.567	14.40		
HMC0246	6	1640	500	401.2	182.0	(50x0.25) TC	14	2.50	0.610	15.50		
HMC0247	7	1640	500	421.1	191.0	(50x0.25) TC	14	2.50	0.610	15.50		
HMC0248	12	1640	500	658.1	298.5	(50x0.25) TC	14	2.50	0.748	19.00		
HMC0249	24	1640	500	1169.5	530.5	(50x0.25) TC	14	2.50	0.996	25.30		
HMC0250	30	1640	500	1352.5	613.5	(50x0.25) TC	14	2.50	1.083	27.50		
HMC0251	2	1640	500	263.4	119.5	(56x0.30) TC	12	4	0.512	13.00		
HMC0252	3	1640	500	317.5	144.0	(56x0.30) TC	12	4	0.535	13.60		
HMC0253	4	1640	500	381.4	173.0	(56x0.30) TC	12	4	0.575	14.60		
HMC0254	5	1640	500	465.2	211.0	(56x0.30) TC	12	4	0.622	15.80		
HMC0255	6	1640	500	539.0	244.5	(56x0.30) TC	12	4	0.669	17.00		
HMC0256	7	1640	500	571.0	259.0	(56x0.30) TC	12	4	0.669	17.00		
HMC0257	2	1640	500	334.0	151.5	(84x0.30) TC	10	6	0.559	14.20		
HMC0258	3	1640	500	409.0	185.5	(84x0.30) TC	10	6	0.587	14.90		
HMC0259	4	1640	500	494.9	224.5	(84x0.30) TC	10	6	0.634	16.10		
HMC0260	5	1640	500	610.7	277.0	(84x0.30) TC	10	6	0.685	17.40		
HMC0261	6	1640	500	713.2	323.5	(84x0.30) TC	10	6	0.740	18.80		
HMC0262	7	1640	500	751.8	341.0	(84x0.30) TC	10	6	0.740	18.80		

TC = Tinned Copper • DCR = DC resistance

# Silicone Rubber – Heavy Duty, Overall Braid

Multicore Cables  
300/500V, 180°C

De- scription	Part No.	No. of Cond. (CDR)	Standard Lengths		Standard Unit Weight		Conductor (Stranding) Diameter Nom. DCR	Nominal Conductor OD		Shielding Material Nom. DCR	Nominal OD		Application
			ft.	m	lbs.	kg		AWG	Section mm <sup>2</sup>		inch	mm	

**180°C • 18 - 10 AWG • Stranded Tinned Copper Wire • Glass Fiber Tape • Mica Tape • Overall Tinned Copper Braid**

**Silicone Halogen-Free Insulation** (Color Code: see chart 11, Tech Info Section) • **Overall Black FRNC/LSNH Jacket**

IEC 60754-1  
VDE 0282  
Part 1

Overall  
> 85% TC  
Braid

Industrial areas with increased temperature requirements, e.g.  
- Traffic technology  
- Power plant technology  
- Mechanical engineering  
- Steel and iron fabrication



HMC0263	2	1640	500	148.8	67.5	(24x0.20) TC	18	0.75	0.429	10.90
HMC0264	3	1640	500	166.4	75.5	(24x0.20) TC	18	0.75	0.445	11.30
HMC0265	4	1640	500	187.4	85.0	(24x0.20) TC	18	0.75	0.465	11.80
HMC0266	5	1640	500	212.7	96.5	(24x0.20) TC	18	0.75	0.492	12.50
HMC0267	6	1640	500	261.2	118.5	(24x0.20) TC	18	0.75	0.528	13.40
HMC0268	7	1640	500	266.8	121.0	(24x0.20) TC	18	0.75	0.528	13.40
HMC0269	2	1640	500	160.9	73.0	(32x0.20) TC	17	1.00	0.445	11.30
HMC0270	3	1640	500	180.8	82.0	(32x0.20) TC	17	1.00	0.461	11.70
HMC0271	4	1640	500	206.1	93.5	(32x0.20) TC	17	1.00	0.484	12.30
HMC0272	5	1640	500	241.4	109.5	(32x0.20) TC	17	1.00	0.520	13.20
HMC0273	6	1640	500	288.8	131.0	(32x0.20) TC	17	1.00	0.547	13.90
HMC0274	7	1640	500	296.5	134.5	(32x0.20) TC	17	1.00	0.547	13.90
HMC0275	2	1640	500	203.9	92.5	(30x0.25) TC	16	1.50	0.480	12.20
HMC0276	3	1640	500	249.1	113.0	(30x0.25) TC	16	1.50	0.508	12.90
HMC0277	4	1640	500	288.8	131.0	(30x0.25) TC	16	1.50	0.535	13.60
HMC0278	5	1640	500	334.0	151.5	(30x0.25) TC	16	1.50	0.567	14.40
HMC0279	6	1640	500	380.3	172.5	(30x0.25) TC	16	1.50	0.602	15.30
HMC0280	7	1640	500	392.4	178.0	(30x0.25) TC	16	1.50	0.602	15.30
HMC0281	8	1640	500	469.6	213.0	(30x0.25) TC	16	1.50	0.646	16.40
HMC0282	10	1640	500	533.5	242.0	(30x0.25) TC	16	1.50	0.701	17.80
HMC0283	12	1640	500	607.4	275.5	(30x0.25) TC	16	1.50	0.724	18.40
HMC0284	14	1640	500	668.0	303.0	(30x0.25) TC	16	1.50	0.772	19.60
HMC0285	16	1640	500	737.4	334.5	(30x0.25) TC	16	1.50	0.803	20.40
HMC0286	18	1640	500	817.9	371.0	(30x0.25) TC	16	1.50	0.839	21.30
HMC0287	20	1640	500	864.2	392.0	(30x0.25) TC	16	1.50	0.858	21.80
HMC0288	24	1640	500	1029.5	467.0	(30x0.25) TC	16	1.50	0.929	23.60
HMC0289	30	1640	500	1209.2	548.5	(30x0.25) TC	16	1.50	1.000	25.40
HMC0290	2	1640	500	271.2	123.0	(50x0.25) TC	14	2.50	0.535	13.60
HMC0291	3	1640	500	316.4	143.5	(50x0.25) TC	14	2.50	0.559	14.20
HMC0292	4	1640	500	372.6	169.0	(50x0.25) TC	14	2.50	0.594	15.10
HMC0293	5	1640	500	466.3	211.5	(50x0.25) TC	14	2.50	0.642	16.30

TC = Tinned Copper • DCR = DC resistance



### Silicone Rubber – Heavy Duty, Overall Braid

Multicore Cables  
300/500V, 180°C

De- scription	Part No.	No. of Cond. (CDR)	Standard Lengths		Standard Unit Weight		Conductor (Stranding) Diameter Nom. DCR	Nominal Conductor OD		Shielding Material Nom. DCR	Nominal OD		Application
			ft.	m	lbs.	kg		AWG	Section mm <sup>2</sup>		inch	mm	

**180°C • 18 - 10 AWG • Stranded Tinned Copper Wire • Glass Fiber Tape • Mica Tape • Overall Tinned Copper Braid (continued)**

**Silicone Halogen-Free Insulation** (Color Code: see chart 11, Tech Info Section) • **Overall Black FRNC/LSNH Jacket**

IEC 60754-1  
VDE 0282  
Part 1

Overall  
> 85% TC  
Braid

Industrial areas with increased temperature requirements, e.g.  
- Traffic technology  
- Power plant technology  
- Mechanical engineering  
- Steel and iron fabrication



HMC0294	6	1640	500	529.1	240.0	(50x0.25) TC	14	2.50	0.681	17.30
HMC0295	7	1640	500	548.9	249.0	(50x0.25) TC	14	2.50	0.681	17.30
HMC0296	12	1640	500	831.1	377.0	(50x0.25) TC	14	2.50	0.823	20.90
HMC0297	24	1640	500	1434.1	650.5	(50x0.25) TC	14	2.50	1.071	27.20
HMC0298	30	1640	500	1733.9	786.5	(50x0.25) TC	14	2.50	1.154	29.30
HMC0299	2	1640	500	306.4	139.0	(56x0.30) TC	12	4	0.575	14.60
HMC0300	3	1640	500	372.6	169.0	(56x0.30) TC	12	4	0.602	15.30
HMC0301	4	1640	500	471.8	214.0	(56x0.30) TC	12	4	0.650	16.50
HMC0302	5	1640	500	562.2	255.0	(56x0.30) TC	12	4	0.693	17.60
HMC0303	6	1640	500	640.4	290.5	(56x0.30) TC	12	4	0.740	18.80
HMC0304	7	1640	500	681.2	309.0	(56x0.30) TC	12	4	0.740	18.80
HMC0305	2	1640	500	402.3	182.5	(84x0.30) TC	10	6	0.630	16.00
HMC0306	3	1640	500	489.4	222.0	(84x0.30) TC	10	6	0.661	16.80
HMC0307	4	1640	500	585.3	265.5	(84x0.30) TC	10	6	0.705	17.90
HMC0308	5	1640	500	714.3	324.0	(84x0.30) TC	10	6	0.760	19.30
HMC0309	6	1640	500	827.8	375.5	(84x0.30) TC	10	6	0.811	20.60
HMC0310	7	1640	500	871.9	395.5	(84x0.30) TC	10	6	0.811	20.60

TC = Tinned Copper • DCR = DC resistance

**FEP**

Multicore Cables

600V, 200°C, peak temp 230°C

De- scription	Part No.	No. of Cond. (CDR)	Standard Lengths		Standard Unit Weight		Conductor (Stranding) Diameter Nom. DCR	Nominal Conductor OD		Shielding Material Nom. DCR	Nominal OD		Application
			ft.	m	lbs.	kg		AWG	Section mm <sup>2</sup>		inch	mm	

**205°C • 18 - 14 AWG • Stranded Silver-Plated Copper Wire**

**FEP Insulation** (Color Code: see chart 11, Tech Info Section) • **Overall Grey FEP Jacket**

Unshielded

Industrial areas with high temperature and increased mechanical stress, e.g.  
 - Instrumentation engineering  
 - Mechanical engineering  
 - Chemical industry  
 - Traffic and automotive  
 - Lighting industry

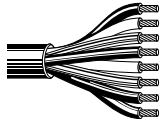

HMC0311	2	1640	500	34.2	15.5	(24x0.20) SPC	18	0.75	0.177	4.50
HMC0312	3	1640	500	46.3	21.0	(24x0.20) SPC	18	0.75	0.189	4.80
HMC0313	4	1640	500	63.9	29.0	(24x0.20) SPC	18	0.75	0.201	5.10
HMC0314	5	1640	500	82.7	37.5	(24x0.20) SPC	18	0.75	0.228	5.80
HMC0315	7	1640	500	101.4	46.0	(24x0.20) SPC	18	0.75	0.240	6.10
HMC0316	2	1640	500	41.9	19.0	(32x0.20) SPC	17	1.00	0.193	4.90
HMC0317	3	1640	500	59.5	27.0	(32x0.20) SPC	17	1.00	0.205	5.20
HMC0318	4	1640	500	77.2	35.0	(32x0.20) SPC	17	1.00	0.224	5.70
HMC0319	5	1640	500	97.0	44.0	(32x0.20) SPC	17	1.00	0.240	6.10
HMC0320	7	1640	500	131.2	59.5	(32x0.20) SPC	17	1.00	0.272	6.90
HMC0321	2	1640	500	58.4	26.5	(30x0.25) SPC	16	1.50	0.213	5.40
HMC0322	3	1640	500	79.4	36.0	(30x0.25) SPC	16	1.50	0.228	5.80
HMC0323	4	1640	500	100.3	45.5	(30x0.25) SPC	16	1.50	0.248	6.30
HMC0324	5	1640	500	129.0	58.5	(30x0.25) SPC	16	1.50	0.280	7.10
HMC0325	7	1640	500	169.8	77.0	(30x0.25) SPC	16	1.50	0.307	7.80
HMC0326	2	1640	500	97.0	44.0	(50x0.25) SPC	14	2.50	0.256	6.50
HMC0327	3	1640	500	125.7	57.0	(50x0.25) SPC	14	2.50	0.283	7.20
HMC0328	4	1640	500	162.0	73.5	(50x0.25) SPC	14	2.50	0.307	7.80
HMC0329	5	1640	500	198.4	90.0	(50x0.25) SPC	14	2.50	0.339	8.60
HMC0330	7	1640	500	267.9	121.5	(50x0.25) SPC	14	2.50	0.382	9.70

SPC = Silver-Plated Copper • DCR = DC resistance

### FEP – Overall Braid

Multicore Cables

600V, 200°C, peak temp 230°C

De- scription	Part No.	No. of Cond. (CDR)	Standard Lengths		Standard Unit Weight		Conductor (Stranding) Diameter Nom. DCR	Nominal Conductor OD		Shielding Material Nom. DCR	Nominal OD		Application
			ft.	m	lbs.	kg		AWG	Section mm <sup>2</sup>		inch	mm	

**205°C • 26 - 20 AWG • Stranded Silver-Plated Copper Wire • Separator Foil • Overall Tinned Copper Braid**

**FEP Insulation** (Color Code: see chart 11, Tech Info Section) • **Overall Grey FEP Jacket**



Overall  
> 85% TC  
Braid

Industrial areas with high temperature and increased mechanical stress, e.g.  
 - Instrumentation engineering  
 - Mechanical engineering  
 - Chemical industry  
 - Traffic and automotive  
 - Lighting industry

HMC0331	2	1640	500	27.6	12.5	(19x0.107) SPC	26	0.14	0.142	3.60	
HMC0332	3	1640	500	33.1	15.0	(19x0.107) SPC	26	0.14	0.150	3.80	
HMC0333	4	1640	500	38.6	17.5	(19x0.107) SPC	26	0.14	0.154	3.90	
HMC0334	5	1640	500	48.5	22.0	(19x0.107) SPC	26	0.14	0.173	4.40	
HMC0335	6	1640	500	56.2	25.5	(19x0.107) SPC	26	0.14	0.193	4.90	
HMC0336	7	1640	500	59.5	27.0	(19x0.107) SPC	26	0.14	0.193	4.90	
HMC0337	2	1640	500	33.1	15.0	(19x0.127) SPC	24	0.25	0.150	3.80	
HMC0338	3	1640	500	38.6	17.5	(19x0.127) SPC	24	0.25	0.157	4.00	
HMC0339	4	1640	500	43.0	19.5	(19x0.127) SPC	24	0.25	0.165	4.20	
HMC0340	5	1640	500	56.2	25.5	(19x0.127) SPC	24	0.25	0.189	4.80	
HMC0341	6	1640	500	60.6	27.5	(19x0.127) SPC	24	0.25	0.197	5.00	
HMC0342	7	1640	500	69.4	31.5	(19x0.127) SPC	24	0.25	0.197	5.00	
HMC0343	2	1640	500	39.7	18.0	(19x0.160) SPC	22	0.34	0.161	4.10	
HMC0344	3	1640	500	48.5	22.0	(19x0.160) SPC	22	0.34	0.169	4.30	
HMC0345	4	1640	500	59.5	27.0	(19x0.160) SPC	22	0.34	0.193	4.90	
HMC0346	5	1640	500	70.5	32.0	(19x0.160) SPC	22	0.34	0.209	5.30	
HMC0347	6	1640	500	79.4	36.0	(19x0.160) SPC	22	0.34	0.224	5.70	
HMC0348	7	1640	500	86.0	39.0	(19x0.160) SPC	22	0.34	0.224	5.70	
HMC0349	2	1640	500	48.5	22.0	(19x0.203) SPC	20	0.50	0.177	4.50	
HMC0350	3	1640	500	61.7	28.0	(19x0.203) SPC	20	0.50	0.193	4.90	
HMC0351	4	1640	500	81.6	37.0	(19x0.203) SPC	20	0.50	0.213	5.40	
HMC0352	5	1640	500	92.6	42.0	(19x0.203) SPC	20	0.50	0.228	5.80	
HMC0353	6	1640	500	108.0	49.0	(19x0.203) SPC	20	0.50	0.248	6.30	
HMC0354	7	1640	500	117.9	53.5	(19x0.203) SPC	20	0.50	0.248	6.30	

TC = Tinned Copper • SPC = Silver-Plated Copper • DCR = DC resistance

### Glass Fiber – Glass Braid

Multicore Cables  
300/300V, 350°C

De- scription	Part No.	No. of Cond. (CDR)	Standard Lengths		Standard Unit Weight		Conductor (Stranding) Diameter Nom. DCR	Nominal Conductor OD		Shielding Material Nom. DCR	Nominal OD		Application
			ft.	m	lbs.	kg		AWG	Section mm <sup>2</sup>		inch	mm	

**350°C • 24 - 12 AWG • Stranded Nickel-Plated Copper Wire • Separator Foil • Overall Silicone Impregnated Glass Fiber Braid**

**Glass Fiber Insulation** (Color Code: see chart 11, Tech Info Section)

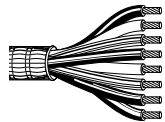

Overall  
Glass Fiber Braid

For wiring at high ambient temperature and increased mechanical stress, e.g.  
- Extrusion and drying installations  
- Electric heatings  
- Steel and iron fabrication  
- Glass and ceramic fabrication

HMC0355	2	1640	500	14.3	6.5	(7x0.20) NPC	24	0.22	0.098	2.50
HMC0356	3	1640	500	16.5	7.5	(7x0.20) NPC	24	0.22	0.106	2.70
HMC0357	4	1640	500	18.7	8.5	(7x0.20) NPC	24	0.22	0.114	2.90
HMC0358	2	1640	500	20.9	9.5	(7x0.25) NPC	22	0.34	0.118	3.00
HMC0359	3	1640	500	16.5	7.5	(7x0.25) NPC	22	0.34	0.130	3.30
HMC0360	4	1640	500	36.4	16.5	(7x0.25) NPC	22	0.34	0.138	3.50
HMC0361	2	1640	500	28.7	13.0	(16x0.20) NPC	20	0.50	0.138	3.50
HMC0362	3	1640	500	39.7	18.0	(16x0.20) NPC	20	0.50	0.146	3.70
HMC0363	4	1640	500	49.6	22.5	(16x0.20) NPC	20	0.50	0.157	4.00
HMC0364	2	1640	500	48.5	22.0	(24x0.20) NPC	18	0.75	0.201	5.10
HMC0365	3	1640	500	61.7	28.0	(24x0.20) NPC	18	0.75	0.220	5.60
HMC0366	4	1640	500	91.5	41.5	(24x0.20) NPC	18	0.75	0.240	6.10
HMC0367	2	1640	500	69.4	31.5	(32x0.20) NPC	17	1.00	0.220	5.60
HMC0368	3	1640	500	97.0	44.0	(32x0.20) NPC	17	1.00	0.236	6.00
HMC0369	4	1640	500	124.6	56.5	(32x0.20) NPC	17	1.00	0.256	6.50
HMC0370	2	1640	500	81.6	37.0	(30x0.25) NPC	16	1.50	0.252	6.40
HMC0371	3	1640	500	113.5	51.5	(30x0.25) NPC	16	1.50	0.268	6.80
HMC0372	4	1640	500	146.6	66.5	(30x0.25) NPC	16	1.50	0.291	7.40
HMC0373	2	1640	500	156.5	71.0	(50x0.25) NPC	14	2.50*	0.327	8.30
HMC0374	3	1640	500	189.6	86.0	(50x0.25) NPC	14	2.50*	0.402	10.20
HMC0375	4	1640	500	248.0	112.5	(50x0.25) NPC	14	2.50*	0.445	11.30
HMC0376	2	1640	500	202.8	92.0	(56x0.30) NPC	12	4*	0.437	11.10
HMC0377	3	1640	500	248.0	112.5	(56x0.30) NPC	12	4*	0.469	11.90
HMC0378	4	1640	500	341.7	155.0	(56x0.30) NPC	12	4*	0.520	13.20

NPC = Nickel-Plated Copper • DCR = DC resistance  
\* 300/500 Volt construction

### Glass Fiber – Glass Braid, Steel Wire Braid (SWB)

Multicore Cables  
300/300V, 350°C

De- scription	Part No.	No. of Cond. (CDR)	Standard Lengths		Standard Unit Weight		Conductor (Stranding) Diameter Nom. DCR	Nominal Conductor OD		Shielding Material Nom. DCR	Nominal OD		Application
			ft.	m	lbs.	kg		AWG	Section mm <sup>2</sup>		inch	mm	

**350°C • 24 - 12 AWG • Stranded NPC Wire • Impregnated Glass Fiber Shield • Separator Foil • Overall Silicone Impregnated Glass Fiber Braid**

**Glass Fiber Insulation** (Color Code: see chart 11, Tech Info Section) • **SWB**

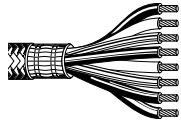

Overall  
Glass Fiber Braid

For wiring at high ambient temperature and increased mechanical stress, e.g.  
- Extrusion and drying installations  
- Electric heatings  
- Steel and iron fabrication  
- Glass and ceramic fabrication

HMC0379	2	1640	500	27.6	12.5	(7x0.20) NPC	24	0.22	0.130	3.30
HMC0380	3	1640	500	33.1	15.0	(7x0.20) NPC	24	0.22	0.138	3.50
HMC0381	4	1640	500	36.4	16.5	(7x0.20) NPC	24	0.22	0.150	3.80
HMC0382	2	1640	500	35.3	16.0	(7x0.25) NPC	22	0.34	0.146	3.70
HMC0383	3	1640	500	41.9	19.0	(7x0.25) NPC	22	0.34	0.154	3.90
HMC0384	4	1640	500	54.0	24.5	(7x0.25) NPC	22	0.34	0.165	4.20
HMC0385	2	1640	500	46.3	21.0	(16x0.20) NPC	20	0.50	0.165	4.20
HMC0386	3	1640	500	57.3	26.0	(16x0.20) NPC	20	0.50	0.173	4.40
HMC0387	4	1640	500	68.3	31.0	(16x0.20) NPC	20	0.50	0.189	4.80
HMC0388	2	1640	500	75.0	34.0	(24x0.20) NPC	18	0.75	0.228	5.80
HMC0389	3	1640	500	97.0	44.0	(24x0.20) NPC	18	0.75	0.248	6.30
HMC0390	4	1640	500	116.8	53.0	(24x0.20) NPC	18	0.75	0.268	6.80
HMC0391	2	1640	500	94.8	43.0	(32x0.20) NPC	17	1.00	0.248	6.30
HMC0392	3	1640	500	122.4	55.5	(32x0.20) NPC	17	1.00	0.264	6.70
HMC0393	4	1640	500	156.5	71.0	(32x0.20) NPC	17	1.00	0.283	7.20
HMC0394	2	1640	500	106.9	48.5	(30x0.25) NPC	16	1.50	0.280	7.10
HMC0395	3	1640	500	146.6	66.5	(30x0.25) NPC	16	1.50	0.295	7.50
HMC0396	4	1640	500	179.7	81.5	(30x0.25) NPC	16	1.50	0.319	8.10
HMC0397	2	1640	500	192.9	87.5	(50x0.25) NPC	14	2.50*	0.346	8.80
HMC0398	3	1640	500	234.8	106.5	(50x0.25) NPC	14	2.50*	0.429	10.90
HMC0399	4	1640	500	327.4	148.5	(50x0.25) NPC	14	2.50*	0.484	12.30
HMC0400	2	1640	500	278.9	126.5	(56x0.30) NPC	12	4*	0.476	12.10
HMC0401	3	1640	500	325.2	147.5	(56x0.30) NPC	12	4*	0.508	12.90
HMC0402	4	1640	500	434.3	197.0	(56x0.30) NPC	12	4*	0.559	14.20

NPC = Nickel-Plated Copper • DCR = DC resistance  
\* 300/500 Volt construction

### Mica – Ceramic Braid, Steel Wire Braid (SWB)

Multicore Cables

380V, 1250°C

De- scription	Part No.	No. of Cond. (CDR)	Standard Lengths		Standard Unit Weight		Conductor (Stranding) Diameter Nom. DCR	Nominal Conductor OD		Shielding Material Nom. DCR	Nominal OD		Application
			ft.	m	lbs.	kg		AWG	Section mm <sup>2</sup>		inch	mm	

**1250°C • 17 - 10 AWG • Stranded SA Wire • Impregnated Ceramic Fiber Shield • Mica Tape • Overall Impregnated Ceramic Fiber Braid**

**Mica Insulation** (Color Code: see chart 11, Tech Info Section) • **SWB**

Overall  
Ceramic Fiber Braid

For wiring at high ambient temperature and increased mechanical stress, e.g.  
- Glass and ceramic fabrication  
- Industrial furnaces  
- Electric heating systems

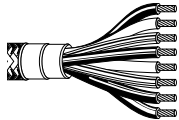

HMC0403	2	328	100	17.0	7.7	(32x0.20) SA	17	1.00	0.323	8.20
HMC0404	3	328	100	22.0	10.0	(32x0.20) SA	17	1.00	0.343	8.70
HMC0405	4	328	100	27.6	12.5	(32x0.20) SA	17	1.00	0.382	9.70
HMC0406	5	328	100	34.6	15.7	(32x0.20) SA	17	1.00	0.417	10.60
HMC0407	2	328	100	20.3	9.2	(30x0.25) SA	16	1.50	0.346	8.80
HMC0408	3	328	100	26.5	12.0	(30x0.25) SA	16	1.50	0.370	9.40
HMC0409	4	328	100	33.3	15.1	(30x0.25) SA	16	1.50	0.409	10.40
HMC0410	5	328	100	41.9	19.0	(30x0.25) SA	16	1.50	0.445	11.30
HMC0411	2	328	100	27.3	12.4	(50x0.25) SA	14	2.50	0.374	9.50
HMC0412	3	328	100	34.8	15.8	(50x0.25) SA	14	2.50	0.398	10.10
HMC0413	4	328	100	44.1	20.0	(50x0.25) SA	14	2.50	0.437	11.10
HMC0414	5	328	100	54.0	24.5	(50x0.25) SA	14	2.50	0.484	12.30
HMC0415	2	328	100	37.9	17.2	(56x0.30) SA	12	4	0.437	11.10
HMC0416	3	328	100	52.5	23.8	(56x0.30) SA	12	4	0.469	11.90
HMC0417	4	328	100	67.5	30.6	(56x0.30) SA	12	4	0.516	13.10
HMC0418	5	328	100	89.1	40.4	(56x0.30) SA	12	4	0.571	14.50
HMC0419	2	328	100	51.6	23.4	(84x0.30) SA	10	6	0.484	12.30
HMC0420	3	328	100	71.4	32.4	(84x0.30) SA	10	6	0.520	13.20
HMC0421	4	328	100	91.9	41.7	(84x0.30) SA	10	6	0.571	14.50
HMC0422	5	328	100	116.6	52.9	(84x0.30) SA	10	6	0.634	16.10

SA = Special Alloy • DCR = DC resistance

### Micaflame® – Glass Braid

Multicore Cables

300/500V, 1550°C short term, 300°C permanent

De- scription	Part No.	No. of Cond. (CDR)	Standard Lengths		Standard Unit Weight		Conductor (Stranding) Diameter Nom. DCR	Nominal Conductor OD		Shielding Material Nom. DCR	Nominal OD		Application
			ft.	m	lbs.	kg		AWG	Section mm <sup>2</sup>		inch	mm	

**1550°C • 17 - 10 AWG • Stranded Nickel-Plated Copper Wire • Glass Fiber Shield • Overall Impregnated Glass Fiber Braid**

**Micaflame® Insulation** (Color Code: see chart 11, Tech Info Section)

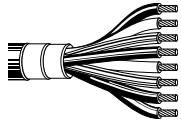

(Jacket optional)

Overall  
Glass Fiber Braid

For wiring at high ambient temperature and increased mechanical stress. These cables are fire resistant and offer at least 15 minutes insulation integrity in liquid steel or aluminium, e.g.  
 - Glass and ceramic fabrication  
 - Industrial furnaces  
 - Electric heating systems

HMC0423	2	328	100	23.4	10.6	(32x0.20) NPC	17	1.00	0.402	10.20
HMC0424	3	328	100	31.5	14.3	(32x0.20) NPC	17	1.00	0.433	11.00
HMC0425	4	328	100	39.9	18.1	(32x0.20) NPC	17	1.00	0.476	12.10
HMC0426	5	328	100	50.7	23.0	(32x0.20) NPC	17	1.00	0.524	13.30
HMC0427	2	328	100	26.7	12.1	(30x0.25) NPC	16	1.50	0.421	10.70
HMC0428	3	328	100	36.2	16.4	(30x0.25) NPC	16	1.50	0.453	11.50
HMC0429	4	328	100	45.9	20.8	(30x0.25) NPC	16	1.50	0.496	12.60
HMC0430	5	328	100	58.6	26.6	(30x0.25) NPC	16	1.50	0.551	14.00
HMC0431	2	328	100	33.1	15.0	(50x0.25) NPC	14	2.50	0.465	11.80
HMC0432	3	328	100	45.4	20.6	(50x0.25) NPC	14	2.50	0.492	12.50
HMC0433	4	328	100	58.4	26.5	(50x0.25) NPC	14	2.50	0.543	13.80
HMC0434	5	328	100	73.2	33.2	(50x0.25) NPC	14	2.50	0.606	15.40
HMC0435	2	328	100	41.4	18.8	(56x0.30) NPC	12	4	0.500	12.70
HMC0436	3	328	100	57.8	26.2	(56x0.30) NPC	12	4	0.535	13.60
HMC0437	4	328	100	74.3	33.7	(56x0.30) NPC	12	4	0.591	15.00
HMC0438	5	328	100	91.5	41.5	(56x0.30) NPC	12	4	0.654	16.60
HMC0439	2	328	100	52.5	23.8	(84x0.30) NPC	10	6	0.555	14.10
HMC0440	3	328	100	74.1	33.6	(84x0.30) NPC	10	6	0.594	15.10
HMC0441	4	328	100	98.8	44.8	(84x0.30) NPC	10	6	0.650	16.50
HMC0442	5	328	100	124.6	56.5	(84x0.30) NPC	10	6	0.728	18.50

NPC = Nickel-Plated Copper • DCR = DC resistance

**PVC LIY(ST)CY**  
 Multicore Cables  
 500V, 80°C

De- scription	Part No.	No. of Cond. (CDR)	Standard Lengths		Standard Unit Weight		Conductor (Stranding) Diameter Nom. DCR	Nominal Conductor OD		Shielding Material Nom. DCR	Nominal OD		Application
			ft.	m	lbs.	kg		AWG	Section mm <sup>2</sup>		inch	mm	

**80°C • 22 - 14 AWG • Stranded Bare Copper Wire • Overall Alufoil • >65% Overall Bare Copper Braid**

**PVC Insulation** (Color Code: see chart 11, Tech Info Section) • **Grey PVC Flame Retardant Jacket**

IEC 332

Overall  
Alufoil  
+ Overall  
65% BC Braid

- Survey and data transmission
- Check and drive systems
- Measure and monitor systems
- Interconnection of computer networks and outskirts interface



HMC0444	2	328	100	70.5	32.0	(11x0.193) BC	22	0.35	0.169	4.30
HMC0445	3	328	100	77.2	35.0	(11x0.193) BC	22	0.35	0.177	4.50
HMC0446	4	328	100	88.2	40.0	(11x0.193) BC	22	0.35	0.189	4.80
HMC0447	5	328	100	110.2	50.0	(11x0.193) BC	22	0.35	0.228	5.80
HMC0448	6	328	100	121.3	55.0	(11x0.193) BC	22	0.35	0.232	5.90
HMC0449	7	328	100	143.3	65.0	(11x0.193) BC	22	0.35	0.236	6.00
HMC0451	2	328	100	79.4	36.0	(16x0.193) BC	20	0.50	0.181	4.60
HMC0452	3	328	100	92.6	42.0	(16x0.193) BC	20	0.50	0.189	4.80
HMC0453	4	328	100	123.5	56.0	(16x0.193) BC	20	0.50	0.228	5.80
HMC0454	5	328	100	134.5	61.0	(16x0.193) BC	20	0.50	0.248	6.30
HMC0455	6	328	100	156.5	71.0	(16x0.193) BC	20	0.50	0.252	6.40
HMC0456	7	328	100	169.8	77.0	(16x0.193) BC	20	0.50	0.256	6.50
HMC0457	8	328	100	202.8	92.0	(16x0.193) BC	20	0.50	0.283	7.20
HMC0458	10	328	100	249.1	113.0	(16x0.193) BC	20	0.50	0.335	8.50
HMC0459	12	328	100	337.3	153.0	(16x0.193) BC	20	0.50	0.354	9.00
HMC0461	2	328	100	92.6	42.0	(22x0.193) BC	18	0.75	0.209	5.30
HMC0462	3	328	100	130.1	59.0	(22x0.193) BC	18	0.75	0.244	6.20
HMC0463	4	328	100	143.3	65.0	(22x0.193) BC	18	0.75	0.248	6.30
HMC0464	5	328	100	165.3	75.0	(22x0.193) BC	18	0.75	0.264	6.70
HMC0465	6	328	100	196.2	89.0	(22x0.193) BC	18	0.75	0.268	6.80
HMC0466	7	328	100	209.4	95.0	(22x0.193) BC	18	0.75	0.276	7.00
HMC0467	8	328	100	244.7	111.0	(22x0.193) BC	18	0.75	0.299	7.60
HMC0468	10	328	100	306.4	139.0	(22x0.193) BC	18	0.75	0.358	9.10
HMC0469	12	328	100	350.5	159.0	(22x0.193) BC	18	0.75	0.374	9.50
HMC0471	2	328	100	123.5	56.0	(20x0.243) BC	17	1.00	0.240	6.10
HMC0472	3	328	100	160.9	73.0	(20x0.243) BC	17	1.00	0.248	6.30
HMC0473	4	328	100	213.8	97.0	(20x0.243) BC	17	1.00	0.291	7.40
HMC0474	5	328	100	238.1	108.0	(20x0.243) BC	17	1.00	0.311	7.90
HMC0475	6	328	100	264.6	120.0	(20x0.243) BC	17	1.00	0.319	8.10
HMC0476	7	328	100	304.2	138.0	(20x0.243) BC	17	1.00	0.335	8.50
HMC0477	8	328	100	357.1	162.0	(20x0.243) BC	17	1.00	0.370	9.40

BC = Bare Copper • DCR = DC resistance



# PVC LiY(St)CY

Multicore Cables

500V, 80°C

De- scription	Part No.	No. of Cond. (CDR)	Standard Lengths		Standard Unit Weight		Conductor (Stranding) Diameter Nom. DCR	Nominal Conductor OD		Shielding Material Nom. DCR	Nominal OD		Application
			ft.	m	lbs.	kg		AWG	Section mm <sup>2</sup>		inch	mm	

80°C • 22 - 14 AWG • Stranded Bare Copper Wire • Overall Alufoil • >65 % Overall Bare Copper Braid (continued)

**PVC Insulation** (Color Code: see chart 11, Tech Info Section) • **Grey PVC Flame Retardant Jacket**

IEC 332

Overall  
Alufoil  
+ Overall  
65% BC Braid

- Survey and data transmission
- Check and drive systems
- Measure and monitor systems
- Interconnection of computer networks and outskirts interface



<b>HMC0479</b>	2	328	100	213.8	97.0	(28x0.245) BC	16	1.50	0.272	6.90	
<b>HMC0480</b>	3	328	100	213.8	97.0	(28x0.245) BC	16	1.50	0.280	7.10	
<b>HMC0481</b>	4	328	100	213.8	97.0	(28x0.245) BC	16	1.50	0.331	8.40	
<b>HMC0482</b>	5	328	100	213.8	97.0	(28x0.245) BC	16	1.50	0.362	9.20	
<b>HMC0483</b>	6	328	100	213.8	97.0	(28x0.245) BC	16	1.50	0.374	9.50	
<b>HMC0484</b>	3	328	100	213.8	97.0	(48x0.243) BC	14	2.50	0.319	8.10	
<b>HMC0485</b>	4	328	100	363.8	165.0	(48x0.243) BC	14	2.50	0.366	9.30	

BC = Bare Copper • DCR = DC resistance

**PVC LIY CY**  
 Multicore Cables  
 750V, 80°C

De- scription	Part No.	No. of Cond. (CDR)	Standard Lengths		Standard Unit Weight		Conductor (Stranding) Diameter Nom. DCR	Nominal Conductor OD		Shielding Material Nom. DCR	Nominal OD		Application
			ft.	m	lbs.	kg		AWG	Section mm <sup>2</sup>		inch	mm	

**80°C • 24 - 14 AWG • Stranded Bare or Tinned Copper Wire • >80% Overall Bare Copper Braid**

**PVC Insulation** (Color Code: see chart 11, Tech Info Section) • **Grey Oil Proof and Flame Retardant PVC Jacket**

IEC 332

+ Overall  
80% BC Braid

- Survey and data transmission
- Check and drive systems
- Measure and monitor systems
- Interconnection of computer networks and outskirts interface



HMC0486	1	328	100	33.1	15.0	(8x0.193) BC	24	0.25	0.118	3.00	
HMC0487	2	328	100	57.3	26.0	(8x0.193) BC	24	0.25	0.161	4.10	
HMC0488	3	328	100	70.5	32.0	(8x0.193) BC	24	0.25	0.173	4.40	
HMC0489	4	328	100	79.4	36.0	(8x0.193) BC	24	0.25	0.181	4.60	
HMC0490	5	328	100	103.6	47.0	(8x0.193) BC	24	0.25	0.217	5.50	
HMC0491	6	328	100	112.4	51.0	(8x0.193) BC	24	0.25	0.220	5.60	
HMC0492	7	328	100	127.9	58.0	(8x0.193) BC	24	0.25	0.228	5.80	
HMC0493	8	328	100	136.7	62.0	(8x0.193) BC	24	0.25	0.236	6.00	
HMC0494	1	328	100	37.5	17.0	(11x0.193) BC	22	0.35	0.122	3.10	
HMC0495	2	328	100	72.8	33.0	(11x0.193) BC	22	0.35	0.173	4.40	
HMC0496	3	328	100	79.4	36.0	(11x0.193) BC	22	0.35	0.181	4.60	
HMC0497	4	328	100	90.4	41.0	(11x0.193) BC	22	0.35	0.193	4.90	
HMC0498	5	328	100	114.6	52.0	(11x0.193) BC	22	0.35	0.232	5.90	
HMC0499	6	328	100	125.7	57.0	(11x0.193) BC	22	0.35	0.236	6.00	
HMC0500	7	328	100	149.9	68.0	(11x0.193) BC	22	0.35	0.240	6.10	
HMC0501	8	328	100	174.2	79.0	(11x0.193) BC	22	0.35	0.248	6.30	
HMC0502	1	328	100	39.7	18.0	(16x0.193) BC	20	0.50	0.126	3.20	
HMC0503	2	328	100	81.6	37.0	(16x0.193) BC	20	0.50	0.185	4.70	
HMC0504	3	328	100	94.8	43.0	(16x0.193) BC	20	0.50	0.193	4.90	
HMC0505	4	328	100	125.7	57.0	(16x0.193) BC	20	0.50	0.232	5.90	
HMC0506	5	328	100	136.7	62.0	(16x0.193) BC	20	0.50	0.252	6.40	
HMC0507	6	328	100	158.7	72.0	(16x0.193) BC	20	0.50	0.256	6.50	
HMC0508	7	328	100	172.0	78.0	(16x0.193) BC	20	0.50	0.260	6.60	
HMC0509	8	328	100	211.6	96.0	(16x0.193) BC	20	0.50	0.287	7.30	
HMC0510	10	328	100	251.3	114.0	(16x0.193) BC	20	0.50	0.339	8.60	
HMC0511	2	328	100	97.0	44.0	(22x0.193) BC	18	0.75	0.213	5.40	
HMC0512	3	328	100	130.1	59.0	(22x0.193) BC	18	0.75	0.248	6.30	
HMC0513	4	328	100	145.5	66.0	(22x0.193) BC	18	0.75	0.268	6.80	
HMC0514	2	328	100	125.7	57.0	(20x0.243) BC	17	1.00	0.244	6.20	
HMC0515	3	328	100	163.1	74.0	(20x0.243) BC	17	1.00	0.252	6.40	
HMC0516	4	328	100	216.1	98.0	(20x0.243) BC	17	1.00	0.295	7.50	
HMC0517	5	328	100	240.3	109.0	(20x0.243) BC	17	1.00	0.315	8.00	

BC = Bare Copper • DCR = DC resistance

### PVC LiY CY

Multicore Cables

750V, 80°C

De- scription	Part No.	No. of Cond. (CDR)	Standard Lengths		Standard Unit Weight		Conductor (Stranding) Diameter Nom. DCR	Nominal Conductor OD		Shielding Material Nom. DCR	Nominal OD		Application
			ft.	m	lbs.	kg		AWG	Section mm <sup>2</sup>		inch	mm	

**80°C • 24 - 14 AWG • Stranded Bare or Tinned Copper Wire • >80% Overall Bare Copper Braid (continued)**

**PVC Insulation (Color Code: see chart 11, Tech Info Section) • Grey Oil Proof and Flame Retardant PVC Jacket**

IEC 332

+ Overall  
80% BC Braid

- Survey and data transmission
- Check and drive systems
- Measure and monitor systems
- Interconnection of computer networks and outskirts interface



HMC0518	2	328	100	169.8	77.0	(28x0.245) BC	16	1.50	0.276	7.00	
HMC0519	3	328	100	207.2	94.0	(28x0.245) BC	16	1.50	0.287	7.30	
HMC0520	4	328	100	269.0	122.0	(28x0.245) BC	16	1.50	0.335	8.50	
HMC0521	5	328	100	363.8	165.0	(28x0.245) BC	16	1.50	0.386	9.80	
HMC0522	2	328	100	231.5	105.0	(48x0.243) BC	14	2.50	0.327	8.30	
HMC0523	3	328	100	319.7	145.0	(48x0.243) BC	14	2.50	0.339	8.60	

### PVC 07BQ-F

Multicore Cables

450/750V, 75°C

De- scription	Part No.	No. of Cond. (CDR)	Standard Lengths		Standard Unit Weight		Conductor (Stranding) Diameter Nom. DCR	Nominal Conductor OD		Shielding Material Nom. DCR	Nominal OD		Application
			ft.	m	lbs.	kg		AWG	Section mm <sup>2</sup>		Inch	mm	

**80°C • 17 - 14 AWG • Stranded Bare Copper Wire**

**PVC Insulation (Color Code: see chart 12, Tech Info Section) • Orange Oil Resistant PUR Jacket**

Unshielded

- Small electrottools
- For mobile tools, not for heavy duty

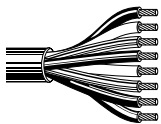

HMC0524	2	328	100	134.5	61.0	(20x0.243) BC	17	1.00	0.268	6.80	
HMC0525	3	328	100	154.3	70.0	(20x0.243) BC	17	1.00	0.272	6.90	
HMC0526	4	328	100	216.1	98.0	(20x0.243) BC	17	1.00	0.315	8.00	
HMC0527	2	328	100	176.4	80.0	(28x0.245) BC	16	1.50	0.299	7.60	
HMC0528	3	328	100	216.1	98.0	(28x0.245) BC	16	1.50	0.323	8.20	
HMC0529	4	328	100	297.6	135.0	(28x0.245) BC	16	1.50	0.366	9.30	
HMC0530	3	328	100	350.5	159.0	(48x0.243) BC	14	2.50	0.398	10.10	

BC = Bare Copper • DCR = DC resistance



# Paired Cables

# 5



## Table of Contents

<b>Paired Cables</b>	<b>Page No.</b>
<b>Introduction</b>	<b>5.2</b>
<b>Selection Guide: Shielded Multi-Pair Computer Cables</b>	<b>5.3</b>
<b>Unshielded</b>	<b>5.4 – 5.5</b>
Audio, Control and Instrumentation Cables	5.4 – 5.5
<b>Overall Beldfoil® Shield</b>	<b>5.6 – 5.11</b>
Cable Characteristics: Attenuation, Rise Time, Bit Rate	5.6
High-Temperature Control, Instrumentation Cables	5.7 – 5.8
Low-Capacitance Computer Cables	5.9
Audio, Control and Instrumentation Cables	5.10 – 5.11
<b>Overall Foil/Braid Shield</b>	<b>5.12 – 5.18</b>
Cable Characteristics: Attenuation, Rise Time, Bit Rate	5.12
Low-Capacitance Computer Cables	5.13 – 5.18
<b>Individually Shielded</b>	<b>5.19 – 5.23</b>
Cable Characteristics: Attenuation, Rise Time, Bit Rate	5.19
Low-Capacitance Computer Cables	5.20
Cable Characteristics: Attenuation, Rise Time, Bit Rate	5.21
Audio, Control and Instrumentation Cables	5.22 – 5.23
<b>Individually Shielded Pairs with Overall Foil/Braid Shield</b>	<b>5.24 – 5.25</b>
Cable Characteristics: Attenuation, Rise Time, Bit Rate	5.24
Low-Capacitance Computer Cables	5.25
<b>Overall Braid Shield</b>	<b>5.26</b>

## Introduction

### Pairing with Belden

Paired cables allow balanced signal transmission, which results in lower crosstalk through common mode rejection. Due to the improved noise immunity of twisted pairs, they generally permit higher data speeds than multi-conductor cables.

Partnership with Belden means solutions to problems with the right cables to provide the right performance for the right price.

### Key Applications

- Transmitters (single ended)
- Devices
- Multipoint networks
- High impedance drives
- Micro processor controls
- Converters
- Repeaters

### Special Features

- Belden paired cables are offered in many variations including plenum and high-temperature versions. Variations include:
  - Gage sizes
  - Dimensions
  - Insulation materials
  - Shielding configurations
  - Jacketing materials
- Paired cables packaging: Belden's unique UnReel® cable dispenser is available for many of the multi-conductor products listed in this section. The letter "U" before the specified put-up length denotes UnReel® packaging.
- Temperature versions to meet the technical requirements of many different types of systems.

### Availability

Most of our paired cables are available from stock. Many of these are available off the shelf from distributors. If you have a new or unusual application or you cannot find a multi-conductor cable in this catalog section that meets your technical requirements, see our U.S. Master Catalog or contact technical support at +31-77-3875-414 or [techsupport.venlo@belden.com](mailto:techsupport.venlo@belden.com).

### Introduction

## Selection Guide: Shielded Multi-Pair Computer Cables RS-232, RS-422, and RS-485 Applications\*

Specifications		Cable Series**													
		9804	8132	9829	8332	9501	8102	9729	8162	9680	8302	8777	9873	9773	
Conductor Size: (AWG)	28	✓	✓												
	24			✓	✓	✓	✓	✓	✓	✓					
	22										✓	✓			
	20												✓		
	18													✓	
Page No.		5.13	5.14	5.16	5.15	5.7	5.17	5.20	5.25	5.9	5.18	5.22	5.23	5.23	
Insulation:	S-R PVC				✓	✓					✓				
	Polyethylene			✓						✓			✓	✓	
	Polypropylene	✓										✓			
	Datalene®†		✓				✓	✓	✓						
Shield:	Overall Foil					✓				✓					
	Individual Foil							✓	✓			✓	✓	✓	
	Overall Foil/Braid	✓	✓	✓	✓		✓		✓		✓				
	Braid Coverage	90%	65%	65%	65%		65%		65%		65%				
Drain Wire:	(see key below)	●	●	●	×	●	●	▲	▲	●	×	▲	▲	▲	
No. of Pairs Available:	1					✓									
	2	✓	✓	✓	✓	✓	✓	✓	✓		✓				
	3	✓	✓	✓	✓	✓	✓	✓	✓	✓	✓	✓	✓	✓	
	4	✓	✓	✓	✓	✓	✓	✓	✓	✓	✓				
	5	✓	✓	✓	✓	✓	✓		✓		✓				
	6			✓	✓	✓	✓	✓	✓	✓	✓	✓	✓	✓	
	7	✓		✓	✓	✓	✓		✓		✓				
	8		✓			✓	✓		✓		✓				
	9	✓		✓		✓		✓		✓		✓	✓	✓	
	10			✓	✓	✓	✓		✓		✓				
	11							✓				✓	✓		
	12	✓		✓				✓				✓	✓	✓	
	12.5		✓		✓		✓			✓	✓				
	13	✓													
	15				✓	✓	✓	✓	✓		✓	✓	✓	✓	
	17							✓				✓			
	18	✓	✓	✓	✓		✓		✓		✓				
	19					✓		✓				✓			
	25	✓	✓	✓	✓	✓	✓		✓		✓				
	27							✓				✓			
31	✓														
37											✓				
50					✓										
Capacitance†† (pF/m)		50.8	36.1	50.8	98.4	98.4	41.0	41.0	41.0	50.8	114.8	98.4	98.4	98.4	

S-R = Semi-Rigid

\* Refer to specifications for recommendations.

\*\* All cables are UL-listed.

† Foam high density polyethylene.

†† Capacitance may vary on some cables.

Drain Wire Key:

● = Drain wire overall.

▲ = Drain wire each pair.

× = No drain wire.

# Unshielded

## Audio, Control and Instrumentation Cables

Description	Part No.	UL NEC / C(UL)CEC Type IEC	Standard Lengths		Standard Unit Weight		Conductor (Stranding) Diameter Nom. DCR	Nominal Insulation OD		Shielding Material Nom. DCR	Nominal OD		Color Code
			ft.	m	lbs.	kg		inch	mm		inch	mm	

**20 AWG • Stranded (7x28) 1.0 mm Tinned Copper • Twisted Pair**

**PVC Insulation • Chrome PVC Jacket**

300V RMS		NEC: CMG CEC: CMG FT4					0.96 mm 20 AWG (7x28) TC	0.064	1.62	Unshielded			see chart 3 (Tech Info Section)
----------	--	--------------------------------	--	--	--	--	--------------------------------	-------	------	------------	--	--	------------------------------------



<b>8205</b>	1-Pair	100	31	2.6	1.2						0.180	4.57		
		U-500	U-152	9.0	4.1									
		500	152	9.0	4.1									
		U-1000	U-305	18.1	8.2									
		1000	305	18.1	8.2									

300V 80°C UL AWM Style 2464	<b>9750</b>		3-Pair	500	152	26.5	12.0					0.299	7.59	
				1000	305	50.0	22.7							



<b>9751</b>	6-Pair	100	31	9.0	4.1							0.366	9.30	
		500	152	45.2	20.5									
		1000	305	89.3	40.5									

<b>9752</b>	9-Pair	100	31	13.0	5.9							0.429	10.90	
		500	152	65.7	29.8									
		1000	305	125.2	56.8									

<b>9755</b>	15-Pair	100	31	17.9	8.1							0.545	13.84	
		1000	305	194.4	88.2									

**18 AWG • Stranded (7x26) 1.2 mm Tinned Copper • Twisted Pair**

**PVC Insulation • Chrome PVC Jacket**

300V RMS	<b>8461</b>	NEC: CMG CEC: CMG FT4	100	31	3.1	1.4	1.22 mm 18 AWG (7x26) TC	0.092	2.34	Unshielded	0.234	5.94	Black, White
			U-500	U-152	14.1	6.4							
			500	152	13.4	6.1							
			U-1000	U-305	26.0	11.8							
			1000	305	26.9	12.2							



1-Pair

**18 AWG • Stranded (16x30) 1.2 mm Tinned Copper • Twisted Pair**

**PVC Insulation • Chrome PVC Jacket**

300V 80°C UL AWM Style 2464		NEC: CMG CEC: CMG FT4					1.20 mm 18 AWG (16x30) TC	0.076	1.92	Unshielded			see chart 3 (Tech Info Section)
--------------------------------	--	--------------------------------	--	--	--	--	---------------------------------	-------	------	------------	--	--	------------------------------------



<b>9740</b>	1-Pair	U-500	U-152	12.6	5.7							0.210	5.33	
		500	152	12.6	5.7									
		U-1000	U-305	24.0	10.9									
		1000	305	24.0	10.9									

For Plenum version of 9740, see 89740, 87740 or 82740.

<b>9156</b>	2-Pair	U-500	U-152	24.9	11.3							0.333	8.46	
		500	152	26.9	12.2									
		U-1000	U-305	48.9	22.2									
		1000	305	51.1	23.2									

TC = Tinned Copper • DCR = DC resistance

# Unshielded

## Audio, Control and Instrumentation Cables

De- scription	Part No.	UL NEC / C(UL)/CEC Type IEC	Standard Lengths		Standard Unit Weight		Conductor (Stranding) Diameter Nom. DCR	Nominal Insulation OD		Shielding Material Nom. DCR	Nominal OD		Color Code
			ft.	m	lbs.	kg		inch	mm		inch	mm	

**18 AWG • Stranded (16x30) 1.2 mm Tinned Copper • Twisted Pair (continued)**

**PVC Insulation • Chrome PVC Jacket**

300V 80°C UL AWM Style 2464	NEC: CMG CEC: CMG FT4						1.20 mm 18 AWG (16x30) TC	0.076	1.92	Unshielded			see chart 3 (Tech Info Section)
--------------------------------	--------------------------------	--	--	--	--	--	---------------------------------	-------	------	------------	--	--	------------------------------------



<b>8690</b>	3-Pair	100	31	7.1	3.2						0.347	8.81		
		U-500	U-152	32.6	14.8									
		500	152	34.0	15.4									
		1000	305	65.0	29.5									
<b>9157</b>	4-Pair	100	31	8.4	3.8						0.381	9.68		
		500	152	41.0	18.6									
		1000	305	83.1	37.7									
<b>9159</b>	5-Pair	500	152	50.0	22.7						0.391	9.93		
		1000	305	99.2	45.0									

**18 AWG • Stranded (19x30) 1.2 mm Tinned Copper • Twisted Pair**

**Plenum • FEP Insulation • Natural Flamarrest® Jacket**

300V RMS Non-conduit	<b>82740</b>	NEC: CMP CEC: CMP FT6	U-1000	U-305	17.0	7.7	1.24 mm 18 AWG (19x30) TC	0.061	1.54	Unshielded	0.147	3.73	Black, Red
-------------------------	--------------	--------------------------------	--------	-------	------	-----	---------------------------------	-------	------	------------	-------	------	------------



**16 AWG • Stranded (19x29) 1.5 mm Tinned Copper • Twisted Pair**

**PVC Insulation • Chrome PVC Jacket**

300V 60°C UL AWM Style 2598	<b>8471</b>	NEC: CMG CEC: CMG FT4	U-500	U-152	20.9	9.5	1.47 mm 16 AWG (19x29) TC	0.104	2.63	Unshielded	0.274	6.96	Black, White
--------------------------------	-------------	--------------------------------	-------	-------	------	-----	---------------------------------	-------	------	------------	-------	------	--------------



**14 AWG • Stranded (41x30) 1.9 mm Tinned Copper • Twisted Pair**

**PVC Insulation • Chrome PVC Jacket**

600V 90°C UL AWM Style 2587	<b>8473</b>	NEC: CL3 CEC: FAS 90 FT4	U-500	U-152	29.1	13.2	1.85 mm 14 AWG (41x30) TC	0.135	3.43	Unshielded	0.340	8.64	Black, White
--------------------------------	-------------	-----------------------------------	-------	-------	------	------	---------------------------------	-------	------	------------	-------	------	--------------



**12 AWG • Stranded (65x30) 2.4 mm Tinned Copper • Twisted Pair**

**PVC Insulation • Chrome PVC Jacket**

600V 90°C UL AWM Style 2587	<b>8477</b>	NEC: CL3R	U-500	U-152	41.4	18.8	2.41 mm 12 AWG (65x30) TC	0.159	4.03	Unshielded	0.386	9.80	Black, White
--------------------------------	-------------	--------------	-------	-------	------	------	---------------------------------	-------	------	------------	-------	------	--------------



TC = Tinned Copper • DCR = DC resistance  
† Spools are one piece, but length may vary ±10% from length shown.



# Overall Beldfoil® Shield

## Cable Characteristics

### Attenuation

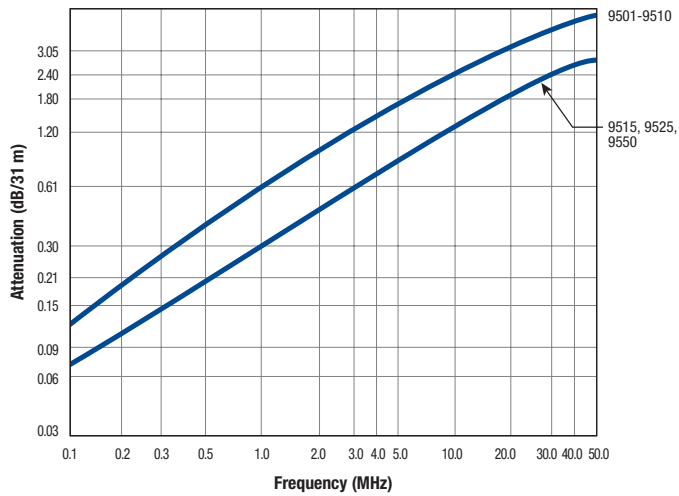

### Rise Time

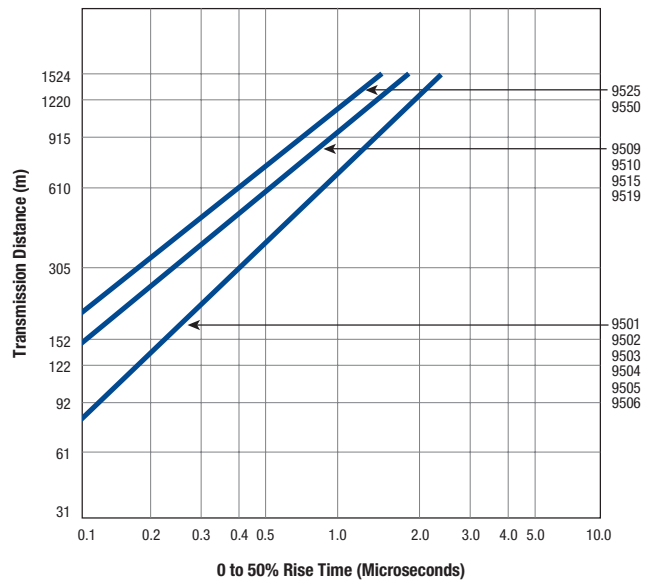

Cables are terminated in their characteristic impedance. Signal source electrical characteristics: 50 Ohm and 10% to 90% rise time less than 5 nanoseconds.

### Bit Rate

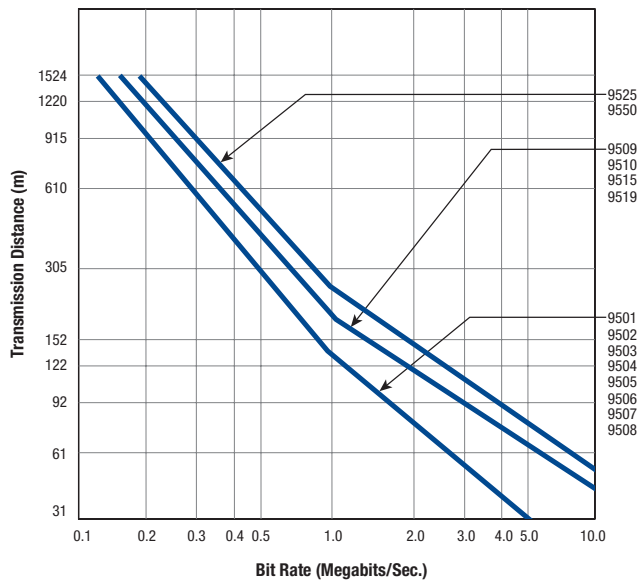

Charts assume 5% peak-to-peak time jitter as determined by eye pattern measurements of pseudorandom NRZ code.

# Overall Beldfoil® Shield

High-Temperature Control, Instrumentation Cables and Computer Cables  
for EIA RS-232 Applications

De-scription	Part No.	UL NEC / C(UL)/CEC Type IEC	Standard Lengths		Standard Unit Weight		Conductor (Stranding) Diameter Nom. DCR	Nominal Insulation OD		Shielding Material Nom. DCR	Nominal OD		Nom. Imp. ( )	Nom. Vel. of Prop.	Nominal Capacitance		Color Code
			ft.	m	lbs.	kg		inch	mm		inch	mm			pF/ft.	pF/m	

**24 AWG • Stranded (7x32) 0.6 mm Tinned Copper • Twisted Pair • Overall Beldfoil® Shield • 24 AWG Tinned Copper Drain Wire**

**Semi-Rigid PVC Insulation • Chrome PVC Jacket**

300V 80°C UL AWM Style 2464 CSA AWM I A	NEC: CMG CEC: CMG FT4	0.61 mm 24 AWG (7x32) TC	0.044	1.12	Overall Beldfoil® + Drain Wire (24 AWG TC)	75	60%	see chart 3 (Tech Info Section)
---	--------------------------------	--------------------------------	-------	------	---	----	-----	---------------------------------------

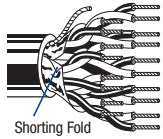

<b>9501</b>	1-Pair	100	31	2.2	1.0	0.156	3.96	CDR/CDR CDR/SCR	40	131
		U-500	U-152	7.5	3.4					
		500	152	7.1	3.2					
		U-1000	U-305	14.1	6.4					
		1000	305	14.1	6.4					
<b>9502†</b>	2-Pair	100	31	3.7	1.7	0.222	5.64	CDR/CDR CDR/SCR	30	98
		U-500	U-152	15.0	6.8					
		500	152	14.6	6.6					
		U-1000	U-305	28.0	12.7					
		1000	305	30.0	13.6					
10000	3048	290.6	131.8	For Plenum version of 9502, see 82502.						
<b>9503</b>	3-Pair	100	31	3.3	1.5	0.232	5.89	CDR/CDR CDR/SCR	30	98
		U-500	U-152	15.0	6.8					
		500	152	14.6	6.6					
		U-1000	U-305	28.0	12.7					
		1000	305	30.0	13.6					
<b>9504</b>	4-Pair	100	31	4.0	1.8	0.265	6.73	CDR/CDR CDR/SCR	30	98
		U-500	U-152	18.1	8.2					
		500	152	16.5	7.5					
		U-1000	U-305	35.1	15.9					
		1000	305	35.9	16.3					
<b>9505</b>	5-Pair	100	31	4.6	2.1	0.289	7.34	CDR/CDR CDR/SCR	30	98
		U-500	U-152	21.6	9.8					
		500	152	22.9	10.4					
		U-1000	U-305	41.0	18.6					
		1000	305	43.0	19.5					
<b>9506</b>	6-Pair	100	31	5.1	2.3	0.289	7.34	CDR/CDR CDR/SCR	30	98
		U-500	U-152	22.9	10.4					
		500	152	24.9	11.3					
		U-1000	U-305	45.0	20.4					
		1000	305	47.2	21.4					
<b>9507</b>	7-Pair	100	31	5.5	2.5	0.294	7.47	CDR/CDR CDR/SCR	30	98
		U-500	U-152	24.9	11.3					
		500	152	27.1	12.3					
		U-1000	U-305	49.2	22.3					
		1000	305	50.9	23.1					
<b>9508</b>	8-Pair	100	31	6.4	2.9	0.324	8.23	CDR/CDR CDR/SCR	30	98
		500	152	30.4	13.8					
		1000	305	60.0	27.2					
<b>9509</b>	9-Pair	100	31	6.8	3.1	0.334	8.48	CDR/CDR CDR/SCR	30	98
		500	152	33.5	15.2					
		1000	305	67.0	30.4					
<b>9510</b>	10-Pair	100	31	7.5	3.4	0.368	9.34	CDR/CDR CDR/SCR	30	98
		500	152	36.6	16.6					
		1000	305	74.1	33.6					
<b>9515</b>	15-Pair	100	31	10.4	4.7	0.417	10.60	CDR/CDR CDR/SCR	30	98
		500	152	52.0	23.6					
		1000	305	102.3	46.4					
<b>9519</b>	19-Pair	100	31	12.8	5.8	0.449	11.40	CDR/CDR CDR/SCR	30	98
		500	152	61.7	28.0					
		1000	305	122.4	55.5					

TC = Tinned Copper • DCR = DC resistance • SCR = Capacitance between one conductor and other conductors connected to shield. • CDR = Capacitance between conductors  
† Pennsylvania Department of Environmental Resources and United States Mine Safety and Health Administration certification. Request quotations of RG/U cables not listed.



## Overall Beldfoil® Shield

High-Temperature Control, Instrumentation Cables and Computer Cables  
for EIA RS-232 Applications

De- scription	Part No.	UL NEC/ C(UL)CEC Type IEC	Standard Lengths		Standard Unit Weight		Conductor (Stranding) Diameter Nom. DCR	Nominal Insulation OD		Shielding Material Nom. DCR	Nominal OD		Nom. Imp. ( )	Nom. Vel. of Prop.	Nominal Capacitance		Color Code
			ft.	m	lbs.	kg		inch	mm		inch	mm			pF/ft.	pF/m	

**24 AWG • Stranded (7x32) 0.6 mm Tinned Copper • Twisted Pair • Overall Beldfoil® Shield • 24 AWG Tinned Copper Drain Wire (continued)**

**Semi-Rigid PVC Insulation • Chrome PVC Jacket**

300V 80°C UL AWM Style 2464 CSA AWM 1 A	NEC: CMG CEC: CMG FT4						0.61 mm 24 AWG (7x32) TC	0.044	1.12	Overall Beldfoil® + Drain Wire (24 AWG TC)			75	60%			see chart 3 (Tech Info Section)
---	--------------------------------	--	--	--	--	--	--------------------------------	-------	------	---	--	--	----	-----	--	--	---------------------------------------

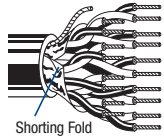

<b>9525</b>	25-Pair	100	31	16.1	7.3							0.504	12.80			CDR/CDR	30	98
		500	152	79.6	36.1											CDR/SCR	50	164
		1000	305	155.0	70.3													
<b>9550</b>	50-Pair	100	31	32.0	14.5											CDR/CDR	30	98
		† 500	152	153.9	69.8											CDR/SCR	50	164
		† 1000	305	311.7	141.4													

**24 AWG • Stranded (7x32) 0.6 mm Tinned Copper • Twisted Pair • Overall Beldfoil® Shield • 24 AWG Tinned Copper Drain Wire**

**Plenum • FEP Insulation • Natural Flamarrest® Jacket**

300V RMS	NEC: CMP CEC: CMP FT6						0.61 mm 24 AWG (7x32) TC	0.036	0.91	Overall Beldfoil® + Drain Wire (24 AWG TC)							see chart 3 (Tech Info Section)
----------	--------------------------------	--	--	--	--	--	--------------------------------	-------	------	---	--	--	--	--	--	--	---------------------------------------



<b>82641</b>	1-Pair	†† U-1000	U-305	9.0	4.1											CDR/CDR	31	102
		†† 1000	305	7.9	3.6											CDR/SCR	59	194
<b>82502</b>	2-Pair	†† U-500	U-152	7.9	3.6											CDR/CDR	25	82
		†† U-1000	U-305	16.1	7.3											CDR/SCR	45	148
		†† 1000	305	14.1	6.4													
<b>82503</b>	3-Pair	†† U-1000	U-305	19.0	8.6											CDR/CDR	25	82
		†† 1000	305	18.1	8.2											CDR/SCR	45	148
<b>82504</b>	4-Pair	†† U-1000	U-305	24.0	10.9											CDR/CDR	25	82
		†† 1000	305	26.0	11.8											CDR/SCR	45	148
<b>82505</b>	5-Pair	†† U-1000	U-305	29.1	13.2											CDR/CDR	25	82
		†† 1000	305	30.9	14.0											CDR/SCR	45	148
<b>82506</b>	6-Pair	†† U-500	U-152	17.6	8.0											CDR/CDR	25	82
		†† U-1000	U-305	34.2	15.5											CDR/SCR	45	148
		†† 1000	305	35.1	15.9													
<b>82509</b>	9-Pair	†† 1000	305	49.2	22.3										CDR/CDR	23	75	
															CDR/SCR	42	138	

TC = Tinned Copper • DCR = DC resistance • SCR = Capacitance between one conductor and other conductors connected to shield. • CDR = Capacitance between conductors

† Spools are one piece, but length may vary 0% to +20% from length shown.

†† Spools and/or UnReel® cartons are one piece, but length may vary ±10% for spools and ±5% for UnReel® from length shown.

# Overall Beldfoil® Shield

## Low-Capacitance Computer Cables for EIA RS-232 and EIA RS-422 Applications

De- scription	Part No.	UL NEC/ C(UL)/CEC Type IEC	Standard Lengths		Standard Unit Weight		Conductor (Stranding) Diameter Nom. DCR	Nominal Insulation OD		Shielding Material Nom. DCR	Nominal OD		Nom. Imp. ( )	Nom. Vel. of Prop.	Nominal Capacitance		Color Code
			ft.	m	lbs.	kg		inch	mm		inch	mm			pF/ft.	pF/m	

**24 AWG • Stranded (7x32) 0.6 mm Tinned Copper • Twisted Pair • Overall Beldfoil® Shield • 24 AWG Tinned Copper Drain Wire**

**Polyethylene Insulation • Chrome PVC Jacket**

30V 80°C UL AWM Style 2919	NEC: CM CEC: CM						0.61 mm 24 AWG (7x32) TC	0.054	1.37	Overall Beldfoil® + Drain Wire (24 AWG TC)			100	66%			see chart 5 (Tech Info Section)
-------------------------------	--------------------------	--	--	--	--	--	--------------------------------	-------	------	---	--	--	-----	-----	--	--	---------------------------------------

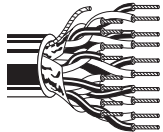

<b>9680</b>	3-Pair	500	152	17.0	7.7	0.282	7.16	CDR/CDR	15	51
		1000	305	38.1	17.3					
<b>9681</b>	4-Pair	500	152	24.0	10.9	0.307	7.80	CDR/CDR	15	51
		1000	305	45.2	20.5					
<b>9682</b>	6-Pair	500	152	29.5	13.4	0.342	8.69	CDR/CDR	15	51
		1000	305	56.2	25.5					
<b>9683</b>	9-Pair	500	152	37.9	17.2	0.398	10.10	CDR/CDR	15	51
		1000	305	79.1	35.9					
<b>9684</b>	12.5-Pair (12 pairs + 1 single)	500	152	49.8	22.6	0.445	11.30	CDR/CDR	15	51
		1000	305	97.2	44.1					

**Datalene® Insulation • Chrome PVC Jacket**

30V 80°C UL AWM Style 2919	NEC: CM CEC: CM						0.61 mm 24 AWG (7x32) TC	0.049	1.24	Overall Beldfoil® + Drain Wire (24 AWG TC)			100	78%			see chart 5 (Tech Info Section)
-------------------------------	--------------------------	--	--	--	--	--	--------------------------------	-------	------	---	--	--	-----	-----	--	--	---------------------------------------

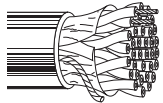

<b>1419A</b>	2-Pair	500	152	13.4	6.1	0.248	6.30	CDR/CDR	13	43			
		1000	305	30.0	13.6						CDR/SCR	22	72
		10000	3048	310.6	140.9								
<b>1420A</b>	3-Pair	500	152	15.0	6.8	0.261	6.63	CDR/CDR	13	43			
		1000	305	34.2	15.5						CDR/SCR	22	72
		10000	3048	340.6	154.5								
<b>1421A</b>	4-Pair	500	152	16.5	7.5	0.280	7.11	CDR/CDR	13	43			
		1000	305	37.0	16.8						CDR/SCR	22	72
<b>1422A</b>	5-Pair	500	152	23.1	10.5	0.294	7.47	CDR/CDR	13	43			
		1000	305	43.0	19.5						CDR/SCR	22	72
<b>1423A</b>	6-Pair	500	152	25.1	11.4	0.319	8.10	CDR/CDR	13	43			
		1000	305	48.1	21.8						CDR/SCR	22	72
		10000	3048	501.1	227.3								
<b>1424A</b>	12.5-Pair (12 pairs + 1 single)	500	152	43.0	19.5	0.418	10.62	CDR/CDR	13	43			
		1000	305	85.1	36.6						CDR/SCR	22	72
<b>1425A</b>	15-Pair	500	152	53.1	24.1	0.473	12.01	CDR/CDR	13	43			
		1000	305	99.2	45.0						CDR/SCR	22	72

TC = Tinned Copper • DCR = DC resistance • SCR = Capacitance between one conductor and other conductors connected to shield. • CDR = Capacitance between conductors

# Overall Beldfoil® Shield

## Audio, Control and Instrumentation Cables

De- scription	Part No.	UL NEC/ C(UL)CEC Type IEC	Standard Lengths		Standard Unit Weight		Conductor (Stranding) Diameter Nom. DCR	Nominal Insulation OD		Shielding Material Nom. DCR	Nominal OD		Nom. Imp. ( )	Nom. Vel. of Prop.	Nominal Capacitance		Color Code
			ft.	m	lbs.	kg		inch	mm		inch	mm			pF/ft.	pF/m	

**22 AWG • Solid 0.6 mm Tinned Copper • Twisted Pair • Overall Beldfoil® Shield • 22 AWG Tinned Copper Drain Wire**

Polyethylene Insulation • Chrome PVC Jacket																								
300V 60°C	<b>8761</b>	NEC:	U-500	U-152	9.0	4.1	0.64 mm	0.057	1.46	Overall Beldfoil® + Drain Wire (22 AWG TC)	0.175	4.45	-	-	CDR/CDR	24	79	Black, Clear						
UL AWM Style 2092		CM:	500	152	9.0	4.1	22 AWG								CDR/SCR	47	154							
		CEC:	U-1000	U-305	17.0	7.7	Solid TC																	
		CM:	1000	305	18.1	8.2																		
			2000	610	35.9	16.3																		
			5000	1524	90.2	40.9																		
			† 10000	3048	170.4	77.3																		

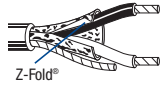

For Plenum versions of 8761, see 88761, 87761 or 82761.

1-Pair

**20 AWG • Stranded (7x28) 1.0 mm Tinned Copper • Twisted Pair • Overall Beldfoil® Shield • 22 AWG Tinned Copper Drain Wire**

PVC Insulation • Beige PVC Jacket																								
300V 80°C	<b>9154</b>	NEC:	U-500	U-152	11.5	5.2	0.96 mm	0.066	1.68	Overall Beldfoil® + Drain Wire (22 AWG TC)	0.198	5.03	-	-	CDR/CDR	60	197	Black, Red						
UL AWM Style 2464		CMG:	500	152	12.1	5.5	20 AWG								CDR/SCR	100	328							
		CEC:	U-1000	U-305	22.0	10.0	(7x28) TC																	
		CMG FT4:	1000	305	23.1	10.5																		

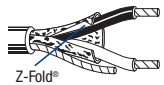

1-Pair

**20 AWG • Stranded (7x28) 1.0 mm Tinned Copper • Twisted Pair • Overall Beldfoil® Shield • 20 AWG Tinned Copper Drain Wire**

Polyethylene Insulation • Chrome PVC Jacket																								
300V 60°C	<b>8762</b>	NEC:	100	31	3.3	1.5	0.96 mm	0.070	1.78	Overall Beldfoil® + Drain Wire (20 AWG TC)	0.204	5.18	-	-	CDR/CDR	27	89	Black, Clear						
UL AWM Style 2092		CM:	250	76	6.2	2.8	20 AWG								CDR/SCR	49	161							
		CEC:	U-500	U-152	12.1	5.5	(7x28) TC																	
		CM:	500	152	12.1	5.5																		
			U-1000	U-305	23.1	10.5																		
			1000	305	23.1	10.5																		
			2000	610	46.1	20.9																		
			10000	3048	240.5	109.1																		

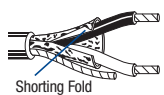

1-Pair

Polyethylene Insulation • Chrome PVC Jacket																								
300V 60°C	<b>9464</b>	NEC:	U-500	U-152	17.0	7.7	0.96 mm	0.070	1.78	Overall Beldfoil® + Drain Wire (20 AWG TC)	0.214	5.44	-	-	CDR/CDR	27	89	Black, Clear						
UL AWM Style 2092		CM:	U-1000	U-305	32.0	14.5	20 AWG								CDR/SCR	49	161							
		CEC:					(7x28) TC																	
		CM:																						



The jacket and shield are bonded so both can be removed with automatic stripping equipment. Drain wire is on the inside of foil shield.

1-Pair

**18 AWG • Stranded (19x30) 1.2 mm Tinned Copper • Twisted Pair • Overall Beldfoil® Shield • 20 AWG Tinned Copper Drain Wire**

Plenum • FEP Insulation • Natural Flamarrst® Jacket																								
300V RMS	<b>82760</b>	NEC:	†† U-500	U-152	11.9	5.4	1.24 mm	0.063	1.60	Overall Beldfoil® + Drain Wire (20 AWG TC)	0.150	3.81	-	-	CDR/CDR	51	167	Black, Red						
		CMP:	†† U-1000	U-305	22.0	10.0	18 AWG								CDR/SCR	97	318							
		CEC:	†† 1000	305	20.9	9.5	(19x30) TC																	
		CMP FT6:																						

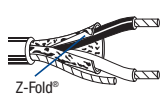

1-Pair

TC = Tinned Copper • DCR = DC resistance • SCR = Capacitance between one conductor and other conductors connected to shield. • CDR = Capacitance between conductors  
 † Length may vary -10% to +20% and may contain 2 pieces. Minimum length of any piece is 460 m (1500 ft).  
 †† Spools and/or UnReel® cartons are one piece, but length may vary ± 10% for spools and ± 5% for UnReel® from length shown.

# Overall Beldfoil® Shield

## Audio, Control and Instrumentation Cables

De- scription	Part No.	UL NEC/ C(UL)/CEC Type IEC	Standard Lengths		Standard Unit Weight		Conductor (Stranding) Diameter Nom. DCR	Nominal Insulation OD		Shielding Material Nom. DCR	Nominal OD		Nom. Imp. ( )	Nom. Vel. of Prop.	Nominal Capacitance		Color Code
			ft.	m	lbs.	kg		inch	mm		inch	mm			pF/ft.	pF/m	

**16 AWG** • Stranded (19x29) 1.5 mm Tinned Copper • Twisted Pair • Overall **Beldfoil®** Shield • 18 AWG Tinned Copper Drain Wire

Polyethylene Insulation • Chrome PVC Jacket																		
600V 80°C	<b>8719</b>	NEC:	U-500	U-152	24.5	11.1	1.47 mm	0.122	3.09	Overall	0.313	7.95	-	-	CDR/CDR	23	75	Black, Clear
UL AWM Style 20253		CM CL2	500	152	25.6	11.6	16 AWG			Beldfoil®					CDR/SCR	44	144	
		CEC:	U-1000	U-305	47.0	21.3	(19x29) TC			+ Drain Wire								
		CM	1000	305	50.0	22.7				(18 AWG TC)								
			2000	610	100.3	45.5												
			5000	1524	245.6	111.4												
			10000	3048	509.9	231.3												



Shorting Fold

1-Pair

**14 AWG** • Stranded (19x27) 1.9 mm Tinned Copper • Twisted Pair • Overall **Beldfoil®** Shield • 16 AWG Tinned Copper Drain Wire

Polyethylene Insulation • Chrome PVC Jacket																		
600V 80°C	<b>8720</b>	NEC:	U-500	U-152	34.0	15.4	1.85 mm	0.137	3.47	Overall	0.355	9.02	-	-	CDR/CDR	24	79	Black, Clear
UL AWM Style 20253		CM CL2	500	152	35.1	15.9	14 AWG			Beldfoil®					CDR/SCR	47	154	
			1000	305	71.2	32.3	(19x27) TC			+ Drain Wire								
			2000	610	138.2	62.7				(16 AWG TC)								



Z-Fold®

1-Pair

**12 AWG** • Stranded (19x25) 2.4 mm Tinned Copper • Twisted Pair • Overall **Beldfoil®** Shield • 14 AWG Tinned Copper Drain Wire

Polyethylene Insulation • Chrome PVC Jacket																		
600V 80°C	<b>8718</b>	NEC:	U-500	U-152	47.6	21.6	2.36 mm	0.167	4.24	Overall	0.400	10.16	-	-	CDR/CDR	25	82	Black, Clear
UL AWM Style 20253		CL2	500	152	50.5	22.9	12 AWG			Beldfoil®					CDR/SCR	49	161	
			1000	305	100.3	45.5	(19x25) TC			+ Drain Wire								
			2000	610	198.4	90.0				(14 AWG TC)								



Z-Fold®

1-Pair

TC = Tinned Copper • DCR = DC resistance • SCR = Capacitance between one conductor and other conductors connected to shield. • CDR = Capacitance between conductors

# Overall Foil/Braid Shield

## Cable Characteristics

### Attenuation

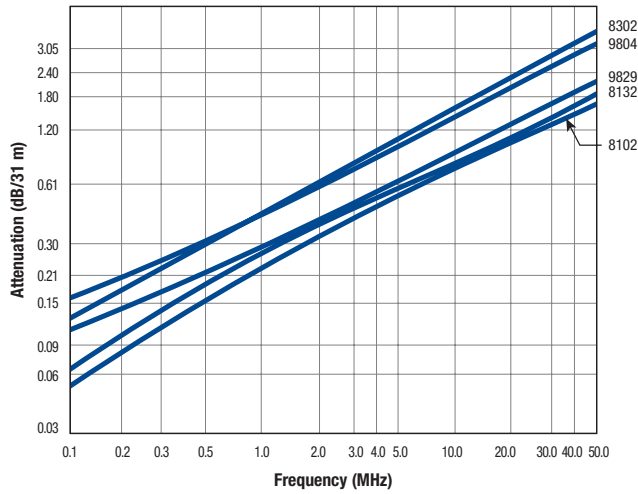

### Rise Time

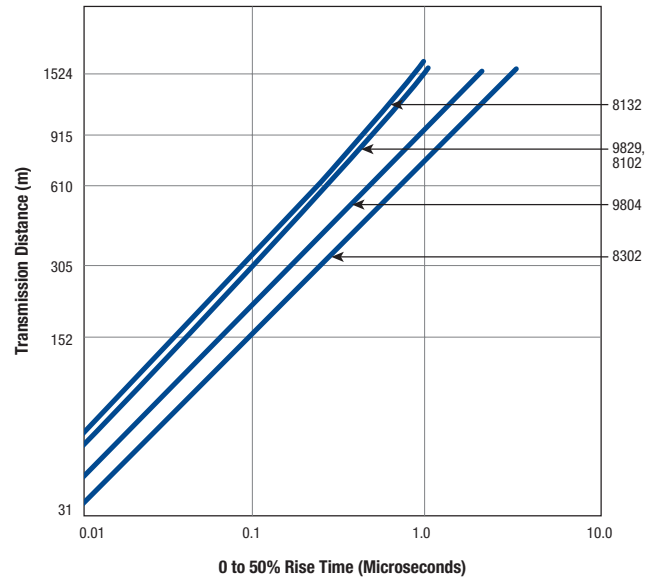

### Bit Rate

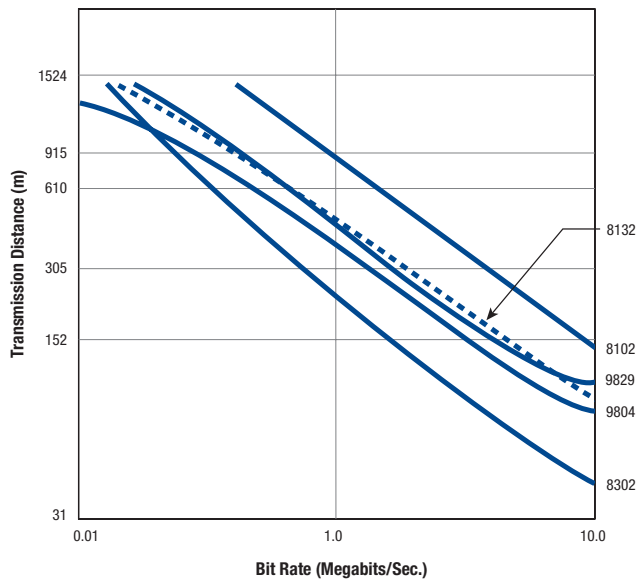

### Overall Foil/Braid Shield

Low-Capacitance Computer Cables  
for EIA RS-232 and EIA RS-422 Applications

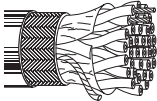
De- scription	Part No.	UL NEC/ C(UL)/CEC Type IEC	Standard Lengths		Standard Unit Weight		Conductor (Stranding) Diameter Nom. DCR	Nominal Insulation OD		Shielding Material Nom. DCR	Nominal OD		Nom. Imp. ( )	Nom. Vel. of Prop.	Nominal Capacitance		Color Code
			ft.	m	lbs.	kg		inch	mm		inch	mm			pF/ft.	pF/m	
<b>28 AWG • Stranded (7x36) 0.4 mm Tinned Copper • Twisted Pair • Overall Beldfoil® Shield + 90 % TC Braid • 28 AWG TC Drain Wire</b> <b>Polypropylene Insulation • Chrome PVC Jacket</b>																	
30V 60°C UL AWM Style 2960		NEC: CL2					0.38 mm 28 AWG (7x36) TC	0.033	0.84	Overall Beldfoil® + Overall 90% TC Braid + Drain Wire (28 AWG TC)			100	66%			see chart 3 (Tech Info Section)
																	
<b>9804</b>	2-Pair		100 500 1000	31 152 305	4.0 14.6 32.0	1.8 6.6 14.5					0.214	5.44			CDR/CDR CDR/SCR	16 28	51 90
<b>9805</b>	3-Pair		100 500 1000	31 152 305	4.2 15.4 35.1	1.9 7.0 15.9					0.222	5.64			CDR/CDR CDR/SCR	16 28	51 90
<b>9806</b>	4-Pair		100 500 1000	31 152 305	4.4 17.4 39.0	2.0 7.9 17.7					0.237	6.02			CDR/CDR CDR/SCR	16 28	51 90
<b>9807</b>	5-Pair		100 500 1000	31 152 305	4.4 19.6 39.0	2.0 8.9 17.7					0.240	6.10			CDR/CDR CDR/SCR	16 28	51 90
<b>9808</b>	7-Pair		100 500 1000	31 152 305	4.9 20.5 44.1	2.2 9.3 20.0					0.256	6.50			CDR/CDR CDR/SCR	16 28	51 90
<b>9809</b>	9-Pair		100 500 1000	31 152 305	5.7 24.9 53.1	2.6 11.3 24.1					0.290	7.37			CDR/CDR CDR/SCR	16 28	51 90
<b>9812</b>	12-Pair		100 500 1000	31 152 305	6.6 31.1 62.2	3.0 14.1 28.2					0.319	8.10			CDR/CDR CDR/SCR	16 28	51 90
<b>9813</b>	13-Pair		100 500 1000	31 152 305	7.1 34.2 66.1	3.2 15.5 30.0					0.336	8.53			CDR/CDR CDR/SCR	16 28	51 90
<b>9819</b>	18-Pair		100 500 1000	31 152 305	8.4 41.0 82.2	3.8 18.6 37.3					0.365	9.27			CDR/CDR CDR/SCR	16 28	51 90
<b>9825</b>	25-Pair		100 500 1000	31 152 305	9.9 54.7 108.2	4.5 24.8 49.1					0.429	10.90			CDR/CDR CDR/SCR	16 28	51 90
<b>9814</b>	31-Pair		100 500 1000	31 152 305	11.9 64.2 127.2	5.4 29.1 57.7					0.462	11.73			CDR/CDR CDR/SCR	16 28	51 90

TC = Tinned Copper • DCR = DC resistance • SCR = Capacitance between one conductor and other conductors connected to shield. • CDR = Capacitance between conductors



### Overall Foil/Braid Shield

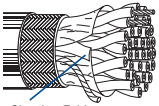

Low-Capacitance Computer Cables  
for EIA RS-232 and EIA RS-485 Applications

De- scription	Part No.	UL NEC/ C(UL)CEC Type IEC	Standard Lengths		Standard Unit Weight		Conductor (Stranding) Diameter Nom. DCR	Nominal Insulation OD		Shielding Material Nom. DCR	Nominal OD		Nom. Imp. ( )	Nom. Vel. of Prop.	Nominal Capacitance		Color Code	
			ft.	m	lbs.	kg		inch	mm		inch	mm			pF/ft.	pF/m		
<b>28 AWG • Stranded (7x36) 0.4 mm Tinned Copper • Twisted Pair • Overall Beldfoil® Shield + 65% TC Braid • 28 AWG TC Drain Wire</b> <b>Datalene® Insulation • Chrome PVC Jacket</b>																		
30V 80°C UL AWM Style 2919	NEC: CL2						0.38 mm 28 AWG (7x36) TC	0.044	1.12	Overall Beldfoil® + Overall 65% TC Braid + Drain Wire (28 AWG TC)			120	78%			see chart 5 (Tech Info Section)	
	Shorting Fold																	
<b>8132</b>	2-Pair		100 500 1000	31 152 305	3.5 14.6 29.1	1.6 6.6 13.2					0.220	5.59			CDR/CDR CDR/SCR	11 20	36 66	
<b>8133</b>	3-Pair		100 500 1000	31 152 305	3.7 15.0 34.2	1.7 6.8 15.5					0.270	6.86			CDR/CDR CDR/SCR	11 20	36 66	
<b>8134</b>	4-Pair		100 500 1000	31 152 305	4.4 18.1 39.0	2.0 8.2 17.7					0.290	7.37			CDR/CDR CDR/SCR	11 20	36 66	
<b>8135</b>	5-Pair		100 1000	31 305	4.6 42.1	2.1 19.1					0.300	7.62			CDR/CDR CDR/SCR	11 20	36 66	
<b>8138</b>	8-Pair		100 500 1000	31 152 305	5.5 27.1 52.0	2.5 12.3 23.6					0.330	8.38			CDR/CDR CDR/SCR	11 20	36 66	
<b>8142</b>	12.5-Pair (12 pairs + 1 single)		100 500 1000	31 152 305	6.8 33.1 65.9	3.1 15.0 29.9					0.375	9.53			CDR/CDR CDR/SCR	11 20	36 66	
<b>8148</b>	18-Pair		100 500 1000	31 152 305	8.6 47.6 92.2	3.9 21.6 41.8					0.465	11.81			CDR/CDR CDR/SCR	11 20	36 66	
<b>8155</b>	25-Pair		100 500 1000	31 152 305	11.0 64.2 121.3	5.0 29.1 55.0					0.565	14.35			CDR/CDR CDR/SCR	11 20	36 66	

TC = Tinned Copper • DCR = DC resistance • SCR = Capacitance between one conductor and other conductors connected to shield. • CDR = Capacitance between conductors

# Overall Foil/Braid Shield

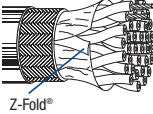
## Low-Capacitance Computer Cables for EIA RS-232 Applications

Description	Part No.	UL NEC/ C(UL)CEC Type IEC	Standard Lengths		Standard Unit Weight		Conductor (Stranding) Diameter Nom. DCR	Nominal Insulation OD		Shielding Material Nom. DCR	Nominal OD		Nom. Imp. ( )	Nom. Vel. of Prop.	Nominal Capacitance		Color Code
			ft.	m	lbs.	kg		inch	mm		inch	mm			pF/ft.	pF/m	
<b>24 AWG • Stranded (7x32) 0.6 mm Tinned Copper • Twisted Pair • Overall Beldfoil® Shield + 65% Tinned Copper Braid</b> <b>Semi-Rigid PVC Insulation • Chrome PVC Jacket</b>																	
300V 80°C UL AWM Style 2464 CSA AWM I A  Z-Fold®		NEC: CMG CEC: CMG FT4					0.61 mm 24 AWG (7x32) TC	0.044 1.12	Overall Beldfoil® + Overall 65% TC Braid			75 60%					see chart 5 (Tech Info Section)
	<b>8332</b>	2-Pair	100 500 1000	31 152 305	4.2 16.5 37.0	1.9 7.5 16.8					0.250 6.35			CDR/CDR CDR/SCR	30 50	98 164	
	<b>8333</b>	3-Pair	100 500 1000	31 152 305	4.9 20.5 44.3	2.2 9.3 20.1					0.265 6.73			CDR/CDR CDR/SCR	30 50	98 164	
	<b>8334</b>	4-Pair	100 500 1000	31 152 305	5.3 22.5 49.2	2.4 10.2 22.3					0.288 7.32			CDR/CDR CDR/SCR	30 50	98 164	
	<b>8335</b>	5-Pair	100 500 1000	31 152 305	6.0 29.5 57.1	2.7 13.4 25.9					0.295 7.49			CDR/CDR CDR/SCR	30 50	98 164	
	<b>8336</b>	6-Pair	100 500 1000	31 152 305	6.6 31.5 62.2	3.0 14.3 28.2					0.310 7.87			CDR/CDR CDR/SCR	30 50	98 164	
	<b>8337</b>	7-Pair	100 500 1000	31 152 305	6.8 32.8 65.0	3.1 14.9 29.5					0.321 8.15			CDR/CDR CDR/SCR	30 50	98 164	
	<b>8340</b>	10-Pair	100 500 1000	31 152 305	9.0 43.4 90.2	4.1 19.7 40.9					0.385 9.78			CDR/CDR CDR/SCR	30 50	98 164	
	<b>8342</b>	12.5-Pair (12 pairs + 1 single)	100 500 1000	31 152 305	11.0 55.1 109.1	5.0 25.0 49.5					0.405 10.29			CDR/CDR CDR/SCR	30 50	98 164	
	<b>8345</b>	15-Pair	500 1000	152 305	61.7 123.2	28.0 55.9					0.445 11.30			CDR/CDR CDR/SCR	30 50	98 164	
300V 80°C UL AWM Style 2464 	<b>8348</b>	18-Pair	100 500 1000	31 152 305	14.1 78.9 152.8	6.4 35.8 69.3					0.480 12.19			CDR/CDR CDR/SCR	30 50	98 164	
	<b>8355</b>	25-Pair	500 1000	152 305	96.8 195.3	43.9 88.6					0.550 13.97			CDR/CDR CDR/SCR	30 50	98 164	

TC = Tinned Copper • DCR = DC resistance • SCR = Capacitance between one conductor and other conductors connected to shield. • CDR = Capacitance between conductors

### Overall Foil/Braid Shield

Low-Capacitance Computer Cables  
for EIA RS-232 and EIA RS-422 Applications

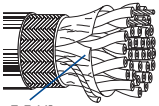
De- scription	Part No.	UL NEC/ C(UL)CEC Type IEC	Standard Lengths		Standard Unit Weight		Conductor (Stranding) Diameter Nom. DCR	Nominal Insulation OD		Shielding Material Nom. DCR	Nominal OD		Nom. Imp. ( )	Nom. Vel. of Prop.	Nominal Capacitance		Color Code	
			ft.	m	lbs.	kg		inch	mm		inch	mm			pF/ft.	pF/m		
<b>24 AWG • Stranded (7x32) 0.6 mm TC • Twisted Pair • Overall Beldfoil® Shield + 65 % Tinned Copper Braid • 24 AWG TC Drain Wire</b>																		
<b>Polyethylene Insulation • Chrome PVC Jacket</b>																		
30V 80°C UL AWM Style 2919		NEC: CM CEC: CM					0.61 mm 24 AWG (7x32) TC	0.054	1.37	Overall Beldfoil® + Overall 65% TC Braid + Drain Wire (24 AWG TC)			100	66%			see chart 5 (Tech Info Section)	
																		Z-Fold®
<b>9829</b>	2-Pair		100	31	4.6	2.1					0.291	7.39			CDR/CDR	16	51	
			500	152	22.0	10.0									CDR/SCR	28	90	
			1000	305	43.0	19.5												
<b>9830</b>	3-Pair		500	152	26.5	12.0					0.305	7.74			CDR/CDR	16	51	
			1000	305	53.1	24.1									CDR/SCR	28	90	
<b>9831</b>	4-Pair		100	31	6.2	2.8					0.330	8.38			CDR/CDR	16	51	
			500	152	30.0	13.6									CDR/SCR	28	90	
			1000	305	58.2	26.4												
<b>9832</b>	5-Pair		100	31	6.6	3.0					0.338	8.59			CDR/CDR	16	51	
			500	152	32.6	14.8									CDR/SCR	28	90	
			1000	305	65.0	29.5												

TC = Tinned Copper • DCR = DC resistance • SCR = Capacitance between one conductor and other conductors connected to shield. • CDR = Capacitance between conductors

### Overall Foil/Braid Shield



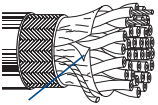







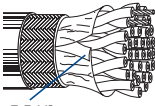

Low-Capacitance Computer Cables  
for EIA RS-232 and EIA RS-422 Applications

De- scription	Part No.	UL NEC/ C(UL)/CEC Type IEC	Standard Lengths		Standard Unit Weight		Conductor (Stranding) Diameter Nom. DCR	Nominal Insulation OD		Shielding Material Nom. DCR	Nominal OD		Nom. Imp. ( )	Nom. Vel. of Prop.	Nominal Capacitance		Color Code	
			ft.	m	lbs.	kg		inch	mm		inch	mm			pF/ft.	pF/m		
<b>24 AWG • Stranded (7x32) 0.6 mm TC • Twisted Pair • Overall Beldfoil® Shield + 65 % Tinned Copper Braid • 24 AWG TC Drain Wire</b> <b>Datalene® Insulation • Chrome PVC Jacket</b>																		
30V 80°C UL AWM Style 2919		NEC: CM CEC: CM					0.61 mm 24 AWG (7x32) TC	0.049	1.24	Overall Beldfoil® + Overall 65% TC Braid + Drain Wire (24 AWG TC)			100	78%			see chart 5 (Tech Info Section)	
																		Shorting Fold
<b>8102</b>	2-Pair		100 500 1000 10000	31 152 305 3048	4.2 17.0 38.1 380.7	1.9 7.7 17.3 172.7					0.270	6.86			CDR/CDR CDR/SCR	13 22	41 72	
<b>8103</b>	3-Pair		100 500 1000 10000	31 152 305 3048	4.6 19.6 42.1 431.0	2.1 8.9 19.1 195.5					0.283	7.19			CDR/CDR CDR/SCR	13 22	41 72	
<b>8104</b>	4-Pair		100 500 1000 10000	31 152 305 3048	5.1 20.9 46.1 491.0	2.3 9.5 20.9 222.7					0.302	7.67			CDR/CDR CDR/SCR	13 22	41 72	
<b>8105</b>	5-Pair		100 500 1000	31 152 305	5.7 28.0 53.1	2.6 12.7 24.1					0.316	8.03			CDR/CDR CDR/SCR	13 22	41 72	
<b>8106</b>	6-Pair		100 500 1000	31 152 305	6.4 30.6 58.2	2.9 13.9 26.4					0.341	8.66			CDR/CDR CDR/SCR	13 22	41 72	
<b>8107</b>	7-Pair		100 500 1000	31 152 305	6.8 33.1 63.1	3.1 15.0 28.6					0.341	8.66			CDR/CDR CDR/SCR	13 22	41 72	
<b>8108</b>	8-Pair		100 500 1000	31 152 305	7.7 37.7 72.3	3.5 17.1 32.8					0.370	9.40			CDR/CDR CDR/SCR	13 22	41 72	
<b>8110</b>	10-Pair		100 500 1000	31 152 305	8.2 45.6 90.2	3.7 20.7 40.9					0.427	10.85			CDR/CDR CDR/SCR	13 22	41 72	
<b>8112</b>	12.5-Pair (12 pairs + 1 single)		100 500 1000	31 152 305	9.3 51.4 101.2	4.2 23.3 45.9					0.440	11.18			CDR/CDR CDR/SCR	13 22	41 72	
<b>8115</b>	15-Pair		500 1000	152 305	63.7 116.2	28.9 52.7					0.495	12.57			CDR/CDR CDR/SCR	13 22	41 72	
<b>8118</b>	18-Pair		100 500 1000	31 152 305	13.2 70.5 144.4	6.0 32.0 65.5					0.537	13.64			CDR/CDR CDR/SCR	13 22	41 72	
<b>8125</b>	25-Pair		100 500 1000	31 152 305	20.7 98.1 191.4	9.4 44.5 86.8					0.632	16.05			CDR/CDR CDR/SCR	13 22	41 72	

TC = Tinned Copper • DCR = DC resistance • SCR = Capacitance between one conductor and other conductors connected to shield. • CDR = Capacitance between conductors

# Overall Foil/Braid Shield

## Low-Capacitance Computer Cables for EIA RS-232 Applications

Description	Part No.	UL NEC/ C(UL)CEC Type IEC	Standard Lengths		Standard Unit Weight		Conductor (Stranding) Diameter Nom. DCR	Nominal Insulation OD		Shielding Material Nom. DCR	Nominal OD		Nom. Imp. ( )	Nom. Vel. of Prop.	Nominal Capacitance		Color Code	
			ft.	m	lbs.	kg		inch	mm		inch	mm			pF/ft.	pF/m		
<b>22 AWG • Stranded (7x30) 0.8 mm Tinned Copper • Twisted Pair • Overall Beldfoil® Shield + 65% Tinned Copper Braid</b>																		
<b>Semi-Rigid PVC Insulation • Chrome PVC Jacket</b>																		
300V 80°C UL AWM Style 2464		NEC: CMG CEC: CMG FT4					0.76 mm 22 AWG (7x30) TC	0.051	1.30	Overall Beldfoil® + Overall 65% TC Braid			70	60%			see chart 3 (Tech Info Section)	
	<b>8302</b>	2-Pair	100	31	4.4	2.0						0.260	6.60			CDR/CDR	40	131
			500	152	19.0	8.6											CDR/SCR	72
			1000	305	41.0	18.6												
	<b>8303</b>	3-Pair	100	31	5.3	2.4						0.270	6.86			CDR/CDR	35	115
			500	152	25.6	11.6											CDR/SCR	63
			1000	305	48.1	21.8												
	<b>8304</b>	4-Pair	100	31	6.6	3.0						0.320	8.13			CDR/CDR	35	115
			500	152	32.4	14.7											CDR/SCR	63
			1000	305	65.0	29.5												
	<b>8305</b>	5-Pair	100	31	7.3	3.3						0.322	8.18			CDR/CDR	35	115
			500	152	35.1	15.9											CDR/SCR	63
			1000	305	67.0	30.4												
	<b>8306</b>	6-Pair	100	31	7.9	3.6						0.348	8.84			CDR/CDR	35	115
			500	152	39.7	18.0											CDR/SCR	63
			1000	305	78.9	35.8												
	<b>8307</b>	7-Pair	100	31	8.6	3.9						0.348	8.84			CDR/CDR	35	115
			500	152	41.9	19.0											CDR/SCR	63
			1000	305	85.1	38.6												
	<b>8308</b>	8-Pair	100	31	10.4	4.7						0.384	9.75			CDR/CDR	35	115
			500	152	50.0	22.7											CDR/SCR	63
			1000	305	101.4	46.0												
	<b>8310</b>	10-Pair	100	31	11.0	5.0						0.440	11.18			CDR/CDR	35	115
			500	152	60.4	27.4											CDR/SCR	63
			1000	305	121.0	54.9												
	<b>8312</b>	12.5-Pair (12 pairs + 1 single)	100	31	13.0	5.9						0.455	11.56			CDR/CDR	35	115
			500	152	72.3	32.8											CDR/SCR	63
			1000	305	140.7	63.8												
	<b>8315</b>	15-Pair	100	31	15.7	7.1						0.502	12.75			CDR/CDR	35	115
			500	152	86.0	39.0											CDR/SCR	63
			1000	305	167.8	76.1												
	<b>8318</b>	18-Pair	100	31	17.6	8.0						0.535	13.59			CDR/CDR	35	115
			500	152	97.4	44.2											CDR/SCR	63
			1000	305	196.4	89.1												
	<b>8325</b>	25-Pair	100	31	23.1	10.5						0.620	15.75			CDR/CDR	35	115
			500	152	126.5	57.4											CDR/SCR	63
			1000	305	247.1	112.1												

TC = Tinned Copper • DCR = DC resistance • SCR = Capacitance between one conductor and other conductors connected to shield. • CDR = Capacitance between conductors

# Individually Shielded Cable Characteristics

## Attenuation

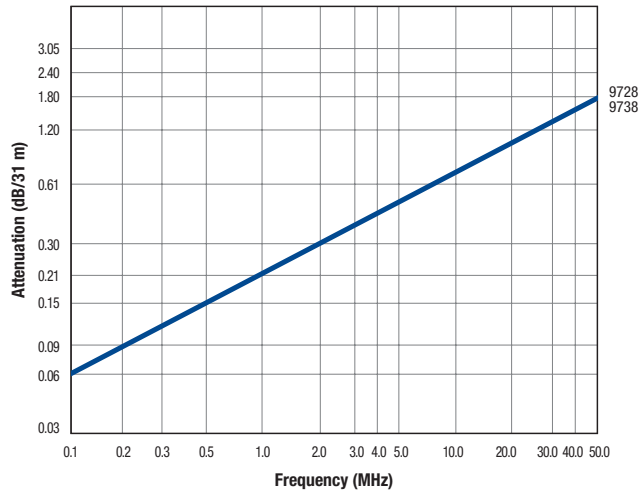

## Rise Time

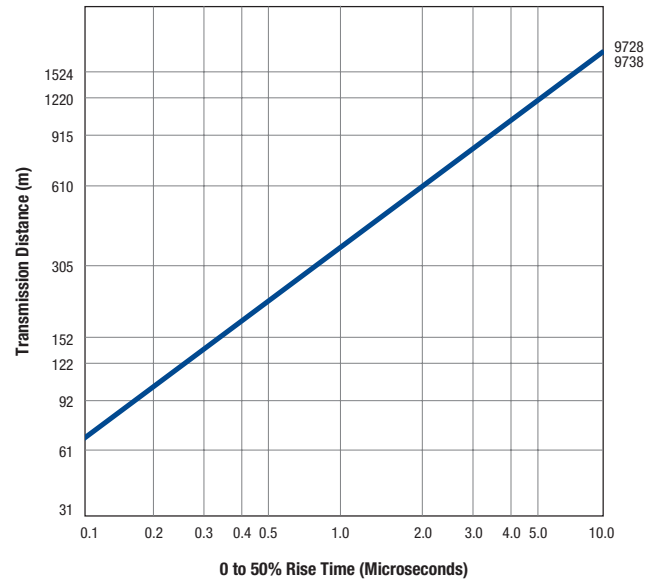

Cables are terminated in their characteristic impedance. Signal source electrical characteristics: 50 Ohm and 10% to 90% rise time less than 5 nanoseconds.

## Bit Rate

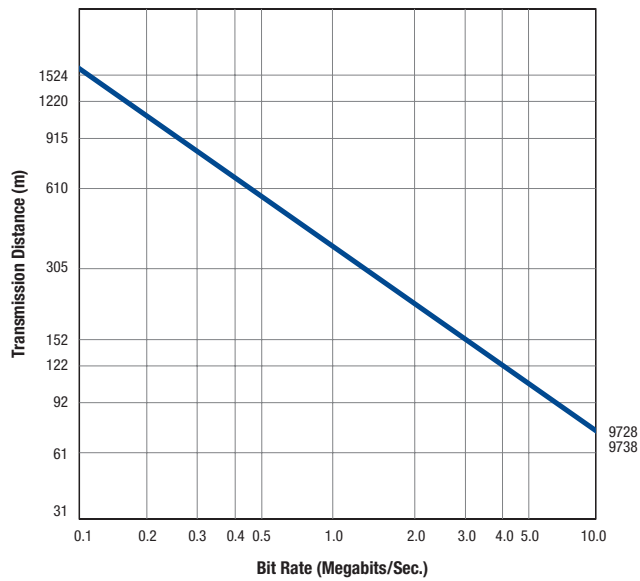

Charts assume 5% peak-to-peak time jitter as determined by eye pattern measurements of pseudorandom NRZ code.

### Individually Shielded

Low-Capacitance 100 Ohm Computer Cables  
for EIA RS-422 and Digital Audio Applications

De- scription	Part No.	UL NEC/ C(UL)CEC Type IEC	Standard Lengths		Standard Unit Weight		Conductor (Stranding) Diameter Nom. DCR	Nominal Insulation OD		Shielding Material Nom. DCR	Nominal OD		Nom. Imp. ( )	Nom. Vel. of Prop.	Nominal Capacitance		Color Code
			ft.	m	lbs.	kg		inch	mm		inch	mm			pF/ft.	pF/m	

**24 AWG • Stranded (7x32) 0.6 mm TC • Twisted Pair • Each Pair Individually Beldfoil® Shielded • 24 AWG Tinned Copper Drain Wire**

**Datalene® Insulation • Chrome PVC Jacket**

300V 60°C UL AWM Style 2493	NEC: CM CEC: CM						0.61 mm 24 AWG (7x32) TC	0.061	1.55	Individual Beldfoil® + Drain Wire (24 AWG TC)			100	76%			see chart 3 (Tech Info Section)
--------------------------------	--------------------------	--	--	--	--	--	--------------------------------	-------	------	--	--	--	-----	-----	--	--	---------------------------------------

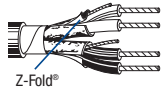

<b>9729</b>	2-Pair	100	31	4.4	2.0						0.266	6.76			CDR/CDR	13	41	
		500	152	20.5	9.3										CDR/SCR	23	76	
		1000	305	39.0	17.7													
		† 10000	3048	392.0	177.8													
For Plenum version of 9729, see 89729 or 82729.																		
<b>9730</b>	3-Pair	100	31	5.1	2.3						0.334	8.48			CDR/CDR	13	41	
		500	152	24.5	11.1										CDR/SCR	23	76	
		1000	305	46.1	20.9													
		† 10000	3048	521.2	236.4													
For Plenum version of 9730, see 89730.																		
<b>9728</b>	4-Pair	100	31	6.0	2.7						0.363	9.22			CDR/CDR	13	41	
		500	152	29.1	13.2										CDR/SCR	23	76	
		1000	305	50.9	23.1													
For Plenum version of 9728, see 89728.																		
<b>9731</b>	6-Pair	100	31	7.5	3.4						0.421	10.69			CDR/CDR	13	41	
		500	152	42.1	19.1										CDR/SCR	23	76	
		1000	305	83.1	37.7													
For Plenum version of 9731, see 89731.																		
<b>9732</b>	9-Pair	100	31	9.9	4.5						0.488	12.40			CDR/CDR	13	41	
		500	152	57.3	26.0										CDR/SCR	23	76	
		1000	305	106.0	48.1													
For Plenum version of 9732, see 89732.																		
<b>9733</b>	11-Pair	500	152	75.2	34.1						0.575	14.61			CDR/CDR	13	41	
														CDR/SCR	23	76		
<b>9734</b>	12-Pair	500	152	79.6	36.1						0.575	14.61			CDR/CDR	13	41	
		1000	305	154.3	70.0										CDR/SCR	23	76	
<b>9735</b>	15-Pair	500	152	95.2	43.2						0.639	16.23			CDR/CDR	13	41	
		1000	305	185.4	84.1										CDR/SCR	23	76	
<b>9736</b>	17-Pair	500	152	103.6	47.0						0.671	17.04			CDR/CDR	13	41	
		1000	305	210.5	95.5										CDR/SCR	23	76	
<b>9737</b>	19-Pair	1000	305	231.5	105.0						0.671	17.04			CDR/CDR	13	41	
														CDR/SCR	23	76		
<b>9738</b>	27-Pair	1000	305	334.7	151.8						0.797	20.24			CDR/CDR	13	41	
														CDR/SCR	23	76		

TC = Tinned Copper • DCR = DC resistance • SCR = Capacitance between one conductor and other conductors connected to shield. • CDR = Capacitance between conductors  
† Spools are one piece, but length may vary ±10% from length shown.

# Individually Shielded Cable Characteristics

## Attenuation

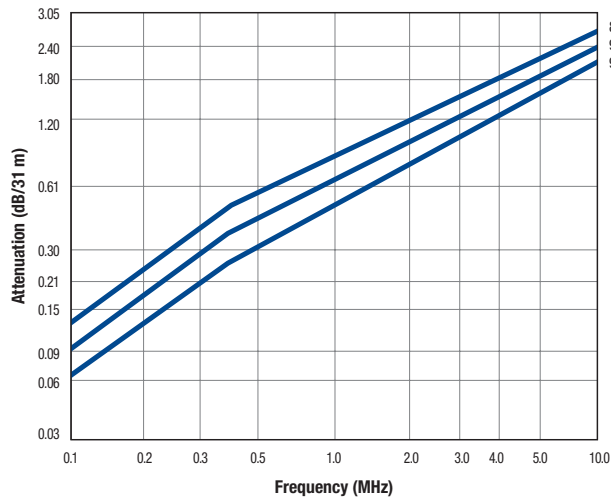

## Rise Time

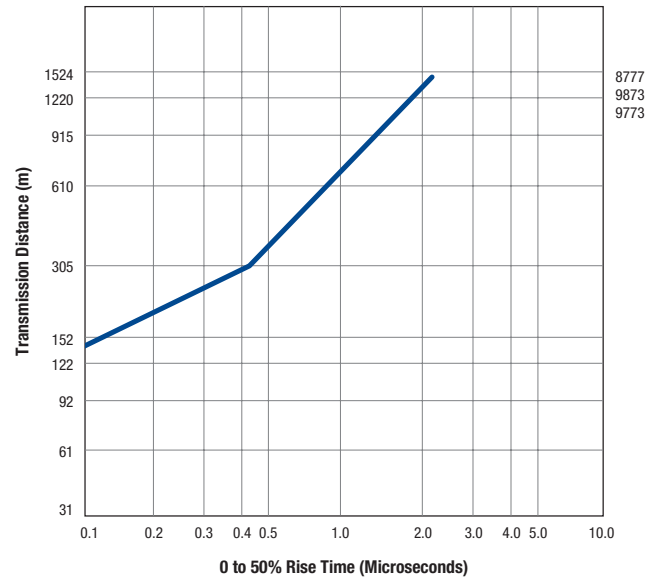

## Bit Rate

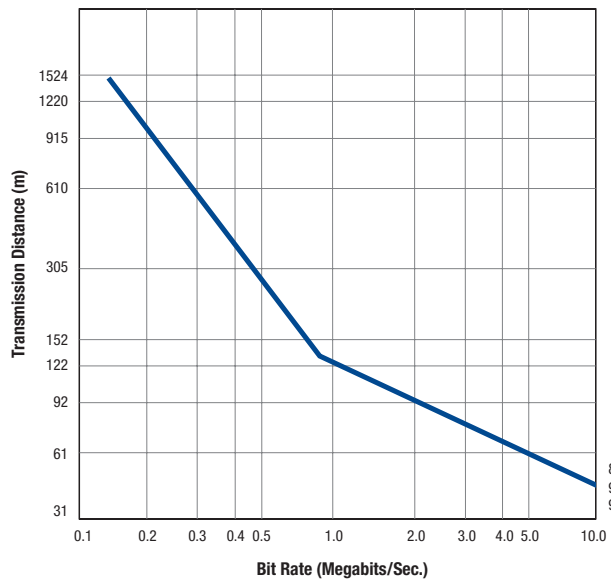

Recommended for audio, pulse, and radio frequency applications requiring superior circuit isolation.

**Insulation resistance between shields:**  
100 megohms/M' nom.

**Capacitance between adjacent shields:**  
377 pF/m nom.

**Working voltage between adjacent shields:**  
50 volt max.



# Individually Shielded

## Audio, Control and Instrumentation Cables

De- scription	Part No.	UL NEC/ C(UL)CEC Type IEC	Standard Lengths		Standard Unit Weight		Conductor (Stranding) Diameter Nom. DCR	Nominal Insulation OD		Shielding Material Nom. DCR	Nominal OD		Nom. Imp. ( )	Nom. Vel. of Prop.	Nominal Capacitance		Color Code
			ft.	m	lbs.	kg		inch	mm		inch	mm			pF/ft.	pF/m	

**22 AWG • Stranded (7x30) 0.8 mm TC • Twisted Pair • Each Pair Individually Beldfoil® Shielded • 24 AWG Tinned Copper Drain Wire**

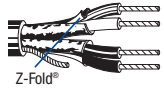
Polypropylene Insulation • Chrome PVC Jacket																			
 Z-Fold®	300V RMS	8723	NEC:	100	31	2.2	1.0	0.76 mm	0.046	1.17	Individual Beldfoil® + Drain Wire (24 AWG TC)	0.160	4.06	45	66%	CDR/CDR	35	115	Red & Black, Green & White
	60°C		CM	U-500	U-152	10.6	4.8	22 AWG											
	CEC:		500	152	9.9	4.5	(7x30) TC												
	CM		U-1000	U-305	19.0	8.6													
			1,000	305	20.1	9.1													
			1640	500	32.8	14.9													
			U-2000	U-610	37.9	17.2													
			2000	610	40.1	18.2													
			3279	1000	65.7	29.8													
			5000	1524	95.2	43.2													
	10000	3049	200.4	90.9															

For halogen-free version see 8723NH.  
Pairs cabled on common axis to reduce diameter

2-Pair

**22 AWG • Stranded (7x30) 0.8 mm TC • Twisted Pair • Each Pair Individually Beldfoil® Shielded • 22 AWG Tinned Copper Drain Wire**

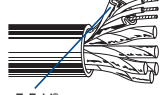
Polypropylene Insulation • Chrome PVC Jacket																			
 Z-Fold®	300V 80°C	UL AWM Style 2919	NEC:					0.76 mm	0.050	1.27	Individual Beldfoil® + Drain Wire (22 AWG TC)			50	66%	CDR/CDR	30	98	see chart 3 (Tech Info Section)
	CM					22 AWG													
	CEC:					(7x30) TC													
	CM																		

8777	3-Pair	100	31	4.6	2.1	0.273	6.93	CDR/CDR	30	98
		250	76	9.9	4.5					
		U-500	U-152	20.9	9.5					
		500	152	20.1	9.1					
		U-1000	U-305	41.0	18.6					
		1000	305	44.1	20.0					
		1640	500	70.5	32.0					
		3279	1000	141.1	64.0					
		5000	1524	215.2	97.6					
		† 10000	3049	460.3	208.8					

For halogen-free version see 8777NH.

8778	6-Pair	100	31	8.4	3.8	0.362	9.19	CDR/CDR	30	98
		250	76	19.0	8.6					
		500	152	43.0	19.5					
		1000	305	83.1	37.7					

For halogen-free version see 8778NH.

8774	9-Pair	100	31	11.5	5.2	0.417	10.59	CDR/CDR	30	98
		250	76	29.5	13.4					
		500	152	57.5	26.1					
		1000	305	113.1	51.3					

**22 AWG • Stranded (7x30) 0.8 mm TC • Twisted Pair • Each Pair Individually Beldfoil® Shielded • 22 AWG Tinned Copper Drain Wire**

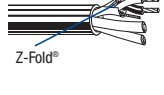
Plenum • FEP Insulation • Natural Flamarest® Jacket																			
 Z-Fold®	300V RMS	82777	NEC:	†† U-500	U-152	19.6	8.9	0.76 mm	0.050	1.27	Individual Beldfoil® + Drain Wire (22 AWG TC)	0.237	6.02	46	62%	CDR/CDR	35	115	see chart 3 (Tech Info Section)
	CMP		U-1000	U-305	38.1	17.3	22 AWG												
	CEC:		†† 1000	305	39.0	17.7	(7x30) TC												
	CMP FT6																		

3-Pair

TC = Tinned Copper • DCR = DC resistance • SCR = Capacitance between one conductor and other conductors connected to shield. • CDR = Capacitance between conductors  
 † Final put-up length may vary -10% to +20% from length shown. May contain 2 pieces. Minimum length of any one piece is 457 m (1500 ft.).  
 †† Spools and/or UnReel® cartons are one piece, but length may vary ±10% for spools and ±5% for UnReel® from length shown.

### Individually Shielded

### Audio, Control and Instrumentation Cables

De-scription	Part No.	UL NEC / C(UL)/CEC Type IEC	Standard Lengths		Standard Unit Weight		Conductor (Stranding) Diameter Nom. DCR	Nominal Insulation OD		Shielding Material Nom. DCR	Nominal OD		Nom. Imp. ( )	Nom. Vel. of Prop.	Nominal Capacitance		Color Code
			ft.	m	lbs.	kg		inch	mm		inch	mm			pF/ft.	pF/m	

**20 AWG • Stranded (7x28) 1.0 mm TC • Twisted Pair • Each Pair Individually Beldfoil® Shielded • 22 AWG Tinned Copper Drain Wire**

Semi-Rigid PVC Insulation • Overall Chrome PVC Jacket																		
300V 80°C UL AWM Style 2464	<b>9402</b>	NEC: CMG CEC: CMG FT4	U-500 1000	U-152 305	26.0 52.2	11.8 23.7	0.96 mm 20 AWG (7x28) TC	0.057	1.46	Individual Beldfoil® + Drain Wire (22 AWG TC)	0.300	7.62	-	-	CDR/CDR CDR/SCR	55 95	180 312	Red & Black, Green & White



Z-Fold®

2-Pair

**20 AWG • Stranded (7x28) 1.0 mm TC • Twisted Pair • Each Pair Individually Beldfoil® Shielded • 22 AWG Tinned Copper Drain Wire**

Polypropylene Insulation • Chrome PVC Jacket																		
30V 80°C UL AWM Style 2919		NEC: CM CEC: CM					0.96 mm 20 AWG (7x28) TC	0.066	1.68	Individual Beldfoil® + Drain Wire (22 AWG TC)			50	66%				see chart 3 (Tech Info Section)

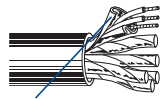

Z-Fold®

<b>9873</b>	3-Pair	100	31	6.6	3.0						0.341	8.66			CDR/CDR	30	98
		250	76	14.6	6.6										CDR/SCR	55	180
		500	152	32.6	14.8												
		1000	305	58.0	26.3												
<b>9874</b>	6-Pair	100	31	10.4	4.7						0.445	11.30			CDR/CDR	30	98
		250	76	29.1	13.2										CDR/SCR	55	180
		500	152	56.7	25.7												
		1000	305	113.1	51.3												
<b>9875</b>	9-Pair	100	31	17.9	8.1						0.555	14.10			CDR/CDR	30	98
		250	76	47.0	21.4										CDR/SCR	55	180
		500	152	94.0	42.8												
		1000	305	188.0	85.6												

**18 AWG • Stranded (19x30) 1.2 mm TC • Twisted Pair • Each Pair Individually Beldfoil® Shielded • 20 AWG Tinned Copper Drain Wire**

Polypropylene Insulation • Chrome PVC Jacket																		
30V 80°C UL AWM Style 2919		NEC: CM CEC: CM					1.24 mm 18 AWG (19x30) TC	0.082	2.08	Individual Beldfoil® + Drain Wire (20 AWG TC)			50	66%				see chart 3 (Tech Info Section)

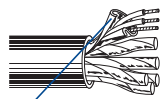

Z-Fold®

<b>9773</b>	3-Pair	100	31	10.8	4.9						0.404	10.26			CDR/CDR	30	98
		500	152	52.5	23.8										CDR/SCR	55	180
		1000	305	107.1	48.6												
<b>9774</b>	6-Pair	100	31	16.1	7.3						0.560	14.22			CDR/CDR	30	98
		500	152	90.2	40.9										CDR/SCR	55	180
		1000	305	178.1	80.8												
<b>9775</b>	9-Pair	100	31	25.8	11.7						0.655	16.64			CDR/CDR	30	98
		500	152	123.0	55.8										CDR/SCR	55	180
		1000	305	241.2	109.4												

TC = Tinned Copper • DCR = DC resistance • SCR = Capacitance between one conductor and other conductors connected to shield. • CDR = Capacitance between conductors

# Individually Shielded Pairs with Overall Foil/Braid Shield

## Cable Characteristics

### Attenuation

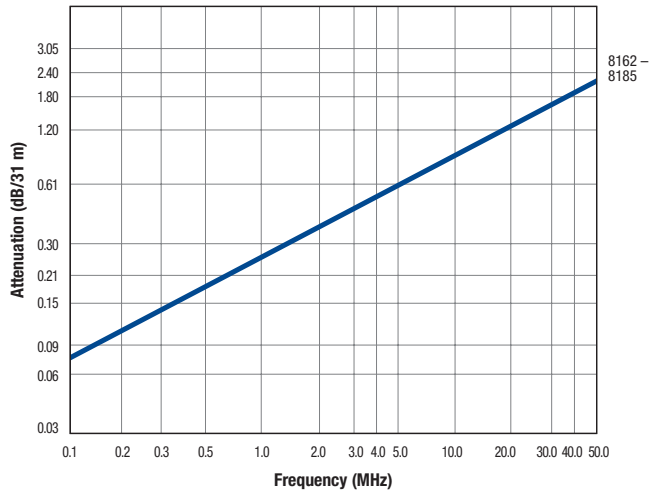

### Rise Time

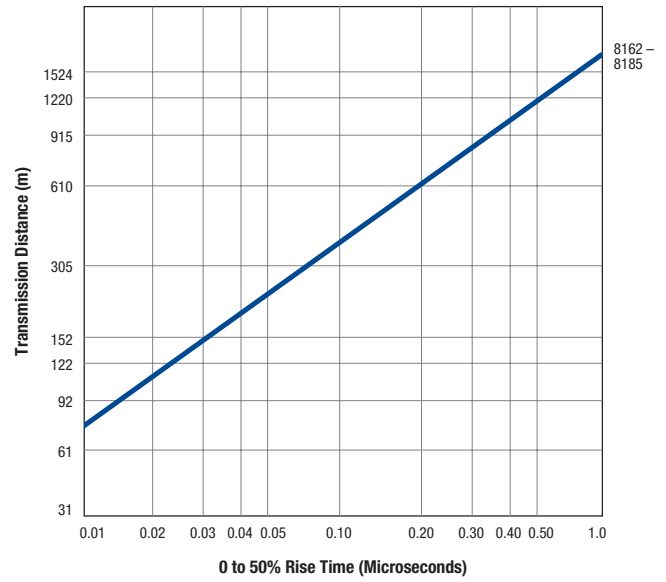

Cables are terminated in their characteristic impedance. Signal source electrical characteristics: 50 Ohm and 10% to 90% rise time less than 5 nanoseconds.

### Bit Rate

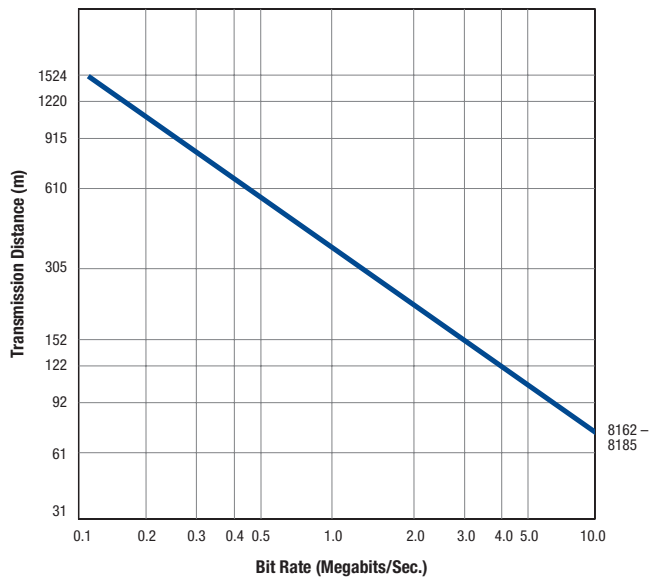

Charts assume 5% peak-to-peak time jitter as determined by eye pattern measurements of pseudorandom NRZ code.

### Individually Shielded Pairs with Overall Foil/Braid Shield

Low-Capacitance Computer Cables for  
EIA RS-232, EIA RS-422 and Digital Audio Applications

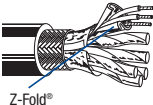
De- scription	Part No.	UL NEC/ C(UL)/CEC Type IEC	Standard Lengths		Standard Unit Weight		Conductor (Stranding) Diameter Nom. DCR	Nominal Insulation OD		Shielding Material Nom. DCR	Nominal OD		Nom. Imp. ( )	Nom. Vel. of Prop.	Nominal Capacitance		Color Code
			ft.	m	lbs.	kg		inch	mm		inch	mm			pF/ft.	pF/m	
<b>24 AWG • Stranded (7x32) 0.6 mm TC • Twisted Pair • Each Pair Beldfoil® Shielded • Overall Beldfoil® Shield + 65% TC Braid • 24 AWG TC DW</b> <b>Datalene® Insulation • Chrome PVC Jacket</b>																	
(60°C) VW-1 UL AWM Style 2493		NEC: CM CEC: CM					0.61 mm 24 AWG (7x32) TC	0.061	1.55	Individual Beldfoil® + Overall Beldfoil® + Overall 65% TC Braid + Drain Wire (24 AWG TC)			100	78%			see chart 3 (Tech Info Section)
																	
<b>8162</b>	2-Pair		100 500 1000	31 152 305	6.2 30.0 57.1	2.8 13.6 25.9					0.343	8.71			CDR/CDR CDR/SCR	13 22	41 72
<b>8163</b>	3-Pair		100 500 1000	31 152 305	7.1 34.2 66.1	3.2 15.5 30.0					0.359	9.12			CDR/CDR CDR/SCR	13 22	41 72
<b>8164</b>	4-Pair		100 500 1000	31 152 305	8.2 39.7 79.1	3.7 18.0 35.9					0.388	9.86			CDR/CDR CDR/SCR	13 22	41 72
<b>8165</b>	5-Pair		100 500 1000	31 152 305	9.0 45.2 89.3	4.1 20.5 40.5					0.413	10.49			CDR/CDR CDR/SCR	13 22	41 72
<b>8166</b>	6-Pair		100 500 1000	31 152 305	9.0 50.0 99.2	4.1 22.7 45.0					0.446	11.33			CDR/CDR CDR/SCR	13 22	41 72
<b>8167</b>	7-Pair		500 1000	152 305	52.7 103.0	23.9 46.7					0.446	11.33			CDR/CDR CDR/SCR	13 22	41 72
<b>8168</b>	8-Pair		100 500 1000	31 152 305	10.8 61.7 115.3	4.9 28.0 52.3					0.479	12.17			CDR/CDR CDR/SCR	13 22	41 72
<b>8170</b>	10-Pair		100 500 1000	31 152 305	18.1 83.1 164.2	8.2 37.7 74.5					0.584	14.83			CDR/CDR CDR/SCR	13 22	41 72
<b>8175</b>	15-Pair		100 500 1000	31 152 305	22.7 107.8 210.5	10.3 48.9 95.5					0.665	16.89			CDR/CDR CDR/SCR	13 22	41 72
<b>8178</b>	18-Pair		100 500 1000	31 152 305	24.7 117.3 238.5	11.2 53.2 108.2					0.686	17.42			CDR/CDR CDR/SCR	13 22	41 72
<b>8185</b>	25-Pair		100 500 1000	31 152 305	32.4 160.9 356.7	14.7 73.0 161.8					0.822	20.88			CDR/CDR CDR/SCR	13 22	41 72

TC = Tinned Copper • DW = Drain Wire • DCR = DC resistance • SCR = Capacitance between one conductor and other conductors connected to shield. • CDR = Capacitance between conductors

# Overall Braid Shield

## Computer Cables for EIA RS-232

De- scription	Part No.	No. of Pair	Standard Lengths		Standard Unit Weight		Conductor (Stranding) Diameter Nom. DCR	Nominal Conductor OD		Shielding Material Nom. DCR	Nominal OD		Application
			ft.	m	lbs.	kg		AWG	Section mm <sup>2</sup>		inch	mm	

**80°C • 24 - 18 AWG • Stranded Bare Copper Wire • Twisted Pair • >80 % Tinned Copper Braid**

**PVC Insulation** (Color Code: see chart 12, Tech Info Section) • **Grey Flame Retardant PVC Jacket**

750V	IEC 332	Overall >80% TC Braid	- Survey and data transmission - Check and drive systems - Measure and monitor systems - Interconnection of computer networks and outskirts interface
------	---------	--------------------------	---

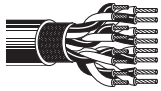

LiYC Y-TP

<b>HMC0630</b>	2	328	100	101.4	46.0	(8x0.193) BC	24	0.25	0.220	5.60
<b>HMC0631</b>	3	328	100	143.3	65.0	(8x0.193) BC	24	0.25	0.258	6.50
<b>HMC0632</b>	4	328	100	169.8	77.0	(8x0.193) BC	24	0.25	0.280	7.10
<b>HMC0633</b>	5	328	100	198.4	90.0	(8x0.193) BC	24	0.25	0.303	7.70
<b>HMC0634</b>	6	328	100	227.1	103.0	(8x0.193) BC	24	0.25	0.323	8.20
<b>HMC0635</b>	8	328	100	284.4	129.0	(8x0.193) BC	24	0.25	0.366	9.30
<b>HMC0636</b>	10	328	100	330.7	150.0	(8x0.193) BC	24	0.25	0.394	10.00
<b>HMC0637</b>	12	328	100	354.9	161.0	(8x0.193) BC	24	0.25	0.417	10.60
<b>HMC0638</b>	2	328	100	154.3	70.0	(16x0.193) BC	20	0.50	0.276	7.00
<b>HMC0639</b>	3	328	100	207.2	94.0	(16x0.193) BC	20	0.50	0.327	8.30
<b>HMC0640</b>	3	328	100	224.9	102.0	(22x0.193) BC	18	0.75	0.335	8.50

TC = Tinned Copper • BC = Bare Copper • DCR = DC resistance



# 6 MIL-C-17 Coaxes

## Table of Contents

MIL-C-17 Coaxes	Page No.
Introduction	6.2
MIL-C-17 Cables	6.3 – 6.6
50 Ohm Coax	6.3 – 6.4
75 Ohm Coax	6.5
95 Ohm Coax	6.6

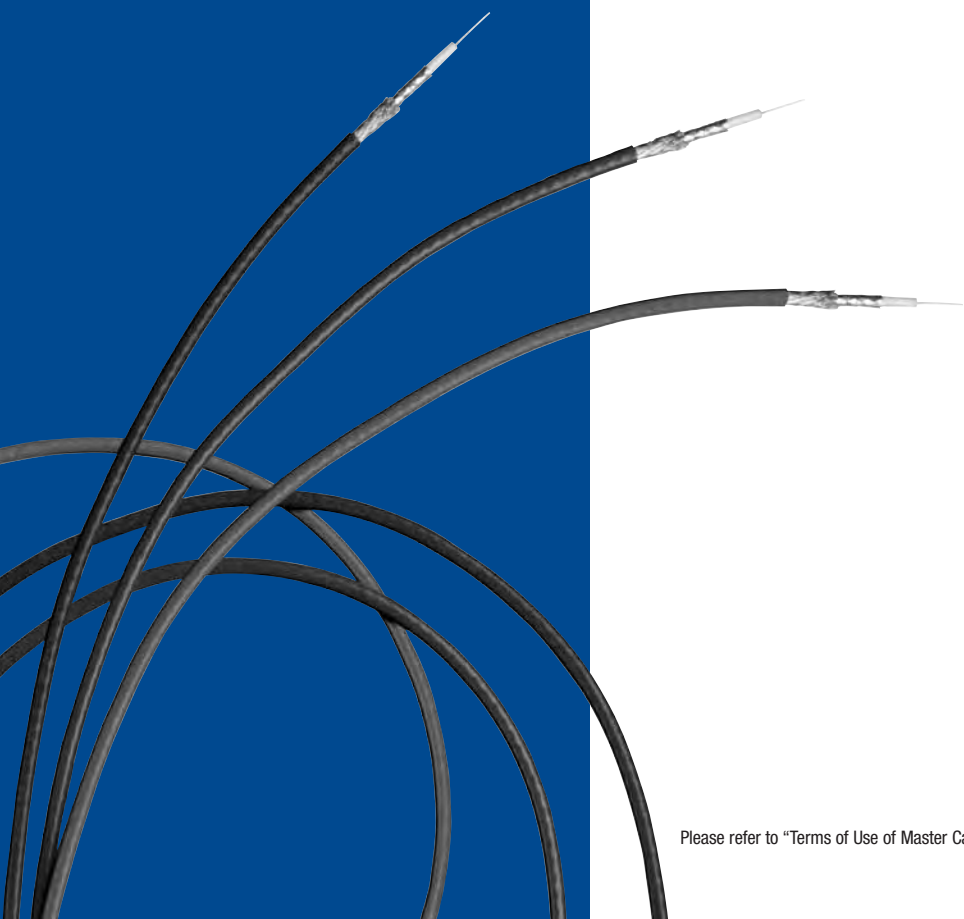

Please refer to "Terms of Use of Master Catalog" on page 23.22.

## Introduction

### From Military to Civilian Use

Micro-coaxial cables are used in various consumer devices, military equipment and ultra-sound scanning equipment. There are different shielding configurations for different applications.

Although fiber optics, T1/E1, satellite and other high-tech methods are becoming the new standards, radio and especially television networks are connected with long distance coaxial cables. The history of these cables starts with the Second World War when the standard types were used by the military – when positive, reliable and trouble-free operation were essential to get users out of trouble.

Today – for different other purposes, Belden’s cables offer performance second to none.

### Key Applications

- Computer networks
- Radio
- Television
- Consumer devices
- Military equipment

### Special Features

- **Short Coaxial Cable**  
Connectivity for home video equipment, or in ham radio setups. Also commonly used for implementing computer networks; in particular ethernet.
- **Long Distance Coaxial Cable**  
Connect radio networks and television networks, though this has largely been superseded by other more high-tech methods (fiber optics, T1/E1, satellite). It is still common for carrying cable television signals.
- **Micro-Coaxial Cable**  
Used in a range of consumer devices, military equipment, and also in ultra-sound scanning equipment.

### Availability

Most of our MIL-C-17 coax cables are available from stock. Many of these are available off the shelf from distributors. If you have a new or unusual application or you cannot find a MIL-C-17 coax cable in this catalog section that meets your technical requirements contact technical support at +31-77-3875-414 or [techsupport.venlo@belden.com](mailto:techsupport.venlo@belden.com).







#### RG Designators

Standard types of coaxial cable were specified for military uses, in the form “RG-#” or “RG-#/U” (RG from radio guide, /U indicates multiple use). These references go back to World War II and were published in MIL-HDBK-216 (1962). These designations are now obsolete.

Currently the military standard is MIL-SPEC MIL-C-17. Numbers, such as M17/75-RG214, are given for military cables and manufacturer’s catalog numbers for civilian applications. However, the RG-series designations were so common for generations that they are still used. Please be aware that since the handbook is withdrawn there is no standard to guarantee the electrical and physical characteristics of a cable described as “RG-# type”.

The RG designators are mostly used to identify compatible connectors that fit the inner conductor, dielectric, and jacket dimensions of the old RG-series cables.

# 50 Ohm Coax

De- scription	Part No.	UL NEC/ C(UL)/CEC Type IEC	Standard Lengths		Standard Unit Weight		Conductor (Stranding) Diameter	Nominal Core OD (Dielectric)		Shielding Material Nom. DCR	Nominal OD		Nom. Imp. ( )	Nom. Vel. of Prop.	Nominal Capacitance		Nominal Attenuation			
			ft.	m	lbs.	kg		inch	mm		inch	mm			pF/ft.	pF/m	MHz	dB/ 100 Ft.	dB/ 100 m	
<b>30 AWG • Stranded (7x0.10) 0.3 mm Silver-Plated Copperweld-Steel-Wire • 96% Silver-Plated Copper Braid</b>																				
<b>PTFE Insulation • Tinted Brown FEP Jacket</b>																				
200°C RG-178 B/U	<b>MRG178</b>		3280	1000	19.8	9.0	0.3 mm 30 AWG (7x0.10) SPCSW	0.033	0.84	96% SPC Braid	0.071	1.80	50	69.5%	32.0	104.9 max.	10	4.9	16.1	
																	50	11.6	38.0	
																	100	16.0	52.5	
																	200	23.0	75.4	
																	400	33.0	108.2	
																	700	45.0	147.6	
																	900	50.0	164.0	
																	1000	52.0	170.6	
																	3000	94.0	308.3	
																				
<b>PTFE Insulation • Tinted Brown PTFE Jacket</b>																				
200°C RG-196 A/U	<b>MRG196</b>		3280	1000	19.0	8.6	0.3 mm 30 AWG (7x0.10) SPCSW	0.033	0.84	96% SPC Braid	0.071	1.80	50	69.5%	32.0	104.9 max.				see above
																				
Also available with White PTFE Jacket.																				
<b>26 AWG • Stranded (7x0.17) 0.51 mm Silver-Plated Copperweld-Steel-Wire • 95% Silver-Plated Copper Braid</b>																				
<b>PTFE Insulation • Tinted Brown FEP Jacket</b>																				
200°C RG-316 /U	<b>MRG316</b>		3280	1000	35.3	16.0	0.51 mm 26 AWG (7x0.17) SPCSW	0.058	1.47	95% SPC Braid	0.098	2.49	50	69.5%	32.0	104.9 max.	10	3.5	11.5	
																	50	7.5	24.6	
																	100	11.0	36.1	
																	200	15.0	49.2	
																	400	21.0	68.9	
																	700	28.0	91.8	
																	900	32.0	105.0	
																	1000	34.0	111.5	
																	3000	58.0	190.2	
																				
<b>PTFE Teflon® Insulation • Tinted Brown TFE Tape Jacket</b>																				
200°C RG-188 A/U	<b>MRG188</b>		3280	1000	33.1	15.0	0.51 mm 26 AWG (7x0.17) SPCSW	0.058	1.47	96% SPC Braid	0.098	2.49	50	69.5%	32.0	104.9 max.				see above
																				
Also available with White PTFE Jacket.																				
<b>19 AWG • Solid 0.9 mm Silver-Plated Copperweld-Steel-Wire • 95% Silver-Plated Copper Braid</b>																				
<b>PTFE Insulation • Tinted Brown FEP Jacket</b>																				
200°C RG-303 /U	<b>MRG303</b>	NEC: CL2P	3280	1000	103.6	47.0	0.94 mm 19 AWG Solid SPCSW	0.116	2.95	95% SPC Braid	0.170	4.31	50	70%	32.0	104.9 max.	10	1.1	3.6	
																	50	2.7	8.9	
																	100	3.9	12.8	
																	200	5.8	19.0	
																	400	8.6	28.2	
																	700	12.0	39.4	
																	900	13.5	44.3	
																	1000	14.5	47.6	
																	3000	27.0	88.6	
																				
<b>PTFE Insulation • Tinted Brown FEP Jacket</b>																				
200°C RG-142 B/U	<b>MRG142</b>	NEC: CMP CEC: CMP FT6	3280	1000	145.5	66.0	0.94 mm 19 AWG Solid SPCSW	0.116	2.95	96% SPC Double Braid	0.195	4.95	50	70%	29.3	96.1	10	1.3	4.1	
																	50	3.0	9.8	
																	100	4.4	14.4	
																	200	6.3	20.7	
																	400	9.3	30.5	
																	700	12.5	41.0	
																	900	14.5	47.6	
																	1000	15.3	50.2	
																	3000	29.3	96.1	
																	8000	57.8	189.6	
																	124000	85.4	280.1	
																				

SPCSW = Silver-Plated Copperweld-Steel-Wire • SPC = Silver-Plated Copper • DCR = DC resistance

Teflon® is a DuPont trademark.



For more information, contact Belden Technical Support +31-77-3875-414 • www.belden-emea.com



# 50 Ohm Coax

De- scription	Part No.	UL NEC/ C(UL)CEC Type IEC	Standard Lengths		Standard Unit Weight		Conductor (Stranding) Diameter	Nominal Core OD (Dielectric)		Shielding Material Nom. DCR	Nominal OD		Nom. Imp. ( )	Nom. Vel. of Prop.	Nominal Capacitance		Nominal Attenuation		
			ft.	m	lbs.	kg		inch	mm		inch	mm			pF/ft.	pF/m	MHz	dB/ 100 Ft.	dB/ 100 m
<b>15 AWG • Solid 1.5 mm Silver-Plated Copperweld-Steel-Wire • 95 % Silver-Plated Copper Braid</b>																			
<b>PTFE Insulation • Tinted Brown FEP Jacket</b>																			
200°C RG-304 /U	<b>MRG304</b>		3280	1000	282.2	128.0	1.50 mm 15 AWG Solid SPCSW	0.187	4.75	95% SPC Braid	0.283	7.20	50	69.5%	32.0	104.9 max.	10	0.7	2.2
																50	1.8	5.9	
																100	2.7	8.9	
																200	4.2	13.8	
																400	6.4	21.0	
																700	9.0	29.5	
																900	10.5	34.4	
																1000	11.1	36.4	
																8000	40.0	131.2	



<b>12 AWG • Stranded (7x0.80) 2.4 mm Silver-Plated Copper • 96 % Silver-Plated Copper Braid</b>																			
<b>PTFE Insulation • Tinted Brown TGL Jacket</b>																			
200°C RG-165 /U	<b>MRG165</b>		3280	1000	436.5	198.0	2.4 mm 12 AWG (7x0.80) SPC	0.283	7.20	96% SPC Braid	0.413	10.50	50	69.5%	29.3	96.1	10	0.5	1.8
																50	1.4	4.6	
																100	2.1	6.9	
																200	3.1	10.2	
																400	4.7	15.4	
																700	6.4	21.0	
																900	7.4	24.3	
																1000	8.0	26.2	
																3000	13.7	44.9	



<b>12 AWG • Stranded (7x0.79) 2.3 mm Silver-Plated Copper • 95 % Silver-Plated Copper Double Braid</b>																			
<b>PTFE Insulation • Tinted Brown TGL Jacket</b>																			
200°C RG-225 /U	<b>MRG225</b>		3280	1000	590.8	268.0	2.3 mm 12 AWG (7x0.79) SPC	0.283	7.20	95% SPC Double Braid	0.425	10.80	50	69.5%	32.3	106.0 max.	400	5.0	16.4



SPCSW = Silver-Plated Copperweld-Steel-Wire • SPC = Silver-Plated Copper • DCR = DC resistance

# 75 Ohm Coax

De- scription	Part No.	UL NEC/ C(UL)/CEC Type IEC	Standard Lengths		Standard Unit Weight		Conductor (Stranding) Diameter	Nominal Core OD (Dielectric)		Shielding Material Nom. DCR	Nominal OD		Nom. Imp. ( )	Nom. Vel. of Prop.	Nominal Capacitance		Nominal Attenuation		
			ft.	m	lbs.	kg		inch	mm		inch	mm			pF/ft.	pF/m	MHz	dB/ 100 Ft.	dB/ 100 m

**30 AWG • Stranded (7x0.10) 0.3 mm Silver-Plated Copperweld-Steel-Wire • 95 % Silver-Plated Copper Braid**

PTFE Insulation • Tinted Brown FEP Jacket																			
200°C RG-179 B/U	<b>MRG179</b>		3280	1000	35.3	16.0	0.3 mm 30 AWG (7x0.10) SPCSW	0.062	1.58	95% SPC Braid	0.100	2.54	75	69.5%	22.9	75.0 max.	400	21.0	68.8



PTFE Insulation • Tinted Brown TFE Tape Jacket																			
200°C RG-187 A/U	<b>MRG187</b>		3280	1000	33.1	15.0	0.3 mm 30 AWG (7x0.10) SPCSW	0.063	1.60	95% SPC Braid	0.103	2.62	75	70%	22.9	75.0 max.			see above



Also available with White PTFE Jacket.

**22 AWG • Solid 0.64 mm Silver-Plated Copperweld-Steel-Wire • 95 % Silver-Plated Copper Braid**

PTFE Insulation • Tinted Brown FEP Jacket																			
200°C RG-302 /U	<b>MRG302</b>		3280	1000	130.1	59.0	0.64 mm 22 AWG Solid SPCSW	0.148	3.75	95% SPC Braid	0.203	5.15	75	69.5%	32.0	104.9 max.	400	8.6	28.2



PTFE Insulation • Tinted Brown TGL Jacket																			
200°C RG-140 /U	<b>MRG140</b>		3280	1000	154.3	70.0	0.64 mm 22 AWG Solid SPCSW	0.148	3.75	95% SPC Braid	0.228	5.80	75	69.5%	19.2	63.0	400	8.0	26.2



SPCSW = Silver-Plated Copperweld-Steel-Wire • SPC = Silver-Plated Copper • DCR = DC resistance

## 95 Ohm Coax

De- scription	Part No.	UL NEC/ C(UL)CEC Type IEC	Standard Lengths		Standard Unit Weight		Conductor (Stranding) Diameter	Nominal Core OD (Dielectric)		Shielding Material Nom. DCR	Nominal OD		Nom. Imp. ( )	Nom. Vel. of Prop.	Nominal Capacitance		Nominal Attenuation		
			ft.	m	lbs.	kg		inch	mm		inch	mm			pF/ft.	pF/m	MHz	dB/ 100 Ft.	dB/ 100 m

**30 AWG • Stranded (7x0.10) 0.3 mm Silver-Plated Copper-Steel-Wire • 91% Silver-Plated Copper Braid**

<b>PTFE Insulation • Tinted Brown FEP Jacket</b>																			
200°C RG-180 B/U	<b>MRG180</b>		3280	1000	61.7	28.0	0.3 mm 30 AWG (7x0.10) SPCSW	0.102	2.60	91% SPC Braid	0.141	3.58	95	69.5%	17.4	57.0 max.	400	17.0	55.7



<b>PTFE Insulation • Tinted Brown PTFE Jacket</b>																			
200°C RG-195 A/U	<b>MRG195</b>		3280	1000	59.5	27.0	0.3 mm 30 AWG (7x0.10) SPCSW	0.102	2.60	91% SPC Braid	0.141	3.58	95	69.5%	17.4	57.0 max.			see above



SPCSW = Silver-Plated Copperweld-Steel-Wire • SPC = Silver-Plated Copper • DCR = DC resistance



# Shipboard and Offshore Cables

## Table of Contents

<b>Shipboard and Offshore Cables</b>	<b>Page No.</b>
<b>Introduction</b>	<b>7.2</b>
<b>Audio, Control and Instrumentation Cables</b>	<b>7.3</b>
LSNH/FRNC	7.3
<b>Broadband Coaxial Cables</b>	<b>7.4</b>
CATV Cables, Series 6, LSNH/FRNC	7.4
<b>Precision Video Cables for Analog and Digital</b>	<b>7.4</b>
Digital Coax, RG-6U Type, LSNH/FRNC	7.4
<b>Networking Cables</b>	<b>7.5</b>
DataTwist 5e ScTP, LSNH/FRNC	7.5
<b>Security Composite Cables</b>	<b>7.5</b>
CCTV plus Audio or Pan/Tilt/Zoom CCTV LSNH/FRNC	7.5
<b>RiserLite® Loose Tube Indoor/Outdoor, Fiber Optic Cables</b>	<b>7.6 – 7.7</b>
Single-Mode and Multimode-Riser-Rated, LSNH/FRNC	7.6 – 7.7
<b>Control for Propulsion Systems</b>	<b>7.8 – 7.9</b>
300/500V, 180°C	7.8 – 7.9
<b>Instrument &amp; Communication</b>	<b>7.10</b>
250V, 90°C	7.10
<b>Power &amp; Control</b>	<b>7.11 – 7.13</b>
300/500V, 90°C	7.11 – 7.13

## Introduction

### All Aboard and Shipshape

Conditions at sea can get rough, so reliable communication is vital. Equipment must function well at all times and in all weathers. Belden cables meet the highest international marine standards – serving across the seven seas.

Belden's new Shipboard & Offshore cable line is comprised of Belden Brilliance®, DataTwist® and classic design cables designed to implement a wide range of shipboard audio, video, security, networking, control, instrument, communication and power applications. The Belden shipboard series also includes a selection of all-dielectric fiber optic cables.

### Key Applications

- Navigational instruments
- A/V equipment
- Propulsion and control system
- Marine networking

### Special Features

- Delivery of the highest quality A/V performance to operators and owners of private yachts, and passengers and crew on commercial ships.
- Fast, easy installation using standard connectors, with no special installation techniques or equipment required.
- Exclusive and unmatched Belden 10 Year Warranty.

### Availability

To assist you in selecting the approval of the proper cable for your application, the approval logos are indicated for each applicable product in this section.

Most of our Shipboard & Offshore cables are available from stock. Many of these are available off the shelf from distributors. If you have a new or unusual application or you cannot find a Shipboard & Offshore cable in this catalog section that meets your technical requirements contact technical support at +31-77-3875-414 or techsupport.venlo@belden.com.

### Corresponding Literature

#### Product Bulletins

NP222: Shipboard Audio/Video ABS approved by ABS for Marine Installations

### Meeting the Standards

Cables comply with industry standards IEEE 45 and applicable sections of IEC 60092-376 for low-smoke and zero-halogen. Because of the global nature of the marine industry, the cables are designed and manufactured to comply with European Union RoHS Directive (2002/95/EC, 27-Jan-2003) governing the Reduction of Hazardous Substances in electrical and electronic equipment.

All Belden Shipboard & Offshore cables are designed to match the type approval program from either:

- ABS (American Bureau of Shipping) is the most widely recognized Safety Standards organization serving the shipbuilding and marine structures industries. This offers third-party certification of products – known as “Type Approval Program”. With ABS approval, no additional special approvals or insurance company exceptions are required for Belden cable system installations. 

or

- GLC (Germanischer Lloyd Certification) offers an independent and professional service for the evaluation of management systems. The Germanischer Lloyd network is a very wide international service covering more than 135 countries. 

# Audio, Control and Instrumentation Cables

## Low-Smoke Zero-Halogen

De-scription	Part No.	UL NEC / C(UL)/CEC Type IEC	Standard Lengths		Standard Unit Weight		Conductor (Stranding) Diameter Nom. DCR	Nominal Insulation OD		Shielding Material Nom. DCR	Nominal OD		Nom. Imp. ( )	Nom. Vel. of Prop.	Nominal Capacitance		Color Code
			ft.	m	lbs.	kg		inch	mm		inch	mm			pF/ft.	pF/m	

**22 AWG • Stranded (7x30) 0.8 mm Tinned Copper • Twisted Pair • Overall Beldfoil® Shield • 22 AWG Tinned Copper Drain Wire**

Polypropylene Insulation • Black FRNC/LSNH Jacket																		
300V RMS 150°C	<b>9451SB</b>	NEC: CEC: CMG-LS FT4 Limited Smoke	1000	305	20.0	9.1	0.76 mm 22 AWG (7x30) TC	0.046	1.16	Overall Beldfoil® + Drain Wire (22 AWG TC)	0.160	4.06	45	66%	CDR/CDR CDR/SCR	35 67	115.0 220.0	Black, Red



0.34 mm²  
1-Pair



The jacket and shield are bonded so both can be removed with automatic stripping equipment.  
Drain wire is inside foil shield.

**22 AWG • Stranded (7x30) 0.8 mm Tinned Copper • Twisted Pair • Beldfoil® • 24 AWG Tinned Copper Drain Wire**

Polypropylene Insulation • Black FRNC/LSNH Jacket																		
300V RMS 105°C	<b>8723SB</b>	NEC: CEC: CMG-LS FT4 Limited Smoke	1000	305	26.0	11.8	0.76 mm 22 AWG (7x30) TC	0.046	1.16	Individual Beldfoil® + Drain Wire (24 AWG TC)	0.196	4.98	45	66%	CDR/CDR CDR/SCR	35 67	115.0 220.0	Black & Red, Green & White



2-Pair



Pairs cabled on common axis to reduce diameter.

**22 AWG • Stranded (7x30) 0.8 mm Tinned Copper • Twisted Pair • Beldfoil® • 22 AWG Tinned Copper Drain Wire**

Polypropylene Insulation • Black FRNC/LSNH Jacket																		
U300V RMS Non-Conduit	<b>8777SB</b>	NEC: CEC: CMG-LS FT4 Limited Smoke	† 500	152	19.6	8.9	0.76 mm 22 AWG (7x30) TC	0.050	1.26	Individual Beldfoil® + Drain Wire (22 AWG TC)	0.273	6.93	50	66%	CDR/CDR CDR/SCR	30 55	98.0 180.0	Black & Red, Black & White, Black & Green

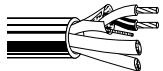

3-Pair



TC = Tinned Copper • DCR = DC resistance  
† Spools are one piece, but length may vary 0% to +20% from length shown.

### Broadband Coaxial Cables

#### CATV Cables, Series 6, Low-Smoke Zero-Halogen

De- scription	Part No.	UL NEC/ C(UL)CEC Type IEC	Standard Lengths		Standard Unit Weight		Conductor (Stranding) Diameter Nom. DCR	Nominal Insulation OD		Shielding Material Nom. DCR	Nominal OD		Nom. Imp. ( )	Nom. Vel. of Prop.	Nominal Capacitance		Nominal Attenuation		
			ft.	m	lbs.	kg		inch	mm		inch	mm			pF/ft.	pF/m	MHz	dB/ 100 ft.	dB/ 100 m
<b>Series 6 • 18 AWG • Solid 1.0 mm Copper-Covered Steel • Duobond® II • 60% Aluminum Braid</b>																			
<b>Gas-Injected Foam Polyethylene Insulation • Black FRNC/LSNH Jacket</b>																			
75°C	<b>9116SB</b>	NEC: CEC: CMG-LS FT4 Limited Smoke	1000	305	31.1	14.1	1.02 mm 18 AWG Solid CCS 121.4 /km* 91.9 /km**	0.180	4.57	Duobond® II + 60% AL Braid 29.5 /km*** 5.4 mm	0.274	6.96	75	83%	16.2	53.1	5	0.54	1.77
																	55	1.45	4.76
																	211	2.64	8.66
																	270	2.97	9.74
																	300	3.13	10.27
																	350	3.39	11.12
																	375	3.52	11.55
																	400	3.65	11.97
																	450	3.88	12.73
																	500	4.09	13.42
																	600	4.51	14.80
																	650	4.72	15.49
																	700	4.92	16.14
																	750	5.11	16.76
																	800	5.27	17.29
																	862	5.47	17.95
																	870	5.49	18.01
																	900	5.60	18.37
																	950	5.79	19.00
																	1000	5.99	19.65
																	1450	7.80	25.60
																	1800	8.60	28.20
																	2250	9.82	32.20
																	3000	11.31	37.10
Sweep tested 5 MHz to 3 GHz																			

\* DC loop resistance • \*\* DC resistance inner conductor • \*\*\* DC resistance outer conductor • DCR = DC resistance • CCS = Copper-Covered Steel • AL = Aluminum

### Precision Video Cable for Analog and Digital

#### Low Loss Serial Digital Coax, RG-6U Type, Low-Smoke Zero-Halogen

De- Description	Part No.	UL NEC/ C(UL)CEC Type IEC	Standard Lengths		Standard Unit Weight		Conductor (Stranding) Diameter Nom. DCR	Nominal Insulation OD		Shielding Material Nom. DCR	Nominal OD		Nom. Imp. ( )	Nom. Vel. of Prop.	Nominal Capacitance		Nominal Attenuation		
			ft.	m	lbs.	kg		Inch	mm		Inch	mm			pF/ft.	pF/m	MHz	dB/ 100 ft.	dB/ 100 m
<b>RG-6/U Type • 18 AWG • Solid 1.0 mm Bare Copper • Duofoil® • 95% Tinned Copper Braid</b>																			
<b>Gas-injected Foam HDPE Insulation • Black FRNC/LSNH Jacket</b>																			
SDI/HDTV Digital Video 75°C	<b>1694SB</b>	NEC: CEC: CMG-LS FT4 Limited Smoke	1000	305	46.0	20.9	1.02 mm 18 AWG Solid BC 30.2 /km* 21.0 /km**	0.180	4.57	Duofoil® + 95% TC Braid 9.2 /km***	0.274	6.96	75	82%	16.2	53.1	1	0.2	0.8
																	3.6	0.5	1.5
																	10	0.7	2.4
																	71.5	1.6	5.2
																	135	2.1	6.9
																	270	3.0	9.7
																	360	3.4	11.3
																	540	4.2	13.9
																	720	4.9	16.2
																	750	5.0	16.4
																	1000	5.9	19.3
																	1500	7.3	24.0
																	2250	9.1	30.0
																	3000	10.7	35.0
																	4500	13.3	43.6
Sweep tested 5 MHz to 4.5 GHz																			

\* DC loop resistance • \*\* DC resistance inner conductor • \*\*\* DC resistance outer conductor • DCR = DC resistance • BC = Bare Copper • TC = Tinned Copper

## Networking Cables

### DataTwist® 5e ScTP, Low-Smoke Zero-Halogen

De- scription	Part No.	UL NEC / C(UL)CEC Type IEC	Standard Lengths		Standard Unit Weight		Conductor (Stranding) Diameter Nom. DCR	Nominal Insulation OD		Shielding Material Nom. DCR	Nominal OD		Freq. MHz	Max. Atten. dB/100m	Min. PSUM			ACR dB/100m	Min. RL dB
			ft.	m	lbs.	kg		inch	mm		inch	mm			NEXT dB	ACR dB/100m	ELFEXT dB/100m		
<b>Cat 5e • 24 AWG • Twisted Pairs • Solid 0.5 mm BC • Overall Beldfoil® Shield • RJ-45 Compatible • 24 AWG TC Drain Wire • 100 Ohm ± 15 %</b>																			
<b>Polypropylene Insulation (Color Code: see chart below) • Black FRNC/LSNH Jacket</b>																			
105°C	1300SB	NEC: CEC: CMG-LS FT4 Limited Smoke	1000	305	35.1	15.9	0.51 mm 24 AWG Solid BC	0.042	1.07	Non- Bonded-Pair Unshielded Overall Beldfoil® + Drain Wire (24 AWG TC)	0.260	6.60	1 4 8 10 16 20 25 31.25 62.5 100	2.0 4.1 5.8 6.5 8.2 9.3 10.4 11.7 17.0 22.0	62.3 53.3 48.8 47.3 44.3 42.8 41.3 39.9 35.4 32.3	60.3 49.2 43.0 40.8 36.1 33.5 30.9 28.2 24.8 20.8	60.8 48.7 42.7 40.8 36.7 34.7 32.8 30.9 28.2 24.8	60.3 49.2 43.0 40.8 36.1 33.5 30.9 28.2 24.8 20.8	20.0 23.0 24.5 25.0 25.0 25.0 24.3 23.6 21.5 20.1

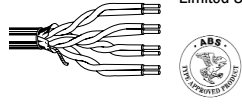

4-Pair

Shield is bonded to jacket inner wall for electrical stability.  
Jacket sequentially marked at 0.6 m intervals. Third party verified to TIA/EIA-568-B.2, Category 5e

BC = Bare Copper • TC = Tinned Copper • ACR = Attenuation Crosstalk Ratio • DCR = DC resistance •  
ELFEXT = Equal Level Far-end Crosstalk • NEXT = Near-end Crosstalk • PSUM = Power Sum •  
RL = Return Loss • ScTP = Screened (Overall Foil) Twisted Pair(s)

#### Color Code

Pair No.	Color Combination
1	White/Blue Stripe & Blue
2	White/Orange Stripe & Orange
3	White/Green Stripe & Green
4	White/Brown Stripe & Brown

## Security Composite Cables

### CCTV plus Audio or Pan/Tilt/Zoom CCTV Control Applications

#### Low-Smoke Zero-Halogen

De- scription	Part No.	UL NEC / C(UL)CEC Type IEC	Standard Lengths		Standard Unit Weight		Color code	Nominal OD		Compo- nent	Description	Shielding Material & Nom. DCR	Insulation Material & Colors	Component Jacket Material & Colors	Component OD	
			ft.	m	lbs.	kg		inch	mm						inch	mm
<b>Composite • (1) Series 6 Coax • 2 Conductor (Audio) stranded</b>																
<b>FPE Coax Insulation • Polypropylene Pair Insulation • Black FRNC/LSNH Jacket</b>																
75°C	1306SB	NEC: CEC: CMG-LS FT4 Limited Smoke	500	152	37.0	16.8	Black & Red	0.514	13.06	1xAudio	1-Pair 18 AWG 1.2 mm (7x26) BC	Unshielded	Polypropylene	FRNC Black	0.239	6.07
										1xCCTV	Series 6 18 AWG 1.0 mm Solid BC	95% BC Braid	FPE	FRNC Black	0.275	6.99

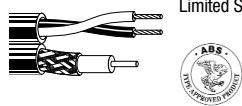

Coax sweep tested to 2.25 GHz and jacket sequentially marked.  
Third party verified to TIA/EIA-568-B.2, Category 5e

BC = Bare Copper • DCR = DC resistance



# RiserLite® Loose Tube Indoor/Outdoor, Fiber Optic Cables#

## Single-Mode and Multimode-Riser-Rated, Low-Smoke Zero-Halogen

De- scription	Part No.	No. of Fibers	Standard Lengths		Standard Unit Weight		Fiber Size µm	Nom. Buffer/ Tube OD		Strength Members	Nominal OD		Central Element mm	Pulling Tension N	Crush Re- sistance kN/m	Energy kJ/m	Bending Radii Cable (mm)	
			ft.	m	lbs.	kg		inch	mm		inch	mm					static	dyna- mic

**M9W • Loose Tube • Single-Mode**

Synthetic Thixotropic Gel Construction • Overall Water-Blocking Tape • Black FRNC/LSNH Jacket																		
70°C	<b>M9W830</b>	6 (1x6)	Manufactured	233.5	105.9	∅ 250 ± 15	0.07	1.90	Aramid Yarn	0.38	9.65	no	2700	20	–	145	193	
	<b>M9W831</b>	12 (2x6)	per Order	233.5	105.9					0.38	9.65							
	<b>M9W832</b>	24 (4x6)		233.5	105.9					0.38	9.65							
	<b>M9W834</b>	48 (4x12)*		332.0	150.6					0.48	12.18							

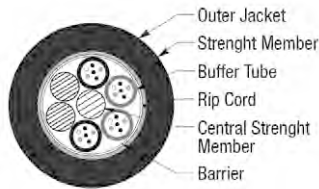

Construction: 6 fibers per tube, cabled with fillers. \*12 fibers per tube

**M9 • Loose Tube • Multimode 50/125 Grade 4**

Synthetic Thixotropic Gel Construction • Overall Water-Blocking Tape • Black FRNC/LSNH Jacket																		
70°C	<b>M97537</b>	2 (2x1)**	Manufactured	233.5	105.9	∅ 250 ± 15	0.07	1.90	Aramid Yarn	0.38	9.65	no	2700	20	–	145	193	
	<b>M9A830</b>	6 (1x6)	per Order	233.5	105.9					0.38	9.65							
	<b>M9A831</b>	12 (2x6)		233.5	105.9					0.38	9.65							
	<b>M9A832</b>	24 (4x6)		233.5	105.9					0.48	12.18							
	<b>M9A834</b>	48 (4x12)*		332.0	150.6													

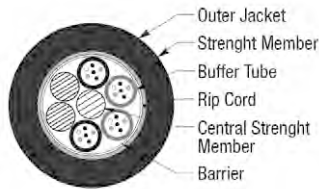

Construction: 6 fibers per tube, cabled with fillers. \*12 fibers per tube, \*\*1 fiber per tube

**M9C • Loose Tube • Multimode 50/125 Grade 4**

Synthetic Thixotropic Gel Construction • Overall Water-Blocking Tape • Black FRNC/LSNH Jacket																		
70°C	<b>M9C830</b>	6 (1x6)	Manufactured	233.5	105.9	∅ 250 ± 15	0.07	1.90	Aramid Yarn	0.38	9.65	no	2700	20	–	145	193	
	<b>M9C831</b>	12 (2x6)	per Order	233.5	105.9					0.38	9.65							
	<b>M9C832</b>	24 (4x6)		233.5	105.9					0.38	9.65							
	<b>M9C834</b>	48 (4x12)*		332.0	150.6					0.48	12.18							

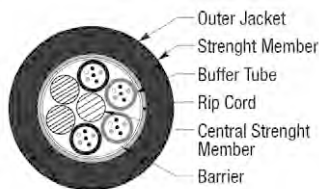

Construction: 6 fibers per tube, cabled with fillers. \*12 fibers per tube

# Available in fiber counts 1 through 144, and in all glass types.

**RiserLite® Loose Tube Indoor/Outdoor, Fiber Optic Cables<sup>#</sup>**Single-Mode and Multimode-Riser-Rated, Low-Smoke Zero-Halogen (*continued*)

Glass Types and Specifications	UOM	Single-Mode Fiber *	Multimode Grade 4	Multimode Grade 5
Operating Wavelength (Short) – nm	nm	1310	850	850
Operating Wavelength (Long) – nm	nm	1550	1300	1300
Min. OFL Bandwidth (@ Short Wavelength)	MHz-km	–	500	1500
Min. OFL Bandwidth (@ Long Wavelength)	MHz-km	–	500	500
Min. Laser Bandwidth (@ Short Wavelength)	MHz-km	–	510	2000
Min. Laser Bandwidth (@ Long Wavelength)	MHz-km	–	500	500
Max. Attenuation (@ Short Wavelength)	db/km	0.4	3.0	3.0
Max. Attenuation (@ Long Wavelength)	db/km	0.3	1.0	1.0
100 Mb/s Fast Ethernet Link Length @ WL = 850 nm	m	–	300	300
100 Mb/s Fast Ethernet Link Length @ WL = 1310 nm	m	5000	2000	2000
1 Gb/s Ethernet Link Length @ WL = 850 nm	m	–	600	1000**
1 Gb/s Ethernet Link Length @ WL = 1310 nm	m	5000	600	600
10 Gb/s Ethernet Link Length @ WL = 850 nm	m	–	82	300
10 Gb/s Ethernet Link Length @ WL = 1310 nm	m	10000	300	300

# Available in fiber counts 1 through 144, and in all glass types.

\* Low water peak single-mode suitable for CWDM use complies with ITU G.652.c/d.

\*\* &gt; 200 m for engineered links

OFL: Overfilled Launch

Laser bandwidth: effective modal bandwidth, determined by RML or DMD performance specifications

Other constructions and fiber-types available, up to 144 fibers.

Minimum order for each construction is 1000 meters. Bulk long reels, manufactured per order.

Operating temperature: -40°C to +70°C

**Control for Propulsion Systems**

300/500V, 180°C

De- scription	Part No.	No. of Cond. (CDR)	Standard Lengths		Standard Unit Weight		Conductor (Stranding) Diameter Nom. DCR	Nominal Conductor OD		Shielding Material Nom. DCR	Nominal OD		Application
			ft.	m	lbs.	kg		AWG	Section mm <sup>2</sup>		inch	mm	

**180°C • 18 - 8 AWG • Stranded Tinned Copper • FEP Inner Sheath • Galvanized Steel Wire Braid****PTFE Insulation • Overall Clear FEP Jacket**

GL 7334077 HH

Unshielded

In industrial areas with high temperature and increased mechanical stress, e.g.

- Shipbuilding industry
- Motor and turbine engineering
- Mechanical engineering



Steel Wire Braid

SHO0001	2	3280	1000	156.5	71.0	(24x0.20) TC	18	0.75	0.284	6.30
SHO0002	3	3280	1000	194.0	88.0	(24x0.20) TC	18	0.75	0.260	6.60
SHO0003	5	3280	1000	291.0	132.0	(24x0.20) TC	18	0.75	0.287	7.30
SHO0004	2	3280	1000	191.8	87.0	(32x0.20) TC	17	1.00	0.256	6.50
SHO0005	3	3280	1000	262.3	119.0	(32x0.20) TC	17	1.00	0.268	6.80
SHO0006	4	3280	1000	286.6	130.0	(32x0.20) TC	17	1.00	0.287	7.30
SHO0007	2	3280	1000	218.3	99.0	(30x0.25) TC	16	1.50	0.280	7.10
SHO0008	3	3280	1000	269.0	122.0	(30x0.25) TC	16	1.50	0.291	7.40
SHO0009	4	3280	1000	310.8	141.0	(30x0.25) TC	16	1.50	0.315	8.00
SHO0010	5	3280	1000	379.2	172.0	(30x0.25) TC	16	1.50	0.339	8.60
SHO0011	7	3280	1000	474.0	215.0	(30x0.25) TC	16	1.50	0.366	9.30
SHO0012	12	3280	1000	868.6	394.0	(30x0.25) TC	16	1.50	0.465	11.80
SHO0013	2	3280	1000	328.5	149.0	(50x0.25) TC	14	2.50	0.327	8.30
SHO0014	3	3280	1000	432.1	196.0	(50x0.25) TC	14	2.50	0.343	8.70
SHO0015	4	3280	1000	540.1	245.0	(50x0.25) TC	14	2.50	0.370	9.40
SHO0016	5	3280	1000	665.8	302.0	(50x0.25) TC	14	2.50	0.406	10.30
SHO0017	7	3280	1000	806.9	366.0	(50x0.25) TC	14	2.50	0.437	11.10
SHO0018	2	3280	1000	487.2	221.0	(56x0.30) TC	12	4	0.394	10.00
SHO0019	3	3280	1000	634.9	288.0	(56x0.30) TC	12	4	0.413	10.50
SHO0020	4	3280	1000	787.0	357.0	(56x0.30) TC	12	4	0.449	11.40
SHO0021	5	3280	1000	1018.5	462.0	(56x0.30) TC	12	4	0.488	12.40
SHO0022	2	3280	1000	608.5	276.0	(84x0.30) TC	10	6	0.492	12.50
SHO0023	3	3280	1000	840.0	381.0	(84x0.30) TC	10	6	0.520	13.20
SHO0024	4	3280	1000	1036.2	470.0	(84x0.30) TC	10	6	0.563	14.30
SHO0025	2	3280	1000	877.4	398.0	(80x0.40) TC	8	10	0.602	15.30
SHO0026	3	3280	1000	1212.5	550.0	(80x0.40) TC	8	10	0.638	16.20
SHO0027	4	3280	1000	1538.8	698.0	(80x0.40) TC	8	10	0.697	17.70

TC = Tinned Copper • DCR = DC resistance

### Control for Propulsion Systems

300/500V, 180°C

De-scription	Part No.	No. of Cond. (CDR)	Standard Lengths		Standard Unit Weight		Conductor (Stranding) Diameter Nom. DCR	Nominal Conductor OD		Shielding Material Nom. DCR	Nominal OD		Application
			ft.	m	lbs.	kg		AWG	Section mm <sup>2</sup>		inch	mm	

**180°C • 18 - 8 AWG • Stranded Tinned Copper • Impregnated Glass Fiber Yarn Inner Sheath • Galvanized Steel Wire Braid**

**PTFE Insulation**

GL 6371373 HH

Unshielded

In industrial areas with high temperature and increased mechanical stress, e.g.  
 - Shipbuilding industry  
 - Motor and turbine engineering  
 - Mechanical engineering

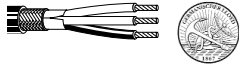

Steel Wire Braid

SHO0028	2	3280	1000	108.0	49.0	(24x0.20) TC	18	0.75	0.193	4.90
SHO0029	3	3280	1000	152.1	69.0	(24x0.20) TC	18	0.75	0.201	5.10
SHO0030	5	3280	1000	207.2	94.0	(24x0.20) TC	18	0.75	0.240	6.10
SHO0031	2	3280	1000	134.5	61.0	(32x0.20) TC	17	1.00	0.205	5.20
SHO0032	3	3280	1000	180.8	82.0	(32x0.20) TC	17	1.00	0.217	5.50
SHO0033	4	3280	1000	207.2	94.0	(32x0.20) TC	17	1.00	0.236	6.00
SHO0034	2	3280	1000	185.2	84.0	(30x0.25) TC	16	1.50	0.224	5.70
SHO0035	3	3280	1000	220.5	100.0	(30x0.25) TC	16	1.50	0.240	6.10
SHO0036	4	3280	1000	260.1	118.0	(30x0.25) TC	16	1.50	0.260	6.60
SHO0037	5	3280	1000	313.1	142.0	(30x0.25) TC	16	1.50	0.287	7.30
SHO0038	7	3280	1000	379.2	172.0	(30x0.25) TC	16	1.50	0.315	8.00
SHO0039	12	3280	1000	612.9	278.0	(30x0.25) TC	16	1.50	0.413	10.50
SHO0040	2	3280	1000	231.5	105.0	(50x0.25) TC	14	2.50	0.268	6.80
SHO0041	3	3280	1000	308.6	140.0	(50x0.25) TC	14	2.50	0.283	7.20
SHO0042	4	3280	1000	383.6	174.0	(50x0.25) TC	14	2.50	0.315	8.00
SHO0043	5	3280	1000	471.8	214.0	(50x0.25) TC	14	2.50	0.343	8.70
SHO0044	7	3280	1000	575.4	261.0	(50x0.25) TC	14	2.50	0.374	9.50
SHO0045	2	3280	1000	348.3	158.0	(56x0.30) TC	12	4	0.327	8.30
SHO0046	3	3280	1000	454.1	206.0	(56x0.30) TC	12	4	0.354	9.00
SHO0047	4	3280	1000	562.2	255.0	(56x0.30) TC	12	4	0.390	9.90
SHO0048	5	3280	1000	729.7	331.0	(56x0.30) TC	12	4	0.425	10.80
SHO0049	2	3280	1000	436.5	198.0	(84x0.30) TC	10	6	0.382	9.70
SHO0050	3	3280	1000	599.7	272.0	(84x0.30) TC	10	6	0.409	10.40
SHO0051	4	3280	1000	740.7	336.0	(84x0.30) TC	10	6	0.461	11.70
SHO0052	2	3280	1000	632.7	287.0	(80x0.40) TC	8	10	0.520	13.20
SHO0053	3	3280	1000	868.6	394.0	(80x0.40) TC	8	10	0.555	14.10
SHO0054	4	3280	1000	1106.7	502.0	(80x0.40) TC	8	10	0.614	15.60

TC = Tinned Copper • DCR = DC resistance

**Instrument & Communication**

250V, 90°C

De- scription	Part No.	No. of Pairs	Standard Lengths		Standard Unit Weight		Conductor (Stranding) Diameter Nom. DCR	Nominal Conductor OD		Shielding Material Nom. DCR	Nominal OD		Application
			ft.	m	lbs.	kg		AWG	Section mm <sup>2</sup>		inch	mm	

**90°C • 18 AWG • Stranded Bare Copper • Twisted Pair • Fleece Cloth • Overall Bare Copper Braid****TPE-E-112 Insulation • Black TPE-O-107 Jacket**

GL 2067604 HH

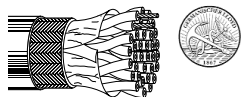
Overall  
BC BraidIn industrial areas, e.g.  
- Shipbuilding industry  
- Mechanical engineering

<b>SHO0055</b>	1	3280	1000	167.5	76.0	(7x0.36) BC	18	0.75		0.252	6.40	
<b>SHO0056</b>	2	3280	1000	227.1	103.0	(7x0.36) BC	18	0.75		0.280	7.10	
<b>SHO0057</b>	4	3280	1000	401.2	182.0	(7x0.36) BC	18	0.75		0.402	10.20	
<b>SHO0058</b>	7	3280	1000	573.2	260.0	(7x0.36) BC	18	0.75		0.492	12.50	
<b>SHO0059</b>	10	3280	1000	745.2	338.0	(7x0.36) BC	18	0.75		0.563	14.30	
<b>SHO0060</b>	14	3280	1000	987.7	448.0	(7x0.36) BC	18	0.75		0.646	16.40	
<b>SHO0061</b>	19	3280	1000	1239.0	562.0	(7x0.36) BC	18	0.75		0.713	18.10	
<b>SHO0062</b>	24	3280	1000	1567.5	711.0	(7x0.36) BC	18	0.75		0.815	20.70	

BC = Bare Copper • DCR = DC resistance

### Power & Control

300/500V, 90°C

De- scription	Part No.	No. of Cond. (CDR)	Standard Lengths		Standard Unit Weight		Conductor (Stranding) Diameter Nom. DCR	Nominal Conductor OD		Shielding Material Nom. DCR	Nominal OD		Application
			ft.	m	lbs.	kg		AWG	Section mm <sup>2</sup>		inch	mm	

90°C • 16 - 2 AWG • Stranded Bare Copper • Fleece Cloth

TPE-E-112 Insulation • Black TPE-O-107 Jacket

GL 3264106 HH

Unshielded

In industrial areas, e.g.  
- Shipbuilding industry  
- Mechanical engineering

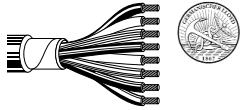

SHO0063	2	3280	1000	158.7	72.0	(7x0.52) BC	16	1.50	0.256	6.50		
SHO0064	3	3280	1000	194.0	88.0	(7x0.52) BC	16	1.50	0.268	6.80		
SHO0065	4	3280	1000	235.9	107.0	(7x0.52) BC	16	1.50	0.291	7.40		
SHO0066	5	3280	1000	284.4	129.0	(7x0.52) BC	16	1.50	0.315	8.00		
SHO0067	7	3280	1000	361.6	164.0	(7x0.52) BC	16	1.50	0.339	8.60		
SHO0068	10	3280	1000	524.7	238.0	(7x0.52) BC	16	1.50	0.425	10.80		
SHO0069	14	3280	1000	690.0	313.0	(7x0.52) BC	16	1.50	0.476	12.10		
SHO0070	19	3280	1000	892.9	405.0	(7x0.52) BC	16	1.50	0.524	13.30		
SHO0071	24	3280	1000	1161.8	527.0	(7x0.52) BC	16	1.50	0.654	16.60		
SHO0072	2	3280	1000	233.7	106.0	(7x0.68) BC	14	2.50	0.303	7.70		
SHO0073	3	3280	1000	295.4	134.0	(7x0.68) BC	14	2.50	0.319	8.10		
SHO0074	4	3280	1000	423.3	192.0	(7x0.68) BC	14	2.50	0.346	8.80		
SHO0075	5	3280	1000	443.1	201.0	(7x0.68) BC	14	2.50	0.378	9.60		
SHO0076	2	3280	1000	324.1	147.0	(56x0.30) BC	12	4	0.343	8.70		
SHO0077	3	3280	1000	412.3	187.0	(56x0.30) BC	12	4	0.362	9.20		
SHO0078	4	3280	1000	535.7	243.0	(56x0.30) BC	12	4	0.409	10.40		
SHO0079	2	3280	1000	465.2	211.0	(84x0.30) BC	10	6	0.406	10.30		
SHO0080	3	3280	1000	597.4	271.0	(84x0.30) BC	10	6	0.429	10.90		
SHO0081	4	3280	1000	745.2	338.0	(84x0.30) BC	10	6	0.469	11.90		
SHO0082	2	3280	1000	826.7	375.0	(80x0.40) BC	8	10	0.555	14.10		
SHO0083	3	3280	1000	1073.6	487.0	(80x0.40) BC	8	10	0.594	15.10		
SHO0084	4	3280	1000	1239.0	562.0	(80x0.40) BC	8	10	0.654	16.60		
SHO0085	3	3280	1000	1560.9	708.0	(126x0.40) BC	6	16	0.697	17.70		
SHO0086	3	3280	1000	2376.6	1078.0	(196x0.40) BC	4	25	0.846	21.50		
SHO0087	3	3280	1000	3871.3	1756.0	(276x0.40) BC	2	35	0.996	25.30		

BC = Bare Copper • DCR = DC resistance

**Power & Control**

300/500V, 90°C

De- scription	Part No.	No. of Cond. (CDR)	Standard Lengths		Standard Unit Weight		Conductor (Stranding) Diameter Nom. DCR	Nominal Conductor OD		Shielding Material Nom. DCR	Nominal OD		Application
			ft.	m	lbs.	kg		AWG	Section mm <sup>2</sup>		inch	mm	

**90°C • 18 - 8 AWG • Stranded Bare Copper • Fleece Cloth • Overall Bare Copper Braid****TPE-E-112 Insulation • Black TPE-O-107 Jacket**

GL 2067504 HH

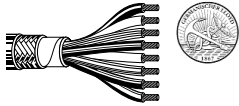
Overall  
BC BraidIn industrial areas, e.g.  
- Shipbuilding industry  
- Mechanical engineering

<b>SHO0098</b>	2	3280	1000	227.1	103.0	(7x0.52) BC	16	1.50	0.280	7.10
<b>SHO0099</b>	3	3280	1000	266.8	121.0	(7x0.52) BC	16	1.50	0.295	7.50
<b>SHO0100</b>	4	3280	1000	321.9	146.0	(7x0.52) BC	16	1.50	0.319	8.10
<b>SHO0101</b>	5	3280	1000	348.3	158.0	(7x0.52) BC	16	1.50	0.346	8.80
<b>SHO0102</b>	7	3280	1000	436.5	198.0	(7x0.52) BC	16	1.50	0.370	9.40
<b>SHO0103</b>	10	3280	1000	637.1	289.0	(7x0.52) BC	16	1.50	0.461	11.70
<b>SHO0104</b>	12	3280	1000	743.0	337.0	(7x0.52) BC	16	1.50	0.492	12.50
<b>SHO0105</b>	14	3280	1000	815.7	370.0	(7x0.52) BC	16	1.50	0.508	12.90
<b>SHO0106</b>	16	3280	1000	932.5	423.0	(7x0.52) BC	16	1.50	0.543	13.80
<b>SHO0107</b>	19	3280	1000	1053.8	478.0	(7x0.52) BC	16	1.50	0.563	14.30
<b>SHO0108</b>	24	3280	1000	1342.6	609.0	(7x0.52) BC	16	1.50	0.654	16.60
<b>SHO0109</b>	2	3280	1000	326.3	148.0	(7x0.68) BC	14	2.50	0.323	8.20
<b>SHO0110</b>	3	3280	1000	392.4	178.0	(7x0.68) BC	14	2.50	0.346	8.80
<b>SHO0111</b>	4	3280	1000	476.2	216.0	(7x0.68) BC	14	2.50	0.378	9.60
<b>SHO0112</b>	2	3280	1000	445.3	202.0	(56x0.30) BC	12	4	0.374	9.50
<b>SHO0113</b>	3	3280	1000	533.5	242.0	(56x0.30) BC	12	4	0.394	10.00
<b>SHO0114</b>	4	3280	1000	705.5	320.0	(56x0.30) BC	12	4	0.449	11.40
<b>SHO0115</b>	2	3280	1000	615.1	279.0	(84x0.30) BC	10	6	0.437	11.10
<b>SHO0116</b>	3	3280	1000	747.4	339.0	(84x0.30) BC	10	6	0.461	11.70
<b>SHO0117</b>	4	3280	1000	948.0	430.0	(84x0.30) BC	10	6	0.508	12.90
<b>SHO0145</b>	2	3280	1000	1104.5	501.0	(80x0.40) BC	8	10	0.594	15.10
<b>SHO0146</b>	4	3280	1000	1505.7	683.0	(80x0.40) BC	8	10	0.701	17.80

BC = Bare Copper • DCR = DC resistance

### Power & Control

300/500V, 90°C

De- scription	Part No.	No. of Cond. (CDR)	Standard Lengths		Standard Unit Weight		Conductor (Stranding) Diameter Nom. DCR	Nominal Conductor OD		Shielding Material Nom. DCR	Nominal OD		Application
			ft.	m	lbs.	kg		AWG	Section mm <sup>2</sup>		inch	mm	

**90°C • 18 - 8 AWG • Stranded Bare Copper • Fleece Cloth • Overall Bare Copper Braid**

**TPE-E-112 Insulation • Black TPE-O-107 Jacket**

GL 2067504 HH

Overall  
BC Braid

In industrial areas, e.g.  
- Shipbuilding industry  
- Mechanical engineering

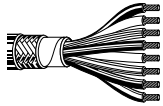

<b>SHO0088</b>	2	3280	1000	167.5	76.0	(7x0.36) BC	18	0.75	0.252	6.40
<b>SHO0089</b>	3	3280	1000	187.4	85.0	(7x0.36) BC	18	0.75	0.264	6.70
<b>SHO0090</b>	5	3280	1000	229.3	104.0	(7x0.36) BC	18	0.75	0.299	7.60
<b>SHO0091</b>	7	3280	1000	280.0	127.0	(7x0.36) BC	18	0.75	0.319	8.10
<b>SHO0092</b>	10	3280	1000	390.2	177.0	(7x0.36) BC	18	0.75	0.386	9.80
<b>SHO0093</b>	12	3280	1000	440.9	200.0	(7x0.36) BC	18	0.75	0.413	10.50
<b>SHO0094</b>	14	3280	1000	493.8	224.0	(7x0.36) BC	18	0.75	0.429	10.90
<b>SHO0095</b>	16	3280	1000	546.7	248.0	(7x0.36) BC	18	0.75	0.449	11.40
<b>SHO0096</b>	19	3280	1000	612.9	278.0	(7x0.36) BC	18	0.75	0.465	11.80
<b>SHO0097</b>	24	3280	1000	749.6	340.0	(7x0.36) BC	18	0.75	0.524	13.30

**90°C • 6 AWG - 3/0 MCM • Stranded Bare Copper • Bare Copper Braid**

**TPE-E-112 Insulation • Black TPE-O-107 Jacket**

Overall  
BC Braid

For internal wiring, e.g.  
- Shipbuilding industry  
- Mechanical engineering



<b>SHO0119</b>	1	3280	1000	593.0	269.0	(126x0.40) BC	6	16	0.398	10.10
<b>SHO0120</b>	1	3280	1000	837.7	380.0	(196x0.40) BC	4	25	0.457	11.60
<b>SHO0121</b>	1	3280	1000	1188.3	539.0	(276x0.40) BC	2	35	0.547	13.90
<b>SHO0122</b>	1	3280	1000	1554.2	705.0	(392x0.40) BC	1	50	0.610	15.50
<b>SHO0123</b>	1	3280	1000	2090.0	948.0	(356x0.50) BC	2/0	70	0.685	17.40
<b>SHO0124</b>	1	3280	1000	2788.8	1265.0	(470x0.50) BC	3/0	95	0.819	20.80

BC = Bare Copper • DCR = DC resistance



**Notes**



# Cable Assemblies

## Table of Contents

Cable Assemblies	Page No
<b>Introduction</b>	<b>8.2</b>
<b>Coax Cable Assemblies</b>	<b>8.3 – 8.5</b>
Video Cords	8.3
RGB Patch Cables	8.4
Triax Cables	8.5
<b>Twisted Pair and Fiber Optic Cable Assemblies</b>	<b>8.6</b>
CatSnake™	8.6
Fiber Optic Assemblies for HDTV Cameras (SMPTE 311)	8.6

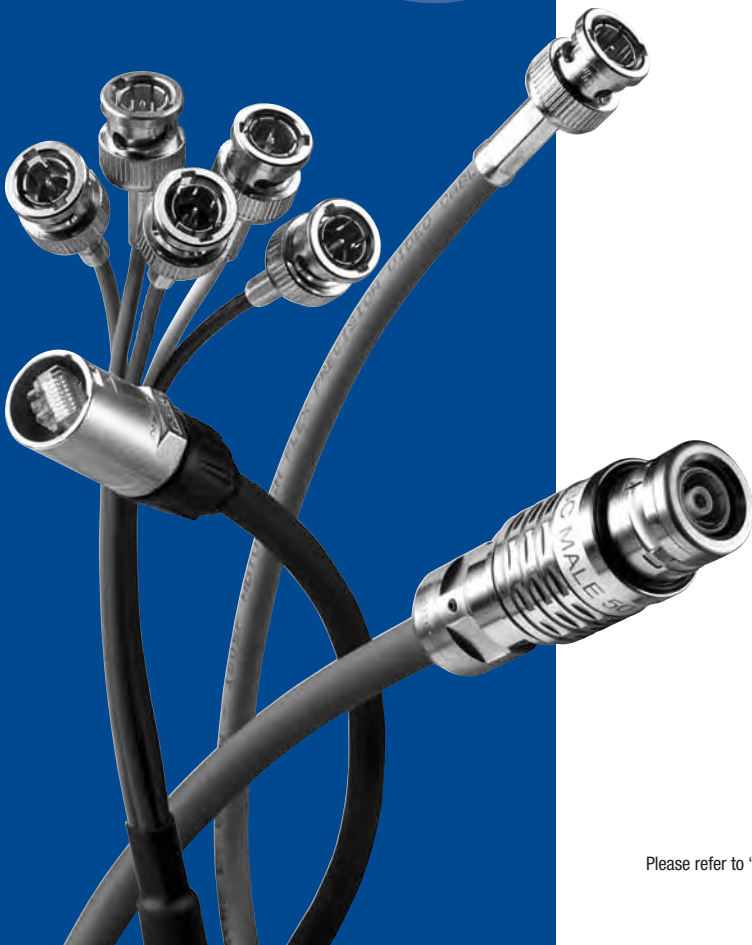

## Introduction

### Brilliant in Every Way

Everyone in HDTV wants unmatched high life cycle performance, quality, longevity and peace of mind. Brilliance Assemblies are designed and optimized for HDTV. This requires the cabling to conform to the very highest of standards so it can deliver the very best in performance throughout its long lifetime. Quite simply, nothing beats a Belden cable – a proven fact, perfectly demonstrated by a product range that delivers top performance in every way and enhances the assurances offered by Brilliance Assemblies.

From precise installation with materials perfectly suited to their requirements to rigorous and proven testing methods supported by the Belden Installable Performance™ processes, users find that Brilliance Assemblies offer a peace of mind that is unmatched.

### Key Applications

- High-resolution monitors
- Project imaging
- OB Vans
- Satellite head ends
- Video networks
- CCTV
- Ethernet professional audio

### Special Features

- **1505F:** This cable is the focus product for video cords, a super high flex coax developed by Belden for digital patch panel cabling requirements. The 1505F has a soft matte PVC jacket which envelopes two tinned copper braids with a unique compacted stranded central conductor. This combines the flexibility borne from its stranded design to stability and RL performance that come right from its solid core. The 1505F is fully sweep tested to 4.5 GHz.
- **Low Return Loss (RL):** Use your head room! Belden delivers Return Loss (RL) performance that offers ample head room below the SMPTE 292M -15dB requirement. Belden products offer a best in class RL performance.

#### Bandwidth

Broadcasting needs are evolving at a rapid rate. Brilliance Assemblies offer the most significant scope for ensuring growth whatever the bandwidth. Belden products offer a best in class RL performance tested to 4.5 GHz throughout the entire installation and monitoring processes and even after packaging.

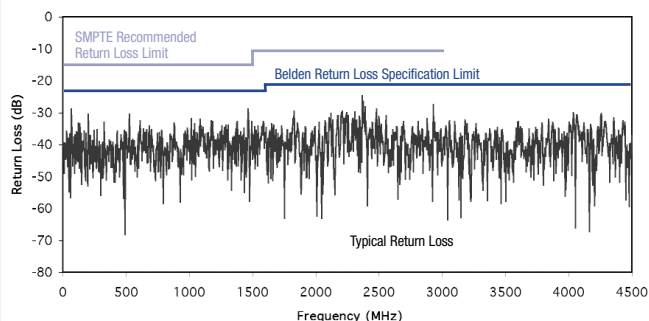

- **Exceptional Flexibility and Superior Cable Life:** Under the stress of repeated pulling, flexing, bending and crushing, cables can quickly display discrepancies that lead to degraded signal transmission – or even breakage. To combat these usage problems, Belden offers robust performance and enhanced flexibility in all Brilliance Assemblies. An abrasion-resistant jacket adds further protection and flexibility.
- **Crush Resistance:** Improves bending/flexing without pushing out the centre pin and/or damaging attached equipment – ideal for the more rugged installations.

High resistance to crushing is provided by the foamed high-density polyethylene. Belden products have as much as twice the crush resistance of similar commercially available products. This means that the cables are less susceptible to diameter variations during their installation and use – resulting in minimal degradation of impedance and RL.

### The Connectors

Brilliance Assemblies are put together using true 75 Ohm connectors that constantly perform to the very highest levels. Nominal 75 Ohm connectors can cause high BER (Bit Error Rate) and significantly reduce transmission distance.

Belden perfectly complements innovative products such as ADC's ProAx™ triax connectors and Neutrik's OpticalCon® next generation of HDTV camera connectors. The Belden line includes three one-piece connectors, a stripping tool and a compression tool that facilitates swift cable connection.

High quality BNC, RCA and F connectors, recommended for RGB patch cables, feature a brass and nickel construction with nickel-plated centre pins. In addition, they offer twin compression points that seal and hold the connector to the coaxial cable. By having two compression points, and a patent-pending viewing window on the connector, installation is made much simpler.

To meet the requirements of the market, Belden is able to deliver Brilliance Assemblies with other popular connector brands.

### Availability

Many of these are available off the shelf from distributors. If you have a new or unusual application or you cannot find your assembly in this catalog section that meets your technical requirements contact technical support at +31-77-3875-414 or techsupport.venlo@belden.com.

ProAx™ is an ADC Krone trademark.  
OpticalCon® is a Neutrik trademark.

# Coax Cable Assemblies

## Video Cords

Part No.	Gender	Standard Lengths		Standard Unit Weight		Cond. AWG (Stranding) Diameter Nom. DCR	Nominal Insulation OD		Shielding Material Nom. DCR	Nominal OD		Nom. Imp. ( )	Nom. Vel. of Prop.	Nominal Capacitance		Nominal Attenuation	
		ft.	m	lbs.	kg		inch	mm		inch	mm			pF/ft.	pF/m	MHz	dB/100 ft.

**Brilliance Assemblies • 1505F HDTV/SDI • BNC, RCA or F Connectors on both ends • Superflex 75 Ohm broadcast quality assembled colored cable with two strain relief boosts**

Digital video and HDTV run at higher frequencies and make better use of composite video for even greater picture clarity. To accommodate the need for higher frequency, and the ability to run more demanding applications such as high resolution VGA on large screens, HDTV, Hi-Res CAD, animation, editing and special effects, Belden uses the extremely popular 1505F which has the optimum design to meet these new high-end requirements. The Belden line includes high performance professional connectors with excellent connector pull strength and minimal signal loss. Perfect for patching, rack wiring, OB vans, satellite headends, CCTV, etc.

**Gas-injected Foam HDPE Insulation • PVC Jacket (Matte Black, Red, Green, Blue, Yellow, White, Violet, Orange)**

1.6	0.5	0.18	0.08	22 AWG	0.145	3.68	Double	0.242	6.15	75	80%	17.0	55.7	1	0.2	0.7
3.3	1.0	0.26	0.12	0.79 mm			95% TC							3.6	0.5	1.6
6.6	2.0	0.43	0.19	(7x29) BC			Braid							10	0.9	2.9
9.8	3.0	0.59	0.27	47.8 /km*			7.8 /km***							71.5	2.5	8.2
16.4	5.0	0.92	0.42	40.0 /km**										135	3.5	11.5
19.7	6.0	1.09	0.49											270	5.1	16.7
49.2	15.0	2.58	1.17											360	6.0	19.7
65.6	20.0	3.40	1.54											540	7.4	24.3
98.4	30.0	5.06	2.29											720	8.7	28.5
147.6	45.0	7.54	3.42											750	8.9	29.2
														1000	10.5	34.4
														1500	13.3	43.6
														2250	16.9	55.4
														3000	20.3	66.6



Return loss at 5-3000 MHz: 15 dB

**1505F BNC-BNC • for Analog & Digital Video, Patchcords, CCTV, Satellite Uplink/Downlink, Telecom**

	Length	Violet	Black	Red	Green	Blue	Yellow	White	Orange
 Example Part No. <b>CA00100</b> 00C0D5 = 1505F BNC-BNC, 0.5 m, violet	0.5	00C0D5	01C0D5	02C0D5	03C0D5	04C0D5	05C0D5	06C0D5	07C0D5
	1.0	00C1	01C1	02C1	03C1	04C1	05C1	06C1	07C1
	2.0	00C2	01C2	02C2	03C2	04C2	05C2	06C2	07C2
	3.0	00C3	01C3	02C3	03C3	04C3	05C3	06C3	07C3
	5.0	00C5	01C5	02C5	03C5	04C5	05C5	06C5	07C5
	6.0	00C6	01C6	02C6	03C6	04C6	05C6	06C6	07C6
	15.0	00C15	01C15	02C15	03C15	04C15	05C15	06C15	07C15
	20.0	00C20	01C20	02C20	03C20	04C20	05C20	06C20	07C20
	30.0	00C30	01C30	02C30	03C30	04C30	05C30	06C30	07C30
	45.0	00C45	01C45	02C45	03C45	04C45	05C45	06C45	07C45

**1505F RCA-RCA • for Audio or Video, Projectors, Digital Audio (S/PDIF) Subwoofer, Analog Audio and Composite Video**

	Length	Violet	Black	Red	Green	Blue	Yellow	White	Orange
 Example Part No. <b>CA00101</b> 00C0D5 = 1505F RCA-RCA, 0.5 m, violet	0.5	00C0D5	01C0D5	02C0D5	03C0D5	04C0D5	05C0D5	06C0D5	07C0D5
	1.0	00C1	01C1	02C1	03C1	04C1	05C1	06C1	07C1
	2.0	00C2	01C2	02C2	03C2	04C2	05C2	06C2	07C2
	3.0	00C3	01C3	02C3	03C3	04C3	05C3	06C3	07C3
	5.0	00C5	01C5	02C5	03C5	04C5	05C5	06C5	07C5
	6.0	00C6	01C6	02C6	03C6	04C6	05C6	06C6	07C6
	15.0	00C15	01C15	02C15	03C15	04C15	05C15	06C15	07C15
	20.0	00C20	01C20	02C20	03C20	04C20	05C20	06C20	07C20
	30.0	00C30	01C30	02C30	03C30	04C30	05C30	06C30	07C30
	45.0	00C45	01C45	02C45	03C45	04C45	05C45	06C45	07C45

**1505F F-F • for Cable TV, Satellite and Antenna. The Brilliance Assemblies RF Video Cords can be Specially Ordered.**

	Length	Violet	Black	Red	Green	Blue	Yellow	White	Orange
 Example Part No. <b>CA00102</b> 00C0D5 = 1505F F-F, 0.5 m, violet	0.5	00C0D5	01C0D5	02C0D5	03C0D5	04C0D5	05C0D5	06C0D5	07C0D5
	1.0	00C1	01C1	02C1	03C1	04C1	05C1	06C1	07C1
	2.0	00C2	01C2	02C2	03C2	04C2	05C2	06C2	07C2
	3.0	00C3	01C3	02C3	03C3	04C3	05C3	06C3	07C3
	5.0	00C5	01C5	02C5	03C5	04C5	05C5	06C5	07C5
	6.0	00C6	01C6	02C6	03C6	04C6	05C6	06C6	07C6
	15.0	00C15	01C15	02C15	03C15	04C15	05C15	06C15	07C15
	20.0	00C20	01C20	02C20	03C20	04C20	05C20	06C20	07C20
	30.0	00C30	01C30	02C30	03C30	04C30	05C30	06C30	07C30
	45.0	00C45	01C45	02C45	03C45	04C45	05C45	06C45	07C45

\* DC loop resistance • \*\* DC resistance inner conductor • \*\*\* DC resistance outer conductor • DCR = DC resistance • M = Male • F = Female • TC = Tinned Copper • BC = Bare Copper

To comfortably support today's broadcast technology, Brilliance Assemblies can be specially ordered:

- for mobile television broadcast trucks with 179DT BNC-BNC (CA00103)
- as an economical version with 1855A BNC-BNC (CA00106)
- for long runs with 1505A BNC-BNC (CA00109)
- for longer runs with 1694A BNC-BNC (CA00112)

All these Brilliance Assemblies are available in 10 colors (1505A with 8 colors).

If you require a specific connector, you can choose from the following brands: ADC, Neutrik, Damar+Hagen, Telegaertner.

Recommended Color Schema:	
<b>Red + Black</b>	Analog audio
<b>RGB</b> (Red, Green, Blue)	Component video
<b>Orange</b>	Digital audio
<b>Yellow</b>	Composite video
<b>Violet</b>	Digital video/HDTV



# Coax Cable Assemblies

## RGB Patch Cables

Part No.	Gender	Standard Lengths		Standard Unit Weight		Cond. AWG (Stranding) Diameter Nom. DCR	Nominal Insulation OD		Shielding Material Nom. DCR	Nominal OD		Nom. Imp. ( )	Nom. Vel. of Prop.	Nominal Capacitance		Nominal Attenuation		
		ft.	m	lbs.	kg		inch	mm		inch	mm			pF/ft.	pF/m	MHz	dB/100 ft.	dB/100 m

**Brilliance Assemblies • 1277R (3-Coax) and 1279R (5-Coax) HDTV/SDI • 3 or 5 BNC Connectors on both ends • Flexible 75 Ohm broadcast quality assembled RGB cable with strain relief boots**

RGB cables are used for component video formatted applications that segment the video signal into Red, Green and Blue elements, identified through use of corresponding cable jacket colors (RGB cables). Synchronization (Sync) and Vertical Hold (Hold) signals can be embedded within one of the elemental video components or they can be transmitted separately utilizing the 4th and 5th coaxes. When present, the 4th coax has a yellow jacket; the 5th coax has a black jacket. The outer jacket of the Belden line is stripped back 150 mm from both ends. The unique design of these cables also makes them ideal for multiple runs of composite video signals such as SDI or HDTV (video snake cable). The Belden lines are ideal for high-resolution monitor and projection imaging in corporate boardrooms, command and control centers, multi-purpose auditoriums, home theaters, performance venues, etc.

Foam HDPE Insulation • Matte Black PVC Jacket																	
CA00150 01C1	BNC-BNC	3.3	1.0	0.24	25 AWG	0.092	2.33	Duofoil®	0.320	8.13	75	80%	17.0	55.7	5	1.2	3.8
CA00150 01C2		6.6	2.0		0.45 mm		Coax OD:	95% TC	0.403	10.24					50	3.7	12.1
CA00150 01C3		9.8	3.0		(Solid) BC	0.114	2.90	Braid							100	4.9	16.1
CA00150 01C6		19.7	6.0												400	9.5	31.2
CA00150 01C15		49.2	15.0												750	13.4	44.0
CA00150 01C20		65.6	20.0												900	15.0	49.2
CA00150 01C30		98.4	30.0												1000	15.8	51.8
CA00150 01C45		147.6	45.0												3000	31.2	102.4

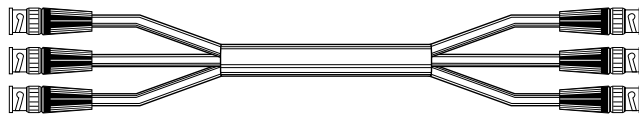

Foam HDPE Insulation • Matte Black PVC Jacket																	
CA00151 01C1	BNC-BNC	3.3	1.0		25 AWG	0.092	2.33	Duofoil®	0.320	8.13	75	80%	17.0	55.7	5	1.2	3.8
CA00151 01C2		6.6	2.0		0.45 mm		Coax OD:	95% TC	0.403	10.24					50	3.7	12.1
CA00151 01C3		9.8	3.0		(Solid) BC	0.114	2.90	Braid							100	4.9	16.1
CA00151 01C6		19.7	6.0												400	9.5	31.2
CA00151 01C15		49.2	15.0												750	13.4	44.0
CA00151 01C20		65.6	20.0												900	15.0	49.2
CA00151 01C30		98.4	30.0												1000	15.8	51.8
CA00151 01C45		147.6	45.0												3000	31.2	102.4

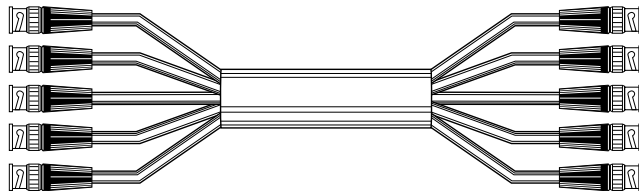

\* DC loop resistance • \*\* DC resistance inner conductor • \*\*\* DC resistance outer conductor • DCR = DC resistance • M = Male • F = Female • TC = Tinned Copper • BC = Bare Copper

To comfortably support today's broadcast technology, Brilliance Assemblies can be specially ordered:

	3-Coax BNC-BNC	5-Coax BNC-BNC
1. same but Banana Peel® design	1281S3 (CA00152)	1281S5 (CA00153)
2. as an economical version with 1855A	7787A (CA00154)	7789A (CA00155)
3. for long runs with 1505A	7794A (CA00156)	7796A (CA00157)
4. for longer runs with 1694A	7710A (CA00158)	7712A (CA00159)

If you require a specific connector you can choose from the following brands: ADC, Neutrik, Damar+Hagen, Telegaertner.

**Additional Accessories for 1277R-1279R and 1281S3-S5 One-Piece Connector**

**1B25A • 75-Ohm BNC (male)**

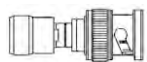

**1R25A • 75-Ohm RCA**

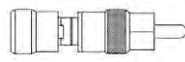

**Stripping and Compression Tool**

**HCST • Cable Prep Tool**



**HCCT • works with BNC, RCA and F Connectors**



# Coax Cable Assemblies

## Triax Cables

Part No.	Gender	Standard Lengths		Standard Unit Weight		Cond. AWG (Stranding) Diameter Nom. DCR	Nominal Insulation OD		Shielding Material Nom. DCR	Nominal OD		Nom. Imp. ( )	Nom. Vel. of Prop.	Nominal Capacitance		Nominal Attenuation	
		ft.	m	lbs.	kg		inch	mm		inch	mm			pF/ft.	pF/m	MHz	dB/100 ft.

**Brilliance Assemblies • 7783AF Triax 8 HDTV/SDI • ProAx™ Triax Camera Connectors: Global Format on both ends • Flexible 75 Ohm broadcast quality assembled Triax cable**

The Belden triax lines are assembled with ADC's ProAx™ triaxial camera connectors. This combination will undoubtedly change your views of triaxial assemblies. ADC's patented ProAx™ triaxial camera connector has a two-piece center conductor offering several options. Key benefits include the ability to swap gender parts from male to female and vice versa in only a few seconds and the way mates can be swapped equally quickly with Kings, Lemo, Fischer and Damar+Hagen parts. The Belden lines are ideal for field use, sporting/live events, mobile trucks, stadiums, fixed wiring, TV/Studio production.

**Foam Insulation • Red PVC Jacket**

CA00200 02C50	Male - Female	164	50	13.56	6.15	0.99 mm	0.178	4.52	90% SPC	0.331	8.40	75	83%	16.5	54.0	1	0.2	0.6
CA00200 02C100		328	100	26.01	11.80	20 AWG			Braid							10	0.7	2.2
CA00200 02C150		492	150	38.47	17.45	(19x0.36) SPC			+ 80% BC							20	1.0	3.2
CA00200 02C200		656	200	50.93	23.10	32.0 /km*			Braid							40	1.4	4.6
CA00200 02C250		820	250	63.38	28.75	22.0 /km**			10.0 /km***							50	1.6	5.1
									6.5 mm							60	1.7	5.6
																100	2.3	7.5
																300	4.2	13.8

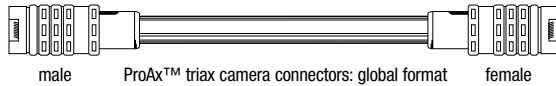

Return loss at 1-100 MHz: 26 dB  
100-300 MHz: 23 dB

Screening attenuation at 30-1000 MHz: 75 dB  
Brilliance® Broadcast Assembly line can be specially ordered with mates for Kings, Lemo Redel F, Fischer SE & KE and Damar+Hagen.

**Brilliance Assemblies • 7784AF Triax 11 HDTV/SDI • ProAx™ Triax Camera Connectors: Global Format on both ends • Flexible 75 Ohm broadcast quality assembled Triax cable**

**Foam Insulation • Red PVC Jacket**

CA00201 02C50	Male - Female	164	50	20.17	9.15	1.4 mm	0.256	6.50	90% SPC	0.433	11.00	75	82%	16.5	54.0	1	0.2	0.5
CA00201 02C100		328	100	39.24	17.80	16 AWG			Braid							10	0.5	1.6
CA00201 02C150		492	150	58.31	26.45	(19x0.28) SPC			+ 80% BC							20	0.7	2.3
CA00201 02C200		656	200	77.38	35.10	26.0 /km*			Braid							40	1.0	3.3
CA00201 02C500		1640	500	191.80	87.00	18.0 /km**			8.0 /km***							50	1.1	3.7
									8.5 mm							60	1.3	4.1
																100	1.6	5.4
																300	3.1	10.3



Return loss at 1-100 MHz: 26 dB  
100-300 MHz: 23 dB

Screening attenuation at 30-1000 MHz: 75 dB  
Brilliance® Broadcast Assembly line can be specially ordered with mates for Kings, Lemo Redel F, Fischer SE & KE and Damar+Hagen.

**Brilliance Assemblies • 7785A Triax 14 HDTV/SDI • ProAx™ Triax Camera Connectors: Global Format on both ends • Flexible 75 Ohm broadcast quality assembled Triax cable**

**Foam Insulation • Red PVC Jacket**

CA00202 02C50	Male - Female	164	50	30.31	13.75	2.21 mm	0.382	9.70	90% SPC	0.551	14.00	75	82%	16.5	54.0	1	0.1	0.4
CA00202 02C100		328	100	59.52	27.00	12 AWG			Braid							10	0.3	1.1
CA00202 02C150		492	150	88.74	40.25	(7x0.75) SPC			+ 80% BC							20	0.5	1.6
CA00202 02C200		656	200	117.95	53.50	14.0 /km*			Braid							40	0.7	2.3
CA00202 02C500		1640	500	293.21	133.00	10.0 /km**			4.0 /km***							50	0.8	2.6
CA00202 02C1000		3280	1000	585.32	265.50				12.7 mm							60	0.9	2.8
																100	1.2	3.8
																300	2.3	7.7



Return loss at 5-850 MHz: 21 dB

Screening attenuation at 30-1000 MHz: 75 dB  
Brilliance® Broadcast Assembly line can be specially ordered with mates for Kings, Lemo Redel F, Fischer SE & KE and Damar+Hagen

\* DC loop resistance • \*\* DC resistance inner conductor • \*\*\* DC resistance outer conductor • DCR = DC resistance • M = Male • F = Female • BC = Bare Copper • SPC = Silver-Plated Copper  
ProAx™ is an ADC Krone trademark.

## Twisted Pair and Fiber Optic Cable Assemblies

### CatSnake™

Part No.	Connector	Standard Lengths		Standard Unit Weight		Conductor (Stranding) Diameter Nom. DCR	Nominal Insulation OD		Shielding Material Nom. DCR	Nominal OD		Freq. MHz	Max. Atten. dB/100m	Min. PSUM			ACR dB/100m	Min. RL dB
		ft.	m	lbs.	kg		inch	mm		inch	mm			NEXT dB	ACR dB/100m	ELFEXT dB/100m		

**Brilliance Assemblies • 1305A • Mobile Cat 5e • Neutrik EtherCon® Connectors • CatSnake™ is a new design from Belden and assembled with standard RJ45 connectors**

The round PVC jacket provides durability and the cable ends are assembled with Neutrik's EtherCon®. This design was developed to provide a comprehensive solution for data transfer in harsh and demanding applications. CatSnake™ assembly is particularly suitable for Ethernet networking in commercial audio, concert sound reinforcement, stage production, DMX lighting and industrial internet access environments.

4 Bonded-pairs UTP • Black PVC Jacket																		
CA00250 01C50	EtherCon®	164	50	11.02	5.0	0.51 mm	0.037	0.95	Bonded-Pair	0.295	7.49	1	2.0	65.3	63.3	60.8	63.3	20.0
CA00250 01C100		328	100	19.84	9.0	24 AWG			Unshielded			4	4.0	56.3	52.3	48.7	52.3	23.0
CA00250 01C500		1640	500	90.39	41.0	(7x32) TC						10	6.4	50.3	43.9	40.8	43.9	25.0
												16	8.1	47.3	39.1	36.7	39.1	25.0
												20	9.2	45.8	35.2	34.7	35.2	25.0
												31.25	11.2	42.9	31.3	30.9	31.3	23.6
												62.5	16.8	38.4	21.6	24.8	21.6	21.9
												100	21.7	35.3	17.1	20.8	17.1	20.1
												155	27.7	32.5	4.7	16.9	4.7	19.0
												200	32.0	30.8	3.0	14.7	3.0	19.0
												310	41.3	27.9	> 0	10.9	> 0	18.0
												350	44.3	27.2	> 0	9.9	> 0	17.0



Brilliance® Broadcast Assembly line can be specially ordered as CA00251 with only RJ-45.

## Fiber Optic Assembly For HDTV Cameras (SMPTE 311)

Part No.	Connector	Standard Lengths		Standard Unit Weight		Conductor (Stranding) Diameter Nom. DCR	Nominal OD		Component	Description	Shielding Material & Nom. DCR	Component OD		Nominal Attenuation	
		ft.	m	lbs.	kg		inch	mm				inch	mm	dB/100 ft.	dB/100 m

**Brilliance Assemblies • 7804C • SMPTE 311M HDTV cable • Single-Mode Fiber with copper conductors • Lemo 3K.93C connectors**

With the rise of high-definition video applications, such as 1080i and 720p, the bandwidth demands on camera cables has grown significantly. To meet these new requirements, Belden now offers (new generation) 7804C, which consists of dual single-mode fiber optic cables and copper components for power and data, and a special connector made by Lemo.

Composite Cable: 2 Power Conductors • SM Fiber (24 AWG and 16 AWG) • Stranded TC Conductors • Black Belflex® Jacket															
CA00270 01C100	2x3K.93C.TLMC	328	100	64.82	29.40	—	0.362	9.2	2xFiber	(2) Breakout Fibers	38 AWG TC Braid	0.079	2.00	0.14	0.45
CA00270 01C500		1640	500	318.79	144.60					SM/125µ/900µ core/clad/buffer	95% Shield Coverage	2.8 /m*			
CA00270 01C1.000		3280	1000	636.25	288.60						2.8 /m* 9.2 /km				
							0.362	9.2	(2) Conductors	24 AWG (7x32) TC	38 AWG TC Braid	0.050	1.27	0.14	0.45
										0.024"	95% Shield Coverage	2.8 /m*			
										23.3 /m* 76.4 /km	2.8 /m* 9.2 /km				
							0.362	9.2	(2) Conductors	16 AWG (65x34) TC	38 AWG TC Braid	0.093	2.36	0.14	0.45
										0.037"	95% Shield Coverage	2.8 /m* 9.2 /km			
										4.3 /m* 14.1 /km	2.8 /m* 9.2 /km				



Brilliance® Broadcast Assembly line can be specially ordered as CA00271 with: Neutrik's OpticalCon® • Suitable for indoor studio and camera applications acc. IEC 60664-1 (Pollution degree 1, over voltage category 1), not compatible to SMPTE standard.

\* DC loop resistance • DCR = DC resistance • TC = Tinned Copper

EtherCon® and OpticalCon® are Neutrik trademarks.



# Broadband Coax Cables

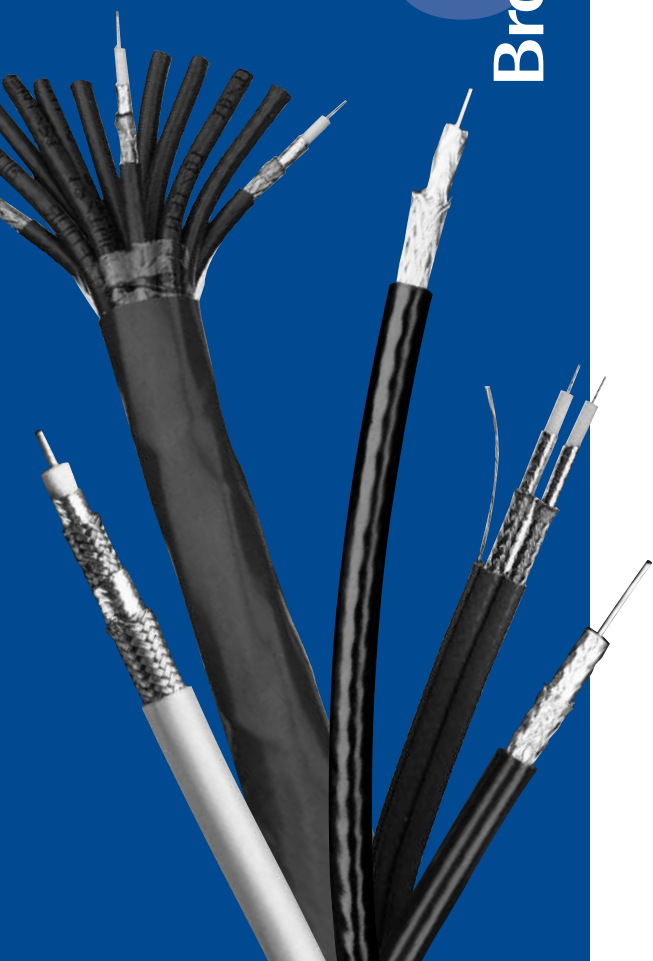

## Table of Contents

<b>Broadband Coax Cables</b>	<b>Page No.</b>
<b>Introduction</b>	<b>9.2 – 9.5</b>
<b>Connector Cross Reference</b>	<b>9.6 – 9.8</b>
<b>Selection Guide: Class A Products</b>	<b>9.8</b>
<b>Broadband Coax</b>	<b>9.9 – 9.26</b>
Trunk Cables	9.9 – 9.11
Distribution Cables	9.12 – 9.15
Drop Cables	9.16 – 9.25
Nom. 15 dB	9.16 – 9.17
Nom. 18 dB	9.18 – 9.23
Nom. 23 dB	9.24 – 9.25
Headend Cables	9.26
<b>Wireless Coax</b>	<b>9.27 – 9.32</b>
Low Loss 50 Ohm Transmission	9.27 – 9.29
50 Ohm Transmission	9.30 – 9.31
50 Ohm Microwave Cables	9.32



## Introduction



### Bringing People Closer

Today, wireless communication is part of everyone's life as we increasingly communicate with each other and source information through networks such as cellular phones, TV broadcasting and WLAN. The strength of Belden is to anticipate market demands, adapt, invent and innovate to meet changing needs for increased bandwidth and easy installation.

Belden offers one of the most comprehensive, economical and modern ranges of reliable 75 Ohm and 50 Ohm coaxial cable products on the market. The distribution and drop coaxes feature Belden's innovative, high-performance Duobond Plus® shielding and/or Belden's Duobond® II shield.

### Key Applications

- Cable TV
- Satellite dish technology
- Broadband applications

### Special Features

#### 75 Ohm CATV

- **Duobond Plus®**  
Belden's Duobond Plus® has a three-shield construction consisting of a Duobond® II (foil tape) surrounded by a braid and an outer layer of foil with a unique shorting fold which creates the effect of a solid metal conduit. This combination offers superior high frequency shielding when compared with traditional Quad shields.

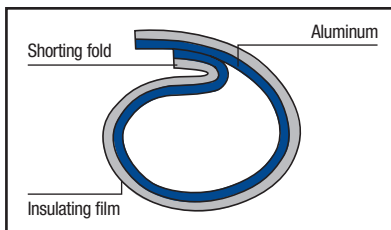
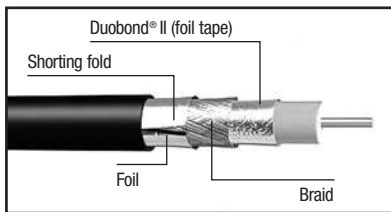

Duobond Plus® is faster to install, because the outer tape shield is bonded to the jacket and can be stripped easily in one step. Furthermore, this construction gives Duobond Plus® a smaller bending radius, greater flexibility and, compared to quad shielded coax, a 10 percent weight reduction.

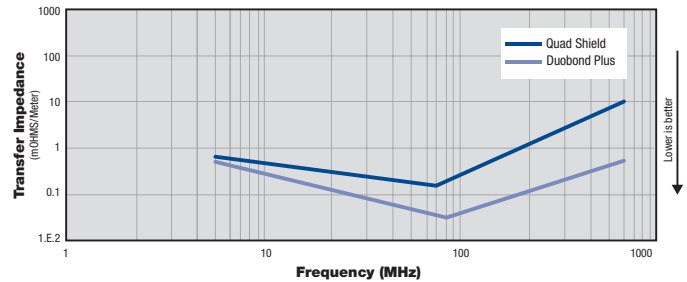

Lower transfer impedance means better shielding performance.

Belden offers two different versions of Duobond Plus®:

- Better-Than-Quad (BTQ) with 50% shielding coverage.
- Better-Than-Triple (BTT) with 40% shielding coverage.

Better performance and easier installation are reasons why Duobond Plus® coax cables are so popular and widely used.

- **Duobond® II**

The foil/braid type combines Duobond with an outer braid. This is added to provide greater protection against interference and to increase overall tensile strength. The combination foil/braid shield combines the advantages of 100% foil coverage with the strength and low DC resistance of the braid.

- **FRNC/LSNH**

Belden has developed low-smoke (LS), fire-retardant (FR) and zero-halogen (ZH) cables. These three properties are annotated as FRNC/LSNH (also known as RNC/LSZH).

## Introduction



### What is Class A?

The demands for screening attenuation and transfer impedance of the CATV cables are defined by European Standard EN50117-2:

1. Drop, indoor 5 MHz to 1000 MHz
2. Drop, outdoor 5 MHz to 1000 MHz
3. Trunk and Distribution 5 MHz to 1000 MHz
4. Drop, indoor 5 MHz to 3000 MHz
5. Drop, outdoor 5 MHz to 3000 MHz

EN-50117-1 is the version for coax cables. Part 1 is the generic specification. This part requires that the test method of transfer impedance and the screening attenuation accords to EN 50289-1-6.

### EN 50117 Screening Classes

Class A++	105 dB from 30 MHz to 1000 MHz (screening attenuation) 95 dB from 1000 MHz to 2000 MHz (screening attenuation) 85 dB from 2000 MHz to 3000 MHz (screening attenuation) 0.9 mOhm/m from 5 to 30 MHz (transfer impedance)
Class A+	95 dB from 30 MHz to 1000 MHz (screening attenuation) 85 dB from 1000 MHz to 2000 MHz (screening attenuation) 75 dB from 2000 MHz to 3000 MHz (screening attenuation) 2.5 mOhm/m from 5 to 30 MHz (transfer impedance)
Class A	85 dB from 30 MHz to 1000 MHz (screening attenuation) 75 dB from 1000 MHz to 2000 MHz (screening attenuation) 65 dB from 2000 MHz to 3000 MHz (screening attenuation) 5 mOhm/m from 5 to 30 MHz (transfer impedance)
Class B	75 dB from 30 MHz to 1000 MHz (screening attenuation) > 65 dB from 1000 MHz to 2000 MHz (screening attenuation) > 55 dB from 2000 MHz to 3000 MHz (screening attenuation) 15 mOhm/m from 5 to 30 MHz (transfer impedance)
Class C	75 dB from 30 MHz to 1000 MHz (screening attenuation) > 65 dB from 1000 MHz to 2000 MHz (screening attenuation) > 55 dB from 2000 MHz to 3000 MHz (screening attenuation) 50 mOhm/m from 5 to 30 MHz (transfer impedance)

### New Technologies Need Better Cables

- From analog to digital.
- More protection from electromagnetic interference for multimedia applications (telephony, internet or video-on-demand).
- Interactive services like Two-Way-TV (TWTv) need return-path capable cables, according to class A.
- Backwards: 5 - 30 (65) MHz - Forward: 47 (80) - 862 MHz.

### Euroclass – European Union to Harmonize Test Standards and Transform All the National Regulations

The Construction Products Directive (CPD) was adopted in 1989. In 2002, the European Union published a series of harmonised test standards, called: Euroclass according to a classification in decreasing quality order from A to F:

Euroclass (draft: 2003)

- A - no inflammable material
- B\* - Low flame height and heat production
- C\* - Moderate flame height and heat production
- D\* - Heat production comparable to that of burning construction wood
- E - Moderate flame height
- F - No fire performance requirement

\* B = EN50399-2-2, C and D = EN50399-2-1

CENELEC is currently working on a final version to cover the next years.

# Introduction



## 50 Ohm Wireless

Belden's 50 Ohm RF cables provide best-in-class transmission performance and superior EMI/RFI shielding for greater noise reduction. They are ruggedly constructed and designed to be flexible for easy installation and routing.

Features include:

- Lowest Loss**  
 Belden's 50 Ohm RF cables provide the lowest loss of any land mobile radio-type coaxial cables on the market (from 5% to 10% lower, depending on the design and frequency). The result is better signal transmission at the same distance, or longer transmission distance with less attenuation. All cables are 100% sweep tested to 6 GHz to assure performance in future high frequency applications.
- Low VSWR**  
 VSWR is guaranteed to be 1.25:1 maximum over all frequencies (RL = -19 dB).
- High Velocity of Propagation**  
 The foamed high-density polyethylene insulation provides the highest velocity of any land mobile radio-type flexible coaxial product on the market. The high-density material properties provide superior crush resistance to minimise impedance variations and return loss, ensuring high performance both before and after installation. (Part number 7805 utilizes a solid PE dielectric).
- Excellent Phase Stability**  
 Belden's 50 Ohm RF cables exhibit excellent phase stability over both temperature changes and flexing, resulting in improved signal integrity and reliability.
- Superior RF Shielding**  
 The combination foil/braid shield provides in excess of 100 dB of effective EMI/RFI shielding.
- Unbonded Foil Shields (on smaller constructions prevent connector shorting)**  
 In the smaller designs – RF200 and under – the spacing between the foil shield and the centre pin of the connector is extremely small. During the cable stripping process, bonded foil shields tend to tear if not cleanly cut, leaving very small foil “stringers” that can short the shield to the center conductor. Unbonded shields allow for the tape to be cut back from the dielectric, thereby eliminating the potential shorting problem. The unbonded shields are featured on RF100A, RF100LL, RF195 and RF200. Larger constructions – including the new water-blocked (WB) versions – have sufficient spacing between the shield and centre pin, and therefore feature bonded foil shields.
- Unique Design**  
 Belden's RF100LL is the only design of its type. It features a slightly larger center conductor and foamed polyethylene insulation, while maintaining the dimensions of the MIL-Spec cable, eliminating the need for special connectors. These two features combined produce an attenuation that is approximately 7% lower than the standard solid polyethylene RF100 design.
- Connector Compatibility**  
 The RF series cables are compatible with all standard land mobile radio-type connectors, including Times Microwave, RF Industries, Amphenol, Trompeter, EF Johnson and others.
- Conformable Coax**  
 For applications requiring low VSWR and high shield effectiveness, Belden's complete product range of 50 Ohm conformable coax cables offers unequalled performance. These patented cables serve as a replacement for semi-rigid cables and, unlike semi-rigid, they are hand formable.

## Guaranteed VSWR

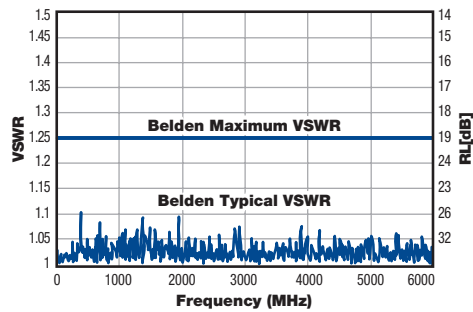

Note: Voltage Standing Wave Ratio (VSWR) is a measurement of the reflected power in a cable or instrument. The higher the VSWR the poorer the transmission characteristics of the cable.

## Power Rating

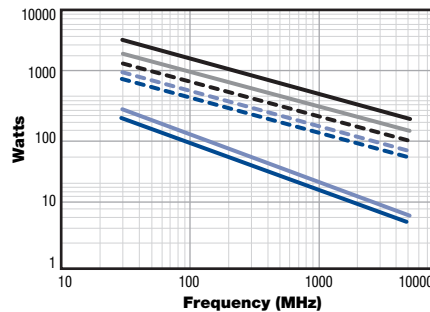

Legend:  
 — RF100A  
 — RF100LL  
 - - - RF195  
 - - - RF200  
 - - - RF240  
 — RF300  
 — RF400

## Attenuation

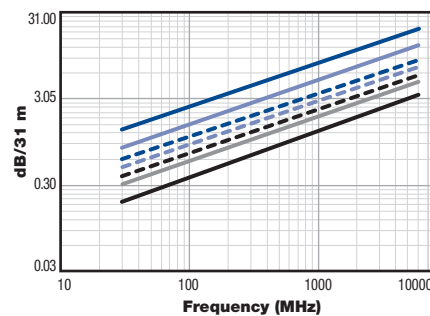

## Phase Stability

Phase Attribute	Typical Range (0.45 GHz to 6.0 GHz)	
	ppm/°C	Degree/GHz/m
Temperature (-40°C to +55°C) <sup>1</sup>	± 9	± 0.6
Bending & Flexing (25 cycles) <sup>2</sup>	NA	± 1.1

1: Per IEC 60965-1 clause 8.8  
 2: Per IEC 60965-1 clause 8.6

# Introduction



## RF Cables Cross-Reference Guide

RG Type	Cable Type	Belden Part No.	Amphenol	Commscope	Harbour Industries	Times Microwave
RG-174	RF100A	<b>7805</b>	–	–	HPP100	LMR®-100A
	RF100LL	<b>7805R</b>	–	–	–	–
RG-58	RF195	<b>7806A</b>	–	WBC™-195	HPP100	LMR®-195
	RF195	<b>7806R</b>	–	WBC™-195R	on request	on request
	RF200	<b>7807A</b>	–	WBC™-200	HPP200	LMR®-200
RG-8X	RF200	<b>7807R</b>	–	WBC™-200R	on request	on request
	RF240	<b>7808A</b>	TWB 2401	WBC™-240	HPP240	LMR®-240
	RF240	<b>7808R</b>	TWB 2401-FR	WBC™-240R	on request	on request
Intermediate	RF240	<b>7808WB</b>	–	–	–	–
	RF300	<b>7809A</b>	–	WBC™-300	HPP300	LMR®-300
	RF300	<b>7809R</b>	–	WBC™-300R	on request	on request
RG-8	RF300	<b>7809WB</b>	–	–	–	LMR®-300-DB
	RF400	<b>7810A</b>	TWB 4001	WBC™-400	HPP400	LMR®-400
	RF400	<b>7810R</b>	TWB 4001-FR	WBC™-400R	on request	on request
	RF400	<b>7810WB</b>	–	–	–	LMR®-400-DB

WBC™ is a Commscope trademark.  
LMR® is a Times Microwave trademark.

## RG Cable Replacement Guide

Belden Part No.	Size	Replacing
7805	RF100A	RG-174/U
7805R	RF100LL	RG-174/U
7806A	RF195	RG-58/U
7807A	RF200	RG-58/U
7808A	RF240	RG-8X
7809A	RF300	RG-8X
7810A	RF400	RG-8/U

### Availability

Many of these cables are available off the shelf from distributors. If you have a new or unusual application or you cannot find a CATV cable in this catalog section that meets your technical requirements contact technical support at +31-77-3875-414 or techsupport.venlo@belden.com.

### Corresponding Literature

#### Product Bulletins

- NP 182: Belden expands line of low loss 50 Ohm RF transmission cable
- NP 186: RF500 and RF600 low loss 50 Ohm
- NP E101: Messenger cable
- NP 230: Wi-Fi Tower shielded twisted pair

# Connector Cross Reference



Belden	Cabelcon Hardline	Cabelcon F-Crimp	Cabelcon F-Compression	Thomas & Betts	PPC Hardline	PPC F-Crimp	PPC F-Compression	Telegaertner (BNC)	ADC	ADC F-Crimp
CX3C0 Coax 3	Type -46	-	-	EI, EFI and X Series	H011	-	-	-	-	-
CX3C1 Coax 3	Type -76	-	-	EI, EFI and X Series	G012	-	-	-	-	-
CX3C2 Coax 3	Type -46	-	-	EI, EFI and X Series	H011	-	-	-	-	-
CX3C3 Coax 3	Type -46	-	-	EI, EFI and X Series	H011	-	-	-	-	-
CX4C0 Coax 4	Type -413	-	-	EI, EFI and X Series	E019	-	-	-	-	-
CX4C1 Coax 4	Type -413	-	-	EI, EFI and X Series	E019	-	-	-	-	-
CX4C2 Coax 4	Type -413	-	-	EI, EFI and X Series	E019	-	-	-	-	-
CX4C3 Coax 4	Type -413	-	-	EI, EFI and X Series	E019	-	-	-	-	-
CT167C1	Type -32	-	-	-	-	-	-	-	-	-
CT167C3	Type -32	-	-	-	-	-	-	-	-	-
CT167C0	Type -32	-	-	-	-	-	-	-	-	-
CT167C2	Type -32	-	-	-	-	-	-	-	-	-
CT125C1	Type -21	F-56-UNIV 5.7/8.8	-	-	-	-	-	-	BNC-27	on request
CT125C3	Type -21	-	-	-	-	-	-	-	BNC-27	on request
CT125C0	Type -21	-	-	-	-	-	-	-	BNC-27	on request
CT100C0	Type -01	-	-	-	-	-	-	J01002A0000	BNC-9	CF-9
CT100C3	Type -01	-	-	-	-	-	-	J01002A0000	BNC-9	CF-9
CT100C1	Type -01	-	-	-	-	-	-	J01002A0000	BNC-9	CF-9
RG6D00 DB+	Type -01	F-56-ALM 4.9/8.4	F-56-CX3 4.9	-	A025	CFS 6	EX6 4.9 + CMP6 4.9	J01002A0000	BNC-8-N	CF-8
RG6D01 DB+	Type -01	F-56-ALM 4.9/8.4	F-56-CX3 4.9	-	A025	CFS 6	EX6 4.9 + CMP6 4.9	J01002A0000	BNC-8-N	CF-8
RG7C01	Type -245	-	F-RG7-CX3 6.0	-	-	-	-	-	BNC-27	on request
RG7C02	Type -245	-	F-RG7-CX3 6.0	-	-	-	-	-	BNC-27	on request
RG7C00	-	-	-	-	-	-	-	-	BNC-27	on request
PRG11A2	Type -32	FM-RG11-ALM 7.4/11.7	FM-RG11-CX3 7.5	SNS11 Range	B004	CFS 11	EX11	J01002A0054 (cut-away foil)	BNC-25-N	on request
PRG11A3	Type -32	FM-RG11-ALM 7.4/11.7	FM-RG11-CX3 7.5	SNS11 Range	B004	CFS 11	EX11	J01002A0054 (cut-away foil)	BNC-25-N	on request
PRG11C0	Type -32	FM-RG11-ALM 7.4/11.7	FM-RG11-CX3 7.5	SNS11 Range	B004	CFS 11	EX11	J01002A0054 (cut-away foil)	BNC-25-N	on request
PRG11C2	Type -32	FM-RG11-ALM 7.4/11.7	FM-RG11-CX3 7.5	SNS11 Range	B004	CFS 11	EX11	J01002A0054 (cut-away foil)	BNC-25-N	on request
PRG11C4	Type -32	FM-RG11-ALM 7.4/11.7	FM-RG11-CX3 7.5	SNS11 Range	B004	CFS 11	EX11	J01002A0054 (cut-away foil)	BNC-25-N	on request
PRG11C6	Type -32	FM-RG11-ALM 7.4/11.7	FM-RG11-CX3 7.5	SNS11 Range	B004	CFS 11	EX11	J01002A0054 (cut-away foil)	BNC-25-N	on request
PRG11D0 DB+	Type -32	FM-RG11-ALM 7.4/11.7	FM-RG11-CX3 7.5	SNS11 Range	B004	CFS 11	EX11	J01002A0054 (cut-away foil)	BNC-25-N	on request
PRG11D1 DB+	Type -32	FM-RG11-ALM 7.4/11.7	FM-RG11-CX3 7.5	SNS11 Range	B004	CFS 11	EX11	J01002A0054 (cut-away foil)	BNC-25-N	on request
PRG11D3 DB+	Type -32	FM-RG11-ALM 7.4/11.7	FM-RG11-CX3 7.5	SNS11 Range	B004	CFS 11	EX11	J01002A0054 (cut-away foil)	BNC-25-N	on request
PRG7A00	Type -21	F-56-UNIV 5.7/8.8	F-56-CX3 5.7	SNS7 Range	A031	-	CMP PRG7	-	-	-
PRG7A01	Type -21	F-56-UNIV 5.7/8.8	F-56-CX3 5.7	SNS7 Range	A031	-	CMP PRG7	-	-	-
PRG7C00	Type -21	F-56-UNIV 5.7/8.8	F-56-CX3 5.7	SNS7 Range	A031	-	CMP PRG7	-	-	-
PRG7C01	Type -21	F-56-UNIV 5.7/8.8	F-56-CX3 5.7	SNS7 Range	A031	-	CMP PRG7	-	-	-

### Connector Cross Reference (continued)



Belden	Cabelcon Hardline	Cabelcon F-Crimp	Cabelcon F-Compression	Thomas & Betts	PPC Hardline	PPC F-Crimp	PPC F-Compression	Telegaertner (BNC)	ADC	ADC F-Crimp
RG6A00	Type -01	F-56-ALM 4.9/8.4	F-56-CX3 4.9	-	A025	CFS 6	EX6 4.9 + CMP6 4.9	J01002A0000	BNC-8-N	CF-8
H105B00	Type -01	F-56-ALM 4.9/8.4	F-56-CX3 4.9	-	A025	CFS 6	EX6 4.9 + CMP6 4.9	J01002A0013	-	-
H106T00	Type -11	F-59-ALM 3.9/7.6	F-59-CX3 3.9	-	A025	CFS 6	EX6 4.9 + CMP6 4.9	J01002A1352	BNC-2-N	on request
H106T01	Type -11	F-59-ALM 3.9/7.6	F-59-CX3 3.9	-	A025	CFS 6	EX6 4.9 + CMP6 4.9	J01002A1352	BNC-2-N	on request
H109C00	-	-	-	-	-	-	-	-	-	-
H109C02	-	-	-	-	-	-	-	-	-	-
H126A00	Type -01	F-56-ALM 4.9/8.4	F-56-CX3 4.9	SNS6 Range	A025	CFS 6	EX6 4.9 + CMP6 4.9	J01002A0000	BNC-8-N	CF-8
H126A02	Type -01	F-56-ALM 4.9/8.4	F-56-CX3 4.9	SNS6 Range	A025	CFS 6	EX6 4.9 + CMP6 4.9	J01002A0000	BNC-8-N	CF-8
H126A03	Type -01	F-56-ALM 4.9/8.4	F-56-CX3 4.9	SNS6 Range	A025	CFS 6	EX6 4.9 + CMP6 4.9	J01002A0000	BNC-8-N	CF-8
H126D00 DB+	Type -01	F-56-ALM 4.9/8.4	F-56-CX3 4.9	SNS6 Range	A025	CFS 6	EX6 4.9 + CMP6 4.9	J01002A0000	BNC-8-N	CF-8
H126D02 DB+	Type -01	F-56-ALM 4.9/8.4	F-56-CX3 4.9	SNS6 Range	A025	CFS 6	EX6 4.9 + CMP6 4.9	J01002A0000	BNC-8-N	CF-8
H126D03 DB+	Type -01	F-56-UNIV 4.9/8.8	F-56-CX3 4.9	SNS6 Range	A025	CFS 6	EX6 4.9 + CMP6 4.9	J01002A0000	BNC-8-N	CF-8
H126D04 DB+	Type -01	F-56-ALM 4.9/8.4	F-56-CX3 4.9	SNS6 Range	A025	CFS 6	EX6 4.9 + CMP6 4.9	J01002A0000	BNC-8-N	CF-8
H125A00	Type -01	F-56-ALM 4.9/8.4	F-56-CX3 5.1	SNS59 Range	A025	CFS 6 JSUV	EX6 5.1 + CMP6 5.1	J01002A0010	BNC-9	CF-9
H125A01	Type -01	F-56-ALM 4.9/8.4	F-56-CX3 5.1	SNS59 Range	A025	CFS 6 JSUV	EX6 5.1 + CMP6 5.1	J01002A0010	BNC-9	CF-9
H125C02	Type -01	F-56-ALM 4.9/8.4	F-56-CX3 5.1	SNS59 Range	A025	CFS 6 JSUV	EX6 5.1 + CMP6 5.1	J01002A0010	BNC-9	CF-9
H125A03	Type -01	F-56-ALM 4.9/8.4	F-56-CX3 5.1	SNS59 Range	A025	CFS 6 JSUV	EX6 5.1 + CMP6 5.1	J01002A0010	BNC-9	CF-9
H125A04	Type -01	F-56-ALM 4.9/8.4	F-56-CX3 5.1	SNS59 Range	A025	CFS 6 JSUV	EX6 5.1 + CMP6 5.1	J01002A0010	BNC-9	CF-9
H125A06	Type -01	F-56-ALM 4.9/8.4	F-56-CX3 5.1	SNS59 Range	A025	CFS 6 JSUV	EX6 5.1 + CMP6 5.1	J01002A0010	BNC-9	CF-9
H125A07	Type -01	F-56-ALM 4.9/8.4	F-56-CX3 5.1	SNS59 Range	A025	CFS 6 JSUV	EX6 5.1 + CMP6 5.1	J01002A0010	BNC-9	CF-9
H125A08	Type -01	F-56-ALM 4.9/8.4	F-56-CX3 5.1	SNS59 Range	A025	CFS 6 JSUV	EX6 5.1 + CMP6 5.1	J01002A0010	BNC-9	CF-9
H125C00	Type -01	F-56-ALM 4.9/8.4	F-56-CX3 5.1	SNS59 Range	A025	CFS 6 JSUV	EX6 5.1 + CMP6 5.1	J01002A0010	BNC-9	CF-9
H125C01	Type -01	F-56-ALM 4.9/8.4	F-56-CX3 5.1	SNS59 Range	A025	CFS 6 JSUV	EX6 5.1 + CMP6 5.1	J01002A0038	BNC-9	CF-9
H125C03	Type -01	F-56-ALM 4.9/8.4	F-56-CX3 5.1	SNS59 Range	A025	CFS 6 JSUV	EX6 5.1 + CMP6 5.1	J01002A0038	BNC-9	CF-9
H125C04	Type -01	F-56-ALM 4.9/8.4	F-56-CX3 5.1	SNS59 Range	A025	CFS 6 JSUV	EX6 5.1 + CMP6 5.1	J01002A0038	BNC-9	CF-9
H125D00	Type -01	F-56-ALM 3.7/6.4	F-56-CX3 5.1	SNS59 Range	A025	CFS 6 JSUV	EX6 5.1 + CMP6 5.1	J01002A0038	BNC-9	CF-9
H121A00	Type -106	F-59-ALM 3.7/6.4	F-59-CX3 3.7	-	-	-	CMP MC 37	J01002A0016	BNC-6	on request
H121A01	Type -106	F-59-ALM 3.7/6.4	F-59-CX3 3.7	-	-	-	CMP MC 37	J01002A0016	BNC-6	on request
H121A02	Type -106	F-59-ALM 3.7/6.4	F-59-CX3 3.7	-	-	-	CMP MC 37	J01002A0016	BNC-6	on request
H121A03	Type -106	F-59-ALM 3.7/6.4	F-59-CX3 3.7	-	-	-	CMP MC 37	J01002A0016	BNC-6	on request
H121A04	Type -106	F-59-ALM 3.7/6.4	F-59-CX3 3.7	-	-	-	CMP MC 37	J01002A0016	BNC-6	on request
H121C00	Type -106	F-59-ALM 3.7/6.4	F-59-CX3 3.7	-	-	-	CMP MC 37	J01002A0016	BNC-26-N	on request

9 • Broadband Coax Cables

### Connector Cross Reference (continued)



Belden	Cabelcon Hardline	Cabelcon F-Crimp	Cabelcon F-Compression	Thomas & Betts	PPC Hardline	PPC F-Crimp	PPC F-Compression	Telegaertner (BNC)	ADC	ADC F-Crimp
H123A02	-	F-60-MINI 3.2/5.6	-	Mini SNS Range	-	-	CMP MC 32	J01002A0030	BNC-26-N	on request
H123A01	-	F-60-MINI 3.2/5.6	-	Mini SNS Range	-	-	CMP MC 32	J01000A0030	BNC-26-N	on request
H123A00	-	F-60-MINI 3.2/5.6	-	Mini SNS Range	-	-	CMP MC 32	J01000A0030	-	-
H1000C3	Type -201/50	NM/50-RG213-EPA 7.6/12.0	-	-	B503	-	-	J01000A0063	-	-
H1000C0	Type -201/50	NM/50-RG213-EPA 7.6/12.0	-	-	B503	-	-	J01000A0063	-	-
H1000C1	Type -201/50	NM/50-RG213-EPA 7.6/12.0	-	-	B503	-	-	J01000A0063	-	-
H1001C1	Type -201/50	NM/50-RG213-EPA 7.6/12.0	-	-	B503	-	-	J01000A0063	-	-
H500C00	Type -204/50	-	-	-	-	-	-	J01000A0063	-	-
MRG5900	-	F-59-UNIV 3.9/8.4	F-59-CX3 3.9 HEC	-	-	-	-	J01002A1352	-	-
MRG2130	Type -206/50	NM/50-RG213-EPA 7.6/12.0	-	-	B501	-	-	J01000A0059	-	-
MRG5800	-	-	-	-	-	-	-	J01000F1255	-	-
1523A	-	-	-	SNS11AS	-	-	-	-	BNC-25-N	on request
1524M	-	-	-	SNS11AS	-	-	-	-	BNC-25-N	on request
9116	-	-	-	SNS1PGU	-	-	-	-	BNC-20	on request
1674A	-	-	-	SNS1PGU	-	-	-	-	-	-





### Selection Guide: Class A Products

Trunk and Distribution Cable			Drop Cable	
Class A++	Class A+	Class A	Class A	
CX3C0	CX4C0	CT167C0	CT125C0	H125D00
CX3C1	CX4C1	CT167C1	CT125C1	H126D00
CX3C2	CX4C2	CT167C2	CT125C3	H126D02
CX3C3	CX4C3	CT167C3	H121A03	H126D03
	PRG11D0	PRG11A2	H121A04	H126D04
	PRG11D1	PRG11A3	H123A01	RG6D00
	PRG11D3	PRG11C0	H123A02	RG6D01
		PRG11C2		
		PRG11C4		
		PRG11C6		
		1523A		
		1524M		
		1525A		

# Broadband Coax

## Trunk Cables



De- scription	Part No.	UL NEC/ C(UL)/CEC Type IEC	Standard Lengths		Standard Unit Weight		Conductor (Stranding) Diameter Nom. DCR	Nominal Core OD (Dielectric)		Shielding Material Nom. DCR	Nominal OD		Nom. Imp. ( )	Nom. Vel. of Prop.	Nominal Capacitance		Nominal Attenuation		
			ft.	m	lbs.	kg		inch	mm		inch	mm			pF/ft.	pF/m	MHz	dB/ 100 ft.	dB/ 100 m
<b>Coax 3C • Solid 3.38 mm Bare Copper • Copper-Foil • 60% Bare Copper Braid</b>																			
<b>Gas-Injected Polyethylene Insulation • Polyethylene Jacket (Black or Green)</b>																			
70°C	<b>CX3C0</b>		2296	700	496.9	225.4	3.38 mm	0.587	14.90	Cu-foil + 60% BC Braid 2.6 /km*** 15.8 mm	0.780	19.80	75	84%	16.5	54.0	5	0.1	0.4
			3444	1050	745.4	338.1	Solid BC 4.5 /km* 1.9 /km**	100	0.5								1.8		
																			
FB20																			
			Return loss at				5-470 MHz: 26 dB 470-1000 MHz: 23 dB 1000-2150 MHz: 18 dB								Screening attenuation at 30-1000 MHz: 100 dB Transfer impedance at 5-30 MHz: 0.8 m /m Screening Class: A++ Pulling Tension: 1200 N				
70°C	<b>CX3C3</b>		2296	700	626.5	284.2	3.38 mm	0.587	14.90	Cu-foil + 60% BC Braid 2.6 /km*** 15.8 mm	0.780	19.80	75	84%	16.5	54.0	see above		
							Solid BC 4.5 /km* 1.9 /km**	x 30.00											
																			
FB20																			
			Return loss at				5-470 MHz: 26 dB 470-1000 MHz: 23 dB 1000-2150 MHz: 18 dB								Screening attenuation at 30-1000 MHz: 100 dB Transfer impedance at 5-30 MHz: 0.8 m /m Screening Class: A++ Pulling Tension: 6000 N				
Available in Black. 7.2 mm ZP messenger																			
<b>Gas-Injected Polyethylene Insulation • Grey FRNC/LSNH Jacket</b>																			
70°C	<b>CX3C2</b>	IEC 332-1	2296	700	620.4	281.4	3.38 mm	0.587	14.90	Cu-foil + 60% BC Braid 2.6 /km*** 15.8 mm	0.780	19.80	75	84%	16.5	54.0	see above		
							Solid BC 4.5 /km* 1.9 /km**												
																			
FB20																			
			Return loss at				5-470 MHz: 26 dB 470-1000 MHz: 23 dB 1000-2150 MHz: 18 dB								Screening attenuation at 30-1000 MHz: 100 dB Transfer impedance at 5-30 MHz: 0.8 m /m Screening Class: A++ Pulling Tension: 1200 N				
<b>Coax 3C • Solid 3.38 mm Bare Copper • Copper-Foil</b>																			
<b>Gas-Injected Polyethylene Insulation • Polyethylene Jacket (Black or Green)</b>																			
70°C	<b>CX3C1</b>		2296	700	419.8	190.4	3.38 mm	0.587	14.90	Cu-foil 2.6 /km*** 15.3 mm	0.709	18.00	75	84%	16.5	54.0	see above		
			3444	1050	629.6	285.6	Solid BC 4.5 /km* 1.9 /km**												
																			
FB18																			
			Return loss at				5-470 MHz: 26 dB 470-1000 MHz: 23 dB 1000-2150 MHz: 18 dB								Screening attenuation at 30-1000 MHz: 100 dB Transfer impedance at 5-30 MHz: 0.8 m /m Screening Class: A++ Pulling Tension: 1200 N				

\* DC loop resistance • \*\* DC resistance inner conductor • \*\*\* DC resistance outer conductor • DCR = DC resistance • BC = Bare Copper • ZP = Stranded Zinc-Plated Steel



# Broadband Coax

## Trunk Cables







De- scription	Part No.	UL NEC/ C(UL)CEC Type IEC	Standard Lengths		Standard Unit Weight		Conductor (Stranding) Diameter Nom. DCR	Nominal Core OD (Dielectric)		Shielding Material Nom. DCR	Nominal OD		Nom. Imp. ( )	Nom. Vel. of Prop.	Nominal Capacitance		Nominal Attenuation		
			ft.	m	lbs.	kg		inch	mm		inch	mm			pF/ft.	pF/m	MHz	dB/ 100 ft.	dB/ 100 m
<b>Coax 3.5A • Solid 3.15 mm Copper-Clad Aluminium • Welded Aluminium Tube</b>																			
<b>Gas-Injected Foam Polyethylene Insulation • Black Polyethylene Jacket</b>																			
70°C	<b>YE00131</b>		3280	1000	282.2	128.0	3.15 mm Solid CCA 5.55 /km* 3.5 /km**	0.513	13.03	Welded Aluminum Tube 2.05 /km*** 13.72 mm	0.610	15.50	75	88%	15.2	50.0	5	0.1	0.5
																	50	0.5	1.5
																	100	0.6	2.1
																	200	1.0	3.1
																	400	1.4	4.5
																	862	2.1	6.9
																	1000	2.3	7.4
Flooded			Return loss at				30-450 MHz: 30 dB	Screening attenuation at 50-2150 MHz: 100 dB				450-600 MHz: 28 dB				600-1000 MHz: 26 dB			
70°C	<b>YE00132</b>		3280	1000	407.9	185.0	3.15 mm Solid CCA 5.55 /km* 3.5 /km**	0.513	13.03	Welded Aluminum Tube 2.05 /km*** 13.72 mm	0.610	15.50	75	88%	15.2	50.0	see above		
																	50	0.5	1.5
																	100	0.6	2.1
																	200	1.0	3.1
																	400	1.4	4.5
																	862	2.1	6.9
																	1000	2.3	7.4
		Return loss at				30-450 MHz: 30 dB	Screening attenuation at 50-2150 MHz: 100 dB				450-600 MHz: 28 dB				600-1000 MHz: 26 dB				
		2.75 mm Steel Wire messenger																	

\* DC loop resistance • \*\* DC resistance inner conductor • \*\*\* DC resistance outer conductor • DCR = DC resistance • CCA = Copper-Clad Aluminium

# Broadband Coax

## Trunk Cables



De- scription	Part No.	UL NEC/ C(UL)/CEC Type IEC	Standard Lengths		Standard Unit Weight		Conductor (Stranding) Diameter Nom. DCR	Nominal Core OD (Dielectric)		Shielding Material Nom. DCR	Nominal OD		Nom. Imp. ( )	Nom. Vel. of Prop.	Nominal Capacitance		Nominal Attenuation		
			ft.	m	lbs.	kg		inch	mm		inch	mm			pF/ft.	pF/m	MHz	dB/ 100 ft.	dB/ 100 m
<b>Coax 4C • Solid 2.23 mm Bare Copper • Copper-Foil • 60% Bare Copper Braid</b>																			
<b>Gas-Injected Polyethylene Insulation • Polyethylene Jacket (Black or Green)</b>																			
70°C	<b>CX4C0</b>		1640	500	183.0	83.0	2.23 mm	0.402	10.20	Cu-foil + 60% BC Braid 4.5 /km*** 11.0 mm	0.543	13.80	75	82%	16.5	54.0	5	0.2	0.6
			3280	1000	366.0	166.0	Solid BC 9.0 /km* 4.5 /km**	50	0.6								1.9		
																			
FB14																			
Return loss at 5-470 MHz: 26 dB 470-1000 MHz: 23 dB 1000-2150 MHz: 18 dB																			
Screening attenuation at 30-1000 MHz: 100 dB Transfer impedance at 5-30 MHz: 1.9 m /m Screening Class: A+ Pulling Tension: 400 N																			
70°C	<b>CX4C3</b>		1640	500	248.0	112.5	2.23 mm	0.402	10.20	Cu-foil + 60% BC x Braid 4.5 /km*** 11.0 mm	0.543	13.80	75	82%	16.5	54.0	see above		
																			
FB14																			
Return loss at 5-470 MHz: 26 dB 470-1000 MHz: 23 dB 1000-2150 MHz: 18 dB																			
Screening attenuation at 30-1000 MHz: 100 dB Transfer impedance at 5-30 MHz: 1.9 m /m Screening Class: A+ Pulling Tension: 6000 N																			
Available in Black. 5.8 mm ZP messenger																			
<b>Gas-Injected Polyethylene Insulation • Grey FRNC/LSNH Jacket</b>																			
70°C	<b>CX4C2</b>	IEC 332-1	1640	500	211.6	96.0	2.23 mm	0.402	10.20	Cu-foil + 60% BC Braid 4.5 /km*** 11.0 mm	0.543	13.80	75	82%	16.5	54.0	see above		
																			
FB14																			
Return loss at 5-470 MHz: 26 dB 470-1000 MHz: 23 dB 1000-2150 MHz: 18 dB																			
Screening attenuation at 30-1000 MHz: 100 dB Transfer impedance at 5-30 MHz: 1.9 m /m Screening Class: A+ Pulling Tension: 400 N																			
<b>Coax 4C • Solid 2.23 mm Bare Copper • Copper-Foil</b>																			
<b>Gas-Injected Polyethylene Insulation • Polyethylene Jacket (Black or Green)</b>																			
70°C	<b>CX4C1</b>		1640	500	177.5	80.5	2.23 mm	0.402	10.20	Cu-foil 4.5 /km*** 10.6 mm	0.543	13.80	75	82%	16.5	54.0	see above		
																			
FB14																			
Return loss at 5-470 MHz: 26 dB 470-1000 MHz: 23 dB 1000-2150 MHz: 18 dB																			
Screening attenuation at 30-1000 MHz: 100 dB Transfer impedance at 5-30 MHz: 1.9 m /m Screening Class: A+ Pulling Tension: 600 N																			

\* DC loop resistance • \*\* DC resistance inner conductor • \*\*\* DC resistance outer conductor • DCR = DC resistance • BC = Bare Copper • ZP = Stranded Zinc-Plated Steel

**Broadband Coax**  
Distribution Cables



De- scription	Part No.	UL NEC/ C(UL)CEC Type IEC	Standard Lengths		Standard Unit Weight		Conductor (Stranding) Diameter Nom. DCR	Nominal Core OD (Dielectric)		Shielding Material Nom. DCR	Nominal OD		Nom. Imp. ( )	Nom. Vel. of Prop.	Nominal Capacitance		Nominal Attenuation		
			ft.	m	lbs.	kg		inch	mm		inch	mm			pF/ft.	pF/m	MHz	dB/ 100 ft.	dB/ 100 m

**CT167C • Solid 1.67 mm Bare Copper • Copper-Foil • 55 % Bare Copper Braid**

<b>5-Cell Polyethylene Insulation • Black Polyethylene Jacket</b>																																	
70°C	CT167C1		328	100	24.5	11.1	1.67 mm Solid BC 15.0 /km* 8.5 /km**	0.287	7.28	Cu-foil + 55% BC Braid 6.5 /km*** 8.1 mm	0.398	10.10	75	81%	16.5	54.0	5	0.3	0.9														
			820	250	61.2	27.8											50	0.9	2.8	230	1.8	6.0	470	2.9	9.4	862	3.8	12.6	1000	4.3	14.0	1350	5.0
Return loss at			5-470 MHz: 26 dB				470-1000 MHz: 23 dB				1000-2150 MHz: 18 dB				Screening attenuation at 30-1000 MHz: 85 dB			Transfer impedance at 5-30 MHz: 5.0 m /m			Screening Class: A			Pulling Tension: 300 N									



<b>5-Cell Polyethylene Insulation • Black RBS Polyethylene Jacket</b>																										
70°C	CT167C3		820	250	63.4	28.8	1.67 mm Solid BC 15.0 /km* 8.5 /km**	0.287	7.28	Cu-foil + 55% BC Braid 6.5 /km*** 8.1 mm	0.398	10.10	75	81%	16.5	54.0	see above									
Return loss at			5-470 MHz: 26 dB				470-1000 MHz: 23 dB				1000-2150 MHz: 18 dB				Screening attenuation at 30-1000 MHz: 85 dB			Transfer impedance at 5-30 MHz: 5.0 m /m			Screening Class: A			Pulling Tension: 300 N		



<b>5-Cell Polyethylene Insulation • Black PVC Jacket</b>																										
70°C	CT167C0		820	250	52.4	23.8	1.67 mm Solid BC 15.0 /km* 8.5 /km**	0.287	7.28	Cu-foil + 55% BC Braid 6.5 /km*** 8.1 mm	0.398	10.10	75	81%	16.5	54.0	see above									
			1640	500	104.7	47.5																				
Return loss at			5-470 MHz: 26 dB				470-1000 MHz: 23 dB				1000-2150 MHz: 18 dB				Screening attenuation at 30-1000 MHz: 85 dB			Transfer impedance at 5-30 MHz: 5.0 m /m			Screening Class: A			Pulling Tension: 300 N		



<b>5-Cell Polyethylene Insulation • Grey FRNC/LSNH Jacket</b>																										
70°C	CT167C2	IEC 322-1	820	250	52.4	23.8	1.67 mm Solid BC 15.0 /km* 8.5 /km**	0.287	7.28	Cu-foil + 55% BC Braid 6.5 /km*** 8.1 mm	0.398	10.10	75	81%	16.5	54.0	see above									
			1640	500	104.7	47.5																				
Return loss at			5-470 MHz: 26 dB				470-1000 MHz: 23 dB				1000-2150 MHz: 18 dB				Screening attenuation at 30-1000 MHz: 85 dB			Transfer impedance at 5-30 MHz: 5.0 m /m			Screening Class: A			Pulling Tension: 300 N		



\* DC loop resistance • \*\* DC resistance inner conductor • \*\*\* DC resistance outer conductor • DCR = DC resistance • BC = Bare Copper

# Broadband Coax

## Distribution Cables



De-scription	Part No.	UL NEC / C(UL)/CEC Type IEC	Standard Lengths		Standard Unit Weight		Conductor (Stranding) Diameter Nom. DCR	Nominal Core OD (Dielectric)		Shielding Material Nom. DCR	Nominal OD		Nom. Imp. ( )	Nom. Vel. of Prop.	Nominal Capacitance		Nominal Attenuation			
			ft.	m	lbs.	kg		inch	mm		inch	mm			pF/ft.	pF/m	MHz	dB/100 ft.	dB/100 m	
<b>Series 11 • 14 AWG • Solid 1.63 mm Copper-Covered Steel • Duobond® II • 60% Aluminum Braid</b>																				
<b>Gas-Injected Foam Polyethylene Insulation • PVC Jacket (Black and White)</b>																				
80°C	1523A	NEC: CATV CEC: CM	1000	305	67.0	30.4	1.63 mm 14 AWG Solid CCS 49.6 /km* 36.1 /km**	0.280	7.11	Duobond® II + 60% AL Braid 13.4 /km*** 7.98 mm	0.400	10.16	75	83%	16.2	53.1	5	0.3	1.1	
																				Return loss at
80°C	1524AM	Aerial	1000	305	90.0	40.8	1.63 mm 14 AWG Solid CCS 49.6 /km* 36.1 /km**	0.280	7.11	Duobond® II + 60% AL Braid 13.4 /km*** 7.98 mm	0.400	10.16	75	83%	16.2	53.1				see above
1.83 mm galvanized steel messenger																				
<b>Gas-Injected Foam Polyethylene Insulation • Polyethylene Jacket (Black or Orange)</b>																				
80°C	1525A	Burial	1000	305	60.2	27.3	1.63 mm 14 AWG Solid CCS 49.6 /km* 36.1 /km**	0.280	7.11	Duobond® II + 60% AL Braid 13.4 /km*** 7.98 mm	0.400	10.16	75	83%	16.2	53.1				see above
Core Guard®																				
<b>PRG11C • Solid 1.55 mm Bare Copper • Copper-Foil • 50% Bare Copper Braid</b>																				
<b>Gas-Injected Polyethylene Insulation • Polyethylene Jacket (Black or Green)</b>																				
70°C	PRG11C0		820	250	37.5	17.0	1.55 mm Solid BC 20.0 /km* 9.4 /km**	0.285	7.25	Cu-foil + 50% BC Braid 10.6 /km*** 7.9 mm	0.398	10.10	75	81%	16.8	55.0	5	0.3	0.9	
1000 m put-up available in Black only.																				
70°C	PRG11C6		820	250	63.4	28.8	1.55 mm Solid BC 20.0 /km* 9.4 /km**	0.285	7.25	Cu-foil + 50% BC Braid 10.6 /km*** 7.9 mm	0.398	10.10	75	81%	16.8	55.0				see above
Available in Black. 4.6 mm ZP messenger																				

\* DC loop resistance • \*\* DC resistance inner conductor • \*\*\* DC resistance outer conductor • DCR = DC resistance • BC = Bare Copper • CCS = Copper-Covered Steel • AL = Aluminum • ZP = Stranded Zinc-Plated Steel

Duobond® II see technical information page 23.13.

# Broadband Coax

## Distribution Cables



De- scription	Part No.	UL NEC/ C(UL)CEC Type IEC	Standard Lengths		Standard Unit Weight		Conductor (Stranding) Diameter Nom. DCR	Nominal Core OD (Dielectric)		Shielding Material Nom. DCR	Nominal OD		Nom. Imp. ( )	Nom. Vel. of Prop.	Nominal Capacitance		Nominal Attenuation		
			ft.	m	lbs.	kg		inch	mm		inch	mm			pF/ft.	pF/m	MHz	dB/ 100 ft.	dB/ 100 m

**PRG11C • Solid 1.55 mm Bare Copper • Copper-Foil • 50% Bare Copper Braid**

<b>Gas-Injected Polyethylene Insulation • Grey FRNC/LSNH Jacket</b>																																	
70°C	PRG11C2	IEC 332-1	820	250	45.2	20.5	1.55 mm Solid BC 20.0 /km* 9.4 /km**	0.285	7.25	Cu-foil + 50% BC Braid 10.6 /km*** 7.9 mm	0.398	10.10	75	81%	16.8	55.0	5	0.3	0.9														
			1640	500	90.4	41.0											50	0.9	2.8	230	1.8	6.0	470	2.7	8.8	862	3.7	12.2	1000	4.1	13.6	1350	4.9

Return loss at 5-470 MHz: 26 dB  
470-1000 MHz: 23 dB  
1000-2000 MHz: 18 dB  
2000-3000 MHz: 16 dB

Screening attenuation at 30-1000 MHz: 85 dB  
Transfer impedance at 5-30 MHz: 5.0 m /m  
Screening Class: A  
Pulling Tension: 225 N

<b>Gas-Injected Polyethylene Insulation • PVC Jacket (Black or White)</b>																																	
70°C	PRG11C4		820	250	44.6	20.3	1.55 mm Solid BC 20.0 /km* 9.4 /km**	0.285	7.25	Cu-foil + 50% BC Braid 10.6 /km*** 7.9 mm	0.398	10.10	75	81%	16.8	55.0	see above																
			1640	500	89.3	40.5											50	0.9	2.9	230	2.0	6.4	470	2.8	9.3	862	4.0	13.0	1000	4.3	14.2	1350	5.1

Return loss at 5-470 MHz: 26 dB  
470-1000 MHz: 23 dB  
1000-2000 MHz: 18 dB  
2000-3000 MHz: 16 dB

Screening attenuation at 30-1000 MHz: 85 dB  
Transfer impedance at 5-30 MHz: 5.0 m /m  
Screening Class: A  
Pulling Tension: 225 N

1000 m put-up available in Black only.

**PRG11A • Solid 1.55 mm Bare Copper • Duofoil® • 50% Tinned Copper Braid**

<b>Gas-Injected Polyethylene Insulation • Black Polyethylene Jacket</b>																													
70°C	PRG11A3		1640	500	67.2	30.5	1.55 mm Solid BC 22.2 /km* 9.4 /km**	0.285	7.25	Duofoil® + 50% TC Braid 12.8 /km*** 7.9 mm	0.398	10.10	75	81%	16.8	55.0	5	0.3	0.9										
			50	0.9	2.9	230											2.0	6.4	470	2.8	9.3	862	4.0	13.0	1000	4.3	14.2	1350	5.1

Return loss at 5-470 MHz: 26 dB  
470-1000 MHz: 23 dB  
1000-2000 MHz: 18 dB  
2000-3000 MHz: 16 dB

Screening attenuation at 30-1000 MHz: 85 dB  
Transfer impedance at 5-30 MHz: 5.0 m /m  
Screening Class: A  
Pulling Tension: 225 N

<b>Gas-Injected Polyethylene Insulation • White PVC Jacket</b>																													
70°C	PRG11A2		1640	500	86.0	39.0	1.55 mm Solid BC 22.2 /km* 9.4 /km**	0.285	7.25	Duofoil® + 50% TC Braid 12.8 /km*** 7.9 mm	0.398	10.10	75	81%	16.8	55.0	see above												
			50	0.9	2.9	230											2.0	6.4	470	2.8	9.3	862	4.0	13.0	1000	4.3	14.2	1350	5.1

Return loss at 5-470 MHz: 26 dB  
470-1000 MHz: 23 dB  
1000-2000 MHz: 18 dB  
2000-3000 MHz: 16 dB

Screening attenuation at 30-1000 MHz: 85 dB  
Transfer impedance at 5-30 MHz: 5.0 m /m  
Screening Class: A  
Pulling Tension: 225 N



\* DC loop resistance • \*\* DC resistance inner conductor • \*\*\* DC resistance outer conductor • DCR = DC resistance • BC = Bare Copper • TC = Tinned Copper

Duofoil® see technical information page 23.13.

# Broadband Coax

## Distribution Cables



De- scription	Part No.	UL NEC/ C(UL)/CEC Type IEC	Standard Lengths		Standard Unit Weight		Conductor (Stranding) Diameter Nom. DCR	Nominal Core OD (Dielectric)		Shielding Material Nom. DCR	Nominal OD		Nom. Imp. ( )	Nom. Vel. of Prop.	Nominal Capacitance		Nominal Attenuation			
			ft.	m	lbs.	kg		inch	mm		inch	mm			pF/ft.	pF/m	MHz	dB/ 100 ft.	dB/ 100 m	
<b>PRG11D • Solid 1.55 mm Bare Copper • Duobond Plus® • 50 % Tinned Copper Braid</b>																				
<b>Gas-Injected Polyethylene Insulation • Black Polyethylene Jacket</b>																				
70°C	PRG11D3		820	250	34.7	15.8	1.55 mm	0.285	7.25	Duobond Plus® + 50% TC Braid 9.5 /km*** 8.1 mm	0.398	10.10	75	81%	16.8	55.0	5	0.3	0.9	
			1640	500	69.4	31.5	Solid BC 18.9 /km* 9.4 /km**	50	0.9								2.8			
	BTQ	Return loss at																		
		5-470 MHz: 26 dB	470-1000 MHz: 23 dB	1000-2000 MHz: 18 dB	2000-3000 MHz: 16 dB	Screening attenuation at 30-1000 MHz: 105 dB	Transfer impedance at 5-30 MHz: 1.9 m /m	Screening Class: A+	Pulling Tension: 250 N	862	3.9	12.7	1000	4.2	13.9	1350	5.0	16.5	1750	5.8
<b>Gas-Injected Polyethylene Insulation • Black FRNC/LSNH Jacket</b>																				
70°C	PRG11D1	IEC 332-1	1640	500	97.0	44.0	1.55 mm	0.285	7.25	Duobond Plus® + 70% TC Braid 7.0 /km*** 8.1 mm	0.398	10.10	75	81%	16.8	55.0	see above			
							Solid BC 16.4 /km* 9.4 /km**										2150	6.4	21.1	
	BTQ	Return loss at																		
		5-470 MHz: 26 dB	470-1000 MHz: 23 dB	1000-2000 MHz: 18 dB	2000-3000 MHz: 16 dB	Screening attenuation at 30-1000 MHz: 105 dB	Transfer impedance at 5-30 MHz: 1.9 m /m	Screening Class: A+	Pulling Tension: 250 N	2400	6.9	22.5	3000	7.7	25.2					
<b>Gas-Injected Polyethylene Insulation • Black PVC Jacket</b>																				
70°C	PRG11D0		1640	500	83.8	38.0	1.55 mm	0.285	7.25	Duobond Plus® + 50% TC Braid 9.5 /km*** 8.1 mm	0.398	10.10	75	81%	16.8	55.0	see above			
							Solid BC 18.9 /km* 9.4 /km**										2150	6.4	21.1	
	BTQ	Return loss at																		
		5-470 MHz: 26 dB	470-1000 MHz: 23 dB	1000-2000 MHz: 18 dB	2000-3000 MHz: 16 dB	Screening attenuation at 30-1000 MHz: 105 dB	Transfer impedance at 5-30 MHz: 1.9 m /m	Screening Class: A+	Pulling Tension: 250 N											

\* DC loop resistance • \*\* DC resistance inner conductor • \*\*\* DC resistance outer conductor • DCR = DC resistance • BC = Bare Copper • TC = Tinned Copper

Duobond Plus® see technical information page 23.13.

# Broadband Coax

## Drop Cables



De- scription	Part No.	UL NEC/ C(UL)/CEC Type IEC	Standard Lengths		Standard Unit Weight		Conductor (Stranding) Diameter Nom. DCR	Nominal Core OD (Dielectric)		Shielding Material Nom. DCR	Nominal OD		Nom. Imp. ( )	Nom. Vel. of Prop.	Nominal Capacitance		Nominal Attenuation		
			ft.	m	lbs.	kg		inch	mm		inch	mm			pF/ft.	pF/m	MHz	dB/ 100 ft.	dB/ 100 m

**CT125C • Solid 1.25 mm Bare Copper • Copper-Foil • 51% Bare Copper Braid**

5-Cell Polyethylene Insulation • Black Polyethylene Jacket																					
70°C	CT125C1	820	250	31.4	14.3	1.25 mm	0.217	5.50	Cu-foil	0.307	7.80	75	81%	16.5	54.0	50	1.1	3.5			
		1640	500	62.8	28.5	Solid BC			+ 51% BC								230	2.4	7.8		
		3280	1000	125.7	57.0	28.5 /km*			Braid								470	3.5	11.6		
						15.0 /km**			13.5 /km***							862	4.7	15.5			
									6.2 mm							1000	5.2	17.0			
																1750	6.7	22.0			
																2150	7.9	26.0			



Return loss at 5-470 MHz: 23 dB  
 470-1000 MHz: 20 dB  
 1000-2000 MHz: 18 dB  
 2000-3000 MHz: 16 dB

Screening attenuation at 30-1000 MHz: 85 dB  
 Transfer impedance at 5-30 MHz: 5.0 m /m  
 Screening Class: A  
 Pulling Tension: 100 N

5-Cell Polyethylene Insulation • Black RBS Polyethylene Jacket																						
70°C	CT125C3	1640	500	88.2	40.0	1.25 mm	0.217	5.50	Cu-foil	0.307	7.80	75	81%	16.5	54.0							
		3280	1000	176.4	80.0	Solid BC			+ 51% BC													see above
						28.5 /km*			Braid													
						15.0 /km**			13.5 /km***													
									6.2 mm													



RBS jacket

Return loss at 5-470 MHz: 23 dB  
 470-1000 MHz: 20 dB  
 1000-2000 MHz: 18 dB  
 2000-3000 MHz: 16 dB

Screening attenuation at 30-1000 MHz: 85 dB  
 Transfer impedance at 5-30 MHz: 5.0 m /m  
 Screening Class: A  
 Pulling Tension: 100 N

5-Cell Polyethylene Insulation • Black PVC Jacket																						
70°C	CT125C0	328	100	15.0	6.8	1.25 mm	0.217	5.50	Cu-foil	0.307	7.80	75	81%	16.5	54.0							
		820	250	37.5	17.0	Solid BC			+ 51% BC													see above
		1640	500	75.0	34.0	28.5 /km*			Braid													
						15.0 /km**			13.5 /km***													
									6.2 mm													



Return loss at 5-470 MHz: 23 dB  
 470-1000 MHz: 20 dB  
 1000-2000 MHz: 18 dB  
 2000-3000 MHz: 16 dB

Screening attenuation at 30-1000 MHz: 85 dB  
 Transfer impedance at 5-30 MHz: 5.0 m /m  
 Screening Class: A  
 Pulling Tension: 100 N

**RG7C • Solid 1.25 mm Bare Copper • Copper-Foil • 50% Bare Copper Braid**

Gas-Injected Polyethylene Insulation • Black Polyethylene Jacket																					
70°C	RG7C01	820	250	34.4	15.6	1.25 mm	0.224	5.70	Cu-foil	0.319	8.10	75	82%	16.5	54.0	5	0.4	1.2			
		1640	500	68.9	31.3	Solid BC			+ 50% BC								50	1.0	3.4		
						26.5 /km*			Braid								100	1.5	4.9		
						14.5 /km**			12.0 /km***							230	2.3	7.5			
									6.3 mm							400	3.1	10.1			
																800	4.5	14.6			
																862	4.6	15.1			
																1000	5.0	16.5			
																1350	5.9	19.5			
																1750	6.9	22.6			
																2150	7.7	25.3			
																2400	8.2	27.0			



Return loss at 5-470 MHz: 23 dB  
 470-1000 MHz: 20 dB  
 1000-2000 MHz: 18 dB  
 2000-3000 MHz: 16 dB

Screening attenuation at 30-1000 MHz: 85 dB  
 Transfer impedance at 5-30 MHz: 15.0 m /m  
 Screening Class: B  
 Pulling Tension: 90 N

Gas-Injected Polyethylene Insulation • Black FRNC/LSNH Jacket																						
70°C	RG7C02 IEC 332-1	820	250	34.4	15.6	1.25 mm	0.224	5.70	Cu-foil	0.319	8.10	75	82%	16.5	54.0							
		1640	500	68.9	31.3	Solid BC			+ 50% BC													see above
						26.5 /km*			Braid													
						14.5 /km**			12.0 /km***													
									6.3 mm													



Return loss at 5-470 MHz: 23 dB  
 470-1000 MHz: 20 dB  
 1000-2000 MHz: 18 dB  
 2000-3000 MHz: 16 dB

Screening attenuation at 30-1000 MHz: 85 dB  
 Transfer impedance at 5-30 MHz: 15.0 m /m  
 Screening Class: B  
 Pulling Tension: 90 N

\* DC loop resistance • \*\* DC resistance inner conductor • \*\*\* DC resistance outer conductor • DCR = DC resistance • BC = Bare Copper

# Broadband Coax

## Drop Cables



De-scription	Part No.	UL NEC / C(UL)CEC Type IEC	Standard Lengths		Standard Unit Weight		Conductor (Stranding) Diameter Nom. DCR	Nominal Core OD (Dielectric)		Shielding Material Nom. DCR	Nominal OD		Nom. Imp. ( )	Nom. Vel. of Prop.	Nominal Capacitance		Nominal Attenuation		
			ft.	m	lbs.	kg		inch	mm		inch	mm			pF/ft.	pF/m	MHz	dB/100 ft.	dB/100 m

**RG7C • Solid 1.25 mm Bare Copper • Copper-Foil • 50% Bare Copper Braid**

Gas-Injected Polyethylene Insulation • Black PVC Jacket																																					
70°C	RG7C00	820	250	34.4	15.6	1.25 mm Solid BC	0.224	5.70	Cu-foil + 50% BC Braid	0.319	8.10	75	82%	16.5	54.0	5	0.5	1.5																			
		1640	500	68.9	31.3											26.5 /km*	14.5 /km**	12.0 /km***	6.3 mm	100	1.5	5.0	230	2.3	7.5	400	3.1	10.1	800	4.5	14.6	862	4.7	15.5	1000	5.2	17.0
Return loss at		5-470 MHz: 23 dB				470-1000 MHz: 20 dB				1000-2000 MHz: 18 dB				2000-3000 MHz: 16 dB				Screening attenuation at 30-1000 MHz: 85 dB				Transfer impedance at 5-30 MHz: 15.0 m /m				Screening Class: B				Pulling Tension: 90 N							

**PRG7C • Solid 1.2 mm Bare Copper • Copper-Foil • 40% Bare Copper Braid**

Gas-Injected Polyethylene Insulation • Polyethylene Jacket (Black or Green)																																								
70°C	PRG7C01	820	250	22.6	10.3	1.2 mm Solid BC	0.213	5.40	Cu-foil + 40% BC Braid	0.280	7.10	75	83%	16.5	54.0	5	0.4	1.2																						
		1640	500	45.2	20.5											34.6 /km*	15.6 /km**	19.0 /km***	5.84 mm	50	1.1	3.6	100	1.6	5.2	230	2.4	7.9	400	3.2	10.5	800	4.6	15.2	862	4.8	15.8	1000	5.2	17.1
Return loss at		5-470 MHz: 23 dB				470-1000 MHz: 20 dB				1000-2000 MHz: 18 dB				2000-3000 MHz: 16 dB				Screening attenuation at 30-1000 MHz: 75 dB				Transfer impedance at 5-30 MHz: 15.0 m /m				Screening Class: B				Pulling Tension: 80 N										

Gas-Injected Polyethylene Insulation • PVC Jacket (Black or White)																																	
70°C	PRG7C00	B-328	B-100	10.4	4.7	1.2 mm Solid BC	0.213	5.40	Cu-foil + 40% BC Braid	0.280	7.10	75	83%	16.5	54.0	see above																	
		820	250	25.9	11.8											34.6 /km*	15.6 /km**	19.0 /km***	5.84 mm														
Return loss at		5-470 MHz: 23 dB				470-1000 MHz: 20 dB				1000-2000 MHz: 18 dB				2000-3000 MHz: 16 dB				Screening attenuation at 30-1000 MHz: 75 dB				Transfer impedance at 5-30 MHz: 15.0 m /m				Screening Class: B				Pulling Tension: 80 N			

**PRG7A • Solid 1.2 mm Bare Copper • Duofoil® • 40% Tinned Copper Braid**

Gas-Injected Polyethylene Insulation • Black PVC Jacket																																								
70°C	PRG7A00	328	100	9.7	4.4	1.2 mm Solid BC	0.213	5.40	Duofoil® + 40% TC Braid	0.280	7.10	75	83%	16.5	54.0	5	0.5	1.6																						
																39.6 /km*	15.6 /km**	24.0 /km***	5.84 mm	50	1.2	3.9	100	1.6	5.4	230	2.5	8.1	400	3.3	10.7	800	4.7	15.5	862	4.9	16.1	1000	5.3	17.5
Return loss at		5-470 MHz: 23 dB				470-1000 MHz: 20 dB				1000-2000 MHz: 18 dB				2000-3000 MHz: 16 dB				Screening attenuation at 30-1000 MHz: 85 dB				Transfer impedance at 5-30 MHz: 39.0 m /m				Screening Class: C				Pulling Tension: 80 N										

Gas-Injected Polyethylene Insulation • Black Polyethylene Jacket																																	
70°C	PRG7A01	3280	1000	147.7	67.0	1.2 mm Solid BC	0.213	5.40	Duofoil® + 40% TC Braid	0.280	7.10	75	83%	16.5	54.0	see above																	
																39.6 /km*	15.6 /km**	24.0 /km***	5.84 mm	14.00													
Return loss at		5-470 MHz: 23 dB				470-1000 MHz: 20 dB				1000-2000 MHz: 18 dB				2000-3000 MHz: 16 dB				Screening attenuation at 30-1000 MHz: 85 dB				Transfer impedance at 5-30 MHz: 39.0 m /m				Screening Class: C				Pulling Tension: 3500 N			

\* DC loop resistance • \*\* DC resistance inner conductor • \*\*\* DC resistance outer conductor • DCR = DC resistance • BC = Bare Copper • TC = Tinned Copper • ZP = Stranded Zinc-Plated Steel Duofoil® see technical information page 23.13.



# Broadband Coax

## Drop Cables



De- scription	Part No.	UL NEC/ C(UL)CEC Type IEC	Standard Lengths		Standard Unit Weight		Conductor (Stranding) Diameter Nom. DCR	Nominal Core OD (Dielectric)		Shielding Material Nom. DCR	Nominal OD		Nom. Imp. ( )	Nom. Vel. of Prop.	Nominal Capacitance		Nominal Attenuation		
			ft.	m	lbs.	kg		inch	mm		inch	mm			pF/ft.	pF/m	MHz	dB/ 100 ft.	dB/ 100 m

**Series 6 • Solid 1.02 mm Copper-Covered Steel • Duobond® II • 60% Aluminum Braid**

Gas-Injected Foam Polyethylene Insulation • Black PVC Jacket																										
80°C	<b>9116</b>	NEC: CATV CM CEC: CM	U-1000 1000	U-305 305	30.0 31.1	13.6 14.1	1.016 mm Solid CCS 121.3 /km* 91.9 /km**	0.180	4.57	Duobond® II + 60% AL Braid 29.5 /km*** 5.4 mm	0.270	6.86	75	83%	16.2	53.1	5	0.5	1.8							
																	55	1.5	4.8							
																	240	2.8	9.2							
																	450	3.9	12.7							
																	862	5.5	18.0							
																	1000	6.0	19.7							
																	1450	7.8	25.6							
																	1800	8.6	28.2							
																	2250	9.8	32.2							
																	3000	11.3	37.1							
Return loss at			5-470 MHz: 23 dB				470-862 MHz: 20 dB				862-2150 MHz: 18 dB				Screening attenuation at 30-1000 MHz: 85 dB				Transfer impedance at 5-30 MHz: 15.0 m /m				Screening Class: B			

**Series 6 • Solid 1.02 mm Copper-Covered Steel • Duobond® III • 60% Aluminum Braid Shield**

Gas-Injected Foam Polyethylene Insulation • Black PVC Jacket																										
80°C	<b>9118</b>	NEC: CATV CM CEC: CM	U-1000 1000	U-305 305	30.0 30.0	13.6 13.6	1.016 mm Solid CCS 113.2 /km* 91.9 /km**	0.180	4.57	Duobond® III + 60% AL Braid Duofoil® 21.3 /km*** 5.4 mm	0.278	7.06	75	83%	16.2	53.1	see above									
Return loss at			5-470 MHz: 23 dB				470-862 MHz: 20 dB				862-2150 MHz: 18 dB				Screening attenuation at 30-1000 MHz: 85 dB				Transfer impedance at 5-30 MHz: 15.0 m /m				Screening Class: B			

**RG6D • Solid 1.0 mm Copper-Covered Steel • Duobond Plus® • 50% Tinned Copper Braid**

Gas-Injected Polyethylene Insulation • White PVC Jacket																																		
70°C	<b>RG6D01</b>		U-820	U-250	27.0	12.3	1.0 mm Solid CCS 69.0 /km* 55.0 /km**	0.180	4.57	Duobond Plus® + 50% TC Braid 14.0 /km*** 5.4 mm	0.272	6.90	75	82%	16.5	54.0	5	0.5	1.8															
																	50	1.4	4.7															
																	100	2.0	6.5															
																	230	3.0	9.8															
																	400	4.0	13.0															
																	800	5.7	18.7															
																	862	5.9	19.5															
																	1000	6.4	21.1															
																	1350	7.6	24.9															
																	1750	8.8	28.8															
																	2150	9.8	32.3															
																	2400	10.5	34.4															
																	3000	12.0	39.2															
Return loss at			5-470 MHz: 20 dB				470-1000 MHz: 18 dB				1000-2000 MHz: 16 dB				2000-3000 MHz: 15 dB				Screening attenuation at 30-1000 MHz: 100 dB				Transfer impedance at 5-30 MHz: 4.5 m /m				Screening Class: A				Pulling Tension: 570 N			

Gas-Injected Polyethylene Insulation • White PVC Jacket																																		
70°C	<b>RG6D00</b>		U-820	U-250	25.9	11.8	1.0 mm Solid CCS 71.0 /km* 55.0 /km**	0.180	4.57	Duobond Plus® + 40% TC Braid 16.0 /km*** 5.4 mm	0.272	6.90	75	82%	16.5	54.0	see above																	
Return loss at			5-470 MHz: 20 dB				470-1000 MHz: 18 dB				1000-2000 MHz: 16 dB				2000-3000 MHz: 15 dB				Screening attenuation at 30-1000 MHz: 100 dB				Transfer impedance at 5-30 MHz: 4.5 m /m				Screening Class: A				Pulling Tension: 570 N			

**RG6A • Solid 1.0 mm Copper-Covered Steel • Duofoil® • 40% Tinned Copper Braid**





Gas-Injected Polyethylene Insulation • PVC Jacket (Black or White)																																		
70°C	<b>RG6A00</b>		B-328 U-820	B-100 U-250	10.6 26.5	4.8 12.0	1.0 mm Solid CCS 131.0 /km* 105.0 /km**	0.180	4.57	Duofoil® + 40% TC Braid 26.0 /km*** 5.3 mm	0.272	6.90	75	82%	16.5	54.0	see above																	
Return loss at			5-470 MHz: 20 dB				470-1000 MHz: 18 dB				1000-2000 MHz: 16 dB				2000-3000 MHz: 15 dB				Screening attenuation at 30-1000 MHz: 85 dB				Transfer impedance at 5-30 MHz: 40.0 m /m				Screening Class: C				Pulling Tension: 570 N			

\* DC loop resistance • \*\* DC resistance inner conductor • \*\*\* DC resistance outer conductor • DCR = DC resistance • TC = Tinned Copper • AL = Aluminum • CCS = Copper-Covered Steel  
Duofoil®, Duobond® II, Duobond® III and Duobond Plus® see technical information page 23.13.

# Broadband Coax

## Drop Cables



De-scription	Part No.	UL NEC / C(UL)CEC Type IEC	Standard Lengths		Standard Unit Weight		Conductor (Stranding) Diameter Nom. DCR	Nominal Core OD (Dielectric)		Shielding Material Nom. DCR	Nominal OD		Nom. Imp. ( )	Nom. Vel. of Prop.	Nominal Capacitance		Nominal Attenuation			
			ft.	m	lbs.	kg		inch	mm		inch	mm			pF/ft.	pF/m	MHz	dB/100 ft.	dB/100 m	
<b>H126D (RG6) • Solid 1.0 mm Bare Copper • Duobond Plus® • 50 % Tinned Copper Braid</b>																				
<b>Gas-Injected Polyethylene Insulation • Black Polyethylene Jacket</b>																				
70°C	H126D04		1640	500	44.1	20.0	1.0 mm Solid BC 37.0 /km* 23.0 /km**	0.180	4.57	Duobond Plus® + 50% TC Braid 14.0 /km*** 5.4 mm	0.272	6.90	75	82%	16.5	54.0	5	0.5	1.8	
																				
BTQ																				
Return loss at 5-470 MHz: 20 dB 470-1000 MHz: 18 dB 1000-2000 MHz: 16 dB 2000-3000 MHz: 15 dB																				
Screening attenuation at 30-1000 MHz: 100 dB Transfer impedance at 5-30 MHz: 4.5 m /m Screening Class: A Pulling Tension: 55 N																				
<b>Gas-Injected Polyethylene Insulation • White FRNC/LSNH Jacket</b>																				
70°C	H126D03	IEC 332-3	B-328 U-820 1640	B-100 U-250 500	10.8 27.0 54.0	4.9 12.3 24.5	1.0 mm Solid BC 37.0 /km* 23.0 /km**	0.180	4.57	Duobond Plus® + 50% TC Braid 14.0 /km*** 5.4 mm	0.272	6.90	75	82%	16.5	54.0	see above			
																				
BTQ																				
Return loss at 5-470 MHz: 20 dB 470-1000 MHz: 18 dB 1000-2000 MHz: 16 dB 2000-3000 MHz: 15 dB																				
Screening attenuation at 30-1000 MHz: 100 dB Transfer impedance at 5-30 MHz: 4.5 m /m Screening Class: A Pulling Tension: 55 N																				
<b>Gas-Injected Polyethylene Insulation • PVC Jacket (Black or White)</b>																				
70°C	H126D02		B-328 U-820 1640	B-100 U-250 500	10.8 27.0 54.0	4.9 12.3 24.5	1.0 mm Solid BC 37.0 /km* 23.0 /km**	0.180	4.57	Duobond Plus® + 50% TC Braid 14.0 /km*** 5.4 mm	0.272	6.90	75	82%	16.5	54.0	see above			
																				
BTQ																				
Return loss at 5-470 MHz: 20 dB 470-1000 MHz: 18 dB 1000-2000 MHz: 16 dB 2000-3000 MHz: 15 dB																				
Screening attenuation at 30-1000 MHz: 100 dB Transfer impedance at 5-30 MHz: 4.5 m /m Screening Class: A Pulling Tension: 55 N																				
500 m put-up available in Black only.																				
<b>Gas-Injected Polyethylene Insulation • PVC Jacket (Black or White)</b>																				
70°C	H126D00		B-328 U-820 1640	B-100 U-250 500	10.4 25.9 51.8	4.7 11.8 23.5	1.0 mm Solid BC 39.0 /km* 23.0 /km**	0.180	4.57	Duobond Plus® + 40% TC Braid 16.0 /km*** 5.4 mm	0.272	6.90	75	82%	16.5	54.0	see above			
																				
BTT																				
Return loss at 5-470 MHz: 20 dB 470-1000 MHz: 18 dB 1000-2000 MHz: 16 dB 2000-3000 MHz: 15 dB																				
Screening attenuation at 30-1000 MHz: 100 dB Transfer impedance at 5-30 MHz: 4.5 m /m Screening Class: A Pulling Tension: 55 N																				
<b>H126A (RG6) • Solid 1.0 mm Bare Copper • Duofoil® • 35% Tinned Copper Braid</b>																				
<b>Gas-Injected Polyethylene Insulation • PVC Jacket (Black or White)</b>																				
70°C	H126A00		B-328 U-820 984 1640	B-100 U-250 300 500	10.6 26.5 31.7 53.5	4.8 12.0 14.4 24.3	1.0 mm Solid BC 49.0 /km* 23.0 /km**	0.180	4.57	Duofoil® + 35% TC Braid 26.0 /km*** 5.25 mm	0.272	6.90	75	82%	16.5	54.0	see above			
																				
Return loss at 5-470 MHz: 20 dB 470-1000 MHz: 18 dB 1000-2000 MHz: 16 dB 2000-3000 MHz: 15 dB																				
Screening attenuation at 30-1000 MHz: 75 dB Transfer impedance at 5-30 MHz: 40.0 m /m Screening Class: C Pulling Tension: 55 N																				
B-100 m put-up available in White only.																				

\* DC loop resistance • \*\* DC resistance inner conductor • \*\*\* DC resistance outer conductor • DCR = DC resistance • BC = Bare Copper • TC = Tinned Copper  
 Duofoil® and Duobond Plus® see technical information page 23.13.

# Broadband Coax

## Drop Cables



De-scription	Part No.	UL NEC/C(UL)CEC Type IEC	Standard Lengths		Standard Unit Weight		Conductor (Stranding) Diameter Nom. DCR	Nominal Core OD (Dielectric)		Shielding Material Nom. DCR	Nominal OD		Nom. Imp. ( )	Nom. Vel. of Prop.	Nominal Capacitance		Nominal Attenuation			
			ft.	m	lbs.	kg		inch	mm		inch	mm			pF/ft.	pF/m	MHz	dB/100 ft.	dB/100 m	
<b>H126A (RG6) • Solid 1.0 mm Bare Copper • Duobond® II • 70% Tinned Copper Braid</b>																				
<b>Gas-Injected Polyethylene Insulation • White PVC Jacket</b>																				
70°C	H126A03		656	200	23.4	10.6	1.0 mm	0.180	4.57	Duobond® II	0.272	6.90	75	82%	16.5	54.0	5	0.5	1.8	
			U-820	U-250	29.2	13.3	Solid BC			+ 70% TC								50	1.4	4.7
			1640	500	58.4	26.5	40.0 /km*			Braid							100	2.0	6.5	
																	230	3.0	9.8	
																	400	4.0	13.0	
																	800	5.7	18.7	
																	862	5.9	19.5	
																	1000	6.4	21.1	
																	1350	7.6	24.9	
																	1750	8.8	28.8	
																	2150	9.8	32.2	
																	2400	10.5	34.4	
																	3000	12.0	39.2	
Return loss at 5-470 MHz: 20 dB      Screening attenuation at 30-1000 MHz: 85 dB																				
470-1000 MHz: 18 dB      Transfer impedance at 5-30 MHz: 25.0 m /m																				
1000-2000 MHz: 16 dB      Screening Class: C																				
2000-3000 MHz: 15 dB      Pulling Tension: 55 N																				
<b>H126A02</b>																				
<b>Gas-Injected Polyethylene Insulation • White PVC Jacket</b>																				
70°C	H126A02		U-820	U-250	25.9	11.8	1.0 mm	0.180	4.57	Duobond® II	0.272	6.90	75	82%	16.5	54.0				see above
							Solid BC			+ 50% TC										
							45.0 /km*			Braid										
																	23.0 /km**			
																	22.0 /km***			
																	5.25 mm			
Return loss at 5-470 MHz: 20 dB      Screening attenuation at 30-1000 MHz: 75 dB																				
470-1000 MHz: 18 dB      Transfer impedance at 5-30 MHz: 50.0 m /m																				
1000-2000 MHz: 16 dB      Screening Class: C																				
2000-3000 MHz: 15 dB      Pulling Tension: 55 N																				
<b>H109C • Solid 1.0 mm Bare Copper • Copper-Foil • 55% Bare Copper Braid</b>																				
<b>5-Cell Polyethylene Insulation • PVC Jacket (Black or Brown)</b>																				
70°C	H109C00		820	250	27.0	12.3	1.0 mm	0.185	4.70	Cu-foil	0.262	6.65	75	80%	17.1	56.0	5	0.5	1.6	
			1640	500	54.0	24.5	Solid BC			+ 55% BC									50	1.4
			16400	5000	540.1	245.0	41.0 /km*			Braid								100	2.0	6.5
																	230	3.0	9.8	
																	400	4.1	13.3	
																	800	5.9	19.2	
																	862	5.9	19.5	
																	1000	6.6	21.5	
																	1750	8.8	29.0	
																	2150	9.9	32.5	
																	2400	10.6	34.7	
Return loss at 5-470 MHz: 20 dB      Screening attenuation at 30-1000 MHz: 75 dB																				
470-1000 MHz: 18 dB      Transfer impedance at 5-30 MHz: 10.0 m /m																				
1000-2000 MHz: 16 dB      Screening Class: B																				
2000-3000 MHz: 15 dB      Pulling Tension: 55 N																				
250 m put-up available in Brown only.																				
500 m put-up available in Black only.																				
<b>H109C02</b>																				
<b>5-Cell Polyethylene Insulation • FRNC/LSNH Jacket (Black or White)</b>																				
70°C	H109C02	IEC 332-1	820	250	24.8	11.3	1.0 mm	0.185	4.70	Cu-foil	0.262	6.65	75	80%	17.1	56.0				see above
							Solid BC			+ 55% BC										
							41.0 /km*			Braid										
																	26.0 /km**			
																	15.0 /km***			
																	5.2 mm			
Return loss at 5-470 MHz: 20 dB      Screening attenuation at 30-1000 MHz: 75 dB																				
470-1000 MHz: 18 dB      Transfer impedance at 5-30 MHz: 10.0 m /m																				
1000-2000 MHz: 16 dB      Screening Class: B																				
2000-3000 MHz: 15 dB      Pulling Tension: 55 N																				
<b>H125C • Solid 1.0 mm Bare Copper • Copper-Foil • 40% Bare Copper Braid</b>																				
<b>Gas-Injected Polyethylene Insulation • Black Polyethylene Jacket</b>																				
70°C	H125C01		B-328	B-100	8.6	3.9	1.0 mm	0.189	4.80	Cu-foil	0.268	6.80	75	81%	16.8	55.0	5	0.4	1.4	
			820	250	21.5	9.8	Solid BC			+ 40% BC									50	1.3
			1640	500	43.0	19.5	41.0 /km*			Braid								100	1.9	6.1
																	230	2.8	9.2	
																	400	3.8	12.3	
																	800	5.4	17.7	
																	862	5.6	18.4	
																	1000	6.1	19.9	
																	1350	7.1	23.4	
																	1750	8.2	27.0	
																	2150	9.2	30.2	
																	2400	9.8	32.1	
Return loss at 5-470 MHz: 23 dB      Screening attenuation at 30-1000 MHz: 85 dB																				
470-1000 MHz: 20 dB      Transfer impedance at 5-30 MHz: 15.0 m /m																				
1000-2000 MHz: 18 dB      Screening Class: B																				
2000-3000 MHz: 16 dB      Pulling Tension: 55 N																				

\* DC loop resistance • \*\* DC resistance inner conductor • \*\*\* DC resistance outer conductor • DCR = DC resistance • BC = Bare Copper • TC = Tinned Copper  
 Duobond® II see technical information page 23.13.

# Broadband Coax

## Drop Cables



De- scription	Part No.	UL NEC/ C(UL)/CEC Type IEC	Standard Lengths		Standard Unit Weight		Conductor (Stranding) Diameter Nom. DCR	Nominal Core OD (Dielectric)		Shielding Material Nom. DCR	Nominal OD		Nom. Imp. ( )	Nom. Vel. of Prop.	Nominal Capacitance		Nominal Attenuation				
			ft.	m	lbs.	kg		inch	mm		inch	mm			pF/ft.	pF/m	MHz	dB/ 100 ft.	dB/ 100 m		
<b>H125C • Solid 1.0 mm Bare Copper • Copper-Foil • 40% Bare Copper Braid</b>																					
<b>Gas-Injected Polyethylene Insulation • Grey FRNC/LSNH Jacket</b>																					
70°C	H125C04	IEC 332-1	1640	500	49.6	22.5	1.0 mm Solid BC 41.0 /km* 23.0 /km**	0.189	4.80	Cu-foil + 40% BC Braid 18.0 /km*** 5.4 mm	0.268	6.80	75	81%	16.8	55.0	5	0.4	1.4		
																		50	1.3	4.3	
																		100	1.9	6.1	
																		230	2.8	9.2	
																		400	3.8	12.3	
																		800	5.4	17.7	
																		862	5.6	18.4	
																		1000	6.1	19.9	
																		1350	7.1	23.4	
																		1750	8.2	27.0	
																		2150	9.2	30.2	
																		2400	9.8	32.1	
																		Return loss at			
																		5-470 MHz:	23 dB	Screening attenuation at 30-1000 MHz:	85 dB
																		470-1000 MHz:	20 dB	Transfer impedance at 5-30 MHz:	15.0 m /m
																		1000-2000 MHz:	18 dB	Screening Class:	B
																		2000-3000 MHz:	16 dB	Pulling Tension:	55 N
<b>Gas-Injected Polyethylene Insulation • PVC Jacket (Black, Brown, Crème, Grey or White)</b>																					
70°C	H125C00		B-328	B-100	10.4	4.7	1.0 mm Solid BC 41.0 /km* 23.0 /km**	0.189	4.80	Cu-foil + 40% BC Braid 18.0 /km*** 5.4 mm	0.268	6.80	75	81%	16.8	55.0	see above				
			820	250	25.9	11.8					0.531	13.50									
			1640	500	51.8	23.5															
			3280	1000	103.6	47.0															
																		Return loss at			
																		5-470 MHz:	23 dB	Screening attenuation at 30-1000 MHz:	85 dB
																		470-1000 MHz:	20 dB	Transfer impedance at 5-30 MHz:	15.0 m /m
																		1000-2000 MHz:	18 dB	Screening Class:	B
																		2000-3000 MHz:	16 dB	Pulling Tension:	55 N
																		Brown, Crème and Grey available in B-100 m only.			
<b>Gas-Injected Polyethylene Insulation • White PVC Jacket</b>																					
70°C	H125C03		820	250	49.1	22.3	1.0 mm Solid BC 41.0 /km* 23.0 /km**	0.189	4.80	Cu-foil + 40% BC Braid 18.0 /km*** 5.24 mm	0.268	6.80	75	81%	16.8	55.0	see above				
																		Return loss at			
																		5-470 MHz:	23 dB	Screening attenuation at 30-1000 MHz:	75 dB
																		470-1000 MHz:	20 dB	Transfer impedance at 5-30 MHz:	15.0 m /m
																		1000-2000 MHz:	18 dB	Screening Class:	B
																		2000-3000 MHz:	16 dB	Pulling Tension:	55 N
																		ShotGun			
<b>H125A • Solid 1.0 mm Bare Copper • Duofoil® • 70% Tinned Copper Braid</b>																					
<b>Gas-Injected Polyethylene Insulation • Black Polyethylene Jacket</b>																					
70°C	H125A08		1640	500	45.2	20.5	1.0 mm Solid BC 41.0 /km* 23.0 /km**	0.189	4.80	Duofoil® + 70% TC Braid 18.0 /km*** 5.5 mm	0.268	6.80	75	81%	16.8	55.0	5	0.5	1.8		
																		50	1.4	4.7	
																		100	2.0	6.5	
																		230	3.0	9.8	
																		400	3.9	12.9	
																		800	5.7	18.6	
																		862	5.9	19.3	
																		1000	6.4	20.9	
																		1350	7.5	24.6	
																		1750	8.7	28.4	
																		2150	9.7	31.9	
																		2400	10.4	34.0	
																		Return loss at			
																		5-470 MHz:	23 dB	Screening attenuation at 30-1000 MHz:	85 dB
																		470-1000 MHz:	20 dB	Transfer impedance at 5-30 MHz:	15.0 m /m
																		1000-2000 MHz:	18 dB	Screening Class:	B
																		2000-3000 MHz:	16 dB	Pulling Tension:	55 N
<b>Gas-Injected Polyethylene Insulation • White FRNC/LSNH Jacket</b>																					
70°C	H125A07	IEC 332-1	B-328	B-100	10.8	4.9	1.0 mm Solid BC 41.0 /km* 23.0 /km**	0.189	4.80	Duofoil® + 70% TC Braid 18.0 /km*** 5.5 mm	0.268	6.80	75	81%	16.8	55.0	see above				
			1640	500	54.0	24.5															
																		Return loss at			
																		5-470 MHz:	23 dB	Screening attenuation at 30-1000 MHz:	85 dB
																		470-1000 MHz:	20 dB	Transfer impedance at 5-30 MHz:	15.0 m /m
																		1000-2000 MHz:	18 dB	Screening Class:	B
																		2000-3000 MHz:	16 dB	Pulling Tension:	55 N

\* DC loop resistance • \*\* DC resistance inner conductor • \*\*\* DC resistance outer conductor • DCR = DC resistance • BC = Bare Copper • TC = Tinned Copper

Duofoil® see technical information page 23.13.

## Broadband Coax

### Drop Cables



De- scription	Part No.	UL NEC/ C(UL)/CEC Type IEC	Standard Lengths		Standard Unit Weight		Conductor (Stranding) Diameter Nom. DCR	Nominal Core OD (Dielectric)		Shielding Material Nom. DCR	Nominal OD		Nom. Imp. ( )	Nom. Vel. of Prop.	Nominal Capacitance		Nominal Attenuation																					
			ft.	m	lbs.	kg		inch	mm		inch	mm			pF/ft.	pF/m	MHz	dB/ 100 ft.	dB/ 100 m																			
<b>H125A • Solid 1.0 mm Bare Copper • Duofoil® • 70 % Tinned Copper Braid</b>																																						
<b>Gas-Injected Polyethylene Insulation • White PVC Jacket</b>																																						
70°C	H125A06		B-328	B-100	10.6	4.8	1.0 mm Solid BC	0.189	4.80	Duofoil® + 70% TC Braid	0.268	6.80	75	81%	16.8	55.0	5	0.5	1.8																			
			U-820	U-250	26.5	12.0											41.0	/km*	18.0	/km***	5.5 mm	100	2.0	6.5	230	3.0	9.8	400	3.9	12.9	800	5.7	18.6	862	5.9	19.3	1000	6.4
Return loss at			5-470 MHz:		23 dB		Screening attenuation at 30-1000 MHz:				85 dB																											
			470-1000 MHz:		20 dB		Transfer impedance at 5-30 MHz:				15.0 m /m																											
			1000-2000 MHz:		18 dB		Screening Class:				B																											
			2000-3000 MHz:		16 dB		Pulling Tension:				55 N																											
<b>Gas-Injected Polyethylene Insulation • Black Polyethylene Jacket</b>																																						
70°C	H125A01		B-328	B-100	8.2	3.7	1.0 mm Solid BC	0.189	4.80	Duofoil® + 40% TC Braid	0.268	6.80	75	81%	16.8	55.0	see above																					
			820	250	20.4	9.3											50.0	/km*	27.0	/km***	5.4 mm	1640	500	40.8	18.5	23.0	/km**											
Return loss at			5-470 MHz:		23 dB		Screening attenuation at 30-1000 MHz:				75 dB																											
			470-1000 MHz:		20 dB		Transfer impedance at 5-30 MHz:				40.0 m /m																											
			1000-2000 MHz:		18 dB		Screening Class:				C																											
			2000-3000 MHz:		16 dB		Pulling Tension:				55 N																											
<b>Gas-Injected Polyethylene Insulation • Grey FRNC/LSNH Jacket</b>																																						
70°C	H125A03	IEC 332-1	B-328	B-100	9.3	4.2	1.0 mm Solid BC	0.189	4.80	Duofoil® + 40% TC Braid	0.268	6.80	75	81%	16.8	55.0	see above																					
			820	250	24.3	11.0											50.0	/km*	27.0	/km***	5.4 mm	1640	500	46.3	21.0	23.0	/km**											
Return loss at			5-470 MHz:		23 dB		Screening attenuation at 30-1000 MHz:				75 dB																											
			470-1000 MHz:		20 dB		Transfer impedance at 5-30 MHz:				40.0 m /m																											
			1000-2000 MHz:		18 dB		Screening Class:				C																											
			2000-3000 MHz:		16 dB		Pulling Tension:				55 N																											
<b>Gas-Injected Polyethylene Insulation • PVC Jacket (Black, Brown, Grey or White)</b>																																						
70°C	H125A00		B-328	B-100	9.7	4.4	1.0 mm Solid BC	0.189	4.80	Duofoil® + 40% TC Braid	0.268	6.80	75	81%	16.8	55.0	see above																					
			U-820	U-250	24.3	11.0											50.0	/km*	27.0	/km***	5.4 mm	1640	500	48.5	22.0	23.0	/km**											
Return loss at			5-470 MHz:		23 dB		Screening attenuation at 30-1000 MHz:				75 dB																											
			470-1000 MHz:		20 dB		Transfer impedance at 5-30 MHz:				40.0 m /m																											
			1000-2000 MHz:		18 dB		Screening Class:				C																											
			2000-3000 MHz:		16 dB		Pulling Tension:				55 N																											
Brown, Crème and Grey available in B-100 m only.																																						
<b>Gas-Injected Polyethylene Insulation • Black PVC Jacket</b>																																						
70°C	H125A04		820	250	46.8	21.3	1.0 mm Solid BC	0.189	4.80	Duofoil® + 40% TC Braid	0.268	6.80	75	81%	16.8	55.0	see above																					
																			50.0	/km*	27.0	/km***	5.4 mm															
Return loss at			5-470 MHz:		23 dB		Screening attenuation at 30-1000 MHz:				75 dB																											
			470-1.000 MHz:		20 dB		Transfer impedance at 5-30 MHz:				40.0 m /m																											
			1000-2000 MHz:		18 dB		Screening Class:				C																											
			2000-3000 MHz:		16 dB		Pulling Tension:				55 N																											
<b>Gas-Injected Polyethylene Insulation • Black PE Jacket</b>																																						
70°C	H125A02		1640	500	83.8	38.0	1.0 mm Solid BC	0.189	4.80	Duofoil® + 50% TC Braid	0.268	6.80	75	81%	16.8	55.0	see above																					
																			41.0	/km*	18.0	/km***	5.4 mm															
Return loss at			5-470 MHz:		23 dB		Screening attenuation at 30-1000 MHz:				75 dB																											
			470-1000 MHz:		20 dB		Transfer impedance at 5-30 MHz:				15.0 m /m																											
			1000-2000 MHz:		18 dB		Screening Class:				B																											
			2000-3000 MHz:		16 dB		Pulling Tension:				3500 N																											
4.4 mm ZP messenger																																						

\* DC loop resistance • \*\* DC resistance inner conductor • \*\*\* DC resistance outer conductor • DCR = DC resistance • BC = Bare Copper • TC = Tinned Copper • ZP = Stranded Zinc-Plated Steel  
 Duofoil® see technical information page 23.13.

**Broadband Coax**  
Drop Cables



De-scription	Part No.	UL NEC / C(UL)CEC Type IEC	Standard Lengths		Standard Unit Weight		Conductor (Stranding) Diameter Nom. DCR	Nominal Core OD (Dielectric)		Shielding Material Nom. DCR	Nominal OD		Nom. Imp. ( )	Nom. Vel. of Prop.	Nominal Capacitance		Nominal Attenuation	
			ft.	m	lbs.	kg		inch	mm		inch	mm			pF/ft.	pF/m	MHz	dB/100 ft.

**H125D • Solid 1.0 mm Bare Copper • Duobond Plus® • 50 % Tinned Copper Shield**

**Gas-Injected Polyethylene Insulation • PE Jacket (Green with White Stripe)**

70°C	<b>H125D00</b>	1640	500	45.2	20.5	1.0 mm	0.189	4.80	Duobond Plus®	0.280	7.10	75	80%	16.8	55.0	5	0.5	1.7								
		3280	1000	90.4	41.0	Solid BC 37.0 /km* 23.0 /km**										+ 50% TC Braid 14.0 /km*** 5.6 mm	100	1.4	4.7							
<p>Shorting Fold</p>																										
BTQ																										
		Return loss at	5-470 MHz:	23 dB			Screening attenuation at 30-1000 MHz:	95 dB																		
			470-1000 MHz:	20 dB			Transfer impedance at 5-30 MHz:	5.0 m /m																		
			1000-2000 MHz:	18 dB			Screening Class:	A																		
			2000-3000 MHz:	16 dB			Pulling Tension:	60 N																		
												1000	6.5	21.2	1350	7.7	25.1	1750	8.8	29.0	2150	10.0	32.7	2400	10.6	34.8

**CT100C • Solid 1.0 mm Bare Copper • Copper-Foil • 53 % Bare Copper Braid**

**5-Cell Polyethylene Insulation • PVC Jacket (Black, Brown and White)**

70°C	<b>CT100C0</b>	328	100	11.5	5.2	1.0 mm	0.185	4.70	Cu-foil + 53% BC Braid 15.0 /km*** 5.35 mm	0.262	6.65	75	82%	16.8	55.0	50	1.5	4.6		
		820	250	28.1	13.0	Solid BC										230	3.0	9.8		
		1640	500	57.3	26.0	41.0 /km*										470	4.6	15.0		
		3280	1000	112.4	51.0	26.0 /km**										862	5.9	19.5		
		Return loss at	5-470 MHz:	23 dB			Screening attenuation at 30-1000 MHz:	75 dB												
			470-1000 MHz:	20 dB			Transfer impedance at 5-30 MHz:	15.0 m /m												
			1000-2000 MHz:	18 dB			Screening Class:	B												
			2000-3000 MHz:	16 dB			Pulling Tension:	55 N												
500 m put-up available in Black only.												1000	6.6	21.5	1750	8.8	29.0	2150	9.9	32.5

**5-Cell Polyethylene Insulation • PVC RBS Jacket (Black and White)**

70°C	<b>CT100C3</b>	328	100	11.2	5.1	1.0 mm	0.185	4.70	Cu-foil + 53% BC Braid 15.0 /km*** 5.35 mm	0.262	6.65	75	82%	16.8	55.0	see above		
		820	250	28.1	12.8	Solid BC										230	3.0	9.8
		1640	500	56.2	25.5	41.0 /km*										470	4.6	15.0
		3280	1000	112.4	51.0	26.0 /km**										862	5.9	19.5
<p>RBS jacket</p>																		
		Return loss at	5-470 MHz:	23 dB			Screening attenuation at 30-1000 MHz:	75 dB										
			470-1000 MHz:	20 dB			Transfer impedance at 5-30 MHz:	15.0 m /m										
			1000-2000 MHz:	18 dB			Screening Class:	B										
			2000-3000 MHz:	16 dB			Pulling Tension:	55 N										

**5-Cell Polyethylene Insulation • Black FRNC/LSNH Jacket**

70°C	<b>CT100C1</b>	3280	1000	116.8	53.0	1.0 mm	0.185	4.70	Cu-foil + 53% BC Braid 15.0 /km*** 5.35 mm	0.262	6.65	75	82%	16.8	55.0	see above		
					Solid BC													
					41.0 /km*													
					26.0 /km**													
		Return loss at	5-470 MHz:	23 dB			Screening attenuation at 30-1000 MHz:	75 dB										
			470-1000 MHz:	20 dB			Transfer impedance at 5-30 MHz:	15.0 m /m										
			1000-2000 MHz:	18 dB			Screening Class:	B										
			2000-3000 MHz:	16 dB			Pulling Tension:	55 N										

**H124A • Solid 1.0 mm Bare Copper • Duofoil® • 31 % Tinned Copper Braid**

**Gas-Injected Polyethylene Insulation • White PVC Jacket**

70°C	<b>H124A00</b>	B-328	B-100	6.8	3.1	1.0 mm	0.173	4.40	Duofoil® + 31% TC Braid 23.0 /km*** 5.1 mm	0.232	5.90	75	84%	16.2	53.0	5	0.6	2.0								
		U-820	U-250	17.1	7.8	Solid BC										50	1.4	4.5								
		1640	500	34.2	15.5	58.0 /km*										100	2.0	6.4								
		16400	5000	341.7	155.0	35.0 /km**										230	2.9	9.5								
		Return loss at	5-470 MHz:	23 dB			Screening attenuation at 30-1000 MHz:	75 dB																		
			470-1000 MHz:	20 dB			Transfer impedance at 5-30 MHz:	40.0 m /m																		
			1000-2000 MHz:	18 dB			Screening Class:	C																		
			2000-3000 MHz:	16 dB			Pulling Tension:	55 N																		
												1000	6.6	21.8	1350	7.8	25.7	1750	9.1	29.7	2150	10.2	33.4	2400	10.9	35.6

\* DC loop resistance • \*\* DC resistance inner conductor • \*\*\* DC resistance outer conductor • DCR = DC resistance • BC = Bare Copper • TC = Tinned Copper

Duofoil® and Duobond Plus® see technical information page 23.13.

# Broadband Coax

## Drop Cables



De- scription	Part No.	UL NEC/ C(UL)CEC Type IEC	Standard Lengths		Standard Unit Weight		Conductor (Stranding) Diameter Nom. DCR	Nominal Core OD (Dielectric)		Shielding Material Nom. DCR	Nominal OD		Nom. Imp. ( )	Nom. Vel. of Prop.	Nominal Capacitance		Nominal Attenuation			
			ft.	m	lbs.	kg		inch	mm		inch	mm			pF/ft.	pF/m	MHz	dB/ 100 ft.	dB/ 100 m	
<b>H121C • Solid 0.8 mm Bare Copper • Copper-Foil • 45% Bare Copper Braid</b>																				
<b>Gas-Injected Polyethylene Insulation • White PVC Jacket</b>																				
70°C	<b>H121C00</b>		B-328 1640	B-100 500	6.0 29.8	2.7 13.5	0.8 mm Solid BC 59.0 /km* 35.0 /km**	0.138	3.50	Cu-foil + 45% BC Braid 24.0 /km*** 4.1 mm	0.197	5.00	75	84%	16.2	53.0	5	0.5	1.7	
																		50	1.6	5.3
																		100	2.3	7.5
																		230	3.5	11.4
																		400	4.6	15.1
																		800	6.6	21.7
																		862	6.9	22.6
																		1000	7.5	24.5
																		1350	8.8	28.7
																		1750	10.1	33.0
																		2150	11.3	36.9
																		2400	12.0	39.2
Return loss at			5-470 MHz: 20 dB				Screening attenuation at 30-1000 MHz: 80 dB													
			470-1000 MHz: 18 dB				Transfer impedance at 5-30 MHz: 10.0 m /m													
			1000-2000 MHz: 16 dB				Screening Class: B													
			2000-3000 MHz: 15 dB				Pulling Tension: 40 N													

### H121A • Solid 0.8 mm Bare Copper • Duofoil® • 75% Tinned Copper Braid

<b>Gas-Injected Polyethylene Insulation • White PVC Jacket</b>																				
70°C	<b>H121A03</b>		B-328 1640	B-100 500	6.4 32.0	2.9 14.5	0.8 mm Solid BC 55.0 /km* 35.0 /km**	0.138	3.50	Duofoil® + 75% TC Braid 20.0 /km*** 4.1 mm	0.197	5.00	75	84%	16.2	53.0	5	0.7	2.3	
																		50	1.8	5.9
																		100	2.5	8.1
																		230	3.7	12.1
																		400	4.8	15.9
																		800	6.9	22.7
																		862	7.2	23.6
																		1000	7.8	25.6
																		1350	9.1	30.0
																		1750	10.5	34.5
																		2150	11.8	38.6
																		2400	12.5	41.0
Return loss at			5-470 MHz: 20 dB				Screening attenuation at 30-1000 MHz: 100 dB													
			470-1000 MHz: 18 dB				Transfer impedance at 5-30 MHz: 4.2 m /m													
			1000-2000 MHz: 16 dB				Screening Class: A													
			2000-3000 MHz: 15 dB				Pulling Tension: 45 N													

<b>Gas-Injected Polyethylene Insulation • White FRNC/LSNH Jacket</b>																				
70°C	<b>H121A04</b>	IEC 332-1	B-328 1640	B-100 500	7.3 36.4	3.3 16.5	0.8 mm Solid BC 55.0 /km* 35.0 /km**	0.138	3.50	Duofoil® + 75% TC Braid 20.0 /km*** 4.1 mm	0.197	5.00	75	84%	16.2	53.0	see above			
Return loss at			5-470 MHz: 20 dB				Screening attenuation at 30-1000 MHz: 100 dB													
			470-1000 MHz: 18 dB				Transfer impedance at 5-30 MHz: 4.2 m /m													
			1000-2000 MHz: 16 dB				Screening Class: A													
			2000-3000 MHz: 15 dB				Pulling Tension: 45 N													

### H121A • Solid 0.8 mm Bare Copper • Duofoil® • 40% Tinned Copper Braid

<b>Gas-Injected Polyethylene Insulation • Black Polyethylene Jacket</b>																				
70°C	<b>H121A01</b>		1640 3280	500 1000	22.0 44.1	10.0 20.0	0.8 mm Solid BC 75.0 /km* 35.0 /km**	0.138	3.50	Duofoil® + 40% TC Braid 40.0 /km*** 4.1 mm	0.197	5.00	75	84%	16.2	53.0	see above			
Return loss at			5-470 MHz: 20 dB				Screening attenuation at 30-1000 MHz: 75 dB													
			470-1000 MHz: 18 dB				Transfer impedance at 5-30 MHz: 33.0 m /m													
			1000-2000 MHz: 16 dB				Screening Class: C													
			2000-3000 MHz: 15 dB				Pulling Tension: 40 N													

<b>Gas-Injected Polyethylene Insulation • PVC Jacket (Black or White)</b>																				
70°C	<b>H121A00</b>		B-328 820 1640	B-100 250 500	6.4 16.0 32.0	2.9 7.3 14.5	0.8 mm Solid BC 75.0 /km* 35.0 /km**	0.138	3.50	Duofoil® + 40% TC Braid 40.0 /km*** 4.1 mm	0.197	5.00	75	84%	16.2	53.0	see above			
Return loss at			5-470 MHz: 20 dB				Screening attenuation at 30-1000 MHz: 75 dB													
			470-1000 MHz: 18 dB				Transfer impedance at 5-30 MHz: 33.0 m /m													
			1000-2000 MHz: 16 dB				Screening Class: C													
			2000-3000 MHz: 15 dB				Pulling Tension: 40 N													

\* DC loop resistance • \*\* DC resistance inner conductor • \*\*\* DC resistance outer conductor • DCR = DC resistance • BC = Bare Copper • TC = Tinned Copper  
Duofoil® see technical information page 23.13.

# Broadband Coax

## Drop Cables



De- scription	Part No.	UL NEC/ C(UL)/CEC Type IEC	Standard Lengths		Standard Unit Weight		Conductor (Stranding) Diameter Nom. DCR	Nominal Core OD (Dielectric)		Shielding Material Nom. DCR	Nominal OD		Nom. Imp. ( )	Nom. Vel. of Prop.	Nominal Capacitance		Nominal Attenuation			
			ft.	m	lbs.	kg		inch	mm		inch	mm			pF/ft.	pF/m	MHz	dB/ 100 ft.	dB/ 100 m	
<b>H121A • Solid 0.8 mm Bare Copper • Duofoil® • 40% Tinned Copper Braid</b>																				
<b>Gas-Injected Polyethylene Insulation • White PVC Jacket</b>																				
70°C	<b>H121A02</b>	C-328	C-100	11.0	5.0	0.8 mm Solid BC 75.0 /km* 35.0 /km**	0.138	3.50	Duofoil® + 40% TC Braid 40.0 /km*** 4.1 mm	0.197	5.00	0.417	10.60	75	84%	16.2	53.0	5	0.7	2.3
ShotGun																				
Return loss at 5-470 MHz: 20 dB 470-1000 MHz: 18 dB 1000-2000 MHz: 16 dB 2000-3000 MHz: 15 dB																				
Screening attenuation at 30-1000 MHz: 75 dB Transfer impedance at 5-30 MHz: 33.0 m /m Screening Class: C Pulling Tension: 40 N																				
1000 7.8 25.6 1350 9.1 30.0 1750 10.5 34.5 2150 11.8 38.6 2400 12.5 41.0																				
<b>H123A • Solid 0.65 mm Bare Copper • Duofoil® • 88% Tinned Copper Braid</b>																				
<b>Gas-Injected Polyethylene Insulation • FRNC / LSNH Jacket (White or Black)</b>																				
70°C	<b>H123A02</b>	IEC 332-1	1640	500	30.9	14.0	0.65 mm Solid BC 72.0 /km* 55.0 /km**	0.114	2.90	Duofoil® + 88% TC Braid 17.0 /km*** 3.4 mm	0.169	4.30	75	84%	16.5	54.0	5	0.8	2.7	
Return loss at 5-470 MHz: 20 dB 470-1000 MHz: 18 dB 1000-2000 MHz: 16 dB 2000-3000 MHz: 15 dB																				
Screening attenuation at 30-1000 MHz: 85 dB Transfer impedance at 5-30 MHz: 15.0 m /m Screening Class: B Pulling Tension: 33 N																				
1000 9.3 30.6 1350 10.9 35.9 1750 12.6 41.2 2150 14.0 46.0 2400 14.9 48.9																				
<b>H123A01</b>																				
70°C		B-328 1640	B-100 500	6.4 32.0	2.9 14.5	0.65 mm Solid BC 72.0 /km* 55.0 /km**	0.114	2.90	Duofoil® + 88% TC Braid 17.0 /km*** 3.4 mm	0.169	4.30	75	84%	16.5	54.0					see above
Return loss at 5-470 MHz: 20 dB 470-1000 MHz: 18 dB 1000-2000 MHz: 16 dB 2000-3000 MHz: 15 dB																				
Screening attenuation at 30-1000 MHz: 85 dB Transfer impedance at 5-30 MHz: 15.0 m /m Screening Class: B Pulling Tension: 33 N																				
<b>H123A00</b>																				
70°C		B-328 1640	B-100 500	4.0 19.8	1.8 9.0	0.65 mm Solid BC 92.0 /km* 55.0 /km**	0.114	2.90	Duofoil® + 44% TC Braid 37.0 /km*** 3.4 mm	0.163	4.15	75	84%	16.5	54.0					see above
Return loss at 5-470 MHz: 20 dB 470-1000 MHz: 18 dB 1000-2000 MHz: 16 dB 2000-3000 MHz: 15 dB																				
Screening attenuation at 30-1000 MHz: 75 dB Transfer impedance at 5-30 MHz: 37.0 m /m Screening Class: C Pulling Tension: 33 N																				
U 250 m and 500 m put-up available in White only.																				
<b>H122A • Solid 0.4 mm Copper-Covered Steel • Duofoil® • 60% Tinned Copper Braid</b>																				
<b>Gas-Injected Polyethylene Insulation • White PVC Jacket</b>																				
70°C	<b>H122A00</b>	B-328 1640	B-100 500	3.1 15.4	1.4 7.0	0.4 mm Solid CCS 490.0 /km* 450.0 /km**	0.077	1.95	Duofoil® + 60% TC Braid 40.0 /km*** 2.1 mm	0.144	3.65	75	80%	16.8	55.0	5	1.4	4.7		
Return loss at 5-470 MHz: 20 dB 470-1000 MHz: 18 dB 1000-2000 MHz: 16 dB 2000-3000 MHz: 15 dB																				
Screening attenuation at 30-1000 MHz: 85 dB Transfer impedance at 5-30 MHz: 25.0 m /m Screening Class: C Pulling Tension: 40 N																				
1000 14.8 48.5 1350 17.2 56.5 1750 19.7 64.8 2150 22.1 72.5 2400 23.4 76.9																				

\* DC loop resistance • \*\* DC resistance inner conductor • \*\*\* DC resistance outer conductor • DCR = DC resistance • BC = Bare Copper • TC = Tinned Copper • CCS = Copper-Covered Steel

Duofoil® see technical information page 23.13.



# Broadband Coax

## Headend Cables



De- scription	Part No.	UL NEC/ C(UL)CEC Type IEC	Standard Lengths		Standard Unit Weight		Conductor (Stranding) Diameter Nom. DCR	Nominal Core OD (Dielectric)		Shielding Material Nom. DCR	Nominal OD		Nom. Imp. ( )	Nom. Vel. of Prop.	Nominal Capacitance		Nominal Attenuation	
			ft.	m	lbs.	kg		inch	mm		inch	mm			pF/ft.	pF/m	MHz	dB/ 100 ft.

**20 AWG • Solid 0.8 mm Silver-Plated Copper-Covered Steel • Duobond Plus® • 95 % Aluminum Braid**

**Gas-Injected Foam Polyethylene Insulation • PVC Jacket** (available in Black, Grey, White, Red, Blue, Yellow, Brown, Orange, Green, Purple, Beige, Pink or Aqua)

80°C	<b>9167</b>	NEC: CATVR CMR CEC: CMG FT4	1000	305	27.1	12.3	0.81 mm 20 AWG Solid SPCCS 99.4 /km* 84.6 /km**	0.144	3.66	Duobond Plus® + 95% AL Braid 14.8 /km*** 4.3 mm	0.242	6.15	75	83%	16.2	53.1	5	0.8	2.5
																	50	1.8	6.0
																	240	3.6	11.7
																	450	5.0	16.3
																	862	7.0	22.9
																	1000	7.7	25.2



Shorting Fold

Return loss at 5-470 MHz: 20 dB  
470-862 MHz: 18 dB  
862-2150 MHz: 16 dB

Screening attenuation at 30-1000 MHz: 85 dB  
Sweep tested. 5 MHz to 1 GHz.

**23 AWG • Solid 0.6 mm Copper-Covered Steel • 95 % Bare Copper Braid**

**Polyethylene Insulation • Black PVC Jacket**

70°C	<b>MRG5900</b>		328	100	10.1	4.6	0.58 mm Solid CCS	0.146	3.70	95% BC Braid 15.0 /km*** 4.3 mm	0.242	6.15	75	66%	20.4	67.0	5	0.9	2.9
			B-328	B-100	10.1	4.6											50	2.4	8.0
			B-656	B-200	20.3	9.2	94.0 /km*										100	3.5	11.6
			1640	500	50.7	23.0	79.0 /km**										230	5.2	17.2
			3280	1000	101.4	46.0											400	7.6	25.0
																	800	11.5	37.8
																	862	12.0	39.2
																	1000	13.1	42.9

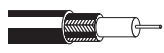

Return loss at 5-470 MHz: 20 dB  
470-1000 MHz: 18 dB  
1000-2000 MHz: 16 dB  
2000-3000 MHz: 15 dB

Screening attenuation at 30-1000 MHz: 65 dB

**23 AWG • Solid 0.6 mm Bare Copper • 92 % Double Tinned Copper Braid**

**Polyethylene Insulation • Black PVC Jacket**

70°C	<b>H106T00</b>		B-328	B-100	12.6	5.7	0.58 mm Solid BC	0.146	3.70	92% TC Braid + 92% TC Braid 18.5 /km*** 4.9 mm	0.236	6.00	75	66%	20.4	67.0	5	0.7	2.4
			1640	500	62.8	28.5	97.5 /km* 79.0 /km**										50	2.4	8.0
																	100	3.5	11.6
																	230	5.6	18.3
																	400	7.6	25.0
																	800	11.5	37.8
																	862	12.0	39.2
																	1000	13.1	42.9



Return loss at 5-470 MHz: 20 dB  
470-1000 MHz: 18 dB

Screening attenuation at 30-1000 MHz: 75 dB

**Polyethylene Insulation • Grey FRNC Jacket**

70°C	<b>H106T01</b>	IEC 332-1	1640	500	63.9	29.0	0.58 mm Solid BC	0.146	3.70	92% TC Braid + 92% TC Braid 18.5 /km*** 4.9 mm	0.236	6.00	75	66%	20.4	67.0			see above
							97.5 /km* 79.0 /km**												



Return loss at 5-470 MHz: 20 dB  
470-1000 MHz: 18 dB

Screening attenuation at 30-1000 MHz: 75 dB

\* DC loop resistance • \*\* DC resistance inner conductor • \*\*\* DC resistance outer conductor • DCR = DC resistance • BC = Bare Copper • TC = Tinned Copper • SPCCS = Silver-Plated Copper-Covered Steel • AL = Aluminum • CCS = Copper-Covered Steel

Duobond Plus® see technical information page 23.13.

# Wireless Coax

## Low Loss 50 Ohm Transmission



De- scription	Part No.	UL NEC / C(UL)CEC Type IEC	Standard Lengths		Standard Unit Weight		Conductor (Stranding) Diameter Nom. DCR	Nominal Core OD (Dielectric)		Shielding Material Nom. DCR	Nominal OD		Nom. Imp. ( )	Nom. Vel. of Prop.	Nominal Capacitance		Nominal Attenuation			
			ft.	m	lbs.	kg		inch	mm		inch	mm			pF/ft.	pF/m	MHz	dB/ 100 ft.	dB/ 100 m	
<b>RG174 • 25 AWG • Solid 0.46 mm Bare Copper • Beldfoil® • 90% Tinned Copper Braid</b>																				
<b>Polyethylene Insulation • Black PVC Jacket</b>																				
80°C	<b>7805</b>		† 100	31	1.8	0.8	0.455 mm	0.061	1.55	Beldfoil®	0.110	2.79	50	66%	31.2	102.4	30	3.8	12.4	
RF 100A			500	152	5.5	2.5	25 AWG			+ 90% TC							50	4.9	16.1	
			1000	305	9.9	4.5	Solid BC			Braid							150	8.6	28.2	
							40.4 /km*			29.9 /km***							220	10.4	34.2	
							10.5 /km**			2.15 mm							450	15.2	49.9	
																	900	22.0	72.3	
																	1500	28.8	94.3	
																	1800	31.7	104.0	
																	2000	33.4	109.7	
																	2500	37.9	124.2	
																	3000	42.0	137.8	
																	4500	52.3	171.5	
																	5800	60.9	199.8	
																	6000	62.0	203.3	
100% Sweep tested. 6 GHz max. VSWR 1.25:1																				
Mates with standard RG-174 connectors. Suitable for aerial applications when supported by a messenger wire.																				
<b>RG174 • 24 AWG • Solid 0.5 mm Bare Copper • Beldfoil® • 93% Tinned Copper Braid</b>																				
<b>Foam HDPE Insulation • Grey PVC Jacket</b>																				
80°C	<b>7805R</b>	NEC:	† 100	31	1.8	0.8	0.5 mm	0.060	1.52	Beldfoil®	0.110	2.79	50	73.5%	26.2	86.0	30	3.5	11.5	
RF 100LL			CMR:	500	152	5.5	2.5	24 AWG			+ 93% TC							50	4.6	15.0
			CEC:	1000	305	9.9	4.5	Solid BC			Braid							150	8.0	26.1
		CMG FT4					124.7 /km*			30.5 /km***							220	9.6	31.6	
							94.2 /km**			2.12 mm							450	14.1	46.1	
																	900	20.2	66.4	
																	1500	26.6	87.3	
																	1800	29.5	96.7	
																	2000	31.2	102.3	
																	2500	35.5	116.3	
																	3000	39.4	129.2	
																	4500	50.1	164.2	
																	5800	59.0	193.6	
																	6000	60.6	198.7	
100% Sweep tested. 6 GHz max. VSWR 1.25:1																				
Mates with standard RG-174 connectors.																				
<b>RG-58 Type • 19 AWG • Solid 0.9 mm Bare Copper • Duofoil® • 90% Tinned Copper Braid</b>																				
<b>Gas-Injected Foam HDPE Insulation • Black Polyethylene Jacket</b>																				
80°C	<b>7806A</b>		500	152	14.6	6.6	0.9 mm	0.110	2.79	Duofoil®	0.195	4.95	50	77%	24.3	79.7	30	2.0	6.6	
RF 195			1000	305	22.9	10.4	19 AWG			+ 90% TC								50	2.5	8.2
							Solid BC			Braid								150	4.1	13.3
							38.7 /km*			13.8 /km***							220	4.9	16.1	
							24.9 /km**			3.39 mm							450	7.1	23.4	
																	900	10.3	33.8	
																	1500	13.7	44.8	
																	1800	15.2	49.7	
																	2000	16.1	52.8	
																	2500	18.3	60.1	
																	3000	20.5	67.3	
																	4500	26.5	86.8	
																	5800	31.2	102.4	
																	6000	32.0	105.0	
100% Sweep tested. 6 GHz max. VSWR 1.25:1																				
Mates with standard RG-58 connectors. Suitable for outdoor and direct burial applications.																				
Available in PVC (7806R)																				
<b>RG-58 Type • 17 AWG • Solid 1.15 mm Bare Copper • Duofoil® • 95% Tinned Copper Braid</b>																				
<b>Gas-Injected Foam HDPE Insulation • Black Polyethylene Jacket</b>																				
80°C	<b>7807A</b>		500	152	15.0	6.8	1.15 mm	0.116	2.95	Duofoil®	0.195	4.95	50	85%	23.5	77.1	30	1.6	5.4	
RF 200			1000	305	24.0	10.9	17 AWG			+ 95% TC								50	2.1	7.0
							Solid BC			Braid								150	3.7	12.1
							24.7 /km*			13.8 /km***							220	4.5	14.6	
							10.9 /km**			3.55 mm							450	6.5	21.2	
																	900	9.2	30.1	
																	1500	12.0	39.2	
																	1800	13.2	43.2	
																	2000	14.0	45.8	
																	2500	15.7	51.6	
																	3000	17.5	57.3	
																	4500	22.0	72.3	
																	5800	25.2	82.7	
																	6000	25.9	85.1	
100% Sweep tested. 6 GHz max. VSWR 1.25:1																				
Mates with standard land mobile radio type connectors. Suitable for outdoor and direct burial applications.																				
Available in PVC (7807R)																				

\* DC loop resistance • \*\* DC resistance inner conductor • \*\*\* DC resistance outer conductor • DCR = DC resistance • BC = Bare Copper • TC = Tinned Copper  
† May contain more than one piece. Min. length of any one piece is 7.6 m (25 ft.).  
Duofoil® see technical information page 23.13.

# Wireless Coax

## Low Loss 50 Ohm Transmission



De- scription	Part No.	UL NEC/ C(UL)CEC Type IEC	Standard Lengths		Standard Unit Weight		Conductor (Stranding) Diameter Nom. DCR	Nominal Core OD (Dielectric)		Shielding Material Nom. DCR	Nominal OD		Nom. Imp. ( )	Nom. Vel. of Prop.	Nominal Capacitance		Nominal Attenuation	
			ft.	m	lbs.	kg		inch	mm		inch	mm			pF/ft.	pF/m	MHz	dB/ 100 ft.

**RG-8X Type • 15 AWG • Solid 1.45 mm Bare Copper • Duobond® II • 95% Tinned Copper Braid**

Gas-Injected Foam HDPE Insulation • Black Polyethylene Jacket																				
80°C	7808A		500	152	18.0	8.2	1.45 mm	0.150	3.81	Duobond® II	0.240	6.10	50	86%	23.0	75.5	30	1.3	4.1	
RF 240			1000	305	39.0	17.7	15 AWG Solid BC			+ 95% TC Braid								50	1.6	5.3
							19.7 /km*			9.2 /km***								150	2.8	9.3
							10.5 /km**			4.41 mm								220	3.4	11.1
																		450	4.9	16.1
																		900	7.0	22.9
																		1500	9.1	30.0
																		1800	10.1	33.2
																		2000	10.7	35.0
																		2500	12.0	39.5
																		3000	13.4	43.9
																		4500	16.7	54.7
																		5800	19.5	64.0
																		6000	19.8	65.0

Available:  
7808R - PVC  
7808WB - Flooded Water-resistant Polyethylene

100% Sweep tested. 6 GHz max. VSWR 1.25:1  
Mates with standard RG-8X connectors. Suitable for outdoor and direct burial applications.

**Intermediate Type • 13 AWG • Solid 1.83 mm Bare Copper • Duobond® II • 95% Tinned Copper Braid**

Gas-Injected Foam HDPE Insulation • Black Polyethylene Jacket																				
80°C	7809A		500	152	30.6	13.9	1.83 mm	0.190	4.83	Duobond® II	0.300	7.62	50	86%	23.0	75.5	30	1.0	3.4	
RF 300			1000	305	58.0	26.3	13 AWG Solid BC			+ 95% TC Braid								50	1.3	4.2
							14.7 /km*			7.8 /km***								150	2.2	7.3
							6.9 /km**			5.55 mm								220	2.7	8.9
																		450	3.9	12.9
																		900	5.6	18.3
																		1500	7.3	24.0
																		1800	8.1	26.5
																		2000	8.6	28.2
																		2500	9.7	31.9
																		3000	10.8	35.4
																		4500	13.5	44.4
																		5800	15.8	51.8
																		6000	16.0	52.6

Available:  
7809R - PVC  
7809WB - Flooded Water-resistant Polyethylene

100% Sweep tested. 6 GHz max. VSWR 1.25:1  
Mates with land mobile radio type connectors. Suitable for outdoor and direct burial applications.

**RG-8 Type • 10 AWG • Solid 2.6 mm Bare Copper-Covered Aluminum • Duobond® II • 95% Tinned Copper Braid**

Gas-Injected Foam HDPE Insulation • Black Polyethylene Jacket																				
80°C	7810A		500	152	42.5	19.3	2.6 mm	0.285	7.24	Duobond® II	0.403	10.23	50	86%	23.0	75.5	30	0.6	2.1	
RF 400			1000	305	86.0	39.0	10 AWG Solid BCCA			+ 95% TC Braid								50	0.9	2.8
							13.6 /km*			9.2 /km***								150	1.5	4.9
							4.4 /km**			8.11 mm								220	1.8	6.0
																		450	2.7	8.8
																		900	3.8	12.6
																		1500	5.1	16.6
																		1800	5.6	18.5
																		2000	6.0	19.6
																		2500	6.7	22.0
																		3000	7.4	24.4
																		4500	9.5	31.1
																		5800	11.1	36.4
																		6000	11.4	37.3

Available:  
7810R - PVC  
7810WB - Flooded Water-resistant Polyethylene

100% Sweep tested. 6 GHz max. VSWR 1.25:1  
Mates with 9913 and land mobile radio type connectors. Suitable for outdoor and direct burial applications.

\* DC loop resistance • \*\* DC resistance inner conductor • \*\*\* DC resistance outer conductor • DCR = DC resistance •  
BC = Bare Copper • BCCA = Bare Copper-Covered Aluminum • TC = Tinned Copper

Duobond® II see technical information page 23.13.

# Wireless Coax

## Low Loss 50 Ohm Transmission



De- scription	Part No.	UL NEC/ C(UL)/CEC Type IEC	Standard Lengths		Standard Unit Weight		Conductor (Stranding) Diameter Nom. DCR	Nominal Core OD (Dielectric)		Shielding Material Nom. DCR	Nominal OD		Nom. Imp. ( )	Nom. Vel. of Prop.	Nominal Capacitance		Nominal Attenuation		
			ft.	m	lbs.	kg		inch	mm		inch	mm			pF/ft.	pF/m	MHz	dB/ 100 ft.	dB/ 100 m
<b>RF 500 Type • 7 AWG • Solid 3.6 mm Bare Copper-Covered Aluminum • Duobond® II • 90 % Tinned Copper Braid</b>																			
<b>Foam HDPE Insulation • Black Polyethylene Jacket</b>																			
	80°C	7976A	500	152	56.0	25.4	3.6 mm	0.370	9.40	Duobond® II + 90% TC Braid	0.500	12.70	50	84%	25.1	82.4	30	0.5	1.8
			1000	305	108.0	49.0	7 AWG	8.0 /km*	5.3 /km***								50	0.7	2.4
							Solid BCCA	2.7 /km**	10.45 mm								150	1.2	3.9
																	220	1.5	4.9
																	450	2.2	7.2
																	900	3.2	10.5
																	1500	4.2	13.8
																	1800	4.7	15.4
																	2000	5.0	16.4
																	2500	5.7	18.7
Available:																	3000	6.3	20.7
7976R - PVC																	4500	8.0	26.2
7976WB - Flooded Water-resistant Polyethylene																	5800	9.3	30.5
100% Sweep tested.																	6000	9.5	31.2
Suitable for outdoor applications and aerial applications when supported by a messenger wire.																			

<b>RF 600 Type • 5.5 AWG • Solid 4.47 mm Bare Copper-Covered Aluminum • Duobond® II • 85% Tinned Copper Braid</b>																			
<b>Foam HDPE Insulation • Black Polyethylene Jacket</b>																			
	80°C	7977A	500	152	73.6	33.4	4.47 mm	0.455	11.56	Duobond® II + 85% TC Braid	0.590	14.99	50	85%	24.6	80.7	30	0.5	1.5
			1000	305	145.1	65.8	5.5 AWG	7.6 /km*	5.9 /km***								50	0.6	2.0
							Solid BCCA	1.7 /km**	12.65 mm								150	1.0	3.2
																	220	1.2	3.9
																	450	1.7	5.6
																	900	2.5	8.3
																	1500	3.4	11.2
																	1800	3.8	12.4
																	2000	4.0	13.2
			Available:																
7977R - PVC																	3000	5.1	16.6
7977WB - Flooded Water-resistant Polyethylene																	3500	5.5	18.2
100% Sweep tested. 6 GHz.																	4500	6.4	21.1
Suitable for outdoor applications and aerial applications when supported by a messenger wire.																	5800	7.6	24.8
										6000	7.8	25.4							

\* DC loop resistance • \*\* DC resistance inner conductor • \*\*\* DC resistance outer conductor • DCR = DC resistance • BCCA = Bare Copper-Covered Aluminum • TC = Tinned Copper

Duobond® II see technical information page 23.13.

# Wireless Coax

## 50 Ohm Transmission



De- scription	Part No.	UL NEC/ C(UL)CEC Type IEC	Standard Lengths		Standard Unit Weight		Conductor (Stranding) Diameter Nom. DCR	Nominal Core OD (Dielectric)		Shielding Material Nom. DCR	Nominal OD		Nom. Imp. ( )	Nom. Vel. of Prop.	Nominal Capacitance		Nominal Attenuation		
			ft.	m	lbs.	kg		inch	mm		inch	mm			pF/ft.	pF/m	MHz	dB/ 100 ft.	dB/ 100 m

**H1000C • Solid 2.6 mm Bare Copper • Copper-Foil • 85% Bare Copper Braid**

Gas-Injected Polyethylene Insulation • Black Polyethylene Jacket																			
70°C	<b>H1000C3</b>		1640	500	97.0	44.0	2.62 mm Solid BC 12.3 /km* 3.5 /km**	0.281	7.15	Cu-foil + 85% BC Braid 8.8 /km*** 8.0 mm	0.406	10.30	50	83%	24.4	80.0	5	0.2	0.8
																	50	0.9	2.8
																	100	1.2	4.0
																	230	1.9	6.1
																	400	2.6	8.4
																	800	3.8	12.3
																	862	4.2	13.8
																	1000	4.3	14.0
																	1350	5.1	16.7
																	1750	5.9	19.5
																	2150	6.9	22.5
																	2400	7.2	23.6
Return loss at			5-470 MHz: 23 dB				Screening attenuation at 30-1000 MHz: 100 dB												
			470-1000 MHz: 20 dB																
			1000-2000 MHz: 18 dB																
			2000-3000 MHz: 16 dB																

**Gas-Injected Polyethylene Insulation • Black PVC Jacket**

70°C	<b>H1000C0</b>	C-328 1640 6560	C-100 500 2000	19.6 98.1 392.4	8.9 44.5 178.0	2.62 mm Solid BC 12.3 /km* 3.5 /km**	0.281	7.15	Cu-foil + 50% BC Braid 8.8 /km*** 7.8 mm	0.406	10.30	50	83%	24.4	80.0	see above				
Return loss at			5-470 MHz: 23 dB				Screening attenuation at 30-1000 MHz: 100 dB													
			470-1000 MHz: 20 dB																	
			1000-2000 MHz: 18 dB																	
			2000-3000 MHz: 16 dB																	

**Gas-Injected Polyethylene Insulation • Black Polyethylene Jacket**

70°C	<b>H1000C1</b>	C-328 1640 3280	C-100 500 1000	15.0 75.0 149.9	6.8 34.0 68.0	2.62 mm Solid BC 12.3 /km* 3.5 /km**	0.281	7.15	Cu-foil + 50% BC Braid 8.8 /km*** 7.8 mm	0.406	10.30	50	83%	24.4	80.0	see above				
Return loss at			5-470 MHz: 23 dB				Screening attenuation at 30-1000 MHz: 100 dB													
			470-1000 MHz: 20 dB																	
			1000-2000 MHz: 18 dB																	
			2000-3000 MHz: 16 dB																	

**H1001C • Stranded (19x0.54) 2.7 mm Bare Copper • Copper-Foil • 50% Bare Copper Braid**

Gas-Injected Polyethylene Insulation • Black Polyethylene Jacket																			
70°C	<b>H1001C1</b>		1640	500	117.9	53.5	2.7 mm (19x0.54) BC 16.5 /km* 4.5 /km**	0.283	7.20	Cu-foil + 50% BC Braid 12.0 /km*** 7.15 mm	0.406	10.30	50	83%	24.4	80.0	5	0.3	1.0
																	50	1.0	3.3
																	100	1.4	4.7
																	230	2.2	7.2
																	400	3.0	9.8
																	800	4.4	14.4
																	862	4.5	14.9
																	1000	5.0	16.3
																	1350	5.9	19.3
																	1750	6.9	22.5
																	2150	7.7	25.4
																	2400	8.3	27.1
Return loss at			5-470 MHz: 23 dB				Screening attenuation at 30-1000 MHz: 100 dB												
			470-1000 MHz: 20 dB																
			1000-2000 MHz: 18 dB																
			2000-3000 MHz: 16 dB																

**H500C • Solid 2.5 mm Bare Copper • Copper-Foil • 50% Bare Copper Braid**

Gas-Injected Polyethylene Insulation • Black Polyethylene Jacket																			
70°C	<b>H500C00</b>	C-328 820 1640 6560	C-100 250 500 2000	23.6 59.0 117.9 471.8	10.7 26.8 53.5 214.0	2.5 mm Solid BC 15.3 /km* 3.8 /km**	0.276	7.00	Cu-foil + 50% BC Braid 11.5 /km*** 7.45 mm	0.386	9.80	50	81%	25.0	82.0	5	0.3	0.9	
																	50	0.9	2.9
																	100	1.3	4.1
																	230	2.0	6.5
																	400	2.7	8.7
																	800	3.9	12.9
																	862	4.1	13.4
																	1000	4.5	14.6
																	1350	5.3	17.4
																	1750	6.2	20.3
																	2150	7.0	23.0
																	2400	7.5	24.6
Return loss at			5-470 MHz: 23 dB				Screening attenuation at 30-1000 MHz: 95 dB												
			470-1000 MHz: 20 dB																
			1000-2000 MHz: 18 dB																
			2000-3000 MHz: 16 dB																

\* DC loop resistance • \*\* DC resistance inner conductor • \*\*\* DC resistance outer conductor • DCR = DC resistance • BC = Bare Copper

## Wireless Coax

### 50 Ohm Transmission



De-scription	Part No.	UL NEC / C(UL)CEC Type IEC	Standard Lengths		Standard Unit Weight		Conductor (Stranding) Diameter Nom. DCR	Nominal Core OD (Dielectric)		Shielding Material Nom. DCR	Nominal OD		Nom. Imp. ( )	Nom. Vel. of Prop.	Nominal Capacitance		Nominal Attenuation		
			ft.	m	lbs.	kg		inch	mm		inch	mm			pF/ft.	pF/m	MHz	dB/100 ft.	dB/100 m

#### MRG213 • Stranded (7x0.75) 2.25 mm Bare Copper • 92% Bare Copper Braid

**Polyethylene Insulation • Black PVC Jacket**

70°C																				
Part No.	MRG2130	Standard Lengths		Standard Unit Weight		Conductor (Stranding) Diameter	Nominal Core OD		Shielding Material Nom. DCR	Nominal OD		Nom. Imp.	Nom. Vel. of Prop.	Nominal Capacitance		Nominal Attenuation				
		ft.	m	lbs.	kg		inch	mm		inch	mm			pF/ft.	pF/m	MHz	dB/100 ft.	dB/100 m		
328	100	29.8	13.5	2.25 mm	0.285	7.25	92% BC Braid	0.406	10.30	50	66%	30.5	100.0	5	0.5	1.5				
820	250	74.4	33.8	(7x0.75) BC													50	1.4	4.6	
1640	500	148.8	67.5	11.5 /km*			5.5 /km***										100	2.0	6.6	
3280	1000	297.6	135.0	6.0 /km**			8.0 mm										230	3.2	10.4	
																		400	4.3	14.1
																		800	6.4	21.1
																		862	6.7	22.1
																		1000	7.3	24.1
																		1350	8.8	29.0
																		1750	10.5	34.3
																		2150	11.9	39.1
																		2400	12.9	42.4

Return loss at 5-470 MHz: 20 dB      Screening attenuation at 30-1000 MHz: 65 dB  
 470-1000 MHz: 18 dB  
 1000-2000 MHz: 16 dB  
 2000-3000 MHz: 15 dB

#### H155A • Stranded (19x0.28) 1.4 mm Tinned Copper • Duofoil® • 80% Bare Copper Braid

**Gas-Injected Polyethylene Insulation • Black Polyethylene Jacket**

70°C																				
Part No.	H155A01	Standard Lengths		Standard Unit Weight		Conductor (Stranding) Diameter	Nominal Core OD		Shielding Material Nom. DCR	Nominal OD		Nom. Imp.	Nom. Vel. of Prop.	Nominal Capacitance		Nominal Attenuation				
		B-328	B-100	ft.	m		lbs.	kg		inch	mm			inch	mm	pF/ft.	pF/m	MHz	dB/100 ft.	dB/100 m
328	100	8.2	3.7	1.41 mm	0.154	3.90	Duofoil® + 80% TC	0.213	5.40	50	80%	25.6	84.0	5	0.8	2.5				
820	250	20.4	9.3	(19x0.28) TC													50	2.1	6.9	
1640	500	40.8	18.5	32.4 /km*			Braid										100	2.8	9.1	
3280	1000	81.6	37.0	15.4 /km**			17.0 /km***										230	4.1	13.4	
																		400	5.5	18.0
																		800	8.0	26.1
																		862	8.3	27.3
																		1000	9.0	29.6
																		1350	10.6	34.9
																		1750	12.3	40.3
																		2150	14.0	46.0
																		2400	15.0	49.1

Return loss at 5-470 MHz: 20 dB      Screening attenuation at 30-1000 MHz: 85 dB  
 470-1000 MHz: 18 dB  
 1000-2000 MHz: 16 dB  
 2000-3000 MHz: 15 dB

**Gas-Injected Polyethylene Insulation • Grey PVC Jacket**

70°C																			
Part No.	H155A00	Standard Lengths		Standard Unit Weight		Conductor (Stranding) Diameter	Nominal Core OD		Shielding Material Nom. DCR	Nominal OD		Nom. Imp.	Nom. Vel. of Prop.	Nominal Capacitance		Nominal Attenuation			
		B-328	B-100	ft.	m		lbs.	kg		inch	mm			inch	mm	pF/ft.	pF/m	MHz	dB/100 ft.
328	100	7.7	3.5	1.41 mm	0.116	2.95	Duofoil® + 80% TC	0.213	5.40	50	80%	25.6	84.0						
820	250	20.4	9.3	(19x0.28) TC															
1640	500	40.8	18.5	32.4 /km*			Braid												
3280	1000	81.6	37.0	15.4 /km**			17.0 /km***												

Return loss at 5-470 MHz: 20 dB      Screening attenuation at 30-1000 MHz: 85 dB  
 470-1000 MHz: 18 dB  
 1000-2000 MHz: 16 dB  
 2000-3000 MHz: 15 dB

#### MRG58 • Stranded (19x0.18) 0.9 mm Tinned Copper • 93% Tinned Copper Braid

**Gas-Injected Polyethylene Insulation • PVC Jacket (Black or White)**

70°C																				
Part No.	MRG5800	Standard Lengths		Standard Unit Weight		Conductor (Stranding) Diameter	Nominal Core OD		Shielding Material Nom. DCR	Nominal OD		Nom. Imp.	Nom. Vel. of Prop.	Nominal Capacitance		Nominal Attenuation				
		ft.	m	lbs.	kg		inch	mm		inch	mm			pF/ft.	pF/m	MHz	dB/100 ft.	dB/100 m		
328	100	7.7	3.5	0.91 mm	0.116	2.95	+ 93% TC	0.195	4.95	50	66%	30.5	100.0	5	1.0	3.3				
1640	500	38.6	17.5	(19x0.18) TC													50	3.2	10.6	
																		100	4.6	15.1
																		230	7.0	23.1
																		400	9.4	30.7
																		800	13.4	44.1
																		862	14.0	45.8
																		1000	15.1	49.6
																		1350	17.7	58.2
																		1750	20.4	66.8
																		2150	22.7	74.6
																		2400	24.1	79.2

Return loss at 5-470 MHz: 20 dB      Screening attenuation at 30-1000 MHz: 65 dB  
 470-1000 MHz: 18 dB  
 1000-2000 MHz: 16 dB  
 2000-3000 MHz: 15 dB

\* DC loop resistance • \*\* DC resistance inner conductor • \*\*\* DC resistance outer conductor • DCR = DC resistance • BC = Bare Copper • TC = Tinned Copper

Duofoil® see technical information page 23.13.

# Wireless Coax

## 50 Ohm Microwave Cables



De- scription	Part No.	UL NEC/ C(UL)CEC Type IEC	Standard Lengths		Standard Unit Weight		Conductor (Stranding) Diameter Nom. DCR	Nominal Core OD (Dielectric)		Shielding Material Nom. DCR	Nominal OD		Nom. Imp. ( )	Nom. Vel. of Prop.	Nominal Capacitance		Nominal Attenuation		
			ft.	m	lbs.	kg		inch	mm		inch	mm			pF/ft.	pF/m	MHz	dB/ 100 ft.	dB/ 100 m

**M17/151 Type • 29 AWG • Solid 0.28 mm Silver-Plated Copper-Covered Steel • 100 % Copper-Tin Composite Braid**

TFE Teflon® Insulation • Unjacketed																			
UL AWM	<b>1674A*</b>		50	15	0.2	0.1	0.279 mm	0.033	0.85	100% CT	0.047	1.19	50	69.5%	29.5	96.8	500	25.0	82.0
Style 10245			100	31	0.4	0.2	29 AWG			Composite							1000	36.7	120.3
(30 V 105°C)			500	152	1.9	0.9	Solid SPCCS			Braid							2000	53.8	176.5
			1000	305	3.7	1.7	698.6 /km*			26.2 /km***							3000	67.3	220.8
							672.4 /km**			1.19 mm							5000	89.3	292.8
																	7000	107.5	352.6
																	10000	130.9	429.5
																	15000	163.8	537.4
																	18000	181.2	594.3
																	20000	192.1	630.0

Available with Silver-Plated Copper CDR (1674B)

**RG-405/U Type • 24 AWG • Solid 0.5 mm Silver-Plated Copper-Covered Steel • 100 % Copper-Tin Composite Braid**

TFE Teflon® Insulation • Unjacketed																			
UL AWM	<b>1671A*</b>		50	15	2.0	0.9	0.5 mm	0.062	1.57	100% CT	0.085	2.16	50	69.5%	29.5	96.8	500	15.0	49.2
Style 10245			100	31	2.4	1.1	24 AWG			Composite							1000	22.2	72.8
(30 V 105°C)			† 500	152	7.5	3.4	Solid SPCCS			Braid							2000	32.8	107.6
			† 1000	305	14.1	6.4	244.1 /km*			33.5 /km***							3000	41.2	135.2
							210.6 /km**			2.16 mm							5000	54.9	180.0
																	7000	66.4	217.9
																	10000	81.2	266.4
																	15000	102.0	334.7
																	18000	113.0	370.8
																	20000	120.0	393.7

Available:  
 1671J - with PVC jacket (Black or Clear)  
 1671B - with Silver-Plated Copper, unjacketed  
 Suitable for outdoor applications.

**RG-402/U Type • 19 AWG • Solid 0.9 mm Silver-Plated Copper-Covered Steel • 100 % Copper-Tin Composite Braid**

TFE Teflon® Insulation • Unjacketed																			
UL AWM	<b>1673A*</b>		50	15	3.3	1.5	0.9 mm	0.116	2.95	100% CT	0.138	3.51	50	69.5%	29.5	96.8	500	8.0	26.2
Style 10245			100	31	4.0	1.8	19 AWG			Composite							1000	12.0	39.4
(30 V 105°C)			† 250	76	7.9	3.6	Solid SPCCS			Braid							2000	18.1	59.4
			500	152	15.0	6.8	82.1 /km*			14.8 /km***							3000	22.9	75.1
							67.3 /km**			4.52 mm							5000	31.0	101.7
																	7000	37.8	124.0
																	10000	46.6	152.9
																	15000	59.1	193.9
																	18000	65.8	215.9
																	20000	70.0	229.7

Available:  
 1673J - with PVC jacket (Black or Clear)  
 1673B - with Silver-Plated Copper, unjacketed

**RG-401/U Type • 14 AWG • Solid 1.65 mm Silver-Plated Copper • 100 % Copper-Tin Composite Braid**

TFE Teflon® Insulation • Unjacketed																			
UL AWM	<b>1675A*</b>		† 50	15	4.0	1.8	1.65 mm	0.210	5.33	100% CT	0.246	6.25	50	69.5%	29.6	97.1	500	3.8	12.5
Style 10245			†† 100	31	8.1	3.7	14 AWG			Composite							1000	4.4	14.4
(30 V 105°C)			†† 250	76	20.3	9.2	Solid SPC			Braid							2000	6.8	22.3
			†† 500	152	40.6	18.4	34.4 /km*			26.2 /km***							3000	10.4	34.1
							8.2 /km**			6.25 mm							5000	13.4	44.0
																	7000	18.5	60.7
																	10000	22.8	74.8
																	15000	28.4	93.2
																	18000	36.6	120.1
																	20000	41.0	134.5

Available with Clear PVC jacket (1675J)

\* DC loop resistance • \*\* DC resistance inner conductor • \*\*\* DC resistance outer conductor • DCR = DC resistance • CT = Copper-Tin • SPC = Silver-Plated Copper •  
 SPCCS = Silver-Plated Copper-Covered Steel  
 # Protected by one or more of U.S. Patent Nos. 4,694,122 and 5,292,001. Patent held in the U.S., Singapore, Australia, Germany, France and England. Patent pending in Japan.

† 76 m put-up: Exact 3 pieces (maximum), 15 m (50 ft.) minimum length.  
 152 m put-up: Exact 5 pieces (maximum), 15 m (50 ft.) minimum length.  
 305 m put-up: Exact 8 pieces (maximum), 15 m (50 ft.) minimum length.  
 †† May contain more than one piece, minimum length of any one piece is 7.6 m (25 ft.).

Teflon® is a DuPont trademark.



# 11 Enclosures and Accessories



## Table of Contents

Enclosures and Accessories	Page No.
<b>Introduction</b>	<b>11.2</b>
<b>Modular Enclosures</b>	<b>11.3 – 11.19</b>
Data Standard Enclosure: 29" W x 30"D (0.73 x 0.76 m)	11.3
Data Standard Enclosure: 29" W x 34"D (0.73 x 0.86 m)	11.6
Data Slim Enclosure: 24" W x 30"D (0.60 x 0.76 m)	11.9
Ultra Server Enclosure: 24" W x 36"D (0.60 x 0.91 m)	11.12
Ultra Deep Server Enclosure: 24" W x 42"D (0.60 x 1.06 m)	11.15
Giga Server Enclosure: 26" W x 42"D (0.66 x 1.06 m)	11.18
<b>Modular Enclosure Options and Accessories</b>	<b>11.20 – 11.27</b>
Enclosure Shelves	11.20
Enclosure Anti-Tip Device	11.22
Grounding Bars	11.22
Enclosure Mounting Hardware	11.22
Enclosure Mounting Rails	11.23
Enclosure Partial Rail Kits	11.23
Front to Rear Cable Management	11.24
Light Kits	11.24
Enclosure Power Strips	11.25
Mission Critical Power Accessories	11.26
Climate Monitor	11.27
Electronic Fan Controller	11.27
Thermostat Fan Controller	11.27
<b>Wall Mount Enclosures and Accessories</b>	<b>11.28 – 11.29</b>
Wall Mount Enclosures	11.28
Wall Mount Enclosure Accessories	11.29
Swing Racks	11.29



## Introduction

### Providing All the Right Connections

Belden is the largest company of its kind, combining cables, connectivity, enclosures and many other product solutions for highly technical industries around the globe. As the exclusive occupant in this market position, Belden provides thousands of satisfied customers with over a billion euros worth of trusted solutions every year, much of which supports the commercial networking sector. By combining our expertise in the design and manufacture of cables, connectivity, enclosures and related products, Belden now offers a product line of staggering magnitude, engineering triumphs and rich resources – worldwide.

### Belden Enclosures

The complete line of Belden enclosure solutions are designed to meet the unique needs of data networks and control console systems. Whether it's the protection of sensitive data equipment, the ability to mount equipment of varied sizes and depths, or the need to organize and neatly route installed cables, Belden has the solution you need. Belden provides you with single source convenience for all of your cable management requirements.

### Enclosures and Racks

Choose from a variety of vertical enclosures, open frame racks and wall mount enclosures, all expertly engineered to optimize product quality and performance. Although standard configurations of the most popular enclosures are offered for fast delivery needs, all custom enclosures and racks have numerous mounting, cable and patch cord management options, along with a variety of accessories. This selection of Belden enclosures and racks will meet virtually any mounting, storage or protection requirement for your application.

### Single Sourcing Convenience

The cable management product families in this catalog are offered to cabling professionals for ultimate convenience in single sourcing. As a Belden customer, you also have the assurance of total dependability by working with a market leader and a trusted partner who has a vested interest in optimizing your operations and investments. We want to make sure you not only get the products you need with ease, but they also perform reliably.

### Availability

Please contact technical support at +31-77-3875-414 or [techsupport.venlo@belden.com](mailto:techsupport.venlo@belden.com) for availability.

### Freestanding Modular Enclosures

Type	Rack Space	Heights		Panel Mount		Width		Depth	
		inch	m	inch	m	inch	m	inch	m
<b>Data Standard</b>	25, 39, 42, 46U	48, 72, 78, 84	1.21, 1.82, 1.98, 2.13	19 or 23	0.48/0.58	29	0.73	30	0.76
<b>Data Deep</b>	39, 42, 46U	72, 78, 84	1.82, 1.98, 2.13	19 or 23	0.48/0.58	29	0.73	34	0.86
<b>Data Slim</b>	25, 39, 42, 46U	48, 72, 78, 84	1.21, 1.82, 1.98, 2.13	19	0.48	24	0.60	30	0.76
<b>Ultra Server</b>	42U, 45U	78, 84	1.98, 2.13	19	0.48	24	0.60	36	0.86
<b>Ultra Deep Server</b>	45U	84	2.13	19	0.48	24	0.60	42	1.06
<b>Giga Server</b>	45U	84	2.13	19	0.48	26	0.66	42	1.06

## Modular Enclosures

### Data Standard Enclosure 29" Wide x 30" Deep (0.73 x 0.76 m)

BST-Style Data Standard Enclosure



#### Data Standard Enclosure

The Data Standard is a freestanding enclosure that easily accommodates large components. The unit's mounting rails can be adjusted, after installation, from 19" (0.48 m) EIA to 23" (0.58 m) EIA spacing to allow for cable management and different depths of equipment. Among the many features and benefits of this modular unit are:

- Reversible doors: Spring-loaded hinges allow quick change of door swing.
- Lift-off side panels: Flush surface lock fasteners permit quick disconnect and lift off.
- Cable gland plate: Adjustable bottom plate minimizes dirt and dust inside the enclosure.
- Cable access top: Features a 14.25" x 4" (0.36 x 0.10 m) cable access rubber gland which helps prevent dust from entering the enclosure.
- Rear cable plate: Two, 3-7/8" x 8-1/2" (0.07 x 0.02 m) openings for cable access with removable plates and edge grommet kit. Also features two 1.75" (0.04 m) capped openings.
- Tempered safety glass: Strengthens door and is easy-to-clean, non-scratching, tinted bronze color enhances overall appearance.
- Grounding kit Included.

#### Frames



BST 48

BST 72

BST 78

BST 84

These products are in the process of being assessed for RoHS compliance. Please check our website for the most current RoHS status.

## Modular Enclosures

Data Standard Enclosure 29" Wide x 30" Deep (0.73 x 0.76 m)

(continued)

### Dimensions

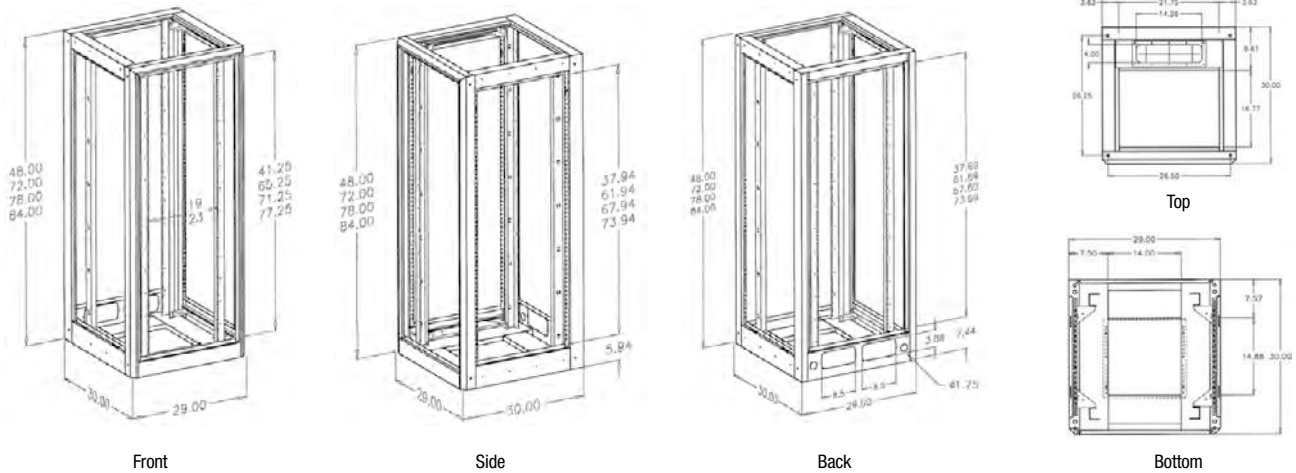

### Technical Specifications

Enclosure Size	Rack Spaces	Mounting	Weight		Heights		Width		Depth	
			lbs.	kg	inch	m	inch	m	inch	m
<b>BST48</b> Frame, Grand Plate, Casters & Levelers	25U	19" (0.48 m), 23" (0.58 m) or Frame Mount Shelf	230	105	48	1.21	29	0.73	30	0.76
<b>BST72</b> Frame, Grand Plate, Casters & Levelers	39U	19" (0.48 m), 23" (0.58 m) or Frame Mount Shelf	325	147	72	1.82	29	0.73	30	0.76
<b>BST78</b> Frame, Grand Plate, Casters & Levelers	42U	19" (0.48 m), 23" (0.58 m) or Frame Mount Shelf	350	158	78	1.98	29	0.73	30	0.76
<b>BST84</b> Frame, Grand Plate, Casters & Levelers	46U	19" (0.48 m), 23" (0.58 m) or Frame Mount Shelf	360	163	84	2.13	29	0.73	30	0.76

### How to order

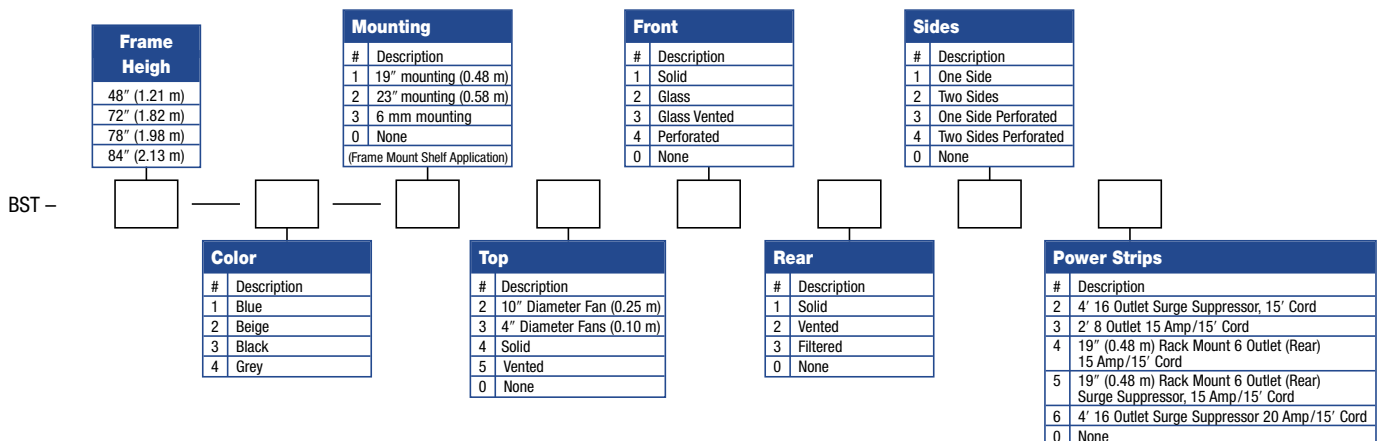

### For Example:

Description	Belden Part Number
Data Standard 84" (2.13 m) Black, 19" (0.48 m) Mounting, 10" (0.25 m) Fan Top, Glass Door, Vented Rear Door, Two Sides, 20 Amp Power Strip	<b>BST84-3-122226</b>
Data Standard 84" (2.13 m) Black Frames w/19" (0.48 m) Mounting	<b>BST84-3-100000</b>

EIA - 310 - D Compliant

These products are in the process of being assessed for RoHS compliance. Please check our website for the most current RoHS status.



## Modular Enclosures

Data Standard Enclosure 29" Wide x 30" Deep (0.73 x 0.76 m)

(continued)

Solid Front Door



Tempered Glass Front Door



Rear Doors: Solid, Vented, Filtered

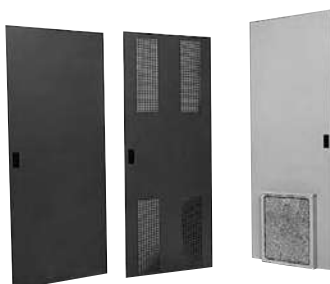

Side Panels

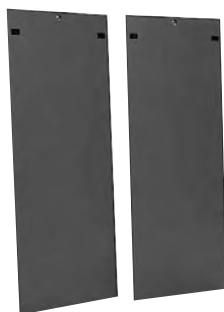

Removable Tops



Description	Belden Part Number
<b>Front Doors</b>	
<b>Solid Front Door</b>	
Solid Steel Front Door with Latch and Lock, 48" (1.21 m)	B4829-SF-C
Solid Steel Front Door with Latch and Lock, 72" (1.82 m)	B7229-SF-C
Solid Steel Front Door with Latch and Lock, 78" (1.98 m)	B7829-SF-C
Solid Steel Front Door with Latch and Lock, 84" (2.13 m)	B8429-SF-C
<b>Tempered Glass Front Door</b>	
Tempered Glass Front Door with Latch and Lock, 48" (1.21 m)	B4829-GF-C
Tempered Glass Front Door with Latch and Lock, 72" (1.82 m)	B7229-GF-C
Tempered Glass Front Door with Latch and Lock, 78" (1.98 m)	B7829-GF-C
Tempered Glass Front Door with Latch and Lock, 84" (2.13 m)	B8429-GF-C
<b>Glass Vented Front Door</b>	
Tempered Glass Front Vented Door with Latch and Lock, 48" (1.21 m)	B4829-VF-C
Tempered Glass Front Vented Door with Latch and Lock, 72" (1.82 m)	B7229-VF-C
Tempered Glass Front Vented Door with Latch and Lock, 78" (1.98 m)	B7829-VF-C
Tempered Glass Front Vented Door with Latch and Lock, 84" (2.13 m)	B8429-VF-C
<b>Perforated Front Door</b>	
Perforated Front Door with Latch and Lock, 48" (1.21 m)	B4829-PD-C
Perforated Front Door with Latch and Lock, 72" (1.82 m)	B7229-PD-C
Perforated Front Door with Latch and Lock, 78" (1.98 m)	B7829-PD-C
Perforated Front Door with Latch and Lock, 84" (2.13 m)	B8429-PD-C
<b>Rear Doors</b>	
<b>Solid Rear Door</b>	
Solid Steel Rear Door with Latch and Lock, 48" (1.21 m)	B4829-SR-C
Solid Steel Rear Door with Latch and Lock, 72" (1.82 m)	B7229-SR-C
Solid Steel Rear Door with Latch and Lock, 78" (1.98 m)	B7829-SR-C
Solid Steel Rear Door with Latch and Lock, 84" (2.13 m)	B8429-SR-C
<b>Vented Rear Door</b>	
Vented Steel Rear Door with Latch and Lock, 48" (1.21 m)	B4829-VR-C
Vented Steel Rear Door with Latch and Lock, 72" (1.82 m)	B7229-VR-C
Vented Steel Rear Door with Latch and Lock, 78" (1.98 m)	B7829-VR-C
Vented Steel Rear Door with Latch and Lock, 84" (2.13 m)	B8429-VR-C
<b>Filtered Rear Door</b>	
Filtered Rear Door with Latch and Lock, 48" (1.21 m)	B4829-FR-C
Filtered Rear Door with Latch and Lock, 72" (1.82 m)	B7229-FR-C
Filtered Rear Door with Latch and Lock, 78" (1.98 m)	B7829-FR-C
Filtered Rear Door with Latch and Lock, 84" (2.13 m)	B8429-FR-C
<b>Side Panels</b>	
<b>Single Side Panels</b>	
1-Solid Lift-off Side Panel with Lock, 48" (1.21 m)	B4801-SP-C
1-Solid Lift-off Side Panel with Lock, 72" (1.82 m)	B7201-SP-C
1-Solid Lift-off Side Panel with Lock, 78" (1.98 m)	B7801-SP-C
1-Solid Lift-off Side Panel with Lock, 84" (2.13 m)	B8401-SP-C
<b>Pair of Side Panels</b>	
2-Solid Lift-off Side Panels with Lock, 48" (1.21 m)	B4802-SP-C
2-Solid Lift-off Side Panels with Lock, 72" (1.82 m)	B7202-SP-C
2-Solid Lift-off Side Panels with Lock, 78" (1.98 m)	B7802-SP-C
2-Solid Lift-off Side Panels with Lock, 84" (2.13 m)	B8402-SP-C
<b>Removable Tops</b>	
Solid Top	B2918-TP-1-C
Vented Top	B2918-TP-2-C
Solid Top with 10" (0.25 m) Diameter Fan, 550 CFM	B2918-TP-3-C
Solid Top with (4) 4" (0.10 m) Diameter Fans, Four Fans = 320 CFM	B2918-TP-4-C

These products are in the process of being assessed for RoHS compliance. Please check our website for the most current RoHS status.

## Modular Enclosures

### Data Deep Enclosure 29" Wide x 34" Deep (0.73 x 0.86 m)

BDP-Style Data Deep Enclosure



#### Data Deep Enclosure

The Data Deep is a freestanding enclosure that features a 34" (0.86 m) depth for mounting servers, UPS units, controllers, battery backups, network monitors and more. The unit's mounting rails can be adjusted, after installation, from 19" (0.48 m) EIA to 23" (0.58 m) EIA spacing to allow for cable management and different depths of equipment. Among the many features and benefits of this modular unit are:

- Reversible doors: Spring-loaded hinges allow quick change of door swing.
- Lift-off side panels: Flush surface lock fasteners permit quick disconnect and lift off.
- Cable gland plate: Adjustable bottom plate minimizes dirt and dust inside the enclosure.
- Cable access top: Features a 14.25" x 4" (0.36 x 0.10 m) cable access rubber gland which helps prevent dust from entering the enclosure.
- Rear cable plate: Two, 3-7/8" x 8-1/2" (0.07 x 0.02 m) openings for cable access with removable plates and edge grommet kit. Also features two 1.75" (0.04 m) capped openings.
- Tempered safety glass: Strengthens door and is easy-to-clean, non-scratching, tinted bronze color enhances overall appearance.
- Grounding kit Included.

#### Frames



BDP 72

BDP 78

BDP 84

These products are in the process of being assessed for RoHS compliance. Please check our website for the most current RoHS status.

### Modular Enclosures

Data Deep Enclosure 29" Wide x 34" Deep (0.73 x 0.86 m)  
(continued)

#### Dimensions

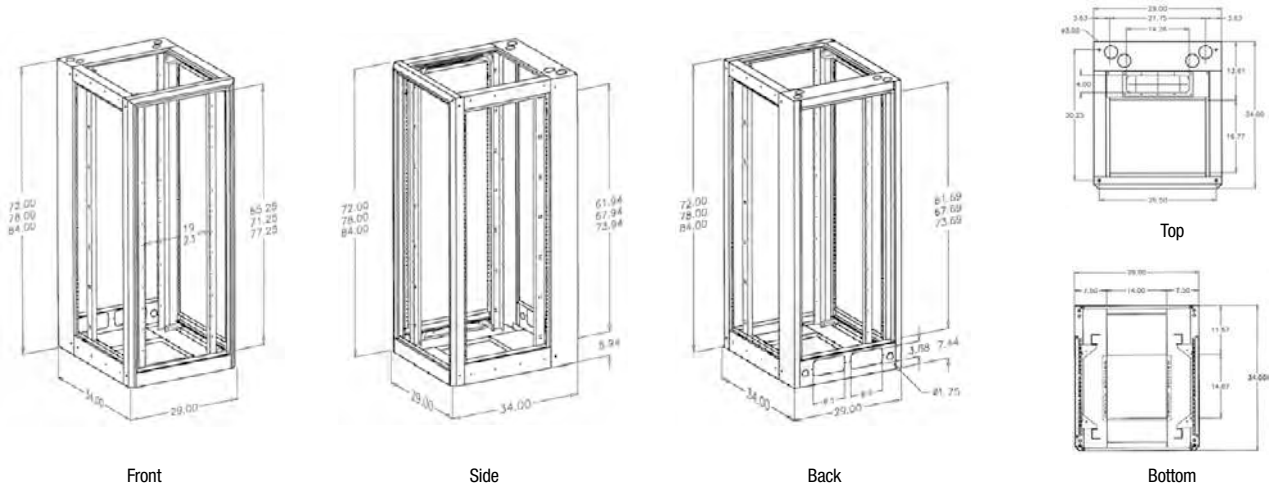

#### Technical Specifications

Enclosure Size	Rack Spaces	Mounting	Weight		Heights		Width		Depth	
			lbs.	kg	inch	m	inch	m	inch	m
<b>BDP72</b> Frame, Grand Plate, Casters & Levelers	39U	19" (0.48 m), 23" (0.58 m) or Frame Mount Shelf	350	158	72	1.82	29	0.73	34	0.86
<b>BDP78</b> Frame, Grand Plate, Casters & Levelers	42U	19" (0.48 m), 23" (0.58 m) or Frame Mount Shelf	380	172	78	1.98	29	0.73	34	0.86
<b>BDP84</b> Frame, Grand Plate, Casters & Levelers	46U	19" (0.48 m), 23" (0.58 m) or Frame Mount Shelf	390	177	84	2.13	29	0.73	34	0.86

#### How to order

BDP - [ ] - [ ] - [ ] - [ ] - [ ] - [ ] - [ ] - [ ]

Frame Height	Mounting	Front	Sides	Color	Top	Rear	Power Strips
72" (1.82 m) 78" (1.98 m) 84" (2.13 m)	# Description 1 19" mounting (0.48 m) 2 23" mounting (0.58 m) 3 6 mm mounting 0 None (Frame Mount Shelf Application)	# Description 1 Solid 2 Glass 3 Glass Vented 4 Perforated 0 None	# Description 1 One Side 2 Two Sides 3 One Side Perforated 4 Two Sides Perforated 0 None	# Description 1 Blue 2 Beige 3 Black 4 Grey	# Description 2 10" Diameter Fan (0.25 m) 3 4" Diameter Fans (0.10 m) 4 Solid 5 Vented 0 None	# Description 1 Solid 2 Vented 3 Filtered 0 None	# Description 2 4' 16 Outlet Surge Suppressor, 15' Cord 3 2' 8 Outlet 15 Amp/15' Cord 4 19" (0.48 m) Rack Mount 6 Outlet (Rear) 15 Amp/15' Cord 5 19" (0.48 m) Rack Mount 6 Outlet (Rear) Surge Suppressor, 15 Amp/15' Cord 6 4' 16 Outlet Surge Suppressor 20 Amp/15' Cord 0 None

#### For Example:

Description	Belden Part Number
Data Standard 84" (2.13 m) Black, 19" (0.48 m) Mounting, 10" (0.25 m) Fan Top, Glass Door, Vented Rear Door, Two Sides, 20 Amp Power Strip	<b>BDP84-3-122226</b>
Data Standard 84" (2.13 m) Black Frames w/19" (0.48 m) Mounting	<b>BDP84-3-100000</b>

EIA - 310 - D Compliant  
These products are in the process of being assessed for RoHS compliance. Please check our website for the most current RoHS status.

## Modular Enclosures

Data Deep Enclosure 29" Wide x 34" Deep (0.73 x 0.86 m)

(continued)

Tempered Glass Front Door



Rear Doors: Solid, Vented, Filtered

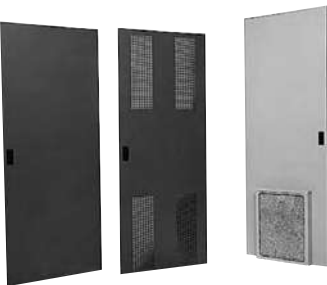

Side Panels

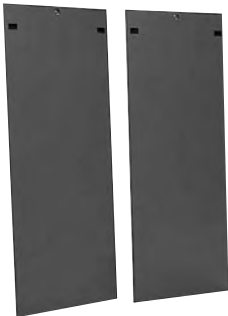

Removable Tops



Description	Belden Part Number
<b>Front Doors</b>	
<b>Solid Front Door</b>	
Solid Steel Front Door with Latch and Lock, 72" (1.82 m)	<b>B7229-SF-C</b>
Solid Steel Front Door with Latch and Lock, 78" (1.98 m)	<b>B7829-SF-C</b>
Solid Steel Front Door with Latch and Lock, 84" (2.13 m)	<b>B8429-SF-C</b>
<b>Tempered Glass Front Door</b>	
Tempered Glass Front Door with Latch and Lock, 72" (1.82 m)	<b>B7229-GF-C</b>
Tempered Glass Front Door with Latch and Lock, 78" (1.98 m)	<b>B7829-GF-C</b>
Tempered Glass Front Door with Latch and Lock, 84" (2.13 m)	<b>B8429-GF-C</b>
<b>Glass Vented Front Door</b>	
Tempered Glass Front Vented Door with Latch and Lock, 72" (1.82 m)	<b>B7229-VF-C</b>
Tempered Glass Front Vented Door with Latch and Lock, 78" (1.98 m)	<b>B7829-VF-C</b>
Tempered Glass Front Vented Door with Latch and Lock, 84" (2.13 m)	<b>B8429-VF-C</b>
<b>Perforated Front Door</b>	
Perforated Front Door with Latch and Lock, 72" (1.82 m)	<b>B7229-PD-C</b>
Perforated Front Door with Latch and Lock, 78" (1.98 m)	<b>B7829-PD-C</b>
Perforated Front Door with Latch and Lock, 84" (2.13 m)	<b>B8429-PD-C</b>
<b>Rear Doors</b>	
<b>Solid Rear Door</b>	
Solid Steel Rear Door with Latch and Lock, 72" (1.82 m)	<b>B7229-SR-C</b>
Solid Steel Rear Door with Latch and Lock, 78" (1.98 m)	<b>B7829-SR-C</b>
Solid Steel Rear Door with Latch and Lock, 84" (2.13 m)	<b>B8429-SR-C</b>
<b>Vented Rear Door</b>	
Vented Steel Rear Door with Latch and Lock, 72" (1.82 m)	<b>B7229-VR-C</b>
Vented Steel Rear Door with Latch and Lock, 78" (1.98 m)	<b>B7829-VR-C</b>
Vented Steel Rear Door with Latch and Lock, 84" (2.13 m)	<b>B8429-VR-C</b>
<b>Filtered Rear Door</b>	
Filtered Rear Door with Latch and Lock, 72" (1.82 m)	<b>B7229-FR-C</b>
Filtered Rear Door with Latch and Lock, 78" (1.98 m)	<b>B7829-FR-C</b>
Filtered Rear Door with Latch and Lock, 84" (2.13 m)	<b>B8429-FR-C</b>
<b>Side Panels</b>	
<b>Single Side Panel</b>	
1-Solid Lift-off Side Panel with Lock, 72" (1.82 m)	<b>B7201-SP-C</b>
1-Solid Lift-off Side Panel with Lock, 78" (1.98 m)	<b>B7801-SP-C</b>
1-Solid Lift-off Side Panel with Lock, 84" (2.13 m)	<b>B8401-SP-C</b>
<b>Pair of Side Panels</b>	
2-Solid Lift-off Side Panels with Lock, 72" (1.82 m)	<b>B7202-SP-C</b>
2-Solid Lift-off Side Panels with Lock, 78" (1.98 m)	<b>B7802-SP-C</b>
2-Solid Lift-off Side Panels with Lock, 84" (2.13 m)	<b>B8402-SP-C</b>
<b>Removable Tops</b>	
Solid Top	<b>B2918-TP-1-C</b>
Vented Top	<b>B2918-TP-2-C</b>
Solid Top with 10" (0.25 m) Diameter Fan, 550 CFM	<b>B2918-TP-3-C</b>
Solid Top with (4) 4" (0.10 m) Diameter Fans, Four Fans = 320 CFM	<b>B2918-TP-4-C</b>

These products are in the process of being assessed for RoHS compliance. Please check our website for the most current RoHS status.

## Modular Enclosures

### Data Slim Enclosure 24" Wide x 30" Deep (0.60 x 0.76 m)

BSL-Style Data Slim Enclosure



#### Data Slim Enclosure

The Data Slim is a freestanding enclosure with a 24" (0.60 m) footprint. This makes the enclosure ideal for computer rooms where space is at a premium. The unit's mounting rails have 19" (0.48 m) EIA spacing to allow for cable management and different depths of equipment. Among the many features and benefits of this modular unit are:

- Reversible doors: Spring-loaded hinges allow quick change of door swing.
- Lift-off side panels: Flush surface lock fasteners permit quick disconnect and lift off.
- Cable gland plate: Adjustable bottom plate minimizes dirt and dust inside the enclosure.
- Cable access top: Features a 14.25" x 4" (0.36 x 0.10 m) cable access rubber gland which helps prevent dust from entering the enclosure.
- Rear cable plate: One, 3-7/8" x 8-1/2" (0.07 x 0.02 m) openings for cable access with a removable plate and edge grommet kit. Also features two 1.75" (0.04 m) capped openings.
- Tempered safety glass: Strengthens door and is easy-to-clean, non-scratching, tinted bronze color enhances overall appearance.
- Grounding kit Included.

#### Frames

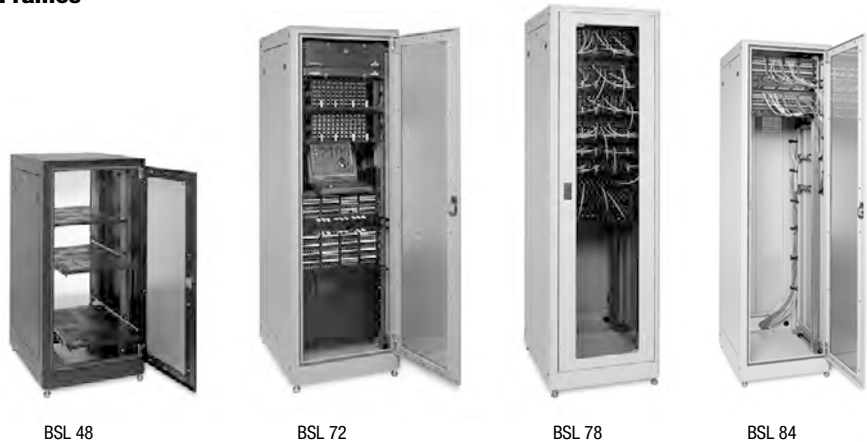

BSL 48

BSL 72

BSL 78

BSL 84

These products are in the process of being assessed for RoHS compliance. Please check our website for the most current RoHS status.



## Modular Enclosures

Data Slim Enclosure 24" Wide x 30" Deep (0.60 x 0.76 m)

(continued)

### Dimensions

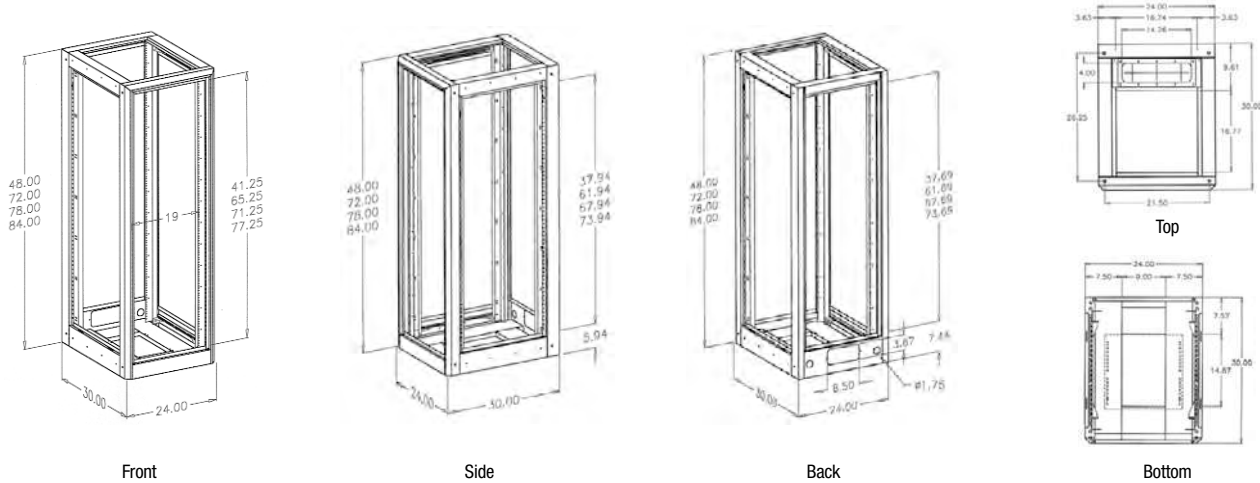

### Technical Specifications

Enclosure Size	Rack Spaces	Mounting	Weight		Heights		Width		Depth	
			lbs.	kg	inch	m	inch	m	inch	m
<b>BSL48</b> Frame, 2-pair 19" (0.48 m) mtg Rails*	25U	19" (0.48 m), 23" (0.58 m) or Frame Mount Shelf	230	105	48	1.21	29	0.73	30	0.76
<b>BSL72</b> Frame, 2-pair 19" (0.48 m) mtg Rails*	39U	19" (0.48 m), 23" (0.58 m) or Frame Mount Shelf	325	147	72	1.82	29	0.73	30	0.76
<b>BSL78</b> Frame, 2-pair 19" (0.48 m) mtg Rails*	42U	19" (0.48 m), 23" (0.58 m) or Frame Mount Shelf	350	158	78	1.98	29	0.73	30	0.76
<b>BSL84</b> Frame, 2-pair 19" (0.48 m) mtg Rails*	46U	19" (0.48 m), 23" (0.58 m) or Frame Mount Shelf	360	163	84	2.13	29	0.73	30	0.76

### How to order

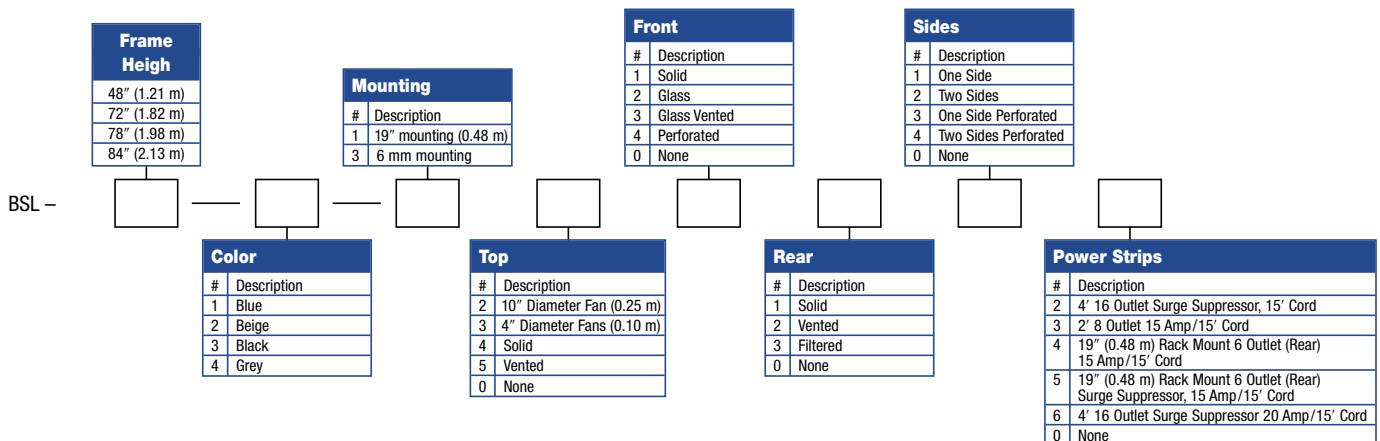

### For Example:

Description	Belden Part Number
Data Standard 84" (2.13 m) Black, 19" (0.48 m) Mounting, 10" (0.25 m) Fan Top, Glass Door, Vented Rear Door, Two Sides, 20 Amp Power Strip	<b>BSL84-3-122226</b>
Data Standard 84" (2.13 m) Black Frames w/19" (0.48 m) Mounting	<b>BSL84-3-100000</b>

\* = Casters & Levelers • EIA - 310 - D Compliant

These products are in the process of being assessed for RoHS compliance. Please check our website for the most current RoHS status.

## Modular Enclosures

Data Slim Enclosure 24" Wide x 30" Deep (0.60 x 0.76 m)

(continued)

Solid Front Door



Tempered Glass Front Door



Rear Doors: Solid, Vented, Filtered



Side Panels

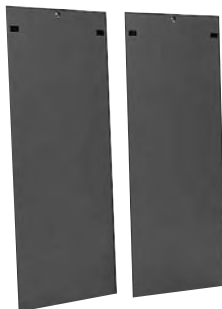

Removable Tops



Description	Belden Part Number
<b>Front Doors</b>	
<b>Solid Front Door</b>	
Solid Steel Front Door with Latch and Lock, 48" (1.21 m)	B4824-SF-C
Solid Steel Front Door with Latch and Lock, 72" (1.82 m)	B7224-SF-C
Solid Steel Front Door with Latch and Lock, 78" (1.98 m)	B7824-SF-C
Solid Steel Front Door with Latch and Lock, 84" (2.13 m)	B8424-SF-C
<b>Tempered Glass Front Door</b>	
Tempered Glass Front Door with Latch and Lock, 48" (1.21 m)	B4824-GF-C
Tempered Glass Front Door with Latch and Lock, 72" (1.82 m)	B7224-GF-C
Tempered Glass Front Door with Latch and Lock, 78" (1.98 m)	B7824-GF-C
Tempered Glass Front Door with Latch and Lock, 84" (2.13 m)	B8424-GF-C
<b>Glass Vented Front Door</b>	
Tempered Glass Front Vented Door with Latch and Lock, 48" (1.21 m)	B4824-VF-C
Tempered Glass Front Vented Door with Latch and Lock, 72" (1.82 m)	B7224-VF-C
Tempered Glass Front Vented Door with Latch and Lock, 78" (1.98 m)	B7824-VF-C
Tempered Glass Front Vented Door with Latch and Lock, 84" (2.13 m)	B8424-VF-C
<b>Perforated Front Door</b>	
Perforated Front Door with Latch and Lock, 48" (1.21 m)	B4824-PD-C
Perforated Front Door with Latch and Lock, 72" (1.82 m)	B7224-PD-C
Perforated Front Door with Latch and Lock, 78" (1.98 m)	B7824-PD-C
Perforated Front Door with Latch and Lock, 84" (2.13 m)	B8424-PD-C
<b>Rear Doors</b>	
<b>Solid Rear Door</b>	
Solid Steel Rear Door with Latch and Lock, 48" (1.21 m)	B4824-SR-C
Solid Steel Rear Door with Latch and Lock, 72" (1.82 m)	B7224-SR-C
Solid Steel Rear Door with Latch and Lock, 78" (1.98 m)	B7824-SR-C
Solid Steel Rear Door with Latch and Lock, 84" (2.13 m)	B8424-SR-C
<b>Vented Rear Door</b>	
Vented Steel Rear Door with Latch and Lock, 48" (1.21 m)	B4824-VR-C
Vented Steel Rear Door with Latch and Lock, 72" (1.82 m)	B7224-VR-C
Vented Steel Rear Door with Latch and Lock, 78" (1.98 m)	B7824-VR-C
Vented Steel Rear Door with Latch and Lock, 84" (2.13 m)	B8424-VR-C
<b>Filtered Rear Door</b>	
Filtered Rear Door with Latch and Lock, 48" (1.21 m)	B4824-FR-C
Filtered Rear Door with Latch and Lock, 72" (1.82 m)	B7224-FR-C
Filtered Rear Door with Latch and Lock, 78" (1.98 m)	B7824-FR-C
Filtered Rear Door with Latch and Lock, 84" (2.13 m)	B8424-FR-C
<b>Side Panels</b>	
<b>Single Side Panels</b>	
1-Solid Lift-off Side Panel with Lock, 48" (1.21 m)	B4801-SP-C
1-Solid Lift-off Side Panel with Lock, 72" (1.82 m)	B7201-SP-C
1-Solid Lift-off Side Panel with Lock, 78" (1.98 m)	B7801-SP-C
1-Solid Lift-off Side Panel with Lock, 84" (2.13 m)	B8401-SP-C
<b>Pair of Side Panels</b>	
2-Solid Lift-off Side Panels with Lock, 48" (1.21 m)	B4802-SP-C
2-Solid Lift-off Side Panels with Lock, 72" (1.82 m)	B7202-SP-C
2-Solid Lift-off Side Panels with Lock, 78" (1.98 m)	B7802-SP-C
2-Solid Lift-off Side Panels with Lock, 84" (2.13 m)	B8402-SP-C
<b>Removable Tops</b>	
Solid Top	B2418-TP-1-C
Vented Top	B2418-TP-2-C
Solid Top with 10" (0.25 m) Diameter Fan, 550 CFM	B2418-TP-3-C
Solid Top with (4) 4" (0.10 m) Diameter Fans, Four Fans = 320 CFM	B2418-TP-4-C

These products are in the process of being assessed for RoHS compliance. Please check our website for the most current RoHS status.

## Modular Enclosures

### Ultra Server Enclosure 24" Wide x 36" Deep (0.60 x 0.91 m)

BUS-Style Ultra Server Enclosure

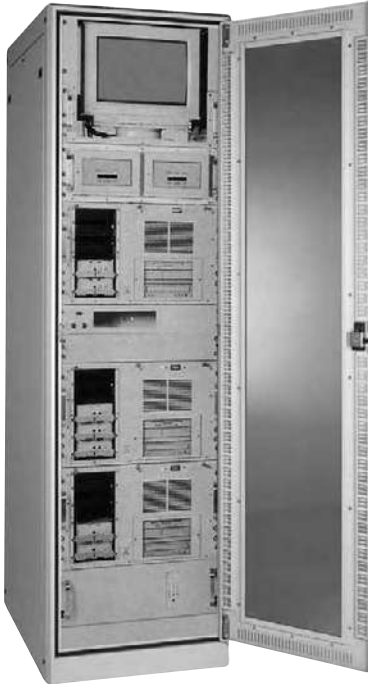

#### Ultra Server Enclosure

The Ultra Server is a freestanding enclosure with a 24" (0.58 m) wide x 36" (0.91 m) deep footprint. The enclosure features numerous top and bottom entry points for easy configuration to match your needs and an anti-tip device to prevent the enclosure from tipping when servers and shelves are extended. The unit's mounting rails have 19" (0.48 m) EIA spacing to allow for cable management and different depths of equipment. Among the many features and benefits of this modular unit are:

- Reversible doors: Spring-loaded hinges allow quick change of door swing.
- Lift-off side panels: Flush surface lock fasteners permit quick disconnect and lift off.
- Door and side panel security: Doors and side panels lock; handles are flush mounted.
- Cable access top: Features a 14.25" x 4" (0.36 x 0.10 m) cable access rubber gland which helps prevent dust from entering the enclosure.
- Tempered safety glass: Strengthens door and is easy-to-clean, non-scratching, tinted bronze color enhances overall appearance.
- Grounding kit Included.

#### Frames



BUS 78

BUS 84

These products are in the process of being assessed for RoHS compliance. Please check our website for the most current RoHS status.

### Modular Enclosures

Ultra Server Enclosure 24" Wide x 36" Deep (0.60 x 0.91 m)

(continued)

#### Dimensions

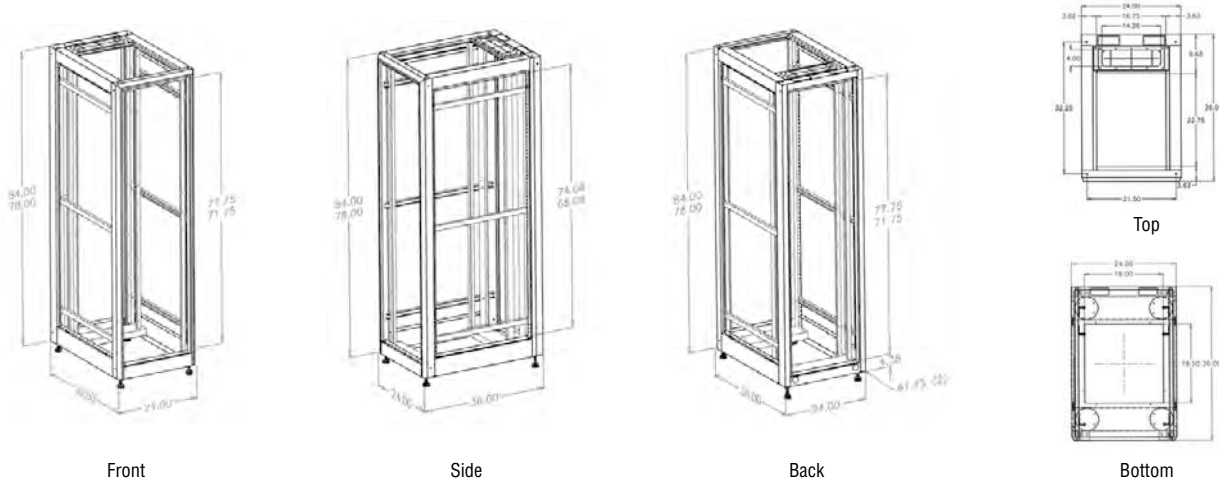

#### Technical Specifications

Enclosure Size	Rack Spaces	Mounting	Weight		Heights		Width		Depth	
			lbs.	kg	inch	m	inch	m	inch	m
<b>BUS78</b> Frame, 3-pair 19" (0.48 m) mtg Rails*	42U	19" (0.48 m)	350	158	78	1.98	24	0.60	36	0.91
<b>BUS84</b> Frame, 3-pair 19" (0.48 m) mtg Rails*	45U	19" (0.48 m)	370	167	84	2.13	24	0.60	36	0.91

#### How to order

BUS -

Frame High	Mounting	Color	Top	Front	Rear	Sides	Power Strips
78" (1.98 m) 84" (2.13 m)	# Description 1 19" (0.48 m) 6 mm - 3 pr.	# Description 2 Beige 3 Black	# Description 1 Perforated 2 10" Diameter Fan (0.25 m) 3 4" Diameter Fans (0.10 m) 4 Solid 0 None	# Description 1 Glass Vented Slam 2 Perforated Slam 3 Glass Vented Swing 4 Perforated Swing 5 Rigid Perf Swing 6 Split Perf Swing 0 None	# Description 1 Glass Vented Slam 2 Perforated Slam 3 Glass Vented Swing 4 Perforated Swing 5 Rigid Perf Swing 6 Split Perf Swing 0 None	# Description 1 One Side 2 Two Sides 3 One Side Perforated 4 Two Sides Perforated 0 None	# Description 2 4' 16 Outlet Surge Suppressor, 15' Cord 3 2' 8 Outlet 15 Amp/15' Cord 4 19" (0.48 m) Rack Mount 6 Outlet (Rear) 15 Amp/15' Cord 5 19" (0.48 m) Rack Mount 6 Outlet (Rear) Surge Suppressor, 15 Amp/15' Cord 6 4' 16 Outlet Surge Suppressor 20 Amp/15' Cord 0 None

#### For Example:

Description	Belden Part Number
Ultra Server 84" (2.13 m) Black, 19" (0.48 m) Mounting, 10" (0.25 m) Fan Top, Perforated Slam Front and Rear Door, 2 Sides, 20 Amp Power Strip	<b>BUS84-3-122226</b>
Ultra Server 84" (2.13 m) Black Frames w/19" (0.48 m) Mounting	<b>BUS84-3-100000</b>

\* = Casters & Levelers • EIA - 310 - D Compliant  
 These products are in the process of being assessed for RoHS compliance. Please check our website for the most current RoHS status.

## Modular Enclosures

Ultra Server Enclosure 24" Wide x 36" Deep (0.60 x 0.91 m)

(continued)

Tempered Glass Vented Doors



Perforated Doors



Side Panels

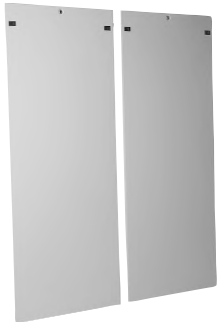

Description	Belden Part Number
<b>Front Door</b>	
<b>Tempered Glass Vented Doors</b>	
Tempered Glass Front/Rear Door with Latch and Lock, 78" (1.98 m)	<b>B7824-SVF-C</b>
Tempered Glass Front/Rear Door with Latch and Lock, 84" (2.13 m)	<b>B8424-SVF-C</b>
<b>Perforated Door</b>	
Perforated Front/Rear Door with Latch and Lock, 78" (1.98 m)	<b>B7824-SPR-C</b>
Perforated Front/Rear Door with Latch and Lock, 84" (2.13 m)	<b>B8424-SPR-C</b>
<b>Side Panels</b>	
<b>Single Side Panel</b>	
1-Solid Lift-off Side Panel with Lock, 78" (1.98 m)	<b>B7836-01-SP-C</b>
1-Solid Lift-off Side Panel with Lock, 84" (2.13 m)	<b>B8436-01-SP-C</b>
<b>Pair of Side Panels</b>	
2-Solid Lift-off Side Panels with Lock, 78" (1.98 m)	<b>B7836-02-SP-C</b>
2-Solid Lift-off Side Panels with Lock, 84" (2.13 m)	<b>B8436-02-SP-C</b>
<b>Removable Tops/Cooling Devices</b>	
Solid Top	<b>B2430-TP-1-C</b>
Solid Top with 10" (0.25 m) Diameter Fan, 550 CFM	<b>B2430-TP-3-C</b>
Solid Top with (4) 4" (0.10 m) Diameter Fans, Four Fans = 320 CFM	<b>B2430-TP-4-C</b>
Perforated Top	<b>B2430-TP-6-C</b>
19" (0.48 m) Fan Tray	<b>B9315-7200</b>

These products are in the process of being assessed for RoHS compliance. Please check our website for the most current RoHS status.

Solid Removable Top w/10" Fan  
(0.25 m)



Solid Removable Top w/(4) 4" Fans  
(0.10 m)



19" Fan Tray  
(0.48 m)



## Modular Enclosures

### Ultra Deep Server Enclosure 24" Wide x 42" Deep (0.60 x 1.06 m)

BUSD-Style Ultra Deep Server Enclosure



#### Ultra Deep Server Enclosure

The Ultra Deep Server is a freestanding enclosure with a 24" (0.60 m) wide x 42" (1.06 m) deep footprint. The enclosure features numerous top and bottom entry points for easy configuration to match your needs and an anti-tip device to prevent the enclosure from tipping when servers and shelves are extended. Among the many features and benefits of this modular unit are:

- Reversible doors: Spring-loaded hinges allow quick change of door swing.
- Split rear doors: French-style perforated rear doors maximize space between enclosures.
- Lift-off side panels: Flush surface lock fasteners permit quick disconnect and lift off.
- Door and side panel security: Doors and side panels lock; handles are flush mounted.
- Cable access top: Features a 14.25" x 4" (0.36 x 0.10 m) cable access rubber gland which helps prevent dust from entering the enclosure.
- Tempered safety glass: Strengthens door and is easy-to-clean, non-scratching, tinted bronze color enhances overall appearance.
- Grounding kit Included.

#### Frames



BUSD 84

These products are in the process of being assessed for RoHS compliance. Please check our website for the most current RoHS status.

## Modular Enclosures

Ultra Deep Server Enclosure 24" Wide x 42" Deep (0.60 x 1.06 m)

(continued)

### Dimensions

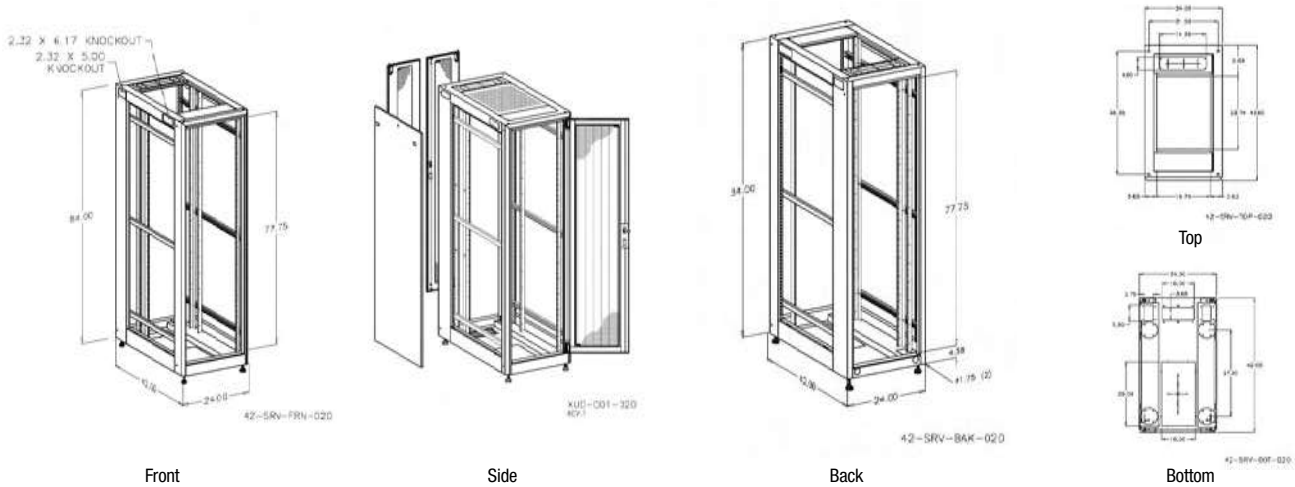

### Technical Specifications

Enclosure Size	Rack Spaces	Mounting	Weight		Heights		Width		Depth	
			lbs.	kg	inch	m	inch	m	inch	m
<b>BUSD84</b> Frame, 3-pair 19" (0.48 m) mtg Rails*	45U	19" (0.48 m)	400	181	84	2.13	24	0.60	42	1.06

### How to order

Ordering structure diagram showing options for Frame Height, Mounting, Color, Top, Front, Rear, Sides, and Power Strips.

**Frame Height**

#	Description
84	84" (2.13 m)

**Mounting**

#	Description
1	19" (0.48 m) 6 mm - 3 pr.

**Color**

#	Description
2	Beige
3	Black

**Top**

#	Description
1	Perforated
2	10" Diameter Fan (0.25 m)
3	4" Diameter Fans (0.10 m)
4	Solid
0	None

**Front**

#	Description
1	Glass Vented Swing
2	Rigid Perf Swing
3	Split Perf Swing
4	Glass Vented Slam
5	Perforated Slam
0	None

**Rear**

#	Description
1	Rigid Perf Swing
2	Split Perf Swing
3	Perforated Swing
4	Glass Vented Swing
5	Glass Vented Slam
6	Perforated Slam
0	None

**Sides**

#	Description
1	One Side Solid
2	Two Sides Solid
3	One Side Perforated
4	Two Sides Perforated
0	None

**Power Strips**

#	Description
2	4' 16 Outlet Surge Suppressor, 15' Cord
3	2' 8 Outlet 15 Amp/15' Cord
4	19" (0.48 m) Rack Mount 6 Outlet (Rear) 15 Amp/15' Cord
5	19" (0.48 m) Rack Mount 6 Outlet (Rear) Surge Suppressor, 15 Amp/15' Cord
6	4' 16 Outlet Surge Suppressor 20 Amp/15' Cord

### For Example:

Description	Belden Part Number
Ultra Deep 84" (2.13 m) Black, 19" (0.48 m) Mounting, 10" (0.25 m) Fan Top, Front Rigid Perforated Door, Rear Split Perforated Door, Two Sides, 20 Amp Power Strip	<b>BUSD84-3-122226</b>
Ultra Server 84" (2.13 m) Black Frames with 19" (0.48 m) Mounting	<b>BUSD84-3-100000</b>

\* = Casters & Levelers • EIA - 310 - D Compliant

These products are in the process of being assessed for RoHS compliance. Please check our website for the most current RoHS status.

## Modular Enclosures

Ultra Deep Server Enclosure 24" Wide x 42" Deep (0.60 x 1.06 m)

(continued)

Tempered Glass Vented Doors



Perforated Doors



Side Panels

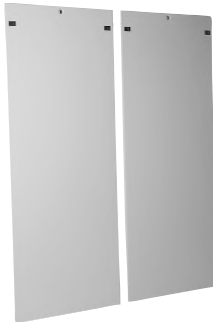

Description	Belden Part Number
<b>Front Door</b>	
<b>Tempered Glass Front Door</b>	
Tempered Glass Front (Vented) Door with Swing Handle, Latch and Lock	<b>B8424-DSVF-C</b>
<b>Rigid Perforated Front Door</b>	
Rigid Perforated Front Door with Swing Handle, Latch and Lock	<b>B8424-DSPR-C</b>
<b>Rear Door</b>	
<b>Perforated Rear Door</b>	
Split Door with Swing Handle, Latch and Lock	<b>B8424-DSSR-C</b>
Rigid Door with Swing Handle, Latch and Lock	<b>B8424-DSPR-C</b>
Door with Swing Handle, Latch and Lock	<b>B8424-DSVR-C</b>
<b>Side Panels</b>	
<b>Single Side Panel</b>	
1-Solid Lift-off Side Panel with Lock	<b>B8436-01-SP-C</b>
1-Perforated Lift-off Side Panel with Lock	<b>B8436-01-SPP-C</b>
<b>Pair of Side Panels</b>	
2-Solid Lift-off Side Panels with Lock	<b>B8436-02-SP-C</b>
2-Perforated Lift-off Side Panels with Lock	<b>B8436-02-SPP-C</b>
<b>Removable Tops/Cooling Devices</b>	
Solid Top	<b>B2430-TP-1-C</b>
Solid Top with 10" (0.25 m) Diameter Fan, 550 CFM	<b>B2430-TP-3-C</b>
Solid Top with (4) 4" (0.10 m) Diameter Fans, Four Fans = 320 CFM	<b>B2430-TP-4-C</b>
Perforated Top	<b>B2430-TP-6-C</b>
19" (0.48 m) Fan Tray	<b>B9315-7200</b>
<b>Cable Management Troughs</b>	
76.5" (1.93 m) Steel Vertical Cable Trough	<b>B433-5114</b>
Steel Front Horizontal Cable Trough	<b>B433-5115-F</b>
Steel Rear Horizontal Cable Trough	<b>B433-5115-R</b>
Steel Side Horizontal Cable Trough	<b>B433-5118</b>

These products are in the process of being assessed for RoHS compliance. Please check our website for the most current RoHS status.

Solid Removable Top w/10" Fan  
(0.25 m)



Solid Removable Top w/(4) 4" Fans  
(0.10 m)



19" Fan Tray  
(0.48 m)





## Modular Enclosures

### Giga Server Enclosure 26" Wide x 42" Deep (0.66 x 1.06 m)

BGS-Style Giga Server Enclosure



#### Giga Server Enclosure

The Giga Server is a freestanding enclosure with a 26" (0.66 m) wide x 42" (1.06 m) deep footprint. Each of the four corners of the enclosure has a built-in vertical cable channel. The unit's mounting rails have 19" (0.48 m) EIA spacing to allow for cable management and different depths of equipment. Hinged cable access panels allow for large bundles of cable to be quickly routed from enclosure to enclosure or from the front of the enclosure to the rear of the enclosure. Among the many features and benefits of this modular unit are:

- Reversible door: Spring-loaded hinges allow quick change of door swing.
- Split rear doors: French-style perforated rear doors maximize space between enclosures.
- Lift-off side panels: Flush surface lock fasteners permit quick disconnect lift off.
- Door and side panel security: Doors and side panels lock; handles are flush mounted.
- Integrated cable management.
- Grounding kit included.

#### Frames



BGS 84

These products are in the process of being assessed for RoHS compliance. Please check our website for the most current RoHS status.

### Modular Enclosures

Giga Server Enclosure 26" Wide x 42" Deep (0.66 x 1.06 m)

(continued)

#### Dimensions

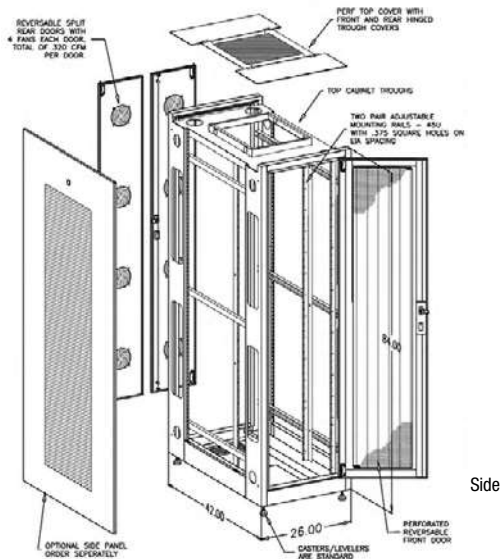

#### Technical Specifications

Enclosure Size	Rack Spaces	Mounting	Weight		Heights		Width		Depth	
			lbs.	kg	inch	m	inch	m	inch	m
BGS84 84" Frame, 3-pr. 19" (0.48 m) mtg Rails*	45U	19" (0.48 m)	400	181	84	2.13	26	0.66	42	1.06

#### How to order

BGS -

<b>Frame Height</b>	<b>Mounting</b>	<b>Front</b>	<b>Sides</b>
# Description	# Description	# Description	# Description
84" (2.13 m)	1 19" (0.48 m) 6 mm - 3 pr.	1 Rigid Perforated	1 One Side Solid
<b>3</b>	<b>1</b>	0 None	2 Two Sides Solid
<b>Color</b>	<b>Top</b>	<b>Rear</b>	3 One Side Perforated
# Description	# Description	# Description	4 Two Sides Perforated
3 Black	1 Perforated	0 None	0 None
	0 None		<b>Power Strips</b>
			# Description
			2 4' 16 Outlet Surge Suppressor, 15' Cord
			3 2' 8 Outlet 15 Amp/15' Cord
			4 19" (0.48 m) Rack Mount 6 Outlet (Rear) 15 Amp/15' Cord
			5 19" (0.48 m) Rack Mount 6 Outlet (Rear) Surge Suppressor, 15 Amp/15' Cord
			6 4' 16 Outlet Surge Suppressor 20 Amp/15' Cord
			0 None

#### For Example:

Description	Belden Part Number
Giga Server 84" (2.13 m) Black, 3-pair 19" (0.48 m) Mounting, Perforated Top, Rigid Perforated Front, Split Fan Doors, Two Perforated Sides, 20 Amp Power Strip	BGS84-3-122226
Giga Server 84" (2.13 m) Black, with 3-pair 19" (0.48 m) Mounting	BGS84-3-10000

\* = Casters & Levelers • EIA - 310 - D Compliant  
 These products are in the process of being assessed for RoHS compliance. Please check our website for the most current RoHS status.

## Modular Enclosure Options and Accessories

### Enclosure Shelves

B9010-1924

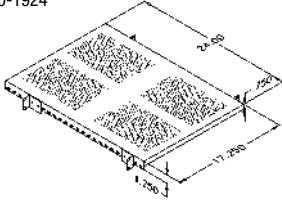

B9011-1918

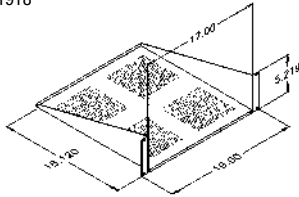

B9011-1918-16

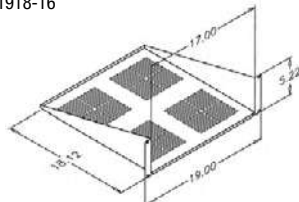

B9010-1930

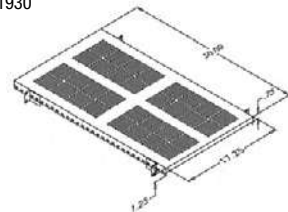

B9012-1918-16

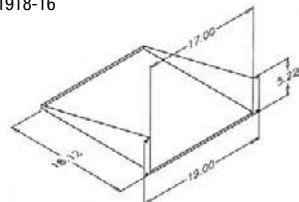

B9013-1936

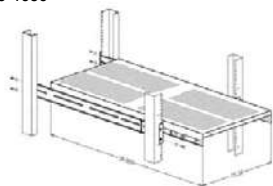

B9012-1918

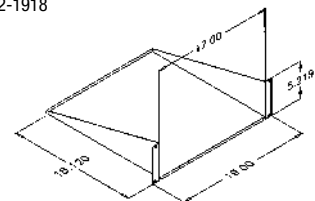

### Enclosure Shelves

Modular Enclosure Shelves are available in widths of 19" (0.48 m) and 23" (0.58 m) with mounting depths of 24" (0.60 m), 30" (0.76 m) and 36" (0.91 m). Load ratings range from 70 lbs. (31 kg) up to 200 lbs. (90 kg). All shelves are black in color unless otherwise noted below.

Description	Belden Part Number
<b>19" (0.48 m) Shelves</b>	
<b>19" (0.48 m) Heavy-Duty Adjustable Shelf (Vented)</b>	
4 Point Mounting, 24" (0.60 m) Depth, 150 lbs. (68 kg) Load Rating	<b>B9010-1924</b>
4 Point Mounting, 30" (0.76 m) Depth, 150 lbs. (68 kg) Load Rating	<b>B9010-1930</b>
4 Point Mounting, 36" (0.91 m) Depth, 150 lbs. (68 kg) Load Rating	<b>B9010-1936</b>
<b>19" (0.48 m) Flush Mount Cantilevered Shelf (Vented)</b>	
12" (0.30 m) Depth, Fits 24" (0.60 m) Wall Mount, 70 lbs. (31 kg) Load Rating	<b>B9011-1912</b>
18" (0.45 m) Depth, 75 lbs. (34 kg) Load Rating	<b>B9011-1918</b>
18" (0.45 m) Depth, 50 lbs. (22 kg) Load Rating	<b>B9011-1918-16</b>
<b>19" (0.48 m) Flush Mount Cantilevered Shelf (Solid)</b>	
18" (0.45 m) Depth, 75 lbs. (34 kg) Load Rating	<b>B9012-1918</b>
18" (0.45 m) Depth, 50 lbs. (22 kg) Load Rating	<b>B9012-1918-16</b>
<b>19" (0.48 m) Heavy Duty Sliding Adjustable Shelf (Vented)</b>	
4 Point Mounting, 24" (0.60 m) Depth, 200 lbs. (90 kg) Load Rating	<b>B9015-1924</b>
4 Point Mounting, 30" (0.76 m) Depth, 100 lbs. (45 kg) Load Rating	<b>B9013-1930</b>
4 Point Mounting, 36" (0.91 m) Depth, 100 lbs. (45 kg) Load Rating	<b>B9013-1936</b>
19" (0.48 m) Keyboard Shelf (Fixed Front of Mounting Rail with Mouse Pad)	<b>B9014-1907</b>
19" (0.48 m) Drawer, Monitor and Keyboard Shelf	<b>B9015-1902</b>
19" (0.48 m) Sliding Rotating Keyboard Shelf	<b>B9015-1909</b>
<b>19" (0.48 m) Center Mount Shelf Kit (2-shelves)</b>	
21" (0.53 m) Depth, Aluminum, 100 lbs. (45 kg) Load Rating	<b>B9016-1921</b>
21" (0.53 m) Depth, Black, 100 lbs. (45 kg) Load Rating	<b>B9016-1921-3</b>
19" (0.48 m) Drawer, Utility, 4U, 16" (0.40 m) Depth	<b>B9017-0200</b>
Pivot Cable Retractor	<b>B9309-0100</b>
<b>19" (0.48 m) Quick Disconnect Shelf</b>	
6 mm Mounting Rails, 24" (0.60 m) Depth, 200 lbs. (90 kg) Load Rating	<b>B9010-1924-Q</b>
6 mm Mounting Rails, 30" (0.76 m) Depth, 200 lbs. (90 kg) Load Rating	<b>B9010-1930-Q</b>

These products are in the process of being assessed for RoHS compliance. Please check our website for the most current RoHS status.

B9016-1921

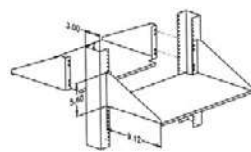

B9014-1907

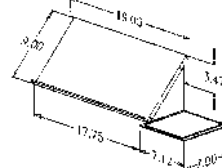

B9015-1909

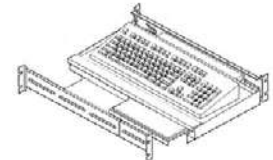

B9010-1930-Q

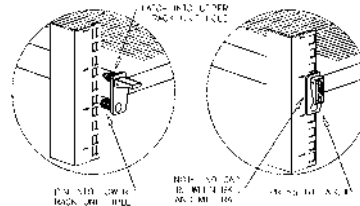
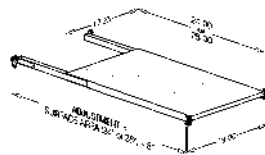

## Modular Enclosure Options and Accessories

### Enclosure Shelves (continued)

B9114-2307

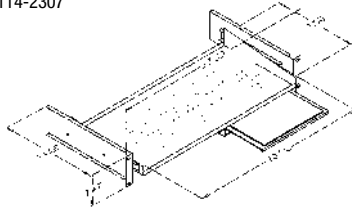

B9110-2324

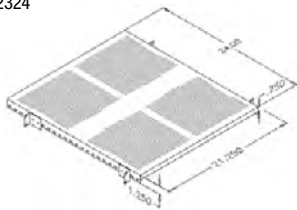

B9112-2318

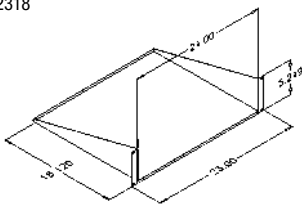

B9111-2318

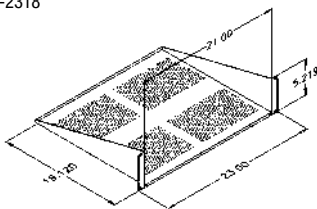

B9113-2324

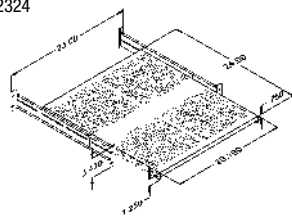

B9210-2923

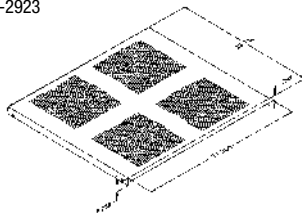

Description	Belden Part Number
<b>23" (0.58 m) Shelves</b>	
<b>23" (0.58 m) Heavy Duty Adjustable Shelf (Vented)</b>	
4 Point Mounting, 180 lbs. (81 kg) Load Rating	<b>B9110-2324</b>
<b>23" (0.58 m) Flush Mount Cantilevered Shelf (Vented)</b>	
70 lbs. (31 kg) Load Rating	<b>B9111-2318</b>
<b>23" (0.58 m) Flush Mount Cantilevered Shelf (Solid)</b>	
70 lbs. (31 kg) Load Rating	<b>B9112-2318</b>
<b>23" (0.58 m) Heavy Duty Sliding Adjustable Shelf (Vented)</b>	
4 Point Mounting, 85 lbs. (38 kg) Load Rating	<b>B9113-2324</b>
23" (0.58 m) Sliding Keyboard Shelf with Mouse Pad	<b>B9114-2307</b>

#### Frame Shelves

<b>27.5" (0.69 m) Wide Side Mount Shelf (Vented)</b>	
23.75" (0.60 m) Depth, 180 lbs. (81 kg) Load Rating	<b>B9210-2923</b>
23.75" (0.60 m) Depth, 90 lbs. (40 kg) Load Rating	<b>B9211-2917</b>
<b>17" (0.43 m) Wide Bottom Mount Sliding Server Shelf (Vented)</b>	
22" (0.55 m) Depth, 100 lbs. (45 kg) Load Rating	<b>B9212-2922</b>

These products are in the process of being assessed for RoHS compliance. Please check our website for the most current RoHS status.

B9212-2922

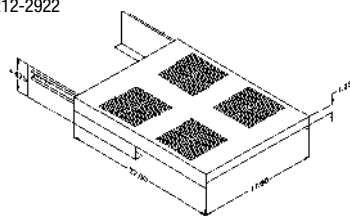

B9211-2917

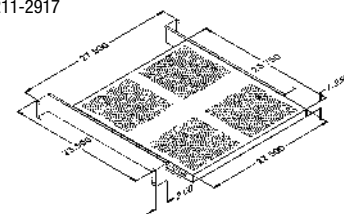

## Modular Enclosure Options and Accessories

### Anti-Tip, Grounding Bars, Mounting Hardware

BUS-ATD-0010



#### Enclosure Anti-Tip Device

The data standard, data slim, data deep and ultra deep server modular enclosures are configured with an anti-tip device which protects the enclosure from tipping when servers and shelves are extended.

Description	Belden Part Number
Anti-Tip Device for Ultra Deep Server	<b>BUS-ATD-0010-C</b>
Anti-Tip Device for Data Standard	<b>BST-ATD-0030-3</b>
Anti-Tip Device for Data Deep	<b>BDP-ATD-0200-3</b>
Anti-Tip Device for Data Slim	<b>BSL/BST-ATD-0300-3</b>

#### Grounding Bars

Copper grounding bars are available for mounting on any of the enclosure types. Grounding bars are available for vertical or horizontal mounting.

Description	Belden Part Number
70" (1.77 m) Vertical Isolated Copper Ground Bar, Tapped 10-32	<b>B9714-0720</b>
10" (0.25 m) Horizontal Isolated Copper Ground Bar, Tapped 10-32	<b>B9714-0190</b>

B9714-0720



#### Enclosure Mounting Hardware

The enclosure mounting hardware line includes a variety of bolts, screws and nuts for securing the enclosure.

Description	Belden Part Number
4, 5/16-18 Hex Head Bolt; 4, 5/16-18 Hex Nut; 8-5/16 Flat Washer	<b>B8910-0100</b>
10-32 Mounting Screws, Package of 50	<b>B8911-0100</b>
M6 Mounting Cagenut, Package of 50	<b>B8913-0100</b>
M6 Mounting Screw, Package of 50	<b>B8914-0100</b>
10-32 Mounting Hardware, 10-32 Floating Cagenut, Package of 50	<b>B8915-0100</b>

B9714-0190

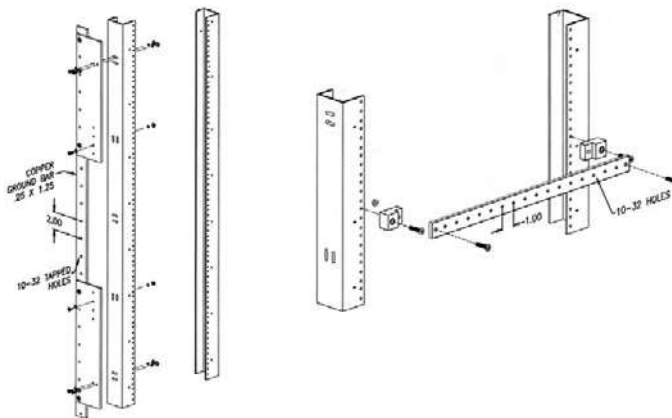

B8913-0100



These products are in the process of being assessed for RoHS compliance. Please check our website for the most current RoHS status.

## Modular Enclosure Options and Accessories

### Mounting Rails

Mounting Rails Demonstrated in Enclosure



BRL-3024-0100



BRL-3012-0200



BRL-3006-0300



#### Enclosure Mounting Rails

The enclosure mounting rail line includes 19" (0.48 m) and 23" (0.58 m) rails which are fully adjustable to accommodate different mounting depths.

Description	Belden Part Number
-------------	--------------------

#### Data Standard

Adjustable Mounting Rails 19" or 23" (0.48 m or 0.58 m)	
Tapped 10-32, 48" (1.21 m)	BST4819-23
Tapped 10-32, 72" (1.82 m)	BST7219-23
Tapped 10-32, 78" (1.98 m)	BST7819-23
Tapped 10-32, 84" (2.13 m)	BST8419-23
6 mm with Hardware, 84" (2.13 m)	BST8419-23SQ

#### Data Slim

Adjustable Mounting Rails 19" or 23" (0.48 m or 0.58 m)	
Tapped 10-32, 72" (1.82 m)	BSL7219
6 mm with Hardware, 72" (1.82 m)	BSL7219SQ-2
Tapped 10-32, 78" (1.98 m)	BSL7819
Tapped 10-32, 84" (2.13 m)	BSL8419

#### Data Deep

Adjustable Mounting Rails 19" or 23" (0.48 m or 0.58 m)	
Tapped 10-32, 72" (1.82 m)	BDP7219-23
6 mm with Hardware, 72" (1.82 m)	BDP7219-23SQ
Tapped 10-32, 78" (1.98 m)	BDP7819-23
Tapped 10-32, 84" (2.13 m)	BDP8419-23

#### Enclosure Partial Rail Kits

The enclosure partial rail kit line includes 6U, 12U and 24U rails for increased mounting flexibility.

Description	Belden Part Number
19" (0.48 m) Partial Rail Kit (6U)	BRL-3006-0300
19" (0.48 m) Partial Rail Kit (12U)	BRL-3012-0200
19" (0.48 m) Partial Rail Kit (24U)	BRL-3024-0100

These products are in the process of being assessed for RoHS compliance. Please check our website for the most current RoHS status.

# Modular Enclosure Options and Accessories

## Cable Management and Light Kits

B9713-0200

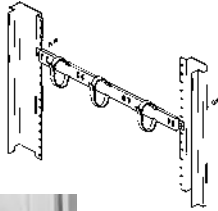

Horizontal: B9713-0200  
Vertical: B9712-0100

B9713-0201



B9713-0202

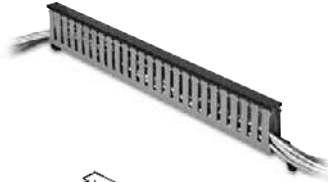

B9712-0100

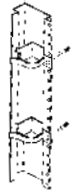

B9712-0101

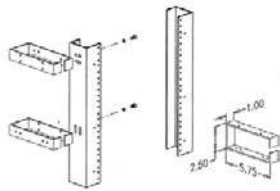

B9712-0103

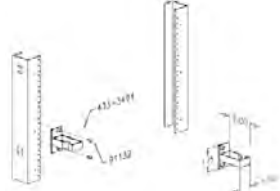

B9712-0102

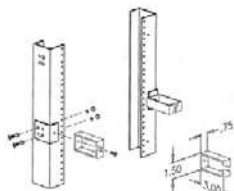

### Front to Rear Cable Management

Front to rear cable management makes routing of cable neat, keeps them secure and manages bend radius.

Description	Belden Part Number
<b>Front to Rear Cable Management</b>	
w/3 Velcro Straps	<b>B9713-0200</b>
for 30" & 34" (0.76 & 0.86 m) deep Enclosure 1" x 3" (0.025 x 0.076 m) Finger Stock	<b>B9713-0201</b>
for 36" deep Enclosure 1" x 3" (0.025 x 0.076 m) Finger Stock	<b>B9713-0202</b>
<b>Vertical Cable Management</b>	
Corner Mount Vertical Cable Management Ring 3" x 3" (0.076 x 0.076 m) w/Velcro Strap	<b>B9712-0100</b>
Side Mount Cable Management 2.5" x 5.75" (0.063 x 0.074 m)	<b>B9712-0101</b>
Front Mount Cable Management 1.5" x 3" (0.038 x 0.076 m)	<b>B9712-0102</b>
1U Cable Manager 1" wide x 2" deep (0.025 x 0.050 m)	<b>B9712-0103</b>
Mounting Rail Single M-Clip (XUSD)	<b>B9712-0106</b>
Mounting Rail Dual M-Clip (XUSD)	<b>B9712-0107</b>
Mounting Rail 84" (2.13 m) Lacing Panel Black (Data Standard, Data Slim, Data Deep)	<b>B9712-0108</b>
78" (1.98 m) Lacing Panel Black (Data Standard, Data Slim, Data Deep)	<b>B9712-0109</b>
78" (1.98 m) Lacing Panel Black (Ultra Server, Ultra Deep Server)	<b>B9712-0109S</b>
<b>Light Kits</b>	
With Dual adjustable 5 Watt Halogen Lights & Dimmer, UL-Listed	<b>B9420-1905</b>
With Single adjustable 5 Watt Halogen Light & Dimmer, UL-Listed	<b>B9420-1906</b>

B9712-0106



B9420-1905



B9712-0108,  
B9712-0109

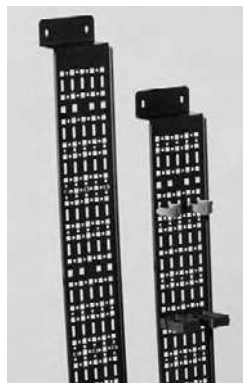

B9420-1906



B9712-0107



These products are in the process of being assessed for RoHS compliance. Please check our website for the most current RoHS status.

## Modular Enclosure Options and Accessories

### Enclosure Power Strips

#### Power Strips

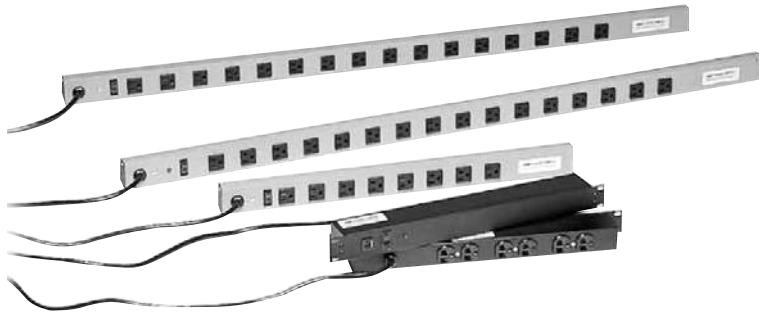
5-15P  
3 ProngL5-15P  
Locking

5-20P

L5-20P  
Locking

#### Technical Specifications

Part Number	Number of Outlets	Amps	Plug Type	Protection		Switch	Outlet Spacing (inch)	Volts	Receptacle Type	Cord Length	
				Surge	Circuit					ft.	m
<b>B9411-1602</b>	16	15	5-15P 3 Prong	Yes	Yes	Yes	2.500	120	5-15R	15	4.6
<b>B9412-0801</b>	8	15	5-15P 3 Prong	No	Yes	Yes	2.000	125	5-15R	15	4.6
<b>B9413-0601</b>	6	15	5-15P 3 Prong	No	Yes	Yes	1.500	125	5-15R	15	4.6
<b>B9414-0602</b>	6	15	5-15P 3 Prong	Yes	Yes	Yes	1.500	125	5-15R	15	4.6
<b>B9415-1601</b>	10	20	L5-20P Locking	No	Yes	Yes	4.300	120	5-15R	15	4.6
<b>B9415-1602</b>	16	20	L5-20P Locking	No	Yes	Yes	2.500	120	5-15R	15	4.6
<b>B9415-1603</b>	16	20	5-20P	No	Yes	Yes	2.430	120	5-15R	15	4.6
<b>B9415-1606</b>	6	20	L5-20P Locking	No	Yes	Yes	2.650	120	5-15R	15	4.6
<b>B9415-1607</b>	10	15	L5-15P Locking	No	Yes	Yes	4.250	120	5-15R	15	4.6
<b>B9415-1608</b>	16	20	L5-20P Locking	No	No	No	2.735	120	5-15R	15	4.6
<b>B9415-1610</b>	16	20	5-20P 3 Prong	Yes	Yes	No	2.250	125	5-20R	15	4.6
<b>B9416-1001</b>	10	20	L5-20P Locking	No	Yes	Yes	–	120	5-15R	15	4.6

Description	Belden Part Number
4' (1.2 m) 16 Outlet Strip Surge Suppressor, 15' (4.6 m) Power Cord, UL-Listed	<b>B9411-1602</b>
2' (0.6 m) 8 Outlet Strip, 15 Amp/15' (4.6 m) Power Cord, UL-Listed	<b>B9412-0801</b>
19" (0.48 m) Rack Mount 6 Outlet Strip (Rear), 15 Amp/15' (4.6 m) Power Cord, UL-Listed	<b>B9413-0601</b>
19" (0.48 m) Rack Mount 6 Outlet Strip (Rear) Surge, 15 Amp/15' (4.6 m) Power Cord, UL-Listed	<b>B9414-0602</b>
4' (1.2 m) 10 Outlet Strip, 20 Amp/15' (4.6 m) Power Cord w/Twist Lock Plug, UL-Listed	<b>B9415-1601</b>
4' (1.2 m) 16 Outlet Strip, 20 Amp/15' (4.6 m) Power Cord w/Twist Lock Plug, UL-Listed	<b>B9415-1602</b>
4' (1.2 m) 16 Outlet Strip, 20 Amp/15' (4.6 m) Power Cord, UL-Listed	<b>B9415-1603</b>
6 Outlet Strip, 20 Amp/15' (4.6 m) Power Cord w/Twist Lock Plug, UL-Listed	<b>B9415-1606</b>
10 Outlet Strip, 15 Amp/15' (4.6 m) Power Cord w/Twist Lock Plug, UL-Listed	<b>B9415-1607</b>
4' (1.2 m) 16 Outlet Strip, 20 Amp/15' (4.6 m) Power Cord	<b>B9415-1608</b>
4' (1.2 m) 16 Outlet Strip, 20 Amp Receptacle, Surge, CB, No Switch, 15' (4.6 m) Cord, UL-Listed	<b>B9415-1610</b>
19" (0.48 m) Rack Mount 6 Outlet Front, 4 Outlet Rear, 20 Amp/15' (4.6 m) Cord, w/Twist Lock Plug	<b>B9416-1001</b>

These products are in the process of being assessed for RoHS compliance. Please check our website for the most current RoHS status.



## Modular Enclosure Options and Accessories

### Mission Critical Power Accessories

Mission Critical Power Accessory

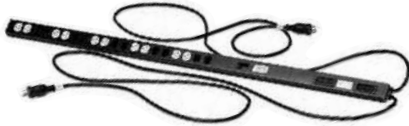

#### Mission Critical Power Accessories

Slim-Line™ low-profile, power distribution, designed for high-density, mission critical server applications, the SL series provides maximum power in a low profile chassis. Employing multiple configurations, the Easy-Read™ digital ammeter and clearly labeled circuits, SL series assures easy management and monitoring for current requirements and future expansions.

- Datacenter grade receptacles
- 1.25" (0.03 m) low profile
- Easy-Read™ digital ammeter

Dual-circuit, vertical power distribution, designed for high-density, mission critical server applications, the DBVD series provides dual-source in one vertical, power distribution unit. Employing multiple configurations, the Easy-Read™ digital ammeter and clearly labeled circuits, DBVD assures easy management and monitoring for current requirements and future expansions.

- High-density, dual source
- Side-by-side outlet configuration
- Easy-Read™ digital ammeter
- Clearly labeled circuits

#### Technical Specifications

Part Number	Circuit Type	Volts	Amps	Unit Length		Plug Type	Cord Length		Outlet Type	Qty.	Power (Watts)	Est. Server Qty.			Ammeter
				inch	m		ft.	m				300W	400W	500W	
<b>B9418-0801</b>	Single	120	20	24	0.60	Straight	15	4.6	5-15/20	8	1920	10	8	6	Yes
<b>B9418-0802</b>	Single	120	20	24	0.60	L5-20	15	4.6	5-15/20	8	1920	10	8	6	Yes
<b>B9418-1201</b>	Single	120	20	60	1.52	L5-20	15	4.6	5-15/20	12	1920	10	8	6	Yes
<b>B9418-2401</b>	Single	120	30	60	1.52	L5-30	15	4.6	5-15/20	24	2880	15	12	9	No
<b>B9418-2402</b>	Dual	120	2 x 20	60	1.52	2 x L5-20	15	4.6	5-15/20	2 x 12	2 x 1920	10	8	6	No
<b>B9418-2403</b>	Dual	120	2 x 20	60	1.52	L5-20	15	4.6	5-15/20	2 x 12	2 x 1920	10	8	6	Yes
<b>B9418-2410</b>	Single	120	30	60	1.52	L5-30	15	4.6	5-15/20	24	2880	15	12	9	Yes
<b>B9418-4801</b>	Dual	208	2 x 30	68	1.72	2 x L6-30	10	3.1	C-13	2 x 24	2 x 4992	24	21	17	Yes
<b>B9418-7201</b>	Dual	208 3-phase	2 x 20	68	1.72	2 x L21-20	10	3.1	C-12	2 x 36	2 x 5757	32	24	19	Yes

Description	Belden Part Number
24" (0.60 m) 8 Outlet 20 Amp Circuit, 120 Volt, Straight Plug, 15' (4.6 m) Power Cord, with Ammeter, UL-Listed	<b>B9418-0801</b>
24" (0.60 m) 8 Outlet 20 Amp Circuit, 120 Volt, L-5 20 Plug, 15' (4.6 m) Power Cord, with Ammeter, UL-Listed	<b>B9418-0802</b>
60" (1.52 m) 12 Outlet 20 Amp 120 Volt, L-5 20 Plug, 15' (4.6 m) Power Cord with Ammeter, UL-Listed	<b>B9418-1201</b>
60" (1.52 m) 24 Outlet 30 Amp 120 Volt, L-5 30 Plug, 15' (4.6 m) Power Cord, UL-Listed	<b>B9418-2401</b>
60" (1.52 m) Dual 12 Outlet, Dual 20 Amp Circuit, 120 Volt, Dual L-5 20 Plug, 15' (4.6 m) Power Cord, UL-Listed	<b>B9418-2402</b>
60" (1.52 m) Dual 12 Outlet, Dual 20 Amp Circuit, 120 Volt, Single L-5 20 Plug, 15' (4.6 m) Power Cord, with Ammeter, UL-Listed	<b>B9418-2403</b>
60" (1.52 m) 24 Outlet 30 Amp 120 Volt, L-5 30 Plug, 15' (4.6 m) Power Cord, with Ammeter, UL-Listed	<b>B9418-2410</b>
68" (1.72 m) Dual 24 Outlet, Dual 30 Amp Circuit, Dual L-6 30 Plug, C-13 Outlets, 10' (3.1 m) Power Cord, with Ammeter, UL-Listed	<b>B9418-4801</b>
68" (1.72 m) Dual 36 Outlet, Dual 20 Amp Circuit, Dual L-21 20 Plug, C-12 Outlets, 10' (3.1 m) Power Cord, with Ammeter, UL-Listed	<b>B9418-7201</b>

These products are in the process of being assessed for RoHS compliance. Please check our website for the most current RoHS status.

## Modular Enclosure Options and Accessories

### Climate Monitors and Controllers

B9318-0400



#### Climate Monitor

Designed specifically for internal computer cabinet installation, this low-cost self-contained unit continually monitors climate via an internally-generated web page or SNMP. Values are graphed to see trends.

Its small size permits mounting in cabinet corners or the cabinet "attic" area and eliminates the environment monitor from occupying a 1-U space.

All software is contained inside the unit. The user supplies an Internet connection and an IP address. Administration of the unit is accomplished via the web page. When user-defined thresholds are exceeded, alarms can be sent via email or SNMP trap.

A full set of internal sensors are included:

- Temperature
- Humidity
- Air flow
- Light
- Sound

A variety of optional remote sensors are easily added. Up to 16 remote sensors can be added using Category 3 telephone wire and RJ-11 connectors. Remote sensors include:

- Webcam
- Door sensors
- Water sensor
- Remote temperature sensor
- City power monitor
- In-line power monitoring

Remote sensors allow the unit to monitor up to 16 cabinets hundreds of feet apart and show the status of air-conditioning outputs. There is one remote RJ-11 sensor receptacle on the unit. Simple splitters are used to expand to use all 16 sensors.

Software protocols include:

- Web (HTTP)
- SMTP/POP
- SNMP (full MIB)
- FTP (firmware upgrades)
- Graphing
- PDA display format
- WAP (cell phone display)
- XML
- Excel™

The webcam used is an IP-based Axis 205; it can be installed locally or remotely. Firmware updates can be made by FTP file transfer which eliminates returning the unit to the factory.

B9318-0300



Description	Belden Part Number
Climate Monitor (Temperature, Heat, Humidity, Airflow, Sound)	<b>B9318-0400</b>

#### Electronic Fan Controller

- Remote temperature sensor with eight feet of cable allows mounting of controller in convenient location while precisely monitoring temperature at any point within the cabinet.
- Digital display shows actual temperature and programmed setpoint.
- Universal mounting bracket allows mounting to EIA rails or enclosure frame.
- Temperature range from -29°C (-20°F) to 60°C (140°F).

Description	Belden Part Number
Electronic Fan Controller	<b>B9318-0300</b>

#### Thermostat Fan Controller

- Low cost mechanical controller with Internal Bi-metal sensing element.
- Position controller inside cabinet where temperature is to be monitored.
- Universal mounting bracket allows mounting to EIA rails or enclosure frame.
- Temperature range from -23°C (-10°F) to 38°C (100°F).

Description	Belden Part Number
Thermostat Fan Controller	<b>B9318-0200</b>

B9318-0200



These products are in the process of being assessed for RoHS compliance. Please check our website for the most current RoHS status.

## Wall Mount Enclosures and Accessories

### Wall Mount Enclosures

BWM 4820-GD



BWM 2406-SD



BWM 2420-SD

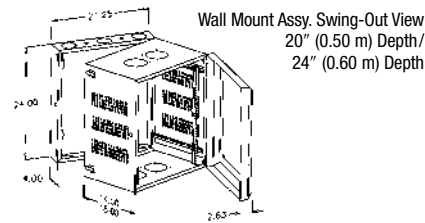

Wall Mount Assy.  
Rear Section  
Mid Section  
Front Door w/Glass

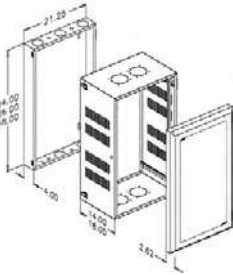

Wall Mount Assy. 4" (0.10 m)  
Depth Rear Section  
Plywood Back Board  
(Opt.) Front Door  
with Glass

6" (0.15 m) Depth

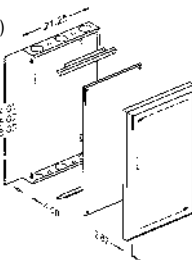

BWM-9312-1600 Fan Assembly  
(2) 4" (0.10 m) Diameter Fans (160 CFM) w/Guard

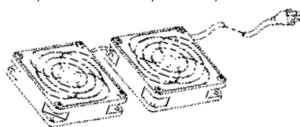

### Wall Mount Enclosure

The Wall Mount Enclosure provides a secure and permanent location for a variety of components. Most units feature 19" (0.48 m) mounting rails and are available with either a glass door with lock or a steel door with lock and 1 pair of 10-32 tapped rails. A 48" (1.21 m) NEMA-12 model is also offered for harsh environments.

Description	Weight	Mounting	Belden Part Number
-------------	--------	----------	--------------------

#### Wall Mount Enclosure

24" (0.60 m) Wall Mount Enclosure 6" (0.15 m) Depth			
with Glass Door with Lock	40 lbs. (18 kg)	Back Board	<b>BWM-2406-GD-C</b>
with Steel Door with Lock	35 lbs. (15 kg)	Back Board	<b>BWM-2406-SD-C</b>
24" (0.60 m) Wall Mount Enclosure 20" (0.50 m) Depth			
with Glass Door with Lock	75 lbs. (34 kg)	12U	<b>BWM-2420-GD-C</b>
with Steel Door with Lock	70 lbs. (31 kg)	12U	<b>BWM-2420-SD-C</b>
24" (0.60 m) Wall Mount Enclosure 24" (0.60 m) Depth			
with Glass Door with Lock	80 lbs. (36 kg)	12U	<b>BWM-2424-GD-C</b>
with Steel Door with Lock	75 lbs. (34 kg)	12U	<b>BWM-2424-SD-C</b>
36" (0.91 m) Wall Mount Enclosure 6" (0.15 m) Depth			
with Glass Door with Lock	45 lbs. (20 kg)	Back Board	<b>BWM-3606-GD-C</b>
with Steel Door with Lock	45 lbs. (20 kg)	Back Board	<b>BWM-3606-SD-C</b>
36" (0.91 m) Wall Mount Enclosure 20" (0.50 m) Depth			
with Glass Door with Lock	90 lbs. (40 kg)	18U	<b>BWM-3620-GD-C</b>
with Steel Door with Lock	85 lbs. (38 kg)	18U	<b>BWM-3620-SD-C</b>
36" (0.91 m) Wall Mount Enclosure 24" (0.60 m) Depth			
with Glass Door with Lock	98 lbs. (44 kg)	18U	<b>BWM-3624-GD-C</b>
with Steel Door with Lock	95 lbs. (43 kg)	18U	<b>BWM-3624-SD-C</b>
48" (1.21 m) Wall Mount Enclosure 6" (0.15 m) Depth			
with Glass Door with Lock	75 lbs. (34 kg)	Back Board	<b>BWM-4806-GD-C</b>
with Steel Door with Lock	65 lbs. (29 kg)	Back Board	<b>BWM-4806-SD-C</b>
48" (1.21 m) Wall Mount Enclosure 20" (0.50 m) Depth			
with Glass Door with Lock	120 lbs. (54 kg)	25U	<b>BWM-4820-GD-C</b>
with Steel Door with Lock	110 lbs. (49 kg)	25U	<b>BWM-4820-SD-C</b>
48" (1.21 m) Wall Mount Enclosure 24" (0.60 m) Depth			
with Glass Door with Lock	135 lbs. (61 kg)	25U	<b>BWM-4824-GD-C</b>
with Steel Door with Lock	125 lbs. (56 kg)	25U	<b>BWM-4824-SD-C</b>
48" (1.21 m) NEMA 12 Wall Mount Enclosure 24" (0.60 m) Depth			
with Steel Door with Latch	205 lbs. (92 kg)	26U	<b>BWM-4830-SD-3S0001</b>

These products are in the process of being assessed for RoHS compliance. Please check our website for the most current RoHS status.

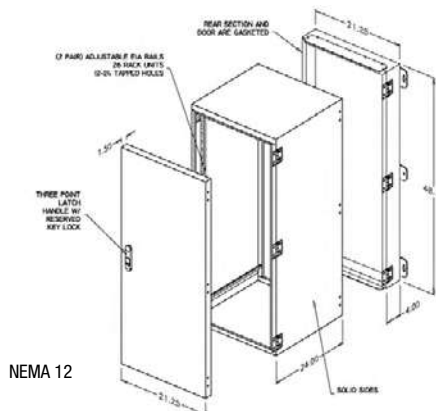

## Wall Mount Enclosures and Accessories

### Accessories and Swing Racks

Optional Basket



#### Wall Mount Enclosure Accessories

Description	Belden Part Number
<b>Caster/Leveler Base</b>	
Caster/Leveler Base, 20" or 24" (0.50 m or 0.60 m)	<b>B8912-0200-C</b>
<b>Back Board</b>	
24" (0.60 m) Plywood Back Board (Black)	<b>BWM-2401</b>
36" (0.91 m) Plywood Back Board (Black)	<b>BWM-3601</b>
48" (1.21 m) Plywood Back Board (Black)	<b>BWM-4801</b>
<b>Fan Assembly</b>	
Fan Assembly (2) 4" (0.10 m) Diameter Fans (160 CFM) with Guard	<b>BWM-9312-1600</b>
<b>Mounting Uprights</b>	
19" (0.48 m) Mounting Uprights, 24" (0.60 m)	<b>BWM-2419</b>
19" (0.48 m) Mounting Uprights, 36" (0.91 m)	<b>BWM-3619</b>
19" (0.48 m) Mounting Uprights, 48" (1.21 m)	<b>BWM-4819</b>

#### Swing Racks

The Swing Rack provides easy access to the rear of rack mounted equipment in a freestanding environment. It is ideal for applications where space is limited and rear access is essential.

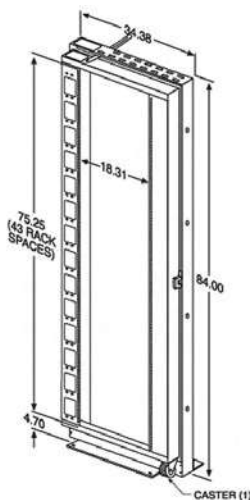

Description	Weight	Mounting	Belden Part Number
84" (2.13 m) Swing-out Distribution Rack	179 lbs. (81 kg)	34U	<b>BSW-8419</b>
Power Strip Mounting Kit (Sold Separately)			<b>BSW-0100</b>
Top Mounting Wire Basket (24"/0.60 m Long) (Sold Separately)			<b>BSW-0200</b>

Swing Racks

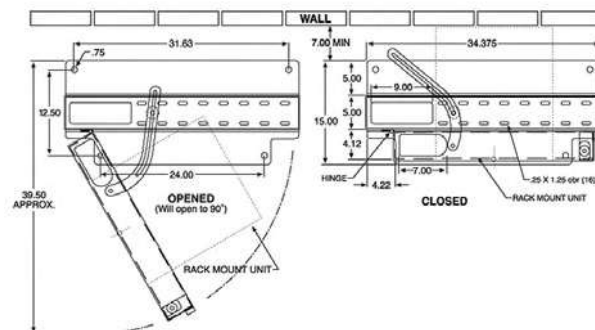

These products are in the process of being assessed for RoHS compliance. Please check our website for the most current RoHS status.

**Notes**



# 12 Open Frame Racks and Accessories



## Table of Contents

<b>Open Frame Racks and Accessories</b>	<b>Page No.</b>
<b>Introduction</b>	<b>12.2</b>
<b>Open Frame Rack Kits &amp; Accessories</b>	<b>12.3 – 12.4</b>
Copper Rack Kit	12.3
Fiber Rack Kit	12.3
Floor Mount Rack	12.3
Distribution Racks	12.3
Vertical Cable Managers	12.3
Vertical Cable Management Channel	12.4
Horizontal Cable Management Channel	12.4
<b>Cable Management Rack</b>	<b>12.4</b>
<b>Server Rack</b>	<b>12.4</b>
<b>Wall Mount Racks &amp; Accessories</b>	<b>12.5</b>
<b>Accessories and Cable/Cord Management Units</b>	<b>12.6 – 12.7</b>
Open Frame Rack Extender Brackets	12.6
Filler Panels	12.6
Patch Cord Organizers	12.6
Organizer Ring Panels	12.7
Organizer Trays	12.7
Brackets	12.7
Patch Cord Organizers	12.7
<b>Cable Ties</b>	<b>12.8 – 12.10</b>
Miniature: 18 lbs. (8 kg) Tensile Strength	12.8
Intermediate: 40 lbs. (18 kg) Tensile Strength	12.8
Standard: 50 lbs. (22 kg) Tensile Strength	12.8
Heavy Duty: 120 lbs. (54 kg) Tensile Strength	12.8
Heavy Duty: 175 lbs. (79 kg) Tensile Strength	12.9
Mount Ties	12.9
Marker Ties	12.9
Cable Tie Mounts	12.9
Velcro Cable Ties	12.10

Please refer to "Terms of Use of Master Catalog" on page 23.22.

## Introduction

### Sources of a Higher Magnitude

Belden is the largest company of its kind, combining cable, connectivity, enclosures and many other product solutions for highly technical industries around the globe. As the exclusive occupant in this market position, Belden provides thousands of satisfied customers with over a billion euros worth of trusted solutions every year, much of which supports the commercial networking sector. By combining our expertise in the design and manufacture of cables, connectivity, enclosures and related products, Belden now offers a product line of staggering magnitude, engineering triumphs and rich resources – worldwide.

### Belden Open Frame Racks

The complete line of Belden open frame racks are designed to meet the unique needs of data networks and other cabling systems. Whether it's the protection of sensitive equipment, the ability to mount equipment of varied sizes and depths, or the need to organize and neatly route installed cables, Belden has the solution you need. Belden provides you with single source convenience for all of your cable management requirements.

### Enclosures and Racks

Choose from a variety of vertical enclosures, open frame racks and wall mount enclosures, all expertly engineered to optimize product quality and performance. Although standard configurations of the most popular enclosures are offered for fast delivery needs, all custom enclosures and racks have numerous mounting, cable and patch cord management options, along with a variety of accessories. This selection of Belden enclosures and racks will meet virtually any mounting, storage or protection requirement for your application.

### Open Frame Racks

Type	Rack Space	Heights		Panel Mount		Width		Depth	
		inch	m	inch	m	inch	m	inch	m
<b>Swing Rack</b>	43U	84	2.13	19	0.48	34, 38	0.86, 0.96	15	0.38
<b>Distribution Rack</b>	25, 39, 44U	48, 72, 84	1.21, 1.82, 2.13	19, 23	0.48, 0.58	21.2, 25.2	0.53, 0.64	21	0.53
<b>Cable Management Rack</b>	44U	84	2.13	19	0.48	23.75, 25.75	0.60, 0.65	15, 22	0.38, 0.55
<b>Copper Rack Kit</b>	44U	84	2.13	19	0.48	30.75	0.78	14	0.35
<b>Fiber Rack Kit</b>	44U	84	2.13	19, 23	0.48, 0.58	25, 29	0.63, 0.73	14	0.35
<b>Wall Mount Rack – Swing-out</b>	19, 25U	36, 48	0.91, 1.21	19	0.48	20	0.50	12 to 18	0.30 to 0.45
<b>Wall Mount Rack – Hinged</b>	2U, 4U, 6U	3.5, 7, 11	0.088, 0.17, 0.27	19	0.48	19, 19.5	0.48, 0.49	4, 9.5	0.10, 0.24

### Cable Ties

Belden cable ties are available in a complete variety of sizes for varying load capacities and are available in standard nylon or weather-resistant nylon.

Type	Tensile / Shear Strength		Length		Weather Resistant
	lbs.	kg	inch	m	
<b>Miniature</b>	18 lbs.	8	4" or 8"	0.70/0.20	
<b>Intermediate</b>	40 lbs.	18	5 1/2" to 14 1/2"	0.13/0.36	•
<b>Standard</b>	50 lbs.	22	8" to 17 3/4"	0.70/0.45	•
<b>Heavy Duty</b>	120 lbs.	54	15"	0.38	
<b>Heavy Duty</b>	175 lbs.	79	17 3/4" to 48"	0.45/1.27	
<b>Velcro</b>	23 lbs./sq.in	10	8" or 12"	0.20/0.30	

### Single Sourcing Convenience

The cable management product families in this catalog are offered to cabling professionals for ultimate convenience in single sourcing. As a Belden customer, you also have the assurance of total dependability by working with a market leader and a trusted partner who has a vested interest in optimizing your operations and investments. We want to make sure you not only get the products you need with ease, but they also perform reliably.

### Availability

Please contact technical support at +31-77-3875-414 or techsupport.venlo@belden.com for availability.

# Open Frame Rack Kits & Accessories

## Distribution Racks, Vertical Cable Managers

AX101174 Rack Kit



BDR-Style Distribution Racks

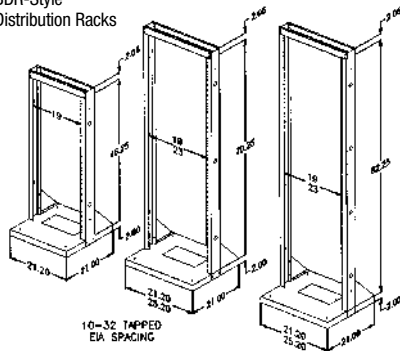

BDR-Style Vertical Cable Managers

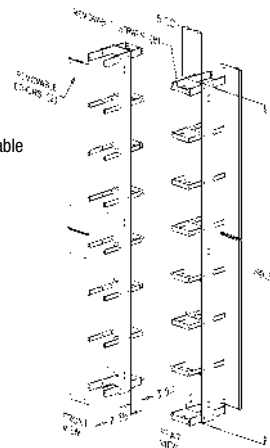

These products are in the process of being assessed for RoHS compliance. Please check our website for the most current RoHS status.

### Open Frame Rack Kits

Rack kits are offered for both copper and fiber cabling. Welded and knock-down rack assemblies are available for copper; knock-down rack kits are available for fiber. All units feature one rack with either one or two vertical and two horizontal channels.

Description	Mounting	Weight		Belden Part Number
		lbs.	kg	
<b>Copper Rack Kit</b>				
Welded Rack Assembly – Black, 19" x 84" (7') (One Rack w/2 Vertical & 2 Horizontal Channels), (0.48 x 2.13 m)	44U	145	66	<b>AX101174</b>
Knock-Down Rack Assembly – Black, 19" x 84" (7') (One Rack w/2 Vertical & 2 Horizontal Channels), (0.48 x 2.13 m)	44U	145	66	<b>AX101175</b>
<b>Fiber Rack Kit</b>				
Knock-Down Rack Assembly – Black, 19" x 84" (7') (One Rack with 1 Vertical & 2 Horizontal Channels), (0.48 x 2.13 m)	44U	106	49	<b>AX101176</b>
Knock-Down Rack Assembly – Grey, 23" x 84" (7') (One Rack with 1 Vertical & 2 Horizontal Channels), (0.58 x 2.13 m)	44U	113	52	<b>AX101177</b>
<b>Floor Mount Rack</b>				
Knock-Down Rack Assembly – Black, 19" x 84" (7') (w/Two Horizontal Channels) (0.48 x 2.13 m)	44U	65	30	<b>AX101178</b>
Knock-Down Rack Assembly – Grey, 19" x 84" (7') (w/Two Horizontal Channels) (0.48 x 2.13 m)	44U	65	30	<b>AX101254</b>
Knock-Down Rack Assembly – Black, 23" x 84" (7') (w/Two Horizontal Channels) (0.58 x 2.13 m)	44U	70	32	<b>AX100931</b>
Knock-Down Rack Assembly – Grey, 23" x 84" (7') (w/Two Horizontal Channels) (0.58 x 2.13 m)	44U	70	32	<b>AX100930</b>
Welded Rack Assembly – Black, 19" x 84" (7') (w/Two Horizontal Channels) (0.48 x 2.13 m)	44U	65	30	<b>AX101179</b>

### Distribution Racks

The distribution rack features 19" or 23" (0.48 m or 0.58 m) mounting rails for attaching a variety of rack mounted equipment. 48", 72" and 84" (1.21 m, 1.82 m and 2.13 m) high models are included in the line.

Description	Mounting	Weight		Belden Part Number
		lbs.	kg	
48" (1.21 m) Distribution Rack, 19" (0.48 m) Mounting Rails	25U	34	15	<b>BDR-4819</b>
72" (1.82 m) Distribution Rack, 19" (0.48 m) Mounting Rails	39U	43	20	<b>BDR-7219</b>
84" (2.13 m) Distribution Rack, 19" (0.48 m) Mounting Rails	39U	50	23	<b>BDR-8419</b>
84" (2.13 m) Distribution Rack, 19" (0.48 m) Mounting Rails, 4" (0.10 m) Channel with Angle Base, 12-24 EIA Spacing	45U	60	27	<b>BDR-8419-4</b>
72" (1.82 m) Distribution Rack, 23" (0.58 m) Mounting Rails	39U	45	20	<b>BDR-7223</b>
84" (2.13 m) Distribution Rack, 23" (0.58 m) Mounting Rails	45U	52	24	<b>BDR-8423</b>
Caster Kit for BDR Racks				<b>B8912-0100</b>

### Vertical Cable Managers

The vertical cable managers are used to manage patch cords in front and cables in the back. Available in 72" (1.82 m) and 84" (2.13 m) heights, the units are available with removable side panels and doors. They can be used with distribution racks (BDR-Style) and rack kit.

Description	Belden Part Number
72" (1.82 m) Vertical Cable Manager	<b>BDR-7201</b>
84" (2.13 m) Vertical Cable Manager	<b>BDR-8401</b>
84" (2.13 m) Vertical Cable Manager, Double Sided with Cover	<b>BDR-8403</b>



## Open Frame Rack Kits & Accessories

### Vertical and Horizontal Cable Management Channel, Cable Management Racks & Server Racks

AX101181 Horizontal Cable Management Channel

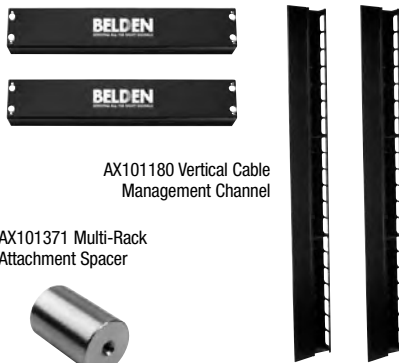

AX101180 Vertical Cable Management Channel

AX101371 Multi-Rack Attachment Spacer



BCR-8419 84" (2.13 m) Cable Management Rack

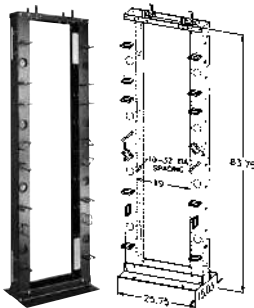

BCR-8419-10 84" (2.13 m) Cable Management Rack w/10" Channel

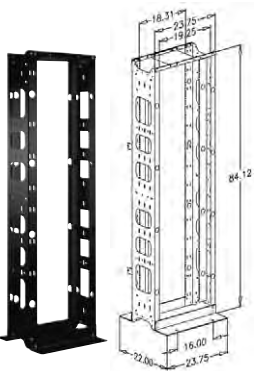

BSR-8419 Server Rack

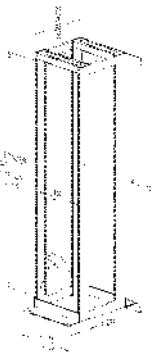

These products are in the process of being assessed for RoHS compliance. Please check our website for the most current RoHS status.

#### Vertical Cable Management Channel

Vertical cable management channels are offered for both copper and fiber cabling. Available in heights of 84" (2.13 m), the channels make cable organization quick and easy, with swing out/removable doors.

Description	Weight		Belden Part Number
	lbs.	kg	
<b>Copper</b>			
Knock-Down Assembly – Black, 5" x 84" (7'), (0.12 x 2.13 m)	40	18	<b>AX101180</b>
<b>Fiber</b>			
Knock-Down Assembly – Grey, 5" x 84" (0.12 x 2.13 m)	35	16	<b>AX100932</b>
Knock-Down Assembly – Black, 5" X 84" (0.12 x 2.13 m)	35	16	<b>AX100933</b>
Multi-Rack Attachment (Spacer) Kit Use between Two Fiber Vertical Managers (AX100932-933)	–	–	<b>AX101371</b>

#### Horizontal Cable Management Channel

Horizontal cable management channels are available in widths of 19" (0.48 m) and 23" (0.58 m). The channels make cable organization quick and easy.

Description	Weight		Belden Part Number
	lbs.	kg	
19" (0.48 m) Horizontal Cable Management Channel, Black	6	3	<b>AX101181</b>
19" (0.48 m) Horizontal Cable Management Channel, Grey	6	3	<b>AX101182</b>
23" (0.58 m) Horizontal Cable Management Channel, Black	8	4	<b>AX101184</b>
23" (0.58 m) Horizontal Cable Management Channel, Grey	8	4	<b>AX101183</b>

#### Cable Management Rack

The cable management racks are designed for 19" (0.48 m) rack-mount equipment and are 84" (2.13 m) high. Model BCR-8419-10 features a channel that can be adjusted up to 10" (0.25 m) deep.

Description	Mounting	Weight		Belden Part Number
		lbs.	kg	
84" (2.13 m) Cable Management Rack, 19" (0.48 m) Mounting Rails	45	53	24	<b>BCR-8419</b>
84" (2.13 m) Cable Management Rack, 19" (0.48 m) Mounting Rails, 10" (0.25 m) Channel with Cable Management	45	60	27	<b>BCR-8419-10</b>

#### Server Rack

Server racks are designed for either 19" (0.48 m) or 23" (0.58 m) rack-mount equipment and are 84" (2.13 m) high. The server rack is available in depths of 24" (0.60 m), 28" (0.71 m) 32" (0.81 m) and 36" (0.91 m) to accommodate different equipment needs.

Description	Belden Part Number
84" (2.13 m) Four Post Server Rack, 19" (0.48 m) Mounting, Depth 24" (0.60 m)	<b>BSR-8419-24</b>
84" (2.13 m) Four Post Server Rack, 19" (0.48 m) Mounting, Depth 28" (0.71 m)	<b>BSR-8419-28</b>
84" (2.13 m) Four Post Server Rack, 19" (0.48 m) Mounting, Depth 32" (0.81 m)	<b>BSR-8419-32</b>
84" (2.13 m) Four Post Server Rack, 19" (0.48 m) Mounting, Depth 36" (0.91 m)	<b>BSR-8419-36</b>
84" (2.13 m) Four Post Server Rack, 23" (0.58 m) Mounting, Depth 24" (0.60 m)	<b>BSR-8423-24</b>
84" (2.13 m) Four Post Server Rack, 23" (0.58 m) Mounting, Depth 28" (0.71 m)	<b>BSR-8423-28</b>
84" (2.13 m) Four Post Server Rack, 23" (0.58 m) Mounting, Depth 32" (0.81 m)	<b>BSR-8423-32</b>
84" (2.13 m) Four Post Server Rack, 23" (0.58 m) Mounting, Depth 36" (0.91 m)	<b>BSR-8423-36</b>

# Wall Mount Racks & Accessories

BWR-3619

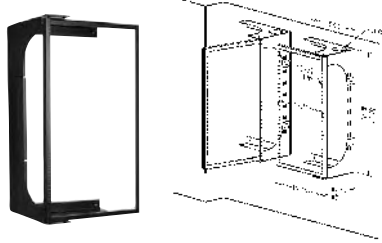

BWR-4819 – Swing-out Distribution Racks  
19" x 48" Depth Range 11.5" to 15.5" (0.29 m - 0.39 m)

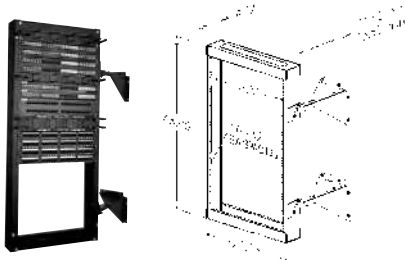

AX100785 Wall Mount Bracket, 2U



BWR-1219 – 12" (0.30 m) Wall Mount Rack  
Hinged Mounting for Easy Access



Adjustable Shelf  
2" - 6" (0.05 m - 0.15 m)



AX102514 – 4U Wall Mount Bracket w/2U Swivel



BER-6X6 – 6U Wall Mount Rack w/6U and 6U Front



## Wall Mount Racks

Wall mount racks are available in two styles: hinged and swing out. The hinged rack is 12" (0.30 m) in height and features an adjustable lower shelf. The swing out rack is available in heights of 36" (0.91 m) and 48" (1.21 m) with 19" (0.48 m) mounting rails. 2U, 4U and 6U wall mount racks are also offered.

Description	Mounting	Weight		Belden Part Number
		lbs.	kg	
<b>Swing Out Rack</b>				
36" (0.91 m) Wall Mount Swing-out Rack, 19" (0.48 m) Mounting Rails x 12" (0.30 m) Fixed Depth	18U	30	14	<b>BWR-3619-12</b>
36" (0.91 m) Wall Mount Swing-out Rack, 19" (0.48 m) Mounting Rails x 18" (0.45 m) Depth	18U	30	14	<b>BWR-3619-18</b>
48" (1.21 m) Wall Mount Swing-out Rack, 19" (0.48 m) Mounting Rails, 11.5" - 15.5" (0.29 m - 0.39 m) Adjustable Depth	25U	39	18	<b>BWR-4819</b>
48" (1.21 m) Wall Mount Swing-out Rack, 19" (0.48 m) Mounting Rails x 12" (0.30 m) Fixed Depth	25U	39	18	<b>BWR-4819-12</b>
48" (1.21 m) Mount Swing-out Rack, 19" (0.48 m) Mounting Rails x 18" (0.45 m) Depth	25U	39	18	<b>BWR-4819-18</b>
<b>Hinged Rack</b>				
12" (0.30 m) Wall Mount Rack, Hinged 19" (0.48 m) Mounting Rails x 9" (0.22 m) Fixed Depth	6U	26	12	<b>BWR-1219</b>
<b>Wall Mount Bracket</b>				
2U Wall Mount Bracket, Black	2U	4	2	<b>AX100785</b>
4U Wall Mount Bracket, Black	4U	8	4	<b>AX100786</b>
4U Wall Mount Bracket w/2U Swivel				<b>AX102514</b>
<b>6U Wall Mount Rack</b>				
6U Wall Mount Rack with 6U Top and 6U Front Rack Space, Tapped 12-24 EIA	6" (0.15 m)	17	8	<b>BER-6X6</b>
Bottom Accessory Shelf	-	-	-	<b>BER-AS</b>
Front Mounted Swing-out Patch Panel Kit, 6U	-	-	-	<b>BER-6UP</b>
Single, 3U Space Top Dust Cover	-	-	-	<b>BER-3UC</b>

These products are in the process of being assessed for RoHS compliance. Please check our website for the most current RoHS status.

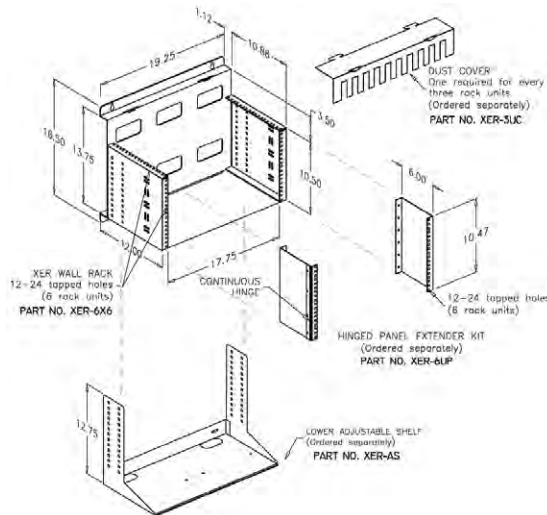

## Open Frame Rack Accessories & Cable / Cord Management Units

### Extender Brackets, Filler Panels, Patch Cord Organizers

Rack Extenders



19" Filler Panels

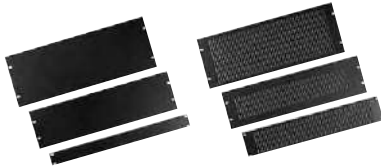

B9511-1902



B9510-1901



B9512-1901



Top: B9512-1902  
Bottom: B9512-1902



#### Open Frame Rack Extender Brackets

The open frame rack extender brackets are used to extend a 19" (0.48 m) panel/equipment mounting for 23" (0.58 m).

Description	Belden Part Number
1U 23" (0.58 m) EIA To 19" (0.48 m) EIA Extender Bracket	<b>B9810-0100</b>
2U 23" (0.58 m) EIA To 19" (0.48 m) EIA Extender Bracket	<b>B9811-0200</b>
3U 23" (0.58 m) EIA To 19" (0.48 m) EIA Extender Bracket	<b>B9812-0300</b>
4U 23" (0.58 m) EIA To 19" (0.48 m) EIA Extender Bracket	<b>B9813-0400</b>

#### Filler Panels

Filler panels are available in solid or vented for improved air flow.

Description	Belden Part Number
1U 19" (0.48 m) Solid Filler Panel, Grey	<b>A0644497</b>
2U 19" (0.48 m) Solid Filler Panel, Grey	<b>A0644499</b>
1U 19" (0.48 m) Solid Filler Panel, Black	<b>B9910-0100</b>
2U 19" (0.48 m) Solid Filler Panel, Black	<b>B9911-0200</b>
3U 19" (0.48 m) Solid Filler Panel, Black	<b>B9912-0300</b>
4U 19" (0.48 m) Solid Filler Panel, Black	<b>B9913-0400</b>
2U 19" (0.48 m) Vented Filler Panel, Black	<b>B9914-0200</b>
3U 19" (0.48 m) Vented Filler Panel, Black	<b>B9915-0300</b>
4U 19" (0.48 m) Vented Filler Panel, Black	<b>B9916-0400</b>

#### Patch Cord Organizers

The patch cord organizers keep wires and cable under control.

Among the many features of the patch cord organizers are:

- Horizontal/vertical patch cord management
- Front/rear management
- Removable covers
- Bend radius control

Description	Belden Part Number
1U 19" (0.48 m) Cable Organizer	<b>B9510-1901</b>
2U 19" (0.48 m) Cable Organizer with Saddle Rings	<b>B9511-1902</b>
1U 19" (0.48 m) Rack Mount Cable Organizer with Finger Stock and Cover (1.5" x 2", 0.038 x 0.050 m)	<b>B9512-1901</b>
2U 19" (0.48 m) Rack Mount Cable Organizer with Finger Stock and Cover (3" x 3", 0.076 x 0.076 m)	<b>B9512-1902</b>
2U 19" (0.48 m) Cable Organizer with Finger Stock and Cover Front and Rear	<b>B9512-1902-FR</b>
2U 19" (0.48 m) Cable Organizer with Quick Touch (2" x 3", 0.050 x 0.076 m)	<b>B9513-1902</b>
1U 19" (0.48 m) Cable Organizer with Radius (Waterfall)	<b>B9514-1901</b>
1U 23" (0.58 m) Cable Organizer	<b>B9610-2301</b>
2U 23" (0.58 m) Cable Organizer with Saddle Rings	<b>B9611-2302</b>

These products are in the process of being assessed for RoHS compliance. Please check our website for the most current RoHS status.

## Open Frame Rack Accessories & Cable/Cord Management Units

### Ring Panels, Organizer Trays, Brackets & Patch Cord Channel

AX100249 Organizer Tray, 3U



AX100463 Rear Cable Bracket

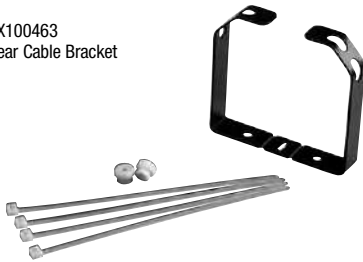

AX101173 Cable Tie Bar



AX100789 Cable Support Bracket

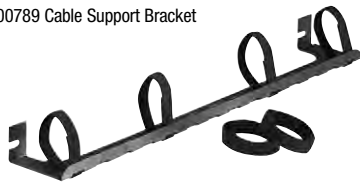

AX100793 Patch Cord Organizer Channel



A0396695 Organizer Ring Panel, 2U



A0644488 Organizer Panel, 1U



### Open Frame Rack Cable and Patch Cord Management

The open frame rack cable and patch cord management accessories can be used with patch panels in open frame racks for distribution cable and patch cord organization, routing and protection. They allow easier cord access and simplify moves, additions and changes.

Description	Mounting	Belden Part Number
Organizer Ring Panel, Grey	2U	A0396695
Organizer Ring Panel, Black	2U	A0403977
Organizer Panel, Grey	1U	A0644488
Organizer Panel, Black	1U	A0644489
Organizer Panel, Grey	2U	A0644490
Organizer Panel, Black	2U	A0644492
Organizer Tray, Grey	3U	AX100248
Organizer Tray, Black	3U	AX100249
Rear Cable Bracket, Grey	-	AX100462
Rear Cable Bracket, Black	-	AX100463
Cable Support Bracket, Grey	0U	AX100788
Cable Support Bracket, Black	0U	AX100789
Patch Cord Organizer Channel, Grey	1U	AX100792
Patch Cord Organizer Channel, Black	1U	AX100793
Patch Cord Organizer Channel, Grey	2U	AX100794
Patch Cord Organizer Channel, Black	2U	AX100795
Patch Cord Organizer Channel, Grey	4U	AX100796
Patch Cord Organizer Channel, Black	4U	AX100797
Cable Tie Bar, Black	0U	AX101173

These products are in the process of being assessed for RoHS compliance. Please check our website for the most current RoHS status.

## Cable Ties

### Miniature, Intermediate, Standard & Heavy-Duty

CTM4018N  
Cable Ties

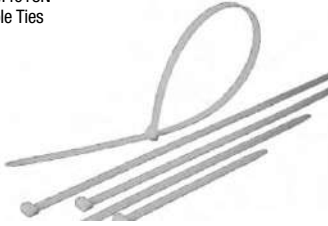

CTM4018B  
Cable Ties



#### Cable Ties

The cable ties line features miniature, intermediate, standard and heavy duty cable ties. They are available in tensile strengths ranging from 8 to 80 kg (18 to 175 lbs.) and are manufactured from various grades of nylon including weather-resistant nylon for use in sunshine/outdoor applications. They are offered in lengths from 4" (0.10 m) to 48" (1.21 m). Color: natural (indoor), black (outdoor). Velcro cable ties are also available.

Description	Length		Width		Loop Tensile Strength		Max. Bundled Diameter		Belden Part Number
	inch	mm	inch	mm	lbs.	N	inch	mm	
<b>Miniature 8 kg (18 lbs.) Tensile Strength</b>									
Nylon Cable Tie, 100 pcs, Natural, 4" (0.10 m)	3.9	100	0.098	2.5	18	80	1.0	25	<b>CTM4018N</b>
Nylon Cable Tie, 100 pcs, Natural, 5.5" (0.13 m)	5.6	142	0.098	2.5	18	80	1.4	35	<b>CTM5P18N</b>
Nylon Cable Tie, 100 pcs, Natural, 8" (0.20 m)	8.0	203	0.098	2.5	18	80	2.2	55	<b>CTM8018N</b>
<b>Intermediate 18 kg (40 lbs.) Tensile Strength</b>									
Nylon Cable Tie, 100 pcs, Natural, 5.5" (0.13 m)	5.6	142	0.125	3.2	40	178	1.4	35	<b>CTI5P40N</b>
Nylon Cable Tie, 100 pcs, Natural, 8" (0.20 m)	8.0	203	0.141	3.6	40	178	2.2	55	<b>CTI8040N</b>
Nylon Cable Tie, 100 pcs, Natural, 11" (0.27 m)	11.5	292	0.141	3.6	40	178	3.3	85	<b>CTI11P40N</b>
Nylon Cable Tie, 100 pcs, Natural, 14.5" (0.36 m)	14.5	368	0.141	3.6	40	178	4.0	103	<b>CTI14P40N</b>
Weather Resistant Nylon Cable Tie, 100 pcs, Black, 5.5" (0.13 m)	5.6	142	0.125	3.2	40	178	1.4	35	<b>CTI5P40BW</b>
Weather Resistant Nylon Cable Tie, 100 pcs, Black, 8" (0.20 m)	8.0	203	0.141	3.6	40	178	2.2	55	<b>CTI8040BW</b>
Weather Resistant Nylon Cable Tie, 100 pcs, Black, 11.5" (0.29 m)	11.5	292	0.141	3.6	40	178	3.3	85	<b>CTI11P40BW</b>
Weather Resistant Nylon Cable Tie, 100 pcs, Black, 14.5" (0.36 m)	14.5	368	0.141	3.6	40	178	4.0	103	<b>CTI14P40BW</b>
<b>Standard 22 kg (50 lbs.) Tensile Strength</b>									
Nylon Cable Tie, 100 pcs, Natural, 8" (0.20 m)	8.0	203	0.180	4.6	50	222	2.2	55	<b>CTS8050N</b>
Nylon Cable Tie, 100 pcs, Natural, 11" (0.27 m)	11.0	280	0.188	4.8	50	222	3.2	81	<b>CTS1150N</b>
Nylon Cable Tie, 100 pcs, Natural, 14.5" (0.36 m)	14.5	368	0.188	4.8	50	222	4.0	103	<b>CTS14P50N</b>
Nylon Cable Tie, 100 pcs, Natural, 17.75" (0.45 m)	17.7	450	0.188	4.8	50	222	5.1	131	<b>CTS17P50N</b>
Weather Resistant Nylon Cable Tie, 100 pcs, Black, 8" (0.20 m)	8.0	203	0.180	4.6	50	222	2.2	55	<b>CTS8050BW</b>
Weather Resistant Nylon Cable Tie, 100 pcs, Black, 11.5" (0.29 m)	11.0	280	0.188	4.8	50	222	3.2	81	<b>CTS1150BW</b>
Weather Resistant Nylon Cable Tie, 100 pcs, Black, 14.5" (0.36 m)	14.5	368	0.188	4.8	50	222	4.0	103	<b>CTS14P50BW</b>
Weather Resistant Nylon Cable Tie, 100 pcs, Black, 17.75" (0.45 m)	17.7	450	0.188	4.8	50	222	5.1	131	<b>CTS17P50BW</b>
<b>Heavy Duty 54 kg (120 lbs.) Tensile Strength</b>									
Nylon Cable Tie, 100 pcs, Natural, 15" (0.38 m)	15.0	380	0.298	7.6	120	533	4.3	111	<b>CTH15120N</b>

These products are in the process of being assessed for RoHS compliance. Please check our website for the most current RoHS status.

### Cable Ties

#### Marker Ties, Cable Tie Mounts

Marker Ties

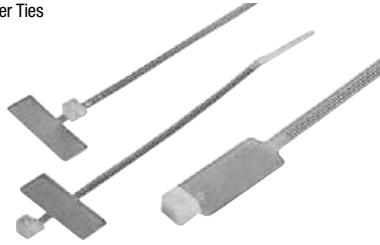

Description	Length		Width		Loop Tensile Strength		Max. Bundled Diameter		Belden Part Number
	inch	mm	inch	mm	lbs.	N	inch	mm	
<b>Heavy Duty Nylon Cable Tie</b> 80 kg (175 lbs.) Tensile Strength									
100 pcs, Natural, 17.75" (0.45 m)	17.7	450	0.313	8.0	175	778	5.2	134	<b>CTH17P175N</b>
100 pcs, Natural, 21.7" (0.55 m)	21.7	550	0.313	8.0	175	778	6.5	167	<b>CTH21P175N</b>
100 pcs, Natural, 36" (0.91 m)	36.0	914	0.352	9.0	175	778	10.6	271	<b>CTH36P175N</b>
100 pcs, Natural, 48" (1.21 m)	48.0	1219	0.352	9.0	175	778	15.0	382	<b>CTH48P175N</b>
<b>Mount Ties</b>									
100 pcs, Natural, 18 kg (40 lbs.), 6" (0.15 m)	6.7	171	0.145	3.7	40	178	1.6	40	<b>CTI6040NM</b>
100 pcs, Natural, 22 kg (50 lbs.), 11.57" (0.29 m)	11.8	300	0.188	4.8	50	222	3.3	85	<b>CTS11P50NM</b>
100 pcs, Natural, 22 kg (50 lbs.), 14.5" (0.36 m)	14.6	370	0.188	4.8	50	222	4.0	103	<b>CTS14P50NM</b>

Cable Tie Mounts

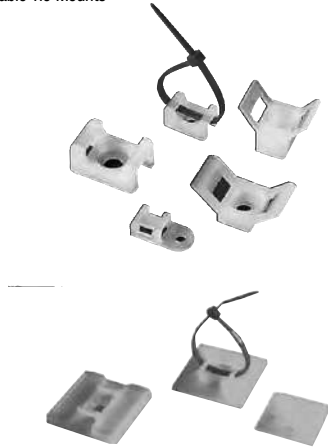

Description	Length		Width		Loop Tensile Strength		Max. Bundled Diameter		Marking Pad		Belden Part Number
	inch	mm	inch	mm	lbs.	N	inch	mm	inch	mm	
<b>Marker Ties</b> 8 kg (18 lbs.) Tensile Strength											
100 pcs, Natural, 4" (0.10 m)	3.9	100	0.098	2.5	18	80	1.0	25	0.98 x 0.31	25 x 8	<b>CTM4018NMK</b>
100 pcs, Natural, 4.25" (0.10 m)	4.3	110	0.098	2.5	18	80	1.0	25	0.98 x 0.32	26 x 8	<b>CTM4P18NMK</b>
100 pcs, Natural, 5" (0.12 m)	5.1	130	0.098	2.5	18	80	1.0	25	1.10 x 0.79	28 x 20	<b>CTM5018NMK</b>
100 pcs, Natural, 8" (0.20 m)	7.9	200	0.098	2.5	18	80	2.0	50	1.18 x 0.59	30 x 15	<b>CTM8018NMK</b>
<b>Marker Ties</b> 22.5 kg (50 lbs.) Tensile Strength											
100 pcs, Natural, 8" (0.20 m)	7.9	200	0.180	4.6	50	222	2.0	50	1.10 x 0.51	28 x 13	<b>CTS8050NMK</b>
100 pcs, Natural, 10.5" (0.26 m)	10.6	270	0.180	4.6	50	222	3.0	75	1.10 x 0.51	28 x 13	<b>CTS10P50NMK</b>

Mount Ties

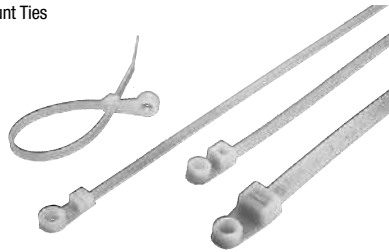

Description	Length		Width		Mounting Method	Belden Part Number
	inch	mm	inch	mm		
<b>Cable Tie Mounts</b>						
Cable Tie Mount S.A. M, 100 per Bag	0.49	12.5	0.49	12.5	Self Adhesive	<b>TM100S4</b>
Cable Tie Mount S.A. M-I, 100 per Bag	0.75	19.0	0.74	19.0	#4 M2.5 Screw + Self Adhesive	<b>TM101SS2</b>
Cable Tie Mount S.A. M-I-S, 100 per Bag	1.10	28.0	1.10	28.0	#4 M2.5 Screw + Self Adhesive	<b>TM102</b>
Cable Tie Mount Sc. M-I, 100 per Bag	0.50	12.8	0.27	7.0	#4 M2.5 Screw	<b>TM1</b>
Cable Tie Mount Sc. I-S-HD, 100 per Bag	0.91	23.0	0.63	16.0	1/4 M6 Screw	<b>TM2</b>
Cable Tie Mount Sc. I-S-HD, 100 per Bag	1.18	30.0	0.58	14.7	#10 M5 Screw	<b>TM4</b>

These products are in the process of being assessed for RoHS compliance. Please check our website for the most current RoHS status.

Cable mounts compatible with following cable tie cross section.  
S.A. = Self Adhesive • M = Miniature • Sc. = Screw on type • I = Intermediate • S = Standard • HD = Heavy Duty

## Cable Ties

### Velcro Ties, Saddles, Saddle Ties

AX100781  
Velcro Saddle



AX102512  
Saddle Tie

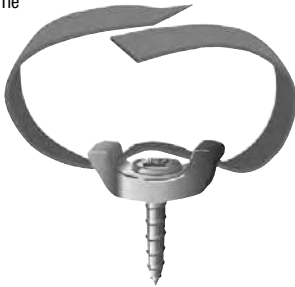

AX102516  
12" Fiber Optic Cable Manager



Description	Belden Part Number
<b>Velcro Cable Ties</b>	
Velcro Cable Ties, 25 per Roll, 8" (0.20 m)	<b>AX100783</b>
Velcro Cable Ties, 25 per Roll, 12" (0.30 m)	<b>AX100784</b>
Velcro Saddle, 25 pcs	<b>AX100781</b>
Velcro Saddle Kit with #8 Wood Screw, 10 pcs	<b>AX102512</b>
Velcro Saddle Kit with 10/32 Rack Screw, 10 pcs	<b>AX102513</b>
15' (4.6 m) Roll x 5/8" (0.20 m) Polywrap, Cut to Length as required	<b>AX102515</b>
12" (0.30 m) Fiber Optic Cable Manager	<b>AX102516</b>
24" (0.60 m) Fiber Optic Cable Manager	<b>AX102517</b>

These products are in the process of being assessed for RoHS compliance. Please check our website for the most current RoHS status.



# Surface Raceway Systems

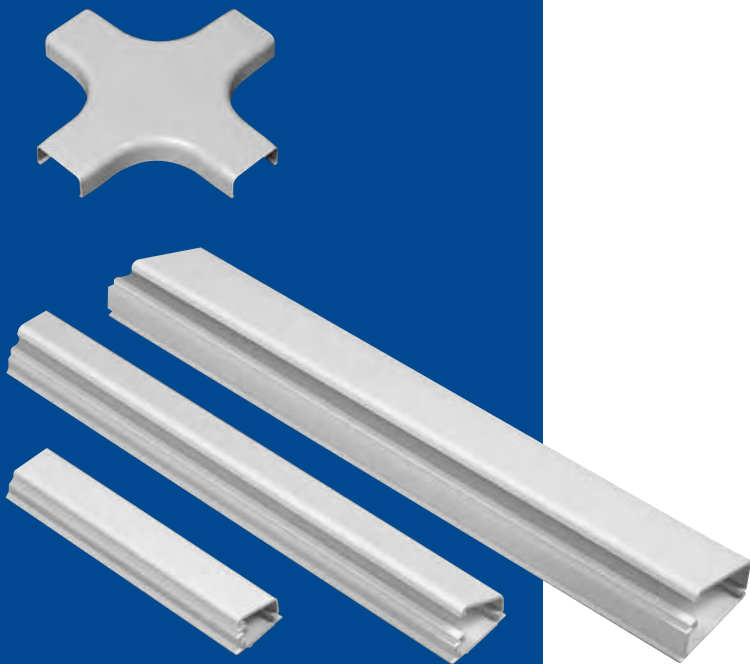

## Table of Contents

Surface Raceway Systems	Page No.
<b>One-Piece Latching Raceway</b>	<b>13.2</b>
<b>Surface Raceway System Accessories</b>	<b>13.3</b>
Ceiling Entries	13.3
Corners: Inside and Outside	13.3
Elbows: Flat and High-Radius	13.3
End Caps	13.3
Splice Covers	13.3
Tees: 3-Way and 4-Way	13.3
<b>Surface Raceway System Adapter Boxes</b>	<b>13.3</b>
MediaFlex Single Gang	13.3
MediaFlex Double Gang	13.3
<b>Technical Information</b>	<b>13.4</b>
Raceway Fill Capacity Chart	13.4



# One-Piece Latching Raceway

BFT-Style Surface Raceway Systems



## Surface Raceway System

The surface raceway system is a functional, affordable, attractive solution for wire enclosure applications in commercial, industrial and residential environments. The product line includes extruded raceways with pre-applied adhesive backings, fittings, and adapter boxes.

- One-piece design features patented hinge (Lid can be opened in any mounting position.)
- Parts are made of a strong, durable, lightweight, UL 94-V0 compliant PVC
- UL 5A specification for 600 volt applications
- One inch (0.025 m) minimum bend radius accessories available for Category 5e, 6 and fiber optic installations

All products are fully paintable and available in three sizes:

- 3/4" x 1/2" (0.700 x 0.050 m, Model No. 03SR)
- 1" x 1/2" (0.025 x 0.050 m, Model No. 05SR)
- 1-1/2" x 3/4" (0.050 x 0.700 m, Model No. 09SR)

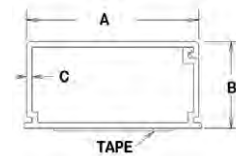

Description	Dimensions								Belden Part Number
	A		B		C		Tape Width		
	inch	mm	inch	mm	inch	mm	inch	mm	
<b>One-piece Latching Raceway</b>									
<b>03SR</b> White, 2.4 m (8 ft.), 20 pcs 3/4" x 1/2" (0.700 x 0.050 m)	0.760	19.3	0.505	12.8	0.050	1.27	0.500	12.7	<b>BFT-03SRW8</b>
<b>05SR</b> White, 2.4 m (8 ft.), 20 pcs 1" x 1/2" (0.025 x 0.050 m)	1.010	25.7	0.505	12.8	0.050	1.27	0.750	19.1	<b>BFT-05SRW8</b>
<b>09SR</b> White, 2.4 m (8 ft.), 20 pcs 1-1/2" x 3/4"(0.050 x 0.700 m)	1.500	38.1	0.755	19.2	0.050	1.27	1.000	25.4	<b>BFT-09SRW8</b>

These products are in the process of being assessed for RoHS compliance. Please check our website for the most current RoHS status.

## Area of Raceway

Modell No.	sq. in.	mm <sup>2</sup>
<b>03SR</b>	0.259	167.10
<b>05SR</b>	0.488	314.84
<b>09SR</b>	0.827	533.55

See chart on page 13.4 for Raceway fill capacities.

## Accessories & Adapter Boxes

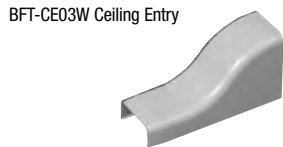

### Surface Raceway System Accessories

A wide variety of accessories are available for the surface raceway system including:

- Ceiling entries
- End caps (end cap doubles as reducer to all three raceway sizes)
- High radius elbows
- Flat elbows
- Inside corners
- Splice covers
- Outside corners
- 3-way and 4-way tees

Description	Belden Part Number		
	03SR	05SR	09SR
Ceiling Entry, White, 10 pcs	<b>BFT-CE03W</b>	<b>BFT-CE05W</b>	<b>BFT-CE09W</b>
Splice Cover, White, 10 pcs	<b>BFT-SC03W</b>	<b>BFT-SC05W</b>	<b>BFT-SC09W</b>
End Cap, White, 10 pcs	<b>BFT-EC03W</b>	<b>BFT-EC05W</b>	<b>BFT-EC09W</b>
3-way Tee, White, 10 pcs	<b>BFT-3T03W</b>	<b>BFT-3T05W</b>	<b>BFT-3T09W</b>
Flat 90 Elbow, White, 10 pcs	<b>BFT-9003W</b>	<b>BFT-9005W</b>	<b>BFT-9009W</b>
Inside Corner, White, 10 pcs	<b>BFT-IN03W</b>	<b>BFT-IN05W</b>	<b>BFT-IN09W</b>
Outside Corner, White, 10 pcs	<b>BFT-OC03W</b>	<b>BFT-OC05W</b>	<b>BFT-OC09W</b>
4-way Tee, White, 10 pcs	<b>BFT-4T03W</b>	<b>BFT-4T05W</b>	<b>BFT-4T09W</b>
High Radius Elbow, White, 10 pcs	<b>BFT-F003W</b>	<b>BFT-F005W</b>	<b>BFT-F009W</b>

### Surface Raceway System Adapter Boxes

MediaFlex surface adapter boxes are one part of the comprehensive line of plates and inserts that snap together to create a full line of modular workstation outlets. MediaFlex surface adapter boxes are designed to work with Belden surface raceway systems. The MediaFlex surface adapter boxes are available in single and double gang configuration.

- Good depth allow more room for cable management and bend radius
- Comes with mounting plate for added installation flexibility
- No special tools required, therefore reduces installation time
- Sturdy design for excellent durability and network protection
- Modern unique aesthetic design

Description	Belden Part Number
MediaFlex Single Gang Adapter Box, Standard, White	<b>AX102611</b>
MediaFlex Double Gang Adapter Box, Standard, White	<b>AX102610</b>

These products are in the process of being assessed for RoHS compliance. Please check our website for the most current RoHS status.

## Technical Information

### Raceway Fill Capacity Chart

Wire Type	Wire Diameter		Wire Area		Number of Cables per Raceway		
	inch	mm	sq. in.	mm <sup>2</sup>	03SR	05SR	09SR
<b>Building Wire THHN</b>							
14 AWG	0.108	2.74	0.0092	5.935	3	5	9
12 AWG	0.126	3.20	0.0125	8.065	2	4	7
10 AWG	0.170	4.32	0.0227	14.645	1	2	4
<b>Signal Wire UL Style 1061 • 300V 80 C°*</b>							
18 AWG	0.066	2.74	0.0034	2.194	30	57	97
20 AWG	0.066	1.68	0.0028	1.806	37	69	117
22 AWG	0.050	1.27	0.0020	1.290	53	99	169
24 AWG	0.045	1.14	0.0016	1.032	65	123	208
<b>Unshielded Twisted Pair Wire (UTP) 24 AWG*</b>							
2-pair	0.140	3.56	0.0154	9.935	7	13	22
3-pair	0.150	3.81	0.0177	11.419	6	11	19
4-pair Cat 5e, Cat 6	0.220	5.59	0.0380	24.516	3	5	9
25-pair	0.510	12.95	0.2042	131.742	0	1	2
<b>Twisted Pair Wire (Shielding)*</b>							
4-pair 24 AWG	0.250	6.35	0.0491	31.677	2	4	7
25-pair 24 AWG	0.510	12.95	0.2042	131.742	0	1	2
Type 1A 22 AWG	0.430	10.92	0.1451	93.613	1	1	2
<b>Coax Cable (Max.)</b>							
RG-58/U	0.193	4.90	0.0292	18.839	4	7	11
RG-59/U, RG-62/U	0.242	6.15	0.0460	29.677	2	4	7
RG-6/U	0.270	6.86	0.0572	36.903	2	3	6
<b>Fiber Optic Cable 62.5/125/900, PVC Jacket, OFNR*</b>							
2-strand	0.175	4.45	0.0240	15.484	4	8	14
4-strand	0.185	4.70	0.0269	17.355	4	7	12
6-strand	0.210	5.33	0.0346	22.323	3	6	10

\* Based on 40% fill ratio

#### Area of Raceway

Model No.	sq. in.	mm <sup>2</sup>
03SR	0.259	167.10
05SR	0.488	314.84
09SR	0.827	533.55



Commercial Networking – Copper

15

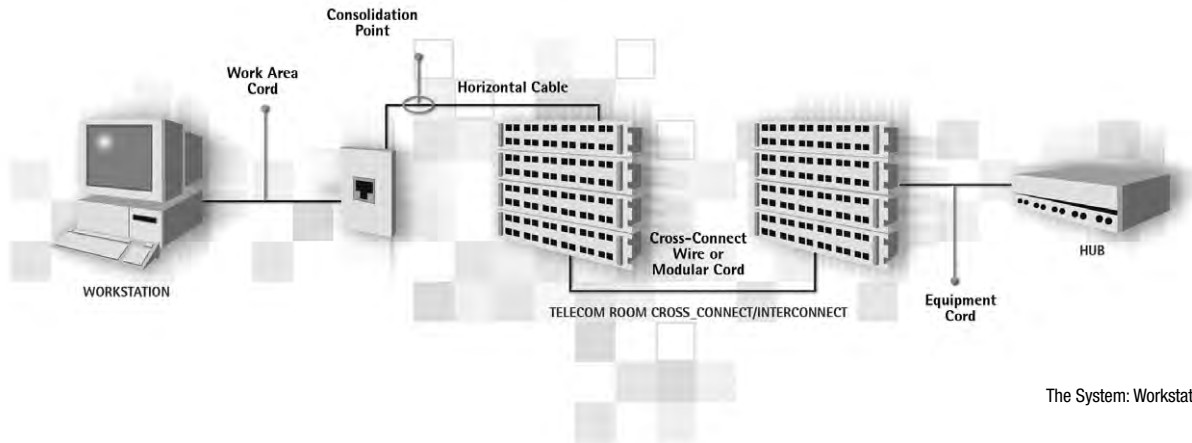

**Table of Contents**

<b>Commercial Networking – Copper</b>	<b>Page No.</b>
<b>Introduction</b>	<b>15.2 – 15.5</b>
<b>Belden IBDN System 10GX</b>	<b>15.6 – 15.8</b>
<b>Belden IBDN System 4800LX</b>	<b>15.9</b>
<b>Belden IBDN System 2400</b>	<b>15.10</b>
<b>Belden IBDN System 1200</b>	<b>15.11</b>
<b>GigaBIX Multi System</b>	<b>15.12 – 15.15</b>
<b>BIX Cross-Connect System</b>	<b>15.16 – 15.20</b>
<b>110 Cross-Connect System</b>	<b>15.21 – 15.23</b>
<b>Labels</b>	<b>15.24</b>
<b>Patch Panels</b>	<b>15.25 – 15.26</b>
<b>Workstation Outlets</b>	<b>15.27 – 15.37</b>
Modules	15.27 – 15.29
Plates and Outlets	15.30 – 15.36
Tools	15.37
<b>Modular Cords</b>	<b>15.38 – 15.41</b>
<b>Network Connectivity Products</b>	<b>15.42</b>
<b>Line Protection and Bonding &amp; Grounding</b>	<b>15.43</b>
<b>Certified System Cables</b>	<b>15.44 – 15.50</b>
<b>Unshielded Twisted Pair (U/UTP) Cables</b>	<b>15.44 – 15.59</b>
Category 6	15.44 – 15.48, 15.51
Category 5e	15.49 – 15.55
Category 5	15.56 – 15.57
Category 3	15.58 – 15.59
<b>Shielded Twisted Pair Cables</b>	<b>15.60 – 15.63</b>
Category 7, Class F, S/FTP	15.60
Category 6, Class E, F/UTP	15.61
Category 5e, Class D, F/UTP	15.62
Category 5e, Class D, SF/UTP	15.63
<b>Patch Cables</b>	<b>15.64 – 15.66</b>
Category 6, Patchcable, U/UTP	15.64
Category 5e, Patchcable, U/UTP	15.65
Category 5e, Patchcable, F/UTP	15.66
<b>Special Application Cables</b>	<b>15.67 – 15.72</b>
Category 6 and 5e, U/UTP for RGB Video	15.67 – 15.68
IEEE 802.3	15.69 – 15.70
IEEE 802.4	15.71
IEEE 802.5	15.71 – 15.72

## Introduction

### Belden IBDN Networking Components and Systems Overview



The System: Workstation through Hub

#### Cables that Communicate

Each of the copper cabling components depicted on the following pages is vital to the overall performance of the network, but to achieve optimum network performance you should consider Belden IBDN end-to-end structured cabling systems. Belden IBDN copper structured cabling systems are recognized the world over for their high quality since they are the result of both Belden's exceptional design and manufacturing expertise and the system's ability to outperform the standards.

#### The Revolutionary Belden IBDN System 10GX (Cat. 6a | 10 Gb/s | 625 MHz)

What differentiates our 10GX system from other 10 Gigabit ethernet offerings? The Belden IBDN system 10GX is not an improved or boosted category 6 system, but a revolutionary innovation designed around a series of dynamic enabling technologies. Because the 10GX system solves two major performance issues: (1) a reduction in alien crosstalk to about 15 dB, or 30 times lower than the alien NEXT for 100BASE-T at a distance of 100 meters, and (2) the system's ability to control insertion loss, return loss, NEXT, PSNEXT, Alien PSNEXT, ELFEXT, PSELFEXT and alien PSFEXT characteristics during high frequency operation – it not only meets the high speed, high bandwidth demands of today's networks, but this advanced solution is ready to meet the challenges of the networks of tomorrow.

#### System 10GX Performance-Enabling Technologies

The performance of each critical component of the 10GX solution has been optimized through use of the following performance-enabling technologies:

- The system's cable is based upon an innovative SpiralFlex™ design that serves to reduce Alien crosstalk by randomizing the distance between the cables.
- A patent pending IDC design and patch panel circuit layout called Matrix IDC™ technology is utilized to substantially eliminate the issue of Alien crosstalk between the system's modules.
- X-Bar™ technology: The X-Bar is a control device that enables the accurate positioning of each UTP pair before the pair is terminated on the 10GX module's IDC pins.

- A patent pending FlexPoint PCB (printed circuit board) is used within the module housing to position the compensation circuitry directly at the plug's point of contact. Instant compensation delivers excellent crosstalk performance up to 625 MHz!

#### 10GX Cable Design Improves Alien Crosstalk

The major technical challenge for traditional UTP cables resides with the electromagnetic coupling between a cable and its neighboring cables. This coupling is typically enhanced by the fact that all the cable pairs have the same twisting lay and therefore have the same resonance frequencies. Belden's use of SpiralFlex technology introduces randomization in the cable in two ways: (1) it induces with neighboring cables – to accomplish this, a filler is twisted around the four cable pairs – and, (2) to create additional randomization along the full length of the cable, a unique internal cross-web is incorporated into the cable design.

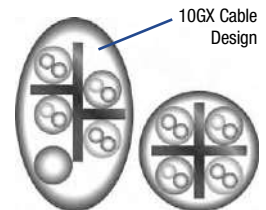

Since these features both increase and randomize the distance between a cable and its neighboring cables, both the ANEXT coupling and RL channel characteristics of the cable are improved. In fact, 10GX Cables were tested in a worst-case scenario – a six-around-one cable environment – and still exhibited performance well over proposed standards. In addition, this unique 10GX Cable design is more flexible and installer-friendly than other 10G cables.

#### Statistically Controlled Modular Cord Manufacturing

To achieve consistent high performance, Belden uses a statistical process control methodology in its modular cord manufacturing process. This assures perfect tuning between the module and the modular cord and offers improved channel performance. The design of the 10GX modular cord is also based upon a patent pending plug management design that controls dNEXT and delivers extended channel performance.

## Introduction

(continued)

### 10GX IDC Design Cancels Out Alien Crosstalk

Traditional Technology



The IDC is one of the most sensitive areas for alien crosstalk management. In traditional designs, all of the IDC contacts are aligned so they become perfect antennas, allowing adjacent pairs to both emit and receive noise.

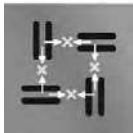

Belden's patent-pending design, called MatriX IDC technology, positions each IDC at 90 degrees to its neighbor – effectively canceling out ANEXT by 15 dB as compared with traditional technology!

MatriX IDC technology

### 10GX Module Eliminates Signal Degradation

Traditional jack designs are performance handicapped at high frequencies because of an inherent crosstalk in the plug that cannot be fully compensated for by the jack. This crosstalk occurs because the compensation circuitry is located at some physical distance from the source of the noise, which is at the plug interface. Even a very small physical distance can have a major impact at high frequencies.

The 10GX modules feature FleXPoint PCB technology. This technology incorporates the use of a flexible PCB that allows the compensation circuitry to be located directly at the point of the plug contact. This reduces the delay between the source of the crosstalk in the plug and the crosstalk cancellation circuitry on the PCB. As a result the crosstalk noise at high frequencies is dramatically reduced for outstanding channel performance to 625 MHz!

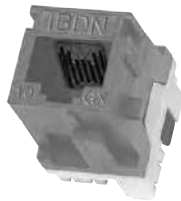

FleXPoint PCB Technology

### Error-Free Termination Practices – Installable Performance®

Since structured cabling systems for Category 6 and beyond are extremely sensitive to installation practices, the 10GX system mitigates and simplifies installation issues to ensure overall 10G system performance. To ensure optimum termination of the cable to the module, a new patent-pending technology called the X-Bar was developed. The X-Bar is a plastic device that affixes to the module to ensure that each UTP pair is consistently positioned for termination on the 10GX module's IDC pins. The X-Bar also controls the amount of unjacketed cable, plus it maintains the conductor twist lays during installation to prevent untwisting. With this consistent termination feature, the superior NEXT and ANEXT performance achieved through use of the system's innovative component designs will be maintained and remain stable throughout the installation process. We call this after-installation assurance installable performance.



FleXPoint PCB Technology

### The 10GX Patch Panel with 10GX Modules

Alien crosstalk control within a patch panel is critical to the success of the system. The high density environment of a patch panel can be subjected to crippling amounts of alien crosstalk. The unique design of the 10GX module's IDC, and its

ability to cancel the “antenna” effect between modules eliminates the Alien crosstalk issue. Because superior ANEXT performance is assured by the module-related technologies, this allows the patch panel ports to be in line. There is no need to compromise on density, and labeling and cable management features are greatly improved. In fact, the module technology is so powerful, Belden is the only manufacturer to be able to offer an ultra high-density solution with 48 ports in a 1U space!

### Belden IBDN Category 5e/Enhanced Category 6 Components and Systems

Belden IBDN Cat. 5e, Cat. 6 and beyond Cat. 6 systems can be designed and installed using either Bonded-Pair UTP cables or non-bonded-pair UTP cables. Both types of cable offer performance well beyond the standards. Bonded-Pair UTP cables – DataTwist® 350, MediaTwist® and DataTwist® 600e – feature a patented design that bonds the individual insulated conductors of each pair along the full length of the cable. This bonded construction delivers installable performance. That is, bonded-pair cables are consistent in the distance between the conductors and in the amount of twist, throughout the installation process, so they deliver the same, superior electrical performance both before and after the cable's installation.

Our non-bonded-pair family of cables include GigaFlex® 1200, 2400 and 4800LX cables. These cables incorporate a patented design which provides complete quality control during the manufacturing process. This allows us to provide high quality cables that consistently offer improved channel performance and large margins over the standards. These cables will provide the capacity and performance to maximize your overall network performance.

Belden IBDN punch-down GigaFlex modules are based on a patented encapsulated lead frame technology that ensures long-term reliability, as well as extremely stable transmission performance. Lead frame technology is inherently more reliable than traditional connector technologies as it uses a single, uninterrupted copper contact path through the connector. The design of the GigaFlex module allows signals to pass virtually unchanged through the connector, providing greater system performance.

GigaBIX® distribution connectors, featuring Belden's BIX technology, are a uniquely designed solution centered around an extremely compact connector equipped with double-sided Insulation displacement connection (IDC) clips. The benefit of this unique design is a considerable reduction in the space that would be required by conventional connecting systems of the same pair count. The density of BIX technology is second to none, allowing up to three hundred pairs to be terminated in a very small area – a real space saver, especially in today's office environment where real estate is at a premium.

### Belden IBDN System 1200 (Cat. 5e | 1.2 Gb/s | 160 MHz)

If your business is riding the current wave of growth and expansion, you may be considering new ways of doing business and a new or upgraded IT system to support these new strategies. This is the ideal time to plan and implement a new cabling system or to upgrade your existing infrastructure.

This Category 5e system was developed to support high-speed network applications such as Gigabit ethernet and provides clear bandwidth up to 160 MHz; an increase of 60% over the Category 5e standard of 100 MHz. Standards organizations such as TIA/EIA and IEEE now recommend Category 5e cabling systems for all new cabling installations.

## Introduction

(continued)

### Belden IBDN System 2400 (Cat. 6 | 2.4 Gb/s | 250 MHz)

If leading-edge communication systems are an element of your competitive strategy and if you consider information technology as one of the drivers of your bottom line, you should consider the speed, reliability and performance advantages of this system.

This Category 6 system meets or exceeds all requirements of the TIA/EIA Category 6 standard specifications and delivers 250 MHz bandwidth, a 25% increase over the 200 MHz bandwidth of typical Category 6 compliant channels. The Belden IBDN system 2400 provides the performance, throughput and reliability necessary to keep your critical applications operating at peak performance.

### Belden IBDN System 4800LX (Beyond Cat. 6 | 4.8 Gb/s | 300 MHz)

If every bit of information that your company processes is mission critical, you need the performance and reliability that is built into the Belden IBDN system 4800LX.

This enhanced Category 6 system was conceived to support the most demanding, ultra-high speed and multi-Gigabit protocols, providing blistering performance.

The Belden IBDN system 4800LX is the industry's first 300 MHz system, far exceeding all TIA/EIA Category 6 specifications.

Solutions			Backbone Cable†		Telecom Room				
Available Channel Bandwidth	Guaranteed Data Rate	UTP Channel STD Compliance	4-Pair Cables	Page	Cross-Connect Hardware				
<b>Belden IBDN System 1200</b>									
<b>160 MHz PowerSum</b>	1.2 Gb/s	Cat. 5e* TIA/EIA ISO/IEC IEEE Gigabit	DataTwist® 350 1700R (CMR)	15.49	GigaBIX® Cross-Connect System				
			DataTwist® 350 1700E (PVC)	15.49					
			DataTwist® 350 1700ENH (LSNH) see Plenum: 1701A and 1701LC	15.49					
						GigaFlex 1212 (CMR)	15.50	PS5E BIX Patch Panel	
						GigaFlex 1213 (CMP)	15.50	PS5E HD-BIX Patch Panel	
						GigaFlex 1224 (LSOH)	15.50	PS5E HD-110 Patch Panel Flex Patch Panel/EZ-MDVO PS5E Module Flex Patch Panel/GigaFlex PS5E Module	
								110 Cross-Connect System	
<b>Belden IBDN System 2400</b>									
<b>250 MHz PowerSum</b>	2.4 Gb/s	Cat. 6** TIA/EIA ISO/IEC IEEE Gigabit	7812E (PVC)	15.46	GigaBIX Cross-Connect System				
			7812ENH (LSNH)	15.46					
			GigaFlex 2412 (CMR)	15.47	GigaFlex PS6+ Patch Panel Flex Patch Panel/GigaFlex PS6+ Module				
			GigaFlex 2413 (CMP)	15.47					
			GigaFlex 2424 (LSOH)	15.47					
<b>Belden IBDN System 4800LX</b>									
<b>300 MHz PowerSum</b>	4.8 Gb/s	Beyond Cat6*** TIA/EIA ISO/IEC IEEE Gigabit	DataTwist® 600e 7851A (CMR)	15.44	GigaBIX Cross-Connect System				
			DataTwist® 600e 7852A (CMP)	15.44					
			DataTwist® 600e 7851NH (LSNH)	15.44					
			GigaFlex 4812LX (CMR)	15.45	GigaFlex PS6+ Patch Panel Flex Patch Panel/GigaFlex PS6+ Module				
			GigaFlex 4813LX (CMP)	15.45					
			GigaFlex 4824LX (LSOH)	15.45					
<b>Belden IBDN System 10GX</b>									
<b>625 MHz</b>	10 Gb/s	Beyond 10G Proposed TIA ISO/IEC IEEE 10 Gigabit	10GX 10GX12 (CMR, Non-bonded-Pair)	15.8	10GX Ultra High-Density Patch Panel (1U, 48 ports) 10GX Patch Panel Flex Patch Panel/10GX Module				
			10GX 10GX13 (CMP, Non-bonded-Pair)	15.8					
			10GX 10GX24 (LSZH, Non-bonded-Pair)	15.8					
						10GX 10GX16 (LC, Non-bonded-Pair)	15.8		
						10GX 10GX32 (CMR, Bonded-Pair)	15.8		
								10GX 10GX44 (LSZH, Bonded-Pair)	15.8
						10GX 10GX66 (LC, Bonded-Pair)	15.8		

\* ANSI/TIA/EIA-568-B.1, ISO/IEC 11801 2nd Edition and IEEE 802.3ab. • \*\* ANSI/TIA/EIA-568-B.2, ISO/IEC 11801 2nd Edition and IEEE 802.3ab.

† Backbone can be configured with Belden IBDN FiberExpress Optical Fiber Cable.

Installable Performance guarantees are available on Bonded-Pair cables. Since the insulated conductors of the pairs are bonded along their longitudinal axes, Bonded-Pair cables remain intact during the installation process, so there is no separation of pair conductors and no degradation of the cables' electrical characteristics.

# Introduction

(continued)

## Quality Installation and Service

Belden IBDN systems are designed, installed and field-tested by full trained and certified system contractors and integrators to further assure superior systems performance. They are also backed by a strict system certification and warranty program.

## System Certification and Warranty Program

The Belden IBDN certification program is a rigorous process that ensures that your Belden IBDN 'certified' system is composed of Belden IBDN components, and that it has been designed and installed by a factory-trained certified system vendor. Belden IBDN 'certified' systems are supported by a series of warranties that surpass conventional product warranties.

Certification adds important end-to-end system performance guarantees and ensures full compliance with cabling industry standard specifications – even after system installation (installable performance). A 25-year product warranty and a lifetime application assurance program accompany each Belden IBDN 'certified' system installation. These warranty programs include coverage for both parts and labor.

	Horizontal Cable			Work Area			
	Cross-Connect Patch System	4-Pair Cables	Page	Installable Performance <sup>9††</sup>	Outlets — Connectors, Faceplates & Adapters	Modular Cords	
GigaBIX Cross-Connect Wire	DataTwist® 350 1700R (CMR)	15.49	●	PS5E BIX DVO Outlet PS5E Modular EZ-MDVO PS5E Module GigaFlex PS5E Module MediaFlex Outlets Interface Plates MDVO Faceplates MDVO Adapters European-style Faceplates French-style Faceplates	GigaFlex Cords		
	DataTwist® 350 1700E (PVC)	15.49					
	DataTwist® 350 1700ENH (LSNH)	15.49					
GigaBIX Patch Cords	see Plenum: 1701A and 1701LC						
GigaFlex PS5E Modular Cords	GigaFlex 1212 (CMR)	15.50					
	GigaFlex 1213 (CMP)	15.50					
	GigaFlex 1224 (LSOH)	15.50					
PS5E 110 Patch Cords							
GigaBIX Cross-Connect Wire	7812E (PVC)	15.46	●			GigaFlex PS6+ Module MediaFlex Outlets Interface Plates MDVO Faceplates MDVO Adapters European-style Faceplates French-style Faceplates	GigaFlex PS6+ Modular Cords
GigaBIX PS6+ Patch Cords	7812ENH (LSNH)	15.46	●				
	GigaFlex 2412 (CMR)	15.47					
GigaFlex PS6+ Modular Cords	GigaFlex 2413 (CMP)	15.47					
	GigaFlex 2424 (LSOH)	15.47					
GigaBIX Cross-Connect Wire	DataTwist® 600e 7851A (CMR)	15.44	●	GigaFlex PS6+ Module MediaFlex Outlets  Interface Plates MDVO Faceplates MDVO Adapters European-style Faceplates French-style Faceplates	GigaFlex PS6+ Modular Cords		
GigaBIX PS6+ Patch Cords	DataTwist® 600e 7852A (CMP)	15.44	●				
	DataTwist® 600e 7851NH (LSNH)	15.44					
	GigaFlex 4812LX (CMR)	15.45					
GigaFlex PS6+ Modular Cords	GigaFlex 4813LX (CMP)	15.45					
	GigaFlex 4824LX (LSOH)	15.45					
10GX Modular Cords	10GX 10GX12 (CMR, Non-bonded-Pair)	15.8		10GX Module MediaFlex Outlets Interface Plates MDVO Faceplates MDVO Adapters	10GX Modular Cords		
	10GX 10GX13 (CMP, Non-bonded-Pair)	15.8					
	10GX 10GX24 (LSZH, Non-bonded-Pair)	15.8					
	10GX 10GX16 (LC, Non-bonded-Pair)	15.8					
	10GX 10GX32 (CMR, Bonded-Pair)	15.8	●				
	10GX 10GX33 (CMP, Bonded-Pair)	15.8	●				
	10GX 10GX44 (LSZH, Bonded-Pair)	15.8	●				
	10GX 10GX66 (LC, Bonded-Pair)	15.8	●				





# Belden IBDN System 10GX

## 10GX Modules and 10GX Patch Panels

AX102272 10GX Module, Black

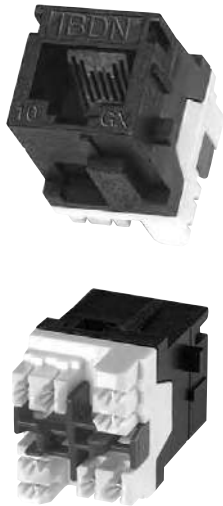

### 10GX Module

The 10GX module is a revolutionary punch down UTP connector designed to be used within the new Belden IBDN system 10GX. In order to achieve true 10G performance, Belden has designed the 10GX module based on three revolutionary module technologies making the 10GX module the most advanced 10G module available. It is designed to work in existing hardware including the Flex modular patch panel and MediaFlex outlet series. It can also be mixed and matched with a wide variety of adapters and boxes to suit practically any installation configuration for workstation outlet, consolidation point and telecommunications closet applications. The unmatched Beyond 10G™ performance exceeds all parameters specified in the proposed augmented Category 6 standard. All performance characteristics including ANEXT, NEXT, FEXT, insertion loss and return loss have been set to guarantee transmission performance up to 625 MHz.

Description	Belden Part Number	
	MDVO-Style	Keystone-Style

### Belden IBDN System 10GX

#### 10GX Module, Augmented Category 6

Description	MDVO-Style	Keystone-Style
MDVO-Style, T568A/B, Grey	AX102269	AX102280
MDVO-Style, T568A/B, White	AX102271	AX102282
MDVO-Style, T568A/B, Black	AX102272	AX102283
MDVO-Style, T568A/B, Red	AX102274	AX102285
MDVO-Style, T568A/B, Yellow	AX102275	AX102286
MDVO-Style, T568A/B, Green	AX102276	AX102287
MDVO-Style, T568A/B, Blue	AX102277	AX102288
MDVO-Style, T568A/B, Ivory	AX102562	AX102281

These products are in the process of being assessed for RoHS compliance. Please check our website for the most current RoHS status.

AX102488 10GX Ultra High-Density Patch Panel 1U, 48-port, Titanium

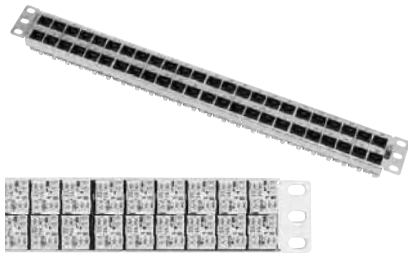

### 10GX Patch Panel

The 10GX patch panel is a fully loaded patch panel designed to be used within the Belden IBDN system 10GX. The 10GX patch panel features the revolutionary 10GX module, specifically designed to meet the difficult challenges of 10 Gb/s transmission. 10GX patch panels are available in high-density options such as 24 ports in 1U or 48 ports in 2U, but the phenomenal ANEXT performance of the 10GX module has allowed Belden to also support an ultra high-density option offering the 10GX ultra high-density patch panel supporting 48 ports in 1U. The unmatched beyond 10G™ performance exceeds all parameters specified in the proposed Augmented Category 6 standard. All performance characteristics including ANEXT, NEXT, FEXT, insertion loss and return loss have been set to guarantee transmission performance up to 625 MHz.

Description	Belden Part Number
-------------	--------------------

### Belden IBDN System 10GX

#### 10GX Ultra High-Density Patch Panel, Augmented Category 6

1U, 48-port, Titanium	AX102488
10GX Patch Panel, Augmented Category 6	
1U, 24-port, Titanium	AX102293
2U, 48-port, Titanium	AX102296

These products are in the process of being assessed for RoHS compliance. Please check our website for the most current RoHS status.

AX102293 10GX Patch Panel 1U, 24-port, Titanium

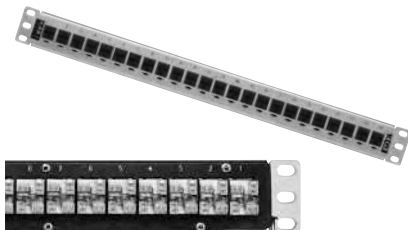

# Belden IBDN System 10GX

## 10GX Modular Cords

AX360015 10GX Modular Cord, Blue



### 10GX Modular Cords

The 10GX modular cords are 4-pair 23 AWG UTP modular cords designed to be used within the Belden IBDN system 10GX. Belden has designed the 10GX modular cord based on a patent pending management bar design which allows for very good control of the internal plug NEXT. The patch cable design offers very good Alien crosstalk performance, while maintaining the important mechanical characteristics such as flexibility.

The 10GX modular cords' design, with a very small footprint, makes them fully compatible with the highest density hubs that utilize RJ45 jack connections. The 10GX modular cords are available in pantone colors that match the colors per the TIA/EIA-606 standard and the product line encompasses CMR modular cords, as well as open-ended cords. The unmatched performance exceeds all parameters specified in the proposed Augmented Category 6 standard. All performance characteristics have been set to guarantee transmission performance up to 625 MHz.

Description	Belden Part Number					
	Blue	White	Grey	Green	Red	Yellow
<b>Belden IBDN System 10GX</b>						
<b>10GX Modular Cord, 4-Pair, 23 AWG Solid, T568A/B - T568A/B, CMR</b>						
2.1 m (7 ft.)	AX360015	AX360051	AX360027	AX360021	AX360045	AX360057
3.0 m (10 ft.)	AX360016	AX360052	AX360028	AX360022	AX360046	AX360058
4.6 m (15 ft.)	AX360017	AX360053	AX360029	AX360023	AX360047	AX360059
7.6 m (25 ft.)	AX360018	AX360054	AX360030	AX360024	AX360048	AX360060
<b>10GX Pigtail, 4-Pair, 23 AWG Solid, T568A - Open, CMR</b>						
4.6 m (15 ft.)	-	-	AX360265	-	-	-
7.6 m (25 ft.)	-	-	AX360266	-	-	-
10.6 m (35 ft.)	-	-	AX360267	-	-	-
15.0 m (50 ft.)	-	-	AX360268	-	-	-
<b>10GX Pigtail, 4-Pair, 23 AWG Solid, T568B - Open, CMR</b>						
4.6 m (15 ft.)	-	-	AX360269	-	-	-
7.6 m (25 ft.)	-	-	AX360270	-	-	-
10.6 m (35 ft.)	-	-	AX360271	-	-	-
15.0 m (50 ft.)	-	-	AX360272	-	-	-

These products are in the process of being assessed for Gb/s compliance. Please check our website for the most current RoHS status.

# Belden IBDN System 10GX

## 10GX Cables

24826395 10GX Cable Series, White



### 10GX Cable

The 10GX cables are 4-pair 23 AWG UTP cables designed to be used within the Belden IBDN system 10GX. The GX cable incorporates the use of patent pending SpiralFlex™ technology, which improves the ANEXT coupling by increasing and randomizing the distance between a cable and the neighboring cables surrounding it. The unmatched beyond 10G™ performance exceeds all parameters specified in the proposed augmented Category 6 standard. All performance characteristics including ANEXT, NEXT, FEXT, Insertion Loss and Return Loss have been set to guarantee channel transmission performance up to 625 MHz. The 10GX cable series is very complete with cable available with bonded-pairs and non-bonded-pairs, and is available in plenum, non-plenum, and limited combustible versions.

Description	Belden Part Number
<b>10GX Cable, Bonded-Pairs</b>	
<b>10GX Cable, CMR</b>	
10GX32 Cable, 4-Pair, 23 AWG UTP, 305 m (1000 ft.), Spool, White	24826395
10GX32 Cable, 4-Pair, 23 AWG UTP, 305 m (1000 ft.), Spool, Blue	24826995
<b>10GX Cable, CMP</b>	
10GX33 Cable, 4-Pair, 23 AWG UTP, 305 m (1000 ft.), Spool, White	24827395
10GX33 Cable, 4-Pair, 23 AWG UTP, 305 m (1000 ft.), Spool, Blue	24827995
<b>10GX Cable, LSZH</b>	
10GX44 Cable, 4-Pair, 23 AWG UTP, 305 m (1000 ft.), Spool, Purple	24828095
<b>10GX Cable, Limited Combustible</b>	
10GX66 Cable, 4-Pair, 23 AWG UTP, 305 m (1000 ft.), Spool, White*	24822395
<b>10GX Cable, Non-Bonded-Pairs</b>	
<b>10GX Cable, CMR</b>	
10GX12 Cable, 4-Pair, 23 AWG UTP, 305 m (1000 ft.), Spool, White	24816395
10GX12 Cable, 4-Pair, 23 AWG UTP, 305 m (1000 ft.), Spool, Blue	24816995
<b>10GX Cable, CMP</b>	
10GX13 Cable, 4-Pair, 23 AWG UTP, 305 m (1000 ft.), Spool, White	24817395
10GX13 Cable, 4-Pair, 23 AWG UTP, 305 m (1000 ft.), Spool, Blue	24817995
<b>10GX Cable, LSZH</b>	
10GX24 Cable, 4-Pair, 23 AWG UTP, 305 m (1000 ft.), Spool, Purple	24818095
<b>10GX Cable, Limited Combustible</b>	
10GX16 Cable, 4-Pair, 23 AWG UTP, 305 m (1000 ft.), Spool, White*	24812395

\* DuPont™ certified limited combustible cable

# Belden IBDN System 4800LX

## Beyond Category 6, 4.8 Gb/s – 300 MHz

AX101067 GigaFlex PS6+ Module

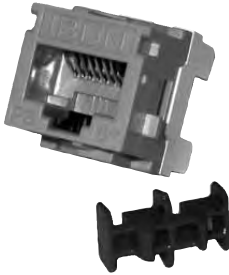

AX101613 GigaFlex PS6+ Patch Panel



AX350061 GigaFlex PS6+ Modular Cord



24586985 GigaFlex 4812LX Cable

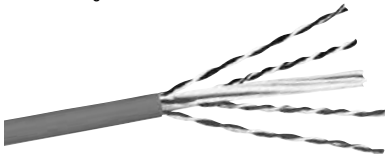

This systems overview page is intended to give you a basic list of the main components used in the system. For a more complete listing of product options and for more detailed product information, see the individual catalog pages listed in this section.

These products are in the process of being assessed for RoHS compliance. Please check our website for the most current RoHS status.

### System 4800LX

The Belden IBDN system 4800LX combines the power and performance of our PS6 connectivity products with our break-through series 4800LX UTP cables to provide industry's first true end-to-end 300 MHz cabling system.

Systems components include: GigaFlex 4800LX unbonded-pair UTP Cables, DataTwist® 600e bonded-pair UTP cables, GigaBIX cross-connect systems, PS6+ patch panels (including fully loaded and modular versions) and related patch cords, outlets, modules, faceplates and adapters.

Description	Belden Part Number	
	MDVO-Style	Keystone-Style
<b>Belden IBDN System 4800LX, Modules*</b>		
<b>GigaFlex PS6+ Module</b>		
T568A/B, White	<b>AX101065</b>	<b>AX101320</b>
T568A/B, Black	<b>AX101066</b>	<b>AX101321</b>

\* See page 15.27 for a more complete listing of products and for more detailed product information.

Description	Belden Part Number
<b>Belden IBDN System 4800LX, Patch Panels*</b>	
<b>GigaFlex PS6+ Patch Panel</b>	
GigaFlex PS6+ Patch Panel, 1U, 24-port, Black, loaded	<b>AX101611</b>
GigaFlex PS6+ Patch Panel, 2U, 48-port, Black, loaded	<b>AX101613</b>
Flex Patch Panel, 1U, 24-port, Black, unloaded	<b>AX101571</b>
Flex Patch Panel, 2U, 48-port, Black, unloaded	<b>AX101458</b>

\* See page 15.25 for a more complete listing of products and for more detailed product information.

Description	Belden Part Number					
	Blue	White	Grey	Green	Red	Yellow
<b>Belden IBDN System 4800LX, Modular Cords*</b>						
<b>GigaFlex PS6+ Modular Cord, LSZH 4-pair, 23 AWG solid, T568B - T568B</b>						
0.5 m (1.6 ft.)	<b>AX102356</b>	<b>AX102350</b>	<b>AX102392</b>	<b>AX102544</b>	<b>AX102550</b>	<b>AX102556</b>
1.0 m (3.3 ft.)	<b>AX102357</b>	<b>AX102351</b>	<b>AX102393</b>	<b>AX102545</b>	<b>AX102551</b>	<b>AX102557</b>
2.0 m (6.5 ft.)	<b>AX102358</b>	<b>AX102352</b>	<b>AX102394</b>	<b>AX102546</b>	<b>AX102552</b>	<b>AX102558</b>
3.0 m (10 ft.)	<b>AX102359</b>	<b>AX102353</b>	<b>AX102395</b>	<b>AX102547</b>	<b>AX102553</b>	<b>AX102559</b>
5.0 m (16.4 ft.)	<b>AX102360</b>	<b>AX102354</b>	<b>AX102396</b>	<b>AX102548</b>	<b>AX102554</b>	<b>AX102560</b>
10.0 m (33 ft.)	<b>AX102361</b>	<b>AX102355</b>	<b>AX102397</b>	<b>AX102549</b>	<b>AX102555</b>	<b>AX102561</b>

\* See pages 15.38 – 15.39 for a more complete listing of products and for more detailed product information.

Description	Belden Part Number		
	Blue	White	Purple
<b>Belden IBDN System 4800LX, Cables*</b>			
<b>Beyond Category 6</b>			
GigaFlex 4812LX Cable, CMR, 23 AWG, 305 m Spool	<b>24586985</b>	<b>24586385</b>	–
GigaFlex 4813LX Cable, CMP, 23 AWG, 305 m Spool	<b>24587985</b>	<b>24587385</b>	–
GigaFlex 4824LX Cable, LSZH, 23 AWG, 305 m Spool	–	–	<b>24588085</b>
DataTwist 600e, CMR, 23 AWG, 305 m Reel	<b>7852A 0061000</b>	<b>7852A 0091000</b>	–
DataTwist 600e, CMP, 23 AWG, 305 m Reel	<b>7852A D151000</b>	<b>7852A 0091000</b>	–

\* See pages 15.44 – 15.45 for a more complete listing of products and for more detailed product information.

# Belden IBDN System 2400

## Category 6, 2.4 Gb/s – 250 MHz

AX101067 GigaFlex PS6+ Module

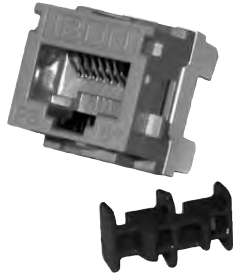

AX101613 GigaFlex PS6+ Patch Panel



AX350061 GigaFlex PS6+ Modular Cord



24568015 GigaFlex 2424 Cable



This systems overview page is intended to give you a basic list of the main components used in the system. For a more complete listing of product options and for more detailed product information, see the individual catalog pages listed in this section.

These products are in the process of being assessed for RoHS compliance. Please check our website for the most current RoHS status.

### System 2400

The Belden IBDN system 2400 installations provide the additional throughput and enhanced error-free performance needed to support high-traffic and high-bit-rate applications. It delivers 250 MHz of user bandwidth as well as support for data rates up to 2.4 gigabits per second.

Systems components include: GigaFlex 2400 unbonded-pair UTP cables, MediaTwist® bonded-pair UTP cables, GigaBIX cross-connect systems, PS6+ patch panels (including fully loaded and modular versions) and related patch cords, outlets, modules, faceplates and adapters.

Description	Belden Part Number	
	MDVO-Style	Keystone-Style

#### Belden IBDN System 2400, Modules\*

GigaFlex PS6+ Module		
T568A/B, White	AX101065	AX101320
T568A/B, Black	AX101066	AX101321

\* See page 15.27 for a more complete listing of products and for more detailed product information.

Description	Belden Part Number
-------------	--------------------

#### Belden IBDN System 2400, Patch Panels\*

GigaFlex PS6+ Patch Panel	
GigaFlex PS6+ Patch Panel, 1U, 24-port, Black, loaded	AX101611
GigaFlex PS6+ Patch Panel, 2U, 48-port, Black, loaded	AX101613
Flex Patch Panel, 1U, 24-port, Black, unloaded	AX101571
Flex Patch Panel, 2U, 48-port, Black, unloaded	AX101458

\* See page 15.25 for a more complete listing of products and for more detailed product information.

Description	Belden Part Number					
	Blue	White	Grey	Green	Red	Yellow

#### Belden IBDN System 2400, Modular Cords\*

GigaFlex PS6+ Modular Cord, LSZH 4-pair, 23 AWG solid, T568B						
0.5 m (1.6 ft.)	AX102356	AX102350	AX102392	AX102544	AX102550	AX102556
1.0 m (3.3 ft.)	AX102357	AX102351	AX102393	AX102545	AX102551	AX102557
2.0 m (6.5 ft.)	AX102358	AX102352	AX102394	AX102546	AX102552	AX102558
3.0 m (10 ft.)	AX102359	AX102353	AX102395	AX102547	AX102553	AX102559
5.0 m (16.4 ft.)	AX102360	AX102354	AX102396	AX102548	AX102554	AX102560
10.0 m (33 ft.)	AX102361	AX102355	AX102397	AX102549	AX102555	AX102561

\* See pages 15.38 – 15.39 for a more complete listing of products and for more detailed product information.

Description	Belden Part Number		
	Blue	White	Purple

#### Belden IBDN System 2400, Cables\*

Category 6			
GigaFlex 2412LX Cable, CMR, 24 AWG, 305 m box	24566915	24566315	-
GigaFlex 2413LX Cable, CMP, 24 AWG, 305 m box	24567915	24567315	-
GigaFlex 2424LX Cable, LSZH, 24 AWG, 305 m box	-	-	24568015
GigaFlex 2424LX Cable, LSZH, 24 AWG, 305 m reel	-	24568315	-
GigaFlex 2424LX Cable, LSZH, 24 AWG, 500 m reel	-	24568331	-
CMR, UTP Bonded-Pair, 23 AWG, 305 m box	7812E.01U305	-	-
LSNH, UTP Bonded-Pair, 23 AWG, 305 m box	7812ENH.01U305	-	-

\* See pages 15.46 – 15.47 for a more complete listing of products and for more detailed product information.

# Belden IBDN System 1200

## Category 5e, 1.2 Gb/s – 160 MHz

AX101046 GigaFlex PS5E Module



AX101571 Flex Patch Panel, Black



AX102344 GigaFlex PS5E Modular Cord



24570157 GigaFlex 1224 Cable

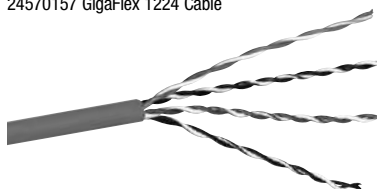

This systems overview page is intended to give you a basic list of the main components used in the system. For a more complete listing of product options and for more detailed product information, see the individual catalog pages listed in this section.

These products are in the process of being assessed for RoHS compliance. Please check our website for the most current RoHS status.

### System 1200

The Belden IBDN system 1200 installations provide the additional throughput and enhanced error-free performance needed to support high-traffic and high-bit-rate applications. It delivers 160 MHz of user bandwidth as well as support for data rates up to 1.2 gigabits per second.

Systems components include: GigaFlex 1200 unbonded-pair UTP cables, DataTwist® 350 bonded-pair UTP cables, GigaBIX and 110 cross-connect systems, PS5E patch panels (including high density and modular versions) and related patch cords, outlets, modules, faceplates and adapters.

Description	Belden Part Number	
	MDVO-Style	Keystone-Style

#### Belden IBDN System 1200, Modules\*

GigaFlex PS5e Module		
T568A/B, White	AX101046	AX101309
T568A/B, Black	AX101047	AX101310

\* See pages 15.28 – 15.29 for a more complete listing of products and for more detailed product information.

Description	Belden Part Number
-------------	--------------------

#### Belden IBDN System 1200, Patch Panels\*

GigaFlex PS5e Patch Panel	
GigaFlex PS5e HD-110 Patch Panel, 1U, 24-port, Black, T568B, loaded	AX100452
GigaFlex PS5e HD-110 Patch Panel, 2U, 48-port, Black, T568B, loaded	AX100454
Flex Patch Panel, 1U, 24-port, Black, unloaded	AX101571
Flex Patch Panel, 2U, 48-port, Black, unloaded	AX101458

\* See page 15.26 for a more complete listing of products and for more detailed product information.

Description	Belden Part Number					
	Blue	White	Grey	Green	Red	Yellow

#### Belden IBDN System 1200, Modular Cords\*

GigaFlex PS5e Modular Cord, LSZH 4-pair, 24 AWG stranded, T568B - T568B						
0.5 m (1.6 ft.)	AX102344	AX102338	AX102386	AX102526	AX102532	AX102538
1.0 m (3.3 ft.)	AX102345	AX102339	AX102387	AX102527	AX102533	AX102539
2.0 m (6.5 ft.)	AX102346	AX102340	AX102388	AX102528	AX102534	AX102540
3.0 m (10 ft.)	AX102347	AX102341	AX102389	AX102529	AX102535	AX102541
5.0 m (16.4 ft.)	AX102348	AX102342	AX102390	AX102530	AX102536	AX102542
10.0 m (33 ft.)	AX102349	AX102343	AX102391	AX102531	AX102537	AX102543

\* See page 15.40 for a more complete listing of products and for more detailed product information.

Description	Belden Part Number			
	Blue	White	Purple	Grey

#### Belden IBDN System 1200, Cables\*

Category 5e • 24 AWG • UTP, 4-pair				
GigaFlex 1212, CMR, 305 m Box	24570161	24570166	–	–
GigaFlex 1213, CMP, 305 m Box	24570800	24570810	–	–
GigaFlex 1224, LSZH, 305 m Box	–	–	24570157	–
GigaFlex 1224, LSZH, 305 m Reel	–	24598301	–	–
GigaFlex 1224, LSZH, 500 m Reel	–	24598331	–	–
DataTwist® 350, LSZH, 305 m Box	–	–	–	1700ENH.004305

\* See pages 15.49 – 15.50 for a more complete listing of products and for more detailed product information.



# GigaBIX Multi System

## Termination Kits and Basic Components

AX101985 GigaBIX Rack Mount Termination Kit, 48-port

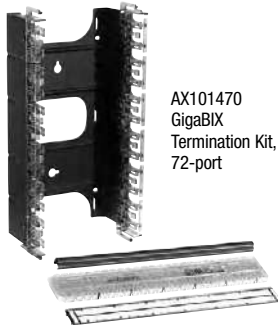
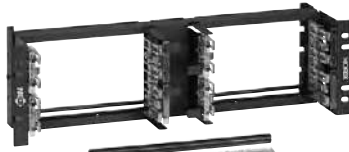

AX101470  
GigaBIX  
Termination Kit,  
72-port

AX101447 GigaBIX Connector,  
6-port

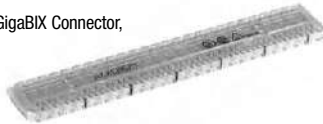

AX101986 GigaBIX Rack Mount Panel

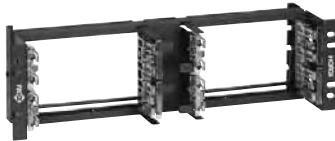

AX101472  
GigaBIX Mount



AX101486 GigaBIX Wire Guard



AX101483 GigaBIX Designation Strip,  
shown here with label

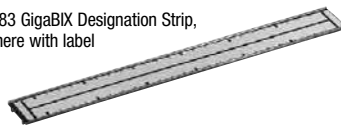

AX101987 GigaBIX/MediaFlex Adapter



### GigaBIX Termination Kits

The GigaBIX termination kits contains all components required to terminate cables in a GigaBIX cross-connect or interconnect system. The termination kits allow for the most cost-effective Category 6 cross-connect or interconnect installations using GigaBIX cross-connect wire or GigaBIX PS6+ patch cords. The GigaBIX mount is designed to accommodate high-performance cables. The GigaBIX connectors have color-coded edges, separation marks and a keying feature that prevents connector insertion in the wrong orientation. Each kit also contains wire guards, designation strips, designation labels, velcro ties and a detailed installation guide.

### GigaBIX Connector

The GigaBIX connector is the core component of the GigaBIX multi system. Its symmetrical construction allows termination of high-performance cables on one side and GigaBIX cross-connect wires or GigaBIX patch cords on the other. Each GigaBIX connector is equipped with 50 double-ended Insulation Displacement Connection (IDC) clips for terminating plastic insulated solid copper conductors without stripping. The connector is built with two staggered rows of IDC clips enclosed in a three-layer construction of fire-retardant plastic wafers. The GigaBIX connectors have color-coded edges, separation marks and a keying feature that prevents connector insertion in the wrong orientation. The GigaBIX connector offers exceptional performance that goes beyond Category 6 which makes it the ideal choice for gigabit cabling networks.

### GigaBIX Mount

The GigaBIX mount for wall installations holds 12 GigaBIX connectors and is designed to accommodate up to 144 high-performance cables when used in a top-to-bottom cross-connect layout.

The GigaBIX rack mount panel allows for customizing rack mount installations for data, voice or multimedia installations. This panel can accommodate up to 8 GigaBIX connectors, for a total of 48 terminations of 4-pair UTP cables, or up to 4 GigaBIX/MediaFlex adapters for a total of 48 multimedia ports.

### GigaBIX Wire Guard

The GigaBIX wire guards are plastic strips that snap behind the GigaBIX connectors after termination to provide strain relief to the twisted pairs. They come as part of the GigaBIX termination kits and can also be ordered separately as replacement components.

### GigaBIX Designation Strip

The GigaBIX designation strips are plastic strips that snap between the GigaBIX connectors to apply the designation labels. They come as part of the GigaBIX termination kits and can also be ordered separately as replacement components. (See the LabelFlex section for designation labels.)

### GigaBIX/MediaFlex Adapter

The GigaBIX/MediaFlex adapter allows for mixed media installation within the expanded GigaBIX multi-family of connectivity. The GigaBIX/MediaFlex adapter can accommodate a variety of MediaFlex inserts including UTP and multimedia inserts to customize multimedia installation in telecommunications rooms, equipment rooms, or consolidation points (see page 15.30 for the accessories).

Description	Belden Part Number
<b>GigaBIX Multi System</b>	
<b>Termination Kits</b>	
GigaBIX Termination Kit, 72-port	<b>AX101470</b>
GigaBIX Termination Kit, 300-pair	<b>AX101471</b>
GigaBIX Rack Mount Termination Kit, 48-port	<b>AX101985</b>
<b>Basic Components</b>	
GigaBIX Connector, 6-port	<b>AX101447</b>
GigaBIX Connector, 25-pair	<b>AX101448</b>
GigaBIX Mount, 12-connector	<b>AX101472</b>
GigaBIX Rack Mount Panel, 48-port	<b>AX101986</b>
GigaBIX Wire Guard	<b>AX101486</b>
GigaBIX Designation Strip	<b>AX101483</b>
GigaBIX/MediaFlex Adapter	<b>AX101987</b>

These products are in the process of being assessed for RoHS compliance. Please check our website for the most current RoHS status.

## GigaBIX Multi System

### Patch Cords and Cross-Connect Wire

AX101945 GigaBIX PS6+ Patch Cord, BIX-BIX, 1.2 m (4 ft.)



AX101951 GigaBIX PS6+ Patch Cord, BIX-8MOD, 1.2 m (4 ft.)



24570521 GigaBIX Cross-connect Wire, 4-pair



#### GigaBIX Patch Cords

GigaBIX patch cords allow for high-density connections, coupled with flexibility for cost-effective installation and administration. Plug-and-go installation and rearrangement of patch cords do not require any special tools or training. GigaBIX patch cords are available in two different configurations: BIX-BIX patch cord configurations for easy cross-connection between equipment and distribution fields, and BIX-8MOD patch cord configurations to easily interconnect equipment utilizing 8-position modular jacks directly into GigaBIX connectors in the distribution field.

The GigaBIX PS6+ patch cords are 4-pair 23 AWG UTP cords. They are used in GigaBIX multi system as part of a Belden IBDN system 2400 and system 4800LX, providing a channel bandwidth of 250 MHz and 300 MHz respectively.

The GigaBIX PS5E patch cords are used in the GigaBIX multi system as part of a Belden IBDN system 1200, providing outstanding channel bandwidth of 160 MHz.

Description	Belden Part Number		
	BIX-BIX	BIX-8MOD T568A-ISDN	BIX-8MOD T568B-ALT

#### GigaBIX Multi System

PS6+ Patch Cords			
1.2 m (4 ft.)	AX101945	AX101951	AX101957
1.8 m (6 ft.)	AX101946	AX101952	AX101958
2.4 m (8 ft.)	AX101947	AX101953	AX101959
3.0 m (10 ft.)	AX101948	AX101954	AX101960
4.6 m (15 ft.)	AX101949	AX101955	AX101961
7.6 m (25 ft.)	AX101950	AX101956	AX101962
PS5E Patch Cords			
1.2 m (4 ft.)	AX101963	AX101969	AX101975
1.8 m (6 ft.)	AX101964	AX101970	AX101976
2.4 m (8 ft.)	AX101965	AX101971	AX101977
3.0 m (10 ft.)	AX101966	AX101972	AX101978
4.6 m (15 ft.)	AX101967	AX101973	AX101979
7.6 m (25 ft.)	AX101968	AX101974	AX101980

These products are in the process of being assessed for RoHS compliance. Please check our website for the most current RoHS status.

#### GigaBIX Cross-Connect Wire

GigaBIX cross-connect wire is intended for use between GigaBIX cross-connect fields in a telecommunications room or in a main cross-connect frame. Using GigaBIX cross-connect wire allows for very flexible and cost-effective installations. The cut-to-length jumper eliminates need for slack management and guarantees permanent installation aesthetics. The GigaBIX cross-connect wire offers transmission performance that goes beyond Category 6 providing additional margin to support Gigabit applications.

Color Code: White/Blue, White/Orange, White/Green, White/Brown

Description	Belden Part Number
-------------	--------------------

#### GigaBIX Multi System

Cross-Connect Wire	
4-pair, 305 m (1000 ft.), Spool	24570521
4-pair, 305 m (1000 ft.), Spool-in-Box	24577B15

These products are in the process of being assessed for RoHS compliance. Please check our website for the most current RoHS status.



# GigaBIX Multi System

## Cable Management Accessories

AX102154 GigaBIX Color-Coded Clip



### GigaBIX Colored Service Clips

The GigaBIX colored service clip is a single-pair plastic clip that snaps on the GigaBIX connectors to visually identify various services when using GigaBIX cross-connect wire.



AX101469 GigaBIX Cable Management Module

### GigaBIX Cable Management Module

The GigaBIX cable management module is designed to be used with a wall mount solution. The accessory allows all terminated cables to be brought from the same side (top or bottom) in a high-density GigaBIX installation (4-mount stack). The modules are stackable side-to-side and top-to-bottom with alignment features to ease installation. The modules can be used horizontally to create a horizontal management channel for more flexibility in a side-to-side patching layout using GigaBIX patch cords.

AX101468 GigaBIX Patch Cord Organizer and AX101521 GigaBIX Patch Cord Organizer Cover

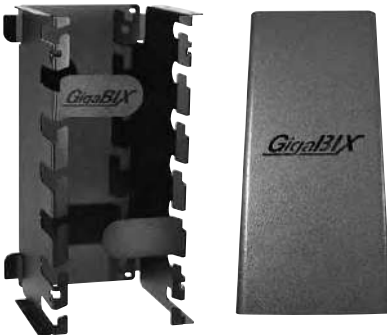

### GigaBIX Patch Cord Organizer

The GigaBIX patch cord organizer is designed to be used with a wall mount solution. The patch cord organizer is a metal trough that interlocks with GigaBIX mounts to create a vertical management channel for GigaBIX patch cords. The patch cord organizer has six (6) openings per side to nicely dress the patch cords while clearing the labeling area on the GigaBIX mount. The organizer can be assembled over cable management modules in large patch cord installations. A patch cord organizer cover can be purchased separately to hide the patch cords and give a very professional and high-tech look to the installation.

### GigaBIX Horizontal Channel Plate

GigaBIX horizontal channel plates are metal plates that attach to the patch cord organizers to create a horizontal management channel for GigaBIX patch cords. The plates are used in pairs and are designed to keep patch cords inside the horizontal channel.



AX101520 GigaBIX Horizontal Channel Plate

### GigaBIX Management Ring

The GigaBIX management ring is a plastic ring that interlocks with the GigaBIX mounts to create a high-density wall mount cross-connect system. The rings are assembled in systems when using cross-connect wire and have a capacity of 450 GigaBIX cross-connect wires (1800-pairs total).



AX101478 GigaBIX Management Ring

Description	Belden Part Number
-------------	--------------------

### GigaBIX Multi System

#### Cable Management Accessories

GigaBIX Color-Coded Clip, Grey	AX102146
GigaBIX Color-Coded Clip, Almond	AX102147
GigaBIX Color-Coded Clip, White	AX102148
GigaBIX Color-Coded Clip, Black	AX102149
GigaBIX Color-Coded Clip, Orange	AX102150
GigaBIX Color-Coded Clip, Red	AX102151
GigaBIX Color-Coded Clip, Yellow	AX102152
GigaBIX Color-Coded Clip, Green	AX102153
GigaBIX Color-Coded Clip, Blue	AX102154
GigaBIX Color-Coded Clip, Purple	AX102155
GigaBIX Color-Coded Clip, Brown	AX102156
GigaBIX Cable Management Module	AX101469
GigaBIX Patch Cord Organizer	AX101468
GigaBIX Patch Cord Organizer, Cover	AX101521
GigaBIX Horizontal Channel Plate	AX101520
GigaBIX Management Ring	AX101478

These products are in the process of being assessed for RoHS compliance. Please check our website for the most current RoHS status.

# GigaBIX Multi System

## Cable Management Accessories

### GigaBIX Distribution Frame & Accessories

GigaBIX distribution frames provide a compact mounting unit for large cross-connect installations of data or voice services.

The GigaBIX distribution frame can accommodate up to (16) 12-connector GigaBIX mounts, eight on the equipment side and eight on the distribution side. The GigaBIX distribution frame has a capacity of 1152 ports or 4800 pairs. It is backwards compatible with BIX mounts (QMBIX12E) and can be used to continue a row of BIX distribution frames (QFBIX24E).

The GigaBIX frame end kit consists of eight (8) cable trays and eight (8) distribution rings plus appropriate mounting hardware. One kit is required to support GigaBIX cross-connect wires on the sides of a single-frame installation or on the end frames of a multi-frame installation.

The GigaBIX overhead kit consists of two (2) metal bars and four (4) "J" bolts plus appropriate mounting hardware to support cable ladder (not included) running over a row of GigaBIX distribution frames.

Description	Belden Part Number
<b>GigaBIX Multi System</b>	
<b>Cable Management Accessories</b>	
Distribution Frame, 1152-ports/4800-pairs	<b>AX102073</b>
Frame End Kit	<b>AX102082</b>
Frame Overhead Kit	<b>AX102145</b>

These products are in the process of being assessed for RoHS compliance. Please check our website for the most current RoHS status.

AX102073 GigaBIX Distribution Frame

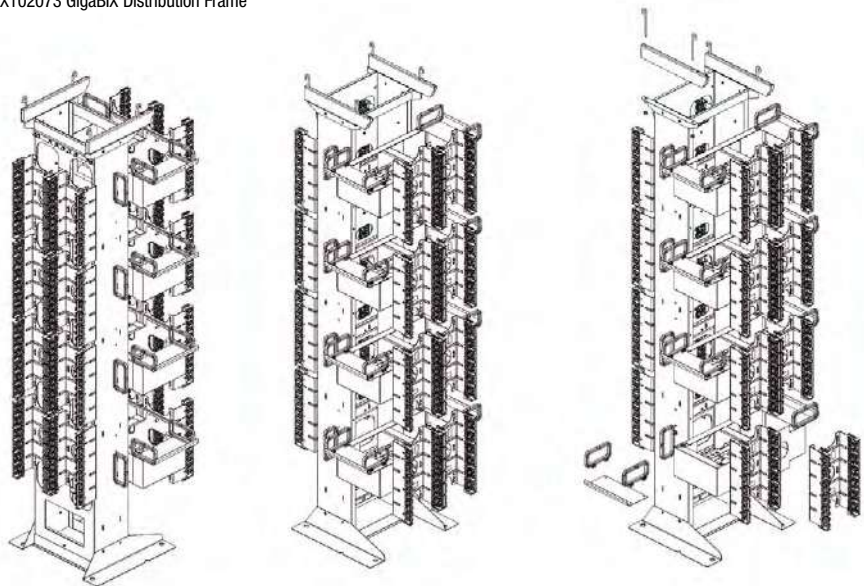

## BIX Cross-Connect System

### Distribution Connectors, Multiplying Connectors and Modular Jack Connectors

A0393146 QCBIX1A4 Connector



#### BIX Distribution Connector

The BIX distribution connector is a 25-pair connector. The connector's symmetrical construction allows termination of cables on one side and cross-connect jumper wires or BIX patch cords on the other. Each BIX connector is equipped with 50 double-ended Insulation Displacement Connection (IDC) clips for terminating plastic insulated solid copper conductors without stripping and pair splitters on each side of the connector facilitate wire insertion.

A0266827 QCBIX5A Multiplying Connector



#### BIX Multiplying Connector

BIX multiplying connectors are used to generate multiple outputs from a single input. Construction of these connectors is identical to that of BIX distribution connectors, except for the IDC clips which are bridged. BIX multiplying connectors are typically used in voice applications.

The QCBIX2A connector is built using 24 sets of bridged clips (2 clips each). It is used to terminate various facilities where multiples of 2 are required.

The QCBIX5A connector is built using 10 sets of bridged clips (5 clips each). It is used for multiple jumper connections to the same equipment.

The QCBIX7A connector is built using 10 sets of bridged clips (four 2-clip and six 7-clip bridged arrangements). It is primarily intended for use with 1A type key telephone systems. Each connector can terminate up to three lines of key equipment providing service to as many as seven key telephone sets per line.

AX100798 BIX Modular Jack Connector



#### BIX Modular Jack Connector

BIX modular jack connectors provide a fast and flexible method to manage small-to-medium cross-connect installations. These connectors are built with a BIX connector pre-wired to standard modular jacks. They allow front-access termination and patching.

The NXXCBMC6U connector is a 6-port, 8-position modular connector used for data applications. It exceeds all Category 5e channel requirements when used with PS5E modular cords in a Belden IBDN 1200 system.

QCBIX36-type connectors are used mostly for voice applications. The QCBIX36D connector is a 6-port, 8-position modular connector. It is pre-wired to USOC 8-wire wiring scheme specifications. The QCBIX36C connector is an 8-port, 6-position modular connector. It is pre-wired to USOC 6-wire wiring scheme specifications. The QCBIX36B connector is a 12-port, 6-position modular connector. It is pre-wired to USOC 4-wire wiring scheme specifications.

Description	Belden Part Number
-------------	--------------------

#### BIX Cross-Connect System

Distribution Connector	
BIX Distribution Connector, 5-pair Marking	A0266828
BIX Distribution Connector, 4-pair Marking	A0393146
Multiplying Connector	
BIX Multiplying Connector, QCBIX2A, 25-pair, 12x2-pair	A0269923
BIX Multiplying Connector, QCBIX5A, 25-pair, 5x5-pair	A0266827
BIX Multiplying Connector, QCBIX7A, 25-pair, 2x2-pair & 3x7-pair	A0269925
Modular Jack Connector	
BIX Modular Jack Connector, NXXCBMC6U, 6-port, PS5E, T568A/B Coded	AX100798
BIX Modular Jack Connector, QCBIX36D, 6-port, USOC, 8-pin	A0341173
BIX Modular Jack Connector, QCBIX36C, 8-port, USOC, 6-pin	A0330864
BIX Modular Jack Connector, QCBIX36B, 12-port, USOC, 4-pin	A0330863

These products are in the process of being assessed for RoHS compliance. Please check our website for the most current RoHS status.

# BIX Cross-Connect System

## Mounts, Covers and Wire Management Accessories

A0340836 QMBIX12E BIX Mount, 300-pair



A0284798 QMBIX10C BIX Mount, 50-pair



A0277853 QMBIX31A 50-pair Mount with Locking Cover



A0285986 Locking Cover for 250-pair Mount



A0276396 BIX Cover, QMBIX10A, Stand-alone installation, Locking



A0270168 Distribution Ring



### BIX Mount

BIX mounts are basic components used in building a cross-connect system. They can accept BIX distribution, multiplying or modular jack connectors. The 300 and 250-pair mounts can be wall-mounted or installed on BIX frames. These mounts feature an interlocking design allowing them to be stacked for larger cross-connect installations.

The BIX 50-pair mount is typically used in small cross-connect installations. Also available is a 50-pair mount with cover that is sold as an assembly and is typically used in small cross-connect installations where security and/or dust protection is required.

### BIX Cover

BIX covers can be used to restrict access of cross-connect installations for better protection and security. Two sizes are available to suit either the QMBIX12E 300-pair mount or the QMBIX10A 250-pair mount. The two locking covers used in wall or frame-mounted installations are molded with translucent plastic allowing visual inspection. Also available are two covers used exclusively in stand-alone QMBIX10A 250-pair mount installations: one locking, the other non-locking – both have four cable entries, one at each corner.

### Distribution Ring

The distribution ring is used in wall mount installations providing a cross-connect channel for jumper wires, patch cords and cables. The distribution ring interlocks with the QMBIX12E or QMBIX10A mounts, providing proper spacing and alignment.

Description	Belden Part Number
<b>BIX Cross-Connect System</b>	
<b>BIX Mount</b>	
BIX Mount, QMBIX12E (300-pair)	A0340836
BIX Mount, QMBIX10A (250-pair)	A0270164
BIX Mount, QMBIX10C (50-pair)	A0284798
<b>BIX Mount with Cover</b>	
BIX Mount with Cover, (Locking), 50-pair	A0277853
BIX Mount with Cover, (Snap-on), 50-pair	A0277854
<b>BIX Locking Cover</b>	
BIX Locking Cover, for QMBIX12E (300-pair)	A0340838
BIX Locking Cover, for QMBIX10A (250-pair)	A0285986
<b>BIX Cover</b>	
BIX Cover, QMBIX10A, Stand-alone installation, locking	A0276396
BIX Cover, QMBIX10A, Stand-alone installation, non-locking	A0276394
<b>Distribution Ring</b>	
Distribution Ring	A0270168

These products are in the process of being assessed for RoHS compliance. Please check our website for the most current RoHS status.

## BIX Cross-Connect System

### BIX Distribution Frames, Universal BIX-PAC and Trunk Access Blocks

A0340837 BIX Frame



#### BIX Distribution Frame

BIX distribution frames provide a compact mounting unit for large cross-connect installations. The QFBIX24E BIX Frame can accommodate up to 16 QMBIX12E 300-pair mounts, eight on the vertical side and eight on the horizontal side. The QFBIX24E BIX frame has a capacity of 4800-pair. The QFBIX24A BIX Frame can accommodate up to 16 QMBIX10A 250-pair mounts, eight on the vertical side and eight on the horizontal side. The QFBIX24A BIX Frame has a capacity of 4000-pair.

The BIX frame end kit consists of eight cable trays and eight distribution rings plus appropriate mounting hardware. One kit is required to support cross-connect wires on the sides of the shelves in a single-frame installation or on the end frames of a multi-frame installation.

The distribution rings are plastic rings used to manage cross-connect wires.

A0321776 Universal BIX-PAC Version 10-10

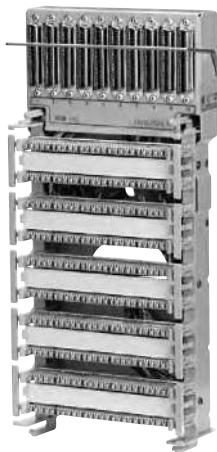

#### Universal BIX-PAC

The universal BIX-PAC provides a fast, factory-wired, pre-tested and easy-to-install method of terminating wiring for the voice environment. A typical application for this product is in the main distribution terminal system or the riser terminal system, where it can provide connectivity and cross-connection for up to 250 pairs. The units come equipped with up to 10 QCBIX1A connectors and 10 fifty-pin type telco connectors for the termination of connectorized cables. Also available is a BIX-PAC enclosure, which is a fire-retardant polystyrene structural foam box that can house one BIX-PAC. The enclosure has a snap-on cover and removable panels for cable entry on top, bottom and sides.

#### BIX Trunk Access Block

BIX trunk access blocks provide a fast, factory-wired, pre-tested and easy-to-install method for demarcation or testing points on customer premises. Typical applications are in the building entrance system or the main distribution terminal system, where the demarcation point between the network provider and the customer equipment usually can be found.

A0318897 BIX PAC Enclosure



A0327326 BIX Trunk Access Block

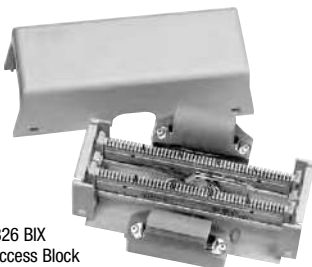

Description	Belden Part Number
-------------	--------------------

#### BIX Cross-Connect System

BIX Distribution Frame	
BIX Distribution Frame, 4800-pair (4 Shelves for 16 Mounts, 300-pair)	A0340837
BIX Distribution Frame, 4000-pair (4 Shelves for 16 Mounts, 250-pair)	A0275511
BIX Distribution Frame Accessories	
BIX Distribution Frame Accessories, End Kit (4 Shelves)	A0275512*
BIX Distribution Frame Accessories, Distribution Ring	P0596540*
Universal BIX-PAC	
Universal BIX-PAC, 10-8, 8 RJ21X Female to 8 QCBIX1A Connectors	A0321775
Universal BIX-PAC, 10-10, 10 RJ21X Female to 10 QCBIX1A Connectors	A0321776
BIX PAC Enclosure	
BIX PAC Enclosure, Grey	A0318897
BIX Trunk Access Block	
BIX Trunk Access Block, 1 RJ21X Female to 1 QCBIX1A Connector	A0327325
BIX Trunk Access Block, 2 RJ21X Female to 2 QCBIX1A Connector	A0327326

\* Eight distribution rings come as part of the BIX distribution frame end kit. Additional distribution rings can be ordered separately. Use (1) end kit per row of frames.

These products are in the process of being assessed for RoHS compliance. Please check our website for the most current RoHS status.

## BIX Cross-Connect System

### BIX Patch Cords and B-Plus Cross-Connect Wire

A0410494 BIX Patch Cord, BIX-BIX, 2-pair



A0410469 BIX Patch Cord, BIX-BIX, 1-pair



22208260 B-Plus Cross-Connect Wire



#### BIX Patch Cords

BIX patch cords allow for high-density connections, coupled with flexibility for cost-effective installation and administration. Installation and rearrangement of patch cords do not require any special tools or training. BIX patch cord plugs terminate directly into QCBIX1A/1A4 connectors.

#### B-Plus Cross-Connect Wire

B-Plus cross-connect wire is intended primarily for use between incoming cables and station equipment in a telecommunications room or at a main cross-connect.

Z cross-connect wire is intended primarily for use in voice applications such as cross-connecting PBX or key telephone system equipment to backbone or horizontal distribution cables.

Description	Belden Part Number
<b>BIX Cross-Connect System</b>	
<b>BIX Patch Cord</b>	
BIX Patch Cord, BIX-BIX, 2-pair, 1.2 m (4 ft.)	<b>A0410494</b>
BIX Patch Cord, BIX-BIX, 1-pair, 1.2 m (4 ft.)	<b>A0410469</b>
BIX Patch Cord, BIX-BIX, 2-pair, 2.1 m (7 ft.)	<b>A0410495</b>
BIX Patch Cord, BIX-BIX, 1-pair, 2.1 m (7 ft.)	<b>A0410471</b>
BIX Patch Cord, BIX-BIX, 2-pair, 3.0 m (10 ft.)	<b>A0410496</b>
BIX Patch Cord, BIX-BIX, 1-pair, 3.0 m (10 ft.)	<b>A0410473</b>
BIX Patch Cord, BIX-BIX, 2-pair, 4.6 m (15 ft.)	<b>A0410497</b>
BIX Patch Cord, BIX-BIX, 1-pair, 4.6 m (15 ft.)	<b>A0410475</b>
BIX Patch Cord, BIX-BIX, 1-pair, 7.6 m (25 ft.)	<b>A0410493</b>

For 4-pair connections, please see the GigaBIX patch cord section.

<b>B-Plus Cross-Connect Wire</b>	
24 AWG, 1-pair, Wh/Bl, 305 m (1000 ft.), K-Carton	<b>22208250</b>
24 AWG, 1-pair, Wh/Bl, 305 m (1000 ft.), Spool (S77)	<b>22208253</b>
24 AWG, 2-pair, Wh/Bl/Wh/Or, 305 m (1000 ft.), K-Carton	<b>22208260</b>
24 AWG, 2-pair, Wh/Gr/Wh/Or, 305 m (1000 ft.), K-Carton	<b>22208231</b>
24 AWG, 3-pair, Wh/Bl/Wh/Or/Wh/Gr, 152 m (500 ft.), K-Carton	<b>22208265</b>
24 AWG, 3-pair, Wh/Bl/Wh/Or/Wh/Gr, 200 m, K-Carton	<b>22208235</b>
24 AWG, 4-pair, Wh/Bl/Wh/Or/Wh/Gr/Wh/Br, 152 m (500 ft.), K-Carton	<b>22208270</b>
<b>Z Cross-Connect Wire</b>	
Z Cross-Connect Wire, 24 AWG, 1-pair, Bl/Ye, 300 m (984 ft.), Spool	<b>22208010</b>
Z Cross-Connect Wire, 24 AWG, 1-pair, Bl/Rd, 300 m (984 ft.), Spool	<b>22208067</b>

These products are in the process of being assessed for RoHS compliance. Please check our website for the most current RoHS status.

# BIX Cross-Connect System

## BIX Tools, Testing Tools, Accessories and Designation Strip

A0270165 BIX Connecting Tool

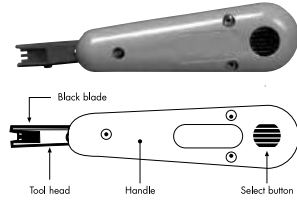

Tool in CUT position      Tool in NO CUT position



C0054642 Tool Pouch



A0270166 BIX Test Probe



A0270172 Special Service Guard



A0325493 Bridging Clip



P0660798 BIX Wire Retainer



C0039222 BIX Cable Tie

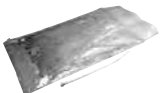

19"/23" (0.48 m/0.58 m) Rack Bracket Kits



A0270169 BIX Designation Strip



### BIX Connecting Tool

The BIX connecting tool is the only tool required to terminate cables, pigtails or jumper wires on all GigaBIX and BIX connection products. The BIX connecting tool is a spring-activated hand tool. A single forward movement will seat the wire into the BIX IDC clip and cut off the excess wire. The tool will terminate 22-26-AWG plastic insulated solid copper conductors. A separate leather BIX tool pouch to carry and protect the BIX tool can be ordered.

### BIX Test Probe

The BIX test probe is a single-pair probe that clips onto the termination clip of BIX distribution or BIX modular jack connectors to facilitate testing.

### BIX Accessories

The BIX special service guard is a single-pair red plastic clip used to identify a connection within a BIX distribution field that requires special attention prior to any maintenance work.

The BIX bridging clip is a single-pair clip used to bridge single-pair connections of two BIX connectors.

The BIX wire retainer is a plastic extrusion that fits over the terminated wires on a BIX connector to prevent them from being pulled out of the IDC contacts. It can be used to secure a permanent connection on either side of a BIX connector.

This 19" (0.48 m) rack bracket kit provides the hardware for BIX mount installation into a 19" (0.48 m) rack. This kit comes complete with two mounting bars, four screws for rack mounting, four screws for BIX mount assemblies and an installation guide. BIX cable ties are used for securing wire bundles to the BIX connector.

### BIX Designation Strip

The BIX designation strip is designed to be used in conjunction with all BIX mounts and BIX connectors. It snaps in between two connectors and provides space for self adhesive BIX labels. The strip is made of white fire-retardant plastic, with ridges on the top and bottom for easy alignment and placement of designation labels. (See the LabelFlex section for designation labels.)

Description	Belden Part Number
<b>BIX Cross-Connect System</b>	
<b>BIX Tools</b>	
BIX Connecting Tool	A0270165
Tool Pouch	C0054642
<b>BIX Test Probe</b>	
BIX Test Probe, 1-pair, 1/pack	A0270166
<b>BIX Accessories</b>	
BIX Special Service Guard, 1-pair, Red, 50/pack	A0270172
BIX Bridging Clip, 1-pair, Grey, 50/pack	A0325091
BIX Bridging Clip, 1-pair, White, 50/pack	A0325493
BIX Wire Retainer, 100/pack	P0660798
19" (0.48 m) Rack Bracket Kit, 2 bars/pack	A0352331
23" (0.58 m) Rack Bracket Kit, 2 bars/pack	NN00043
BIX Cable Tie, 100/pack	C0039222
<b>BIX Designation Strip</b>	
BIX Designation Strip, White, 50/pack	A0270169

These products are in the process of being assessed for RoHS compliance. Please check our website for the most current RoHS status.

## 110 Cross-Connect System

110 Cross-Connect Kits, 110 Connecting Blocks, 110 Wall Mount Frame Kits and 110 Wiring Blocks

AX100694 110 Cross-Connect Kit, 100-pair

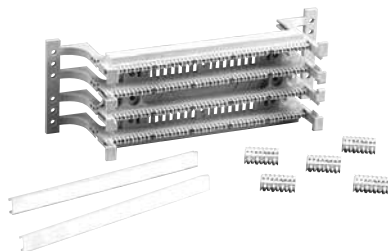

AX100696 110 Cross-Connect Kit, 300-pair

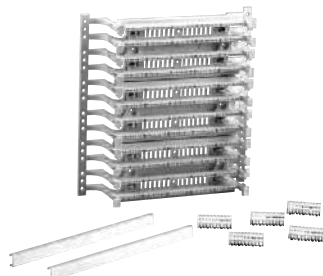

AX100707 110 Connecting Block, 4-pair



AX100708 110 Connecting Block, 5-pair

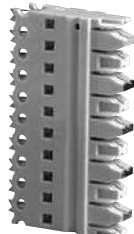

AX100697 110 Wall Mount Frame Kit, 300-pair



AX100692 Wiring Block, 300-pair

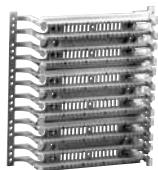

AX100691 Wiring Block, 100-pair



### 110 Cross-Connect Kit

110 cross-connect kits contain all material required to terminate distribution or equipment cables into a 110 cross-connect system. Kits consist of one wiring block (100-pair or 300-pair) with legs, connecting blocks (4-pair or 5-pair), designation strips and labels.

### 110 Connecting Block

The 110 connecting blocks are modular connectors equipped with double-sided Insulation Displacement Connection (IDC) clips that are used to terminate plastic insulated solid copper conductors in 110 wiring blocks. The color-coded connecting blocks are available in 4-pair and 5-pair configurations. These blocks are compatible with other existing 110 cross-connect systems.

### 110 Wall Mount Frame Kit

110 wall mount frame kits simplify planning, organizing and implementation of wall mounted cross-connect systems. They are available in 300-pair and 900-pair configurations making them ideal for small telecommunications room installations. Kits consist of wiring blocks and cable management troughs to be mounted on a cable channel. Kits include all components required to complete a 110 cross-connect installation with either 4-pair or 5-pair connecting blocks.

### 110 Wiring Block

110 wiring blocks are rigid plastic indexing strip assemblies designed to hold and align wires prior to terminating 110 connecting blocks. 110 wiring blocks are available in 100-pair and 300-pair configurations with legs and 100-pair without legs. 110 wiring blocks are compatible with 22 to 26 AWG wires and accept 4-pair or 5-pair connecting blocks. They are specially designed to simplify data cabling installations. A deeper channel and open slots in the base allow cable to be brought close to the termination point. These blocks are compatible with other existing 110 cross-connect systems.

Description	Belden Part Number
<b>110 Cross-Connect System</b>	
<b>110 Cross-Connect Kit</b>	
110 Cross-Connect Kit, 100-pair, with 4-pair Connecting Blocks	<b>AX100693</b>
110 Cross-Connect Kit, 100-pair, with 5-pair Connecting Blocks	<b>AX100694</b>
110 Cross-Connect Kit, 300-pair, with 4-pair Connecting Blocks	<b>AX100695</b>
110 Cross-Connect Kit, 300-pair, with 5-pair Connecting Blocks	<b>AX100696</b>
<b>110 Connecting Block</b>	
110 Connecting Block, 110C4, 4-pair	<b>AX100707</b>
110 Connecting Block, 110C5, 5-pair	<b>AX100708</b>
<b>110 Wall Mount Frame Kit</b>	
110 Wall Mount Frame Kit, 300-pair, with 4-pair Connecting Blocks	<b>AX100697</b>
110 Wall Mount Frame Kit, 300-pair, with 5-pair Connecting Blocks	<b>AX100698</b>
110 Wall Mount Frame Kit, 900-pair, with 4-pair Connecting Blocks	<b>AX100699</b>
110 Wall Mount Frame Kit, 900-pair, with 5-pair Connecting Blocks	<b>AX100700</b>
<b>110 Wiring Block</b>	
110 Wiring Block, 100-pair, without legs	<b>AX100690</b>
110 Wiring Block, 100-pair, with legs	<b>AX100691</b>
110 Wiring Block, 300-pair, with legs	<b>AX100692</b>

The 110 cross-connect system is not available in all countries.

These products are in the process of being assessed for RoHS compliance. Please check our website for the most current RoHS status.



# 110 Cross-Connect System

## 110 Designation Strip and Management Accessories

AX100721 110 Designation Strip



### 110 Designation Strip

The 110 designation strip is designed to be used in conjunction with all 110 wiring blocks. It snaps in between two rows of 110 connecting blocks and provides space to insert a designation label. The strip is made of clear PVC.

AX100705 Cable Management Trough



### 110 Management Accessories

Cable management troughs are utilized as channels positioned between wiring blocks for horizontal or vertical dressing of cross-connect wires and patch cords. They are available with and without mounting legs.

Cable management rings are used for management of cross-connect wires and cables in 110 cross-connect systems. They can be mounted directly onto a plywood backboard between columns of wiring blocks. They are available in two different sizes.

AX100706 Cable Management Trough with Legs

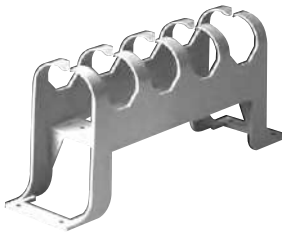

Wall mount cable management frames are pre-assembled vertical cable managers that are used between 110 wall mount frame kits for vertical management of patch cords. They simplify planning and installation of 110 cross-connect systems. They are available in two sizes to use with 300-pair and 900-pair wall mount frame kits.

AX100703 Cable Management Ring

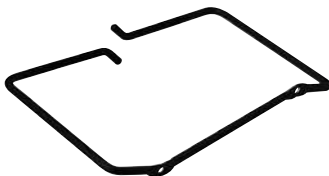

Description	Belden Part Number
<b>110 Cross-Connect System</b>	
<b>110 Designation Strip</b>	
110 Designation Strip	AX100721
<b>110 Management Accessories</b>	
Cable Management Trough, without legs	AX100705
Cable Management Trough, with legs	AX100706
Cable Management Ring, Small 144.8 mm (5.7")	AX100703
Cable Management Ring, Large 216 mm (8.5")	AX100704
Wall Mount Cable Management Frame, 300-pair	AX100701
Wall Mount Cable Management Frame, 900-pair	AX100702

The 110 cross-connect system is not available in all countries.

These products are in the process of being assessed for RoHS compliance. Please check our website for the most current RoHS status.

AX100701 Wall Mount Cable Management Frame, 300-pair



# 110 Cross-Connect System

## 110 Patch Cords

AX300001 PS5E 110 Patch Cord, 110-110, 4-pair



AX300010 PS5E 110 Patch Cord, 110-8MOD, 4-pair



AX300013 110 Patch Cord, 110-110, 2-pair



### 110 Patch Cord

110 patch cords allow for high density connections in a 110 cross-connect system. 110 patch cord rearrangements do not require any special tools or training thus providing flexibility for cost-effective installation and administration. 110 patch cords are available in two different configurations. 110-110 patch cord configurations are used for easy cross-connection between equipment and distribution fields.

110-8MOD patch cord configurations are used to easily interconnect equipment utilizing 8-position modular jacks directly into 110C4/C5 connecting blocks in the distribution field. PS5E 110 patch cords offer Category 5e performance. These patch cords are compatible with other existing 110 cross-connect systems.

### 110 Patch Cord Connector

110 patch cord connectors are available in 1, 2 and 4-pair configurations for field assembly of Category 5 patch cords. They can terminate plastic insulated stranded copper conductors 24 AWG.

Description	Belden Part Number
<b>110 Cross-Connect System</b>	
<b>110 Patch Cord</b>	
110 Patch Cord, PS5E 110-110, 4-pair, 1.2 m (4 ft.)	AX300001
110 Patch Cord, PS5E 110-110, 4-pair, 1.8 m (6 ft.)	AX300002
110 Patch Cord, PS5E 110-110, 4-pair, 2.4 m (8 ft.)	AX300025
110 Patch Cord, PS5E 110-110, 4-pair, 3.0 m (10 ft.)	AX300026
110 Patch Cord, PS5E 110-110, 4-pair, 6.1 m (20 ft.)	AX300027
110 Patch Cord, PS5E 110-8MOD, 4-pair, T568A, 1.2 m (4 ft.)	AX300010
110 Patch Cord, PS5E 110-8MOD, 4-pair, T568A, 1.8 m (6 ft.)	AX300009
110 Patch Cord, PS5E 110-8MOD, 4-pair, T568A, 2.4 m (8 ft.)	AX300029
110 Patch Cord, PS5E 110-8MOD, 4-pair, T568A, 3.0 m (10 ft.)	AX300030
110 Patch Cord, PS5E 110-8MOD, 4-pair, T568A, 6.1 m (20 ft.)	AX300032
110 Patch Cord, PS5E 110-8MOD, 4-pair, T568B, 1.2 m (4 ft.)	AX300008
110 Patch Cord, PS5E 110-8MOD, 4-pair, T568B, 1.8 m (6 ft.)	AX300005
110 Patch Cord, PS5E 110-8MOD, 4-pair, T568B, 2.4 m (8 ft.)	AX300011
110 Patch Cord, PS5E 110-8MOD, 4-pair, T568B, 3.0 m (10 ft.)	AX300034
110 Patch Cord, PS5E 110-8MOD, 4-pair, T568B, 6.1 m (20 ft.)	AX300017
110 Patch Cord, 110-110, 2-pair, 1.2 m (4 ft.)	AX300013
110 Patch Cord, 110-110, 2-pair, 1.8 m (6 ft.)	AX300014
110 Patch Cord, 110-110, 2-pair, 2.4 m (8 ft.)	AX300015
110 Patch Cord, 110-110, 2-pair, 3.0 m (10 ft.)	AX300037
110 Patch Cord, 110-110, 2-pair, 6.1 m (20 ft.)	AX300038
110 Patch Cord, 110-110, 1-pair, 0.6 m (2 ft.)	AX300039
110 Patch Cord, 110-110, 1-pair, 1.2 m (4 ft.)	AX300006
110 Patch Cord, 110-110, 1-pair, 1.8 m (6 ft.)	AX300007
110 Patch Cord, 110-110, 1-pair, 2.4 m (8 ft.)	AX300012
110 Patch Cord, 110-110, 1-pair, 3.0 m (10 ft.)	AX300021
110 Patch Cord, 110-110, 1-pair, 6.1 m (20 ft.)	AX300040
<b>110 Patch Cord Connector</b>	
110 Patch Cord Connector, 4-pair	AX100711
110 Patch Cord Connector, 2-pair	AX100710
110 Patch Cord Connector, 1-pair	AX100709

The 110 cross-connect system is not available in all countries. Other lengths are available, please contact customer service for further details.

These products are in the process of being assessed for RoHS compliance. Please check our website for the most current RoHS status.

# Labels

## LabelFlex

AX101537 LabelFlex Labels



### LabelFlex – Automated Labeling Solution

The LabelFlex solution is aimed at simplifying network management. Using the labeling system (software and label types), the installer can rapidly produce quality, application specific labels for most Belden IBDN products in a fraction of the time taken by traditional methods.

The range of Belden IBDN products covered by the labeling system is:

- GigaBIX & BIX cross-connect systems
- Flex patch panels
- ID tubes
- BIX Modular jack connectors
- Workstation outlets
- PS5E HD patch panels
- 110 cross-connect system
- MediaFlex faceplates series
- GigaFlex PS6+ patch panels
- Cable applications, 4-pair and 25-pair

Description	Belden Part Number
<b>Labels for MediaFlex Faceplates</b>	
Almond/Silver, 30 labels/sheet, 10 sheets/pack	AX101820
White, 30 labels/sheet, 10 sheets/pack	AX101821
<b>Labels for BIX and GigaBIX</b>	
Grey, 15 labels/sheet, 5 sheets/pack	AX101532
White, 15 labels/sheet, 5 sheets/pack	AX101533
Orange, 15 labels/sheet, 5 sheets/pack	AX101534
Red, 15 labels/sheet, 5 sheets/pack	AX101535
Yellow, 15 labels/sheet, 5 sheets/pack	AX101536
Green, 15 labels/sheet, 5 sheets/pack	AX101537
Blue, 15 labels/sheet, 5 sheets/pack	AX101538
Purple, 15 labels/sheet, 5 sheets/pack	AX101539
Brown, 15 labels/sheet, 5 sheets/pack	AX101540
Silver, 15 labels/sheet, 5 sheets/pack	AX101541
<b>Labels for BIX Modular Jack Connector</b>	
Grey, 28 labels/sheet, 5 sheets/pack	AX101542
White, 28 labels/sheet, 5 sheets/pack	AX101543
Orange, 28 labels/sheet, 5 sheets/pack	AX101544
Red, 28 labels/sheet, 5 sheets/pack	AX101545
Yellow, 28 labels/sheet, 5 sheets/pack	AX101546
Green, 28 labels/sheet, 5 sheets/pack	AX101547
Blue, 28 labels/sheet, 5 sheets/pack	AX101548
Purple, 28 labels/sheet, 5 sheets/pack	AX101549
Brown, 28 labels/sheet, 5 sheets/pack	AX101550
Silver, 28 labels/sheet, 5 sheets/pack	AX101584
<b>Labels for Patch Panels, Outlets and Cables</b>	
Labels for Flex Patch Panels, White, 28 labels/sheet, 5 sheets/pack	AX101551
Labels for Workstation Faceplates, White, 80 labels/sheet, 25 sheets/pack	AX101552
Labels for Workstation Single Port ID, White, 450 labels/sheet, 5 sheets/pack	AX101553
Labels for HD Patch Panels, White, 18 labels/sheet, 5 sheets/pack	AX101554
Labels for GigaFlex PS6+ Patch Panels, White, 28 labels/sheet, 5 sheets/pack	AX101626
Labels for 4-pair cables, Grey, 48 labels/sheet, 25 sheets/pack	AX101555
Labels for 25-pair cables, White, 24 labels/sheet, 25 sheets/pack	AX101556
<b>Labels for 110 Cross-Connect</b>	
Grey, 18 labels/sheet, 5 sheets/pack	AX101557
White, 18 labels/sheet, 5 sheets/pack	AX101558
Orange, 18 labels/sheet, 5 sheets/pack	AX101559
Red, 18 labels/sheet, 5 sheets/pack	AX101560
Yellow, 18 labels/sheet, 5 sheets/pack	AX101561
Green, 18 labels/sheet, 5 sheets/pack	AX101562
Blue, 18 labels/sheet, 5 sheets/pack	AX101563
Purple, 18 labels/sheet, 5 sheets/pack	AX101564
Brown, 18 labels/sheet, 5 sheets/pack	AX101565
<b>Labels for ID Tubes</b>	
3.1" (0.08 m) long, White, 32 labels/sheet, 5 sheets/pack	AX101566
4.4" (0.11 m) long, White, 30 labels/sheet, 5 sheets/pack	AX101567
7.4" (0.19 m) long, White, 19 labels/sheet, 5 sheets/pack	AX101568
<b>Software</b>	
Automated LabelFlex Advanced Software, 1 CD/pack	AX101569

The 110 cross-connect system is not available in all countries. Other lengths are available, please contact customer service for further details.

These products are in the process of being assessed for RoHS compliance. Please check our website for the most current RoHS status.

## Patch Panels

### GigaFlex PS6+ Patch Panels Category 6, Telepanel

AX101613 GigaFlex PS6+ Patch Panel, 2U, 48-port



#### GigaFlex PS6+ Patch Panel

The GigaFlex PS6+ patch panel is a fully loaded patch panel using black GigaFlex PS6+ modules. The unmatched performance of the GigaFlex PS6+ module exceeds all parameters specified in the Category 6 standard. All performance characteristics including NEXT, FEXT, Attenuation and Return Loss have been set to guarantee transmission performance up to 300 MHz and a data-rate of up to 4.8 Gb/s.

Description	Belden Part Number
-------------	--------------------

#### Patch Panels

GigaFlex PS6+ Patch Panel	
GigaFlex PS6+ Patch Panel, 1U, 24-port, Grey	<b>AX101612</b>
GigaFlex PS6+ Patch Panel, 1U, 24-port, Black	<b>AX101611</b>
GigaFlex PS6+ Patch Panel, 2U, 48-port, Grey	<b>AX101614</b>
GigaFlex PS6+ Patch Panel, 2U, 48-port, Black	<b>AX101613</b>

These products are in the process of being assessed for RoHS compliance. Please check our website for the most current RoHS status.

E1005460 Telepanel, Black



#### Telepanel

The 50-ports telepanel is supplied in an easy and functional design with fixed cable guide prepared for use of Velcro tape or strips. All jacks are mounted as RJ45, enabling the use of general patch cables. The panel is available in white and black color with numbering from 1 to 50. Mounting is carried out by means of a "KRONE" tool.

Description	Belden Part Number
-------------	--------------------

#### Telepanel

Telepanel, 1U, 50-ports, Black	<b>E1005460</b>
--------------------------------	-----------------

These products are in the process of being assessed for RoHS compliance. Please check our website for the most current RoHS status.

## Patch Panels

### PS5E HD Patch Panels Category 5e, PS5E BIX Patch Panels Category 5e and Flex Patch Panels

AX100465 PS5E HD Patch Panel, 1U, 24-port



#### PS5E HD Patch Panel

The Universal PS5E HD patch panels series includes a variety of product styles, sizes and wiring configurations. PS5E HD patch panels are robust and installer-friendly products by design, combining punch down connectors with standard modular jacks. They are available in both BIX and 110 Insulation Displacement Connection (IDC) options. A color-coded icon labeling system can be used to tag each patch panel port and simplify network management (ordered separately). PS5E HD patch panels offer Category 5e performance.

AX100473 PS5E HD Patch Panel, 2U, 48-port



#### PS5E BIX Patch Panel

The PS5E BIX patch panel is a medium density panel, 24-port in 2 rack space units, for easier installation and cable management than high density panels. The PS5E BIX patch panel is a robust and installer-friendly product by design, combining BIX punch down connectors with standard modular jacks. The patch panel features built-in wire management to secure cable bundles and to control and maintain patch cord bend radius. A color-coded icon labeling system can be used to tag each patch panel port and simplify network management (ordered separately). The PS5E BIX patch panel offers Category 5e performance.

AX100506 BIX Patch Panel, 2U, 24-port



#### Flex Patch Panel

Flex patch panels provide a flexible and versatile termination solution for telecommunications room rack-mounted installations. The panels can be custom configured in the field to suit practically any particular configuration. Flex patch panels are compatible with GigaFlex and EZ-MDVO modules as well as MDVO-style multimedia modules. Modules are ordered separately.

AX101456 Flex Patch Panel



Description	Belden Part Number
<b>Patch Panels</b>	
<b>PS5E HD Patch Panel</b>	
PS5E HD-BIX Patch Panel, 1U, 24-port, Grey, T568A/B	<b>AX100464</b>
PS5E HD-BIX Patch Panel, 1U, 24-port, Black, T568A/B	<b>AX100465</b>
PS5E HD-BIX Patch Panel, 2U, 48-port, Grey, T568A/B	<b>AX100472</b>
PS5E HD-BIX Patch Panel, 2U, 48-port, Black, T568A/B	<b>AX100473</b>
PS5E HD-110 Patch Panel, 1U, 24-port, Black, T568B/A	<b>AX100452</b>
PS5E HD-110 Patch Panel, 2U, 48-port, Black, T568B/A	<b>AX100454</b>

The PS5E HD-110 Patch Panel is not available in all countries. Other configurations are available, please contact customer service for further details.

<b>PS5E BIX Patch Panel</b>	
PS5E BIX Patch Panel, 2U, 24-port, Grey, T568A-ISDN	<b>AX100505</b>
PS5E BIX Patch Panel, 2U, 24-port, Black, T568A-ISDN	<b>AX100506</b>
<b>Flex Patch Panel</b>	
Flex Patch Panel, 1U, 24-port, Grey	<b>AX101571</b>
Flex Patch Panel, 1U, 24-port, Black	<b>AX101456</b>
Flex Patch Panel, 2U, 48-port, Grey	<b>AX101573</b>
Flex Patch Panel, 2U, 48-port, Black	<b>AX101458</b>

These products are in the process of being assessed for RoHS compliance. Please check our website for the most current RoHS status.

## Workstation Outlets

### GigaFlex PS6+ Modules Category 6

AX101067 GigaFlex PS6+Module



#### GigaFlex PS6+ Module

The GigaFlex PS6+ module is a punch down UTP connector based on a patented encapsulated lead frame technology ensuring excellent long-term reliability as well as extremely stable transmission performance. The unmatched Beyond Cat 6 performance exceeds all parameters specified in the Category 6 standard. All performance characteristics have been set to guarantee transmission performance up to 300 MHz and a data-rate of up to 4.8 Gb/s.

The GigaFlex PS6+ is the module of choice for terminating UTP cables into the MediaFlex and interface outlet series. It can also be mixed and matched with a wide variety of MDVO adapters, boxes and patch panels to suit practically any installation configuration for workstation outlet, consolidation point and telecommunications room applications.

A keystone-style is also available for terminating UTP cables into keystone-style mounting hardware. It can be easily snapped into simple sheet metal cut-outs (panel mounting) for installation into consolidation point or multi-user custom-built devices.

Also available is the GigaFlex PS6+ module, clipsal-style which is fully compatible with clipsal faceplates and mounting hardware.

Description	Belden Part Number	
	MDVO-Style	Keystone-Style

#### Workstation Outlets

GigaFlex PS6+ Module		
T568A/B, Grey	<b>AX101063</b>	<b>AX101318</b>
T568A/B, Almond	<b>AX101064</b>	<b>AX101319</b>
T568A/B, White	<b>AX101065</b>	<b>AX101320</b>
T568A/B, Black	<b>AX101066</b>	<b>AX101321</b>
T568A/B, Orange	<b>AX101067</b>	<b>AX101322</b>
T568A/B, Red	<b>AX101068</b>	<b>AX101323</b>
T568A/B, Yellow	<b>AX101069</b>	<b>AX101324</b>
T568A/B, Green	<b>AX101070</b>	<b>AX101325</b>
T568A/B, Blue	<b>AX101071</b>	<b>AX101326</b>
T568A/B, Purple	<b>AX101072</b>	<b>AX101327</b>
T568A/B, Brown	<b>AX101073</b>	<b>AX101328</b>
T568A/B, Ivory	<b>AX102563</b>	-

These products are in the process of being assessed for RoHS compliance. Please check our website for the most current RoHS status.

## Workstation Outlets

### GigaFlex PS5E Modules Category 5e

AX101051 GigaFlex PS5E Module



#### GigaFlex PS5E Module

The GigaFlex PS5E module is a punch down UTP connector based on a patented encapsulated lead frame technology ensuring excellent long term reliability as well as extremely stable transmission performance. The PS5E-rated performance exceeds all requirements specified in the Category 5e standard. All performance parameters including NEXT, FEXT, Attenuation and Return Loss have been set to guarantee transmission performance up to 160 MHz and a data-rate of up to 1.2 Gb/s.

The GigaFlex PS5E is the module of choice for terminating UTP cables into the MediaFlex and interface outlet series. It can also be mixed and matched with a wide variety of MDVO adapters, boxes and patch panels to suit practically any installation configuration for workstation outlet, consolidation point and telecommunications room applications.

A keystone-style is also available for terminating UTP cables into keystone-style mounting hardware. It can be easily snapped into simple sheet metal cut-outs (panel mounting) for installation into consolidation point or multi-user custom-built devices.

Description	Belden Part Number	
	MDVO-Style	Keystone-Style

#### Workstation Outlets

GigaFlex PS5E Module		
T568A/B, Grey	<b>AX101044</b>	<b>AX101307</b>
T568A/B, Almond	<b>AX101045</b>	<b>AX101308</b>
T568A/B, White	<b>AX101046</b>	<b>AX101309</b>
T568A/B, Black	<b>AX101047</b>	<b>AX101310</b>
T568A/B, Orange	<b>AX101048</b>	<b>AX101311</b>
T568A/B, Red	<b>AX101049</b>	<b>AX101312</b>
T568A/B, Yellow	<b>AX101050</b>	<b>AX101313</b>
T568A/B, Green	<b>AX101051</b>	<b>AX101314</b>
T568A/B, Blue	<b>AX101052</b>	<b>AX101315</b>
T568A/B, Purple	<b>AX101053</b>	<b>AX101316</b>
T568A/B, Brown	<b>AX101054</b>	<b>AX101317</b>
T568A/B, Ivory	<b>AX102564</b>	-

These products are in the process of being assessed for RoHS compliance. Please check our website for the most current RoHS status.

## Workstation Outlets

### EZ-MDVO PS5E Modules Category 5e

AX100654 EZ-MDVO PS5E Module



#### EZ-MDVO PS5E Module

The EZ-MDVO module is built with a patented lead frame design and encapsulated insulation displacement contacts, ensuring reliable connections and performance well above Category 5e standards. The EZ-MDVO module termination cap is what is so unique about this product. It allows for a simple and fast “press-fit” installation while ensuring consistent wire termination every time it is snap-locked. The module termination cap is color-coded to facilitate wire arrangement and speed up installation time. The termination cap is printed with the T568A/B color-codes. The EZ-MDVO modules can be mixed and matched with a wide variety of MediaFlex, Interface and MDVO-style faceplates, adapters and boxes to suit practically any installation configuration for workstation outlet installations.

A keystone-style is also available for terminating UTP cables into keystone-style mounting hardware. It can be easily snapped into simple sheet metal cut-outs (panel mounting) for installation into consolidation point or multi-user custom-built devices. Clipsal-style EZ-MDVO modules are available for installations using commercially available clipsal faceplates and HPM-style EZ-MDVO modules are available for installations using commercially available HPM faceplates.

Description	Belden Part Number	
	MDVO-Style	Keystone-Style

#### Workstation Outlets

EZ-MDVO PS5E Module		
T568A/B coded, Grey	<b>AX100645</b>	<b>AX100577</b>
T568A/B coded, Almond	<b>AX100646</b>	<b>AX100578</b>
T568A/B coded, White	<b>AX100647</b>	<b>AX100579</b>
T568A/B coded, Black	<b>AX100648</b>	<b>AX100580</b>
T568A/B coded, Orange	<b>AX100649</b>	<b>AX100581</b>
T568A/B coded, Red	<b>AX100650</b>	<b>AX100582</b>
T568A/B coded, Yellow	<b>AX100651</b>	<b>AX100583</b>
T568A/B coded, Green	<b>AX100652</b>	<b>AX100584</b>
T568A/B coded, Blue	<b>AX100653</b>	<b>AX100585</b>
T568A/B coded, Purple	<b>AX100654</b>	<b>AX100586</b>
T568A/B coded, Brown	<b>AX100655</b>	<b>AX100587</b>

These products are in the process of being assessed for RoHS compliance. Please check our website for the most current RoHS status.



# Workstation Outlets

## MediaFlex Inserts

AX101756 MediaFlex MDVO (style) Insert, 2-port, Angled



AX101752 MediaFlex MDVO (style) Insert, 2-port, Flush

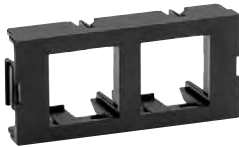

AX101760 MediaFlex Filler Insert, 1-unit



AX101764 MediaFlex Filler Insert, 2-unit



AX101768 PS6+ MediaFlex GigaFlex Insert, 2-port



### MediaFlex Insert

MediaFlex inserts provide optimum flexibility in configuring multimedia workstation outlets that respond to any present or future network needs. MediaFlex MDVO-style Inserts along with MediaFlex filler inserts and MediaFlex GigaFlex inserts allow for the easy configuration of outlets. All inserts are front loaded and easily snapped in and out of the MediaFlex plates for simple installation and maintenance.

MediaFlex MDVO-style inserts are available in a 2-port configuration in both flush and angled versions. They are compatible with all GigaFlex and MDVO modules (EZ-MDVO and multimedia). The inserts are two units high for the flush version and three units high for the angled version. Therefore three flush inserts or two angled inserts are required to fully populate a single gang MediaFlex plate.

MediaFlex GigaFlex Inserts are available in a 2-port configuration in both PS5E (Category 5e) and PS6+ (beyond Category 6) performance levels. The inserts are two units high, therefore three inserts can be used to fully populate a single gang MediaFlex plate making up a 6-port outlet.

MediaFlex filler inserts are used to fill the unused spaces in low density workstation outlets. They are available in one unit and two unit sizes.

Description	Belden Part Number
-------------	--------------------

### Workstation Outlets

MediaFlex MDVO (style) Insert	Flush	Angled
2-port, Grey, bag of 10 units	<b>AX101749</b>	<b>AX101753</b>
2-port, Almond, bag of 10 units	<b>AX101750</b>	<b>AX101754</b>
2-port, Elec. White, bag of 10 units	<b>AX101751</b>	<b>AX101755</b>
2-port, Black, bag of 10 units	<b>AX101752</b>	<b>AX101756</b>
2-port, White, bag of 10 units	<b>AX102612</b>	<b>AX102613</b>
2-port, Ivory, bag of 10 units	<b>AX102572</b>	<b>AX102573</b>
MediaFlex GigaFlex Insert	PS6+	PS5E
2-port, Grey	<b>AX101765</b>	<b>AX101769</b>
2-port, Almond	<b>AX101766</b>	<b>AX101770</b>
2-port, Elec. White	<b>AX101767</b>	<b>AX101771</b>
2-port, Black	<b>AX101768</b>	<b>AX101772</b>
2-port, Ivory	<b>AX102574</b>	<b>AX102575</b>
MediaFlex Filler Insert	1-Unit	2-Unit
Grey, bag of 10 units	<b>AX101757</b>	<b>AX101761</b>
Almond, bag of 10 units	<b>AX101758</b>	<b>AX101762</b>
Elec. White, bag of 10 units	<b>AX101759</b>	<b>AX101763</b>
Black, bag of 10 units	<b>AX101760</b>	<b>AX101764</b>
White, bag of 10 units	<b>AX102614</b>	<b>AX102615</b>
Ivory, bag of 10 units	<b>AX102576</b>	<b>AX102577</b>

These products are in the process of being assessed for RoHS compliance. Please check our website for the most current RoHS status.

## Workstation Outlets

### Interface Plate and Surface Adapter Boxes

AX101431 Interface Plate, 2-port, shown here with modules



AX101438 Interface Plate, 4-port, shown here with modules



AX101441 Interface Plate, 6-port, shown here with modules



AX101474 Interface / MDVO Surface Adapter Box



#### Interface Plate, Flush

Interface plates combine flexibility and ease of use in work area installations. They are designed to accept the EZ-MDVO and GigaFlex UTP modules as well as all the MDVO multimedia modules. The interface plates are available in Single gang and can accept up to 6 modules. They also have labeling capabilities using built-in labeling windows. The faceplates can be attached to standard electrical boxes or wall-mounting hardware for flush-mount installations. The faceplates can also fit over the interface adapter boxes for surface mount installations.

#### Interface / MDVO Surface Adapter Box

The Interface/MDVO surface adapter box allows surface mounting of interface plates as well as MDVO flush and angled entry faceplates. The box can be mounted on any flat surface or can be attached to standard electrical boxes or wall-mounting hardware for additional storage space.

Description	Belden Part Number
<b>Workstation Outlets</b>	
<b>Interface Plate</b>	
Flush, 2-port, Grey	AX101431
Flush, 2-port, Almond	AX101432
Flush, 2-port, White	AX101433
Flush, 2-port, Black	AX101434
Flush, 2-port, Ivory	AX102582
Flush, 4-port, Grey	AX101435
Flush, 4-port, Almond	AX101436
Flush, 4-port, White	AX101437
Flush, 4-port, Black	AX101438
Flush, 4-port, Ivory	AX102583
Flush, 6-port, Grey	AX101439
Flush, 6-port, Almond	AX101440
Flush, 6-port, White	AX101441
Flush, 6-port, Black	AX101442
Flush, 6-port, Ivory	AX102584
<b>Interface / MDVO Surface Adapter Box</b>	
Single Gang, Grey	AX101474
Single Gang, Almond	AX101475
Single Gang, White	AX101476
Single Gang, Black	AX101477
Single Gang, Ivory	AX102589

These products are in the process of being assessed for RoHS compliance. Please check our website for the most current RoHS status.

## Workstation Outlets

### MDVO Adapters

A0645271 MDVO Side Entry Box, shown here with modules



AX100311 MDVO 106 Adapter, 4-port, shown here with modules

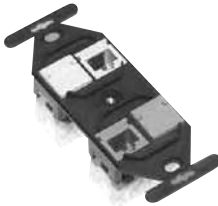

A0409654 MDVO Deco Adapter, shown here with modules



AX100925 MDVO Modular Furniture Adapter, 4-port, shown here with modules



### MDVO Adapters

All MDVO adapters are compatible with GigaFlex, EZ-MDVO and MDVO multimedia modules.

The MDVO side entry box can be easily mounted directly on the wall, as well as on modular furniture panels, baseboards and utility poles. The compact size of the box allows secure installation in confined areas such as behind a desk or underneath a workstation.

The MDVO 106 adapters are designed for installations using standard NEMA electrical-style faceplates also referred to as 106-type or duplex wall plates.

The MDVO deco adapter is designed for installations using Decora style wall plates.

MDVO modular furniture adapters are the ideal outlet adapters for open office furniture applications. They can be snapped into any standard opening, in modular furniture settings.

Description	Belden Part Number
<b>Workstation Outlets</b>	
<b>MDVO Adapters</b>	
MDVO Side Entry Box, 2-port, Grey	A0645271
MDVO Side Entry Box, 2-port, Almond	A0645272
MDVO Side Entry Box, 2-port, White	A0645273
MDVO Side Entry Box, 2-port, Black	A0645274
MDVO Side Entry Box, 2-port, Ivory	AX102590
MDVO 106 Adapter, 2-port, Grey	AX100304
MDVO 106 Adapter, 2-port, Almond	AX100305
MDVO 106 Adapter, 2-port, White	AX100306
MDVO 106 Adapter, 2-port, Black	AX100307
MDVO 106 Adapter, 2-port, Ivory	AX102591
MDVO 106 Adapter, 4-port, Grey	AX100308
MDVO 106 Adapter, 4-port, Almond	AX100309
MDVO 106 Adapter, 4-port, White	AX100310
MDVO 106 Adapter, 4-port, Black	AX100311
MDVO 106 Adapter, 4-port, Ivory	AX102592
MDVO Deco Adapter, 3-port, Grey	A0409651
MDVO Deco Adapter, 3-port, Almond	A0409652
MDVO Deco Adapter, 3-port, White	A0409653
MDVO Deco Adapter, 3-port, Black	A0409654
MDVO Deco Adapter, 3-port, Ivory	AX102593
MDVO Modular Furniture Adapter, 3-port, Grey	A0407071
MDVO Modular Furniture Adapter, 3-port, Almond	A0407072
MDVO Modular Furniture Adapter, 3-port, White	A0407073
MDVO Modular Furniture Adapter, 3-port, Black	A0407074
MDVO Modular Furniture Adapter, 3-port, Ivory	AX102648
MDVO Modular Furniture Adapter, 4-port, Grey	AX100925
MDVO Modular Furniture Adapter, 4-port, Almond	AX100926
MDVO Modular Furniture Adapter, 4-port, White	AX100927
MDVO Modular Furniture Adapter, 4-port, Black	AX100928
MDVO Modular Furniture Adapter, 4-port, Ivory	AX102594

These products are in the process of being assessed for RoHS compliance. Please check our website for the most current RoHS status.

## Workstation Outlets

### European Style Faceplates and Inserts

AX101372-73 European "6C" Style Faceplates and AX101377-75-76 European "6C" Inserts



#### European "6C" Style Faceplate

The European "6C" style faceplates and inserts are designed to accept the GigaFlex and EZ-MDVO UTP modules. They include a shutter to protect the module against dust and other contaminants.

#### French Style Faceplate

The french style faceplates are designed to accept the EZ-MDVO and GigaFlex UTP modules as well as all the MDVO multimedia modules. The faceplates can be attached to standard 45 mm x 45 mm boxes or mounting hardware for flush-mount installations.

AX101413-14 French Style Faceplates



Description	Belden Part Number
-------------	--------------------

#### Workstation Outlets

European "6C" Style Faceplate	
European "6C" Style Faceplate, Single Gang, Single Aperture, White	AX101372
European "6C" Style Faceplate, Single Gang, Dual Aperture, White	AX101373
European "6C" Style Faceplate, Double Gang, Quad Aperture, White	AX101374
European "6C" Shuttered Module Holder, 1-port, Flush, White	AX101375
European "6C" Shuttered Module Holder, 1-port, Angled, White	AX101376
European "6C" Blank Insert, White	AX101377
French Style Faceplate	
1-port, Flush, White	AX101413
2-port, Flush, White	AX101414
1-port, Angled, White	AX101415
2-port, Angled, White	AX101416

These products are in the process of being assessed for RoHS compliance. Please check our website for the most current RoHS status.

AX101415-16 French Style Faceplates

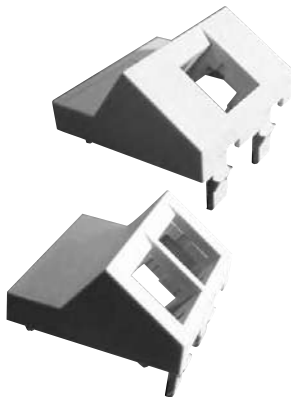

## Workstation Outlets

### MDVO Multimedia Outlet Boxes, Multi-User Outlet Boxes and Multi-User Adapter Strips

A0643205 MDVO Multimedia Outlet Box,  
shown here as terminated

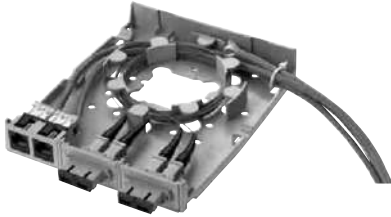

AX100222 Multi-User Outlet Box,  
shown here with modules



AX100223 MDVO Adapter Strip, 12-port



#### MDVO Multimedia Outlet Box

The MDVO multimedia outlet box brings unique versatility for multimedia work area installations. The box design provides cable management and helps maintain cable bend radius. The outlet box's low profile design and side-entry offers better protection for patch cords. The outlet box can accept up to six EZ-MDVO, GigaFlex or MDVO multimedia modules or three SC duplex adapters.

The MDVO multimedia outlet box can be mounted directly on the wall or attached to standard electrical boxes. Included with the MDVO multimedia box are three SC duplex mounting bezels and three MDVO adapters.

#### Multi-User Outlet Box

The multi-user outlet box is a versatile box that can be used in many different applications. The outlet box can accommodate up to 24 connections of any type, UTP, fiber or coax. The outlet box is ideal for use as a multi-user telecommunications assembly, or simply as a high-density multimedia telecommunications outlet. The multi-user outlet box can also be used as a wall mounted patch panel in confined areas, such as shallow rooms and cabinets.

#### Multi-User Adapter Strips

The Multi-User outlet box design allows for mixed media installations with a choice of connection strips. The box can accept either one or two 12-port MDVO adapter strips, PS5E HD connector module strips (BIX or 110), or a combination of both for a maximum of 24 connections.

Description	Belden Part Number
<b>Workstation Outlets</b>	
<b>MDVO Multimedia Outlet Box</b>	
6-port, Grey	A0643205
6-port, Almond	A0643206
6-port, White	A0643207
6-port, Black	A0643208
6-port, Ivory	AX102595
<b>Multi-User Outlet Box</b>	
24-port, Grey	AX100219
24-port, Almond	AX100220
24-port, White	AX100221
24-port, Black	AX100222
<b>Multi-User Adapter Strips</b>	
MDVO Adapter Strip, 12-port, Empty, Black	AX100223
PS5E HD-BIX Connector Module Strip, Universal Wiring 12-port, T568A/B	AX100224
PS5E HD-110 Connector Module Strip, Universal Wiring 12-port, T568B/A	AX100494

These products are in the process of being assessed for RoHS compliance. Please check our website for the most current RoHS status.

## Workstation Outlets

### MDVO Multimedia Modules

A0407005 MDVO SC Fiber Module



A0649254 SC Duplex Adapter



A0407010 MDVO ST Compatible Fiber Module



AX101467 MDVO MTRJ Fiber Module



A0406997 MDVO BNC Coaxial Module



A0406999 MDVO Video F Coaxial Module



### MDVO Multimedia Module

MDVO multimedia modules address audio/video and fiber applications. Fiber modules are available for LC Duplex, SC Simplex, ST compatible multimode and MT-RJ multimode & single-mode connections. The SC duplex adapter is a fiber adapter sleeve with flanges that mounts into the SC duplex mounting bezel (included in the MDVO multimedia outlet box). Audio/video modules are available for SVHS, RCA, BNC and video F connections.

Description	Belden Part Number				
	Grey	Almond	White	Black	Ivory

### Workstation Outlets

MDVO Multimedia Module					
LC Duplex, Multimode	AX102209	AX102210	AX102211	AX102619	–
LC Duplex, Single-mode	AX102213	AX102214	AX102215	AX102216	–
SC Simplex, Multimode	A0407003	A0407004	A0407005	A0407006	AX102596
SC Duplex Adapter, Multimode	–	A0649254	–	–	–
ST Compatible, Multimode	A0407007	A0407008	A0407009	A0407010	AX102597
MT-RJ, Multimode	–	AX101467	–	–	–
MT-RJ, Single-mode, Blue	–	AX101466	–	–	–

Description	Belden Part Number				
	Grey Holder	Almond Holder	White Holder	Black Holder	Ivory Holder
Coaxial, BNC	A0406995	A0406996	A0406997	A0406998	AX102598
Coaxial, Video F	A0406999	A0407000	A0407001	A0407002	AX102599
RCA, feedthrough, White insert	AX101823	AX101824	AX101825	AX101826	AX102601
RCA, feedthrough, Yellow insert	AX101827	AX101828	AX101829	AX101830	AX102602
RCA, feedthrough, Red insert	AX101831	AX101832	AX101833	AX101834	AX102603
RCA, feedthrough, Black insert	AX101835	AX101836	AX101837	AX101838	AX102604
SVHS, feedthrough	AX101839	AX101840	AX101841	AX101842	AX102605
3.5 mm Stereo	AX102624	AX102625	AX102626	AX102627	AX102628

Custom multimedia connectors are also available, please contact customer service for more details. These products are in the process of being assessed for RoHS compliance. Please check our website for the most current RoHS status.

# Workstation Outlets

## Outlet Accessories

A0405538 MDVO Blank Insert



### MDVO Blank Insert

MDVO blank inserts can be used in any MediaFlex outlets, interface plates, MDVO faceplates, adapters or boxes to fill in unused ports.

### Colored Bezel

The colored bezels are plastic inserts that fit over the face of GigaFlex and EZ-MDVO modules to modify their color. They are particularly useful in installations where the churn rate is high and color identification of outlets is critical (ex.: segmented network with security levels). They also contribute to simplifying the management of the cabling infrastructure by using only one color of module for Moves, Adds and Changes (MACs).

AX102022 Colored Bezel

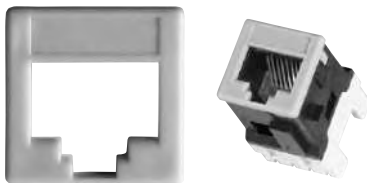

### ID Tab

ID tabs are color-coded identification caps that can be inserted over the GigaFlex and EZ-MDVO modules. The ID tabs are available as blank, data or voice coded. They are available in eleven colors to facilitate identification and to match modern office decor. The flexible identification cap also acts as a protective cover eliminating exposure to dust and other contaminants when the module is not in use.

AX100196 ID Tab



Description	Belden Part Number
-------------	--------------------

### Workstation Outlets

MDVO Blank Insert	
Grey	A0405536
Almond	A0405537
White	A0405538
Black	A0405539
Electric White	AX102607
Ivory	AX102600
Colored Bezel	
Grey	AX102014
Almond	AX102015
White	AX102016
Black	AX102017
Orange	AX102018
Red	AX102019
Yellow	AX102020
Green	AX102021
Blue	AX102022
Purple	AX102023
Brown	AX102024
Ivory	AX102606

Description	Belden Part Number		
	Blank	Data	Voice

ID Tab			
Grey	AX100182	AX100193	AX100204
Almond	AX100183	AX100194	AX100205
White	AX100184	AX100195	AX100206
Black	AX100185	AX100196	AX100207
Orange	AX100186	AX100197	AX100208
Red	AX100187	AX100198	AX100209
Yellow	AX100188	AX100199	AX100210
Green	AX100189	AX100200	AX100211
Blue	AX100190	AX100201	AX100212
Purple	AX100191	AX100202	AX100213
Brown	AX100192	AX100203	AX100214

These products are in the process of being assessed for RoHS compliance. Please check our website for the most current RoHS status.

## Workstation Outlets

### Tools

AX100749 GigaFlex Connecting Tool



#### GigaFlex Connecting Tool

The GigaFlex connecting tool is a no-impact connecting tool used to terminate cables, pigtails or cross-connect wires on any GigaFlex module or 110 product. The GigaFlex tool is a spring-activated hand tool. A single forward movement will seat the wire into the IDC clip and cut off the excess wire. The tool will terminate 22, 24 and 26 AWG plastic insulated solid copper conductors.

1797B Cable Preparation Tool



#### Bonded-Pair Cable Preparation Tool

The bonded-pair cable preparation tool makes it faster and easier to prepare cables for connector termination. This tool is ideal for use with Belden's DataTwist® 350, MediaTwist®, and DataTwist® 600e bonded-pair cables, providing special features that help separate twisted pairs. It can also be used to prepare any non-bonded-pair cable for installation.

AX101852 Termination Station

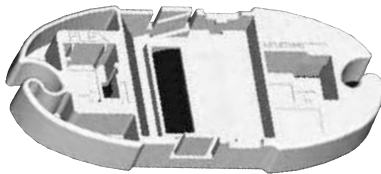

#### Termination Station

The termination station is an ergonomically designed holder that provides stability to the GigaFlex module during the termination process. The station has pockets with locking features that steadily holds either MDVO-style or Keystone-style GigaFlex modules or MediaFlex Inserts during pair placement and wire termination. Cable retainers on each end of the station will secure and hold cables during the pair placements process. The flat bottom surface will provide the required stability to safely terminate the modules. The tool is made of very durable plastic and its low profile makes it an easy tool to use and carry.

AX101185 Outlet Release Tool



#### Outlet Release Tool

The outlet release tool is a very convenient tool for servicing the MediaFlex and interface outlets. Its bent tip allows for easy front removal of MediaFlex inserts, especially when used in angled entry plates. It is also very useful to extract GigaFlex modules from miscellaneous mounting hardware and to remove the protective cap for GigaFlex module re-termination.

Description	Belden Part Number
<b>Workstation Outlets</b>	
<b>Tools</b>	
GigaFlex Connecting Tool	<b>AX100749</b>
Bonded-Pair Cable Preparation Tool	<b>1797B</b>
Termination Station	<b>AX101852</b>
Outlet Release Tool	<b>AX101185</b>

These products are in the process of being assessed for RoHS compliance. Please check our website for the most current RoHS status.



## Modular Cords

### Belden IBDN System 4800LX and 2400 Modular Cords Enhanced Category 6

AX350061 GigaFlex PS6+ Modular Cord



#### GigaFlex PS6+ Modular Cord

The GigaFlex PS6+ modular cords are 4-pair 23 AWG UTP modular cords designed for use with the Belden IBDN systems 2400 and 4800LX, providing channel bandwidths of 250 MHz and 300 MHz, respectively. The GigaFlex PS6+ modular cords have been designed to provide a mated-connection performance that exceeds the Category 6 requirements.

The GigaFlex PS6+ modular cord's patented design, with a very small footprint, makes them fully compatible with any of the highest density hubs with RJ45 jack connections.

Description	Belden Part Number					
	Blue	White	Grey	Green	Red	Yellow

#### Belden IBDN System 2400, Modular Cords\*

GigaFlex PS6+ Modular Cord, LSZH 4-pair, 23 AWG solid, T568B - T568B						
0.5 m (1.6 ft.)	AX102356	AX102350	AX102392	AX102544	AX102550	AX102556
1.0 m (3.3 ft.)	AX102357	AX102351	AX102393	AX102545	AX102551	AX102557
2.0 m (6.5 ft.)	AX102358	AX102352	AX102394	AX102546	AX102552	AX102558
3.0 m (10 ft.)	AX102359	AX102353	AX102395	AX102547	AX102553	AX102559
5.0 m (16.4 ft.)	AX102360	AX102354	AX102396	AX102548	AX102554	AX102560
10.0 m (33 ft.)	AX102361	AX102355	AX102397	AX102549	AX102555	AX102561

Description	Belden Part Number		
	Purple	White	Grey

#### Belden IBDN System 2400, Modular Cords\*

GigaFlex PS6+ Modular Cord, LSZH 4-pair, 23 AWG solid, T568B - T568B			
6 m (20 ft.)		AC301311	-
10 m (33 ft.)		AC300656	-
15 m (50 ft.)		AC301215	AC301325

These products are in the process of being assessed for RoHS compliance. Please check our website for the most current RoHS status.

## Modular Cords

### Belden IBDN System 4800LX and 2400 Modular Cords Enhanced Category 6

AX350061 GigaFlex PS6+ Modular Cord



#### GigaFlex PS6+ Modular Cord

The GigaFlex PS6+ modular cords are 4-pair 23 AWG UTP modular cords designed for use with the Belden IBDN systems 2400 and 4800LX, providing channel bandwidths of 250 MHz and 300 MHz, respectively. The GigaFlex PS6+ modular cords have been designed to provide a mated-connection performance that exceeds the Category 6 requirements.

The GigaFlex PS6+ modular cord's patented design, with a very small footprint, makes them fully compatible with any of the highest density hubs with RJ45 jack connections.

Description	Belden Part Number					
	Blue	White	Grey	Green	Red	Yellow

#### Modular Cords

GigaFlex PS6+ Modular Cord, CMR 4-pair, 23 AWG solid, T568A - T568A						
0.6 m (2 ft.)	AX350037	AX350043	AX350049	AX350055	AX350061	AX350067
1.2 m (4 ft.)	AX350038	AX350044	AX350050	AX350056	AX350062	AX350068
2.1 m (7 ft.)	AX350039	AX350045	AX350051	AX350057	AX350063	AX350069
3.0 m (10 ft.)	AX350040	AX350046	AX350052	AX350058	AX350064	AX350070
4.6 m (15 ft.)	AX350041	AX350047	AX350053	AX350059	AX350065	AX350071
7.6 m (25 ft.)	AX350042	AX350048	AX350054	AX350060	AX350066	AX350072
CMR 4-pair, 23 AWG solid, T568A/B - open						
4.6 m (15 ft.)	-	-	AX350160	-	-	-
7.6 m (25 ft.)	-	-	AX350161	-	-	-
10.6 m (35 ft.)	-	-	AX350162	-	-	-
15.0 m (50 ft.)	-	-	AX350163	-	-	-

These products are in the process of being assessed for RoHS compliance. Please check our website for the most current RoHS status.

AX380014 GigaFlex PS6+ Bonded Modular Cord



#### GigaFlex PS6+ Bonded Modular Cords

The GigaFlex PS6+ bonded modular cords are 4-pair 24 AWG bonded-pair UTP modular cords designed for use with the Belden IBDN systems 2400 and 4800LX, providing channel bandwidths of 250 MHz and 300 MHz, respectively. The GigaFlex PS6+ bonded modular cords have been designed to provide a mated-connection performance that exceeds the Category 6 requirements.

The GigaFlex PS6+ bonded modular cord's patented design, with a very small footprint, makes them fully compatible with the highest density hubs, with any RJ45 jack connections. The special cord design offers increased stability in crosstalk and impedance performance to support the many moves, adds and changes performed in the lifetime of the system.

Description	Belden Part Number			
	Blue	Grey	White	Yellow

#### Modular Cords

GigaFlex PS6+ Bonded Mod. Cord, CMR, 4-pair, Bonded 24 AWG Solid, T568A - T568A				
1.2 m (4 ft.)	AX380014	AX380026	AX380050	AX380056
2.1 m (7 ft.)	AX380015	AX380027	AX380051	AX380057
3.0 m (10 ft.)	AX380016	AX380028	AX380052	AX380058
4.6 m (15 ft.)	AX380017	AX380029	AX380053	AX380059
7.6 m (25 ft.)	AX380018	AX380030	AX380054	AX380060

These products are in the process of being assessed for RoHS compliance. Please check our website for the most current RoHS status.

## Modular Cords

### GigaFlex PS5e Modular Cords and GigaFlex PS5e VoIP Cords Category 5e

AX102344 GigaFlex PS5e Modular Cord



#### GigaFlex PS5e Modular Cords

The GigaFlex PS5e modular cords are 4-pair 24 AWG UTP modular cords that are designed for use with the Belden IBDN Plus cabling system and the Belden IBDN system 1200 providing channel bandwidths of 100 MHz and 160 MHz, respectively.

The GigaFlex PS5e modular cord's patented design features a very small footprint, making them fully compatible with the highest density hubs which use RJ45 jack connections. The GigaFlex PS5e modular cords have been designed to provide a mated-connection performance that exceeds the Category 5e standard.

Description	Belden Part Number					
	Blue	White	Grey	Green	Red	Yellow

#### Belden IBDN System 1200, Modular Cords

GigaFlex PS5e Modular Cord, LSZH 4-pair, 24 AWG stranded, T568B - T568B						
0.5 m (1.6 ft.)	AX102344	AX102338	AX102386	AX102526	AX102532	AX102538
1.0 m (3.3 ft.)	AX102345	AX102339	AX102387	AX102527	AX102533	AX102539
2.0 m (6.5 ft.)	AX102346	AX102340	AX102388	AX102528	AX102534	AX102540
3.0 m (10 ft.)	AX102347	AX102341	AX102389	AX102529	AX102535	AX102541
5.0 m (16.4 ft.)	AX102348	AX102342	AX102390	AX102530	AX102536	AX102542
10.0 m (33 ft.)	AX102349	AX102343	AX102391	AX102531	AX102537	AX102543

These products are in the process of being assessed for RoHS compliance. Please check our website for the most current RoHS status.

AX350013 GigaFlex PS5e Modular Cord



#### GigaFlex PS5e Modular Cords

The GigaFlex PS5e modular cords are 4-pair 24 AWG UTP modular cords that are designed for use with the Belden IBDN plus cabling system and the Belden IBDN system 1200 providing channel bandwidths of 100 MHz and 160 MHz, respectively.

The GigaFlex PS5e modular cord's patented design features a very small footprint, making them fully compatible with the highest density hubs which use RJ45 jack connections. The GigaFlex PS5e modular cords have been designed to provide a mated-connection performance that exceeds the Category 5e standard.

Description	Belden Part Number					
	Blue	White	Grey	Green	Red	Yellow

#### Modular Cords

GigaFlex PS5e Mod. Cord, CMR 4-pair, 24 AWG stranded, T568A - T568A						
0.6 m (2 ft.)	AX350001	AX350007	AX350013	AX350019	AX350025	AX350031
1.2 m (4 ft.)	AX350002	AX350008	AX350014	AX350020	AX350026	AX350032
2.1 m (7 ft.)	AX350003	AX350009	AX350015	AX350021	AX350027	AX350033
3.0 m (10 ft.)	AX350004	AX350010	AX350016	AX350022	AX350028	AX350034
4.6 m (15 ft.)	AX350005	AX350011	AX350017	AX350023	AX350029	AX350035
7.6 m (25 ft.)	AX350006	AX350012	AX350018	AX350024	AX350030	AX350036
GigaFlex PS5e Mod. Cord, CMR 4-pair, 24 AWG solid, T568A to open						
4.6 m (15 ft.)	-	-	AX350149	-	-	-
7.6 m (25 ft.)	-	-	AX350093	-	-	-

These products are in the process of being assessed for RoHS compliance. Please check our website for the most current RoHS status.

## Modular Cords

### GigaFlex PS5e VoIP Cords Category 5e

AX330015 GigaFlex PS5E VoIP Modular Cord



VoIP Modular Cord features very short body RJ 45 phone connector on other end

#### GigaFlex PS5E VoIP Modular Cords

The GigaFlex PS5E VoIP modular cords are 4-pair 24 AWG UTP modular cords that are designed for use with the Belden IBDN plus cabling system and the Belden IBDN system 1200 providing channel bandwidths of 100 MHz and 160 MHz, respectively. The GigaFlex PS5E VoIP modular cord is designed for use with VoIP phones that can not accommodate standard booted patch cords which would make the phone unstable or difficult to wall mount. The GigaFlex PS5E VoIP modular cord is designed with a regular booted RJ 45 plug on one end (at the wall) and a bootless very short body RJ 45 plug on the other end (at the phone). The GigaFlex PS5E VoIP modular cords meet all the enhanced Category 5 modular cord requirements as per the Category 5e standard, and are completely backward compatible with Category 5 jacks. The GigaFlex PS5E VoIP modular cords have been designed to provide a mated-connection performance that exceeds the Category 5e standard. The GigaFlex PS5E VoIP modular cord product line encompass CMR-rated cords.

Description	Belden Part Number					
	Blue	White	Grey	Green	Red	Yellow

#### Modular Cords

GigaFlex PS5E VoIP Mod.Cord, CMR, 4-pair, 24 AWG stranded, T568A - T568A						
0.6 m (2 ft.)	<b>AX330013</b>	<b>AX330049</b>	<b>AX330025</b>	<b>AX330019</b>	<b>AX330043</b>	<b>AX330055</b>
1.2 m (4 ft.)	<b>AX330014</b>	<b>AX330050</b>	<b>AX330026</b>	<b>AX330020</b>	<b>AX330044</b>	<b>AX330056</b>
2.1 m (7 ft.)	<b>AX330015</b>	<b>AX330051</b>	<b>AX330027</b>	<b>AX330021</b>	<b>AX330045</b>	<b>AX330057</b>
3.0 m (10 ft.)	<b>AX330016</b>	<b>AX330052</b>	<b>AX330028</b>	<b>AX330022</b>	<b>AX330046</b>	<b>AX330058</b>
4.6 m (15 ft.)	<b>AX330017</b>	<b>AX330053</b>	<b>AX330029</b>	<b>AX330023</b>	<b>AX330047</b>	<b>AX330059</b>
7.6 m (25 ft.)	<b>AX330018</b>	<b>AX330054</b>	<b>AX330030</b>	<b>AX330024</b>	<b>AX330048</b>	<b>AX330060</b>

These products are in the process of being assessed for RoHS compliance. Please check our website for the most current RoHS status.

## Network Connectivity Products

### Media Converters, Transceivers & Hubs and Network Tester

Media Converters



#### Media Converters for Ethernet and Fast Ethernet

Media converters enable the connection of dissimilar network cabling types, while maintaining the same network speed. A legacy Thinnet segment can be connected to a 10Base-T Hub or switch port with a AX-200 converter or, link two different 10Base-T networks together over a multimode fiber optic link with a pair of AX-270s. Connect a legacy Thinnet segment over fiber with the AX-280 converter. The AX-5270 can be used for interbuilding links or attached to a fiber backbone.

AX-1912 Media Converter Rack

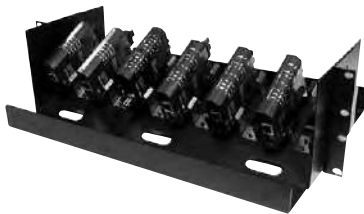

#### Transceivers and Ethernet Hubs

The AX-50, 70 and 80 transceivers enable the connection of a legacy AUI port to 10Base-T, Thinnet, or fiber optic media. The transceiver is powered from the host and requires no external power supply.

The AX-509 Ethernet Hub has an AUI port which accepts UTP, Fiber Optic or BNC transceivers. Specified for use by many U.S. Government Agencies. Includes a 110v/12v power supply.

AX050, 70 and 80 Transceivers and AX-509 Ethernet Hub



#### Realtime 10/100 Base-TX Ethernet Network Test Unit

The AX-110BT Realtime 10/100 Base-TX ethernet network test unit is a cost effective way to quickly determine a network's operating condition. Plug the unit's patch cord into the tester then into any open RJ-45 jack in an office, cubicle or conference room. Immediately see if the jack is a live network node capable of either 100 Mb/s or 10 Mb/s. Next check patch cord continuity and polarity. Connect the downlink to a PC to check NIC card link, speed and full or half duplex capabilities. Connect the uplink to a hub or switch port to verify link and speed.

AX-110BT Realtime 10/100 Base-TX Ethernet Network Test Unit



Description	Belden Part Number
<b>Network Connectivity Products</b>	
<b>Media Converter</b>	
10Base-T/10Base2, RJ-45 to BNC	<b>AX-200</b>
10Base-T/10Base-FL, RJ-45 to ST-Compatible fiber connectors	<b>AX-270</b>
10Base2/10Base-FL, BNC to ST-Compatible fiber connectors	<b>AX-280</b>
100Base-TX/100Base-FX, SC-Compatible fiber connectors	<b>AX-5270SC</b>
100Base-TX/100Base-FX, ST-Compatible fiber connectors	<b>AX-5270ST</b>
<b>Media Converter Rack</b>	
Holds up to 12 converters and multi lead power supplies, 19" (0.48 m) rack-mount ready	<b>AX-1912-MCR</b>
Power Supply, 4-lead 110v/12v, powers up to 4 converters	<b>AX-270P4U</b>
Power Supply, 8-lead 110v/12v, powers up to 8 converters	<b>AX-270P8U</b>
<b>Transceivers and Ethernet Hubs</b>	
UTP Transceiver, 10Base-T, AUI to RJ-45, side port	<b>AX-50</b>
UTP Transceiver, 10Base-T, AUI to RJ-45, rear port	<b>AX-50R</b>
Fiber Transceiver, 10Base-FL, AUI to ST-Compatible	<b>AX-70</b>
Thinnet Transceiver, 10Base2, AUI to BNC	<b>AX-80</b>
Ethernet Hub with 8 RJ-45 10Base-T ports and 1 AUI port	<b>AX-509</b>
<b>Network Tester</b>	
Realtime 10/100 Base-TX Ethernet Network Test Unit	<b>AX-110BT</b>

These products are in the process of being assessed for RoHS compliance. Please check our website for the most current RoHS status.

## Line Protection and Bonding & Grounding

### IDC 4-pair Protector Modules, PVCi Ground Wires, Bond Clamp and Accessories

AX100826 Cat-5e, 4-pair Protector

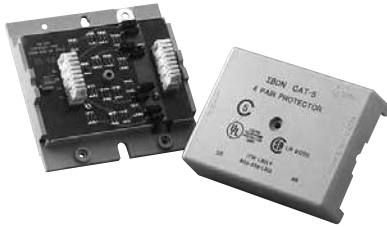

#### IDC 4-pair Protector Module

The IDC 4-pair protector module is a high-performance Category 5e, solid-state protection for local area networks. Protects sensitive electronic workstations, network equipment, and cables from damage caused by transient voltage surges. Provides 100% protection with easy-to-install BIX or 110 IDC termination in a convenient 4-pair module.

Description	Belden Part Number
<b>Line Protection</b>	
<b>IDC 4-pair Protector Module</b>	
IDC Protector Module, Category 5e, 4-pair, BIX Protector, 1/pack	<b>AX100826</b>
IDC Protector Module, Category 5e, 4-pair, 110 Protector, 1/pack	<b>AX100827</b>

These products are in the process of being assessed for RoHS compliance. Please check our website for the most current RoHS status.

PVCi Ground Wire

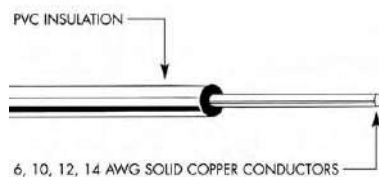

#### PVCi Ground Wire

PVCi ground wire consists of 6, 10, 12 and 14 AWG solid annealed copper conductors individually insulated with polyvinyl chloride compound.

X9905753 Bond Clamp



#### Bond Clamp

The bond clamps are used to attach the cable shield to the ground via ground wire. They are recommended for use with riser cables and outside plant cables. The bond clamps consist of heavy plates and a securing nut with an integral spring washer. The plates are curved to conform to the contours of the cable. The upper plate has "teeth" which penetrate the polyethylene cable jacket and align with the perforations in the lower plate. The lower plate has burred perforations that penetrate into the metallic sheath of the cable.

AX100226 Six-position Ground Bracket



#### Accessories

A six-position ground bracket is used to terminate and ground up to 5 cable sheaths. The sixth position on the bracket is used to provide the ground return to the distribution terminal and is not available to ground a cable. Two ground wire clips on each side of the ground wire are required to ground one cable.

X9908359 6 AWG Ground Wire Clip



Description	Belden Part Number
<b>Bonding &amp; Grounding</b>	
<b>PVCi Ground Wire</b>	
PVCi Ground Wire, 6 AWG, Black, 75 m (246 ft.), Coil	<b>22214348</b>
PVCi Ground Wire, 10 AWG, Black, 50 m (164 ft.), Coil	<b>22214500</b>
PVCi Ground Wire, 12 AWG, Almond, 50 m (164 ft.), Coil	<b>22214700</b>
PVCi Ground Wire, 14 AWG, Olive Grey, 75 m (246 ft.), Coil	<b>22214900</b>
<b>Bond Clamp</b>	
Bond Clamp, QCF1A 19 mm (0.75") cable and above	<b>X9905753</b>
Bond Clamp, QCF2A 19 mm (0.75") cable and below	<b>X9905754</b>
<b>Accessories</b>	
Bond Clamp Accessories, Six-position Ground Bracket	<b>AX100226</b>
Bond Clamp Accessories, 6 AWG Ground Wire Clip	<b>X9908359</b>

These products are in the process of being assessed for RoHS compliance. Please check our website for the most current RoHS status.

# DataTwist® 600e U/UTP Cables

TIA/EIA-568-B.2-1, Category 6,  
Enhanced Category 6 Bonded-Pair Cables

**Certified System 480LX**

De- scription	Part No.	UL NEC/ C(UL)CEC Type IEC	Standard Lengths		Standard Unit Weight		Conductor (Stranding) Diameter Nom. DCR	Nominal Insulation OD		Shielding Material Nom. DCR	Nominal OD		Freq. MHz	Max. Atten. dB/100m	Min. PSUM			Input Imp. ( )	Min. RL dB
			ft.	m	lbs.	kg		inch	mm		inch	mm			NEXT dB	ACR dB/100m	ELFEXT dB/100m		

**Cat 6 • 23 AWG • Bonded-Pair • Solid 0.6 mm Bare Copper • Patented E-Spline Center Member • Rip Cord**

**Polyolefin Insulation • PVC Jacket** (Red, Orange, Yellow, Green, Blue, Black, White and Grey)

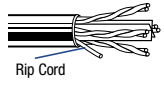
 Rip Cord  4-Pair	<b>7851A</b> NEC: CMR CEC: CMR	1000	305	37.9	17.2	0.57 mm 23 AWG Solid BC	0.044 1.13	<b>Bonded-Pair</b> Unshielded U/UTP	0.227	5.77	1 10 62.5 100 155 200 250 350 400 500 550 600	1.9 5.7 10.2 18.9 23.9 27.5 31.2 37.7 40.2 40.6 46.2 48.8 51.4	80.3 65.3 57.9 53.4 47.5 45.8 44.3 40.2 39.3 37.8 37.2 36.6	78.5 59.6 47.7 38.7 34.9 30.8 27.0 22.8 24.8 22.8 19.9 18.8 16.8 16.0 15.2	100 ± 12 100 ± 12 100 ± 15 100 ± 15 100 ± 15 100 ± 15 100 ± 20 100 ± 22 100 ± 22 100 ± 22 100 ± 22 100 ± 22	20.0 25.0 25.0 25.0 22.8 21.7 20.5 19.8 19.5 18.4 18.0 17.6
---	--	------	-----	------	------	-------------------------------	---------------	---	-------	------	--	--	--	--	--	--

Color Code: see chart below

Third party verified to TIA/EIA-568-B.2-1, Category 6  
 U.S. Patents 5,606,151; 5,734,126; 5,789,711 and 6,297,454-B1  
 Jacket sequentially marked at 0.6 m intervals. Features descending length marking.

**Polyolefin Insulation • Grey Haloarrest® Jacket**

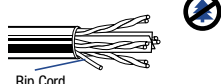
 Rip Cord  4-Pair	<b>7851NH</b>	1000	305	39.0	17.7	0.57 mm 23 AWG Solid BC	0.044 1.13	<b>Bonded-Pair</b> Unshielded U/UTP	0.241	6.12	0.291 8.36	6.12 8.36	see above
		A-1000	A-305	48.1	21.8								

Color Code: see chart below

Third party verified to TIA/EIA-568-B.2-1, Category 6  
 U.S. Patents 5,606,151; 5,734,126; 5,789,711 and 6,297,454-B1  
 Jacket sequentially marked at 1 m intervals. Features descending length marking.

**Plenum • FEP Teflon® Insulation • Flamarrrest® Jacket** (Red, Orange, Yellow, Green, Blue, Black, White and Grey)

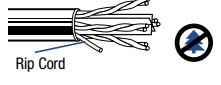
 Rip Cord  4-Pair	<b>7852A</b> NEC: CMP CEC: CMP	1000	305	39.9	18.1	0.57 mm 23 AWG Solid BC	0.043 1.08	<b>Bonded-Pair</b> Unshielded U/UTP	0.218	5.54	0.290 7.37	5.54 7.37	see above
		A-1000	A-305	48.9	22.2								

Color Code: see chart below  
 A-305 m put-up not available in Red.

Third party verified to TIA/EIA-568-B.2-1, Category 6  
 U.S. Patents 5,606,151; 5,734,126; 5,789,711 and 6,297,454-B1  
 Jacket sequentially marked at 0.6 m intervals. Features descending length marking.

BC = Bare Copper • ACR = Attenuation Crosstalk Ratio •  
 ELFEXT = Equal Level Far-end Crosstalk •  
 NEXT = Near-end Crosstalk • PSUM = Power Sum •  
 RL = Return Loss • DCR = DC resistance  
 \* PSUM ACR > 0 is guaranteed to 460 MHz.

Teflon® is a DuPont trademark.

 Not RoHS compliant at time of printing.

**Color Code**

Pair No.	Color
1	White/Blue Stripe, Blue
2	White/Orange Stripe, Orange
3	White/Green Stripe, Green
4	White/Brown Stripe, Brown

**DataTwist 600e: Beyond Category 6**

Belden DataTwist 600e data cable is a revolutionary UTP cable engineered specifically to perform well beyond Category 6 standards. While Category 6 cable is specified only to 250 MHz, DataTwist 600e is the only Cat 6 UTP cable in the industry fully characterized with guaranteed performance to 600 MHz. So users have far more headroom to compensate for unforeseen factors that can inhibit the performance of a cabling system today...and protection of their technology investment for the future.

**Handy Cable Preparation Tool Speeds Installation of Bonded-Pair Cables**

You know the high-performance benefits of using data cables featuring Belden's unique Bonded-Pair technology. The Belden cable preparation tool (1797B) now makes it faster and easier than ever to prepare cables for connector termination providing special features that help separate twisted pairs. The cable preparation tool is packed with every spool of DataTwist® 600e. See page 15.37 for more information.



# GigaFlex 4800LX Cables Series

ANSI/TIA/EIA-568-B.2-1, Category 6,  
Enhanced Category 6 Non-Bonded-Pair Cables

**Certified System 4800LX**

De- scription	Part No.	UL NEC/ C(UL)/CEC Type IEC	Standard Lengths		Standard Unit Weight		Conductor (Stranding) Diameter Nom. DCR	Nominal Insulation OD		Shielding Material Nom. DCR	Nominal OD		Freq. MHz	Max. Atten. dB/100m	Min. PSUM			Input Imp. ( )	Min. RL dB
			ft.	m	lbs.	kg		inch	mm		inch	mm			NEXT dB	ACR dB/100m	ELFEXT dB/100m		

**Cat 6 • 23 AWG • Solid 0.6 mm Bare Copper • Twisted Pair • Central Cross Web Filler • Rip Cord**

**Polyolefin Insulation • PVC Jacket**

White-Reel	<b>24586385</b>	NEC:	1000	305	29.1	13.2	0.57 mm	0.044	1.11	Non- Bonded-Pair Unshielded U/UTP	0.245	6.22	0.772	1.7	80.0	78.3	74.0	100 ± 12	-	
Blue-Reel	<b>24586985</b>	CMR					23 AWG							1	1.8	78.3	76.5	71.8	100 ± 12	20.0
		CEC:					Solid BC							4	3.4	69.3	65.9	59.7	100 ± 12	23.0
		CMR												8	4.8	64.8	60.0	53.7	100 ± 12	25.0
														10	5.3	63.3	58.0	51.8	100 ± 12	25.0
														16	6.8	60.3	53.5	47.7	100 ± 12	25.0
														20	7.6	58.8	51.2	45.7	100 ± 12	25.0
														25	8.5	57.3	48.8	43.8	100 ± 15	24.6
														31.25	9.6	55.9	46.3	41.9	100 ± 15	24.2
														62.5	13.8	51.4	37.6	35.8	100 ± 15	23.0
														100	17.8	48.3	30.5	31.8	100 ± 15	22.1
														200	26.2	43.8	17.6	25.7	100 ± 15	20.9
														250	29.7	42.3	12.6	23.8	100 ± 20	20.5
													300	33.0	41.2	8.2	22.2	100 ± 20	20.2	
													350	36.1	40.2	4.1	20.9	100 ± 22	19.9	
													400	39.0	39.3	0.3	19.7	100 ± 22	19.7	
													450*	41.8	38.5	-3.3	18.7	100 ± 22	19.5	
													500*	44.5	37.8	-6.7	17.8	100 ± 22	19.3	
													550*	47.1	37.2	-9.9	16.9	100 ± 22	19.1	

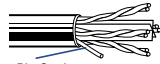

Rip Cord

4-Pair

Color Code: see chart below

Third party verified to TIA/EIA-568-B.2-1, Category 6  
Jacket sequentially marked at 0.6 m intervals. Features descending length marking.

**Polyolefin Insulation • FRNC/LSNH Polymer Alloy**

Violet-Reel	<b>24588085</b>	NEC:	1000	305	31.1	14.1	0.57 mm	0.044	1.11	Non- Bonded-Pair Unshielded U/UTP	0.240	6.10							see above	
		CMR					23 AWG													
		CEC:					Solid BC													
		CMR																		

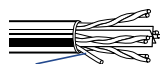

Rip Cord

4-Pair

Color Code: see chart below

Third party verified to TIA/EIA-568-B.2-1, Category 6  
Jacket sequentially marked at 0.6 m intervals. Features descending length marking.

**Plenum • FEP Insulation • FRNC/LSNH Polymer Alloy**

White-Reel	<b>24587385</b>	NEC:	1000	305	30.6	13.9	0.57 mm	0.043	1.10	Non- Bonded-Pair Unshielded U/UTP	0.229	5.81							see above	
Blue-Reel	<b>24587985</b>	CMP					23 AWG													
		CEC:					Solid BC													
		CMP																		

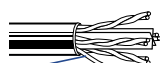

Rip Cord

4-Pair

Color Code: see chart below

Third party verified to TIA/EIA-568-B.2-1, Category 6  
Jacket sequentially marked at 0.6 m intervals. Features descending length marking.

BC = Bare Copper • ACR = Attenuation Crosstalk Ratio • ELFEXT = Equal Level Far-end Crosstalk • NEXT = Near-end Crosstalk • PSUM = Power Sum • RL = Return Loss • DCR = DC resistance  
\* Values provided for information only.

**Color Code**

Pair No.	Color
1	White/Blue Stripe, Blue
2	White/Orange Stripe, Orange
3	White/Green Stripe, Green
4	White/Brown Stripe, Brown



### Category 6 U/UTP Cables

TIA/EIA-568-B.2, Category 6,  
Bonded-Pair Cables

**Certified System 2400**

De- scription	Part No.	UL NEC/ C(UL)CEC Type IEC	Standard Lengths		Standard Unit Weight		Conductor (Stranding) Diameter Nom. DCR	Nominal Insulation OD		Shielding Material Nom. DCR	Nominal OD		Freq. MHz	Max. Atten. dB/100m	Min. PSUM			Input Imp. ( )	Min. RL dB
			ft.	m	lbs.	kg		inch	mm		inch	mm			NEXT dB	ACR dB/100m	ELFEXT dB/100m		

**Cat 6 • 23 AWG • Bonded-Pair • Solid 0.6 mm Bare Copper • Twisted Pair**

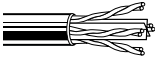
<b>Polyolefin Insulation • PVC Jacket (Grey and Blue)</b>																			
	7812E	B-328	B-100	9.5	4.3	0.57 mm 23 AWG Solid BC	0.042	1.06	<b>Bonded-Pair</b> Unshielded U/UTP	0.256	6.50	1	2.1	72.0	70.2	65.0	100 ± 15	20.0	
		U-1000	U-305	28.9	13.1							4	3.8	63.0	59.4	53.0	100 ± 15	23.0	
		1640	500	47.4	21.5							10	6.0	57.0	51.3	45.0	100 ± 15	25.0	
		3280	1000	94.8	43.0							16	7.6	54.0	46.6	41.0	100 ± 15	25.0	
		20	8.5	53.0	44.3							39.0	100 ± 15	25.0					
		25	9.6	51.0	41.8							37.0	100 ± 15	24.3					
		31.25	10.7	50.0	39.1							35.0	100 ± 15	23.6					
		62.5	15.5	45.0	29.9							29.0	100 ± 15	21.5					
		100	19.9	42.0	22.4							25.0	100 ± 15	20.1					
		155	25.3	39.0	14.1							21.0	100 ± 22	18.8					
200	29.1	38.0	8.6	19.0	100 ± 22	18.0													
250	33.0	36.0	3.3	17.0	100 ± 22	17.3													

Color Code: see chart below

Applicable industry standards: EN 50173, ISO/IEC 11801, TIA/EIA 568-B2

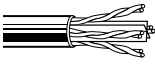
<b>Polyolefin Insulation • FRNC / LSNH Jacket (Grey and Blue)</b>																			
	7812ENH	B-328	B-100	9.5	4.3	0.57 mm 23 AWG Solid BC	0.042	1.06	<b>Bonded-Pair</b> Unshielded U/UTP	0.256	6.50	see above							
		1000	305	28.9	13.1														
		1640	500	47.4	21.5														

4-Pair

Color Code: see chart below

Burning Energy: 535 kJ/m

Applicable industry standards: EN 50173, ISO/IEC 11801, TIA/EIA 568-B2

BC = Bare Copper • ACR = Attenuation Crosstalk Ratio • ELFEXT = Equal Level Far-end Crosstalk • NEXT = Near-end Crosstalk • PSUM = Power Sum • RL = Return Loss • DCR = DC resistance

**Color Code**

Pair No.	Color
1	White/Blue Stripe, Blue
2	White/Orange Stripe, Orange
3	White/Green Stripe, Green
4	White/Brown Stripe, Brown

**Get the Bonded-Pairs  
Cable Preparation Tool**

See page 15.37 for details.  
(Part No. 1797B)



# GigaFlex 2400 Cables Series

ANSI/TIA/EIA-568-B.2-1, Category 6,  
Enhanced Category 6 Non-Bonded-Pair Cables

**Certified System 2400**

De- scription	Part No.	UL NEC/ C(UL)/CEC Type IEC	Standard Lengths		Standard Unit Weight		Conductor (Stranding) Diameter Nom. DCR	Nominal Insulation OD		Shielding Material Nom. DCR	Nominal OD		Freq. MHz	Max. Atten. dB/100m	Min. PSUM			Input Imp. ( )	Min. RL dB
			ft.	m	lbs.	kg		inch	mm		inch	mm			NEXT dB	ACR dB/100m	ELFEXT dB/100m		

**Cat 6 • 24 AWG • Solid 0.5 mm Bare Copper • Twisted Pair • Rip Cord**

<b>Polyolefin Insulation • PVC Jacket</b>																				
White †	<b>24566315</b>	NEC:	1000	305	26.0	11.8	0.51 mm	0.042	1.06	Non- Bonded-Pair Unshielded U/UTP	0.214	5.44	0.772	1.8	75.0	73.2	70.0	100 ± 15	19.7	
Blue †	<b>24566915</b>	CMR					24 AWG							1	2.0	73.3	71.3	67.8	100 ± 15	20.0
White	<b>24566345</b>	CEC:					Solid BC							4	3.7	64.3	60.6	55.8	100 ± 15	23.0
Blue	<b>24566945</b>	CMR												8	5.2	59.8	54.6	49.7	100 ± 15	24.5
														10	5.8	58.3	52.5	47.8	100 ± 15	25.0
														16	7.4	55.2	47.9	43.7	100 ± 15	25.0
														20	8.3	53.8	45.5	41.8	100 ± 15	25.0
														25	9.3	52.3	43.1	39.8	100 ± 15	24.3
														31.25	10.4	50.9	40.5	37.9	100 ± 15	23.6
														62.5	15.0	46.4	31.4	31.9	100 ± 15	21.5
														100	19.3	43.3	24.0	27.8	100 ± 15	20.1
														200	28.3	38.8	10.5	21.8	100 ± 15	18.0
														250	32.1	37.3	5.3	19.8	100 ± 32	17.3
														300*	35.6	36.1	0.5	18.3	100 ± 32	16.8
													350*	38.9	35.1	-3.7	16.9	100 ± 32	16.3	
													400*	42.0	34.3	-7.7	15.8	100 ± 32	15.9	
													450*	45.0	33.5	-11.5	14.7	100 ± 32	15.5	

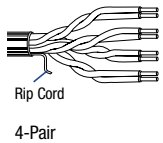

Color Code: see chart below

Third party verified to TIA/EIA-568-B.2-1, Category 6  
Jacket sequentially marked at 0.6 m intervals. Features descending length marking.

<b>Polyolefin Insulation • FRNC/LSNH Polymer Alloy</b>																					
Violet-Reel	<b>24568005</b>	NEC:	1000	305	28.0	12.7	0.51 mm	0.043	1.08	Non- Bonded-Pair Unshielded U/UTP	0.214	5.44								see above	
Violet-Box	<b>24568015</b>	CMR	1000	305	28.0	12.7	24 AWG														
White-Box	<b>24568315</b>	CEC:	1000	305	28.0	12.7	Solid BC														
White-Reel	<b>24568331</b>	CMR	1640	500	45.9	20.8															

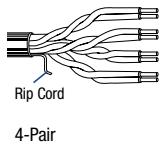

Color Code: see chart below

Third party verified to TIA/EIA-568-B.2-1, Category 6  
Jacket sequentially marked at 0.6 m intervals. Features descending length marking.

<b>Plenum • FEP Insulation • Low-Smoke PVC Jacket</b>																					
White †	<b>24567315</b>	NEC:	1000	305	24.0	10.9	0.51 mm	0.042	1.06	Non- Bonded-Pair Unshielded U/UTP	0.210	5.33								see above	
Blue †	<b>24567915</b>	CMR					24 AWG														
White	<b>24567345</b>	CEC:					Solid BC														
Blue	<b>24567945</b>	CMR																			

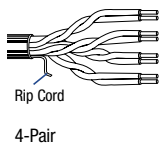

Color Code: see chart below

Third party verified to TIA/EIA-568-B.2-1, Category 6  
Jacket sequentially marked at 0.6 m intervals. Features descending length marking.

BC = Bare Copper • ACR = Attenuation Crosstalk Ratio • ELFEXT = Equal Level Far-end Crosstalk • NEXT = Near-end Crosstalk • PSUM = Power Sum • RL = Return Loss • DCR = DC resistance  
\* Values provided for information only.  
† Reel-in-Box

**Color Code**

Pair No.	Color
1	White/Blue Stripe, Blue
2	White/Orange Stripe, Orange
3	White/Green Stripe, Green
4	White/Brown Stripe, Brown

### MediaTwist® U/UTP Cables

TIA/EIA-568-B.2-1, Category 6,  
Enhanced Category 6 Bonded-Pair Cables

**Certified System 2400**

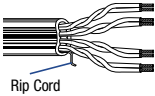
De- scription	Part No.	UL NEC/ C(UL)CEC Type IEC	Standard Lengths		Standard Unit Weight		Conductor (Stranding) Diameter Nom. DCR	Nominal Insulation OD		Shielding Material Nom. DCR	Nominal OD		Freq. MHz	Max. Atten. dB/100m	Min. PSUM			Input Imp. ( )	Min. RL dB
			ft.	m	lbs.	kg		inch	mm		inch	mm			NEXT dB	ACR dB/100m	ELFEXT dB/100m		
<b>Cat 6 • 23 AWG • Solid 0.6 mm Bare Copper • Rip Cord</b>																			
<b>Polyolefin Insulation • PVC Jacket</b> (Blue, Red, Yellow, Orange, Green, Gold, Violet, White, Black and Grey)																			
 Rip Cord  4-Pair	<b>1872A</b>	NEC: CMR CEC: CMR	1000 A-1000	305 A-305	37.0 37.0	16.8 16.8	0.57 mm 23 AWG Solid BC	0.042 1.06	<b>Bonded-Pair</b> Unshielded U/UTP	0.365 x 0.165	9.27 x 4.19	1 4 8 10 16 25 31.25 62.5 100 155 200 250 300 350 400* 500*	1.9 3.7 5.3 5.9 7.5 9.5 10.6 15.4 19.8 25.1 29.0 32.8 35.2 39.8 43.0 49.0	72.3 63.3 58.8 57.3 54.3 51.4 49.9 45.4 42.3 39.5 37.8 36.3 35.2 34.2 - -	70.0 59.0 53.0 51.0 46.0 42.0 39.0 30.0 25.0 14.0 10.0 3.0 - -	64.8 52.8 46.7 44.8 40.7 36.8 34.9 28.9 24.8 20.9 18.8 16.8 15.2 13.9 - -	100 ± 12 100 ± 12 100 ± 12 100 ± 12 100 ± 12 100 ± 15 100 ± 15 100 ± 15 100 ± 15 100 ± 15 100 ± 15 100 ± 20 100 ± 20 100 ± 22 100 ± 32 100 ± 32	20.0 23.0 24.5 25.0 25.0 24.3 23.6 21.5 21.0 21.0 21.0 18.0 18.0 17.0 14.0 14.0	

Color Code: see chart below  
A-305 m put-up not available in Black.

Third party verified to TIA/EIA-568-B.2-1, Category 6  
U.S. Patents 5,606,151; 5,734,126; 5,821,467  
Jacket sequentially marked at 0.6 m intervals. Features descending length marking.

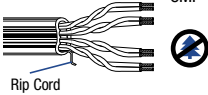
<b>Plenum • FEP Teflon® Insulation • Flamarrest® Jacket</b> (Blue, Natural, Grey, Red, Yellow, Orange, Green, Gold, Violet, White and Black)																				
 Rip Cord  4-Pair	<b>1874A</b>	NEC: CMP CEC: CMP	1000 A-1000	305 A-305	37.0 37.9	16.8 17.2	0.57 mm 23 AWG Solid BC	0.039 1.00	<b>Bonded-Pair</b> Unshielded U/UTP	0.365 x 0.165	9.27 x 4.19									see above

Color Code: see chart below  
A-305 m put-up not available in Black.

Third party verified to TIA/EIA-568-B.2-1, Category 6  
U.S. Patents 5,606,151; 5,734,126; 5,821,467  
Jacket sequentially marked at 0.6 m intervals. Features descending length marking.

BC = Bare Copper • ACR = Attenuation Crosstalk Ratio • ELFEXT = Equal Level Far-end Crosstalk • NEXT = Near-end Crosstalk • PSUM = Power Sum • RL = Return Loss • DCR = DC resistance  
\* Values provided for information only.

Teflon® is a DuPont trademark.

 Not RoHS compliant at time of printing.

#### Color Code

Pair No.	Color
1	White/Blue Stripe, Blue
2	White/Orange Stripe, Orange
3	White/Green Stripe, Green
4	White/Brown Stripe, Brown

#### Get the Bonded-Pairs Cable Preparation Tool

See page 15.37 for details.  
(Part No. 1797B)



# DataTwist® 350 U/UTP Cables

TIA/EIA-568-B.2, Category 5e,  
Enhanced Category 5e Bonded-Pair Cables

**Certified System 1200**

De- scription	Part No.	UL NEC/ C(UL)/CEC Type IEC	Standard Lengths		Standard Unit Weight		Conductor (Stranding) Diameter Nom. DCR	Nominal Insulation OD		Shielding Material Nom. DCR	Nominal OD		Freq. MHz	Max. Atten. dB/100m	Min. PSUM			Input Imp. ( )	Min. RL dB
			ft.	m	lbs.	kg		inch	mm		inch	mm			NEXT dB	ACR dB/100m	ELFEXT dB/100m		

**Cat 5e • 24 AWG • Bonded-Pair • Solid 0.5 mm Bare Copper • Rip Cord**

**Polyolefin Insulation • PVC Jacket** (Red, Orange, White, Black, Yellow, Green, Blue, Violet, Light Grey and Grey)

1700A	NEC: CM CEC: CM	U-1000 1000 1640 3000 3280	U-305 305 500 914 1000	22.0 10.0 22.0 10.0 22.0	10.0 10.0 16.4 28.6 32.8	0.51 mm 24 AWG Solid BC	0.038 0.97	Bonded-Pair Unshielded U/UTP	0.200 5.08	1 4 8 10 16 25 31.25 62.5 100 155 200 250 350	2.0 4.0 5.7 6.4 8.1 10.3 11.6 16.8 21.7 27.7 32.0 36.4 44.3	65.3 56.3 51.8 50.3 47.3 44.3 42.9 38.4 35.3 32.5 30.8 29.3 27.2	63.3 52.3 46.1 43.9 39.1 34.1 31.3 21.6 17.1 4.7 3.0 > 0 > 0	60.8 48.8 42.7 40.8 36.7 32.8 30.9 24.8 20.8 16.9 14.7 12.8 9.9	100 ± 12 100 ± 12 100 ± 12 100 ± 12 100 ± 12 100 ± 15 100 ± 15 100 ± 15 100 ± 15 100 ± 18 100 ± 18 100 ± 20 100 ± 22	20.0 23.0 24.5 25.0 25.0 24.3 23.6 21.5 20.1 19.0 19.0 18.0 17.0
-------	--------------------------	--	------------------------------------	--------------------------------------	--------------------------------------	-------------------------------	---------------	------------------------------------	---------------	---	---	--	--	---	--	--

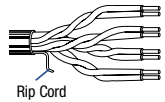

Rip Cord

4-Pair

305 m put-up not available in Grey.  
914 m put-up available in Red, Blue,  
White or Light Grey only.  
500 m put-up available in Light Grey or Blue only.  
1000 m put-up available in Light Grey only.

Third party verified to TIA/EIA-568-B.2, Category 5e  
U.S. Patents 5,606,151 and 5,734,126  
Jacket sequentially marked at 0.6 m intervals. Features descending length marking.

Color Code: see chart below

**Polyolefin Insulation • PVC Jacket** (Grey and Blue)

1700E	B-328 U-1000 1000 1640 3280	B-100 U-305 305 500 1000	6.1 18.7 18.7 30.9 61.7	2.8 8.5 8.5 14.0 28.0	0.51 mm 24 AWG Solid BC	0.038 0.97	Bonded-Pair Unshielded U/UTP	0.197 5.00
-------	---	--------------------------------------	-------------------------------------	-----------------------------------	-------------------------------	---------------	------------------------------------	---------------

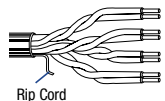

Rip Cord

4-Pair

Color Code: see chart below

Applicable industry standards: EN 50173, ISO/IEC 11801, TIA/EIA 568-B2

**Polyolefin Insulation • FRNC/LSNH Jacket** (Grey and Blue)

1700ENH	60332-1 CSA FT1 UL CM UL ISDI (Vertical Tray)	B-328 U-1000 1640 3280	B-100 U-305 500 1000	6.1 18.7 30.9 61.7	2.8 8.5 14.0 28.0	0.51 mm 24 AWG Solid BC	0.038 0.97	Bonded-Pair Unshielded U/UTP	0.197 5.00	see above
---------	---	---------------------------------	-------------------------------	-----------------------------	----------------------------	-------------------------------	---------------	------------------------------------	---------------	-----------

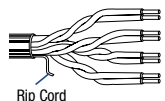

Rip Cord

4-Pair

Color Code: see chart below  
305 m and 1000 m put-up available in Grey only.

Burning Energy: 298 kJ/m  
Flame Test: IEC 60332-2, UL CM UL ISDI Vertical Tray, CAS FT1  
Applicable industry standards: EN 50173, ISO/IEC 11801, TIA/EIA 568-B2

BC = Bare Copper • ACR = Attenuation Crosstalk Ratio • ELFEXT = Equal Level Far-end Crosstalk • NEXT = Near-end Crosstalk • PSUM = Power Sum • RL = Return Loss • DCR = DC resistance

**Color Code**

Pair No.	Color
1	White/Blue Stripe, Blue
2	White/Orange Stripe, Orange
3	White/Green Stripe, Green
4	White/Brown Stripe, Brown

**Get the Bonded-Pairs  
Cable Preparation Tool**

See page 15.37 for details.  
(Part No. 1797B)



### GigaFlex 1200 Cables Series

ANSI/TIA/EIA-568-B.2, Category 5e,  
Enhanced Category 5e Non-Bonded-Pair Cables

**Certified System 1200**

De- scription	Part No.	UL NEC/ C(UL)CEC Type IEC	Standard Lengths		Standard Unit Weight		Conductor (Stranding) Diameter Nom. DCR	Nominal Insulation OD		Shielding Material Nom. DCR	Nominal OD		Freq. MHz	Max. Atten. dB/100m	Min. PSUM			Input Imp. ( )	Min. RL dB
			ft.	m	lbs.	kg		inch	mm		inch	mm			NEXT dB	ACR dB/100m	ELFEXT dB/100m		

**Cat 5e • 24 AWG • Solid 0.5 mm Bare Copper • Twisted Pair • Rip Cord**

Polyolefin Insulation • PVC Jacket																				
White, Box	24570166	NEC:	1000	305	24.0	10.9	0.51 mm	0.035	0.89	Non-	0.186	4.72	0.772	1.8	69.0	67.3	63.0	100 ± 15	-	
Blue, Box	24570161	CMR					24 AWG			Bonded-Pair				1	2.0	67.3	65.3	60.8	100 ± 15	20.0
White, Reel	24570460	CEC:					Solid BC			Unshielded				4	4.0	58.3	54.3	48.7	100 ± 15	23.0
Blue, Reel	24570452	CMR								U/UTP				8	5.7	53.8	48.1	42.7	100 ± 15	24.5
														10	6.3	52.3	46.0	40.8	100 ± 15	25.0
														16	8.1	49.3	41.2	36.7	100 ± 15	25.0
														20	9.1	47.8	38.7	34.7	100 ± 15	25.0
														25	10.2	46.3	36.1	32.8	100 ± 15	24.3
														31.25	11.5	44.9	33.4	30.9	100 ± 15	23.6
														62.5	16.7	40.4	23.7	24.8	100 ± 15	21.5
														100	21.6	37.3	15.7	20.8	100 ± 15	20.1
														200*	31.9	32.8	0.9	14.7	100 ± 22	18.0
														250*	36.3	31.3	- 4.9	12.8	100 ± 22	17.3
														300*	40.3	30.2	- 10.2	11.2	100 ± 22	16.8
														350*	44.2	29.2	- 15.0	9.9	100 ± 22	16.3

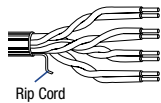

Color Code: see chart below

Third party verified to TIA/EIA-568-B.2, Category 5e  
Jacket sequentially marked at 0.6 m intervals. Features descending length marking.

Polyolefin Insulation • FRNC / LSNH Polymer Alloy																				
Violet, Box	24570157	NEC:	1000	305	24.9	11.3	0.51 mm	0.035	0.89	Non-	0.198	5.03								see above
White, Box	24598301	CMR	1000	305	24.9	11.3	24 AWG			Bonded-Pair										
White, Reel	24598331	CEC:	1640	500	40.8	18.5	Solid BC			Unshielded										
		CMR								U/UTP										

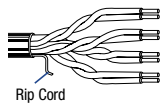

4-Pair

Color Code: see chart below

Third party verified to TIA/EIA-568-B.2, Category 5e  
Jacket sequentially marked at 0.6 m intervals. Features descending length marking.

Plenum • Polyolefin / FEP Insulation • Low-Smoke PVC Jacket																				
White, Box	24570810	NEC:	1000	305	22.0	9.98	0.51 mm	0.035	0.90	Non-	0.188	4.78								see above
Blue, Box	24570800	CMP					24 AWG			Bonded-Pair										
White, Reel	24570808	CEC:					Solid BC			Unshielded										
Blue, Reel	24570812	CMP								U/UTP										

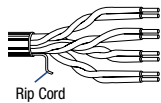

4-Pair

Color Code: see chart below

Third party verified to TIA/EIA-568-B.2, Category 5e  
Jacket sequentially marked at 0.6 m intervals. Features descending length marking.

BC = Bare Copper • ACR = Attenuation Crosstalk Ratio • ELFEXT = Equal Level Far-end Crosstalk • NEXT = Near-end Crosstalk • PSUM = Power Sum • RL = Return Loss • DCR = DC resistance  
\* Values provided for information only.

**Color Code**

Pair No.	Color
1	White/Blue Stripe, Blue
2	White/Orange Stripe, Orange
3	White/Green Stripe, Green
4	White/Brown Stripe, Brown

### DataTwist® 6 U/UTP Cables

TIA/EIA-568-B.2, Category 6,  
Non-Bonded-Pair Cables

De- scription	Part No.	UL NEC/ C(UL)/CEC Type IEC	Standard Lengths		Standard Unit Weight		Conductor (Stranding) Diameter Nom. DCR	Nominal Insulation OD		Shielding Material Nom. DCR	Nominal OD		Freq. MHz	Max. Atten. dB/100m	Min. PSUM			Input Imp. ( )	Min. RL dB	
			ft.	m	lbs.	kg		inch	mm		inch	mm			NEXT dB	ACR dB/100m	ELFEXT dB/100m			
<b>Cat 6 • 23 AWG • Unbonded-Pair • Solid 0.6 mm Bare Copper • Twisted Pair</b>																				
<b>Polyolefin Insulation • PVC Jacket (Grey and Blue)</b>																				
	<b>7965E</b>		B-328	B-100	9.5	4.3	0.57 mm	0.040	1.01	Non- Bonded-Pair Unshielded U/UTP	0.244	6.20	1	2.1	72.0	70.2	65.0	100 ± 15	20.0	
			U-1000	U-305	28.9	13.1	23 AWG							4	3.8	63.0	59.4	53.0	100 ± 15	23.0
			1000	305	28.9	13.1	Solid BC							10	6.0	57.0	51.3	45.0	100 ± 15	25.0
			1640	500	47.4	21.5								16	7.6	54.0	46.6	41.0	100 ± 15	25.0
			3280	1000	94.8	43.0								20	8.5	53.0	44.3	39.0	100 ± 15	25.0
														25	9.6	51.0	41.8	37.0	100 ± 15	24.3
														31.25	10.7	50.0	39.1	35.0	100 ± 15	23.6
														62.5	15.5	45.0	29.9	29.0	100 ± 15	21.5
														100	19.9	42.0	22.4	25.0	100 ± 15	20.1
														155	25.3	39.0	14.1	21.0	100 ± 22	18.8
													200	29.1	38.0	8.6	19.0	100 ± 22	18.0	
													250	33.0	36.0	3.3	17.0	100 ± 22	17.3	

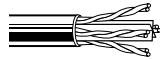

4-Pair

Color Code: see chart below  
305 m, 500 m and 1000 m put-up available in Blue only.

Applicable industry standards: EN 50173, ISO/IEC 11801, TIA/EIA 568-B2

<b>Polyolefin Insulation • FRNC/LSNH Jacket (Grey or Blue)</b>																					
	<b>7965ENH</b>		B-328	B-100	9.5	4.3	0.57 mm	0.040	1.01	Non- Bonded-Pair Unshielded U/UTP	0.244	6.20								see above	
			1000	305	28.9	13.1	23 AWG														
			1640	500	47.4	21.5	Solid BC														
			3280	1000	94.8	43.0															

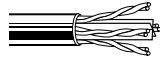

4-Pair

Color Code: see chart below

Applicable industry standards: EN 50173, ISO/IEC 11801, TIA/EIA 568-B2  
Burning Energy: 478 kJ/m

BC = Bare Copper • ACR = Attenuation Crosstalk Ratio • ELFEXT = Equal Level Far-end Crosstalk • NEXT = Near-end Crosstalk • PSUM = Power Sum • RL = Return Loss • DCR = DC resistance

#### Color Code

Pair No.	Color
1	White/Blue Stripe, Blue
2	White/Orange Stripe, Orange
3	White/Green Stripe, Green
4	White/Brown Stripe, Brown

# DataTwist® 5e U/UTP Cables

ANSI/TIA/EIA-568-B.2, Category 5e,  
Non-Bonded-Pair Cables

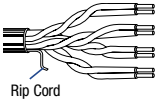
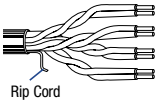
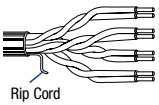
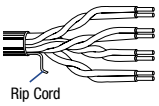
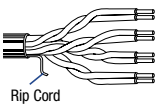
De- scription	Part No.	UL NEC/ C(UL)CEC Type IEC	Standard Lengths		Standard Unit Weight		Conductor (Stranding) Diameter Nom. DCR	Nominal Insulation OD		Shielding Material Nom. DCR	Nominal OD		Freq. MHz	Max. Atten. dB/100m	Min. PSUM			Input Imp. ( )	Min. RL dB		
			ft.	m	lbs.	kg		inch	mm		inch	mm			NEXT dB	ACR dB/100m	ELFEXT dB/100m				
<b>Cat 5e • 24 AWG • Solid 0.5 mm Bare Copper • Twisted Pair</b>																					
<b>Polyolefin Insulation • PVC Jacket</b> (White, Black, Grey, Blue, Red, Orange, Yellow, Green and Pink)																					
 Rip Cord  4-Pair	<b>1583A</b>	NEC:	U-1000	U-305	20.9	9.5	0.51 mm 24 AWG Solid BC	0.037	0.93	Non- Bonded-Pair Unshielded U/UTP	0.195	4.95	1	2.0	62.3	60.3	60.8	100 ± 15	20.0		
		CM	1000	305	20.9	9.5									4	4.1	53.3	49.2	48.7	100 ± 15	23.0
		CEC:	1640	500	34.6	15.7									10	6.5	47.3	40.8	40.8	100 ± 15	25.0
		CM	3000	914	63.1	28.6									16	8.2	44.3	36.0	36.7	100 ± 15	25.0
															31.25	11.7	39.9	28.2	30.9	100 ± 15	23.6
															62.5	17.0	35.4	19.0	24.9	100 ± 15	21.5
					100	22.0	32.3	10.3	20.8	100 ± 15	20.1										
					200	32.0	27.8	1.0	14.7	100 ± 25	15.0										
Color Code: see chart below 500 m put-up available in Dark Grey or Blue only. 914 m put-up available in Dark Grey, White or Blue only.																					
										Third party verified to TIA/EIA-568-B.2, Category 5e Jacket sequentially marked at 0.6 m intervals.											
<b>Polyolefin Insulation • PVC Jacket</b> (Grey and Blue)																					
 Rip Cord  4-Pair	<b>1583E</b>	B-328	B-100	6.1	2.8	0.51 mm 24 AWG Solid BC	0.037	0.93	Non- Bonded-Pair Unshielded U/UTP	0.197	5.00	see above									
		U-1000	U-305	18.7	8.5																
		1000	305	18.7	8.5																
		1640	500	30.9	14.0																
		3280	1000	61.7	28.0																
Color Code: see chart below 500 m put-up available in Grey only.																					
										Applicable industry standards: EN 50173, ISO/IEC 11801, TIA/EIA 568-B2											
<b>Polyolefin Insulation • FRNC/LSNH Jacket</b> (Grey and Blue)																					
 Rip Cord  4-Pair	<b>1583ENH</b>	CSA FT1	B-328	B-100	6.1	2.8	0.51 mm 24 AWG Solid BC	0.037	0.93	Non- Bonded-Pair Unshielded U/UTP	0.197	5.00	see above								
		UL CM	U-1000	U-305	18.7	8.5															
		UL ISDI	1000	305	18.7	8.5															
		(Vertical Tray)	1640	500	30.9	14.0															
			3280	1000	61.7	28.0															
Color Code: see chart below 1000 m put-up available in Grey only.																					
										Applicable industry standards: EN 50173, ISO/IEC 11801, TIA/EIA 568-B2 Burning Energy: 310 kJ/m											
<b>Polyolefin Insulation • UV Resistant PVC Jacket</b> (Grey, White and Ivory)																					
Indoor/ Outdoor	<b>1594A</b>	NEC:	U-1000	U-305	26.0	11.8	0.51 mm 24 AWG Solid BC	0.034	0.87	Non- Bonded-Pair Unshielded U/UTP	0.220	5.58	see above								
		CMR/CMX CEC: CMR/CMX																			
 Rip Cord  4-Pair	Color Code: see chart below Third party verified to TIA/EIA-568-B.2, Category 5e Jacket sequentially marked at 0.6 m intervals.																				
	<b>Outside Plant • Polyolefin Insulation • Black Gel-Filled Polyethylene Jacket</b>																				
Outdoor	<b>7997A</b>	U-1000	U-305	37.9	17.2	0.51 mm 24 AWG Solid BC	0.041	1.04	Non- Bonded-Pair Unshielded U/UTP	0.251	6.38	1	2.0	68.3	66.3	64.8	100 ± 15	20.0			
 Rip Cord  4-Pair	Color Code: see chart below Third party verified to TIA/EIA-568-B.2, Category 5e Jacket sequentially marked at 0.6 m intervals.																				

BC = Bare Copper • ACR = Attenuation Crosstalk Ratio • ELFEXT = Equal Level Far-end Crosstalk • NEXT = Near-end Crosstalk • PSUM = Power Sum • RL = Return Loss • DCR = DC resistance

### Color Code

Pair No.	Color
1	White/Blue Stripe, Blue
2	White/Orange Stripe, Orange
3	White/Green Stripe, Green
4	White/Brown Stripe, Brown

# DataTwist® 5e U/UTP Cables

TIA/EIA-568-B.2, Category 5e,  
Non-Bonded-Pair Cables

De- scription	Part No.	UL NEC/ C(UL)/CEC Type IEC	Standard Lengths		Standard Unit Weight		Conductor (Stranding) Diameter Nom. DCR	Nominal Insulation OD		Shielding Material Nom. DCR	Nominal OD		Freq. MHz	Max. Atten. dB/100m	Min. PSUM			Input Imp. ( )	Min. RL dB
			ft.	m	lbs.	kg		inch	mm		inch	mm			NEXT dB	ACR dB/100m	ELFEXT dB/100m		

**Cat 5e • 24 AWG • Solid 0.5 mm Bare Copper • Twisted Pair**

**Plenum • FEP Teflon® Insulation • Flammarrest® Jacket** (Red, Orange, Yellow, Green, Grey, White, Black, Pink, Natural and Blue)

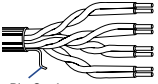
 <p>Rip Cord</p>	<b>1585A</b>	NEC:	U-1000	U-305	23.1	10.5	0.51 mm	0.035	0.88	Non- Bonded-Pair Unshielded U/UTP	0.198	5.03	1	2.0	62.3	60.3	60.8	100 ± 15	20.0		
		CMP	1000	305	24.0	10.9	24 AWG								4	4.1	53.3	49.2	48.7	100 ± 15	23.0
		CEC:	3000	915	69.2	31.4	Solid BC								10	6.5	47.3	40.8	40.8	100 ± 15	25.0
		CMP FT6													16	8.2	44.3	36.0	36.7	100 ± 15	25.0
															31.25	11.7	39.9	28.2	30.9	100 ± 15	23.6
															62.5	17.0	35.4	19.0	24.9	100 ± 15	21.5
															100	22.0	32.3	10.3	20.8	100 ± 15	20.1
								200	32.0	27.8	1.0	14.7	100 ± 25	15.0							

Color Code: see chart below  
915 m put-up available in Natural or Blue only.  
Third party verified to TIA/EIA-568-B.2, Category 5e  
Jacket sequentially marked at 0.6 m intervals.

**Polyolefin Insulation • Grey PVC Jacket**

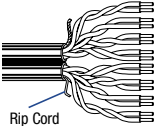
 <p>Rip Cord</p>	<b>1667E</b>	CSA FT1	B-328	B-100	12.3	5.6	0.51 mm	0.035	0.89	Non- Bonded-Pair Unshielded U/UTP	0.197	5.00	1	2.1	62.0	60.2	61.0	100 ± 15	20.0				
		UL CM	1000	305	37.5	17.0	24 AWG								x	x	4	4.0	53.0	49.3	49.0	100 ± 15	23.0
		UL ISDI (Vertical Tray)	1640	500	61.7	28.0	Solid BC								8	5.7	49.0	43.1	43.0	100 ± 15	24.5		
															10	6.3	47.0	41.0	41.0	100 ± 15	25.0		
															16	8.0	44.0	36.2	37.0	100 ± 15	25.0		
															20	9.0	43.0	33.8	35.0	100 ± 15	23.6		
															25	10.1	41.0	31.2	33.0	100 ± 15	24.3		
								31.25	11.4	40.0	28.5	31.0	100 ± 15	23.6									
								62.5	16.5	35.0	18.8	25.0	100 ± 15	21.5									
								100	21.3	32.0	11.0	41.0	100 ± 15	20.1									

Color Code: see chart below  
Applicable industry standards: EN 50173, ISO/IEC 11801, TIA/EIA 568-B2

**Polyolefin Insulation • Grey FRNC/LSNH Jacket**

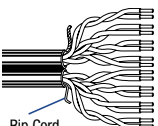
 <p>Rip Cord</p>	<b>1667ENH</b>	CSA FT1	B-328	B-100	12.3	5.6	0.51 mm	0.035	0.89	Non- Bonded-Pair Unshielded U/UTP	0.197	5.00	1	2.1					see above				
		UL CM	1000	305	37.5	17.0	24 AWG								x	x							
		UL ISDI (Vertical Tray)	1640	500	61.7	28.0	Solid BC								0.413	10.50							
			3280	1000	123.5	56.0																	

Color Code: see chart below  
Applicable industry standards: EN 50173, ISO/IEC 11801, TIA/EIA 568-B2  
Burning Energy: 621 kJ/m

BC = Bare Copper • ACR = Attenuation Crosstalk Ratio • ELFEXT = Equal Level Far-end Crosstalk • NEXT = Near-end Crosstalk • PSUM = Power Sum • RL = Return Loss • DCR = DC resistance

Teflon® is a DuPont trademark.

**Color Code**

Pair No.	Color
1	White/Blue Stripe, Blue
2	White/Orange Stripe, Orange
3	White/Green Stripe, Green
4	White/Brown Stripe, Brown



# IBDN Plus 25-Pair Cat5e U/UTP Cables

TIA/EIA-568-B.2, Category 5e,  
Enhanced Category 5e, Non-Bonded-Pair Cables

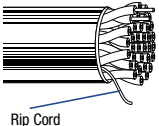
De- scription	Part No.	UL NEC/ C(UL)CEC Type IEC	Standard Lengths		Standard Unit Weight		Conductor (Stranding) Diameter Nom. DCR	Nominal Insulation OD		Shielding Material Nom. DCR	Nominal OD		Freq. MHz	Max. Atten. dB/100m	Min. PSUM			Input Imp. ( )	Min. RL dB
			ft.	m	lbs.	kg		inch	mm		inch	mm			NEXT dB	ACR dB/100m	ELFEXT dB/100m		
<b>Cat 5e • 24 AWG • Solid 0.5 mm Bare Copper • Twisted Pair • Rip Cord</b>																			
<b>Polyolefin Insulation • Grey PVC Jacket</b>																			
Grey, Reel	24576125	NEC: CMP CEC: CMR	1000	305	119.0	54.0	0.51 mm 24 AWG Solid BC	0.041	1.03	Non- Bonded-Pair Unshielded U/UTP	0.490	12.45	0.772	1.8	64.0	63.0	-	100 ± 15	19.4
 <p>Rip Cord</p>													1	2.0	62.3	63.8	-	100 ± 15	20.0
													4	4.1	53.3	48.8	-	100 ± 15	23.0
													8	15.8	48.8	42.7	-	100 ± 15	24.5
													10	16.5	47.3	40.8	-	100 ± 15	25.0
													16	8.2	44.2	36.7	-	100 ± 15	25.0
													20	9.3	42.8	34.8	-	100 ± 15	25.0
													25	10.4	41.3	32.8	-	100 ± 15	24.3
													31.25	11.7	39.9	30.9	-	100 ± 15	23.6
													62.5	17.0	35.4	24.9	-	100 ± 15	21.5
													100	22.0	32.3	20.8	-	100 ± 15	20.1

25-Pair      Color Code: see chart below      Third party verified to TIA/EIA-568-B.2, Category 5e  
Jacket sequentially market at 0.6 m intervals.

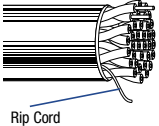
<b>Polyolefin Insulation • Grey FRNC/LSNH Jacket</b>																															
Grey, Reel	24577125	NEC: CMP CEC: CMP	1000	305	127.0	57.6	0.51 mm 24 AWG Solid BC	0.041	1.03	Non- Bonded-Pair Unshielded U/UTP	0.429	10.90								see above											
 <p>Rip Cord</p>																															

25-Pair      Color Code: see chart below      Third party verified to TIA/EIA-568-B.2, Category 5e  
Jacket sequentially market at 0.6 m intervals.

BC = Bare Copper • ACR = Attenuation Crosstalk Ratio • ELFEXT = Equal Level Far-end Crosstalk • NEXT = Near-end Crosstalk • PSUM = Power Sum • RL = Return Loss • DCR = DC resistance

### Color Code

Pair No.	Tip	Ring	Pair No.	Tip	Ring
1	White	Blue	16	Yellow	Blue
2	White	Orange	27	Yellow	Orange
3	White	Green	38	Yellow	Green
4	White	Brown	49	Yellow	Brown
5	White	Slate	20	Yellow	Slate
6	Red	Blue	21	Violet	Blue
7	Red	Orange	22	Violet	Orange
8	Red	Green	23	Violet	Green
9	Red	Brown	24	Violet	Brown
10	Red	Slate	25	Violet	Slate
11	Black	Blue			
12	Black	Orange			
13	Black	Green			
14	Black	Brown			
15	Black	Slate			

# DataTwist® 350 Composite U/UTP Cables

ANSI/TIA/EIA-568-B.2, Category 5e,

Banana Peel® Jacketless Cables

De- scription	Part No.	UL NEC/ C(UL)/CEC Type IEC	Standard Lengths		Standard Unit Weight		Conductor (Stranding) Diameter Nom. DCR	Nominal Insulation OD		Shielding Material Nom. DCR	Nominal OD		Freq. MHz	Max. Atten. dB/100m	Min. PSUM			Input Imp. ( )	Min. RL dB
			ft.	m	lbs.	kg		inch	mm		inch	mm			NEXT dB	ACR dB/100m	ELFEXT dB/100m		

**Cat 5e • 24 AWG • Bonded-Pair • Solid 0.5 mm Bare Copper • Rip Cord**

<b>Polyolefin Insulation • PVC Inner Jacket (Light Blue and Grey) • No Overall Jacket</b>																			
 <p>24-Pair</p>	<b>1700S6</b> NEC: CMR CEC: CMG	500	152	77.6	35.2	0.51 mm 24 AWG Solid BC	0.038 0.97	<b>Bonded-Pair</b> Unshielded U/UTP	0.204 5.18	1 10 16 31.25 62.5 100 200 250 350	2.0 6.4 8.1 11.6 16.8 21.7 32.0 36.4 44.3	65.3 50.3 47.3 42.9 38.4 35.3 30.8 29.3 27.2	63.3 43.9 39.1 31.3 21.6 17.1 3.0 > 0 -	60.8 40.8 36.7 30.9 24.9 20.8 14.7 12.8 9.9	100 ± 12 100 ± 12 100 ± 12 100 ± 15 100 ± 15 100 ± 15 100 ± 20 100 ± 20 100 ± 22	20.0 25.0 25.0 23.6 21.5 20.1 19.0 18.0 17.0	Color Code: see chart below		Individual leg is third party verified to ANSI/TIA/EIA 568-B.2, Category 5e U.S. Patents 5,606,151; 5,734,126; 7,049,523.
		1700S6	1000	305	149.1												67.7		
		1700R Bundled	0.60/15.24																

<b>Plenum • FEP Insulation • Flam arrest® Inner Jacket (Blue and Natural) • No Overall Jacket</b>																			
 <p>24-Pair</p>	<b>1701S6</b> NEC: CMP CEC: CMP	500	152	81.6	37.0	0.51 mm 24 AWG Solid BC	0.036 0.91	<b>Bonded-Pair</b> Unshielded U/UTP	0.195 4.95	1 10 16 31.25 62.5 100 200 250 350	2.0 6.4 8.1 11.6 16.8 21.7 32.0 36.4 44.3	65.3 50.3 47.3 42.9 38.4 35.3 30.8 29.3 27.2	63.3 43.9 39.1 31.3 21.6 17.1 3.0 > 0 -	60.8 40.8 36.7 30.9 24.9 20.8 14.7 12.8 9.9	100 ± 12 100 ± 12 100 ± 12 100 ± 15 100 ± 15 100 ± 15 100 ± 20 100 ± 20 100 ± 22	20.0 25.0 25.0 23.6 21.5 20.1 19.0 18.0 17.0	Color Code: see chart below		Individual leg is third party verified to ANSI/TIA/EIA 568-B.2, Category 5e U.S. Patents 5,606,151; 5,734,126; 7,049,523.
		1701S6	1000	305	157.1												71.3		
		1700R Bundled	0.60/15.24																

BC = Bare Copper • ACR = Attenuation Crosstalk Ratio • ELFEXT = Equal Level Far-end Crosstalk • NEXT = Near-end Crosstalk • PSUM = Power Sum • RL = Return Loss • DCR = DC resistance

**Color Code**

Pair No.	Color
1	White/Blue Stripe, Blue
2	White/Orange Stripe, Orange
3	White/Green Stripe, Green
4	White/Brown Stripe, Brown

### Data Grade Armored Riser 25-Pair U/UTP Cables

TIA/EIA-568-A, Category 5,  
Non-Bonded-Pair Cables

De- scription	Part No.	UL NEC/ C(UL)CEC Type IEC	Standard Lengths		Standard Unit Weight		Conductor (Stranding) Diameter Nom. DCR	Nominal Insulation OD		Shielding Material Nom. DCR	Nominal OD		Freq. MHz	Max. Atten. dB/100m	Min. PSUM			Input Imp. ( )	Min. RL dB	
			ft.	m	lbs.	kg		inch	mm		inch	mm			NEXT dB	ACR dB/100m	ELFEXT dB/100m			
<b>Cat 5 • 24 AWG • Solid 0.5 mm Bare Copper • Twisted Pair • Rip Cord</b>																				
<b>Flame Retardant Polymer Insulation • ALVYAN Sheath • PVC Jacket</b>																				
Grey, Reel	<b>25500027</b>	NEC:	8200	2500	205.0	93.0	0.51 mm	0.039	0.98	Non- Bonded-Pair Unshielded U/UTP	0.618	15.70	0.772	1.8	64.0	-	-	100 ± 15	-	
Grey, Reel	<b>25500028</b>	CMR				24 AWG								1	2.1	62.3	-	-	100 ± 15	23.0
		CEC:				Solid BC								4	4.3	53.3	-	-	100 ± 15	23.0
		CMR												8	5.9	48.8	-	-	100 ± 15	23.0
														10	6.6	47.3	-	-	100 ± 15	23.0
														16	8.2	44.3	-	-	100 ± 15	23.0
														20	9.2	42.8	-	-	100 ± 15	23.0
														25	10.5	41.3	-	-	100 ± 15	22.0
														31.25	11.8	40.9	-	-	100 ± 15	21.0
														62.5	17.1	35.4	-	-	100 ± 15	18.0
														100	22.0	32.3	-	-	100 ± 15	16.0

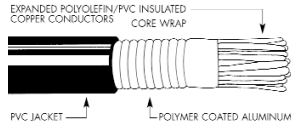

25-Pair

Color Code: see chart below

Third party verified to TIA/EIA-568-A, Category 5  
Jacket sequentially marked at 0.6 m intervals. Featuring descending length marking.

BC = Bare Copper • ACR = Attenuation Crosstalk Ratio • ELFEXT = Equal Level Far-end Crosstalk • NEXT = Near-end Crosstalk • PSUM = Power Sum • RL = Return Loss • DCR = DC resistance

#### Color Code

Pair No.	Tip	Ring
1	White	Blue
2	White	Orange
3	White	Green
4	White	Brown
5	White	Slate
6	Red	Blue
7	Red	Orange
8	Red	Green
9	Red	Brown
10	Red	Slate
11	Black	Blue
12	Black	Orange
13	Black	Green
14	Black	Brown
15	Black	Slate

Pair No.	Tip	Ring
16	Yellow	Blue
27	Yellow	Orange
38	Yellow	Green
49	Yellow	Brown
20	Yellow	Slate
21	Violet	Blue
22	Violet	Orange
23	Violet	Green
24	Violet	Brown
25	Violet	Slate

# DataTwist® 5 U/UTP Cables

TIA/EIA-568-A, Category 5,  
Non-Bonded-Pair Cables

De- scription	Part No.	UL NEC/ C(UL)/CEC Type IEC	Standard Lengths		Standard Unit Weight		Conductor (Stranding) Diameter Nom. DCR	Nominal Insulation OD		Shielding Material Nom. DCR	Nominal OD		Freq. MHz	Max. Atten. dB/100m	Min. PSUM			Input Imp. ( )	Min. RL dB
			ft.	m	lbs.	kg		inch	mm		inch	mm			NEXT dB	ACR dB/100m	ELFEXT dB/100m		

**Cat 5 • 24 AWG • Solid 0.5 mm Bare Copper • Twisted Pair • Rip Cord**

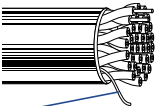
Polyolefin Insulation • PVC Jacket (Light Grey and Blue)																					
 <p>Rip Cord</p>	1864A	NEC: CMR CEC: CMR FT4	1000	305	144.2	65.4	0.51 mm 24 AWG Solid BC	0.041	1.03	Non- Bonded-Pair Unshielded U/UTP	0.526	13.36	1	2.0	62.3	-	-	100 ± 15	23.0		
															10	6.5	47.3	-	-	100 ± 15	23.0
															16	8.2	44.3	-	-	100 ± 15	23.0
															31.25	11.7	39.9	-	-	100 ± 15	21.1
															62.5	17.1	35.4	-	-	100 ± 15	18.0
															100	22.0	32.3	-	-	100 ± 15	16.0

25-Pair

Color Code: see chart below

Third party verified to TIA/EIA-568-A, Category 5  
Jacket sequentially marked at 0.6 m intervals.

**Plenum • FEP Teflon® Insulation • FEP Jacket (Blue Tint and White Tint)**

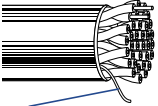
 <p>Rip Cord</p>	1871A	NEC: CMP CEC: CMP	1000	305	131.2	59.5	0.51 mm 24 AWG Solid BC	0.041	1.03	Non- Bonded-Pair Unshielded U/UTP	0.430	10.92	see above					
---	-------	----------------------------	------	-----	-------	------	-------------------------------	-------	------	--	-------	-------	-----------	--	--	--	--	--

25-Pair

Color Code: see chart below

Third party verified to TIA/EIA-568-A, Category 5  
Jacket sequentially marked at 0.6 m intervals.

BC = Bare Copper • ACR = Attenuation Crosstalk Ratio • ELFEXT = Equal Level Far-end Crosstalk • NEXT = Near-end Crosstalk • PSUM = Power Sum • RL = Return Loss • DCR = DC resistance  
Teflon® is a DuPont trademark.

**Color Code 1864A**

Pair No.	Color
1	White & Blue
2	White & Orange
3	White & Green
4	White & Brown
5	White & Grey
6	Red & Blue
7	Red & Orange
8	Red & Green
9	Red & Brown
10	Red & Grey
11	Black & Blue
12	Black & Orange
13	Black & Green
14	Black & Brown
15	Black & Grey
16	Yellow & Blue
17	Yellow & Orange
18	Yellow & Green
19	Yellow & Brown
20	Yellow & Grey
21	Purple & Blue
22	Purple & Orange
23	Purple & Green
24	Purple & Brown
25	Purple & Grey

**Color Code 1871A**

Pair No.	Color
1	White/Blue Stripe, Blue
2	White/Orange Stripe, Orange
3	White/Green Stripe, Green
4	White/Brown Stripe, Brown
5	White/Grey Stripe, Grey
6	Red/Blue Stripe, Blue
7	Red/Orange Stripe, Orange
8	Red/Green Stripe, Green
9	Red/Brown Stripe, Brown
10	Red/Grey Stripe, Grey
11	Black/Blue Stripe, Blue
12	Black/Orange Stripe, Orange
13	Black/Green Stripe, Green
14	Black/Brown Stripe, Brown
15	Black/Grey Stripe, Grey
16	Yellow/Blue Stripe, Blue
17	Yellow/Orange Stripe, Orange
18	Yellow/Green Stripe, Green
19	Yellow/Brown Stripe, Brown
20	Yellow/Grey Stripe, Grey
21	Purple/Blue Stripe, Blue
22	Purple/Orange Stripe, Orange
23	Purple/Green Stripe, Green
24	Purple/Brown Stripe, Brown
25	Purple/Grey Stripe, Grey

### DataTwist® 3 U/UTP Cables

TIA/EIA-568-A, Category 3,  
Non-Bonded-Pair Cables

De- scription	Part No.	No. of Pairs	Standard Lengths		Standard Unit Weight		Conductor (Stranding) Diameter Nom. DCR	Nominal Insulation OD		Shielding Material Nom. DCR	Nominal OD		Nom. Imp. ( )	Nom. Vel. of Prop.	Nominal Capacitance		Nominal Attenuation		
			ft.	m	lbs.	kg		inch	mm		inch	mm			pF/ft.	pF/m	MHz	dB/ 100 ft.	dB/ 100 m

**Cat 3 • 24 AWG • Solid 0.5 mm Bare Copper • Twisted Pair • Rip Cord**

**Polyolefin Insulation • Grey PVC Jacket**

NEC: CMR CEC: CMR							0.51 mm 24 AWG Solid BC	0.035	0.90	Non- Bonded-Pair Unshielded U/UTP			100	70%	19.0	62.3	1	7.8	2.6
																	4	17.0	5.6
																	10	30.0	9.7
																	16	40.0	13.1

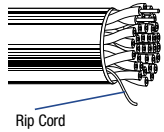

<b>1227A1</b>	2-Pair	U-1000	U-305	13.2	6.0							0.173	4.39						
<b>1229A1</b>	4-Pair	U-1000	U-305	22.0	10.0							0.197	5.00						
<b>1232A1</b>	25-Pair	† 1000	305	104.1	47.2							0.399	10.14						

Color Code: see chart below  
Third party verified to TIA/EIA-568-A, Category 3 • Jacket sequentially marked at 0.6 m intervals.

**Plenum • Low-Smoke PVC Insulation • White Low-Smoke PVC Jacket**

NEC: CMP CEC: CMP							0.51mm 24 AWG Solid BC	0.038	0.96	Non- Bonded-Pair Unshielded U/UTP			100	61%	19.0	62.3			see above
----------------------------	--	--	--	--	--	--	------------------------------	-------	------	--	--	--	-----	-----	------	------	--	--	-----------

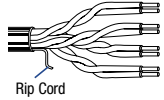

<b>1243A2</b>	2-Pair	U-1000	U-305	14.1	6.4							0.170	4.32						
<b>1245A2</b>	4-Pair	U-1000	U-305	22.9	10.4							0.200	5.08						

Color Code: see chart below  
Third party verified to TIA/EIA-568-A, Category 3 • Jacket sequentially marked at 0.6 m intervals.

BC = Bare Copper • DCR = DC resistance  
† 25-pair NEXT is Power Sum tested.

ⓧ Not RoHS compliant at time of printing.

**Color Code**

Pair No.	Color
1	White/Blue Stripe & Blue/White Stripe
2	White/Orange Stripe & Orange/White Stripe
3	White/Green Stripe & Green/White Stripe
4	White/Brown Stripe & Brown/White Stripe
5	White/Grey Stripe & Grey/White Stripe
6	Red/Blue Stripe & Blue/Red Stripe
7	Red/Orange Stripe & Orange/Red Stripe
8	Red/Green Stripe & Green/Red Stripe
9	Red/Brown Stripe & Brown/Red Stripe
10	Red/Grey Stripe & Grey/Red Stripe

**Color Code**

Pair No.	Color
11	Black/Blue Stripe & Blue/Black Stripe
12	Black/Orange Stripe & Orange/Black Stripe
13	Black/Green Stripe & Green/Black Stripe
14	Black/Brown Stripe & Brown/Black Stripe
15	Black/Grey Stripe & Grey/Black Stripe
16	Yellow/Blue Stripe & Blue/Yellow Stripe
17	Yellow/Orange Stripe & Orange/Yellow Stripe
18	Yellow/Green Stripe & Green/Yellow Stripe
19	Yellow/Brown Stripe & Brown/Yellow Stripe
20	Yellow/Grey Stripe & Grey/Yellow Stripe
21	Purple/Blue Stripe & Blue/Purple Stripe
22	Purple/Orange Stripe & Orange/Purple Stripe
23	Purple/Green Stripe & Green/Purple Stripe
24	Purple/Brown Stripe & Brown/Purple Stripe
25	Purple/Grey Stripe & Grey/Purple Stripe

### D-Series Multipair U/UTP Cables

TIA/EIA-568-A, Category 3,  
Non-Bonded-Pair Cables

De- scription	Part No.	UL NEC / C(UL)/CEC Type IEC	Standard Lengths		Standard Unit Weight		Conductor (Stranding) Diameter Nom. DCR	Nominal Insulation OD		Shielding Material Nom. DCR	Nominal OD		Freq. MHz	Max. Atten. dB/100m	Min. PSUM			Input Imp. ( )	Min. RL dB
			ft.	m	lbs.	kg		inch	mm		inch	mm			NEXT dB	ACR dB/100m	ELFEXT dB/100m		

**Cat 3 • 24 AWG • Solid 0.5 mm Bare Copper • Twisted Pair • Rip Cord**

**Polyolefin Insulation • LSNH Jacket (Grey or Blue)**

Olive Grey, Reel							0.51 mm 24 AWG Solid BC	0.031	0.80	Non- Bonded-Pair Unshielded U/UTP			1	2.6	41.0	-	-	100 ± 15	12.0
													4	5.6	32.0	-	-	100 ± 15	12.0
													8	8.5	28.0	-	-	100 ± 15	12.0
													10	9.7	26.0	-	-	100 ± 15	12.0
													16	13.1	23.0	-	-	100 ± 15	10.0

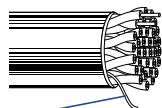

Rip Cord

<b>NN00097</b>	25-Pair	1000 3280	305 1000	107.4 352.0	48.8 160.0							0.417	10.60						
<b>NN00099</b>	50-Pair	1000 3280	305 1000	199.3 653.4	90.6 297.0							0.630	16.00						
<b>NN00101</b>	100-Pair	1575 3280	480 1000	370.4 1214.4	168.4 552.0							0.827	21.00						

Color Code: see chart below  
Applicable industry standards: EN 50173, ISO/IEC 11801, TIA/EIA-568-A

BC = Bare Copper • ACR = Attenuation Crosstalk Ratio • ELFEXT = Equal Level Far-end Crosstalk • NEXT = Near-end Crosstalk • PSUM = Power Sum • RL = Return Loss • DCR = DC resistance

#### Color Code

Pair No.	Tip	Ring
1	White/Blue	Blue/White
2	White/Orange	Orange/White
3	White/Green	Green/White
4	White/Brown	Brown/White
5	White/Slate	Slate/White
6	Red/Blue	Blue/Red
7	Red/Orange	Orange/Red
8	Red/Green	Green/Red
9	Red/Brown	Brown/Red
10	Red/Slate	Slate/Red
11	Black/Blue	Blue/Black
12	Black/Orange	Orange/Black
13	Black/Green	Green/Black
14	Black/Brown	Brown/Black
15	Black/Slate	Slate/Black

Pair No.	Tip	Ring
16	Yellow/Blue	Blue/Yellow
27	Yellow/Orange	Orange/Yellow
38	Yellow/Green	Green/Yellow
49	Yellow/Brown	Brown/Yellow
20	Yellow/Slate	Slate/Yellow
21	Violet/Blue	Blue/Violet
22	Violet/Orange	Orange/Violet
23	Violet/Green	Green/Violet
24	Violet/Brown	Brown/Violet
25	Violet/Slate	Slate/Violet

### Category 7 S/FTP Cables

EN 50173, ISO/IEC 11801, TIA/EIA-568-TSB 36, Class F, Category 7, Non-Bonded-Pair Cables

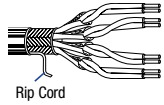
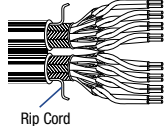
De- scription	Part No.	UL NEC/ C(UL)CEC Type IEC	Standard Lengths		Standard Unit Weight		Conductor (Stranding) Diameter Nom. DCR	Nominal Insulation OD		Shielding Material Nom. DCR	Nominal OD		Freq. MHz	Max. Atten. dB/100m	Min. PSUM			Input Imp. ( )	Min. RL dB	
			ft.	m	lbs.	kg		inch	mm		inch	mm			NEXT dB	ACR dB/100m	ELFEXT dB/100m			
<b>Cat 7 • 23 AWG • Solid 0.6 mm Bare Copper • Twisted Pair • Individual Beldfoil® + Overall Tinned Copper Braid • Rip Cord</b>																				
<b>Foam Skin Polyolefin Insulation • PVC Jacket (Grey, Blue and Yellow)</b>																				
	<b>1885ENH</b>		B-328 1640 3280	B-100 500 1000	13.2 66.1 132.3	6.0 30.0 60.0	0.57 mm 23 AWG Solid BC	0.057	1.45	Non- Bonded-Pair Individual Beldfoil® + Overall TC Braid S/FTP	0.315	8.00	1 4 10 16 20 31.25 62.5 100 155 200 300 600 1000	2.0 3.7 75.0 75.0 8.3 10.4 14.9 19.0 24.0 27.5 34.2 50.1 66.9	75.0 75.0 75.0 75.0 75.0 75.0 72.0 69.0 67.0 65.0 62.0 58.0 54.0	73.0 71.3 69.1 67.6 66.7 64.6 57.6 51.0 47.0 45.0 41.0 35.0 -	75.0 75.0 71.0 67.0 65.0 61.0 55.0 51.0 47.0 45.0 41.0 35.0 31.0	100 ± 15 100 ± 15 100 ± 15 100 ± 15 100 ± 15 100 ± 15 100 ± 15 100 ± 15 100 ± 22 100 ± 22 100 ± 25 100 ± 25 100 ± 25	20.0 23.0 25.0 25.0 25.0 23.6 21.5 20.1 18.8 18.0 16.8 14.7 13.1	
																				
	4-Pair																			
Color Code: see chart below										Burning Energy: 500 kJ/m										
500 m put-up not available in Grey.																				
<b>Foam Skin Polyolefin Insulation • PVC Jacket (Grey, Blue and Yellow)</b>																				
	<b>1887ENH</b>		328 1640	100 500	26.5 132.3	12.0 60.0	0.57 mm 23 AWG Solid BC	0.057	1.45	Non- Bonded-Pair Individual Beldfoil® + Overall TC Braid S/FTP	0.650	16.50							see above	
																				
	8-Pair, Twin																			
Color Code: see chart below										Burning Energy: 1000 kJ/m										
100 m put-up available in Grey only.																				

TC = Tinned Copper • BC = Bare Copper • ACR = Attenuation Crosstalk Ratio • ELFEXT = Equal Level Far-end Crosstalk • NEXT = Near-end Crosstalk • PSUM = Power Sum • RL = Return Loss • DCR = DC resistance

#### Color Code

Pair No.	Color
1	White/Blue Stripe, Blue
2	White/Orange Stripe, Orange
3	White/Green Stripe, Green
4	White/Brown Stripe, Brown

### Category 6 F/UTP Cables

EN 50173, ISO/IEC 11801, Class E, Category 6,  
Bonded-Pair Cables

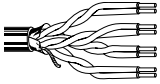
De- scription	Part No.	UL NEC/ C(UL)/CEC Type IEC	Standard Lengths		Standard Unit Weight		Conductor (Stranding) Diameter Nom. DCR	Nominal Insulation OD		Shielding Material Nom. DCR	Nominal OD		Freq. MHz	Max. Atten. dB/100m	Min. PSUM			Input Imp. ( )	Min. RL dB		
			ft.	m	lbs.	kg		inch	mm		inch	mm			NEXT dB	ACR dB/100m	ELFEXT dB/100m				
<b>Cat 6 • 23 AWG • Solid 0.6 mm Bare Copper • Twisted Pair • Overall Beldfoil® Shield • 26 AWG Tinned Copper Drain Wire</b>																					
<b>Polyolefin Insulation • FRNC/LSNH Jacket (Grey and Blue)</b>																					
 4-Pair	7860ENH		B-328	B-100	11.0	5.0	0.57 mm	0.046	1.17	<b>Bonded-Pair</b> Overall Beldfoil® + Drain Wire (26 AWG TC) F/UTP	0.287	7.30	1	2.1	72.0	70.2	65.0	100 ± 15	20.0		
			1640	500	54.9	24.9	23 AWG								4	3.8	63.0	59.4	53.0	100 ± 15	23.0
			3280	1000	110.2	50.0	Solid BC								10	6.0	57.0	51.3	45.0	100 ± 15	25.0
															16	7.6	54.0	46.6	41.0	100 ± 15	25.0
															20	8.5	53.0	44.3	39.0	100 ± 15	25.0
															25	9.6	51.0	41.8	37.0	100 ± 15	24.3
															31.25	10.7	50.0	39.1	35.0	100 ± 15	23.6
															62.5	15.5	45.0	29.9	29.0	100 ± 15	21.5
															100	19.9	42.0	22.4	25.0	100 ± 15	20.1
															155	25.3	39.0	14.1	21.0	100 ± 22	18.8
											200	29.1	38.0	8.6	19.0	100 ± 22	18.0				
											250	33.0	36.0	3.3	17.0	100 ± 22	17.3				

Color Code: see chart below

Burning Energy: 560 kJ/m

### Category 6 SF/UTP Cables

EN 50173, ISO/IEC 11801, Class E, Category 6,  
Bonded-Pair Cables

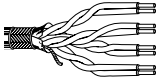
De- scription	Part No.	UL NEC/ C(UL)/CEC Type IEC	Standard Lengths		Standard Unit Weight		Conductor (Stranding) Diameter Nom. DCR	Nominal Insulation OD		Shielding Material Nom. DCR	Nominal OD		Freq. MHz	Max. Atten. dB/100m	Min. PSUM			Input Imp. ( )	Min. RL dB		
			ft.	m	lbs.	kg		inch	mm		inch	mm			NEXT dB	ACR dB/100m	ELFEXT dB/100m				
<b>Cat 6 • 23 AWG • Solid 0.6 mm Bare Copper • Twisted Pair • Overall Beldfoil® Shield • 26 AWG TC Drain Wire • Overall TC Braid</b>																					
<b>Polyolefin Insulation • FRNC/LSNH Jacket (Grey and Blue)</b>																					
 4-Pair Braided 7860E	7860ENS		B-328	B-100	12.5	5.7	0.57 mm	0.046	1.17	<b>Bonded-Pair</b> Overall Beldfoil® + Drain Wire (26 AWG TC) + TC Braid SF/UTP	0.295	7.50	1	2.1	72.0	70.2	65.0	100 ± 15	20.0		
			1640	500	62.8	28.5	23 AWG								4	3.8	63.0	59.4	53.0	100 ± 15	23.0
			3280	1000	125.4	56.9	Solid BC								10	6.0	57.0	51.3	45.0	100 ± 15	25.0
															16	7.6	54.0	46.6	41.0	100 ± 15	25.0
															20	8.5	53.0	44.3	39.0	100 ± 15	25.0
															25	9.6	51.0	41.8	37.0	100 ± 15	24.3
															31.25	10.7	50.0	39.1	35.0	100 ± 15	23.6
															62.5	15.5	45.0	29.9	29.0	100 ± 15	21.5
															100	19.9	42.0	22.4	25.0	100 ± 15	20.1
															155	25.3	39.0	14.1	21.0	100 ± 22	18.8
											200	29.1	38.0	8.6	19.0	100 ± 22	18.0				
											250	33.0	36.0	3.3	17.0	100 ± 22	17.3				

Color Code: see chart below

Burning Energy: 560 kJ/m

TC = Tinned Copper • BC = Bare Copper • ACR = Attenuation Crosstalk Ratio • ELFEXT = Equal Level Far-end Crosstalk • NEXT = Near-end Crosstalk • PSUM = Power Sum • RL = Return Loss • DCR = DC resistance

#### Color Code

Pair No.	Color
1	White/Blue Stripe, Blue
2	White/Orange Stripe, Orange
3	White/Green Stripe, Green
4	White/Brown Stripe, Brown

#### Get the Bonded-Pairs Cable Preparation Tool

See page 15.37 for details.  
(Part No. 1797B)





### DataTwist® 5e F/UTP Cables

EN 50173, ISO/IEC 11801, Class D, Category 5e,  
Non-Bonded-Pair Cables

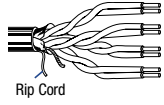
De- scription	Part No.	UL NEC/ C(UL)CEC Type IEC	Standard Lengths		Standard Unit Weight		Conductor (Stranding) Diameter Nom. DCR	Nominal Insulation OD		Shielding Material Nom. DCR	Nominal OD		Freq. MHz	Max. Atten. dB/100m	Min. PSUM			Input Imp. ( )	Min. RL dB
			ft.	m	lbs.	kg		inch	mm		inch	mm			NEXT dB	ACR dB/100m	ELFEXT dB/100m		
<b>Cat 5e • 24 AWG • Solid 0.5 mm Bare Copper • Twisted Pair • Overall Beldfoil® Shield • 24 AWG Tinned Copper Drain Wire • Rip Cord</b>																			
<b>Polyolefin Insulation • PVC Jacket (Grey and Blue)</b>																			
 Rip Cord  4-Pair	1633E		B-328	B-100	9.5	4.3	0.51 mm 24 AWG Solid BC	0.041	1.05	Non- Bonded-Pair Overall Beldfoil® + Drain Wire (24 AWG TC) F/UTP	0.236	6.00	1	2.1	62.0	60.2	61.0	100 ± 15	20.0
			1000	305	28.7	13.0							4	4.0	53.0	49.3	49.0	100 ± 15	23.0
			1640	500	47.4	21.5							8	5.7	49.0	43.1	43.0	100 ± 15	24.5
			3280	1000	94.8	43.0							10	6.3	47.0	41.0	41.0	100 ± 15	25.0
													16	8.0	44.0	36.2	37.0	100 ± 15	25.0
													20	9.0	43.0	33.8	35.0	100 ± 15	25.0
													25	10.1	41.0	31.2	33.0	100 ± 15	24.3
				31.25	11.4	40.0	28.5	31.0	100 ± 15	23.6									
				62.5	16.5	35.0	18.8	25.0	100 ± 15	21.5									
				100	21.3	32.0	11.0	21.0	100 ± 15	20.1									

Color Code: see chart below

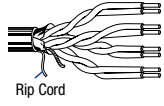
<b>Polyolefin Insulation • FRNC/LSNH Jacket (Grey and Blue)</b>																				
 Rip Cord  4-Pair	1633ENH		B-328	B-100	9.5	4.3	0.51 mm 24 AWG Solid BC	0.041	1.05	Non- Bonded-Pair Overall Beldfoil® + Drain Wire (24 AWG TC) F/UTP	0.236	6.00								see above
			1000	305	28.7	13.0														
			1640	500	47.4	21.5														
			3280	1000	94.8	43.0														

Color Code: see chart below  
500 m put-up available in Blue only.  
Burning Energy: 464 kJ/m

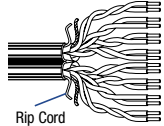
<b>Polyolefin Insulation • Grey PVC Jacket</b>																				
 Rip Cord  8-Pair, Twin	1668E		B-164	B-50	18.9	8.6	0.51 mm 24 AWG Solid BC	0.041	1.05	Non- Bonded-Pair Overall Beldfoil® + Drain Wire (24 AWG TC) F/UTP	0.236	6.00								see above
			1000	305	57.3	26.0							x	x						
			1640	500	94.8	43.0							0.531	13.50						

Color Code: see chart below  
Burning Energy: 929 kJ/m

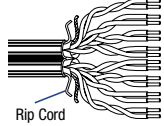
<b>Polyolefin Insulation • FRNC/LSNH Grey Jacket</b>																				
 Rip Cord  8-Pair, Twin	1668ENH		1640	500	94.8	43.0	0.51 mm 24 AWG Solid BC	0.041	1.05	Non- Bonded-Pair Overall Beldfoil® + Drain Wire (24 AWG TC) F/UTP	0.236	6.00								see above
			x	x																
			0.531	13.50																

Color Code: see chart below  
Burning Energy: 929 kJ/m

TC = Tinned Copper • BC = Bare Copper • ACR = Attenuation Crosstalk Ratio • ELFEXT = Equal Level Far-end Crosstalk • NEXT = Near-end Crosstalk • PSUM = Power Sum • RL = Return Loss • DCR = DC resistance

#### Color Code

Pair No.	Color
1	White/Blue Stripe, Blue
2	White/Orange Stripe, Orange
3	White/Green Stripe, Green
4	White/Brown Stripe, Brown

#### Get the Bonded-Pairs Cable Preparation Tool

See page 15.37 for details.  
(Part No. 1797B)



# DataTwist® 5e SF/UTP Cables

## EN 50173, ISO/IEC 11801, Class D, Category 5e, Non-Bonded-Pair Cables

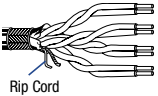
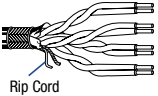
De-scription	Part No.	UL NEC / C(UL)/CEC Type IEC	Standard Lengths		Standard Unit Weight		Conductor (Stranding) Diameter Nom. DCR	Nominal Insulation OD		Shielding Material Nom. DCR	Nominal OD		Freq. MHz	Max. Atten. dB/100m	Min. PSUM			Input Imp. ( )	Min. RL dB
			ft.	m	lbs.	kg		inch	mm		inch	mm			NEXT dB	ACR dB/100m	ELFEXT dB/100m		
<b>Cat 5e • 24 AWG • Solid 0.5 mm Bare Copper • Twisted Pair • Overall Beldfoil® Shield • 24 AWG TC Drain Wire • Overall TC Braid • Rip Cord</b>																			
<b>Polyolefin Insulation • Grey PVC Jacket</b>																			
 <p>Rip Cord</p>	1633ES	B-328 1000 1640 3280	B-100 305 500 1000	10.6 32.2 52.9 105.8	4.8 14.6 24.0 48.0	0.51 mm 24 AWG Solid BC	0.041	1.05	Non-Bonded-Pair Overall Beldfoil®	0.248	6.30	1	2.1	62.0	60.2	61.0	100 ± 15	20.0	
																	100 ± 15	23.0	
																	100 ± 15	24.5	
																	100 ± 15	25.0	
																	100 ± 15	25.0	
																	100 ± 15	25.0	
 <p>Rip Cord</p>	1633ENS	1640	500	52.9	24.0	0.51 mm 24 AWG Solid BC	0.041	1.05	Non-Bonded-Pair Overall Beldfoil®	0.248	6.30	1	2.1	62.0	60.2	61.0	100 ± 15	20.0	
																	100 ± 15	23.0	
																	100 ± 15	24.5	
																	100 ± 15	25.0	
																	100 ± 15	25.0	
																	100 ± 15	25.0	

4-Pair Braided 1633E

Color Code: see chart below

**Polyolefin Insulation • Grey FRNC/LSNH Jacket**

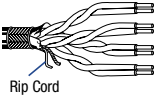
 <p>Rip Cord</p>	1633ENH	1640	500	52.9	24.0	0.51 mm 24 AWG Solid BC	0.041	1.05	Non-Bonded-Pair Overall Beldfoil®	0.248	6.30	1	2.1	62.0	60.2	61.0	100 ± 15	20.0
																	100 ± 15	23.0
																	100 ± 15	24.5
																	100 ± 15	25.0
																	100 ± 15	25.0
																	100 ± 15	25.0

4-Pair Braided 1633ENH

Color Code: see chart below

Burning Energy: 505 kJ/m

**Polyolefin Insulation • Grey PVC Jacket**

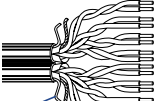
 <p>Rip Cord</p>	1668ES	B-164 1000 1640	B-50 305 500	10.6 32.2 52.9	4.8 14.6 24.0	0.51 mm 24 AWG Solid BC	0.041	1.05	Non-Bonded-Pair Overall Beldfoil®	0.543	13.80	1	2.1	62.0	60.2	61.0	100 ± 15	20.0
																	100 ± 15	23.0
																	100 ± 15	24.5
																	100 ± 15	25.0
																	100 ± 15	25.0
																	100 ± 15	25.0

8-Pair, Twin

Color Code: see chart below

**Polyolefin Insulation • FRNC/LSNH Jacket (Grey and Blue)**

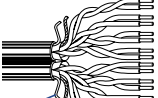
 <p>Rip Cord</p>	1668ENS	1640	500	105.8	48.0	0.51 mm 24 AWG Solid BC	0.041	1.05	Non-Bonded-Pair Overall Beldfoil®	0.543	13.80	1	2.1	62.0	60.2	61.0	100 ± 15	20.0
																	100 ± 15	23.0
																	100 ± 15	24.5
																	100 ± 15	25.0
																	100 ± 15	25.0
																	100 ± 15	25.0

8-Pair, Twin

Color Code: see chart below

Burning Energy: 1010 kJ/m

TC = Tinned Copper • BC = Bare Copper • ACR = Attenuation Crosstalk Ratio • ELFEXT = Equal Level Far-end Crosstalk • NEXT = Near-end Crosstalk • PSUM = Power Sum • RL = Return Loss • DCR = DC resistance

**Color Code**

Pair No.	Color
1	White/Blue Stripe, Blue
2	White/Orange Stripe, Orange
3	White/Green Stripe, Green
4	White/Brown Stripe, Brown

# MediaTwist® and DataTwist® 6 U/UTP Patch Cables

TIA/EIA-568-B.2-1, Category 6,  
Enhanced Category 6, Bonded-Pair Cables

De- scription	Part No.	UL NEC/ C(UL)CEC Type IEC	Standard Lengths		Standard Unit Weight		Conductor (Stranding) Diameter Nom. DCR	Nominal Insulation OD		Shielding Material Nom. DCR	Nominal OD		Freq. MHz	Max. Atten. dB/100m	Min. PSUM			Input Imp. ( )	Min. RL dB
			ft.	m	lbs.	kg		inch	mm		inch	mm			NEXT dB	ACR dB/100m	ELFEXT dB/100m		

**Cat 6 • 24 AWG • Bonded-Pair • Stranded (7x32) 0.6 mm Tinned Copper • RJ-45 Compatible**

<b>Polyolefin Insulation • PVC Jacket</b> (Yellow, Green, Blue, Violet, Light Grey, Grey, White and Black)																			
MediaTwist® <b>1875GB</b>	NEC:	1000	305	31.1	14.1	0.61 mm 24 AWG (7x32) TC	0.041	1.05	<b>Bonded-Pair</b> Unshielded U/UTP	0.365	9.27	1	1.9	72.3	70.0	64.8	100 ± 12	20.0	
	CMR	A-1000	A-305	32.0	14.5							8	5.3	58.8	53.0	46.7	100 ± 12	23.0	
	CEC:											10	5.9	57.3	51.0	44.8	100 ± 12	25.0	
	CMR											16	7.5	54.3	46.0	40.7	100 ± 12	25.0	
												25	9.5	51.4	42.0	36.8	100 ± 15	24.3	
												31.25	10.6	49.9	39.0	34.9	100 ± 15	23.6	
												62.5	15.4	45.4	30.0	28.9	100 ± 15	21.5	
												100	19.8	42.3	25.0	24.8	100 ± 15	21.0	
												155	25.1	39.5	14.0	20.9	100 ± 15	21.0	
												200	29.0	37.8	10.0	18.8	100 ± 15	21.0	
												250	32.8	36.3	3.0	16.8	100 ± 20	18.0	
												300	35.2	35.2	> 0	15.2	100 ± 20	18.0	
												350	39.8	34.2	-	13.9	100 ± 22	17.0	
					400	43.0	-	-	-	100 ± 32	14.0								
					500	49.0	-	-	-	100 ± 32	14.0								

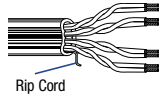

4-Pair

Color Code: see chart below\*  
305 m put-up not available in Purple.  
A-305 m put-up not available in Black.

Third party verified to TIA/EIA-568-B.2-1, Category 6 Patch  
U.S. Patents 5,606,151; 5,734,126; 5,763,823 and 5,821,467  
Jacket sequentially marked at 0.6 m intervals.

**Cat 6 • 24 AWG • Solid 0.5 mm Bare Copper • Twisted Pair • Central Slit-Film Filler • RJ-45 Compatible**

<b>Polyolefin Insulation • PVC Jacket</b> (Red, Orange, Yellow, Green, Blue, Violet, White and Black)																			
DataTwist® <b>7883A</b>	NEC:	1000	305	24.0	10.9	0.51 mm 24 AWG Solid BC	0.038	0.97	<b>Bonded-Pair</b> Unshielded U/UTP	0.205	5.21	1	2.4	72.3	69.9	64.8	100 ± 15	20.0	
	CM											10	7.1	57.3	50.2	44.8	100 ± 15	25.0	
	CEC:											20	10.2	52.8	42.6	38.8	100 ± 15	25.0	
	CM											31.25	12.8	49.9	37.1	34.9	100 ± 15	23.6	
												62.5	18.5	45.4	26.9	28.9	100 ± 15	21.5	
												100	23.8	42.3	18.5	24.8	100 ± 15	20.1	
					200	34.8	37.8	3.0	18.8	100 ± 22	18.0								
					250	39.4	36.3	-	16.8	100 ± 32	17.3								

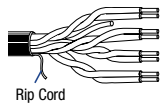

4-Pair

Color Code: see chart below\*  
Third party verified to TIA/EIA-568-B.2-1, Category 6 Patch  
Jacket sequentially marked at 0.6 m intervals.

TC = Tinned Copper • BC = Bare Copper • ACR = Attenuation Crosstalk Ratio • ELFEXT = Equal Level Far-end Crosstalk •  
NEXT = Near-end Crosstalk • PSUM = Power Sum • RL = Return Loss • DCR = DC resistance  
\* Color rotation available for T568-A or T568-B wiring schemes.

**Color Code 1875GB**

Pair No.	Color
1	White/Brown Stripe, Brown
2	White/Blue Stripe, Blue
3	White/Green Stripe, Green
4	White/Orange Stripe, Orange

**Color Code 7883A**

Pair No.	Color
1	White/Blue Stripe, Blue
2	White/Orange Stripe, Orange
3	White/Green Stripe, Green
4	White/Brown Stripe, Brown

**Get the Bonded-Pairs  
Cable Preparation Tool**



See page 15.37 for details.  
(Part No. 1797B)

### DataTwist® 350 U/UTP Patch Cables

TIA/EIA-568-B.2, Category 5e,  
Enhanced Category 5e, Bonded-Pair Cables

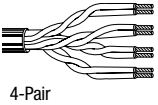
De- scription	Part No.	UL NEC/ C(UL)/CEC Type IEC	Standard Lengths		Standard Unit Weight		Conductor (Stranding) Diameter Nom. DCR	Nominal Insulation OD		Shielding Material Nom. DCR	Nominal OD		Freq. MHz	Max. Atten. dB/100m	Min. PSUM			Input Imp. ( )	Min. RL dB
			ft.	m	lbs.	kg		inch	mm		inch	mm			NEXT dB	ACR dB/100m	ELFEXT dB/100m		
<b>Cat 5e • 24 AWG • Bonded-Pair • Stranded (7x32) 0.6 mm Tinned Copper • RJ-45 Compatible</b>																			
<b>Polyolefin Insulation • PVC Jacket</b> (Yellow, Green, Blue, Violet, Light Grey, Grey, White and Black)																			
 <p>4-Pair</p>	1752A	NEC:	U-1000	U-305	24.0	10.9	0.61 mm	0.038	1.00	Bonded-Pair Unshielded U/UTP	0.220	5.59	1	2.4	65.3	62.9	60.8	100 ± 12	20.0
		CM	1000	305	26.0	11.8	24 AWG					4	4.8	56.3	51.5	48.7	100 ± 12	23.0	
		CEC:					(7x32) TC					8	6.8	51.8	45.0	42.7	100 ± 12	24.5	
		CM										10	7.7	50.3	42.6	40.8	100 ± 12	25.0	
												16	9.7	47.3	37.5	36.7	100 ± 12	25.0	
												25	12.4	44.3	31.9	32.8	100 ± 15	24.3	
												31.25	13.9	42.9	29.0	30.9	100 ± 15	23.6	
												62.5	20.2	38.4	18.3	24.9	100 ± 15	21.5	
												100	26.0	35.3	9.2	20.8	100 ± 15	20.1	
												155	33.2	32.5	-	16.9	100 ± 18	19.0	
												200	38.4	30.8	-	14.7	100 ± 20	19.0	
									250	43.7	29.3	-	12.8	100 ± 20	18.0				
									350	53.2	27.2	-	9.9	100 ± 22	17.0				

Color Code: see chart below

Third party verified to TIA/EIA-568-B.2, Category 5e Patch  
U.S. Patents 5,606,151; 5,734,126 and 5,763,823  
Jacket sequentially marked at 0.6 m intervals.

### DataTwist® 5e U/UTP Patch Cables

TIA/EIA-568-B.2, Category 5e,  
Non-Bonded-Pair Cables

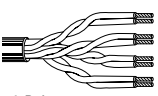
De- scription	Part No.	UL NEC/ C(UL)/CEC Type IEC	Standard Lengths		Standard Unit Weight		Conductor (Stranding) Diameter Nom. DCR	Nominal Insulation OD		Shielding Material Nom. DCR	Nominal OD		Freq. MHz	Max. Atten. dB/100m	Min. PSUM			Input Imp. ( )	Min. RL dB
			ft.	m	lbs.	kg		inch	mm		inch	mm			NEXT dB	ACR dB/100m	ELFEXT dB/100m		
<b>Cat 5e • 24 AWG • Stranded (7x32) 0.6 mm Bare Copper • Twisted Pair • RJ-45 Compatible*</b>																			
<b>Polyolefin Insulation • PVC Jacket</b> (Red, Orange, Yellow, Green, Blue, Violet, Light Grey, White and Black)																			
 <p>4-Pair</p>	1592A	NEC:	U-1000	U-305	22.0	10.0	0.61 mm	0.040	1.02	Non- Bonded-Pair Unshielded U/UTP	0.213	5.41	1	2.5	62.3	-	60.8	100 ± 15	20.0
		CM	1000	305	23.1	10.5	24 AWG					4	4.9	53.3	-	48.7	100 ± 15	23.0	
		CEC:					(7x32) BC					10	7.8	47.3	-	40.8	100 ± 15	25.0	
		CM FT1										16	9.9	44.3	-	36.7	100 ± 15	25.0	
												31.25	14.1	39.9	-	30.9	100 ± 15	23.6	
												62.5	20.4	35.4	-	24.8	100 ± 15	21.5	
												100	26.4	32.3	-	20.8	100 ± 15	20.1	
												200	38.9	27.8	-	14.7	100 ± 25	15.0	

Color Code: see chart below

Third party verified to TIA/EIA-568-B.2, Category 5e Patch  
Jacket sequentially marked at 0.6 m intervals.

TC = Tinned Copper • BC = Bare Copper • ACR = Attenuation Crosstalk Ratio • ELFEXT = Equal Level Far-end Crosstalk •  
NEXT = Near-end Crosstalk • PSUM = Power Sum • RL = Return Loss • DCR = DC resistance  
\* RJ-45 compatible for either T568-A or T568-B configurations.

#### Color Code

Pair No.	Color
1	White/Blue Stripe, Blue
2	White/Orange Stripe, Orange
3	White/Green Stripe, Green
4	White/Brown Stripe, Brown

#### Get the Bonded-Pairs Cable Preparation Tool

See page 15.37 for details.  
(Part No. 1797B)



### DataTwist® 5e F/UTP Patch Cables

EN 50173, ISO/IEC 11801, Category 5e,  
Non-Bonded-Pair Cables

De- scription	Part No.	UL NEC/ C(UL)CEC Type IEC	Standard Lengths		Standard Unit Weight		Conductor (Stranding) Diameter Nom. DCR	Nominal Insulation OD		Shielding Material Nom. DCR	Nominal OD		Freq. MHz	Max. Atten. dB/100m	Min. PSUM			Input Imp. ( )	Min. RL dB	
			ft.	m	lbs.	kg		inch	mm		inch	mm			NEXT dB	ACR dB/100m	ELFEXT dB/100m			
<b>Cat 5e • 26 AWG • Stranded (7x34) 0.5 mm Bare Copper • Twisted Pair • Overall Beldfoil® Shield • 24 AWG TC Drain Wire • Rip Cord</b>																				
<b>Polyolefin Insulation • PVC Jacket (Grey and Blue)</b>																				
	<b>1868E</b>		1640	500	29.8	13.5	0.51 mm 26 AWG (7x34) BC	0.037	0.95	Non- Bonded-Pair Overall Beldfoil® + Drain Wire (24 AWG TC) F/UTP	0.205	5.20	1	3.2	62.0	59.1	61.0	100 ± 15	20.0	
		3280	1000	59.5	27.0	4									6.0	53.0	47.3	49.0	100 ± 15	23.0
						8									8.5	49.0	40.3	43.0	100 ± 15	24.5
						10									9.5	47.0	37.8	41.0	100 ± 15	25.0
						16									12.1	44.0	32.2	37.0	100 ± 15	25.0
						20									13.6	43.0	29.2	35.0	100 ± 15	25.0
						25									15.2	41.0	26.1	33.0	100 ± 15	24.3
						31.25									17.1	40.0	22.8	31.0	100 ± 15	23.6
						62.5									24.8	35.0	10.6	25.0	100 ± 15	21.5
						100									32.0	32.0	0.3	21.0	100 ± 15	20.1

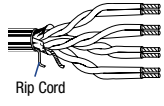

4-Pair

Color Code: see chart below

<b>Polyolefin Insulation • Grey FRNC/LSNH Jacket</b>																			
	<b>1868ENH</b>		1640	500	29.8	13.5	0.51 mm 26 AWG (7x34) BC	0.037	0.95	Non- Bonded-Pair Overall Beldfoil® + Drain Wire (24 AWG TC) F/UTP	0.205	5.20							see above
		3280	1000	59.5	27.0														

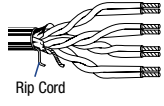

4-Pair

Color Code: see chart below

Burning Energy: 355 kJ/m

TC = Tinned Copper • BC = Bare Copper • ACR = Attenuation Crosstalk Ratio • ELFEXT = Equal Level Far-end Crosstalk • NEXT = Near-end Crosstalk • PSUM = Power Sum • RL = Return Loss • DCR = DC resistance

#### Color Code

Pair No.	Color
1	White/Blue Stripe, Blue
2	White/Orange Stripe, Orange
3	White/Green Stripe, Green
4	White/Brown Stripe, Brown

### VideoTwist® 6 U/UTP Cables for RGB Video

TIA/EIA-568-B.2-1, Category 6,  
Bonded-Pair Cables

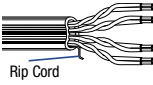
De- scription	Part No.	UL NEC/ C(UL)/CEC Type IEC	Standard Lengths		Standard Unit Weight		Conductor (Stranding) Diameter Nom. DCR	Nominal Insulation OD		Shielding Material Nom. DCR	Nominal OD		Freq. MHz	Max. Atten. dB/100m	Min. PSUM			Input Imp. ( )	Min. RL dB
			ft.	m	lbs.	kg		inch	mm		inch	mm			NEXT dB	ACR dB/100m	ELFEXT dB/100m		
<b>NanoSkew™ • Category 6 • 23 AWG Bonded-Pairs • Solid 0.6 mm Bare Copper • Skew 10.0 ns/100 m Nominal • Rip Cord</b>																			
<b>Polyolefin Insulation • Blue PVC Jacket</b>																			
300V RMS <b>7989R</b> NEC CMR CEC CMR FT4   Rip Cord  4-Pair MediaTwist™ Construction	NEC	1000	305	32.0	14.5	0.57 mm	0.042	1.06	Bonded-Pair	0.365	9.27	1	2.0	72.3	70.3	64.8	100 ± 15	20.0	
	CMR	1640	500	52.5	23.8	23 AWG			Unshielded	x	x	8	3.8	63.3	59.5	52.7	100 ± 15	23.0	
	CEC					Solid BC			U/UTP	0.165	4.19	10	6.0	57.3	51.3	44.8	100 ± 15	25.0	
												16	7.6	54.3	46.7	40.7	100 ± 15	25.0	
												20	8.5	52.8	44.3	38.7	100 ± 15	25.0	
												25	9.5	51.4	41.8	36.8	100 ± 15	24.3	
												31.25	10.7	49.9	39.2	34.9	100 ± 15	23.6	
												62.5	15.4	45.4	30.0	28.8	100 ± 15	21.5	
												100	19.8	42.3	22.5	24.8	100 ± 15	20.1	
												155	25.2	39.5	14.3	20.9	100 ± 22	18.8	
												200	29.0	37.8	8.8	18.7	100 ± 22	18.0	
												250	32.8	36.3	3.5	16.8	100 ± 32	17.3	

Color Code: see chart below

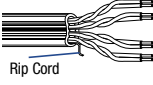
<b>Plenum • Polyolefin Insulation • Blue PVC Jacket</b>																			
300V RMS <b>7989P</b> NEC CMR CEC CMR FT4   Rip Cord  4-Pair MediaTwist™ Construction	NEC	1000	305	32.0	14.5	0.57 mm	0.039	1.00	Bonded-Pair	0.365	9.27								see above
	CMR	1640	500	52.5	23.8	23 AWG			Unshielded	x	x								
	CEC					Solid BC			U/UTP	0.165	4.19								
	CMR FT4																		

Color Code: see chart below

BC = Bare Copper • ACR = Attenuation Crosstalk Ratio • ELFEXT = Equal Level Far-end Crosstalk • NEXT = Near-end Crosstalk • PSUM = Power Sum • RL = Return Loss • DCR = DC resistance

#### Color Code

Pair No.	Color
1	White/Blue Stripe, Blue
2	White/Orange Stripe, Orange
3	White/Green Stripe, Green
4	White/Brown Stripe, Brown

#### Get the Bonded-Pairs Cable Preparation Tool

See page 15.37 for details.  
(Part No. 1797B)



## VideoTwist® 5e U/UTP Cables for RGB Video

TIA/EIA-568-B.2, Category 5e,  
Bonded-Pair Cables

De- scription	Part No.	UL NEC/ C(UL)CEC Type IEC	Standard Lengths		Standard Unit Weight		Conductor (Stranding) Diameter Nom. DCR	Nominal Insulation OD		Shielding Material Nom. DCR	Nominal OD		Freq. MHz	Max. Atten. dB/100m	Min. PSUM			Input Imp. ( )	Min. RL dB
			ft.	m	lbs.	kg		inch	mm		inch	mm			NEXT dB	ACR dB/100m	ELFEXT dB/100m		

**Cat 5e • 24 AWG • Bonded-Pair • Solid 0.5 mm Bare Copper • Twisted Pair • Skew 9.0 ns/100 nom. • Rip Cord**

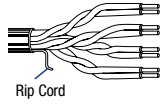
Polypropylene Insulation • Green PVC Jacket																				
 <p>Rip Cord</p>	7988R	NEC:	1000	305	22.0	10.0	0.51 mm 24 AWG Solid BC	0.038	0.97	Bonded-Pair Unshielded U/UTP	0.204	5.18	1	2.0	65.3	60.3	60.8	100 ± 15	20.0	
		CMR:	1640	500	36.2	16.4								4	4.1	53.3	49.3	48.7	100 ± 15	23.0
		CEC:												10	6.5	47.3	40.8	40.8	100 ± 15	25.0
		CMG:												16	8.2	44.3	36.0	36.7	100 ± 15	25.0
														31.25	11.7	39.9	28.2	30.9	100 ± 15	23.6
														62.5	17.0	35.4	18.4	24.8	100 ± 15	21.5
														100	22.0	32.3	10.3	20.8	100 ± 15	20.1
					200	32.4	27.8	1.0	14.7	100 ± 15	15.0									

4-Pair

Color Code: see chart below

Third party verified to TIA/EIA-568-B.2, Category 5e  
Jacket sequentially marked at 0.6 m intervals.

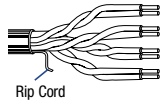
Plenum • FEP Insulation • Green Flamarrest® Jacket																			
 <p>Rip Cord</p>	7988P	NEC:	1000	305	22.9	10.4	0.51 mm 24 AWG Solid BC	0.036	0.91	Bonded-Pair Unshielded U/UTP	0.193	4.90	see above						
		CMF:	1640	500	37.7	17.1													
		CEC:																	
		CMF:																	

4-Pair

Color Code: see chart below

Third party verified to TIA/EIA-568-B.2, Category 5e  
Jacket sequentially marked at 0.6 m intervals.

BC = Bare Copper • ACR = Attenuation Crosstalk Ratio • ELFEXT = Equal Level Far-end Crosstalk • NEXT = Near-end Crosstalk • PSUM = Power Sum • RL = Return Loss • DCR = DC resistance

### Color Code

Pair No.	Color
1	White/Blue Stripe, Blue
2	White/Orange Stripe, Orange
3	White/Green Stripe, Green
4	White/Brown Stripe, Brown





### Get the Bonded-Pairs Cable Preparation Tool

See page 15.37 for details.  
(Part No. 1797B)



## IEEE 802.3, ISO/IEC 8802.3 10Base2 and 10Base5

### Trunk Cables – Thinnet and Thicknet

De-scription	Part No.	UL NEC / C(UL)/CEC Type IEC	Standard Lengths		Standard Unit Weight		Conductor (Stranding) Diameter Nom. DCR	Nominal Core OD (Dielectric)		Shielding Material Nom. DCR	Nominal OD		Nom. Imp. ( )	Nom. Vel. of Prop.	Nominal Capacitance		Nominal Attenuation		
			ft.	m	lbs.	kg		inch	mm		inch	mm			pF/ft.	pF/m	MHz	dB/100 ft.	dB/100 m
<b>Thinnet 10Base2 • 20 AWG • Stranded (19x32) 0.9 mm Tinned Copper • Duobond® II • 93 % Tinned Copper Braid</b>																			
<b>Ethernet • Foam HDPE Insulation • Grey PVC Jacket</b>																			
 30V 60°C <b>9907</b> UL AWM Style 1354	NEC:	500	152	12.6	5.7	0.94 mm	0.102	2.59	Duobond® II + 93% TC 19.0 /km***	0.185	4.70	50	80%	25.4	83.3	1	0.4	1.4	
	CL2, CM	U-1000	U-305	25.1	11.4	20 AWG										10	1.3	4.3	
	CEC:	1000	305	25.1	11.4	(19x32) TC										50	2.9	9.5	
	CM	1640	500	41.0	18.6	47.9 /km*										100	4.2	13.8	
		2500	762	62.6	28.4	28.9 /km**										200	6.1	20.0	
	3280	1000	82.2	37.3				400	8.9	29.2									
																700	12.1	39.7	
																900	13.9	45.6	
																1000	14.8	48.6	
DEC Part No. 17-01248-00 For Plenum version of 9907, see 89907 or 82907.																			
<b>Plenum • Ethernet • Foam FEP Insulation • Natural Flamarrest® Jacket</b>																			
 300V 75°C <b>82907</b>	NEC:	† 500	152	12.6	5.7	0.94 mm	0.095	2.41	Duobond® II + 93% TC 19.0 /km***	0.160	4.06	50	80%	25.4	83.3	1	0.4	1.4	
	CL2P	U-1000	U-305	23.1	10.5	20 AWG										10	1.3	4.3	
	CMP	† 1000	305	24.0	10.9	(19x32) TC										50	2.9	9.5	
	CEC:	† 2500	762	57.5	26.1	47.9 /km*										100	4.2	13.8	
	CMP					28.9 /km**										200	6.1	20.0	
																400	9.2	30.2	
																700	12.9	42.3	
																900	15.0	49.2	
																1000	16.0	52.5	
<b>Plenum • Ethernet • Foam FEP Insulation • Grey Fluorocopolymer Jacket</b>																			
 300V 150°C <b>89907</b>	NEC:	† 500	152	12.6	5.7	0.94 mm	0.095	2.41	Duobond® II + 93% TC 19.0 /km***	0.160	4.06	50	80%	25.4	83.3				
	CL2, CM	† 1000	305	24.0	10.9	20 AWG										see above			
	CEC:	† 2500	762	60.2	27.3	(19x32) TC													
	CM					47.9 /km*													
						28.9 /km**													
DEC Part No. 17-01246-00 Suitable for outdoor and direct burial applications.																			
<b>Thinnet 10Base2 • 12 AWG • Solid 2.05 mm Bare Copper • Duobond® IV Quad Shield</b>																			
<b>Ethernet • Foam Polyethylene Insulation • Yellow PVC Jacket</b>																			
 30V 60°C <b>9880</b> UL AWM Style 1478	NEC:	500	152	66.1	30.0	2.05 mm	0.243	6.17	Duobond® IV Quad Shield 5.0 /km***	0.405	10.29	50	78%	25.9	85.0	1	0.2	0.6	
	CL2, CM	1000	305	131.2	59.5	12 AWG										5	0.4	1.2	
	CEC:	1640	500	220.2	99.9	Solid BC										10	0.5	1.7	
	CM					9.66 /km*										50	1.2	3.9	
						4.66 /km**										100	1.7	5.6	
																200	2.6	8.4	
																400	3.9	12.8	
																700	5.5	18.1	
																900	6.5	21.3	
																1000	6.9	22.6	
DEC Part No. 17-00451-00 5.0 /km For Plenum version of 9880, see 89880. Ring-band stripes marked every 2.5 meters to aid users in tap placement.																			
<b>Plenum • Ethernet • Foam FEP Insulation • Orange Fluorocopolymer Jacket</b>																			
 150°C <b>89880</b>	NEC:	† 1000	305	134.3	60.9	2.05 mm	0.245	6.22	Duobond® IV* Quad Shield 5.0 /km***	0.375	9.53	50	78%	25.9	85.0	1	0.2	0.6	
	CL2P	† 1640	500	225.1	102.1	12 AWG										5	0.4	1.2	
	CMP					Solid BC										10	0.5	1.7	
	CEC:					9.66 /km*										50	1.1	3.8	
	CMP					4.66 /km**										100	1.6	5.4	
																200	2.5	8.0	
																400	3.8	12.5	
																700	5.6	18.4	
																900	6.8	22.3	
																1000	7.2	23.6	
DEC Part No. 17-00324-00 Suitable for outdoor and direct burial applications. Ring-band stripes marked every 2.5 meters to aid users in tap placement.																			

\* DC loop resistance • \*\* DC resistance inner conductor • \*\*\* DC resistance outer conductor • TC = Tinned Copper • BC = Bare Copper • DCR = DC resistance  
 † Spools and/or UnReel® cartons are one piece, but length may vary ±10% from length shown.

Duobond® II and Duobond® IV see technical information page 23.13.

 Not RoHS compliant at time of printing.



# IEEE 802.3, ISO/IEC 8802.3 10Base5

## Transceiver Cables

De-scription	Part No.	UL NEC/ C(UL)CEC Type IEC	Standard Lengths		Standard Unit Weight		Conductor (Stranding) Diameter Nom. DCR	Nominal Insulation OD		Shielding Material Nom. DCR	Nominal OD		Nom. Imp. ( )	Nom. Vel. of Prop.	Nominal Capacitance		Color Code
			ft.	m	lbs.	kg		inch	mm		inch	mm			pF/ft.	pF/m	

**28 and 24 AWG** • Stranded (7x36) 0.4 mm and (7x32) 0.6 mm Tinned Copper • **Beldfoil®** • Twisted Pair •

**Overall Polyester Isolation Tape + Duofoil® + 92% Tinned Copper Braid + 24 AWG Tinned Copper Drain Wire**

Polypropylene Insulation • Light Grey PVC Jacket																	
30V 80°C UL AWM Style 2919	<b>9903</b>	NEC: CMG CEC: CMG	500 1000	152 305	21.6 43.0	9.8 19.5	3-Pair: 0.38 mm 28 AWG (7x36) TC  1-Pair: 0.61 mm 24 AWG (7x32) TC	0.033  0.044	0.84  1.12	Individual Beldfoil® + Drain Wire (24 AWG TC) + Overall Duofoil® + 92% TC Braid	0.250  0.250	6.35  6.35	78*  78*	66%  66%	CDR/CDR  CDR/CDR	19.7 34.8 64.6 114.2	Grey/White, Yellow/Orange  Blue/Green, Black/Red

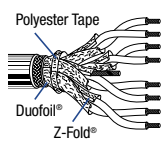

4-Pair  
\* 3-Pair

**20 AWG** • Stranded (7x28) 1.0 mm Tinned Copper • **Beldfoil®** • Twisted Pair •

**Overall Polyester Isolation Tape + Duofoil® + 95% Tinned Copper Braid + 22 AWG Tinned Copper Drain Wire**

Datalene® Insulation • Light Grey PVC Jacket																	
30V 80°C UL AWM Style 2919	<b>9901</b>	NEC: CL2, CM CEC: CM	500 1000	152 305	53.6 106.3	24.3 48.2	1.0 mm 20 AWG (7x28) TC	0.077  0.077	1.96  1.96	Individual Beldfoil® + Drain Wire (22 AWG TC) + Overall Duofoil® + 95% TC Braid	0.415  0.415	10.54  10.54	78  78	78%  78%	CDR/CDR  CDR/CDR	16.7 29.5 54.8 96.8	Grey/White Yellow/Orange, Blue/Green, Black/Red

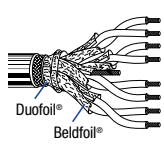

4-Pair  
DEC Part No. 17-01320-00

**Plenum • FEP Teflon® Insulation\*\* • Light Grey Fluorocopolymer (PVDF) Jacket**

150°C	<b>89901</b>	NEC: CMP CEC: CMP	** 500 ** 1000	152 305	51.6 104.3	23.4 47.3	1.0 mm 20 AWG (7x28) TC	0.060  0.060	1.52  1.52	Individual Beldfoil® + Drain Wire (22 AWG TC) + Overall Duofoil® + 95% TC Braid	0.370  0.370	9.40  9.40	78  78	78%  78%	CDR/CDR  CDR/CDR	16.7 29.5 54.8 96.8	Grey/White Yellow/Orange, Blue/Green, Black/Red
-------	--------------	----------------------------	-------------------	------------	---------------	--------------	-------------------------------	--------------------	------------------	---	--------------------	------------------	--------------	----------------	------------------------	------------------------------	--

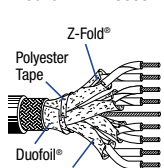

4-Pair  
DEC Part No. 17-01319-00  
Suitable for outdoor and direct burial applications.

**20 and 22 AWG** • Stranded (7x30) 0.8 mm and (7x28) 1.0 mm Tinned Copper • **Beldfoil®** • Twisted Pair •

**Overall Duofoil® + 95% Tinned Copper Braid + 22 AWG Tinned Copper Drain Wire**

Ethernet • Foam HDPE (22 AWG) and PVC (20 AWG) Insulation • Light Blue PVC Jacket																	
30V 80°C UL AWM Style 2919	<b>9891</b>	NEC: CM CEC: CM	100 500 1000	30 152 305	8.2 35.9 70.1	3.7 16.3 31.8	3-Pair: 0.76 mm 22 AWG (7x30) TC  1-Pair: 0.96 mm 20 AWG (7x28) TC	0.063  0.062	1.59  1.57	Individual Beldfoil® + Drain Wire (22 AWG TC) + Overall Duofoil® + 95% TC Braid	0.315  0.315	8.00  8.00	78*  78*	78%  78%	CDR/CDR  CDR/CDR	16.7 29.5 54.8 96.8	Black/White Yellow/Orange, Blue/Green, Black/Red  Blue/Green, Grey/Violet

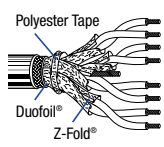

4-Pair  
\* 3-Pair

TC = Tinned Copper • DCR = DC resistance • \*\* Foam FEP (data pairs) and solid FEP (power pair).  
Duofoil® see technical information page 23.13. Teflon® is a DuPont trademark.

 Not RoHS compliant at time of printing

### IEEE 802.4, MAP & Mini-MAP, IEEE 802.7

#### Broadband Coaxial Cables

De- scription	Part No.	UL NEC/ C(UL)/CEC Type IEC	Standard Lengths		Standard Unit Weight		Conductor (Stranding) Diameter Nom. DCR	Nominal Core OD (Dielectric)		Shielding Material Nom. DCR	Nominal OD		Nom. Imp. ( )	Nom. Vel. of Prop.	Nominal Capacitance		Nominal Attenuation		
			ft.	m	lbs.	kg		inch	mm		inch	mm			pF/ft.	pF/m	MHz	dB/ 100 ft.	dB/ 100 m
<b>14 AWG • Solid 1.6 mm Copper-Covered Steel • Duobond® IV Quad Shield</b>																			
<b>Gas-Injected Foam Polyethylene Insulation • Grey PVC Jacket</b>																			
	3094A	NEC:	500	152	31.1	14.1	1.63 mm	0.280	7.11	Duobond® IV Quad Shield 4.9 /km*** 7.9 mm	0.407	10.34	75	82%	16.2	53.1	1	0.2	0.5
		CL2R	1000	305	62.2	28.2	14 AWG										2	0.2	0.6
		CMR	† 2000	610	121.9	55.3	Solid CCS										5	0.3	0.9
		CEC:					20.0 /km*										10	0.4	1.2
		CMG					36.1 /km**										20	0.5	1.8
																	50	0.8	2.7
								100	1.2	3.8									
								200	1.6	5.3									
								300	2.0	6.6									
								400	2.3	7.6									

RG-11/U Type

Tap marks every 2.6 meters to aid users in installation.  
152 m and 305 m exact 1 pc.

Sweep tested 5 MHz to 400 MHz.  
CPE jacket optional.

### IEEE 802.5, ISO/IEC 8802.5

#### IBM Cabling System

#### Types 1A and 1

De- Description	Part No.	UL NEC/ C(UL)/CEC Type IEC	Standard Lengths		Standard Unit Weight		Conductor (Stranding) Diameter Nom. DCR	Nominal Core OD (Dielectric)		Shielding Material Nom. DCR	Nominal OD		Nom. Imp. ( )	Nom. Vel. of Prop.	Nominal Capacitance		Nominal Attenuation					
			ft.	m	lbs.	kg		inch	mm		inch	mm			pF/ft.	pF/m	MHz	dB/ 100 ft.	dB/ 100 m			
<b>IBM Type 1a • 22 AWG • Solid 0.6 mm Bare Copper • Each Pair Individually Beldfoil® Shielded • 65% Overall Tinned Copper Braid • Rip Cord</b>																						
<b>Flame-Retardant Foam Polyethylene Insulation • Black PVC Jacket</b>																						
	IBM Part No. 9688	NEC:	† 500	152	26.5	12.0	0.64 mm	0.099	2.51	Individual Beldfoil® + Overall 65% TC Braid	0.296	7.52	150	-	8.5	27.9	4	0.7	2.2			
		4716748	CMG	† 1000	305	50.0	22.7	22 AWG										x	x	16	1.3	4.4
		33G2772	CEC:	† 2000	610	102.1	46.3	Solid BC										0.431	10.95	100	3.8	12.3
			CMG	† 3600	1098	190.7	86.5													300	6.5	21.4
																	100 ††	4.1	13.4			
																	300 ††	7.1	23.3			
																	600 ††	10.0	32.9			

Rip Cord

Meets IEEE 802.5 and TIA/EIA-568-A specifications, ETL verified. For token ring (4/16 Mbps), FDDI over copper, and video applications.  
IBM qualified type 1A media cable for use in IBM cabling systems. For non-suffix "A" type IBM product, see 1634A below.

2-Pair

#### IBM Type 1 • 22 AWG • Solid 0.6 mm Bare Copper • Each Pair Individually Beldfoil® Shielded • 65% Overall Tinned Copper Braid • Rip Cord

De- Description	Part No.	UL NEC/ C(UL)/CEC Type IEC	Standard Lengths		Standard Unit Weight		Conductor (Stranding) Diameter Nom. DCR	Nominal Core OD (Dielectric)		Shielding Material Nom. DCR	Nominal OD		Nom. Imp. ( )	Nom. Vel. of Prop.	Nominal Capacitance		Nominal Attenuation					
			ft.	m	lbs.	kg		inch	mm		inch	mm			pF/ft.	pF/m	MHz	dB/ 100 ft.	dB/ 100 m			
<b>IBM Type 1 • 22 AWG • Solid 0.6 mm Bare Copper • Each Pair Individually Beldfoil® Shielded • 65% Overall Tinned Copper Braid • Rip Cord</b>																						
<b>Flame-retardant Foam Polyethylene Insulation • Black PVC Jacket</b>																						
	IBM Part No. 1634A	NEC:	† 1000	305	50.0	22.7	0.64 mm	0.099	2.51	Individual Beldfoil® + Overall 65% TC Braid	0.296	7.52	150	-	8.5	27.9	4	0.7	2.2			
		4716748	CMG	† 2000	610	102.3	46.4	22 AWG										x	x	16	1.3	4.4
			CEC:	† 3600	1098	191.1	86.7	Solid BC										0.431	10.95	100	3.8	12.3
			CMG																	300	6.5	21.4
																	100 ††	4.1	13.4			
																	300 ††	7.1	23.3			
																	600 ††	10.0	32.9			

Rip Cord

Meets IEEE 802.5 and TIA/EIA-568-A specifications, ETL verified.  
IBM qualified type 1A media cable for use in IBM cabling systems. For token ring (4/16 Mbps), FDDI over copper, and video applications.

2-Pair

\* DC loop resistance • \*\* DC resistance inner conductor • \*\*\* DC resistance outer conductor • CCS = Copper-Covered Steel • TC = Tinned Copper • BC = Bare Copper • DCR = DC resistance  
† Spools are one piece, but length may vary ±10% from length shown.  
†† Common mode

Duobond® IV see technical information page 23.13.

 Not RoHS compliant at time of printing

# IEEE 802.5, ISO/IEC 8802.5

## IBM Cabling System

### Types 2A and 6A

De- scription	Part No.	UL NEC/ C(UL)CEC Type IEC	Standard Lengths		Standard Unit Weight		Conductor (Stranding) Diameter Nom. DCR	Nominal Core OD (Dielectric)		Shielding Material Nom. DCR	Nominal OD		Nom. Imp. ( )	Nom. Vel. of Prop.	Nominal Capacitance		Nominal Attenuation	
			ft.	m	lbs.	kg		inch	mm		inch	mm			pF/ft.	pF/m	MHz	dB/ 100 ft.

**IBM Type 6a • 26 AWG • Stranded (7x34) 0.5 mm Bare Copper • Twisted Pair • Individual Beldfoil® • 65% Overall Tinned Copper Braid**

<b>Datalene® Insulation • Striated Black PVC Jacket</b>																		
<b>IBM Part No. 1215A</b>	NEC:	† 998	304	46.1	20.9	0.48 mm	0.078	1.98	Individual	0.325	8.26	150	–	8.5	27.9	4	1.0	3.3
4716743	CL2, CM					26 AWG			Beldfoil®							16	2.0	6.6
33G2775	CEC:					(7x34) BC			+ 65% TC							100	5.7	18.7
	CM								Braid							300	9.8	32.3

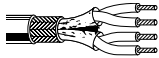

2-Pair

IBM qualified type 6A office cable for use in IBM cabling systems.

**IBM Type 2a • 22 AWG • Solid 0.6 mm Bare Copper • Twisted Pair • Individual Beldfoil® • 65% Overall Tinned Copper Braid • Rip Cord**

<b>Flame-Retardant Foam Polyethylene Insulation • Black PVC Jacket</b>																		
<b>IBM Part No. 9689</b>	NEC:	† 1000	305	80.2	36.4	2-Pair*	0.099	2.51	Beldfoil®	0.324	8.32	150@	–	8.5	27.9	0.1k**	0.04	0.1
4716739	CMG	† 3600	1098	299.4	135.8	0.64 mm			Each Pair	x	x	1 MHz		(data)	(data)	4	0.7	2.2
33G2773	CEC:					22 AWG			+ 65% TC	0.466	11.84	(data)				16	1.3	4.4
	CMG					Solid BC			Braid							100	3.8	12.3
												600@				300	6.5	21.4
						4-Pair*	0.045	1.14				1 KHz				100 ††	4.1	13.4
						0.64 mm						(voice)				300 ††	7.1	23.3
						22 AWG										600 ††	10.0	32.9
						Solid BC												

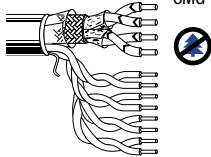

IBM qualified type 2A media cable for use in IBM cabling systems.

TC = Tinned Copper • BC = Bare Copper • DCR = DC resistance  
 † Spools are one piece, but length may vary ±10% from length shown.  
 †† Common mode  
 \* (2) shielded Data-grade pair; (4) unshielded voice-grade media pair.  
 \*\* Voice pairs (1 kHz); Data pairs (4-600 MHz)





# Commercial Networking – Optical Fiber



## Table of Contents

<b>Commercial Networking – Optical Fiber</b>	<b>Page No.</b>
<b>Introduction</b>	<b>16.2 – 16.3</b>
<b>Optical Fiber Connectivity Products</b>	<b>16.4 – 16.17</b>
FiberExpress Connectors	16.4 – 16.5
Pre-Connectorized Assemblies	16.6 – 16.8
FiberExpress Secure/Keyed LC System	16.9 – 16.10
FiberExpress Manager	16.11
FiberExpress Patch Panels	16.12 – 16.13
FiberExpress Patch Panels Accessories	16.14
FiberExpress Outlets	16.15 – 16.16
Network Connectivity Products	16.17
<b>Introduction Cables</b>	<b>16.18 – 16.24</b>
<b>Guide to Installation and Handling</b>	<b>16.20</b>
<b>Cable Finder Optical Fibers</b>	<b>16.22</b>
<b>Color Codes</b>	<b>16.23</b>
<b>Cable Selection Guide: Plenum</b>	<b>16.24</b>
<b>Optical Fiber Cables</b>	<b>16.25 – 16.58</b>
Interconnect Cables	16.25 – 16.27
Breakout Cables	16.28
Mini Breakout Cables (Distribution)	16.29 – 16.32
Breakout Kit Cables	16.32
Central Loose Tube Cables	16.33 – 16.40
Multi Loose Tube Cables	16.41 – 16.58
<b>Plenum Optical Fiber Cables</b>	<b>16.59 – 16.64</b>
Interconnect Cables	16.59
Distribution Cables	16.60 – 16.61
Breakout Style Cables	16.62
Industrial Armored Cables	16.63
Central Loose Tube Cables	16.64

Please refer to "Terms of Use of Master Catalog" on page 23.22.

## Introduction

### Fiber Solutions for Even Faster Performance

Belden IBDN FiberExpress systems offer many benefits: high bandwidth and transmission speed, the potential for network growth, extended reach, fault tolerance, greater data security and support for Gigabit and multi-Gigabit protocols and networked applications. Beyond these traditional benefits, however, Belden offers the FiberExpress solution, a complete end-to-end cabling system supporting both centralized and fiber-to-the-desk topologies, as well as backbone and campus cabling configurations. Our FiberExpress solutions meet or exceed all applicable TIA/EIA, ISO/IEC and IEEE standards and offer:

- Reduced design complexities
- Greater deployment facility
- Quick installation
- Increased flexibility
- Cost effective pricing

### Primary FiberExpress System Components

Key components of the FiberExpress systems are summarized below and are found on the catalog pages that follow.

#### • Optimax® Connectors

Optimax® connectors are a revolutionary field-installable optical fiber connector. The unique design of the patented mechanical splice body of Optimax® incorporates a factory mounted fiber stub and a pre-polished ceramic ferrule. This technology consistently provides a fast, secure and reliable LC, SC or ST compatible optical fiber termination for multimode or single-mode cable. All critical steps are performed in the factory, ensuring a superior quality connection every time.



#### • The FiberExpress Manager

The FiberExpress manager makes fiber management easier than ever before. Designed to streamline termination, connection and maintenance activities, the FiberExpress manager uses a scalable, modular approach to adapt to a wide variety of situations. The total system provides extra high connection density while facilitating cable routing and patch cord management. The FiberExpress manager is adaptable for almost all situations, traditional field termination or pre-terminated modules, which reduces design complexity and increases deployment efficiency.

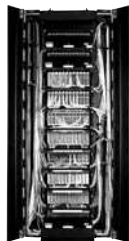

#### • Extended Reach Optical Fiber Cables

Extended Reach Optical Fiber Cables propel your network into the future of cable technology with our multimode FiberExpress FX300, FX600 or FX2000 series. These series were developed to meet the existing needs of networks at 1 Gb/s (ethernet, 1000Base-SX and 1000Base-LX) and new networks at 10 Gb/s (ethernet, 10GBase-S and 10GBase-LX4). These series offer better reach for laser-based systems. For 1 Gb/s Ethernet at 850 nm (VCSEL), the FX300 and FX600 series provide a range of 984 ft. (300 m) and 1968 ft. (600 m), respectively. For 10 Gb/s ethernet at 850 nm (VCSEL), the FX2000 series provide a range of 984 ft. (300 m) for 10GBase-S where all of multimode series can offer a 984 ft. (300 m) range at 1300 nm (laser) for 10GBase-LX4. All of this while assuring total compatibility with LED systems and FDDI fiber installation cables. Our single-mode cable offering enhances the options for longer distance support up to 40 km – for any of the Gigabit ethernet applications.



#### • The FiberExpress Bar

The FiberExpress bar is an extremely compact, modular and resilient linking panel. Resembling a power bar, it offers 6 or 12 fibers, pre-terminated with an SC, SC duplex, ST-compatible, LC, MT-RJ or FC connectors and a cord terminated with a multi-fiber MPO connector – all of which are factory verified. The FiberExpress bar can adapt to all kinds of properties or developments, and can serve as a consolidation or linking point. It's available in both single-mode and multimode media.



For the ultimate in quick, easy and reliable optical networking we also offer the FiberExpress pre-connectorized system. Based on the concept of building blocks, the complete range of pre-terminated FiberExpress components bring flexibility to the design stage. The in-factory fabrication and verification of pre-terminated connections ensures the high-performance and high-quality of the product. These products are “plug and go” and their deployment requires no specialized tools – you can deploy 12 fibers in the same amount of time it takes to connect a power cord to a standard electrical plug. This pre-terminated technology will help to preserve the initial investment by its ability to be re-deployed while always ensuring quality results.

### Quality Installation and Service

All Belden IBDN systems are designed, installed and field-tested by fully-trained and certified system contractors and integrators to further assure superior systems performance. They are also backed by a strict system certification and warranty program.

### System Certification and Warranty Program

The Belden IBDN Certification Program is a rigorous process that ensures that your Belden IBDN ‘Certified’ System is composed of Belden IBDN components, designed and installed by a factory-trained Certified System Vendor. Belden IBDN ‘certified’ systems are supported by a series of warranties that surpass conventional product warranties. Certification adds important end-to-end system performance guarantees and ensures full compliance with cabling industry standard specifications – even after system installation (Installable Performance®). A 25-year product warranty and a lifetime application assurance program accompany each Belden IBDN ‘certified’ system installation. These warranty programs include coverage for both parts and labor.

## Introduction

### Fiber Channel Topology

FiberExpress System Matrix	Page No.	Fiber-to-the-Desk (FTTD) and Centralized Fiber	Fiber Backbone (In-Building)	Fiber Backbone (Campus)	FiberExpress Pre-Terminated Solutions*
<b>FiberExpress Cables</b>					
Distribution & Breakout Cable Series Multimode and Single-mode	16.28 – 16.32	●			●
Interconnect Cable Series Multimode and Single-mode	16.25 – 16.27	●			
Loose Tube (Campus) Cable Series MM, SM, Composite MM/SM	16.33 – 16.58			●	●
<b>Cross-Connect Hardware in the Telecom Room</b>					
FiberExpress Manager with FiberExpress Manager Connector Modules Multimode and Single-mode	16.11	●	●	●	●
FiberExpress Rack Mount Patch Panel with Universal Adapter Strips Multimode and Single-mode	16.12	●		●	●
FiberExpress Wall Mount Patch Panel with Universal Adapter Strips Multimode and Single-mode	16.13	●		●	●
FiberExpress Bar: Multimode and Single-mode	16.8	●	●	●	●
<b>Patch Cords in the Telecom Room and at the Work Area</b>					
FiberExpress Patch Cords: Multimode and Single-mode	16.6	●	●	●	●
<b>Outlets at the Work Area</b>					
MDVO® Multimedia Outlets with MDVO Multimedia Modules	16.16	●			
MediaFlex® Outlets with MediaFlex Multimedia Inserts	16.15	●			
FiberExpress Bar Multimode and Single-mode (as MUTOA)	16.8	●	●		
<b>Fiber Connectivity</b>					
Optimax® Connectors Multimode and Single-mode	16.4	●		●	●
Epoxy Field Mountable Connectors Multimode and Single-mode	16.5	●		●	●
Fiber Pigtails Multimode and Single-mode	16.9	●		●	●

MM = Multimode • SM = Single-mode

\* FiberExpress pre-terminated solutions provide simple-to-install, high-performance fiber channels through custom length, high precision factory terminated cables and matching optical connectivity components.

## FiberExpress Connectors

### Optimax® Field Installable Connectors and Installation Tool Kits

AX101982 Optimax® LC connector



AX100029 with AX101794 Optimax® SC connector



A0408835 with AX101793 Optimax® ST compatible connector



AX100947 Optimax® tool kit



These products are in the process of being assessed for RoHS compliance. Please check our website for the most current RoHS status.

\* For 900 µm buffered fiber only. For Optimax® single-mode termination on jacketed fiber, please use the appropriate Accessory Kit.

#### Optimax® Field Installable Connector

The Optimax® connectors are reliable field installable optical fiber connectors that are easy to install. They do not require epoxy, curing or polishing. Their unique design incorporates a factory polished fiber stub in a splice mechanism which provides a fast, secure, and reliable termination on optical fiber cables. All critical steps are performed in the factory, ensuring a superior-quality connection every time. Only simple tools are required for installation, making Optimax® a cost effective field termination.

Optimax® connectors are high-quality LC, SC and ST compatible connectors that use a ceramic ferrule with a physical contact (PC) polish for multimode and super physical contact (SPC) polish for single-mode that ensures the best possible mating of optical fibers. Connectors are available for 62.5 or 50/125 µm multimode fiber and single-mode fiber installations.

#### Optimax® Installation Tool Kit

The Optimax® installation tool kit is packaged in a small convenient carrying case and includes an Optimax® LC, SC and ST compatible installation and training video, installation instructions and all the tools required to terminate 900 µm buffered optical fiber and jacketed optical fiber.

The Optimax® installation tool kit has all the tools and supplies required to install both the Optimax® LC, SC or ST compatible multimode and single-mode connectors. Certain tool kit items can be purchased separately to accommodate installers already possessing basic optical fiber installation tools.

Description	Belden Part Number
<b>FiberExpress Connectors</b>	
<b>Optimax® Field Installable Connector</b>	
LC 62.5 µm, Multimode*	AX101981
LC 50 µm, Multimode*	AX101982
LC Single-mode*	AX101983
SC 62.5 µm, Multimode*	AX100029
SC 50 µm, Multimode*	AX101077
SC Single-mode*	AX101792
ST Compatible 62.5 µm, Multimode*	A0408835
ST Compatible 50 µm, Multimode*	AX101075
ST Compatible Single-mode*	AX101791
LC Accessory Kit for jacketed fiber (2 mm boot and a crimp sleeve)	AX101984
SC Accessory Kit for jacketed fiber (3 mm boot, crimp sleeves, cord adapter)	AX101794
ST Accessory Kit for jacketed fiber (3 mm boot, crimp sleeves)	AX101793
<b>Optimax® Installation Tool Kit</b>	
LC/SC/ST Compatible (includes installation tools, fiber cleaver, crimping tool, instruction manual, microscope, tweezers, alcohol wipes, marker, scissors, waste bottle, fiber stripper, cable stripper and training video)	AX100947
Basic (excludes fiber stripper & cleaver)	AX100949
Optimax® LC Tool Kit Upgrade (includes LC installation tool, instructions manual, foam for the case)	AX102061
<b>Optimax® Individual Components</b>	
Fiber Cleaver	A0408829
Installation Tool LC (does not include tool-clamp)	AX102062
Installation Tools ST Compatible and SC (includes tool-clamp)	A0403634
Microscope	AX100910
Refurbishing Materials (80 alcohol wipes and a black felt tip marker)	AX100951
Installation Instruction Manual, LC	AX102063
Installation Instruction Manual, SC	PX101318
Installation Instruction Manual, ST Compatible	PX101317
Installation & Training Video, CD (see literature ordering form on the web)	NOT0651
Crimp Tool complete with die	A0403641

## FiberExpress Connectors

### Epoxy Field Installable Connectors

A0390851 Optical Fiber Field Installable Epoxy connector, ST compatible



#### Epoxy Field Installable Connector

Epoxy field installable connectors are available as multimode and single-mode ST compatible and SC field installable connectors. They require heat-cured epoxy and polishing. Both types have a ceramic ferrule. Each connector comes complete with all the parts necessary for termination of tight-buffered fibers as well as jacketed fibers. Parts include crimp sleeves, boots, cord adapter and dust cap.

Description	Belden Part Number	
	Multimode	Single-Mode

#### FiberExpress Connectors

Epoxy Field Installable Connector		
ST Compatible	<b>A0390851</b>	<b>AX101412</b>
SC Simplex	<b>AX100919</b>	<b>AX101411</b>
SC Duplex	<b>AX100929</b>	–

These products are in the process of being assessed for RoHS compliance. Please check our website for the most current RoHS status.



## Pre-Connectorized Assemblies

### FiberExpress Patch Cords

AX200057 Patch Cord Multimode SC Duplex (568SC)



#### FiberExpress Patch Cords

FiberExpress duplex patch cord assemblies are of the highest quality available. They are assembled and 100% optically tested in our factory prior to shipment. All patch cords are built with high-quality connectors and cables which guarantees superior performance and excellent reliability.

Description	Belden Part Number			
	Multimode, FX300, 62.5 μm	Multimode, FX600, 50.0 μm	Multimode, FX2000, 50.0 μm	Single-Mode SPC

#### FiberExpress Pre-Connectorized Assemblies

Duplex Patch Cord				
ST-ST, 2 m (6 ft.)	70102419	AX200341	AX200799	AX200090
ST-ST, 3 m (10 ft.)	70102420	AX200459	AX200795	AX200091
ST-ST, 5 m (16 ft.)	70102447	AX200413	AX200800	AX200092
568SC-568SC, 2 m (6 ft.)	AX200056	AX200084	AX200603	AX200094
568SC-568SC, 3 m (10 ft.)	AX200057	AX200082	AX200589	AX200095
568SC-568SC, 5 m (16 ft.)	AX200058	AX200280	AX200624	AX200096
LC duplex-LC duplex, 2 m (6 ft.)	AX200517	AX200527	AX200664	AX200507
LC duplex-LC duplex, 3 m (10 ft.)	AX200518	AX200528	AX200665	AX200508
LC duplex-LC duplex, 5 m (16 ft.)	AX200519	AX200529	AX200666	AX200509
MTRJ-MTRJ, 2 m (6 ft.)	AX101122	AX101139	AX200801	AX101157
MTRJ-MTRJ, 3 m (10 ft.)	AX101123	AX101138	AX200802	AX101156
MTRJ-MTRJ, 5 m (16 ft.)	AX101125	AX101137	AX200803	AX101155
Hybrid Patch Cord				
568SC-ST, 3 m (10 ft.)	AX200060	AX200196	AX200900	AX200421
LC duplex-ST, 3 m (10 ft.)	AX200699	AX200695	AX200809	AX200698
LC duplex-568SC, 3 m (10 ft.)	AX200580	AX200581	AX200668	AX200667
MTRJ-ST, 3 m (10 ft.)	AX101133	AX101151	AX200810	AX101166
MTRJ-568SC, 3 m (10 ft.)	AX101128	AX101143	AX200797	AX101161
Single-Ended (pigtailed)				
ST-open, 2 m (6 ft.)	70100390	AX200458	AX200811	AX200097
SC-open, 2 m (6 ft.)	70101714	AX200192	AX200653	AX200098
LC-open, 2 m (6 ft.)	AX200657	AX200658	AX200660	AX200659
MTRJ (m)-open, 3 m (10 ft.)	AX101366	AX101367	AX200812	AX101368

Also available as Simplex Patch Cords or custom assemblies, please contact customer service for more details. These products are in the process of being assessed for RoHS compliance. Please check our website for the most current RoHS status.

# FiberExpress Pre-Connectorized Assemblies

## Cable Assemblies

AX250105 MPO Cable Assembly



Multi-fiber Cable Assembly

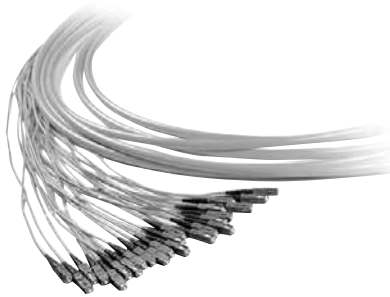

900 µm Fan-out Assembly

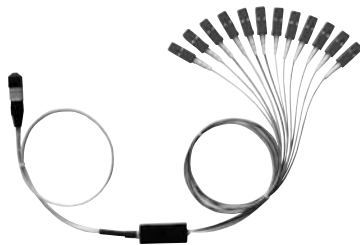

These products are in the process of being assessed for RoHS compliance. Please check our website for the most current RoHS status.

### MPO Cable Assembly

MPO cable assemblies are multi-fiber cables using single MPO connectors 6, 8 and 12-fiber that are used to interconnect pre-terminated devices such as FiberExpress pre-terminated modules and FiberExpress bars. Depending on the application, MPO cable assemblies can use ribbon cables or loose tube cables. MPO cables are available in lengths of up to 500 meters with a pulling-eye for ease of deployment.

### Multi-Fiber Cable Assembly

Multi-fiber cable assemblies are factory-terminated fiber cables of various constructions (distribution, breakout or ribbon) using simplex, duplex or multi-fiber connectors. They are available in configurations from 2-fiber up to 144-fiber with various kinds of fan-out constructions, lengths and geometry to suit virtually any application.

Description	Belden Part Number	
	Multimode	Single-Mode

### FiberExpress Pre-Connectorized Assemblies

MPO Cable Assembly, FOMC, MPO(f)-MPO(f)		
1 pulling eye, OFNP, 12 fibers, 10 m (33 ft.)	AX250021	AX250345
1 pulling eye, OFNP, 12 fibers, 20 m (66 ft.)	AX250105	AX250376
1 pulling eye, OFNP, 12 fibers, 50 m (164 ft.)	AX250349	AX250065
1 pulling eye, OFNP, 12 fibers, 75 m (246 ft.)	AX250060	AX250066
1 pulling eye, OFNP, 12 fibers, 100 m (328 ft.)	AX250061	AX250067
	Multimode	Single-Mode
1 pulling eye, OFNP, 12 fibers, 10 m (33 ft.)	AX250457	AX250224
1 pulling eye, OFNP, 12 fibers, 20 m (66 ft.)	AX250412	AX250106
1 pulling eye, OFNP, 12 fibers, 50 m (164 ft.)	AX250387	AX250071
1 pulling eye, OFNP, 12 fibers, 75 m (246 ft.)	AX250413	AX250072
1 pulling eye, OFNP, 12 fibers, 100 m (328 ft.)	AX250458	AX250073

Also available in 6 or 8-fiber MPO Cable Assemblies, please contact customer service for more details.

Description	Belden Part Number
Multi-Fiber Cable Assembly, MPO(m)-ST	
Multimode FX300, 62.5 µm, 12 fibers	NXC-RPML-PGPNNN-STPFBN-N-01.5
Multimode FX600, 50 µm, 12 fibers	NXC-RPNL-PGPNNN-STPFBN-N-01.5
Multimode FX2000, 50 µm, 12 fibers	NXC-RPFL-PGPNNN-STPFBN-N-01.5
Single-mode, 12 fibers	NXC-RPSL-PGANNN-STSFBN-N-01.5
Multi-Fiber Cable Assembly, MPO(m)-SC	
Multimode FX300, 62.5 µm, 12 fibers	NXC-RPML-PGPNNN-SCPFBN-N-01.5
Multimode FX600, 50 µm, 12 fibers	NXC-RPNL-PGPNNN-SCPFBN-N-01.5
Multimode FX2000, 50 µm, 12 fibers	NXC-RPFL-PGPNNN-SCPFBN-N-01.5
Single-mode, 12 fibers	NXC-RPSL-PGANNN-SCSFBN-N-01.5
Multi-Fiber Cable Assembly, MPO(m)-LC	
Multimode, FX300, 62.5 µm, 12 fibers	NXC-RPML-PGPNNN-LCPFBN-N-01.5
Multimode FX600, 50 µm, 12 fibers	NXC-RPNL-PGPNNN-LCPFBN-N-01.5
Multimode FX2000, 50 µm, 12 fibers	NXC-RPFL-PGPNNN-LCPFBN-N-01.5
Single-mode, 12 fibers	NXC-RPSL-PGANNN-LCSFBN-N-01.5
Multi-Fiber Cable Assembly, MPO(m)-MTRJ(m)	
Multimode FX300, 62.5 µm, 12 fibers	NXC-RPML-PGPNNN-JBPFBN-N-01.5
Multimode FX600, 50 µm, 12 fibers	NXC-RPNL-PGPNNN-JBPFBN-N-01.5
Multimode FX2000, 50 µm, 12 fibers	NXC-RPFL-PGPNNN-JBPFBN-N-01.5
Single-mode, 12 fibers	NXC-RPSL-PGANNN-JBSFBN-N-01.5

## FiberExpress Pre-Connectorized Assemblies

### FiberExpress Bar

AX250001 FiberExpress Bar 12ST



MX100154 FiberExpress MPO Adapter



#### FiberExpress Bar

The FiberExpress bar consists of a custom length fiber cable with, at one end, a factory pre-terminated rugged mini patch panel and, at the other end, a factory installed multi-fiber MPO connector. The very compact fiber patch panel contains 6 or 12 factory-terminated and tested connectors in a variety of styles. The ruggedness of the FiberExpress bar makes it an ideal candidate for disaster recovery, industrial applications and other fiber deployment in harsh environment.

#### FiberExpress Bar Accessories

The MPO adapter is the sleeve that provides primary alignment and locking when connecting the two MPO connectors (male to female). It has a flange and a metal clip for panel mounting and it is included with each FiberExpress bar (1m with male connector).

The 19" (0.48 m) rack mount housing is a 1U metal panel that holds one FiberExpress bar. It has a live hinge on the left-hand side and swings out giving access to the MPO connection and facilitate cable management and slack storage when used with the slack storage tray.

The front cover is a smoked plexiglas cover that protects the fiber cords connected to the FiberExpress bar. It has 2 push rivets for positive locking and easy handling.

The slack storage tray attaches to the back of the 19" (0.48 m) rack mount housing to facilitate cable management and slack storage. It has a storage capacity of 5 meters of 12-fiber ribbon cable. The wall mount enclosure can contain one FiberExpress bar. It is made of heavy gage steel and has a locking cover.

Description	Belden Part Number	
	Multimode, FX300, 62.5 μm	Multimode, FX600, 50.0 μm

#### FiberExpress Pre-Connectorized Assemblies

FiberExpress Bar		
12 ST type, MPO (m), 1 m	AX250001	AX250052
6 SC duplex, MPO (m), 12 fibers, 1 m	AX250005	AX250054
6 MT-RJ, MPO (m), 12 fibers, 1 m	AX250178	AX250179
12 LC, MPO (m), 1 m	AX250539	AX250540
	Multimode, FX2000, 50.0 μm	Single-Mode
12 ST type, MPO (m), 1 m	AX250459	AX250009
6 SC duplex, MPO (m), 12 fibers, 1 m	AX250460	AX250011
6 MT-RJ, MPO (m), 12 fibers, 1 m	AX250461	AX250180
12 LC, MPO (m), 1 m	AX250541	AX250542

Also available for 6 fibers, please contact customer service for more details.

Description	Belden Part Number
FiberExpress Bar Accessories	
MPO Adapter (6 or 12 fibers) included with each FiberExpress Bar (1 m - male)	MX100154
19" (0.48 m) Rack Mount Housing for FiberExpress Bar, Grey	AX100331
19" (0.48 m) Rack Mount Housing for FiberExpress Bar, Black	AX100330
Front Cover for FiberExpress Rack Mount Housing	AX100332
Slack Storage Tray for FiberExpress Bar, (capacity: 5 meters) including top cover, Grey	AX100329
Slack Storage Tray for FiberExpress Bar, (capacity: 5 meters) including top cover, Black	AX100328
Wall Mount Enclosure, can contain one bar, Black	AC200004

These products are in the process of being assessed for RoHS compliance. Please check our website for the most current RoHS status.

# FiberExpress Secure/Keyed LC System

## Optimax® Field Installable Connectors and Patch Cords & Pigtails

AX102197 Secure/keyed LC Optimax®



Secure/keyed LC System



### FiberExpress Secure/Keyed LC System

The FiberExpress secure/keyed LC system allows for physical segregation of network segments in secure fiber cabling infrastructures. All secure/keyed LC products are available with 6 different keying options each carrying a different color to facilitate network administration. The keying detail inside the connector is totally tamper-resistant and cannot be re-produced inside a standard LC connector to violate the network security. All products comply with the FOCIS 10 standard and optical performance exceeds all industry standards for SFF connectors.

The secure/keyed LC Optimax® field installable connectors are available in multimode 50 µm laser-optimized and 62.5 µm fiber versions. They are high-quality connectors that use a ceramic ferrule with a physical contact (PC) polish for multimode connectors.

The secure/keyed LC patch cords and pigtails are offered in multimode 62.5 µm (FX300), 50/125 µm (FX600) and laser-optimized 50/125 µm (FX2000) for the most demanding network performance.

Description	Belden Part Number					
	K1, Red	K2, Green	K3, Yellow	K4, Black	K5, Orange	K6, Blue
<b>FiberExpress Secure/Keyed LC System</b>						
<b>Secure/Keyed LC Optimax**</b>						
Multimode 62.5 µm**	AX102203	AX102204	AX102205	AX102206	AX102207	AX102208
Multimode 50 µm**	AX102197	AX102198	AX102199	AX102200	AX102201	AX102202
<b>Secure/Keyed LC Duplex Patch Cord, KEYx-KEYx*</b>						
2 m (6 ft.), Multimode FX300, 62.5 µm	AX201365	AX201366	AX201367	AX201368	AX201369	AX201370
2 m (6 ft.), Multimode FX600, 50 µm	AX201383	AX201384	AX201385	AX201386	AX201387	AX201388
2 m (6 ft.), Multimode FX2000, 50 µm	AX201401	AX201402	AX201403	AX201404	AX201405	AX201406
3 m (10 ft.), Multimode FX300, 62.5 µm	AX201371	AX201372	AX201373	AX201374	AX201375	AX201376
3 m (10 ft.), Multimode FX600, 50 µm	AX201389	AX201390	AX201391	AX201392	AX201393	AX201394
3 m (10 ft.), Multimode FX2000, 50 µm	AX201407	AX201408	AX201409	AX201410	AX201411	AX201412
5 m (16 ft.), Multimode FX300, 62.5 µm	AX201377	AX201378	AX201379	AX201380	AX201381	AX201382
5 m (16 ft.), Multimode FX600, 50 µm	AX201395	AX201396	AX201397	AX201398	AX201399	AX201400
5 m (16 ft.), Multimode FX2000, 50 µm	AX201413	AX201414	AX201415	AX201416	AX201417	AX201418
<b>Secure/Keyed LC Duplex Hybrid Patch Cord, KEYx-LCD*</b>						
2 m (6 ft.), Multimode FX300, 62.5 µm	AX201419	AX201420	AX201421	AX201422	AX201423	AX201424
2 m (6 ft.), Multimode FX600, 50 µm	AX201437	AX201438	AX201439	AX201440	AX201441	AX201442
2 m (6 ft.), Multimode FX2000, 50 µm	AX201455	AX201456	AX201457	AX201458	AX201459	AX201460
3 m (10 ft.), Multimode FX300, 62.5 µm	AX201425	AX201426	AX201427	AX201428	AX201429	AX201430
3 m (10 ft.), Multimode FX600, 50 µm	AX201443	AX201444	AX201445	AX201446	AX201447	AX201448
3 m (10 ft.), Multimode FX2000, 50 µm	AX201461	AX201462	AX201463	AX201464	AX201465	AX201466
5 m (16 ft.), Multimode FX300, 62.5 µm	AX201431	AX201432	AX201433	AX201434	AX201435	AX201436
5 m (16 ft.), Multimode FX600, 50 µm	AX201449	AX201450	AX201451	AX201452	AX201453	AX201454
5 m (16 ft.), Multimode FX2000, 50 µm	AX201467	AX201468	AX201469	AX201470	AX201471	AX201472
<b>Secure/Keyed LC Duplex Hybrid Patch Cord, KEYx-SCD*</b>						
2 m (6 ft.), Multimode FX300, 62.5 µm	AX201473	AX201474	AX201475	AX201476	AX201477	AX201478
2 m (6 ft.), Multimode FX600, 50 µm	AX201491	AX201492	AX201493	AX201494	AX201495	AX201496
2 m (6 ft.), Multimode FX2000, 50 µm	AX201509	AX201510	AX201511	AX201512	AX201513	AX201514
3 m (10 ft.), Multimode FX300, 62.5 µm	AX201479	AX201480	AX201481	AX201482	AX201483	AX201484
3 m (10 ft.), Multimode FX600, 50 µm	AX201497	AX201498	AX201499	AX201500	AX201501	AX201502
3 m (10 ft.), Multimode FX2000, 50 µm	AX201515	AX201516	AX201517	AX201518	AX201519	AX201520
5 m (16 ft.), Multimode FX300, 62.5 µm	AX201485	AX201486	AX201487	AX201488	AX201489	AX201490
5 m (16 ft.), Multimode FX600, 50 µm	AX201503	AX201504	AX201505	AX201506	AX201507	AX201508
5 m (16 ft.), Multimode FX2000, 50 µm	AX201521	AX201522	AX201523	AX201524	AX201525	AX201526
<b>Secure/Keyed LC Pigtail, KEYx-open*</b>						
2 m (6 ft.), Multimode FX300, 62.5 µm	AX201527	AX201528	AX201529	AX201530	AX201531	AX201532
2 m (6 ft.), Multimode FX600, 50 µm	AX201533	AX201534	AX201535	AX201536	AX201537	AX201538
2 m (6 ft.), Multimode FX2000, 50 µm	AX201539	AX201540	AX201541	AX201542	AX201543	AX201544

These products are in the process of being assessed for RoHS compliance. Please check our website for the most current RoHS status.

\* Patent pending. • \*\* For 900 µm buffered fiber only. The same accessory kit (AX101984) is used for 2 mm jacketed cable connector termination as for our regular Optimax® LC offering.

## FiberExpress Secure/Keyed LC System

### Adapter Modules, Adapter Strips and FiberExpress Manager Modules

AX102098 Secure/keyed LC Adapter Module



#### FiberExpress Secure/Keyed LC System

The FiberExpress secure/keyed LC System allows for physical segregation of network segments in secure fiber cabling infrastructures. All secure/keyed LC products are available with 6 different keying options each carrying a different color to facilitate network administration. The keying detail inside the connector is totally tamper-resistant and cannot be re-produced inside a standard LC connector to violate the network security. All products comply with the FOCIS 10 standard and optical performance exceeds all industry standards for SFF connectors.

The secure/keyed LC adapter modules and adapter strips can be used in all mounting hardware for workstation area, consolidation point or Telecom room applications.

AX102124 Secure/keyed LC Adapter Strip



The secure/keyed LC FiberExpress manager modules can be used in 19" (0.48 m) and 23" (0.58 m) FiberExpress manager shelves to provide a high-density management system of up to 1920 terminated fibers per rack.

AX102114 Secure/keyed LC FiberExpress Manager Module



Description	Belden Part Number					
	K1, Red	K2, Green	K3, Yellow	K4, Black	K5, Orange	K6, Blue
<b>FiberExpress Secure/Keyed LC System</b>						
<b>Secure/Keyed LC Adapter Module*</b>						
Grey holder	AX102089	AX102090	AX102091	AX102092	AX102093	AX102094
Almond holder	AX102095	AX102096	AX102097	AX102098	AX102099	AX102100
White holder	AX102101	AX102102	AX102103	AX102104	AX102105	AX102106
Black holder	AX102107	AX102108	AX102109	AX102110	AX102111	AX102112
<b>Secure/Keyed LC FiberExpress Adapter Strip*</b>						
12 fibers	AX102119	AX102120	AX102121	AX102122	AX102123	AX102124
24 fibers	AX102125	AX102126	AX102127	AX102128	AX102129	AX102130
<b>Secure/Keyed LC FiberExpress Manager Module*</b>						
12 fibers	AX102113	AX102114	AX102115	AX102116	AX102117	AX102118
24 fibers	AX102310	AX102311	AX102312	AX102313	AX102314	AX102315

\* Patent pending.  
 These products are in the process of being assessed for RoHS compliance. Please check our website for the most current RoHS status.

# FiberExpress Manager

## Rack Components and Modules

AX100934  
FiberExpress  
Manager Shelf



### FiberExpress Manager Shelf

FiberExpress modules are rack-mounted using FiberExpress manager shelves. The shelves provide the total system with extra high connection density while facilitating cable routing and patch cord management. For 19" (0.48 m) or 23" (0.58 m) h rack: 19" (0.48 m) shelf holds up to 12 modules; 23" (0.58 m) shelf holds up to 16 modules.

AX101943 FiberExpress  
Manager 1U Rack Mount  
Patch Panel



### FiberExpress Manager 1U

The FiberExpress manager 1U rack mount patch panel is a low-cost, compact assembly designed for interconnection or splicing of optical fiber cables, using up to three FiberExpress manager modules. The low-profile design minimizes rack space to only 45 mm (1.75"). An optional FiberExpress manager 1U cable management accessory is also available.

AX102032 FiberExpress  
Manager 1U Cable  
Management  
Accessory



### FiberExpress Manager Connector Module

The connector module is the basic building block of the FiberExpress manager. It is designed with a unique release mechanism that allows it to slide from the shelf like a PC card, easing management of patch cords.

AX101525 Connector Module  
Pre-terminated  
MPO-MT-RJ

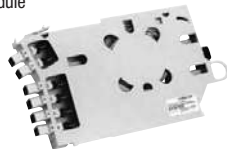

Description	Belden Part Number	
	Grey	Black

### FiberExpress Manager

FiberExpress Manager		
Shelf, 23" (0.58 m), 10.9 kg (24 lbs.)	AX100934	AX100935
Shelf, 19" (0.48 m), 8.2 kg (18 lbs.)	AX101084	AX101085
1U, Rack Mount Patch Panel, 19" (0.48 m), 5 kg (11 lbs.)	AX101944	AX101943
1U, Cable Management Accessory, 19" (0.48 m), 1 kg (2 lbs.)	AX102033	AX102032

Description	Belden Part Number					
	ST Type	SC Simplex	SC Duplex	SC Duplex (ST in)	LC	FC

### FiberExpress Manager

FiberExpress Manager Connector Module						
Metal Sleeve, Multimode, 6 fibers	AX101089	-	AX101092	-	-	-
Zirconia Ceramic, Single-mode, 6 fibers	AX100936	AX100943	AX100944	-	-	-
Metal Sleeve, Multimode, 12 fibers	AX101187	-	AX101714	AX101120	AX101528	-
Zirconia Ceramic, Single-mode, 12 fibers	AX101186	-	AX101713	AX101119	AX101527	-
Zirconia Ceramic, Single-mode, 12 UPC pigtails	-	-	AX101715	-	-	-
Metal Sleeve, Multimode, 24 fibers	-	-	-	-	AX102306	-
Zirconia Ceramic, Single-mode, 24 fibers	-	-	-	-	AX102305	-
Zirconia Ceramic, Single-mode/Multimode, 6 fibers	-	-	-	-	-	AX100937

Description	Belden Part Number			
	Multimode 62.5 µm	Multimode 50.0 µm	Single-Mode	-
MPO(m)-ST type, 12 pre-terminated	AX101189	AX101190	AX101188	-
MPO(m)-SC Duplex, 12 pre-terminated	AX101091	AX101114	AX101090	-
MPO(m)-MT-RJ(m), 12 pre-terminated	AX101525	AX101526	AX101524	-
MPO(m)-LC, 12 pre-terminated	AX101530	AX101531	AX101529	-
MPO(m)-LC, 24 pre-terminated	AX102309	AX102308	AX102307	-
MT-RJ, Beige, Multimode, 12 fibers	-	-	-	AX101096
MT-RJ, Blue, Single-mode, 12 fibers	-	-	-	AX101581

These products are in the process of being assessed for RoHS compliance. Please check our website for the most current RoHS status.



## FiberExpress Patch Panels

### Rack Mount Patch Panels

AX100041 FiberExpress, 12/24 Port (1U) Rack Mount Patch Panel



AX100069 FiberExpress, 24/48 Port (2U) Rack Mount Patch Panel



AX100078 FiberExpress (3U) Rack Mount Patch Panel



AX100115 FiberExpress, 48/96 Port (4U) Rack Mount Patch Panel



If single-ended patch cords are to be spliced to the fiber cable, don't forget to order splice organizer trays or kits. Both these, and the universal adapter strips can be ordered in the FiberExpress accessories section.

\* IMPORTANT: The FiberExpress 1U accepts two (2) 203 mm (8") splice trays. The 2U accepts four (4) 203 mm (8") splice trays.

These products are in the process of being assessed for RoHS compliance. Please check our website for the most current RoHS status.

#### FiberExpress Rack Mount Patch Panel 1U and 2U

The FiberExpress 1U and 2U rack mount patch panels are equipped with a special hinge that allows easy access to the rear of the patch panel without disturbing the optical fiber cable. A specially designed front panel allows connector protection and easy routing of optical fiber patch cords. The FiberExpress rack mount patch panels are also compatible with our 203 mm (8") splice organizer trays. This allows the optical fiber cable to be either terminated with fiber single-ended patch cords or field-installable connectors. The patch panels can be used with ST Compatible, SC, 568SC, FC, LC or MT-RJ adapters strips (ordered separately).

The FiberExpress 1U rack mount patch panel is a low-cost, compact assembly designed for interconnection or splicing of optical fiber cables, from 12 up to 48 fibers if MT-RJ or LC double density adapter strips are used. The low-profile design minimizes rack space to only 45 mm (1.75"). An optional smoked plexiglass front cover is also available.

The FiberExpress 2U rack mount patch panel offers a high fiber capacity, 96 fibers if using double density MT-RJ or LC adapter strips. The FiberExpress 2U comes equipped with a smoked plexiglass front cover that protects fiber connections while allowing for quick visual inspection.

#### FiberExpress Rack Mount Patch Panel 3U

The FiberExpress 3U rack mount patch panel can accommodate up to 96 optical fiber connections using MT-RJ or LC connectors. The connector panel is mounted on a sliding drawer for easy access to the back side (cable side) of the panel. The FiberExpress 3U rack mount patch panel can be used with either optical fiber single-ended patch cords or field-installable connectors. If optical single-ended patch cords are to be used, organizer trays are easily accessible via the removable front access pull-out drawer. (Trays must be ordered separately.)

The FiberExpress 3U rack mount patch panel is a compact cross-connect assembly for the termination of optical fiber cables. The low-profile design minimizes required rack space to 127 mm (5"). It is compatible with ST compatible, SC, 568SC, MT-RJ, LC and FC adapters strips (ordered separately).

#### FiberExpress Rack Mount Patch Panel 4U

The FiberExpress 4U rack mount patch panel is an economical solution for the protection of optical fiber terminations and splices, up to 192 optical fibers if using MT-RJ or LC connectors. The connector panel, accepting the universal adapter strips, is located inside the enclosure and swings out (left or right) to give easy access to the cable and splices.

The FiberExpress 4U rack mount patch panel is a compact cross-connect enclosure for the cross-connection, interconnection or splicing of optical fiber cables. The low-profile design minimizes required rack space to 178 mm (7"). It can be used with ST Compatible, SC, 568SC, MT-RJ, LC and FC adapters strips (ordered separately).

Description	Belden Part Number
<b>FiberExpress Patch Panels</b>	
<b>FiberExpress Rack Mount Patch Panel 1U*</b>	
Grey	AX100042
Black	AX100041
<b>FiberExpress Rack Mount Patch Panel 2U*</b>	
Grey	AX100069
Black	AX100068
<b>FiberExpress Rack Mount Patch Panel 3U</b>	
Grey	AX100078
Black	AX100077
<b>FiberExpress Rack Mount Patch Panel 4U</b>	
Grey	AX100115
Black	AX100116

## FiberExpress Patch Panels

### Rack Mount Accessories and Wall Mount Patch Panels

AX101800 127 mm (5") Universal Offset Bracket Kit, for 19" (0.48 m) and 23" (0.58 m) Racks 1U



AX101802 23" (0.58 m) Rack Universal Extension Bracket for 1U and 2U



AX100047 Right Side Cable Entry Bracket for 1U



AX100045 Front Cover for 1U



AX100543 Large Wall Mount



### FiberExpress Rack Mount Patch Panels 1U and 2U Accessories

The accessories provide additional panel mounting flexibility for racks, cabinets and cable entry.

Description	Belden Part Number
<b>FiberExpress Patch Panels</b>	
<b>Rack Mount Accessories (1U and 2U)</b>	
127 mm (5") Universal Offset Bracket Kit:	
for 19" (0.48 m) and 23" (0.58 m) racks (1U), Black	AX101799
for 19" (0.48 m) and 23" (0.58 m) racks (1U), Grey	AX101800
for 19" (0.48 m) and 23" (0.58 m) racks (2U), Black	AX101797
for 19" (0.48 m) and 23" (0.58 m) racks (2U), Grey	AX101798
23" (0.58 m) Universal extension bracket, Black	AX101801
23" (0.58 m) Universal extension bracket, Grey	AX101802
Right side cable entry bracket (1U), Black	AX100046
Right side cable entry bracket (1U), Grey	AX100047
Right side cable entry bracket (2U), Black	AX100073
Right side cable entry bracket (2U), Grey	AX100074
Front Cover (1U), Smoked Plexiglass	AX100045

### FiberExpress Wall Mount Patch Panel

The FiberExpress wall mount patch panel series is an economical solution for the protection of optical fiber terminations and splices in hostile environments. Using the FiberExpress universal adapter strips (ordered separately), the wall mount patch panels allow for flexible and customized patch panel design. They are compatible with most industry standard connections: ST compatible, SC, 568SC, MT-RJ, LC and FC.

Available in grey and black, the FiberExpress wall mount patch panels have an ergonomic design, rugged construction and compact assemblies to effectively protect your optical fiber terminations and splices.

Description	Belden Part Number
<b>FiberExpress Patch Panels</b>	
<b>Wall Mount</b>	
Small, Grey	AX100496
Small, Black	AX100495
Medium, Grey	AX100541
Medium, Black	AX100540
Large, Grey	AX100543
Large, Black	AX100542

If optical single-ended patch cords are to be spliced to the fiber cable, don't forget to order splice organizer trays or kits in FiberExpress accessories section. Universal adapter strips can be ordered in FiberExpress patch panels section. These products are in the process of being assessed for RoHS compliance. Please check our website for the most current RoHS status.

AX100541 Medium Wall Mount



AX100495 Small Wall Mount





# FiberExpress Patch Panels Accessories

## Universal Optical Fiber Adapter Strips and Accessories

AX101729 Adapters  
loaded with 6 LC Duplex



AX100094 Adapters  
loaded with 3 SC Duplex



AX100066 Blank Strip



AX101100 Field Breakout Kit

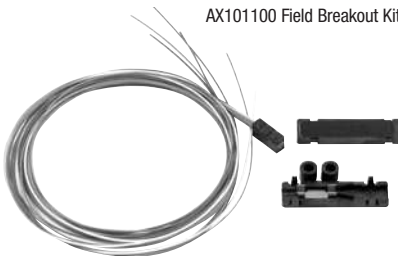

A0649869 Optical Fiber Splice Organizer Kits and Trays

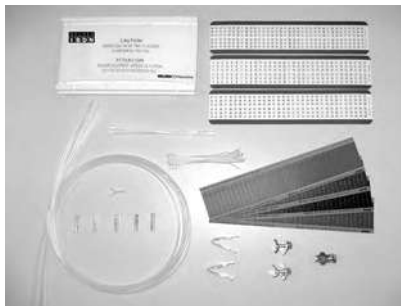

AX100945 Flex Kit



AX101098 Splice Holder Kit

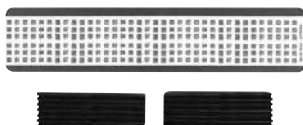

### Optical Fiber Adapter Strips

Universal optical fiber adapter strips are pre-loaded with six (single density) or 12 (double density) adapter sleeves. Two types of adapter sleeves are available: phosphor bronze and zirconia ceramic. Adapter sleeves are used as the connecting interface between two optical fiber connectors. A blank adapter strip is also available and can be used with any FiberExpress patch panel to fill in unused adapter strip openings.

### Optical Fiber Accessories

The field breakout kit is designed to attach to one tube of a loose-tube cable. Each kit has either six or twelve 900 µm tubes that hold each of the coated fibers. For each end of the cable, one kit is needed for every tube. For example, a 12-fiber 62.5 µm cable contains two 6-fiber tubes. This cable would require four kits, two for each end. Optical fiber splice organizer kits provide the accessories necessary for installing the FiberExpress fiber patch panels, as well as other fiber terminals that accommodate the standard Belden organizer tray. The Flex Kit contains tubes and manifolds designed to split cables into individual fiber strands, and is suitable for 6 fibers up to 12 fibers. It is necessary for use with loose tube cables or when the fiber cable count does not match the number of connections in the FiberExpress manager connector module. The Flex Kit tubes help to maintain proper fiber bend radius. One kit is required per 12 modules (one 19"/0.48 m shelf). A splice holder kit can be used to hold fusion or mechanical splices. Each splice holder can handle up to 6 splices.

Description	Belden Part Number	
	Phosphor Bronze, Multimode	Zirconia Ceramic, Single-Mode

### FiberExpress Optical Fiber Adapter Strips

Single Density, Black		
Loaded with 6 ST Compatible Adapters	AX100088	AX100534
Loaded with 3 SC Duplex Adapters	AX100094	AX101407
Loaded with 6 SC Simplex Adapters	AX100092	AX100538
Loaded with 6 FC Adapters	AX100090	AX100536
Loaded with 6 LC Duplex Adapters	AX101729	AX101731
MT-RJ, loaded with 6 MT-RJ, Multimode/Single-mode	AX101115	
Double Density, Black		
Loaded with 12 ST Compatible Adapters	AX100080	AX100528
Loaded with 6 SC Duplex Adapters	AX100098	AX101409
Loaded with 12 SC Simplex Adapters	AX100084	AX100532
Loaded with 12 FC Adapters	AX100082	AX100530
Loaded with 12 LC Duplex Adapters	AX101741	AX101743
MT-RJ, loaded with 12 MT-RJ, Multimode/Single-mode	AX101117	
Blank Strip		
Black	AX100066	

### FiberExpress Accessories

Optical Fiber Field Breakout Kit	
6 fibers, 1/pack	AX101100
12 fibers, 1/pack	AX101101
Optical Fiber Splice Organizer Kit	
Splice kit, tray, 203 mm (8")	A0649869
Splice kit, tray, 305 mm (12")	A0318904
Optical Fiber Splice Tray	
Fusion, 203 mm (8")	A0335015
Fusion, 305 mm (12")	A0316446
Universal (mechanical or fusion), 203 mm (8")	AX100079
Universal (mechanical or fusion), 305 mm (12")	A0394328
Tray cover, 203 mm (8")	A0394331
Tray cover, 305 mm (12")	A0394330
Flex Kit	AX100945
Splice Holder Kit	AX101098

These products are in the process of being assessed for RoHS compliance. Please check our website for the most current RoHS status.

# FiberExpress Outlets

## MediaFlex Plates and Inserts

AX101869 MediaFlex Plate, Double Gang



### MediaFlex Plate

MediaFlex plates are one part of the comprehensive line of plates and inserts that snap together to create a full line of modular workstation outlets. MediaFlex plates can be mounted over standard NEMA type outlet boxes and rings to provide support for a variety of MediaFlex adapters and inserts. The fully modular construction combined with the front access design provides extensive configuration flexibility for current and future network needs. MediaFlex plates are available in single gang and double gang configurations.

The double gang faceplate comes with a stand-off ring included in the package. This ring allows for easy mounting with virtually any industry electrical box or mud/adaptor rings, therefore providing added installation flexibility. Each plate has the capacity of up to 6 ports per single gang and 12 ports per double gang.

AX101874 MediaFlex Adapter Box, Double Gang

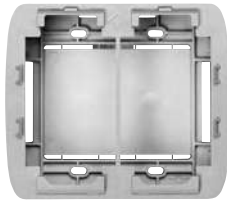

### MediaFlex Adapter Box

MediaFlex surface adapter boxes are one part of the comprehensive line of plates and inserts that snap together to create a full line of modular workstation outlets.

MediaFlex surface adapter boxes can be mounted over standard NEMA type outlet boxes and rings to provide support for the MediaFlex plates. The MediaFlex surface adapter boxes are available as a double gang configuration. The double gang box allows more room for cable management and bend radius control.

AX101756 MediaFlex MDVO (style) Insert, 2-port, Angled



### MediaFlex MDVO (style) Insert

MediaFlex MDVO-style Inserts are available in a 2-port configuration in both Flush and Angled versions. They are compatible with all GigaFlex and MDVO modules (EZ-MDVO and multimedia). The inserts are two units high for the flush version and three units high for the angled version. Therefore three flush inserts or two angled inserts are required to fully populate a single gang MediaFlex plate.

AX101937 MediaFlex SC Duplex Insert, Angled



### MediaFlex Multimedia Insert

MediaFlex multimedia inserts provide optimum flexibility in configuring multimedia workstation outlets that respond to any present or future network needs. MediaFlex multimedia inserts along with other MediaFlex inserts allow for easy configuration of outlets. All inserts are front loaded and easily snapped in and out of the MediaFlex plates for easy installation and maintenance.

MediaFlex multimedia Inserts are available in angled versions only in order to allow for proper management of cable bend radius. The inserts are three units high, therefore two inserts are required to fully populate a single gang faceplate and four inserts will fully populate a double gang faceplate.

Description	Belden Part Number					
	K1, Red	K2, Green	K3, Yellow	K4, Black	K5, Orange	K6, Blue
<b>FiberExpress Outlets</b>						
<b>MediaFlex Plate</b>						
Single Gang	AX101745	AX101746	AX101747	AX101748	AX102608	AX102569
Double Gang	AX101869	AX101870	AX101871	AX101872	AX102609	AX102570
<b>MediaFlex Adapter Box</b>						
Single Gang	AX102480	AX102481	AX102482	AX102483	AX102484	AX102485
Double Gang	AX101873	AX101874	AX101875	AX101876	AX102610	AX102571
<b>MediaFlex MDVO (style) Insert</b>						
2-port, Flush, bag of 10 units	AX101749	AX101750	AX101751	AX101752	AX102612	AX102572
2-port, Angled, bag of 10 units	AX101753	AX101754	AX101755	AX101756	AX102613	AX102573
<b>MediaFlex SC Duplex</b>						
SC Duplex Single-mode	AX101935	AX101936	AX101937	AX101938	AX102619	AX102649
SC Duplex Multimode	AX101939	AX101940	AX101941	AX101942	AX102620	AX102650

These products are in the process of being assessed for RoHS compliance. Please check our website for the most current RoHS status.

## FiberExpress Outlets

### MDVO Multimedia Outlet Boxes & Modules and Multi-User Outlet Boxes

A0643205 MDVO Multimedia Outlet Box, shown here as terminated

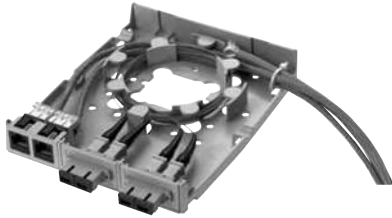

A0407005 MDVO SC Fiber Module



A0649254 SC Duplex Adapter



A0407010 MDVO ST Compatible Fiber Module



AX101467 MDVO MT-RJ Fiber Module

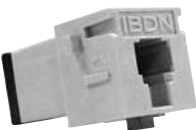

AX100222 Multi-User Outlet Box, shown here with modules



#### MDVO Multimedia Outlet Box

The MDVO multimedia outlet box brings unique versatility for multimedia work area installations. The box design provides cable management and helps maintain cable bend radius. The low-profile design and side-entry of the outlet box offer better protection for patch cords. The outlet box can accept up to six EZ-MDVO, GigaFlex or MDVO multimedia modules or three SC duplex adapters.

The MDVO multimedia outlet box can be mounted directly on the wall or attached to standard electrical boxes. Included with the MDVO multimedia box are three SC duplex mounting bezels and three MDVO adapters.

#### MDVO Multimedia Modules

MDVO multimedia modules address audio/video and fiber applications. Fiber modules are available for LC duplex, SC simplex, ST compatible multimode and MT-RJ multimode & single-mode connections. The SC duplex adapter is a fiber adapter sleeve with flanges that mounts into the SC duplex mounting bezel (included in the MDVO multimedia outlet box). Audio/video modules are available for SVHS, RCA, BNC and Video F connections.

#### Multi-User Outlet Box

The multi-user outlet box is a versatile box that can be used in many different applications. The outlet box can accommodate up to 24 connections of any type, UTP, fiber or coax. The outlet box is ideal for use as a multi-user telecommunications assembly, or simply as a high-density multimedia telecommunications outlet. The multi-user outlet box can also be used as a wall mounted patch panel in confined areas, such as shallow rooms and cabinets.

Description	Belden Part Number			
	MOVO-Style	MOVO-Style	MOVO-Style	Keystone-Style

#### FiberExpress Outlets

MDVO Multimedia Outlet Box				
6-port	A0643205	A0643206	A0643207	A0643208

Please note that SC Duplex adapters must be ordered separately (A0649254).

MDVO Multimedia Module				
LC Duplex Multimode	AX102209	AX102210	AX102211	AX102212
LC Duplex Single-mode	AX102213	AX102214	AX102215	AX102216
SC Simplex, Multimode, Blue insert	A0407003	A0407004	A0407005	A0407006
SC Duplex Adapter, Multimode	-	A0649254	-	-
ST Compatible, Multimode	A0407007	A0407008	A0407009	A0407010
MT-RJ, Multimode	-	AX101467	-	-
MT-RJ, Single-mode, Blue	-	AX101466	-	-

Custom multimedia connectors are also available, please contact customer service for more details.

Multi-User Outlet Box				
24-port	AX100219	AX100220	AX100221	AX100222

These products are in the process of being assessed for RoHS compliance. Please check our website for the most current RoHS status.

## Network Connectivity Products

### Media Converters, Transceivers & Hubs and Network Tester

Media Converters

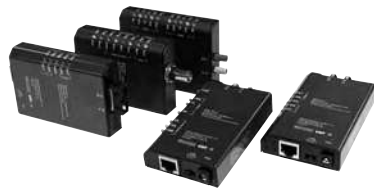

#### Media Converters for Ethernet and Fast Ethernet

Media converters enable the connection of dissimilar network cabling types, while maintaining the same network speed. A legacy thinnet segment can be connected to a 10Base-T Hub or switch port with an AX-200 Converter or, link two different 10Base-T networks together over a multimode fiber optic link with a pair of AX-270s. Connect a legacy thinnet segment over fiber with the AX-280 converter. The AX-5270 can be used for interbuilding links or attached to a fiber backbone.

AX-1912 Media Converter Rack

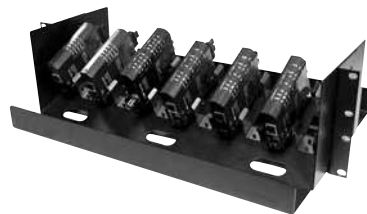

#### Transceivers and Ethernet Hubs

The AX-50, 70 and 80 transceivers enable the connection of a legacy AUI port to 10Base-T, Thinnet, or Fiber Optic media. The transceiver is powered from the host and requires no external power supply. The AX-509 Ethernet Hub has an AUI port which accepts UTP, Fiber Optic or BNC transceivers. Specified for use by many U.S. Government Agencies. Includes a 110v/12v power supply.

AX050, 70 and 80 Transceivers and AX-509 Ethernet Hub



#### Realtime 10/100 Base-TX Ethernet Network Test Unit

The AX-110BT realtime 10/100 Base-TX ethernet network test unit is a cost effective way to quickly determine a network's operating condition. Plug the unit's patch cord into the tester, then into any open RJ-45 jack in an office, cubicle or conference room. Immediately see if the jack is a live network node capable of either 100 Mb/s or 10 Mb/s. Next check patch cord continuity and polarity. Connect the downlink to a PC to check NIC card link, speed and full or half duplex capabilities. Connect the uplink to a hub or switch port to verify link and speed.

AX-110BT Realtime 10/100 Base-TX Ethernet Network Test Unit



Description	Belden Part Number
<b>Network Connectivity Products</b>	
<b>Media Converter</b>	
10Base-T/10Base2, RJ-45 to BNC	AX-200
10Base-T/10Base-FL, RJ-45 to ST-Compatible fiber connectors	AX-270
10Base2/10Base-FL, BNC to ST-Compatible fiber connectors	AX-280
100Base-TX/100Base-FX, SC-Compatible fiber connectors	AX-5270SC
100Base-TX/100Base-FX, ST-Compatible fiber connectors	AX-5270ST
<b>Media Converter Rack</b>	
Holds up to 12 converters and multi lead power supplies, 19" (0.48 m) rack-mount ready	AX-1912-MCR
Power Supply, 4-lead 110v/12v, powers up to 4 converters	AX-270P4U
Power Supply, 8-lead 110v/12v, powers up to 8 converters	AX-270P8U
<b>Transceivers and Ethernet Hubs</b>	
UTP Transceiver, 10Base-T, AUI to RJ-45, side port	AX-50
UTP Transceiver, 10Base-T, AUI to RJ-45, rear port	AX-50R
Fiber Transceiver, 10Base-FL, AUI to ST-Compatible	AX-70
Thinnet Transceiver, 10Base2, AUI to BNC	AX-80
Ethernet Hub with 8 RJ-45 10Base-T ports and 1 AUI port	AX-509
<b>Network Tester</b>	
Realtime 10/100 Base-TX Ethernet Network Test Unit	AX-110BT

These products are in the process of being assessed for RoHS compliance. Please check our website for the most current RoHS status.

## Introduction Cables

### Advanced Networks Need Advanced Technology

Today's advanced networks are diverse and very varied and almost always complex. The right way ahead is to future-proof these networks and take precautions to protect them against anything that will create problems, damage or disrupt. That means matching the right hardware with the right cabling to guarantee performance – and that means choosing fiber optic cable. This type of cable has become essential for bringing light-speed communication to hospitals, corporate campuses, educational facilities and other projects.

### Key Applications

- Closed circuit television
- Network circuitry
- Factory automation
- Major commercial networks
- Video conferencing
- Medical imaging
- CAD/CAM

### Special Features

- **Interconnect Cables**  
Featuring semi-tight buffer and tight buffer technology for easy cable preparation during termination.
    - Semi-tight buffered fiber cables are available in dry or jelly-filled constructions; both have excellent strippability properties ( $\leq 100$  cm).
    - Tight-buffered fiber cables are dry constructions and designed for easy stripping in cable preparation ( $\leq 10$  cm).
  - **Breakout Cables (BO)**  
Breakout cables are the preferred choice for direct termination methods. Each numbered fiber subunit is protected by a layer of aramid yarn and encased in a FRNC/LSNH jacket. The individual subunits are cabled and then jacketed with a flame resistant FRNC/LSNH compound. Each fiber uses either the tight buffer technology or semi-tight buffer technology for excellent fiber stripping.
  - **Belden's Mini-Breakout**  
These cables offer dry constructions with semi-tight or tight buffer technology for easier fiber stripping during cable preparation. They are perfect for both indoor and indoor/outdoor use.
  - **Mobile Fiber Cables**  
Mobile fiber cable is a special cable in the range is Belden's mobile fiber cable. The semi-tight buffer technology is designed for rugged field applications and will withstand temperature extremes and vehicle traffic. Repeating bending is  $> 500000$  times according to IEC 60794-1-2-E6. For indoor use, it has flame retardancy acc. IEC 60332-2.
  - **Central Loose Tube Cables (CLT)**  
Central loose tube cables are designed either for indoor/outdoor application or outdoor use only as direct burial, duct and outside tray. For better performance, Belden only uses (non-dripping and silicone-free) jelly-filled loose tubes. The central loose tube series has a polyethylene or halogen-free jacket. These cables have been updated with a longitudinal watertightness swellable yarn for weather-resistance.
    - Standard and improved rodent protection designs are available with up to 24 fiber counts.
    - Central loose tube cables are also available with Corrugated Steel Tape (CST), Steel Wire Armor (SWA) or Fiber Reinforced Plastic armor (FRP) to protect the whole cable from mechanical damage and rodents.
  - **Multi Loose Tube Cables (MLT)**  
Multi loose tube cables, with no aquagel between the tubes (dry core) or with jelly-filled cable core, are designed for direct burial, duct, outside tray and aerial applications. For better performance, Belden only uses (non dripping and silicone-free) jelly-filled loose tubes. Tubes and (when necessary) blind elements are S-Z stranded around the central element. The multi loose tube series has a High-Density-Polyethylene (HDPE) or halogen-free jacket. These cables have been updated with water-blocking aramid or glass yarn. Standard and improved rodent protection designs are available with high fiber counts up to 432 fibers.
    - The multi loose tube cables are also available either with Corrugated Steel Tape armor (CST) or with galvanized Steel Wire Armor (SWA) for total protection.
    - Longitudinal watertightness: to guarantee longitudinal watertightness acc. to IEC 60793-1-2-F5, Belden uses swellable yarns and/or tapes or filling compound.
- Options:
- All loose tube cables with additional PA (nylon) jacket for termite/rodent protection, improved chemical resistance and reduced friction.
  - Replace PE jacket by Orgalloy to improve chemical resistance.

## Introduction Cables

- **Belden's Universal Cables**

Belden's universal cables provide a unique combination of construction and performance characteristics that make them ideal for both outdoor and indoor use. The advantage is that splicing is not necessary when running cable from outside to inside.

- Because all fibers show surface imperfections, Belden exclusively uses fibers with proof test-level  $\geq 8.8 \text{ N} / \geq 1\%$  ( $\geq 100 \text{ kpsi}$ ). This means the expected life of the optical fiber cable is  $> 30$  years.

- **Belden Halogen-Free Optical Fiber Cables**

This cables meet the most important international standards. The jacketing material is suitable for outdoor use, such as direct burial. Compared with other products containing halogens (such as PVC), Belden halogen-free materials offer considerable advantages in the event of a fire:

- Better vision
- Minimal poisonous gases
- No release of highly caustic acids
- Greater safety for people, materials and the environment

Belden's halogen-free optical fiber cables are both FRNC (Flame-Retardant, Non-Corrosive) and LSNH (Low-Smoke, Non-Halogen) according to recognized standards.

- **Direct Burial Cables**

In general loose tube cables are suitable for direct burial. However, in case of rocky soil armored cables are recommended.

- **Belden Optical Fiber Cables**

All cable constructions are in accordance with IEC 60793, and have been tested according to IEC 60794.

### Rodent Protection

The Belden fiber optic cable line offers two different kind of rodent protection:

- **Standard Rodent Protection**  
Optical fiber cables with glass reinforced yarns for strength also provide normal protection against rodents.
- **Improved Rodent Protection**  
Belden offers cables with improved rodent protection. These have extra glass reinforced yarns or an extra layer of nylon (polyamide). The idea behind this is that rodents will look for the easiest route. Rodents will bite anything in order to keep their teeth in proper shape but will only continue if they feel comfortable. With the nylon layer or "glass" yarns they will normally stop and move elsewhere.

It is important to note that non-armored cable never guarantees a 100% protection against rodents.

Armored cables (CST, SWA, FRP) are heavy rodent protected.

## Introduction Cables

### Guide to Installation and Handling

#### General

When laying and installing optical fiber cables it is vitally important not to exceed the specified values set for pulling tension, bending radii and temperature. The installation methods have to be in accordance with the common standards.

If a cable needs to be fastened, constrictions  $\geq 1$  mm (multi-tube cable) or  $\geq 0.3$  mm (central-tube cable, distribution cable) must be prevented.

#### Outdoor/Universal Cables

It is advisable to cap the cable-ends during outdoor storage.

- **Outdoor/Universal Loose Tube Cables**
  - To ease insertion into tubes by means of compressed air or pulling wire, certified lubricants (e.g. paraffin) may be used. The use of soap or similar substances as lubricants is strictly prohibited.
  - The jelly-filling inside the tubes can be removed using a tissue soaked in turpentine.

#### Indoor Cables

Indoor optical fiber cables have been designed for use inside buildings. Consequently they are not longitudinally watertight.

- **Indoor Interconnection (Simplex, Duplex) Cables**
  - In cable with jelly-filled semi-tight buffered optical fibers the primary and secondary coating are separated by means of a very thin layer of jelly. Consequently the strippability is very good. If necessary the jelly can be removed using a tissue soaked in turpentine, for example.
  - Interconnection optical fiber cables have been designed for short distance applications (tens of meters) inside buildings.
- **Pigtails**  
(Semi-) Tight-buffered optical fibers have been designed for short distance ( $\leq 10$  m) applications

# Introduction Cables

## Part Number Coding (except Plenum Optical Fiber)

1	2	Product	3	Type	4	Construction	5	Quality	6	Fiber Count (mm)	7	Fiber Count
G	A	Messenger figure 8	A	Aramid	A	CLT T12 [1x12]	1	62.5/125-OM1	A	Simplex Duplex 1.6 mm		
	B	Outdoor Dry MLT	B	Breakout	B	CLT T24 [1x24]	2	50/125-OM2	B	Simplex Duplex 1.8 mm		
	C	Universal Dry MLT	C	CST Single sheath	C	MLT T48 [6x8] (helical)	3	50/125-OM3	C	Simplex Duplex 2.0 mm		
	D	Outdoor Filled MLT	D	CST Double Sheath	D	MLT T72 [6x12]	4	50/125-OM2e	D	Simplex Duplex 2.4 mm		
	E	Universal Filled MLT	F	FRP	E	MLT T96 [8x12]	5	50/125-OM2	E	Simplex Duplex 2.8 mm		
	I	Indoor	L	AL/PE Sheath	F	MLT T144 [12x12]	6	50/125-OM3+	F	Simplex Duplex 3.0 mm		
	M	Mobile	M	Mini-Breakout	G	MLT T36 [6x6]	7	9/125-G655	0-9	Part of Fibercount	0-9	Part of Fibercount
	O	Outdoor Dry	O	Pigtail	H	MLT T24 [6x4]	8	9/125-G652D				
	U	Universal Dry	P	Patchcord	I	MLT T192 [8x24]	9	9/125-G652B				
			R	Improved RP	J	MLT T288 [12x24]	0	No Fiber, APF				
			S	Standard RP	K	Semi-Tight (dry)						
			X	Mini-BO+RP	L	MLT T432 [18x24]						
			W	SWA	M	MLT T216 [18x12]						
					S	Semi-Tight (Jelly-Filled)						
					T	Tight						

RP = Rodent Protection • SWA = Galvanised Steel Wire Armor • CST = Corrugated Steel Tape • FRP = Fiber Reinforced Plastic Armor

To specify Part Number

1. Example: GIBT412

1	2	3	4	5	6	7
G	I	B	T	4	1	2
Fiber	Indoor	Breakout	Tight Buffer	50/125-OM2e	12	

2. Example: GDDF744

1	2	3	4	5	6	7
G	D	D	F	7	4	4
Fiber	MLT Outdoor Filled SZ	CST Double Sheat	MLT144 (12x12)	9/125-G655	144	

## Optical Characteristics

European Part Number Coding (position 5)	Fiber-Type	Mode-Field Diameter / Cladding Diameter (µm)	Wavelength (nm)	Dispersion (ps / (nm • km))	PMD (ps / √km)	Cable Cut-off Wavelength (nm)	Refractive Index	Attenuation	
								Loose Tube Cables average/max. (dB / km)	(Semi-) Tight average/max. (dB / km)
<b>Characteristics (Cabled) Single-Mode – Matched-Cladded Optical Fibers according to ITU-G.652</b>									
9	9/125-OS1 ITU-G.652B	9.2 ± 0.4 125 ± 1	1310 1550	≤ 3.5 ≤ 18	≤ 0.2	≤ 1260	1.467 1.467	0.32/0.4 0.21/0.3	0.35/0.5 0.21/0.3
8	9/125-OS1 ITU-G.652D	9.2 ± 0.4 125 ± 0.7	1310 1550	≤ 3.5 ≤ 18	≤ 0.2	≤ 1260	1.467 1.467	0.32/0.4 0.21/0.3	0.35/0.5 0.21/0.3
<b>Characteristics (Cabled) Single-Mode – Matched-Cladded Optical Fibers According to ITU-G.655</b>									
7	9/125	8.4 ± 0.6/125 ± 1	1550	3.5 - 8.5	≤ 0.1 <sup>A</sup>	≤ 1260	1.470	0.25/0.3	0.25/0.28

Note A: Link design value

European Part Number Coding (position 5)	Fiber-Type	Core / Cladding Diameter (µm)	Wavelength (nm)	Bandwidth (MHz • km)	Ethernet Performance (m)		Numerical Aperture (µm)	Refractive Index	Attenuation	
					1GbE	10GbE			Loose Tube Cables average/max. (dB / km)	(Semi-) Tight average/max. (dB / km)
<b>Characteristics (Cabled) Multimode – Graded-Index Optical Fibers According to IEC 60793</b>										
1	62.5/125 OM1	62.5 ± 2.5 125 ± 1	850 1300	≤ 200 ≤ 600	275 550	33 N.A.	0.275 ± 0.015	1.495 1.490	2.7/3.2 0.6/1.1	3.0/3.2 0.7/0.9
5	50.0/125 OM2	50.0 ± 2.5 125 ± 1	850 1300	≤ 500 ≤ 500	600 600	82 N.A.	0.200 ± 0.015	1.481 1.476	2.4/3.0 0.7/1.0	2.6/2.8 0.6/0.9
2	50.0/125 OM2	50.0 ± 2.5 125 ± 1	850 1300	≤ 600 ≤ 1200	600 600	82 N.A.	0.200 ± 0.015	1.481 1.476	2.3/2.8 0.6/0.9	2.6/2.8 0.6/0.9
4	50.0/125 OM2e	50.0 ± 2.5 125 ± 1	850 1300	≤ 600 ≤ 1200	750 2000	110 N.A.	0.200 ± 0.015	1.481 1.476	2.3/2.8 0.6/0.9	2.6/2.8 0.6/0.9
3	50.0/125 OM3	50.0 ± 2.5 125 ± 1	850 1300	≤ 1500 ≤ 500	900 550	300 N.A.	0.200 ± 0.015	1.482 1.477	2.5/3.0 0.5/1.0	2.6/2.8 0.6/0.9
6	50.0/125 OM3+	50.0 ± 2.5 125 ± 1	850 1300	≤ 3500 ≤ 500	900 550	550 N.A.	0.200 ± 0.015	1.482 1.477	2.5/3.0 0.5/1.0	2.6/2.8 0.6/0.9



## Introduction Cables

### Cable Finder Guide Optical Fibers

Part No.	Description	Buffer	Construction	Remarks	Fiber Size $\mu$ m	Application	VDE	Page
----------	-------------	--------	--------------	---------	--------------------	-------------	-----	------

#### Intex, Indoor and Mobile Cables with (Semi-) Tight-Buffered Optical Fibers

Interconnect Cables								
GIOK	Pigtails	Semi-Tight	Dry	Excellent Strippability, LSNH	245	Indoor	I-K	16.25
GIPS	Simplex	Semi-Tight	Jelly-Filled	Excellent Strippability, FRNC/LSNH	245	Indoor	I-W(ZN)H	16.25
GIPS	Simplex, furcation tube	–	Dry	Empty Tube, PUR	–	Indoor	–	16.32
GIPS	Duplex	Semi-Tight	Jelly-Filled	Excellent Strippability, FRNC/LSNH, Figure 8	245	Indoor	I-W(ZN)H	16.26
GIPK	Heavy Duplex	Semi-Tight	Dry	Excellent Strippability, FRNC/LSNH, flat	245	Indoor	I-K(ZN)HH	16.26
GIPT	Mini-Zip	Tight	Dry	FRNC/LSNH, Figure 8	280	Indoor	I-V(ZN)H	16.27
Breakout Cables								
GIBT	2-24 Fibers	Tight	Dry	FRNC/LSNH	280	Indoor	I-V(ZN)HH	16.28
GIBK	2-12 Fibers	Semi-Tight	Dry	FRNC/LSNH	245	Indoor	I-K(ZN)HH	16.28
Mini-Breakout Cables (Distribution)								
GIMT	2-24 Fibers	Tight	Dry	FRNC/LSNH	280	Indoor	I-V(ZN)H	16.29
GIMK	2-8 Fibers	Semi-Tight	Dry	FRNC/LSNH	245	Indoor	I-K(ZN)H	16.29
GUMT	4-24 Fibers	Tight	Dry	FRNC/LSNH	280	In/Outdoor	A/I-VQ(ZN)H	16.30
GUXT	4-24 Fibers	Tight	Dry	FRNC/LSNH, Improved Rodent Protection	280	In/Outdoor	A/I-VQ(ZN)BH	16.31
GMMT	4-8 Fibers	Tight	Dry	Intex Mobile, PUR	280	In/Outdoor	A/I-VQ(ZN)11Y	16.32

#### Universal and Outdoor Cables with Loose Tubes

Central Loose Tube Cables (CLT)								
GOSA	2-12 Fibers	–	Dry	PE, Standard Rodent Protection	250	Outdoor	A-DQ(ZN)2Y	16.33
GOSB	2-24 Fibers	–	Dry	PE, Standard Rodent Protection	250	Outdoor	A-DQ(ZN)2Y	16.33
GORA	2-12 Fibers	–	Dry	PE, Improved Rodent Protection	250	Outdoor	A-DQ(ZN)B2Y	16.34
GORB	2-24 Fibers	–	Dry	PE, Improved Rodent Protection	250	Outdoor	A-DQ(ZN)B2Y	16.34
GOFB	2-24 Fibers	–	Dry	PE, Full Rodent Protection, Armored (FRP)	250	Outdoor	A-DQB2Y (FRP1.0)	16.35
GOWB	2-24 Fibers	–	Dry	Double PE, Full Rodent Protection, Armored (SWA)	250	Outdoor	A-DQ(ZN)2YB2Y (R0.63vzk)	16.35
GOCB	2-24 Fibers	–	Dry	PE, Full Rodent Protection, Armored (CST)	250	Outdoor	A-DQ(ZN)(SR)2Y	16.36
GODA	2-12 Fibers	–	Dry	Double PE, Full Rodent Protection, Armored (CST)	250	Outdoor	A-DQ(ZN)2Y(SR)2Y	16.36
GODB	2-24 Fibers	–	Dry	Double PE, Full Rodent Protection, Armored (CST)	250	Outdoor	A-DQ(ZN)2Y(SR)2Y	16.36
GUSA	2-12 Fibers	–	Dry	FRNC/LSNH, Standard Rodent Protection	250	In/Outdoor	A/I-DQ(ZN)H	16.37
GUSB	2-24 Fibers	–	Dry	FRNC/LSNH, Standard Rodent Protection	250	In/Outdoor	A/I-DQ(ZN)H	16.37
GURA	2-12 Fibers	–	Dry	FRNC/LSNH, Improved Rodent Protection	250	In/Outdoor	A/I-DQ(ZN)BH	16.38
GURB	2-24 Fibers	–	Dry	FRNC/LSNH, Improved Rodent Protection	250	In/Outdoor	A/I-DQ(ZN)BH	16.38
GUCB	2-24 Fibers	–	Dry	FRNC/LSNH, Full Rodent Protection, Armored (CST)	250	In/Outdoor	A/I-DQ(ZN)(SR)H	16.39
GUWB	2-24 Fibers	–	Dry	Double FRNC/LSNH, Full RP, Armored (SWA)	250	In/Outdoor	A/I-DQ(ZN)HBH (R0.63vzk)	16.40
GUDA	2-12 Fibers	–	Dry	Double FRNC/LSNH, Full RP, Armored (CST)	250	In/Outdoor	A/I-DQ(ZN)H(SR)H	16.39
GUDB	2-24 Fibers	–	Dry	Double FRNC/LSNH, Full RP, Armored (CST)	250	In/Outdoor	A/I-DQ(ZN)H(SR)H	16.39
Multi Loose Tube Cables (MLT)								
GBA	4-432 Fibers	–	Dry	HDPE	250	Outdoor	A-DQ(ZN)2Y	16.41
GDA	4-432 Fibers	–	Filled	HDPE	250	Outdoor	A-DF(ZN)2Y	16.42
GBR	4-432 Fibers	–	Dry	HDPE, Improved Rodent Protection	250	Outdoor	A-DQ(ZN)B2Y	16.43
GDR	4-432 Fibers	–	Filled	HDPE, Improved Rodent Protection	250	Outdoor	A-DF(ZN)B2Y	16.44
GBD	4-432 Fibers	–	Dry	HDPE, Full Rodent Protection, Armored (CST)	250	Outdoor	A-DQ(ZN)2Y(SR)2Y	16.45
GDD	4-432 Fibers	–	Filled	HDPE, Full Rodent Protection, Armored (CST)	250	Outdoor	A-DF(ZN)2Y(SR)2Y	16.46
GBW	4-432 Fibers	–	Dry	HDPE, Full Rodent Protection, Armored (SWA)	250	Outdoor	A-DQ2YB2Y (R1.0vzk)	16.47
GDW	4-432 Fibers	–	Filled	HDPE, Full Rodent Protection, Armored (SWA)	250	Outdoor	A-DF2YB2Y (R1.0vzk)	16.48
GALH	4-24 Fibers	–	Filled	PE, Steel Wire Messenger, Figure 8	250	Aerial-Outdoor	A-DSF(L)2YT	16.49
GALD	12-72 Fibers	–	Filled	PE, Steel Wire Messenger, Figure 8	250	Aerial-Outdoor	A-DSF(L)2YT	16.49
GAAD	12-72 Fibers	–	Filled	PE, Dielectric Messenger, Figure 8	250	Aerial-Outdoor	A-DF(ZN)2YT	16.50
GCA	4-432 Fibers	–	Dry	LSZH	250	In/Outdoor	A/I-DQ(ZN)H	16.51
GEA	4-432 Fibers	–	Filled	LSZH	250	In/Outdoor	A/I-DF(ZN)H	16.52
GCR	4-432 Fibers	–	Dry	LSZH, Improved Rodent Protection	250	In/Outdoor	A/I-DQ(ZN)BH	16.53
GER	4-432 Fibers	–	Filled	LSZH, Improved Rodent Protection	250	In/Outdoor	A/I-DF(ZN)BH	16.54
GCD	4-432 Fibers	–	Dry	LSZH, Full Rodent Protection, Armored (CST)	250	In/Outdoor	A/I-DQ(ZN)H(SR)H	16.55
GED	4-432 Fibers	–	Filled	LSZH, Full Rodent Protection, Armored (CST)	250	In/Outdoor	A/I-DF(ZN)H(SR)H	16.56
GCW	4-432 Fibers	–	Dry	LSZH, Full Rodent Protection, Armored (SWA)	250	In/Outdoor	A/I-DQHBH (R1.0vzk)	16.57
GEW	4-432 Fibers	–	Filled	LSZH, Full Rodent Protection, Armored (SWA)	250	In/Outdoor	A/I-DFHBH (R1.0vzk)	16.58

# Introduction Cables

## Color Codes

### Interconnect Cables

Fiber No.	Color (Sec. Coating)
SM 9/125	Yellow
MM 50/125	Green
MM 62.5/125	Blue

### Breakout Cables

Fiber No.	Color (Sub-unit Jacket)
1-24 (MM)	Orange
1-24 (SM)	Yellow

### Mini-Breakout Cables

Fiber No.	Color (Sec. Coating)
1	White
2	Red
3	Blue
4	Yellow
5	Green
6	Violet
7	Brown
8	Black
9	Orange
10	Turquoise
11	Pink
12	Grey

Fiber No.	Color (Prim. Coating*)
13	White
14	Red
15	Blue
16	Yellow
17	Green
18	Violet
19	Brown
20	Black
21	Orange
22	Turquoise
23	Pink
24	Grey

\* secondary coating is transparent

### Central Loose Tube Cables\*

Fiber No.	Color
1	Red
2	Green
3	Blue
4	Yellow
5	White
6	Grey
7	Brown
8	Violet
9	Turquoise
10	Black
11	Orange
12	Pink

Fiber No.	Color
13	Red/Black
14	Green/Black
15	Blue/Black
16	Yellow/Black
17	White/Black
18	Grey/Black
19	Brown/Black
20	Violet/Black
21	Turquoise/Black
22	Natural/Black
23	Orange/Black
24	Pink/Black

\* fiber color code according to IEC 60304; different color coding available on request

### Multi Loose Tube Cables\*

Fiber No.	Color
1	Red
2	Green
3	Blue
4	Yellow
5	White
6	Grey
7	Brown
8	Violet
9	Turquoise
10	Black
11	Orange
12	Pink

Fiber No.	Color
13	Red/Black
14	Green/Black
15	Blue/Black
16	Yellow/Black
17	White/Black
18	Grey/Black
19	Brown/Black
20	Violet/Black
21	Turquoise/Black
22	Natural/Black
23	Orange/Black
24	Pink/Black

\* fiber color code according to IEC 60304; different color coding available on request

### Color Code Tubes

Tube No.	Color
1	Red
2	Green
Rest	White

## Introduction Cables

### Cable Selection Guide Plenum

#### Optical Fiber Selection

Type	Grade	Fiber Size (μ)	Standards Compliance	Link Length (m)	Data Rate (Gb)
Multimode	6	50/125	exceeds TIA/EIA-568-B.3-1 ISO 11801 OM3	500	10
	5	50/125	TIA/EIA-568-B.3-1 ISO 11801 OM3	300	10
	4	50/125	TIA/EIA-568-B.3	600	1
	3	62.5/125	TIA/EIA-568-B.3	1000	1
	2	62.5/125	TIA/EIA-568-B.3	550	1
	1*	62.5/125	FDDI grade †	–	–
Single-mode	–	–	ITU G.652.c/d ††	–	–

\* Grade 1 fibers are available upon request.

† Used in most current cable plants, but not recommended for future installations, except as patch cordage.

†† Low water peak fiber with advantages for CWDM applications.

#### Color Code Charts

##### Jacket Color Chart

Cable Type	Jacket Color
Loose Tube & Outside Plant Cables	Black
Industrial Tray Cables	Orange
Tight-Buffered Cables	
Grades 2, 3, 4	Orange
Grades 5, 6	Aqua
Single-mode	Yellow

Nonstandard jacket colors are available upon request.

##### Fiber Sub-Unit Color Code Chart\*

Fiber/Tube No.	Color	Fiber/Tube No.	Color
1	Blue	7	Red
2	Orange	8	Black
3	Green	9	Yellow
4	Brown	10	Violet
5	Slate	11	Rose
6	White	12	Aqua

\* Per EIA/TIA 598-A

#### Optical Specifications

Grade:	2	3	4	5	6	Single-Mode Enhanced <sup>6</sup>
Glass Type:	62.5/125 μ	62.5/125 μ	50/125 μ	50/125 μ	50/125μ	
Operating Wavelength (nm)	850/1300	850/1300	850/1300	850/1300	850/1300	1310/1550
Min. OFL <sup>1</sup> Bandwidth (MHz-km)	200/500	200/500	500/500	1500/500	3000/500	–
Min. Laser <sup>2</sup> Bandwidth (MHz-km)	220/500	385/500	510/500	2000/500	4000/500	–
Max. Attenuation Loose Tube (dB/km)	3.25/1.0	3.25/1.0	3.0/1.0	3.0/1.0	3.0/1.0	0.40/0.30
Max. Attenuation Tight-Buffered <sup>3</sup> (dB/km)	3.50/1.25	3.50/1.25	3.50/1.25	3.50/1.25	3.50/1.25	0.80/0.50
100 Mb Fast Ethernet Min. Link Length (meters S/L <sup>4</sup> )	300/2000	300/2000	300/2000	300/2000	300/2000	–/5000
1 Gb Ethernet Min. Link Length (meters S/L <sup>4</sup> )	300/550	500/1000	600/600	1000 <sup>5</sup> /600	1000 <sup>5</sup> /600	–/5000
10 Gb Ethernet Min. Link Length (meters S/L <sup>4</sup> )	35/300	35/300	85/300	300/300	500/300	–/10000

<sup>1</sup> OFL = Overfilled launch

<sup>2</sup> Effective modal bandwidth, determined by RML or DMD performance specifications

<sup>3</sup> Max. attenuation for tight-buffered, ribbon, micro-loose tube and loose tube plenum cables

<sup>4</sup> S/L = Short wavelength (850 nm)/Long wavelength (1310 nm)

<sup>5</sup> > 2000 meters for engineered links

<sup>6</sup> Low water peak single-mode suitable for CWDM use complies with ITU G.652.c/d

#### Availability

Many of these are available off the shelf from distributors. If you have a new or unusual application or you cannot find a fiber cable in this catalog section that meets your technical requirements contact technical support at +31-77-3875-414 or techsupport.venlo@belden.com.

# Interconnect Cables

## Indoor

De- scription	Part No.	No. of Fibers	Standard Lengths		Standard Unit Weight		Fiber Size µm	Nom. Buffer/ Tube OD		Strength Members	Nominal OD		Central Element mm	Pulling Tension N	Crush Re- sistance kN/m	Energy kJ/m	Bending radii cable (mm)	
			ft.	m	lbs.	kg		inch	mm		inch	mm					static	dyna- mic

**GIOK • Pigtails • Semi-Tight Buffer • Excellent Strippability • I-K**

<b>Dry Construction • Halogen-Free Jacket</b> (Blue, Green, Green with Black Rings or Yellow)																		
-30/70°C	IEC 60332-2	6888	2100	3.1	1.4	Ø 245 ± 10				-			no	3	4	19		



<b>GIOK101</b>	1	62.5/125 OM1 in Blue										0.04	0.9	25	35
<b>GIOK201</b>	1	50/125 OM2 in Green										0.04	0.9	25	35
<b>GIOK301</b>	1	50/125 OM3 in Green with Black rings										0.04	0.9	25	35
<b>GIOK401</b>	1	50/125 OM2e in Green										0.04	0.9	25	35
<b>GIOK901</b>	1	9/125 OS1 in Yellow										0.04	0.9	25	35

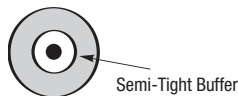

Strippability secondary coating = 100 cm

**GIPS • Simplex • Semi-Tight Buffer • Excellent Strippability • I-W(ZN)H**

<b>Jelly-Filled Construction • Orange FRNC/LSNH Jacket</b>																		
-5/55°C	IEC 60332-1	6888	2100	32.9	14.9	Ø 245 ± 10				Reinforced Aramid Yarn			no	200	10	128		



<b>GIPSxA1</b>																		0.06	1.6	24	32	
<b>GIPSxB1</b>																			0.07	1.8	27	36
<b>GIPSxC1</b>																			0.08	2.0	30	40
<b>GIPSxD1</b>																			0.09	2.4	36	48
<b>GIPSxE1</b>																			0.11	2.8	42	56
<b>GIPSxF1</b>																			0.12	3.0	45	60

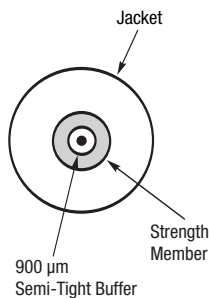

Strippability secondary coating = 100 cm  
Color Code: see chart page 16.23

Optical characteristics see page 16.21.

# Interconnect Cables

## Indoor

De- scription	Part No.	No. of Fibers	Standard Lengths		Standard Unit Weight		Fiber Size µm	Nom. Buffer/ Tube OD		Strength Members	Nominal OD		Central Element mm	Pulling Tension N	Crush Re- sistance kN/m	Energy kJ/m	Bending Radii Cable (mm)	
			ft.	m	lbs.	kg		inch	mm		inch	mm					static	dyna- mic

**GIPS • Duplex • Figure 8 • Semi-Tight Buffer • Excellent Strippability • I-W(ZN)H**

Jelly-Filled Construction • Orange FRNC/LSNH Jacket																		
-5/55°C	IEC 60332-1		6888	2100	65.3	29.6	∅ 245 ± 10		Reinforced Aramid Yarn		no	400	20	256				

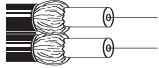

GIPSxA2											0.13	3.3					33	50
GIPSxB2											0.15	3.7					37	56
GIPSxC2											0.16	4.1					41	62
GIPSxD2											0.19	4.9					49	74
GIPSxE2											0.22	5.7					57	86
GIPSxF2											0.24	6.1					61	92

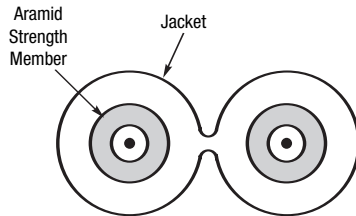

Strippability secondary coating = 100 cm  
Color Code: see chart page 16.23

**GIPK • Heavy Duplex • Semi-Tight Buffer • Excellent Strippability • I-K(ZN)HH**

Dry Construction • Orange FRNC/LSNH Jacket																		
-5/55°C	IEC 60332-1		6888	2100	115.3	52.3	∅ 245 ± 10		Reinforced Aramid Yarn		no	400	20	256				

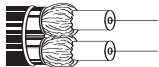

GIPKxA2											0.17	4.3					43	65
GIPKxB2											0.19	4.7					47	71
GIPKxC2											0.20	5.1					51	77
GIPKxD2											0.23	5.9					59	89
GIPKxE2											0.26	6.7					67	101
GIPKxF2											0.28	7.1					71	107

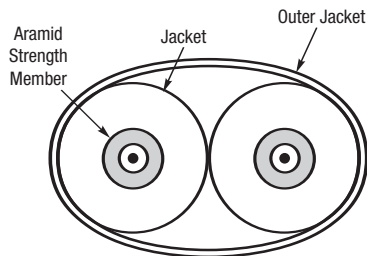

Strippability secondary coating = 100 cm  
Color Code: see chart page 16.23

Optical characteristics see page 16.21.

# Interconnect Cables

## Indoor

De- scription	Part No.	No. of Fibers	Standard Lengths		Standard Unit Weight		Fiber Size μm	Nom. Buffer/ Tube OD		Strength Members	Nominal OD		Central Element mm	Pulling Tension N	Crush Re- sistance kN/m	Energy kJ/m	Bending Radii Cable (mm)	
			ft.	m	lbs.	kg		inch	mm		inch	mm					static	dyna- mic

**GIPT • Mini-Zip • Figure 8 • Tight Buffer • I-V(ZN)H**

Dry Construction • Orange FRNC/LSNH Jacket																		
-30/70°C	IEC 60332-1		6888	2100	26.4	12.0	Ø 280 ± 15			Reinforced Aramid Yarn			no	400	20	19		

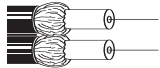

GIPTxA2											0.13	3.4					34	51
GIPTxB2											0.15	3.9					39	58

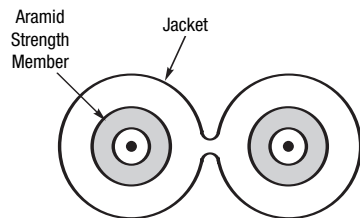

Color Code: see chart page 16.23

Optical characteristics see page 16.21.

# Breakout Cables

## Indoor

De- scription	Part No.	No. of Fibers	Standard Lengths		Standard Unit Weight		Fiber Size µm	Nom. Buffer/ Tube OD		Strength Members	Nominal OD		Central Element mm	Pulling Tension N	Crush Re- sistance kN/m	Energy kJ/m	Bending Radii Cable (mm)	
			ft.	m	lbs.	kg		inch	mm		inch	mm					static	dyna- mic

**GIBT • Tight Buffer • With Rip Cord • I-V(ZN)HH**

**Dry Construction • Orange FRNC/LSNH Jacket**

-5/55°C	IEC 60332-1	6888	2100			Ø 280 ± 15			Reinforced Aramid Yarn	0.08	2.1	Filler						
---------	-------------	------	------	--	--	------------	--	--	---------------------------	------	-----	--------	--	--	--	--	--	--

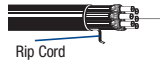

<b>GIBT</b> x02	2			115.7	52.5				2 + 2 BE	0.21	5.3		400	7.5	379	53	80
<b>GIBT</b> x04	4			143.5	65.1				CE + 4	0.24	6.2		400	7.5	507	62	93
<b>GIBT</b> x06	6			273.1	123.9				CE + 6	0.31	8.0		600	7.5	928	80	120
<b>GIBT</b> x08	8			356.5	161.7				CE + 8	0.37	9.4		800	7.5	1235	94	141
<b>GIBT</b> x12	12			402.8	182.7				3 + 9	0.41	10.5		1200	7.5	1424	105	158
<b>GIBT</b> x24	24			810.2	367.5				2 + 8 + 14	0.56	14.3		2400	7.5	2677	143	215

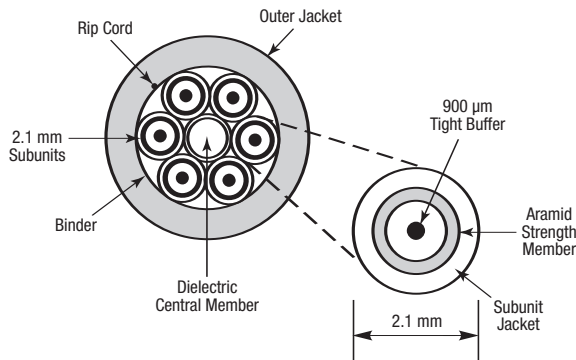

Color Code: see chart page 16.23

**GIBK • Semi-Tight Buffer • With Rip Cord • Excellent Strippability • I-K(ZN)HH**

**Dry Construction • Orange FRNC/LSNH Jacket**

-5/55°C	IEC 60332-1	6888	2100	115.3	52.3	Ø 245 ± 10			Reinforced Aramid Yarn	0.10	2.5	Filler					
---------	-------------	------	------	-------	------	------------	--	--	---------------------------	------	-----	--------	--	--	--	--	--



<b>GIBK</b> x02	2			120.4	54.6				Flat		6.30 x 3.8		400	7.5	382	-	-
<b>GIBK</b> x04	4			185.2	84.0				CE + 4	0.28	7.2		400	7.5	607	72	108
<b>GIBK</b> x06	6			338.0	153.3				CE + 6	0.37	9.4		600	7.5	1124	94	141
<b>GIBK</b> x08	8			430.6	195.3				CE + 8	0.43	10.9		800	7.5	1450	109	164
<b>GIBK</b> x12	12			513.9	233.1				3 + 9	0.46	11.8		1200	7.5	1675	118	177

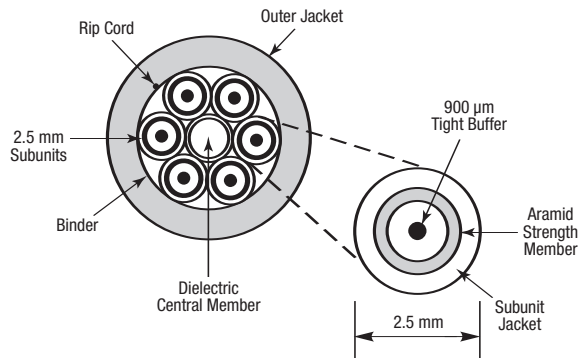

Color Code: see chart page 16.23

Optical characteristics see page 16.21.



For more information, contact Belden Technical Support +31-77-3875-414 • www.belden-emea.com

# Mini-Breakout Cables (Distribution)

Indoor

De- scription	Part No.	No. of Fibers	Standard Lengths		Standard Unit Weight		Fiber Size μm	Nom. Buffer/ Tube OD		Strength Members	Nominal OD		Central Element mm	Pulling Tension N	Crush Re- sistance kN/m	Energy kJ/m	Bending Radii Cable (mm)	
			ft.	m	lbs.	kg		inch	mm		inch	mm					static	dyna- mic

**GIMT • Tight Buffer • I-V(ZN)H**

**Dry Construction • Orange FRNC /LSNH Jacket**

-5/55°C	IEC 60332-2	6888	2100			Ø 280 ± 15			Reinforced Aramid Yarn		no			4				
---------	-------------	------	------	--	--	------------	--	--	---------------------------	--	----	--	--	---	--	--	--	--

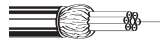

<b>GIMT</b> x02	2			74.1	33.5						0.16	4.0		400		227	40	60
<b>GIMT</b> x04	4			88.0	39.9						0.19	4.8		400		294	48	72
<b>GIMT</b> x06	6			106.5	48.3						0.21	5.3		450		339	53	80
<b>GIMT</b> x08	8			115.7	52.5						0.21	5.3		450		351	53	80
<b>GIMT</b> x12	12			185.2	84.0						0.28	7.0		500		619	70	105
<b>GIMT</b> x16	16			226.9	102.9						0.31	8.0		500		886	80	120
<b>GIMT</b> x24	24			263.9	119.7						0.35	9.0		600		1044	90	135

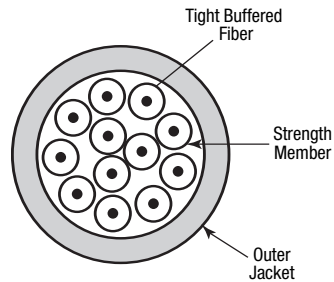

Available in multimode only.  
Color Code: see chart page 16.23

**GIMK • Semi-Tight Buffer • I-K(ZN)H**

**Dry Construction • Orange FRNC /LSNH Jacket**

-5/55°C	IEC 60332-2	6888	2100			Ø 245 ± 10			Reinforced Aramid Yarn		no			4				
---------	-------------	------	------	--	--	------------	--	--	---------------------------	--	----	--	--	---	--	--	--	--

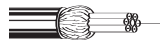

<b>GIMK</b> x02	2			88.0	39.9						0.16	4.0		400		235	40	60
<b>GIMK</b> x04	4			92.6	42.0						0.19	4.8		400		310	48	72
<b>GIMK</b> x06	6			106.5	48.3						0.21	5.3		450		339	53	80
<b>GIMK</b> x08	8			120.4	54.6						0.21	5.3		450		381	53	80

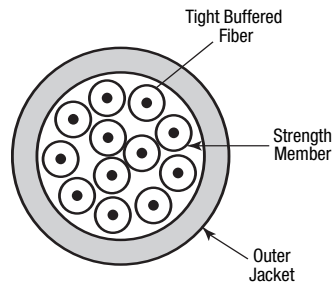

Available in multimode only.  
Color Code: see chart page 16.23

Optical characteristics see page 16.21.





### Mini-Breakout Cables (Distribution)

Universal – Indoor/Outdoor, Standard Rodent Protection

De- scription	Part No.	No. of Fibers	Standard Lengths		Standard Unit Weight		Fiber Size µm	Nom. Buffer/ Tube OD		Strength Members	Nominal OD		Central Element mm	Pulling Tension N	Crush Re- sistance kN/m	Energy kJ/m	Bending Radii Cable (mm)	
			ft.	m	lbs.	kg		inch	mm		inch	mm					static	dyna- mic

**GUMT • Tight Buffer • A/I-VQ(ZN)H**

**Dry Construction • Orange FRNC/LSNH Jacket**

-30/70°C	IEC 60332-2	6888	2100			∅ 280 ± 15				Longitudinal watertightness Swellable Glass Yarn (6)			no		4			
----------	-------------	------	------	--	--	------------	--	--	--	---	--	--	----	--	---	--	--	--

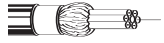

<b>GUMTx04</b>	4			120.4	54.6						0.21	5.4		400		296	54	81
<b>GUMTx06</b>	6			138.0	63.0						0.23	5.9		450		347	59	89
<b>GUMTx08</b>	8			148.1	67.2						0.23	5.9		450		371	59	89
<b>GUMTx12</b>	12			208.3	94.5						0.30	7.6		500		622	76	114
<b>GUMTx16</b>	16			245.4	111.3						0.34	8.6		500		845	86	129
<b>GUMTx24</b>	24			300.9	136.5						0.38	9.6		600		1082	96	144

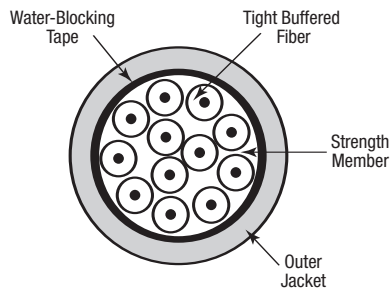

Color Code: see chart page 16.23

Optical characteristics see page 16.21.

### Mini-Breakout Cables (Distribution)

Universal – Indoor/Outdoor, Improved Rodent Protection

De- scription	Part No.	No. of Fibers	Standard Lengths		Standard Unit Weight		Fiber Size µm	Nom. Buffer/ Tube OD		Strength Members	Nominal OD		Central Element mm	Pulling Tension N	Crush Re- sistance kN/m	Energy kJ/m	Bending Radii Cable (mm)	
			ft.	m	lbs.	kg		inch	mm		inch	mm					static	dyna- mic

**GUXT • Tight Buffer • A/I-VQ(ZN)BH**

**Dry Construction • Orange FRNC/LSNH Jacket**

-30/70°C IEC 60332-2	6888	2100					Ø 280 ± 15			Longitudinal watertightness Swellable Glass Yarn			no		4			
----------------------	------	------	--	--	--	--	------------	--	--	---	--	--	----	--	---	--	--	--

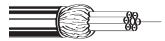

<b>GUXTx04</b>	4			203.7	92.4						0.28	7.0		2000		375	70	105
<b>GUXTx06</b>	6			236.1	107.1						0.29	7.3		2000		445	73	110
<b>GUXTx08</b>	8			259.3	117.6						0.29	7.3		2000		472	73	110
<b>GUXTx12</b>	12			351.9	159.6						0.37	9.4		3000		801	94	141
<b>GUXTx24</b>	24			560.2	254.1						0.42	10.6		4000		1243	106	159

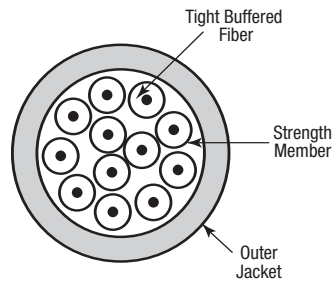

Color Code: see chart page 16.23

Optical characteristics see page 16.21.

### Mini-Breakout Cables (Distribution)

Special – Indoor/Outdoor

De- scription	Part No.	No. of Fibers	Standard Lengths		Standard Unit Weight		Fiber Size µm	Nom. Buffer/ Tube OD		Strength Members	Nominal OD		Central Element mm	Pulling Tension N	Crush Re- sistance kN/m	Energy kJ/m	Bending Radii Cable (mm)	
			ft.	m	lbs.	kg		inch	mm		inch	mm					static	dyna- mic

**GMMT • Intex Mobile • Tight Buffer • Designed for Despooling and Respooling • A/I-VQ(ZN)11Y**

**Dry Construction • PUR Jacket (Orange or Black)**

-30/70°C	IEC 60332-1	6888	2100			∅ 280 ± 15				Longitudinal watertightness Swellable Glass Yarn			no					
----------	-------------	------	------	--	--	------------	--	--	--	---	--	--	----	--	--	--	--	--

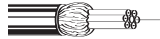

GMMTx04	4			143.5	65.1						0.23	5.8		800	4	580	58	87
GMMTx06	6			175.9	79.8						0.25	6.3		950	4	725	63	95
GMMTx08	8			217.6	98.7						0.28	7.0		1100	4	890	70	105

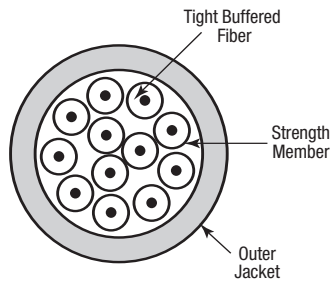

Color Code: see chart page 16.23

Optical characteristics see page 16.21.

### Breakout Kit Cables

Universal – Indoor/Outdoor

De- scription	Part No.	No. of Fibers	Standard Lengths		Standard Unit Weight		Fiber Size µm	Nom. Buffer/ Tube OD		Strength Members	Nominal OD		Central Element mm	Pulling Tension N	Crush Re- sistance kN/m	Energy kJ/m	Bending radii cable (mm)	
			ft.	m	lbs.	kg		inch	mm		inch	mm					static	dyna- mic

**GIPS • Simplex • With Furcation Tube (no Fiber)**

**Dry Construction • Orange PUR Jacket**

-5/55°C	IEC 60332-2	6888	2100	42.5	19.3					Reinforced Aramid Yarn	0.11	2.8	no	110	-	128	28	42
---------	-------------	------	------	------	------	--	--	--	--	---------------------------	------	-----	----	-----	---	-----	----	----

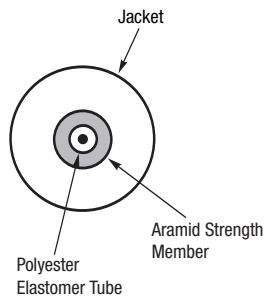

Color Code: see chart page 16.23

# Central Loose Tube Cables

## Outdoor – Standard Rodent Protection

De- scription	Part No.	No. of Fibers	Standard Lengths		Standard Unit Weight		Fiber Size µm	Nom. Buffer/ Tube OD		Strength Members	Nominal OD		Central Element mm	Pulling Tension N	Crush Re- sistance kN/m	Energy kJ/m	Bending Radii Cable (mm)	
			ft.	m	lbs.	kg		inch	mm		inch	mm					static	dyna- mic

**GOSA • Loose Tube (Jelly-Filled, Non-Dripping and Silicone-Free) • Longitudinal Watertightness • A-DQ(ZN)2Y**

<b>Dry Construction • Black PE (UV-resistant) Jacket</b>																		
-30/70°C			13448	4100	334.4	151.7	Ø 250 ± 15	0.13	3.2	Longitudinal watertightness Swellable Glass Yarn (6)	0.23	5.8	no	700	10	-	58	87



- GOSAx02 2
- GOSAx04 4
- GOSAx06 6
- GOSAx08 8
- GOSAx12 12

Color Code: see chart page 16.23

**GOSB • Loose Tube (Jelly-Filled, Non-Dripping and Silicone-Free) • Longitudinal Watertightness • A-DQ(ZN)2Y**

<b>Dry Construction • Black PE (UV-resistant) Jacket</b>																		
-30/70°C			6888	2100	305.6	138.6	Ø 250 ± 15	0.17	4.2	Longitudinal watertightness Swellable Glass Yarn (6)	0.34	8.7	no	1400	15	-	87	131



- GOSBx02 2
- GOSBx04 4
- GOSBx06 6
- GOSBx08 8
- GOSBx12 12
- GOSBx16 16
- GOSBx24 24

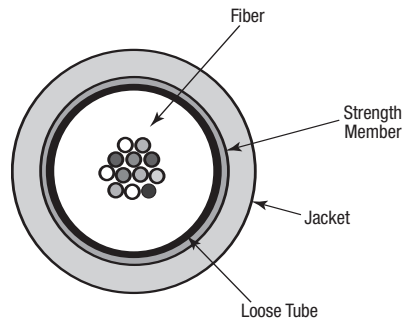

Color Code: see chart page 16.23

Optical characteristics see page 16.21.

# Central Loose Tube Cables

## Outdoor – Improved Rodent Protection

De- scription	Part No.	No. of Fibers	Standard Lengths		Standard Unit Weight		Fiber Size µm	Nom. Buffer/ Tube OD		Strength Members	Nominal OD		Central Element mm	Pulling Tension N	Crush Re- sistance kN/m	Energy kJ/m	Bending Radii Cable (mm)	
			ft.	m	lbs.	kg		inch	mm		inch	mm					static	dyna- mic

**GORA • Loose Tube (Jelly-Filled, Non-Dripping and Silicone-Free) • Longitudinal Watertightness • A-DQ(ZN)B2Y**

**Dry Construction • Black PE (UV-resistant) Jacket**

-30/70°C			13448	4100	497.1	225.5	∅ 250 ± 15	0.13	3.2	Longitudinal watertightness Swellable Glass Yarn (14)	0.28	7.1	no	1400	10	755	71	107
----------	--	--	-------	------	-------	-------	------------	------	-----	--	------	-----	----	------	----	-----	----	-----



- GORAx02 2
- GORAx04 4
- GORAx06 6
- GORAx08 8
- GORAx12 12

Color Code: see chart page 16.23

**GORB • Loose Tube (Jelly-Filled, Non-Dripping and Silicone-Free) • Longitudinal Watertightness • A-DQ(ZN)B2Y**

**Dry Construction • Black PE (UV-resistant) Jacket**

-30/70°C			6888	2100	444.4	201.6	∅ 250 ± 15	0.17	4.2	Longitudinal watertightness Swellable Glass Yarn (14)	0.40	10.2	no	4000	15	2200	102	153
----------	--	--	------	------	-------	-------	------------	------	-----	--	------	------	----	------	----	------	-----	-----



- GORBx02 2
- GORBx04 4
- GORBx06 6
- GORBx08 8
- GORBx12 12
- GORBx16 16
- GORBx24 24

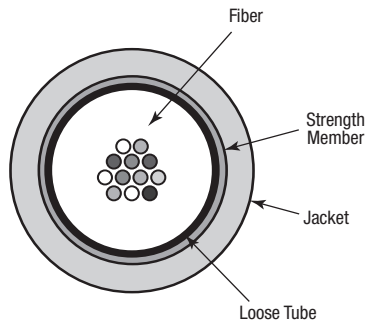

Color Code: see chart page 16.23

Optical characteristics see page 16.21.

### Central Loose Tube Cables

#### Outdoor – Fiber Reinforced Plastic Armor (FRP), Full Rodent Protection

De- scription	Part No.	No. of Fibers	Standard Lengths		Standard Unit Weight		Fiber Size µm	Nom. Buffer/ Tube OD		Strength Members	Nominal OD		Central Element mm	Pulling Tension N	Crush Re- sistance kN/m	Energy kJ/m	Bending Radii Cable (mm)	
			ft.	m	lbs.	kg		inch	mm		inch	mm					static	dyna- mic

**GOFB** • Loose Tube (Jelly-Filled, Non-Dripping and Silicone-Free) • Water-Blocked • FRP • **A-DQB2Y (FRP1.0)**

<b>Dry Construction • Single Black PE Jacket</b>																		
-30/70°C			6888	2100	352.7	160.0	Ø 250 ± 15	0.16	4.0	FRP Rods	0.354	9.0	no	4000	40	-	90	180

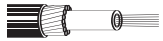

- GOFBx02 2
- GOFBx04 4
- GOFBx06 6
- GOFBx08 8
- GOFBx12 12
- GOFBx16 16
- GOFBx24 24

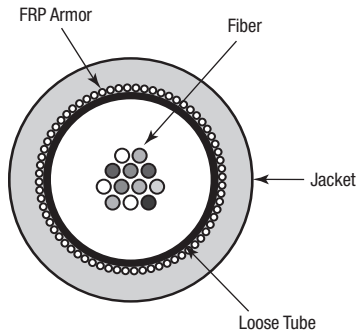

Color Code: see chart page 16.23

#### Outdoor – Steel Wire Armor (SWA), Full Rodent Protection

De- scription	Part No.	No. of Fibers	Standard Lengths		Standard Unit Weight		Fiber Size µm	Nom. Buffer/ Tube OD		Strength Members	Nominal OD		Central Element mm	Pulling Tension N	Crush Re- sistance kN/m	Energy kJ/m	Bending radii cable (mm)	
			ft.	m	lbs.	kg		inch	mm		inch	mm					static	dyna- mic

**GOWB** • Loose Tube (Jelly-Filled, Non-Dripping and Silicone-Free) • Longitudinal Watertightness • SWA • **A-DQ(ZN)2YB2Y (R0.63vzk)**

<b>Dry Construction • Double Black PE Jacket</b>																		
-30/70°C			6888	2100	1029.7	467.0	Ø 250 ± 15	0.16	4.0	Longitudinal watertightness Swellable Glass Yarn	0.512	13.0	no	6500	50	-	130	260

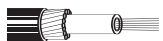

- GOWBx02 2
- GOWBx04 4
- GOWBx06 6
- GOWBx08 8
- GOWBx12 12
- GOWBx16 16
- GOWBx24 24

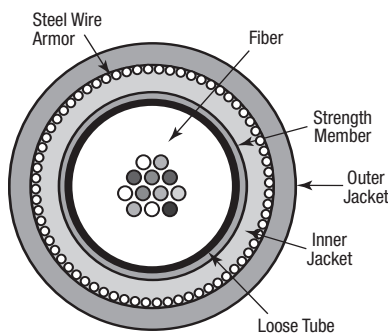

Color Code: see chart page 16.23

Optical characteristics see page 16.21.

### Central Loose Tube Cables

Outdoor – Corrugated Steel Tape Armor (CST), Full Rodent Protection

De- scription	Part No.	No. of Fibers	Standard Lengths		Standard Unit Weight		Fiber Size µm	Nom. Buffer/ Tube OD		Strength Members	Nominal OD		Central Element mm	Pulling Tension N	Crush Re- sistance kN/m	Energy kJ/m	Bending Radii Cable (mm)	
			ft.	m	lbs.	kg		inch	mm		inch	mm					static	dyna- mic

**GOCB** • Loose Tube (Jelly-Filled, Non-Dripping and Silicone-Free) • Longitudinal Watertightness • CST • **A-DQ(ZN)(SR)2Y**

<b>Dry Construction • Single Black PE Jacket</b>																		
-30/70°C			6888	2100	518.5	235.2	∅ 250 ± 15	0.16	4.0	Longitudinal watertightness Swellable Glass Yarn	0.42	10.6	no	2000	40	-	106	212



- GOCBx02 2
- GOCBx04 4
- GOCBx06 6
- GOCBx08 8
- GOCBx12 12
- GOCBx16 16
- GOCBx24 24

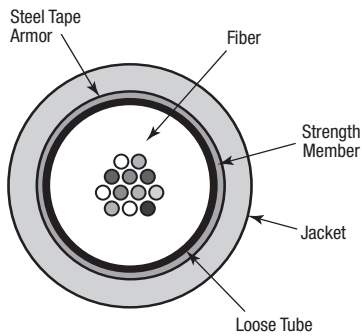

Color Code: see chart page 16.23

**GOD** • Loose Tube (Jelly-Filled, Non-Dripping and Silicone-Free) • Longitudinal Watertightness • CST • **A-DQ(ZN)2Y(SR)2Y**

<b>Dry Construction • Double Black PE Jacket</b>																		
-30/70°C			6888	2100			∅ 250 ± 15			Longitudinal watertightness Swellable Glass Yarn								

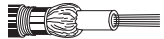

GODAx02	2				666.7	302.4			0.11	2.8		0.43	11.0	no	2000	40	-	110	220
GODAx04	4																		
GODAx06	6																		
GODAx08	8																		
GODAx12	12																		
GODBx16	16				822.3	373.0			0.16	4.0		0.496	12.6	no	2000	40	-	126	232
GODBx24	24																		

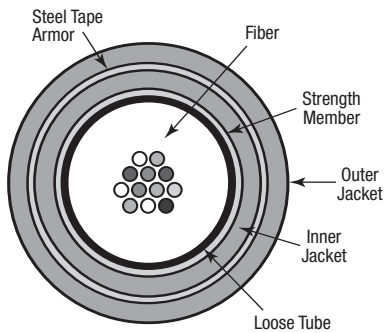

Color Code: see chart page 16.23

Optical characteristics see page 16.21.

### Central Loose Tube Cables

Universal – Indoor/Outdoor, Standard Rodent Protection

De- scription	Part No.	No. of Fibers	Standard Lengths		Standard Unit Weight		Fiber Size µm	Nom. Buffer/ Tube OD		Strength Members	Nominal OD		Central Element mm	Pulling Tension N	Crush Re- sistance kN/m	Energy kJ/m	Bending Radii Cable (mm)	
			ft.	m	lbs.	kg		inch	mm		inch	mm					static	dyna- mic

**GUSA • Loose Tube (Jelly-Filled, Non-Dripping and Silicone-Free) • Longitudinal Watertightness • A/I-DQ(ZN)H**

Dry Construction • Orange FRNC/LSNH Jacket																		
-30/70°C	IEC 60332-3C		13448	4100	334.4	151.7	Ø 250 ± 15	0.13	3.2	Longitudinal watertightness Swellable Glass Yarn (6)	0.23	5.8	no	700	10	550	58	87



- GUSAx02 2
- GUSAx04 4
- GUSAx06 6
- GUSAx08 8
- GUSAx12 12

Color Code: see chart page 16.23

**GUSB • Loose Tube (Jelly-Filled, Non-Dripping and Silicone-Free) • Longitudinal Watertightness • A/I-DQ(ZN)H**

Dry Construction • Orange FRNC/LSNH Jacket																		
-30/70°C	IEC 60332-3C		6888	2100	333.3	151.2	Ø 250 ± 15	0.17	4.2	Longitudinal watertightness Swellable Glass Yarn (6)	0.34	8.7	no	1400	15	1370	87	131



- GUSBx02 2
- GUSBx04 4
- GUSBx06 6
- GUSBx08 8
- GUSBx12 12
- GUSBx16 16
- GUSBx24 24

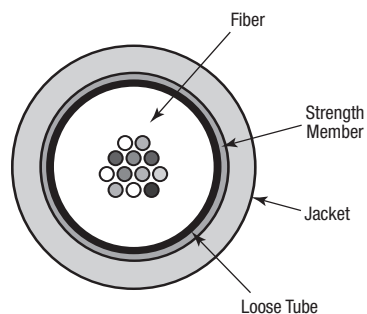

Color Code: see chart page 16.23

Optical characteristics see page 16.21.



### Central Loose Tube Cables

Universal – Indoor/Outdoor, Improved Rodent Protection

De- scription	Part No.	No. of Fibers	Standard Lengths		Standard Unit Weight		Fiber Size µm	Nom. Buffer/ Tube OD		Strength Members	Nominal OD		Central Element mm	Pulling Tension N	Crush Re- sistance kN/m	Energy kJ/m	Bending Radii Cable (mm)	
			ft.	m	lbs.	kg		inch	mm		inch	mm					static	dyna- mic

**GURA** • Loose Tube (Jelly-Filled, Non-Dripping and Silicone-Free) • Longitudinal Watertightness • **A/I-DQ(ZN)BH**

Dry Construction • Orange FRNC/LSNH Jacket																		
-30/70°C	IEC 60332-3C		13448	4100	497.1	225.5	Ø 250 ± 15	0.13	3.2	Longitudinal watertightness Swellable Glass Yarn (14)	0.28	7.1	no	1400	10	755	71	107



- GURAx02 2
- GURAx04 4
- GURAx06 6
- GURAx08 8
- GURAx12 12

Color Code: see chart page 16.23

**GURB** • Loose Tube (Jelly-Filled, Non-Dripping and Silicone-Free) • Longitudinal Watertightness • **A/I-DQ(ZN)BH**

Dry Construction • Orange FRNC/LSNH Jacket																		
-30/70°C	IEC 60332-3C		6888	2100	481.5	218.4	Ø 250 ± 15	0.17	4.2	Longitudinal watertightness Swellable Glass Yarn (14)	0.40	10.2	no	4000	15	1680	102	153



- GURBx04 4
- GURBx06 6
- GURBx08 8
- GURBx12 12
- GURBx16 16
- GURBx24 24

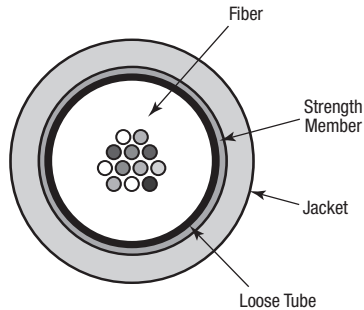

Color Code: see chart page 16.23

Optical characteristics see page 16.21.

### Central Loose Tube Cables

Universal – Indoor/Outdoor, Corrugated Steel Tape Armor (CST), Full Rodent Protection

De- scription	Part No.	No. of Fibers	Standard Lengths		Standard Unit Weight		Fiber Size µm	Nom. Buffer/ Tube OD		Strength Members	Nominal OD		Central Element mm	Pulling Tension N	Crush Re- sistance kN/m	Energy kJ/m	Bending radii cable (mm)	
			ft.	m	lbs.	kg		inch	mm		inch	mm					static	dyna- mic

**GUCB** • Loose Tube (Jelly-Filled, Non-Dripping and Silicone-Free) • Longitudinal Watertightness • CST • **A/I-DQ(ZN)(SR)H**

Dry Construction • Single Black FRNC/LSNH Jacket																		
-30/70°C	EN 50266-2-2		6888	2100	685.2	310.8	∅ 250 ± 15	0.16	4.0	Longitudinal watertightness	0.42	10.6	no	2000	40	-	106	212
	EN 50267-2-2									Swellable								
	EN 50268-2, EN 60331-25									Glass Yarn								



- GUCBx02 2
- GUCBx04 4
- GUCBx06 6
- GUCBx08 8
- GUCBx12 12
- GUCBx16 16
- GUCBx24 24

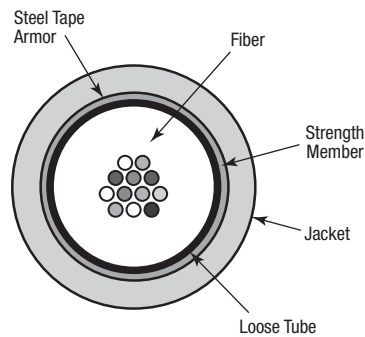

Color Code: see chart page 16.23

**GUD** • Loose Tube (Jelly-Filled, Non-Dripping and Silicone-Free) • Longitudinal Watertightness • CST • **A/I-DQ(ZN)H(SR)H**

Dry Construction • Double Black FRNC/LSNH Jacket																		
-30/70°C	EN 50266-2-2		6888	2100			∅ 250 ± 15			Longitudinal watertightness								
	EN 50267-2-2									Swellable								
	EN 50268-2									Glass Yarn								



- GUDAx02 2
- GUDAx04 4
- GUDAx06 6
- GUDAx08 8
- GUDAx10 10
- GUDAx12 12
- GUDBx16 16
- GUDBx24 24

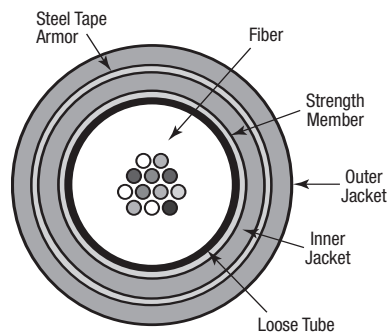

Color Code: see chart page 16.23

Optical characteristics see page 16.21.

### Central Loose Tube Cables

Universal – Indoor/Outdoor, Steel Wire Armor (SWA), Full Rodent Protection

De- scription	Part No.	No. of Fibers	Standard Lengths		Standard Unit Weight		Fiber Size µm	Nom. Buffer/ Tube OD		Strength Members	Nominal OD		Central Element mm	Pulling Tension N	Crush Re- sistance kN/m	Energy kJ/m	Bending Radii Cable (mm)	
			ft.	m	lbs.	kg		inch	mm		inch	mm					static	dyna- mic

**GUWB • Loose Tube (Jelly-Filled, Non-Dripping and Silicone-Free) • Longitudinal Watertightness • SWA • A/I-DQ(ZN)HBH (R0.63vzk)**

**Dry Construction • Double Black FRNC/LSNH Jacket**

-30/70°C	6888	2100	1263.8	561.0	∅ 250 ± 15	0.16	4.0	Longitudinal watertightness Swellable Glass Yarn	0.51	13.0	no	6500	50	-	130	260
----------	------	------	--------	-------	------------	------	-----	---	------	------	----	------	----	---	-----	-----



- GUWBx02 2
- GUWBx04 4
- GUWBx06 6
- GUWBx08 8
- GUWBx12 12
- GUWBx16 16
- GUWBx24 24

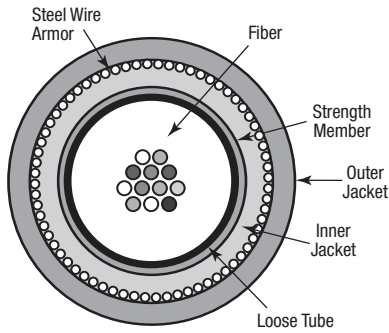

Color Code: see chart page 16.23

Optical characteristics see page 16.21.

# Multi Loose Tube Cables

## Outdoor

De-scription	Part No.	No. of Fibers	Standard Lengths		Standard Unit Weight		Fiber Size $\mu\text{m}$	Nom. Buffer/Tube OD		Strength Members	Nominal OD		Central Element mm	Pulling Tension N	Crush Resistance kN/m	Energy kJ/m	Bending Radii Cable (mm)	
			ft.	m	lbs.	kg		inch	mm		inch	mm					static	dyna-mic

**GBA** • Loose Tubes\*/PE Blind Elements are S-Z Stranded Around the Central Element • Water-Blocked • **A-DQ(ZN)2Y**

**Dry Construction • Black PE (HDPE) Jacket**

-30/70°C



<b>GBAGx04</b>	4 (1x4)	6888	2100	333.3	151.2	$\emptyset 250 \pm 15$	0.07	1.9	Water-blocking Aramid Yarn	0.41	10.3	2.0	3000	20	-	155	206
<b>GBAGx06</b>	6 (1x6)	13448	4100	650.8	295.2												
<b>GBAGx08</b>	8 (2x4)																
<b>GBAGx12</b>	12 (2x6)																
<b>GBAGx18</b>	18 (3x6)																
<b>GBAGx24</b>	24 (4x6)																
<b>GBAGx30</b>	30 (5x6)																
<b>GBAGx36</b>	36 (6x6)																
<b>GBADx24</b>	24 (2x12)	6888	2100	458.3	207.9	$\emptyset 250 \pm 15$	0.10	2.5	Water-blocking Aramid Yarn	0.48	12.2	2.7	3500	20	-	183	244
<b>GBADx36</b>	36 (3x12)	13448	4100	894.8	405.9												
<b>GBADx48</b>	48 (4x12)																
<b>GBADx60</b>	60 (5x12)																
<b>GBADx72</b>	72 (6x12)																
<b>GBAEx84</b>	84 (7x12)	6888	2100	588.0	266.7	$\emptyset 250 \pm 15$	0.10	2.5	Water-blocking Aramid Yarn	0.54	13.8	3.0/4.3	4000	20	-	207	276
<b>GBAEx96</b>	96 (8x12)	13448	4100	1147.9	520.7												
<b>GBAFx08</b>	108 (9x12)	6888	2100	888.9	403.2	$\emptyset 250 \pm 15$	0.10	2.5	Water-blocking Aramid Yarn	0.67	17.0	3.0/7.5	4000	20	-	255	340
<b>GBAFx20</b>	120 (10x12)	13448	4100	1735.5	787.2												
<b>GBAFx32</b>	132 (11x12)																
<b>GBAFx44</b>	144 (12x12)																
<b>GBAMx16</b>	216 (18x12)	6888	2100	1041.7	472.5	$\emptyset 250 \pm 15$	0.10	2.5	Water-blocking Aramid Yarn	0.72	18.2	2.7	4000	20	-	273	364
		13448	4100	2033.7	922.5												
<b>GBAlx92</b>	192 (8x24)	6888	2100	1064.8	483.0	$\emptyset 250 \pm 15$	0.14	3.5	Water-blocking Aramid Yarn	0.71	18.0	3.0/6.0	4000	20	-	270	360
		13448	4100	2078.9	943.0												
<b>GBAJx88</b>	288 (12x24)	6888	2100	1643.5	745.5	$\emptyset 250 \pm 15$	0.14	3.5	Water-blocking Aramid Yarn	0.88	22.4	3.0/10.5	4000	20	-	336	448
<b>GBALx32</b>	432 (18x24)	6888	2100	1643.5	745.5	$\emptyset 250 \pm 15$	0.14	3.5	Water-blocking Aramid Yarn	0.91	23.2	2.7/3.7	4000	20	-	348	464

Color Code: see chart page 16.23

Loose tubes: 1. Red, 2. Green, rest of tubes White

Blind elements: Clear

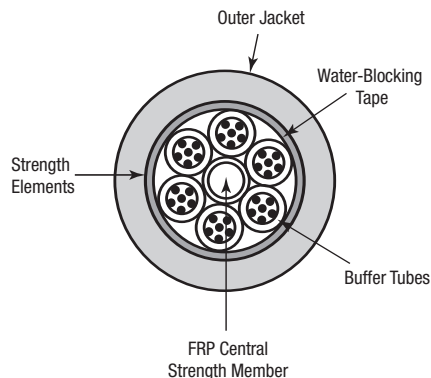

Optical characteristics see page 16.21.  
\* jelly-filled, non-dripping and silicone-free

# Multi Loose Tube Cables

## Outdoor

De- scription	Part No.	No. of Fibers	Standard Lengths		Standard Unit Weight		Fiber Size µm	Nom. Buffer/ Tube OD		Strength Members	Nominal OD		Central Element mm	Pulling Tension N	Crush Re- sistance kN/m	Energy kJ/m	Bending Radii Cable (mm)	
			ft.	m	lbs.	kg		inch	mm		inch	mm					static	dyna- mic

**GDA** • Loose Tubes\*/PE Blind Elements are S-Z Stranded Around the Central Element • Water-Blocked • **A-DF(ZN)2Y**

**Filled Construction • Black PE (HDPE) Jacket**

-30/70°C



<b>GDA</b> Gx04	4 (1x4)	6888	2100	342.6	155.4	∅ 250 ± 15	0.07	1.9	Water-blocking Aramid Yarn	0.39	10.0	2.0	3000	20	-	150	200
<b>GDA</b> Gx06	6 (1x6)	13448	4100	668.9	303.4												
<b>GDA</b> Gx08	8 (2x4)																
<b>GDA</b> Gx12	12 (2x6)																
<b>GDA</b> Gx18	18 (3x6)																
<b>GDA</b> Gx24	24 (4x6)																
<b>GDA</b> Gx30	30 (5x6)																
<b>GDA</b> Gx36	36 (6x6)																
<b>GDA</b> Dx24	24 (2x12)	6888	2100	490.7	222.6	∅ 250 ± 15	0.10	2.5	Water-blocking Aramid Yarn	0.47	12.0	2.7	3500	20	-	180	240
<b>GDA</b> Dx36	36 (3x12)	13448	4100	958.1	434.6												
<b>GDA</b> Dx48	48 (4x12)																
<b>GDA</b> Dx60	60 (5x12)																
<b>GDA</b> Dx72	72 (6x12)																
<b>GDA</b> Ex84	84 (7x12)	6888	2100	629.6	285.6	∅ 250 ± 15	0.10	2.5	Water-blocking Aramid Yarn	0.54	13.6	3.0/4.3	4000	20	-	204	272
<b>GDA</b> Ex96	96 (8x12)	13448	4100	1229.3	557.6												
<b>GDA</b> Fx08	108 (9x12)	6888	2100	949.1	430.5	∅ 250 ± 15	0.10	2.5	Water-blocking Aramid Yarn	0.66	16.8	3.0/7.5	4000	20	-	252	336
<b>GDA</b> Fx20	120 (10x12)	13448	4100	1853.0	840.5												
<b>GDA</b> Fx32	132 (11x12)																
<b>GDA</b> Fx44	144 (12x12)																
<b>GDA</b> Mx16	216 (18x12)	6888 13448	2100 4100	1134.3 2214.5	514.5 1004.5	∅ 250 ± 15	0.10	2.5	Water-blocking Aramid Yarn	0.69	17.5	2.7	4000	20	-	263	350
<b>GDA</b> Ix92	192 (8x24)	6888 13448	2100 4100	1041.7 2033.7	472.5 922.5	∅ 250 ± 15	0.14	3.5	Water-blocking Aramid Yarn	0.69	17.6	3.0/6.0	4000	20	-	264	352
<b>GDA</b> Jx88	288 (12x24)	6888	2100	1736.1	787.5	∅ 250 ± 15	0.14	3.5	Water-blocking Aramid Yarn	0.87	22.1	3.0/10.5	4000	20	-	332	442
<b>GDA</b> Lx32	432 (18x24)	6888	2100	1851.9	840.0	∅ 250 ± 15	0.14	3.5	Water-blocking Aramid Yarn	0.89	22.5	2.7/3.7	4000	20	-	338	450

Color Code: see chart page 16.23

Loose tubes: 1. Red, 2. Green, rest of tubes White

Blind elements: Clear

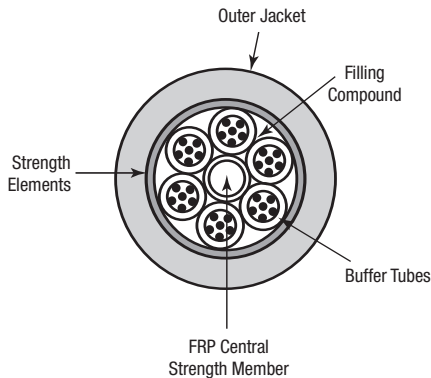

Optical characteristics see page 16.21.

\* jelly-filled, non-dripping and silicone-free

# Multi Loose Tube Cables

## Outdoor – Improved Rodent Protection

De- scription	Part No.	No. of Fibers	Standard Lengths		Standard Unit Weight		Fiber Size µm	Nom. Buffer/ Tube OD		Strength Members	Nominal OD		Central Element mm	Pulling Tension N	Crush Re- sistance kN/m	Energy kJ/m	Bending Radii Cable (mm)	
			ft.	m	lbs.	kg		inch	mm		inch	mm					static	dyna- mic

**GBR • Loose Tubes\*/PE Blind Elements are S-Z Stranded Around the Central Element • Water-Blocked • A-DQ(ZN)B2Y**

**Dry Construction • Black PE (HDPE) Jacket**  
-30/70°C



<b>GBRGx04</b>	4 (1x4)	6888	2100	486.1	220.5	Ø 250 ± 15	0.07	1.9	Water-blocking Glass Yarn	0.46	11.8	2.0	3000	20	-	177	236	
<b>GBRGx06</b>	6 (1x6)	13448	4100	949.1	430.5													
<b>GBRGx08</b>	8 (2x4)																	
<b>GBRGx12</b>	12 (2x6)																	
<b>GBRGx18</b>	18 (3x6)																	
<b>GBRGx24</b>	24 (4x6)																	
<b>GBRGx30</b>	30 (5x6)																	
<b>GBRGx36</b>	36 (6x6)																	
<b>GBRDx24</b>	24 (2x12)	6888	2100	625.0	283.5	Ø 250 ± 15	0.10	2.5	Water-blocking Glass Yarn	0.54	13.7	2.7	3500	20	-	206	274	
<b>GBRDx36</b>	36 (3x12)	13448	4100	1220.2	553.5													
<b>GBRDx48</b>	48 (4x12)																	
<b>GBRDx60</b>	60 (5x12)																	
<b>GBRDx72</b>	72 (6x12)																	
<b>GBREx84</b>	84 (7x12)	6888	2100	787.0	357.0	Ø 250 ± 15	0.10	2.5	Water-blocking Glass Yarn	0.60	15.3	3.0/4.3	4000	20	-	230	306	
<b>GBREx96</b>	96 (8x12)	13448	4100	1536.6	697.0													
<b>GBRFx08</b>	108 (9x12)	6888	2100	1088.0	493.5	Ø 250 ± 15	0.10	2.5	Water-blocking Glass Yarn	0.73	18.5	3.0/7.5	4000	20	-	278	370	
<b>GBRFx20</b>	120 (10x12)	13448	4100	2124.1	963.5													
<b>GBRFx32</b>	132 (11x12)																	
<b>GBRFx44</b>	144 (12x12)																	
<b>GBRMx16</b>	216 (18x12)	6888	2100	1250.0	567.0	Ø 250 ± 15	0.10	2.5	Water-blocking Glass Yarn	0.78	19.7	2.7	4000	20	-	296	394	
		13448	4100	2440.5	1107.0													
<b>GBRlx92</b>	192 (8x24)	6888	2100	1296.3	588.0	Ø 250 ± 15	0.14	3.5	Water-blocking Glass Yarn	0.77	19.5	3.0/6.0	4000	20	-	293	390	
		13448	4100	2530.9	1148.0													
<b>GBRJx88</b>	288 (12x24)	6888	2100	1898.2	861.0	Ø 250 ± 15	0.14	3.5	Water-blocking Glass Yarn	0.94	23.9	3.0/10.5	4000	20	-	359	478	
<b>GBRLx32</b>	432 (18x24)	6888	2100	1898.2	861.0	Ø 250 ± 15	0.14	3.5	Water-blocking Glass Yarn	0.97	24.7	2.7/3.7	4000	20	-	371	494	

Color Code: see chart page 16.23  
Loose tubes: 1. Red, 2. Green, rest of tubes White  
Blind elements: Clear

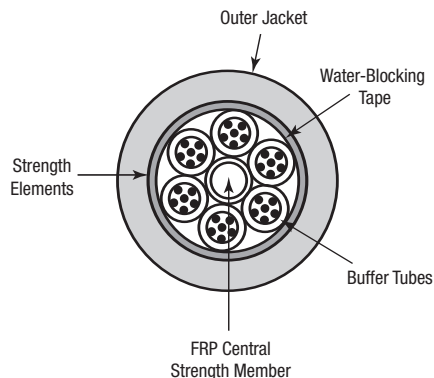

Optical characteristics see page 16.21.  
\* jelly-filled, non-dripping and silicone-free

# Multi Loose Tube Cables

## Outdoor – Improved Rodent Protection

De- scription	Part No.	No. of Fibers	Standard Lengths		Standard Unit Weight		Fiber Size µm	Nom. Buffer/ Tube OD		Strength Members	Nominal OD		Central Element mm	Pulling Tension N	Crush Re- sistance kN/m	Energy kJ/m	Bending Radii Cable (mm)	
			ft.	m	lbs.	kg		inch	mm		inch	mm					static	dyna- mic

**GDR** • Loose Tubes\*/PE Blind Elements are S-Z Stranded Around the Central Element • Water-Blocked • **A-DF(ZN)B2Y**

**Filled Construction • Black PE (HDPE) Jacket**

-30/70°C



<b>GDRGx04</b>	4 (1x4)	6888	2100	476.9	216.3	∅ 250 ± 15	0.07	1.9	Water-blocking Glass Yarn	0.45	11.5	2.0	3000	20	-	173	230
<b>GDRGx06</b>	6 (1x6)	13448	4100	931.0	422.3												
<b>GDRGx08</b>	8 (2x4)																
<b>GDRGx12</b>	12 (2x6)																
<b>GDRGx18</b>	18 (3x6)																
<b>GDRGx24</b>	24 (4x6)																
<b>GDRGx30</b>	30 (5x6)																
<b>GDRGx36</b>	36 (6x6)																
<b>GDRDx24</b>	24 (2x12)	6888	2100	629.6	285.6	∅ 250 ± 15	0.10	2.5	Water-blocking Glass Yarn	0.53	13.4	2.7	3500	20	-	201	268
<b>GDRDx36</b>	36 (3x12)	13448	4100	1229.3	557.6												
<b>GDRDx48</b>	48 (4x12)																
<b>GDRDx60</b>	60 (5x12)																
<b>GDRDx72</b>	72 (6x12)																
<b>GDREx84</b>	84 (7x12)	6888	2100	805.6	365.4	∅ 250 ± 15	0.10	2.5	Water-blocking Glass Yarn	0.59	15.0	3.0/4.3	4000	20	-	225	300
<b>GDREx96</b>	96 (8x12)	13448	4100	1572.8	713.4												
<b>GDRFx08</b>	108 (9x12)	6888	2100	1134.3	514.5	∅ 250 ± 15	0.10	2.5	Water-blocking Glass Yarn	0.72	18.2	3.0/7.5	4000	20	-	273	364
<b>GDRFx20</b>	120 (10x12)	13448	4100	2214.5	1004.5												
<b>GDRFx32</b>	132 (11x12)																
<b>GDRFx44</b>	144 (12x12)																
<b>GDRMx16</b>	216 (18x12)	6888 13448	2100 4100	1319.5 2576.1	598.5 1168.5	∅ 250 ± 15	0.10	2.5	Water-blocking Glass Yarn	0.75	19.0	2.7	4000	20	-	285	380
<b>GDRIx92</b>	192 (8x24)	6888 13448	2100 4100	1226.9 2395.3	556.5 1086.5	∅ 250 ± 15	0.14	3.5									
<b>GDRJx88</b>	288 (12x24)	6888 13448	2100 4100	1944.5 3796.3	882.0 1722.0	∅ 250 ± 15	0.14	3.5	Water-blocking Glass Yarn	0.93	23.5	3.0/10.5	4000	20	-	353	470
<b>GDRLx32</b>	432 (18x24)	6888 13448	2100 4100	2037.1 3977.1	924.0 1804.0	∅ 250 ± 15	0.14	3.5									

Color Code: see chart page 16.23  
 Loose tubes: 1. Red, 2. Green, rest of tubes White  
 Blind elements: Clear

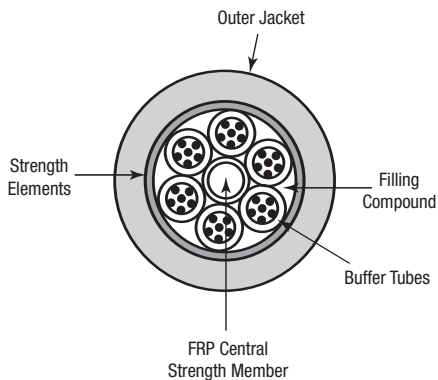

Optical characteristics see page 16.21.  
 \* jelly-filled, non-dripping and silicone-free

### Multi Loose Tube Cables

#### Outdoor – Full Rodent Protection, Corrugated Steel Tape Armor (CST)

De- scription	Part No.	No. of Fibers	Standard Lengths		Standard Unit Weight		Fiber Size µm	Nom. Buffer/ Tube OD		Strength Members	Nominal OD		Central Element mm	Pulling Tension N	Crush Re- sistance kN/m	Energy kJ/m	Bending Radii Cable (mm)	
			ft.	m	lbs.	kg		inch	mm		inch	mm					static	dyna- mic

**GBD** • Loose Tubes\*/PE Blind Elements are S-Z Stranded Around the Central Element • Water-Blocked • CST • **A-DQ(ZN)2Y(SR)2Y**

**Dry Construction • Double Black PE (HDPE) Jacket**

-30/70°C



<b>GBDGx04</b>	4 (1x4)	6888	2100	838.0	380.1	∅ 250 ± 15	0.07	1.9	Water-blocking Aramid Yarn	0.52	13.2	2.0	3000	50	-	198	264
<b>GBDGx06</b>	6 (1x6)	13448	4100	1636.0	742.1												
<b>GBDGx08</b>	8 (2x4)																
<b>GBDGx12</b>	12 (2x6)																
<b>GBDGx18</b>	18 (3x6)																
<b>GBDGx24</b>	24 (4x6)																
<b>GBDGx30</b>	30 (5x6)																
<b>GBDGx36</b>	36 (6x6)																
<b>GBDDx24</b>	24 (2x12)	6888	2100	1046.3	474.6	∅ 250 ± 15	0.10	2.5	Water-blocking Aramid Yarn	0.60	15.2	2.7	3500	50	-	228	304
<b>GBDDx36</b>	36 (3x12)																
<b>GBDDx48</b>	48 (4x12)																
<b>GBDDx60</b>	60 (5x12)																
<b>GBDDx72</b>	72 (6x12)																
<b>GBDEx84</b>	84 (7x12)	6888	2100	1273.2	577.5	∅ 250 ± 15	0.10	2.5	Water-blocking Aramid Yarn	0.69	17.4	3.0/4.3	4000	50	-	261	348
<b>GBDEx96</b>	96 (8x12)																
<b>GBDFx08</b>	108 (9x12)	6888	2100	1555.6	705.6	∅ 250 ± 15	0.10	2.5	Water-blocking Aramid Yarn	0.81	20.5	3.0/7.5	4000	50	-	308	410
<b>GBDFx20</b>	120 (10x12)																
<b>GBDFx32</b>	132 (11x12)																
<b>GBDFx44</b>	144 (12x12)																
<b>GBDMx16</b>	216 (18x12)	6888	2100	1759.3	798.0	∅ 250 ± 15	0.10	2.5	Water-blocking Aramid Yarn	0.85	21.5	2.7	4000	50	-	323	430
<b>GBDLx92</b>	192 (8x24)	6888	2100	-	-	∅ 250 ± 15	0.14	3.5	Water-blocking Aramid Yarn	0.85	21.5	3.0/6.0	4000	50	-	323	430
<b>GBDJx88</b>	288 (12x24)	6888	2100	-	-	∅ 250 ± 15	0.14	3.5	Water-blocking Aramid Yarn	1.02	26.0	3.0/10.5	4000	50	-	390	520
<b>GBDLx32</b>	432 (18x24)	6888	2100	-	-	∅ 250 ± 15	0.14	3.5	Water-blocking Aramid Yarn	1.04	26.5	2.7/3.7	4000	50	-	398	530

Color Code: see chart page 16.23  
 Loose tubes: 1. Red, 2. Green, rest of tubes White  
 Blind elements: Clear

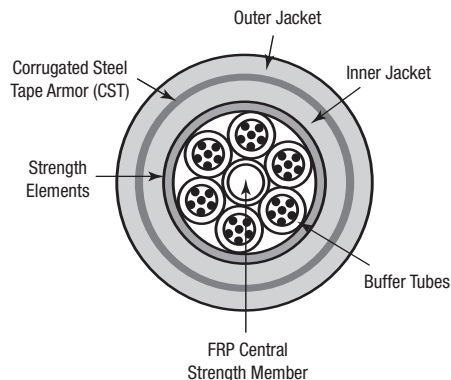

Optical characteristics see page 16.21.  
 \* jelly-filled, non-dripping and silicone-free



### Multi Loose Tube Cables

Outdoor – Full Rodent Protection, Corrugated Steel Tape Armor (CST)

De- scription	Part No.	No. of Fibers	Standard Lengths		Standard Unit Weight		Fiber Size µm	Nom. Buffer/ Tube OD		Strength Members	Nominal OD		Central Element mm	Pulling Tension N	Crush Re- sistance kN/m	Energy kJ/m	Bending Radii Cable (mm)	
			ft.	m	lbs.	kg		inch	mm		inch	mm					static	dyna- mic

**GDD** • Loose Tubes\*/PE Blind Elements are S-Z Stranded Around the Central Element • Water-Blocked • CST • **A-DF(ZN)2Y(SR)2Y**

**Filled Construction • Double Black PE (HDPE) Jacket**

-30/70°C



<b>GDDGx04</b>	4 (1x4)	6888	2100	851.9	386.4	Ø 250 ± 15	0.07	1.9	Water-blocking Aramid Yarn	0.51	13.0	2.0	3000	50	-	195	260
<b>GDDGx06</b>	6 (1x6)	13448	4100	1663.2	754.4												
<b>GDDGx08</b>	8 (2x4)																
<b>GDDGx12</b>	12 (2x6)																
<b>GDDGx18</b>	18 (3x6)																
<b>GDDGx24</b>	24 (4x6)																
<b>GDDGx30</b>	30 (5x6)																
<b>GDDGx36</b>	36 (6x6)																
<b>GDDx24</b>	24 (2x12)	6888	2100	1083.3	491.4	Ø 250 ± 15	0.10	2.5	Water-blocking Aramid Yarn	0.59	15.0	2.7	3500	50	-	225	300
<b>GDDx36</b>	36 (3x12)																
<b>GDDx48</b>	48 (4x12)																
<b>GDDx60</b>	60 (5x12)																
<b>GDDx72</b>	72 (6x12)																
<b>GDDEx84</b>	84 (7x12)	6888	2100	1319.5	598.5	Ø 250 ± 15	0.10	2.5	Water-blocking Aramid Yarn	0.67	17.1	3.0/4.3	4000	50	-	257	342
<b>GDDEx96</b>	96 (8x12)																
<b>GDDFx08</b>	108 (9x12)	6888	2100	1745.4	791.7	Ø 250 ± 15	0.10	2.5	Water-blocking Aramid Yarn	0.81	20.5	3.0/7.5	4000	50	-	308	410
<b>GDDFx20</b>	120 (10x12)																
<b>GDDFx32</b>	132 (11x12)																
<b>GDDFx44</b>	144 (12x12)																
<b>GDDMx16</b>	216 (18x12)	6888	2100	1990.8	903.0	Ø 250 ± 15	0.10	2.5	Water-blocking Aramid Yarn	0.83	21.0	2.7	4000	50	-	315	420
<b>GDDIx92</b>	192 (8x24)	6888	2100	-	-	Ø 250 ± 15	0.14	3.5	Water-blocking Aramid Yarn	0.83	21.0	3.0/6.0	4000	50	-	315	420
<b>GDDJx88</b>	288 (12x24)	6888	2100	-	-	Ø 250 ± 15	0.14	3.5	Water-blocking Aramid Yarn	1.00	25.5	3.0/10.5	4000	50	-	383	510
<b>GDDLx32</b>	432 (18x24)	6888	2100	-	-	Ø 250 ± 15	0.14	3.5	Water-blocking Aramid Yarn	1.02	26.0	2.7/3.7	4000	50	-	390	520

Color Code: see chart page 16.23

Loose tubes: 1. Red, 2. Green, rest of tubes White

Blind elements: Clear

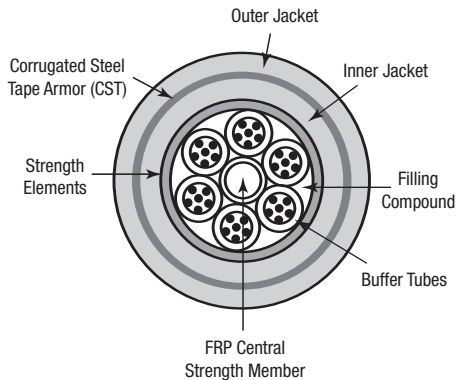

Optical characteristics see page 16.21.

\* jelly-filled, non-dripping and silicone-free

### Multi Loose Tube Cables

Outdoor – Full Rodent Protection, Galvanised Steel Wire Armor (SWA)

De- scription	Part No.	No. of Fibers	Standard Lengths		Standard Unit Weight		Fiber Size µm	Nom. Buffer/ Tube OD		Strength Members	Nominal OD		Central Element mm	Pulling Tension N	Crush Re- sistance kN/m	Energy kJ/m	Bending Radii Cable (mm)	
			ft.	m	lbs.	kg		inch	mm		inch	mm					static	dyna- mic

**GBW** • Loose Tubes\*/PE Blind Elements are S-Z Stranded Around the Central Element • Water-Blocked • SWA • **A-DQ2YB2Y (R1.0vzk)**

**Dry Construction • Double Black PE Jacket**

-30/70°C

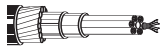

<b>GBWGx04</b> 4 (1x4)	6888	2100	1342.6	609.0	∅ 250 ± 15	0.07	1.9	-	0.53	13.5	2.0	8000	50	-	203	270
<b>GBWGx06</b> 6 (1x6)	13448	4100	2621.3	1189.0												
<b>GBWGx08</b> 8 (2x4)																
<b>GBWGx12</b> 12 (2x6)																
<b>GBWGx18</b> 18 (3x6)																
<b>GBWGx24</b> 24 (4x6)																
<b>GBWGx30</b> 30 (5x6)																
<b>GBWGx36</b> 36 (6x6)																
<b>GBWDx24</b> 24 (2x12)	6888	2100	1666.7	756.0	∅ 250 ± 15	0.10	2.5	-	0.61	15.5	2.7	8000	50	-	233	310
<b>GBWDx36</b> 36 (3x12)	13448	4100	3254.0	1476.0												
<b>GBWDx48</b> 48 (4x12)																
<b>GBWDx60</b> 60 (5x12)																
<b>GBWDx72</b> 72 (6x12)																
<b>GBWEx84</b> 84 (7x12)	6888	2100	1875.0	850.5	∅ 250 ± 15	0.10	2.5	-	0.67	17.0	3.0/4.3	8000	50	-	255	340
<b>GBWEx96</b> 96 (8x12)	13448	4100	3660.7	1660.5												
<b>GBWEx08</b> 108 (9x12)	6888	2100	2592.6	1176.0	∅ 250 ± 15	0.10	2.5	-	0.80	20.2	3.0/7.5	8000	50	-	303	404
<b>GBWEx20</b> 120 (10x12)	13448	4100	5061.8	2296.0												
<b>GBWEx32</b> 132 (11x12)																
<b>GBWEx44</b> 144 (12x12)																
<b>GBWMx16</b> 216 (18x12)	6888	2100	2777.8	1260.0	∅ 250 ± 15	0.10	2.5	-	0.83	21.0	2.7	8000	50	-	315	420
<b>GBWix92</b> 192 (8x24)	6888	2100	-	-	∅ 250 ± 15	0.14	3.5	-	0.83	21.0	3.0/6.0	8000	50	-	315	420
<b>GBWJx88</b> 288 (12x24)	6888	2100	-	-	∅ 250 ± 15	0.14	3.5	-	1.00	25.5	3.0/10.5	8000	50	-	383	510
<b>GBWLx32</b> 432 (18x24)	6888	2100	-	-	∅ 250 ± 15	0.14	3.5	-	1.02	26.0	2.7/3.7	8000	50	-	390	520

Color Code: see chart page 16.23

Loose tubes: 1. Red, 2. Green, rest of tubes White

Blind elements: Clear

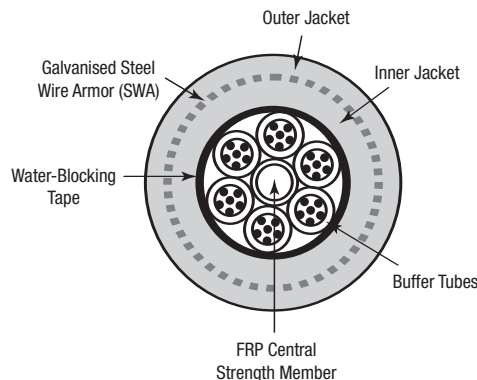

Optical characteristics see page 16.21.  
\* jelly-filled, non-dripping and silicone-free

### Multi Loose Tube Cables

Outdoor – Full Rodent Protection, Galvanised Steel Wire Armor (SWA)

De- scription	Part No.	No. of Fibers	Standard Lengths		Standard Unit Weight		Fiber Size µm	Nom. Buffer/ Tube OD		Strength Members	Nominal OD		Central Element mm	Pulling Tension N	Crush Re- sistance kN/m	Energy kJ/m	Bending Radii Cable (mm)	
			ft.	m	lbs.	kg		inch	mm		inch	mm					static	dyna- mic

**GDW** • Loose Tubes\*/PE Blind Elements are S-Z Stranded Around the Central Element • Water-Blocked • SWA • **A-DF2YB2Y (R1.0vzk)**

**Filled Construction • Double Black PE Jacket**

-30/70°C

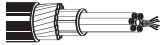

<b>GDWGx04</b> 4 (1x4)	6888	2100	1388.9	630.0	∅ 250 ± 15	0.07	1.9	–	0.53	13.5	2.0	8000	50	–	203	270
<b>GDWGx06</b> 6 (1x6)	13448	4100	2711.7	1230.0												
<b>GDWGx08</b> 8 (2x4)																
<b>GDWGx12</b> 12 (2x6)																
<b>GDWGx18</b> 18 (3x6)																
<b>GDWGx24</b> 24 (4x6)																
<b>GDWGx30</b> 30 (5x6)																
<b>GDWGx36</b> 36 (6x6)																
<b>GDWDx24</b> 24 (2x12)	6888	2100	1713.0	777.0	∅ 250 ± 15	0.10	2.5	–	0.61	15.5	2.7	8000	50	–	233	310
<b>GDWDx36</b> 36 (3x12)	13448	4100	3344.4	1517.0												
<b>GDWDx48</b> 48 (4x12)																
<b>GDWDx60</b> 60 (5x12)																
<b>GDWDx72</b> 72 (6x12)																
<b>GDWEx84</b> 84 (7x12)	6888	2100	1921.3	871.5	∅ 250 ± 15	0.10	2.5	–	0.66	16.8	3.0/4.3	8000	50	–	252	336
<b>GDWEx96</b> 96 (8x12)	13448	4100	3751.1	1701.5												
<b>GDWFx08</b> 108 (9x12)	6888	2100	2638.9	1197.0	∅ 250 ± 15	0.10	2.5	–	0.80	20.2	3.0/7.5	8000	50	–	303	404
<b>GDWFx20</b> 120 (10x12)	13448	4100	5152.2	2337.0												
<b>GDWFx32</b> 132 (11x12)																
<b>GDWFx44</b> 144 (12x12)																
<b>GDWMx16</b> 216 (18x12)	6888	2100	2824.1	1281.0	∅ 250 ± 15	0.10	2.5	–	0.81	20.5	2.7	8000	50	–	308	410
<b>GDWix92</b> 192 (8x24)	6888	2100	–	–	∅ 250 ± 15	0.14	3.5	–	0.81	20.5	3.0/6.0	8000	50	–	308	410
<b>GDWJx88</b> 288 (12x24)	6888	2100	–	–	∅ 250 ± 15	0.14	3.5	–	0.98	25.0	3.0/10.5	8000	50	–	375	500
<b>GDWLx32</b> 432 (18x24)	6888	2100	–	–	∅ 250 ± 15	0.14	3.5	–	1.00	25.5	2.7/3.7	8000	50	–	383	510

Color Code: see chart page 16.23

Loose tubes: 1. Red, 2. Green, rest of tubes White

Blind elements: Clear

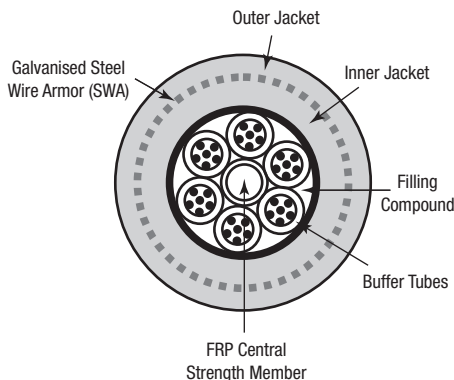

Optical characteristics see page 16.21.

\* jelly-filled, non-dripping and silicone-free

# Multi Loose Tube Cables

Aerial – Outdoor

De- scription	Part No.	No. of Fibers	Standard Lengths		Standard Unit Weight		Fiber Size μm	Nom. Buffer/ Tube OD		Strength Members	Nominal OD		Central Element mm	Pulling Tension N	Crush Re- sistance kN/m	Energy kJ/m	Bending Radii Cable (mm)	
			ft.	m	lbs.	kg		inch	mm		inch	mm					static	dyna- mic

**GALH** • Loose Tubes\*/PE Blind Elements are S-Z Stranded Around the Central Element • Water-Blocked • **A-DSF(L)2YT (Span = 50 m)**

Filled Construction • Black PE (HDPE) Jacket • Figure 8, Steel Messenger																		
-30/70°C			6888	2100	793.7	360.0	∅ 250 ± 15	0.059	1.5	Steel Messenger	0.380 0.790	9.8 20.0	1.7	4000	20	-	147	196

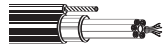

- GALHx04 4 (1x4)
- GALHx08 8 (2x4)
- GALHx12 12 (3x4)
- GALHx16 16 (4x4)
- GALHx20 20 (5x4)
- GALHx24 24 (6x4)

Color Code: see chart page 16.23  
Optional: higher pulling tension available upon request.

**GALD** • Loose Tubes\*/PE Blind Elements are S-Z Stranded Around the Central Element • Water-Blocked • **A-DSF(L)2YT (Span = 50 m)**

Filled Construction • Black PE (HDPE) Jacket • Figure 8, Steel Messenger																		
-30/70°C			6888	2100	1091.3	495.0	∅ 250 ± 15	0.098	2.5	Steel Messenger	0.500 0.914	12.8 23.0	2.7	4000	20	-	192	256

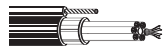

- GALDx12 12 (1x12)
- GALDx24 24 (2x12)
- GALDx36 36 (3x12)
- GALDx48 48 (4x12)
- GALDx60 60 (5x12)
- GALDx72 72 (6x12)

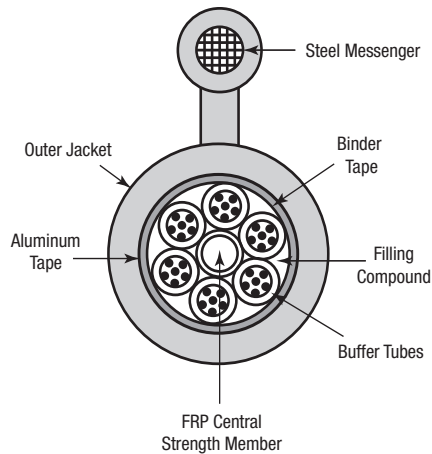

Color Code: see chart page 16.23  
Optional: higher pulling tension available upon request.

Optical characteristics see page 16.21.

## Multi Loose Tube Cables

Aerial – Outdoor, All Dielectric

De- scription	Part No.	No. of Fibers	Standard Lengths		Standard Unit Weight		Fiber Size µm	Nom. Buffer/ Tube OD		Strength Members	Nominal OD		Central Element mm	Pulling Tension N	Crush Re- sistance kN/m	Energy kJ/m	Bending Radii Cable (mm)	
			ft.	m	lbs.	kg		inch	mm		inch	mm					static	dyna- mic

**GAAD** • Loose Tubes\*/PE Blind Elements are S-Z Stranded Around the Central Element • Water-Blocked • **A-DF(ZN)2YT (Span = 50 m)**

Filled Construction • Black PE (HDPE) Jacket • Figure 8, Dielectric Messenger																		
-30/70°C			6888	2100	910.5	413.0	∅ 250 ± 15	0.098	2.5	FRP Rod Messenger	0.50 0.95	12.7 24.0	2.7	4000	20	-	192	256



- GAADx12 12 (1x12)
- GAADx24 24 (2x12)
- GAADx36 36 (3x12)
- GAADx48 48 (4x12)
- GAADx60 60 (5x12)
- GAADx72 72 (6x12)

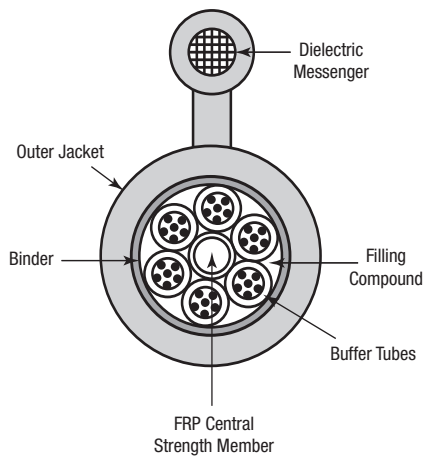

Color Code: see chart page 16.23  
 Optional: higher pulling tension available upon request.

Optical characteristics see page 16.21.

# Multi Loose Tube Cables

Universal – Indoor/Outdoor

De- scription	Part No.	No. of Fibers	Standard Lengths		Standard Unit Weight		Fiber Size µm	Nom. Buffer/ Tube OD		Strength Members	Nominal OD		Central Element mm	Pulling Tension N	Crush Re- sistance kN/m	Energy kJ/m	Bending Radii Cable (mm)	
			ft.	m	lbs.	kg		inch	mm		inch	mm					static	dyna- mic

**GCA** • Loose Tubes\*/PE Blind Elements are S-Z Stranded Around the Central Element • Water-Blocked • **A/I-DQ(ZN)H**

**Dry Construction • Black LSZH Jacket**

-30/70°C EN 50266-2-2  
EN 50267-2-2  
EN 50628-2



<b>GCA</b> Gx04	4 (1x4)	6888	2100	439.8	199.5	∅ 250 ± 15	0.07	1.9	Water-blocking Aramid Yarn	0.41	10.3	2.0	3000	20	–	155	206
<b>GCA</b> Gx06	6 (1x6)	13448	4100	858.7	389.5												
<b>GCA</b> Gx08	8 (2x4)																
<b>GCA</b> Gx12	12 (2x6)																
<b>GCA</b> Gx18	18 (3x6)																
<b>GCA</b> Gx24	24 (4x6)																
<b>GCA</b> Gx30	30 (5x6)																
<b>GCA</b> Gx36	36 (6x6)																
<b>GCA</b> Dx24	24 (2x12)	6888	2100	588.0	266.7	∅ 250 ± 15	0.10	2.5	Water-blocking Aramid Yarn	0.48	12.2	2.7	3500	20	–	183	244
<b>GCA</b> Dx36	36 (3x12)	13448	4100	1147.9	520.7												
<b>GCA</b> Dx48	48 (4x12)																
<b>GCA</b> Dx60	60 (5x12)																
<b>GCA</b> Dx72	72 (6x12)																
<b>GCA</b> Ex84	84 (7x12)	6888	2100	736.1	333.9	∅ 250 ± 15	0.10	2.5	Water-blocking Aramid Yarn	0.54	13.8	3.0/4.3	4000	20	–	207	276
<b>GCA</b> Ex96	96 (8x12)	13448	4100	1437.2	651.9												
<b>GCA</b> Fx08	108 (9x12)	6888	2100	1074.1	487.2	∅ 250 ± 15	0.10	2.5	Water-blocking Aramid Yarn	0.67	17.0	3.0/7.5	4000	20	–	255	340
<b>GCA</b> Fx20	120 (10x12)	13448	4100	2097.0	951.2												
<b>GCA</b> Fx32	132 (11x12)																
<b>GCA</b> Fx44	144 (12x12)																
<b>GCA</b> Mx16	216 (18x12)	6888	2100	1250.0	567.0	∅ 250 ± 15	0.10	2.5	Water-blocking Aramid Yarn	0.72	18.2	2.7	4000	20	–	273	364
		13448	4100	2440.5	1107.0												
<b>GCA</b> Ix92	192 (8x24)	6888	2100	1273.2	577.5	∅ 250 ± 15	0.14	3.5	Water-blocking Aramid Yarn	0.71	18.0	3.0/6.0	4000	20	–	270	360
		13448	4100	2485.7	1127.5												
<b>GCA</b> Jx88	288 (12x24)	6888	2100	1921.3	871.5	∅ 250 ± 15	0.14	3.5	Water-blocking Aramid Yarn	0.88	22.4	3.0/10.5	4000	20	–	336	448
<b>GCA</b> Lx32	432 (18x24)	6888	2100	1944.5	882.0	∅ 250 ± 15	0.14	3.5	Water-blocking Aramid Yarn	0.91	23.2	2.7/3.7	4000	20	–	348	464

Color Code: see chart page 16.23  
Loose tubes: 1. Red, 2. Green, rest of tubes White  
Blind elements: Clear

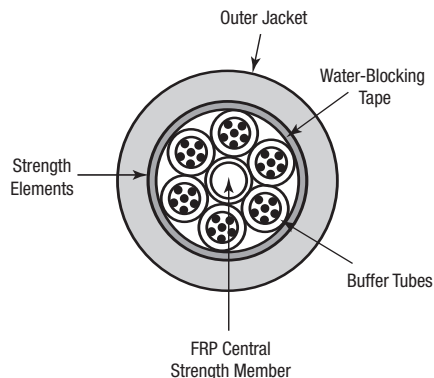

Optical characteristics see page 16.21.  
\* jelly-filled, non-dripping and silicone-free

# Multi Loose Tube Cables

Universal – Indoor/Outdoor

De- scription	Part No.	No. of Fibers	Standard Lengths		Standard Unit Weight		Fiber Size µm	Nom. Buffer/ Tube OD		Strength Members	Nominal OD		Central Element mm	Pulling Tension N	Crush Re- sistance kN/m	Energy kJ/m	Bending Radii Cable (mm)	
			ft.	m	lbs.	kg		inch	mm		inch	mm					static	dyna- mic

**GEA** • Loose Tubes\*/PE Blind Elements are S-Z stranded Around the Central Element • Water-Blocked • **A/I-DF(ZN)H**

**Filled Construction • Black LSZH Jacket**

-30/70°C EN 50266-2-2  
EN 50267-2-2  
EN 50628-2



GEAGx04	4 (1x4)	6888	2100	449.1	203.7	∅ 250 ± 15	0.07	1.9	Water-blocking Aramid Yarn	0.39	10.0	2.0	3000	20	-	150	200
GEAGx06	6 (1x6)	13448	4100	876.8	397.7												
GEAGx08	8 (2x4)																
GEAGx12	12 (2x6)																
GEAGx18	18 (3x6)																
GEAGx24	24 (4x6)																
GEAGx30	30 (5x6)																
GEAGx36	36 (6x6)																
GEADx24	24 (2x12)	6888	2100	620.4	281.4	∅ 250 ± 15	0.10	2.5	Water-blocking Aramid Yarn	0.47	12.0	2.7	3500	20	-	180	240
GEADx36	36 (3x12)	13448	4100	1211.2	549.4												
GEADx48	48 (4x12)																
GEADx60	60 (5x12)																
GEADx72	72 (6x12)																
GEAEx84	84 (7x12)	6888	2100	787.0	357.0	∅ 250 ± 15	0.10	2.5	Water-blocking Aramid Yarn	0.54	13.6	3.0/4.3	4000	20	-	204	272
GEAEx96	96 (8x12)	13448	4100	1536.6	697.0												
GEAFx08	108 (9x12)	6888	2100	1157.4	525.0	∅ 250 ± 15	0.10	2.5	Water-blocking Aramid Yarn	0.66	16.8	3.0/7.5	4000	20	-	252	336
GEAFx20	120 (10x12)	13448	4100	2259.7	1025.0												
GEAFx32	132 (11x12)																
GEAFx44	144 (12x12)																
GEAMx16	216 (18x12)	6888 13448	2100 4100	1342.6 2621.3	609.0 1189.0	∅ 250 ± 15	0.10	2.5	Water-blocking Aramid Yarn	0.69	17.5	2.7	4000	20	-	263	350
GEAlx92	192 (8x24)	6888 13448	2100 4100	1250.0 2440.5	567.0 1107.0	∅ 250 ± 15	0.14	3.5	Water-blocking Aramid Yarn	0.69	17.6	3.0/6.0	4000	20	-	264	352
GEAlx88	288 (12x24)	6888	2100	2013.9	913.5	∅ 250 ± 15	0.14	3.5	Water-blocking Aramid Yarn	0.87	22.1	3.0/10.5	4000	20	-	332	442
GEALx32	432 (18x24)	6888	2100	2129.6	966.0	∅ 250 ± 15	0.14	3.5	Water-blocking Aramid Yarn	0.89	22.5	2.7/3.7	4000	20	-	338	450

Color Code: see chart page 16.23  
Loose tubes: 1. Red, 2. Green, rest of tubes White  
Blind elements: Clear

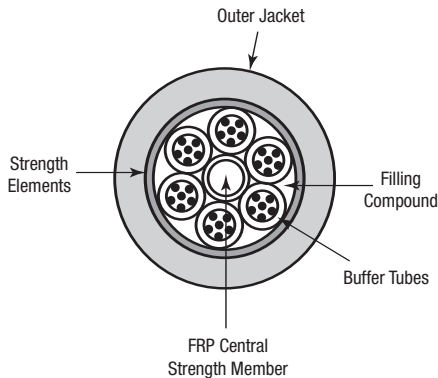

Optical characteristics see page 16.21.  
\* jelly-filled, non-dripping and silicone-free

# Multi Loose Tube Cables

Universal – Indoor/Outdoor, Improved Rodent Protection

De- scription	Part No.	No. of Fibers	Standard Lengths		Standard Unit Weight		Fiber Size µm	Nom. Buffer/ Tube OD		Strength Members	Nominal OD		Central Element mm	Pulling Tension N	Crush Re- sistance kN/m	Energy kJ/m	Bending Radii Cable (mm)	
			ft.	m	lbs.	kg		inch	mm		inch	mm					static	dyna- mic

**GCR • Loose Tubes\*/PE Blind Elements are S-Z Stranded Around the Central Element • Water-Blocked • A/I-DQ(ZN)BH**

**Dry Construction • Black LSZH Jacket**

-30/70°C EN 50266-2-2  
EN 50267-2-2  
EN 50268-2



<b>GCRGx04</b>	4 (1x4)	6888	2100	597.2	270.9	∅ 250 ± 15	0.07	1.9	Water-blocking Glass Yarn	0.46	11.8	2.0	3000	20	-	177	236	
<b>GCRGx06</b>	6 (1x6)	13448	4100	1166.0	528.9													
<b>GCRGx08</b>	8 (2x4)																	
<b>GCRGx12</b>	12 (2x6)																	
<b>GCRGx18</b>	18 (3x6)																	
<b>GCRGx24</b>	24 (4x6)																	
<b>GCRGx30</b>	30 (5x6)																	
<b>GCRGx36</b>	36 (6x6)																	
<b>GCRDx24</b>	24 (2x12)	6888	2100	750.0	340.2	∅ 250 ± 15	0.10	2.5	Water-blocking Glass Yarn	0.54	13.7	2.7	3500	20	-	206	274	
<b>GCRDx36</b>	36 (3x12)	13448	4100	1464.3	664.2													
<b>GCRDx48</b>	48 (4x12)																	
<b>GCRDx60</b>	60 (5x12)																	
<b>GCRDx72</b>	72 (6x12)																	
<b>GCREx84</b>	84 (7x12)	6888	2100	930.6	422.1	∅ 250 ± 15	0.10	2.5	Water-blocking Glass Yarn	0.60	15.3	3.0/4.3	4000	20	-	230	306	
<b>GCREx96</b>	96 (8x12)	13448	4100	1816.8	824.1													
<b>GCRFx08</b>	108 (9x12)	6888	2100	1277.8	579.6	∅ 250 ± 15	0.10	2.5	Water-blocking Glass Yarn	0.73	18.5	3.0/7.5	4000	20	-	278	370	
<b>GCRFx20</b>	120 (10x12)	13448	4100	2494.7	1131.6													
<b>GCRFx32</b>	132 (11x12)																	
<b>GCRFx44</b>	144 (12x12)																	
<b>GCRMx16</b>	216 (18x12)	6888	2100	1481.5	672.0	∅ 250 ± 15	0.10	2.5	Water-blocking Glass Yarn	0.78	19.7	2.7	4000	20	-	296	394	
		13448	4100	2892.4	1312.0													
<b>GCRlx92</b>	192 (8x24)	6888	2100	1481.5	672.0	∅ 250 ± 15	0.14	3.5	Water-blocking Glass Yarn	0.77	19.5	3.0/6.0	4000	20	-	293	390	
		13448	4100	2892.4	1312.0													
<b>GCRJx88</b>	288 (12x24)	6888	2100	2129.6	966.0	∅ 250 ± 15	0.14	3.5	Water-blocking Glass Yarn	0.94	23.9	3.0/10.5	4000	20	-	359	478	
<b>GCRlx32</b>	432 (18x24)	6888	2100	2129.6	966.0	∅ 250 ± 15	0.14	3.5	Water-blocking Glass Yarn	0.97	24.7	2.7/3.7	4000	20	-	371	494	

Color Code: see chart page 16.23  
Loose tubes: 1. Red, 2. Green, rest of tubes White  
Blind elements: Clear

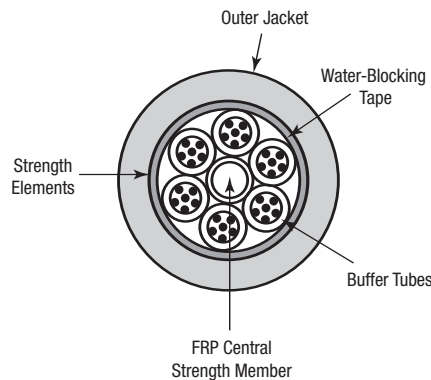

Optical characteristics see page 16.21.  
\* jelly-filled, non-dripping and silicone-free



### Multi Loose Tube Cables

Universal – Indoor/Outdoor, Improved Rodent Protection

De- scription	Part No.	No. of Fibers	Standard Lengths		Standard Unit Weight		Fiber Size µm	Nom. Buffer/ Tube OD		Strength Members	Nominal OD		Central Element mm	Pulling Tension N	Crush Re- sistance kN/m	Energy kJ/m	Bending Radii Cable (mm)	
			ft.	m	lbs.	kg		inch	mm		inch	mm					static	dyna- mic

**GER** • Loose Tubes\*/PE Blind Elements are S-Z Stranded Around the Central Element • Water-Blocked • **A/I-DF(ZN)BH**

**Filled Construction • Black LSZH Jacket**

-30/70°C EN 50266-2-2  
EN 50267-2-2  
EN 50268-2



<b>GERGx04</b>	4 (1x4)	6888	2100	601.9	273.0	∅ 250 ± 15	0.07	1.9	Water-blocking Glass Yarn	0.45	11.5	2.0	3000	20	-	173	230
<b>GERGx06</b>	6 (1x6)	13448	4100	1175.1	533.0												
<b>GERGx08</b>	8 (2x4)																
<b>GERGx12</b>	12 (2x6)																
<b>GERGx18</b>	18 (3x6)																
<b>GERGx24</b>	24 (4x6)																
<b>GERGx30</b>	30 (5x6)																
<b>GERGx36</b>	36 (6x6)																
<b>GERDx24</b>	24 (2x12)	6888	2100	777.8	352.8	∅ 250 ± 15	0.10	2.5	Water-blocking Glass Yarn	0.53	13.4	2.7	3500	20	-	201	268
<b>GERDx36</b>	36 (3x12)	13448	4100	1518.5	688.8												
<b>GERDx48</b>	48 (4x12)																
<b>GERDx60</b>	60 (5x12)																
<b>GERDx72</b>	72 (6x12)																
<b>GEREx84</b>	84 (7x12)	6888	2100	967.6	438.9	∅ 250 ± 15	0.10	2.5	Water-blocking Glass Yarn	0.59	15.0	3.0/4.3	4000	20	-	225	300
<b>GEREx96</b>	96 (8x12)	13448	4100	1889.1	856.9												
<b>GERFx08</b>	108 (9x12)	6888	2100	1333.3	604.8	∅ 250 ± 15	0.10	2.5	Water-blocking Glass Yarn	0.72	18.2	3.0/7.5	4000	20	-	273	364
<b>GERFx20</b>	120 (10x12)	13448	4100	2603.2	1180.8												
<b>GERFx32</b>	132 (11x12)																
<b>GERFx44</b>	144 (12x12)																
<b>GERMx16</b>	216 (18x12)	6888 13448	2100 4100	1527.8 2982.8	693.0 1353.0	∅ 250 ± 15	0.10	2.5	Water-blocking Glass Yarn	0.75	19.0	2.7	4000	20	-	285	380
<b>GERIx92</b>	192 (8x24)	6888 13448	2100 4100	1435.2 2802.0	651.0 1271.0	∅ 250 ± 15	0.14	3.5	Water-blocking Glass Yarn	0.75	19.0	3.0/6.0	4000	20	-	285	380
<b>GERJx88</b>	288 (12x24)	6888	2100	2222.2	1008.0	∅ 250 ± 15	0.14	3.5	Water-blocking Glass Yarn	0.93	23.5	3.0/10.5	4000	20	-	353	470
<b>GERLx32</b>	432 (18x24)	6888	2100	2314.8	1050.0	∅ 250 ± 15	0.14	3.5	Water-blocking Glass Yarn	0.94	24.0	2.7/3.7	4000	20	-	360	480

Color Code: see chart page 16.23  
Loose tubes: 1. Red, 2. Green, rest of tubes White  
Blind elements: Clear

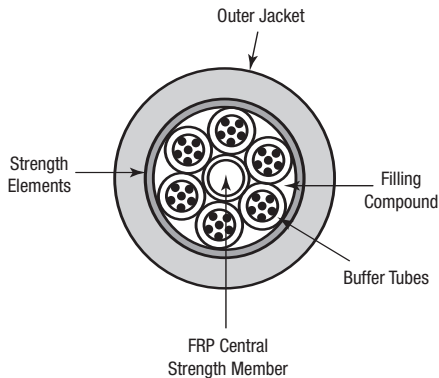

Optical characteristics see page 16.21.  
\* jelly-filled, non-dripping and silicone-free

### Multi Loose Tube Cables

Universal – Indoor/Outdoor, Full Rodent Protection, Corrugated Steel Tape Armor (CST)

De- scription	Part No.	No. of Fibers	Standard Lengths		Standard Unit Weight		Fiber Size µm	Nom. Buffer/ Tube OD		Strength Members	Nominal OD		Central Element mm	Pulling Tension N	Crush Re- sistance kN/m	Energy kJ/m	Bending Radii Cable (mm)	
			ft.	m	lbs.	kg		inch	mm		inch	mm					static	dyna- mic

**GCD** • Loose Tubes\*/PE Blind Elements are S-Z Stranded Around the Central Element • Water-Blocked • CST • **A/I-DQ(ZN)H(SR)H**

**Dry Construction • Double Black LSZH Jacket**

-30/70°C EN 50266-2-2  
EN 50267-2-2  
EN 50268-2



<b>GCDGx04</b>	4 (1x4)	6888	2100	1041.7	472.5	∅ 250 ± 15	0.07	1.9	Water-blocking Aramid Yarn	0.52	13.2	2.0	3000	50	-	198	264
<b>GCDGx06</b>	6 (1x6)	13448	4100	2033.7	922.5												
<b>GCDGx08</b>	8 (2x4)																
<b>GCDGx12</b>	12 (2x6)																
<b>GCDGx18</b>	18 (3x6)																
<b>GCDGx24</b>	24 (4x6)																
<b>GCDGx30</b>	30 (5x6)																
<b>GCDGx36</b>	36 (6x6)																
<b>GCDx24</b>	24 (2x12)	6888	2100	1296.3	588.0	∅ 250 ± 15	0.10	2.5	Water-blocking Aramid Yarn	0.60	15.2	2.7	3500	50	-	228	304
<b>GCDx36</b>	36 (3x12)																
<b>GCDx48</b>	48 (4x12)																
<b>GCDx60</b>	60 (5x12)																
<b>GCDx72</b>	72 (6x12)																
<b>GCDEx84</b>	84 (7x12)	6888	2100	1574.1	714.0	∅ 250 ± 15	0.10	2.5	Water-blocking Aramid Yarn	0.69	17.4	3.0/4.3	4000	50	-	261	348
<b>GCDEx96</b>	96 (8x12)																
<b>GCDFx08</b>	108 (9x12)	6888	2100	2055.6	932.4	∅ 250 ± 15	0.10	2.5	Water-blocking Aramid Yarn	0.81	20.5	3.0/7.5	4000	50	-	308	410
<b>GCDFx20</b>	120 (10x12)																
<b>GCDFx32</b>	132 (11x12)																
<b>GCDFx44</b>	144 (12x12)																
<b>GCDMx16</b>	216 (18x12)	6888	2100	2268.5	1029.0	∅ 250 ± 15	0.10	2.5	Water-blocking Aramid Yarn	0.85	21.5	2.7	4000	50	-	323	430
<b>GCDIx92</b>	192 (8x24)	6888	2100	-	-	∅ 250 ± 15	0.14	3.5	Water-blocking Aramid Yarn	0.85	21.5	3.0/6.0	4000	50	-	323	430
<b>GCDJx88</b>	288 (12x24)	6888	2100	-	-	∅ 250 ± 15	0.14	3.5	Water-blocking Aramid Yarn	1.02	26.0	3.0/10.5	4000	50	-	390	520
<b>GCDLx32</b>	432 (18x24)	6888	2100	-	-	∅ 250 ± 15	0.14	3.5	Water-blocking Aramid Yarn	1.04	26.5	2.7/3.7	4000	50	-	398	530

Color Code: see chart page 16.23  
Loose tubes: 1. Red, 2. Green, rest of tubes White  
Blind elements: Clear

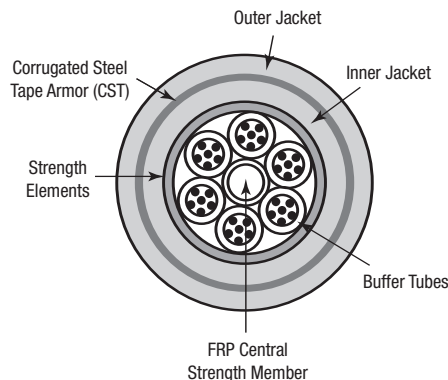

Optical characteristics see page 16.21.  
\* jelly-filled, non-dripping and silicone-free

### Multi Loose Tube Cables

Universal – Indoor/Outdoor, Full Rodent Protection, Corrugated Steel Tape Armor (CST)

De- scription	Part No.	No. of Fibers	Standard Lengths		Standard Unit Weight		Fiber Size µm	Nom. Buffer/ Tube OD		Strength Members	Nominal OD		Central Element mm	Pulling Tension N	Crush Re- sistance kN/m	Energy kJ/m	Bending Radii Cable (mm)	
			ft.	m	lbs.	kg		inch	mm		inch	mm					static	dyna- mic

**GED** • Loose Tubes\*/PE Blind Elements are S-Z Stranded Around the Central Element • Water-Blocked • CST • **A/I-DF(ZN)H(SRJ)H**

**Filled Construction • Double Black LSZH Jacket**

-30/70°C EN 50266-2-2  
EN 50267-2-2  
EN 50268-2



<b>GEDGx04</b>	4 (1x4)	6888	2100	1050.9	476.7	∅ 250 ± 15	0.07	1.9	Water-blocking Aramid Yarn	0.51	13.0	2.0	3000	50	-	195	260
<b>GEDGx06</b>	6 (1x6)	13448	4100	2051.8	930.7												
<b>GEDGx08</b>	8 (2x4)																
<b>GEDGx12</b>	12 (2x6)																
<b>GEDGx18</b>	18 (3x6)																
<b>GEDGx24</b>	24 (4x6)																
<b>GEDGx30</b>	30 (5x6)																
<b>GEDGx36</b>	36 (6x6)																
<b>GEDDx24</b>	24 (2x12)	6888	2100	1324.1	600.6	∅ 250 ± 15	0.10	2.5	Water-blocking Aramid Yarn	0.59	15.0	2.7	3500	50	-	225	300
<b>GEDDx36</b>	36 (3x12)																
<b>GEDDx48</b>	48 (4x12)																
<b>GEDDx60</b>	60 (5x12)																
<b>GEDDx72</b>	72 (6x12)																
<b>GEDEx84</b>	84 (7x12)	6888	2100	1606.5	728.7	∅ 250 ± 15	0.10	2.5	Water-blocking Aramid Yarn	0.67	17.1	3.0/4.3	4000	50	-	257	342
<b>GEDEx96</b>	96 (8x12)																
<b>GEDFx08</b>	108 (9x12)	6888	2100	2101.9	953.4	∅ 250 ± 15	0.10	2.5	Water-blocking Aramid Yarn	0.81	20.5	3.0/7.5	4000	50	-	308	410
<b>GEDFx20</b>	120 (10x12)																
<b>GEDFx32</b>	132 (11x12)																
<b>GEDFx44</b>	144 (12x12)																
<b>GEDMx16</b>	216 (18x12)	6888	2100	2361.1	1071.0	∅ 250 ± 15	0.10	2.5	Water-blocking Aramid Yarn	0.83	21.0	2.7	4000	50	-	315	420
<b>GEDIx92</b>	192 (8x24)	6888	2100	-	-	∅ 250 ± 15	0.14	3.5	Water-blocking Aramid Yarn	0.83	21.0	3.0/6.0	4000	50	-	315	420
<b>GEDJx88</b>	288 (12x24)	6888	2100	-	-	∅ 250 ± 15	0.14	3.5	Water-blocking Aramid Yarn	1.00	25.5	3.0/10.5	4000	50	-	383	510
<b>GEDLx32</b>	432 (18x24)	6888	2100	-	-	∅ 250 ± 15	0.14	3.5	Water-blocking Aramid Yarn	1.02	26.0	2.7/3.7	4000	50	-	390	520

Color Code: see chart page 16.23  
Loose tubes: 1. Red, 2. Green, rest of tubes White  
Blind elements: Clear

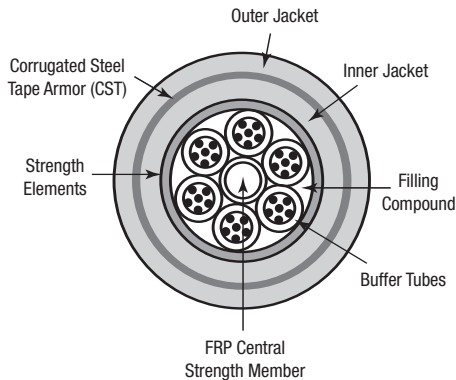

Optical characteristics see page 16.21.  
\* jelly-filled, non-dripping and silicone-free

## Multi Loose Tube Cables

Universal – Indoor/Outdoor, Full Rodent Protection, Galvanised Steel Wire Armor (SWA)

De- scription	Part No.	No. of Fibers	Standard Lengths		Standard Unit Weight		Fiber Size µm	Nom. Buffer/ Tube OD		Strength Members	Nominal OD		Central Element mm	Pulling Tension N	Crush Re- sistance kN/m	Energy kJ/m	Bending Radii Cable (mm)	
			ft.	m	lbs.	kg		inch	mm		inch	mm					static	dyna- mic

**GCW • Loose Tubes\*/PE Blind Elements are S-Z Stranded Around the Central Element • Water-Blocked • SWA • A/I-DQHBH (R1.0vzk)**

**Dry Construction • Double Black LSZH Jacket**

-30/70°C EN 50266-2-2  
EN 50267-2-2  
EN 50268-2

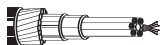

<b>GCWGx04</b> 4 (1x4)	6888	2100	1574.1	714.0	Ø 250 ± 15	0.07	1.9	-	0.54	13.6	2.0	8000	50	-	204	272
<b>GCWGx06</b> 6 (1x6)	13448	4100	3073.2	1394.0												
<b>GCWGx08</b> 8 (2x4)																
<b>GCWGx12</b> 12 (2x6)																
<b>GCWGx18</b> 18 (3x6)																
<b>GCWGx24</b> 24 (4x6)																
<b>GCWGx30</b> 30 (5x6)																
<b>GCWGx36</b> 36 (6x6)																
<b>GCWDx24</b> 24 (2x12)	6888	2100	1912.0	867.3	Ø 250 ± 15	0.10	2.5	-	0.61	15.5	2.7	8000	50	-	233	310
<b>GCWDx36</b> 36 (3x12)	13448	4100	3733.0	1693.3												
<b>GCWDx48</b> 48 (4x12)																
<b>GCWDx60</b> 60 (5x12)																
<b>GCWDx72</b> 72 (6x12)																
<b>GCWEx84</b> 84 (7x12)	6888	2100	2152.8	976.5	Ø 250 ± 15	0.10	2.5	-	0.67	17.0	3.0/4.3	8000	50	-	255	340
<b>GCWEx96</b> 96 (8x12)	13448	4100	4203.1	1906.5												
<b>GCWEx108</b> 108 (9x12)																
<b>GCWFx20</b> 120 (10x12)	13448	4100	5694.5	2583.0												
<b>GCWFx32</b> 132 (11x12)																
<b>GCWFx44</b> 144 (12x12)																
<b>GCWMx16</b> 216 (18x12)	6888	2100	3101.9	1407.0	Ø 250 ± 15	0.10	2.5	-	0.83	21.0	2.7	8000	50	-	315	420
<b>GCWix92</b> 192 (8x24)	6888	2100	-	-	Ø 250 ± 15	0.14	3.5	-	0.83	21.0	3.0/6.0	8000	50	-	315	420
<b>GCWJx88</b> 288 (12x24)	6888	2100	-	-	Ø 250 ± 15	0.14	3.5	-	1.00	25.5	3.0/10.5	8000	50	-	383	510
<b>GCWLx32</b> 432 (18x24)	6888	2100	-	-	Ø 250 ± 15	0.14	3.5	-	1.02	26.0	2.7/3.7	8000	50	-	390	520

Color Code: see chart page 16.23  
Loose tubes: 1. Red, 2. Green, rest of tubes White  
Blind elements: Clear

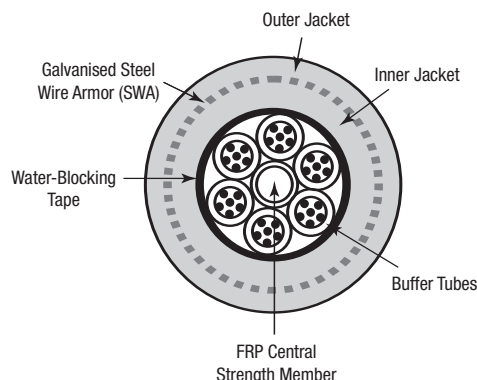

Optical characteristics see page 16.21.  
\* jelly-filled, non-dripping and silicone-free

### Multi Loose Tube Cables

Universal – Indoor/Outdoor, Full Rodent Protection, Galvanised Steel Wire Armor (SWA)

De- scription	Part No.	No. of Fibers	Standard Lengths		Standard Unit Weight		Fiber Size µm	Nom. Buffer/ Tube OD		Strength Members	Nominal OD		Central Element mm	Pulling Tension N	Crush Re- sistance kN/m	Energy kJ/m	Bending Radii Cable (mm)	
			ft.	m	lbs.	kg		inch	mm		inch	mm					static	dyna- mic

**GEW** • Loose Tubes\*/PE Blind Elements are S-Z Stranded Around the Central Element • Water-Blocked • SWA • **A/I-DFHBH (R1.0vzk)**

**Filled Construction • Double Black LSZH Jacket**

-30/70°C EN 50266-2-2  
EN 50267-2-2  
EN 50268-2

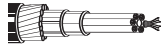

GEWx04	4 (1x4)	6888	2100	1574.1	714.0	Ø 250 ± 15	0.07	1.9	-	0.53	13.5	2.0	8000	50	-	203	270
GEWx06	6 (1x6)	13448	4100	3073.2	1394.0												
GEWx08	8 (2x4)																
GEWx12	12 (2x6)																
GEWx18	18 (3x6)																
GEWx24	24 (4x6)																
GEWx30	30 (5x6)																
GEWx36	36 (6x6)																
GEWd24	24 (2x12)	6888	2100	1944.5	882.0	Ø 250 ± 15	0.10	2.5	-	0.61	15.5	2.7	8000	50	-	233	310
GEWd36	36 (3x12)	13448	4100	3796.3	1722.0												
GEWd48	48 (4x12)																
GEWd60	60 (5x12)																
GEWd72	72 (6x12)																
GEWex84	84 (7x12)	6888	2100	2199.1	997.5	Ø 250 ± 15	0.10	2.5	-	0.66	16.8	3.0/4.3	8000	50	-	252	336
GEWex96	96 (8x12)	13448	4100	4293.5	1947.5												
GEWfx08	108 (9x12)	6888	2100	2963.0	1344.0	Ø 250 ± 15	0.10	2.5	-	0.80	20.2	3.0/7.5	8000	50	-	303	404
GEWfx20	120 (10x12)	13448	4100	5784.9	2624.0												
GEWfx32	132 (11x12)																
GEWfx44	144 (12x12)																
GEWmx16	216 (18x12)	6888	2100	3101.9	1407.0	Ø 250 ± 15	0.10	2.5	-	0.81	20.6	2.7	8000	50	-	309	412
GEWix92	192 (8x24)	6888	2100	-	-	Ø 250 ± 15	0.14	3.5	-	0.81	20.5	3.0/6.0	8000	50	-	308	410
GEWJx88	288 (12x24)	6888	2100	-	-	Ø 250 ± 15	0.14	3.5	-	0.98	25.0	3.0/10.5	8000	50	-	375	500
GEWLx32	432 (18x24)	6888	2100	-	-	Ø 250 ± 15	0.14	3.5	-	1.00	25.5	2.7/3.7	8000	50	-	383	510

Color Code: see chart page 16.23  
Loose tubes: 1. Red, 2. Green, rest of tubes White  
Blind elements: Clear

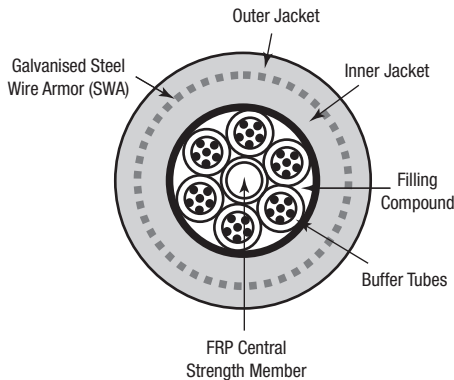

Optical characteristics see page 16.21.  
\* jelly-filled, non-dripping and silicone-free

## Interconnect Cables – Simplex and Duplex

### Tight Buffer – Plenum Rated

#### Applications

- Patch panels
- Workstation equipment connections
- Horizontal distribution in open office environments

#### Product Description

Interconnect cables are designed for low fiber-count premises environments. They are small and very flexible, making them ideal for confined spaces. Their aesthetic appearance makes these cables suitable for use in open office environments. Available in 1 or 2 fibers. One sub-unit is marked to permit easy identification of transmit and receive fibers. Length markings to facilitate installation.

<b>Jacket Material</b>	PVC
<b>Tight Buffer</b>	PVC
<b>Strength Member</b>	Aramid Yarn
<b>Color Code (Tight Buffer)</b>	Per EIA/TIA 598-A, see page 16.24
<b>Jacket Color</b>	
Single-mode	Yellow
62.5/125 μm	Orange
50/125 μm/1 Gbe	Orange
50/125 μm/10 Gbe	Aqua

#### Ratings

##### Plenum

UL Type	OFNP
cUL Type	OFN FT6
Flame resistance	NFPA 262

#### Specifications

<b>Temperature Range</b>	
Storage	-40 to +70°C
Operating	-20 to +70°C
<b>Crush Resistance (EIA-455-41)</b>	200 N/cm
<b>Impact Resistance (EIA-455-25)</b>	20 Impacts @ 1.0 N-m
<b>Cyclic Flexing (EIA-455-104)</b>	2000 cycles, min.
<b>Min. Bend Radius</b>	
Installation	15xOD
Long term	10xOD
<b>Optical Specifications</b>	see page 16.24

#### Fiber Bundle Detail

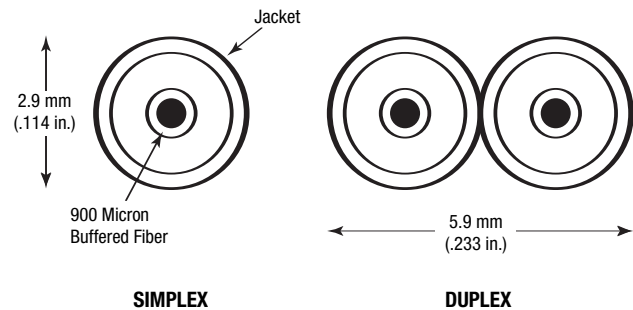

No. of Fibers	Belden Part Number				Outside Diameter		Weight		Max. Install Load	
	62.5/125 μm Std./1 Gbe	50.0/125 μm Std./1 Gbe	50.0/125 μm 10 Gbe - 300M	Single-Mode Enhanced	inch	mm	lbs./1000'	kg/km	lbs.	N

#### Interconnect Cable Series

Plenum (NEC/CEC OFNP/OFN FT6)										
1	M98086	M9A003	M9C003	M9W003	0.114	2.9	6	9	90	400
2	M96919	M9A004	M9C004	M9W004	0.11 x 0.23	2.9 x 5.9	13	19	180	801

## Distribution Cables

### Tight Buffer – Indoor Plenum Rated

#### Applications

- Low to high fiber count requirements
- In-building backbone
- Fiber-to-the-desk applications
- Computer room

#### Product Description

Flexible thermoplastic jacket provides excellent handling characteristics. Fibers and cable sub-units are color coded for easy identification. Length markings in meters for easy determination of cable length. Full dielectric construction, no grounding required. For Riser offering, MSHA approved cables are available.

<b>Jacket Material</b>	
Non-unitized Plenum	PVC
Unitized Plenum	PVDF
<b>Tight Buffer</b>	
Plenum	PVC
<b>Strength Member</b>	
	Aramid Yarn
<b>Color Code (Tight Buffer)</b>	
	Per EIA/TIA 598-A, see page 16.24
<b>Jacket Color</b>	
Single-mode	Yellow
62.5/125 μm	Orange (Green for LSZH only)
50/125 μm/1 Gbe	Orange
50/125 μm/10 Gbe	Aqua

#### Ratings

<b>Plenum</b>	
UL Type	OFNP
cUL Type	OFN FT6
Flame resistance	NFPA 262

#### Specifications

<b>Temperature Range</b>	
Storage	-40 to +80°C
Operating	-20 to +70°C
<b>Crush Resistance (EIA-455-41)</b>	
	2000 N/cm
<b>Impact Resistance (EIA-455-25)</b>	
	2000 Impacts @ 1.6 N-m
<b>Cyclic Flexing (EIA-455-104)</b>	
	2000 cycles, min.
<b>Min. Bend Radius</b>	
Installation	15xOD
Long term	10xOD
<b>Optical Specifications</b>	
	see page 16.24

#### Fiber Bundle Detail

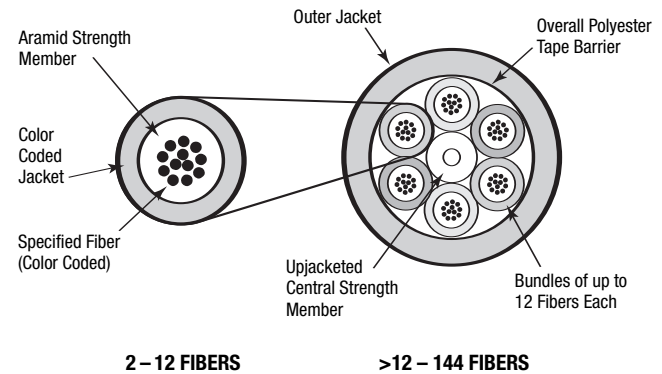

## Distribution Cables

Tight Buffer – Indoor Plenum Rated (*continued*)

No. of Fibers	Belden Part Number				Outside Diameter		Weight		Max. Install Load	
	62.5/125 µm Std./1 Gbe	50.0/125 µm Std./1 Gbe	50.0/125 µm 10 Gbe - 300M	Single-Mode Enhanced	inch	mm	lbs./1000'	kg/km	lbs.	N

### Distribution Cable Series

Plenum (NEC/CEC OFNP/OFN FT6)										
2	M9B043	M9A043	M9C043	M9W043	0.184	4.67	14	21	180	801
4	M9B044	M9A044	M9C044	M9W044	0.174	4.42	13	19	195	867
6	M9B045	M9A045	M9C045	M9W045	0.190	4.83	16	24	270	1201
8	M9B046	M9A046	M9C046	M9W046	0.222	5.64	19	28	270	1201
12	M9B048	M9A048	M9C048	M9W048	0.225	5.72	22	33	300	1334
24	M9B611*	M9A611*	M9C611*	M9W611*	0.330	8.38	40	60	390	1735
24	M9B612	M9A612	M9C612	M9W612	0.493	12.52	89	132	1263	5618
36	M9B614	M9A614	M9C614	M9W614	0.594	15.09	134	199	1913	8509
48	M9B616	M9A616	M9C616	M9W616	0.599	15.21	131	195	1245	5538
72	M9B620	M9A620	M9C620	M9W620	0.754	19.15	197	293	2093	9310
96	M9B623	M9A623	M9C623	M9W623	0.904	22.96	268	399	2160	9608
144	M9B621	M9A621	M9C621	M9W621	1.047	26.59	365	543	3645	16213

Composite Plenum Cables										
6xSM/ 6x62.5	M97174									
6xSM/ 12x62.5	M97041									
12xSM/ 12x62.5	M97219									
6xSM/ 6x50	M97412									
6xSM/ 12x50	M97411									
12xSM/ 12x50	M96780									

Construction for LSZH cables differs from the drawing. Alternative fiber counts are available.  
 \* Single jacket design.



# Breakout Style Cables

## Tight Buffer — Indoor Plenum Rated

### Applications

- Low to medium fiber count requirements
- In-building backbone or horizontal deployment
- Office wiring
- Factory floor automation and harsh environment installations

### Product Description

Full dielectric construction, no grounding required. Available with 2 to 36 fibers. Fiber subunits are color coded for easy identification. Length markings in meters for easy determination of cable length. For riser offering, MSHA approved cables are available.

<b>Outer Jacket Material</b>	
Riser & Plenum	PVC
Plenum	PVDF
<b>Sub-unit Jacket Material</b>	
Riser & Plenum	PVC
<b>Tight Buffer</b>	
Riser & Plenum	PVC
<b>Strength Member</b>	
	Aramid Yarn
<b>Color Code (Tight Buffer)</b>	
	Per EIA/TIA 598-A, see page 16.24
<b>Jacket Color</b>	
Single-mode	Yellow
62.5/125 μm	Orange (Green for LSZH only)
50/125 μm/1 Gbe	Orange
50/125 μm/10 Gbe	Aqua

### Specifications

<b>Temperature Range</b>	
Storage	-40 to +80°C
Operating	-20 to +70°C
<b>Crush Resistance (EIA-455-41)</b>	
	2000 N/cm
<b>Impact Resistance (EIA-455-25)</b>	
	2000 Impacts @ 1.6 N-m
<b>Cyclic Flexing (EIA-455-104)</b>	
	2000 cycles, min.
<b>Min. Bend Radius</b>	
Installation	15xOD
Long term	10xOD
<b>Optical Specifications</b>	
	see page 16.24

### Fiber Bundle Detail

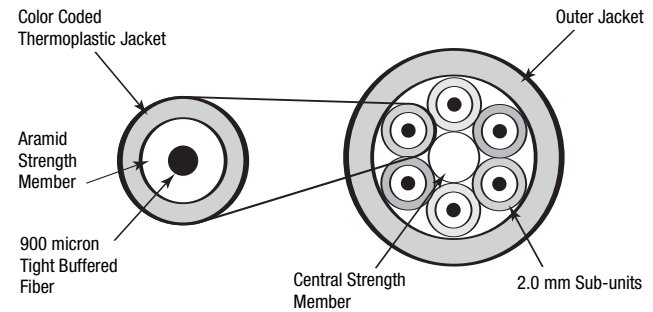

### Ratings

<b>Plenum</b>	
UL Type	OFNP
cUL Type	OFN FT6
Flame resistance	NFPA 262

No. of Fibers	Belden Part Number				Outside Diameter		Weight		Max. Install Load	
	62.5/125 μm Std./1 Gbe	50.0/125 μm Std./1 Gbe	50.0/125 μm 10 Gbe - 300M	Single-Mode Enhanced	inch	mm	lbs./1000'	kg/km	lbs.	N

### Breakout Cable Series

Plenum (NEC/CEC OFNP/OFN FT6)										
2	M9B013	M9A013	M9C013	M9W013	0.230	5.84	20	30	180	801
4	M9B014	M9A014	M9C014	M9W014	0.263	6.68	30	45	345	1535
6	M9B015	M9A015	M9C015	M9W015	0.309	7.85	41	61	465	2068
8	M9B016	M9A016	M9C016	M9W016	0.336	8.53	55	82	600	2700
10	M9B017	M9A017	M9C017	M9W017	0.385	9.78	73	109	600	2700
12	M9B018	M9A018	M9C018	M9W018	0.391	9.93	65	97	600	2700
18	M9B019	M9A019	M9C019	M9W019	0.456	11.58	89	132	600	2700
24	M9B020	M9A020	M9C020	M9W020	0.544	13.82	117	174	600	2700
36	M9B082	M9A082	M9C082	M9W082	0.612	15.54	154	229	600	2700

2.5 mm Breakout Cables are also available.

## Industrial Armored Cables

### Tight Buffer — Indoor Plenum Rated (*continued*)

#### Applications

- Industrial environments
- Rugged installations
- Manufacturing plants
- Mining operations
- Telecommunications and data trunk
- Inter- and intra-building installations

#### Product Description

Heavy duty construction with interlocking aluminum armor (steel available on request) provides excellent mechanical protection from cutting or crushing and eliminates need for innerduct. Rodent resistant. Also available for outside plant. Loose tube design available on request.

<b>Jacket Material</b>		
Plenum	PVC	
<b>Buffer Tube</b>	PVC	
<b>Strength Member</b>	Aramid Yarn	
<b>Central Strength Member</b>	E-Glass	
<b>Armor</b>	Aluminum	
<b>Color Code (Buffer)</b>	Per EIA/TIA 598-A, see page 16.24	
<b>Jacket Color</b>		
Single-mode	Yellow	
62.5/125 μm	Orange	
50/125 μm/1 Gbe	Orange	
50/125 μm/10 Gbe	Aqua	

#### Ratings

<b>Plenum</b>	
UL Type	OFCP
cUL Type	OFC FT6
Flame resistance	NFPA 262

#### Specifications

<b>Temperature Range</b>	
Storage	-40 to +70°C
Operating	-20 to +70°C
<b>Crush Resistance (EIA-455-41)</b>	2000 N/cm
<b>Impact Resistance (EIA-455-25)</b>	2000 Impacts @ 3.0 N-m
<b>Min. Bend Radius</b>	
Installation	20xOD
Long term	15xOD
<b>Optical Specifications</b>	see page 16.24

#### Fiber Bundle Detail

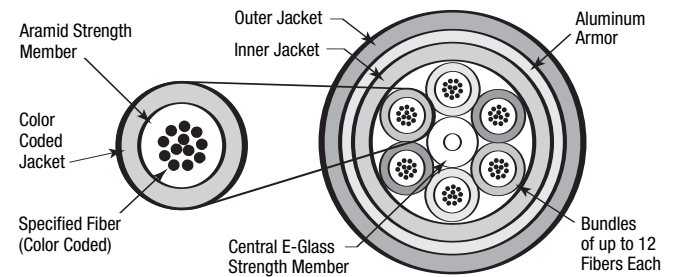

No. of Fibers	Belden Part Number				Outside Diameter		Weight		Max. Install Load	
	62.5/125 μm Std./1 Gbe	50.0/125 μm Std./1 Gbe	50.0/125 μm 10 Gbe - 300M	Single-Mode Enhanced	inch	mm	lbs./1000'	kg/km	lbs.	N

#### Industrial Armored Series

Plenum (NEC/CEC OFCP/OFC FT6)										
6	M9B240	M9A240	M9C240	M9W240	0.471	12.00	87	129	270	1201
12	M9B241	M9A241	M9C241	M9W241	0.506	12.90	103	153	300	1334
24	M9B242*	M9A242*	M9C242*	M9W242*	0.631	16.00	151	225	390	1735
24	M9B243	M9A243	M9C243	M9W243	0.781	19.84	289	430	600	2700
36	M9B244	M9A244	M9C244	M9W244	0.881	22.38	309	460	600	2700
48	M9B245	M9A245	M9C245	M9W245	0.906	23.01	320	476	600	2700
72	M9B246	M9A246	M9C246	M9W246	1.056	26.82	451	671	600	2700
96	M9B247	M9A247	M9C247	M9W247	1.256	31.90	608	905	600	2700
144	M9B248	M9A248	M9C248	M9W248	1.331	33.81	687	1022	600	2700

All optical fiber products can be supplied in compliance with RoHS regulations.  
\*Single jacket design.

# Single Jacket, All Dielectric Cable

## Loose Tube – Indoor/Outdoor Plenum Rated

### Applications

- Medium to high fiber count requirements
- Inter-building duct installations
- Lashed aerial
- Indoor/outdoor
- Campus backbones
- Data centers
- High-density cable trays

### Product Description

Dry water-blocking technology used within tubes and under jacket. Available as plenum rated cable, thereby eliminating the need for service entrance splicing to in-building cable. Small diameter and bend radius facilitate installation in tight spaces. Full dielectric construction, no grounding required. Available with up to 144 fibers. Fibers grouped into sets of 12 for maximum density. Length markings in meters for easy determination of cable length.

<b>Jacket Material</b>	
Non-unitized	PVC
Unitized	PVDF
<b>Buffer Tube</b>	PVC
<b>Strength Member</b>	E-Glass and Aramid Yarn
<b>Central Strength Member</b>	Upjacketed
<b>Color Code (Buffer)</b>	Per EIA/TIA 598-A, see page 16.24
<b>Jacket Color</b>	Black

### Ratings

<b>Plenum</b>	
UL Type	OFNP
cUL Type	OFN FT6
Flame resistance	NFPA 262

### Specifications

<b>Temperature Range</b>	
Storage	-40 to +80°C
Operating	-40 to +70°C
Installation	0 to +60°C
<b>Crush Resistance (EIA-455-41)</b>	2000 N/cm
<b>Impact Resistance (EIA-455-25)</b>	2000 Impacts @ 1.6 N-m
<b>Cyclic Flexing (EIA-455-104)</b>	2000 cycles, min.
<b>Min. Bend Radius</b>	
Installation	20xOD
Long term	15xOD
<b>Optical Specifications</b>	see page 16.24

### Fiber Bundle Detail

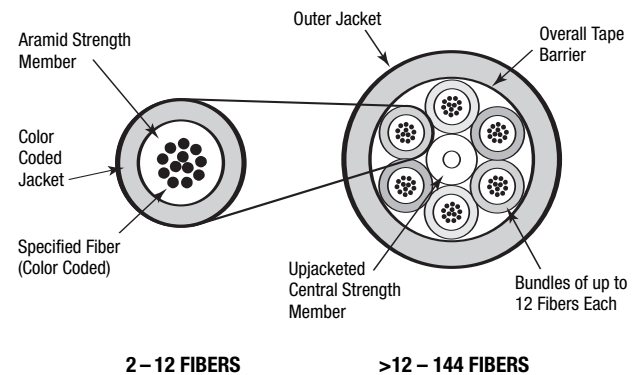

No. of Fibers	Fibers per tube	Belden Part Number				Outside Diameter		Weight		Max. Install Load	
		62.5/125 µm Std./1 Gbe	50.0/125 µm Std./1 Gbe	50.0/125 µm 10 Gbe - 300M	Single-Mode Enhanced	inch	mm	lbs./1000'	kg/km	lbs.	N

### Loose Tube Series

Plenum (NEC/CEC OFNP/OFN FT6)											
6	6	M9B202	M9A202	M9C202	M9W202	0.265	6.70	33	49	320	1423
12	12	M9B204	M9A204	M9C204	M9W204	0.265	6.70	33	49	320	1423
24	12	M9B205	M9A205	M9C205	M9W205	0.359	9.12	47	70	405	1801
36	12	M9B206	M9A206	M9C206	M9W206	0.359	9.12	47	70	405	1801
48	12	M9B207	M9A207	M9C207	M9W207	0.359	9.12	48	71	405	1801
72	12	M9B209	M9A209	M9C209	M9W209	0.429	10.90	71	106	585	2602
96	12	M9B211	M9A211	M9C211	M9W211	0.501	12.73	105	156	903	4017
144	12	M9B215	M9A215	M9C215	M9W215	0.665	16.89	189	281	1263	5618

Alternative fiber counts and hybrid constructions are available.



# Commercial Networking – Training

## Table of Contents

<b>Commercial Networking – Training</b>	<b>Page No.</b>
<b>Overview: Belden IBDN Training</b>	<b>17.2</b>
<b>Course Descriptions/Course Number</b>	<b>17.3–17.6</b>
Intro to Belden Belden IBDN 305	17.3
Project Management Belden IBDN 201/202	17.3
Design and Concept Belden IBDN 303	17.4
Installation Belden IBDN 700	17.4
Copper Products Belden IBDN 726	17.5
Optical Fiber Products Belden IBDN 746	17.5
End-to-End Installation/Testing – Copper Belden IBDN 727	17.6
End-to-End Installation/Testing – Optical Fiber Belden IBDN 747	17.6

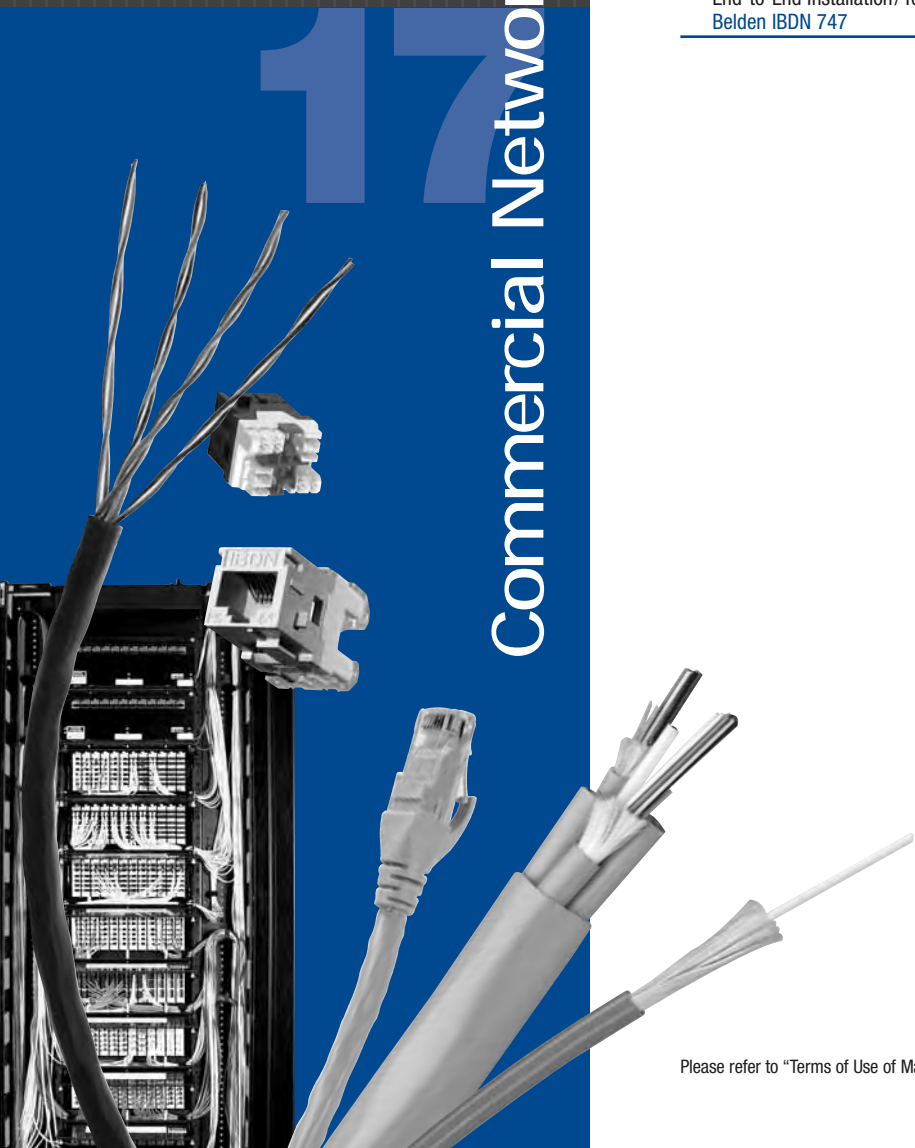

Please refer to "Terms of Use of Master Catalog" on page 23.22.

## Belden IBDN Training

### Overview



#### Ensuring Competency Worldwide

The Belden IBDN training center has been an integral part of the structured cabling industry landscape for over 14 years, having earned an international reputation for delivering the industry's most comprehensive and effective structured cabling training.

This reputation is forged on the experiences of more than 65000 students trained worldwide since 1991. Today, the Belden IBDN training center serves the needs of more than 5000 students each year. Our goal is to provide our students with the skills and knowledge necessary to ensure the highest quality and optimal performance in every Belden IBDN system that they design and install.

Ensuring competency and understanding of new technologies, techniques and industry standards is a key goal in our course development. Each Belden IBDN training course is regularly updated to include the most current information on Belden IBDN products and practices, as well as new developments in cabling industry standards.

#### Learn from the Experts

Belden IBDN instructors have combined experience of well over 100 years in the planning, design and installation of structured cabling systems. In addition to real life experiences, most are BICSI™ accredited RCDD and RCDD/LAN specialists, and many have additional technical credentials from industry leaders such as Microsoft™ and Cisco Systems™. Many of them have taught Belden IBDN courses all around the world, and all have the industry knowledge and professional teaching style that maximizes the learning experience.

#### The Purpose of the Belden IBDN Training Center

To ensure solid and optimal network performance, a cabling system supplier should be evaluated on the following criteria:

- Credibility and industry standing
- System offerings
- Customer care
- Business partners
- Warranty program

Through the Belden IBDN training center, Belden ensures that our students and business partners consistently and accurately represent Belden IBDN systems, products, and installation standards, with the goal of optimizing network performance.

#### For More Information and Registration

For information on course dates, locations and fees, please refer to: [www.beldenibdn.com](http://www.beldenibdn.com). Or contact your nearest Belden office. Please look at the back cover of this catalog for this.

# Belden IBDN Training

## Course Descriptions



### Belden IBDN 305

#### Introduction to Belden

(by correspondence on CD Rom)

#### Who Should Attend:

End-users, networking and structured cabling sales people

#### Course Benefits:

Provides students with an overview of Belden as a leader in telecommunications and offers an overall picture of the Belden IBDN Systems and products, as well as the positioning of Belden in the industry.

#### What will be Covered:

- Introduction to cabling
- Overview of Belden IBDN systems and products, including:
  - GigaFlex cables: 1200, 2400, 4800LX,
  - Bonded-pair cables: DataTwist 350, MediaTwist®, DataTwist® 600e,
  - GigaBIX, FiberExpress, IntelliMAC-Plus, PowerSense and 10GX solutions.
- Certification and exercises
- Case studies
- Reference materials

Prerequisite: None  
 Written Exam: Yes  
 BICSI CECs: RCDD (7),  
 INS, Level 2/Technician (7)

### Belden IBDN 201/202

#### Project Management for Belden IBDN including Belden IBDN System Audit

(2 days)

#### Who Should Attend:

Installation managers, installation supervisors participant must be familiar with Belden IBDN systems as well as the certification program

#### Course Benefits:

Develop the skills to recognize the scale of the project and therefore be prepared to put an efficient work plan in place in order to deliver the project on time.

Gain an understanding of the Belden IBDN system design and installation requirements as related to the Belden IBDN certification program.

Learn how to conduct and write audit reports.

#### What will be Covered:

- Project manager responsibilities
- Project planning
- Project execution
- Project closing
- When, why and how audits are conducted
- Audit preparation
- Audit visit
- Audit report

Prerequisites: Belden IBDN-303\* and Belden IBDN-700\*  
 \*Taken after January 2001

Written Exam: Yes, two  
 BICSI CECs: RCDD (14), RCDD/LAN (14), INS, Level 2/Technician (12), OSP (14), RES (12)

#### General Course Information

- Our courses are recognized by BICSI and earn BICSI Continuing Education Credits (CECs).
- Our courses qualify students by giving them a professional recognition that may accelerate their career advancement.
- In addition to the cabling contractor community, our courses are recognized and valued by end-customers, architects, engineers and consultants as well. If you need to increase your knowledge of structured cabling systems, the Belden IBDN training center is an excellent training investment.
- Our course content is offered in many different languages including English, French, Japanese, Spanish, Mandarin and Cantonese.
- Refresher courses for pre-qualified students are also available.
- Special rates and group discounts are available.
- Fees include a certificate of completion for selected courses, continental breakfast, coffee breaks and course materials.

# Belden IBDN Training

## Course Descriptions

Belden IBDN 303	Belden IBDN 700	
<p><b>Belden IBDN Design and Concept</b>  <i>(2 days – Can also be provided by correspondence on CD Rom)</i></p>	<p><b>Belden IBDN Installation</b>  <i>(2 days)</i></p>	<p><b>What will be Covered (continued):</b></p>
<p><b>Who Should Attend:</b></p> <p>Architects, designers, networking consultants</p>	<p><b>Who Should Attend:</b></p> <p>Belden Certified System Vendor (CSV) installers, and distributors</p>	<ul style="list-style-type: none"> <li>• High-density PS5E/PS6+ patch panel system</li> <li>• PS5E patch box and multi-user box</li> <li>• PS5E DVO outlets, MDVO adapters and EZ-MDVO modules</li> <li>• Optical fiber overview                             <ul style="list-style-type: none"> <li>- Belden IBDN FiberExpress systems and products</li> <li>- Products overview, fiber termination, (1U/2U), (3U) and (4U) patch panel installation</li> </ul> </li> <li>• OPTIMAX field installable connector (ST, SC, LC)</li> </ul>
<p><b>Course Benefits:</b></p> <p>Gain the ability to design a Belden IBDN structured cabling system.</p> <p>Learn about standards and planning procedures related to the installation of structured cabling systems.</p>	<p><b>Course Benefits:</b></p> <p>Develop a fundamental understanding of a Belden IBDN structured cabling system.</p> <p>Gain valuable experience on how to install and maintain a complete Belden IBDN structured cabling system.</p>	<ul style="list-style-type: none"> <li>• Breakout kit installation</li> <li>• 10GX solution overview</li> <li>• Reference materials</li> <li>• 75% In-class exercises</li> </ul> <p>Prerequisite: None                      Written Exam: No                      BICSI CECs: RCDD (14),                      INS, Level 2/Technician (14)</p>
<p><b>What will be Covered:</b></p> <ul style="list-style-type: none"> <li>• Belden IBDN systems and products:                             <ul style="list-style-type: none"> <li>- GigaFlex cables: 1200, 2400, 4800LX,</li> <li>- Bonded-pair cables: DataTwist® 350, MediaTwist®, DataTwist® 600e,</li> <li>- GigaBIX, FiberExpress, IntelliMAC-Plus, PowerSense and 10GX solutions</li> </ul> </li> <li>• Structured cabling overview</li> <li>• Standards update</li> <li>• Horizontal distribution standards</li> <li>• Backbone distribution standards</li> <li>• Entrance facility</li> <li>• Bonding and grounding</li> <li>• Reference materials</li> <li>• 60% In-class exercises</li> </ul> <p>Prerequisite: None                      Written Exam: Yes                      BICSI CECs: RCDD (14),                      INS, Level 2/Technician (14)</p>	<p><b>What will be Covered:</b></p> <ul style="list-style-type: none"> <li>• Belden company overview</li> <li>• Structured cabling history</li> <li>• Standards overview</li> <li>• Belden IBDN systems and products:                             <ul style="list-style-type: none"> <li>- GigaFlex cables: 1200, 2400, 4800LX,</li> <li>- Bonded-pair cables: DataTwist® 350, MediaTwist®, DataTwist® 600e,</li> <li>- GigaBIX and FiberExpress solutions</li> </ul> </li> <li>• Certification overview</li> <li>• Installation preambles for Belden IBDN Systems</li> <li>• Work area products installation:                             <ul style="list-style-type: none"> <li>- GigaFlex Modules, faceplates and workstation outlets</li> </ul> </li> <li>• BIX and GigaBIX solutions:                             <ul style="list-style-type: none"> <li>- IDC system installation</li> <li>- Wall mount, rack-mount patch panel system installation</li> </ul> </li> <li>• Modular jack and patch cord system</li> </ul>	

## Belden IBDN Training

### Course Descriptions

#### Belden IBDN 726

##### Belden IBDN Copper Products

(1 day)

##### Who Should Attend:

Structured cabling installers

##### Course Benefits:

Gain the ability to install copper structured cabling systems.

##### What will be Covered:

- Belden company overview
- Belden IBDN systems and products:
  - GigaFlex cables: 1200, 2400, 4800LX,
  - Bonded-pair cables: DataTwist® 350, MediaTwist®, DataTwist® 600e,
  - GigaBIX
- Installation preambles for Belden IBDN systems
- Work area products installation:
  - GigaFlex modules, faceplates and workstation outlets
- BIX and GigaBIX solutions:
  - IDC system installation
  - Wall mount, rack mount patch panel system installation
- Modular jack and patch cord system
- High-density PS5E/PS6+ patch panel system
- PS5E patch box and multi-user box
- PS5E DVO outlets, MDVO adapters and EZ-MDVO modules
- 10GX solution overview
- Reference materials
- 75% In-Class exercises

Prerequisites: None

Written Exam: No

BICSI CECs: RCDD (7),  
INS, Level 2/Technician (7)

#### Belden IBDN 746

##### Belden IBDN Fiber Products

(1 day)

##### Who Should Attend:

Structured cabling installers

##### Course Benefits:

Gain an understanding of the principles behind optical fiber cabling media.

Gain the ability to install optical fiber components and solutions.

##### What will be Covered:

- Belden company overview
- Optical fiber overview
  - Belden IBDN FiberExpress system and products
  - Products overview, fiber termination, (1U/2U), (3U) and (4U) patch panel installation
- OPTIMAX field installable connector (ST, SC, LC)
- Breakout kit installation
- Reference materials
- 75% In-class exercises

Prerequisite: None

Written Exam: No

BICSI CECs: RCDD (7),  
INS, Level 2/Technician (7)





# Belden IBDN Training

## Course Descriptions

### Belden IBDN 727

**Belden IBDN End-to-End Installation and Testing – Copper Media**  
(2 days)

**Who Should Attend:**

Belden channel partners or employees contractors, technicians, supervisors, engineers and designers

**Course Benefits:**

Learn detailed installation methods of key copper Belden IBDN system components.

Learn appropriate methods and procedures of testing copper Belden IBDN systems.

**What will be Covered:**

- Review Belden IBDN systems and key copper components
- Basic balanced twisted-pair transmission and performance theories
- Installation practice reviews
- Installation and testing of End-to-End systems
- In detail, installation methods of:
  - Copper Belden IBDN systems components,

**Belden IBDN 1200, 2400 and 4800LX Systems including:**

- GigaFlex cables: 1200, 2400 and 4800LX,
- Bonded-pair cables: DataTwist® 350, MediaTwist®, DataTwist® 600e
- Learn testing methods of Belden IBDN systems and how to troubleshoot typical problems
- Understand the correlation between:
  - Basic theories of end-to-end system transmission,
  - Component and system installation practices,
  - Test results and system performances
- 10GX solution overview
- 90% In-class exercises

Prerequisite: None  
 Written Exam: Yes  
 BICSI CECs: RCDD (14),  
 INS, Level 2/Technician (14)

### Belden IBDN 747

**Belden IBDN End-to-End Installation and Testing – Optical Fiber Media**  
(2 days)

**Who Should Attend:**

Belden channel partners or employees contractors, technicians, supervisors, engineers and designers

**Course Benefits:**

Learn detailed installation methods of key Belden IBDN FiberExpress system components.

Learn appropriate methods and procedures of testing Belden IBDN FiberExpress systems.

**What will be Covered:**

- Review Belden IBDN FiberExpress systems and key fiber components
- Basic optical fiber transmission and performance theories
- Installation practice reviews
- Installation and testing of End-to-End systems
- In detail, installation methods of:
  - Belden IBDN FiberExpress system components,
  - Belden IBDN FiberExpress systems including: multimode (FX300, FX600 and FX2000) and single-mode systems
- Learn testing methods of Belden IBDN systems and how to troubleshoot typical problems
- Understand the correlation between:
  - Basic theories of end-to-end system transmission,
  - Component and system installation practices,
  - Test results and system performances
- 90% In-class exercises

Prerequisite: None  
 Written Exam: Yes  
 BICSI CECs: RCDD (14),  
 INS, Level 2/Technician (14)





Industrial Cables

18

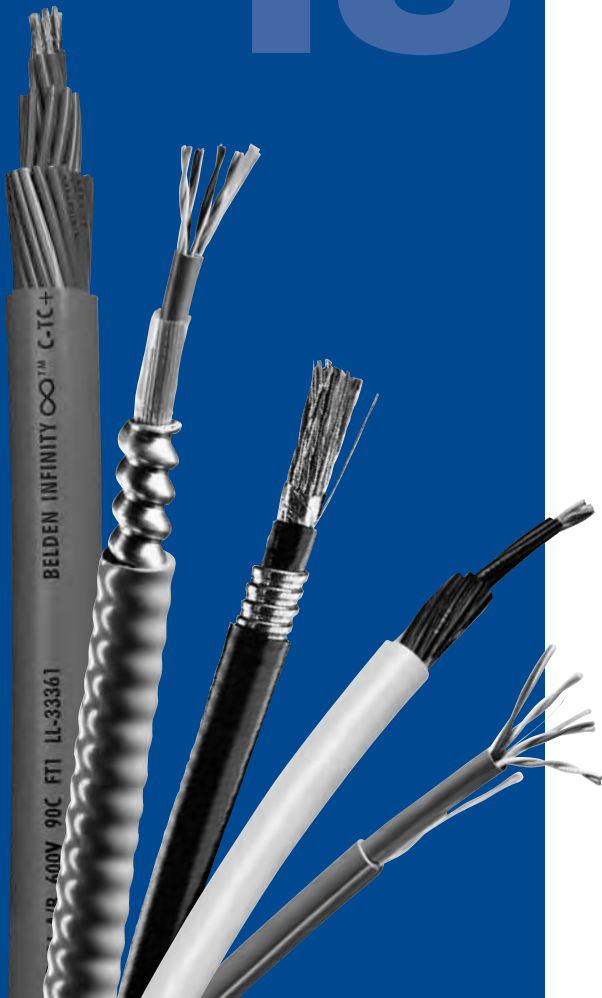

**Table of Contents**

Industrial Automation and Control Cables	Page No.
<b>Introduction</b>	<b>18.2</b>
<b>PLC/DCS Cross Reference Guide</b>	<b>18.3 – 18.4</b>
<b>Industrial Communications Protocol</b>	<b>18.5</b>
<b>Selection Guide: DataTuff® Industrial Ethernet Cables</b>	<b>18.6</b>
<b>Industrial Data Solutions®</b>	<b>18.7 – 18.36</b>
Industrial Ethernet	
Category 5e DataTuff® Twisted Pair Cables, Heavy Duty Sunlight- and Oil-Resistant Jackets	18.7 – 18.11
Coaxial Cables	18.12
Industrial Twinax	
Blue Hose® Cables	18.13 – 18.14
Twinaxial Cables	18.15 – 18.16
DataTray® 600V Twinaxial Cables	18.17
Industrial Coax	
ControlNet™ Quad Shielded Coax	18.18 – 18.19
Industrial Data	
DataBus® ISA/SP-50 FOUNDATION Fieldbus or PROFIBUS Cables	18.20 – 18.21
DeviceBus® for ODVA DeviceNet™ Cables	18.22 – 18.24
DeviceBus® for Honeywell Smart Distributed System Cables	18.25
DeviceBus® for Square D/Seriplex® Cables	18.26
DeviceBus® for Phoenix Contact InterBus®-S Cables	18.27
ASI Bus Flatcable	18.28
EIA Industrial RS-485 PLTC/CM	18.28
CC-Link Cables	18.29
LonWorks Cables	18.30 – 18.31
Low-Capacitance Computer Cables for EIA RS-485 Applications	18.32
Interconnect Cables	
Shielded Twisted Pair Cables	18.33 – 18.35
Industrial Fiber	
Tactical Mobile Fiber	18.36
<b>Selection Guide: Industrial Ethernet Fiber Optic Cables</b>	<b>18.36</b>
<b>Belden Infinity® Flexible Automation Cables</b>	<b>18.37 – 18.38</b>
300V Flex Data Cables (1 Million Flex Cycles)	18.37 – 18.38

ControlNet™ is a ControlNet International trademark.  
ODVA DeviceNet™ is an Open DeviceNet Vendor Association Inc. trademark.  
Seriplex® is a Square D/Schneider AEG registered trademark.

## Introduction



### Tough Cables that Keep Performing.

High performance cabling solutions have changed the face of modern production facilities, manufacturing processes and the industrial infrastructure. Today, industry depends on reliability and demands long life, superb performance, often in the toughest of environments – in practice, that means peace of mind to get on with the job.

### Key applications

- Programmable logic controllers
- Human machine interfaces
- Remote I/O
- 4-20 mA systems (PLTC & TC instrumentation)

### IndustrialTuff™

This is the world's most comprehensive line of industrial cabling solutions – whether for networking factory floor equipment, hardware and controllers or relay-ing data between the control room, the engineering department and remote manufacturing sites or a combination of all the above. Belden industrial cables are designed to provide reliable communication between corporate headquarters and the plant, management and employees and everywhere in between.

### Industrial Solutions

#### • Industrial Ethernet: Networking Cables with Installable Performance™

The reliability of an industrial ethernet network fully depends on the cable infrastructure. Transmission errors can result in lost production time – and even downtime or safety issues. Belden understands the critical nature and demands of each industry and has designed its industrial ethernet cables to provide top performance for different, often very demanding, industrial applications.

Belden's patented bonded-pair cable constructions are included in the range of industrial ethernet products. Bonded-pair technology means installable performance – where cables are designed to withstand the pulling, bending, kinking, coiling and crushing that routinely takes place during installation.

#### • Industrial Data Solutions®

Belden's full range of Industrial Data Solutions® includes cables for all types of bus applications such as Profibus, Fieldbus, DeviceNet™, ControlNet™, InterBus-S®.

Belden practically invented Blue Hose® twinax cables from the original IBM specification; today these are the dominant call-out for PLC and DCS applications.

ControlBus quad shielded coax cables are for ControlNet™ applications – all Belden industrial coax cables provide the dependability for long-lasting performance. Also available is a full range of cables for Profibus and Fieldbus applications, as well as DeviceBus cables for ODVA DeviceNet™ systems.

In addition, Belden offers a wide range of Variable Frequency Drive (VFD) cables, Control and Instrumentation cables and the Infinity® line of flexible automation cables.

#### • Diverse Manufacturing Facilities

Belden cables can have many different characteristics to meet the requirements of different industrial cabling applications. The cables are resistant to:

- Effects of temperature
- UV sunlight
- Oils
- Gasoline
- Other chemical solvents

#### • Belden Infinity® Flexible Automation Cable

Belden Infinity is used when the application requires highly flexible cables offering exceptional life and performance.

##### - Reduced Cable Memory

Belden Infinity's unique design and neutralized cabling, results in cables that are relaxed, with almost no memory.

##### - Greater Flex Life

Belden Infinity cables offer superior flexibility and are able to handle the vigorous motions and high speeds encountered in automated equipment.

##### - Greater System Uptime

Belden Infinity cables combine specialized manufacturing techniques with precision copper stranding and rugged insulation and jacketing compounds to maximize flex life and reliability.

##### - No Talc Problems

Unlike the potentially harmful talc used in other cables, Belden's non-toxic, non-irritating slipper compound facilitates flexing and also complies with OSHA regulations. It's safer for employees and operators and is less likely to contaminate solder joints or mechanical compounds.

##### - CE Conformity

All Belden Infinity cables are CE marked per the Conformité Européenne low voltage directive, allowing trade of product in Europe.

##### - Custom Designs

Other designs available upon request.

#### • Armoring Capabilities

Belden offers both steel wire armor and interlocking (steel or aluminum) armor for extra protection against crushing and abrasion. Other solutions can be tailored to particular requirements.

#### To Specify Part Number:

1	2	3456
Overall Jacket Type	Armor Type	Core Trade Number

#### Overall Jacket Type

Code	Material
1	PVC
3	CPE
4	TPE
5	HDPE
6	Oil Res II
7	Haloarrest®

#### Armor Type

Code	Material
2	Aluminum Interlock
3	Steel Interlock
8	Continuous Corrugated Aluminum

### Availability

Many of these are available off the shelf from distributors. If you have a new or unusual application or you cannot find an Industrial cable in this catalog section that meets your technical requirements, see our U.S. Master Catalog or contact technical support at +31-77-3875-414 or techsupport.venlo@belden.com.

### Corresponding Literature

#### Product Bulletins

CB001: Belden's instrumentation & control capabilities

NP158: Blue Hose® cables

## Introduction



- NP159: DeviceBus® cables for DeviceNet™ applications
- NP164: Profibus® cables for Fieldbus applications
- NP165: Seriplex® cables
- NP177: Cable preparation tool for bonded-pair cables
- NP185: Multimedia cables for analog & digital system controllers

- NP195: IndustrialTuff® ControlBus® Low-loss coax cables
- NP196: Industrial Fieldbus cables
- NP218: Infinity® cables for factory automated systems
- NP224: Cables for variable-frequency AC motor drive applications
- NP231: Belden expands the DataTuff® Category 5e and 6

## PLC/DCS Cable Cross Reference Guide

PLC/DCS Manufacturer	System Name	Belden Part No.	
ABB/ Bailey Controls	Infinet	9880 Network Trunk Cable	
		9463 Blue Hose® (Standard)	
		9463LS Steel Wire Armor (9463)	
		9463NH Low-Smoke, Halogen-Free (9463)	
	Masterpiece 200	9880 Network Trunk Cable 9907 Thin Network Trunk Cable	
	MICRO-DCI	3105A 1 Pair, RS-485	
	MICROLINK	9860 Twinax, 16 AWG, 124 Ohm 9860LS Steel Wire Armor (9860) 9860NH Low-Smoke, Halogen-Free (9860)	
	Modcell	3105A 1 Pair, RS-485	
Allen-Bradley/ Rockwell Automation	ControlNet™	See Protocol Listings on page 18.5	
	DeviceNet™	See Protocol Listings on page 18.5	
	DH	9463 Blue Hose® (Standard)	
		9463LS Steel Wire Armor (9463)	
		9463NH Low-Smoke, Halogen-Free (9463)	
		9463F Flexible Version (9463)	
		129463 Aluminum Armor (9463)	
		139463 Steel Armor (9463)	
		189463 Cast Aluminum (9463)	
		YR28826 Dual Version (9463)	
9463DB Direct Burial (9463)			
YR29565 Various Color Jackets (9463)			
3072F 600V TC Rated (9463)			
YR28764 Super Thick (PLTC)			
89463 FEP* 200°C, Plenum			
DH-485	3074F 600V Tray Cable		
	3106A 1.5 Pair, RS-485 (PLTC)		
	9842 2 Pair, RS-485, NH, LS		
	9842LS Steel Wire Armor (9842)		
	9842NH Low-Smoke, Halogen-Free (9842)		
YM39500 Flexible Version (3106A)			
Longline Communications	8723 Interface Cable		
	88723 Plenum Version		
Cutler-Hammer/ Westinghouse	IMPACC System	YR29090 Proprietary Trunk Cable	
	I/Q System	9463 Blue Hose® (Standard) 9463LS Steel Wire Armor (9463) 9463NH Low-Smoke, Halogen-Free (9463)	
Emerson Process Management (Fisher/Rosemount Controls)	Fieldbus (Type SP50 ISA/IEC)	See Protocol Listings on page 18.5	
	Hart	See Protocol Listings on page 18.5	
	Provox Plus	3094A RG-11 Quad Shield PVC 3131A RG-6 Quad Shield PVC	
GE Fanuc	Genius I/O System	YR29841 PLTC Version 9182 Communications Bus 89182 Plenum Version	
Honeywell	Access 4000 System	9248 RG-6 PVC	
	Fieldbus (Type SP50 ISA/IEC)	See Protocol Listings on page 18.5	
	IPC 620 System	I/O	9271 Twinax, 25 AWG, 124 Ohm
			9729 Up to 1220 m (4000 ft.)
			9182 Up to 3049 m (10000 ft.)
9182 Plenum			
3000 UCN & LCN	3131A RG-6 Quad Shield PVC 9094A RG-11 Quad Shield PVC		

\* Fluorinated Ethylene-Propylene

PLC/DCS Manufacturer	System Name	Belden Part No.
Honeywell Micro-switch Division	Smart Distributed System	3086A Mini 3087A Micro
Invensys/Foxboro	Fieldbus (Type SP50 ISA/IEC)	See Protocol Listings on page 18.5
		I/A Series Carrier Band
	I/A Series Fieldbus	9207 Twinax
		9207NH Low-Smoke, Halogen-Free (9207) 89207 200°C, Plenum 3073F 600V Tray Cable
	Node Bus	9880 Trunk Cable 89880 Plenum Version
Limitorque	DCC 100	3105A Actuator Bus Cable, 1 Pair, RS-485
Matsushita	FP Series C-NET	9207 Twinax, 20 AWG, Stranded, 100 Ohm 9207NH Low-Smoke, Halogen-Free (9207)
		9860 Twinax, 16 AWG, Solid, 124 Ohm 9860LS Steel Wire Armor (9860) 9860NH Low-Smoke, Halogen-Free (9860)
	MEWNET-F	9207 Twinax, 20 AWG, Stranded, 100 Ohm 9207NH Low-Smoke, Halogen-Free (9207)
		9860 Twinax, 16 AWG, Solid, 124 Ohm 9860LS Steel Wire Armor (9860) 9860NH Low-Smoke, Halogen-Free (9860)
	MEWNET-H	9248 RG-6, 75 Ohm, 18 AWG
	MEWNET-TR	9207 Twinax, 20 AWG, Stranded, 100 Ohm 9207NH Low-Smoke, Halogen-Free (9207)
		9860 Twinax, 16 AWG, Solid, 124 Ohm 9860LS Steel Wire Armor (9860) 9860NH Low-Smoke, Halogen-Free (9860)
	MEWNET-W	9207 Twinax, 20 AWG, Stranded, 100 Ohm 9207NH Low-Smoke, Halogen-Free (9207)
		9806 4 Pair, RS-232, RS-422
	MEWNET-W2	9207 Twinax, 20 AWG, Stranded, 100 Ohm 9207NH Low-Smoke, Halogen-Free (9207)
9860 Twinax, 16 AWG, Solid, 124 Ohm 9860LS Steel Wire Armor (9860) 9860NH Low-Smoke, Halogen-Free (9860)		
TRNET	9207 Twinax, 20 AWG, Stranded, 100 Ohm 9207NH Low-Smoke, Halogen-Free (9207) 9860 Twinax, 16 AWG, Solid, 124 Ohm 9860LS Steel Wire Armor (9860) 9860NH Low-Smoke, Halogen-Free (9860)	
Mitsubishi	DeviceNet™	See Protocol Listings on page 18.5
	CC-Link	1348A Three-Conductor 1349A Three-Conductor + Power
	Melsecnet (II) 10/10H	1505A Precision RG-59/U Coax 1505F High Flex (1505A)
		1506A Plenum Precision Rg-59/U, Outdoor, Direct Burial
		8241 Standard RG-59/U Coax 8241F High Flex (8241F)
Profibus DP & FMS	See Protocol Listings on page 18.5	
Serial Communications	8777 Control and Instrumentation Interconnect Cable 8777LS Steel Wire Armor (8777) 8777NH Low-Smoke, Halogen-Free (8777)	

ControlNet™ is a ControlNet International trademark.  
DeviceNet™ is an Open DeviceNet Vendor Association Inc. trademark.  
Seriplex® is a Square D/Schneider AEG registered trademark.



# PLC/DCS Cable Cross Reference Guide

(continued)



PLC/DCS Manufacturer	System Name	Belden Part No.
Modicon/ Schneider AEG	Modbus	8777 Modem Drop Cable, 22 AWG, 3 Pair
		8777LS Steel Wire Armor (8777)
		8777NH Low-Smoke, Halogen-Free (8777)
		128777 Aluminum Armor (8777)
		138777 Steel Armor (8777)
	88777 FEP* 200°C, Plenum	
	Modbus II	3092A RG-6 Quad Shield PVC
		3132A RG-6 Quad Shield, 150°C, Plenum
		3092F RG-6 Quad Shield PVC, Flexible Version
		123092A Aluminum Armor (3092A)
133092A Steel Armor (3092A)		
Modbus Plus	YM29560 24 AWG, 1 Pair, RS-485	
	YC39000 Aluminum Armor (YM29560)	
	YC39222 Steel Armor (YM29560)	
	YQ29258 24 AWG, 1 Pair, 150°C, Plenum	
Remote I/O	3092A RG-6 Quad Shield PVC	
	3092F RG-6 Quad Shield PVC, Flexible Version	
	123092A Aluminum Armor (3092A)	
	133092A Steel Armor (3092A)	
	123092F Aluminum Armor, RG-6 Quad Shield PVC	
	3132A RG-6 Quad Shield, 150°C, Plenum	
	3094A RG-11 Quad Shield PVC	
	123094A Aluminum Armor (3094A)	
	133094A Steel Armor (3094A)	
	3095A RG-11 Quad Shield, 150°C, Plenum	
Omron	AS Interface	See Protocol Listings on page 18.5
	CompoBus/D (DeviceNet™)	See DeviceNet™ Protocol listings on page 18.5
	CompoBus/S	9409 1 Pair, 18 AWG, 300V PLTC Control
		9318 1 Pair, 18 AWG, 300V PLTC Control, Shielded
		3073F 600V Twinax Tray Cable
		3076ENH Fieldbus, Low-Smoke, Halogen-Free
	89740 1 Pair, 18 AWG, 300V Control	
	Controller Link	9207 Twinax
		9207NH Low-Smoke, Halogen-Free (9207)
		89207 Twinax, 200°C, Plenum
9815 100 Ohm Twinax, Direct Burial		
3073F 600V Twinax Tray Cable		
SYSBUS-2	3073F 600V Tray Cable Twinax	
SYSMAC BUS	9841 24 AWG, 1 Pair, RS-485	
	9841LS Steel Wire Armor (9841)	
	9841NH Low-Smoke, Halogen-Free (9841)	
	3105A 22 AWG, 1 Pair, RS-485	
SYSMAC LINK	9231 Coax	
Phoenix Contact	DeviceNet™	See Protocol Listings on page 18.5
	InterBus®-S	See Protocol Listings on page 18.5
	Profibus DP FMS & PA	See Protocol Listings on page 18.5
Reliance/A-B	Auto Max Distributed Power	MTB6002 2 Fiber Breakout 1100255 2 Fiber Loose Tube PVC 1100266 2 Fiber Loose Tube CPE
	R-Net	9259 RG-59 PVC 89259 RG-59, 200°C, Plenum
Rotork	Pakscan II E RS-485	3105A 22 AWG, 1 Pair, RS-485
Siemens/Moore	FMC (Field Mountable Controller)	3105A 1 Pair, RS-485
		3106A 1.5 Pair, RS-485
		3107A 2 Pair, RS-485
		3108A 3 Pair, RS-485
		3109A 4 Pair, RS-485
	Hiway	9860 Network Trunk Cable
		9860LS Steel Wire Armor (9860)
9860NH Low-Smoke, Halogen-Free (9860)		

\* Fluorinated Ethylene-Propylene

PLC/DCS Manufacturer	System Name	Belden Part No.	
Siemens/Moore (continued)	MODULNET	3094A RG-11 Quad Shield PVC 3131A RG-6 Quad Shield PVC	
	Profibus DP & FMS (Purple)	See Protocol Listings on page 18.5	
	Profibus PA (Blue)	See Protocol Listings on page 18.5	
	SINEC Series	H1	9907 Thin Network Trunk Cable 9880 Network Trunk Cable
		H2B	3131A RG-6 Quad Shield 3094A RG-11 Quad Shield
	SINEC Series	L1	31071A 2 Pair, RS-485
		L2	3079A 300V Twinax 3079ALS Steel Wire Armor (3079A) 3079ANH Low-Smoke, Halogen-Free (3079A) 3079E Stranded Conductor (3079A)
	Thicknet Ethernet Trunk	9880 Network Trunk Cable 129880 Aluminum Interlocked Armor Trunk 139880 Steel Interlocked Armor Trunk See Protocol listings on page 18.5	
	Thinnet Ethernet Trunk	9907 Thin Network Trunk Cable See Protocol listings on page 18.5	
	Smar	Fieldbus (Type SP50 ISA/IEC)	See Protocol Listings on page 18.5
Profibus DP, FMS & PA		See Protocol Listings on page 18.5	
RS-485		See Protocol Listings on page 18.5	
Square D/ Schneider AEG	FIP/Fieldbus	3079A 22 AWG, 1 Pair, Shielded 3079ALS Steel Wire Armor (3079A) 3079ANH Low-Smoke, Halogen-Free (3079A) 3079E Stranded Conductor (3079A) 123079A Aluminum Armor (3079A)	
	Model 50, RS-422 Cable	8760 18 AWG, 1 Pair, Shielded 128760 Aluminum Armor (8760)	
	Passport I/O – I/O Net	3105A 22 AWG, 1 Pair, RS-485 123105A Aluminum Armor (3105A) 3106A 22 AWG, 1.5 Pair, RS-485 123106A Aluminum Armor (3106A)	
	Power Logic	9841 24 AWG, 1 Pair, RS-485	
		9841LS Steel Wire Armor (9841)	
		9841NH Low-Smoke, Halogen-Free (9841)	
		9842 24 AWG, 2 Pair, RS-485	
	9842LS Steel Wire Armor (9842)		
	9842NH Low-Smoke, Halogen-Free (9842)		
	Seriplex®	3124A CBL-1822-P20	
3125A CBL-1622-P16			
3126A CBL-162212-P16			
123124A Aluminum Armor (3124A)			
123125A Aluminum Armor (3125A)			
123126A Aluminum Armor (3126A)			
SY/Net Network Trunk Cable	9463 Blue Hose® (Standard)		
	9463F Flexible Version (9463)		
	129463 Aluminum Armor (9463)		
	139463 Steel Armor (9463)		
	189463 Cast Aluminum (9463)		
	YR28826 Dual Version (9463)		
	9463DB Direct Burial (9463)		
YR29565 Various Color Jackets (9463)			
3072F 600V TC Rated (9463)			
YR41194 Low-Smoke, Halogen-Free			
YR28764 Super Thick (PLTC)			
89463 FEP* 200°C, Plenum			
SY/Net TNIM Cable	9272 20 AWG, 1 Pair, Shielded 89272 FEP* 200°C, Plenum		
Yokogawa	Fieldbus (Type SP50 ISA/IEC)	See Protocol Listings on page 18.5	
Westinghouse	WDPF	9292 RG-11 PVC	

ControlNet™ is a ControlNet International trademark.  
 DeviceNet™ is an Open DeviceNet Vendor Association Inc. trademark.  
 InterBus® is a Phoenix Contact trademark.  
 Seriplex® is a Square D/Schneider AEG registered trademark.

## Industrial Communications Protocol

### Cross Reference



System Name	Belden Part No.
AS Interface	3999E Yellow Bus Cable
ControlNet™	3092A RG-6 PVC Quad Shield 3092F RG-6 PVC Quad Shield, Flex Version, Aluminum Braid YR28890 RG-6 PVC Flex Version, Copper Braid 3093A RG-6 FEP* Quad Shield, Plenum
DeviceNet™	3082A PVC (Thick) 3082F High-Flex (Thick) 3082K CL2 (Flat) 3082KP Auxiliary Power (Flat) 3083A CPE (Thick) 3084A PVC (Thin) 3084F High-Flex (Thin) 3085A CPE (Thin) 7895A CL2 PVC (Cable III Mid) 7896A CL1 PVC (Type V Trunk Cable) 7897A CL1 PVC (Thick) 7900A CL1 Unshielded (Drop Cable IV)
Ethernet – Fiber Optic	See Industrial Ethernet Fiber Optic Cable Selection Guide on page 18.36
Ethernet – Thicknet	9880 10 Base 5 Network Trunk Cable 89880 Plenum (9880)
Ethernet – Thinnet	9907 10 Base 2 Network Trunk Cable 89907 Plenum (9907)
Ethernet – Twisted Pair	See DataTuff® Industrial Ethernet Cable Selection Guide on page 18.36
Fieldbus (Type SP50 ISA/IEC)	3076F Type A, H1 1900 m (31.25K) 3076ELS Steel Wire Armor (3076F) 3076ENH Low-Smoke, Halogen-Free (3076F) 3077F Type B, H1 1200 m (31.25K) 3077ELS Steel Wire Armor (3077F) 3077ENH Low-Smoke, Halogen-Free (3077F) 3078F High-Speed (1.0 + 2.5 mbits/s) HSE Copper & Fiber (See Cables for Industrial Ethernet)
Hart	3105A 1 Pair, RS-485 3106A 1.5 Pair, RS-485 3107A 2 Pair, RS-485
InterBus®-S	3119A 18/3C, 24/3 Pair, Composite 3120A 24/3 Pair
Profibus DP & FMS (Purple)	3079A 300V Twinax 3079ALS Steel Wire Armor (3079A) 3079ANH Low-Smoke, Halogen-Free (3079A) 3079E Stranded Conductor (3079A)
Profibus PA (Blue)	3076F 18 AWG, 2 Conductors, Type A 3076ELS Steel Wire Armor (3076F) 3076ENH Low-Smoke, Halogen-Free (3076F)
RS-485/HART/CAN	9841 1 Pair 9841LS Steel Wire Armor (9841) 9841NH Low-Smoke, Halogen-Free (9841) 9842 2 Pair 9842LS Steel Wire Armor (9842) 9842NH Low-Smoke, Halogen-Free (9842) 9843 3 Pair 9843NH Low-Smoke, Halogen-Free (9843) 9844 4 Pair 3105A 1 Pair (PLTC) 3106A 1.5 Pair (PLTC) 3107A 2 Pair (PLTC) 3108A 3 Pair (PLTC) 3109A 4 Pair (PLTC)

\* Fluorinated Ethylene-Propylene

ControlNet™ is a ControlNet International trademark.

DeviceNet™ is an Open DeviceNet Vendor Association Inc. trademark.

InterBus® is a Phoenix Contact trademark.

# Industrial Data Solutions® – Industrial Ethernet



## DataTuff® Industrial Ethernet Cable Selection Guide (See Pages 18.7 – 18.11 for Product Detail.)

Part No.	Pulling Tension	Shielding		Conductor		Installation Stress Resistance†	Environmental Issues			Industrial Grade Jacket					
		Un-shielded	Shielded*	Solid	Stranded**		Oil Resistance	UV Sun-light Resistance	Gasoline Resistance	HI/LO Temp	Heavy	Upjacket	Armored	PVC	LSHN/FRNC
<b>Category 5e</b>															
BEB1212	–	●		●		●	●	●							●
BEB3212	–		●	●		●	●	●							●
7923A	40	●		●		●	●	●							●
7929A	35		●	●		●	●	●							●
7921A	75		●	●		●	●	●							●
11700A	40	●		●		●	●	●					●		●
121700A	40	●		●		●	●	●						●	●
7924A	40	●			●	●	●	●					●		●
7928A	40	●		●		●	●	●	●	●			●		●
7918A	35	●		●		●	●	●					●		●
7919A	25		●	●		●	●	●					●		●
<b>Category 6</b>															
7927A	45	●		●		●	●	●					●		●
7931A	40	●		●		●	●	●	●	●			●		●
11872A	45	●		●		●	●	●					●		●
121872A	45	●		●		●	●	●						●	●

\* Shielded products are recommended for high-noise environments.  
 \*\* Stranded products are recommended where more flexibility is needed.  
 † Products with bonded-pair technology provide Installable Performance™ advantages.

### Cable that Meets the Requirements of EN50170-2-2:1996 for Communications up to 12 Mbaud

	9.6	19.2	93.75	187.5	500.0	1500.0	12000.0
Baud Rate (k baud)	9.6	19.2	93.75	187.5	500.0	1500.0	12000.0
Maximum Trunk Length (m)	1200	1200	1200	1000	400	200	100

### DeviceNet™ Communications Rate Table

Communi-cations Rate	Maximum Distance																			
	3082A		3082F		3082K		3083A		3084F		3084A/3085A		7895A		7896A		7897A		7900A	
	ft.	m	ft.	m	ft.	m	ft.	m	ft.	m	ft.	m	ft.	m	ft.	m	ft.	m	ft.	m
125 Kbps	1640	500	1640	500	1378	420	1640	500	328	100	328	100	984	300	1378	400	1640	500	328	100
250 Kbps	820	250	820	250	656	200	820	250	328	100	328	100	820	250	656	200	820	250	328	100
500 Kbps	328	100	328	100	328	100	328	100	328	100	328	100	328	100	328	100	328	100	328	100

DeviceNet™ is an Open DeviceNet Vendor Association Inc. trademark.

# Industrial Data Solutions® – Industrial Ethernet Cables

Category 5e DataTuff® Twisted Pair Cables  
Heavy Duty Sunlight- and Oil-Resistant Jackets



De-scription	Part No.	UL NEC/ C(UL)/CEC Type IEC	Standard Lengths		Standard Unit Weight		Conductor (Stranding) Diameter Nom. DCR	Nominal Insulation OD		Shielding Material Nom. DCR	Nominal OD		Freq. MHz	Max. Atten. dB/100m	Min. PSUM			Input Imp. (Ω)	Min. RL dB
			ft.	m	lbs.	kg		inch	mm		inch	mm			NEXT dB	ACR dB/100m	ELFEXT dB/100m		

**Cat 5e • 24 AWG • Bonded-Pair • Solid 0.5 mm Bare Copper • Rip Cord**

Polyethylene Insulation • Industrial Grade Sunlight- and Oil-Resistant FRNC/LSNH Jacket (Black and Grey)																					
<p>Rip Cord</p>	<b>BEB1212</b> IEC 60332-1		1000	305	20.1	9.1	0.51 mm 24 AWG Solid BC	0.037	0.95	Bonded-Pair Unshielded	0.217	5.50	1	2.0	62.3	60.3	60.8	100 ± 15	20.0		
			1640	500	33.1	15.0									4	4.1	53.3	49.2	48.7	100 ± 15	23.0
															10	6.3	47.3	41.0	40.8	100 ± 15	25.0
															16	8.0	44.3	36.2	36.7	100 ± 15	25.0
															25	10.1	41.3	31.2	32.8	100 ± 15	25.0
															62.5	16.5	35.4	18.9	24.8	100 ± 15	21.5
				100	21.3	32.3	11.0	20.8	100 ± 15	20.1											

4-Pair  
**EtherNet/IP** Compliant

Color Code: see chart below  
Burning Energy: 400 kJ/m  
RJ-45 Compatible, -25°C Cold Bend

Verified to ISO/IEC 11801 (2nd Edition), EN-50173-1, TIA/EIA-568-B.2, Category 5e  
U.S. Patents 5,606,151 and 5,734,126  
Jacket sequentially marked at 1 m intervals.

**Cat 5e • 24 AWG • Bonded-Pair • Solid 0.5 mm Bare Copper • Overall Beldfoil® Shield + 40% TC Braid • 26 AWG TC Drain Wire**

Polyethylene Insulation • Industrial Grade Sunlight- and Oil-Resistant FRNC/LSNH Jacket (Black, Grey and Blue)																					
<p>4-Pair <b>EtherNet/IP</b> Compliant</p>	<b>BEB3212</b> IEC 60332-1	Heavy Shielded	1000	305	30.9	14.0	0.51 mm 24 AWG Solid BC	0.041	1.05	Bonded-Pair Overall Beldfoil® + Overall 40% TC Braid + Drain Wire (26 AWG TC)	0.262	6.65	1	2.0	62.3	60.3	60.8	100 ± 15	20.0		
			1640	500	50.7	23.0									4	4.1	53.3	49.2	48.7	100 ± 15	23.0
															10	6.5	47.3	40.8	40.8	100 ± 15	25.0
															16	8.2	44.3	36.1	36.7	100 ± 15	25.0
															31.25	11.7	39.9	28.2	30.9	100 ± 15	23.6
															62.5	17.0	35.4	18.4	24.8	100 ± 15	21.5
				100	22.0	32.3	10.3	20.8	100 ± 15	20.1											
				200	32.4	27.8	1.0	14.7	100 ± 15	15.0											

4-Pair  
**EtherNet/IP** Compliant

Color Code: see chart below  
Burning Energy: 575 kJ/m  
RJ-45 Compatible, -25°C Cold Bend

Verified to ISO/IEC 11801 (2nd Edition), EN-50173-1, Category 5e  
U.S. Patents 5,606,151 and 5,734,126  
Jacket sequentially marked at 1 m intervals.

**Enhanced Cat 5e • 24 AWG • Bonded-Pair • Solid 0.5 mm Bare Copper • Overall Beldfoil® Shield • 24 AWG Tinned Copper Drain Wire**

Polyolefin Insulation • Industrial Grade Sunlight- and Oil-Resistant Black PVC Jacket (Black and Blue)																					
<p>4-Pair</p>	<b>7929A</b> NEC: CMR CMX-Outdoor CEC: CMR FT4	Shielded	1000	305	37.0	16.8	0.51 mm 24 AWG Solid BC	0.045	1.14	Bonded-Pair Overall Beldfoil® + Drain Wire (24 AWG TC)	0.265	6.73	1	2.0	62.3	60.3	60.8	100 ± 15	20.0		
			2000	610	72.1	32.7									4	4.1	53.3	49.2	48.7	100 ± 15	23.0
															10	6.5	47.3	40.8	40.8	100 ± 15	25.0
															16	8.2	44.3	36.1	36.7	100 ± 15	25.0
															31.25	11.7	39.9	28.2	30.9	100 ± 15	23.6
															62.5	17.0	35.4	18.4	24.8	100 ± 15	21.5
				100	22.0	32.3	10.3	20.8	100 ± 15	20.1											
				200	32.4	27.8	1.0	14.7	100 ± 15	15.0											

4-Pair

Color Code: see chart below  
RJ-45 Compatible, -25°C Cold Bend  
610 m put-up available in Black only.

Third party verified to TIA/EIA-568-B.2, Category 5e  
U.S. Patents 5,606,151 and 5,734,126  
Shield is bonded to jacket inner wall for electrical stability. Jacket sequentially marked at 0.6 m intervals.

**Enhanced Cat 5e • 24 AWG • Bonded-Pair • Solid 0.5 mm BC • Overall Beldfoil® Shield + 70% TC Braid • 24 AWG Spiral Drain Wire**

Polyolefin Insulation • Industrial Grade Sunlight- and Oil-Resistant Black PVC Jacket (Black, Red, Blue and Teal)																					
<p>4-Pair</p>	<b>7921A</b> NEC: CMR CMX-Outdoor CEC: CMR FT4	Heavy Shielded	1000	305	54.9	24.9	0.51 mm 24 AWG Solid BC	0.047	1.19	Bonded-Pair Overall Beldfoil® + Overall 70% TC Braid + Drain Wire (24 AWG TC)	0.330	8.38	1	2.0	62.3	60.3	60.8	100 ± 15	20.0		
			2000	610	106.0	48.1									4	4.1	53.3	49.2	48.7	100 ± 15	23.6
															10	6.5	47.3	40.8	40.8	100 ± 15	26.0
															16	8.2	44.3	36.1	36.7	100 ± 15	26.0
															31.25	11.7	39.9	28.2	30.9	100 ± 15	25.0
															62.5	17.0	35.4	18.4	24.8	100 ± 15	23.5
				100	22.0	32.3	10.3	20.8	100 ± 15	22.5											

4-Pair

Color Code: see chart below  
-25°C Cold Bend  
610 m put-up available in Black only.

Third party verified to TIA/EIA-568-B.2, Category 5e  
U.S. Patents 5,606,151 and 5,734,126  
Jacket sequentially marked at 0.6 m intervals.

TC = Tinned Copper • BC = Bare Copper • ACR = Attenuation Crosstalk Ratio • ELFEXT = Equal Level Far-end Crosstalk • NEXT = Near-end Crosstalk • PSUM = Power Sum • RL = Return Loss • DCR = DC resistance

**Color Code**

Pair No.	Color
1	White/Blue Stripe, Blue
2	White/Orange Stripe, Orange
3	White/Green Stripe, Green
4	White/Brown Stripe, Brown



For more information, contact Belden Technical Support +31-77-3875-414 • www.belden-emea.com



# Industrial Data Solutions® - Industrial Ethernet Cables

Category 5e DataTuff® Twisted Pair Cables  
Heavy Duty Sunlight- and Oil-Resistant Jackets



De- scription	Part No.	UL NEC/ C(UL)CEC Type IEC	Standard Lengths		Standard Unit Weight		Conductor (Stranding) Diameter Nom. DCR	Nominal Insulation OD		Shielding Material Nom. DCR	Nominal OD		Freq. MHz	Max. Atten. dB/100m	Min. PSUM			Input Imp. (Ω)	Min. RL dB
			ft.	m	lbs.	kg		inch	mm		inch	mm			NEXT dB	ACR dB/100m	ELFEXT dB/100m		

**Enhanced Cat 5e • 24 AWG • Solid 0.5 mm Bare Copper • Rip Cord**

**Polyolefin Insulation • Industrial Grade Sunlight- and Oil-Resistant PVC Jacket (Black and Blue)**

<p>Rip Cord</p>	7918A	NEC:	1000	305	28.0	12.7	0.51 mm	0.037	0.94	Non- Bonded-Pair Unshielded	0.230	5.84	1	2.0	62.3	60.3	60.8	100 ± 15	20.0		
		CMR	2000	610	52.0	23.6	24 AWG								4	4.1	53.3	49.2	48.7	100 ± 15	23.0
		CMX-Outdoor					Solid BC								10	6.5	47.3	40.8	40.8	100 ± 15	25.0
		CEC:													16	8.2	44.3	36.1	36.7	100 ± 15	25.0
		CMR FT4													31.25	11.7	39.9	28.2	30.9	100 ± 15	23.6
															62.5	17.0	35.4	18.4	24.8	100 ± 15	21.5
															100	22.0	32.3	10.3	20.8	100 ± 15	20.1
								200	32.4	27.8	1.0	14.7	100 ± 25	15.0							

4-Pair  
Cable passes -40°C Cold Bend per UL1581  
Installation Temperature: -25°C to +75°C  
Operating Temperature: -40°C to +75°C\*  
610 m put-up available in Black only.

RJ-45 Compatible  
Third party verified to TIA/EIA-568-B.2, Category 5e  
Jacket sequentially marked at 0.6 m intervals.  
Color Code: see chart below

**Enhanced Cat 5e • 24 AWG • Solid 0.5 mm Bare Copper • Overall Beldfoil® Shield • 24 AWG Tinned Copper Drain Wire**

**Polyolefin Insulation • Industrial Grade Sunlight- and Oil-Resistant Black PVC Jacket**

<p>4-Pair</p>	7919A	NEC:	1000	305	35.1	15.9	0.51 mm	0.042	1.07	Non- Bonded-Pair Overall Beldfoil® + Drain Wire (24 AWG TC)	0.265	6.73	1	2.0	62.3	60.3	60.8	100 ± 15	20.0		
		CMR	2000	610	68.1	30.9	24 AWG								4	4.1	53.3	49.2	48.7	100 ± 15	23.0
		CMX-Outdoor					Solid BC								10	6.5	47.3	40.8	40.8	100 ± 15	25.0
		CEC:													16	8.2	44.3	36.1	36.7	100 ± 15	25.0
		CMR FT4													31.25	11.7	39.9	28.2	30.9	100 ± 15	23.6
															62.5	17.0	35.4	18.4	24.8	100 ± 15	21.5
															100	22.0	32.3	10.3	20.8	100 ± 15	20.1

4-Pair  
Cable passes -40°C Cold Bend per UL1581  
Installation Temperature: -25°C to +75°C  
Operating Temperature: -40°C to +75°C\*  
610 m put-up available in Black only.

RJ-45 Compatible  
Third party verified to TIA/EIA-568-B.2, Category 5e • P-07-KA060004-MSHA\*\*  
Shield is bonded to jacket inner wall for electrical stability. Jacket sequentially marked at 0.6 m intervals.  
Color Code: see chart below

**Enhanced Cat 5e • 24 AWG • Bonded-Pair • Solid 0.5 mm Bare Copper • Overall Beldfoil® Shield • 24 AWG Tinned Copper Drain Wire**

**Polyolefin Insulation • Industrial Grade Sunlight- and Oil-Resistant PVC Jacket (Black, Red and Teal)**

<p>2-Pair</p>	7933A	NEC:	1000	305	32.0	14.5	0.51 mm	0.038	0.97	Bonded-Pair Overall Beldfoil® + Drain Wire (24 AWG TC)	0.227	5.77	1	2.0	62.3	60.3	60.8	100 ± 15	20.0		
		CMR FT4	2000	610	64.8	29.4	24 AWG								4	4.1	53.3	49.2	48.7	100 ± 15	23.6
		CEC:					Solid BC								10	6.5	47.3	40.8	40.8	100 ± 15	26.0
		CMR FT4													16	8.2	44.3	36.1	36.7	100 ± 15	26.0
															31.25	11.7	39.9	28.2	30.9	100 ± 15	25.0
															62.5	17.0	35.4	18.4	24.8	100 ± 15	23.5
															100	22.0	32.3	10.3	20.8	100 ± 15	22.5
								200	32.4	27.8	1.0	14.7	100 ± 25	15.0							

2-Pair  
Cable passes -40°C Cold Bend per UL1581  
Installation Temperature: -25°C to +75°C  
Operating Temperature: -40°C to +75°C\*  
610 m put-up available in Black only.

M-12 or RJ-45 Compatible  
Third party verified to TIA/EIA-568-B.2, Category 5e • U.S. Patents 5,606,151 and 5,734,126  
Shield is bonded to jacket inner wall for electrical stability. Jacket sequentially marked at 0.6 m intervals.  
Color Code: see chart below

EtherNet/IP Compliant

**Enhanced Cat 5e • 24 AWG • Bonded-Pair • Solid 0.5 mm Bare Copper**

**Plenum • FEP Insulation • Sunlight-, Oil- and Gas-Resistant Black FEP Jacket**

<p>4-Pair</p>	7928A	NEC:	1000	305	24.0	10.9	0.51 mm	0.036	0.91	Bonded-Pair Unshielded	0.187	4.57	1	2.0	65.3	63.3	60.8	100 ± 12	20.0		
		High & Low Temp	Limited				24 AWG								4	4.0	56.3	52.3	48.7	100 ± 12	23.6
		Oil Res I & II	Combustible				Solid BC								10	6.4	50.3	43.9	40.8	100 ± 12	26.0
		Gas Res	FHC 25/50												16	8.1	47.3	39.1	36.7	100 ± 12	26.0
			CMP												31.25	11.6	42.9	31.3	30.9	100 ± 15	25.0
			CEC:												62.5	16.8	38.4	21.6	24.8	100 ± 15	23.5
			CMP FT6												100	21.7	35.3	17.1	20.8	100 ± 15	22.5
								350	44.3	27.2	-	9.9	100 ± 22	17.0							

4-Pair  
Cable passes -70°C Cold Bend per UL1581  
Installation Temperature: -55°C to +150°C  
Operating Temperature: -70°C to +150°C\*

RJ-45 Compatible • Jacket sequentially marked at 0.6 m intervals.  
Third party verified to TIA/EIA-568-B.2, Category 5e • U.S. Patents 5,606,151 and 5,734,126  
Color Code: see chart below

EtherNet/IP Compliant

TC = Tinned Copper • BC = Bare Copper • ACR = Attenuation Crosstalk Ratio • ELFEXT = Equal Level Far-end Crosstalk • NEXT = Near-end Crosstalk • PSUM = Power Sum • RL = Return Loss • DCR = DC resistance • \* Subject to length de-rating. • \*\* Pennsylvania Department of Environmental Resources and United States Mine Safety and Health Administration Certification.

**Color Code**

Pair No.	Color	Pair No.	Color
1	White/Blue Stripe, Blue	3	White/Green Stripe, Green
2	White/Orange Stripe, Orange	4	White/Brown Stripe, Brown



# Industrial Data Solutions® – Industrial Ethernet Cables

Category 5e DataTuff® Twisted Pair Cables  
Heavy Duty Sunlight- and Oil-Resistant Jackets



De-scription	Part No.	UL NEC / C(UL)/CEC Type IEC	Standard Lengths		Standard Unit Weight		Conductor (Stranding) Diameter Nom. DCR	Nominal Insulation OD		Shielding Material Nom. DCR	Nominal OD		Freq. MHz	Max. Atten. dB/100m	Min. PSUM			Input Imp. (Ω)	Min. RL dB
			ft.	m	lbs.	kg		inch	mm		inch	mm			NEXT dB	ACR dB/100m	ELFEXT dB/100m		

**Enhanced Cat 5e • 24 AWG • Bonded-Pair • Solid 0.5 mm Bare Copper • Twisted Pairs • Rip Cord**

**Polyolefin Insulation • Industrial Grade Sunlight- and Oil-Resistant PVC Jacket (Black, Red or Teal)**

<p>Rip Cord</p> <p>4-Pair</p>	7923A	NEC:	1000	305	28.0	12.7	0.51 mm	0.038	0.97	Bonded-Pair	0.230	5.84	1	2.0	65.3	68.3	60.8	100 ± 12	20.0	
		CMR	2000	610	54.0	24.5	24 AWG			Unshielded				4	4.0	56.3	52.3	48.7	100 ± 12	23.6
		CMX-Outdoor					Solid BC							8	5.7	51.8	46.1	42.7	100 ± 12	25.4
		CEC:												10	6.4	50.3	43.9	40.8	100 ± 12	26.0
		CMR FT4												16	8.1	47.3	39.1	36.7	100 ± 12	26.0
														25	10.3	44.3	34.1	32.1	100 ± 15	25.5
														31.25	11.6	42.9	31.3	30.9	100 ± 15	25.0
														62.5	16.8	38.4	21.6	24.8	100 ± 15	23.5
														100	21.7	35.3	17.1	20.8	100 ± 15	22.5
														155	27.7	32.5	4.7	16.9	100 ± 18	19.0
												200	32.0	30.8	3.0	14.7	100 ± 20	19.0		
												250	36.4	29.3	-	12.8	100 ± 20	18.0		
												350	44.3	27.2	-	9.9	100 ± 22	17.0		

Cable passes -40°C Cold Bend per UL1581  
Installation Temperature: -25°C to +75°C  
Operating Temperature: -40°C to +75°C\*  
610 m put-up available in Black only.

RJ-45 Compatible  
Third party verified to TIA/EIA-568-B.2, Category 5e • U.S. Patents 5,606,151 and 5,734,126  
P-07-KA060003-MSHA\*\*  
Jacket sequentially marked at 0.6 m intervals.

EtherNet/IP Compliant

**Enhanced Cat 5e • 24 AWG • Bonded-Pair • Solid 0.5 mm Bare Copper • Rip Cord**

**Polyolefin Insulation • PVC Inner Jacket • Industrial Grade PVC Outer Jacket (Black, Grey, Red, Teal or Blue)**

<p>Rip Cord</p> <p>4-Pair</p>	Upjacketed 11700A	NEC:	1000	305	39.0	17.7	0.51 mm	0.038	0.97	Bonded-Pair	0.285	7.24							see above	
		CMR	3000	914	117.3	53.2	24 AWG			Unshielded										
		CMX-Outdoor					Solid BC													
		CEC:																		
		CMR FT4																		

Cable passes -40°C Cold Bend per UL1581  
Installation Temperature: -25°C to +75°C  
Operating Temperature: -40°C to +75°C\*  
914 m put-up available in Black only.

RJ-45 Compatible  
Third party verified to TIA/EIA-568-B.2, Category 5e • U.S. Patents 5,606,151 and 5,734,126  
P-07-KA060005-MSHA\*\*  
Outer jacket is sunlight- and oil-resistant. Jacket sequentially marked at 0.6 m intervals.

EtherNet/IP Compliant

**Enhanced Cat 5e • 24 AWG • Bonded-Pair • Solid 0.5 mm Bare Copper • Polyester Wrap • Rip Cord**

**Polyolefin Insulation • PVC Inner Jacket • Interlocked AL Armor • Industrial Grade PVC Outer Jacket (Black or Grey)**

<p>Rip Cord</p> <p>4-Pair CMG</p>	Interlocked AL Armor 121700A	NEC:	1000	305	158.7	72.0	0.51 mm	0.038	0.97	Bonded-Pair	0.530	13.46							see above	
		CM	3000	914	464.3	210.6	24 AWG			Unshielded										
		CEC:					Solid BC													
		HL																		
		CMG FT4																		

Cable passes -40°C Cold Bend per UL1581  
Installation Temperature: -25°C to +75°C  
Operating Temperature: -40°C to +75°C\*  
914 m put-up available in Black only.

RJ-45 Compatible  
Third party verified to TIA/EIA-568-B.2, Category 5e • U.S. Patents 5,606,151 and 5,734,126  
Verified to TIA/EIA-568-B.2, Category 5e  
Outer jacket is sunlight- and oil-resistant. Jacket sequentially marked at 1 m intervals.

TC = Tinned Copper • BC = Bare Copper • ACR = Attenuation Crosstalk Ratio • ELFEXT = Equal Level Far-end Crosstalk • NEXT = Near-end Crosstalk • PSUM = Power Sum • RL = Return Loss • DCR = DC resistance  
\* Subject to length de-rating. • \*\* Pennsylvania Department of Environmental Resources and United States Mine Safety and Health Administration Certification.

**Color Code**

Pair No.	Color
1	White/Blue Stripe, Blue
2	White/Orange Stripe, Orange
3	White/Green Stripe, Green
4	White/Brown Stripe, Brown



# Industrial Data Solutions® - Industrial Ethernet Cables

Category 5e DataTuff® Twisted Pair Cables  
Heavy Duty Sunlight- and Oil-Resistant Jackets



De- scription	Part No.	UL NEC/ C(UL)/CEC Type IEC	Standard Lengths		Standard Unit Weight		Conductor (Stranding) Diameter Nom. DCR	Nominal Insulation OD		Shielding Material Nom. DCR	Nominal OD		Freq. MHz	Max. Atten. dB/100m	Min. PSUM			Input Imp. (Ω)	Min. RL dB
			ft.	m	lbs.	kg		inch	mm		inch	mm			NEXT dB	ACR dB/100m	ELFEXT dB/100m		

**Enhanced Cat 5e • 24 AWG • Bonded-Pair • Stranded (7x32) 0.6 mm Tinned Copper**

**Polyolefin Insulation • Industrial Grade Sunlight- and Oil-Resistant PVC Jacket (Black, Red or Teal)**

Stranded Flexible	<b>7924A</b>	NEC: CMR CMX-Outdoor CEC: CMR FT4	1000	305	30.0	13.6	0.61 mm 24 AWG (7x32) TC	0.039	0.99	Bonded-Pair Unshielded	0.242	6.15	1	2.4	65.3	62.9	60.8	100 ± 12	20.0
			2000	610	58.0	26.3							4	4.8	56.3	51.5	48.7	100 ± 12	23.6
			8	6.8	51.8	45.0							42.7	100 ± 12	25.4				
			10	7.7	50.3	42.6							40.8	100 ± 12	26.0				
			16	9.7	47.3	37.5							36.7	100 ± 12	26.0				
			25	12.4	44.3	31.9							32.8	100 ± 15	25.5				
			31.25	13.9	42.9	29.0							30.9	100 ± 15	25.0				
			62.5	20.2	38.4	18.3							24.8	100 ± 15	23.5				
			100	26.0	35.3	9.2							20.8	100 ± 15	22.5				
			155	33.2	32.5	-							16.9	100 ± 18	19.0				
			200	38.4	30.8	-							14.7	100 ± 20	19.0				
			250	43.7	29.3	-							12.8	100 ± 20	18.0				
			350	53.2	27.2	-							9.9	100 ± 22	17.0				

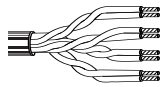

4-Pair

Cable passes -40°C Cold Bend per UL1581  
Installation Temperature: -25°C to +75°C  
Operating Temperature: -40°C to +75°C\*  
610 m put-up available in Black only.

RJ-45 Compatible  
Third party verified to TIA/EIA-568-B.2, Category 5e • U.S. Patents 5,606,151; 5,734,126 and 5,763,823  
Jacket sequentially marked at 0.6 m intervals.  
Color Code: see chart below

**Enhanced Cat 5e • 22 AWG • Bonded-Pair • Solid 0.6 mm Bare Copper • Rip Cord**

**Polyolefin Insulation • Industrial Grade Sunlight- and Oil-Resistant Black PVC Jacket**

PLTC Flexible	<b>7922A</b>	NEC: PLTC CMR CMX-Outdoor CEC: CMR FT4	1000	305	46.3	21.0	0.64 mm 22 AWG Solid BC	0.048	1.22	Bonded-Pair Unshielded	0.301	7.65	1	2.0	65.3	63.3	60.8	100 ± 12	20.0
			2000	610	92.6	42.0							4	4.0	56.3	52.3	48.7	100 ± 12	23.0
			8	5.7	51.8	46.1							42.7	100 ± 12	24.5				
			10	6.4	50.3	43.9							40.8	100 ± 12	25.0				
			16	8.1	47.3	39.1							36.7	100 ± 12	25.0				
			25	10.3	44.3	34.1							32.8	100 ± 15	24.3				
			31.25	11.6	42.9	31.3							30.9	100 ± 15	23.6				
			62.5	16.8	38.4	21.6							24.8	100 ± 15	21.5				
			100	21.7	35.3	17.1							20.8	100 ± 15	20.1				
			155	27.7	32.5	4.7							16.9	100 ± 18	19.0				
			200	32.0	30.8	3.0							14.7	100 ± 20	19.0				
			250	36.4	29.3	-							12.8	100 ± 20	18.0				
			350	44.3	27.2	-							9.9	100 ± 22	17.0				

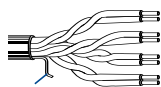

Rip Cord

4-Pair

Cable passes -25°C Cold Bend per UL1581  
Installation Temperature: -10°C to +75°C  
Operating Temperature: -25°C to +75°C\*

Third party verified to TIA/EIA-568-B.2, Category 5e  
U.S. Patents 5,606,151 and 5,734,126  
Jacket sequentially marked at 0.6 m intervals.  
Color Code: see chart below

**Cat 6 • 23 AWG • Bonded-Pair • Solid 0.6 mm Bare Copper**

**Plenum • FEP Insulation • Sunlight-, Oil- and Gas-Resistant Black FEP Jacket**

High & Low Temp Oil Res I & II Gas Res	<b>7931A</b>	NEC: Limited Combustible FHC 25/50 CMP CEC: CMP FT6	1000	305	35.1	15.9	0.57 mm 23 AWG Solid BC	0.038	0.97	Bonded-Pair Unshielded	0.214	5.44	1	2.0	72.3	70.3	64.8	100 ± 15	20.0
			10	6.0	57.3	51.3							44.8	100 ± 15	25.0				
			20	8.5	52.8	44.3							38.7	100 ± 15	25.0				
			31.25	10.7	49.9	39.2							34.9	100 ± 15	23.6				
			62.5	15.4	45.4	30.0							28.8	100 ± 15	21.5				
			100	19.8	42.3	22.5							24.8	100 ± 15	20.1				
			200	29.0	37.8	8.8							18.7	100 ± 22	18.0				
250	32.8	36.3	3.5	16.8	100 ± 32	17.3													

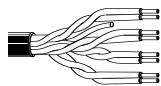

4-Pair

Cable passes -70°C Cold Bend per UL1581  
Installation Temperature: -55°C to +150°C  
Operating Temperature: -70°C to +150°C\*

RJ-45 Compatible  
Third party verified to TIA/EIA-568-B.2-1, Category 6 • U.S. Patents 5,606,151 and 5,734,126  
Jacket sequentially marked at 0.6 m intervals.  
Color Code: see chart below

TC = Tinned Copper • BC = Bare Copper • ACR = Attenuation Crosstalk Ratio • ELFEXT = Equal Level Far-end Crosstalk • NEXT = Near-end Crosstalk • PSUM = Power Sum • RL = Return Loss • DCR = DC resistance  
\* Subject to length de-rating.

**Color Code**

Pair No.	Color
1	White/Blue Stripe, Blue
2	White/Orange Stripe, Orange
3	White/Green Stripe, Green
4	White/Brown Stripe, Brown



# Industrial Data Solutions® – Industrial Ethernet Cables

Category 5e DataTuff® Twisted Pair Cables  
Heavy Duty Sunlight- and Oil-Resistant Jackets



De-scription	Part No.	UL NEC/ C(UL)/CEC Type IEC	Standard Lengths		Standard Unit Weight		Conductor (Stranding) Diameter Nom. DCR	Nominal Insulation OD		Shielding Material Nom. DCR	Nominal OD		Freq. MHz	Max. Atten. dB/100m	Min. PSUM			Input Imp. (Ω)	Min. RL dB
			ft.	m	lbs.	kg		inch	mm		inch	mm			NEXT dB	ACR dB/100m	ELFEXT dB/100m		
<b>Enhanced Cat 6 • 23 AWG • Bonded-Pair • Solid 0.6 mm Bare Copper • Patented E-Spline Center Member • Rip Cord</b>																			
<b>Polyolefin Insulation • Industrial Grade Sunlight- and Oil-Resistant Black PVC Jacket</b>																			
<p>Rip Cord</p> <p>4-Pair</p>	7927A	NEC:	1000	305	44.1	20.0	0.57 mm	0.042	1.07	Bonded-Pair	0.251	6.38	1	1.9	80.3	78.5	70.8	100 ± 12	20.0
		CMR	2000	610	88.0	39.9	23 AWG			Unshielded	x	x	10	5.7	65.3	59.6	50.8	100 ± 12	25.0
		CEC:					Solid BC				0.339	8.61	31.25	10.2	57.9	47.7	40.9	100 ± 15	25.0
		CMR FT4											62.5	14.7	53.4	38.7	34.9	100 ± 15	25.0
													100	18.9	50.3	31.4	30.8	100 ± 15	25.0
													155	23.9	47.5	23.5	27.0	100 ± 15	22.8
													200	27.5	45.8	18.3	24.8	100 ± 15	21.7
													250	31.2	44.3	13.2	22.8	100 ± 20	20.5
													350	37.7	40.2	4.5	19.9	100 ± 22	19.8
													400	40.6	39.3	0.6	18.8	100 ± 22	19.5
											500	46.2	37.8	> 0*	16.8	100 ± 22	18.4		
											550	48.8	37.2	-	16.0	100 ± 22	18.0		
											600	51.4	36.6	-	15.2	100 ± 22	17.6		
Cable passes -40°C Cold Bend per UL1581										RJ-45 Compatible									
Installation Temperature: -25°C to +75°C										Third party verified to TIA/EIA-568-B.2-1, Category 6									
Operating Temperature: -40°C to +75°C*										U.S. Patents 5,606,151; 5,734,126; 5,789,711 and 6,297,454-B1									
										Jacket sequentially marked at 0.6 m intervals.									
* PSUM ACR > 0 is guaranteed to 460 MHz																			

<b>Enhanced Cat 6 • 23 AWG • Bonded-Pair • Solid 0.6 mm Bare Copper • Rip Cord</b>																					
<b>Polyolefin Insulation • PVC Inner Jacket • Industrial Grade PVC Outer Jacket (Black and Grey)</b>																					
<p>Rip Cord</p> <p>4-Pair Mediatwist™ Construction</p>	11872A	NEC:	1000	305	66.1	30.0	0.57 mm	0.041	1.04	Bonded-Pair	0.475	12.07	1	1.9	72.3	70.0	64.8	100 ± 12	20.0		
		CM					23 AWG			Unshielded	x	x	4	3.7	63.3	59.0	52.7	100 ± 12	23.0		
		CEC:					Solid BC				0.265	6.73	10	5.9	57.3	51.0	44.8	100 ± 12	25.0		
		CM											16	7.5	54.3	46.0	40.7	100 ± 12	25.0		
		FT1											Upjacketed O.D.	31.25	10.6	49.9	39.0	34.9	100 ± 15	25.0	
													0.365	9.27	62.5	15.4	45.4	30.0	28.8	100 ± 15	21.5
													x	x	100	19.8	42.3	25.0	24.8	100 ± 15	21.0
													0.165	4.19	155	25.1	39.5	14.0	20.9	100 ± 15	21.0
															200	29.0	37.9	10.0	18.7	100 ± 15	21.0
															310	37.1	34.9	-	14.9	100 ± 20	18.0
													350	39.8	34.2	-	13.9	100 ± 22	17.0		
													400*	43.0	33.3	-	12.7	100 ± 32	14.0		
													500*	49.0	31.8	-	10.8	100 ± 32	14.0		
Cable passes -25°C Cold Bend per UL1581										RJ-45 Compatible											
Installation Temperature: -10°C to +75°C										Verified to TIA/EIA-568-B.2-1, Category 6											
Operating Temperature: -25°C to +75°C*										U.S. Patents 5,606,151, 5,734,126 and 5,821,467											
										Jacket sequentially marked at 0.6 m intervals.											
* Value provided for information only.																					

<b>Enhanced Cat 6 • 23 AWG • Bonded-Pair • Solid 0.6 mm Bare Copper • Polyester Wrap • Rip Cord</b>																					
<b>Polyolefin Insulation • PVC Inner Jacket • Interlocked AL Armor • Industrial Grade PVC Outer Jacket (Black and Grey)</b>																					
<p>Rip Cord</p> <p>4-Pair Mediatwist™ Construction</p>	121872A	NEC:	1000	305	221.8	100.8	0.57 mm	0.041	1.04	Bonded-Pair	0.684	17.37								see above	
		AL Armor					23 AWG			Unshielded											
		CEC:					Solid BC														
		HL																			
		CMG FT4																			
Cable passes -40°C Cold Bend per UL1581										RJ-45 Compatible											
Installation Temperature: -25°C to +75°C										Verified to TIA/EIA-568-B.2-1, Category 6											
Operating Temperature: -40°C to +75°C*										U.S. Patents 5,606,151, 5,734,126 and 5,821,467											
										Jacket sequentially marked at 1 m intervals.											

BC = Bare Copper • ACR = Attenuation Crosstalk Ratio • ELFEXT = Equal Level Far-end Crosstalk • NEXT = Near-end Crosstalk • PSUM = Power Sum • RL = Return Loss • DCR = DC resistance  
\* Subject to length de-rating.

### Color Code

Pair No.	Color
1	White/Blue Stripe, Blue
2	White/Orange Stripe, Orange
3	White/Green Stripe, Green
4	White/Brown Stripe, Brown

# Industrial Data Solutions® – Industrial Ethernet Cables

## Coaxial Cables



De- scription	Part No.	UL NEC/ C(UL)CEC Type IEC	Standard Lengths		Standard Unit Weight		Conductor (Stranding) Diameter Nom. DCR	Nominal Insulation OD		Shielding Material Nom. DCR	Nominal OD		Nom. Imp. (Ω)	Nom. Vel. of Prop.	Nominal Capacitance		Nominal Attenuation		
			ft.	m	lbs.	kg		inch	mm		inch	mm			pF/ft.	pF/m	MHz	dB/ 100 ft.	dB/ 100 m

**Thinnest 10Base2 Ethernet • 20 AWG • Stranded (19x32) 0.9 mm Tinned Copper • Duobond® II • 93% Tinned Copper Braid**

Ethernet • Foam HDPE Insulation • Grey PVC Jacket																				
	30V 60°C	<b>9907</b>	NEC:	500	152	12.6	5.7	0.94 mm	0.102	2.59	Duobond® II	0.185	4.70	50	80%	25.4	83.3	1	0.4	1.4
	UL AWM Style 1354		CL2	U-1000	U-305	25.1	11.4	20 AWG			+ 93% TC							10	1.3	4.3
			CM	1000	305	25.1	11.4	(19x32) TC			Braid							50	2.9	9.5
			CEC:	1640	500	41.0	18.6	47.9 Ω/km*			19.0 Ω/km***							100	4.2	13.8
			CM	3280	1000	82.2	37.3	28.9 Ω/km**										200	6.1	20.0
																	400	8.9	29.2	
																	700	12.1	39.7	
																	900	13.9	45.6	
																	1000	14.8	48.6	

DEC Part No. 17-01248-00

Plenum • Ethernet • Foam FEP Insulation • Grey Fluorocopolymer Jacket																				
	300V 150°C	<b>89907</b>	NEC:	† 500	152	12.6	5.7	0.94 mm	0.095	2.41	Duobond® II	0.160	4.06	50	80%	25.4	83.3	1	0.4	1.4
			CL2P	† 1000	305	24.0	10.9	20 AWG			+ 93% TC							10	1.3	4.3
			CMP	† 2500	762	60.2	27.3	(19x32) TC			Braid							50	2.9	9.5
			CEC:					47.9 Ω/km*			19.0 Ω/km***							100	4.2	13.8
			CMP					28.9 Ω/km**										200	6.1	20.0
																	400	9.2	30.2	
																	700	12.9	42.3	
																	900	15.0	49.2	
																	1000	16.0	52.5	

RG-58/U Type

DEC Part No. 17-01248-00

Suitable for outdoor and direct burial applications.

**Thickest 10Base5 Ethernet • 12 AWG • Solid 2.1 mm Bare Copper • Duobond® IV Quad Shield**

Ethernet • Foam PE Insulation • Yellow PVC Jacket																				
	30V 60°C	<b>9880</b>	NEC:	500	152	66.1	30.0	2.05 mm	0.243	6.17	Duobond® IV	0.405	10.29	50	78%	25.9	85.3	1	0.2	0.6
	UL AWM Style 1478		CL2	1000	305	131.2	59.5	12 AWG			Quad Shield							5	0.4	1.2
			CM	1640	500	220.2	99.9	Solid BC			5.0 Ω/km***							10	0.5	1.7
			CEC:					9.7 Ω/km*										50	1.2	3.9
			CM					4.7 Ω/km**										100	1.7	5.6
																	200	2.6	8.4	
																	400	3.9	12.8	
																	700	5.5	18.1	
																	900	6.5	21.3	
																	1000	6.9	22.6	

DEC Part No. 17-00451-00

Ring-band stripes marked every 2.5 m to aid users in tap placement.

Plenum • Foam FEP Insulation • Orange Fluorocopolymer Jacket																				
	150°C	<b>89880</b>	NEC:	1000	305	134.3	60.9	2.05 mm	0.245	6.22	Duobond® IV	0.375	9.53	50	78%	25.9	85.3			see above
			CL2P	†† 1640	500	225.1	102.1	12 AWG			Quad Shield									
			CMP					Solid BC			5.0 Ω/km***									
			CEC:					9.7 Ω/km*												
			CMP FT6					4.7 Ω/km**												

DEC Part No. 17-00324-00

Ring-band stripes marked every 2.5 m to aid users in tap placement. Suitable for outdoor and direct burial applications.

\* DC loop resistance • \*\* DC resistance inner conductor • \*\*\* DC resistance outer conductor • TC = Tinned Copper • BC = Bare Copper • DCR = DC resistance

† Spools are one piece, but length may vary ±10% from length shown.

†† Final put-up length may vary from length shown ±10% for spools and reels, ±5% for UnReel® cartons.

Duobond® II and Duobond® IV see technical information page 23.13.

# Industrial Data Solutions® – Industrial Twinax

## Blue Hose® Cables



De-scription	Part No.	UL NEC / C(UL)/CEC Type IEC	Standard Lengths		Standard Unit Weight		Conductor (Stranding) Diameter Nom. DCR	Nominal Insulation OD		Shielding Material Nom. DCR	Nominal OD		Nom. Imp. (Ω)	Nom. Vel. of Prop.	Nominal Capacitance		Nominal Attenuation		
			ft.	m	lbs.	kg		inch	mm		inch	mm			pF/ft.	pF/m	MHz	dB/100 ft.	dB/100 m

**20 AWG • Stranded (7x28) 1.0 mm Tinned Copper • Overall Beldfoil® + 55% Tinned Copper Braid • 20 AWG Tinned Copper Drain Wire**

**Polyethylene Insulation • Blue Sunlight-Resistant PVC Jacket**

300V 80°C	<b>9463</b>	NEC:	100	31	4.2	1.9	0.96 mm	0.076	1.92	Overall	0.238	6.05	78	66%	19.7	64.6	1	0.6	2.0
UL AWM Style 2464		CM CL2	U-500	U-152	18.5	8.4	20 AWG			Beldfoil®							10	2.1	6.9
		CEC:	500	152	18.5	8.4	(7x28) TC			+ Overall							50	5.0	16.4
		CM	U-1000	U-305	37.0	16.8				55% TC Braid							100	7.5	24.6
			1000	305	37.0	16.8				+ Drain Wire							200	11.0	36.1
			† 6000	1829	233.9	106.1				(20 AWG TC)							400	16.0	52.5
			† 10000	3048	370.8	168.2													



Z-Fold®

Color Code: Clear, Blue  
305 m, 1829 m and 3048 m put-ups also available in Brown, Orange or Violet.

Allen-Bradley P/N 1770-CD  
P-7K-SC-182141-MSHA\*  
CPE jacket optional.

**Polyethylene Insulation • Blue FRNC/LSNH Jacket**

300V 80°C	<b>9463NH</b>	IEC	1000	305	37.5	17.0	0.96 mm	0.077	1.96	Overall	0.250	6.35	78	66%	19.7	64.6			see above	
		332-3C	1640	500	64.6	29.3	20 AWG			Beldfoil®										
		BS 7655	3280	1000	117.5	53.3	(7x28) TC			+ Overall										
										55% TC Braid										
										+ Drain Wire										
										(20 AWG TC)										



Z-Fold®

Color Code: Clear, Blue

**Polyethylene Insulation • Blue FRNC/LSNH Inner Jacket • Steel Wire Armor • Blue FRNC/LSNH Outer Jacket**

300V 80°C	<b>9463LS</b>	IEC	1640	500	249.1	113.0	0.96 mm	0.077	1.96	Overall	0.250	6.35	78	66%	19.7	64.6			see above	
Steel Wire Armor		332-3C	3280	1000	537.9	244.0	20 AWG			Beldfoil®	0.423	10.75								
		BS 7655	4920	1500	925.9	420.0	(7x28) TC			+ Overall										
										55% TC Braid										
										+ Drain Wire										
										(20 AWG TC)										



Z-Fold®

Color Code: Clear, Blue

**Polyethylene Insulation • Blue Sunlight-Resistant LDPE Jacket**

300V 80°C	<b>9463DB</b>		1000	305	33.1	15.0	0.96 mm	0.076	1.92	Overall	0.240	6.10	78	66%	19.7	64.6			see above	
Flooded			5000	1524	155.2	70.4	20 AWG			Beldfoil®										
Direct Burial							(7x28) TC			+ Overall										
										55% TC Braid										
										+ Drain Wire										
										(20 AWG TC)										



Z-Fold®

Color Code: Clear, Blue

Allen-Bradley P/N 1770-CD

**20 AWG • Stranded (42x36) 1.0 mm Tinned Copper • Overall Beldfoil® + 85% Tinned Copper Braid**

**Polyethylene Insulation • Blue Sunlight-Resistant PVC Jacket**

300V 60°C	<b>9463F</b>	NEC:	1000	305	42.1	19.1	0.97 mm	0.075	1.91	Overall	0.243	6.17	78	66%	19.7	64.6			see above	
UL AWM Style 2464		CM CL2	5000	1524	205.2	93.1	20 AWG			Beldfoil®										
		CEC:					(42x36) TC			+ Overall										
		CM								85% TC Braid										



Z-Fold®

High-Flex

Color Code: Clear, Blue

Allen-Bradley P/N 1770-CD  
P-7K-SC-182141-MSHA\*

TC = Tinned Copper • DCR = DC resistance

† Final put-up length may vary ±10% from length shown.

\* Pennsylvania Department of Environmental Resources and United States Mine Safety and Health Administration Certification.

# Industrial Data Solutions® - Industrial Twinax

## Blue Hose® Cables



De- scription	Part No.	UL NEC/ C(UL)CEC Type IEC	Standard Lengths		Standard Unit Weight		Conductor (Stranding) Diameter Nom. DCR	Nominal Insulation OD		Shielding Material Nom. DCR	Nominal OD		Nom. Imp. (Ω)	Nom. Vel. of Prop.	Nominal Capacitance		Nominal Attenuation		
			ft.	m	lbs.	kg		inch	mm		inch	mm			pF/ft.	pF/m	MHz	dB/ 100 ft.	dB/ 100 m

**20 AWG • Stranded (7x28) 1.0 mm Tinned Copper • Overall Beldfoil® + 76% Tinned Copper Braid • 20 AWG Tinned Copper Drain Wire**

Plenum • FEP Insulation • Blue FEP Jacket																						
 Z-Fold®	300V 200°C	<b>89463</b>	NEC:	1000	305	34.0	15.4	0.96 mm	0.073	1.85	Overall	0.203	5.16	78	66%	19.7	64.6	1	0.6	2.0		
	High Temperature		CMP CL2P	2500	762	90.2	40.9	20 AWG			Beldfoil®								10	2.1	6.9	
			CEC:					(7x28) TC			+ Overall									50	5.0	16.4
			CMP FT6								76% TC Braid									100	7.5	24.6
											+ Drain Wire									200	11.0	36.1
										(20 AWG TC)									400	16.0	52.5	

Color Code: Clear, Blue

Allen-Bradley P/N 1770-CD

**20 AWG • Stranded (7x28) 1.0 mm Tinned Copper • Beldfoil® • 55% Tinned Copper Braid • 20 AWG Tinned Copper Drain Wire**

Polyethylene Insulation • Blue PVC Inner Jacket • Aluminum Interlocked Armor • Blue Sunlight-Resistant PVC Outer Jacket																					
 Aluminum Armored	300V 60°C	<b>129463</b>	NEC:	1000	305	122.4	55.5	0.96 mm	0.076	1.92	Overall	*0.238	*6.05	78	66%	19.7	64.6			see above	
			CM CL2	6000	1829	925.9	420.0	20 AWG			Beldfoil®	**0.563	**14.30								
			CEC:					(7x28) TC			+ Overall										
			CM								55% TC Braid										
			CMG FT4 HLBCD (Haz Loc)								+ Drain Wire										
										(20 AWG TC)											

\* Over Armor  
\*\* Under Armor

Color Code: Clear, Blue

Allen-Bradley P/N 1770-CD

Polyethylene Insulation • Blue PVC Inner Jacket • Steel Armor • Blue Sunlight-Resistant PVC Outer Jacket																					
 Steel Armored	300V 60°C	<b>139463</b>	NEC:	1000	305	220.5	100.0	0.96 mm	0.076	1.92	Overall	*0.238	*6.05	78	66%	19.7	64.6			see above	
			CM CL2	6000	1829	1491.2	676.4	20 AWG			Beldfoil®	**0.563	**14.30								
			CEC:					(7x28) TC			+ Overall										
			CM								55% TC Braid										
			CMG FT4 HLBCD (Haz Loc)								+ Drain Wire										
										(20 AWG TC)											

\* Over Armor  
\*\* Under Armor

Color Code: Clear, Blue

Allen-Bradley P/N 1770-CD

Polyethylene Insulation • Blue PVC Inner Jacket • Continuously Corrugated Aluminum Armor • Blue Sunlight-Resistant PVC Outer Jacket																					
 Continuously Armored	300V 60°C	<b>189463</b>	NEC:	2000	610	258.2	117.1	0.96 mm	0.076	1.92	Overall	*0.238	*6.05	78	66%	19.7	64.6			see above	
			PLTC					20 AWG			Beldfoil®	**0.500	**12.70								
								(7x28) TC			+ Overall										
											55% TC Braid										
											+ Drain Wire										
										(20 AWG TC)											

\* Over Armor  
\*\* Under Armor

Color Code: Clear, Blue

Allen-Bradley P/N 1770-CD

TC = Tinned Copper • DCR = DC resistance

# Industrial Data Solutions® – Industrial Twinax

## Twinaxial Cables



De- scription	Part No.	UL NEC/ C(UL)/CEC Type IEC	Standard Lengths		Standard Unit Weight		Conductor (Stranding) Diameter Nom. DCR	Nominal Insulation OD		Shielding Material Nom. DCR	Nominal OD		Nom. Imp. (Ω)	Nom. Vel. of Prop.	Nominal Capacitance		Nominal Attenuation		
			ft.	m	lbs.	kg		inch	mm		inch	mm			pF/ft.	pF/m	MHz	dB/ 100 ft.	dB/ 100 m

**20 AWG • Stranded (7x28) 1.0 mm One Tinned, One Bare Copper • Duofoil® • 86% Tinned Copper Braid**

**Polyethylene Insulation • Polyethylene Inner Jacket • Black PVC Outer Jacket**

	75°C	<b>9207</b>	NEC:	100	31	7.1	3.2	0.96 mm	0.083	2.11	Overall	0.330	8.38	100	66%	14.5	47.6	1	0.3	1.0
			CMG CL2	U-500	U-152	34.2	15.5	20 AWG			Duofoil®							10	1.2	3.9
			CEC:	500	152	34.6	15.7	(7x28) TC + BC			+ Overall							50	2.8	9.2
			CMG FT4	1000	305	68.1	30.9				86% TC Braid							100	4.1	13.5
				1640	500	111.8	50.7											200	6.4	21.0
				2000	610	136.2	61.8											400	10.2	33.5
				3280	1000	220.2	99.9													
			5000	1524	350.8	159.1														

Color Code: Clear, Clear

IBM P/N 7362211

CPE jacket optional

**Polyethylene Insulation • Black FRNC/LSNH Jacket**

	80°C	<b>9207NH</b>	IEC 332	1000	305	44.3	20.1	0.96 mm	0.077	1.96	Overall	0.339	8.60	100	66%	14.5	47.6			see above	
			BS 7655	1640	500	69.9	31.7	20 AWG			Duofoil®										
				3280	1000	143.7	65.2	(7x28) TC + BC			+ Overall										
											86% TC Braid										

Color Code: Clear, Clear

**16 AWG • Solid 1.3 mm Bare Copper • Duofoil® • 90% Tinned Copper Braid**

**Foam Polyethylene Insulation • Black PVC Jacket**

	30V 60°C	<b>9860</b>	NEC:	500	152	52.0	23.6	1.29 mm	0.161	4.09	Overall	0.440	11.18	124	78%	10.9	35.8	1	0.2	0.6	
	UL AWM Style 2448		CMX	1000	305	103.2	46.8	16 AWG			Duofoil®								10	0.7	2.3
			CEC:	2000	610	202.4	91.8	Solid BC			+ Overall								50	1.8	5.9
			CMX								90% TC Braid								100	2.9	9.5
																			200	4.1	13.5
																			400	6.2	20.3

Color Code: Clear, Blue

CPE jacket optional

**Foam Polyethylene Insulation • Black FRNC/LSNH Jacket**

	80°C	<b>9860NH</b>	IEC 332	1640	500	183.0	83.0	1.29 mm	0.161	4.09	Overall	0.441	11.20	124	78%	10.9	35.8			see above	
			BS 7655	3280	1000	354.9	161.0	16 AWG			Duofoil®										
								Solid BC			+ Overall										
											90% TC Braid										

Color Code: Clear, Blue

**Foam Polyethylene Insulation • FRNC/LSNH Chrome Inner Jacket • Steel Wire Armor • Black FRNC/LSNH Outer Jacket**

	80°C	<b>9860LS</b>	IEC	1640	500	581.8	263.8	1.29 mm	0.161	4.09	Overall	*0.441	*11.20	124	78%	10.9	35.8			see above	
			332-3C	3280	1000	1262.6	572.7	16 AWG			Duofoil®	**0.650	**16.50								
			BS 7655					Solid BC			+ Overall										
											90% TC Braid										

Color Code: Clear, Blue

\* Under Armor

\*\* Over Armor

TC = Tinned Copper • DCR = DC resistance  
Duofoil® see technical information page 23.13.



# Industrial Data Solutions® - Industrial Twinax

## Twinaxial Cables



De- scription	Part No.	UL NEC/ C(UL)CEC Type IEC	Standard Lengths		Standard Unit Weight		Conductor (Stranding) Diameter Nom. DCR	Nominal Insulation OD		Shielding Material Nom. DCR	Nominal OD		Nom. Imp. (Ω)	Nom. Vel. of Prop.	Nominal Capacitance		Nominal Attenuation	
			ft.	m	lbs.	kg		inch	mm		inch	mm			pF/ft.	pF/m	MHz	dB/ 100 ft.

**22 AWG • Stranded (19x34) 0.8 mm Tinned Copper • Duofoil® • 22 AWG Tinned Copper Drain Wire**

<b>Datalene® Insulation • Black PVC Jacket</b>																			
30V 60°C	<b>9182</b>	NEC:	U-500	U-152	22.5	10.2	0.78 mm	0.137	3.49	Overall	0.345	8.76	150	78%	8.8	28.9	1	0.4	1.3
UL AWM Style 2668		CL2X CMX	500	152	22.9	10.4	22 AWG			Duofoil®							10	1.2	3.9
		CEC:	1000	305	44.1	20.0	(19x34) TC			+ Drain Wire							50	2.7	8.9
		CMX								(22 AWG TC)							100	4.3	14.1
																	200	6.2	20.3
																	400	8.8	28.9



VW-1  
 Color Code: Black, Yellow  
 Dual version: YR41609  
 CPE jacket optional.

<b>Datalene® Insulation • Black FRNC/LSNH Jacket</b>																			
300V 80°C	<b>9182NH</b>	IEC 332-1	1000	305	50.3	22.8	0.78 mm	0.136	3.45	Overall	0.346	8.80	150	78%	8.8	28.9	1	0.4	1.3
		BS 7655	1640	500	80.0	36.3	22 AWG			Duofoil®							5	0.9	2.8
			3280	1000	150.1	68.1	(19x34) TC			+ Drain Wire							10	1.2	3.9
										(22 AWG TC)							20	1.7	5.6
																	50	2.7	8.9
																	100	4.3	14.1
																	200	6.2	20.3
																	400	8.8	28.9



Color Code: Black, Yellow

<b>Plenum • Foam FEP Teflon® Insulation • Black FEP Teflon® Jacket</b>																			
	<b>89182</b>	NEC:	100	31	6.4	2.9	0.78 mm	0.139	3.53	Overall	0.307	7.80	150	78%	8.8	28.9	1	0.4	1.3
		CMP	† 500	152	28.0	12.7	22 AWG			Duofoil®							10	1.2	3.9
		CL2P	† 1000	305	53.1	24.1	(19x34) TC			+ Drain Wire							50	2.7	8.9
		CEC:								(22 AWG TC)							100	4.3	14.1
		CMP FT6															200	6.2	20.3
																	400	8.8	28.9



Color Code: Black, Yellow

TC = Tinned Copper • DCR = DC resistance  
 † Spools are one piece, but length may vary ±10% from length shown.

Duofoil® see technical information page 23.13.

Teflon® is a DuPont trademark.

# Industrial Data Solutions® – Industrial Twinax

## DataTray® 600V Twinaxial Cables



De- scription	Part No.	UL NEC/ C(UL)/CEC Type IEC	Standard Lengths		Standard Unit Weight		Conductor (Stranding) Diameter Nom. DCR	Nominal Insulation OD		Shielding Material Nom. DCR	Nominal OD		Nom. Imp. (Ω)	Nom. Vel. of Prop.	Nominal Capacitance		Nominal Attenuation		
			ft.	m	lbs.	kg		inch	mm		inch	mm			pF/ft.	pF/m	MHz	dB/ 100 ft.	dB/ 100 m

**18 AWG • Stranded (7x26) 1.2 mm Tinned Copper • Beldfoil® • 55 % Tinned Copper Braid • 20 AWG Tinned Copper Drain Wire**

**Flame-Retardant Polyolefin Insulation • Blue Sunlight-Resistant PVC Jacket**

600V 75°C UL Type TC	<b>3072F</b>	NEC:	250	76	17.6	8.0	1.22 mm	0.096	2.44	Overall Beldfoil®	0.324	8.23	78	65%	19.5	64.0	1	0.5	1.7
		CMG, ITC	500	152	35.1	15.9	18 AWG			+ Overall							10	2.0	6.6
		TC, PLTC	1000	305	69.0	31.3	(7x26) TC			55% TC Braid							50	3.8	12.4
		CEC:	2500	762	170.2	77.2				+ Drain Wire							100	5.4	17.6
		CMG FT4	5000	1524	345.2	156.6				(20 AWG TC)							200	7.6	24.8
			10000	3049	710.5	322.3											400	10.7	35.1



Z-Fold®

VW-1

Color Code: Natural, Blue

For CPE jacketed version order Part No. YM45044  
P-MSHA-C-7K-1827\*

**Flame-Retardant Polyolefin Insulation • Blue Sunlight-Resistant PVC Jacket**

600V 75°C UL Type TC	<b>3073F</b>	NEC:	250	76	20.9	9.5	1.22 mm	0.123	3.12	Overall Beldfoil®	0.388	9.86	100	65%	15.3	50.2	1	0.4	1.3
		CMG, ITC	1000	305	85.1	38.6	18 AWG			+ Overall							10	1.3	4.4
		TC, PLTC	5000	1524	420.4	190.7	(7x26) TC			55% TC Braid							50	3.0	9.7
		CEC:								+ Drain Wire							100	4.2	13.8
		CMG FT4								(20 AWG TC)							200	5.9	19.5
																	400	7.5	24.7



Z-Fold®

Color Code: Natural, Blue

CPE jacket optional.

**Flame-Retardant Polyolefin Insulation • Blue Sunlight-Resistant PVC Jacket**

600V 75°C UL Type TC	<b>3074F</b>	NEC:	500	152	62.6	28.4	1.22 mm	0.164	4.17	Overall Beldfoil®	0.460	11.68	124	65%	12.3	40.3	1	0.3	1.1
		CMG, ITC	1000	305	121.0	54.9	18 AWG			+ Overall							10	1.1	3.5
		TC, PLTC	2500	762	300.3	136.2	(7x26) TC			55% TC Braid							50	2.4	7.8
		CEC:								+ Drain Wire							100	3.4	11.1
		CMG FT4								(20 AWG TC)							200	4.8	15.7
																	400	6.8	22.2



Z-Fold®

Color Code: Natural, Blue

CPE jacket optional.

TC = Tinned Copper • DCR = DC resistance

\* Pennsylvania Department of Environmental Resources and United States Mine Safety and Health Administration Certification.

**Industrial Data Solutions® – Industrial Coax**

**ControlNet™ Quad Shielded Coax**



De- scription	Part No.	UL NEC/ C(UL)CEC Type IEC	Standard Lengths		Standard Unit Weight		Conductor (Stranding) Diameter Nom. DCR	Nominal Insulation OD		Shielding Material Nom. DCR	Nominal OD		Nom. Imp. (Ω)	Nom. Vel. of Prop.	Nominal Capacitance		Nominal Attenuation	
			ft.	m	lbs.	kg		inch	mm		inch	mm			pF/ft.	pF/m	MHz	dB/ 100 ft.

**18 AWG • Solid 1.0 mm Copper-Covered Steel • Duobond® IV Quad Shield**

**Foam Polyethylene Insulation • PVC Jacket (Black or Intrinsically Safe Blue)**

	<b>3092A</b>	NEC:	500	152	20.1	9.1	1.02 mm	0.180	4.57	Duobond® IV Quad Shield 11.8 Ω/km***	0.298	7.57	75	82%	16.2	53.1	1	0.3	1.1
		CL2R CMR	1000	305	39.0	17.7	18 AWG								2	0.4	1.2		
		CEC:	2000	610	78.0	35.4	Solid CCS								5	0.5	1.5		
		CMG FT4	2500	762	92.6	42.0	103.6 Ω/km*								10	0.6	1.9		
							91.8 Ω/km**								20	0.9	2.8		
															50	1.4	4.5		
								100	2.0	6.5									
								200	2.8	9.3									
								300	3.5	11.4									
								400	4.1	13.3									

RG-6/U Type

Sweep tested 5 MHz to 50 MHz. CPE jacket optional.  
For Rockwell authorized flexible ControlNet™ order YR28890 (Tinned Copper Braid version).

**Plenum • Foam FEP Insulation • Fluorocopolymer Jacket (Black or Intrinsically Safe Blue)**

	<b>3093A</b>	NEC:	1000	305	40.1	18.2	1.02 mm	0.170	4.32	Duobond® IV Quad Shield 11.8 Ω/km***	0.274	6.96	75	82%	16.3	53.5	1	0.4	1.2
		CMP	† 2000	610	80.0	36.3	18 AWG								2	0.4	1.2		
		CEC:	† 2500	762	95.0	43.1	Solid CCS								5	0.5	1.6		
		CMP FT6					103.6 Ω/km*								10	0.6	2.1		
							91.8 Ω/km**								20	0.9	3.1		
															50	1.5	4.9		
								100	2.1	7.0									
								200	3.0	9.8									
								300	3.7	12.0									
								400	4.2	13.9									

RG-6/U Type

Sweep tested 5 MHz to 50 MHz. Allen-Bradley P/N 1786  
Blue available as standard in 305 m only. Suitable for outdoor and direct burial applications

**18 AWG • Stranded (105x40) 1.0 mm Bare Copper • Duobond® IV Quad Shield**

**Foam Polyethylene Insulation • Black PVC Jacket**

	<b>3092F</b>	NEC:	1000	305	44.1	20.0	1.02 mm	0.183	4.65	Duobond® IV Quad Shield 11.8 Ω/km***	0.303	7.70	75	79%	17.0	55.8	1	0.4	1.2
		CL2R CMR	5000	1524	220.0	99.8	18 AWG								2	0.5	1.5		
		CEC:					(105x40) BC								5	0.8	2.6		
		CMR FT4					46.2 Ω/km*								10	1.2	3.9		
							34.4 Ω/km**								20	2.0	6.6		
															50	3.2	10.5		
								100	4.6	15.1									
								200	6.5	21.3									
								300	8.0	26.2									
								400	9.3	30.5									

RG-6/U Type

Sweep tested 5 MHz to 400 MHz. 123092F – Aluminum Armor  
Allen-Bradley P/N 1786 133092F – Steel Armor  
IEEE 802.4 MAP/IEEE 802.7 Mini-MAP.  
CPE jacket optional.  
For Rockwell authorized flexible ControlNet™ order YR28890 (Tinned Copper Braid version).

\* DC loop resistance • \*\* DC resistance inner conductor • \*\*\* DC resistance outer conductor • BC = Bare Copper • CCS = Copper-Covered Steel • DCR = DC resistance  
† Final put-up length may vary 0% to +10% from length shown.

Duobond® IV see technical information page 23.13.

ControlNet™ is a ControlNet International trademark.

# Industrial Data Solutions® – Industrial Coax

## ControlBus™ Quad Shielded Coax



De- scription	Part No.	UL NEC/ C(UL)/CEC Type IEC	Standard Lengths		Standard Unit Weight		Conductor (Stranding) Diameter Nom. DCR	Nominal Insulation OD		Shielding Material Nom. DCR	Nominal OD		Nom. Imp. (Ω)	Nom. Vel. of Prop.	Nominal Capacitance		Nominal Attenuation		
			ft.	m	lbs.	kg		inch	mm		inch	mm			pF/ft.	pF/m	MHz	dB/ 100 ft.	dB/ 100 m

**18 AWG • Solid 1.0 mm Copper-Covered Steel • Duobond® IV Quad Shield**

**Gas-Injected Foam Polyethylene Insulation • Grey PVC Jacket**

	3131A	NEC:	1000	305	41.0	18.6	1.02 mm	0.180	4.57	Duobond® IV Quad Shield 11.8 Ω/km***	0.300	7.62	75	82%	16.2	53.1	1	0.3	1.1		
		CL2R CMR	2500	762	100.1	45.4	18 AWG										2	0.4	1.2		
		CEC:															Solid CCS	5	0.5	1.5	
		CMG FT4															103.6 Ω/km*	10	0.6	1.9	
																	91.8 Ω/km**	20	0.9	2.8	
																		50	1.4	4.5	
RG-6/U Type																					
Sweep tested 5 MHz to 400 MHz. CPE jacket optional.																					
IEEE 802.4 MAP/IEEE 802.7 Mini-MAP Tap marks every 2.6 m to aid users in installation.																					

**Plenum • Foam FEP Insulation • Grey Fluorocopolymer Jacket**

	150°C 3132A	NEC:	1000	305	36.2	16.4	1.02 mm	0.170	4.32	Duobond® IV Quad Shield 11.8 Ω/km***	0.274	6.96	75	82%	16.3	53.5	1	0.4	1.2		
		CMP															18 AWG	2	0.4	1.2	
		CEC:															Solid CCS	5	0.5	1.6	
		CMG FT6															103.6 Ω/km*	10	0.6	2.1	
																	91.8 Ω/km**	20	0.9	3.1	
																		50	1.5	4.9	
RG-6/U Type																					
Sweep tested 5 MHz to 400 MHz. Tap marks every 2.6 m to aid users in installation.																					
IEEE 802.4 MAP/IEEE 802.7 Mini-MAP Suitable for outdoor and direct burial applications.																					

**14 AWG • Solid 1.6 mm Copper-Covered Steel • Duobond® IV Quad Shield**

**Gas-Injected Foam Polyethylene Insulation • Grey PVC Jacket**

	3094A	NEC:	500	152	35.5	16.1	1.63 mm	0.280	7.11	Duobond® IV Quad Shield 4.9 Ω/km***	0.407	10.34	75	82%	16.2	53.1	1	0.2	0.5		
		CL2R CMR	1000	305	61.9	28.1	14 AWG										2	0.2	0.6		
		CEC:	2500	762	140.2	63.6	Solid CCS										5	0.3	0.9		
		CMG FT4															41.0 Ω/km*	10	0.4	1.2	
																	36.1 Ω/km**	20	0.5	1.8	
																		50	0.8	2.7	
RG-11/U Type																					
Sweep tested 5 MHz to 400 MHz. CPE jacket optional.																					
IEEE 802.4 MAP Tap marks every 2.6 m to aid users in installation.																					

**Plenum • Foam FEP Insulation • Grey Fluorocopolymer Jacket**

	150°C 3095A	NEC:	1000	305	76.1	34.5	1.63 mm	0.280	7.11	Duobond® IV Quad Shield 12.8 Ω/km***	0.387	9.83	75	82%	16.5	54.1	1	0.2	0.6		
		CMP															14 AWG	2	0.2	0.7	
		CEC:															Solid CCS	5	0.3	0.9	
		CMG FT6															48.9 Ω/km*	10	0.4	1.3	
																	36.1 Ω/km**	20	0.6	2.0	
																		50	1.2	3.9	
RG-11/U Type																					
Sweep tested 5 MHz to 400 MHz. Tap marks every 2.6 m to aid users in installation.																					
IEEE 802.4 MAP Suitable for outdoor and direct burial applications.																					

\* DC loop resistance • \*\* DC resistance inner conductor • \*\*\* DC resistance outer conductor • CCS = Copper-Covered Steel • DCR = DC resistance  
Duobond® IV see technical information page 23.13.

# Industrial Data Solutions® - Industrial Data

## DataBus® ISA/SP-50 FOUNDATION Fieldbus or PROFIBUS Cables



De- scription	Part No.	UL NEC/ C(UL)/CEC Type IEC	Standard Lengths		Standard Unit Weight		Conductor (Stranding) Diameter Nom. DCR	Nominal Insulation OD		Shielding Material Nom. DCR	Nominal OD		Nom. Imp. (Ω)	Nom. Vel. of Prop.	Nominal Capacitance		Nominal Attenuation		
			ft.	m	lbs.	kg		inch	mm		inch	mm			pF/ft.	pF/m	MHz	dB/ 100 ft.	dB/ 100 m

**FOUNDATION Fieldbus/PROFIBUS PA • 18 AWG • Stranded (7x26) 1.2 mm Tinned Copper • Beldfoil® • 20 AWG Tinned Copper Drain Wire**

**Polyolefin Insulation • PVC Jacket (Orange and Blue)**

Type A	<b>3076F</b>	NEC:	250	76	10.6	4.8	1.22 mm	0.088	2.24	Overall	0.253	6.43	100 @	66%	24.0	78.7	0.039	0.1	0.26
300V 75°C		PLTC CM	500	152	18.5	8.4	18 AWG			Beldfoil®			31.25 KHz						
(31.25 kbits/sec)		ITC	1000	305	34.2	15.5	(7x26) TC			+ Drain Wire									
		CEC:	2500	762	85.1	38.6				(20 AWG TC)									
		CM	† 5000	1524	170.4	77.3													



Shorting Fold

Color Code: Orange, Blue  
 Fieldbus: Orange jacket  
 Profibus PA: Intrinsically safe Blue jacket.  
 Blue available as standard in 305 m put-up only.  
 CPE jacket optional.

123076F – Version with Aluminum Interlocked Armor  
 133076F – Version with Steel Interlocked Armor  
 YM47023 – CPE jacketed version  
 YM46698 – Black & White color-coded pairs  
 YM47090 – Various colored jackets  
 YM41725 – LSZH (FRNC) jacketed version

**Polyolefin Insulation • FRNC/LSNH Jacket (Blue and Orange)**

300V 80°C	<b>3076NH</b>	IEC	1640	500	98.3	44.6	1.22 mm	0.088	2.24	Overall	0.295	7.50	100	66%	24.4	80.0	0.01	0.1	0.4	
		332-3C	3280	1000	191.1	86.7	18 AWG			Beldfoil®							0.039	0.2	0.5	
		BS 7655					(7x26) TC			+ Drain Wire								0.1	0.2	0.8
										(20 AWG TC)								0.5	0.6	2.1
																		1.0	1.0	3.2



Shorting Fold

Color Code: White, Black

**Polyolefin Insulation • FRNC/LSNH Inner Jacket (Black and Blue) • Steel Wire Armor • Black FRNC/LSNH Outer Jacket**

300V 80°C	<b>3076LS</b>	IEC	1640	500	394.8	179.1	1.22 mm	0.088	2.24	Overall	*0.295	*7.50	100	66%	24.4	80.0			see above
		332-3C	3280	1000	737.0	334.3	18 AWG			Beldfoil®	**0.512	**13.00							
		BS 7655					(7x26) TC			+ Drain Wire									
										(20 AWG TC)									



Shorting Fold

\* Under Armor  
 \*\* Over Armor

Color Code: White, Black

**FOUNDATION Fieldbus • 22 AWG • Stranded (7x30) 0.8 mm Tinned Copper • Beldfoil® • 20 AWG Tinned Copper Drain Wire**

**Polyolefin Insulation • Orange PVC Jacket**

Type B	<b>3077F</b>	NEC:	† 500	152	11.0	5.0	0.76 mm	0.059	1.50	Overall	0.196	4.97	100 @	66%	23.5	77.1	0.039	0.1	0.5
300V 150°C		PLTC CM	† 1000	305	22.9	10.4	22 AWG			Beldfoil®			31.25 KHz						
(31.25 kbits/sec)		ITC					(7x30) TC			+ Drain Wire									
		CEC:								(20 AWG TC)									
		CM																	



Shorting Fold

Color Code: Orange, Blue  
 CPE and LSZH jacketed versions also available.

123077F – Version with Aluminum Interlocked Armor  
 133077F – Version with Steel Interlocked Armor

**Polyolefin Insulation • FRNC/LSNH Jacket (Blue and Orange)**

300V 80°C	<b>3077NH</b>	IEC	1640	500	86.9	39.4	0.76 mm	0.059	1.50	Overall	0.295	7.50	100	66%	25.9	85.0	0.01	0.2	0.6	
		332-3C	3280	1000	168.2	76.3	22 AWG			Beldfoil®							0.039	0.2	0.7	
		BS 7655					(7x30) TC			+ Drain Wire								0.1	0.3	0.9
										(20 AWG TC)								0.5	1.1	3.5
																		1.0	1.6	5.1



Shorting Fold

Color Code: White, Black

**Polyolefin Insulation • FRNC/LSNH Inner Jacket (Black and Blue) • Steel Wire Armor • Black FRNC/LSNH Outer Jacket**

300V 80°C	<b>3077LS</b>	IEC	1640	500	381.8	173.2	0.76 mm	0.059	1.50	Overall	*0.295	*7.50	100	66%	25.9	85.0			see above
		332-3C	3280	1000	741.8	336.5	22 AWG			Beldfoil®	**0.512	**13.00							
		BS 7655					(7x30) TC			+ Drain Wire									
										(20 AWG TC)									



Shorting Fold

\* Under Armor  
 \*\* Over Armor

Color Code: White, Black

TC = Tinned Copper • DCR = DC resistance  
 † Final put-up length may vary 0% to +10% from length shown.

# Industrial Data Solutions® – Industrial Data

## DataBus® ISA/SP-50 FOUNDATION Fieldbus or PROFIBUS Cables



De-scription	Part No.	UL NEC/ C(UL)/CEC Type IEC	Standard Lengths		Standard Unit Weight		Conductor (Stranding) Diameter Nom. DCR	Nominal Insulation OD		Shielding Material Nom. DCR	Nominal OD		Nom. Imp. (Ω)	Nom. Vel. of Prop.	Nominal Capacitance		Nominal Attenuation		
			ft.	m	lbs.	kg		inch	mm		inch	mm			pF/ft.	pF/m	MHz	dB/100 ft.	dB/100 m

### FOUNDATION Fieldbus • 22 AWG • Stranded (7x30) 0.8 mm Tinned Copper • Beldfoil® • 20 AWG Tinned Copper Drain Wire

FHDPE Insulation • Orange PVC Jacket																		
High Speed 3078F	NEC:	250	76	9.9	4.5	0.76 mm	0.121	3.07	Overall	0.351	8.92	150 @	78%	8.5	27.9	0.25	0.2	0.6
300V 75°C	PLTC CM	500	152	22.9	10.4	22 AWG			Beldfoil®			1 MHz				0.625	0.3	0.9
(1.0 & 2.5 Mbits/sec)	CEC:	1000	305	44.1	20.0	(7x30) TC			+ Drain Wire							1.25	0.3	1.1
	CM	2500	762	115.1	52.2				(20 AWG TC)							3.125	0.6	1.8

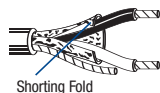

Shorting Fold

Color Code: Orange, Blue  
CPE and LSZH jacketed versions also available.

123078F – Version with Aluminum Interlocked Armor  
133078F – Version with Steel Interlocked Armor

### DataBus® PROFIBUS • DP EN50170-2-2

De-scription	Part No.	UL NEC/ C(UL)/CEC Type IEC	Standard Lengths		Standard Unit Weight		Conductor (Stranding) Diameter Nom. DCR	Nominal Insulation OD		Shielding Material Nom. DCR	Nominal OD		Nom. Imp. (Ω)	Nom. Vel. of Prop.	Nominal Capacitance		Nominal Attenuation		
			ft.	m	lbs.	kg		inch	mm		inch	mm			pF/ft.	pF/m	MHz	dB/100 ft.	dB/100 m

### Profibus DP • 22 AWG • Solid 0.6 mm Bare Copper • Beldfoil® • 65% Tinned Copper Braid

FHDPE Insulation • Chrome and Violet PVC Jacket																			
300V 75°C	3079A	NEC:	1000	305	56.0	25.4	0.64 mm	0.099	2.52	Overall	0.315	8.00	150	78%	8.5	27.9	0.2	0.3	0.9
		PLTC CMG	2000	610	112.0	50.8	22 AWG			Beldfoil®							4	0.7	2.2
		CEC:	3600	1098	201.5	91.4	Solid BC			+ Overall							16	1.4	4.5
		CMG FT4							65% TC Braid								100	3.8	12.3
																	300	6.5	21.4



Color Code: Red, Green  
Siemens Sinec L2 cable  
UL AWM 20201 (600V)

123079A – Aluminum Interlocked Armor  
133079A – Steel Interlocked Armor  
YR45047 – CPE jacketed version  
YR44731 – LSZH (FRNC) jacketed version

### Profibus DP • 22 AWG • Stranded (7x30) 0.8 mm Bare Copper • Beldfoil® • 65% Tinned Copper Braid

FR-FPE Insulation • Violet PVC Jacket																			
300V 75°C	3079E	NEC:	1000	305	44.1	20.0	0.76 mm	0.099	2.52	Overall	0.315	8.00	150	78%	8.5	27.9	0.2	0.3	1.1
		PLTC CMG	1640	500	73.9	33.5	22 AWG			Beldfoil®							4	0.8	2.7
		CEC:	3280	1000	144.4	65.5	(7x30) BC			+ Overall							16	1.6	5.4
		CMG FT4							65% TC Braid								100	3.8	12.3



Color Code: Red, Green  
For CPE jacketed version order Part No. YR45047

### Cellular Polyolefin Insulation • Violet FRNC/LSNH Jacket

300V 80°C	3079ANH	IEC	1000	305	214.1	97.1	0.64 mm	0.099	2.52	Overall	0.315	8.00	150	78%	8.8	29.0	0.2	0.3	0.9
		332-3C	1640	500	358.2	162.5	22 AWG			Beldfoil®							4	0.7	2.2
		BS 7655	3280	1000	711.2	322.6	Solid BC			+ Overall							16	1.4	4.5
									65% TC Braid								100	3.8	12.3



Color Code: Red, Green

### Cellular Polyolefin Insulation • Black PVC Jacket • Steel Wire Armor

300V 80°C	3079ALS	IEC	1640	500	102.5	46.5	0.64 mm	0.099	2.52	Overall	*0.315	*8.00	150	78%	8.5	27.9	0.2	0.3	0.9
		332-3C	3280	1000	183.0	83.0	22 AWG			Beldfoil®	**0.488	**12.40					4	0.7	2.2
		BS 7655					Solid BC			+ Overall							16	1.4	4.5
									65% TC Braid										



Color Code: Red, Green

\* Under Armor  
\*\* Over Armor

TC = Tinned Copper • BC = Bare Copper • DCR = DC resistance

# Industrial Data Solutions® - Industrial Data

DeviceBus® for ODVA DeviceNet™ Cables



De- scription	Part No.	UL NEC/ C(UL)CEC Type IEC	Standard Lengths		Standard Unit Weight		Color Code	Nominal OD		Compo- nent	Description	Shielding Material & Nom. DCR	Insulation Material & Colors	Component Jacket Material & Colors	Insulation OD	
			ft.	m	lbs.	kg		inch	mm						inch	mm

**600V Class 1 Thick • 15 AWG and 18 AWG • Stranded Tinned Copper • Beldfoil® • 18 AWG TC Drain Wire • Overall 65% TC Braid**

**PVC/Nylon Insulation (Power) • FEP Insulation (Data) • Grey Sunlight/Oil-Resistant PVC Jacket**

High Velocity Thick 600V 75°C	<b>7897A</b>	NEC:	500	152	69.7	31.6	Red, Black	0.461	11.70	Power	2-Conductor 15 AWG 1.7 mm (19x28) TC	Individual Beldfoil®	PVC/Nylon			0.099	2.51
		TC-ER	1000	305	135.1	61.3											
			2000	610	274.3	124.4											



Blue, White	Data	2-Conductor 18 AWG 1.24 mm (19x30) TC VOP: 75% 120 Ohm	Individual Beldfoil®	FEP		0.146	3.71
-------------	------	---	-------------------------	-----	--	-------	------

Meter marks on jacket to aid users in installation.  
Allen-Bradley P/N 1485 CPI-A

**600V Class 1 ODVA Cable V • 16 AWG and 18 AWG • Stranded TC • Beldfoil® • 16 AWG TC Drain Wire • Overall 65% TC Braid**

**PVC/Nylon Insulation (Power) • F-R Polypropylene Insulation (Data) • Grey Sunlight/Oil-Resistant PVC Jacket**

600V 75°C	<b>7896A</b>	NEC:	500	152	89.1	40.4	Red, Black	0.525	13.34	Power	2-Conductor 16 AWG 1.47 mm (19x29) TC	Individual Beldfoil®	PVC/Nylon			0.101	2.57
		TC-ER	1000	305	168.0	76.2											
			2000	610	339.9	154.2											



Blue, White	Data	2-Conductor 18 AWG 1.24 mm (19x30) TC VOP: 64% 120 Ohm	Individual Beldfoil®	F-R PP		0.182	4.62
-------------	------	---	-------------------------	--------	--	-------	------

Meter marks on jacket to aid users in installation.  
Allen-Bradley P/N 1485 CPI-A

**600V Class 1 ODVA IV • 16 AWG and 18 AWG • Stranded Tinned Copper • Unshielded**

**PVC/Nylon Insulation (Power) • F-R Polypropylene Insulation (Data) • Grey Sunlight/Oil-Resistant PVC Jacket**

Drop 600V 75°C	<b>7900A</b>	NEC:	500	152	50.9	23.1	Red, Black	0.430	10.92	Power	2-Conductor 16 AWG 1.47 mm (19x29) TC	Unshielded	PVC/Nylon			0.101	2.57
		TC-ER	1000	305	104.9	47.6											



Blue, White	Data	2-Conductor 18 AWG 1.24 mm (19x30) TC VOP: 64% 120 Ohm	Unshielded	F-R PP		0.098	2.49
-------------	------	---	------------	--------	--	-------	------

Meter marks on jacket to aid users in installation.  
Allen-Bradley P/N 1485 CPI-C

**600V Class 2 Thick • 15 AWG and 18 AWG • Stranded Tinned Copper • Beldfoil® • 18 AWG TC Drain Wire • Overall 65% TC Braid**

**PVC Insulation (Power) • FPE Insulation (Data) • Sunlight/Oil-Resistant PVC Jacket (Grey and Red)**

Thick 75°C UL AWM 20201	<b>3082A</b>	NEC:	500	152	71.0	32.2	Red, Black	0.480	12.19	Power	2-Conductor 15 AWG 1.7 mm (19x28) TC	Individual Beldfoil®	PVC			0.109	2.77
		CMG	1000	305	138.0	62.6											
		PLTC-ER	2000	610	280.0	127.0											



Blue, White	Data	2-Conductor 18 AWG 1.24 mm (19x30) TC VOP: 75% 120 Ohm	Individual Beldfoil®	FPE		0.150	3.81
-------------	------	---	-------------------------	-----	--	-------	------





Meter marks on jacket to aid users in installation.  
Allen-Bradley P/N 1485 CPI-A  
152 m and 610 m put-ups not available in Red.

TC = Tinned Copper • DCR = DC resistance  
ODVA DeviceNet™ is an Open DeviceNet Vendor Association Inc. trademark.

# Industrial Data Solutions® – Industrial Data

DeviceBus® for ODVA DeviceNet™ Cables



De-scription	Part No.	UL NEC / C(UL)CEC Type IEC	Standard Lengths		Standard Unit Weight		Color Code	Nominal OD		Component	Description	Shielding Material & Nom. DCR	Insulation Material & Colors	Component Jacket Material & Colors	Insulation OD								
			ft.	m	lbs.	kg		inch	mm						inch	mm							
<b>300V Class 2 Thick • 15 AWG and 18 AWG • Stranded Tinned Copper • Beldfoil® • 18 AWG TC Drain Wire • Overall 65 % TC Braid</b>																							
<b>PVC Insulation (Power) • FPE Insulation (Data) • Grey Sunlight / Oil-Resistant PVC Jacket</b>																							
High-Flex Thick 75°C UL AWM 20201  C(UL) AWM I/II A	<b>3082F</b>	NEC:	500	152	72.5	32.9	Red, Black	0.480	12.19	Power	2-Conductor 15 AWG 1.7 mm (65x33) TC	Individual Beldfoil®	PVC			0.109	2.77						
		CMG	1000	305	140.0	63.5										Blue, White	Data	2-Conductor 18 AWG 1.2 mm (65x36) TC VOP: 75 % 120 Ohm	Individual Beldfoil®	FPE		0.153	3.89
		PLTC-ER CEC: CMG FT4	2000	610	284.0	128.8																	
Meter marks on jacket to aid users in installation. Allen-Bradley P/N 1485 CPI-A 152 m and 610 m put-ups not available in Red.																							
<b>PVC Insulation (Power) • FPE Insulation (Data) • Yellow CPE Jacket</b>																							
Thick 75°C  C(UL) AWM I/II A	<b>3083A</b>	NEC:	1000	305	136.9	62.1	Red, Black	0.475	12.07	Power	2-Conductor 15 AWG 1.7 mm (19x28) TC	Individual Beldfoil®	PVC			0.109	2.77						
		CMG	2000	610	278.0	126.1										Blue, White	Data	2-Conductor 18 AWG 1.24 mm (19x30) TC VOP: 75 % 120 Ohm	Individual Beldfoil®	FPE		0.150	3.81
		PLTC CEC: CMG FT4																					
Meter marks on jacket to aid users in installation. Allen-Bradley P/N 1485 CPI-A																							
<b>300V Class 2 Thin • 22 AWG and 24 AWG • Stranded Tinned Copper • Beldfoil® • 22 AWG TC Drain Wire • Overall 65 % TC Braid</b>																							
<b>PVC Insulation (Power) • FPE Insulation (Data) • Grey Sunlight / Oil-Resistant PVC Jacket</b>																							
Thin 75°C  C(UL) AWM I/II A	<b>3084A</b>	NEC:	500	152	22.0	10.0	Red, Black	0.280	7.11	Power	2-Conductor 22 AWG 0.78 mm (19x34) TC	Individual Beldfoil®	PVC			0.072	1.83						
		CL2 CMG	1000	305	47.0	21.3										Blue, White	Data	2-Conductor 24 AWG 0.61 mm (19x36) TC VOP: 75 % 120 Ohm	Individual Beldfoil®	FPE		0.077	1.96
		CEC: CMG FT4	2000	610	96.1	43.6																	
Meter marks on jacket to aid users in installation. Allen-Bradley P/N 1485 CPI-C 305 m put-up also available in Red.																							
<b>PVC Insulation (Power) • FPE Insulation (Data) • Grey Sunlight / Oil-Resistant PVC Jacket</b>																							
High-Flex Thin 75°C  C(UL) AWM I/II A	<b>3084F</b>	NEC:	500	152	22.0	10.0	Red, Black	0.275	6.99	Power	2-Conductor 22 AWG 0.76 mm (154x44) TC	Individual Beldfoil®	PVC			0.062	1.57						
		CL2 CMG	1000	305	47.0	21.3										Blue, White	Data	2-Conductor 24 AWG 0.58 mm (105x44) TC VOP: 75 % 120 Ohm	Individual Beldfoil®	FPE		0.081	2.06
		CEC: CMG FT4	2000	610	96.1	43.6																	
Meter marks on jacket to aid users in installation. Allen-Bradley P/N 1485 CPI-C																							

TC = Tinned Copper • DCR = DC resistance

ODVA DeviceNet™ is an Open DeviceNet Vendor Association Inc. trademark.



For more information, contact Belden Technical Support +31-77-3875-414 • www.belden-emea.com



# Industrial Data Solutions® - Industrial Data

## DeviceBus® for ODVA DeviceNet™ Cables



De-scription	Part No.	UL NEC/ C(UL)CEC Type IEC	Standard Lengths		Standard Unit Weight		Color Code	Nominal OD		Component	Description	Shielding Material & Nom. DCR	Insulation Material & Colors	Component Jacket Material & Colors	Insulation OD	
			ft.	m	lbs.	kg		inch	mm						inch	mm

**300V Class 2 Thin • 22 AWG and 24 AWG • Stranded Tinned Copper • Beldfoil® • 22 AWG TC Drain Wire • Overall 65% TC Braid**

**PVC Insulation (Power) • FPE Insulation (Data) • Yellow CPE Jacket**

Thin 75°C	3085A	NEC:	500	152	25.1	11.4	Red, Black	0.280	7.11	Power	2-Conductor 22 AWG 0.78 mm (19x34) TC	Individual Beldfoil®	PVC			0.072	1.83
		CL2 CMG	1000	305	47.2	21.4											
		CEC: CMG FT4	2000	610	96.1	43.6											
										Data	2-Conductor 24 AWG 0.61 mm (19x36) TC VOP: 75% 120 Ohm	Individual Beldfoil®	FPE			0.077	1.96



Meter marks on jacket to aid users in installation.  
Allen-Bradley P/N 1485 CPI-C

**300V Class 2 ODVA Cable III • 20 AWG and 18 AWG • Stranded TC • Beldfoil® • 20 AWG TC Drain Wire • Overall 65% TC Braid**

**PVC Insulation (Power) • FPE Insulation (Data) • Grey Sunlight/Oil-Resistant PVC Jacket**

Mid 75°C	7895A	NEC:	500	152	41.0	18.6	Red, Black	0.378	9.60	Power	2-Conductor 20 AWG 0.94 mm (19x32) TC	Individual Beldfoil®	PVC			0.080	2.03
		UL AWM 20201 (600V) CMG	1000	305	84.0	38.1											
		PLTC CEC: CMG FT4															
										Data	2-Conductor 18 AWG 1.24 mm (19x30) TC VOP: 75% 120 Ohm	Individual Beldfoil®	FPE			0.129	3.28



Meter marks on jacket to aid users in installation.

**Flat • 16 AWG • Stranded (19x29) 1.5 mm Tinned Copper • Unshielded**

**PVC Insulation (Power) • FPE Insulation (Data) • Grey Sunlight/Oil-Resistant PVC Jacket**

Class 2 300V 75°C	3082K	NEC:	246	75	30.9	14.0	Red, Black	0.430	10.92	Power	2-Conductor 16 AWG 1.47 mm (19x29) TC	Unshielded	PVC			0.110	2.80
		CMG CL2	656	200	78.7	35.7											
		PLTC CEC: CMG FT4	1378	420	165.6	75.1											
										Data	2-Conductor 16 AWG 1.47 mm (19x29) TC VOP: 75% 120 Ohm	Unshielded	FPE			0.110	2.80



Allen-Bradley P/N 1485 CPI-G

**PVC Insulation (Power) • Black Sunlight-Resistant PVC Jacket**

Class 1 Power 600V 75°C	3082KP	NEC:	246	75	32.0	14.5	Red, Black	0.430	10.92	Power	2-Conductor 16 AWG 1.47 mm (19x29) TC	Unshielded	PVC			0.110	2.80
		CMG ITC	656	200	81.3	36.9											
		PLTC TC CEC: CMG FT4	1378	420	171.1	77.6											
										Data	2-Conductor 16 AWG 1.47 mm (19x29) TC VOP: 75% 120 Ohm	Unshielded	PVC			0.110	2.80



Allen-Bradley P/N 1485 CPI-G

TC = Tinned Copper • DCR = DC resistance

ODVA DeviceNet™ is an Open DeviceNet Vendor Association Inc. trademark.



**Industrial Data Solutions® – Industrial Data**  
 DeviceBus® for Honeywell Smart Distributed System Cables



De- scription	Part No.	UL NEC/ C(UL)/CEC Type IEC	Standard Lengths		Standard Unit Weight		Color Code	Nominal OD		Compo- nent	Description	Shielding Material & Nom. DCR	Insulation Material & Colors	Component Jacket Material & Colors	Insulation OD	
			ft.	m	lbs.	kg		inch	mm						inch	mm

**22 AWG • Stranded Tinned Copper • Each Pair Individually Beldfoil® Shielded • 22 AWG Tinned Copper Drain Wire**

**PVC Insulation (Power) • FPE Insulation (Data) • Grey PVC Jacket**

30V 80°C UL AWM Style 2464	<b>3087A</b>	NEC: CL2 CEC: FT1	500 1000 2000	152 305 610	19.0 41.0 84.0	8.6 18.6 38.1	Blue, Brown	0.290	7.37	Power	2-Conductor 22 AWG 0.78 mm (19x34) TC	Individual Beldfoil®	PVC		0.050	1.27
-------------------------------	--------------	----------------------------	---------------------	-------------------	----------------------	---------------------	-------------	-------	------	-------	--	-------------------------	-----	--	-------	------



							Black, White			Data	2-Conductor 22 AWG 0.78 mm (19x34) TC VOP: 76 % 120 Ohm	Individual Beldfoil®	FPE		0.098	2.49
--	--	--	--	--	--	--	--------------	--	--	------	--	-------------------------	-----	--	-------	------

CSA AWM I/II A  
Micro Cable (Drop)

Honeywell Smart Distributed System

**16 AWG and 20 AWG • Stranded Tinned Copper • Each Pair Individually Beldfoil® Shielded • 20 AWG Tinned Copper Drain Wire**

**PVC Insulation (Power) • FPE Insulation (Data) • Grey PVC Jacket**

30V 80°C UL AWM Style 2464	<b>3086A</b>	NEC: CL2 CEC: FT1	500 1000	152 305	43.4 88.0	19.7 39.9	Blue, Brown	0.398	10.11	Power	2-Conductor 16 AWG 1.47 mm (19x29) TC	Individual Beldfoil®	PVC		0.090	2.29
-------------------------------	--------------	----------------------------	-------------	------------	--------------	--------------	-------------	-------	-------	-------	--	-------------------------	-----	--	-------	------



							Black, White			Data	2-Conductor 20 AWG 0.94 mm (19x32) TC VOP: 76 % 120 Ohm	Individual Beldfoil®	FPE		0.120	3.05
--	--	--	--	--	--	--	--------------	--	--	------	--	-------------------------	-----	--	-------	------

CSA AWM I/II A  
Mini Cable (Trunk)

Honeywell Smart Distributed System

TC = Tinned Copper • DCR = DC resistance

**Industrial Data Solutions® - Industrial Data**

DeviceBus® for Square D/Seriplex® Cables



De- scription	Part No.	UL NEC/ C(UL)CEC Type IEC	Standard Lengths		Standard Unit Weight		Color Code	Nominal OD		Compo- nent	Description	Shielding Material & Nom. DCR	Insulation Material & Colors	Component Jacket Material & Colors	Insulation OD	
			ft.	m	lbs.	kg		inch	mm						inch	mm

**18 AWG and 22 AWG • Stranded Tinned Copper • Overall Beldfoil® • 22 AWG Tinned Copper Drain Wire**

Foam HDPE Insulation (Power) • Foam HDPE Insulation (Data) • Orange PVC Jacket																	
	600V 75°C	<b>3124A</b>	NEC: CL2 CM	1000	305	47.0	21.3	Red, Black	0.308	7.82	Power	2-Conductor 18 AWG 1.2 mm (16x30) TC	Unshielded	Foam HDPE		0.098	2.49
	UL AWM Style 20201		CEC: CM														
								White, Green			Data	2-Conductor 22 AWG 0.76 mm (7x30) TC VOP: 78%	Unshielded	Foam HDPE		0.092	2.34
Seriplex® CBL 1822-P18																	

**16 AWG and 22 AWG • Stranded Tinned Copper • Overall Beldfoil® • 22 AWG Tinned Copper Drain Wire**

Foam HDPE Insulation (Power) • Foam HDPE Insulation (Data) • Orange PVC Jacket																	
	300V 75°C	<b>3125A</b>	NEC: CL2 CM	500	152	31.5	14.3	Red, Black	0.368	9.35	Power	2-Conductor 16 AWG 1.5 mm (26x30) TC	Unshielded	Foam HDPE		0.110	2.79
			CEC: CM	1000	305	63.1	28.6										
								White, Green			Data	2-Conductor 22 AWG 0.76 mm (7x30) TC VOP: 78%	Unshielded	Foam HDPE		0.110	2.79
Seriplex® CBL 1622-P1																	

**16 AWG, 22 AWG and 12 AWG • Stranded Tinned Copper • Twisted Pair • Overall Beldfoil® • 22 AWG Tinned Copper Drain Wire**

Foam HDPE Insulation (Control) • Foam HDPE Insulation (Data) • PVC Insulation (Power) • Orange PVC Jacket																	
	300V 75°C	<b>3126A</b>	NEC: CL2 CM	1000	305	112.0	50.8	Red, Black	0.486	12.34	Control	2-Conductor 16 AWG 1.5 mm (26x30) TC VOP: 78%	Unshielded	Foam HDPE		0.110	2.79
			CEC: CM							x	x						
								White, Green			Data	2-Conductor 22 AWG 0.76 mm (7x30) TC VOP: 78%	Unshielded	Foam HDPE		0.110	2.79
								Black/White, Red/White			Power	2-Conductor 12 AWG 2.41 mm (65x30) TC VOP: 48%	Unshielded	PVC		0.123	3.12
Seriplex® CBL 162212-P16																	

TC = Tinned Copper • DCR = DC resistance

Seriplex® is a Square D/Schneider AEG registered trademark.

**Industrial Data Solutions® – Industrial Data**  
 DeviceBus® for Phoenix Contact InterBus®-S Cables



De- scription	Part No.	UL NEC/ C(UL)CEC Type IEC	Standard Lengths		Standard Unit Weight		Color Code	Nominal OD		Compo- nent	Description	Shielding Material & Nom. DCR	Insulation Material & Colors	Component Jacket Material & Colors	Insulation OD	
			ft.	m	lbs.	kg		inch	mm						inch	mm

**18 AWG and 24 AWG • Stranded Tinned Copper • Overall Beldfoil® + 90% Tinned Copper Braid**

**PVC Insulation (Power) • Polyethylene Insulation (Data) • Green Polyurethane Jacket**

300V 80°C UL AWM Style 20233	<b>3119A</b>		500	152	35.5	16.1	Red, Blue and Green (with Yellow Stripe)	0.333	8.46	Control	3-Conductor 18 AWG 1.22 mm (7x26) TC	Unshielded	PVC			0.066	1.68
---------------------------------	--------------	--	-----	-----	------	------	---	-------	------	---------	---	------------	-----	--	--	-------	------

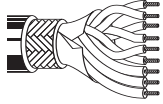

							White/Brown, Pink/Grey, Yellow/Green			Power	3-Pair 24 AWG 0.61 mm (7x32) TC VOP: 66% 100 Ohm	Unshielded	PE			0.056	1.42
--	--	--	--	--	--	--	--	--	--	-------	---	------------	----	--	--	-------	------

De- scription	Part No.	UL NEC/ C(UL)CEC Type IEC	Standard Lengths		Standard Unit Weight		Conductor (Stranding) Diameter Nom. DCR	Nominal Insulation OD		Shielding Material Nom. DCR	Nominal OD		Nom. Imp. (Ω)	Nom. Vel. of Prop.	Nominal Capacitance		Color Code
			ft.	m	lbs.	kg		inch	mm		inch	mm			pF/ft.	pF/m	

**24 AWG • Stranded (7x32) 0.6mm Tinned Copper • Overall Beldfoil® + 90% Tinned Copper Braid**

**Polyethylene Insulation • Green Polyurethane Jacket**

300V 80°C UL AWM Style 20233	<b>3120A</b>		500	152	26.0	11.8	0.61 mm 24 AWG (7x32) TC	0.056	1.42	Overall Beldfoil® + Overall 90% TC Braid	0.277	7.04	100	66%	15.4	50.5	White/Brown, Pink/Grey, Yellow/Green
---------------------------------	--------------	--	-----	-----	------	------	--------------------------------	-------	------	---	-------	------	-----	-----	------	------	--



3-Pair

TC = Tinned Copper • DCR = DC resistance

InterBus® is a Phoenix Contact trademark.

# Industrial Data Solutions® - Industrial Data

## ASI Bus Flatcable



De- scription	Part No.	UL NEC/ C(UL)CEC Type IEC	Standard Lengths		Standard Unit Weight		Conductor (Stranding) Diameter Nom. DCR	Nominal Insulation OD		Shielding Material Nom. DCR	Nominal OD		Nom. Imp. (Ω)	Nom. Vel. of Prop.	Nominal Capacitance		Nominal Attenuation	
			ft.	m	lbs.	kg		inch	mm		inch	mm			pF/ft.	pF/m	MHz	dB/ 100 ft.

**16 AWG • Stranded (84x0.15) 1.5 mm Tinned Copper**

PVC Insulation • Yellow TPE-O Jacket																			
300V 80°C	3999E		328	100	63.9	29.0	1.5 mm 16 AWG (84x0.15) TC	0.096	2.45	Unshielded	0.157	4.00							
											x	x							
											0.394	10.00							

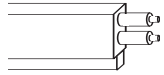

Color Code: Blue, Brown

2-Conductor

# Industrial Data Solutions® - Industrial Data

## EIA Industrial RS-485 PLTC/CM

De- scription	Part No.	UL NEC/ C(UL)CEC Type IEC	Standard Lengths		Standard Unit Weight		Conductor (Stranding) Diameter Nom. DCR	Nominal Insulation OD		Shielding Material Nom. DCR	Nominal OD		Nom. Imp. (Ω)	Nom. Vel. of Prop.	Nominal Capacitance		Color Code
			ft.	m	lbs.	kg		inch	mm		inch	mm			pF/ft.	pF/m	

**22 AWG • Stranded (7x30) 0.8 mm Tinned Copper • Twisted Pair • Beldfoil® • 90% Tinned Copper Braid • 22 AWG Tinned Copper Drain Wire**

**Datalene® Insulation • Black UV Resistant Jacket (CPE Jacket Optional)**

300V Oil Res II		NEC: CM PLTC CEC: CM FT1					0.76 mm 22 AWG (7x30) TC	0.087	2.21	Overall Beldfoil® + Overall 90% TC Braid + Drain Wire (22 AWG TC)			120	78%			
--------------------	--	-----------------------------------	--	--	--	--	--------------------------------	-------	------	--	--	--	-----	-----	--	--	--



<b>3105A</b>	1-Pair DMX512 Type	500 1000 † 5000	152 305 1524	23.0 50.0 255.2	10.4 22.7 115.8						0.284	7.21			CDR/CDR CDR/SCR	20.9 11.0	68.6 36.1	see chart below
For CPE jacketed version order Part No. YR44345.																		
<b>3106A</b>	1.5-Pair*	500 1000 † 5000	152 305 1524	27.1 51.1 260.4	12.3 23.2 118.1						0.300	7.62			CDR/CDR CDR/SCR	20.9 11.0	68.6 36.1	White/Orange, Orange/White Blue/White
For CPE jacketed version order Part No. YR46721.																		
<b>3107A</b>	2-Pair DMX512 Type	1000 4000 † 5000	305 1,219 1524	69.1 300.2 385.3	31.3 136.2 174.8						0.356	9.04			CDR/CDR CDR/SCR	20.9 11.0	68.6 36.1	see chart below
For CPE jacketed version order Part No. YR46792.																		
<b>3108A</b>	3-Pair	1000 2000	305 610	93.0 184.0	42.2 83.5						0.420	10.67			CDR/CDR CDR/SCR	20.9 11.0	68.6 36.1	see chart below
For CPE jacketed version order Part No. YR45287.																		
<b>3109A</b>	4-Pair	1000 2000	305 610	107.2 218.2	48.6 99.0						0.420	10.67			CDR/CDR CDR/SCR	20.9 11.0	68.6 36.1	see chart below
For CPE jacketed version order Part No. YR44768.																		

TC = Tinned Copper • DCR = DC resistance  
 † Final put-up length may vary 0% to +10% from length shown. • \* All conductors are under the braid shield; one pair is under the Beldfoil shield.

### Color Code

Pair No.	Color
1	White/Blue Stripe, Blue/White Stripe
2	White/Orange Stripe, Orange/White Stripe
3	White/Green Stripe, Green/White Stripe
4	White/Brown Stripe, Brown/White Stripe

**Industrial Data Solutions® – Industrial Data**

**CC-Link Cables**



De- scription	Part No.	UL NEC/ C(UL)/CEC Type IEC	Standard Lengths		Standard Unit Weight		Conductor (Stranding) Diameter Nom. DCR	Nominal Insulation OD		Shielding Material Nom. DCR	Nominal OD		Nom. Imp. (Ω)	Nom. Vel. of Prop.	Nominal Capacitance		Nominal Attenuation		
			ft.	m	lbs.	kg		inch	mm		inch	mm			pF/ft.	pF/m	MHz	dB/ 100 ft.	dB/ 100 m

**20 AWG • Stranded (7x28) 1.0 mm Bare Copper • Beldfoil® • 78% Tinned Copper Braid • 22 AWG Tinned Copper Drain Wire**

**Foam HDPE Insulation • Red PVC Jacket**

60°C	1348A	NEC:	1000	305	57.1	25.9	0.96 mm	0.094	2.39	Overall Beldfoil® + Overall 78% TC Braid + Drain Wire (22 AWG TC)	0.303	7.70	110	75%	18.3	60.0	1	0.5	1.6	
		CM	2000	610	114.2	51.8	20 AWG (7x28) BC													
		CEC:																		
		CM																		



Color Code: Blue, White, Yellow

3 CDR

De- scription	Part No.	UL NEC/ C(UL)/CEC Type IEC	Standard Lengths		Standard Unit Weight		Color Code	Nominal OD		Compo- nent	Description	Shielding Material & Nom. DCR	Insulation Material & Colors	Component Jacket Material & Colors	Insulation OD	
			ft.	m	lbs.	kg		inch	mm						inch	mm

**Power Limited Tray Cable • 16 AWG and 22 AWG • Stranded Tinned Copper • Overall Beldfoil® • 22 AWG Tinned Copper Drain Wire**

**PVC Insulation (Power) • Foam HDPE Insulation (Data) • Red UV Resistant PVC Jacket**

105°C	1349A	NEC:	1000	305	126.1	57.2	White, Black	0.512	13.00	Power	2-Conductor 18 AWG 1.22 mm (7x26) TC	Unshielded	PVC	–	0.091	2.31
		PLTC CM														
		CEC:														
		CM					Blue, White and Yellow			Data	3-Conductor 20 AWG 0.96 mm (7x28) TC VOP: 76% 110 Ohm	Beldfoil® 78% TC + Drain Wire	HDPE	PVC	0.098	2.49

TC = Tinned Copper • BC = Bare Copper • DCR = DC resistance

# Industrial Data Solutions® - Industrial Data

## LonWorks Cables



De- scription	Part No.	UL NEC/ C(UL)CEC Type IEC	Standard Lengths		Standard Unit Weight		Conductor (Stranding) Diameter Nom. DCR	Nominal Insulation OD		Shielding Material Nom. DCR	Nominal OD		Nom. Imp. (Ω)	Nom. Vel. of Prop.	Nominal Capacitance		Nominal Attenuation		
			ft.	m	lbs.	kg		inch	mm		inch	mm			pF/ft.	pF/m	MHz	dB/ 100 ft.	dB/ 100 m

**22 AWG • Solid 0.6 mm Bare Copper • Twisted Pair**

Foam Polyethylene Insulation • White FRNC/LSNH Jacket																			
80°C	7701NH	IEC	1000	305	10.6	4.8	0.64 mm	0.046	1.17	Unshielded	0.138	3.50	100	68%	14.0	46.0	1	0.4	1.3
		332-3C	1640	500	17.6	8.0	22 AWG	1	0.5								1.5		
		BS 7655					Solid BC	4	0.9								3.1		
								10	1.5								4.9		
								16	1.9								6.3		
																	20	2.1	6.9



1-Pair  
Color Code: White/Blue, Blue/White

**Foam Polyethylene Insulation • White FRNC/LSNH Jacket**

80°C	7702NH	IEC	1000	305	19.6	8.9	0.64 mm	0.046	1.14	Unshielded	0.205	5.20	100	68%	14.0	46.0	see above		
		332-3C					22 AWG												
		BS 7655					Solid BC												



2-Pair  
Color Code: White/Blue, Blue/White, Orange/White, White/Orange

**22 AWG • Solid 0.6 mm Bare Copper • Twisted Pair • Beldfoil® • 24 AWG Tinned Copper Drain Wire**

Foam Polyethylene Insulation • White FRNC/LSNH Jacket																			
80°C	7703NH	IEC	1000	305	17.9	8.1	0.64 mm	0.061	1.55	Overall Beldfoil® + Drain Wire (24 AWG TC)	0.181	4.60	100	68%	24.4	80.0	1	0.5	1.8
		332-3C	1640	500	44.3	20.1	22 AWG	1	0.6								2.0		
		BS 7655					Solid BC	4	1.1								3.6		
								10	1.7								5.5		
								16	2.1								7.0		
																	20	2.4	7.8



1-Pair  
Color Code: White/Blue, Blue/White

**Foam Polyethylene Insulation • White FRNC/LSNH Jacket**

	7704NH	IEC	1000	305	27.1	12.3	0.64 mm	0.053	1.35	Overall Beldfoil® + Drain Wire (24 AWG TC)	0.256	6.50	100	68%	12.2	40.0	see above								
		332-3C	1640	500	44.3	20.1	22 AWG																		
		BS 7655	3346	1020	88.6	40.2	Solid BC																		



2-Pair  
Color Code: White/Blue, Blue/White, Orange/White, White/Orange

**16 AWG • Stranded (19x29) 1.5 mm Tinned Copper • Twisted Pair**

**PVC Insulation • Chrome PVC Jacket**

UL AWM Style 2598	8471	NEC:	U-500	U-152	20.1	9.1	1.47 mm	0.105	2.67	Unshielded	0.274	6.96						
		CMG	500	152	20.1	9.1	16 AWG											
		CEC:	U-1000	U-305	39.0	17.7	(19x29) TC											
		CMG FT4	1000	305	40.1	18.2												



1-Pair  
Color Code: Black, White

TC = Tinned Copper • BC = Bare Copper • DCR = DC resistance

**Industrial Data Solutions® – Industrial Data**

LonWorks Cables



De- scription	Part No.	UL NEC/ C(UL)/CEC Type IEC	Standard Lengths		Standard Unit Weight		Conductor (Stranding) Diameter Nom. DCR	Nominal Insulation OD		Shielding Material Nom. DCR	Nominal OD		Color Code
			ft.	m	lbs.	kg		inch	mm		inch	mm	

**16 AWG • Stranded (19x29) 1.5 mm Tinned Copper • Twisted Pair**

**Polyethylene Insulation • Chrome FRNC/LSNH Jacket**

Part 1	<b>8471NH</b>	IEC 60332	1000	305	60.5	27.5	1.47 mm	0.105	2.67	Unshielded	0.280	7.10	Black, White
			1640	500	66.1	30.0	16 AWG						
			3280	1000	132.3	60.0	(19x29) TC						



1-Pair

**Polyethylene Insulation • FRNC/LSNH Inner Jacket • Steel Wire Armor • Chrome FRNC/LSNH Outer Jacket**

Part 1	<b>8471LS</b>	IEC 60332	1000	305	248.9	112.9	1.47 mm	0.032	0.81	Unshielded	0.413	10.50	Black, White
			1640	500	407.9	185.0	16 AWG						
			3280	1000	815.7	370.0	(19x29) TC						



1-Pair

**Tefzel® Insulation • Clear Tefzel® Jacket**

300V RMS 80° VW-1	<b>85102</b>		500	152	20.1	9.1	1.47 mm	0.015	0.38	Unshielded	0.211	5.36	Black, White
			1000	305	33.1	15.0	16 AWG (19x29) TC						



1-Pair

**16 AWG • Stranded (19x29) 1.5 mm Tinned Copper • Twisted Pair • Beldfoil® • 18 AWG Tinned Copper Drain Wire**

**Polyethylene Insulation • Chrome PVC Jacket**

300V RMS 80° UL AWM Style 20253	<b>8719</b>	NEC: CM CL2 CEC: CM	U-500	U-152	24.5	11.1	1.47 mm	0.032	0.81	Overall Beldfoil® + Drain Wire (18 AWG TC)	0.313	7.95	Black, Clear
			500	152	24.5	11.1	16 AWG						
			U-1000	U-305	47.2	21.4	(19x29) TC						
			1000	305	49.2	22.3							
			2000	610	100.3	45.5							
5000	1524	245.6	111.4										
10000	3049	431.0	195.5										



1-Pair

TC = Tinned Copper • DCR = DC resistance



Tefzel® is a DuPont trademark.



# Industrial Data Solutions® - Industrial Data

## Low-Capacitance Computer Cables for EIA RS-485 Applications



De- scription	Part No.	UL NEC/ C(UL)CEC Type IEC	Standard Lengths		Standard Unit Weight		Conductor (Stranding) Diameter Nom. DCR	Nominal Insulation OD		Shielding Material Nom. DCR	Nominal OD		Nom. Imp. (Ω)	Nom. Vel. of Prop.	Nominal Capacitance		Color Code	
			ft.	m	lbs.	kg		inch	mm		inch	mm			pF/ft.	pF/m		
<b>24 AWG • Stranded (7x32) 0.6 mm Tinned Copper • Overall Beldfoil® + 90% Tinned Copper Braid • 24 AWG Tinned Copper Drain Wire</b>																		
<b>Polyethylene Insulation • Chrome PVC Jacket</b>																		
30V 80°C UL AWM Style 2919		NEC: CM CEC: CM					0.61 mm 24 AWG (7x32) TC	0.068	1.73	Overall Beldfoil® + Overall 90% TC Braid + Drain Wire (24 AWG TC)			120	66%	CDR/CDR CDR/SCR	12.8 23.0	42.0 75.5	see chart 5 (Tech Info Section)
																		
DMX 512																		
<b>9841</b>	1-Pair		100	31	4.9	2.2						0.232	5.89					
			500	152	20.1	9.1												
			1000	305	40.1	18.2												
<b>9842</b>	2-Pair		100	31	5.7	2.6						0.340	8.64					
			500	152	29.5	13.4												
			1000	305	57.1	25.9												
<b>9843</b>	3-Pair		100	31	7.1	3.2						0.360	9.14					
			500	152	34.6	15.7												
			1000	305	67.2	30.5												
<b>9844</b>	4-Pair		500	152	43.0	19.5						0.390	9.91					
			1000	305	83.1	37.7												
<b>Polyethylene Insulation • Chrome FRNC/LSNH Jacket</b>																		
80°C		IEC 332-3C BS 7655					0.61 mm 24 AWG (7x32) TC	0.068	1.73	Overall Beldfoil® + Overall 90% TC Braid + Drain Wire (24 AWG TC)			120	66%	CDR/CDR CDR/SCR	12.8 23.0	42.0 75.5	see chart 5 (Tech Info Section)
																		
<b>9841NH</b>	1-Pair		1000	305	38.1	17.3						0.232	5.90					
			1640	500	65.0	29.5												
			3280	1000	124.8	56.6												
<b>9842NH</b>	2-Pair		1000	305	64.4	29.2						0.341	8.65					
			1640	500	102.7	46.6												
			3280	1000	196.4	89.1												
<b>9843NH</b>	3-Pair		1000	305	69.0	31.3						0.358	9.10					
<b>Polyethylene Insulation • Chrome FRNC/LSNH Inner Jacket • Steel Wire Armor • Black Sunlight-Resistant FRNC/LSNH Jacket</b>																		
80°C		IEC 332-3C BS 7655					0.61 mm 24 AWG (7x32) TC	0.068	1.73	Overall Beldfoil® + Overall 90% TC Braid + Drain Wire (24 AWG TC)			120	66%	CDR/CDR CDR/SCR	12.8 23.0	42.0 75.5	see chart 5 (Tech Info Section)
																		
<b>9841LS</b>	1-Pair		1000	305	154.1	69.9						*0.232	*5.90					
			1640	500	276.9	125.6						**0.406	**10.30					
			3280	1000	624.3	283.2												
<b>9842LS</b>	2-Pair		1000	305	195.5	88.7						*0.341	*8.65					
			1640	500	335.1	152.0						**0.516	**13.10					
			3280	1000	648.2	294.0												
* Under Armor																		
** Over Armor																		

TC = Tinned Copper • DCR = DC resistance

# Industrial Data Solutions® – Interconnect Cables

## Shielded Twisted Pair Cables



De-scription	Part No.	UL NEC / C(UL)/CEC Type IEC	Standard Lengths		Standard Unit Weight		Conductor (Stranding) Diameter Nom. DCR	Nominal Insulation OD		Shielding Material Nom. DCR	Nominal OD		Nom. Imp. (Ω)	Nom. Vel. of Prop.	Nominal Capacitance		Color Code
			ft.	m	lbs.	kg		inch	mm		inch	mm			pF/ft.	pF/m	

**24 AWG • Stranded (7x32) 0.6 mm Tinned Copper • Twisted Pair • Beldfoil® • 24 AWG Tinned Copper Drain Wire**

Datalene® Insulation • Chrome PVC Jacket																			
300V 60°C	<b>9729</b>	NEC:	100	31	4.4	2.0	0.61 mm	0.061	1.55	Individual Beldfoil® + Drain Wire (24 AWG TC)	0.266	6.76	100	76%	CDR/CDR	12.5	41.0	Red, Black White, Black	
UL AWM Style 2493		CM	500	152	20.5	9.3	24 AWG									CDR/SCR	23.2		76.1
		CEC:	1000	305	39.0	17.7	(7x32) TC												
		CM	10000	3049	390.4	177.1													



Z-Fold®

2-Pair

**Datalene® Insulation • Black FRNC/LSNH Jacket • Color Coded Foils (Red, Green)**

300V 80°C	<b>9729NH</b>	IEC	1000	305	44.1	20.0	0.61 mm	0.061	1.55	Individual Beldfoil® + Drain Wire (24 AWG TC)	0.335	8.50	100	76%	CDR/CDR	12.5	41.0	Red, Black White, Black	
		332-3C	1640	500	74.5	33.8	24 AWG									CDR/SCR	23.2		76.1
		BS 7655	3280	1000	137.3	62.3	(7x32) TC												



Z-Fold®

2-Pair

**Datalene® Insulation • Chrome FRNC/LSNH Inner Jacket • Steel Wire Armor • Black Sunlight-Resistant FRNC/LSNH Jacket • Color Coded Foils (Red, Green)**

300V 80°C	<b>9729LS</b>	IEC	1640	500	347.2	157.5	0.61 mm	0.061	1.55	Individual Beldfoil® + Drain Wire (24 AWG TC)	*0.335	*8.50	100	76%	CDR/CDR	12.5	41.0	Red, Black White, Black	
		332-3C	3280	1000	672.4	305.0	24 AWG				**0.512	**13.00				CDR/SCR	23.2		76.1
		BS 7655					(7x32) TC												



Z-Fold®

2-Pair

\* Under Armor  
\*\* Over Armor

**22 AWG • Stranded (7x30) 0.8 mm Tinned Copper • Twisted Pair • Beldfoil® • 22 AWG Tinned Copper Drain Wire**

Polypropylene Insulation • Chrome PVC Jacket																			
30V 80°C	<b>8777</b>	NEC:	100	31	4.6	2.1	0.76 mm	0.050	1.27	Individual Beldfoil® + Drain Wire (22 AWG TC)	0.273	6.93	50	66%	CDR/CDR	30.0	98.0	Red, Black White, Black Green, Black	
UL AWM Style 2919		CM	250	76	11.0	5.0	22 AWG									CDR/SCR	55.0		180.0
		CEC:	U-500	U-152	20.9	9.5	(7x30) TC												
		CM	500	152	20.9	9.5													



Z-Fold®

3-Pair

For Plenum version of 8777, see 88777, 87777 or 82777.

**Polypropylene Insulation • Chrome FRNC/LSNH Jacket • Color Coded Foils (Red, Green, Blue)**

300V 80°C	<b>8777NH</b>	IEC	1000	305	50.7	23.0	0.76 mm	0.050	1.27	Individual Beldfoil® + Drain Wire (22 AWG TC)	0.276	7.00	50	66%	CDR/CDR	30.0	98.4	Red, Black White, Black Green, Black	
		332-3C	1640	500	78.5	35.6	22 AWG									CDR/SCR	55.0		180.4
		BS 7655	3280	1000	151.5	68.7	(7x30) TC												

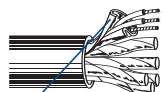

Z-Fold®

3-Pair

TC = Tinned Copper • DCR = DC resistance



# Industrial Data Solutions® – Interconnect Cables

## Shielded Twisted Pair Cables



De- scription	Part No.	UL NEC/ C(UL)CEC Type IEC	Standard Lengths		Standard Unit Weight		Conductor (Stranding) Diameter Nom. DCR	Nominal Insulation OD		Shielding Material Nom. DCR	Nominal OD		Nom. Imp. (Ω)	Nom. Vel. of Prop.	Nominal Capacitance		Color Code
			ft.	m	lbs.	kg		inch	mm		inch	mm			pF/ft.	pF/m	

**22 AWG • Stranded (7x30) 0.8 mm Tinned Copper • Twisted Pair • Beldfoil® • 22 AWG Tinned Copper Drain Wire**

<b>Polyethylene Insulation • Chrome FRNC/LSNH Inner Jacket • Steel Wire Armor • Black Sunlight-Resistant FRNC/LSNH Jacket • Color Coded Foils (Red, Green, Blue)</b>																		
300V 80°C	<b>8777LS</b>	IEC	1640	500	290.3	131.7	0.76 mm	0.050	1.27	Individual Beldfoil® + Drain Wire (22 AWG TC)	*0.276	*7.00	50	66%	CDR/CDR	30.0	98.4	Red, Black
		332-3C	3280	1000	712.5	323.2	22 AWG				**0.425	**10.80			CDR/SCR	55.0	180.4	Green, White
		BS 7655					(7x30) TC											Green, Black

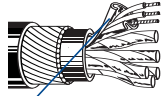

Z-Fold®

3-Pair

\* Under Armor  
\*\* Over Armor

**22 AWG • Stranded (7x30) 0.8 mm Tinned Copper • Twisted Pair • Beldfoil® • 24 AWG Tinned Copper Drain Wire**

<b>Polypropylene Insulation • Chrome PVC Jacket</b>																		
300V RMS 60°C	<b>8723</b>	NEC:	100	31	2.2	1.0	0.76 mm	0.046	1.17	Individual Beldfoil® + Drain Wire (24 AWG TC)	0.168	4.27	45	66%	CDR/CDR	35.0	115.0	Red, Black
		CM	U-500	U-152	10.6	4.8	22 AWG								CDR/SCR	62.0	203.0	Green, White
		CEC:	500	152	9.9	4.5	(7x30) TC											
		CM	U-1000	U-305	20.1	9.1												
			1000	305	20.1	9.1												
			1640	500	32.8	14.9												
			U-2000	U-610	40.1	18.2												
			2000	610	40.1	18.2												
			3280	1000	65.7	29.8												
			5000	1524	95.0	43.1												
			10000	3049	200.4	90.9												



2-Pair

For Plenum version of 8723, see 88723, 87723 or 82723  
Pairs cabled on common axis to reduce diameter.

<b>Polypropylene Insulation • Chrome FRNC/LSNH Jacket</b>																		
300V 80°C	<b>8723NH</b>	IEC	1000	305	23.1	10.5	0.76 mm	0.046	1.17	Individual Beldfoil® + Drain Wire (24 AWG TC)	0.179	4.55	45	66%	CDR/CDR	35.0	114.8	Red, Black
		332-3C	1640	500	36.8	16.7	22 AWG								CDR/SCR	62.0	203.4	Green, White
		BS 7655	3280	1000	75.0	34.0	(7x30) TC											



2-Pair

Pairs cabled on common axis to reduce diameter.

<b>Polypropylene Insulation • Chrome FRNC/LSNH Inner Jacket • Steel Wire Armor • Black Sunlight-Resistant FRNC/LSNH Jacket</b>																		
300V 80°C	<b>8723LS</b>	IEC	1640	500	168.7	76.5	0.76 mm	0.046	1.17	Individual Beldfoil® + Drain Wire (24 AWG TC)	*0.179	*4.55	45	66%	CDR/CDR	35.0	114.8	Red, Black
		332-3C	3280	1000	350.1	158.8	22 AWG				**0.346	**8.80			CDR/SCR	62.0	203.4	Green, White
		BS 7655					(7x30) TC											



2-Pair

\* Under Armor  
\*\* Over Armor

<b>Plenum • FEP Insulation • Red FEP Jacket</b>																		
300V RMS Non-conduit	<b>88723</b>	NEC:	100	31	3.3	1.5	0.76 mm	0.046	1.17	Individual Beldfoil® + Drain Wire (24 AWG TC)	0.148	3.76	40	69%	CDR/CDR	35.0	115.0	Red, Black
		CMP	500	152	11.0	5.0	22 AWG								CDR/SCR	67.0	220.0	Green, White
		CEC:	1000	305	20.9	9.5	(7x30) TC											
		CMP FT6																



Z-Fold®

2-Pair

TC = Tinned Copper • DCR = DC resistance



# Industrial Data Solutions® – Interconnect Cable

## Shielded Twisted Pair Cables



De- scription	Part No.	UL NEC/ C(UL)/CEC Type IEC	Standard Lengths		Standard Unit Weight		Conductor (Stranding) Diameter Nom. DCR	Nominal Insulation OD		Shielding Material Nom. DCR	Nominal OD		Nom. Imp. (Ω)	Nom. Vel. of Prop.	Nominal Capacitance		Color Code
			ft.	m	lbs.	kg		inch	mm		inch	mm			pF/ft.	pF/m	

**18 AWG • Stranded (16x30) 1.2 mm Tinned Copper • Twisted Pair • Beldfoil® • 20 AWG Tinned Copper Drain Wire**

<b>Polyethylene Insulation • Chrome PVC Jacket</b>																					
<p>Shorting Fold</p>	300V 60°C	<b>8760</b>	NEC:	250	76	6.8	3.1	1.2 mm	0.082	2.08	Overall Beldfoil® + Drain Wire (20 AWG TC)	0.222	5.64	–	–	CDR/CDR	24.0	79.0	Black, Clear		
	UL AWM Style 2092		CM	U-500	U-152	13.0	5.9	18 AWG									CDR/SCR	44.0		144.0	
			CEC:	500	152	13.0	5.9	(16x30) TC													
			CM	U-1000	U-305	26.0	11.8														
				1000	305	26.0	11.8														
				2000	610	50.0	22.7														
			5000	1524	135.1	61.3															
			10000	3049	260.1	118.0															

1-Pair

For Plenum version of 8760, see 88760, 87760 or 82760.

<b>Polyethylene Insulation • Chrome FRNC/LSNH Jacket</b>																					
<p>Shorting Fold</p>	300V 80°C	<b>8760NH</b>	IEC	1000	305	34.6	15.7	1.2 mm	0.082	2.08	Overall Beldfoil® + Drain Wire (20 AWG TC)	0.236	6.00	60	66%	CDR/CDR	24.0	78.7	Black, Clear		
			332-3C	1640	500	54.2	24.6	18 AWG									CDR/SCR	44.0		144.4	
			BS 7655	3280	1000	110.5	50.1	(16x30) TC													

1-Pair

<b>Polyethylene Insulation • Chrome FRNC/LSNH Inner Jacket • Steel Wire Armor • Black Sunlight-Resistant FRNC/LSNH Jacket</b>																				
<p>Shorting Fold</p>	300V 80°C	<b>8760LS</b>	IEC	1640	500	270.1	122.5	1.2 mm	0.082	2.08	Overall Beldfoil® + Drain Wire (20 AWG TC)	*0.236	*6.00	60	66%	CDR/CDR	24.0	78.7	Black, Clear	
			332-3C	3280	1000	610.5	276.9	18 AWG					**0.409	**10.40			CDR/SCR	44.0		144.4
			BS 7655					(16x30) TC												

1-Pair

\* Under Armor  
\*\* Over Armor

TC = Tinned Copper • DCR = DC resistance

# Industrial Data Solutions® - Industrial Fiber

## Tactical Mobile Fiber



De- scription	Part No.	No. of Fibers	Standard Lengths		Standard Unit Weight		Fiber Size µm	Nom. Buffer/ Tube OD		Strength Members	Nominal OD		Central Element mm	Pulling Tension N	Crush Re- sistance kN/m	Energy kJ/m	Bending Radii Cable (mm)	
			ft.	m	lbs.	kg		inch	mm		inch	mm					static	dyna- mic

**GMMT • Intex Mobile • Tight Buffer • Designed for Despooling and Respooling • A/I-VQ(ZN)H**

**Dry Construction • PUR Jacket (Orange or Black)**

70°C	6888	2100	Ø 280 ± 15	Longitudinal watertightness Swellable Reinforced Yarn	no
------	------	------	------------	--	----

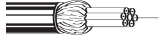

GMMTx04	4	143.5	65.1	0.23	5.8	800	4	580	58	87
GMMTx06	6	175.9	79.8	0.25	6.3	950	4	725	63	95
GMMTx08	8	217.6	98.7	0.28	7.0	1100	4	890	70	105

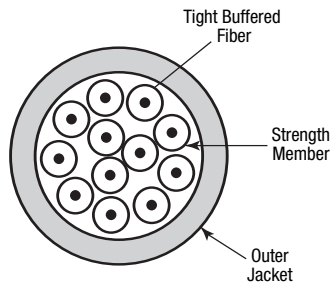

Color Code: see chart page 16.23

Optical characteristics see page 16.21.

### Industrial Ethernet Fiber Optic Cable Selection Guide

This chart is meant to help users to select the right cable. Refer to cable specifications for details. See [www.belden-emea.com](http://www.belden-emea.com) for fiber optic cable recommendations and technical data sheets.

Part No.	Jacket Material	No. of Fibers	Description	Outer Diameter	
				inch	mm

**Fiber (9/125) Micron, Single-mode, OS1**  
**Central Loose Tube, Steel Wire Armor, Improved Rodent Protection**

GOWA904	PE	4	Outdoor, T12	0.421	10.7
GOWA908	PE	8	Outdoor, T12	0.421	10.7
GOWA912	PE	12	Outdoor, T12	0.421	10.7
GUWA908	FRNC	8	Universal, T12	0.421	10.7
GUWA912	FRNC	12	Universal, T12	0.421	10.7
GUWB924	FRNC	24	Universal, T24	0.543	13.8
GOWB924	FRNC	24	Outdoor, T24	0.543	13.8

**Fiber (50/125) Micron, Multimode, OM2**  
**Central Loose Tube, Steel Wire Armor, Improved Rodent Protection**

GOWA204	PE	4	Outdoor, T12	0.421	10.7
GOWA206	PE	6	Outdoor, T12	0.421	10.7
GOWA212	PE	12	Outdoor, T12	0.421	10.7
GUWA204	FRNC	4	Universal, T12	0.421	10.7
GUWA208	FRNC	8	Universal, T12	0.421	10.7
GUWA212	FRNC	12	Universal, T12	0.421	10.7

Part No.	Jacket Material	No. of Fibers	Description	Outer Diameter	
				inch	mm

**Fiber (62.5/125) Micron, Multimode, OM1**  
**Central Loose Tube, Steel Wire Armor, Improved Rodent Protection**

GOWA106	PE	6	Outdoor, T12	0.421	10.7
GOWA112	PE	12	Outdoor, T12	0.421	10.7
GUWA104	FRNC	4	Universal, T12	0.421	10.7
GUWA108	FRNC	8	Universal, T12	0.421	10.7
GUWA112	FRNC	12	Universal, T12	0.421	10.7
GUWB124	FRNC	24	Universal, T24	0.543	13.8



# Belden Infinity® Flexible Automation Cables

300V Flex Data Cables (1 Million Flex Cycles#)



De- scription	Part No.	UL NEC/ C(UL)/CEC Type IEC	Standard Lengths		Standard Unit Weight		Conductor (Stranding) Diameter Nom. DCR	Nominal Insulation OD		Shielding Material Nom. DCR	Nominal OD		Nom. Imp. (Ω)	Nom. Vel. of Prop.	Nominal Capacitance		Color Code
			ft.	m	lbs.	kg		inch	mm		inch	mm			pF/ft.	pF/m	

**Flex Data • 24 AWG • Stranded (41x40) 0.6 mm BC • Twisted Pair • Overall Beldfoil® Shield + Overall 85% TC Braid • 24 AWG TC Drain Wire**

**Foam Polyethylene Insulation with Skin • Bright Green Oil-Resistant PVC Jacket**

300V 80°C	NEC: CM CEC: CM						0.58 mm 24 AWG (41x40) BC	0.071	1.80	Overall Beldfoil® + Overall 85% TC Braid + Drain Wire (24 AWG TC)				-			
-----------	--------------------------	--	--	--	--	--	---------------------------------	-------	------	--	--	--	--	---	--	--	--



<b>7200A</b>	1-Pair	500 1000	152 305	17.0 38.1	7.7 17.3						0.240	6.10	120		CDR/CDR	15	49	White, Blue	
																			RS-232, RS-485
<b>7201A</b>	2-Pair	500 1000	152 305	31.1 60.0	14.1 27.2						0.322	8.18	120		CDR/CDR	15	49	see chart 5 (Tech Info Section)	
																			RS-232, RS-485
<b>7202A</b>	3-Pair	500 1000	152 305	33.5 68.1	15.2 30.9						0.347	8.81	120		CDR/CDR	15	49	see chart 5 (Tech Info Section)	
																			RS-232, RS-485
<b>7203A</b>	4-Pair	500 1000	152 305	39.0 79.1	17.7 35.9						0.362	9.20	120		CDR/CDR	15	49	see chart 5 (Tech Info Section)	
																			RS-232, RS-485
<b>7205A</b>	1-Pair	500 1000	152 305	17.4 38.1	7.9 17.3						0.232	5.89	100		CDR/CDR	14	46	White, Blue	
																			RS-232, RS-422
<b>7206A</b>	1-Pair	1000	305	59.1	26.8						0.302	7.67	150		CDR/CDR	10	33	White, Blue	
																			RS-232, RS-485

Temp. Rating: -20° to 60°C (-5°C to 60°C flexing)

TC = Tinned Copper • BC = Bare Copper • DCR = DC resistance

# Based on proper installation techniques in a C-track cable guide.

# Belden Infinity® Flexible Automation Cables

300V Flex Data Cables (1 Million Flex Cycles#)



De- scription	Part No.	UL NEC/ C(UL)CEC Type IEC	Standard Lengths		Standard Unit Weight		Conductor (Stranding) Diameter Nom. DCR	Nominal Insulation OD		Shielding Material Nom. DCR	Nominal OD		Nom. Imp. (Ω)	Nom. Vel. of Prop.	Nominal Capacitance		Nominal Attenuation		
			ft.	m	lbs.	kg		inch	mm		inch	mm			pF/ft.	pF/m	MHz	dB/ 100 ft.	dB/ 100 m

**Sub-Mini Type • 30 AWG • Stranded (7x38) 0.3 mm Tinned Cadmium Bronze • 95% Tinned Copper French Braid®**

Foam Polyethylene Insulation • Matte Blue Belflex® Jacket																			
30V 80°C	<b>7500A</b>	CEC:	† 250	76	3.1	1.4	0.31 mm	0.056	1.42	French Braid®	0.110	2.79	75	78%	16.7	54.8	2.2	0.9	2.95
UL AWM Style 1354	FT1		† 500	152	5.1	2.3	30 AWG			+ 95% TC							5	1.4	4.59
			† 1000	305	9.0	4.1	(7x38) TCB			43.6 Ω/km***							10	2.0	6.56
							379.9 Ω/km*										30	3.4	11.16
							354.3 Ω/km**										50	4.4	14.44
																	100	6.4	21.00

CSA AWM I/II A/B

**Mini Type • 25 AWG • Stranded (19x38) 0.5 mm Bare Copper • 95% Tinned Copper French Braid®**

Foam Polyethylene Insulation • Matte Blue Belflex® Jacket																			
30V 80°C	<b>7501A</b>	CEC:	† 500	152	7.5	3.4	0.48 mm	0.090	2.29	French Braid®	0.146	3.71	75	77%	17.7	58.1	2.2	0.6	1.97
UL AWM Style 1354	FT1		† 1000	305	14.1	6.4	25 AWG			+ 95% TC							5	0.9	2.95
							(19x38) BC			29.9 Ω/km***							10	1.3	4.27
							144.7 Ω/km*										30	2.2	7.22
							114.8 Ω/km**										50	2.9	9.52
																	100	4.2	13.78

CSA AWM I/II A/B

**RG-59 Type • 22 AWG • Stranded (19x34) 0.8 mm Bare Copper • 95% Tinned Copper French Braid®**

Foam Polyethylene Insulation • Matte Blue Belflex® Jacket																			
30V 80°C	<b>7502A</b>	CEC:	† 250	76	10.6	4.8	0.79 mm	0.146	3.71	French Braid®	0.242	6.15	75	79%	18.0	59.1	2.2	0.4	1.31
UL AWM Style 1354	FT1		† 500	152	18.1	8.2	22 AWG			+ 95% TC							5	0.5	1.64
			† 1000	305	34.0	15.4	(19x34) BC			21.0 Ω/km***							10	0.8	2.63
							65.0 Ω/km*										30	1.4	4.59
							44.0 Ω/km**										50	1.8	5.91
																	100	2.7	8.86

CSA AWM I/II A/B

**RG-6/U Type • 18 AWG • Stranded (7x15x40) 1.0 mm Bare Copper • 95% Tinned Copper French Braid®**

Foam Polyethylene Insulation • Matte Blue Belflex® Jacket																			
30V 80°C	<b>7503A</b>	CEC:	† 250	76	12.1	5.5	1.02 mm	0.185	4.70	French Braid®	0.275	6.99	75	80%	17.3	56.8	2.2	0.3	0.98
UL AWM Style 1354	FT1		† 500	152	20.9	9.5	18 AWG			+ 95% TC							5	0.4	1.31
			† 1000	305	40.1	18.2	(7x15x40) BC			36.1 Ω/km***							10	0.6	1.97
							62.7 Ω/km*										30	1.1	3.61
							26.6 Ω/km**										50	1.5	4.92
																	100	2.2	7.22

CSA AWM I/II A/B

**RG-11 Type • 16 AWG • Stranded (7x37x40) 1.7 mm Bare Copper • 95% Tinned Copper French Braid®**

Foam Polyethylene Insulation • Matte Blue Belflex® Jacket																			
30V 80°C	<b>7504A</b>	CEC:	† 1000	305	84.0	38.1	1.65 mm	0.285	7.24	French Braid®	0.405	10.29	75	81%	17.3	56.8	2.2	0.2	0.66
UL AWM Style 1354	FT1						16 AWG			+ 95% TC							5	0.3	0.98
							(7x37x40) BC			11.8 Ω/km***							10	0.4	1.31
							23.3 Ω/km*										30	0.8	2.63
							11.5 Ω/km**										50	1.0	3.28
																	100	1.5	4.92

CSA AWM I/II A/B

TC = Tinned Copper • BC = Bare Copper • DCR = DC resistance  
 \* DC loop resistance • \*\* DC resistance inner conductor • \*\*\* DC resistance outer conductor  
 † Final put-up length may vary ±10% from length shown.

# Based on proper installation techniques in a C-track cable guide.



**Brilliance® Broadcast Cables**

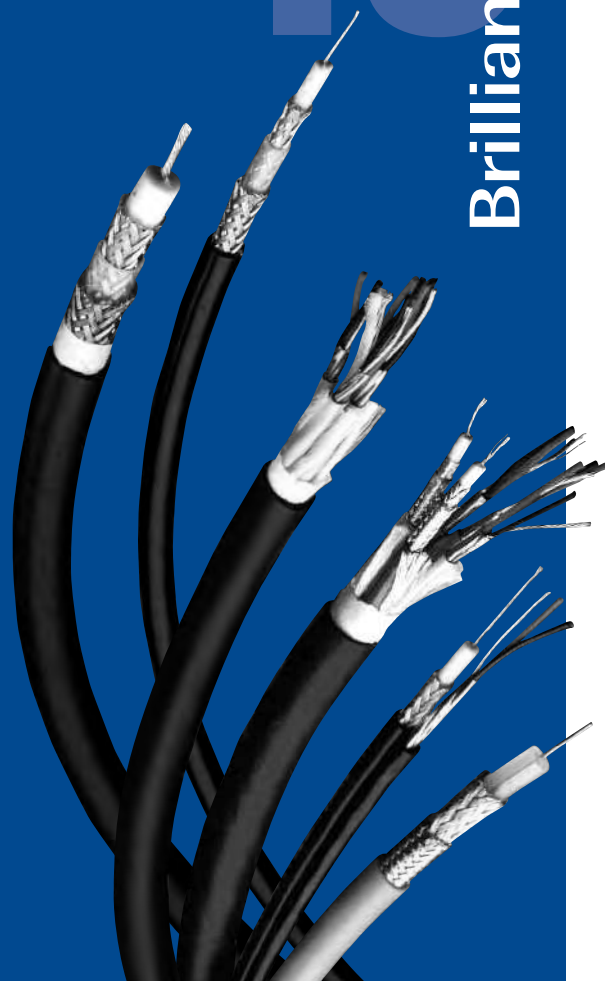

**Table of Contents**

<b>Brilliance® Broadcast Cables</b>	<b>Page No.</b>
<b>Introduction</b>	<b>19.2 – 19.7</b>
<b>Optical Fiber Cables</b>	<b>19.8</b>
SMPTÉ 311M	19.8
Tactical Mobile Optical Fiber	19.8
<b>Microphone and Musical Instrument Cables</b>	<b>19.9 – 19.10</b>
Two-Conductor, Low-Impedance Cables	19.9
Three-Conductor, Low-Impedance Cables	19.9
Four-Conductor, Star-Quad	19.10
<b>Line Level Analog Audio Cables</b>	<b>19.11</b>
Single- and Double-Pair Cables: Audio-Connect	19.11
<b>Analog Multi-Pair Snake Cables</b>	<b>19.12 – 19.15</b>
Flexible, Field Use, Rugged-Stage, 26 AWG	19.12
Super-Flexible, High-Performance, Star Quad, 26 AWG	19.12
FlexSnake® Super-Flexible, High-Performance, 24 AWG	19.13
Beldfoil® High-Performance, 24 AWG	19.14
Beldfoil® High-Performance, FRNC/LSNH, 24 AWG	19.14
Beldfoil® High-Performance, 22 AWG	19.15
<b>AES/EBU Digital Audio Cables</b>	<b>19.16</b>
Single- and Double-Pair Cables: Audio-Connect	19.16
<b>AES/EBU Multi-Pair Snake Cables</b>	<b>19.17 – 19.18</b>
Beldfoil® High-Performance, Low Capacitance, 26 AWG	19.17
Fire Resistant, Installation, FRNC/LSNH IEC 332-3C, 26 AWG	19.17
SlimSnake™, Installation, Halogen-Free, 26 AWG	19.18
Beldfoil® High-Performance, Low-Capacitance, 24 AWG	19.18
<b>Speaker Cables</b>	<b>19.19 – 19.20</b>
Audio/Power	19.19
High-Flex Bi-Amp and Tri-Amp Speaker Connections	19.19
PVC Speaker Cables	19.20
<b>Special Audio, Communication &amp; Instrumentation Cables</b>	<b>19.21</b>
Musical/Instrument Cables	19.21
DMX512 Cables	19.21
Audio/Video Combination Cables	19.21
<b>RJ-45 Cable for A/V Applications</b>	<b>19.22</b>
<b>Video Triax Cables</b>	<b>19.23 – 19.24</b>
<b>Standard Analog Video Cables</b>	<b>19.25 – 19.26</b>
75 Ohm Coax	19.25
RGB Component Video Multicore Cables	19.26
<b>Low Loss HDTV/SDI Digital Coax</b>	<b>19.27 – 19.34</b>
75 Ohm Coax	19.27 – 19.30
RGB Component Video Multicore Cables – VideoFlex®	19.31 – 19.32
RGB Component Video Multicore Cables – Banana Peel®	19.33 – 19.34



## Introduction



### The Broadcasters' Choice

Perhaps there is no other industry which values reliability so highly because inferior broadcast performance has immediate, far-reaching and embarrassing results. Cable performance means assured product quality, absolute signal integrity and no system downtime. Did you watch television last night or listen to the radio this morning? Chances are the link were made with Belden cable – and with so much dedication to development and innovation, the link with Belden increases.

Belden products offer the highest performance in both critical field applications (where cable is dragged, crunched and trodden on) and permanent studio installations (where long runs are all important). Belden cables are an important link in network and cable broadcasts (e.g. BBC, CNN, NBC, NOB, ZDF), film studios (Lucas film) and corporate broadcasting (USA Today, Merrill Lynch).

### Key Applications

- Television monitors
- LCD screens
- Microphones
- Lighting, DMX
- VGA on large screens
- Animation, editing
- Loudspeakers
- HD/SDI

### Key Markets

- Broadcast TV and radio, music and entertainment industries
- OB vans
- Sports, entertainment stadiums/arenas, theatres, cinemas and hotels
- Airports, convention centers and other public facilities
- Race tracks and casinos
- Film studios
- Cruise ships

### Key Products

Belden's commitment to product innovation and technical excellence in the broadcast industry has resulted in a range of reliable audio and video cabling products called Brilliance®. Known for sound and picture brilliance and improved signal integrity, Brilliance® embraces all Belden audio/video products.

The range includes:

- **Optical Fiber Cables:**
  - **HDTV Fiber/Copper Composite Cables**  
Designed specifically for high-definition cameras, these composite cables can multiplex audio and video signals and power. The cables meet all the requirements of the SMPTE 311 standard developed by the Society of Motion Picture and Television Engineers (SMPTE). They are also compatible with industry standard SMPTE 304M connectors.
  - **Mobile Fiber Cables**  
Broadcast truck owners and operators always appreciate the chance to reduce the size and/or weight of any component being carried. Lighter weight Belden mobile optical fiber cable with PUR jacket is extreme rugged and designed for despooling and respooling.

- **Flexible Microphone Cables**  
Belden microphone cable is used for connecting low level microphones. Key properties of microphone (MIC) cables are ruggedness, flexibility, flex life and interference immunity. Low impedance MIC cables use balanced 2-, 3- or 4-conductor (quad) designs.
- **High-Conductivity Copper Cables**  
All Belden microphone cables with bare copper conductors (except: BE46349) use only high-conductivity copper. The refining process, called Electrolytic Tough Pitch (ETP), produces a copper conductor that is 99.95% pure copper resulting in high-conductivity per ASTM B115. The high purity obtained from ETP copper results in microphone cables performance that is comparable to that of oxygen-free copper cables.
- **Plastic Cables**  
These are recommended for lower capacitance, lower loss, greater ozone and oil resistance, lighter weight, smaller diameter.
- **Rubber (EPDM) Cables**  
These are recommended for greater abrasion and impact resistance and extra limpness so the cable will lie flat on stage or on studio floors.
- **Four-Conductor Star Quad Cables**  
Quad connection scheme: The two blue wires (or wires directly opposite one another) are connected together to form one conductor; similarly the two white wires (or remaining wires) are connected together to form the second conductor. Conductors joined in this manner reduce the chance of induced noise.
- **Line Level Analog Audio Cables:** Belden analog audio cables are used for connecting line level audio equipment, in either permanent or semi-permanent installations. They consist of one or two individually foil-shielded, twisted pairs. Once installed, they are not intended to be moved while in operation. For cables that are in motion during use, refer to the microphone and musical instrument cable section in this catalog.  
  
Belden's analog audio cable range consists of several designs to handle a variety of audio applications. Belden part no. 8451 has a paper tape separator to facilitate easy long length jacket stripping. Part no. 9451 comes with a bonded Beldfoil® shield so that the shield and jacket strip simultaneously with automatic stripping equipment. A special matte PVC jacket material is used on part no. 1883A to make it a highly flexible construction. Double-pair cables are available in a round construction (part no. 8728).
- **Analog Multi-Pair Snake Cables:** Specially designed for the broadcast industry, Belden's full family of multi-pair audio "Snake" cables feature different options and constructions for virtually every application.
  - **Applications**  
Snake cables are used to connect multiple audio channels in low-level (microphone) and high-level (line) configurations, such as console board equipment for recording studios, radio television stations, post-production facilities and sound system installations. With Belden's individually shielded and jacketed snakes, pairs can be split out of the overall jacket for any length and connected directly without the need for heat shrink tubing or costly and time-consuming preparation. 26 AWG and 24 AWG sizes are also ideal for punch down connector applications.
  - **Numbered and Color Coded**  
Jacketed pairs are individually numbered and color coded (following the familiar resistor color code) for easy identification.  
  
Belden's BE46313 Series; jacketed pairs are grey and individually numbered.

# Introduction



**- Mobile and Fixed Installations**

Foil-shielded multicore cables are mainly used for permanent installations while Belden's braid shield constructions are recommended for mobile (semi-permanent) applications.

**- French Braid® Shield**

Belden's patented "French Braid" shield is a double spiral (double serve) bare copper shield with the two spirals tied together by one weave. This improves flex life over standard spiral shields, improves flexibility over conventional braid shields and lowers microphonic or triboelectric noise. The "French Braid" is easy to terminate since it is not fully woven. It also provides for lower DC loop resistance than the single spiral braid. The "French Braid" is featured in Belden's FlexSnake® Cables (1900 Series) and quad snake cables (7880 Series).

**- Beldfoil® Shield**

The foil shield of each pair is bonded to the jacket with the drain wire inside the foil. This makes the cable easier to strip. A standard stripping tool removes both the insulation and foil and greatly speeds up the installation time.

- **AES/EBU Digital Audio Cables:** The specification for digital audio was developed jointly by the Audio Engineering Society (AES) & European Broadcast Union (EBU). The key difference between twisted pair specifications for digital audio cable and standard analog audio cable is the impedance specification.

The detailed specifications of this standard are:

Sampling rate: from 32 KHz to 192 KHz

Bandwidth: from 4.096 MHz to 24.5 MHz

Impedance: 110 Ω ± 20%

Sampling Rate	Bandwidth
32 kHz	4.096 MHz
44.1 kHz	5.6448 MHz
48 kHz	6.144 MHz
96 kHz	12.228 MHz
192 kHz	24.576 MHz

AES/EBU, with its broad tolerance, allows cables with impedances from 88 Ohm to 132 Ohm to be used. Standard analog audio cable impedance is 45 Ohm to 70 Ohm. This amount of potential mismatch can result in signal reflections and jitter, causing bit errors at the receiver. For this reason, Belden recommends 100 to 120 Ohm shielded twisted pair cables.

**How to Choose a AES/EBU Cable.**

**Single and Double Pairs**

- **9180**  
26 Gage (0.14 mm<sup>2</sup>/0.5 mm), Beldfoil®, Datalene®
- **1800B**  
24 Gage (0.22 mm<sup>2</sup>/0.6 mm), Beldfoil®, Datalene®
- **1802B**  
24 Gage (0.22 mm<sup>2</sup>/0.6 mm), Beldfoil®, Datalene®, Double-Pairs
- **1800F**  
24 Gage (0.22 mm<sup>2</sup>/0.6 mm), FrenchBraid®, Datalene®, several colors
- **1696A**  
22 Gage (0.34 mm<sup>2</sup>/0.8 mm), Beldfoil®/FrenchBraid®, Datalene®

**Multi-Pair Snake Cables**

- **7880A Series**  
26 Gage (0.14 mm<sup>2</sup>/0.5 mm), Beldfoil®/Overall Beldfoil®, Datalene®, Color coded
- **BE46935 Series**  
26 Gage (0.14 mm<sup>2</sup>/0.5 mm), Braid/Overall Braid, FRNC IEC 332-3C
- **BE46266 SlimSnake™**  
26 Gage (0.14 mm<sup>2</sup>/0.5 mm), Braid/Overall Braid, Halogen-Free
- **1803F Series**  
24 Gage (0.22 mm<sup>2</sup>/0.6 mm), Beldfoil®/Overall Beldfoil®, Datalene®, Color coded

**Maximum Recommended Transmission Distance at Digital Audio Data Rates**

Part No.	AWG	2 MHz		4 MHz		5 MHz		6 MHz		12 MHz		25 MHz	
		ft.	m	ft.	m	ft.	m	ft.	m	ft.	m	ft.	m
<b>110 Ohm</b>													
9180, 7880A Series	26	1197	365	948	289	869	265	813	248	633	193	472	144
1800F	24	1233	376	922	281	764	233	666	203	423	129	279	85
1800B, 1802B, 1803F Series	24	1538	469	1282	391	1178	359	1105	337	876	267	649	198
1696A	22	2148	655	1738	530	1666	508	1538	469	1250	381	1014	309
<b>75 Ohm</b>													
179DT	28.5	1492	455	1197	365	1148	350	1004	306	722	220	522	159
1855A	23	3519	1073	2427	740	2175	663	1991	607	1538	469	1112	339
1505F	22	5881	1793	3772	1150	3332	1016	2985	910	2040	622	1387	423
1505A	20	4864	1483	3477	1060	3175	968	2909	887	2221	677	1538	469
1694A	18	5881	1793	4182	1275	3703	1129	3408	1039	2499	762	2001	610

Much longer transmission distance is achievable but is contingent upon system component quality.



## Introduction



### • Speaker Cables

Speaker cables are used to connect receivers or power amplifiers to speakers and are also used for the internal wiring of the speakers themselves.

Because the impedance of the loudspeaker is quite low (typically 3 to 10 Ohm) much of the power conducted through the cable is carried in the current domain which is affected by conductor resistance. The resistance of the cable between the speaker and the amplifier turns some of the amplifier's power into heat and does not get to the speaker.

The feedback from the speaker is altered by the cable. This feedback is used by the amplifier to correct the speaker's non-linearity. This is measured as the 'damping' factor by amplifier designers and is called "Servoing" by the Hi-fi community.

In general, the higher the cable resistance, the lower the power level getting to the speaker. This results in "sloppier" speaker performance due to damping.

Ultimately, the system designer must decide how to compromise system performance against system cost. In general, one of the least expensive ways to squeeze increased and better performance out of the system hardware is to use larger speaker cables and cut your losses where they occur rather than try to "band-aid" the system later with equalization or more power.

The cable selection guide can aid in determining the proper gage selection depending on the speaker impedance, acceptable power loss and cable run length.

### • Special Cables

Cables listed in this section are for special audio applications – unbalanced audio cables, DMX512 cable and CatSnake™.

#### - Unbalanced Audio Cables

Traditional unbalanced (coaxial) cables use two lines to transmit the audio signal – a hot line which carries the signal and an earth line. This is all that is required to transmit audio and is common in short cables (where noise is less of a problem).

#### - DMX512 Cables

The DMX512 standard describes a method of digital data transmission between controllers and controlled lighting equipment and accessories, including dimmers and related equipment. The cable has a nominal characteristic impedance of 100 to 120 Ohm and shielded twisted pairs approved by its manufacturer for EIA-422/EIA-485-A use at 250 Kbits/second and distances of 500 meters or more.

#### - CatSnake™

Belden now offers Brilliance CatSnake™. This is a mobile Category 5e cable which employs Belden's patented bonded-pair design, for use in high traffic areas in a broadcast studio or in any type of tactical field deployable digital audio/video installation.

#### - Video Triax Cables

Triaxial cables are used to interconnect video cameras to related equipment. They contain two isolated shields and a solid or stranded center conductor. Isolated shields allow the triax to provide multiple functions over one cable through multiplexing techniques.

Applications include: DC power to camera, intercom to operator, teleprompter feeds, monitoring feeds and even automatic or robotic functions.

The O.D. describes size and distance – Triax 8 for short runs, Triax 11 for long runs and Triax 14 for very long runs.

Silver-plated copper: Typical triax cable construction in the industry is bare copper. Four of Belden's new triax cables use silver-plated copper for the inner conductor and the first shield. This construction provides exceptional electrical characteristics (attenuation and impedance stability) for excellent picture quality over extended transmission distances. These cables are also suitable for the latest digital camera triax applications.

#### - Standard Analog Video Cables

Belden standard video cables are typically used in non-critical video applications such as video equipment rack wiring, Closed Circuit TV (CCTV), Master Antenna TV (MATV) and color or monochrome video monitor hook-ups. Applications such as these do not require precision video coaxes which have extremely tight electrical tolerances.

Video coax cables have a characteristic impedance of 75 Ohm. This value was not chosen arbitrarily. Physics shows that optimum attenuation characteristics occur at 77 Ohm. Materials and design lead to the selection of 75 Ohm as the optimum compromise for low power applications. Standard video coaxes are available in both solid and stranded designs.

#### - Low Loss HDTV/SDI Digital Coax

HDTV/SDI video cables usually have solid center conductors and dual shields. The dielectrics can either be foamed or for better crush resistance have foamed HDPE insulation. Tighter impedance and attenuation tolerances, superior Return Loss (RL) specifications and improved shielding give precision video cables their no-compromise performance.

## Cable Selection Guide

AWG	mm <sup>2</sup>	4 Ω Speaker			8 Ω Speaker			70 V Speaker*		
		Power (%) / Loss dB/m								
		11% 0.5	21% 1.0	50% 3.0	11% 0.5	21% 1.0	50% 3.0	11% 0.5	21% 1.0	50% 3.0
11	4.00	53	116	438	109	232	871	2637	5675	21341
13	2.50	34	74	282	71	151	564	1711	3678	13834
14	2.10	27	59	226	56	120	451	1369	2942	11067
16	1.50	18	38	143	35	76	285	866	1860	6997
26	0.14	2	6	21	5	11	41	127	273	1027

The number of meter of cable you can run for a given loss and performance budget.

## How to Use the Guide

Step One: Select the appropriate speaker impedance column.

Step Two: Select the appropriate power loss column deemed to be acceptable.

Step Three: Select the applicable wire gage size and follow the row over to the columns determined in steps one and two. The number listed is the maximum cable run length.

Example: The maximum run for 11 AWG in a 4 Ohm speaker system with 11% or 0.5 dB loss is 53 m.

\* 70 volt line drive systems, while considered a potential for Hi-fi performance, follow the same cable loss physics as the higher current (lower impedance) system. For the sake of this calculation a 25 watt 70 volts system (196 Ohm) was used.

## Introduction



### The Future is HDTV

The Society of Motion Picture and Television Engineers (SMPTE) has developed several standards for serial digital video transmissions (SDI) and a 540 Mb/s format is currently under development. There is also a European standards body known as the ITU (formerly CCIR) that has developed the composite video standard for Europe known as PAL/SECAM. The most common is the 270 Mb/s SDI (Serial Digital Interface). All of the specifications differ in bandwidth requirements and transmission technology, i.e. composite, component and digital:

Data Rate	Bandwidth	Standard	Description
143 Mb/s	71.5 MHz	SMPTE 259M	NTSC
177 Mb/s	88.5 MHz	ITU-R BT.601	PAL/SECAM
270 Mb/s	135.0 MHz	SMPTE 259M	Component Video 4:3
360 Mb/s	180.0 MHz	SMPTE 259M	Component 16:9
540 Mb/s	270.0 MHz	SMPTE 344M	Component Widescreen
1.5 Gb/s	750.0 MHz	SMPTE 292M	HDTV

High Definition Television (HDTV) will require upgrades throughout the broadcasting industry, creating additional opportunities. International competitions such as the Olympic Games, Formula One, football and many other sporting events are very popular and demand the best broadcasting technology to guarantee viewer satisfaction.

Belden has a range of available coaxes that exceeds the SMPTE RL specification for HDTV distribution and provides maximum "RL headroom" to ensure that the user can achieve the SMPTE's requirement for signal distribution:

Specification RL Limit	RL	Frequency
SMPTE Recommendation	> 15 dB	5 - 1.5 GHz
Belden Guaranteed RL	> 23 dB	5 - 850 MHz
Belden Guaranteed RL	> 21 dB	850 MHz - 4.5 GHz

Using Belden coaxial cable will result in a minimum 6 dB of headroom to accommodate RL reduction created by connectors and patch-bays etc.

Below you will find the actual RL data of Belden 1505A. The cable is typically -30 dB:

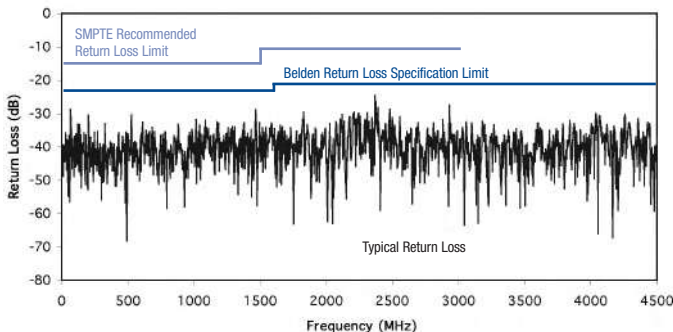

Belden's extremely popular HDTV Brilliance® Broadcast video cables are now 4.5 GHz sweep tested! Prepared for 1080p formats, 1855, 1505A, 1694A and 7731A cables are sweep tested to 4.5 GHz. Belden has always tested every finished put-up to be certain of a top quality product. This is the only way in which damage introduced in finishing operations can be detected. This process sets Belden apart from competitors who only test in batches.

# Introduction



## Maximum Transmission Distance at Serial Digital Data Rates

Data Rate:	143 Mb/s		177 Mb/s		270 Mb/s		360 Mb/s		540 Mb/s		1.5 Gb/s		1.5 Gb/s		3.0 Gb/s		
Spec:	SMPTE 259M		ITU-R BT .601		SMPTE 259M		SMPTE 259M		SMPTE 344M		SMPTE 292M		Independent Test		SMPTE 424M		
Application:	Composite NTSC		Composite PAL		Composite Video		Component Widescreen		Component Widescreen		HDTV		HDTV		Prog. Scan HDTV		
Part No.	ft.	m	ft.	m	ft.	m	ft.	m	ft.	m	ft.	m	ft.	m	ft.	m	
179DT	500	152	450	137	380	116	340	104	280	85	110	34	132	40	+6	80	24
1855A	980	299	950	290	790	241	680	207	560	171	260	79	263	80	+1	150	46
1855ENH	-	-	-	-	-	-	-	-	-	-	-	-	328	100	-	-	-
1505A	1430	436	1360	415	1110	338	970	296	790	241	310	94	394	120	+26	220	67
1505F	1200	366	1071	327	857	261	732	223	588	179	225	69	328	100	+31	-	-
1694A	1880	573	1710	521	1.430	436	1240	378	1010	308	400	122	459	140	+18	270	82
7731A	2750	838	2480	756	2.040	622	1760	536	1430	436	550	168	656	200	+32	360	110

## Crush Resistance

Manufacturers may provide very good cable and test data for their product in the laboratory or on the package spool. However, the rigors of installation can have a serious affect on the actual physical layer performance.

Any change in impedance at any point would cause a reflection. This reflection may have serious repercussions on the cable's performance.

Belden products maintain superiority in crush resistance. Belden products use a gas-injected foam high-density polyethylene dielectric material in precision video cables in order to maintain:

- Better field ruggedness
- The ability to handle tighter bend radii
- More weight in cable trays
- Bending/flexing without pushing out the center pin and/or damaging attached equipment
- More rugged installation practices
- Plus various other environmental and installation benefits

## Return Loss (dB)

The tested cables were loaded with 50 N (50 Newton = 5 kilograms), according to EN50289-3-5.

75 Ohm Brilliance® precision video cable 1505A: RL 28 dB - 850 MHz, 22dB - 3 GHz

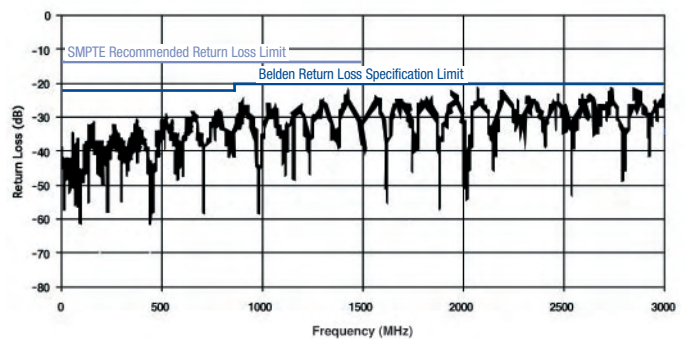

Manufacturer X: RL 12 dB - 850 MHz, 11 dB - 3 GHz

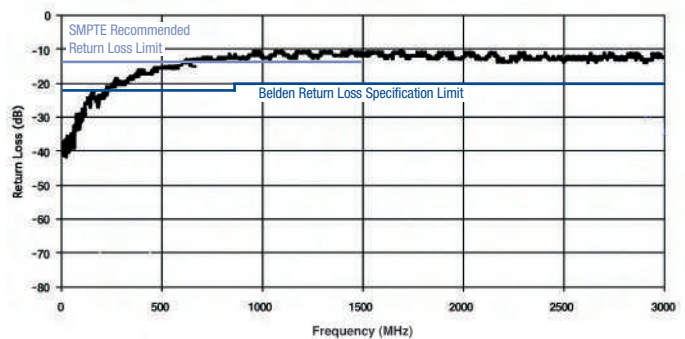

## Introduction



### Connector Cross

Belden	Type	ADC	Bomar	Damar + Hagen	Fischer	Lemo	Neutrik	Radiall	Telegärtner	Trompeter	Vitelec
179DT	0.3/1.4	BNC-31	–	–	–	–	NBCT75 BF14	–	–	–	–
152xA	0.3/1.42 RGB	–	–	on request	–	FGG.3B.244.CL.CD82	NBCT75 BF14	R142.004.000	J01002A0027	-D7	VB10-2036
12xxR	0.45/1.9 RGB	BNC-16	–	1-xxxx-2100	–	9.1.04	NBCT75 BNN5	–	9.1.04	105-2053-9	–
14xxB	0.5/2.3 RGB	BNC-13	–	1-3397-3602	–	–	NBCT75 BVV5	–	–	-D1	–
1865A	0.5/2.4	BNC-12	–	on request	–	FFSOA.250.NTAC40	NBCT75 BXX6	R142.078.161	J01002F1350	-D1	VB10-2063
1855A	0.6/2.6	BNC-13	SBC1855A	1-6097-2100	–	FFSOA.250.NTAC47	NBNC75 BDD6	R142.081.320	J01002A0030	-D1	–
1855ENH	0.6/2.8	BNC-26	–	1-4271-2100	–	FFSOA.250.NTAE63	NBNC75 BFG7	R142.082.027	J01002A0018	-D24	–
8241	0.6/3.7	BNC-2	–	1-1190-2100	–	on request	NBNC75 BLP7	R142.016.000	J01002A0003	-D3	–
1505A	0.8/3.7	BNC-1	SBC1505A	1-4253-2100	–	FFSOA.250.NTAE63	NBNC75 BLP9	R142.084.161	J01002A0031	-D2	–
8281	0.8/4.9	BNC-3	–	1-1194-2100	–	on request	NBNC75 BXY9	R142.090.161	J01002A0014	-D10	VB10-2026
1694A	1.0/4.6	BNC-8	SBC1694A	1-4482-2100	–	on request	NBNC75 BTU11	R142.086.161	J01002A0010	-D4	VB10-2024
1694F	1.0/5.7	BNC-8F-N	–	–	–	–	–	–	–	–	–
7731A	1.6/7.2	BNC-25	SBC7731A	1-5044-2100	–	FFA.4E.675.CTAC10	NBLC75 BVZ17	R142.186.000	J01002A1940	-D5	–
7783A	Triax 8	ProAx™	–	Serie47	1051 A004-5	FFA.4E.675.CTAC85	–	–	–	305-1365-1	–
1856A	Triax 9	ProAx™	–	Serie47	1051 A004-5	FFA.4E.675.CTAC95	–	–	–	305-0088-2	–
7784A	Triax 11	ProAx™	–	Serie47	1051 A004-5	FFA.4E.675.CTAC11	–	R142.017.000	–	305-1289-1	–
7785A	Triax 14	ProAx™	–	Serie47	1051 A004-4	on request	–	–	–	–	–

ProAx™ is an ADC Krone trademark.

### Multicore Cables

#### • Video Multicore Cables

Belden's video multicore cables (RGBs) are designed for high resolution VGA on large screens, HDTV, Hi-Res CAD, animation, editing and special effects.

RGB coaxial cables are used for sending Red, Green and Blue signals through separate coaxes in component video applications. This type of video transmission provides a sharper, clearer picture than the composite video format.

Bundled coaxial cables are available in 3-, 4- or 5-conductor versions and are color coded for easy identification. Cable selection depends on whether the component transmission is RGB (3 cdr.), RGB and Sync (4 cdr.) or RGB, Sync and Hold (5 cdr.).

All Belden RGB cables are pre-timed to less than 4.0 ns/m delay difference between each coax. This allows for cut-and-connect installation with no TDR or Vectorscope timing required.

#### • Banana Peel® - RGB Cable without a Jacket

Series 1281 is an enhanced version of traditional RGB cables and feature 25 AWG solid copper center conductors for lower attenuation and easier termination. Flexible PVC jackets and high frequency Beldfoil® foil shields are used in combination with Belden's unique interlocked serve copper shield for 100% coverage. The unique shielding design also prevents the shields from bunching up when flexed, yet the shield is easier to comb out than a full braid.

Banana Peel® hi-res composite video cables will decrease labor costs because the overall jacket has been eliminated. Without the overall jacket, a whole step in the termination process has been removed. In addition, the individual cable components are all instantly identifiable (the individual cables are color-coded and the print legends are immediately visible). Jacketed RGB cables are also notoriously difficult to strip for termination – Banana Peel® RGBs overcome this problem.

#### Exceptional Benefits:

- Labor saving
- Easy identification
- Smaller outer diameter than jacketed version
- More flexible than jacketed version

### Availability

Most of our Brilliance® broadcast cables are available from stock. Many of these are available off the shelf from distributors. If you have a new or unusual application or you cannot find a Brilliance® broadcast cable in this catalog section that meets your technical requirements contact Technical Support at +31-77-3875-414 or techsupport.venlo@belden.com.

### Corresponding Literature

#### Technical Bulletins

- TB-65: Digital studio guide
- TB E100: Video multicores
- TB E101: Belden exceeds the standards of HD
- TB E104: Flame retardant triax and coax

#### Product Bulletins

- NP151: Siamese cables (9451D)
- NP152: Star quad cables
- NP183: 1505F, flexible version of 1505A
- NP198: Mini High-Res RGBs (127XR)
- NP207: DigiTruck (179DT)
- NP217: Banana Peel® Mini-RGBs (Serie1281)
- NP228: CatSnake™ (1305A)
- NP233: 1694F, Flexible version of 1694A
- NP234: Banana Peel® designed SDI RGBs (1855S5/1505S5)
- NP108E: SlimSnake™ halogen-free AES/EBU multi-pair cable

# Optical Fiber Cables

## SMPTE 311M HDTV Cables



De- scription	Part No.	UL NEC/ C(UL)/CEC Type IEC	Standard Lengths		Standard Unit Weight		Conductor (Stranding) Diameter Nom. DCR	Shielding Material	Nominal OD		Compo- nent	Description	Shielding Material & Nom. DCR	Jacket Material & Colors	Component OD	
			ft.	m	lbs.	kg			inch	mm					inch	mm

**SMPTE 311M • 2 Power Conductors • SM Fiber w/24 and 16 AWG • Stranded (7x32 and 65x34) TC • Overall 95% Tinned Copper Braid**

PVC Insulation • Black Belflex® Jacket																
	<b>7804C</b>	NEC:	328	100	33.1	15.0	–	+ 95% TC Braid	0.362	9.20	2x Fiber	2 Breakout Fibers SM/125µ/900µ core/clad/buffer	Unshielded	PVC Blue Yellow	0.079	2.00
		CMR:	500	152	47.6	21.6										
		CEC:	1000	305	95.9	43.5										
		CMG FT4	1640	500	152.6	69.2										
			3280	1000	314.8	142.8										
										2x Data	2 Conductors 24 AWG 0.61 mm (7x32) TC	Unshielded	PVC Red Grey	0.050	1.27	
											2x Power	2 Conductors 16 AWG 1.5 mm (65x34) TC	Unshielded	PVC Black White	0.093	2.36

Plenum version and other conductor counts/diameters available by special order.  
Fibers and aramid fillers contained within a 0.008" (2.0 mm) diameter PVC breakout jacket.

**SMPTE 311M • 4 Power Conductors • SM Fiber w/24 and 20 AWG • Stranded (7x32 and 19x32) TC • Overall 95% Tinned Copper Braid**

PVC Insulation • Black Belflex® Jacket																
	<b>7804R</b>	NEC:	328	100	32.8	14.9	–	+ 95% TC Braid	0.362	9.20	2x Fiber	2 Fibers SM/125µ/900µ core/clad/buffer	Unshielded	PVC Blue Yellow	0.035	0.89
		CMR:	500	152	48.9	22.2										
		CEC:	1000	305	99.0	44.9										
		CMG FT4	1640	500	157.4	71.4										
			3280	1000	324.7	147.3										
											2x Data	2 Conductors 24 AWG 0.61 mm (7x32) TC	Unshielded	PVC Red Grey	0.050	1.27
											4x Power	4 Conductors 20 AWG 0.94 mm (19x32) TC	Unshielded	PVC Black White White/Black Black/White	0.063	1.60

Plenum version and other conductor counts/diameters available by special order.

## Tactical Mobile Optical Fiber

De- Description	Part No.	No. of Fibers	Standard Lengths		Standard Unit Weight		Fiber Size µm	Nom. Buffer/ Tube OD		Strength Members	Nominal OD		Central Element mm	Pulling Tension N	Crush Re- sistance kN/m	Energy kJ/m	Bending radii cable (mm)	
			ft.	m	lbs.	kg		inch	mm		inch	mm					static	dyna- mic

**GMMT • Intex Mobile • Tight Buffer • Designed for Despooling and Respooling • A/I-VQ(ZN)11Y**

Dry Construction • PUR Jacket (Orange or Black)																		
-30/70°C	IEC 60332-1		6888	2100			Ø 280 ± 15			Longitudinal watertightness Swellable Reinforced Yarn			no					
	<b>GMMT</b> x04	4			143.5	65.1					0.23	5.8		800	4	580	58	87
	<b>GMMT</b> x06	6			175.9	79.8					0.25	6.3		950	4	725	63	95
	<b>GMMT</b> x08	8			217.6	98.7					0.28	7.0		1100	4	890	70	105

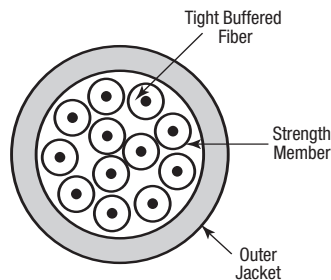

Color coding of the buffered fibers: White, Red, Blue, Yellow, Green, Violet, Brown, Black  
Optical characteristics see page 16.21.

TC = Tinned Copper • DCR = DC resistance

## Microphone and Musical Instrument Cables

### Two-Conductor, Low-Impedance Cables



De-scription	Part No.	UL NEC / C(UL)CEC Type IEC	Standard Lengths		Standard Unit Weight		Conductor (Stranding) Diameter Nom. DCR	Nominal Insulation OD		Shielding Material Nom. DCR	Nominal OD		Nom. Imp. (Ω)	Nom. Vel. of Prop.	Nominal Capacitance		Color Code
			ft.	m	lbs.	kg		inch	mm		inch	mm			pF/ft.	pF/m	

**24 AWG • Stranded (105x44) 0.6 mm High-Conductivity (Oxygen-Free) BC • Conductors Cabled with Fillers • 97 % BC Double Spiral Braid**

<b>PVC Insulation • Matte Black PVC Jacket</b>																		
300V RMS 80°C	<b>9397</b>		500	152	12.1	5.5	0.61 mm 24 AWG (105x44) BC	0.048	1.22	Overall Double Spiral + 97% BC Braid	0.176	4.47	47	-	CDR/CDR CDR/SCR	47 86	154 283	White, Green



0.22 mm<sup>2</sup>

Pulling Tension: 44 N

**24 AWG • Stranded (32x0.1) 0.6 mm Bare Copper • Conductors Cabled with Fillers • 92 % Bare Copper Spiral Serve Braid**

<b>Polyethylene Insulation • PVC Jacket (Red, Yellow, Green, Blue, Grey, White and Black)</b>																		
100V RMS 60°C	<b>BE46349</b>		328	100	9.3	4.2	0.6 mm 24 AWG (32x0.1) BC	0.057	1.45	Overall Spiral Serve + 92% BC Braid	0.240	6.10	-	-	CDR/CDR CDR/SCR	18 34	60 110	Red, Blue



0.25 mm<sup>2</sup>

Pulling Tension: 44 N

**20 AWG • Stranded (26x34) 0.9 mm High-Conductivity (Oxygen-Free) TC • Cotton Wrap • Conductors Cabled • Rayon Braid • 85 % TC Braid**

<b>EPDM Rubber Insulation • EPDM Jacket (Black, Red, Yellow and Blue)</b>																		
600V RMS 90°C	<b>8412</b>		100	31	5.2	2.4	0.94 mm 20 AWG (26x34) TC	0.083	2.11	Overall 85% TC Braid	0.262	6.65	52	-	CDR/CDR CDR/SCR	30 55	98 180	White, Black
			250	76	12.1	5.5												
			U-500	U-152	24.0	10.9												
			500	152	24.0	10.9												
			U-1000	U-305	46.0	20.9												
			1000	305	47.1	21.4												



0.52 mm<sup>2</sup>

Pulling Tension: 445 N  
Red, Yellow or Blue available in 305 m put-up only.

### Three-Conductor, Low-Impedance Cables

De-scription	Part No.	UL NEC / C(UL)CEC Type IEC	Standard Lengths		Standard Unit Weight		Conductor (Stranding) Diameter Nom. DCR	Nominal Insulation OD		Shielding Material Nom. DCR	Nominal OD		Nom. Imp. (Ω)	Nom. Vel. of Prop.	Nominal Capacitance		Color Code
			ft.	m	lbs.	kg		inch	mm		inch	mm			pF/ft.	pF/m	

**24 AWG • Stranded (105x44) 0.6 mm High-Conductivity (Oxygen-Free) Bare Copper • Double Spiral Braid • 97% Bare Copper Braid**

<b>PVC Insulation • Matte Black PVC Jacket</b>																		
300V RMS 80°C	<b>9398</b>		1000	305	25.1	11.4	0.61 mm 24 AWG (105x44) BC	0.048	1.22	Overall Double Spiral + 97% BC Braid	0.185	4.70	47	-	CDR/CDR CDR/SCR	40 110	131 361	White, Green, Brown



0.22 mm<sup>2</sup>

Pulling Tension: 200 N

TC = Tinned Copper • BC = Bare Copper • EPDM = Ethylene Propylene Diene Monomer • DCR = DC resistance  
SCR = Capacitance between one conductor and other conductors connected to shield. • CDR = Capacitance between conductors



# Microphone and Musical Instrument Cables

## Four-Conductor, Star-Quad



De- scription	Part No.	UL NEC/ C(UL)/CEC Type IEC	Standard Lengths		Standard Unit Weight		Conductor (Stranding) Diameter Nom. DCR	Nominal Insulation OD		Shielding Material Nom. DCR	Nominal OD		Nom. Imp. (Ω)	Nom. Vel. of Prop.	Nominal Capacitance		Color Code
			ft.	m	lbs.	kg		inch	mm		inch	mm			pF/ft.	pF/m	

**28 AWG • Stranded (19x40) 0.4 mm High-Conductivity (Oxygen-Free) Silver-Plated Copper Alloy • 78 % Tinned Copper Braid**

Polypropylene Insulation • Matte PVC Jacket (Red, Yellow, Blue, Beige and Black)																		
100V RMS 60°C	<b>1804A*</b>		100	31	1.6	0.7	0.38 mm 28 AWG (19x40) SPC	0.030	0.76	Overall 78% TC Braid	0.115	2.92	40	–	CDR/CDR CDR/SCR	40 60	131 196	see chart below



0.09 mm<sup>2</sup>

31 m put-up available in Black only.

2/c 23 AWG equivalent DCR when connected to a 3-pin XLR.  
Pulling Tension: 106 N

**26 AWG • Stranded (30x40) 0.5 mm High-Conductivity (Oxygen-Free) BC • Conductors Cabled • 95 % TC French Braid® • 28 AWG BC Drain Wire**

Polyethylene Insulation • Matte PVC Jacket (Red, Green, Yellow, Blue, Grey and Black)																		
100V RMS 60°C	<b>1172A*</b>		500	152	13.5	6.1	0.53 mm 26 AWG (30x40) BC	0.045	1.14	Overall French Braid® 95% TC + Drain Wire (28 AWG BC)	0.190	4.83	39	–	CDR/CDR CDR/SCR	39 57	129 188	see chart below



0.14 mm<sup>2</sup>

152 m put-up available in Black only.

2/c 23 AWG equivalent DCR when connected to a 3-pin XLR.  
Pulling Tension: 164 N

**24 AWG • Stranded (41x40) 0.6 mm High-Conductivity (Oxygen-Free) Bare Copper • Conductors Cabled • 95 % Tinned Copper Braid**

Polyethylene Insulation • Matte PVC Jacket (Red, Green, Yellow, Blue, Grey and Black)																		
100V RMS 75°C	<b>1192A*</b>		100	31	4.1	1.9	0.58 mm 24 AWG (41x40) BC	0.056	1.42	Overall 95% TC Braid	0.245	6.22	40	–	CDR/CDR CDR/SCR	39 57	129 188	see chart below



0.22 mm<sup>2</sup>

31 m put-up available in Black only.  
152 m put-up available in Blue or Black only.

2/c 21 AWG equivalent DCR when connected to a 3-pin XLR.  
Pulling Tension: 93 N

**20 AWG • Stranded (26x34) 0.9 mm High-Conductivity (Oxygen-Free) TC • Cotton Wrap • Conductors Cabled • Rayon Braid • 85 % TC Braid**

EPDM Rubber Insulation • Cotton Wrap • Black EPDM Rubber Jacket																		
600V RMS 90°C	<b>8424</b>		100	31	6.8	3.1	0.91 mm 20 AWG (26x34) TC	0.083	2.11	Overall 85% TC Braid	0.294	7.47	52	–	CDR/CDR CDR/SCR	47 59	154 194	Black, White, Red, Green



0.52 mm<sup>2</sup>

2/c 17 AWG equivalent DCR when connected to a 3-pin XLR.  
Pulling Tension: 387 N

TC = Tinned Copper • BC = Bare Copper • SPC = Silver-Plated Copper • DCR = DC resistance  
SCR = Capacitance between one conductor and other conductors connected to shield. • CDR = Capacitance between conductors  
\* One Blue conductor and one White conductor are striped for use in MIDI and other four conductor applications.  
▲ May contain more than one piece. Min. length of any one piece is 15 m (50 ft).

**Color Code**

Pair No.	Color
1	Blue
2	White
3	Blue with White Stripe
4	White with Blue Stripe



# Line Level Analog Audio Cables

Single- and Double-Pair Cables  
Audio-Connect



De- scription	Part No.	UL NEC/ C(UL)/CEC Type IEC	Standard Lengths		Standard Unit Weight		Conductor (Stranding) Diameter Nom. DCR	Nominal Insulation OD		Shielding Material Nom. DCR	Nominal OD		Nom. Imp. (Ω)	Nom. Vel. of Prop.	Nominal Capacitance		Color Code
			ft.	m	lbs.	kg		inch	mm		inch	mm			pF/ft.	pF/m	

**24 AWG • Stranded (7x32) 0.6 mm Tinned Copper Conductors • Twisted Pair • Overall Beldfoil® Shield • 24 AWG Tinned Copper Drain Wire**

Polypropylene Insulation • Grey PVC Jacket																		
300V RMS 75°C CEC: CMG FT4	1883A	NEC:	U-1000	U-305	11.0	5.0	0.61 mm 24 AWG (7x32) TC	0.040	1.02	Overall Beldfoil® + Drain Wire (24 AWG TC)	0.123	3.12	52	-	CDR/CDR	31	101	Black, Red
		CMR	1000	305	11.0	5.0									CDR/SCR	58	190	
		CEC:																



0.22 mm²

U-305 m put-up also available in Brown, Red, Orange, Yellow, Green, Blue, Violet, White or Black.  
Jacket and shield are bonded so both can be removed with automatic stripping equipment.  
Pulling Tension: 71 N

**24 AWG • Stranded (19x36) 0.6 mm High-Conductivity (Oxygen-Free) Tinned Copper • Twisted Pair • Overall Beldfoil® Shield (Unbonded) • 24 AWG Tinned Copper Drain Wire • Noise Reducing Tape**

High-density Polyethylene Insulation • Black PVC Jacket																		
200V RMS 75°C	9452	NEC:	U-500	U-152	6.6	3.0	0.61 mm 24 AWG (19x36) TC	0.040	1.02	Overall Beldfoil® + Drain Wire (24 AWG TC)	0.135	3.43	56	-	CDR/CDR	30	98	Black, Red
		CMR	500	152	6.0	2.7									CDR/SCR	58	190	
		CEC:	U-1000	U-305	12.0	5.4												



Shorting Fold

0.22 mm²

Pulling Tension: 79 N

**22 AWG • Stranded (7x30) 0.8 mm Tinned Copper • Twisted Pair • Overall Beldfoil® Shield • 22 AWG Tinned Copper Drain Wire**

Polypropylene Insulation • PVC Jacket (Black, Grey, Brown, Red, Orange, Yellow, Green, Blue, Violet and White)																		
300V RMS 75°C 1-Pair CEC: CMG FT4	9451	NEC:	U-500	U-152	8.0	3.6	0.76 mm 22 AWG (7x30) TC	0.050	1.27	Overall Beldfoil® + Drain Wire (22 AWG TC)	0.135	3.43	45	-	CDR/CDR	35	115	Black, Red
		CMR	500	152	8.0	3.6									CDR/SCR	67	220	
		CEC:	T-1000	T-305	18.0	8.2												



0.34 mm²

U-152 m, 152 m and T-305 m put-ups available in Grey only.  
The jacket and shield are bonded so both can be removed with automatic stripping equipment. Drain wire is inside foil shield.  
Pulling Tension: 120 N

**22 AWG • Stranded (7x30) 0.8 mm TC • Twisted Pair • Overall Beldfoil® Shield (Unbonded) • 22 AWG Tinned Copper Drain Wire**

Polyethylene Insulation • Paper Wrap • PVC Jacket (Black or Grey)																		
300V RMS 75°C	8451	NEC:	100	31	2.3	1.0	0.76 mm 22 AWG (7x30) TC	0.050	1.27	Overall Beldfoil® + Drain Wire (22 AWG TC)	0.138	3.51	45	-	CDR/CDR	34	112	Black, Red
		CMR	U-500	U-152	8.5	3.9									CDR/SCR	67	220	
		CEC:	500	152	8.0	3.6												



Z-Fold®

0.34 mm²

31 m put-up available in Black only.  
Pulling Tension: 120 N  
Belden's miniature type broadcast audio and instrumentation cables occupy 1/2 to 2/3 less space than standard cables. Unique paper separator facilitates jacket stripping.

**22 AWG • Stranded (7x30) 0.8 mm Tinned Copper • Dual Pairs • Overall Beldfoil® Shield (Unbonded) • 24 AWG Tinned Copper Drain Wire**

Polypropylene Insulation • Chrome PVC Jacket																		
80°C UL AWM Style 2717	8728	NEC:	U-500	U-152	15.0	6.8	0.76 mm 22 AWG (7x30) TC	0.050	1.27	Individual Beldfoil® + Drain Wire (24 AWG TC) + Overall Beldfoil®	0.215	5.46	50	-	CDR/CDR	35	115	Black, Red, Green, White
		CM	500	152	15.5	7.0									CDR/SCR	62	203	
		CEC:	U-1000	U-305	30.0	13.6												



0.34 mm²

Each pair Beldfoil shielded with individual drain wire plus polyester film over each shield.  
Pulling Tension: 161 N

TC = Tinned Copper • DCR = DC resistance • SCR = Capacitance between one conductor and other conductors connected to shield. • CDR = Capacitance between conductors

# Analog Multi-Pair Snake Cables

Flexible, Field Use, Rugged-Stage Cables  
Individually Shielded and Jacketed Pairs



De- scription	Part No.	UL NEC/ C(UL)CEC Type IEC	Standard Lengths		Standard Unit Weight		Conductor (Stranding) Diameter Nom. DCR	Nominal Insulation OD		Shielding Material Nom. DCR	Nominal OD		Nom. Imp. (Ω)	Nom. Vel. of Prop.	Nominal Capacitance		Color Code
			ft.	m	lbs.	kg		inch	mm		inch	mm			pF/ft.	pF/m	

**26 AWG • Stranded (18x0.1) 0.5 mm TC • Each Pair Individually TC Spiral Braid • Numbered PVC Jackets • Overall > 80% TC Braid**

<b>Polyethylene Insulation • Overall Black PVC Jacket</b>																	
100V RMS 75°C							0.48 mm 26 AWG (18x0.1) TC	0.041	1.05	Individual Spiral Serve > 90% TC Braid + Overall Braid		95	-	CDR/CDR CDR/SCR	18 34	60 110	White, Red
										Jacketed Pairs O.D.:							
										0.122	3.10						
0.14 mm <sup>2</sup>	<b>BE46312</b>	4-Pair	1640	500	212.5	96.4						0.492	12.50				
	<b>BE46313</b>	8-Pair	1640	500	323.6	146.8						0.591	15.00				
	<b>BE46315</b>	12-Pair	1640	500	374.6	169.9						0.638	16.20				
	<b>BE46305</b>	16-Pair	1640	500	470.0	213.2						0.709	18.00				
	<b>BE46306</b>	24-Pair	820	250	343.9	156.0						0.882	22.40				
	<b>BE46948</b>	40-Pair	820	250	555.6	252.0						1.075	27.30				

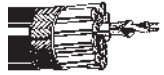

# Super-Flexible, High-Performance Cables, Star Quad

Individually Shielded and Jacketed Pairs

De- scription	Part No.	UL NEC/ C(UL)CEC Type IEC	Standard Lengths		Standard Unit Weight		Conductor (Stranding) Diameter Nom. DCR	Nominal Insulation OD		Shielding Material Nom. DCR	Nominal OD		Nom. Imp. (Ω)	Nom. Vel. of Prop.	Nominal Capacitance		Color Code
			ft.	m	lbs.	kg		inch	mm		inch	mm			pF/ft.	pF/m	

**26 AWG • Stranded (19x38) 0.5 mm High-Conductivity (Oxygen-Free) Bare Copper • Each Pair 95% Bare Copper French Braid® • 26 AWG Tinned Copper Drain Wire • Numbered and Color Coded PVC Jackets**

<b>Polyethylene Insulation • Overall Black PVC Jacket with 20 AWG Tinned Copper Drain Wire</b>																	
300V RMS 60°C							0.51 mm 26 AWG (19x38) BC	0.045	1.14	Individual French Braid® 95% BC + Drain Wire (26 AWG TC)		40	-	CDR/CDR CDR/SCR	39 57	129 188	see chart below
										Jacketed Pairs O.D.:							
										0.157	3.99						
0.14 mm <sup>2</sup> Star-Quad	<b>7884A</b>	2-Pair	250 † 500 † 1000	76 152 305	27.0 49.0 98.0	12.2 22.2 44.5						0.458	11.63				396 N
	<b>7885A</b>	4-Pair	250 † 500 † 1000	76 152 305	36.3 70.5 136.0	16.5 32.0 61.7						0.498	12.65				792 N
	<b>7886A</b>	8-Pair	† 500 † 1000	152 305	146.5 314.0	66.5 142.4						0.782	19.86				1584 N
	<b>7887A</b>	12-Pair	250 † 500 † 1000	76 152 305	89.5 177.5 365.0	40.6 80.5 165.6						0.828	21.03				2380 N
	<b>7888A</b>	16-Pair	250 † 500 † 1000	76 152 305	114.0 238.5 468.0	51.7 108.2 212.3						0.938	23.83				3172 N
	<b>7889A</b>	24-Pair	† 500 † 1000	152 305	396.0 798.0	179.6 362.0						1.232	31.29				4759 N

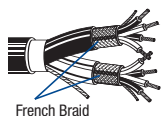

2/c 21 AWG equivalent DCR when connected to a 3-pin XLR.

TC = Tinned Copper • BC = Bare Copper • DCR = DC resistance  
SCR = Capacitance between one conductor and other conductors connected to shield.  
CDR = Capacitance between conductors  
† Length may vary -10% to 0% from length shown.

**Color Code**

Pair No.	Color
1	Blue
2	White

Pair No.	Color
3	Blue with White Stripe
4	White with Blue Stripe



### Analog Multi-Pair Snake Cables

FleXsnake® Super-Flexible, High-Performance Cables  
 Individually Shielded and Jacketed Pairs



De- scription	Part No.	UL NEC/ C(UL)/CEC Type IEC	Standard Lengths		Standard Unit Weight		Conductor (Stranding) Diameter Nom. DCR	Nominal Insulation OD		Shielding Material Nom. DCR	Nominal OD		Nom. Imp. (Ω)	Nom. Vel. of Prop.	Nominal Capacitance		Color Code
			ft.	m	lbs.	kg		inch	mm		inch	mm			pF/ft.	pF/m	

**24 AWG** • Stranded (41x40) 0.6 mm High-Conductivity (Oxygen-Free) Bare Copper • Each Pair Individually 93% **French Braid**® •  
 24 AWG Tinned Copper Drain Wire • Numbered and Color Coded PVC Jackets

**Polyolefin Insulation • Overall Black PVC Jacket**

300V RMS 60°C							0.58 mm 24 AWG (41x40) BC	0.040	1.02	Individual French Braid® 93% + Drain Wire (24 AWG TC)			60	-	CDR/CDR CDR/SCR	26 48	86 156	Red, Black
------------------	--	--	--	--	--	--	---------------------------------	-------	------	---	--	--	----	---	--------------------	----------	-----------	------------

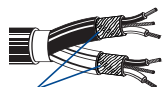

French Braid

Jacketed Pairs O.D.:  
 0.119 3.02

0.22 mm²

Pulling Tension:

<b>1902A</b>	2-Pair	250 † 500 † 1000	76 152 305	12.0 27.5 53.0	5.4 12.5 24.0							0.330	8.38					258 N
<b>1904A</b>	4-Pair	250 † 500 † 1000	76 152 305	19.8 40.5 78.0	9.0 18.4 35.4							0.333	8.45					534 N
<b>1906A</b>	6-Pair	250 † 500 † 1000	76 152 305	28.5 55.5 111.0	12.9 25.2 50.3							0.449	11.40					801 N
<b>1908A</b>	8-Pair	250 † 500 † 1000	76 152 305	36.0 72.5 141.0	16.3 32.9 64.0							0.480	12.20					1023 N
<b>1912A</b>	12-Pair	250 † 500 † 1000	76 152 305	51.8 102.5 203.0	23.5 46.5 92.1							0.602	15.30					1557 N
<b>1916A</b>	16-Pair	250 † 500 † 1000	76 152 305	71.0 138.0 279.0	32.2 62.6 126.6							0.681	17.30					2091 N
<b>1924A</b>	24-Pair	250 † 500 † 1000	76 152 305	108.0 214.5 437.0	49.0 97.3 198.2							0.827	21.00					3114 N
<b>1932A</b>	32-Pair	250 † 500 † 1000	76 152 305	135.3 274.0 539.0	61.4 124.3 244.5							0.969	24.60					4173 N

TC = Tinned Copper • BC = Bare Copper • DCR = DC resistance • SCR = Capacitance between one conductor and other conductors connected to shield. • CDR = Capacitance between conductors  
 † Length may vary -10% to 0% from length shown.

# Analog Multi-Pair Snake Cables

## Beldfoil® High-Performance Cables

### Individually Shielded and Jacketed Pairs



De- scription	Part No.	UL NEC/ C(UL)CEC Type IEC	Standard Lengths		Standard Unit Weight		Conductor (Stranding) Diameter Nom. DCR	Nominal Insulation OD		Shielding Material Nom. DCR	Nominal OD		Nom. Imp. (Ω)	Nom. Vel. of Prop.	Nominal Capacitance		Color Code
			ft.	m	lbs.	kg		inch	mm		inch	mm			pF/ft.	pF/m	

**24 AWG • Stranded (7x32) 0.6 mm High-Conductivity (Oxygen-Free) Tinned Copper • Each Pair Beldfoil® Shielded • 24 AWG Tinned Copper Drain Wire • Numbered and Color Coded PVC Jackets • Overall Beldfoil® Shield • Rip Cord**

**Polyolefin Insulation • Overall Black PVC Jacket with 18 AWG Tinned Copper Drain Wire**

300V RMS 75°C	NEC: CM CEC: CM		0.61 mm 24 AWG (7x32) TC	0.040	1.02	Individual Beldfoil® + Drain Wire (24 AWG TC) + Overall Beldfoil®	60	-	CDR/CDR CDR/SCR	31 58	102 190	Brown, Red		
												Jacketed Pairs O.D.:		
												0.111	2.82	

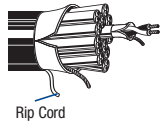

													Pulling Tension:		
0.22 mm <sup>2</sup>	<b>1508A</b>	1-Pair	500 1000	152 305	6.5 11.0	2.9 5.0					0.131	3.33			73 N
	<b>1509C</b>	2-Pair	500 1000	152 305	24.0 46.0	10.9 20.9					0.301	7.65			246 N
	<b>1510C</b>	4-Pair	500 1000	152 305	35.5 72.0	16.1 32.7					0.352	8.94			393 N
	<b>1511C</b>	6-Pair	500 1000	152 305	52.0 102.0	23.6 46.3					0.418	10.61			544 N
	<b>1512C</b>	8-Pair	500 1000	152 305	65.5 124.0	29.7 56.2					0.452	11.48			676 N
	<b>1513C</b> (DT-12)	12-Pair	500 1000	152 305	89.5 178.0	40.6 80.7					0.561	14.25			980 N
	<b>1514C</b>	16-Pair	500 1000	152 305	122.5 241.0	55.6 109.3					0.628	15.95			1273 N
	<b>1515C</b>	20-Pair	500 1000	152 305	142.5 288.0	64.6 130.6					0.770	19.56			1567 N
	<b>1516C</b>	24-Pair	500 1000	152 305	180.5 371.0	81.9 168.3					0.807	20.50			1861 N
	<b>1517C</b>	26-Pair	500 1000	152 305	187.5 385.0	85.0 174.6					0.823	20.90			2007 N
	<b>1518C</b>	32-Pair	500 1000	152 305	236.5 481.0	107.3 218.2					0.897	22.78			2448 N
	<b>1519C</b>	52-Pair	500 1000	152 305	372.5 731.0	169.0 331.6					1.117	28.37			3916 N

**24 AWG • Stranded (7x32) 0.6 mm High-Conductivity (Oxygen-Free) Tinned Copper • Each Pair Beldfoil® Shielded • 24 AWG Tinned Copper Drain Wire • Numbered FRNC Jackets • Overall Beldfoil® Shield • Rip Cord**

**Polyolefin Insulation • Overall Black FRNC/LSNH Jacket with 18 AWG Tinned Copper Drain Wire**

300V RMS 75°C	NEC: CM CEC: CM		0.61 mm 24 AWG (7x32) TC	0.040	1.02	Individual Beldfoil® + Drain Wire (24 AWG TC) + Overall Beldfoil®	60	-	CDR/CDR CDR/SCR	28 55	92 180	Brown, Red		
												Jacketed Pairs O.D.:		
												0.111	2.82	

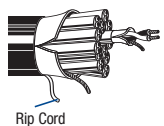

													Pulling Tension:		
0.22 mm <sup>2</sup>	<b>1508ENH</b>	1-Pair	1640 3280	500 1000	21.0 42.4	9.5 19.1					0.131	3.33			73 N
	<b>1509ENH</b>	2-Pair	1640	500	79.1	35.9					0.301	7.65			246 N
	<b>1512ENH</b>	8-Pair	1640 3280	500 1000	215.4 430.8	97.7 195.4					0.453	11.50			676 N

TC = Tinned Copper • DCR = DC resistance • SCR = Capacitance between one conductor and other conductors connected to shield. • CDR = Capacitance between conductors

### Analog Multi-Pair Snake Cables

Beldfoil® High-Performance Cables, Long Runs  
Individually Shielded and Jacketed Pairs



De- scription	Part No.	UL NEC/ C(UL)/CEC Type IEC	Standard Lengths		Standard Unit Weight		Conductor (Stranding) Diameter Nom. DCR	Nominal Insulation OD		Shielding Material Nom. DCR	Nominal OD		Nom. Imp. (Ω)	Nom. Vel. of Prop.	Nominal Capacitance		Color Code
			ft.	m	lbs.	kg		inch	mm		inch	mm			pF/ft.	pF/m	

**22 AWG** • Stranded (7x30) 0.8 mm High-Conductivity (Oxygen-Free) Tinned Copper • Each Pair **Beldfoil®** Shielded •  
22 AWG Tinned Copper Drain Wire • Numbered and Color Coded PVC Jackets • Overall **Beldfoil®** Shield • Rip Cord

**Polyolefin Insulation • Overall Matte Black PVC Jacket** with Stranded 18 AWG Tinned Copper Drain Wire, except 1814 with 22 AWG

300V RMS 60°C	NEC: CMR CEC: CMG FT4	0.76 mm 22 AWG (7x30) TC	0.050	1.27	Individual Beldfoil® + Drain Wire (22 AWG TC) + Overall Beldfoil®	50	66	CDR/CDR CDR/SCR	31.0 56.1	102 184	Red, Black
		Jacketed Pairs O.D.:									
		0.133		3.38							

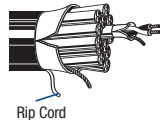

											Pulling Tension:	
0.35 mm <sup>2</sup>	<b>1814R</b>	2-Pair	500 1000	152 305	30.0 59.0	13.6 26.8			0.330	8.38		283 N
	<b>1815R</b>	4-Pair	500 1000	152 305	45.0 91.0	20.4 41.3			0.383	9.74		485 N
	<b>1816R</b>	6-Pair	500 1000	152 305	65.0 131.0	29.5 59.4			0.462	11.73		838 N
	<b>1817R</b>	8-Pair	500 1000	152 305	80.0 152.0	36.3 68.9			0.503	12.78		1081 N
	<b>1818R</b>	12-Pair	500 1000	152 305	121.0 241.0	54.9 109.3			0.638	16.21		1623 N
	<b>1819R</b>	16-Pair	500 1000	152 305	180.0 364.0	81.6 165.1			0.776	19.71		2052 N
	<b>1820R</b>	20-Pair	500 1000	152 305	216.0 442.0	98.0 200.5			0.865	21.97		2538 N
	<b>1821R</b>	24-Pair	500 1000	152 305	263.5 518.0	119.5 235.0			0.969	24.61		3024 N
	<b>1822R</b>	26-Pair	500 1000	152 305	280.5 552.0	127.2 250.4			0.989	25.12		3266 N
	<b>1823R</b>	32-Pair	500 1000	152 305	335.5 692.0	152.2 313.9			1.072	27.23		3995 N

TC = Tinned Copper • DCR = DC resistance • SCR = Capacitance between one conductor and other conductors connected to shield. • CDR = Capacitance between conductors

# AES/EBU Digital Audio Cables

## Single- and Double-Pair Cables

### Audio-Connect



De- scription	Part No.	UL NEC/ C(UL)/CEC Type IEC	Standard Lengths		Standard Unit Weight		Conductor (Stranding) Diameter Nom. DCR	Nominal Insulation OD		Shielding Material Nom. DCR	Nominal OD		Nom. Imp. (Ω)	Nom. Vel. of Prop.	Nominal Capacitance		Nominal Attenuation		
			ft.	m	lbs.	kg		inch	mm		inch	mm			pF/ft.	pF/m	MHz	dB/ 100 ft.	dB/ 100 m

**26 AWG • Stranded (7x34) 0.5 mm Tinned Copper • Twisted Pair • Beldfoil® • 26 AWG Tinned Copper Drain Wire**

Datalene® Insulation • PVC Jacket (Chrome or Violet)																							
300V RMS 75°C	<b>9180</b>	NEC:	1000	305	10.0	4.5	0.48 mm	0.049	1.24	Overall Beldfoil® + Drain Wire (26 AWG TC)	0.144	3.66	110	76%	13.0	42.6	2.0	1.7	5.5				
		CMG:					26 AWG											4.1	2.1	7.0			
		CEC:					(7x34) TC												5.6	2.4	7.9		
		CMG FT4																	11.3	3.1	10.1		
																				12.3	3.2	10.4	
																					24.6	4.2	13.8



Shorting Fold

0.14 mm<sup>2</sup>  
Digital Video Time Code

Color Code: Black, White  
Pulling Tension: 46 N

**24 AWG • Stranded (7x32) 0.6 mm Tinned Copper • Twisted Pair • Overall Beldfoil® Shield • 24 AWG Tinned Copper Drain Wire**

Datalene® Insulation • PVC Jacket (Grey or Violet)																							
300V RMS 60°C	<b>1800B</b>	NEC:	500	152	8.0	3.6	0.61 mm	0.068	1.73	Overall Beldfoil® + Drain Wire (24 AWG TC)	0.177	4.50	110	76%	12.0	39.3	2.0	1.3	4.3				
		CMG:	U-1000	U-305	17.0	7.7	24 AWG												4.1	1.6	5.2		
		CEC:	1000	305	16.0	7.3	(7x32) TC												5.6	1.8	5.8		
		CMG FT4	5000	1524	90.0	40.8													11.3	2.2	7.3		
																				12.3	2.3	7.5	
																					24.6	3.1	10.1



0.22 mm<sup>2</sup>

152 m put-up available in Grey only.  
1524 m put-up available in Violet only.  
Color Code: Red, Black

The jacket and shield are bonded so both can be removed with automatic stripping equipment.  
Pulling Tension: 73 N

**24 AWG • Stranded (7x32) 0.6 mm Tinned Copper • Dual Twisted Pairs • Individual Beldfoil® Shield • 24 AWG Tinned Copper Drain Wire**

Datalene® Insulation • PVC Jacket (Grey or Violet)																							
300V RMS 60°C	<b>1802B</b>	NEC:	500	152	16.5	7.5	0.61 mm	0.068	1.73	Individual Beldfoil® + Drain Wire (24 AWG TC)	0.180	4.57	110	76%	12.0	39.3	2.0	1.3	4.3				
		CMG:	U-1000	U-305	35.0	15.9	24 AWG					x	x						4.1	1.6	5.2		
		CEC:	1000	305	37.0	16.8	(7x32) TC					0.360	9.14						5.6	1.8	5.8		
		CMG FT4																	11.3	2.2	7.3		
																				12.3	2.3	7.5	
																					24.6	3.1	10.1



0.22 mm<sup>2</sup>

Color Code: Red, Black

The jacket and shield are bonded so both can be removed with automatic stripping equipment.  
Pulling Tension: 73 N

**24 AWG • Stranded (41x40) 0.6 mm High-Conductivity (Oxygen-Free) Bare Copper • Twisted Pair with Fillers • Conductors Cabled with Fillers • 95% Tinned Copper French Braid® • 26 AWG Bare Copper Drain Wire**

Datalene® Insulation • Matte PVC Jacket (Red, Yellow, Green, Blue, Grey and Black)																							
300V RMS 60°C	<b>1800F</b>	NEC:	500	152	12.0	5.4	0.58 mm	0.058	1.47	Overall French Braid® 95% TC + Drain Wire (26 AWG BC)	0.211	5.36	110	76%	12.0	39.3	2.0	1.3	4.3				
		CL2R	U-1000	U-305	26.0	11.8	24 AWG												4.1	2.2	7.3		
			1000	305	24.0	10.9	(41x40) BC												5.6	2.9	9.5		
																			11.3	4.5	14.9		
																				12.3	4.8	15.7	
																					24.6	7.1	23.3



French Braid

0.22 mm<sup>2</sup>

152 m and 305 m put-ups available in Black only.  
Color Code: Red, Black

Pulling Tension: 184 N

**22 AWG • Stranded (7x30) 0.8 mm TC • Twisted Pair with Fillers • Overall Beldfoil® Shield (Unbonded) • 90% TC French Braid® • 24 AWG Tinned Copper Drain Wire**

Datalene® Insulation • Black High-Flex Matte PVC Jacket																							
300V RMS 60°C	<b>1696A</b>		250	76	8.0	3.6	0.76 mm	0.082	2.08	Overall French Braid® 90% TC + Drain Wire (24 AWG TC)	0.234	5.94	110	76%	13.0	42.6	2.0	0.9	2.9				
			500	152	14.5	6.6	22 AWG												4.1	1.1	3.6		
			U-1000	U-305	30.0	13.6	(7x30) TC												5.6	1.3	4.3		
			1000	305	32.0	14.5													11.3	1.7	5.7		
																				12.3	1.8	5.8	
																					24.6	2.4	7.9



Z-Fold®

0.34 mm<sup>2</sup>

Color Code: Light Blue, White  
Pulling Tension: 249 N

TC = Tinned Copper • BC = Bare Copper • DCR = DC resistance

### AES/EBU Digital Multi-Pair Snake Cables

Beldfoil® High-Performance Cable, Low-Capacitance  
Individually Shielded and Jacketed Pairs



De- scription	Part No.	UL NEC/ C(UL)/CEC Type IEC	Standard Lengths		Standard Unit Weight		Conductor (Stranding) Diameter Nom. DCR	Nominal Insulation OD		Shielding Material Nom. DCR	Nominal OD		Nom. Imp. (Ω)	Nom. Vel. of Prop.	Nominal Capacitance		Nominal Attenuation			
			ft.	m	lbs.	kg		inch	mm		inch	mm			pF/ft.	pF/m	MHz	dB/ 100 ft.	dB/ 100 m	
<b>26 AWG • Stranded (7x34) 0.5 mm High-Conductivity (Oxygen-Free) TC • Each Pair Beldfoil® Shielded • 26 AWG Tinned Copper Drain Wire • Numbered and Color Coded PVC Jackets • Overall Beldfoil® Shield • Rip Cord</b>																				
<b>Datalene® Insulation • Overall Matte Black PVC Jacket with 26 AWG Tinned Copper Drain Wire</b>																				
 300V RMS 80°C  Rip Cord 0.14 mm²		NEC: CMG CEC: CMG FT4					0.48 mm 26 AWG (7x34) TC	0.054	1.37	Individual Beldfoil® + Drain Wire (26 AWG TC) + Overall Beldfoil®			110	76%	13.0	42.7	2.0	1.7	5.5	
																		4.0	2.1	6.9
																		5.0	2.3	7.5
																		6.0	2.5	8.1
																		12.0	3.2	10.4
																		25.0	4.2	13.8
																		Pulling Tension:		
	<b>7891A</b>	2-Pair	500	152	28.0	12.7						0.343	8.71							107 N
			1000	305	56.0	25.4														
	<b>7890A</b>	4-Pair	100	31	8.2	3.7						0.399	10.13							200 N
			250	76	18.0	8.2														
			500	152	31.0	14.1														
			1000	305	61.0	27.7														
	<b>7880A</b>	8-Pair (Fits D-Sub connectors)	† 250	76	28.0	12.7						0.541	13.74							374 N
			500	152	57.0	25.9														
			1000	305	142.0	64.4														
	<b>7892A</b>	12-Pair	500	152	85.0	38.6						0.679	17.25							574 N
			1000	305	174.0	78.9														
	<b>7893A</b>	16-Pair	500	152	109.5	49.7						0.770	19.56							761 N
			1000	305	240.0	108.9														
Color Code: Red, Black																				

### Fire Resistant, Installation Cable, FRNC/LSNH IEC 332-3C Individually Shielded and Jacketed Pairs

De- scription	Part No.	UL NEC/ C(UL)/CEC Type IEC	Standard Lengths		Standard Unit Weight		Conductor (Stranding) Diameter Nom. DCR	Nominal Insulation OD		Shielding Material Nom. DCR	Nominal OD		Nom. Imp. (Ω)	Nom. Vel. of Prop.	Nominal Capacitance		Nominal Attenuation				
			ft.	m	lbs.	kg		inch	mm		inch	mm			pF/ft.	pF/m	MHz	dB/ 100 ft.	dB/ 100 m		
<b>26 AWG • Stranded (18x0.1) 0.5 mm TC • Each Pair Individually Tinned Copper Spiral Braid • Numbered FRNC/LSNH Jackets • Overall &gt; 90% Tinned Copper Braid</b>																					
<b>Polyethylene Insulation • Overall Grey FRNC/LSNH Jacket with 26 AWG Tinned Copper Drain Wire</b>																					
 100V RMS 70°C  0.14 mm²		IEC 332-3C					0.5 mm 26 AWG (18x0.1) TC	0.044	1.13	Individual Spiral Serve > 90% TC Braid + Overall Braid	0.488	12.39	110	60%	17.4	57.0	0.1	0.3	0.9		
																		1.0	0.7	2.2	
																		4.0	1.9	6.3	
																		10.0	3.7	12.0	
																		Burning Energy:			Pulling Tension:
	<b>YE00193</b>	1-Pair	1640	500	13.4	6.1						0.114	2.90							–	
	<b>BE46959</b>	1-Pair	1640	500	24.3	11.0						0.154	3.90							283 kJ/m	85 N
	<b>BE46923</b>	2-Pair	1640	500	102.1	46.3						0.331	8.40							913 kJ/m	150 N
	<b>BE46925</b>	4-Pair	1640	500	134.5	61.0						0.374	9.50							1271 kJ/m	250 N
	<b>BE46935</b>	8-Pair	1640	500	245.6	111.4						0.492	12.50							2023 kJ/m	400 N
	<b>BE46936</b>	10-Pair	1640	500	278.0	126.1						0.524	13.30							2325 kJ/m	500 N
	<b>BE46937</b>	12-Pair	1640	500	301.6	136.8						0.559	14.20							2644 kJ/m	600 N
	<b>BE46938</b>	16-Pair	1640	500	392.9	178.2						0.630	16.00							3292 kJ/m	750 N
Color Code: White, Blue																					

TC = Tinned Copper • DCR = DC resistance  
† 7880A is designed to fit in 25-pin D-sub connectors used in digital console board equipment.



### AES/EBU Digital Multi-Pair Snake Cables

SlimSnake™, Installation Cable, Halogen-Free  
Individually Shielded and Jacketed Pairs



De- scription	Part No.	UL NEC/ C(UL)/CEC Type IEC	Standard Lengths		Standard Unit Weight		Conductor (Stranding) Diameter Nom. DCR	Nominal Insulation OD		Shielding Material Nom. DCR	Nominal OD		Nom. Imp. (Ω)	Nom. Vel. of Prop.	Nominal Capacitance		Nominal Attenuation		
			ft.	m	lbs.	kg		inch	mm		inch	mm			pF/ft.	pF/m	MHz	dB/ 100 ft.	dB/ 100 m
<b>26 AWG • Stranded (7x0.16) 0.5 mm TC • Each Pair Individually TC Spiral Braid • Numbered PA Jackets • Overall &gt; 90% TC Braid</b> <b>Foam Polyethylene Insulation • Overall Purple Halogen-Free Jacket</b>																			
100V RMS 70°C							0.5 mm 26 AWG (7x0.16) TC	0.043	1.10	Individual Spiral Serve > 90% TC Braid + Overall Braid			110	60%	15.2	50.0	0.1	0.3	0.9
							Jacketed Pairs O.D.: 0.114 2.90												
0.14 mm <sup>2</sup>	<b>BE46273</b>	1-Pair	820 1640	250 500	5.7 11.2	2.6 5.1					0.110	2.80							
	<b>BE46202</b>	1-Pair	820 1640	250 500	6.6 12.1	3.0 5.5					0.154	3.90							
	<b>BE46203</b>	2-Pair	820 1640	250 500	42.1 84.2	19.1 38.2					0.319	8.10							150 N
	<b>BE46204</b>	4-Pair	820 1640	250 500	57.3 114.4	26.0 51.9					0.354	9.00							250 N
	<b>BE46266</b>	8-Pair	820 1640	250 500	85.8 171.5	38.9 77.8					0.406	10.30							400 N
	<b>BE46208</b>	10-Pair	820 1640	250 500	97.0 193.8	44.0 87.9					0.480	12.20							500 N
	<b>BE46205</b>	12-Pair	820 1640	250 500	124.1 248.2	56.3 112.6					0.504	12.80							600 N
	<b>BE46207</b>	16-Pair	820 1640	250 500	171.7 343.3	77.9 155.7					0.602	15.30							750 N

Color Code: White, Blue

### Beldfoil® High-Performance Cable, Low-Capacitance, Long-Runs Individually Shielded and Jacketed Pairs

De- scription	Part No.	UL NEC/ C(UL)/CEC Type IEC	Standard Lengths		Standard Unit Weight		Conductor (Stranding) Diameter Nom. DCR	Nominal Insulation OD		Shielding Material Nom. DCR	Nominal OD		Nom. Imp. (Ω)	Nom. Vel. of Prop.	Nominal Capacitance		Nominal Attenuation		
			ft.	m	lbs.	kg		inch	mm		inch	mm			pF/ft.	pF/m	MHz	dB/ 100 ft.	dB/ 100 m
<b>24 AWG • Stranded (7x32) 0.6 mm High-Conductivity (Oxygen-Free) TC • Each Pair Beldfoil® Shielded • 24 AWG Tinned Copper Drain Wire • Numbered and Color Coded PVC Jackets • Overall Beldfoil® Shield • Rip Cord</b> <b>Datalene® Insulation • Overall Matte Black PVC Jacket with 16 AWG Tinned Copper Drain Wire</b>																			
300V RMS 60°C		NEC: CMG CEC: CMG FT4					0.61 mm 24 AWG (7x32) TC	0.068	1.73	Individual Beldfoil® + Drain Wire (24 AWG TC) + Overall Beldfoil®			110	76%	12.0	39.4	2.0	1.3	4.3
							Jacketed Pairs O.D.: 0.167 4.24												
0.22 mm <sup>2</sup>	<b>1803F</b>	4-Pair	500 1000	152 305	57.5 107.0	26.1 48.5					0.488	12.39							367 N
	<b>1805F</b>	8-Pair	500 1000	152 305	106.5 211.0	48.3 95.7					0.661	16.79							609 N
	<b>1806F</b>	12-Pair	500 1000	152 305	160.0 330.0	72.6 149.7					0.829	21.06							890 N
	<b>1850F</b>	16-Pair	500 1000	152 305	208.0 407.0	94.3 184.6					0.944	23.98							1174 N
	<b>1852F</b>	24-Pair	500 1000	152 305	321.0 644.0	145.6 292.1					1.205	30.61							1779 N
	<b>1854F</b>	32-Pair	1000	305	841.0	381.5					1.346	34.19							2356 N

Color Code: Red, Black

TC = Tinned Copper • DCR = DC resistance

# Speaker Cables

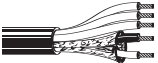

De-scription	Part No.	UL NEC / C(UL)CEC Type IEC	Standard Lengths		Standard Unit Weight		Shielding Material	Nominal OD		Component	Description	Shielding Material & Nom. DCR	Insulation Material & Colors	Component Jacket Material & Colors	Component OD	
			ft.	m	lbs.	kg		inch	mm						inch	mm
<b>26 AWG • 2 CDR (Audio) Stranded (18x0.1) 0.5 mm BC + 3 CDR (Power) Stranded (32x0.2) 1.2 mm BC • Conductors Cabled with Fillers</b>																
<b>Polyethylene Insulation • Overall Matte Black PVC Jacket</b>																
300V RMS 60°C	<b>BE43908</b>		328	100	37.5	17.0	Unshielded	0.461	11.7	1xAudio	1-Pair 26 AWG 0.48 mm (18x0.1) BC	Overall 90% BC Braid	PE Black Red	PVC Black	0.044	1.12
			1640	500	187.4	85.0					1xPower				3 Conductors 18 AWG 1.15 mm (32x0.2) BC	Unshielded
 <p>2x0.14 mm<sup>2</sup> (Audio) 3x1.20 mm<sup>2</sup> (Power)</p> <p>Pulling Tension: 200 N</p>																

De-scription	Part No.	UL NEC / C(UL)CEC Type IEC	Standard Lengths		Standard Unit Weight		Conductor (Stranding) Diameter Nom. DCR	Nominal Insulation OD		Shielding Material Nom. DCR	Nominal OD		Nom. Imp. (Ω)	Nom. Vel. of Prop.	Nominal Capacitance		Color Code	
			ft.	m	lbs.	kg		inch	mm		inch	mm			pF/ft.	pF/m		
<b>16 AWG • 2 Conductor • Stranded (25x0.23) 1.5 mm Bare Copper</b>																		
<b>PVC Insulation • Overall Matte Black PVC Jacket (Grey or Black)</b>																		
300V RMS 60°C	<b>BE46382</b> 2 CDR		328	100	15.9	7.2	1.5 mm 16 AWG (25x0.23) BC	0.098	2.50	Unshielded	0.276	7.00	12	-	CDR/CDR	35	115	Black, Red
			1640	500	79.8	36.2												
			3280	1000	159.4	72.3												
 <p>2x1.5 mm<sup>2</sup></p> <p>1000 m put-up available in Black only. Pulling Tension: 240 N</p>																		

<b>14 AWG • 4 or 8 Conductor • Stranded (104x34) 1.9 mm Bare Copper • Conductors Cabled with Fillers • Paper Wrap</b>																		
<b>PVC Insulation • Overall Matte Black PVC Jacket</b>																		
300V RMS 60°C	<b>1810A</b> 4 CDR		250	76	26.3	11.9	1.85 mm 14 AWG (104x34) BC	0.025	0.64	Unshielded	0.390	9.91	8.8	-	CDR/CDR CDR/SCR	19 57	61 187	Red, Green, White, Black
			500	152	55.5	25.2												
			1000	305	114.0	51.7												
 <p>High-Flex 4x2.1 mm<sup>2</sup></p> <p>Compatible with Speakon® connectors. Pulling Tension: 889 N</p>																		
<b>PVC Insulation • Overall Matte Black PVC Jacket</b>																		
300V RMS 60°C	<b>1811A</b> 8 CDR		1000	305	205.0	93.0	1.85 mm 14 AWG (104x34) BC	0.025	0.64	Unshielded	0.515	13.08	8.8	-	CDR/CDR CDR/SCR	19 57	61 187	Brown, Red, Orange, Yellow, Green, White, Blue, Black
			8x2.1 mm <sup>2</sup>	Compatible with Speakon® connectors. Pulling Tension: 1779 N														

BC = Bare Copper • PE = Polyethylene • DCR = DC resistance • SCR = Capacitance between one conductor and other conductors connected to shield. • CDR = Capacitance between conductors

Speakon® is a Neutrik trademark.

# Speaker Cables



De- scription	Part No.	UL NEC/ C(UL)CEC Type IEC	Standard Lengths		Standard Unit Weight		Conductor (Stranding) Diameter Nom. DCR	Nominal Insulation OD		Shielding Material Nom. DCR	Nominal OD		Nom. Imp. (Ω)	Nom. Vel. of Prop.	Nominal Capacitance		Color Code
			ft.	m	lbs.	kg		inch	mm		inch	mm			pF/ft.	pF/m	

**13 AWG • 2 Conductor • Stranded (50x0.25) 2.1 mm Bare Copper**

<b>PVC Insulation • Overall Matte PVC Jacket (Grey or Black)</b>																		
300V RMS 60°C	<b>BE46381</b> 2 CDR		328	100	22.5	10.2	2.05 mm 13 AWG (50x0.25) BC	0.114	2.90	Unshielded	0.317	8.05	7.4	–	CDR/CDR	40	131	Black, Red



2x2.5 mm<sup>2</sup>

1000 m put-up available in Black only.  
Pulling Tension: 400 N

**13 AWG • 4 Conductor • Stranded (50x0.25) 2.1 mm Bare Copper • Conductors Cabled with Fillers • Paper Wrap**

<b>PVC Insulation • Overall Matte Black PVC Jacket</b>																		
300V RMS 60°C	<b>BE46379</b> 4 CDR		3280	1000	399.5	181.2	2.05 mm 13 AWG (50x0.25) BC	0.114	2.90	Unshielded	0.394	10.00	7.4	–	CDR/CDR	40	131	Red, Green, White, Black



4x2.5 mm<sup>2</sup>

Pulling Tension: 200 N

**13 AWG • 8 Conductor • Stranded (300x0.1) 2.1 mm Bare Copper • Conductors Cabled with Fillers • Paper Wrap**

<b>PVC Insulation • Overall Matte Black PVC Jacket</b>																		
300V RMS 60°C	<b>BE43907</b> 8 CDR		820	250	160.5	72.8	2.05 mm 13 AWG (300x0.1) BC	0.114	2.90	Unshielded	0.488	12.40	7.4	–	CDR/CDR	40	131	Red, Green, White, Black, Yellow, Purple, Brown, Blue

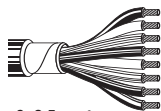

8x2.5 mm<sup>2</sup>

Pulling Tension: 1500 N

**11 AWG • 2 Conductor • Stranded (56x0.3) 2.6 mm Bare Copper**

<b>PVC Insulation • Overall Matte PVC Jacket (Grey or Black)</b>																		
300V RMS 60°C	<b>BE46380</b> 2 CDR		328	100	31.5	14.3	2.6 mm 11 AWG (56x0.3) BC	0.138	3.50	Unshielded	0.354	9.00	4.5	–	CDR/CDR	35	116	Black, Red



2x4.0 mm<sup>2</sup>

500 m put-up available in Grey only.  
Pulling Tension: 600 N

BC = Bare Copper • DCR = DC resistance • SCR = Capacitance between one conductor and other conductors connected to shield. • CDR = Capacitance between conductors

# Special Cables



De- scription	Part No.	UL NEC/ C(UL)/CEC Type IEC	Standard Lengths		Standard Unit Weight		Conductor (Stranding) Diameter Nom. DCR	Nominal Insulation OD		Shielding Material Nom. DCR	Nominal OD		Nom. Imp. (Ω)	Nom. Vel. of Prop.	Nominal Capacitance		Color Code
			ft.	m	lbs.	kg		inch	mm		inch	mm			pF/ft.	pF/m	

**25 AWG • Stranded (7x33) 0.5 mm High-Conductivity Copper (Oxygen-Free) • (3) Strands TC, (4) Strands TCCS • Rayon Braid • 80 % TC Braid**

**Rayon Braid, Rubber Insulation • Black EPDM Rubber Jacket**

3000 VDC 60°C	<b>8410</b>		1640	500	18.5	8.4	0.53 mm 25 AWG (3x33, 4x33) TC, TCCS	0.154	3.91	Overall 80% TC Braid	0.245	6.22	52	-	CDR/CDR	33	108	-
------------------	-------------	--	------	-----	------	-----	---	-------	------	----------------------------	-------	------	----	---	---------	----	-----	---



Pulling Tension: 267 N

**22 AWG • Stranded (7x0.25) Tinned Copper • Dual Twisted Pairs • Aluminum-Foil • 24 AWG (7x0.20) Drain Wire • 80 % Tinned Copper Braid**

**Polyethylene Insulation • Overall Matte PVC Jacket (Black or Blue)**

300V 70°C	<b>BE43906</b>		1640	500	68.8	31.2	0.75 mm 22 AWG (7x0.25) TC	0.053	1.35	Overall 80% TC Braid + Drain Wire (24 AWG TC)	0.268	6.80	110	-	CDR/CDR	21.3	70	White, Red, Green, Black
-----------	----------------	--	------	-----	------	------	----------------------------------	-------	------	---	-------	------	-----	---	---------	------	----	-----------------------------



DMX512  
0.34 mm²

1000 m put-up available in Black only.

22 AWG: 3105A - 1 Pair DMX512 (see Industrial section)  
3107A - 2 Pair DMX512 (see Industrial section)  
24 AWG: 9841, 9842, 9843 and 9844 (see Industrial section)

De- scription	Part No.	UL NEC/ C(UL)/CEC Type IEC	Standard Lengths		Standard Unit Weight		Shielding Material	Nominal OD		Compo- nent	Description	Shielding Material & Nom. DCR	Insulation Material & Colors	Component Jacket Material & Colors	Component OD	
			ft.	m	lbs.	kg		inch	mm						inch	mm

**(2) Coax 20 AWG • Solid 0.8 mm Bare Copper • Duofoil® • (4) Audio 22 AWG (7x30) Tinned Copper Shielded Pair**

**Gas-Injected FPE Insulation (Coax) • Polypropylene Insulation (Conductors) • Black F-R PVC Jacket**

300V RMS 75°C	<b>1347A</b>	NEC: CMR CEC: CMR FT4	500	152	232.2	105.3	-	0.630	16.00	2xVideo	2-Coax (1505A) 20 AWG 0.8 mm Solid BC	Duofoil® 100% 95% TC Braid	HDPE	PVC Black, White	0.233	5.92
------------------	--------------	--------------------------------	-----	-----	-------	-------	---	-------	-------	---------	--	-------------------------------------	------	------------------------	-------	------



4xAudio	4 Pair 22 AWG 0.8 mm (7x30) BC	Overall Beldfoil® 100% + Drain Wire (22 AWG TC)	Polypropylene	PVC Brown, Red, Orange, Yellow	0.135	3.43 each Pair
---------	---	---	---------------	---	-------	-------------------

2 Coax + 4 Pair

Pulling Tension: 947 N

TC = Tinned Copper • TCCS = Tinned Copper-Covered Steel • BC = Bare Copper • DCR = DC resistance  
SCR = Capacitance between one conductor and other conductors connected to shield. • CDR = Capacitance between conductors

Duofoil® see technical information page 23.13.





# RJ-45 Cables for A/V Applications



De- scription	Part No.	UL NEC/ C(UL)CEC Type IEC	Standard Lengths		Standard Unit Weight		Conductor (Stranding) Diameter Nom. DCR	Nominal Insulation OD		Shielding Material Nom. DCR	Nominal OD		Freq. MHz	Max. Atten. dB/100m	Min. PSUM			Input Imp. (Ω)	Min. RL dB
			ft.	m	lbs.	kg		inch	mm		inch	mm			NEXT dB	ACR dB/100m	ELFEXT dB/100m		

**CatSnake™ (Mobile Cat 5e) • 24 AWG • Bonded-Pair • Stranded (7x32) 0.6 mm Bare Copper Conductors • Rip Cord**

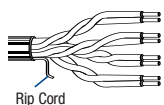

**Heavy-Duty Jacketed • Polyolefin Insulation • Flexible Matte Black PVC Jacket • Category 5e**

 Rip Cord  4-Pairs	1304A		1000	305	27.8	12.6	0.61 mm 24 AWG (7x32) BC	0.037	0.95	Bonded-Pair Unshielded U/UTP	0.245	6.22	1	2.4	62.3	63.3	60.8	100±12	20.0	
			500	152	14.3	6.5												100±12	23.0	

RJ-45 Compatible • -40°C Cold Bend  
 U.S. Patents 5,606,151; 5,734,126 and 5,763,823  
 Color Code: see chart below

Jacket sequentially marked at 0.6 m intervals.  
 Third party verified to TIA/EIA-568-B.2, Category 5e

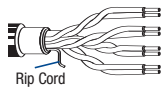
**Upjacketed • Polyolefin Insulation • PVC Inner Jacket • Matte Black Flexible PVC Outer Jacket • Category 5e**

 Rip Cord  4-Pairs EtherCon® compatible	1305A		1000	305	39.9	18.1	0.61 mm 24 AWG (7x32) BC	0.037	0.95	Bonded-Pair Unshielded U/UTP	0.295	7.49	1	2.4	62.3	63.3	60.8	100±12	20.0	
			500	152	19.8	9.0												100±12	23.0	

RJ-45 Compatible • -40°C Cold Bend  
 U.S. Patents 5,606,151 and 5,734,126  
 Color Code: see chart below

Jacket sequentially marked at 0.6 m intervals  
 Third party verified to TIA/EIA-568-B.2, Category 5e

BC = Bare Copper • DCR = DC resistance • ACR = Attenuation Crosstalk Ratio • ELFEXT = Equal Level Far-end Crosstalk • NEXT = Near-end Crosstalk • PSUM = Power Sum • RL = Return Loss

EtherCon® is a Neutrik trademark.

**Color Code**

Pair No.	Color
1	White/Blue Stripe, Blue
2	White/Orange Stripe, Orange
3	White/Green Stripe, Green
4	White/Brown Stripe, Brown





# Video Triax Cables



De- scription	Part No.	UL NEC/ C(UL)CEC Type IEC	Standard Lengths		Standard Unit Weight		Conductor (Stranding) Diameter Nom. DCR	Nominal Insulation OD		Shielding Material Nom. DCR	Nominal OD		Nom. Imp. (Ω)	Nom. Vel. of Prop.	Nominal Capacitance		Nominal Attenuation		
			ft.	m	lbs.	kg		inch	mm		inch	mm			pF/ft.	pF/m	MHz	dB/ 100 ft.	dB/ 100 m

**Triax 14 • Stranded (7x0.75) 2.2 mm Silver-Plated Copper • 80% Silver-Plated Copper Braid • 80% Bare Copper Braid**

<b>Foam Polyethylene Insulation • Red PVC Jacket</b>																				
70°C	<b>7785A</b>	1000	305	157.9	76.2	2.21 mm	0.382	9.70	80% SPC	0.571	14.50	75	82%	16.5	54.0	1	0.1	0.4		
		1640	500	259.0	124.9	12 AWG			Braid								10	0.4	1.3	
		1968	600	310.8	149.9	(7x0.75) SPC			+ 80% BC								20	0.5	1.7	
						12.1 Ω/km*			Braid								40	0.8	2.5	
						5.7 Ω/km**			6.4 Ω/km***							50	0.9	2.8		
									10.4 mm							60	0.9	3.1		
																100	1.3	4.2		
																300	2.3	7.6		
																1000	4.4	14.3		

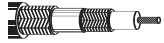

Return loss at 5-850 MHz: ≥ 21 dB  
 Screening attenuation at 30-1000 MHz: ≥ 75 dB  
 Pulling Tension: 550 N  
 Spools are one piece, but length may vary 305 m 0% to +5%,  
 500 m ±10%, 600 m ±10% from length shown.

<b>Foam Polyethylene Insulation • Red PVC Jacket</b>																				
70°C	<b>7785ANH</b>	1000	305	157.9	80.3	2.21 mm	0.382	9.70	80% SPC	0.571	14.50	75	82%	16.5	54.0					
		1640	500	259.0	131.6	12 AWG			Braid											
		1968	600	310.8	157.9	(7x0.75) SPC			+ 80% BC											
						12.1 Ω/km*			Braid											
						5.7 Ω/km**			6.4 Ω/km***											
									10.4 mm											

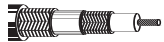





Return loss at 5-850 MHz: ≥ 21 dB  
 Screening attenuation at 30-1000 MHz: ≥ 75 dB  
 Pulling Tension: 550 N  
 Spools are one piece, but length may vary 305 m 0% to +5%,  
 500 m ±5%, 600 m 0% to +10% from length shown.

\* DC loop resistance • \*\* DC resistance inner conductor • \*\*\* DC resistance outer conductor • DCR = DC resistance • BC = Bare Copper • SPC = Silver-Plated Copper

# Standard Analog Video Cables

## 75 Ohm Coax



De- scription	Part No.	UL NEC/ C(UL)/CEC Type IEC	Standard Lengths		Standard Unit Weight		Conductor (Stranding) Diameter Nom. DCR	Nominal Insulation OD		Shielding Material Nom. DCR	Nominal OD		Nom. Imp. (Ω)	Nom. Vel. of Prop.	Nominal Capacitance		Nominal Attenuation			
			ft.	m	lbs.	kg		inch	mm		inch	mm			pF/ft.	pF/m	MHz	dB/ 100 ft.	dB/ 100 m	
<b>23 AWG • Solid 0.6 mm Copper-Covered Steel Conductor • 95 % Bare Copper Braid</b>																				
<b>Polyethylene Insulation • Black PVC Jacket</b>																				
30V RMS	<b>8241</b>	NEC:	100	31	4.4	2.0	0.58 mm	0.146	3.71	95% BC Braid 8.5 Ω/km***	0.240	6.10	75	66%	20.5	67.3	1	0.6	2.0	
75°C		CM	U-500	U-152	19.5	8.8	23 AWG										10	1.1	3.6	
UL AWM Style 1354, VW1		CEC:	500	152	18.5	8.4	Solid CCS										50	2.4	7.9	
		U-1000	U-305	38.0	17.2	169.2 Ω/km*											100	3.4	11.2	
		1000	305	40.0	18.1	160.7 Ω/km**											200	4.9	16.1	
		2000	610	80.0	36.3												400	7.0	23.0	
0.6/3.7		5000	1524	200.0	90.7				700	9.7	31.8									
RG-59/U Typ									900	11.1	36.4									
									1000	12.0	39.4									
U-305 m put-up also available in Red, Yellow, Green, Light Blue, White, Orange and Black.								Nominal Delay: 5.053 ns/m Pulling Tension: 276 N												
<b>22 AWG • Stranded (7x30) 0.8 mm Bare Copper Conductor • 95 % Bare Copper Braid</b>																				
<b>Polyethylene Insulation • Black PVC Jacket</b>																				
30V RMS	<b>9259</b>	NEC:	100	31	4.1	1.9	0.76 mm	0.146	3.71	95% BC Braid 8.5 Ω/km***	0.241	6.12	75	78%	17.3	56.7	1	0.3	1.0	
80°C		CM	U-500	U-152	18.1	8.2	22 AWG										10	0.9	3.0	
UL AWM Style 1354		CEC:	500	152	16.6	7.5	(7x30) BC										50	2.1	6.9	
		U-1000	U-305	35.0	15.9	57.7 Ω/km*											100	3.0	9.8	
		1000	305	37.0	16.8	49.2 Ω/km**											200	4.5	14.8	
																	400	6.6	21.7	
0.7/3.7									700	8.9	29.2									
									900	10.1	33.1									
									1000	10.9	35.8									
For CCTV applications.								Nominal Delay: 5.053 ns/m Pulling Tension: 275 N												
<b>20 AWG • Solid 0.8 mm Bare Copper • 98 % Tinned Copper Double Braid</b>																				
<b>Polyethylene Insulation • Polyethylene Jacket (Red, Yellow, Green, Light Blue, White, Orange and Black)</b>																				
80°C	<b>8281</b>		500	152	37.5	17.0	0.81 mm	0.198	5.03	Double Braid 98% TC 3.6 Ω/km***	0.305	7.75	75	66%	21.0	68.9	1	0.3	1.0	
			1000	305	74.0	33.6	20 AWG										3.6	0.5	1.6	
							Solid BC										10	0.8	2.6	
							36.1 Ω/km*										71.5	2.1	6.9	
							32.5 Ω/km**										135	3.0	9.8	
																	270	4.3	14.1	
0.8/5.0									360	5.1	16.7									
RG-59/U Type									540	6.3	20.7									
									720	7.4	24.3									
									750	7.6	24.9									
									1000	9.2	30.2									
152 m put-up not available in White.								Nominal Delay: 5.053 ns/m Pulling Tension: 515 N												
<b>18 AWG • Solid 1.0 mm Bare Copper • Duofoil® • 60 % Tinned Copper Braid</b>																				
<b>Gas-Injected Foam HDPE Insulation • Black PVC Jacket</b>																				
30V RMS	<b>9248</b>	NEC:	U-500	U-152	16.5	7.5	1.02 mm	0.180	4.57	Duofoil® + 60% TC Braid 18.4 Ω/km***	0.270	6.86	75	82%	16.2	53.1	1	0.3	1.0	
80°C		CM	500	152	15.0	6.8	18 AWG										10	0.7	2.3	
UL AWM Style 1354		CEC:	U-1000	U-305	32.0	14.5	Solid BC										50	1.5	4.9	
		CM	1000	305	33.0	15.0	39.4 Ω/km*										100	2.0	6.6	
			1640	500	55.8	25.3	21.0 Ω/km**										200	2.8	9.2	
			3280	1000	108.2	49.1											400	4.0	13.1	
1.0/4.6									700	5.3	17.4									
RG-6									900	6.1	20.0									
									1000	6.5	21.3									
									1500	8.3	27.2									
								Nominal Delay: 4.068 ns/m Pulling Tension: 195 N												
<b>14 AWG • Solid 1.6 mm Bare Copper • Duofoil® • 60 % Tinned Copper Braid</b>																				
<b>Gas-Injected Foam HDPE Insulation • Black PVC Jacket</b>																				
80°C	<b>9292</b>		1000	305	75.0	34.0	1.63 mm	0.280	7.11	Duofoil® + 60% TC Braid 9.8 Ω/km***	0.405	10.29	75	84%	16.1	52.8	1	0.2	0.6	
							14 AWG										10	0.5	1.6	
							Solid BC										50	0.9	3.0	
							18.3 Ω/km*										100	1.3	4.3	
							8.5 Ω/km**										200	1.6	5.3	
																	400	2.3	7.5	
1.6/7.2									700	3.3	10.8									
RG-11									900	4.0	13.1									
									1000	4.3	14.1									
								Nominal Delay: 3.937 ns/m Pulling Tension: 435 N												

\* DC loop resistance • \*\* DC resistance inner conductor • \*\*\* DC resistance outer conductor • DCR = DC resistance • TC = Tinned Copper • BC = Bare Copper • CCS = Copper-Covered Steel Duofoil® see technical information page 23.13.



# Standard Analog Video Cables

## RGB Component Video Multicore Cables



De- scription	Part No.	UL NEC/ C(UL)CEC Type IEC	Standard Lengths		Standard Unit Weight		Conductor (Stranding) Diameter Nom. DCR	Nominal Insulation OD		Shielding Material Nom. DCR	Nominal OD		Nom. Imp. (Ω)	Nom. Vel. of Prop.	Nominal Capacitance		Nominal Attenuation	
			ft.	m	lbs.	kg		inch	mm		inch	mm			pF/ft.	pF/m	MHz	dB/ 100 ft.

**30 AWG • Stranded (7x38) 0.3 mm Tinned Copper • Duofoil® • 90% Tinned Copper Braid (Coaxes) • Overall Beldfoil® Shield • TC Drain Wire**

**Foam HDPE Insulation • Overall Black PVC Jacket**

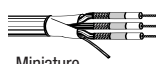
 Miniature 0.3/1.4	30V RMS 60°C	NEC: CL2					0.31 mm 30 AWG (7x38) TC 413.2 Ω/km* 382.1 Ω/km**	0.056	1.42	Duofoil® + 90% TC Braid 31.1 Ω/km***	75	78%	17.3	56.8	1	0.8	2.6		
															5	1.5	4.9		
															10	2.2	7.2		
															30	4.0	13.1		
															50	5.4	17.7		
															100	8.2	26.9		
														1000	32.8	107.6			

Pulling Tension:

<b>1520A</b>	3 Coax	500 1000	152 305	23.0 50.0	10.4 22.7														187 N
<b>1521A</b>	4 Coax	500 1000	152 305	31.0 60.0	14.1 27.2														249 N
<b>1522A</b>	5 Coax	500 1000	152 305	34.5 67.0	15.6 30.4														311 N

Nominal Delay: 4.265 ns/m  
100% Sweep tested. 10 MHz to 40 MHz.  
Color Code: see chart below

**26 AWG • Stranded (7x34) 0.5 mm Bare Copper • Duofoil® • 93% Tinned Copper Braid (Coaxes)**

**Foam HDPE Insulation • Overall Matte Black PVC Jacket**

 High-Flex 0.5/2.3	30V RMS 60°C						0.48 mm 26 AWG (7x34) TC 164.3 Ω/km* 136.1 Ω/km**	0.090	2.29	Duofoil® + 93% TC Braid 28.2 Ω/km***	75	78%	17.3	56.8	1	0.6	2.0		
															5	1.3	4.3		
															10	1.8	5.9		
															30	3.1	10.2		
															50	3.9	12.8		
															100	5.4	17.7		
														1000	15.9	52.2			

Pulling Tension:

<b>1406B</b>	3 Coax	1000	305	79.0	35.8														458 N
<b>1407B</b>	4 Coax	1000	305	100.0	45.4														614 N
<b>1417B</b>	5 Coax	1000	305	110.0	49.9														765 N

Nominal Delay: 4.265 ns/m  
100% Sweep tested. 10 MHz to 40 MHz.  
Color Code: see chart below

\* DC loop resistance • \*\* DC resistance inner conductor • \*\*\* DC resistance outer conductor • DCR = DC resistance • TC = Tinned Copper

Duofoil® see technical information page 23.13.

### Color Code

Cond.	Color
1	Red
2	Green
3	Blue
4	White
5	Yellow

# Low Loss HDTV/SDI Digital Coax

## 75 Ohm Coax



De-scription	Part No.	UL NEC / C(UL)CEC Type IEC	Standard Lengths		Standard Unit Weight		Conductor (Stranding) Diameter Nom. DCR	Nominal Insulation OD		Shielding Material Nom. DCR	Nominal OD		Nom. Imp. (Ω)	Nom. Vel. of Prop.	Nominal Capacitance		Nominal Attenuation		
			ft.	m	lbs.	kg		inch	mm		inch	mm			pF/ft.	pF/m	MHz	dB/100 ft.	dB/100 m
<b>28.5 AWG • Solid 0.3 mm Bare Copper Conductor • Duobond® foil • 95 % Tinned Copper Braid</b>																			
<b>Gas-Injected Foam HDPE Insulation • PVC Jacket</b> (Brown, Red, Orange, Yellow, Green, Blue, Violet, Grey, White and Black)																			
DigiTruck HDTV/SDI Digital Video 70°C	<b>179DT</b>	NEC: CM CEC: CMG FT4	500 1000	152 305	5.0 8.0	2.3 3.6	0.31 mm 28.5 AWG Solid BC 379.2 Ω/km* 350.0 Ω/km**	0.056 1.42		Duobond® + 95% TC Braid 29.2 Ω/km***	0.100 2.54	75 77%			17.5 57.4	1 5 10 67.5 71.5 100 135 270 360 540 720 750 1000 1500 2000 2250 3000 4500	1.2 1.9 2.4 5.9 6.0 6.9 7.9 10.8 12.5 15.4 17.9 18.3 21.3 26.3 30.8 32.8 38.3 47.5	3.9 6.1 7.8 19.3 19.6 22.6 25.8 35.4 41.0 50.5 58.7 60.0 69.9 86.3 101.1 107.6 125.7 155.8	
<p>0.3/1.4 RG-179</p>		<p>Return loss at 5-1600 MHz: ≥ 23 dB 1600-3000 MHz: ≥ 21 dB</p> <p>Nominal Delay: 4.331 ns/m 100% Sweep tested. 5 Mhz to 3 GHz. Pulling Tension: 66 N</p>																	

<b>25 AWG • Stranded (19x37) 0.5 mm Bare Copper • Duofoil® • 95 % Tinned Copper Braid</b>																			
<b>Gas-Injected Foam HDPE Insulation • PVC Jacket</b> (Brown, Red, Orange, Yellow, Blue, Violet, Grey, White and Black)																			
HDTV/SDI Digital Video 75°C	<b>1865A</b>	NEC: CMR CEC: CMG FT4	1000	305	14.0	6.4	0.53 mm 25 AWG (19x37) BC 107.6 Ω/km* 89.9 Ω/km**	0.094 2.39		Duofoil® + 95% TC Braid 17.7 Ω/km***	0.150 3.81	75 82%			16.5 54.1	1 5 71.5 360 540 750 1000 1500 2250 3000	0.5 1.1 3.7 8.2 10.1 12.0 13.9 17.0 20.8 24.0	1.5 3.6 12.1 26.9 33.1 39.4 45.6 55.8 68.2 78.7	
<p>0.5/2.4 RG-59/U Type</p>		<p>Nominal Delay: 4.068 ns/m 100% Sweep tested. 5 Mhz to 3 GHz.</p> <p>Pulling Tension: 133 N</p>																	

<b>23 AWG • Solid 0.6 mm Bare Copper Conductor • Duofoil® • 95 % Tinned Copper Braid</b>																			
<b>Gas-Injected Foam HDPE Insulation • PVC Jacket</b>																			
HDTV/SDI Digital Video 75°C	<b>1855A</b>	NEC: CMR CEC: CMG FT4	500 1000	152 305	9.0 16.0	4.1 7.3	0.58 mm 23 AWG Solid BC 90.8 Ω/km* 65.9 Ω/km**	0.102 2.59		Duofoil® + 95% TC Braid 24.9 Ω/km***	0.159 4.04	75 82%			16.3 53.5	1 3.6 10 71.5 135 270 360 540 720 750 1000 1500 2000 2250 3000 4500	0.4 0.8 1.2 3.1 3.8 5.4 6.2 7.7 9.5 9.6 10.5 13.0 15.1 16.0 18.5 22.8	1.3 2.6 3.9 10.0 12.5 17.7 20.3 25.3 31.1 31.5 34.4 42.6 49.5 52.5 60.7 74.8	
<p>0.6/2.6 RG-59/U Type</p>		<p>Return loss at 5-1600 MHz: ≥ 23 dB 1601-4500 MHz: ≥ 21 dB</p> <p>Nominal Delay: 4.003 ns/m 100% Sweep tested. 5 Mhz to 3 GHz. Pulling Tension: 160 N</p> <p>152 m put-up available in Black only.</p> <p>Also available in multiples, bundled. See page 19.31 and 19.33.</p>																	

<b>22 AWG • Solid 0.6 mm Tinned Copper • Duofoil® • 90 % Tinned Copper Braid</b>																			
<b>Gas-Injected Foam HDPE Insulation • Green with FRNC Jacket</b>																			
HDTV/SDI Digital Video 75°C	<b>1855ENH</b>		328 1640	100 500	6.2 30.9	2.8 14.0	0.64 mm 22 AWG Solid TC 69.0 Ω/km* 52.0 Ω/km**	0.110 2.80		Duofoil® + 90% TC Braid 17.0 Ω/km***	0.175 4.45	75 84%			16.2 53.0	71.5 135 270 360 540 750 1500 3000	2.6 3.5 4.9 5.7 7.0 8.2 11.8 17.1	8.6 11.5 16.1 18.6 22.8 26.9 38.7 56.1	
<p>0.6/2.8 RG-59/U Type</p>																			

\* DC loop resistance • \*\* DC resistance inner conductor • \*\*\* DC resistance outer conductor • DCR = DC resistance • TC = Tinned Copper • BC = Bare Copper

Duofoil® and Duobond® see technical information page 23.13.

# Low Loss HDTV/SDI Digital Coax

## 75 Ohm Coax



De- scription	Part No.	UL NEC/ C(UL)CEC Type IEC	Standard Lengths		Standard Unit Weight		Conductor (Stranding) Diameter Nom. DCR	Nominal Insulation OD		Shielding Material Nom. DCR	Nominal OD		Nom. Imp. (Ω)	Nom. Vel. of Prop.	Nominal Capacitance		Nominal Attenuation		
			ft.	m	lbs.	kg		inch	mm		inch	mm			pF/ft.	pF/m	MHz	dB/ 100 ft.	dB/ 100 m
<b>23 AWG • Solid 0.6 mm Bare Copper • 90% Tinned Copper Double Braid + 85% Tinned Copper Braid</b>																			
<b>Polyethylene Insulation • Cream PVC Jacket</b>																			
SDI	<b>BE43187</b>		328	100	7.5	7.0	0.58 mm	0.146	3.70	Double Braid	0.248	6.30	75	66%	20.7	68.0	1	0.3	1.1
Digital Video			1640	500	37.5	35.0	23 AWG			90% TC							10	1.1	3.5
75°C							Solid BC			85% TC							135	3.8	12.5
																	270	5.5	17.9
																	360	6.3	20.8
																	540	8.0	26.2
																	750	9.8	32.0
																	1000	11.3	37.0
0.6/3.7																			
RG-59/U Type																			
<b>22 AWG • Stranded (7x29) 0.8 mm Bare Compacted Copper# • 98% Tinned Copper Double Braid</b>																			
<b>Gas-Injected Foam HDPE Insulation • PVC Jacket (Matte Black, Red, Green, Blue, Yellow, White and Violet)</b>																			
HDTV/SDI	<b>1505F</b>	NEC:	1000	305	45.0	20.4	0.76 mm	0.145	3.68	Double Braid	0.242	6.15	75	80%	17.0	55.7	1	0.2	0.7
Digital Video		CM					22 AWG			98% TC							3.6	0.5	1.6
75°C		CEC:					(7x29) BCC			Braid							5	0.6	2.0
		CM					47.8 Ω/km**			7.8 Ω/km***							7	0.7	2.4
							40.0 Ω/km**										10	0.9	2.4
																	71.5	2.5	8.2
																	100	3.0	9.8
																	135	3.5	11.5
																	270	5.1	16.7
																	360	6.0	19.7
																	540	7.4	24.3
																	720	8.7	28.5
																	750	8.9	29.2
																	1000	10.5	34.4
																	1500	13.3	43.6
																	2000	15.7	51.5
																	2250	16.9	55.4
																	3000	20.3	66.6
0.8/3.7																			
RG-59/U Type																			
Return loss at 5-3000 MHz: ≥ 15 dB										Nominal Delay: 4.265 ns/m 100% Sweep tested. 5 Mhz to 3 Ghz. Pulling Tension: 400 N									
<b>20 AWG • Solid 0.8 mm Bare Copper • Duofoil® • 95% Tinned Copper Braid</b>																			
<b>Gas-Injected Foam HDPE Insulation • PVC Jacket (Brown, Red, Orange, Yellow, Green, Blue, Violet, Grey, White and Black)</b>																			
HDTV/SDI	<b>1505A</b>	NEC:	500	152	17.5	7.9	0.81 mm	0.145	3.68	Duofoil®	0.233	5.92	75	83%	16.3	53.5	1	0.3	1.0
Digital Video		CMR	1000	305	36.0	16.3	20 AWG			95% TC							3.6	0.5	1.8
75°C		CEC:	5000	1524	165.4	75.0	Solid BC			Braid							5	0.6	2.1
		CMG FT4					45.3 Ω/km**			12.5 Ω/km***							7	0.7	2.4
							32.8 Ω/km**										10	0.9	2.9
																	71.5	2.1	6.9
																	100	2.3	7.6
																	135	2.7	8.9
																	270	3.8	12.5
																	360	4.4	14.4
																	540	5.5	18.0
																	720	6.4	21.0
																	750	6.5	21.3
																	1000	7.6	24.9
																	1500	9.3	30.5
																	2000	9.3	30.5
																	2250	11.6	38.0
																	3000	13.4	44.0
																	4500	16.4	53.8
0.8/3.7																			
RG-59/U Type																			
152 m put-up available in Black, Red or Blue only.										Nominal Delay: 4.003 ns/m 100% Sweep tested. 5 Mhz to 3 Ghz. Pulling Tension: 209 N Also available in bundled versions. See page 19.32 and 19.34.									
<b>Gas-Injected Foam HDPE • Black FRNC/LSNH Jacket</b>																			
HDTV/SDI	<b>1505ANH</b>	IEC 332-3C	1000	305	36.0	15.5	0.81 mm	0.145	3.68	Duofoil®	0.233	5.92	75	83%	16.3	53.5			
Digital Video		IEC 332-1					20 AWG			95% TC									
75°C		IEC 61034-1					Solid BC			Braid									
		IEC 60331-11					45.2 Ω/km*			12.4 Ω/km***									
		IEC 60754-1					32.8 Ω/km**												
		IEC 60754-2																	
0.8/3.7																			
RG-59/U Type																			
Return loss at 5-1600 MHz: ≥ 23 dB 1601-4500 MHz: ≥ 21 dB										Nominal Delay: 4.003 ns/m 100% Sweep tested. 5 Mhz to 3 Ghz. Pulling Tension: 209 N									

\* DC loop resistance • \*\* DC resistance inner conductor • \*\*\* DC resistance outer conductor • DCR = DC resistance • TC = Tinned Copper • BC = Bare Copper • BCC = Bare Compacted Copper # Compacted conductor combines impedance uniformity of solid conductors and "nick-resistance" of stranded conductors.

Duofoil® see technical information page 23.13.



# Low Loss HDTV/SDI Digital Coax

## 75 Ohm Coax



De- scription	Part No.	UL NEC/ C(UL)CEC Type IEC	Standard Lengths		Standard Unit Weight		Conductor (Stranding) Diameter Nom. DCR	Nominal Insulation OD		Shielding Material Nom. DCR	Nominal OD		Nom. Imp. (Ω)	Nom. Vel. of Prop.	Nominal Capacitance		Nominal Attenuation		
			ft.	m	lbs.	kg		inch	mm		inch	mm			pF/ft.	pF/m	MHz	dB/ 100 ft.	dB/ 100 m

**14 AWG • Solid 1.6 mm Bare Copper • Duofoil® • 95% Tinned Copper Braid**

**Gas-Injected Foam HDPE Insulation • PVC Jacket** (Brown, Red, Orange, Yellow, Green, Blue, Violet, Grey, White and Black)

HDTV/SDI	<b>7731A</b>	NEC:	500	152	46.5	21.1	1.63 mm	0.280	7.11	Duofoil®	0.400	10.16	75	85%	16.0	52.5	1	0.2	0.5
Digital Video		CMR	1000	305	95.0	43.1	14 AWG			+ 95% TC							10	0.5	1.5
75°C		CEC:	4000	1219	388.0	176.0	Solid BC			Braid							71.5	1.1	3.6
		CMG FT4					13.1 Ω/km*			4.9 Ω/km***							135	1.5	4.8
							8.2 Ω/km**										270	2.1	6.9
																	360	2.5	8.0
																	540	3.1	10.0
																	720	3.6	11.7
																	750	3.7	12.0
																	1000	4.3	14.1
																	1500	5.5	18.0
																	2250	6.9	22.6
																	3000	8.2	26.9
																	4500	10.4	34.1



1.6/7.2  
RG-11/U Type

Return loss at 5-1600 MHz: ≥ 23 dB  
1601-4500 MHz: ≥ 21 dB

Nominal Delay: 3.97 ns/m  
100% Sweep tested. 5 Mhz to 3 GHz.

152 m put-up available in Black only. Pulling Tension: 644 N

**Gas-Injected Foam HDPE • Black FRNC Jacket**

HDTV/SDI	<b>7731ANH</b>	IEC 332-3C	1000	305	100.0	40.4	1.63 mm	0.280	7.11	Duofoil®	0.400	10.16	75	85%	16.0	52.5	see above		
Digital Video		IEC 332-1	1640	500	164.0	66.3	14 AWG			+ 95% TC									
70°C		IEC 61034-1	3280	1000	328.0	132.5	Solid BC			Braid									
		IEC 60331-11	4000	1219	400.0	161.5	13.1 Ω/km*			4.9 Ω/km***									
		IEC 60754-1					8.2 Ω/km**												
		IEC 60754-2																	



1.6/7.2  
RG-11/U Type

Return loss at 5-1600 MHz: ≥ 23 dB  
1601-4500 MHz: ≥ 21 dB

Nominal Delay: 3.97 ns/m  
100% Sweep tested. 5 Mhz to 3 GHz.

Pulling Tension: 644 N

\* DC loop resistance • \*\* DC resistance inner conductor • \*\*\* DC resistance outer conductor • DCR = DC resistance • TC = Tinned Copper • BC = Bare Copper

Duofoil® see technical information page 23.13.

# HDTV/SDI Digital Coax

## RGB Component Video Multicore Cables

### VideoFlex® Snake Cables



De-scription	Part No.	UL NEC/ C(UL)/CEC Type IEC	Standard Lengths		Standard Unit Weight		Conductor (Stranding) Diameter Nom. DCR	Nominal Insulation OD		Shielding Material Nom. DCR	Nominal OD		Nom. Imp. (Ω)	Nom. Vel. of Prop.	Nominal Capacitance		Nominal Attenuation		
			ft.	m	lbs.	kg		inch	mm		inch	mm			pF/ft.	pF/m	MHz	dB/ 100 ft.	dB/ 100 m

**25 AWG • Solid 0.5 mm Tinned Copper • Duobond® • 95 % Tinned Interlocked Serve (Coaxes)**

**FPFA Insulation • Overall Matte Black PVC Jacket**

<p>HDTV/SDI Digital Video 60°C Miniature 0.5/1.9</p>	NEC:	0.46 mm	0.074	1.88	Duobond®	0.114	2.90	75	80%	17.0	55.8	1	0.5	1.7
	CMR	25 AWG			95% TC							5	1.2	3.8
	CEC:	Solid TC			Serve							50	3.7	12.1
	CMG	129.2 Ω/km*			17.7 Ω/km***							100	4.9	16.1
		111.5 Ω/km**										200	6.7	22.0
												400	9.5	31.2

Nominal Delay: 4.068 ns/m • Color Code: see chart 1

Pulling Tension:

<b>1277R</b>	3 Coax	† 500	152	25.5	11.6					0.320	8.13				400 N
		† 1000	305	48.0	21.8										
<b>1278R</b>	4 Coax	250	76	21.8	9.9					0.351	8.92				489 N
		† 500	152	31.5	14.3										
		† 1000	305	60.0	27.2										
<b>1279R</b>	5 Coax	† 500	152	40.5	18.4					0.403	10.24				578 N
		† 1000	305	80.0	36.3										
<b>1280R</b>	6 Coax	† 500	152	44.0	20.0					0.423	10.74				601 N
		† 1000	305	87.0	39.5										

**23 AWG • Solid 0.6 mm Tinned Copper • Duofoil® • 95% Tinned Copper Braid (Coaxes)**

**Gas-Injected Foam HDPE Insulation • Overall Matte Black PVC Jacket**

<p>HDTV/SDI Digital Video 75°C 1855A Bundled 0.6/2.6</p>	NEC:	0.58 mm	0.100	2.55	Duofoil®	0.159	4.03	75	83%	16.5	54.1	1	0.4	1.3
	CMR	23 AWG			+ 95% TC							3.6	0.8	2.6
	CEC:	Solid TC			Braid							10	1.2	3.9
	CMG FT4	90.8 Ω/km*			24.9 Ω/km***							270	5.4	17.7
		65.9 Ω/km**										360	6.2	20.3
												750	9.5	31.2

Nominal Delay: 4.068 ns/m • Sweep tested. 5 MHz to 3 GHz. • Color Code: see chart 2

Pulling Tension:

<b>7787A</b>	3 Coax	500	152	47.5	21.5					0.432	10.97				480 N
		1000	305	94.0	42.6										
<b>7788A</b>	4 Coax	1000	305	110.0	49.9					0.481	12.22				640 N
<b>7789A</b>	5 Coax	500	152	73.0	33.1					0.539	13.69				801 N
		1000	305	142.0	64.4										
<b>7790A</b>	6 Coax	500	152	88.5	40.1					0.597	15.16				961 N
		1000	305	176.0	79.8										
<b>7791A</b>	10 Coax	500	152	155.5	70.5					0.796	20.22				1601 N
		1000	305	304.0	137.9										
<b>7792A</b>	12 Coax	500	152	178.5	81.0					0.825	20.96				1922 N
		1000	305	367.0	166.5										

\* DC loop resistance • \*\* DC resistance inner conductor • \*\*\* DC resistance outer conductor • TC = Tinned Copper • FPFA = Foam Perfluoroalkoxy • HDPE = High-density Polyethylene • DCR = DC resistance • † Spools are one piece, but length may vary ±10% from length shown. • Duobond® see technical information page 23.13.

**Color Code (Chart 1)**

Cond.	Color	Cond.	Color	Cond.	Color
1	Red	3	Blue	5	Black
2	Green	4	Yellow	6	White

**Color Code (Chart 2)**

Cond.	Color	Cond.	Color	Cond.	Color	Cond.	Color	Cond.	Color
1	Red	3	Blue	5	Yellow	7	Orange	9	Purple
2	Green	4	White	6	Brown	8	Grey	10	Black
								11	Pink
								12	Tan



# HDTV/SDI Digital Coax

## RGB Component Video Multicore Cables

### VideoFlex® Snake Cables



De- scription	Part No.	UL NEC/ C(UL)CEC Type IEC	Standard Lengths		Standard Unit Weight		Conductor (Stranding) Diameter Nom. DCR	Nominal Insulation OD		Shielding Material Nom. DCR	Nominal OD		Nom. Imp. (Ω)	Nom. Vel. of Prop.	Nominal Capacitance		Nominal Attenuation	
			ft.	m	lbs.	kg		inch	mm		inch	mm			pF/ft.	pF/m	MHz	dB/ 100 ft.

**20 AWG • Solid 0.8 mm Bare Copper • Duofoil® • 95 % Tinned Copper Braid (Coaxes)**

**Gas-Injected Foam HDPE Insulation • Overall Matte Black PVC Jacket**

HDTV/SDI Digital Video 75°C   1505A Bundled 0.8/3.7	NEC:	0.81 mm	0.145	3.68	Duofoil®	0.235	5.97	75	83%	16.2	53.1	1	0.3	1.0
	CMR	20 AWG			+ 95% TC							3	0.5	1.8
	CEC:	Solid BC			Braid							10	0.9	2.9
	CMG FT4	45.3 Ω/km*			12.5 Ω/km***							270	3.8	12.5
		32.8 Ω/km**										360	4.4	14.4
												750	6.5	21.3

															Pulling Tension:	
<b>7794A</b>	3 Coax	500	152	94.5	42.9							0.631	16.03			961 N
		1000	305	187.0	84.8											
<b>7795A</b>	4 Coax	500	152	116.5	52.8							0.706	17.93			1281 N
		1000	305	237.0	107.5											
<b>7796A</b>	5 Coax	500	152	153.0	69.4							0.790	20.07			1601 N
		1000	305	299.0	135.6											
<b>7798A</b>	10 Coax	500	152	319.5	144.9							1.166	29.62			3203 N
		1000	305	625.0	283.5											

Nominal Delay: 4.265 ns/m • Sweep tested. 5 MHz to 3 GHz.  
Color Code: see chart below

**18 AWG • Solid 1.0 mm Bare Copper • Duofoil® • 95 % Tinned Copper Braid (Coaxes)**

**Gas-Injected Foam HDPE Insulation • Overall Matte Black PVC Jacket**

HDTV/SDI Digital Video 75°C   1694A Bundled 1.0/4.6	NEC:	1.02 mm	0.180	4.57	Duofoil®	0.275	6.99	75	82%	16.2	53.1	1	0.2	0.8
	CMR	18 AWG			+ 95% TC							3.6	0.5	1.5
	CEC:	Solid BC			Braid							10	0.7	2.4
	CMG FT4	30.8 Ω/km*			9.8 Ω/km***							270	3.0	9.7
		21.0 Ω/km**										360	3.4	11.3
												750	5.0	16.4

															Pulling Tension:	
<b>7710A</b>	3 Coax	500	152	137.5	62.4							0.770	19.56			921 N
		1000	305	285.0	129.3											
<b>7711A</b>	4 Coax	500	152	179.5	81.4							0.900	22.86			1227 N
		1000	305	350.0	158.8											
<b>7712A</b>	5 Coax	500	152	216.5	98.2							0.970	24.64			1534 N
		1000	305	454.0	205.9											
<b>7713A</b>	10 Coax	500	152	463.0	210.0							1.386	35.20			3069 N
		1000	305	904.0	410.1											

Nominal Delay: 4.068 ns/m • Sweep tested. 5 MHz to 3 GHz.  
Color Code: see chart below

\* DC loop resistance • \*\* DC resistance inner conductor • \*\*\* DC resistance outer conductor • DCR = DC resistance • TC = Tinned Copper • BC = Bare Copper  
Duofoil® see technical information page 23.13.

**Color Code**

<b>Cond.</b>	<b>Color</b>	<b>Cond.</b>	<b>Color</b>	<b>Cond.</b>	<b>Color</b>	<b>Cond.</b>	<b>Color</b>	<b>Cond.</b>	<b>Color</b>
1	Red	3	Blue	5	Yellow	7	Orange	9	Purple
2	Green	4	White	6	Brown	8	Grey	10	Black

# HDTV/SDI Digital Coax

## RGB Component Video Multicore Cables

### Banana Peel® Unjacketed Bundles



De- scription	Part No.	UL NEC/ C(UL)/CEC Type IEC	Standard Lengths		Standard Unit Weight		Conductor (Stranding) Diameter Nom. DCR	Nominal Insulation OD		Shielding Material Nom. DCR	Nominal OD		Nom. Imp. (Ω)	Nom. Vel. of Prop.	Nominal Capacitance		Nominal Attenuation		
			ft.	m	lbs.	kg		inch	mm		inch	mm			pF/ft.	pF/m	MHz	dB/ 100 ft.	dB/ 100 m

**25 AWG • Solid 0.5 mm Tinned Copper • Duobond® • 95 % Tinned Copper Interlocked Serve Braid (Coaxes) • Banana Peel® Unjacketed, Bonded to Central Spline**

**Foam HDPE Insulation • PVC Jackets in Colors**

<p>HDTV/SDI Digital Video 75°C</p>	NEC:	0.46 mm	0.074	1.88	Duobond®	0.114	2.90	75	80%	17.0	55.8	5	1.2	3.8
	CMR	25 AWG			95% TC							50	3.7	12.1
	CEC:	Solid TC			Serve							100	4.9	16.1
	CMG	129.2 Ω/km*			17.7 Ω/km***							200	6.7	22.0
		111.5 Ω/km**										400	9.5	31.2
												750	13.4	44.0
											900	15.0	49.2	
											1000	15.8	51.8	

Miniature  
0.5/1.9

Pulling Tension:

<b>1281S3</b> 3 Coax	† 500	152	17.0	7.7		0.246	6.25										400 N
	† 1000	305	31.0	14.1													
<b>1281S4</b> 4 Coax	† 500	152	23.5	10.7		0.275	6.99										489 N
	† 1000	305	44.0	20.0													
<b>1281S5</b> 5 Coax	† 250	76	16.0	7.3		0.308	7.82										578 N
	† 500	152	28.5	12.9													
	† 1000	305	55.0	24.9													
<b>1281S6</b> 6 Coax	† 500	152	33.5	15.2		0.342	8.69										601 N
	† 1000	305	68.0	30.8													

100% Sweep tested. 5 MHz to 850 MHz. Patent pending.

Nominal Delay: 4.068 ns/m  
Color Code: see chart 1

**23 AWG • Solid 0.6 mm Bare Copper • Duofoil® • 95 % TC Braid (Coaxes) • Banana Peel® Unjacketed, Bonded to Central Spline**

**Gas-Injected Foam HDPE Insulation • PVC Jacket**

<p>HDTV/SDI Digital Video 75°C</p>	NEC:	0.58 mm	0.102	2.59	Duofoil®	0.159	4.04	75	82%	16.3	53.5	1	0.4	1.3
	CMR	23 AWG			+ 95% TC							3.6	0.8	2.6
	CEC:	Solid BC			Braid							10	1.2	3.9
	CMG	90.8 Ω/km*			24.9 Ω/km***							360	6.2	20.3
		65.9 Ω/km**										750	9.6	31.5
												1000	10.5	34.4
											2000	15.1	49.5	
											2250	16.0	52.5	
											3000	18.5	60.7	
											4500	22.8	74.8	

1855A Bundled  
0.6/2.6

Pulling Tension:

<b>1855S3</b> 3 Coax	500	152	29.5	13.4		0.343	8.71										480 N
	1000	305	57.1	25.9													
<b>1855S5</b> 5 Coax	500	152	51.5	23.4		0.429	10.90										800 N
	1000	305	102.1	46.3													
<b>1855S6</b> 6 Coax	500	152	64.1	29.1		0.477	12.12										960 N
	1000	305	121.1	54.9													

Return loss at 5-625 MHz: ≥ 20 dB  
625-675 MHz: ≥ 15 dB  
675-850 MHz: ≥ 20 dB  
850-4500 MHz: ≥ 15 dB

Nominal Delay: 4.068 ns/m  
100% Sweep tested. 5 MHz to 5 GHz.  
152 m put-up available in Black only.  
Color Code: see chart 2

\* DC loop resistance • \*\* DC resistance inner conductor • \*\*\* DC resistance outer conductor • DCR = DC resistance • TC = Tinned Copper • BC = Bare Copper  
† Spools are one piece, but length may vary ±10% from length shown. • Duofoil® and Duobond® see technical information page 23.13.

**Color Code (Chart 1)**

Cond.	Color	Cond.	Color	Cond.	Color
1	Red	3	Blue	5	Black
2	Green	4	Yellow	6	White

**Color Code (Chart 2)**

Cond.	Color	Cond.	Color	Cond.	Color
1	Red	3	Blue	5	Yellow
2	Green	4	White	6	Brown





# HDTV/SDI Digital Coax

## RGB Component Video Multicore Cables

### Banana Peel® Unjacketed Bundles



De- scription	Part No.	UL NEC/ C(UL)CEC Type IEC	Standard Lengths		Standard Unit Weight		Conductor (Stranding) Diameter Nom. DCR	Nominal Insulation OD		Shielding Material Nom. DCR	Nominal OD		Nom. Imp. (Ω)	Nom. Vel. of Prop.	Nominal Capacitance		Nominal Attenuation	
			ft.	m	lbs.	kg		inch	mm		inch	mm			pF/ft.	pF/m	MHz	dB/ 100 ft.

**20 AWG • Solid 0.8 mm Bare Copper • Duofoil® • 95 % TC Braid (Coaxes) • Banana Peel® Unjacketed, Bonded to Central Spline**

Foam HDPE Insulation • Individual PVC Jackets in Colors																			
 HDTV/SDI Digital Video 75°C  1505A Bundled 0.8/3.7 RG-59/U Type	NEC:					0.81 mm	0.145	3.68	Duofoil®	0.235	5.97	75	83%	16.2	53.1	1	0.3	0.9	
	CMR					20 AWG			+ 95% TC								3.6	0.6	1.9
	CEC:					Solid BC			Braid								10	0.9	2.9
	CMG					45.2 Ω/km*			12.4 Ω/km***								71.5	2.1	6.8
						32.8 Ω/km**											135	2.7	8.8
																	270	3.8	12.4
																	360	4.4	14.4
																	540	5.5	18.0
																	720	6.4	20.9
																	750	6.5	21.3
																1000	7.6	24.9	
																1500	9.4	30.8	
																2500	12.4	40.6	
																3000	13.8	45.2	
																4500	16.5	54.2	

Pulling Tension:

<b>1505S3</b> 3 Coax	500	152	55.5	25.2		0.502	12.75												960 N
	1000	305	104.0	47.2															
<b>1505S5</b> 5 Coax	500	152	95.0	43.1		0.629	15.98												1601 N
	1000	305	185.0	83.9															
<b>1505S6</b> 6 Coax	500	152	117.6	53.3		0.790	20.07												1921 N
	1000	305	250.3	113.5															

Return loss at 5-475 MHz: ≥ 20 dB  
 475-525 MHz: ≥ 15 dB  
 525-850 MHz: ≥ 20 dB  
 850-4500 MHz: ≥ 15 dB

Nominal Delay: 4.003 ns/m  
 100% Sweep tested, 5 MHz to 4.5 GHz. Patent pending.  
 Color Code: see chart below

\* DC loop resistance • \*\* DC resistance inner conductor • \*\*\* DC resistance outer conductor • DCR = DC resistance • TC = Tinned Copper • BC = Bare Copper

Duofoil® see technical information page 23.13.

### Color Code

Cond.	Color	Cond.	Color
1	Red	4	White
2	Green	5	Yellow
3	Blue	6	Brown



New Generation® Cables

20



**Table of Contents**

<b>New Generation® Sound, Security and Alarm Cables</b>	<b>Page No.</b>
<b>Introduction</b>	<b>20.2 – 20.2</b>
<b>New Generation® Cable Finder Guide</b>	<b>20.3 – 20.9</b>
<b>Security Multi-Conductor Cables</b>	<b>20.10</b>
Residential, Light Commercial and Institutional Applications	20.10
<b>Security and Alarm Cables</b>	<b>20.11 – 20.33</b>
Commercial Applications Unshielded	20.11 – 20.17
Commercial Applications Shielded	20.18 – 20.27
Water-Blocked for Use in Underground Ducts Unshielded and Shielded	20.28
Commercial Applications Unshielded Twisted Pairs	20.29
Commercial Applications Shielded Twisted Pairs	20.30 – 20.31
Commercial Applications Individually Shielded Twisted Pairs	20.32
Commercial Applications Individually Shielded Twisted Pairs plus Conductors	20.33
<b>Security Coaxial Cables</b>	<b>20.34 – 20.38</b>
Surveillance and CCTV Applications	20.34
Surveillance and CCTV Applications, Shielded or Flooded for Use in Underground Ducts	20.35 – 20.36
Water-Blocked for Use in Underground Ducts	20.37
CATV and MATV Applications, Commercial or Schlage Systems	20.38
<b>Security Composite Cables</b>	<b>20.39 – 20.45</b>
CCTV plus Audio or PAN and Tilt CCTV Control Applications	20.39 – 20.40
CCTV PTZ Camera Cables	20.41
CCTV Fixed and PTZ Camera Cables	20.42
Video Control System Cables	20.43
Banana Peel® PTZ Camera Cable Composite Cables Jacketless	20.44
Banana Peel® Access Control Composite Cables Jacketless	20.45
<b>Fire Alarm Cables</b>	<b>20.46 – 20.55</b>
Commercial Applications, Power-Limited Unshielded	20.46 – 20.49
Commercial Applications, Power-Limited Shielded	20.50 – 20.51
Commercial Applications, Addressable Systems, Power-Limited, Mid-Capacitance Unshielded and Shielded	20.52 – 20.53
NPLF Systems, Non-Power-Limited Signaling Cable Unshielded and Shielded	20.54 – 20.55
<b>Circuit Integrity &amp; Fire Protection Cables</b>	<b>20.56</b>
Commercial Applications, Power-Limited Shielded	20.56

## Introduction



### Changing the Future

The demands of the market are constantly changing the boundaries of cable technology. Nowhere is the demand for uncompromising quality and leading-edge technology more critical than in the increasingly complex fields of security and alarm systems and audio/visual applications – that's why choice, imagination, technical expertise and exceptional quality are vital.

Belden's New Generation® range comprises low voltage electronic cables. It includes one of the largest, modern and economical/cost effective selections of reliable multi-conductor and coaxial products on the market.

Innovations include Belden's revolutionary Banana Peel® access control composite cable, Banana Peel® CCTV PTZ (Power, Tilt, Zoom) cable, and Belcoil packaging for selected cables – all designed for easier and more efficient installation.

### Key Applications

- Security systems
- Intercom/PA systems
- Sound/audio systems
- Power-limited controls
- Single line telephone
- Addressable fire systems
- Data circuits
- Monitor/detection
- Control circuits
- Initiating circuits
- Notification circuits

### Special Features

#### • Banana Peel® Composite Cables

Belden's (patent pending) Banana Peel® cable technology fixes individual cables to a center spline or substrate. The individual cables can be easily peeled away eliminating the need for composite cables with an overall jacket. Banana Peel® technology is available in access control cables and CCTV PTZ camera cables.

Benefits include:

- Reduced installation time
- Smaller overall diameter
- Easier and more reliable installations – less set-up, pulling and termination time compared to individual cables
- Quicker identification of individual components

#### • Banana Peel® Access Control Cables

Belden Banana Peel® access control composite cables enable more cost effective security installations for access control devices such as card readers, retina scanners and hand-scanning devices. Whether the installation is in a commercial building, hospital, school, university, commercial building or government facility, Banana Peel® access control cables are designed to bring a whole new level of ease and convenience to the workplace.

Benefits include:

- Cost effective security
- Ease and convenience of installation
- Reliable day to day use

#### • Banana Peel® CCTV Power Tilt Zoom (PTZ) Camera Cable

Many public and private sector buildings today – such as offices, hospitals, airports, amusement parks, retail establishments, educational facilities, casinos, sports stadiums, prisons and other places – all have surveillance systems to monitor visitors and employees. The purpose of these systems is clear – to protect people, to protect the facility and to protect its assets.

CCTV cameras that can swivel and zoom in on particular areas are increasingly common. Banana Peel® PTZ cables facilitate the most effective camera installation and operation by providing all the video, power, and control cables needed in one easy-to-use composite cable.

Benefits include:

- High level security
- High-performance monitoring
- Protection of people
- Protection of premises and contents

#### • New Generation® Fire Resistant, Circuit Integrity Cables

When a fire occurs, there is no time for hesitation and every second counts. It is critical that fire detection, warning and alarm circuits continue to operate even under the most extreme conditions of fire, smoke and heat. There is nothing more important than the safety and evacuation of personnel and the fire alarm system must not fail.

Belden's New Generation® range features cables specifically designed for use during severe fires where a low-smoke, zero-halogen cable is required to maintain circuit integrity. The range includes cables that meet IEC 331 requirements for circuit integrity applications.

These cables are ideal for fire detection systems, emergency lighting, video surveillance and public address systems.

Benefits include:

- Fire detection and warning
- High-performance alarm circuits
- Continual operation during severe fires

### Availability

Many of these are available off the shelf from distributors. If you have a new or unusual application or you cannot find a New Generation® cable in this catalog section that meets your technical requirements, see our U.S. Master Catalog or contact technical support at +31-77-3875-414 or techsupport.venlo@belden.com.

### Corresponding Literature

#### Product Bulletins

- NP193: Belcoil packaging
- NP199: Banana Peel® access control composite cables, jacketless
- NP206: UTP composite cables for CCTV camera applications
- NP216: Banana Peel® PTZ composite cables for CCTV camera applications

### Cable Finder Guide – New Generation® Coax



No. of Cond.	Material	Stranded (mm)	Solid (mm)	Nom. Imp. Ohm	CDR Dia. (mm)	Braid			Cu-foil/Braid			Duobond®/Braid			Duobond II®/Braid			Duofoil®/Braid			
						Part No.	BC	Page	Part No.	BC	Page	Part No.	AL	Page	Part No.	TC	Page	Part No.		Page	
<b>25 AWG 0.55 0.45</b>																					
1	BC		solid	75	0.46	473945	95%	20.35													
	BC		solid	75	0.46	573945	94%	20.35													
<b>22 AWG 0.80 0.60</b>																					
1	BC	7x30		75	0.76	451945	95%	20.35													
	BC	7x30		75	0.76	551945	95%	20.35													
<b>20 AWG 0.90 0.80</b>																					
1	BC		solid	75	0.81	443945	95%	20.36													
	BC		solid	75	0.81	543945	95%	20.35													
	BC		solid	75	0.81									5439W5#	95%	20.37					
	BC		solid	75	0.80												H121A00	40% TC	20.34		
<b>18 AWG 1.20 1.00</b>																					
1	BC		solid	75	1.02													4339B5	63% BC	20.38	
	BC		solid	75	1.02													4339Q5*	60% AL + 40% AL	20.38	
	BC		solid	75	1.02	433945	95%	20.36													
	BC		solid	75	1.02	533945	95%	20.36													
	BC		solid	75	1.02													5339B5	60% AL	20.38	
	BC		solid	75	1.02													5339Q5*	60% AL + 40% AL	20.38	
	BC		solid	75	1.02													5339W5#	60% AL	20.37	
	BC		solid	75	1.02							5399B5	60%	20.38							
	BC		solid	75	1.00				H109A00	55%	20.34										
	BC		solid	75	1.00													H125A00	40% TC	20.34	
<b>14 AWG 1.85 1.60</b>																					
1	BC		solid	75	1.63	413945	95%	20.36													
	BC		solid	75	1.63	513945	95%	20.36													

\* Quad Shield = Duofoil Tape + 60% Aluminum Braid + Duofoil Tape + 40% Aluminum Braid

# CoreGuard®

TC = Tinned Copper • BC = Bare Copper • AL = Aluminum

### Cable Finder Guide – New Generation® Multi-Conductor and Twisted Pair

No. of Cond.	No. of Pairs	Stranded (mm)	Solid (mm)	Drain Wire	Unshielded		Overall Foil		Individual Foil	
					Part No.	Page	Part No.	Page	Part No.	Page
<b>24 AWG 0.22 mm<sup>2</sup> 0.60 0.50</b>										
2	none	7x32		x			5600FE	20.18		
	none	7x0.193					SEC0008	20.18		
	1	7x0.193					SEC0027	20.19		
4	none	7x0.193					SEC0009	20.18		
	2	7x0.193					SEC0028	20.19		
	1/1	7x0.193					SEC0037	20.19		
	1/1	7x0.193					SEC0042	20.19		
6	none	7x0.193					SEC0010	20.18		
	3	7x0.193					SEC0029	20.19		
	2/1	7x0.193					SEC0038	20.19		
	2/1	7x0.193					SEC0043	20.19		

AWG values are approximate where cables are made to European standards (mm<sup>2</sup>), and vice versa.

Where the current reaches upper limits, the varying operation conditions for installation and laying acc. to standards are to be taken into consideration.



### Cable Finder Guide

#### New Generation® Multi-Conductor and Twisted Pair (continued)



No. of Cond.	No. of Pairs	Stranded (mm)	Solid (mm)	Drain Wire	Unshielded		Overall Foil		Individual Foil	
					Part No.	Page	Part No.	Page	Part No.	Page
<b>24 AWG 0.22 mm<sup>2</sup> 0.60 0.50 (continued)</b>										
8	4		solid		1500A	20.42				
	4		solid		1583E	20.42				
	none	7x0.193					SEC0011	20.18		
	4	7x0.193					SEC0030	20.19		
	3/1	7x0.193					SEC0039	20.19		
	3/1	7x0.193					SEC0044	20.19		
10	none	7x0.193					SEC0012	20.18		
	5	7x0.193					SEC0031	20.19		
	4/1	7x0.193					SEC0040	20.19		
	4/1	7x0.193					SEC0045	20.19		
12	none	7x0.193					SEC0013	20.18		
	6	7x0.193					SEC0032	20.19		
	5/1	7x0.193					SEC0041	20.19		
	5/1	7x0.193					SEC0046	20.19		
14	7	7x0.193					SEC0033	20.19		
16	none	7x0.193					SEC0014	20.18		
	8	7x0.193					SEC0034	20.19		
20	10	7x0.193					SEC0035	20.19		
22	11	7x0.193					SEC0036	20.19		
2/2	none	7x0.193					SEC0015	20.18		
	none	7x0.193					SEC0021	20.18		
4/2	none	7x0.193					SEC0016	20.18		
	none	7x0.193					SEC0022	20.18		
6/2	none	7x0.193					SEC0017	20.18		
	none	7x0.193					SEC0023	20.18		
8/2	none	7x0.193					SEC0018	20.18		
	none	7x0.193					SEC0024	20.18		
10/2	none	7x0.193					SEC0019	20.18		
	none	7x0.193					SEC0025	20.18		
12/2	none	7x0.193					SEC0020	20.18		
	none	7x0.193					SEC0026	20.18		
<b>23 AWG 0.26 mm<sup>2</sup> 0.65 0.57</b>										
8	4		solid		7881A	20.42				
<b>22 AWG 0.34 mm<sup>2</sup> 0.80 0.60</b>										
2	none	7x30		x			4500FE	20.21		
	none	7x30			4500UE	20.12				
	none	7x30					5500F1	20.28		
	none	7x30		x			5500FE	20.20		
	none	7x30			5500UE	20.11				
	none	7x30			5500UG	20.10				
3	none	7x30		x			4501FE	20.21		
	none	7x30			4501UE	20.12				
	none	7x30		x			5501FE	20.20		
	none	7x30			5501UE	20.11				
	1+1/C	7x30		x					5501GE	20.33
4	none	7x30		x			4502FE	20.21		
	none	7x30			4502UE	20.12				
	none	7x30		x			5502FE	20.20		
	none	7x30			5502UE	20.11				
	none	7x30			5502UG	20.10				
	none		solid	x			5522FL	20.50		
	none		solid	x	5522UL	20.46				

AWG values are approximate where cables are made to European standards (mm<sup>2</sup>), and vice versa. Where the current reaches upper limits, the varying operation conditions for installation and laying acc. to standards are to be taken into consideration.

### Cable Finder Guide

#### New Generation® Multi-Conductor and Twisted Pair (continued)



No. of Cond.	No. of Pairs	Stranded (mm)	Solid (mm)	Drain Wire	Unshielded		Overall Foil		Individual Foil		
					Part No.	Page	Part No.	Page	Part No.	Page	
<b>22 AWG 0.34 mm<sup>2</sup></b>		<b>0.80</b>	<b>0.60 (continued)</b>								
4	1+2/C	7x30		x					4502GE	20.33	
	1+2/C	7x30		x					5502GE	20.33	
	2	7x30			5541UE	20.29					
	2	7x30		x			4541FE	20.30			
	2	7x30		x			5541FE	20.30			
5	none	7x30		x			5503FE	20.20			
	none	7x30			5503UE	20.11					
6	none	7x30		x			4504FE	20.21			
	none	7x30			4504UE	20.12					
	none	7x30		x			5504FE	20.20			
	none	7x30			5504UE	20.11					
	none		solid		5542UL	20.46					
	1+2/TP	7x30		x					5542GE	20.33	
	3	7x30			5542UE	20.29					
8	3	7x30		x			4542FE	20.30			
	3	7x30		x			5542FE	20.30			
	none	7x30		x			4506FE	20.21			
	none	7x30			4506UE	20.12					
	none	7x30		x			5506FE	20.20			
	none	7x30			5506UE	20.11					
10	4	7x30			5543UE	20.29					
	4	7x30		x			5543FE	20.30			
	4	7x30		x					5543PE	20.32	
	none	7x30									
12	none	7x30		x			4508FE	20.21			
	none	7x30		x			5508FE	20.20			
	none	7x30			5508UE	20.11					
18	none	7x30			4509UE	20.12					
	none	7x30			5509UE	20.11					
	6	7x30		x			4545FE	20.30			
	6	7x30		x			5545FE	20.30			
20 AWG 0.50 mm <sup>2</sup>	<b>0.90</b>	<b>0.80</b>									
2	9	7x30			5547UE	20.29					
	none	7x28		x			4400FE	20.22			
	none	7x28			4400UE	20.13					
	none	7x28					5400F1	20.28			
	none	7x28		x			5400FE	20.22			
3	none	7x28			5400UE	20.13					
	none	7x28		x			4401FE	20.22			
	1+1/C	7x28		x					5401GE	20.33	
	none	7x28		x			5401FE	20.22			
4	none	7x28			5401UE	20.13					
	none	7x28			4402UE	20.13					
	none	7x28		x			4402FE	20.22			
	2	7x28		x			4441FE	20.31			
	none	7x28		x			5402FE	20.22			
	1+2/C	7x28		x					5402GE	20.33	
	none	7x28			5402UE	20.13					
5	2	7x28		x			5441FE	20.30			
	none	7x28		x			4403FE	20.22			
	none	7x28		x			5403FE	20.22			
6	none	7x28			5403UE	20.13					
	3	7x28		x			5442FE	20.30			
7	none	7x28		x			5405FE	20.22			
	none	7x28			5405UE	20.13					

AWG values are approximate where cables are made to European standards (mm<sup>2</sup>), and vice versa. Where the current reaches upper limits, the varying operation conditions for installation and laying acc. to standards are to be taken into consideration.

### Cable Finder Guide

#### New Generation® Multi-Conductor and Twisted Pair (continued)



No. of Cond.	No. of Pairs	Stranded (mm)	Solid (mm)	Drain Wire	Unshielded		Overall Foil		Individual Foil		
					Part No.	Page	Part No.	Page	Part No.	Page	
<b>20 AWG 0.50 mm<sup>2</sup></b>		<b>0.90</b>	<b>0.80</b>	<i>(continued)</i>							
8	none	7x28			5406UE	20.13					
9	none	7x28		x			5407FE	20.22			
	none	7x28			5407UE	20.13					
10	none	7x28			5408UE	20.13					
12	none	7x28			5409UE	20.13					
	6	7x28		x			4445FE	20.31			
	6	7x28		x			5445FE	20.30			
20	none	7x28			540BUE	20.13					
<b>18 AWG 0.75 mm<sup>2</sup></b>		<b>1.20</b>	<b>1.00</b>								
2	none	7x26		x			4300FE	20.24			
	none	7x26			4300UE	20.15					
	none	7x26					5300F1	20.28			
	none	7x26		x			5300FE	20.23			
	none	7x26			5300U1	20.28					
	none	7x26			5300UE	20.14					
	none	7x26			5300UG	20.10					
	none		solid					5320FJ	20.52		
	none		solid	x				5320FL	20.50		
	none		solid	x				5320FN	20.54		
	none		solid		5320UJ	20.52					
	none		solid		5320UL	20.46					
	none		solid		5320UN	20.54					
	none	20x0.243						SEC0047	20.25		
3	none	7x26		x			4301FE	20.24			
	none	7x26			4301UE	20.15					
	none	7x26		x			5301FE	20.23			
	none	7x26			5301UE	20.14					
	none	20x0.243					SEC0048	20.25			
4	none	7x26		x			4302FE	20.24			
	none	7x26			4302UE	20.15					
	none	7x26		x			5302FE	20.23			
	none	7x26			5302UE	20.14					
	none		solid	x				4320FL	20.50		
	none		solid	x				4322FL	20.50		
	none		solid		4322UL	20.47					
	none		solid					5322FJ	20.52		
	none		solid	x				5322FL	20.50		
	none		solid	x				5322FN	20.54		
	none		solid		5322UL	20.46					
	none		solid		5322UN	20.54					
	1+2/C	7x26		x						5302GE	20.33
	2	7x26				4341UE	20.29				
2	7x26				5341UE	20.29					
2	7x26		x				4341FE	20.31			
2	7x26		x				5341FE	20.31			
none	20x0.243						SEC0049	20.25			
5	none	7x26		x			4303FE	20.24			
	none	7x26			4303UE	20.15					
	none	7x26		x			5303FE	20.23			
	none	7x26			5303UE	20.14					
	none	20x0.243					SEC0050	20.25			
6	none	7x26		x			4304FE	20.24			
	none	7x26			4304UE	20.15					
	none	7x26		x			5304FE	20.23			
	none	7x26			5304UE	20.14					
	none		solid		4324UL	20.47					

AWG values are approximate where cables are made to European standards (mm<sup>2</sup>), and vice versa. Where the current reaches upper limits, the varying operation conditions for installation and laying acc. to standards are to be taken into consideration.

### Cable Finder Guide

#### New Generation® Multi-Conductor and Twisted Pair (continued)



No. of Cond.	No. of Pairs	Stranded (mm)	Solid (mm)	Drain Wire	Unshielded		Overall Foil		Individual Foil	
					Part No.	Page	Part No.	Page	Part No.	Page
<b>18 AWG 0.75 mm<sup>2</sup> 1.20 1.00 (continued)</b>										
6	none		solid		5324UL	20.46				
	3	7x26			5342UE	20.29				
	3	7x26		x			4342FE	20.31		
	3	7x26		x			5342FE	20.31		
7	none	7x26		x			5305FE	20.23		
	none	7x26			5305UE	20.14				
8	none	7x26		x			4306FE	20.24		
	none	7x26			4306UE	20.15				
	none	7x26		x			5306FE	20.23		
	none	7x26			5306UE	20.14				
	none		solid		5326UL	20.46				
	4	7x26			5343UE	20.29				
	4	7x26		x			4343FE	20.31		
9	4	7x26		x			5343FE	20.31		
	none	7x26		x			4307FE	20.24		
	none	7x26		x			5307FE	20.23		
	none	7x26			5307UE	20.14				
10	none	7x26			4308UE	20.15				
	none	7x26			5308UE	20.14				
	none		solid		5328UL	20.46				
12	none	7x26			4309UE	20.15				
	none	7x26			5309UE	20.14				
	none		solid		5329UL	20.46				
	6	7x26			5345UE	20.29				
	6	7x26		x			4345FE	20.31		
	6	7x26		x			5345FE	20.31		
18	9	7x26			5347UE	20.29				
20	none	7x26			5308UE	20.14				
<b>17 AWG 1.00 mm<sup>2</sup> 1.20 1.00</b>										
2	none		solid	x			4K20FX*	20.56		
3	none		solid	x			4K21FX*	20.56		
4	none		solid	x			4K22FX*	20.56		
<b>16 AWG 1.50 mm<sup>2</sup> 1.50 1.30</b>										
2	none	19x29		x			4200FE	20.26		
	none	19x29			4200UE	20.16				
	none		solid	x			4220FL	20.50		
	none		solid		4220UL	20.48				
	none	19x29		x			5200FE	20.26		
	none	19x29			5200UE	20.15				
	none		solid				5220FJ	20.52		
	none		solid	x			5220FL	20.50		
	none		solid	x			5220FN	20.55		
	none		solid			5220UJ	20.52			
	none		solid			5220UL	20.48			
	none		solid			5220UN	20.54			
3	none	19x29		x			4201FE	20.26		
	none	19x29			4201UE	20.16				
	none	19x29		x			5201FE	20.26		
	none	19x29			5201UE	20.15				
4	none	19x29		x			4202FE	20.26		
	none	19x29			4202UE	20.16				
	none		solid		4222UL	20.48				
	none	19x29		x			5202FE	20.26		
	none	19x29			5202UE	20.15				

\* Mica/Glass Fire Barrier, XL Polyolefin FROH and Aluminum/Polyester taped Screen • AWG values are approximate where cables are made to European standards (mm<sup>2</sup>), and vice versa. Where the current reaches upper limits, the varying operation conditions for installation and laying acc. to standards are to be taken into consideration.



### Cable Finder Guide

#### New Generation® Multi-Conductor and Twisted Pair (continued)



No. of Cond.	No. of Pairs	Stranded (mm)	Solid (mm)	Drain Wire	Unshielded		Overall Foil		Individual Foil	
					Part No.	Page	Part No.	Page	Part No.	Page
<b>16 AWG 1.50 mm<sup>2</sup> 1.50 1.30 (continued)</b>										
4	none		solid				5222FJ	20.52		
	none		solid	x			5222FL	20.50		
	none		solid	x			5222FN	20.55		
	none		solid		5222UL	20.48				
	none		solid		5222UN	20.54				
7	none	19x29			5205UE	20.15				
<b>15 AWG 1.65 mm<sup>2</sup> 1.40</b>										
2	none		solid	x			4L20FX*	20.56		
3	none		solid	x			4L21FX*	20.56		
4	none		solid	x			4L22FX*	20.56		
7	none		solid	x			4L25FX*	20.56		
<b>14 AWG 2.50 mm<sup>2</sup> 1.85 1.60</b>										
2	none	19x27		x			4100FE	20.27		
	none	19x27			4100UE	20.16				
	none		solid	x			4120FL	20.51		
	none		solid		4120UL	20.48				
	none	19x27		x			5100FE	20.27		
	none	19x27			5100UE	20.16				
	none		solid				5120FJ	20.53		
	none		solid	x			5120FL	20.51		
	none		solid	x			5120FN	20.55		
	none		solid		5120UL	20.48				
3	none	19x27			4101UE	20.16				
none	19x27		x				5101FE	20.27		
none	19x27				5101UE	20.16				
4	none	19x27			4102UE	20.16				
	none		solid		4122UL	20.48				
	none	19x27			5102UE	20.16				
	none		solid	x			5122FL	20.51		
	none		solid	x			5122FN	20.55		
	none		solid		5122UL	20.48				
<b>13 AWG 2.63 mm<sup>2</sup> 2.10 1.80</b>										
2	none		solid	x			4N20FX*	20.56		
3	none		solid	x			4N21FX*	20.56		
4	none		solid	x			4N22FX*	20.56		
<b>12 AWG 4.00 mm<sup>2</sup> 2.40 2.10</b>										
2	none	19x25		x			4000FE	20.27		
	none	19x25			4000UE	20.17				
	none		solid	x			4020FL	20.51		
	none		solid		4020UL	20.49				
	none	19x25		x			5000FE	20.27		
	none	19x25			5000UE	20.17				
	none		solid				5020FJ	20.53		
	none		solid	x			5020FL	20.51		
	none		solid	x			5020FN	20.55		
3	none	19x25			4001UE	20.17				
none	19x25				5001UE	20.17				

\* Mica/Glass Fire Barrier, XL Polyolefin FROH and Aluminum/Polyester taped Screen

AWG values are approximate where cables are made to European standards (mm<sup>2</sup>), and vice versa.

Where the current reaches upper limits, the varying operation conditions for installation and laying acc. to standards are to be taken into consideration.

# Cable Finder Guide – New Generation® Combination



No. of Cond.	Part No.	Description		Shielding	Component	Page
		Conductor / Gage	mm			
<b>Combination Gages</b>						
3	SEC0001	2 cdr - 26 AWG 1 co - 21 AWG	0.50 0.41	Unshielded Alu + 72% BC Braid	1xData 1xCoax	20.40
	SEC0003	2 cdr - 20 AWG 1 co - 26 AWG	1.00 0.41	Unshielded Alu + 72% BC Braid	1xData 1xCoax	20.40
	439945	1 pr - 18 AWG 1 co - 18 AWG	1.22 1.02	Unshielded 95% BC Braid	2xData 1xCoax	20.39
	449945	1 pr - 18 AWG 1 co - 20 AWG	1.22 0.80	Unshielded 95% BC Braid	2xData 1xCoax	20.39
	539945	1 pr - 18 AWG 1 co - 18 AWG	1.22 1.02	Unshielded 95% BC Braid	2xData 1xCoax	20.39
	549945	1 pr - 18 AWG 1 co - 20 AWG	1.22 0.80	Unshielded 95% BC Braid	2xData 1xCoax	20.39
5	SEC0002	1 co - 20 AWG 2 cdr - 16 AWG 2 cdr - 26 AWG	0.81 1.50 0.50	Alu + 55% TC Braid Unshielded Unshielded	1xCoax 1xData 1xControl	20.40
	SEC0004	1 co - 26 AWG 2 cdr - 24 AWG 2 cdr - 26 AWG	0.41 0.22 0.50	Alu + 72% TC Braid Unshielded Unshielded	1xCoax 1xData 1xControl	20.40
	500PTZ	1 co - 20 AWG 1 pr - 23 AWG 2 cdr - 18 AWG	0.81 0.57 1.22	95% BC Braid Unshielded Unshielded	Video Control Power	20.44
	501PTZ	1 co - 20 AWG 1 pr - 22 AWG 2 cdr - 18 AWG	0.81 0.76 1.22	95% BC Braid Beldfoil® Unshielded	Video Control Power	20.44
	502PTZ	1 co - 20 AWG 1 pr - 18 AWG 2 cdr - 18 AWG	0.81 1.24 1.22	95% BC Braid Beldfoil® Unshielded	Video Control Power	20.44
6	5284UE	2 pr - 23 AWG 2 cdr - 16 AWG	0.60 1.47	Unshielded Unshielded	1xData 2xPower	20.41
	5284US	2 pr - 24 AWG 2 cdr - 16 AWG	0.50 1.47	Unshielded Unshielded	1xData 2xPower	20.41
8	SEC0006	2 cdr - 16 AWG 3 pr - 28 AWG	1.50 0.35	Unshielded Unshielded	Power Control	20.43
10	5288US	4 pr - 24 AWG 2 cdr - 16 AWG	0.50 1.47	Unshielded Unshielded	1xData 2xPower	20.41
13	SEC0005	1 co - 23 AWG 3 cdr - 20 AWG 9 cdr - 22 AWG	0.58 1.00 0.75	55% TC Braid Unshielded Unshielded	Coax Power Control	20.43
15	SEC0007	1 co - 21 AWG 2 cdr - 22 AWG 6 cdr - 26 AWG 3 pr - 28 AWG	0.75 0.75 0.50 0.35	80% BC Braid Unshielded Unshielded Unshielded	Coax Power Data Control	20.43
16	558AFS	4 cdr - 18 AWG 3 pr - 22 AWG 2 cdr - 22 AWG 4 cdr - 22 AWG	1.22 0.76 0.76 0.76	Overall Beldfoil® Overall Beldfoil® Overall Beldfoil® Overall Beldfoil®	Lock Power Card Reader Door Contact Rex/Spare	20.45

co = Coax • cdr = Conductor(s) • pr = Pair

Halar® is a Solvay Solexis trademark.  
Teflon® is a DuPont trademark.

## How to Interpret a Catalog Number

Can be used with part numbers starting with 4 or 5.

### Standard Multi-Conductor, Paired, Fire Alarm, Combination Gage Cables:

5 3 0 0 U E

**Location**  
 5 = Non-plenum  
 6 = Plenum  
 4 = LSNH

**Gage**  
 E = 8/8.4 mm<sup>2</sup> (solid)  
 T = 10/5.3 mm<sup>2</sup> (solid)  
 0 = 12/3.3 mm<sup>2</sup> (solid)/3.6 mm<sup>2</sup> (stranded)  
 1 = 14/2.1 mm<sup>2</sup>/2.2 mm<sup>2</sup>  
 2 = 16/1.3 mm<sup>2</sup>/1.4 mm<sup>2</sup>  
 3 = 18/0.82 mm<sup>2</sup>/0.90 mm<sup>2</sup>  
 4 = 20/0.52 mm<sup>2</sup>/0.56 mm<sup>2</sup>  
 5 = 22/0.33mm<sup>2</sup>/0.36 mm<sup>2</sup>  
 6 = 24/0.21 mm<sup>2</sup>/0.23 mm<sup>2</sup>  
 K = 1.0 mm<sup>2</sup>  
 L = 1.5 mm<sup>2</sup>  
 M = 2.0 mm<sup>2</sup>  
 N = 2.5 mm<sup>2</sup>

**Type of Conductor**  
 0 = Stranded multi-conductor  
 2 = Solid multi-conductor  
 4 = Stranded paired conductor  
 6 = Solid paired conductor  
 8 = Composite Cable

**Number of Conductors**  
 0 = 2 conductors  
 1 = 3 conductors or 2 pairs  
 2 = 4 conductors or 3 pairs  
 3 = 5 conductors or 4 pairs  
 4 = 6 conductors  
 5 = 7 conductors or 6 pairs  
 6 = 8 conductors  
 7 = 9 conductors or 9 pairs  
 8 = 10 conductors or 12 pairs  
 9 = 12 conductors  
 A = 16 conductors  
 B = 20 conductors

**Shielding**  
 C = Foil plus 85% braid, overall (m/c, pairs)  
 F = Overall foil w/drain (m/c or multipair)  
 G = One foil shielded pair w/drain (m/c, pair(s) combo)  
 H = SPOS – shielded pairs and O/A foil shield  
 P = Individual shielded pairs with drain (multipairs)  
 U = Unshielded (m/c, pairs)

**Application**  
 1 = Water-blocked multi-conductor  
 A = FEP Insulation/Teflon® jacket, plenum cable  
 C = Halar® jacket, plenum cable  
 E = Power-limited communication cable, high-capacitance  
 G = Non-riser rated, may be un-cabled  
 J = Power-limited fire protective, mid-capacitance  
 K = Fire Alarm, Halar®/Flamarrest®, mid-capacitance  
 L = Power-limited fire protective, high-capacitance  
 N = PVC/Nylon Insulation, NPLF rated  
 P = High Strand Audio  
 Q = Residential Audio  
 S = Spline  
 X = Circuit Integrity, IEC 331

# Security Multi-Conductor Cables

Residential, Light Commercial and Institutional Applications



De- scription	Part No.	UL NEC/ C(UL)CEC Type IEC	Standard Lengths		Standard Unit Weight		Conductor (Stranding) Diameter Nom. DCR	Nominal Insulation OD		Shielding Material Nom. DCR	Nominal OD		Color Code
			ft.	m	lbs.	kg		inch	mm		inch	mm	

**22 AWG • Stranded (7x30) 0.8 mm Bare Copper • Numbered and Color Coded • Conductors may not be Cabled**

**Polypropylene Insulation • PVC Jacket** (Beige, Brown, Orange, Yellow, Green, Blue, Violet, Grey and Natural)

300V 75°C	NEC: CM CEC: CM FT1						0.76 mm 22 AWG (7x30) BC	0.045	1.14	Unshielded			
--------------	------------------------------	--	--	--	--	--	--------------------------------	-------	------	------------	--	--	--



<b>5500UG</b>	2 CDR	C-500	C-152	3.5	1.6						0.114	2.90	Black, Red	
		U-500	U-152	5.1	2.3									
		C-1000	C-305	7.1	3.2									
		U-1000	U-305	9.0	4.1									

U-305 m put-up available in Brown, Grey or Natural only.

<b>5502UG</b>	4 CDR	U-500	U-152	7.5	3.4						0.131	3.33	Black, Red, White, Green
		U-1000	U-305	14.1	6.4								

U-152 m put-up available in Grey or White only.

**18 AWG • Stranded (7x26) 1.2 mm Bare Copper • Numbered and Color Coded • Conductors may not be Cabled**

**Polypropylene Insulation • PVC Jacket** (Beige, Brown, Orange, Yellow, Green, Blue, Violet, Grey and Natural)

300V 75°C	<b>5300UG</b>	NEC: CM CEC: CM FT1	C-500	C-152	7.5	3.4	1.22 mm 18 AWG (7x26) BC	0.063	1.60	Unshielded	0.148	3.76	Black, Red
--------------	---------------	------------------------------	-------	-------	-----	-----	--------------------------------	-------	------	------------	-------	------	------------



Available in Grey, Black or Natural only.

2 CDR

BC = Bare Copper • DCR = DC resistance

# Security and Alarm Cables

## Commercial Applications Unshielded



De- scription	Part No.	UL NEC/ C(UL)/CEC Type IEC	Standard Lengths		Standard Unit Weight		Conductor (Stranding) Diameter Nom. DCR	Nominal Insulation OD		Shielding Material Nom. DCR	Nominal OD		Color Code
			ft.	m	lbs.	kg		inch	mm		inch	mm	

**22 AWG • Stranded (7x30) 0.8 mm Bare Copper • Numbered and Color Coded • Rip Cord**

**PVC Insulation • Grey PVC Jacket**

300V  
75°C  
NEC:  
CMR  
CEC:  
CMF FT4  
0.76 mm  
22 AWG  
(7x30) BC  
0.040  
1.01  
Unshielded  
see chart below

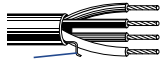

Rip Cord

<b>5500UE</b>	2 CDR	C-500	C-152	4.0	1.8	0.128	3.25						
		U-500	U-152	5.5	2.5								
		500	152	5.5	2.5								
		C-1000	C-305	7.9	3.6								
		U-1000	U-305	9.9	4.5								
1000	305	9.0	4.1										
<b>5501UE</b>	3 CDR	U-1000	U-305	13.0	5.9	0.135	3.43						
		1000	305	13.0	5.9								
		<b>5502UE</b>	4 CDR	C-500	C-152			7.5	3.4	0.148	3.76		
U-500	U-152	9.0		4.1									
U-1000	U-305	16.1		7.3									
1000	305	16.1		7.3									
<b>5503UE</b>	5 CDR	U-1000		U-305	20.1	9.1	0.162	4.11					
1000		305	20.1	9.1									
<b>5504UE</b>	6 CDR	C-500	C-152	12.6	5.7	0.177	4.50						
		U-500	U-152	14.1	6.4								
		500	152	13.4	6.1								
		U-1000	U-305	27.1	12.3								
		1000	305	27.1	12.3								
Also available in White.													
<b>5506UE</b>	8 CDR	U-1000	U-305	29.1	13.2	0.192	4.88						
		1000	305	30.0	13.6								
<b>5508UE</b>	10 CDR	U-1000	U-152	35.9	16.3	0.226	5.74						
		1000	305	41.0	18.6								
<b>5509UE</b>	12 CDR	U-500	U-152	21.6	9.8	0.233	5.92						
		U-1000	U-305	42.1	19.1								
		1000	305	47.2	21.4								

BC = Bare Copper • DCR = DC resistance

**Color Code**

Cond. No.	Color	Cond. No.	Color
1	Black	7	Orange
2	Red	8	Yellow
3	White	9	Purple
4	Green	10	Grey
5	Brown	11	Pink
6	Blue	12	Tan

# Security and Alarm Cables

## Commercial Applications Unshielded



De- scription	Part No.	UL NEC/ C(UL)CEC Type IEC	Standard Lengths		Standard Unit Weight		Conductor (Stranding) Diameter Nom. DCR	Nominal Insulation OD		Shielding Material Nom. DCR	Nominal OD		Color Code
			ft.	m	lbs.	kg		inch	mm		inch	mm	

**22 AWG • Stranded (7x30) 0.8 mm Bare Copper • Numbered and Color Coded • Rip Cord**

**Polyethylene Insulation • Grey FRNC/LSNH Jacket**

300V IEC 60754-2 0.76 mm 0.049 1.25 Unshielded see chart below  
 70°C 22 AWG  
 (7x30) BC

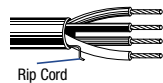

<b>4500UE</b>	2 CDR	328 1640	100 500	3.1 15.4	1.4 7.0						0.130	3.30	
<b>4501UE</b>	3 CDR	328 1640	100 500	3.1 15.4	1.4 7.0						0.130	3.30	
<b>4502UE</b>	4 CDR	328 1640	100 500	5.3 26.0	2.4 11.8						0.154	3.90	
<b>4504UE</b>	6 CDR	328 1640	100 500	7.3 36.2	3.3 16.4						0.177	4.50	
<b>4506UE</b>	8 CDR	328 1640	100 500	8.8 43.7	4.0 19.8						0.193	4.90	
<b>4509UE</b>	12 CDR	328 1640	100 500	13.4 66.8	6.1 30.3						0.232	5.90	

BC = Bare Copper • DCR = DC resistance

### Color Code

Cond. No.	Color
1	Black
2	Red
3	White
4	Green
5	Brown
6	Blue

Cond. No.	Color
7	Orange
8	Yellow
9	Purple
10	Grey
11	Pink
12	Tan

# Security and Alarm Cables

## Commercial Applications Unshielded



De- scription	Part No.	UL NEC / C(UL)/CEC Type IEC	Standard Lengths		Standard Unit Weight		Conductor (Stranding) Diameter Nom. DCR	Nominal Insulation OD		Shielding Material Nom. DCR	Nominal OD		Color Code
			ft.	m	lbs.	kg		inch	mm		inch	mm	

**20 AWG • Stranded (7x28) 1.0 mm Bare Copper • Numbered and Color Coded PVC Jackets • Rip Cord**

**PVC Insulation • Grey PVC Jacket**

300V  
75°C  
NEC:  
CMR  
CEC:  
CMF FT4  
0.96 mm  
20 AWG  
(7x28) BC  
0.048 1.21 Unshielded see chart below

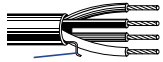

Rip Cord

<b>5400UE</b>	2 CDR	C-500 U-1000 1000	C-152 U-305 305	6.0 13.0 13.0	2.7 5.9 5.9						0.142	3.61	
<b>5401UE</b>	3 CDR	500 U-1000 1000	152 U-305 305	9.0 18.1 18.1	4.1 8.2 8.2						0.150	3.81	
<b>5402UE</b>	4 CDR	C-500 U-1000 1000	C-152 U-305 305	10.6 23.1 23.1	4.8 10.5 10.5						0.165	4.19	
<b>5403UE</b>	5 CDR	U-1000 1000	U-305 305	26.9 28.0	12.2 12.7						0.181	4.60	
<b>5405UE</b>	7 CDR	500 1000	152 305	19.0 40.1	8.6 18.2						0.198	5.03	
<b>5406UE</b>	8 CDR	U-1000 1000	U-305 305	41.0 43.0	18.6 19.5						0.215	5.46	
<b>5407UE</b>	9 CDR	1000	305	48.1	21.8						0.233	5.92	
<b>5408UE</b>	10 CDR	1000	305	53.1	24.1						0.254	6.45	
<b>5409UE</b>	12 CDR	1000	305	61.9	28.1						0.262	6.65	
<b>5408UE</b>	20 CDR	1000	305	110.0	49.9						0.347	8.81	

**Polyethylene Insulation • Grey FRNC/LSNH Jacket**

300V  
75°C  
IEC 60754-2  
0.96 mm  
20 AWG  
(7x28) BC  
0.057 1.45 Unshielded see chart below



Rip Cord

<b>4400UE</b>	2 CDR	328 1640	100 500	3.7 18.7	1.7 8.5						0.142	3.60	
<b>4402UE</b>	4 CDR	328 1640	100 500	6.4 31.7	2.9 14.4						0.165	4.20	

BC = Bare Copper • DCR = DC resistance

**Color Code**

Cond. No.	Color
1	Black
2	Red
3	White
4	Green
5	Brown
6	Blue
7	Orange
8	Yellow
9	Purple
10	Grey

Cond. No.	Color
11	Pink
12	Tan
13	White/Black
14	White/Red
15	White/Green
16	White/Orange
17	White/Blue
18	White/Brown
19	White/Yellow
20	White/Purple

# Security and Alarm Cables

## Commercial Applications Unshielded



De- scription	Part No.	UL NEC/ C(UL)CEC Type IEC	Standard Lengths		Standard Unit Weight		Conductor (Stranding) Diameter Nom. DCR	Nominal Insulation OD		Shielding Material Nom. DCR	Nominal OD		Color Code
			ft.	m	lbs.	kg		inch	mm		inch	mm	

**18 AWG • Stranded (7x26) 1.2 mm Bare Copper • Numbered and Color Coded • Rip Cord**

**PVC Insulation • Grey PVC Jacket**

300V  
75°C  
NEC:  
CMR  
CEC:  
CMG FT4  
1.22 mm  
18 AWG  
(7x26) BC  
0.058 1.47 Unshielded see chart below

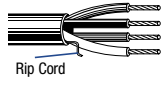

<b>5300UE</b>	2 CDR	C-500 U-500 500 U-1000 1000	C-152 U-152 152 U-305 305	8.6 9.5 9.5 17.0 18.1	3.9 4.3 4.3 7.7 8.2						0.161	4.09	
Also available in White or Black.													
<b>5301UE</b>	3 CDR	500 U-1000 1000	152 U-305 305	12.6 24.9 24.9	5.7 11.3 11.3						0.171	4.34	
<b>5302UE</b>	4 CDR	C-250 U-500 500 U-1000 1000	C-76 U-152 152 U-305 305	7.5 16.5 16.1 32.0 32.0	3.4 7.5 7.3 14.5 14.5						0.188	4.78	
<b>5303UE</b>	5 CDR	500 U-1000 1000	152 U-305 305	20.5 39.0 39.0	9.3 17.7 17.7						0.207	5.26	
<b>5304UE</b>	6 CDR	500 U-1000 1000	152 U-305 305	26.0 51.1 52.0	11.8 23.2 23.6						0.226	5.74	
<b>5305UE</b>	7 CDR	U-1000 1000	U-305 305	51.1 52.0	23.2 23.6						0.226	5.74	
<b>5306UE</b>	8 CDR	500 1000	152 305	30.0 59.1	13.6 26.8						0.248	6.30	
<b>5307UE</b>	9 CDR	1000	305	66.1	30.0						0.269	6.83	
<b>5308UE</b>	10 CDR	500 1000	152 305	38.6 74.1	17.5 33.6						0.294	7.47	
<b>5309UE</b>	12 CDR	500 1000	152 305	47.6 90.2	21.6 40.9						0.314	7.98	
<b>530BUE</b>	20 CDR	1000	305	152.1	69.0						0.400	10.16	

BC = Bare Copper • DCR = DC resistance

**Color Code**

Cond. No.	Color
1	Black
2	Red
3	White
4	Green
5	Brown
6	Blue
7	Orange
8	Yellow
9	Purple
10	Grey

Cond. No.	Color
11	Pink
12	Tan
13	White/Black
14	White/Red
15	White/Green
16	White/Orange
17	White/Blue
18	White/Brown
19	White/Yellow
20	White/Purple

# Security and Alarm Cables

## Commercial Applications Unshielded



De- scription	Part No.	UL NEC / C(UL)/CEC Type IEC	Standard Lengths		Standard Unit Weight		Conductor (Stranding) Diameter Nom. DCR	Nominal Insulation OD		Shielding Material Nom. DCR	Nominal OD		Color Code
			ft.	m	lbs.	kg		inch	mm		inch	mm	

**18 AWG • Stranded (7x26) 1.2 mm Bare Copper • Numbered and Color Coded • Rip Cord**

**Polyethylene Insulation • Grey FRNC/LSNH Jacket**

300V 70°C	IEC 60754-2						1.22 mm 18 AWG (7x26) BC	0.068	1.72	Unshielded		see chart below	
--------------	-------------	--	--	--	--	--	--------------------------------	-------	------	------------	--	-----------------	--

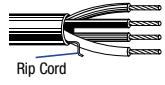

<b>4300UE</b>	2 CDR	328 1640	100 500	6.0 29.3	2.7 13.3						0.161	4.10	
<b>4301UE</b>	3 CDR	328 1640	100 500	7.7 38.4	3.5 17.4						0.161	4.10	
<b>4302UE</b>	4 CDR	328 1640	100 500	10.1 50.7	4.6 23.0						0.189	4.80	
<b>4303UE</b>	5 CDR	328 1640	100 500	12.1 60.4	5.5 27.4						0.209	5.30	
<b>4304UE</b>	6 CDR	328 1640	100 500	15.0 74.5	6.8 33.8						0.224	5.70	
<b>4306UE</b>	8 CDR	328 1640	100 500	18.5 92.6	8.4 42.0						0.248	6.30	
<b>4308UE</b>	10 CDR	328 1640	100 500	22.9 114.9	10.4 52.1						0.295	7.50	
<b>4309UE</b>	12 CDR	328 1640	100 500	27.1 135.8	12.3 61.6						0.315	8.00	

**16 AWG • Stranded (19x29) 1.5 mm Bare Copper • Numbered and Color Coded • Rip Cord**

**PVC Insulation • Grey PVC Jacket**

300V 75°C	NEC: CMR CEC: CMG FT4						1.47 mm 16 AWG (19x29) BC	0.068	1.72	Unshielded		see chart below	
--------------	--------------------------------	--	--	--	--	--	---------------------------------	-------	------	------------	--	-----------------	--

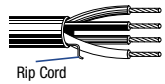

<b>5200UE</b>	2 CDR	C-500 U-500 500 U-1000 1000	C-152 U-152 152 U-305 305	11.5 13.0 12.6 24.0 25.1	5.2 5.9 5.7 10.9 11.4						0.184	4.67	
<b>5201UE</b>	3 CDR	U-500 500 U-1000 1000	U-152 152 U-305 305	18.5 18.1 35.1 38.1	8.4 8.2 15.9 17.3						0.196	4.98	
<b>5202UE</b>	4 CDR	U-500 500 U-1000 1000	U-152 152 U-305 305	23.6 22.9 45.0 47.0	10.7 10.4 20.4 21.3						0.216	5.49	
<b>5205UE</b>	7 CDR	1000	305	77.2	35.0						0.261	6.63	

BC = Bare Copper • DCR = DC resistance

**Color Code**

Cond. No.	Color	Cond. No.	Color	Cond. No.	Color
1	Black	5	Brown	9	Purple
2	Red	6	Blue	10	Grey
3	White	7	Orange	11	Pink
4	Green	8	Yellow	12	Tan





# Security and Alarm Cables

## Commercial Applications Unshielded



De- scription	Part No.	UL NEC/ C(UL)CEC Type IEC	Standard Lengths		Standard Unit Weight		Conductor (Stranding) Diameter Nom. DCR	Nominal Insulation OD		Shielding Material Nom. DCR	Nominal OD		Color Code
			ft.	m	lbs.	kg		inch	mm		inch	mm	

**16 AWG • Stranded (19x29) 1.5 mm Bare Copper • Numbered and Color Coded • Rip Cord**

**Polyethylene Insulation • Grey FRNC/LSNH Jacket**

300V  
70°C IEC 60754-2 1.47 mm  
16 AWG  
(19x29) BC 0.077 1.95 Unshielded

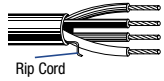

Rip Cord

<b>4200UE</b>	2 CDR	328 1640	100 500	7.5 37.3	3.4 16.9						0.185	4.70	Black, White
<b>4201UE</b>	3 CDR	328 1640	100 500	9.9 49.8	4.5 22.6						0.197	5.00	Black, White, Red
<b>4202UE</b>	4 CDR	328 1640	100 500	13.2 65.7	6.0 29.8						0.217	5.50	Black, White, Red, Green

**14 AWG • Stranded (19x27) 1.9 mm Bare Copper • Numbered and Color Coded • Rip Cord**

**Polyethylene Insulation • Grey PVC Jacket**

300V  
75°C NEC:  
CMR  
FPLR  
CL3R 1.85 mm  
14 AWG  
(19x27) BC 0.087 2.21 Unshielded

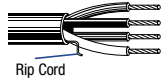

Rip Cord

<b>5100UE</b>	2 CDR	500 U-1000 1000	152 U-305 305	20.1 37.9 40.1	9.1 17.2 18.2						0.234	5.94	Black, White
Also available in Red for fire alarm (FPLR).													
<b>5101UE</b>	3 CDR	1000	305	56.2	25.5						0.249	6.32	Black, White, Red
<b>5102UE</b>	4 CDR	500 1000	152 305	38.6 73.2	17.5 33.2						0.276	7.01	Black, White, Red, Green

**Polyethylene Insulation • Grey FRNC/LSNH Jacket**

300V  
70°C IEC 60754-2 1.85 mm  
14 AWG  
(19x27) BC 0.099 2.52 Unshielded

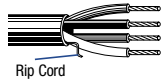

Rip Cord

<b>4100UE</b>	2 CDR	328 1640	100 500	11.5 57.8	5.2 26.2						0.232	5.90	Black, White
<b>4101UE</b>	3 CDR	328 1640	100 500	15.4 76.9	7.0 34.9						0.248	6.30	Black, White, Red
<b>4102UE</b>	4 CDR	328 1640	100 500	20.5 103.0	9.3 46.7						0.276	7.00	Black, White, Red, Green

BC = Bare Copper • DCR = DC resistance

# Security and Alarm Cables

## Commercial Applications Unshielded



De-scription	Part No.	UL NEC / C(UL)/CEC Type IEC	Standard Lengths		Standard Unit Weight		Conductor (Stranding) Diameter Nom. DCR	Nominal Insulation OD		Shielding Material Nom. DCR	Nominal OD		Color Code
			ft.	m	lbs.	kg		inch	mm		inch	mm	

**12 AWG • Stranded (19x25) 2.4 mm Bare Copper • Numbered and Color Coded • Rip Cord**

**Polyethylene Insulation • Grey PVC Jacket**

300V 75°C	NEC: CL3R						2.36 mm 12 AWG (19x25) BC	0.107	2.72	Unshielded			
--------------	--------------	--	--	--	--	--	---------------------------------	-------	------	------------	--	--	--

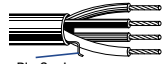

Rip Cord

<b>5000UE</b>	2 CDR	500	152	29.1	13.2						0.268	6.81	Black, White
		1000	305	57.1	25.9								

Also available in Red for fire alarm (FPLR).

<b>5001UE</b>	3 CDR	1000	305	82.2	37.3						0.286	7.26	Black, White, Red
---------------	-------	------	-----	------	------	--	--	--	--	--	-------	------	-------------------

**Polyethylene Insulation • Grey FRNC/LSNH Jacket**

300V 75°C	IEC 60754-2						2.36 mm 12 AWG (19x25) BC	0.118	3.00	Unshielded			
--------------	-------------	--	--	--	--	--	---------------------------------	-------	------	------------	--	--	--

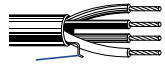

Rip Cord

<b>4000UE</b>	2 CDR	328	100	16.5	7.5						0.268	6.80	Black, White
		1640	500	83.1	37.7								

<b>4001UE</b>	3 CDR	1640	500	375.2	170.2						0.287	7.30	Black, White, Red
---------------	-------	------	-----	-------	-------	--	--	--	--	--	-------	------	-------------------

BC = Bare Copper • DCR = DC resistance

# Security and Alarm Cables

## Commercial Applications Shielded



De- scription	Part No.	UL NEC/ C(UL)CEC Type IEC	Standard Lengths		Standard Unit Weight		Conductor (Stranding) Diameter Nom. DCR	Nominal Insulation OD		Shielding Material Nom. DCR	Nominal OD		Color Code
			ft.	m	lbs.	kg		inch	mm		inch	mm	

**24 AWG • Stranded (7x32) 0.6 mm Bare Copper • Beldfoil® Shield • 24 AWG Tinned Copper Drain Wire • Numbered and Color Coded**

**PVC Insulation • Grey PVC Jacket**

300V 75°C	<b>5600FE</b>	NEC: CMR CEC: CMG FT4	U-1000 1000	U-305 305	11.0 9.9	5.0 4.5	0.61 mm 24 AWG (7x32) BC	0.034	0.86	Overall Beldfoil® + Drain Wire (24 AWG TC)	0.120	3.05	see chart 12 (Tech Info Section)
--------------	---------------	--------------------------------	----------------	--------------	-------------	------------	--------------------------------	-------	------	---	-------	------	-------------------------------------

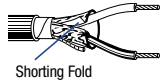

Shorting Fold

2 CDR

De- scription	Part No.	No. of Cond. (CDR)	Standard Lengths		Standard Unit Weight		Conductor (Stranding) Diameter Nom. DCR	Nominal Conductor OD		Shielding Material Nom. DCR	Nominal OD		Application
			ft.	m	lbs.	kg		AWG	Section mm <sup>2</sup>		inch	mm	

**24 AWG • Stranded (7x0.193) 0.6 mm Bare Copper • Overall Alufoil • Color Coded**

**PVC Insulation • White Flame-Resistant PVC Jacket (Color Code: see chart 11, Tech Info Section)**

500V 70°C										Overall Alufoil			- Alarm systems - Antitrust systems - Smoke survey - Fire survey - Industrial checks
--------------	--	--	--	--	--	--	--	--	--	--------------------	--	--	--



LiY (St) Y

<b>SEC0008</b>	2	328	100	39.7	18.0	(7x0.193) BC	24	0.22			0.150	3.80	
<b>SEC0009</b>	4	328	100	61.7	28.0	(7x0.193) BC	24	0.22			0.165	4.20	
<b>SEC0010</b>	6	328	100	75.0	34.0	(7x0.193) BC	24	0.22			0.181	4.60	
<b>SEC0011</b>	8	328	100	97.0	44.0	(7x0.193) BC	24	0.22			0.209	5.30	
<b>SEC0012</b>	10	328	100	114.6	52.0	(7x0.193) BC	24	0.22			0.228	5.80	
<b>SEC0013</b>	12	328	100	136.7	62.0	(7x0.193) BC	24	0.22			0.240	6.10	
<b>SEC0014</b>	16	328	100	160.9	73.0	(7x0.193) BC	24	0.22			0.276	7.00	
<b>SEC0015</b>	2/2	328	100	83.8	38.0	(7x0.193) BC	24	0.22 + 0.50			0.193	4.90	
<b>SEC0016</b>	4/2	328	100	97.0	44.0	(7x0.193) BC	24	0.22 + 0.50			0.205	5.20	
<b>SEC0017</b>	6/2	328	100	114.6	52.0	(7x0.193) BC	24	0.22 + 0.50			0.232	5.90	
<b>SEC0018</b>	8/2	328	100	141.1	64.0	(7x0.193) BC	24	0.22 + 0.50			0.256	6.50	
<b>SEC0019</b>	10/2	328	100	158.7	72.0	(7x0.193) BC	24	0.22 + 0.50			0.264	6.70	
<b>SEC0020</b>	12/2	328	100	172.0	78.0	(7x0.193) BC	24	0.22 + 0.50			0.272	6.90	
<b>SEC0021</b>	2/2	328	100	97.0	44.0	(7x0.193) BC	24	0.22 + 0.75			0.205	5.20	
<b>SEC0022</b>	4/2	328	100	114.6	52.0	(7x0.193) BC	24	0.22 + 0.75			0.220	5.60	
<b>SEC0023</b>	6/2	328	100	132.3	60.0	(7x0.193) BC	24	0.22 + 0.75			0.244	6.20	
<b>SEC0024</b>	8/2	328	100	143.3	65.0	(7x0.193) BC	24	0.22 + 0.75			0.252	6.40	
<b>SEC0025</b>	10/2	328	100	158.7	72.0	(7x0.193) BC	24	0.22 + 0.75			0.264	6.70	
<b>SEC0026</b>	12/2	328	100	174.2	79.0	(7x0.193) BC	24	0.22 + 0.75			0.283	7.20	

TC = Tinned Copper • BC = Bare Copper • DCR = DC resistance

# Security and Alarm Cables

## Commercial Applications Shielded



De- scription	Part No.	No. of Pairs	Standard Lengths		Standard Unit Weight		Conductor (Stranding) Diameter Nom. DCR	Nominal Conductor OD		Shielding Material Nom. DCR	Nominal OD		Application
			ft.	m	lbs.	kg		AWG	Section mm <sup>2</sup>		inch	mm	

**24 AWG • Stranded (7x0.193) 0.6 mm Bare Copper • Mylar® Tape • Overall Alufoil • Color Coded**

**Thermoplastic M9 Insulation • White FRNC/LSNH Jacket** (Color Code: see chart below)

60/90V  
70°C

Overall  
Alufoil

- Cables for anti-theft installations
- Cables for detection of smokes and fires
- To be used in public areas  
(like banks, hospitals, big stores, hotels, theaters)



LiH (St) H

SEC0027	1	328	100	41.9	19.0	(7x0.193) BC	24	0.22	0.157	4.00
SEC0028	2	328	100	66.1	30.0	(7x0.193) BC	24	0.22	0.217	5.50
SEC0029	3	328	100	83.8	38.0	(7x0.193) BC	24	0.22	0.228	5.80
SEC0030	4	328	100	105.8	48.0	(7x0.193) BC	24	0.22	0.260	6.60
SEC0031	5	328	100	132.3	60.0	(7x0.193) BC	24	0.22	0.295	7.50
SEC0032	6	328	100	149.9	68.0	(7x0.193) BC	24	0.22	0.307	7.80
SEC0033	7	328	100	169.8	77.0	(7x0.193) BC	24	0.22	0.319	8.10
SEC0034	8	328	100	194.0	88.0	(7x0.193) BC	24	0.22	0.362	9.20
SEC0035	10	328	100	231.5	105.0	(7x0.193) BC	24	0.22	0.382	9.70
SEC0036	11	328	100	269.0	122.0	(7x0.193) BC	24	0.22	0.406	10.30
SEC0037	1/1	328	100	158.7	72.0	(7x0.193) BC	24	0.22 + 0.50	0.264	6.70
SEC0038	2/1	328	100	172.0	78.0	(7x0.193) BC	24	0.22 + 0.50	0.272	6.90
SEC0039	3/1	328	100	97.0	44.0	(7x0.193) BC	24	0.22 + 0.50	0.205	5.20
SEC0040	4/1	328	100	114.6	52.0	(7x0.193) BC	24	0.22 + 0.50	0.220	5.60
SEC0041	5/1	328	100	132.3	60.0	(7x0.193) BC	24	0.22 + 0.50	0.244	6.20
SEC0042	1/1	328	100	97.0	44.0	(7x0.193) BC	24	0.22 + 0.75	0.260	6.60
SEC0043	2/1	328	100	119.0	54.0	(7x0.193) BC	24	0.22 + 0.75	0.283	7.20
SEC0044	3/1	328	100	145.5	66.0	(7x0.193) BC	24	0.22 + 0.75	0.307	7.80
SEC0045	4/1	328	100	158.7	72.0	(7x0.193) BC	24	0.22 + 0.75	0.323	8.20
SEC0046	5/1	328	100	172.0	78.0	(7x0.193) BC	24	0.22 + 0.75	0.331	8.40

BC = Bare Copper • DCR = DC resistance

Mylar® is a DuPont trademark.

### Color Code

Pair No.	Color
1	Red, Black
2	White/Blue, Blue
3	White/Orange, Orange
4	White/Green, Green
5	White/Brown, Brown
6	White/Grey, Grey
7	Red/Blue, Blue
8	Red/Orange, Orange
9	Red/Green, Green
10	Red/Brown, Brown
11	Red/Grey, Grey

Pair No.	Color
12	Black/Blue, Blue
13	Black/Orange, Orange
14	Black/Green, Green
15	Black/Brown, Brown
16	Black/Grey, Grey
17	Violet/Blue, Blue
18	Violet/Orange, Orange
19	Violet/Green, Green
20	Violet/Brown, Brown
21	Violet/Grey, Grey

# Security and Alarm Cables

## Commercial Applications Shielded



De- scription	Part No.	UL NEC/ C(UL)CEC Type IEC	Standard Lengths		Standard Unit Weight		Conductor (Stranding) Diameter Nom. DCR	Nominal Insulation OD		Shielding Material Nom. DCR	Nominal OD		Color Code
			ft.	m	lbs.	kg		inch	mm		inch	mm	

**22 AWG • Stranded (7x30) 0.8 mm Bare Copper • Beldfoil® Shield • 24 AWG Tinned Copper Drain Wire • Numbered and Color Coded**

**PVC Insulation • Grey PVC Jacket**

300V 75°C	NEC: CMR CEC: CMG FT4						0.76 mm 22 AWG (7x30) BC	0.040	1.01	Overall Beldfoil® + Drain Wire (24 AWG TC)		see chart below	
--------------	--------------------------------	--	--	--	--	--	--------------------------------	-------	------	---	--	-----------------	--

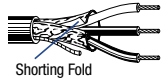

<b>5500FE</b>	2 CDR	C-500	C-152	5.5	2.5						0.130	3.30	
		U-500	U-152	6.6	3.0								
		500	152	6.6	3.0								
		U-1000	U-305	11.9	5.4								
		1000	305	11.9	5.4								
<b>5501FE</b>	3 CDR	C-500	C-152	7.1	3.2						0.138	3.51	
		U-500	U-152	7.9	3.6								
		500	152	7.5	3.4								
		U-1000	U-305	15.0	6.8								
		1000	305	15.0	6.8								
<b>5502FE</b>	4 CDR	C-500	C-152	8.6	3.9						0.152	3.86	
		U-500	U-152	9.5	4.3								
		500	152	9.5	4.3								
		U-1000	U-305	18.1	8.2								
		1000	305	18.1	8.2								
<b>5503FE</b>	5 CDR	1000	305	22.0	10.0						0.165	4.19	
<b>5504FE</b>	6 CDR	C-500	C-152	13.4	6.1						0.179	4.55	
		U-500	U-152	15.0	6.8								
		U-1000	U-305	29.1	13.2								
		1000	305	29.1	13.2								
<b>5506FE</b>	8 CDR	U-500	U-152	16.5	7.5						0.196	4.98	
		U-1000	U-305	32.0	14.5								
		1000	305	32.0	14.5								
<b>5508FE</b>	10 CDR	U-500	U-152	19.6	8.9						0.230	5.84	
		U-1000	U-305	37.9	17.2								
		1000	305	44.1	20.0								

TC = Tinned Copper • BC = Bare Copper • DCR = DC resistance

**Color Code**

Cond. No.	Color
1	Black
2	Red
3	White
4	Green
5	Brown

**Color Code**

Cond. No.	Color
6	Blue
7	Orange
8	Yellow
9	Purple
10	Grey

# Security and Alarm Cables

## Commercial Applications Shielded



De- scription	Part No.	UL NEC / C(UL)/CEC Type IEC	Standard Lengths		Standard Unit Weight		Conductor (Stranding) Diameter Nom. DCR	Nominal Insulation OD		Shielding Material Nom. DCR	Nominal OD		Color Code
			ft.	m	lbs.	kg		inch	mm		inch	mm	

**22 AWG • Stranded (7x30) 0.8 mm Bare Copper • Beldfoil® Shield • 24 AWG Tinned Copper Drain Wire • Numbered and Color Coded**

**Polyethylene Insulation • Grey FRNC/LSNH Jacket**

300V 70°C	IEC 60754-2						0.76 mm 22 AWG (7x30) BC	0.049	1.25	Overall Beldfoil® + Drain Wire (24 AWG TC)	see chart below
--------------	-------------	--	--	--	--	--	--------------------------------	-------	------	---	-----------------

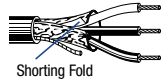

<b>4500FE</b>	2 CDR	328 1640	100 500	4.0 19.6	1.8 8.9						0.130	3.30
<b>4501FE</b>	3 CDR	328 1640	100 500	4.6 23.1	2.1 10.5						0.138	3.50
<b>4502FE</b>	4 CDR	328 1640	100 500	6.0 29.3	2.7 13.3						0.154	3.90
<b>4504FE</b>	6 CDR	328 1640	100 500	7.7 38.6	3.5 17.5						0.181	4.60
<b>4506FE</b>	8 CDR	328 1640	100 500	9.7 48.7	4.4 22.1						0.197	5.00
<b>4508FE</b>	10 CDR	U-500 1000	U-152 305	10.8 53.6	4.9 24.3						0.197	5.00

TC = Tinned Copper • BC = Bare Copper • DCR = DC resistance

### Color Code

Cond. No.	Color
1	Black
2	Red
3	White
4	Green
5	Brown
6	Blue
7	Orange
8	Yellow
9	Purple
10	Grey

# Security and Alarm Cables

## Commercial Applications Shielded



De- scription	Part No.	UL NEC/ C(UL)CEC Type IEC	Standard Lengths		Standard Unit Weight		Conductor (Stranding) Diameter Nom. DCR	Nominal Insulation OD		Shielding Material Nom. DCR	Nominal OD		Color Code
			ft.	m	lbs.	kg		inch	mm		inch	mm	

**20 AWG • Stranded (7x28) 1.0 mm Bare Copper • Beldfoil® Shield • 24 AWG Tinned Copper Drain Wire • Numbered and Color Coded**

**PVC Insulation • Grey PVC Jacket**

<b>300V 75°C</b>	NEC: CMR CEC: CMG FT4						0.96 mm 20 AWG (7x28) BC	0.048	1.21	Overall Beldfoil® + Drain Wire (24 AWG TC)		see chart below
----------------------	--------------------------------	--	--	--	--	--	--------------------------------	-------	------	---	--	-----------------

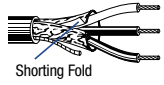

<b>5400FE</b>	2 CDR	C-500 U-500 500 U-1000 1000	C-152 U-152 152 U-305 305	7.9 9.0 8.6 15.9 15.9	3.6 4.1 3.9 7.2 7.2						0.145	3.68
<b>5401FE</b>	3 CDR	U-500 500 U-1000 1000	U-152 152 U-305 305	11.0 10.6 20.9 20.9	5.0 4.8 9.5 9.5						0.153	3.89
<b>5402FE</b>	4 CDR	C-500 U-500 500 U-1000 1000	C-152 U-152 152 U-305 305	11.9 12.6 13.0 24.9 26.0	5.4 5.7 5.9 11.3 11.8						0.168	4.27
<b>5403FE</b>	5 CDR	U-1000 1000	U-305 305	30.0 30.0	13.6 13.6						0.184	4.67
<b>5405FE</b>	7 CDR	U-1000 1000	U-305 305	39.0 40.1	17.7 18.2						0.201	5.11
<b>5407FE</b>	9 CDR	1000	305	51.1	23.2						0.236	5.99

**Polyethylene Insulation • Grey FRNC/LSNH Jacket**

<b>300V 70°C</b>	IEC 60754-2						0.96 mm 20 AWG (7x28) BC	0.057	1.45	Overall Beldfoil® + Drain Wire (24 AWG TC)		see chart below
----------------------	-------------	--	--	--	--	--	--------------------------------	-------	------	---	--	-----------------

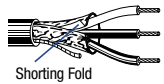

<b>4400FE</b>	2 CDR	328 1640	100 500	4.6 23.6	2.1 10.7						0.146	3.70
<b>4401FE</b>	3 CDR	328 1640	100 500	6.0 30.0	2.7 13.6						0.154	3.90
<b>4402FE</b>	4 CDR	328 1640	100 500	7.5 37.9	3.4 17.2						0.169	4.30
<b>4403FE</b>	5 CDR	328 1640	100 500	4.6 23.6	2.1 10.7						0.185	4.70

TC = Tinned Copper • BC = Bare Copper • DCR = DC resistance

**Color Code**

Cond. No.	Color
1	Black
2	Red
3	White
4	Green
5	Brown

**Color Code**

Cond. No.	Color
6	Blue
7	Orange
8	Yellow
9	Purple

# Security and Alarm Cables

## Commercial Applications Shielded



De- scription	Part No.	UL NEC/ C(UL)/CEC Type IEC	Standard Lengths		Standard Unit Weight		Conductor (Stranding) Diameter Nom. DCR	Nominal Insulation OD		Shielding Material Nom. DCR	Nominal OD		Color Code
			ft.	m	lbs.	kg		inch	mm		inch	mm	

**18 AWG • Stranded (7x26) 1.2 mm Bare Copper • Beldfoil® Shield • 24 AWG Tinned Copper Drain Wire • Numbered and Color Coded**

**PVC Insulation • Grey PVC Jacket**

300V 75°C	NEC: CMR CEC: CMG FT4						1.22 mm 18 AWG (7x26) BC	0.058	1.47	Overall Beldfoil® + Drain Wire (24 AWG TC)	see chart below		
--------------	--------------------------------	--	--	--	--	--	--------------------------------	-------	------	---	-----------------	--	--

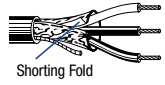

<b>5300FE</b>	2 CDR	C-500	C-152	11.0	5.0						0.165	4.19
		U-500	U-152	12.1	5.5							
		500	152	12.1	5.5							
		U-1000	U-305	22.9	10.4							
		1000	305	22.9	10.4							
<b>5301FE</b>	3 CDR	U-500	U-152	15.4	7.0						0.175	4.45
		500	152	15.0	6.8							
		U-1000	U-305	30.0	13.6							
		1000	305	30.0	13.6							
<b>5302FE</b>	4 CDR	C-250	C-76	8.8	4.0						0.192	4.88
		U-500	U-152	19.0	8.6							
		500	152	20.5	9.3							
		U-1000	U-305	35.9	16.3							
		1000	305	37.0	16.8							
<b>5303FE</b>	5 CDR	U-500	U-152	22.5	10.2						0.211	5.36
		500	152	22.5	10.2							
		U-1000	U-305	43.0	19.5							
		1000	305	45.2	20.5							
<b>5304FE</b>	6 CDR	U-500	U-152	28.4	12.9						0.230	5.84
		500	152	26.0	11.8							
		1000	305	57.1	25.9							
<b>5305FE</b>	7 CDR	1000	305	57.1	25.9					0.230	5.84	
<b>5306FE</b>	8 CDR	500	152	32.0	14.5					0.270	6.86	
		1000	305	64.2	29.1							
Also available in Natural.												
<b>5307FE</b>	9 CDR	1000	305	71.2	32.3					0.272	6.91	

TC = Tinned Copper • BC = Bare Copper • DCR = DC resistance

### Color Code

Cond. No.	Color
1	Black
2	Red
3	White
4	Green
5	Brown
6	Blue
7	Orange
8	Yellow
9	Purple



# Security and Alarm Cables

## Commercial Applications Shielded



De- scription	Part No.	UL NEC/ C(UL)CEC Type IEC	Standard Lengths		Standard Unit Weight		Conductor (Stranding) Diameter Nom. DCR	Nominal Insulation OD		Shielding Material Nom. DCR	Nominal OD		Color Code
			ft.	m	lbs.	kg		inch	mm		inch	mm	

**18 AWG • Stranded (7x26) 1.2 mm Bare Copper • Beldfoil® Shield • 24 AWG Tinned Copper Drain Wire • Numbered and Color Coded**

**Polyethylene Insulation • Grey FRNC/LSNH Jacket**

<b>300V 70°C</b>	IEC 60754-2						1.22 mm 18 AWG (7x26) BC	0.068	1.72	Overall Beldfoil® + Drain Wire (24 AWG TC)		see chart below	
----------------------	-------------	--	--	--	--	--	--------------------------------	-------	------	---	--	-----------------	--

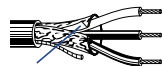

Shorting Fold

<b>4300FE</b>	2 CDR	328 1640	100 500	7.1 35.5	3.2 16.1						0.165	4.20	
<b>4301FE</b>	3 CDR	328 1640	100 500	9.3 45.9	4.2 20.8						0.177	4.50	
<b>4302FE</b>	4 CDR	328 1640	100 500	11.7 58.2	5.3 26.4						0.193	4.90	
<b>4303FE</b>	5 CDR	328 1640	100 500	12.8 63.7	5.8 28.9						0.193	4.90	
<b>4304FE</b>	6 CDR	328 1640	100 500	16.5 82.7	7.5 37.5						0.228	5.80	
<b>4306FE</b>	8 CDR	328 1640	100 500	20.5 102.7	9.3 46.6						0.272	6.90	
<b>4307FE</b>	9 CDR	328 1640	100 500	22.0 110.2	10.0 50.0						0.283	7.20	

TC = Tinned Copper • BC = Bare Copper • DCR = DC resistance

### Color Code

Cond. No.	Color
1	Black
2	Red
3	White
4	Green
5	Brown
6	Blue
7	Orange
8	Yellow
9	Purple

# Security and Alarm Cables

## Commercial Applications Shielded



De- scription	Part No.	No. of Cond. (CDR)	Standard Lengths		Standard Unit Weight		Conductor (Stranding) Diameter Nom. DCR	Nominal Conductor OD		Shielding Material Nom. DCR	Nominal OD		Application
			ft.	m	lbs.	kg		AWG	Section mm <sup>2</sup>		inch	mm	

**18 AWG • Stranded (32x0.20) 1.2 mm Bare Copper • Overall Alufoil • Color Coded**

**PVC Insulation • White Flame-Resistant PVC Jacket** (Color Code: see chart 11, Tech Info Section)

500V										Overall Alufoil			<ul style="list-style-type: none"> <li>- Alarm systems</li> <li>- Smoke survey</li> <li>- Fire survey</li> <li>- Industrial checks</li> </ul>
------	--	--	--	--	--	--	--	--	--	--------------------	--	--	---



LiY (St) Y	Part No.	No. of Cond.	ft.	m	lbs.	kg	Conductor (Stranding) Diameter Nom. DCR	AWG	Section mm <sup>2</sup>	Shielding Material Nom. DCR	inch	mm	Application
	<b>SEC0047</b>	2	328	100	110.2	50.0	(20x0.243) BC	17	1.00		0.220	5.60	
	<b>SEC0048</b>	3	328	100	132.3	60.0	(20x0.243) BC	17	1.00		0.256	6.50	
	<b>SEC0049</b>	4	328	100	187.4	85.0	(20x0.243) BC	17	1.00		0.276	7.00	
	<b>SEC0050</b>	5	328	100	220.5	100.0	(20x0.243) BC	17	1.00		0.319	8.10	

BC = Bare Copper • DCR = DC resistance

20 • New Generation® Cables

# Security and Alarm Cables

## Commercial Applications Shielded



De-scription	Part No.	UL NEC/ C(UL)CEC Type IEC	Standard Lengths		Standard Unit Weight		Conductor (Stranding) Diameter Nom. DCR	Nominal Insulation OD		Shielding Material Nom. DCR	Nominal OD		Color Code
			ft.	m	lbs.	kg		inch	mm		inch	mm	

**16 AWG • Stranded (19x29) 1.5 mm Bare Copper • Beldfoil® Shield • 18 AWG Tinned Copper Drain Wire • Numbered and Color Coded**

**PVC Insulation • Grey PVC Jacket**

300V 75°C	NEC: CMR CEC: CMG FT4						1.47 mm 16 AWG (19x29) BC	0.068	1.72	Overall Beldfoil® + Drain Wire (18 AWG TC)			
--------------	--------------------------------	--	--	--	--	--	---------------------------------	-------	------	---	--	--	--

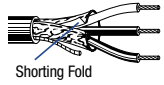

<b>5200FE</b>	2 CDR	U-500	U-152	16.5	7.5						0.188	4.78	Black, Red	
		500	152	16.5	7.5									
		U-1000	U-305	31.1	14.1									
		1000	305	32.0	14.5									
Also available in White.														
<b>5201FE</b>	3 CDR	500	152	21.6	9.8						0.200	5.08	Black, Red, White	
		U-1000	U-305	43.0	19.5									
		1000	305	42.1	19.1									
<b>5202FE</b>	4 CDR	500	152	26.5	12.0						0.220	5.59	Black, Red, White, Green	
		1000	305	54.0	24.5									

**Polyethylene Insulation • Grey FRNC/LSNH Jacket**

300V 70°C	IEC 60754-2						1.47 mm 16 AWG (19x29) BC	0.077	1.95	Overall Beldfoil® + Drain Wire (18 AWG TC)			
--------------	----------------	--	--	--	--	--	---------------------------------	-------	------	---	--	--	--

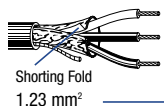

<b>4200FE</b>	2 CDR	328	100	9.7	4.4						0.189	4.80	Black, Red
		1640	500	48.1	21.8								
<b>4201FE</b>	3 CDR	328	100	11.9	5.4						0.201	5.10	Black, Red, White
		1640	500	59.5	27.0								
<b>4202FE</b>	4 CDR	328	100	15.2	6.9						0.220	5.60	Black, Red, White, Green
		1640	500	75.8	34.4								

TC = Tinned Copper • BC = Bare Copper • DCR = DC resistance

# Security and Alarm Cables

## Commercial Applications Shielded



De- scription	Part No.	UL NEC/ C(UL)/CEC Type IEC	Standard Lengths		Standard Unit Weight		Conductor (Stranding) Diameter Nom. DCR	Nominal Insulation OD		Shielding Material Nom. DCR	Nominal OD		Color Code
			ft.	m	lbs.	kg		inch	mm		inch	mm	

**14 AWG • Stranded (19x27) 1.9 mm Bare Copper • Beldfoil® Shield • 16 AWG Tinned Copper Drain Wire**

**PVC Insulation • Grey PVC Jacket**

300V 75°C		NEC: CL3R					1.85 mm 14 AWG (19x27) BC	0.087	2.21	Overall Beldfoil® + Drain Wire (16 AWG TC)			
--------------	--	--------------	--	--	--	--	---------------------------------	-------	------	---	--	--	--

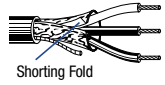

<b>5100FE</b>	2 CDR		500	152	28.4	12.9					0.238	6.05	Black, White
			U-1000	U-305	48.9	22.2							
			1000	305	51.1	23.2							
<b>5101FE</b>	3 CDR		1000	305	66.1	30.0					0.253	6.43	Black, White, Red

**Polyethylene Insulation • Grey FRNC/LSNH Jacket**

300V 70°C	<b>4100FE</b>	IEC 60754-2	328	100	14.3	6.5	1.85 mm 14 AWG (19x27) BC	0.099	2.52	Overall Beldfoil® + Drain Wire (16 AWG TC)	0.240	6.10	Black, White
--------------	---------------	----------------	-----	-----	------	-----	---------------------------------	-------	------	---	-------	------	--------------

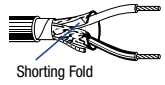

2 CDR

**12 AWG • Stranded (19x25) 2.4 mm Bare Copper • Beldfoil® Shield • 16 AWG Tinned Copper Drain Wire**

**PVC Insulation • Grey PVC Jacket**

300V 75°C	<b>5000FE</b>	NEC: CL3R	500	152	36.6	16.6	2.36 mm 12 AWG (19x25) BC	0.107	2.72	Overall Beldfoil® + Drain Wire (16 AWG TC)	0.272	6.91	Black, White
--------------	---------------	--------------	-----	-----	------	------	---------------------------------	-------	------	---	-------	------	--------------

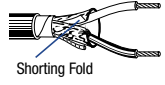

2 CDR

**Polyethylene Insulation • Grey FRNC/LSNH Jacket**

300V 70°C	<b>4000FE</b>	IEC 60754-2	328	100	19.2	8.7	2.36 mm 12 AWG (19x25) BC	0.118	3.00	Overall Beldfoil® + Drain Wire (16 AWG TC)	0.272	6.90	Black, White
--------------	---------------	----------------	-----	-----	------	-----	---------------------------------	-------	------	---	-------	------	--------------

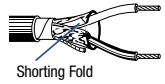

2 CDR

TC = Tinned Copper • BC = Bare Copper • DCR = DC resistance

20 • New Generation® Cables

## Security and Alarm Cables

Water-Blocked for Use in Underground Ducts  
Unshielded and Shielded



De- scription	Part No.	UL NEC/ C(UL)/CEC Type IEC	Standard Lengths		Standard Unit Weight		Conductor (Stranding) Diameter Nom. DCR	Nominal Insulation OD		Shielding Material Nom. DCR	Nominal OD		Color Code
			ft.	m	lbs.	kg		inch	mm		inch	mm	

**18 AWG • Stranded (7x26) 1.2 mm Tinned Copper • Overall Water-Blocking Tape • Numbered and Color Coded • Rip Cord**

**PVC Insulation • Grey PVC Jacket**

300V 105°C	<b>5300U1</b>	NEC:	U-500	U-152	12.1	5.5	1.22 mm	0.058	1.47	Unshielded	0.207	5.26	Black, Red
		CM	500	152	13.4	6.1	18 AWG						
		CEC:	U-1000	U-305	22.0	10.0	(7x26) TC						
		CM FT1	1000	305	24.0	10.9							



Rip Cord

2 CDR

**22 AWG • Stranded (7x30) 0.8 mm Tinned Copper • Beldfoil® Shield • Overall Water-Blocking Tape • Numbered and Color Coded**

**PVC Insulation • Grey PVC Jacket**

300V 105°C	<b>5500F1</b>	NEC:	U-500	U-152	9.0	4.1	0.76 mm	0.058	1.47	Overall Beldfoil®	0.192	4.88	Black, Red
		CM	500	152	9.0	4.1	22 AWG						
		CEC:	U-1000	U-305	16.1	7.3	(7x30) TC						
		CM FT1	1000	305	17.0	7.7							

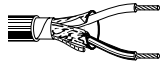

2 CDR

**20 AWG • Stranded (7x28) 1.0 mm Tinned Copper • Beldfoil® Shield • Overall Water-Blocking Tape • Numbered and Color Coded**

**PVC Insulation • Grey PVC Jacket**

300V 105°C	<b>5400F1</b>	NEC:	U-500	U-152	11.5	5.2	0.96 mm	0.048	1.21	Overall Beldfoil®	0.206	5.23	Black, Red
		CM	500	152	11.0	5.0	20 AWG						
		CEC:	U-1000	U-305	20.9	9.5	(7x28) TC						
		CM FT1	1000	305	20.9	9.5							



2 CDR

**18 AWG • Stranded (7x26) 1.2 mm Tinned Copper • Beldfoil® Shield • Overall Water-Blocking Tape • Numbered and Color Coded**

**PVC Insulation • Grey PVC Jacket**

300V 105°C	<b>5300F1</b>	NEC:	U-500	U-152	15.0	6.8	1.22 mm	0.058	1.47	Overall Beldfoil®	0.222	5.64	Black, Red
		CM	500	152	15.0	6.8	18 AWG						
		CEC:	U-1000	U-305	29.1	13.2	(7x26) TC						
		CM FT1	1000	305	30.0	13.6							

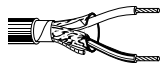

2 CDR

TC = Tinned Copper • BC = Bare Copper • DCR = DC resistance

# Security and Alarm Cables

## Commercial Applications Unshielded Twisted Pairs



De- scription	Part No.	UL NEC/ C(UL)/CEC Type IEC	Standard Lengths		Standard Unit Weight		Conductor (Stranding) Diameter Nom. DCR	Nominal Insulation OD		Shielding Material Nom. DCR	Nominal OD		Color Code
			ft.	m	lbs.	kg		inch	mm		inch	mm	

**22 AWG • Stranded (7x30) 0.8 mm Bare Copper • Twisted Pair • Numbered and Color Coded • Rip Cord**

**PVC Insulation • Grey PVC Jacket**

300V 75°C	NEC: CMR CEC: CM FT4						0.76 mm 22 AWG (7x30) BC	0.040	1.01	Unshielded		see chart below
--------------	-------------------------------	--	--	--	--	--	--------------------------------	-------	------	------------	--	-----------------

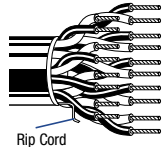

<b>5541UE</b>	2-Pair	U-1000 1000	U-305 305	18.1 19.0	8.2 8.6							0.206	5.23
<b>5542UE</b>	3-Pair	U-500 U-1000 1000	U-152 U-305 305	13.0 24.0 25.1	5.9 10.9 11.4							0.220	5.59
<b>5543UE</b>	4-Pair	U-1000 1000	U-305 305	32.0 32.0	14.5 14.5							0.243	6.17
<b>5547UE</b>	9-Pair	1000	305	70.1	31.8							0.334	8.48

**18 AWG • Stranded (7x26) 1.2 mm Bare Copper • Twisted Pair • Numbered and Color Coded • Rip Cord**

**PVC Insulation • Grey PVC Jacket**

300V 75°C	NEC: CMR CEC: CM FT4						1.22 mm 18 AWG (7x26) BC	0.058	1.47	Unshielded		see chart below
--------------	-------------------------------	--	--	--	--	--	--------------------------------	-------	------	------------	--	-----------------

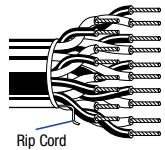

<b>5341UE</b>	2-Pair	U-1000 1000	U-305 305	34.0 36.2	15.4 16.4							0.266	6.76
<b>5342UE</b>	3-Pair	U-1000 1000	U-305 305	48.1 50.0	21.8 22.7							0.283	7.19
<b>5343UE</b>	4-Pair	1000	305	67.2	30.5							0.320	8.13
<b>5345UE</b>	6-Pair	1000	305	96.1	43.6							0.362	9.19
<b>5347UE</b>	9-Pair	1000	305	140.2	63.6							0.434	11.02

**Polyethylene Insulation • Grey FRNC/LSNH Jacket**

300V 75°C	<b>4341UE</b>	IEC 60754-2	328 1640	100 500	10.6 53.1	4.8 24.1	1.22 mm 18 AWG (7x26) BC	0.058	1.47	Unshielded	0.264	6.70	see chart below
--------------	---------------	----------------	-------------	------------	--------------	-------------	--------------------------------	-------	------	------------	-------	------	-----------------

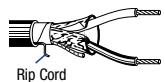

2-Pair

BC = Bare Copper • DCR = DC resistance

**Color Code**

<b>Pair No.</b>	<b>Color</b>	<b>Pair No.</b>	<b>Color</b>	<b>Pair No.</b>	<b>Color</b>
1	Black, Red	4	Black, Blue	7	Black, Orange
2	Black, White	5	Black, Yellow	8	Black, White
3	Black, Green	6	Black, Brown	9	Black, Green



# Security and Alarm Cables

## Commercial Applications Shielded Twisted Pairs



De- scription	Part No.	UL NEC/ C(UL)CEC Type IEC	Standard Lengths		Standard Unit Weight		Conductor (Stranding) Diameter Nom. DCR	Nominal Insulation OD		Shielding Material Nom. DCR	Nominal OD		Color Code
			ft.	m	lbs.	kg		inch	mm		inch	mm	

**22 AWG** • Stranded (7x30) 0.8 mm BC • Twisted Pair • **Beldfoil®** Shield • 24 AWG TC Drain Wire • Numbered and Color Coded • Rip Cord

**PVC Insulation • Grey PVC Jacket**

300V 75°C	NEC: CMR CEC: CM FT4						0.76 mm 22 AWG (7x30) BC	0.040	1.01	Overall Beldfoil® + Drain Wire (24 AWG TC)		see chart below
--------------	-------------------------------	--	--	--	--	--	--------------------------------	-------	------	---	--	-----------------

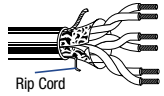

<b>5541FE</b>	2-Pair	U-500 U-1000 1000	U-152 U-305 305	11.5 20.9 22.9	5.2 9.5 10.4						0.209	5.31
<b>5542FE</b>	3-Pair	U-1000 1000	U-305 305	27.1 29.1	12.3 13.2						0.223	5.66
<b>5543FE</b>	4-Pair	1000	305	34.0	15.4						0.246	6.25
<b>5545FE</b>	6-Pair	U-1000 1000	U-305 305	46.1 48.1	20.9 21.8						0.278	7.06

**Polyethylene Insulation • Grey FRNC/LSNH Jacket**

300V 70°C							0.76 mm 22 AWG (7x30) BC	0.049	1.25	Overall Beldfoil® + Drain Wire (24 AWG TC)		see chart below
--------------	--	--	--	--	--	--	--------------------------------	-------	------	---	--	-----------------

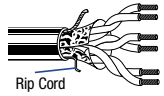

<b>4541FE</b>	2-Pair	328 1640	100 500	6.2 31.5	2.8 14.3						0.209	5.30
<b>4542FE</b>	3-Pair	328 1640	100 500	7.7 39.0	3.5 17.7						0.224	5.70
<b>4545FE</b>	6-Pair	328 1640	100 500	13.9 69.4	6.3 31.5						0.280	7.10

**20 AWG** • Stranded (7x28) 1.0 mm BC • Twisted Pair • **Beldfoil®** Shield • 24 AWG TC Drain Wire • Numbered and Color Coded • Rip Cord

**PVC Insulation • Grey PVC Jacket**

300V 75°C	NEC: CMR CEC: CM FT4						0.96 mm 20 AWG (7x28) BC	0.048	1.21	Overall Beldfoil® + Drain Wire (24 AWG TC)		see chart below
--------------	-------------------------------	--	--	--	--	--	--------------------------------	-------	------	---	--	-----------------

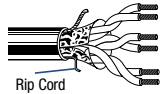

<b>5441FE</b>	2-Pair	500 U-1000 1000	152 U-305 305	15.0 29.1 29.1	6.8 13.2 13.2						0.235	5.97
<b>5442FE</b>	3-Pair	U-1000 1000	U-305 305	37.9 37.9	17.2 17.2						0.252	6.40
<b>5445FE</b>	6-Pair	1000	305	72.1	32.7						0.323	8.20

TC = Tinned Copper • BC = Bare Copper • DCR = DC resistance

**Color Code**

Pair No.	Color	Pair No.	Color
1	Black, Red	4	Black, Blue
2	Black, White	5	Black, Yellow
3	Black, Green	6	Black, Brown



# Security and Alarm Cables

## Commercial Applications Shielded Twisted Pairs



De- scription	Part No.	UL NEC / C(UL)/CEC Type IEC	Standard Lengths		Standard Unit Weight		Conductor (Stranding) Diameter Nom. DCR	Nominal Insulation OD		Shielding Material Nom. DCR	Nominal OD		Color Code
			ft.	m	lbs.	kg		inch	mm		inch	mm	

**20 AWG • Stranded (7x28) 1.0 mm BC • Twisted Pair • Beldfoil® Shield • 24 AWG Tinned Copper Drain Wire • Numbered and Color Coded**

**Polyethylene Insulation • Grey FRNC/LSNH Jacket**

300V 70°C	IEC 60754-2						0.96 mm 20 AWG (7x28) BC	0.057	1.45	Overall Beldfoil® + Drain Wire (24 AWG TC)	see chart below		
--------------	-------------	--	--	--	--	--	--------------------------------	-------	------	---	-----------------	--	--



<b>4441FE</b>	2-Pair	328 1640	100 500	7.7 39.0	3.5 17.7							0.236	6.00
<b>4445FE</b>	6-Pair	328 1640	100 500	18.7 93.3	8.5 42.3							0.323	8.20

**18 AWG • Stranded (7x26) 1.2 mm BC • Twisted Pair • Beldfoil® Shield • 24 AWG Tinned Copper Drain Wire • Numbered and Color Coded**

**PVC Insulation • Overall Grey PVC Jacket**

300V 75°C	NEC: CMR CEC: CM FT4						1.22 mm 18 AWG (7x26) BC	0.058	1.47	Overall Beldfoil® + Drain Wire (24 AWG TC)	see chart below		
--------------	-------------------------------	--	--	--	--	--	--------------------------------	-------	------	---	-----------------	--	--



<b>5341FE</b>	2-Pair	500 U-1000 1000	152 U-305 305	20.9 39.9 42.1	9.5 18.1 19.1							0.270	6.86
<b>5342FE</b>	3-Pair	1000	305	52.0	23.6							0.275	6.99
<b>5343FE</b>	4-Pair	1000	305	70.1	31.8							0.318	8.08
<b>5345FE</b>	6-Pair	500 1000	152 305	52.7 103.2	23.9 46.8							0.373	9.47

**Polyethylene Insulation • Grey FRNC/LSNH Jacket**

300V 70°C	IEC 60754-2						1.22 mm 18 AWG (7x26) BC	0.068	1.72	Overall Beldfoil® + Drain Wire (24 AWG TC)	see chart below		
--------------	-------------	--	--	--	--	--	--------------------------------	-------	------	---	-----------------	--	--



<b>4341FE</b>	2-Pair	328 1640	100 500	13.7 68.6	6.2 31.1							0.264	6.70
<b>4342FE</b>	3-Pair	1640	500	82.0	37.2							0.276	7.00
<b>4343FE</b>	4-Pair	1640	500	103.0	46.7							0.319	8.10
<b>4345FE</b>	6-Pair	1640	500	161.6	73.3							0.374	9.50

TC = Tinned Copper • BC = Bare Copper • DCR = DC resistance

**Color Code**

Pair No.	Color
1	Black, Red
2	Black, White
3	Black, Green

Pair No.	Color
4	Black, Blue
5	Black, Yellow
6	Black, Brown





## Security and Alarm Cables

Commercial Applications Individually Shielded Twisted Pairs



De- scription	Part No.	UL NEC/ C(UL)CEC Type IEC	Standard Lengths		Standard Unit Weight		Conductor (Stranding) Diameter Nom. DCR	Nominal Insulation OD		Shielding Material Nom. DCR	Nominal OD		Color Code
			ft.	m	lbs.	kg		inch	mm		inch	mm	

**22 AWG • Stranded (7x30) 0.8 mm BC • Twisted Pair • Each Pair Beldfoil® Shielded • 24 AWG TC Drain Wire • Numbered and Color Coded**

PVC Insulation • Grey PVC Jacket													
300V 75°C	<b>5543PE</b>	NEC: CMR CEC: CMG FT4	1000	305	55.1	25.0	0.76 mm 22 AWG (7x30) BC	0.040	1.01	Individual Beldfoil® + Drain Wire (24 AWG TC)	0.303	7.70	see chart below

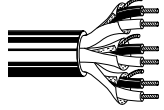

4-Pair

TC = Tinned Copper • BC = Bare Copper • DCR = DC resistance

### Color Code

Pair No.	Color
1	Black, Red
2	Black, White
3	Black, Green
4	Black, Blue

### Security and Alarm Cables

Commercial Applications, Individually Shielded Twisted Pairs plus Conductors



De- scription	Part No.	UL NEC/ C(UL)/CEC Type IEC	Standard Lengths		Standard Unit Weight		Conductor (Stranding) Diameter Nom. DCR	Nominal Insulation OD		Shielding Material Nom. DCR	Nominal OD		Color Code
			ft.	m	lbs.	kg		inch	mm		inch	mm	

**22 AWG** • Stranded (7x30) 0.8 mm BC • Twisted Pair • Each Pair **Beldfoil®** Shielded • 24 AWG TC Drain Wire • With Additional Conductor(s) • Numbered and Color Coded

**PVC Insulation • Grey PVC Jacket**

<p>300V 75°C</p> <p>Shorting Fold</p>	NEC: CMR CEC: CMG FT4						0.76 mm 22 AWG (7x30) BC	0.040	1.01	Individual Beldfoil® + Drain Wire (24 AWG TC)			
	<b>5501GE</b>	1 STP +1/C	U-1000	U-305	16.1	7.3					0.171	4.34	Black & Red (shielded pair), White
	<b>5502GE</b>	1 STP +2/C	U-500 U-1000 1000	U-152 U-305 305	9.9 19.0 19.0	4.5 8.6 8.6					0.186	4.72	Black & Red (shielded pair), White, Green
	<b>5542GE</b>	1 STP +2/TP	U-1000	U-305	26.0	11.8					0.220	5.59	Black & Red (shielded pair), Black & Red, Black & Green pairs

**Polyethylene Insulation • Grey FRNC/LSNH Jacket**

<p>300V 70°C</p> <p>Shorting Fold</p>	<b>4502GE</b>	IEC 60754-2	328 1640	100 500	6.0 30.0	2.7 13.6	0.76 mm 22 AWG (7x30) BC	0.049	1.25	Individual Beldfoil® + Drain Wire (24 AWG TC)	0.185	4.70	Black & Red (shielded pair), White, Green

1 STP + 2/C

**20 AWG** • Stranded (7x28) 1.0 mm BC • Twisted Pair • Each Pair **Beldfoil®** Shielded • 24 AWG TC Drain Wire • With Additional Conductor(s) • Numbered and Color Coded

**PVC Insulation • Grey PVC Jacket**

<p>300V 75°C</p> <p>Shorting Fold</p>	NEC: CMR CEC: CMG FT4						0.96 mm 20 AWG (7x28) BC	0.042	1.06	Individual Beldfoil® + Drain Wire (24 AWG TC)			
	<b>5401GE</b>	1 STP +1/C	1000	305	22.9	10.4					0.196	4.98	Black & Red (shielded pair), White
	<b>5402GE</b>	1 STP +2/C	U-1000	U-305	26.0	11.8					0.200	5.08	Black & Red (shielded pair), White, Green

**18 AWG** • Stranded (7x26) 1.2 mm BC • Twisted Pair • Each Pair **Beldfoil®** Shielded • 24 AWG TC Drain Wire • With Additional Conductor(s) • Numbered and Color Coded

**PVC Insulation • Grey PVC Jacket**

<p>300V 70°C</p> <p>Shorting Fold</p>	<b>5302GE</b>	NEC: CMR CEC: CMG FT4	1000	305	31.5	14.3	1.22 mm 18 AWG (7x26) BC	0.058	1.47	Individual Beldfoil® + Drain Wire (24 AWG TC)	0.225	5.72	Black & Red (shielded pair), White

1 STP + 2/C

TC = Tinned Copper • BC = Bare Copper • STP = Shielded Twisted Pair(s) • /C = Conductor(s) • DCR = DC resistance

20 • New Generation® Cables

# Security Coaxial Cables

## Surveillance and CCTV Applications



De- scription	Part No.	UL NEC/ C(UL)CEC Type IEC	Standard Lengths		Standard Unit Weight		Conductor (Stranding) Diameter Nom. DCR	Nominal Insulation OD		Shielding Material Nom. DCR	Nominal OD		Nom. Imp. (□)	Nom. Vel. of Prop.	Nominal Capacitance		Nominal Attenuation		
			ft.	m	lbs.	kg		inch	mm		inch	mm			pF/ft.	pF/m	MHz	dB/ 100 ft.	dB/ 100 m

**H109A** • Solid 1.0 mm Bare Copper • **Copper-foil** • 55 % Bare Copper Braid

5-Cell Gas-Injected Polyethylene Insulation • Black PVC Jacket																														
80°C	<b>H109A00</b>	328	100	10.4	4.7	1.0 mm	0.185	4.70	Cu-foil + 55% BC Braid 15.0 □/km*** 5.2 mm	0.262	6.65	75	80%	17.1	56.0	5	0.5	1.6												
		820	250	26.0	11.8	Solid BC	41.0 □/km*	50								1.4	4.6													
		1640	500	26.0	11.8	41.0 □/km*	26.0 □/km**	100								2.0	6.5													
						26.0 □/km**		230								3.0	9.8													
																	400	4.5	14.8											
																	800	5.9	19.2											
																	860	5.9	19.5											
																	1000	6.6	21.5											
1.0/4.8			Return loss at				5-470 MHz: □23 dB				470-862 MHz: □20 dB				862-2150 MHz: □18 dB				Screening attenuation at 30-1000 MHz: □75 dB				Transfer impedance at 5-30 MHz: □15.0 m□/m				Pulling Tension: 55 N			

**H125A** • Solid 1.0 mm Bare Copper • **Duofoil®** • 40 % Tinned Copper Braid

Gas-Injected Polyethylene Insulation • PVC Jacket (Brown, Black and White)																														
80°C	<b>H125A00</b>	328	100	10.4	4.7	1.0 mm	0.189	4.80	Duofoil® + 40% TC Braid 27.0 □/km***	0.268	6.80	75	81%	16.8	55.0	5	0.5	1.8												
		820	250	26.0	11.8	Solid BC	50.0 □/km*	50								1.4	4.7													
		1640	500	51.8	23.5	50.0 □/km*	23.0 □/km**	100								2.0	6.5													
						23.0 □/km**		230								3.0	9.8													
																	400	3.9	12.9											
																	800	5.7	18.6											
																	860	5.9	19.3											
																	1000	6.4	20.9											
1.0/4.8			Return loss at				5-470 MHz: □23 dB				470-862 MHz: □20 dB				862-2150 MHz: □18 dB				Screening attenuation at 30-1000 MHz: □75 dB				Transfer impedance at 5-30 MHz: □40.0 m□/m				Pulling Tension: 55 N			

**H121A** • Solid 0.8 mm Bare Copper • **Duofoil®** • 40 % Tinned Copper Braid

Gas-Injected Polyethylene Insulation • PVC Jacket (Brown, Black and White)																														
80°C	<b>H121A00</b>	328	100	15.1	6.9	0.8 mm	0.138	3.50	Duofoil® + 40% TC Braid 40.0 □/km*** 4.1 mm	0.197	5.00	75	82%	16.5	54.0	5	0.5	1.7												
		820	250	37.9	17.2	Solid BC	75.0 □/km*	50								1.8	5.9													
		1640	500	75.7	34.4	75.0 □/km*	35.0 □/km**	100								2.0	8.1													
						35.0 □/km**		230								3.7	12.1													
																	400	4.8	15.9											
																	800	6.9	22.7											
																	860	7.2	23.6											
																	1000	7.8	25.6											
1.0/4.8			Return loss at				5-470 MHz: □20 dB				470-862 MHz: □18 dB				862-2150 MHz: □16 dB				Screening attenuation at 30-1000 MHz: □75 dB				Transfer impedance at 5-30 MHz: □40.0 m□/m				Pulling Tension: 55 N			





\* DC loop resistance • \*\* DC resistance inner conductor • \*\*\* DC resistance outer conductor • DCR = DC resistance • TC = Tinned Copper • BC = Bare Copper

Duofoil® see technical information page 23.13.

# Security Coaxial Cables

Surveillance and CCTV Applications  
Shielded or Flooded for Use in Underground Ducts



De- scription	Part No.	UL NEC/ C(UL)/CEC Type IEC	Standard Lengths		Standard Unit Weight		Conductor (Stranding) Diameter Nom. DCR	Nominal Insulation OD		Shielding Material Nom. DCR	Nominal OD		Nom. Imp. (□)	Nom. Vel. of Prop.	Nominal Capacitance		Nominal Attenuation			
			ft.	m	lbs.	kg		inch	mm		inch	mm			pF/ft.	pF/m	MHz	dB/ 100 ft.	dB/ 100 m	
<b>25 AWG • Solid 0.5 mm Bare Copper • 94 % Bare Copper Braid</b>																				
<b>Gas-Injected Foam PE Insulation • PVC Jacket (Brown, Red, Yellow, Green, Blue, White and Black)</b>																				
75°C	<b>573945</b>	NEC: CM CEC: CM FT1	U-1000 1000	U-305 305	15.0 14.1	6.8 6.4	0.46 mm 25 AWG Solid BC 101.7 □/km* 83.3 □/km**	0.085	2.16	94% BC Braid 18.4 □/km***	0.146	3.71	75	80%	16.9	55.4	1	0.5	1.5	
																				
Mini RG-59																				
															Nominal Delay: 4.167 ns/m			Pulling Tension: 125 N		
<b>Gas-Injected Foam PE Insulation • Grey FRNC/LSNH Jacket</b>																				
70°C	<b>473945</b>	IEC 60754-2	328 1640	100 500	4.6 23.1	2.1 10.5	0.46 mm 25 AWG Solid BC 101.7 □/km* 83.3 □/km**	0.085	2.16	95% BC Braid 18.4 □/km***	0.146	3.70	75	80%	16.9	55.4	see above			
																				
Mini RG-59																				
															Nominal Delay: 4.167 ns/m			Pulling Tension: 125 N		
<b>22 AWG • Stranded (7x30) 0.8 mm Bare Copper • 95 % Bare Copper Braid</b>																				
<b>Gas-Injected Foam PE Insulation • Black PVC Jacket</b>																				
75°C	<b>551945</b>	NEC: CM CEC: CM FT1	U-1000 1000	U-305 305	33.1 30.0	15.0 13.6	0.76 mm 22 AWG (7x30) BC 49.2 □/km* 40.7 □/km**	0.140	3.56	95% BC Braid 8.5 □/km***	0.232	5.89	75	78%	17.3	56.8	1	0.3	1.0	
																				
RG-59																				
															Nominal Delay: 4.265 ns/m			Pulling Tension: 218 N		
<b>Gas-Injected Foam PE Insulation • Grey FRNC/LSNH Jacket</b>																				
70°C	<b>451945</b>	IEC 60754-2	328 1640	100 500	8.2 41.2	3.7 18.7	0.76 mm 22 AWG (7x30) BC 49.2 □/km* 40.7 □/km**	0.140	3.56	95% BC Braid 8.5 □/km***	0.232	5.90	75	78%	17.3	56.8	see above			
																				
RG-59																				
															Nominal Delay: 4.265 ns/m			Pulling Tension: 218 N		
<b>20 AWG • Solid 0.8 mm Bare Copper • 95 % Bare Copper Braid</b>																				
<b>Gas-Injected Foam PE Insulation • PVC Jacket (White or Black)</b>																				
75°C	<b>543945</b>	NEC: CM CEC: CM FT1	U-500 500	U-152 152	12.6 13.2	5.7 6.0	0.81 mm 20 AWG Solid BC 32.8 □/km* 21.4 □/km**	0.145	3.68	95% BC Braid 11.4 □/km***	0.232	5.89	75	83%	16.3	53.5	1	0.3	1.0	
																				
RG-59																				
															Nominal Delay: 3.97 ns/m			Pulling Tension: 218 N		

\*DC loop resistance • \*\*DC resistance inner conductor • \*\*\* DC resistance outer conductor • DCR = DC resistance • BC = Bare Copper

# Security Coaxial Cables

Surveillance and CCTV Applications  
Shielded or Flooded for Use in Underground Ducts



De- scription	Part No.	UL NEC/ C(UL)CEC Type IEC	Standard Lengths		Standard Unit Weight		Conductor (Stranding) Diameter Nom. DCR	Nominal Insulation OD		Shielding Material Nom. DCR	Nominal OD		Nom. Imp. (□)	Nom. Vel. of Prop.	Nominal Capacitance		Nominal Attenuation		
			ft.	m	lbs.	kg		inch	mm		inch	mm			pF/ft.	pF/m	MHz	dB/ 100 ft.	dB/ 100 m
<b>20 AWG • Solid 0.8 mm Bare Copper • 95 % Bare Copper Braid</b>																			
<b>Gas-Injected Foam PE Insulation • Grey FRNC/LSNH Jacket</b>																			
70°C	443945	IEC 60754-2	328 1640	100 500	10.6 52.5	4.8 23.8	0.81 mm 20 AWG Solid BC 32.8 □/km* 21.4 □/km**	0.145 3.68	3.68	95% BC Braid 11.4 □/km***	0.232 5.90	5.90	75	83%	16.3 53.5	53.5	1 5 10 50 100 200 400 700 900 1000	0.3 0.7 2.0 1.9 2.6 3.6 5.0 7.0 8.0 8.5	1.0 2.1 3.0 6.2 8.5 11.8 16.4 23.0 26.2 27.9
																			
RG-59																			
Nominal Delay: 3.97 ns/m										Pulling Tension: 218 N									

<b>18 AWG • Solid 1.0 mm Bare Copper • 95 % Bare Copper Braid</b>																			
<b>Foam PE Insulation • PVC Jacket (White or Black)</b>																			
75°C	533945	NEC: CM CEC: CM FT1	500 U-1000 1000	152 U-305 305	20.9 39.9 41.0	9.5 18.1 18.6	1.02 mm 18 AWG Solid BC 20.9 □/km* 10.8 □/km**	0.180 4.57	4.57	95% BC Braid 10.1 □/km***	0.266 6.76	6.76	75	83%	16.3 53.5	53.5	1 5 10 50 100 200 400 700 900 1000	0.2 0.5 2.0 1.5 2.1 4.8 6.9 9.8 14.1 19.0 22.0 23.3	0.7 1.5 2.1 4.8 6.9 9.8 14.1 19.0 22.0 23.3
																			
RG-6																			
Nominal Delay: 4.003 ns/m										Pulling Tension: 507 N									

<b>Gas-Injected Foam PE Insulation • Grey FRNC/LSNH Jacket</b>																				
70°C	433945	IEC 60754-2	328 1640	100 500	13.4 67.2	6.1 30.5	1.02 mm 18 AWG Solid BC 20.9 □/km* 10.8 □/km**	0.180 4.57	4.57	95% BC Braid 10.1 □/km***	0.266 6.75	6.75	75	83%	16.3 53.5	53.5	see above			
																				
RG-6																				
Nominal Delay: 4.003 ns/m										Pulling Tension: 507 N										

<b>14 AWG • Solid 1.6 mm Bare Copper • 95 % Bare Copper Braid</b>																			
<b>Gas-Injected Foam PE Insulation • Black PVC Jacket</b>																			
75°C	513945	NEC: CM CEC: CM FT1	500 1000	152 305	52.5 98.1	23.8 44.5	1.63 mm 14 AWG Solid BC 8.5 □/km* 4.6 □/km**	0.280 7.11	7.11	95% BC Braid 3.9 □/km***	0.405 10.29	10.29	75	84%	16.1 52.8	52.8	1 10 50 100 200 400 700 900 1000	0.2 0.4 0.9 1.3 1.9 2.9 4.1 4.8 5.2	0.6 1.1 3.0 4.3 6.2 9.5 13.5 15.7 17.1
																			
RG-11																			
Nominal Delay: 3.97 ns/m										Pulling Tension: 640 N									

<b>Gas-Injected Foam PE Insulation • Grey FRNC/LSNH Jacket</b>																				
70°C	413945	IEC 60754-2	500 1640	152 500	100.0 159.4	14.5 72.3	1.63 mm 14 AWG Solid BC 8.5 □/km* 4.6 □/km**	0.280 7.11	7.11	95% BC Braid 3.9 □/km***	0.406 10.30	10.30	75	84%	16.1 52.8	52.8	see above			
																				
RG-11																				
Nominal Delay: 3.97 ns/m										Pulling Tension: 640 N										

\*DC loop resistance • \*\*DC resistance inner conductor • \*\*\* DC resistance outer conductor • DCR = DC resistance • BC = Bare Copper

# Security Coaxial Cables

Water-Blocked for Use in Underground Ducts



De- scription	Part No.	UL NEC/ C(UL)/CEC Type IEC	Standard Lengths		Standard Unit Weight		Conductor (Stranding) Diameter Nom. DCR	Nominal Insulation OD		Shielding Material Nom. DCR	Nominal OD		Nom. Imp. (□)	Nom. Vel. of Prop.	Nominal Capacitance		Nominal Attenuation		
			ft.	m	lbs.	kg		inch	mm		inch	mm			pF/ft.	pF/m	MHz	dB/ 100 Ft.	dB/ 100 m

**20 AWG • Solid 0.8 mm Bare Copper • Duobond® II • 95 % Tinned Copper Braid • CoreGuard®**

<b>Gas-Injected Foam PE Insulation • Black UV-Resistant PVC Jacket</b>																			
75°C	<b>5439W5</b>	NEC:	U-500	U-152	17.4	7.9	0.81 mm	0.145	3.68	Duobond® II + 95% TC Braid	0.236	5.99	75	83%	16.3	53.5	1	0.3	1.0
		CM	500	152	17.4	7.9	20 AWG										5	0.6	2.1
		CEC:	U-1000	U-305	34.0	15.4	Solid BC										10	2.0	2.9
		CM FT1	1000	305	34.0	15.4	32.8 □/km*										50	1.7	5.6
							24.6 □/km**										100	2.3	7.5
																200	3.4	11.2	
																	400	4.7	15.4
																	700	6.3	20.7
																	900	7.3	24.0
																	1000	7.8	25.6



CoreGuard®

RG-59

Nominal Delay: 3.97 ns/m

Pulling Tension: 253 N

**18 AWG • Solid 1.0 mm Bare Copper • Duofoil® • 60 % Aluminum Braid • CoreGuard®**

<b>Gas-Injected Foam PE Insulation • Black UV-Resistant PVC Jacket</b>																			
75°C	<b>5339W5</b>	NEC:	U-500	U-152	15.4	7.0	1.02 mm	0.180	4.57	Duofoil® + 60% AL Braid	0.270	6.86	75	83%	16.3	53.5	4	0.6	2.0
		CM	500	152	15.4	7.0	18 AWG										30	1.3	4.4
		CEC:	U-1000	U-305	30.0	13.6	Solid BC										211	2.0	10.1
		CM FT1	1000	305	30.0	13.6	20.9 □/km*										270	3.5	11.5
							10.8 □/km**										300	3.7	12.1
																	330	3.9	12.8
																	400	4.3	14.1
																	450	4.6	15.0
																	550	5.1	16.7
																	750	6.0	19.7
																	870	6.5	21.3
																	1000	7.0	23.0



CoreGuard®

RG-6

Nominal Delay: 3.97 ns/m

Pulling Tension: 302 N

\*DC loop resistance • \*\*DC resistance inner conductor • \*\*\* DC resistance outer conductor • DCR = DC resistance • TC = Tinned Copper • BC = Bare Copper • AL = Aluminum

Duofoil® and Duobond® II see technical information page 23.13.

# Security Coaxial Cables

CATV and MATV Applications Commercial or Schlage Systems



De- scription	Part No.	UL NEC/ C(UL)CEC Type IEC	Standard Lengths		Standard Unit Weight		Conductor (Stranding) Diameter Nom. DCR	Nominal Insulation OD		Shielding Material Nom. DCR	Nominal OD		Nom. Imp. (□)	Nom. Vel. of Prop.	Nominal Capacitance		Nominal Attenuation		
			ft.	m	lbs.	kg		inch	mm		inch	mm			pF/ft.	pF/m	MHz	dB/ 100 ft.	dB/ 100 m

**18 AWG • Solid 1.0 mm Bare Copper • Duofoil® • 60% Aluminum Braid**

Gas-Injected Foam PE Insulation • PVC Jacket (White or Black)																											
75°C	<b>5339B5</b>	NEC:	U-500	U-152	17.4	7.9	1.02 mm	0.180	4.57	Duofoil® + 60% AL Braid 10.1 □/km***	0.266	6.76	75	83%	16.3	53.5	5	0.8	2.7								
		CM:	500	152	15.4	7.0	18 AWG																				
		CEC:	U-1000	U-305	34.0	15.4	Solid BC																				
		CM FT1	1000	305	35.1	15.9	20.9 □/km*																				
							10.8 □/km**																				

Series 6  
RG-6

Also available in White. Nominal Delay: 3.97 ns/m  
Pulling Tension: 302 N

Gas-Injected Foam PE Insulation • Grey FRNC/LSNH Jacket																											
70°C	<b>4339B5</b>	IEC	328	100	11.9	5.4	1.02 mm	0.180	4.57	Duofoil® + 63% BC Braid 10.1 □/km***	0.272	6.90	75	83%	16.3	53.5	see above										
		60754-2	1640	500	59.3	26.9	18 AWG																				
		IEC 332-1					Solid BC																				
							20.9 □/km*																				

Series 6  
RG-6

Nominal Delay: 3.97 ns/m  
Pulling Tension: 302 N

**18 AWG • Solid 1.0 mm Bare Copper • Quad Shield**

Gas-Injected Foam PE Insulation • PVC Jacket (White or Black)																											
75°C	<b>5339Q5</b>	NEC:	500	152	19.0	8.6	1.02 mm	0.180	4.57	Duofoil® + 60% AL Braid Duofoil® + 40% AL Braid 10.1 □/km***	0.298	7.57	75	83%	16.3	53.5	see above										
		CM:	U-1000	U-305	35.9	16.3	18 AWG																				
		CEC:	1000	305	35.9	16.3	Solid BC																				
		CM FT1					20.9 □/km*																				
							10.8 □/km**																				

Series 6  
RG-6

Nominal Delay: 3.97 ns/m  
Pulling Tension: 462 N

Gas-Injected Foam PE Insulation • Grey FRNC/LSNH Jacket																										
70°C	<b>4339Q5</b>	IEC	328	100	12.3	5.6	1.02 mm	0.180	4.57	Duofoil® + 60% AL Braid Duofoil® + 40% AL Braid 10.1 □/km***	0.299	7.60	75	83%	16.3	53.5	see above									
		60754-2	1640	500	62.6	28.4	18 AWG																			
		IEC 332-1					Solid BC																			
							20.9 □/km*																			

Series 6  
RG-6

Nominal Delay: 3.97 ns/m  
Pulling Tension: 462 N

**18 AWG • Solid 1.0 mm Bare Copper • Duobond® (Schlage Systems) • 60% Aluminum Braid**

Foam PE Insulation • Black PVC Jacket																											
75°C	<b>5399B5</b>	NEC:	U-1000	U-305	28.0	12.7	1.02 mm	0.180	4.57	Duobond® + 60% AL Braid 10.1 □/km***	0.270	6.86	75	83%	16.3	53.5	4	0.6	2.0								
		CM:	1000	305	29.1	13.2	18 AWG																				
		CEC:					Solid BC																				
		CM FT1					20.9 □/km*																				
							10.8 □/km**																				

Series 6  
RG-6

Nominal Delay: 3.97 ns/m  
Pulling Tension: 302 N

\*DC loop resistance • \*\*DC resistance inner conductor • \*\*\* DC resistance outer conductor • DCR = DC resistance • TC = Tinned Copper • BC = Bare Copper • AL = Aluminum

Quad Shield = Duofoil Tape + 60% Aluminum Braid + Duofoil Tape + 40% Aluminum Braid  
Duofoil® and Duobond® see technical information page 23.13.

### Security Composite Cables

CCTV Plus Audio or Pan and Tilt CCTV Control Applications



De- scription	Part No.	UL NEC/ C(UL)/CEC Type IEC	Standard Lengths		Standard Unit Weight		Shielding Material	Nominal OD		Compo- nent	Description	Shielding Material & Nom. DCR	Insulation Material & Colors	Component Jacket Material & Colors	Component OD	
			ft.	m	lbs.	kg		inch	mm						inch	mm

Composite • (1) Pair Unshielded 18 AWG • (1) Coax Solid 0.8 mm Bare Copper • 95 % Bare Copper Braid

**PVC Insulation (Pairs) • Foam Insulation (Coax) • Black PVC Jacket**

300V 75°C	<b>549945</b>	NEC: CM CEC: CM FT1	500 1000	152 305	30.0 60.2	13.6 27.3	Unshielded	0.460	11.68	2xData	1-Pair 18 AWG 1.22 mm (7x26) BC	Unshielded	PVC 1.47 mm	PVC Black	0.228	5.79
--------------	---------------	------------------------------	-------------	------------	--------------	--------------	------------	-------	-------	--------	--	------------	----------------	--------------	-------	------



RG-59

1xCoax	20 AWG 0.8 mm Solid BC	95% BC	Foam Polyolefin	PVC Black	0.232	5.89
--------	------------------------------	--------	--------------------	--------------	-------	------

Color Code 1-Pair: Black and Red

**PVC Insulation (Pairs) • Foam Insulation (Coax) • Grey FRNC/LSNH Jacket**

300V 70°C	<b>449945</b>	IEC 60754-2	328 1640	100 500	19.8 98.8	9.0 44.8	Unshielded	0.461	11.70	2xData	1-Pair 18 AWG 1.22 mm (7x26) BC	Unshielded	PE 1.47 mm	FRNC Grey	0.228	5.79
--------------	---------------	----------------	-------------	------------	--------------	-------------	------------	-------	-------	--------	--	------------	---------------	--------------	-------	------



RG-59

1xCoax	20 AWG 0.8 mm Solid BC	95% BC	Foam PE	FRNC Grey	0.232	5.90
--------	------------------------------	--------	------------	--------------	-------	------

Color Code 1-Pair: Black and Red

Composite • (1) Pair Unshielded 18 AWG • (1) Coax Solid 1.0 mm Bare Copper • 95 % Bare Copper Braid

**PVC Insulation (Pairs) • Foam Insulation (Coax) • Black PVC Jacket**

300V 75°C	<b>539945</b>	NEC: CM CEC: CM FT1	500 1000	152 305	34.2 69.0	15.5 31.3	Unshielded	0.500	12.70	2xData	1-Pair 18 AWG 1.22 mm (7x26) BC	Unshielded	PVC 1.47 mm	PVC Black	0.228	5.79
--------------	---------------	------------------------------	-------------	------------	--------------	--------------	------------	-------	-------	--------	--	------------	----------------	--------------	-------	------



RG-6

Kötter approved

1xCoax	18 AWG 1.0 mm Solid BC	95% BC	Foam Polyolefin	PVC Black	0.266	6.76
--------	------------------------------	--------	--------------------	--------------	-------	------

Color Code 1-Pair: Black and Red

**PVC Insulation (Pairs) • Foam Insulation (Coax) • Grey FRNC/LSNH Jacket**

300V 70°C	<b>439945</b>	IEC 60754-2	328 1640	100 500	22.9 114.9	10.4 52.1	Unshielded	0.500	12.70	2xData	1-Pair 18 AWG 1.22 mm (7x26) BC	Unshielded	PE 1.47 mm	FRNC Grey	0.228	5.79
--------------	---------------	----------------	-------------	------------	---------------	--------------	------------	-------	-------	--------	--	------------	---------------	--------------	-------	------



RG-6

Kötter approved

1xCoax	18 AWG 1.0 mm Solid BC	95% BC	Foam PE	FRNC Grey	0.268	6.80
--------	------------------------------	--------	------------	--------------	-------	------

Color Code 1-Pair: Black and Red



BC = Bare Copper • DCR = DC resistance



### Security Composite Cables

CCTV Plus Audio or Pan and Tilt CCTV Control Applications

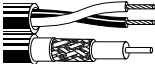
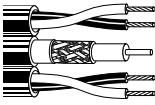

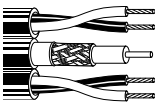
De- scription	Part No.	UL NEC/ C(UL)CEC Type IEC	Standard Lengths		Standard Unit Weight		Shielding Material	Nominal OD		Compo- nent	Description	Shielding Material & Nom. DCR	Insulation Material & Colors	Component Jacket Material & Colors	Component Insulation OD	
			ft.	m	lbs.	kg		inch	mm						inch	mm
Composite • <b>(2) Conductor</b> 26 AWG • <b>(1) Coax</b> Solid 0.4 mm Bare Copper • Alu Triplex/Duplex • 72% Tinned Copper Braid																
<b>PVC Insulation (Conductors) • Gas-Injected PE Insulation (Coax) • Grey PVC Jacket</b>																
	SEC0001		328	100	11.7	5.3	Unshielded	0.252	6.40	1xData	2 Conductor 26 AWG 0.50 mm (16x0.193) BC	Unshielded	PVC 1.90 mm	PVC	0.062	1.57
										1xCoax	21 AWG 0.41 mm Solid BC	Alu Triplex/Duplex 72% TC Braid	Foam Polyethylene	PVC	0.142	3.60
Composite • <b>(2) Conductor</b> 16 AWG • <b>(1) Coax</b> Solid 0.8 mm BC • Alu Triplex/Duplex • 55% Tinned Copper Braid • <b>(2) Conductor</b> 26 AWG																
<b>PVC Insulation (Conductors) • Gas-Injected PE Insulation (Coax) • Grey PVC Jacket</b>																
	SEC0002		328	100	29.8	13.5	Unshielded	0.315	8.00	1xData	2 Conductor 16 AWG 1.50 mm (30x0.25) BC	Unshielded	PE 3.50 mm	PVC	0.101	2.56
										1xCoax	20 AWG 0.81 mm Solid BC	Alu Triplex/Duplex 55% TC Braid	Foam Polyethylene	PVC	0.142	3.60
										1xControl	2 Conductor 26 AWG 0.50 mm (16x0.20) BC	Unshielded	PE 3.50 mm	PVC	0.062	1.57
Composite • <b>(2) Conductor</b> 20 AWG • <b>(1) Coax</b> Solid 0.4 mm Bare Copper • Alu Triplex/Duplex • 72% Tinned Copper Braid																
<b>PVC Insulation (Conductors) • Gas-Injected PE Insulation (Coax) • Grey PVC Jacket</b>																
	SEC0003		328	100	14.8	6.7	Unshielded	0.291	7.40	1xData	2 Conductor 20 AWG 1.00 mm (32x0.20) BC	Unshielded	PVC 1.90 mm	PVC	0.085	2.17
										1xCoax	26 AWG 0.41 mm Solid BC	Alu Triplex/Duplex 72% TC Braid	Foam Polyethylene	PVC	0.142	3.60
Composite • <b>(2) Conductor</b> 24 AWG • <b>(1) Coax</b> Solid 0.4 mm BC • Alu Triplex/Duplex • 72% Tinned Copper Braid • <b>(2) Conductor</b> 26 AWG																
<b>PVC Insulation (Conductors) • Gas-Injected PE Insulation (Coax) • Grey PVC Jacket</b>																
	SEC0004		328	100	13.4	6.1	Unshielded	0.260	6.60	1xData	2 Conductor 24 AWG 0.22 mm (30x0.25) BC	Unshielded	PVC 1.90 mm	PVC	0.045	1.15
										1xCoax	26 AWG 0.41 mm Solid BC	Alu Triplex/Duplex 72% TC Braid	Foam Polyethylene	PVC	0.142	3.60
										1xControl	2 Conductor 26 AWG 0.50 mm (16x0.20) BC	Unshielded	PE 3.50 mm	PVC	0.062	1.57

TC = Tinned Copper • BC = Bare Copper • DCR = DC resistance

# Security Composite Cables

## CCTV PTZ Camera Cable



De-scription	Part No.	UL NEC / C(UL)/CEC Type IEC	Standard Lengths		Standard Unit Weight		Shielding Material	Nominal OD		Component	Description	Shielding Material & Nom. DCR	Insulation Material & Colors	Component Jacket Material & Colors	Component OD	
			ft.	m	lbs.	kg		inch	mm						inch	mm

Composite • (1) **2-Pair UTP** 24 AWG • (2) **16 AWG** (19x29) 1.47 mm Tinned Copper Conductors

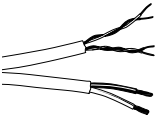
Polyolefin Insulation (Pairs) • PVC Insulation (Conductors) • PVC Jacket (White or Black)																
	<b>5284US</b>	NEC:	500	152	25.5	11.6	Unshielded	0.426	10.80	1xData	2-Pair UTP 24 AWG 0.50 mm Solid BC	Unshielded	Polyolefin	F-R PVC	0.200	5.08
		CMR:	1000	305	44.0	20.0										
										2xPower	2-Conductor 16 AWG 1.47 mm (19x29) TC	Unshielded	PVC 2.03 mm	PVC	0.226	5.74

Jacket sequentially marked.

Composite • (1) **2-Pair UTP** 23 AWG • (2) **16 AWG** (19x29) 1.47 mm Tinned Copper Conductors

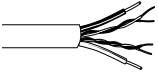
Polyolefin Insulation (Pairs) • PVC Insulation (Conductors) • PVC Jacket (White or Black)																
	<b>5284UE</b>	NEC:	500	152	22.5	10.2	Unshielded	0.233	5.92	1xData	2-Pair UTP 23 AWG 0.60 mm Solid BC	Unshielded	Polyolefin 1.01 mm	-	-	-
		CMR:	1000	305	44.0	20.0										
										2xPower	2-Conductor 16 AWG 1.47 mm (19x29) TC	Unshielded	PP 1.96 mm	-	-	-

Jacket sequentially marked.

Composite • (1) **Cat 5e 4-Bonded-Pair UTP** 24 AWG • (2) **16 AWG** (19x29) 1.47 mm Tinned Copper Conductors

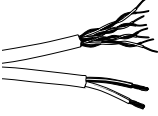
Polyolefin Insulation (Pairs) • PVC Insulation (Conductors) • PVC Jacket (White or Black)																
	<b>5288US</b>	NEC:	500	152	27.5	12.5	Unshielded	0.424	10.80	1xData	4-Pair UTP 24 AWG 0.50 mm Solid BC	Unshielded	Polyolefin	F-R PVC	0.198	5.03
		CMR:	1000	305	52.0	23.6										
										2xPower	2-Conductor 16 AWG 1.47 mm (19x29) TC	Unshielded	PVC 2.03 mm	PVC	0.226	5.74

Jacket sequentially marked.

TC = Tinned Copper • BC = Bare Copper • DCR = DC resistance

### Color Code

Pair No.	Color
1	White/Blue Stripe, Blue
2	White/Orange Stripe, Orange
3	White/Green Stripe, Green
4	White/Brown Stripe, Brown

# Security Composite Cables

## CCTV Fixed and PTZ Camera Cable



De- scription	Part No.	UL NEC/ C(UL)CEC Type IEC	Standard Lengths		Standard Unit Weight		Conductor (Stranding) Diameter Nom. DCR	Nominal Insulation OD		Shielding Material Nom. DCR	Nominal OD		Freq. MHz	Max. Atten. dB/100m	Min. PSUM			ACR dB/100m	Min. RL dB
			ft.	m	lbs.	kg		inch	mm		inch	mm			NEXT dB	ACR dB/100m	ELFEXT dB/100m		
<b>DataTwist® Cat 5e • 24 AWG • Solid 0.5 mm Bare Copper Conductors • Rip Cord</b>																			
<b>Polyolefin Insulation • Flexible Matte Black PVC Jacket • Category 5e</b>																			
<p>Rip Cord</p>	1583E	B-328 U-1000 1000 1640 3280	B-100 U-305 305 500 1000	6.1 18.7 18.7 30.9 61.7	2.8 8.5 8.5 14.0 28.0	0.51 mm 24 AWG Solid BC	0.035	0.90	Non- Bonded-Pair Unshielded U/UTP	0.197	5.00	1	2.1	62.0	60.2	61.0	63.2	20.0	
												4	4.0	53.0	49.3	49.0	52.3	23.0	
												8	5.7	49.0	43.1	43.0	46.1	24.5	
												10	6.3	47.0	41.0	41.0	44.0	25.0	
												16	8.0	44.0	36.2	37.0	39.2	25.0	
												20	9.0	43.0	33.8	35.0	36.8	23.6	
												25	10.1	41.0	31.2	33.0	34.2	24.3	
												31.25	11.4	40.0	28.5	31.0	31.5	23.6	
												62.5	16.5	35.0	18.8	25.0	21.8	21.5	
												100	21.3	32.0	11.0	21.0	14.0	20.1	
4-Pair		Input Impedance (□) 100 + 15%										Color Code: see chart below							
		500 m put-up available in Grey only.										Applicable industry standards: EN 50173, ISO/IEC 11801, TIA/EIA 568-B2							

<b>DataTwist® Cat 5e+ • 24 AWG • Solid 0.5 mm Bare Copper Conductors • Rip Cord</b>																			
<b>Polyolefin Insulation • PVC Jacket (Red, Orange, Yellow, Green, White, Blue and Dark Grey)</b>																			
<p>Rip Cord</p>	1500A	NEC: CM CEC: CM	A-1000 1000	A-305 305	26.0 22.9	11.8 10.4	0.51 mm 24 AWG Solid BC	0.035	0.89	Non- Bonded-Pair Unshielded U/UTP	0.190	4.83	1	2.0	65.3	63.3	60.8	-	20.0
													4	4.0	56.3	52.3	48.7	-	23.0
													8	5.7	51.8	46.1	42.7	-	24.5
													10	6.4	50.3	43.9	40.8	-	25.0
													16	8.1	47.3	39.1	36.7	-	25.0
													25	10.3	44.3	34.1	32.8	-	24.3
													31.25	11.6	42.9	31.3	30.9	-	23.6
													62.5	16.8	38.4	21.6	24.8	-	21.5
													100	21.7	35.3	17.1	20.8	-	20.1
													155	27.7	32.5	4.7	16.9	-	19.0
200	32.0	30.8	3.0	14.7	-	19.0													
250	36.4	29.3	-	12.8	-	18.0													
300	44.3	27.2	-	9.9	-	17.0													
4-Pair		Input Impedance (□) 1-16: 100 + 12%										Color Code: see chart below							
		25-100: + 15%										Applicable industry standards: EN 50173, ISO/IEC 11801, TIA/EIA 568-B2							
		155: + 18%																	
		200-250: + 20%																	
		350: + 22%																	

<b>DataTwist® Cat 6 • 23 AWG • Solid 0.6 mm Bare Copper Conductors • Central Rod Filler • Rip Cord</b>																																
<b>Polyolefin Insulation • PVC Jacket (Red, Orange, Yellow, Green, White, Blue and Dark Grey)</b>																																
<p>Rip Cord</p>	7881A	NEC: CM CEC: CMR FT4	A-1000 1000	A-305 305	33.1 30.0	15.0 13.6	0.57 mm 23 AWG Solid BC	0.043	1.09	Non- Bonded-Pair Unshielded U/UTP	0.235	5.97	1	2.0	72.3	70.3	64.8	-	20.0													
													10	6.0	57.3	51.3	44.8	-	25.0													
													20	8.5	52.8	44.3	38.7	-	25.0													
													31.25	10.7	49.9	39.2	34.9	-	23.6													
													62.5	15.4	45.4	30.0	28.8	-	21.5													
													100	19.8	42.3	22.5	24.8	-	20.1													
													200	29.0	37.8	8.8	18.7	-	18.0													
													250	32.8	36.3	3.5	16.8	-	17.3													
													4-Pair		Input Impedance (□) 1-100: 100 + 15%										Color Code: see chart below							
															200: + 22%										Applicable industry standards: EN 50173, ISO/IEC 11801, TIA/EIA 568-B2							
		250: + 32%																														

BC = Bare Copper • DCR = DC resistance



### Color Code

Pair No.	Color
1	White/Blue Stripe, Blue
2	White/Orange Stripe, Orange
3	White/Green Stripe, Green
4	White/Brown Stripe, Brown

# Security Composite Cables

## Video Control System Cables

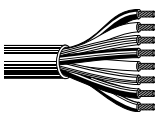

De- scription	Part No.	UL NEC/ C(UL)/CEC Type IEC	Standard Lengths		Standard Unit Weight		Shielding Material	Nominal OD		Compo- nent	Description	Shielding Material & Nom. DCR	Insulation Material & Colors	Component Jacket Material & Colors	Component Insulation OD	
			ft.	m	lbs.	kg		inch	mm						inch	mm
Composite • <b>(3) Conductor</b> 20 AWG • <b>(1) Coax</b> Solid 0.6 mm Bare Copper • 55% Tinned Copper Braid • <b>(9) Conductor</b> 20 AWG <b>PVC Insulation (Conductors) • Gas-Injected PE Insulation (Coax) • Grey PVC Jacket</b>																
	<b>SEC0005</b>		328	100	48.5	22.0	Unshielded	0.472	12.00	Power	3 Conductor 20 AWG 1.00 mm (20x0.243) BC	Unshielded	PVC	PVC	0.085	2.17
										Coax	23 AWG 0.58 mm Solid BC	55% TC Braid	PE 3.70 mm	PVC	0.146	3.70
										Control	9 Conductor 22 AWG 0.75 mm (22x0.193) BC	Unshielded	PVC	PVC	0.070	1.77
Composite • <b>(2) Conductor</b> 16 AWG • <b>(3) Pair</b> 28 AWG <b>PVC Insulation • Grey PVC Jacket</b>																
	<b>SEC0006</b>		328	100	26.5	12.0	Unshielded	0.374	9.50	Power	2 Conductor 16 AWG 1.50 mm (30x0.25) BC	Unshielded	PVC	PVC	0.101	2.56
										Control	3-Pair 28 AWG 0.35 mm (11x0.193) BC	Unshielded	PVC	PVC	0.056	1.42
Composite • <b>(2) Conductor</b> 22 AWG • <b>(1) Coax</b> Solid 0.75 mm BC • 80% Tinned Copper Braid • <b>(6) Conductor</b> 26 AWG • <b>(3) Pair</b> 28 AWG <b>PVC Insulation (Conductors) • Gas-Injected PE Insulation (Coax) • Grey PVC Jacket</b>																
	<b>SEC0007</b>		328	100	36.4	16.5	Unshielded	0.421	10.70	Power	2 Conductor 22 AWG 0.75 mm (22x0.193) BC	Unshielded	PE	PVC	0.070	1.77
										Coax	21 AWG 0.75 mm Solid BC	80% TC Braid	PE	PVC	0.134	3.40
										Data	6 Conductor 26 AWG 0.50 mm (16x0.193) BC	Unshielded	PE	PVC	0.062	1.57
										Control	3-Pair 28 AWG 0.35 mm (11x0.193) BC	Unshielded	PE	PVC	0.056	1.42

TC = Tinned Copper • BC = Bare Copper • DCR = DC resistance

20 • New Generation® Cables

### Security Composite Cables

### Banana Peel® PTZ Camera Cable Composite Cables Jacketless



De-scription	Part No.	UL NEC/ C(UL)CEC Type IEC	Standard Lengths		Standard Unit Weight		Shielding Material	Nominal OD		Component	Description	Shielding Material & Nom. DCR	Insulation Material & Colors	Component Jacket Material & Colors	Component OD	
			ft.	m	lbs.	kg		inch	mm						inch	mm

Composite • **(1) Coax** 20 AWG 0.8 mm • **(1) Pair Unshielded** 23 AWG 0.6 mm • **(2) CDR Unshielded** 18 AWG 1.2 mm • **Banana Peel®** Unjacketed, Bonded to Central Spline

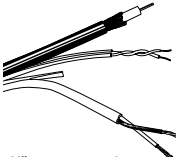
PVC Insulation (Pairs) • Foam Insulation (Coax) • Black PVC Jacket															
300V 75°C    Kötter approved	<b>500PTZ</b>  NEC: CMR CEC: CMG FT4 Shaft UL 1666	500	152	36.8	17.5	0.409	10.40	Video	1-Coax RG59/U 20 AWG 0.81 mm Solid BC	95% BC	Foam Polyethylene 5.76 mm	F-R PV Black	0.227	5.77	
		1000	305	71.2	32.3										
		White, Blue	Control	1-Pair 23 AWG 0.57 mm Solid BC	Unshielded										Polyolefin 1.04 mm
		Red, Black	Power	2-Conductor 18 AWG 1.22 mm (7x26) BC	Unshielded	PVC 2.20 mm	PVC White	0.171	4.34						

Composite • **(1) Coax** 20 AWG 0.8 mm • **(1) Pair Shielded** 22 AWG 0.6 mm • 22 AWG Drain Wire • **(2) CDR Unshielded** 18 AWG 1.2 mm • **Banana Peel®** Unjacketed, Bonded to Central Spline

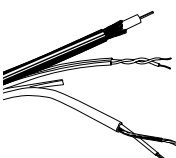
PVC Insulation (Pairs) • Foam Insulation (Coax) • Black PVC Jacket															
300V 75°C    Kötter approved	<b>501PTZ</b>  NEC: CMR CEC: CMG FT4 Shaft UL 1666	500	152	41.0	18.6	0.417	10.60	Video	1-Coax RG59/U 20 AWG 0.81 mm Solid BC	95% BC	Foam Polyethylene 5.76 mm	F-R PV Black	0.219	5.57	
		1000	305	76.1	34.5										
		White/Blue Stripe, Blue	Control	1-Pair 22 AWG 0.76 mm (7x30) BC	Overall Beldfoil® + Drain Wire (22 AWG TC)										Polyolefin 1.57 mm
		Red, Black	Power	2-Conductor 18 AWG 1.22 mm (7x26) BC	Unshielded	PVC 2.20 mm	PVC White	0.171	4.34						

Composite • **(1) Coax** 20 AWG 0.8 mm • **(1) Pair Shielded** 18 AWG 1.2 mm • 20 AWG Drain Wire • **(2) CDR Unshielded** 18 AWG 1.2 mm • **Banana Peel®** Unjacketed, Bonded to Central Spline

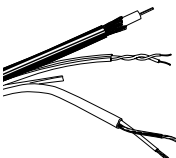
PVC Insulation (Pairs) • Foam Insulation (Coax) • Black PVC Jacket															
300V 75°C    Kötter approved	<b>502PTZ</b>  NEC: CMR CEC: CMG FT4 Shaft UL 1666	500	152	50.0	22.7	0.453	11.50	Video	1-Coax RG59/U 20 AWG 0.81 mm Solid BC	95% BC	Foam Polyethylene 5.76 mm	F-R PV Black	0.219	5.57	
		1000	305	93.9	42.6										
		White/Blue Stripe, Blue	Control	1-Pair 18 AWG 1.24 mm (19x30) BC	Overall Beldfoil® + Drain Wire (20 AWG TC)										Polyolefin 2.03 mm
		Red, Black	Power	2-Conductor 18 AWG 1.22 mm (7x26) BC	Unshielded	PVC 2.20 mm	PVC White	0.171	4.34						

TC = Tinned Copper • BC = Bare Copper • DCR = DC resistance

### Security Composite Cables

#### Banana Peel® Access Control Composite Cables Jacketless



De- scription	Part No.	UL NEC/ C(UL)/CEC Type IEC	Standard Lengths		Standard Unit Weight		Shielding Material	Nominal OD		Compo- nent	Description	Shielding Material & Nom. DCR	Insulation Material & Colors	Component Jacket Material & Colors	Component OD	
			ft.	m	lbs.	kg		inch	mm						inch	mm

Composite • **4 CDR Beldfoil®** 18 AWG 1.22 mm • **3 Pair Beldfoil®** 22 AWG 0.8 mm • **2 CDR Beldfoil®** 22 AWG 0.8 mm • **4 CDR Beldfoil®** 22 AWG 0.8 mm • **Banana Peel®** Unjacketed, Bonded Central Spline

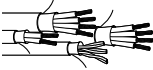
PVC Insulation (Pairs) • Foam Insulation (Coax) • Black PVC Jacket																	
 <p>Kötter approved</p>	300V 75°C	<b>558AFS</b>	NEC: CMR CEC: CMG	500 1000	152 305	58.4 108.0	26.5 49.0	White, Black, Red, Green	0.448	11.38	Lock Power	4-Conductor 18 AWG 1.22 mm (7x26) BC	Overall Beldfoil®	PVC 2.89 mm	PVC Grey	0.202	5.13
								White & Green, Orange & Brown, Red & Black			Card Reader	3-Pair 22 AWG 0.76 mm (7x30) BC	Overall Beldfoil®	PVC 1.25 mm	PVC Orange	0.233	5.92
								Black, Red			Door Contact	2-Conductor 22 AWG 0.76 mm (7x30) BC	Overall Beldfoil®	PVC 2.00 mm	PVC White	0.140	3.56
								White, Black, Red, Green			Rex/ Spare	4-Conductor 22 AWG 0.76 mm (7x30) BC	Overall Beldfoil®	PVC 2.00 mm	PVC Blue	0.161	4.09

BC = Bare Copper • DCR = DC resistance

**Fire Alarm Cables**  
Commercial Applications  
Power-Limited Unshielded



De- scription	Part No.	UL NEC/ C(UL)CEC Type IEC	Standard Lengths		Standard Unit Weight		Conductor (Stranding) Diameter Nom. DCR	Nominal Insulation OD		Shielding Material Nom. DCR	Nominal OD		Color Code
			ft.	m	lbs.	kg		inch	mm		inch	mm	

**22 AWG • Solid 0.6 mm Bare Copper • Numbered and Color Coded • Rip Cord**

**PVC Insulation • Red PVC Jacket**

300V 75°C	NEC: FPLR CEC: CMG FT4						0.64 mm 22 AWG Solid BC	0.035	0.89	Unshielded		see chart below	
--------------	---------------------------------	--	--	--	--	--	-------------------------------	-------	------	------------	--	-----------------	--

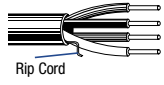

<b>5522UL</b>	4 CDR	C-500	C-152	7.1	3.2						0.125	3.18	
		U-1000 1000	U-305 305	16.1 16.1	7.3 7.3								
<b>5542UL</b>	6 CDR	C-500	C-152	10.1	4.6						0.168	4.27	
		U-1000	U-305	20.9	9.5								

**18 AWG • Solid 1.0 mm Bare Copper • Numbered and Color Coded • Rip Cord**

**PVC Insulation • Red PVC Jacket**

300V 75°C	NEC: FPLR CEC: CMG FT4						1.02 mm 18 AWG Solid BC	0.050	1.27	Unshielded		see chart below	
--------------	---------------------------------	--	--	--	--	--	-------------------------------	-------	------	------------	--	-----------------	--

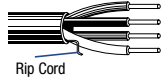

<b>5320UL</b>	2 CDR	C-500	C-152	7.9	3.6						0.151	3.84	
		U-500	U-152	9.0	4.1								
		500	152	9.0	4.1								
		U-1000 1000	U-305 305	18.1 17.0	8.2 7.7								
<b>5322UL</b>	4 CDR	C-250	C-76	7.1	3.2						0.176	4.47	
		C-500	C-152	13.2	6.0								
		U-500	U-152	15.4	7.0								
		U-1000	U-305	30.0	13.6								
		1000	305	30.0	13.6								
<b>5324UL</b>	6 CDR	500	152	23.6	10.7						0.212	5.38	
		U-1000	U-305	43.0	19.5								
		1000	305	44.1	20.0								
<b>5326UL</b>	8 CDR	1000	305	61.1	27.7						0.230	5.84	
<b>5328UL</b>	10 CDR	1000	305	71.2	32.3						0.272	6.91	
<b>5329UL</b>	12 CDR	1000	305	83.1	37.7						0.281	7.14	

BC = Bare Copper • DCR = DC resistance

**Color Code**

Cond. No.	Color	Cond. No.	Color	Cond. No.	Color	Cond. No.	Color
1	Black	4	Blue	7	Purple	10	Red/White
2	Red	5	Orange	8	Green	11	Red/Green
3	Brown	6	Yellow	9	Red/Black	12	Red/Blue

# Fire Alarm Cables

Commercial Applications  
Power-Limited Unshielded



De- scription	Part No.	UL NEC/ C(UL)/CEC Type IEC	Standard Lengths		Standard Unit Weight		Conductor (Stranding) Diameter Nom. DCR	Nominal Insulation OD		Shielding Material Nom. DCR	Nominal OD		Color Code
			ft.	m	lbs.	kg		inch	mm		inch	mm	

**22 AWG** • Solid 0.6 mm Bare Copper • Numbered and Color Coded • Rip Cord

**Polyethylene Insulation • Red FRNC/LSNH Jacket**

300V 75°C	IEC 60754-2						1.02 mm 18 AWG Solid BC	0.068	1.72	Unshielded		see chart below	
--------------	-------------	--	--	--	--	--	-------------------------------	-------	------	------------	--	-----------------	--

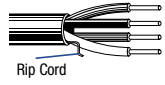

Part No.	Conductor	Length (ft.)	Length (m)	Weight (lbs.)	Weight (kg)	Insulation OD (inch)	Insulation OD (mm)
4322UL	4 CDR	328	100	9.3	4.2	0.177	4.50
		1640	500	46.3	21.0		
4324UL	6 CDR	328	100	13.0	5.9	0.213	5.40
		1640	500	65.0	29.5		

BC = Bare Copper • DCR = DC resistance

**Color Code**

Cond. No.	Color	Cond. No.	Color
1	Black	4	Blue
2	Red	5	Orange
3	Brown	6	Yellow

20 • New Generation® Cables



**Fire Alarm Cables**  
Commercial Applications  
Power-Limited Unshielded



De- scription	Part No.	UL NEC/ C(UL)CEC Type IEC	Standard Lengths		Standard Unit Weight		Conductor (Stranding) Diameter Nom. DCR	Nominal Insulation OD		Shielding Material Nom. DCR	Nominal OD		Color Code
			ft.	m	lbs.	kg		inch	mm		inch	mm	

**16 AWG • Solid 1.3 mm Bare Copper • Numbered and Color Coded • Rip Cord**

**PVC Insulation • Red PVC Jacket**

300V  
75°C  
NEC:  
FPLR  
CEC:  
CMG FT4  
1.29 mm  
16 AWG  
Solid BC  
0.061 1.54 Unshielded

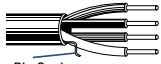

Rip Cord

<b>5220UL</b>	2 CDR	500	152	13.0	5.9	0.174	4.42	Black, Red
		U-1000 1000	U-305 305	24.0 25.1	10.9 11.4			

<b>5222UL</b>	4 CDR	1000	305	45.0	20.4	0.204	5.18	Black, Red, Brown, Blue
---------------	-------	------	-----	------	------	-------	------	-------------------------

**Polyethylene Insulation • Red FRNC / LSNH Jacket**

300V  
70°C  
IEC 60754-2  
1.29 mm  
16 AWG  
Solid BC  
0.077 1.95 Unshielded

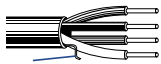

Rip Cord

<b>4220UL</b>	2 CDR	328	100	7.7	3.5	0.173	4.40	Black, Red
		1640	500	38.4	17.4			

<b>4222UL</b>	4 CDR	1640	500	67.7	30.7	0.201	5.10	Black, Red, Brown, Blue
---------------	-------	------	-----	------	------	-------	------	-------------------------

**14 AWG • Solid 1.6 mm Bare Copper • Numbered and Color Coded • Rip Cord**

**PVC Insulation • Red PVC Jacket**

300V  
75°C  
NEC:  
FPLR  
CEC:  
CMG FT4  
1.63 mm  
14 AWG  
Solid BC  
0.077 1.96 Unshielded

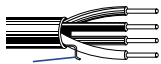

Rip Cord

<b>5120UL</b>	2 CDR	500	152	19.0	8.6	0.213	5.41	Black, Red
		1000	305	38.1	17.3			

<b>5122UL</b>	4 CDR	1000	305	70.1	31.8	0.251	6.38	Black, Red, Brown, Blue
---------------	-------	------	-----	------	------	-------	------	-------------------------

**Polyethylene Insulation • Red FRNC / LSNH Jacket**

300V  
70°C  
IEC 60754-2  
1.63 mm  
14 AWG  
Solid BC  
0.085 2.15 Unshielded



Rip Cord

<b>4120UL</b>	2 CDR	328	100	11.2	5.1	0.213	5.40	Black, Red
		1640	500	56.0	25.4			

<b>4122UL</b>	4 CDR	328	100	19.8	9.0	0.252	6.40	Black, Red, Brown, Blue
		1640	500	99.9	45.3			

BC = Bare Copper • DCR = DC resistance

# Fire Alarm Cables

Commercial Applications  
Power-Limited Unshielded



De- scription	Part No.	UL NEC/ C(UL)/CEC Type IEC	Standard Lengths		Standard Unit Weight		Conductor (Stranding) Diameter Nom. DCR	Nominal Insulation OD		Shielding Material Nom. DCR	Nominal OD		Color Code
			ft.	m	lbs.	kg		inch	mm		inch	mm	

**12 AWG • Solid 2.1 mm Bare Copper • Numbered and Color Coded • Rip Cord**

**PVC Insulation • Red PVC Jacket**

300V 75°C	<b>5020UL</b>	NEC: FPLR CEC: CMG FT4	1000	305	55.1	25.0	2.05 mm 12 AWG Solid BC	0.094	2.38	Unshielded	0.247	6.27	Black, Red
--------------	---------------	---------------------------------	------	-----	------	------	-------------------------------	-------	------	------------	-------	------	------------

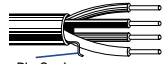

Rip Cord

2 CDR

**Polyethylene Insulation • Red FRNC/LSNH Jacket**

300V 70°C	<b>4020UL</b>	IEC 60754-2	1640	500	85.3	38.7	2.05 mm 12 AWG Solid BC	0.107	2.72	Unshielded	0.248	6.30	Black, Red
--------------	---------------	----------------	------	-----	------	------	-------------------------------	-------	------	------------	-------	------	------------

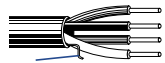

Rip Cord

2 CDR

BC = Bare Copper • DCR = DC resistance

20 • New Generation® Cables

**Fire Alarm Cables**  
Commercial Applications  
Power-Limited Shielded



De- scription	Part No.	UL NEC/ C(UL)CEC Type IEC	Standard Lengths		Standard Unit Weight		Conductor (Stranding) Diameter Nom. DCR	Nominal Insulation OD		Shielding Material Nom. DCR	Nominal OD		Color Code
			ft.	m	lbs.	kg		inch	mm		inch	mm	

**22 AWG • Solid 0.6 mm Bare Copper • Beldfoil® Shield • 24 AWG Tinned Copper Drain Wire • Numbered and Color Coded • Rip Cord**

**PVC Insulation • Red PVC Jacket**

300V 75°C	<b>5522FL</b>	NEC: FPLR CEC: CMG FT4	C-500 U-1000 1000	C-152 U-305 305	9.0 19.0 19.0	4.1 8.6 8.6	0.64 mm 22 AWG Solid BC	0.035 0.89		Overall Beldfoil® + Drain Wire (24 AWG TC)	0.145 3.68		Black, Red, Brown, Blue
--------------	---------------	---------------------------------	-------------------------	-----------------------	---------------------	-------------------	-------------------------------	---------------	--	---	---------------	--	-------------------------



Shorting Fold

4 CDR

**18 AWG • Solid 1.0 mm Bare Copper • Beldfoil® Shield • 24 AWG Tinned Copper Drain Wire • Numbered and Color Coded • Rip Cord**

**PVC Insulation • Red PVC Jacket**

300V 75°C		NEC: FPLR CEC: CMG FT4					1.02 mm 18 AWG Solid BC	0.050 1.27		Overall Beldfoil® + Drain Wire (24 AWG TC)			
--------------	--	---------------------------------	--	--	--	--	-------------------------------	---------------	--	---	--	--	--



Shorting Fold

<b>5320FL</b>	2 CDR	C-500 U-500 500 U-1000 1000	C-152 U-152 152 U-305 305	10.6 11.5 11.5 22.0 22.0	4.8 5.2 5.2 10.0 10.0						0.155 3.94		Black, Red
---------------	-------	---	---------------------------------------	--------------------------------------	-----------------------------------	--	--	--	--	--	---------------	--	------------

<b>5322FL</b>	4 CDR	C-500 500 U-1000 1000	C-152 152 U-305 305	15.4 16.5 32.0 34.0	7.0 7.5 14.5 15.4						0.170 4.32		Black, Red, Brown, Blue
---------------	-------	--------------------------------	------------------------------	------------------------------	----------------------------	--	--	--	--	--	---------------	--	-------------------------

**Polyethylene Insulation • Red FRNC / LSNH Jacket**

300V 70°C		IEC 60754-2					1.02 mm 18 AWG Solid BC	0.060 1.52		Overall Beldfoil® + Drain Wire (24 AWG TC)			Black, Red, Brown, Blue
--------------	--	-------------	--	--	--	--	-------------------------------	---------------	--	---	--	--	-------------------------



Shorting Fold

<b>4320FL</b>	4 CDR	328 1640	100 500	3.3 16.5	1.5 7.5						0.157 4.00		
---------------	-------	-------------	------------	-------------	------------	--	--	--	--	--	---------------	--	--

<b>4322FL</b>	4 CDR	328 1640	100 500	3.7 18.1	1.7 8.2						0.169 4.30		
---------------	-------	-------------	------------	-------------	------------	--	--	--	--	--	---------------	--	--

**16 AWG • Solid 1.3 mm Bare Copper • Beldfoil® Shield • 24 AWG Tinned Copper Drain Wire • Numbered and Color Coded • Rip Cord**

**PVC Insulation • Red PVC Jacket**

300V 75°C		NEC: FPLR CEC: CMG FT4					1.29 mm 16 AWG Solid BC	0.061 1.54		Overall Beldfoil® + Drain Wire (24 AWG TC)			
--------------	--	---------------------------------	--	--	--	--	-------------------------------	---------------	--	---	--	--	--



Shorting Fold

<b>5220FL</b>	2 CDR	1000	305	29.1	13.2						0.178 4.52		Black, Red
---------------	-------	------	-----	------	------	--	--	--	--	--	---------------	--	------------

<b>5222FL</b>	4 CDR	1000	305	50.0	22.7						0.208 5.28		Black, Red, Brown, Blue
---------------	-------	------	-----	------	------	--	--	--	--	--	---------------	--	-------------------------

**Polyethylene Insulation • Red FRNC / LSNH Jacket**

300V 70°C	<b>4220FL</b>	IEC 60754-2	328 1640	100 500	8.8 44.5	4.0 20.2	1.29 mm 16 AWG Solid BC	0.071 1.80		Overall Beldfoil® + Drain Wire (24 AWG TC)	0.177 4.50		Black, Red
--------------	---------------	-------------	-------------	------------	-------------	-------------	-------------------------------	---------------	--	---	---------------	--	------------



Shorting Fold

2 CDR

TC = Tinned Copper • BC = Bare Copper • DCR = DC resistance

**Fire Alarm Cables**  
Commercial Applications  
Power-Limited Shielded



De- scription	Part No.	UL NEC/ C(UL)/CEC Type IEC	Standard Lengths		Standard Unit Weight		Conductor (Stranding) Diameter Nom. DCR	Nominal Insulation OD		Shielding Material Nom. DCR	Nominal OD		Color Code
			ft.	m	lbs.	kg		inch	mm		inch	mm	

**14 AWG • Solid 1.6 mm Bare Copper • Beldfoil® Shield • 24 AWG Tinned Copper Drain Wire • Numbered and Color Coded • Rip Cord**

**PVC Insulation • Red PVC Jacket**

300V 75°C		NEC: FPLR CEC: CMG FT4					1.63 mm 14 AWG Solid BC	0.077	1.96	Overall Beldfoil® + Drain Wire (24 AWG TC)			
--------------	--	---------------------------------	--	--	--	--	-------------------------------	-------	------	---	--	--	--



Shorting Fold

<b>5120FL</b>	2 CDR	500 1000	152 305	22.0 43.0	10.0 19.5						0.217	5.51	Black, Red
<b>5122FL</b>	4 CDR	1000	305	79.1	35.9						0.255	6.48	Black, Red, Brown, Blue

**Polyethylene Insulation • Red FRNC/LSNH Jacket**

300V 70°C	<b>4120FL</b>	IEC 60754-2	1640	500	64.4	29.2	1.63 mm 14 AWG Solid BC	0.085	2.15	Overall Beldfoil® + Drain Wire (24 AWG TC)	0.217	5.50	Black, Red
--------------	---------------	----------------	------	-----	------	------	-------------------------------	-------	------	---	-------	------	------------



Shorting Fold

2 CDR

**12 AWG • Solid 2.0 mm Bare Copper • Beldfoil® Shield • 24 AWG Tinned Copper Drain Wire • Numbered and Color Coded • Rip Cord**

**Polyethylene Insulation • Red FRNC/LSNH Jacket**

300V 75°C	<b>5020FL</b>	NEC: FPLR CEC: CMG FT4	1000	305	60.0	27.2	2.05 mm 12 AWG Solid BC	0.094	2.38	Overall Beldfoil® + Drain Wire (24 AWG TC)	0.251	6.38	Black, Red
--------------	---------------	---------------------------------	------	-----	------	------	-------------------------------	-------	------	---	-------	------	------------



Shorting Fold

2 CDR

**Polyethylene Insulation • Red FRNC/LSNH Jacket**

300V 70°C	<b>4020FL</b>	IEC 60754-2	1640	500	90.4	41.0	2.05 mm 12 AWG Solid BC	0.107	2.72	Overall Beldfoil® + Drain Wire (24 AWG TC)	0.252	6.40	Black, Red
--------------	---------------	----------------	------	-----	------	------	-------------------------------	-------	------	---	-------	------	------------



Shorting Fold

2 CDR

TC = Tinned Copper • BC = Bare Copper • DCR = DC resistance

# Fire Alarm Cables

Commercial Applications, Addressable Systems  
Power-Limited, Mid-Capacitance Unshielded and Shielded



De- scription	Part No.	UL NEC/ C(UL)CEC Type IEC	Standard Lengths		Standard Unit Weight		Conductor (Stranding) Diameter Nom. DCR	Nominal Insulation OD		Shielding Material Nom. DCR	Nominal OD		Color Code
			ft.	m	lbs.	kg		inch	mm		inch	mm	

**18 AWG • Solid 1.0 mm Bare Copper • Numbered and Color Coded • Rip Cord**

**Foam Polyethylene Insulation • Red PVC Jacket**

300V 75°C	<b>5320UJ</b>	NEC: FPL	U-1000	U-305	22.0	10.0	1.02 mm 18 AWG Solid BC	0.055	1.40	Unshielded	0.206	5.23	Black, Red
--------------	---------------	-------------	--------	-------	------	------	-------------------------------	-------	------	------------	-------	------	------------

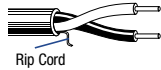

2 CDR

**16 AWG • Solid 1.3 mm Bare Copper • Numbered and Color Coded • Rip Cord**

**Foam Polyethylene Insulation • Red PVC Jacket**

300V 75°C	<b>5220UJ</b>	NEC: FPL	500 1000	152 305	16.1 32.0	7.3 14.5	1.29 mm 16 AWG Solid BC	0.066	1.67	Unshielded	0.230	5.84	Black, Red
--------------	---------------	-------------	-------------	------------	--------------	-------------	-------------------------------	-------	------	------------	-------	------	------------



2 CDR

**18 AWG • Solid 1.0 mm Bare Copper • Numbered and Color Coded • Beldfoil® Shield • Rip Cord**

**Foam Polyethylene Insulation • Red PVC Jacket**

300V 75°C		NEC: FPL					1.02 mm 18 AWG Solid BC	0.055	1.40	Overall Beldfoil®			
--------------	--	-------------	--	--	--	--	-------------------------------	-------	------	----------------------	--	--	--



<b>5320FJ</b>	2 CDR	U-1000 1000	U-305 305	27.1 28.0	12.3 12.7						0.211	5.36	Black, Red
<b>5322FJ</b>	4 CDR	1000	305	43.0	19.5						0.240	6.10	Black, Red, Brown, Blue

**16 AWG • Solid 1.3 mm Bare Copper • Numbered and Color Coded • Beldfoil® Shield • Rip Cord**

**Foam Polyethylene Insulation • Red PVC Jacket**

300V 75°C		NEC: FPL					1.29 mm 16 AWG Solid BC	0.066	1.67	Overall Beldfoil®			
--------------	--	-------------	--	--	--	--	-------------------------------	-------	------	----------------------	--	--	--



<b>5220FJ</b>	2 CDR	U-1000 1000	U-305 305	18.1 35.1 37.0	8.2 15.9 16.8						0.235	5.97	Black, Red
<b>5222FJ</b>	4 CDR	1000	305	59.1	26.8						0.269	6.83	Black, Red, Brown, Blue

BC = Bare Copper • DCR = DC resistance

### Fire Alarm Cables

Commercial Applications, Addressable Systems  
 Power-Limited, Mid-Capacitance Unshielded and Shielded



De- scription	Part No.	UL NEC/ C(UL)/CEC Type IEC	Standard Lengths		Standard Unit Weight		Conductor (Stranding) Diameter Nom. DCR	Nominal Insulation OD		Shielding Material Nom. DCR	Nominal OD		Color Code
			ft.	m	lbs.	kg		inch	mm		inch	mm	

**14 AWG** • Solid 1.6 mm Bare Copper • Numbered and Color Coded • **Beldfoil®** Shield • Rip Cord

Foam Polyethylene Insulation • Red PVC Jacket													
300V 75°C	<b>5120FJ</b>	NEC: FPL	1000	305	49.2	22.3	1.63 mm 14 AWG Solid BC	0.084	2.14	Overall Beldfoil®	0.279	7.09	Black, Red



Shorting Fold  
 2 CDR  
 Shielded

**12 AWG** • Solid 2.1 mm Bare Copper • Numbered and Color Coded • **Beldfoil®** Shield • Rip Cord

Foam Polyethylene Insulation • Red PVC Jacket													
300V 75°C	<b>5020FJ</b>	NEC: FPL	1000	305	69.0	31.3	2.1 mm 12 AWG Solid BC	0.084	2.14	Overall Beldfoil®	0.317	8.05	Black, Red



Shorting Fold  
 2 CDR

BC = Bare Copper • DCR = DC resistance

20 • New Generation® Cables

# Fire Alarm Cables

NPLF Systems

Non-Power-Limited Signaling Cable Unshielded and Shielded



De- scription	Part No.	UL NEC/ C(UL)CEC Type IEC	Standard Lengths		Standard Unit Weight		Conductor (Stranding) Diameter Nom. DCR	Nominal Insulation OD		Shielding Material Nom. DCR	Nominal OD		Color Code
			ft.	m	lbs.	kg		inch	mm		inch	mm	

**18 AWG • Solid 1.0 mm Bare Copper • Numbered and Color Coded • Rip Cord**

**PVC/Nylon Insulation • Red PVC Jacket**

150V 75°C	NEC: NPLF						1.02 mm 18 AWG Solid BC	0.061	1.55	Unshielded			
--------------	--------------	--	--	--	--	--	-------------------------------	-------	------	------------	--	--	--

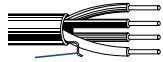

Rip Cord

<b>5320UN</b>	2 CDR	500	152	14.1	6.4						0.239	6.07	Black, Red
		1000	305	31.1	14.1								
<b>5322UN</b>	4 CDR	500	152	28.0	12.7						0.283	7.19	Black, Red, Brown, Blue
		1000	305	52.9	24.0								

**16 AWG • Solid 1.3 mm Bare Copper • Numbered and Color Coded • Rip Cord**

**PVC/Nylon Insulation • Red PVC Jacket**

150V 75°C	NEC: NPLF						1.29 mm 16 AWG Solid BC	0.072	1.82	Unshielded			
--------------	--------------	--	--	--	--	--	-------------------------------	-------	------	------------	--	--	--



Rip Cord

<b>5220UN</b>	2 CDR	500	152	22.0	10.0						0.262	6.65	Black, Red
		1000	305	39.9	18.1								
<b>5222UN</b>	4 CDR	1000	305	71.2	32.3						0.311	7.90	Black, Red, Brown, Blue

**14 AWG • Solid 1.6 mm Bare Copper • Numbered and Color Coded • Rip Cord**

**PVC/Nylon Insulation • Red PVC Jacket**

150V 75°C	<b>5120UN</b>	NEC: NPLF	500	152	28.7	13.0	1.63 mm 14 AWG Solid BC	0.085	2.16	Unshielded	0.299	7.59	Black, Red
--------------	---------------	--------------	-----	-----	------	------	-------------------------------	-------	------	------------	-------	------	------------



Rip Cord

2 CDR

**18 AWG • Solid 1.0 mm Bare Copper • Numbered and Color Coded • Beldfoil® Shield • 20 AWG Tinned Copper Drain Wire • Rip Cord**

**PVC/Nylon Insulation • Red PVC Jacket**

150V 75°C	NEC: NPLF						1.02 mm 18 AWG Solid BC	0.061	1.55	Overall Beldfoil® + Drain Wire (20 AWG TC)			
--------------	--------------	--	--	--	--	--	-------------------------------	-------	------	---	--	--	--



Shorting Fold

<b>5320FN</b>	2 CDR	500	152	15.4	7.0						0.243	6.17	Black, Red
		1000	305	35.1	15.9								
<b>5322FN</b>	4 CDR	500	152	31.1	14.1						0.287	7.29	Black, Red, Brown, Blue
		1000	305	57.1	25.9								



TC = Tinned Copper • BC = Bare Copper • DCR = DC resistance

# Fire Alarm Cables

NPLF Systems

Non-Power-Limited Signaling Cable Unshielded and Shielded



De-scription	Part No.	UL NEC / C(UL)/CEC Type IEC	Standard Lengths		Standard Unit Weight		Conductor (Stranding) Diameter Nom. DCR	Nominal Insulation OD		Shielding Material Nom. DCR	Nominal OD		Color Code
			ft.	m	lbs.	kg		inch	mm		inch	mm	
<b>16 AWG • Solid 1.3 mm Bare Copper • Numbered and Color Coded • Beldfoil® Shield • 20 AWG Tinned Copper Drain Wire • Rip Cord</b>													
<b>PVC/Nylon Insulation • Red PVC Jacket</b>													
150V 75°C		NEC: NPLF					1.29 mm 16 AWG Solid BC	0.072	1.82	Overall Beldfoil® + Drain Wire (20 AWG TC)			
													
	<b>5220FN</b>	2 CDR	500 1000	152 305	23.6 45.2	10.7 20.5					0.266	6.76	Black, Red
	<b>5222FN</b>	4 CDR	500 1000	152 305	40.6 76.1	18.4 34.5					0.315	8.00	Black, Red, Brown, Blue
<b>14 AWG • Solid 1.6 mm Bare Copper • Numbered and Color Coded • Beldfoil® Shield • 20 AWG Tinned Copper Drain Wire • Rip Cord</b>													
<b>PVC/Nylon Insulation • Red PVC Jacket</b>													
150V 75°C		NEC: NPLF					1.63 mm 14 AWG Solid BC	0.085	2.16	Overall Beldfoil® + Drain Wire (20 AWG TC)			
													
	<b>5120FN</b>	2 CDR	500 1000	152 305	32.0 61.1	14.5 27.7					0.303	7.70	Black, Red
	<b>5122FN</b>	4 CDR	500 1000	152 305	50.7 102.3	23.0 46.4					0.348	8.84	Black, Red, Brown, Blue
<b>12 AWG • Solid 2.1 mm Bare Copper • Numbered and Color Coded • Beldfoil® Shield • 20 AWG Tinned Copper Drain Wire • Rip Cord</b>													
<b>PVC/Nylon Insulation • Red PVC Jacket</b>													
150V 75°C	<b>5020FN</b>	NEC: FPL	500 1000	152 305	43.0 83.1	19.5 37.7	2.05 mm 12 AWG Solid BC	0.102	2.58	Overall Beldfoil® + Drain Wire (20 AWG TC)	0.337	8.56	Black, Red
													
		2 CDR											

TC = Tinned Copper • BC = Bare Copper • DCR = DC resistance



# Circuit Integrity & Fire Protection Cables

Commercial Applications  
Power-Limited Shielded



De- scription	Part No.	UL NEC/ C(UL)CEC Type IEC	Standard Lengths		Standard Unit Weight		Conductor (Stranding) Diameter Nom. DCR	Nominal Insulation OD		Shielding Material Nom. DCR	Nominal OD		Color Code
			ft.	m	lbs.	kg		inch	mm		inch	mm	

**17 AWG** • Solid 1.13 mm Plain Annealed Copper to BS6360 • Circuit Protection Conductor • Mica/Glass Fire Barrier • Aluminum/Polyester Taped Screen • Drain Wire

**XL Polyolefin FROH Insulation • Red FRNC/LSNH Jacket**

<p>300V 70°C</p> <p>1.0 mm<sup>2</sup></p>	IEC 331	1.13 mm 17 AWG Solid Plain Annealed Copper BS6360 + Circuit Protection	0.115	2.93	Mica/Glass Fire Barrier Overall Alu/PE foil FROH + Drain Wire	4K20FX	2 CDR	328 1640	100 500	21.2 105.8	9.6 48.0	0.313	7.96	Black, Red
						4K21FX	3 CDR	328 1640	100 500	25.4 126.8	11.5 57.5	0.331	8.41	Black, Red, Yellow
						4K22FX	4 CDR	328 1640	100 500	28.4 142.2	12.9 64.5	0.361	9.17	Black, Red, Yellow, Blue

**15 AWG** • Solid 1.38 mm Plain Annealed Copper to BS6360 • Circuit Protection Conductor • Mica/Glass Fire Barrier • Aluminum/Polyester Taped Screen • Drain Wire

**XL Polyolefin FROH Insulation • Red FRNC/LSNH Jacket**

<p>300V 70°C</p> <p>1.5 mm<sup>2</sup></p>	IEC 331	1.38 mm 15 AWG Solid Plain Annealed Copper BS6360 + Circuit Protection	0.126	3.20	Mica/Glass Fire Barrier Overall Alu/PE foil FROH + Drain Wire	4L20FX	2 CDR	328 1640	100 500	26.2 131.2	11.9 59.5	0.335	8.50	Black, Red
						4L21FX	3 CDR	328 1640	100 500	33.3 166.4	15.1 75.5	0.354	8.99	Black, Red, Yellow
						4L22FX	4 CDR	328 1640	100 500	37.7 188.5	17.1 85.5	0.387	9.82	Black, Red, Yellow, Blue
						4L25FX	7 CDR	328 1640	100 500	57.8 288.8	26.2 131.0	0.469	11.90	Black, Red, Yellow, Blue, Black, Red, Yellow

**13 AWG** • Solid 1.78 mm Plain Annealed Copper to BS6360 • Circuit Protection Conductor • Mica/Glass Fire Barrier • Aluminum/Polyester Taped Screen • Drain Wire

**XL Polyolefin FROH Insulation • Red FRNC/LSNH Jacket**

<p>300V 70°C</p> <p>2.5 mm<sup>2</sup></p>	IEC 331	1.78 mm 13 AWG Solid Plain Annealed Copper BS6360 + Circuit Protection	0.149	3.79	Mica/Glass Fire Barrier Overall Alu/PE foil FROH + Drain Wire	4N20FX	2 CDR	328 1640	100 500	36.2 180.8	16.4 82.0	0.381	9.68	Black, Red
						4N21FX	3 CDR	328 1640	100 500	49.2 245.8	22.3 111.5	0.412	10.46	Black, Red, Yellow
						4N22FX	4 CDR	328 1640	100 500	56.9 255.7	25.8 116.0	0.467	11.85	Black, Red, Yellow, Blue

Alu = Aluminum • PE = Polyester • DCR = DC resistance



Residential Cables

21

**Table of Contents**

<b>Residential Cables</b>	<b>Page No.</b>
<b>Introduction</b>	<b>21.2 – 21.3</b>
<b>Composite Data, Audio, Video, Security and Control Cables</b>	<b>21.4 – 21.8</b>
Banana Peel® Jacketless Cables: <i>Category 5e</i>	21.4 – 21.5
Siamese Cables: <i>Category 5e</i>	21.6
Multimedia Control Cables	21.7 – 21.8
<b>Brilliance® VideoTwist®</b>	<b>21.9</b>
Low Skew UTP Cables for Video Transmission	21.9
<b>Home Cinema Audio Cables</b>	<b>21.10 – 21.11</b>
High-Conductivity Copper (Oxygen-Free) Speaker Cables	21.10 – 21.11
<b>Home Cinema Video Cables</b>	<b>21.12 – 21.13</b>
Low Loss HDTV/SDI Digital Coax and SVHS Coax	21.12
Multicore Cables	21.13
<b>Tools and Accessories</b>	<b>21.14</b>

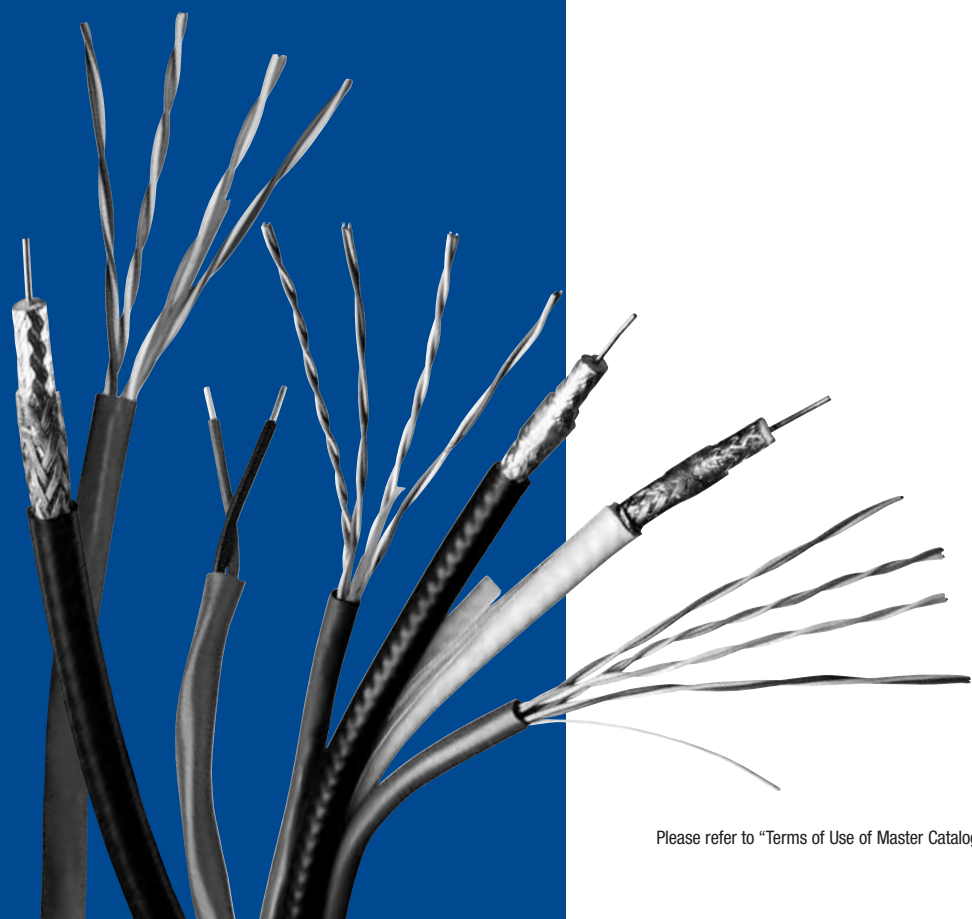

## Introduction



### A House is More than a Home.

The intelligent home is here – a living, working, entertaining, learning place. Cables tie the whole experience together providing high quality, superior performance, proven reliability and wide choice to meet all the needs of changing technology and the demands of the discerning consumer.

### Key Applications

- Home office
- Audio/video
- Climate control
- Window shade automation
- Lighting

### Special Features

Every Belden cable (and connector) is subject to the industry's most rigorous quality control process.

- **High-Performance, Easy-to-Install Cables and Connectors**  
Individual or single application cables are available for any data, video, audio, control or security need, including:
  - Category 5e UTP and optical fiber cables for multimedia, voice, video and data use.
  - Coax cables for HDTV, DBS, CATV, SVHS, CCTV, S-Video, SPIF and cable modem applications.
  - High-conductivity (oxygen-free) speaker cables for audio distribution.
  - Paired, unshielded cables for control applications.
  - Non-category, Cat 5e and Cat 6 low skew performance UTP cables for video signals over twisted pair cables.
  - One-piece connectors and tools that facilitates fast and easy cable connection.
- **Belden also Offers Several Different Composite Cables.**  
Composite cables simplify a multiple use installation by combining Belden data cables, coaxial cables, paired and multi-conductor cables and fiber optic cables in a single-pull product.  
  
Installation of these cables means that residential properties will be "future-proof" – ready to embrace the next generation of home entertainment and new technology. This makes a property more saleable and more attractive to the buyer.
- **Time-tested and Preferred in other Industries**  
Many Belden Residential cables in this catalog have been long-standing leaders in other industries such as:
  - **Computer Networks**  
Where Belden offers the most innovative cables and the leading data cable technology worldwide.
  - **Broadcast**  
Where network studios prefer Belden over any other cable for picture-perfect quality and professional audio technicians demand Belden for crystal-clear audio quality.

- **Broadband CATV**  
Where Belden Duobond® Plus (tri-shield) cables have consistently outperformed the more elaborate quad-shielded cables.
- **Alarm/Security**  
Where Belden has been a favorite among installers for many years.

Now, these industry-leading and time-tested cables are available, along with many new innovations, for wiring the home of the 21st Century...only from Belden.

- **Better Design and Better Performance**  
Some unique high performance technologies are used in the manufacture of the various cables, including:
  - **Bonded-Pair Data Cables to Provide the Assurance of Installable Performance™**  
With patented bonded-pair design, the cables are able to withstand the rigors of a typical installation without any degradation in performance. This means, for example, that the Cat 5e cable will not only meet the Cat 5e specifications before installation but, more importantly, it will continue to meet them after installation.
  - **Coax Cables with Belden's Exclusive Duobond® Plus Shielding**  
Duobond® Plus consists of a Duofoil® II (foil tape) surrounded by an 80% braid and an outer layer of foil with a shorting fold. This unique construction provides optimum shielding effectiveness.
  - **Composite Cables – Without a Jacket**  
Belden Banana Peel® composite cables feature a patent-pending design that eliminates the need for an overall jacket, making the cables easy to handle, identify, pull and terminate. All that is necessary is to peel the cables off the center spline. These cables are increasingly used for multiple installations in new homes.
- **BNC and RCA Connectors**  
One-piece BNC and RCA connectors feature a solid, one-piece brass and nickel-plated construction with gold-plated center pins. They are recommended for mini hi-res video cables:
  - 1277R-1280R
  - 1281R
  - 1281S3-S6

To ensure proper connection an easy-to-use compression tool and a stripping tool is available.
- **Multimedia Control Cable**  
1502R is a multimedia touch panel control cable for modern audio-video (A/V) and building management systems. When used in conjunction with a touch panel control, these cables improve user comfort and convenience, security and personal enjoyment.
- **Enhanced Sound Performance**  
The copper conductors of Brilliance low cap OFHC speaker cable have been manufactured using an upright shaft manufacturing process. The result of this process is a high-conductivity copper conductor that is inherently free of impurities. Exceptional sound clarity is also achieved by using polyolefin insulation, a much better dielectric than traditional PVC. The low capacitance of this insulation material provides the cable with a superior high frequency response and the facility for extended distance runs.

## Introduction



### • Easy Installation

Easy installation features include the following:

- Brightly colored jackets for easy identification
- Print legends that facilitate location identification (Room 12345, Zone ABCDE)
- Cable jackets with ascending/descending sequential markings at 0.6 m intervals
- Extremely flexible, easy-to-pull constructions (highly stranded conductors; PVC)

### Brilliance® VideoTwist® UTP Cables

To meet the new video/data UTP requirements, Belden has designed a new series of cables. High resolution videos require high performance cables that have low signal skew and low return loss. Typically, these systems use bundled coax for the cable interconnection. Increasingly, however, system designers are turning to unshielded twisted pair (UTP) transmission equipment to distribute component RGB video because UTP is cheaper than coax. UTP cables also mean that the same cable can be used for premise LAN wiring – eliminating the need for two separate cables.

Brilliance VideoTwist® UTP cables offer the best low skew and return loss performance in the marketplace and are designed for quality video applications – plus they meet applicable TIA/EIA standards for data transmissions. The cables dramatically reduce installation costs but retain the appearance, feel and familiarity of a standard category twisted pair cable.

	Nominal Skew (ns/100 m)	Video Transmisson Distance*	
		ft.	m
Typical UTP Data Cables	25 - 45	370 - 520	112 - 158
RGB Coax Cables	15.0	850	259
VideoTwist® 7987	2.2	5900	1798
VideoTwist® 7988	9.0	1475	450
VideoTwist® 7989	10.0	1300	396

\* Based on Broadcast standard of 40nd maximum total skew and the use of amplification equipment.

### Security

Belden's answer to this challenge is a broad line of security cables which can be found in the New Generation section 20 in this catalog.

### Everything you Need for the Intelligent Home

These structured cabling products for the intelligent home are all brought to you by Belden – the most innovative and trusted manufacturer in the cable industry. Belden offers the most comprehensive, time-tested and proven products for cabling the home.

### Availability

Many of these are available off the shelf from distributors. If you have a new or unusual application or you cannot find a Residential cable in this catalog section that meets your technical requirements, see our U.S. Master Catalog or contact technical support at +31-77-3875-414 or techsupport.venlo@belden.com.

### Corresponding Literature

#### Product Bulletins

NP185: Multimedia control cables (1502R)

NP212: Brilliance® VideoTwist® UTP low skew cables

NP229: BNC and RNC connectors

NP232: Brilliance® low cap OFHC speaker cables

# Composite Data, Audio, Video, Security and Control Cables

## Banana Peel® Jacketless Cables

### Category 5e



De- scription	Part No.	UL NEC/ C(UL)CEC Type IEC	Standard Lengths		Standard Unit Weight		Color Code	Nominal Insulation OD		Compo- nent	Description	Shielding Material & Nom. DCR	Insulation Material & Colors	Component Jacket Material & Colors	Core OD	
			ft.	m	lbs.	kg		inch	mm						inch	mm

Composite • **(2) Cat 5e** 4-Bonded-Pair UTP 24 AWG • **(2) Series 6 Coax** with **Duobond® Plus** (Bonded Tri-Shield) • **Banana Peel® Unjacketed**, Bonded to Central Spine

Polyolefin Insulation (Pairs) • Gas-Injected FPE Insulation (Coax) • F-R PVC Jacket • No Overall Jacket															
<b>7876S</b>	NEC:	500	152	63.1	28.6	0.550	13.97	2xData	4-Pair UTP Bonded-Pairs 24 AWG 0.5 mm Solid BC	Unshielded	Polyolefin	F-R PVC (1) Blue (1) Green	0.204	5.18	
	CMR:	1000	305	119.0	54.0										
	CEC:														
	CMG FT4														
<p>Shorting Fold</p>															
								2xCoax	Series 6 18 AWG 1.0 mm Solid BC	Duobond® Plus + 77% AL Braid + AL Foil w/shorting fold	Gas-Injected Foam Polyethylene	F-R PVC (1) Black (1) White	0.275	6.99	

Third party verified to TIA/EIA-568-B.2, Category 5e  
 U.S. Patents 7,049,523; 5,606,151; 5,734,126.  
 Coax sweep tested to 3.0 GHz and jacket sequentially marked.  
 Coax shield effectiveness 125 dB @ 1 GHz is better than quad shield.

Composite • **(2) Cat 5e** 4-Bonded-Pair UTP 24 AWG • **(2) Series 6 Coax** with **Duobond® Plus (1) 2-Fiber LANlite®** • **Banana Peel® Unjacketed**, Bonded to Central Spine

Polyolefin Insulation (Pairs) • Gas-Injected FPE Insulation (Coax) • F-R PVC Jacket • No Overall Jacket															
<b>7878S</b>	NEC:	500	152	70.8	32.1	0.595	15.11	2xData	4-Pair UTP Bonded-Pairs 24 AWG 0.5 mm Solid BC	Unshielded	Polyolefin	F-R PVC (1) Blue (1) Green	0.204	5.18	
	CMR OF	1000	305	136.9	62.1										
	CEC:														
	CMG OF FT4														
<p>Shorting Fold</p>															
								2xCoax	Series 6 18 AWG 1.0 mm Solid BC	Duobond® Plus + 77% AL Braid + AL Foil w/shorting fold	Gas-Injected Foam Polyethylene	F-R PVC (1) Black (1) White	0.275	6.99	
								2xFiber LANlite®	Gigabit Ethernet 62.5µ/125µ/900µ (core/clad/coating) Tight-Buffered		PVC (1) Blue (1) Orange	F-R PVC (1) Orange	0.175	4.45	

Third party verified to TIA/EIA-568-B.2, Category 5e  
 U.S. Patents 7,049,523; 5,606,151; 5,734,126.  
 Coax sweep tested to 3.0 GHz and jacket sequentially marked.  
 Coax shield effectiveness 125 dB @ 1 GHz is better than quad shield.

BC = Bare Copper • AL = Aluminum • DCR = DC resistance

Duobond® Plus see technical information page 23.13.

#### Color Code

Pair No.	Color
1	White/Blue Stripe, Blue
2	White/Orange Stripe, Orange
3	White/Green Stripe, Green
4	White/Brown Stripe, Brown

# Composite Data, Audio, Video, Security and Control Cables

## Banana Peel® Jacketless Cables

### Category 5e



De- scription	Part No.	UL NEC/ C(UL)/CEC Type IEC	Standard Lengths		Standard Unit Weight		Color Code	Nominal Insulation OD		Compo- nent	Description	Shielding Material & Nom. DCR	Insulation Material & Colors	Component Jacket Material & Colors	Core OD	
			ft.	m	lbs.	kg		inch	mm						inch	mm

Composite • **(1) NanoSkew™** 4-Non-Bonded-Pair UTP 24 AWG • **(1) RG59 Coax** with **Duofoil® (1) 1502R** • **Banana Peel® Unjacketed**, Bonded to Central Spline

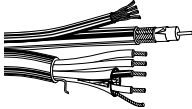
Polyolefin Insulation (Pairs) • Gas-Injected FPE Insulation (Coax) • Polyolefin Insulation (Control) • F-R PVC Jacket • No Overall Jacket																
	<b>YR48902</b>	NEC CMR OF CEC CMG OF FT4	1000	305	132.3	60.0		0.595	15.11	1xData 7987R	4-Pair UTP Non-Bonded-Pairs 24 AWG 0.5 mm Solid BC	Unshielded	Polyolefin	F-R PVC	0.195	4.95
										1xCoax 1505A	0.8 mm 20 AWG Solid BC	Duofoil® 100% 95% TC Braid	Gas-Injected HPDE	F-R PVC Black	0.233	5.92
										1xControl 1502R	1-Pair 22 AWG 0.8 mm (7x30) TC 2 Conductors 18 AWG 1.2 mm (16x30) TC	Unshielded	Foam HPDE	F-R PVC Green	0.250	6.35

Third party verified to TIA/EIA-568-B.2, Category 5e  
Coax sweep tested to 2.25 GHz and jacket sequentially marked.

**(6) Cat 5e** 4-Bonded-Pair UTP 24 AWG • Solid 0.5 mm BC • Rip Cord • **Banana Peel® Unjacketed**, Bonded to Central Spline

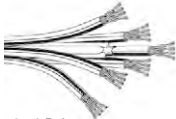
Polyolefin Insulation • Numbered F-R PVC Jackets (Light Blue or Grey) • No Overall Jacket																
	<b>1700S6</b>	CMR CMG	500 1000	152 305	77.6 149.3	35.2 67.7		0.600	15.24	6xData	4-Pair UTP Bonded-Pairs 24 AWG 0.5 mm Solid BC	Unshielded	Polyolefin	F-R PVC	0.204	5.18

6x4 Pairs

1-20 MHz Ohm 100 + 12%  
21-100 MHz + 15%  
101-155 MHz + 18%  
156-310 MHz + 20%  
311-350 MHz + 22%

Third party verified to TIA/EIA-568-B.2, Category 5e

TC = Tinned Copper • BC = Bare Copper • DCR = DC resistance

Duofoil® see technical information page 23.13.

### Color Code

Pair No.	Color
1	White/Blue Stripe, Blue
2	White/Orange Stripe, Orange
3	White/Green Stripe, Green
4	White/Brown Stripe, Brown

# Composite Data, Audio, Video, Security and Control Cables

## Siamese Cables

### Category 5e and Category 5



De- scription	Part No.	UL NEC/ C(UL)CEC Type IEC	Standard Lengths		Standard Unit Weight		Color Code	Nominal Insulation OD		Compo- nent	Description	Shielding Material & Nom. DCR	Insulation Material & Colors	Component Jacket Material & Colors	Core OD	
			ft.	m	lbs.	kg		inch	mm						inch	mm

Composite • **(1) Cat 5e** 4-Bonded-Pair UTP 24 AWG • **(1) Series 6 Coax** with **Duobond® Plus** Bonded Tri-Shield

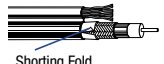
Polyolefin Insulation (Pairs) • Gas-Injected FPE Insulation (Coax) • Overall Green F-R PVC Jacket																
	7911A	NEC:	500	152	35.1	15.9		0.275	6.99	1xData	4-Pair UTP	Unshielded	Polyolefin	F-R PVC (1) Green	0.200	5.08
		CMR:	1000	305	60.0	27.2		x	x		Bonded-Pairs					
		CEC:						0.529	13.44		24 AWG					
		CMG FT4									0.5 mm					
										1xCoax	Series 6	Duobond® Plus	Gas-Injected	F-R PVC	0.275	6.99
											18 AWG	+ 77% AL	Foam	(1) Green		
											1.0 mm	Braid	Polyethylene			
											Solid BC	+ AL Foil				
												w/shorting fold				

Third party verified to TIA/EIA-568-B.2, Category 5e  
Coax sweep tested to 3.0 GHz and jacket sequentially marked.  
Coax shield effectiveness 125 dB @ 1 GHz is better than quad shield.

Composite • **(1) Cat 5** 4-Pair UTP 24 AWG • **(4) 14 AWG** (19x27) 1.85 mm Bare Copper Conductors

Polyolefin Insulation (Pairs) • PVC Insulation (Conductors) • Overall Green F-R PVC Jacket																
	7952A	NEC:	500	152	58.0	26.3		0.289	7.34	1xData	4-Pair UTP	Unshielded	Polyolefin	F-R PVC (1) Blue	0.216	5.49
		CMR:						x	x		24 AWG					
		CEC:						0.535	13.59		0.5 mm					
		CMG FT4									Solid BC					
										4xCDR	Series 6	Unshielded	PVC	-	0.104	2.64
										4x1.93 mm <sup>2</sup>	14 AWG		Red			
											1.85 mm		White			
											(19x27) BC		Green			
													Black			

Third party verified to TIA/EIA-568-B.2, Category 5  
Jacket sequentially marked.

De- scription	Part No.	UL NEC/ C(UL)CEC Type IEC	Standard Lengths		Standard Unit Weight		Conductor (Stranding) Diameter Nom. DCR	Nominal Insulation OD		Shielding Material Nom. DCR	Nominal OD		Freq. MHz	Max. Atten. dB/100m	Min. PSUM			Input Imp. (Ω)	Min. RL dB
			ft.	m	lbs.	kg		inch	mm		inch	mm			NEXT	ACR	ELFEXT		

**Cat 5e • 24 AWG • Unbonded-Pairs • Solid 0.5 mm BC • Overall Beldfoil® Shield • Rip Cord • 24 AWG TC Drain Wire • Overall TC Braid**

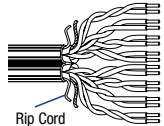
Polyolefin Insulation • PVC Grey Jacket																				
	1668ES	B-164	B-50	10.6	4.8	0.51 mm	0.043	1.10	Non- Bonded-Pair Overall Beldfoil® + Drain Wire (24 AWG TC) + Overall TC Braid SF/UTP	0.248	6.30	1	2.1	62.0	60.2	61.0	100 ± 15	20.0		
		1000	305	64.4	29.2	24 AWG								4	4.0	53.0	49.3	49.0	100 ± 15	23.0
		1640	500	105.8	48.0	Solid BC								8	5.7	49.0	43.1	43.0	100 ± 15	24.5
														10	6.3	47.0	41.0	41.0	100 ± 15	25.0
														16	8.0	44.0	36.2	37.0	100 ± 15	25.0
														20	9.0	43.0	33.8	35.0	100 ± 15	25.0
														25	10.1	41.0	31.2	33.0	100 ± 15	24.3
														31.25	11.4	40.0	28.5	31.0	100 ± 15	23.6
														62.5	16.5	35.0	18.8	25.0	100 ± 15	21.5
														100	21.3	32.0	11.0	21.0	100 ± 15	20.1

Color Code: see chart below  
Applicable industry standards: EN 50173, ISO/IEC 11801

8-Pair, Twin

TC = Tinned Copper • BC = Bare Copper • AL = Aluminum • ACR = Attenuation Crosstalk Ratio • ELFEXT = Equal Level Far-end Crosstalk • NEXT = Near-end Crosstalk • PSUM = Power Sum • RL = Return Loss • DCR = DC resistance

Duobond® Plus see technical information page 23.13.

### Color Code

Pair No.	Color
1	White/Blue Stripe, Blue
2	White/Orange Stripe, Orange
3	White/Green Stripe, Green
4	White/Brown Stripe, Brown

# Composite Data, Audio, Video, Security and Control Cables

## Multimedia Control Cables



De- scription	Part No.	UL NEC/ C(UL)/CEC Type IEC	Standard Lengths		Standard Unit Weight		Conductor (Stranding) Diameter Nom. DCR	Shielding Material	Nominal Insulation OD		Compo- nent	Description	Shielding Material & Nom. DCR	Jacket Material & Colors	Insulation OD	
			ft.	m	lbs.	kg			inch	mm					inch	mm

Control • **(1) Data** 22 AWG Stranded (7x30) 0.8 mm TC • Twisted Pair with **Beldfoil®** Shield • 24 AWG TC Drain Wire • **(2) Power** 18 AWG (16x30) TC Unshielded Pair • Rip Cord

**HDFPE Insulation (Data) • F-R PVC Insulation (Power) • F-R PVC Jacket** (Black, White and Aqua)

300V 75°C <b>1502R</b> NEC: CMR CEC: CMG FT4	500	152	20.1	9.1	–	Beldfoil®	0.250	6.35	1xData	1-Pair 22 AWG 0.8 mm (7x30) TC	Overall Beldfoil® 100% + Drain Wire (24 AWG TC)	HDFPE Blue White	–	–
	1000	305	44.1	20.0					1xPower	2 Conductors 18 AWG 1.2 mm (16x30) TC	Unshielded	F-R-PVC Red Black	–	–

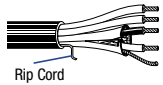

Rip Cord

1 STP + 2 CDR

Sequential footing marking every 0.6 m.

Pulling Tension: 266 N

De- scription	Part No.	UL NEC/ C(UL)/CEC Type IEC	Standard Lengths		Standard Unit Weight		Conductor (Stranding) Diameter Nom. DCR	Nominal Insulation OD		Shielding Material Nom. DCR	Nominal OD		Nom. Imp. (□)	Nom. Vel. of Prop.	Nominal Capacitance		Nominal Attenuation		
			ft.	m	lbs.	kg		inch	mm		inch	mm			pF/ft.	pF/m	MHz	dB/ 100 ft.	dB/ 100 m

**22 AWG • Solid 0.6 mm Bare Copper • Twisted Pair**

**Polyolefin Insulation • White FRNC/LSNH Jacket**

80°C <b>7701NH</b> 33203C BS 7655	1000	305	10.6	4.8	0.64 mm	0.046	1.17	Unshielded	0.138	3.50	100	68%	14.0	46.0	0.772	0.4	1.3	
	1640	500	17.6	8.0	22 AWG										1	0.5	1.5	
					Solid BC										4	0.9	3.1	
															10	1.5	4.9	
															16	1.9	6.3	
														20	2.1	6.9		



Color Code: White/Blue and Blue/White

LonWorks



TC = Tinned Copper • BC = Bare Copper • DCR = DC resistance



## Composite Data, Audio, Video, Security and Control Cables

### Multimedia Control Cables



De- scription	Part No.	UL NEC/ C(UL)CEC Type IEC	Standard Lengths		Standard Unit Weight		Conductor (Stranding) Diameter Nom. DCR	Nominal Insulation OD		Shielding Material Nom. DCR	Nominal OD		Nom. Imp. (□)	Nom. Vel. of Prop.	Nominal Capacitance		Color Code	
			ft.	m	lbs.	kg		inch	mm		inch	mm			pF/ft.	pF/m		
<b>20 AWG • Solid 0.8 mm Bare Copper • Twisted Pair • Plastic Foil • 26 AWG Bare Copper Drain Wire</b>																		
<b>PVC Insulation • Green F-R PVC Jacket</b>																		
300V RMS 70°C	<b>YE00820</b>	NEC: CMR CEC: CMR FT4	100 500 1000	30 152 305	11.5 57.3 114.6	5.2 26.0 52.0	0.81 mm 20 AWG Solid BC	0.056 1.43		Overall Alu-foil + Drain Wire (26 AWG BC)	0.276 7.00		– 73		CDR/CDR CDR/SCR	30.0 91.0	100.0 300.0	Red, Black White, Yellow
																		
			EIB/KNX															
			Pulling Tension: 50 N															
<b>PVC Insulation • Green F-R LSNH/FRNC Jacket</b>																		
300V RMS 70°C	<b>YE00906</b>	NEC: CMR CEC: CMR FT4	100 500 1000	30 152 305	12.3 61.7 123.5	5.6 28.0 56.0	0.81 mm 20 AWG Solid BC	0.063 1.60		Overall Alu-foil + Drain Wire (26 AWG BC)	0.283 7.20		– 73		CDR/CDR CDR/SCR	30.0 91.0	100.0 300.0	Red, Black White, Yellow
																		
			EIB/KNX															
			Pulling Tension: 50 N															
<b>16 AWG • Stranded (19x29) 1.5 mm Tinned Copper • Twisted Pair</b>																		
<b>PVC Insulation • Chrome PVC Jacket</b>																		
300V 60°C UL AWM Style 2598	<b>8471</b>	NEC: CMG CEC: CMG FT4	U-500 500 U-1000 1000	U-152 152 U-305 305	21.0 61.7 41.0 43.0	9.5 9.1 18.6 19.5	1.47 mm 16 AWG (19x29) TC	0.105 2.67		Unshielded	0.274 6.96		– –		CDR/CDR	30.0	100.0	Black, White
																		
			LonWorks															
			Pulling Tension: 271 N															

TC = Tinned Copper • BC = Bare Copper • DCR = DC resistance • SCR = Capacitance between one conductor and other conductors connected to shield. • CDR = Capacitance between conductors

# Brilliance® VideoTwist®

## Low Skew UTP Cables for Video Transmission

### Category and Non-Category Styles



De-scription	Part No.	UL NEC / C(UL)/CEC Type IEC	Standard Lengths		Standard Unit Weight		Conductor (Stranding) Diameter Nom. DCR	Nominal Insulation OD		Shielding Material Nom. DCR	Nominal OD		Freq. MHz	Max. Atten. dB/100m	Min. PSUM			Input Imp. (□)	Min. RL dB
			ft.	m	lbs.	kg		inch	mm		inch	mm			NEXT dB	ACR dB/100m	ELFEXT dB/100m		
<b>NanoSkew™ • 24 AWG Non-Bonded-Pair • Solid 0.5 mm BC • Twisted Pair • Skew 2.2 ns/100 m Nominal • Rip Cord • Non-Category Style</b>																			
<b>Polyolefin Insulation • Maroon PVC Jacket</b>																			
300V RMS <b>7987R</b> NEC: CMR CEC: CMG		U-1000 U-1640	U-305 U-500	22.0 36.2	10.0 16.4	0.51 mm 24 AWG Solid BC	0.038	0.97	Non-Bonded-Pair Unshielded UTP	0.195	4.95	1	2.0	-	-	-	100 ± 15	15.0	
												4	4.1	-	-	-	-	-	
												8	5.8	-	-	-	-	-	
												10	6.5	-	-	-	-	-	
												16	8.2	-	-	-	-	-	
												20	9.3	-	-	-	-	-	
												25	10.4	-	-	-	-	-	
												31.25	11.7	-	-	-	-	-	
												62.5	17.0	-	-	-	-	-	
												100	22.0	-	-	-	-	-	
												155	28.1	-	-	-	-	-	
												200	32.0	-	-	-	-	-	
												250*	36.4	-	-	-	-	-	
350*	44.8	-	-	-	-	-													

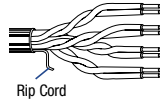

Color Code: see chart below

<b>NanoSkew™ • Category 5e • 24 AWG Bonded-Pair • Solid 0.5 mm Bare Copper • Skew 9.0 ns/100 m Nominal • Rip Cord</b>																			
<b>Polyolefin Insulation • Green PVC Jacket</b>																			
300V RMS <b>7988R</b> NEC: CMR CEC: CMG FT4		U-1000 U-1640	U-305 U-500	22.0 36.2	10.0 16.4	0.51 mm 24 AWG Solid BC	0.038	0.97	Bonded-Pair Unshielded UTP	0.204	5.18	1	2.0	65.3	60.3	60.8	100 ± 15	20.0	
												4	4.1	53.3	49.2	48.7	100 ± 15	23.0	
												8	5.8	48.8	43.0	42.7	100 ± 15	24.5	
												10	6.5	47.3	40.8	40.8	100 ± 15	25.0	
												16	8.2	44.3	36.0	36.7	100 ± 15	25.0	
												20	9.3	42.8	33.5	34.7	100 ± 15	25.0	
												25	10.4	41.3	30.9	32.8	100 ± 15	24.3	
												31.25	11.7	39.9	28.2	30.9	100 ± 15	23.6	
												62.5	17.0	35.4	18.4	24.8	100 ± 15	21.5	
												100	22.0	32.3	10.3	20.8	100 ± 15	20.1	
												155	28.1	29.5	2.0	16.9	100 ± 25	15.8	
												200	32.4	27.8	1.0	14.7	100 ± 25	15.0	

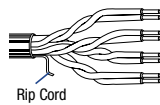

Color Code: see chart below

<b>NanoSkew™ • Category 6 • 23 AWG Bonded-Pairs • Solid 0.6 mm Bare Copper • Skew 10.0 ns/100 m Nominal • Rip Cord</b>																			
<b>Polyolefin Insulation • Blue PVC Jacket</b>																			
300V RMS <b>7989R</b> NEC CMR CEC CMR FT4		1000 1640	305 500	32.0 52.5	14.5 23.8	0.57 mm 23 AWG Solid BC	0.042	1.06	Bonded-Pair Unshielded UTP	0.365 x 0.165	9.27 x 4.19	1	2.0	72.3	70.3	64.8	100 ± 15	20.0	
												4	3.8	63.3	59.5	52.7	100 ± 15	23.0	
												8	5.3	58.8	53.4	46.7	100 ± 15	24.5	
												10	6.0	57.3	51.3	44.8	100 ± 15	25.0	
												16	7.6	54.3	46.7	40.7	100 ± 15	25.0	
												20	8.5	52.8	44.3	38.7	100 ± 15	25.0	
												25	9.5	51.4	41.8	36.8	100 ± 15	24.3	
												31.25	10.7	49.9	39.2	34.9	100 ± 15	23.6	
												62.5	15.4	45.4	30.0	28.8	100 ± 15	21.5	
												100	19.8	42.3	22.5	24.8	100 ± 15	20.1	
												155	25.2	39.5	14.3	20.9	100 ± 22	18.8	
												200	29.0	37.8	8.8	18.7	100 ± 22	18.0	
												250	32.8	36.3	3.5	16.8	100 ± 32	17.3	

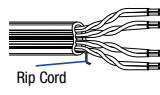

Color Code: see chart below

BC = Bare Copper • ACR = Attenuation Crosstalk Ratio • ELFEXT = Equal Level Far-end Crosstalk • NEXT = Near-end Crosstalk • PSUM = Power Sum • RL = Return Loss • DCR = DC resistance  
\* Values provided for information only.

#### Color Code

Pair No.	Color
1	White/Blue Stripe, Blue
2	White/Orange Stripe, Orange
3	White/Green Stripe, Green
4	White/Brown Stripe, Brown

## Home Cinema Audio Cables

### High-Conductivity (Oxygen-Free) Copper Speaker Cables



De- scription	Part No.	UL NEC/ C(UL)CEC Type IEC	Standard Lengths		Standard Unit Weight		Conductor (Stranding) Diameter Nom. DCR	Nominal Insulation OD		Shielding Material Nom. DCR	Nominal OD		Nom. Imp. (□)	Nom. Vel. of Prop.	Nominal Capacitance		Color Code
			ft.	m	lbs.	kg		inch	mm		inch	mm			pF/ft.	pF/m	

**22 AWG** • Stranded Conductors (19x34) 0.8 mm TC • Dual Twisted Pair • Individual **Beldfoil®** Shield • 24 AWG Tinned Copper Drain Wire

**PVC Insulation • PVC Jacket in Zip-Cord Construction** (Red and Green, Red and Black, Red and Violet or Red and Grey)

150V RMS 60°C	<b>1504A</b>	NEC: CM CEC: CM	U-1000 2000	U-305 610	32.0 63.9	14.5 29.0	0.79 mm 22 AWG (19x34) TC	0.010	0.25	Individual Beldfoil® + Drain Wire (24 AWG TC)	0.143 x 0.286	3.63 x 7.26	45	-	CDR/CDR CDR/SCR	57.0 100.0	187.0 328.0	Black, Red
------------------	--------------	--------------------------	----------------	--------------	--------------	--------------	---------------------------------	-------	------	--	---------------------	-------------------	----	---	--------------------	---------------	----------------	------------

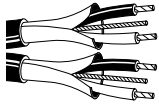

2-Pair

610 m put-up available in Red  
and Grey or Red and Green only.

Pulling Tension: 111 N

The jacket and shield are bonded so both can be removed with automatic stripping equipment. Drain wire is inside foil shield.

**16 AWG** • Stranded (26x30) 1.5 mm High-Conductivity (Oxygen-Free) Tinned and Bare Copper

**PVC Insulation • Clear PVC Jacket**

300V RMS 60°C	<b>9716</b>		U-1000 1000	U-305 305	27.1 26.0	12.3 11.8	1.5 mm 16 AWG (26x30) TC/BC	0.027	0.69	Unshielded	0.115 x 0.230	2.92 x 5.84	13	-	-	-	-	Transparent
------------------	-------------	--	----------------	--------------	--------------	--------------	-----------------------------------	-------	------	------------	---------------------	-------------------	----	---	---	---	---	-------------

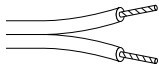

2 CDR  
2x1.5 mm<sup>2</sup>

Parallel Zip Construction

Pulling Tension: 347 N

**Low Cap • 16 AWG** • Stranded (65x34) 1.5 mm Oxygen-Free High-Conductivity Bare Copper • Conductors Cabled

**Polyolefin Insulation • PVC Jacket** (Green, Blue, Grey, White and Black)

	<b>1307A</b>	NEC: CMR, CL3R CEC: CMG FT 4	U-500 1000	U-152 305	15.0 29.1	6.8 13.2	1.5 mm 16 AWG (65x34) BC	0.013	0.32	Unshielded	0.210	5.33	-	-	CDR/CDR	19.9	65.3	Black, Red
--	--------------	---------------------------------------	---------------	--------------	--------------	-------------	--------------------------------	-------	------	------------	-------	------	---	---	---------	------	------	------------



2 CDR  
2x1.5 mm<sup>2</sup>

For audio use only.  
305 m put-ups not available in Blue or Green.  
Suitable for direct burial applications.  
White and Black jackets are sunlight-resistant.

Brightly colored jackets for easy identification.  
Print legends that incorporate location information (room 12345, zone ABCDE).  
Cable jackets with ascending/descending sequential markings at 0.6 m intervals.  
Extremely flexible, easy-to-pull constructions (highly stranded conductors; PVC jackets)

**Polyolefin Insulation • PVC Jacket** (Green, Blue, Grey, White and Black)

	<b>1308A</b>	NEC: CMR, CL3R CEC: CMG FT 4	U-500 1000	U-152 305	26.5 54.0	12.0 24.5	1.5 mm 16 AWG (65x34) BC	0.013	0.32	Unshielded	0.270	6.86	-	-	CDR/CDR	19.9	65.3	Black, Red
--	--------------	---------------------------------------	---------------	--------------	--------------	--------------	--------------------------------	-------	------	------------	-------	------	---	---	---------	------	------	------------



4 CDR  
4x1.5 mm<sup>2</sup>

For audio use only.  
305 m put-ups not available in Blue or Green.  
Suitable for direct burial applications.  
White and Black jackets are sunlight-resistant.

Brightly colored jackets for easy identification.  
Print legends that incorporate location information (room 12345, zone ABCDE).  
Cable jackets with ascending/descending sequential markings at 0.6 m intervals.  
Extremely flexible, easy-to-pull constructions (highly stranded conductors; PVC jackets)

TC = Tinned Copper • BC = Bare Copper • DCR = DC resistance • SCR = Capacitance between one conductor and other conductors connected to shield. • CDR = Capacitance between conductors

# Home Cinema Audio Cables

## High-Conductivity (Oxygen-Free) Copper Speaker Cables



De- scription	Part No.	UL NEC/ C(UL)/CEC Type IEC	Standard Lengths		Standard Unit Weight		Conductor (Stranding) Diameter Nom. DCR	Nominal Insulation OD		Shielding Material Nom. DCR	Nominal OD		Nom. Imp. ( $\Omega$ )	Nom. Vel. of Prop.	Nominal Capacitance		Color Code
			ft.	m	lbs.	kg		inch	mm		inch	mm			pF/ft.	pF/m	

**Low Cap • 14 AWG • Stranded (105x34) 1.9 mm Oxygen-Free High-Conductivity Bare Copper • Conductors Cabled**

**Polyolefin Insulation • PVC Jacket (Green, Blue, Grey, White and Black)**

	<b>1309A</b>	NEC:	U-500	U-152	22.5	10.2	1.85 mm	0.015	0.39	Unshielded	0.264	6.71	-	-	CDR/CDR	20.5	67.3	Black, Red
		CMR, CL3R	2000	610	46.1	20.9	14 AWG											
		CEC:					(105x34) BC											
		CMG FT4																

2 CDR  
2x2.1 mm<sup>2</sup>

For audio use only.  
305 m put-ups not available in Blue or Green.  
Suitable for direct burial applications.  
White and Black jackets are sunlight-resistant.

Brightly colored jackets for easy identification.  
Print legends that incorporate location information (room 12345, zone ABCDE).  
Cable jackets with ascending/descending sequential markings at 0.6 m intervals.  
Extremely flexible, easy-to-pull constructions (highly stranded conductors; PVC jackets)

**Polyolefin Insulation • PVC Jacket (Green, Blue, Grey, White and Black)**

	<b>1310A</b>	NEC:	500	152	41.4	18.8	1.85 mm	0.015	0.39	Unshielded	0.319	8.10	-	-	CDR/CDR	20.5	67.3	Black, Red
		CMR, CL3R	1000	305	84.0	38.1	14 AWG											
		CEC:					(105x34) BC											
		CMG FT4																

4 CDR  
4x2.1 mm<sup>2</sup>

For audio use only.  
305 m put-ups not available in Blue or Green.  
Suitable for direct burial applications.  
White and Black jackets are sunlight-resistant.

Brightly colored jackets for easy identification.  
Print legends that incorporate location information (room 12345, zone ABCDE).  
Cable jackets with ascending/descending sequential markings at 0.6 m intervals.  
Extremely flexible, easy-to-pull constructions (highly stranded conductors; PVC jackets)

**Low Cap • 12 AWG • Stranded (165x34) 2.4 mm Oxygen-Free High-Conductivity Bare Copper • Conductors Cabled**

**Polyolefin Insulation • PVC Jacket (Grey, White and Black)**

	<b>1311A</b>	NEC:	U-500	U-152	36.6	16.6	2.41 mm	0.018	0.46	Unshielded	0.352	8.94	-	-	CDR/CDR	22.3	73.2	Black, Red
		CMR, CL3R	500	152	36.6	16.6	12 AWG											
		CEC:	1000	305	74.1	33.6	(165x34) BC											
		CMG FT 4																

2 CDR  
2x3.2 mm<sup>2</sup>

For audio use only.  
305 m put-ups not available in Blue or Green.  
Suitable for direct burial applications.  
White and Black jackets are sunlight-resistant.

Brightly colored jackets for easy identification.  
Print legends that incorporate location information (room 12345, zone ABCDE).  
Cable jackets with ascending/descending sequential markings at 0.6 m intervals.  
Extremely flexible, easy-to-pull constructions (highly stranded conductors; PVC jackets)

**Polyolefin Insulation • PVC Jacket (Grey, White and Black)**

	<b>1312A</b>	NEC:	500	152	66.6	30.2	2.41 mm	0.018	0.46	Unshielded	0.423	10.74	-	-	CDR/CDR	22.3	73.2	Black, Red
		CMR, CL3R	1000	305	132.1	59.9	12 AWG											
		CEC:					(165x34) BC											
		CMG FT 4																

4 CDR  
4x3.2 mm<sup>2</sup>

For audio use only.  
305 m put-ups not available in Blue or Green.  
Suitable for direct burial applications.  
White and Black jackets are sunlight-resistant.

Brightly colored jackets for easy identification.  
Print legends that incorporate location information (room 12345, zone ABCDE).  
Cable jackets with ascending/descending sequential markings at 0.6 m intervals.  
Extremely flexible, easy-to-pull constructions (highly stranded conductors; PVC jackets)

**Low Cap • 10 AWG • Stranded (259x34) 3.0 mm Oxygen-Free High-Conductivity Bare Copper • Conductors Cabled**

**Polyolefin Insulation • PVC Jacket (Grey, White and Black)**

	<b>1313A</b>	NEC:	500	152	55.1	25.0	2.97 mm	0.026	0.66	Unshielded	0.428	10.87	-	-	CDR/CDR	23.2	76.1	Black, Red
		CMR, CL3R	1000	305	109.1	49.5	10 AWG											
		CEC:					(259x34) BC											
		CMG FT 4																

2 CDR  
2x5.2 mm<sup>2</sup>

For audio use only.  
305 m put-ups not available in Blue or Green.  
Suitable for direct burial applications.  
White and Black jackets are sunlight-resistant.

Brightly colored jackets for easy identification.  
Print legends that incorporate location information (room 12345, zone ABCDE).  
Cable jackets with ascending/descending sequential markings at 0.6 m intervals.  
Extremely flexible, easy-to-pull constructions (highly stranded conductors; PVC jackets)

TC = Tinned Copper • BC = Bare Copper • DCR = DC resistance • CDR = Capacitance between conductors



# Home Cinema Video Cables

## Low Loss HDTV/SDI Digital Coax and SVHS Coax



De- scription	Part No.	UL NEC/ C(UL)CEC Type IEC	Standard Lengths		Standard Unit Weight		Conductor (Stranding) Diameter Nom. DCR	Nominal Insulation OD		Shielding Material Nom. DCR	Nominal OD		Nom. Imp. ( $\Omega$ )	Nom. Vel. of Prop.	Nominal Capacitance		Nominal Attenuation		
			ft.	m	lbs.	kg		inch	mm		inch	mm			pF/ft.	pF/m	MHz	dB/ 100 ft.	dB/ 100 m

**28.5 AWG • Solid 0.3 mm Bare Copper • Duobond® • 95 % Tinned Copper Braid**

<b>Gas-Injected Foam HDPE Insulation • PVC Jacket (Brown, Red, Orange, Yellow, Green, Blue, Violet, Grey, White and Black)</b>																			
DigiTruck®	<b>179DT</b>	NEC:	500	152	5.0	2.3	0.31 mm	0.056	1.42	Duobond®	0.100	2.54	75	77%	17.5	57.4	1	1.2	3.9
SDI/HDTV		CMR	1000	305	8.0	3.6	28.5 AWG			+ 95% TC							5	1.9	6.1
Digital Video 75°C		CEC:					Solid BC			Braid							10	2.4	7.8
		CMG FT4					379.2 $\square$ /km*			29.2 $\square$ /km***							67.5	5.9	19.3
							350.0 $\square$ /km**										71.5	6.0	19.6
																	100	6.9	22.6
																	135	7.9	25.8
																	270	10.8	35.4
																	360	12.5	41.0
																	540	15.4	50.5
																	720	17.9	58.7
																	750	18.3	60.0
																	1000	21.3	69.9
																	1500	26.3	86.3
																	2000	30.8	101.1
																	2250	32.8	107.6
																	3000	38.3	125.7



Mini Video Patch  
0.3/1.4

Guaranteed Return Loss: -21dB Min.  
152 m put-up available in Black only.

Nominal Delay: 4.331 ns/m  
Pulling Tension: 66 N  
100% Sweep tested to 3 GHz.

**22 AWG • Stranded (7x29) 0.8 mm Bare Compacted Copper • 95 % Tinned Copper Double Braid**

<b>Gas-Injected Foam HDPE Insulation • PVC Jacket (Matte Black, Red, Green, Blue, Yellow, White, Orange and Violet)</b>																			
High-Flex	<b>1505F</b>	NEC:	1000	305	45.0	20.4	0.76 mm	0.145	3.68	Double Braid	0.242	6.15	75	80%	17.0	55.7	1	0.2	0.7
SDI/HDTV		CM					22 AWG			95% TC							3.6	0.5	1.6
Video Patch 75°C		CEC:					(7x29) BCC			Braid							10	0.9	2.9
		CM					47.8 $\square$ /km*			7.8 $\square$ /km***							71.5	2.5	8.2
							40.0 $\square$ /km**										135	3.5	11.5
																	270	5.1	16.7
																	360	6.0	19.7
																	540	7.4	24.3
																	720	8.7	28.5
																	750	8.9	29.2
																	1000	10.5	34.4
																	1500	13.3	43.6
																	2250	16.9	55.4
																	3000	20.3	66.6

SPDIF, FBAS,  
Composite Video, Audio  
0.8/3.7

Return loss at 5-3000 MHz:  $\square$  15 dB  
100% Sweep tested: 5 Mhz to 3 GHz  
Compacted conductor combines impedance uniformity of solid conductors and "nick-resistance" of stranded conductor.

Nominal Delay: 4.265 ns/m  
Pulling Tension: 400 N

**High-Flex S-video • 30 AWG • Stranded (7x38) 0.3 mm Tinned Copper • 90 % Tinned Copper Serve**

<b>Foam HDPE Insulation • Matte Black PVC Jacket (Inner PVC Jackets Color Code: Black and Yellow)</b>																			
Round	<b>1808A</b>	2 Coax	U-500	U-152	14.5	6.6	0.31 mm	0.058	1.47	Serve	0.255	6.48	75	78%	17.3	56.7	1	0.6	2.0
Construction			500	152	16.5	7.5	30 AWG			90% TC							5	1.4	4.6
			U-1000	U-305	31.0	14.1	(7x38) TC			24.6 $\square$ /km***							10	2.1	6.9
			1000	305	33.0	15.0	352.6 $\square$ /km*										30	3.8	12.5
							328.0 $\square$ /km**										50	5.1	16.7
																	100	7.6	24.9
																	200	11.3	37.1
																	400	16.9	55.4
																	700	23.3	76.4
																	900	26.9	88.3
																	1000	28.6	93.8

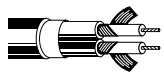

Return loss at 5-3000 MHz:  $\square$  15 dB  
Nominal Delay: 4.265 ns/m  
Pulling Tension: 52 N

\* DC loop resistance • \*\* DC resistance inner conductor • \*\*\* DC resistance outer conductor • DCR = DC resistance • TC = Tinned Copper • BC = Bare Copper • BCC = Bare Compacted Copper

Duobond® see technical information page 23.13.

## Home Cinema Video Cables

### Multicore Cables



De- scription	Part No.	UL NEC/ C(UL)/CEC Type IEC	Standard Lengths		Standard Unit Weight		Conductor (Stranding) Diameter Nom. DCR	Nominal Insulation OD		Shielding Material Nom. DCR	Nominal OD		Nom. Imp. (□)	Nom. Vel. of Prop.	Nominal Capacitance		Nominal Attenuation		
			ft.	m	lbs.	kg		inch	mm		inch	mm			pF/ft.	pF/m	MHz	dB/ 100 ft.	dB/ 100 m

#### 25 AWG • Solid 0.5 mm Tinned Copper • Duobond® • 95 % Tinned Copper Interlocked Serve (Coaxes)

##### FPFA Insulation • Overall Matte Black PVC Jacket

HDTV/SDI Digital Video 60°C	NEC: CMR CEC: CMG						0.46 mm 25 AWG Solid TC 129.3 □/km* 111.6 □/km**	0.074	1.88	Duobond® 95% TC Serve 17.7 □/km***			75	80%	17.0	55.8	1	0.5	1.7
																	5	1.2	3.8
																	50	3.7	12.1
																	100	4.9	16.1
																	200	6.7	22.0
																	400	9.5	31.2
																	750	13.4	44.0
																	900	15.0	49.2
																	1000	15.8	51.8
																	3000	31.2	102.4



Miniature  
0.5/1.9

Pulling Tension:

<b>1277R</b>	3 Coax	500	152	25.5	11.6	0.320	8.13	400 N
		1000	305	48.0	21.8			
<b>1278R</b>	4 Coax	250	76	21.8	9.9	0.351	8.92	489 N
		500	152	31.5	14.3			
		1000	305	60.0	27.2			
<b>1279R</b>	5 Coax	500	152	40.5	18.4	0.403	10.24	578 N
		1000	305	80.0	36.3			
<b>1280R</b>	6 Coax	500	152	44.0	20.0	0.423	10.74	601 N
		1000	305	87.0	39.5			

Nominal Delay: 4.068 ns/m  
Color Code: see chart below

#### 25 AWG • Solid 0.5 mm TC • Duobond® • 95 % TC Interlocked Serve (Coaxes) • Banana Peel® Unjacketed, Bonded to Central Spine

##### Foam HDPE Insulation • PVC Jacket in Colors

HDTV/SDI Digital Video 75°C	NEC: CMR CEC: CMG						0.46 mm 25 AWG Solid TC 129.3 □/km* 111.6 □/km**	0.074	1.88	Duobond® 95% TC Serve 17.7 □/km***	0.114	2.90	75	80%	17.0	55.8			see above
-----------------------------------	----------------------------	--	--	--	--	--	--	-------	------	--	-------	------	----	-----	------	------	--	--	-----------

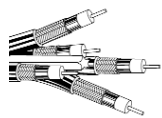

Miniature  
0.5/1.9

Pulling Tension:

<b>1281S3</b>	3 Coax	500	152	17.0	7.7	0.246	6.25	400 N
		1000	305	31.0	14.1			
<b>1281S4</b>	4 Coax	500	152	23.5	10.7	0.275	6.99	489 N
		1000	305	44.0	20.0			
<b>1281S5</b>	5 Coax	250	76	16.0	7.3	0.308	7.82	578 N
		500	152	28.5	12.9			
		1000	305	55.0	24.9			
<b>1281S6</b>	6 Coax	500	152	33.5	15.2	0.342	8.69	601 N
		1000	305	68.0	30.8			

Nominal Delay: 4.068 ns/m  
100% Sweep tested. 5 MHz to 850 MHz. Patent pending.  
Color Code: see chart below

\* DC loop resistance • \*\* DC resistance inner conductor • \*\*\* DC resistance outer conductor • DCR = DC resistance • TC = Tinned Copper  
Duobond® see technical information page 23.13.

#### Color Code

Cond.	Color	Cond.	Color	Cond.	Color
1	Red	3	Blue	5	Black
2	Green	4	Yellow	6	White

## Tools and Accessories

### For Mini Hi-Res Coaxial Cables



De- scription	Part No.	UL NEC/ C(UL)CEC Type IEC	Pieces		Standard Unit Weight		AWG of Cable	Cable Reten- tion Force		Body Material/ Plating	Center Pin Retention		Nom. Imp. ( $\square$ )	Current Rating	Insertion Loss
			Carton	Box	lbs.	kg		> lbs.	> kg		inch	mm			

**One-Piece-Connector • Male BNC • 25 AWG (Mini RG-59) • 2-stud Bayonet Lock • Solid, One-Piece-Brass with Gold-Plated Center Pins • Patent Pending Viewing Window**

#### Gold-Plated Construction

**300V RMS 1B25A** \*100 10 3.8 1.7 25 AWG 40.0 18.1 Nickel Brass Compression Gold-Plated Center Pin (> 0.01 mm Gold on Beryllium Cu) 0.331 0.150 75 5 amp < 0.1 dB @ 1 GHz

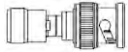

\* Stand packages cannot be broken.  
Including termination instructions.

Return loss at 5-1000 MHz:  $\square$  20 dB  
RFI: > 100 dB

Frequency Range: DC-3.0 GHz (dependent upon cable limitations)  
Can be used with video multicores 127xR and 1281Sx.

**One-Piece-Connector • RCA • 25 AWG (Mini RG-59) • Solid, One-Piece-Brass with Gold-Plated Center Pins • Patent Pending Viewing Window**

#### Gold-Plated Construction

**300V RMS 1R25A** \*100 10 3.3 1.5 25 AWG 40.0 18.1 Nickel Brass Compression Gold-Plated Center Pin 0.331 0.150 N/A 2 amp < 0.1 dB @ 1 GHz



\* Stand packages cannot be broken.  
Including termination instructions.

Return loss at 5-1000 MHz:  $\square$  20 dB

Frequency Range: DC-3.0 GHz (dependent upon cable limitations)  
Can be used with video multicores 127xR and 1281Sx.

**Stripping Tool • 3-Cut • 25 AWG (Mini RG-59)**

#### Cable Preparation Tool

**HCST** 1 1 0.8 0.4 25 AWG



Can be used with video-multicores 127xR and 1281Sx.

**Compression Tool • BNC/RCA die • 25 AWG (Mini RG-59)**

#### Easy-to-Use Compression Tool

**HCCT** 1 1 1.8 0.8 25 AWG



Can be used with video-multicores 127xR and 1281Sx.



Glossary of Terms

22



**Table of Contents**

<b>Glossary of Terms</b>	Page No.
Glossary	22.2 – 22.13



## Glossary of Terms

**5-Mil Copper** — Solid Copper Shield. Provides added electrical protection.

**802.14** — IEEE's Cable TV MAC and PHY Protocol Working Group.

**10GBASE-T** — IEEE standard for 10 Gigabit Ethernet transmission over copper.

**10GX®** — Belden's most advanced end-to-end UTP structured cabling system delivering guaranteed performance of 625 MHz and data-rates of 10 Gb/s.

**A** — Ampere.

**ABR** — Available Bit Rate.

**Abrasion Resistance** — Ability of a wire, cable or material to resist surface wear.

**Abrasion Stripper** — More accurately described as "buffing stripper," which is a motorized device for removing flat cable insulation by means of one or two buffing wheels that melt the insulation and brush it away from the conductors.

**AC** — Alternating current. Electric current that alternates or reverses polarity in a cyclical manner (e.g. 60 Hz AC power).

**Accelerated Aging** — A test that simulates long time environmental conditions in a relatively short time.

**ACMC** — Alien Crosstalk Margin Computation is the Pass/Fail criteria to determine if a channel complies with 10GBASE-T Alien noise requirements.

**ACR** — Attenuation Crosstalk Ratio. The difference between attenuation and crosstalk, measured in dB, at a given frequency. Important characteristic in networking transmission to assure that signal sent down a twisted pair is stronger at the receiving end of the cable than are any interference signals imposed on that same pair by crosstalk from other pairs.

**ADSL** — Asymmetric Digital Subscriber Line.

**AES/EBU** — Informal name of a digital audio standard established jointly by the AES (Audio Engineering Society) and EBU (European Broadcast Union) organizations.

**AF** — Audio frequency.

**AFEXT** — Alien far-end crosstalk loss is a measure of the unwanted signal coupling from near-end disturbing channel pairs into a disturbed pair of a neighboring channel or part thereof, measured at the far-end.

**Air Core** — Cables that are not gel filled.

**Air-Gap Dielectric** — A coaxial design in which a monofilament of plastic holds the center conductor in place in a hollow plastic tube allowing the remainder of the dielectric to be air. Typical velocities of up to 84% can be achieved in this design.

**Alien crosstalk** — A measure of the unwanted signal coupling between cabling or components in close proximity.

**Alloy** — A combination of two or more different polymers/metals. Usually combined to make use of different properties of each polymer/metal.

**Alpeth** — Coated Aluminum Polyethylene. Basic sheath.

**Alternating Current (AC)** — Electric current that alternates or reverses polarity in a cyclical manner (e.g. 60 Hz AC power).

**AM** — Amplitude modulation.

**Ambient** — Conditions that exist in the environment of the cable. Conditions existing at a test or operating location prior to energizing equipment (e.g. ambient temperature).

**American Wire Gage (AWG)** — A standard for expressing wire diameter. As the AWG number gets smaller, the wire diameter gets larger.

**Ampacity** — Current handling capability expressed in amperes. The maximum current a conductor can carry without being heated beyond a safe limit.

**Ampere** — A standard unit of current. Defined as the amount of current that flows when one volt of electromotive force (EMF) is applied across one ohm of resistance. One ampere of current is produced by one coulomb of charge passing a point in one second.

**Amplitude** — The magnitude of a current or voltage. It can be the maximum, minimum, average or RMS value of an alternating current (AC) signal. These four magnitudes are the same for a direct current (DC) signal.

**Analog** — Representation of data by continuously variable quantities as opposed to a finite number of discrete quantities in digital.

**Analog Signal** — An electrical signal which varies continuously, not having discrete values. Analog signals are copies or representations of other waves in nature. An analog audio signal, for instance, is a representation of the pressure waves which make up audible sound.

**ANEXT** — Alien near-end crosstalk loss is a measure of the unwanted signal coupling from near-end disturbing channel pairs into a disturbed pair of a neighboring channel or part thereof, measured at the near-end.

**Anneal** — To soften and relieve strains in any solid material, such as metal or glass, by heating to just below its melting point and then slowly cooling it. Annealing generally lowers the tensile strength of the material, while improving its flex life and flexibility.

**ANSI** — American National Standards Institute.

**ASP** — Aluminum Steel Polyethylene. Provides mechanical and electrical protection.

**ASTM** — The American Society for Testing and Materials, a standards organization which suggests test methods, definitions and practices.

**Asynchronous Transfer Mode** — The SONET standard for a packet switching technique which uses packets of a fixed length.

**ATM** — Asynchronous Transfer Mode.

**Attenuation** — The decrease in magnitude of a signal as it travels through any transmitting medium, such as a cable or circuitry. Attenuation is usually expressed logarithmically as the ratio of the original and decreased signal amplitudes. It is usually expressed in decibels (dB).

**Audio** — A term used to describe sounds within the range of human hearing (20 Hz to 20 kHz). Also used to describe devices which are designed to operate within this range.

**Audio Frequency** — Frequencies within the range of human hearing (approximately 20 Hz to 20 kHz).

**Augmented Category 6** — TIA standard for a cabling system and components specified to 500MHz to support 10GBASE-T and other high frequency applications.

**AWG** — American Wire Gage. A wire diameter specification. The smaller the AWG number, the larger the wire diameter.

**AWM** — Appliance Wiring Material. A UL designation for a type of wire.

**Backbone** — The cable used to connect all systems of a multi-level distributed system to an intermediate system.

**Backshell** — Housing on a connector that covers the area where the cable conductors connect to the connector contacts. It can be a metal housing providing continuity of the shield through IDC connectors.

**Balanced Line** — A cable having two identical conductors which carry voltages opposite in polarity, but equal in magnitude with respect to ground, suitable for differential signal transmission.

**Balun** — Balanced to unbalanced (Bal-un) transformer used to connect an unbalanced transmission line (i.e. coaxial cable) to a balanced system or cable, or vice versa. It can also provide impedance transformation, as 300 ohm balanced to 75 ohm unbalanced.

**Bandwidth** — The difference between the upper and lower limits of a given band of frequencies. It is expressed in Hertz. The range of frequencies that a transmitted communications signal occupies or that a receiving system can accept. For example, it takes more bandwidth to download a photograph in a second than to download a page of text. Virtual reality and three-dimensional audio/visual presentations require even more.

**Baud** — Rate of digital transmission equal to the reciprocal of the time of one output signaling element.

**Bel** — A unit that represents the logarithm of the ratio of two levels. One bel equals the base 10 logarithm of the ratio of two power levels. It is also equal to the base 10 logarithm of square of the ratio of two voltage or current levels, provided the impedances are the same at the two levels. (See *dB*)

**Belden** — A leading manufacturer of the specialty wire, cable and fiber products needed for new applications in data, audio, video and voice signal transmission, among other things.

**Belflex®** — A premium hybrid matte-finish jacket material that exhibits superior flexibility at low temperatures along with resistance compared to standard PVC jacketing materials.

**Beldfoil®** — Belden trademark for highly effective electrostatic shield of reinforced metallic foil.

## Glossary of Terms

- Beldsol™** — Solderable Belden magnet wire combining insulating films of polyurethane for excellent dielectric characteristics and nylon for mechanical protection.
- Bend Loss** — A form of increased attenuation caused by (a) having an optical fiber curved around a restrictive radius of curvature or (b) microbends caused by minute distortions in the fiber imposed by externally induced perturbations.
- Bend Radius** — Radius of curvature that a flat, round fiber optic or metallic cable can bend without any adverse effects.
- Binder** — A tape or thread used for holding assembled cable components in place.
- Bit** — One binary digit.
- Bit Error Rate** — The number of errors occurring in a system per unit of time (e.g. bits per second).
- Bits Per Second** — The number of binary bits that can be transmitted per second (bps), i.e. Mb/s (Mega = million), Gb/s (Giga = billion).
- BNC** — Abbreviation for “Bayonet Neil-Concelman.” A coaxial cable connector used extensively in video and RF applications and named for its inventors.
- Bonded** — 1) Adhesive application of a metallic shielding tape to the dielectric of a coaxial cable to improve electrical performance and ease of connector installation. Also refers to adhesive application of a metallic shielding tape to the jacket of a cable. 2) Steel is bonded to polyethylene with a copolymer adhesive. All Stalpath and some ASP cables are bonded. Provides extra strength to jacket, primarily used in underground applications.
- Bonded ASP** — Aluminum Steel Polyethylene where the steel is bonded to polyethylene for strength. Filled cables for use in ducts.
- Bonding** — The method used to produce good electrical contact between metallic parts of any device. Used extensively in automobiles and aircraft to prevent static buildup. Also refers to the connectors and straps used to bond equipment.
- Booster** — An amplifier inserted into a cable to increase the signal amplitude in order to compensate for signal loss due to attenuation. This extends the transmission range of the cable. Transformers may be employed to boost AC voltages. The term booster is also applied to amplifiers used in television receiving antenna systems.
- BPS** — Bits per second. (See *Bits Per Second*.)
- BPSK** — Binary Phase Shift Keying. A type of digital transmission where two phases of the signal are possible to represent binary one and zero.
- Braid** — A group of textile or metallic filaments interwoven to form a tubular flexible structure which may be applied over one or more wires or flattened to form a strap.
- Braid Angle** — The angle between a strand of wire in a braid shield and the longitudinal axis (i.e. axis along the length of the center) of the cable it is wound around.
- Breakdown Voltage** — The voltage at which the insulation between two conductors will fail and allow electricity to conduct or “arc.”
- Breakout** — The point at which a conductor or conductors are separated from a multi-conductor cable to complete circuits at various points along the main cable.
- BRI** — Basic Rate Interface ISDN.
- Broadband** — The technique used to multiplex multiple networks on a single cable without interfering with each other. Technologies that allow you to transmit or receive higher volumes of data at higher speeds.
- Buffer** — A protective coating over an optical fiber.
- Buffing Stripper** — A motorized device for removing flat cable insulation by means of one or two buffing wheels that melt the insulation and brush it away from the conductors. Also called Abrasion Stripper.
- Bunch Strand** — Conductors twisted together with the same lay and direction without regard to geometric pattern.
- Buried** — Cables that are required to go underground.
- Bus-bar Wire** — Uninsulated tinned copper wire used as a common lead.
- Butyl Rubber** — A synthetic rubber with good electrical insulating properties.
- Byte** — A group of eight adjacent binary digits (8 bits).
- C** — Capacitance (electrical). Celsius (temperature).
- Cable** — A group of individually insulated conductors or subcomponents twisted helically.
- Cable Modem** — A device that enables you to hook up your PC to a local cable TV line and receive data at much faster rates than telephone modems and ISDN lines. A strong competitor to DSL telephone service.
- Cabling** — The grouping or twisting together of two or more insulated conductors or subcomponents to form a cable.
- CACSP** — Coated Aluminum, Coated Steel, Polyethylene. Provides additional strength and protection.
- California Proposition 65 (Prop 65)** — Refers to the California Proposition 65 Consent Judgement for wire & cable manufacturers (San Francisco Superior Court nos. 312962 and 320342). *Compliant Products* have less than 300 ppm of lead (by weight) in their outer surface layer. *Exempt Products* are those that are infrequently handled, manufactured before September 2003, distributed/sold outside the State of California, internal components not normally accessible to the consumer, or contain Prop 65 substances as part of the internal conductor or other component not normally accessible to the consumer. Contact Belden Customer Service or visit [www.belden-emea.com](http://www.belden-emea.com) for product specific details.
- Canadian Electrical Code (CEC)** — Canadian version of the U.S. National Electrical Code (NEC).
- CAP** — Carrierless Amplitude Phase Modulation.
- Capacitance** — The ability of a dielectric material between conductors to store energy when a difference of potential exists between the conductors. The unit of measurement is the farad. Cable capacitance is usually measured in picofarads (pF).
- Capacitive Crosstalk** — Cable crosstalk or interference resulting from the coupling of the electrostatic field of one conductor upon one or more others.
- Capacitive Reactance** — The opposition to alternating current due to the capacitance of a capacitor, cable or circuit. It is measured in ohms and is equal to  $1/(2\pi fC)$  where pi is approximately 3.1416, f is the frequency in Hz and C is the capacitance in farads.
- Capacitor** — Two conducting surfaces separated by a dielectric material. The capacitance is determined by the area of the surfaces, type of dielectric and spacing between the conducting surfaces.
- Carrier Strip** — Also referred to as substrate. A film that is on one side of a laminated flat cable.
- CASPIC** — Coated Aluminum, Coated Steel.
- Category** — Rating of a local area network (LAN) cable established by TIA/EIA to indicate the level of electrical performance.
- Category Cables** — Belden manufactures Category 3 to 7 cables, all high performance twisted pair data cables. The higher the category number, the greater the bandwidth. Category 7 is currently the highest performance telecommunication wire available. Ours is certified to applicable UL standards.
- CATV** — Abbreviation for Community Antenna Television. Cable TV.
- CB** — Citizens band.
- CBR** — Constant Bit Rate.
- CCTV** — Closed-circuit television.
- Cellular Polyethylene** — Expanded or “foam” polyethylene, consists of individual closed cells of inert gas suspended in a polyethylene medium. The result is a desirable reduction of the dielectric constant compared to solid polyethylene, which decreases attenuation and increases the velocity of propagation.
- Center-to-Center Distance** — Pitch. Nominal distance from center-to-center of adjacent conductors within a cable. When conductors are flat, pitch is usually measured from the reference edge of a conductor to the reference edge of the adjacent conductor.
- Channel** — The horizontal cable including the workstation outlet and patch panel in the telecommunications closet plus a maximum combined length of up to ten meters of patch cable at each end (maximum length of 100 meters).
- Characteristic Impedance** — In a transmission cable of infinite length, the ratio of the applied voltage to the resultant current at the point the voltage is applied. Or the impedance which makes a transmission cable seem infinitely long, when connected across the cable’s output terminals.
- Chrominance Signal** — The portion of a video signal that contains the color information.
- Circuit** — A system of conducting media designed to pass an electric current.

## Glossary of Terms

- Circular Mil** — Area of a wire that is one-thousandth of an inch (0.001 inch, one mil) in diameter. This area is  $\pi/4$  of a square mil. The circular mil area (CMA, cmil) equals the diameter in mils squared. By knowing the CMA of various conductors, they can be used to determine what conductivity and gage size various combinations will produce.
- Cladding** — A low refractive index material that surrounds the core of an optical fiber causing the transmitted light to travel down the core and protects against surface contaminant scattering or a layer of metal applied over another. Cladding is often chosen to improve conductivity or to resist corrosion.
- CO** — Central Office.
- Coaxial Cable** — A cylindrical transmission line composed of a conductor centered inside a metallic tube or shield, separated by a dielectric material, and usually covered by an insulating jacket. Used by cable TV companies to distribute signals to homes and businesses. Also used by telephone companies in some applications and by cellular telephone, radio and television installations.
- Coil Effect** — The inductive effect exhibited by a spiral-wrapped shield, especially above audio frequencies.
- Color Code** — A system of different colors or stripes used to identify components of cables such as individual conductors or groups of conductors.
- COLS** — Commercial Online Service.
- Component Video** — The unencoded output of a camera, video tape recorder, etc., whereby each red, green, and blue video signal is transmitted down a separate cable (usually coax) to improve picture quality. Can also refer to a video system where the luminance and chrominance video components are kept separate.
- Composite Cable** — Cable having conductors with two or more AWG sizes or more than one cable type.
- Composite Video** — The encoded output of a camera, video tape recorder, etc., whereby the red, green and blue video signals are combined with the synchronizing, blanking and color burst signals and are transmitted simultaneously down one cable.
- Concentric Stranding** — A group of uninsulated wires twisted together and containing a center core with subsequent layers spirally wrapped around the core with alternating lay directions to form a single conductor.
- Conductivity** — The ability of a material to allow electrons to flow, measured by the current per unit of voltage applied. It is the reciprocal of resistivity and is measured in siemens (S) or mhos.
- Conductor** — A substance, usually metal, used to transfer electrical energy from point to point.
- Conduit** — A tube of metal or plastic through which wire or cable can be run. Used to protect the wire or cable and, in the case of metal conduit, to contain the fire of a burning wire or cable.
- Connector** — A device designed to allow electrical flow from one wire or cable to a device on another cable. A connector will allow interruption of the circuit or the transfer to another circuit without any cutting of wire or cable or other preparation.
- Copperweld®** — Trademark of Copperweld Steel Co. for copper-clad steel conductor.
- Cord** — A very flexible insulated cable.
- Core** — The light conducting central portion of an optical fiber with a refractive index higher than that of the cladding. The center of a cable construction. Most often applies to a coaxial cable, where the core is the center conductor and the dielectric material applied to it.
- CoreGuard®** — PE grease flooding over the braid in a coax cable to resist water migration in outdoor applications.
- Corona** — The ionization of gasses about a conductor that results when the potential gradient reaches a certain value.
- Coupling** — The transfer of energy (without direct electrical contact) between two or more cables or components of a circuit.
- Coverage** — How well a metal shield covers the underlying surface. Measured in percent.
- CPE** — Chlorinated polyethylene can be used as either a thermoplastic or thermoset. It is a tough chemical- and oil-resistant material and makes an excellent jacket for industrial control cable. As a thermoset, it can be used as an oil-resistant cord jacket. Other outstanding properties include low water absorption and superior crush resistance, which are important attributes in industrial control applications.
- CPS** — Abbreviation for cycles per second. This term has been replaced by Hertz in common usage.
- CPU** — Central Processing Unit.
- Crosstalk** — A type of interference caused by signals from one pair or cable being coupled into adjacent pairs or cables. Can occur with audio, data or RF signals.
- CRT** — Cathode Ray Tube.
- CSA** — Abbreviation for Canadian Standards Association, the Canadian version of the Underwriters Laboratories.
- CSMA/CD** — Carrier Sense Multiple Access/Collision Detection.
- CSR** — Customer Service Representative.
- CUPIC** — Copper.
- Current Carrying Capacity** — The maximum current a conductor can carry without being heated beyond a safe limit. Ampacity.
- Current Loop** — A two wire transmit/receive interface.
- Current, Alternating (AC)** — Electric current that alternates or reverses polarity in a cyclical manner (e.g. 60 Hz AC power).
- Current, Direct (DC)** — Electrical current whose electrons flow in one direction only and is generally constant.
- Cut-through Resistance** — A test to determine the ability of a material to withstand the application of blades or sharp edges without being cut.
- D1** — A component digital video recording format that conforms to the CCIR-601 standard. Records on 19 mm magnetic tape. (Often used incorrectly to indicate component digital video.)
- D2** — A composite digital video recording format. Records on 19 mm magnetic tape.
- D3** — A composite digital video recording format. Records on 1/2 inch (12.7 mm) magnetic tape.
- Daisy Chain** — A cable assembly with three or more termination areas.
- Datalene®** — Belden trademark for foam polyolefin.
- DAVIC** — Digital Audio Video Council.
- dB** — Decibel.
- DBS** — Direct Broadcast Satellite.
- DC** — Direct current.
- DC Resistance** — See *Resistance*.
- Decibel (dB)** — A decibel is one-tenth of a bel and is equal to 10 times the logarithm of the power ratio, 20 times the log of the voltage ratio, or 20 times the log of the current ratio. Decibels are also used to express acoustic power, such as the apparent level of a sound. The decibel can express an actual level only when comparing with some definite reference level that is assumed to be zero dB.
- Delay Line** — A transmission line or equivalent device designed to delay a wave or signal for a specific length of time.
- DEPIC** — Dual Expanded Plastic Insulated Conductor (Foam Skin). Decreases outside diameter of cable.
- Derating Factor** — A multiplier used to reduce the current carrying capacity of conductors in more adverse environments, such as higher temperature, or where multiple conductors are together in one conduit.
- DES** — Data Encryption Standard.
- DHCP** — Dynamic Host Configuration Protocol.
- Dielectric** — An insulating (nonconducting) medium. It is the insulating material between conductors carrying a signal in a cable. In coaxial cables it is between the center conductor and the outer conductor. In twisted pair cables it is the insulation between conductors plus any surrounding air or other material.
- Dielectric Breakdown** — Any change in the properties of a dielectric that causes it to become conductive. Normally a catastrophic failure of an insulation because of excessive voltage.
- Dielectric Constant** — Also called relative permittivity. That property of a dielectric which determines the amount of electrostatic energy that can be stored by the material when a given voltage is applied to it. Actually, the ratio of the capacitance of a capacitor using the dielectric to the capacitance of an identical capacitor using a vacuum (which has a dielectric constant of 1) as a dielectric. A number which indicates the quality of a material to resist holding an electrical charge when placed between two conductors.
- Dielectric Heating** — The heating of an insulating material when placed in a radio-frequency field, caused by internal losses during the rapid polarization reversal of molecules in the material.

## Glossary of Terms

- Dielectric Loss** — The power dissipated in a dielectric as the result of the friction produced by molecular motion when an alternating electric field is applied.
- Dielectric Strength** — The voltage an insulation can withstand before it breaks down. Usually expressed as volts per mil.
- Dielectric Withstand Voltage** — The voltage an insulation can withstand before it breaks down. Usually expressed as volts per mil.
- Digital Signal** — An electrical signal which possesses two distinct states (on/off, positive/negative).
- Dispersion** — The cause of bandwidth limitations in an optical fiber. Dispersion causes a broadening of input pulses along the length of the fiber. Two major types are (a) mode dispersion caused by differential optical path lengths in a multimode fiber, and (b) material dispersion caused by a differential delay of various wavelengths of light in a wave guide material.
- Distortion** — Any undesired change in a wave form or signal.
- Distribution Cable** — In a CATV system, the transmission cable between the distribution amplifier and the drop cable.
- Disturbed Conductor** — A conductor that receives energy generated by the field of another conductor or an external source, e.g. the quiet line.
- DMT** — Discrete Multitone.
- DOCSIS** — Data Over Cable Service Interface Specification™. Defines interface requirements for cable modems involved in high-speed data distribution over cable television system networks.
- Drain Wire** — A non-insulated wire in contact with parts of a cable, usually the shield, and used in the termination to that shield and as a ground connection.
- Drop Cable** — In a CATV system, the transmission cable from the distribution cable to a dwelling.
- DSL** — Digital Subscriber Line. A technology for bringing high-bandwidth information to homes and small businesses over ordinary copper telephone lines. A DSL line can carry both data and voice signals, with the data part of the line remaining continuously connected. Currently competes with the cable modem in bringing broadband services to homes and small businesses.
- Duobond® II** — Belden trademark for a laminated shielding tape consisting of heat sensitive adhesive, aluminum foil, polyester or polypropylene and aluminum foil.
- Duobond Plus®** — Belden trademark for a foil/braid/foil connection with a shorting fold in the outermost shield.
- Duofoil®** — Belden trademark for a shield in which metallic foil is applied to both sides of a supporting plastic film.
- DVB** — Digital Video Broadcasting.
- E** — Voltage (electromotive force).
- Earth** — British terminology for zero-reference ground.
- Edge Margin** — Margin.
- EFP** — Electronic Field Production. Video production for commercials, television shows and other non-news purposes done outside the studio.
- EIA** — Electronic Industries Association (formerly RMA or RETMA).
- Elastomer** — Any material that will return to its original dimensions after being stretched or distorted.
- Electromagnetic** — Referring to the combined electric and magnetic fields caused by electron motion through conductors.
- Electromagnetic Coupling** — The transfer of energy by means of a varying magnetic field. Inductive coupling.
- Electron Volt** — A measure of the energy gained by an electron passing through an electric field produced by one volt.
- Electrostatic** — Pertaining to static electricity or electricity at rest. An electric charge, for example.
- Electrostatic Coupling** — The transfer of energy by means of a varying electrostatic field. Capacitive coupling.
- ELFEXT** — Equal Level Far End Crosstalk (dB). A subtraction of attenuation from FEXT. By subtracting the attenuation, ELFEXT negates the effects of attenuation on the interference as it propagates down the cable, thus bringing it to an equal level.
- Elongation** — The increase in length of a wire or cable caused by longitudinal tension.
- EMF** — Electromotive force (voltage).
- EMI** — Electromagnetic Interference.
- End of Life Vehicle (ELV)** — Refers to EU directive 2000/53/EC (18-SEPT-2000), which bans the use of certain substances in automobiles. This would require the use of a HMF or RoHS compliant cable.
- Energy** — The capability of doing work.
- Energy Dissipation** — Loss of energy from a system due to the conversion of work energy into an undesirable form, usually heat. Dissipation of electrical energy occurs when current flows through a resistance.
- ENG** — Electronic News Gathering.
- EPDM** — Ethylene-propylene-diene monomer rubber. A chemically cross-linked elastomer with good electrical insulating properties and excellent flexibility at high and low temperatures. It has good insulation resistance and dielectric strength, as well as excellent abrasion resistance and mechanical properties. EPDM has better cut-through resistance than silicone rubber, which it replaces in some applications.
- EPR** — Ethylene-propylene copolymer rubber. A material with good electrical insulating properties.
- Equilay** — More than one layer of helically laid wires with the length of the lay the same for each layer.
- ETP** — Abbreviation for a copper refining process called Electrolytic Tough Pitch. This process produces a conductor that is 99.95% pure copper (per ASTM B115) resulting in high conductivity.
- eV** — Electron volt.
- Expanded Polyethylene** — Expanded or “foam” polyethylene, consists of individual closed cells of inert gas suspended in a polyethylene medium, resulting in a desirable reduction of the dielectric constant.
- Extruded Cable** — Conductors are simultaneously insulated and the cable is formed by a continuous extrusion process.
- f** — Frequency.
- Farad** — A unit of capacity that will store one coulomb of electrical charge when one volt of electrical pressure is applied.
- FAS** — Fire Alarm and Signal Cable, CSA (Canadian Standards Association) Cable Designation.
- FAQ** — Frequently Asked Question.
- FCFC** — Abbreviation for flat conductor flat cable.
- FDDI** — Fiber Distributed Data Interface.
- FEC** — Forward Error Correction.
- Feedback** — Energy that is extracted from a high-level point in a circuit and applied to a lower level. Positive feedback reduces the stability of a device and is used to increase the sensitivity or produce oscillation in a system. Negative feedback, also called inverse feedback, increases the stability of a system as the feedback improves stability and fidelity.
- Feeder Cable** — In a CATV system, the transmission cable from the head end (signal pickup) to the trunk amplifier. Also called a trunk cable.
- FEP** — Fluorinated ethylene-propylene. A thermoplastic material with good electrical insulating properties and chemical and heat resistance.
- Ferrous** — Composed of and/or containing iron. A ferrous metal exhibits magnetic characteristics.
- FEXT** — Far End Crosstalk. Crosstalk induced on the pairs, measured at the far end of the cable, referenced to the near end input signal. Usually expressed in decibels (dB).
- Fiber** — A single, separate optical transmission element characterized by core and cladding.
- Fiber Optics** — Light transmission through optical fibers for communication and signaling. A technology that transmits information as light pulses along a glass or plastic fiber. Optical fiber carries much more information than conventional copper wire and is generally not subject to interference. Most telephone company long-distance lines are optical fiber. See RUS 1755.900.
- Fiber to the home (FTTH)** — A technology that provides voice, data and video services from the phone company's branch office to local customers over an all-fiber optic link. Still in its infancy, FTTH technology is substantially more expensive and labor-intensive to install and maintain than competing technologies.
- Field** — An area through which electric and/or magnetic lines of force pass.
- Filled** — Cables that are gel filled.

## Glossary of Terms

**Fillers** — Non-conducting components cabled with the insulated conductors or optical fibers to impart roundness, flexibility, tensile strength or a combination of all three to the cable.

**Flamarrest®** — Belden trademark for a plenum grade chloride-based thermoplastic jacketing material with low smoke and low flame spread properties; more flexible than traditional fluorocopolymer jacket materials. Cables jacketed with Flamarrest meet the ANSI/NFPA Standard 2621-985 (UL-910) Flame Test.

**Flame Resistance** — The ability of a material not to fuel a flame once the source of heat is removed.

**Flat Cable** — Also referred to as planar and/or ribbon cable. Any cable with two or more parallel conductors in the same plane encapsulated by insulating material.

**Flat Conductor** — A conductor with a width-to-thickness ratio of arbitrarily 5 to 1 or greater.

**Flat Conductor Cable** — A flat cable with a plurality of flat conductors.

**Flex Life** — The qualification of the number of times a cable may bend before breaking.

**Flexibility** — The ability of a cable to bend in a short radius. The ability of a cable to lay flat or conform to a surface as with microphone cables.

**FlexPoint PCB** — Belden's patent-pending 10GX® Module design which reduces the compensation circuitry's time delay, ensuring stable high performance and enabling transmission rates of 625 MHz and data-rates of 10Gb/s.

**Floating** — Referring to a circuit which has no connection to ground.

**Fluorocopolymer** — Generic term for PVDF.

**FM** — Frequency modulation.

**Foam Polyethylene** — Expanded or "foam" polyethylene, consists of individual closed cells of inert gas suspended in a polyethylene medium, resulting in a desirable reduction of the dielectric constant.

**FPFA** — Foam Perfluoroalkoxy

**FR-TPE** — FR-TPE, flame retarded thermoplastic elastomer, is a rubber-like plastic that has properties similar to rubber yet is processed as a thermoplastic. It is used as the insulation and jacket in an all TPE construction which meets UL 13 and 1277 industrial cable requirements. It has good electrical properties, abrasion resistance, colorability and flame retardance. This compound is ideal for cold weather applications.

**FREP** — Flame retardant ethylene propylene is a special flame retardant version of EPDM rubber. It is designed for use as an industrial control insulation and has excellent electrical characteristics, deformation resistance and also meets the flame retardant needs of industrial control cables.

**Frequency** — The number of times a periodic action occurs in one second. Measured in Hertz.

**Frequency Response** — The amplitude versus frequency characteristics of a device. Also may refer to the range of frequencies over which the device operates within prescribed performance.

**Frequency, Power** — Normally, the 50 or 60 Hz power used to operate most AC powered equipment. The frequency of AC power supplied by electric utilities companies.

**FSK** — Frequency Shift Keying.

**FTTC** — Fiber-to-the-Curb.

**Gage** — The physical diameter of a wire. A standard for expressing wire diameter. As the AWG number gets smaller, the wire diameter gets larger.

**Gain** — The increase of voltage, current, or power over a standard or previous reading. Usually expressed in decibels (dB).

**Geosol** — A solderable, extra tough film insulation developed by Belden for use in geophysical cables and miniature cables.

**Giga** — One billion.

**Gigahertz (GHz)** — A unit of frequency equal to one billion Hz.

**GND** — Ground.

**Gopher** — Gopher Resistant Copper Alloy. Provides shield and added protection in a single layer.

**GOPIC** — Gopher.

**Graded-Index** — A type of optical fiber in which the refractive index of the core is in the form of a parabolic curve, decreasing toward the cladding. This type of fiber provides high bandwidth capabilities.

**Ground** — An electrical connection between a circuit and the earth. Also refers to a conductor connected to earth. In some instances, can refer to a central metallic point designated as having zero potential.

**Ground Conductor** — A conductor in a transmission cable or line that is grounded.

**Ground Loop** — A completed circuit between shielded pairs of a multiple pair created by random contact between shields. An undesirable circuit condition in which interference is created by ground currents when grounds are connected at more than one point.

**Ground Potential** — The potential of the earth. A circuit, terminal, or chassis is said to be at ground potential when it is used as a reference point for other potentials in the system.

**H** — Symbolic designation for magnetic field intensity. Abbreviation for henrys (unit of inductance).

**Halar®** — A Solvay Solexis trademark for thermoplastic fluoropolymer material with excellent chemical resistance, electrical properties, thermal characteristics and impact resistance.

**Haloarrest® I** — Haloarrest I is a non-halogenated flame retarded thermoplastic polyolefin with excellent low smoke and flame properties. It is used as a jacket over the XLPE insulated singles (non-XHHW), and the entire construction meets the UL 13 and 1277 specifications as a non-halogenated PLTC/TC cable. Haloarrest I meets the European Specifications on acid gas evolution and % Halogen content. This jacket can also be used with XHHW conductors for wet ratings.

**Harness** — A flat cable or group of cables, usually with many breakouts with the wire ends prepared for termination or terminated to connectors and ready to install.

**HDSL** — High bit-rate Digital Subscriber Line.

**Headroom** — The amount by which a cable ACR exceeds the specified requirements. The TIA/EIA-568B standard specifies a minimum of 10 dB of ACR for Category 5e certification at 100 MHz.

**Heavy Metal Free (HMF)** — General term for a product or material that does not contain restricted heavy metals, such as Lead or Cadmium. See also Restriction of Hazardous Substances.

**Henry** — Unit of inductance (H) that will produce a voltage drop of one volt when the current changes at the rate of one ampere per second.

**Hertz (Hz)** — Unit of frequency equal to one cycle per second.

**Heterogeneous Insulation** — A cable insulating system composed of two or more layers of different insulating materials.

**HF** — High Frequency. International Telecommunication Union designation for the 3 to 30 MHz band of frequencies.

**HFC** — Hybrid Fiber/Coaxial.

**High Frequency** — International Telecommunication Union designation for the 3 to 30 MHz band of frequencies.

**Homogeneous Insulation** — A complete cable insulation structure whose components cannot be identified as layers of different materials.

**Hook-Up Wire** — Single conductor wire with various types of insulation.

**Horizontal Cable** — Cable used between the workstation outlet and the telecommunications closet. Limited to 90 meters maximum per TIA/EIA-568B.1.

**HSCDS** — High-Speed Cable Data Service.

**HTML** — Hypertext Markup Language.

**HTTP** — Hypertext Transfer Protocol.

**Hum** — Term used to describe noise in a audio, video or other system that comes from 60 Hz power or its harmonic(s). So named for the low-frequency humming sound produced in audio systems. Usually hum is the result of undesired coupling from a 60 Hz source or of inadequate filtering of the DC output of an AC input power supply.

**Hypalon®** — A DuPont trade name for a synthetic rubber (chlorosulfonated polyethylene) used as insulating and jacketing material for wire and cable.

**I** — Symbol used to designate current.

**I/O Interconnection** — Input/Output interface to the outside world.

**I<sup>2</sup>R** — Formula for power in watts, where I = current in amperes, R = resistance in ohms.

**ICEA** — Insulated Cable Engineers Association.

## Glossary of Terms

- IDC** — Insulation Displacement Connector. Type of connector where contact is made to the cable conductor(s) by cutting through the individual conductor's insulation. The conductor does not need to have its insulation removed prior to connection. Flat cable often uses IDCs to simultaneously connect all conductors.
- ISDL** — ISDN Digital Subscriber Line.
- IEEE** — Institute of Electrical and Electronic Engineers.
- IETF** — Internet Engineering Task Force.
- IF** — Intermediate Frequency.
- IFB** — Interrupted Feedback (Foldback). A monitoring scheme often used in television where the feed of program audio to an on-air person can be interrupted with directions, cues or other information. Usually integrated into the intercom system.
- IGMP** — Internet Group Management Protocol.
- Impedance** — The total opposition that a circuit offers to the flow of alternating current or any other varying current at a particular frequency.
- Impedance Match** — A condition whereby the impedance of a particular circuit, cable or component is the same as the impedance of the circuit, cable or device to which it is connected.
- Impedance Matching Stub** — A section of transmission line or pair of conductors cut to match the impedance of a load. Also called matching stub.
- Impedance Matching Transformer** — A transformer designed to match the impedance of one circuit to that of another.
- Impedance, Characteristic** — In a transmission cable of infinite length, the ratio of the applied voltage to the resultant current at the point the voltage is applied. Or the impedance which makes a transmission cable seem infinitely long, when connected across the cable's output terminals.
- Impedance, High** — Generally, the area of 25,000 ohms or higher.
- Impedance, Low** — Generally, the area of 1 through 600 ohms.
- Index Edge** — Reference Edge.
- Inductance** — The property of wire which stores electrical current in a magnetic field around the wire. By coiling wire, the effect can be intensified. It is measured in Henrys.
- Induction** — The phenomenon of a voltage, magnetic field or electrostatic charge being produced in an object from the source of such fields.
- Induction Heating** — Heating a conducting material by placing it in a rapidly changing magnetic field. The changing field induces electric currents in the material and losses account for the resultant heat.
- Inductive Crosstalk** — Crosstalk resulting from the coupling of the electromagnetic field of one conductor upon another.
- Injection Laser Diode** — Sometimes called the semiconductor diode. A laser in which the lasing occurs at the junction of N-type and P-type semiconductor materials.
- INMS** — Integrated Network Management System.
- Input** — A signal (or power) which is applied to a piece of electric apparatus or the terminals on the apparatus to which a signal or power is applied.
- Insertion Loss** — A measure of the attenuation of a cable and/or component(s) by determining the output of a system before and after the device is inserted into the system.
- Insulation** — A material having good dielectric properties which is used to separate close electrical components, such as cable conductors and circuit components.
- Insulation Displacement Connector (IDC)** — A mass termination connector for flat cable with contacts that displace the conductor insulation to complete termination.
- Insulation Stress** — The molecule separation pressure caused by a potential difference across an insulator. The practical stress on insulation is expressed in volts per mil.
- Interface** — The region where two systems or a major and a minor system meet and interact with each other.
- Interference** — Disturbances of an electrical or electromagnetic nature that introduce undesirable responses into other electronic equipment.
- Intermediate Frequency** — A frequency to which a signal is converted for ease of handling. Receives its name from the fact that it is an intermediate step between the initial and final conversion or detection stages.
- Ionization** — The formation of ions. Ions are produced when polar compounds are dissolved in a solvent and when a liquid, gas, or solid is caused to lose or gain electrons due to the passage of an electric current.
- Ionization Voltage** — The potential at which a material ionizes. The potential at which an atom gives up an electron.
- IP** — Internet Protocol.
- IPCDN** — IP Over Cable Data Network working group of the IETF.
- IR** — Insulation Resistance.
- IR Drop** — The designation of a voltage drop in terms of current and resistance. (See also *Voltage Drop*.)
- IRC** — Inter Relay Chat.
- IRS** — Ignition Radiation Suppression.
- Integrated Services Digital Network** — An alternative to telephone modems that allows digital transmission over ordinary telephone copper wire and other media. Home and business users can get highly graphic Web pages more quickly through ISDN adapters than through dial-up connections.
- ISO** — International Standards Organization.
- Isolation** — The ability of a circuit or component to reject interference, usually expressed in dB.
- ISP** — Internet Service Provider.
- ITFS** — Instructional Television Fixed Service.
- ITU** — International Telecommunications Union.
- Jacket** — Pertaining to wire and cable, the outer protective covering that may also provide additional insulation.
- Jumper** — A short length of conductor or flat cable used to make a connection between terminals or around a break in a circuit or between circuit boards.
- kB** — Kilobyte.
- keV** — 1000 electron volts.
- Kilo** — One thousand.
- KPSI** — Tensile strength in thousands of pounds per square inch.
- kV** — Kilovolt (1000 volts).
- kVA** — Kilo Volt-ampere. One thousand volt-amperes (VA). (See also *VA*.)
- kW** — Kilowatt.
- L** — Symbol for inductance.
- Laminated Cable** — Insulated or uninsulated wires which are encapsulated by two sheets of laminate material to maintain a predetermined pitch.
- LAN** — Local Area Network. A data network connecting any number of users, intended to serve a small area. A group of computers and associated devices that shares a common communications line and typically shares the resources of a single processor or server within a small geographic area.
- Laser** — A coherent source of light with a narrow beam and a narrow spectral bandwidth (about 2 nm).
- Lay** — The length measured along the axis of a wire or cable required for a single strand (in stranded wire) or conductor (in cable) to make one complete turn about the axis of the conductor or cable. In a twisted pair cable, the lay length is the distance it takes for the two wires to completely twist around each other.
- Lay Direction** — The direction of the progressing spiral twist in a cable while looking along the axis of the cable away from the observer. The lay direction can be either left or right.
- Lead Dress** — The placement or routing of wiring and component leads in an electrical circuit.
- Lead Free** — Unless otherwise specified, a homogeneous material containing less than 300ppm of lead (Pb) which is not intentionally added. See also *Heavy Metal Free*.
- Lead-in** — The cable that provides the path for RF energy between the antenna and the receiver or transmitter.
- Leakage** — The undesirable passage of current over the surface of or through an insulator.
- LEC** — Local Exchange Carrier.
- Level** — A measure of the difference between a quantity or value and an established reference.
- LF** — Low frequency. International Telecommunication Union designation for the 30 to 300 kHz band of frequencies.

## Glossary of Terms

- Light Emitting Diode (LED Source)** — A semiconductor device that emits incoherent light formed by the P-N junction. Light intensity is roughly proportional to electrical current flow.
- Limpness** — The ability of a cable to lay flat or conform to a surface as with microphone cables. The ability of a cable to bend in a short radius.
- Line Drop** — A voltage loss occurring between any two points in a power or transmission line. Such loss or drop is due to the resistance, reactance or leakage of the line. (See also *Voltage Drop* and *IR Drop*.)
- Line Equalizer** — A reactance (inductance and/or capacitance) connected in series with a transmission line to alter the frequency-response characteristics of the line.
- Line Level** — Refers to the output voltage level of a piece of electronic equipment. Usually expressed in decibels (e.g. 0 dBV).
- Line Voltage** — The value of the potential existing on a supply or power line.
- LMDS** — Local Multipoint Distribution Service
- Load** — A device that consumes power from a source and uses that power to perform a function.
- Loaded Line** — A transmission line that has lumped elements (inductance or capacitance) added at uniformly spaced intervals. Loading is used to provide a given set of characteristics to a transmission line.
- Loading** — A transmission line that has lumped elements (inductance or capacitance) added at uniformly spaced intervals. Loading is used to provide a given set of characteristics to a transmission line.
- Local Area Network** — A data network connecting any number of users, intended to serve a small area. (See also *LAN*.)
- Long-wire Antenna** — An antenna conductor length in excess of one-half of a wavelength.
- Loss** — Energy or signal lost without accomplishing useful work.
- Lossy** — Having high losses resulting in efficiency.
- Low Frequency** — International Telecommunication Union designation for the 30 to 300 kHz band of frequencies.
- Luminance Signal** — The portion of the composite video signal that represents the brightness or the black and white information.
- m** — Prefix for milli or one-thousandth.
- M** — Mutual inductance. The abbreviation for mega or 1 million. And also indicates 1000 (one thousand) feet in the wire industry. Lower case m is for milli or one-thousandth. (See also *m*.)
- M'** — Notation representing 1000 feet.
- mA** — milliamper (one-thousandth of an ampere).
- MAC** — Media Access Control (layer of OSI Reference Model).
- MAN** — Metropolitan Area Network.
- Manufacturing Automation Protocol** — A manufacturing automation protocol based on IEEE 802.4 standards.
- MAP** — Manufacturing Automation Protocol.
- Margin** — Distance between reference edge of cable and nearest edge of first conductor or center of first conductor.
- Mass-Termination** — The process of simultaneously terminating all conductors in a single operation.
- Matrix IDC™** — Belden's patent pending 10GX® Module IDC design which reduces the ANEXT between pairs of adjacent modules by 15dB, enabling transmission rates of 625 MHz and data rates of 10Gb/s.
- Matte Finish PVC** — A special formulation of PVC which very closely looks and feels like rubber.
- MATV** — Abbreviation for Master Antenna Television.
- MB** — Megabyte.
- Mb/s** — Mega bits per second. The number of bits, in millions, transmitted per second.
- MCNS** — Multimedia Cable Network System Partners Ltd.
- MDS** — Multipoint Distribution System.
- Mega** — Prefix meaning million.
- Megahertz (MHz)** — Unit of frequency equal to one million Hertz.
- Metropolitan Area Network (MAN)** — A data network intended to serve the area of a city or an area of similar size.
- mfd** — Microfarad (one-millionth of a farad). Modern abbreviation is  $\mu\text{F}$  (lower case Greek *mu* followed by F).
- Mho** — The unit of conductance equal to the reciprocal of the unit of resistance (ohm).
- MHz** — Megahertz. (See also *Megahertz*.)
- Micro** — Prefix meaning one-millionth.
- Microfarad** — One-millionth of a farad ( $\mu\text{f}$ ,  $\mu\text{fd}$ ,  $\text{mf}$  and  $\text{mfd}$  are common abbreviations).
- Micromicrofarad** — One-millionth of a microfarad ( $\mu\mu\text{f}$ ,  $\mu\mu\text{fd}$ ,  $\text{mmf}$ ,  $\text{mmfd}$  are common abbreviations). Modern usage is picofarad (pF).
- Micron** — Millionth of a meter. ( $\mu$  is a common abbreviation).
- Microphonics** — Noise caused by mechanical excitation of a system component. In a single-conductor microphone cable, for example, microphonics can be caused by the shield rubbing against the dielectric as the cable is flexed.
- Mil** — A unit of length equal to one thousandth of an inch (0.001).
- Milli** — Prefix meaning one-thousandth.
- Mitigation** — Strategies or methods to improve Alien Crosstalk performance in the field for 10G transmission over installed-base cabling.
- Mode** — A single electromagnetic wave traveling in an optical fiber.
- Modem** — Modulator-Demodulator. Device that converts signals in one form to another form compatible with another kind of equipment.
- Modulation** — Altering the characteristics of a carrier wave to convey information. Modulation techniques include amplitude frequency, phase, plus many other forms of on-off digital coding.
- Molded Cable** — Cable assemblies with molded connectors on one or both ends.
- Mono Filament** — A single strand filament as opposed to a braided or twisted filament.
- MSO** — Multiple System Operator. Cable TV term referring to companies that operate multiple cable TV systems in numerous cities.
- MTP** — Simple Mail Transfer Protocol.
- Multi-Conductor Cable** — Cable with more than one conductor.
- Multiplex** — A technique for putting two or more signals into a single channel.
- Mutual Capacitance** — Effective capacitance between two conductors when the effects of the other conductors and shield, if present, are removed.
- mV** — Millivolt (one-thousandth of a volt).
- mW** — Milliwatt (one-thousandth of a watt).
- Mylar®** — DuPont trademark for polyethylene terephthalate (polyester) film.
- N** — Type of coaxial connector named after its inventor, Paul Neil of Bell Labs. Also the symbol for Newton.
- Nano** — One-billionth.
- Nanometer (nm)** — One billionth of a meter.
- Nanosecond** — One billionth of a second.
- NAP** — Network Access Point.
- National Electrical Code (NEC)** — A publication of the National Fire Protection Association (NFPA) which outlines requirements for electrical wiring and building construction.
- NBR** — Butadiene-acrylonitrile copolymer rubber, a material with good oil and chemical resistance.
- NEC** — National Electrical Code.
- NEMA** — National Electrical Manufacturers Association.
- Neoprene** — A synthetic rubber with good resistance to oil, chemical, and flame. Also called polychloroprene.
- Network** — A method of data communications between computers.
- NEXT** — Near-end Crosstalk. Crosstalk induced on the pairs, measured at the end near the transmitter. Usually expressed in decibels (dB).
- NFPA** — National Fire Protection Association.
- Nibble** — One half byte (4 bits).

## Glossary of Terms

**NOC** — Network Operations Center.

**Noise** — In a cable or circuit, any extraneous signal which tends to interfere with the signal normally present in or passing through the system.

**Non-Paired Cable** — Cable with two or more cabled conductors that are not in a paired configuration.

**Non-Plenum** — A description for a cable that does not meet the requirements of NFPA 262 (UL 910) CMP flame test. Such a cable cannot be installed in an area that is used for air return (plenum).

**Notch** — The removal of the web section between conductors of a flat cable to aid in stripping, slitting and termination.

**NTSC** — National Television System Committee. Organization that formulated standards for the current U.S. color television system. This system is used in most countries of the Americas and in other parts of the world. It was designed to be compatible with the existing monochrome TV sets, so that they would not become obsolete. Color televisions would also be able to receive monochrome transmissions. NTSC uses a 3.579545 MHz subcarrier whose phase varies with the instantaneous hue of the televised color and whose amplitude varies with the instantaneous saturation of the color. NTSC employs 525 lines per frame, 29.97 frames per second and 59.94 fields per second.

**Numerical Aperture (NA)** — A measure of the angular acceptance for a fiber. It is approximately the sine of the half-angle of the acceptance cone.

**Nylon** — An abrasion-resistant thermoplastic with good chemical resistance.

**OFDM** — Orthogonal Frequency Division Multiplexing.

**OFHC** — Abbreviation for oxygen-free, high conductivity copper. It has 99.95% minimum copper content and an average annealed conductivity of 101% compared to standard copper.

**Ohm** — The unit of electrical resistance. The value of resistance through which a potential difference of one volt will maintain a current of one ampere.

**Ohm's Law** — Stated  $E=IR$ ,  $I=E/R$  or  $R=E/I$ . The current  $I$  in a circuit is directly proportional to the voltage  $E$ , and inversely proportional to the resistance  $R$ .

**Optical Waveguide Fiber** — A transparent filament of high refractive index core and low refractive index cladding that transmits light.

**OSI** — Open System Interconnect (Model for networking protocols).

**OSS** — Operations Support Systems.

**Output** — The useful power or signal delivered by a circuit or device.

**Ozone** — Extremely reactive form of oxygen, normally occurring around electrical discharges and present in the atmosphere in small but active quantities. In sufficient concentrations it can break down certain rubber insulations under tension (such as a bent cable).

**Paired Cable** — Cable with conductors cabled in groups of two.

**PAL** — Phase Alternation Line. PAL is a European color TV system featuring 625 lines per frame, 25 frames and 50 fields per second. Used mainly in Europe, China, Malaysia, Australia, New Zealand, the Middle East, and parts of Africa. PAL-M is a Brazilian color TV system with 525 lines per frame, 30 frames and 60 fields per second.

**Parallel Circuit** — A circuit in which the identical voltage is presented to all components, with current dividing among the components according to the resistances or the impedances of the components.

**Parallel Digital** — Digital information that is transmitted in parallel form. The digits are sent on separate conductors rather than sequentially on one transmission line (serial). Often used informally to refer to parallel digital television signals.

**PASP** — Polyethylene Aluminum Steel Polyethylene. Provides additional lightning and gopher protection.

**Patchcord** — A flexible piece of cable terminated at both ends with plugs. Used for interconnecting circuits on a patchboard, in a wiring closet or at the work area.

**PC** — Personal Computer.

**PE** — Polyethylene.

**Peak** — The maximum instantaneous value of a varying current or voltage.

**Peel Strength** — The force necessary to separate two adjacent conductors of a bonded or laminated flat cable.

**Periodicity** — The uniformly spaced cable impedance variations that result in addition of the reflections of a signal. The distance between them is the half wavelength of the most affected frequency. Multiples of that frequency are also affected. Even very slight variations, which appear over and over in a construction or installation, can have major effects on signal integrity because of periodicity.

**Permanent Link** — The horizontal cable including the workstation outlet and patch panel in the telecommunications closet plus two meters of cable at each end for testing. Limited to a maximum of 90 meters in TIA/EIA-568B.1.

**PFA** — Perfluoroalkoxy.

**Phase** — An angular relationship between waves.

**Phase Shift** — A change in the phase relationship between two alternating quantities.

**Photodetector (Receiver)** — Converts light energy to electrical energy. The silicone photo diode is most commonly used for relatively fast speeds and good sensitivity in the 0.75 micron to 0.95 micron wavelength region. Avalanche photodiodes (APD) combine the detection of optical signals with internal amplification of photocurrent. Internal gain is realized through avalanche multiplication of carriers in the junction region. The advantage in using an APD is its higher signal-to-noise ratio, especially at high bit rates.

**PHY** — Physical (layer of OSI Reference Model). (See also *Physical Layer*)

**Physical Layer** — The actual portion of a network that is used to physically connect computers of a network and over which the data is transmitted — the cable.

**PIC** — Plastic Insulated Conductor. Provides strong insulation.

**Pickup** — Any device which is capable of transforming a measurable quantity of intelligence (such as sound) into relative electrical signals (e.g. a microphone).

**Pico** — One-trillionth.

**Picofarad** — One trillionth of a farad. A micromicrofarad. Abbreviated pF in modern usage or mmF in earlier usage.

**Pin-diode** — A photodetector used to convert optical signals to electrical signals in a receiver. (See also *Photodetector*.)

**Pitch** — Nominal distance from center-to-center of adjacent conductors within a cable. When conductors are flat, pitch is usually measured from the reference edge of a conductor to the reference edge of the adjacent conductor. Spacing.

**Planar Cable** — Also referred to as flat and/or ribbon cable. Any cable with two or more parallel conductors in the same plane encapsulated by insulating material.

**Plastic** — High polymeric substances, including both natural and synthetic products that are capable of flowing under heat and pressure, called thermoplastics. Unlike rubber and other thermoset compounds, plastics can be remelted and reused.

**Plasticizer** — A chemical added to plastics to make them softer and more flexible.

**Plenum** — A compartment or chamber to which one or more air ducts are connected and that forms part of the air distribution system. A description for a cable that passes the NFPA 262 (UL-910) CMP flame test requirements.

**Plug** — A male housing with male or female contacts.

**Point-to-Point Wiring** — Wiring that consists of continuous conductors terminated at each end to circuit destination.

**Polarization** — The orientation of a flat cable or a rectangular connector (e.g. for gray flat cable), the colored edge indicating the number one conductor.

**Polybutadiene** — A type of synthetic rubber often blended with other synthetic rubbers to improve their properties.

**Polyethylene (PE)** — A thermoplastic material having excellent electrical properties. Low dielectric constant, a stable dielectric constant over all frequencies, very high insulation resistance. In terms of flexibility, polyethylene can be rated stiff to very hard, depending on molecular weight and density — low density being the most flexible and the high-density, high-molecular weight formulation being very hard. Moisture resistance is rated excellent.

**Polymer** — A substance made of many repeating chemical units or molecules. The term polymer is often used in place of plastic, rubber or elastomer.

**Polyolefin** — Any of the polymers and copolymers of the ethylene family of hydrocarbons, such as polyethylene and polypropylene.



## Glossary of Terms

- Polypropylene (PP)** — A thermoplastic similar to polyethylene but stiffer and having a higher softening point (temperature). This material is primarily used as an insulation material. Typically, it is harder than polyethylene. This makes it suitable for thin wall insulations. The dielectric constant is 2.25 for solid and 1.55 for cellular designs.
- Polyurethane (PUR)** — Broad class of polymers noted for good abrasion and solvent resistance. Can be in solid or cellular form. This thermoplastic material is used primarily as a cable jacket material. It has excellent oxidation, oil, and ozone resistance. Some formulations also have good flame resistance. It is a hard material with excellent abrasion resistance. It has outstanding memory properties, making it an ideal jacket material for retractile cords.
- Polyvinyl Chloride (PVC)** — A general purpose thermoplastic used for wire and cable insulation and jackets.
- Portable Cordage** — Cable with two or more twisted conductors for flexible applications. Also called flexible cord.
- POTS** — Plain Old Telephone Service. Sometimes used in discussions of new telephone technologies in which the question of whether and how existing voice transmission for ordinary telephone communication can be accommodated. For example, DSL and ISDN provide part of their channels for POTS, while using most of their bandwidth for digital data transmission.
- Potting** — Sealing by filling with a substance to exclude moisture.
- Power** — The amount of work per unit of time. Usually expressed in watts. Power equals the product of voltage and current ( $P = V \times I$ ).
- Power Loss** — The difference between the total power delivered to a circuit, cable or device and the power delivered by that device to a load.
- Power Ratio** — The ratio of power appearing at the load to the input power.
- PP** — Polypropylene.
- PPP** — Point-to-Point Protocol.
- Precision Video** — Video coaxial cables having very tight electrical tolerances in impedance, velocity of propagation, attenuation and return loss. Used in high quality applications such as live broadcast in network studios and pre- or post-production facilities.
- Premise Cabling** — Refers to the entire cabling system used for voice, data, video and power on a user's premise. For Local Area Networks, the cabling of choice includes unshielded twisted pairs (UTP), fiber optic and coaxial cables. Of these, the UTP market is the largest, with greatest demand for cables with four pairs that meet certain standards of performance, such as Category 5 and Category 5e.
- PRI** — Primary Rate Interface ISDN.
- Prop 65** — See *California Proposition 65*.
- Propagation Delay** — Time required for a signal to pass from the input to the output of a device.
- PSAELFEXT** — Power sum alien equal level far-end crosstalk is a computation of the unwanted signal coupling between pairs in cabling in close proximity from multiple transmit signals at the near-end into another pair measured at the far-end, and relative to the received signal level.
- PSAFEXT** — Power sum alien far-end crosstalk loss is a computation of the unwanted signal coupling between pairs in cabling in close proximity from multiple transmit signals at the near-end into another pair measured at the far-end.
- PSANEXT** — Power sum alien near-end crosstalk loss is a computation of the unwanted signal coupling between pairs in cabling in close proximity from multiple transmit signals at the near-end into a pair measured at the near-end.
- Pseudo Random NRZ** — A wave form of binary signals that may be used in a computer system. It is called NRZ, Non-Return to Zero, because the voltage does not return to zero after each bit.
- PSDN** — Public Switched Telephone Network.
- Pulse** — A current or voltage which changes abruptly from one value to another and back to the original value in a finite length of time. Used to describe one particular variation in a series of wave motions.
- Put-up** — Packaging of finished wire or cable.
- PVC** — Polyvinyl Chloride. (See also *Polyvinyl Chloride*.)
- PVDF** — Polyvinylidene Fluoride.
- QAM** — Quadrature Amplitude Modulation.
- QOS** — Quality of Service.
- QPSK** — Quaternary Phase Shift Keying or Quadrature PSK.
- Quad** — A four conductor cable. Also called star quad.
- R** — Symbol for resistance.
- Radio Frequency (RF)** — Radio Frequency. Includes frequencies from a few kilohertz to several gigahertz. Used to transmit information from point to point over the air-waves or cable.
- RAM** — Random Access Memory.
- Rated Temperature** — The maximum temperature at which an electric component can operate for extended periods without loss of its basic properties.
- Rated Voltage** — The maximum voltage at which an electric component can operate for extended periods without undue degradation or safety hazard.
- RDC** — Regional Data Center.
- Reactance** — A measure of the combined effects of capacitance and inductance on an alternating current. The amount of such opposition varies with the frequency of the current. The reactance of a capacitor decreases with an increase in frequency; the opposite occurs with an inductance.
- Receiver** — A unit that converts an RF signal to another type of signal (e.g. radio, television). Also refers to an electronic package that converts light energy to electrical energy in a fiber optic system. (See also *Photodetector*.)
- Receptacle** — A female housing with male or female contacts.
- Reference Edge** — Edge of cable or conductor from which measurements are made, such as in flat cable. Sometimes indicated by a thread, identification stripe or printing. Conductors are usually identified by their sequential position from the reference edge, with number one conductor closest to this edge.
- Reflection** — The change in direction (or return) of waves striking a surface. For example, electromagnetic energy reflections can occur at an impedance mismatch or variation in a transmission line, causing standing waves.
- Reflection Loss** — The part of a signal which is lost due to reflection of power at a line discontinuity.
- Refractive Index** — The ratio of light velocity in a vacuum to its velocity in the transmitting medium.
- Registration** — Alignment of one object with relation to another. In flat cables it involves aligning conductors with contacts or solder pads. Also called register.
- Repeater** — A receiver and transmitter combination used to regenerate an attenuated signal.
- Resistance** — In DC circuits, the opposition a material offers to current flow, measured in ohms. In AC circuits, resistance is the real component of impedance, and may be higher than the value measured at DC.
- Resonance** — An AC circuit condition in which inductive and capacitive reactances interact to cause a minimum or maximum circuit impedance.
- Restricted Flame Retardants** — Refers to the EU directive 2003/11/EC (6-FEB-2003), which bans the use of Penta- and Octa- BDE compounds. Belden is currently using these substances in certain CPE jacket materials only, and plans to phase out usage by January 2006.
- Restriction of Hazardous Substances (RoHS)** — Refers to the EU directive 2002/95/EC (27-JAN-2003) which bans the use of certain substances as of July 2006. The following items are of primary concern in cables, namely: Asbestos and its compounds, Cadmium and its compounds, Chromium VI and its compounds, Lead and its compounds, Mercury and its compounds, and Polybrominated Biphenyls (pbbs) and their ethers/oxides (PBDEs, PBBEs). Contact Belden Customer Service or visit [www.belden-emea.com](http://www.belden-emea.com) for product specific details.
- Retractile Cord** — A cord having specially treated insulation or jacket so that it will retract like a spring. Retractability may be added to all or part of a cord's length.
- Return Loss** — Measure of signal reflections from a cable or device with a fixed, standard reference impedance on the measuring equipment. Expressed in decibels (dB).
- RF** — Radio Frequency.
- RFI** — Radio Frequency Interference.
- RFP** — Request for Proposals.
- RG/U** — RG is the abbreviation for radio guide, a military designation for a coaxial cable, and U stands for universal.

## Glossary of Terms

- RGB** — Abbreviation for the three parts of color video signal: red, green and blue. Also refers to multi-coaxial cables carrying these signals.
- Ribbon Cable** — A flat cable made with parallel round conductors in the same plane. Also referred to as planar and/or flat cable. Any cable with two or more parallel conductors in the same plane encapsulated by insulating material.
- Ringin Out** — The process of locating or identifying specific conductor paths by means of passing a current through selected conductors.
- Riser** — The system of pathways that are provided to run riser cables from one floor to another.
- RJ-45** — Modular telecommunications connector.
- RL** — Return Loss.
- RMS** — Root-mean-square.
- Rope Strand** — A conductor composed of groups of twisted strands.
- Round Conductor Flat Cable (RCFC)** — A cable made with parallel round conductors in the same plane.
- Routing** — The path followed by a cable or conductor.
- RSVP** — Resource Reservation Protocol.
- RTP** — Real-Time Transport Protocol.
- Rubber (Wire Insulation)** — A general term used to describe wire insulations made of thermosetting elastomers, such as natural or synthetic rubbers, neoprene, Hypalon® butyl rubber and others.
- RUS 1755.900 (aka PE90)** — A specification for fiber optic cables currently in high demand by the telecommunications industry. Only a handful of U.S. manufacturers can produce fiber optic cables to this specification. Belden is one of them.
- S-CDMA** — Synchronous Code Division Multiple Access.
- S-HDSL** — Single-pair High bit-rate Digital Subscriber Line.
- SAE** — Society of Automotive Engineers.
- SBR** — A copolymer of styrene and butadiene. Also GR-S or Buna-S. Most commonly used type of synthetic rubber.
- ScTP** — Screened Twisted Pair. Premise network cable with an overall foil shield.
- SDI** — Serial Digital Interface.
- SDSL** — Symmetric Digital Subscriber Line.
- SEALPIC** — Aluminum Shield. Sealed Aluminum.
- Self-extinguishing** — The characteristic of a material that extinguishes its own flame after the igniting flame is removed.
- Self-Support** — Undulated core with aluminum, polyethylene and a support strand. For aerial use.
- Semiconductor** — In wire industry terminology, a material possessing electrical conductivity that falls somewhere between that of conductors and insulators. Usually made by adding carbon particles to an insulator. Not the same as semiconductor materials such as silicone, germanium, etc. Used for making transistors and diodes.
- Semi-Solid Dielectric** — A coaxial design in which a monofilament of plastic holds the center conductor in place in a hollow plastic tube allowing the remainder of the dielectric to be air. Typical velocities of up to 84% can be achieved in this design.
- Separator** — Pertaining to wire and cable, a layer of insulating material such as textile, paper, Mylar®, etc., which is placed between a conductor and its dielectric, between a cable jacket and the components it covers, or between various components of a multiple-conductor cable. It can be utilized to improve stripping qualities, flexibility or can offer additional mechanical or electrical protection to the components it separates.
- Serial Digital** — Digital information that is transmitted in serial form. SDI informally refers to serial digital television signals that conform to the SMPTE 259M standard.
- Serial Digital Interface** — Informally refers to serial digital television signals that conform to the SMPTE 259M standard.
- Series Circuit** — A circuit in which the components are arranged end to end to form a single path for current.
- Serve Shield** — A metallic shield consisting of several strands of wire, helically wound and laid parallel around a cable core in only one direction, as opposed to the two directions with interleaving of a braid shield.
- Shannon Capacity** — A theoretical calculation of the maximum available data-rate for a channel.
- Sheath** — Pertaining to wire and cable, the outer protective covering, also called jacket, that may also provide additional insulation.
- Shield** — A tape, serve or braid (usually copper, aluminum or other conductive material) placed around or between electric circuits or cables or their components, to prevent signal leakage or interference.
- Shield Coverage** — The optical percentage of a cable actually covered by shielding material.
- Shield Effectiveness** — The relative ability of a shield to screen out undesirable interference or prevent signal leakage out of the cable. Frequently confused with the term shield coverage.
- Shield Percentage** — The percentage of physical area of a circuit or cable actually covered by shielding material.
- Shielded Armored** — Types of Shield: Aluminum, Aluminum/Steel and Copper. Cables that require some sort of shield.
- Signal** — Any visible or audible indication which can convey information. Also, the information conveyed through a communication system.
- Signal Conductor** — A conductor in a transmission cable or line that carries electrical signals.
- Signal to Noise Ratio** — Ratio of desired signal to undesired signal (noise) that is often expressed in decibels. Commonly used interchangeably with Attenuation Crosstalk Ratio (ACR) – the difference between attenuation and crosstalk, measured in decibels (dB), at a given frequency. Important characteristic in networking transmission to assure that signal sent down a twisted pair is stronger at the receiving end of the cable than are any interference signals imposed on that same pair by crosstalk from other pairs.
- Silicone** — A material made from silicone and oxygen. Can be in thermosetting elastomer or liquid form. The thermosetting elastomer form is noted for high heat resistance. This is a very soft thermoset insulation. It has excellent electrical properties plus ozone resistance, low moisture absorption, weather resistance, and radiation resistance. It typically has low mechanical strength and poor scuff resistance.
- Single-mode Fiber** — An optical fiber wave guide in which only one mode will propagate. The fiber has a very small core diameter of approximately 8 micro meters. It permits signal transmission at extremely high bandwidths and is generally used with laser diodes.
- Single-ended** — Unbalanced, such as grounding one side of a circuit or transmission line.
- Sinusoidal** — Varying in proportion to the sine of an angle or time function. Ordinary alternating current is sinusoidal.
- SIS** — Single conductor having synthetic thermosetting insulation of heat-resistant, moisture-resistant, flame-retarding grade. Also made with chemically cross-linked polyethylene insulation. Used for switched wiring only.
- Skew Rays** — A ray that does not intersect the fiber axis. Generally, a light ray that enters the fiber core at a very high angle.
- Skin Effect** — The tendency of alternating current to travel only on the surface of a conductor as its frequency increases.
- SMA** — Subminiature A connector commonly used in VHF, UHF, RF and microwave applications.
- SMB** — Subminiature B connector snap-mount connector.
- SMC** — Subminiature C connector.
- Snake Cable** — A name given to individually shielded or individually shielded and jacketed, multi-pair audio cables. Used in the connection of multi-channel line level audio equipment.
- SNMP** — Simple Network Management Protocol.
- SNR** — Signal to Noise Ratio.
- SONET** — Synchronous Optical Network.
- Source** — The device from which a signal is marked into a cable. The device (usually LED or laser) used to convert an electrical information-carrying signal into a corresponding optical signal for transmission by an optical wave guide.
- Spacing** — The distance between the centers of two adjacent conductors. Pitch.
- Span** — The distance between the center of the first conductor and the center of the last conductor in a flat cable.
- Spectral Bandwidth** — The difference between wavelengths at which the radiant intensity of illumination is half its peak intensity.
- Spectrum** — Frequencies that exist in a continuous range and have a common characteristic. A spectrum may be inclusive of many spectrums (e.g. the electromagnetic radiation spectrum includes the light spectrum, radio spectrum, infrared spectrum, etc.).

## Glossary of Terms

**Speed of Light (c)** — Approximately  $2.998 \times 10^8$  meters per second.

**SpiralFlex™** — Belden's patent-pending cable design for the 10GX® Cable which increases randomization and pair separation, enabling transmission rates of 625 MHz and data-rates of 10Gb/s.

**Splitter** — A device that sends the signal from one source to two or more receiving devices by allocating a portion of the signal to each receiver (e.g. cable TV splitter). A device that divides a high bandwidth signal into two or more lower bandwidth signals, each carrying a selected frequency range. Users connected to a DSL line, for example, may have a splitter installed at their home or business to divide the incoming signal into low frequencies to send to their phone and high frequencies for data to the computer.

**SRL** — Structural Return Loss.

**Stalpath (DUCTPIC)** — Aluminum steel bonded to the polyethylene jacket. Helps minimize jacket damage.

**Standing Wave** — The stationary pattern of waves produced by two waves of the same frequency traveling in opposite directions on the same transmission line. The existence of voltage and current maxima and minima along a transmission line is a result of reflected energy from an impedance mismatch.

**Standing Wave Ratio (SWR)** — A ratio of the maximum amplitude to the minimum amplitude of a standing wave stated in current or voltage amplitudes. (See also *Standing Wave*.)

**Star Quad** — Term given to 4-conductor microphone cables where the conductors are spiraled together, which, when connected in an x configuration, greatly increases common mode noise rejection.

**Static Charge** — An electrical charge that is bound to an object. An unmoving electrical charge.

**Stay Cord** — A component of a cable, usually of high tensile strength, used to anchor the cable ends at their points of termination and keep any pull on the cable from being transferred to the electrical conductors.

**Step Insulated** — Process of applying insulation in two layers. Typically used in shielded networking cables such that the outer layer of insulation can be removed and remaining conductor and insulation can be terminated in a RJ-45 type connector.

**Step-index Fiber** — An optical fiber in which the core is of a uniform refractive index with a sharp decrease in the index of refraction at the core/cladding interface.

**STP** — Shielded Twisted Pair(s).

**Strain Gage** — A device for determining the amount of strain (change in dimensions) when a stress is applied.

**Strand** — A single uninsulated wire.

**Stranded Conductor** — A conductor composed of several strands or groups of uninsulated wires.

**Strip** — To remove insulation from a cable or wire.

**Stripping Groove** — The controlled thinning of the lamination between two conductors in a flat cable to allow easy hand separation. Tear feature.

**Structural Return Loss** — Magnitude of the internal cable reflections, measured in decibels (dB), relative to the actual cable impedance, not the system impedance. Measure of signal reflections caused by the structure of the cable without the additional reflections from any impedance mismatch between the cable and the measuring equipment. Measure of internal cable reflections using a reference impedance in the measuring equipment that is adjusted to the nominal or average impedance of the cable. (See also *Return Loss*.)

**Surge** — A temporary and relatively large increase in the voltage or current in an electric circuit or cable. Also called transient.

**S-Video** — Transmission method for video in which the two parts of the signal, the chrominance and luminance, are sent on separate transmission lines to provide better picture quality.

**Sweep Test** — Testing a characteristic of a cable or device across a range of frequencies. In cable, it usually implies return loss or structural return loss. (See also *Return Loss* or *Structural Return Loss*.)

**TCP/IP** — Transmission Control Protocol/Internet Protocol.

**TDMA** — Time Division Multiple Access.

**Tear Feature** — The controlled thinning of the lamination between two conductors in a flat cable to allow easy hand separation.

**Teflon®** — DuPont Company trademark for fluorocarbon resins.

**Tefzel®** — DuPont Company trademark for a ETFE. Fluorocopolymer thermoplastic material which has excellent electrical properties, heat resistance, chemical resistance, toughness, radiation resistance and flame resistance.

**Temperature Rating** — The maximum temperature at which the insulating material or cable may be used in continuous operation without change in its basic properties.

**Tensile Strength** — The pull stress required to break a bare wire.

**TFE** — Tetrafluoroethylene. A thermoplastic material with good electrical insulating properties and chemical and heat resistance.

**Thermal Rating** — The temperature range in which a material will perform its function without undue degradation.

**Thermoplastic** — A material which will soften, flow or distort appreciably when subjected to sufficient heat and pressure. Examples are polyvinyl chloride and polyethylene.

**Thermoset** — A material which will not soften, flow or distort appreciably when subjected to heat and pressure. Vulcanizable. Examples are rubber and neoprene.

**TIA** — Telecommunications Industry Association. Body which authored the TIA/EIA-568-B Commercial Building Telecommunications Wiring Standard in conjunction with EIA.

**TIA/EIA-568-B** — Commercial Building Telecommunications Wiring Standard defines a generic telecommunications wiring system for commercial buildings that will support a multi-product, multi-vendor environment. It also provides direction for the design of telecommunications products for commercial enterprises.

**Tinsel** — A type of electrical conductor composed of a number of tiny threads, each thread having a fine, flat ribbon of copper or other metal closely spiraled about it. Used for small size cables requiring limpness and extra-long flex life.

**Topcoated Wire** — Conductor produced by applying a layer of tin over a stranded bare copper conductor holding the strands together allowing easier soldering and preventing the fraying of strands.

**TP-PMD** — Twisted Pair-Physical Medium Dependent.

**Transducer** — A device for converting one form of energy to another, such as mechanical energy to electrical energy.

**Transfer Impedance** — For a specified cable length, transfer impedance relates to a current on one surface of a shield to the voltage drop generated by this current on the opposite surface of the shield. Transfer impedance is used to determine shield effectiveness against both ingress and egress of interfering signals. Cable shields are normally designed to reduce the transfer of interference — hence, shields with lower transfer impedance are more effective than shields with higher transfer impedance.

**Transmission Line** — An arrangement of two or more conductors, such as a coaxial cable or a waveguide used to transfer signal energy from one location to another.

**Transmission Line Cable** — Two or more conductors placed within a dielectric material in such a way as to control the electrical characteristics.

**Transmitter** — Equipment that generates RF or electrical signals for transmission through the air or space or over a transmission line. Also refers to the electronic package that converts electrical energy to light energy in a fiber optic system.

**Triad Cable** — Cable with three twisted conductors.

**Triaxial Cable** — A cable construction having a conductor and two isolated braid shields, all insulated from each other. A coaxial cable with a second braid applied over an inner jacket and an outer jacket applied over the outer braid. Commonly used in television camera systems.

**Triboelectric Noise** — Noise generated in a shielded cable due to variations in capacitance between the shield and conductors as the cable is flexed.

**Trunk Cable** — In a CATV system, the transmission cable from the head end (signal pickup) to the trunk amplifier. Also called a feeder cable.

**Turn-key** — A contractual arrangement in which one party designs and installs a system and turns over the keys to another party who will operate the system.

**TVRO** — TV Receive only.

## Glossary of Terms

**Twin-lead** — A transmission line having two parallel conductors separated by insulating material. Line impedance is determined by the diameter and spacing of the conductors and the insulating material and is usually 300 ohms for television receiving antennas.

**Twinax Cable** — Cable with two twisted conductors with established electrical properties (one pair = two conductors sharing a common axis = twinax).

**Twisted Pair** — Two lengths of insulated conductors twisted together. The traditional method for connecting home and many business computers to the telephone company. Gets its name because two insulated copper wires are twisted together, both of which are needed for each connection. In commercial environments, performance of data transmission can be improved by adding a composite tape to the wire. This is known as shielded twisted pair.

**Two-pair Premise Wiring** — Refers to the two pairs of voice grade (low bandwidth) twisted pair wire installed in most homes since the 1950s. The extra pair makes it possible for you to add another line when you need it.

**UHF** — Ultra High Frequency. International Telecommunications Union designation for the 300 to 3000 MHz band of frequencies.

**UL** — Underwriters Laboratories. A nonprofit organization which tests and verifies construction and performance of electronic parts and equipment, including wire and cable.

**UM** — Unsoldered Mechanical Protection. Additional steel and polyethylene over inner polyethylene jacket. Provides additional mechanical protection.

**Unbalanced Line** — A transmission line in which voltages on the two conductors are unequal with respect to ground. A coaxial cable is a common type of unbalanced line.

**Unilay** — A conductor with more than one layer of helically laid wires with the direction of lay and length of lay the same for all layers.

**UTP** — Unshielded Twisted Pair(s).

**V** — Volt. (See also *Volt*)

**VA** — Volt-ampere. Measure of apparent power in a reactive circuit found by multiplying the voltage by the current.

**VC/MTM** — Variable Constellation/Multi-Tone Modulation.

**VDSL** — Very high bit rate Digital Subscriber Line.

**Velocity of Propagation (VP)** — The transmission speed of electrical energy in a length of cable compared to speed of light in free space. Usually expressed as a percentage.

**VHF** — Very High Frequency. International Telecommunications Union designation for the 30 to 300 MHz band of frequencies.

**VHS** — Abbreviation for Video Home System.

**Video** — Pertaining to picture information in a television system.

**VLF** — Very Low Frequency. International Telecommunications Union designation for the 3 to 30 kHz band of frequencies.

**Volt** — A unit of electromotive force.

**Voltage** — Electrical potential of electromotive force expressed in volts.

**Voltage Drop** — The voltage developed across a component or conductor by the current flow through the resistance or impedance of the component or conductor.

**Voltage Rating** — The highest voltage that may be continuously applied to a cable construction in conformance with standards or specifications.

**Voltage Standing Wave Ratio** — Ratio of maximum voltage of the standing wave to the minimum voltage of the standing wave. (See also *Standing Wave Ratio*.)

**VSWR** — Voltage Standing Wave Ratio.

**VW-1** — A flammability rating established by Underwriters Laboratories for wires and cables that pass a specially designed vertical flame test, formerly designed FR-1.

**W** — Symbol for watt or wattage.

**Wall Thickness** — The thickness of an insulation or jacket.

**WAN** — Wide Area Network.

**Watt** — A unit of electrical power.

**Wave Form** — A graphical representation of a varying quantity. Usually, time is represented on the horizontal axis, and the current or voltage value is represented on the vertical axis.

**Wavelength** — The distance between positive peaks of a signal. As the frequency increases, and waves get closer together, the wavelength decreases.

**WCS** — Wireless Communications Service.

**Wire** — A conductor, either bare or insulated.

**Wireless** — Really a misnomer. Belden makes a variety of cables needed to build the transmitting infrastructure required to support wireless devices. Wireless is a technology that allows a device (phone, pager or satellite dish) to be unconnected from the transmission point of a voice, video or data signal. The transmission infrastructure required to support such wireless devices is a wired platform of transmission towers and stations that communicate point to point and to telephone central offices.

**X** — Symbol for reactance.

**X-Bar™** — The X-Bar is a plastic device that is used for installing 10GX® Cable onto a 10GX Module, optimizing the termination process and practically eliminating performance variation due to termination variances.

**XLPE** — Cross-linked polyethylene is a thermoset and is cross-linked by radiation, thermally, or by moisture. XLPE offers a wide range of operating temperatures, excellent deformation, abrasion, and flame resistance. XLPE can be formulated with halogenated or non-halogenated flame retardant packages. Some grades are also rated XHHW-2 which offers excellent wet electrical properties.

**XLR** — A multi-pin audio connector (typically 3 pins) used in microphone, line level and snake cable audio connections.

**XPE-PVC** — Expanded Polyethylene-Polyvinyl Chloride. Fire retardant.

**Z** — Symbol for impedance.

Halar® is a Solvay Solexis trademark.  
Mylar®, Teflon® and Tefzel® are DuPont trademarks.

**Notes**



## Table of Contents

Technical Information	Page No.
<b>Conductors</b>	<b>23.2 – 23.5</b>
Table 1: Solid Copper Wire, American Wire Gage	23.2
Table 2: Stranded Copper Wire, American Wire Gage	23.3
Table 3: Current Ratings for Belden Electronic Cables	23.4
Table 4: Metric/Imperial/Circular Mills/AWG Equivalents	23.5
<b>Insulations and Jackets</b>	<b>23.6 – 23.11</b>
Insulations and Jackets: Overview	23.6
Characteristics of Popular Insulation and Jacket Compounds	23.7
Table 5: Comparative Properties of Plastic Compounds	23.8
Table 6: Comparative Properties of Fluoropolymer	23.9
Table 7: Comparative Properties of Rubber Insulations	23.10
Table 8: Nominal Temperature Ranges	23.11
<b>Shielding and Armoring</b>	<b>23.12 – 23.14</b>
Shielding: Overview	23.12
Characteristics of Belden Shield Types and Armor Styles	23.13
Foil Shields	23.13
Braid Shields	23.13
Spiral/Serve Shields	23.13
“French Braid” Shields	23.13
Combination Shields	23.13
Shield Types: Application Guide	23.14
Table 9: Relative Cost Comparison of Shield Types	23.14
Table 10: Shield Performance Comparison	23.14
Armoring: Overview	23.14
<b>Metric Conversions</b>	<b>23.15 – 23.16</b>
Table 11: Temperature Conversions	23.15
Table 12: Distance and Weight Conversion Formulas	23.15
Table 13: RG Types	23.15
Table 14: Conductor Size Equivalents	23.16
<b>Belden Color Code Charts</b>	<b>23.17 – 23.19</b>
<b>Halogen-Free Standards: Overview</b>	<b>23.20</b>
<b>Environmental Regulations and Compliance</b>	<b>23.21</b>
<b>Cable Packaging</b>	<b>23.22</b>
<b>Terms of Use</b>	<b>23.22</b>

The information, graphs, tables and illustrations presented in this section are provided to assist Belden customers with the selection of the most appropriate cable for their application. For further assistance, contact Belden technical support at: +31-77-3875-414.

## Conductor

Table 1: Solid Copper Wire, American Wire Gage

Gage (AWG)	Nominal OD			Nominal Circular MIL Area	Nominal Weight		Nominal Resistance @ 68°F (20°C)	
	inch	mm	mm <sup>2</sup>		lbs./1000 ft.	kg/km	□/1000 ft.	□/km
40	0.0031	0.079	0.005	9.61	0.02993	0.04	1080.0	3542.40
39	0.0035	0.089	0.006	12.20	0.03774	0.06	847.8	2780.78
38	0.0040	0.102	0.008	15.72	0.04759	0.07	648.6	2127.41
37	0.0045	0.114	0.010	19.83	0.0613	0.09	512.1	1679.69
36	0.0050	0.127	0.013	25.00	0.07568	0.11	414.8	1360.54
35	0.0056	0.142	0.016	31.52	0.09542	0.14	331.0	1085.68
34	0.0063	0.160	0.020	39.75	0.1203	0.18	260.9	855.75
33	0.0071	0.180	0.025	50.13	0.1517	0.23	206.9	678.63
32	0.0080	0.203	0.032	63.21	0.1913	0.28	164.1	538.25
31	0.0089	0.226	0.040	79.7	0.2413	0.36	130.1	426.73
30	0.0100	0.254	0.051	100.5	0.3042	0.45	103.2	338.50
29	0.0113	0.287	0.064	126.7	0.3836	0.57	81.83	268.40
28	0.0126	0.320	0.080	159.8	0.4837	0.72	64.90	212.87
27	0.0142	0.361	0.102	201.5	0.6100	0.91	51.47	168.82
26	0.0159	0.404	0.127	253.0	0.7692	1.14	40.81	133.86
25	0.0179	0.455	0.163	320.4	0.9699	1.44	32.37	106.17
24	0.0201	0.511	0.203	404.0	1.223	1.82	25.67	84.20
23	0.0226	0.574	0.259	511.5	1.542	2.29	20.36	66.78
22	0.0253	0.643	0.322	640.4	1.945	2.89	16.14	52.94
21	0.0285	0.724	0.412	812.1	2.452	3.65	12.80	41.98
20	0.0320	0.813	0.514	1020.0	3.092	4.60	10.15	33.29
19	0.0359	0.912	0.653	1200.0	3.899	5.80	8.051	26.41
18	0.0403	1.02	0.816	1620.0	4.917	7.32	6.385	20.94
17	0.0453	1.15	1.039	2050.0	6.200	9.22	5.064	16.61
16	0.0508	1.29	1.300	2583.0	7.818	11.63	4.016	13.17
15	0.0571	1.45	1.651	3260.0	9.858	14.67	3.184	10.44
14	0.0641	1.63	2.070	4107.0	12.43	18.49	2.525	8.28
13	0.0720	1.83	2.630	5178.0	15.68	23.33	2.003	6.57
12	0.0808	2.05	3.290	6530.0	19.77	29.41	1.588	5.21
11	0.0907	2.30	4.155	8234.0	24.92	37.08	1.260	4.13
10	0.1019	2.60	5.230	10380.0	31.43	46.76	0.9989	3.28

\* AWG 10 through 30 per UL Subject 13.

Information from National Bureau of Standards Copper Wire Tables – Handbook 100.

### Unparalleled Performance

Belden is one of only a very few cable manufacturers to draw and anneal its own conductors. This is a time-consuming process, but it allows us to ensure signal integrity, as well as proper physical characteristics.

In addition, the standards under which we design and manufacture our fiber optic cabling are among the strictest in the industry. The result is a comprehensive offering of products which give unparalleled performance and can satisfy your most demanding operating and environmental challenges.

**Conductor**

Table 2: Stranded Copper Wire, American Wire Gage

Gage (AWG)	Stranding (Nom. AWG)	Min. Average CD of Strand	Approximate OD			ASTM Min. Circular MIL Area	Min. Weight		Max. Resistance @ 68°F (20°C)	
			inch	mm	mm <sup>2</sup>		lbs./1000 ft.	kg/km	□ /1000 ft.	□ /km
36	7x44	0.0019	0.006	0.152	0.014	25	0.076	0.11	414.8	1360.54
34	7x42	0.0024	0.0075	0.191	0.022	39.7	0.121	0.18	260.9	855.75
32	7x40	0.0030	0.0093	0.236	0.034	64	0.195	0.29	164.1	538.25
	19x44	0.0018	0.010	0.254	0.039	64	0.195	0.29	164.1	538.25
30	7x38	0.0038	0.012	0.305	0.056	100	0.304	0.45	112.0	367.36
	19x42	0.0023	0.012	0.305	0.060	100	0.304	0.45	112.0	367.36
28	7x36	0.0048	0.015	0.381	0.071	159	0.484	0.72	70.7	231.90
	19x40	0.0029	0.016	0.406	0.093	159	0.484	0.72	70.7	231.90
27	7x35	0.0054	0.017	0.432	0.111	202	0.614	0.91	55.6	182.37
26	7x34	0.0060	0.019	0.483	0.140	253	0.770	1.15	44.4	145.63
	10x36	0.0050	0.021	0.533	0.127	253	0.770	1.15	44.4	145.63
	19x38	0.0036	0.020	0.508	0.153	253	0.770	1.15	44.4	145.63
24	7x32	0.0076	0.024	0.610	0.226	404	1.229	1.83	27.7	90.86
	10x34	0.0064	0.024	0.610	0.200	404	1.229	1.83	27.7	90.86
	19x36	0.0046	0.024	0.610	0.239	404	1.229	1.83	27.7	90.86
	42x40	0.0031	0.023	0.584	0.201	404	1.229	1.83	27.7	90.86
22	7x30	0.0096	0.030	0.762	0.352	640	1.947	2.90	17.5	57.40
	19x34	0.0058	0.031	0.787	0.380	640	1.947	2.90	17.5	57.40
	26x36	0.0050	0.030	0.762	0.327	640	1.947	2.90	17.5	57.40
20	7x28	0.0126	0.038	0.965	–	1020	3.103	4.62	10.9	35.75
	10x30	0.0101	0.037	0.940	0.612	1020	3.103	4.62	10.9	35.75
	19x32	0.0073	0.037	0.940	0.612	1020	3.103	4.62	10.9	35.75
	26x34	0.0063	0.036	0.914	0.520	1020	3.103	4.62	10.9	35.75
	42x36	0.0049	0.038	0.965	–	1020	3.103	4.62	10.9	35.75
18	7x26	0.0152	0.048	1.22	0.891	1620	4.93	7.33	6.92	22.70
	16x30	0.0101	0.047	1.19	0.808	1620	4.93	7.33	6.92	22.70
	19x30	0.0092	0.049	1.24	0.957	1620	4.93	7.33	6.92	22.70
	42x34	0.0062	0.047	1.19	0.819	1620	4.93	7.33	6.92	22.70
	65x36	0.0050	0.047	1.19	–	1620	4.93	7.33	6.92	22.70
16	7x24	0.0192	0.060	1.52	1.420	2580	7.85	11.68	4.35	14.27
	19x29	0.0117	0.058	1.47	1.216	2580	7.85	11.68	4.35	14.27
	26x30	0.0100	0.059	1.50	1.310	2580	7.85	11.68	4.35	14.27
	65x34	0.0063	0.059	1.50	1.300	2580	7.85	11.68	4.35	14.27
	105x36	0.0050	0.059	1.50	1.365	2580	7.85	11.68	4.35	14.27
14	7x22	0.0242	0.076	1.93	–	4110	12.50	18.60	2.73	8.95
	19x26	0.0147	0.071	1.80	–	4110	12.50	18.60	2.73	8.95
	42x30	0.0099	0.075	1.91	–	4110	12.50	18.60	2.73	8.95
	105x34	0.0063	0.075	1.91	–	4110	12.50	18.60	2.73	8.95
12	7x20	0.0305	0.096	2.44	3.610	6530	19.86	29.55	1.71	5.61
	19x25	0.0185	0.093	2.36	3.070	6530	19.86	29.55	1.71	5.61
	65x30	0.0100	0.095	2.41	3.270	6530	19.86	29.55	1.71	5.61
	165x34	0.0063	0.095	2.41	3.300	6530	19.86	29.55	1.71	5.61
10	37x26	0.0167	0.115	2.92	4.710	10380	31.58	46.98	1.08	3.54
	65x28	0.0126	0.120	3.05	–	10380	31.58	46.98	1.08	3.54
	105x30	0.0099	0.118	3.00	–	10380	31.58	46.98	1.08	3.54

\* AWG 10 through 30 per UL subject 13.

Belden has standardized on the stranded conductors used in the design of all Belden products.



## Conductor

Table 3: Current Ratings for Belden Electronic Cables

The maximum continuous current rating for an electronic cable is limited by conductor size, number of conductors contained within the cable, maximum temperature rating of the cable, and environmental conditions such as ambient temperature and air flow. To use the current capacity chart, first determine conductor size, temperature rating, and number of conductors from the applicable product description for the cable of interest.

Next, find the current value on the chart for the proper temperature rating and conductor size. To calculate the maximum current rating/conductor, multiply the chart value by the appropriate conductor factor. The chart assumes cable is surrounded by still air at an ambient temperature of 25°C. Current values are in RMS amperes and are valid for copper conductors only. For conditions other than specified, contact Belden technical support at +31-77-3875-414.

Note: Current ratings are intended as general guidelines for low power electronic communications and control applications. Current ratings for power applications generally are set by regulatory agencies such as UL, CSA, NEC, and others.

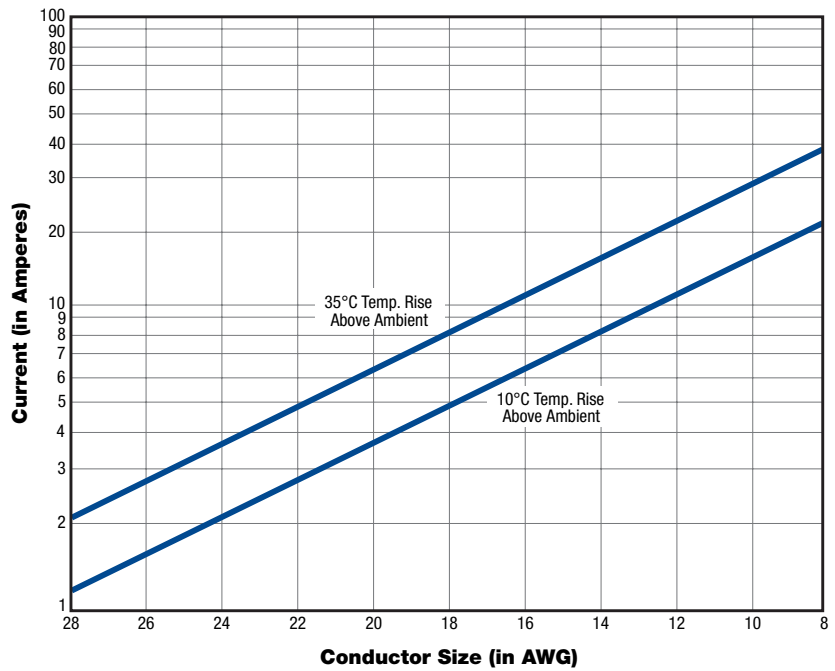

### Current Rating

No. of Conductors*	Factor
1	1.6
2 to 3	1.0
4 to 5	0.8
6 to 15	0.7
16 to 30	0.5

\* Do not count shields unless used as conductor.

### Conductor

Table 4: Metric/Imperial/AWG Equivalents  
(Square Millimeters/Square Inches/Circular Mils/AWG)

mm <sup>2</sup>	sq. in.	Circular mils	AWG	mm <sup>2</sup>	sq. in.	Circular mils	AWG	mm <sup>2</sup>	sq. in.	Circular mils	AWG
1000	1.550	1974000		55	0.0853	108570		5.00	0.00775	9870	
975	1.511	1924700		—	—	105600	1/0	4.75	0.00736	9377	
950	1.472	1875300		50	0.0775	98700		4.50	0.00698	8883	
925	1.434	1826000		45	0.0698	88830		4.25	0.00659	8390	
900	1.395	1776600		—	—	83690	1	—	—	8230	11
875	1.356	1727300		40	0.0620	78960		4.00	0.00620	7896	
850	1.317	1677900		35	0.0542	69090		3.75	0.00581	7403	
825	1.279	1628600		—	—	66360	2	3.50	0.00542	6909	
800	1.240	1579200		30	0.0465	59220		—	—	6530	12
775	1.201	1529900		—	—	52620	3	3.25	0.00504	6416	
750	1.163	1480500		25	0.0388	49350		3.00	0.00465	5922	
725	1.124	1431200		—	—	41740	4	2.75	0.00426	5429	
700	1.085	1381800		20.0	0.0310	39480		2.63	—	5180	13
675	1.046	1332500		19.5	0.0302	38490		2.50	0.00388	4935	
650	1.008	1283100		19.0	0.0294	37510		2.25	0.00349	4422	
625	0.969	1233800		18.5	0.0287	36520		—	—	4110	14
600	0.930	1184400		18.0	0.0279	35530		2.00	0.00310	3948	
575	0.891	1135100		17.5	0.0271	34550		1.75	0.00271	3455	
550	0.853	1085700	1000 MCM	17.0	0.0264	33560		1.65	—	3260	15
525	0.814	1036400		—	—	33090	5	1.50	0.00233	2961	
500	0.775	987000		16.5	0.0256	32560		—	—	2580	16
475	0.736	937700		16.0	0.0248	31580		1.25	0.00194	2468	
450	0.698	888300		15.5	0.0240	30600	6	—	—	2050	17
425	0.659	839000		15.0	0.0233	29610		1.00	0.00155	1974	
400	0.620	789600	750 MCM	14.5	0.0225	28620		0.90	0.00140	1777	
375	0.581	740300		14.0	0.0217	27640		—	—	1620	18
350	0.542	690900		13.5	0.0209	26650		0.75	0.00116	1481	
325	0.504	641600	600 MCM	—	—	26420		0.70	0.00109	1382	
300	0.465	592200		13.0	0.0201	25660		0.65	—	1290	19
275	0.426	542900	500 MCM	12.5	0.0194	24680		0.60	0.00093	1184	
250	0.388	493500		12.0	0.0186	23690		—	—	1029	20
225	0.349	444200	350 MCM	11.5	0.0178	22700		0.50	0.000775	987	
200	0.310	394800		11.0	0.0171	21710					
185	—	—		—	—	20820	7				
175	0.271	345500	300 MCM	10.5	0.0163	20730					
150	0.233	296100		10.0	0.0155	19740					
125	0.1938	246800		9.5	0.01472	18753					
120	—	211600	4/0	9.0	0.01395	17766					
100	0.1550	197400		8.5	0.01317	16779					
95	0.1472	187530		—	—	16510	8				
90	0.1395	177660		8.0	0.01240	15792					
—	—	167800	3/0	7.7	0.01163	14805					
85	0.1317	167790		7.0	0.01085	13818					
80	0.1240	157920		—	—	13090	9				
75	0.1163	148050		6.5	0.01008	12831					
70	0.1085	138180		6.0	0.00930	11844					
—	—	133100	2/0	5.5	0.00853	10857					
65	0.1008	128310		—	—	10380	10				
60	0.0930	118440									

To Convert:	Multiply by:
Inches to millimeters	25.4
Millimeters to inches	0.03937

## Insulations and Jackets

### Overview

#### Insulations

Belden expends a great amount of time and effort to formulate its own insulations. As a result, Belden insulations provide superior performance under a variety of hostile environmental conditions.

Among the insulations we utilize are:

- **Polyethylene**
- **Polyvinyl Chloride (PVC)**
- **Polypropylene**

Also available are:

- **Datalene®**  
For computer and data transmission. Datalene is crush resistant, lightweight, and offers good performance characteristics over a wide range of temperatures.
- **Teflon® Insulated Plenum & High-temperature Cables**  
For data communications, instrumentation/control, and other commercial and industrial applications. Plenum cables eliminate the need for conduit and reduce installation time.

#### Jackets

Belden electronic cables are manufactured in a wide selection of jacketing materials.

- **Polyvinyl Chloride**
- **Polyethylene**
- **Polyurethane**
- **Teflon®**
- **Tefzel®**
- **Neoprene**
- **EPDM**
- **Silicone rubber**
- **Natural rubber**

Special compounds and variations of standard compounds are used as well.

Teflon® and Tefzel® are DuPont trademarks.

## Insulations and Jackets

### Typical Characteristics of Popular Insulation and Jacketing Compounds

#### EPDM

EPDM (ethylene-propylene-diene elastomer) is a chemically cross-linked elastomer with excellent flexibility at low and high temperatures (-55°C to 150°). It has good insulation resistance and dielectric strength, as well as excellent abrasion resistance and mechanical properties. EPDM also has better cut-through resistance than silicone rubber, which it replaces in some applications.

EPDM is compatible with most varnishes, but after the dip and bake cycle varnish tends to adhere to the insulation (because EPDM, unlike some rubber insulations, does not exude oils or waxes). As lead wires are pulled apart for termination, the varnish cracks, sometimes breaking the insulation.

To resolve this problem, a stearic solution is applied to the lead wire during the put-up process. This ensures that rigid varnish does not cause EPDM insulation to rupture when the wire is terminated.

Field evaluations by numerous users reveal that the coated EPDM has excellent varnish resistance at least equal to synthetic elastomers, cross-link polyethylene, or silicone glass braid in dip and bake systems.

#### Neoprene

The temperature range of this material can vary from -55°C to 90°C. The actual range would depend on the formulation used. Neoprene is both oil-resistant and sunlight-resistant, making it ideal for many outdoor applications. The most stable colors are Black, Dark Brown, and Gray. The electrical properties are not as good as other insulation materials. Because of this, thicker insulation should be used. Typical designs where this material is used are lead wire insulation and cable jackets.

#### Polyethylene (Solid and Foamed)

A very good insulation in terms of electrical properties. Low dielectric constant, a stable dielectric constant over all frequencies, very high insulation resistance. In terms of flexibility, polyethylene can be rated stiff to very hard, depending on molecular weight and density – low density being the most flexible, with high-density, high-molecular weight formulation being very hard. Moisture resistance is rated excellent. Black and specially formulated colored versions have excellent weather resistance. The dielectric constant is 2.3 for solid insulation and typically 1.64 for foam designs. Flame retardant formulations are available with dielectric constants ranging from about 1.7 for foam flame retardant to 2.58 for solid flame retardant polyethylene.

#### Polypropylene (Solid and Foam)

Similar in electrical properties to polyethylene. This material is primarily used as an insulation material. Typically, it is harder than polyethylene. This makes it suitable for thin wall insulations. UL maximum temperature rating may be 60°C, 80°C or 105°C. The dielectric constant is 2.25 for solid and typically 1.55 for foam designs.

#### Polyurethane

This material is used primarily as a cable jacket material. It has excellent oxidation, oil, and ozone resistance. Some formulations also have good flame resistance. It is a hard material with excellent abrasion resistance. It has outstanding “memory” properties, making it an ideal jacket material for retractile cords.

#### PVC

Sometimes referred to as vinyl or polyvinylchloride. Extremely high or low temperature properties cannot be found in one formulation. Certain formulations may have -55°C to 105°C rating. Other common vinyls may have -20°C to 60°C. There are many formulations for the variety of different applications. The many varieties of PVC also differ in pliability and electrical properties. The price range can vary accordingly. Typical dielectric constant values can vary from 3.5 to 6.5.

#### Rubber

The description of rubber normally includes natural rubber and SBR compounds. Both of these materials can be used for insulations and jackets. There are many formulations of these basic materials. Each formulation is for a specific application. Some formulations are suitable for -55°C minimum, while others are suitable for 75°C maximum.

#### Silicone

This is a very soft insulation which has a temperature range from -80°C to 200°C. It has excellent electrical properties plus ozone resistance, low moisture absorption, weather resistance, and radiation resistance. It typically has low mechanical strength and poor scuff resistance.

#### Teflon®

This material has excellent electrical properties, temperature range and chemical resistance. It is not suitable where subjected to nuclear radiation and does not have good high voltage characteristics. FEP Teflon® is extrudable in a manner similar to PVC and polyethylene. This means that long wire and cable lengths are available. TFE Teflon® is extrudable in a hydraulic ram type process. Lengths are limited due to amount of material in the ram, thickness of the insulation, and preform size. TFE must be extruded over a silver- or nickel-coated wire. The nickel- and silver-coated designs are rated 260°C and 200°C maximum, respectively. The cost of Teflon® is approximately 8 to 10 times more per weight unit than that of PVC.

Teflon® is a DuPont trademark.

## Insulations and Jackets

Table 5: Comparative Properties of **Plastic** Insulating and Jacketing Compounds

Properties	PVC	LDPE	Cellular Polyethylene	HDPE	Polypropylene	Cellular Polypropylene	PUR	Nylon	CPE	LSNH	FEP Teflon®
<b>Oxidation Resistance</b>	E	E	E	E	E	E	E	E	E	E	O
<b>Heat Resistance</b>	G-E	G	G	E	E	E	G	E	E	G-E	O
<b>Oil Resistance</b>	F	G-E	G	G-E	F	F	E	E	E	G	E
<b>Low-temperature Flexibility</b>	P-G	E	E	E	P	P	G	G	E	F-G	O
<b>Weather, Sun Resistance</b>	G-E	E	E	E	E	E	G	E	E	G	O
<b>Ozone Resistance</b>	E	E	E	E	E	E	E	E	E	E	E
<b>Abrasion Resistance</b>	F-G	G	F	E	F-G	F-G	O	E	E-O	F-G	E
<b>Electrical Properties</b>	F-G	E	E	E	E	E	P	P	E	G	E
<b>Flame Resistance</b>	E	P	P	P	P	P	P	P	E	E	E
<b>Nuclear Radiation Resistance</b>	F	G-E	G	G-E	F	F	G	F-G	O	F	P
<b>Water Resistance</b>	F-G	E	E	E	E	E	P-G	P-F	O	G	E
<b>Acid Resistance</b>	G-E	G-E	G-E	E	E	E	F	P-F	E	P-F	E
<b>Alkali Resistance</b>	G-E	G-E	G-E	E	E	E	F	E	E	G	E
<b>Aliphatic Hydrocarbons Resistance</b> (Gasoline, Kerosene, etc.)	P	G-E	G	G-E	P-F	P	P-G	G	E	F	E
<b>Aromatic Hydrocarbons Resistance</b> (Benzol, Toluol, etc.)	P-F	P	P	P	P-F	P	P-G	G	G-E	P-F	E
<b>Halogenated Hydrocarbons Resistance</b> (Degreaser Solvents)	P-F	G	G	G	P	P	P-G	G	E	P	E
<b>Alcohol Resistance</b>	P-F	E	E	E	E	E	P-G	P	E	G	E
<b>Underground Burial</b>	P-G	G	N/A	E	N/A	N/A	G	P	E-O	F	E

CPE = Chlorinated Polyethylene • HDPE = High-density Polyethylene • LDPE = Low-density Polyethylene • PUR = Polyurethane • LSNH = Low-smoke Non-halogen • FEP = Fluorinated Ethylene-Propylene • P = Poor • F = Fair • G = Good • E = Excellent • O = Outstanding

These ratings are based on average performance of general purpose compounds. Any given property can usually be improved by the use of selective compounding.

Teflon® is a DuPont trademark.

## Insulations and Jackets

Table 6: Comparative Properties of **Fluoropolymer** Insulating and Jacketing Compounds

Properties	FEP Teflon®	Tefzel® (ETFE)	PTFE Teflon®
<b>Oxidation Resistance</b>	O	E	O
<b>Heat Resistance</b>	O	E	O
<b>Oil Resistance</b>	O	E	E-O
<b>Low-temperature Flexibility</b>	O	E	O
<b>Weather, Sun Resistance</b>	O	E	O
<b>Ozone Resistance</b>	E	E	O
<b>Abrasion Resistance</b>	E	E	O
<b>Electrical Properties</b>	E	E	E
<b>Flame Resistance</b>	O	G	E
<b>Nuclear Radiation Resistance</b>	P-G	E	P
<b>Water Resistance</b>	E	E	E
<b>Acid Resistance</b>	E	E	E
<b>Alkali Resistance</b>	E	E	E
<b>Aliphatic Hydrocarbons Resistance</b> (Gasoline, Kerosene, etc.)	E	E	E
<b>Aromatic Hydrocarbons Resistance</b> (Benzol, Toluol, etc.)	E	E	E
<b>Halogenated Hydrocarbons Resistance</b> (Degreaser Solvents)	E	E	E
<b>Alcohol Resistance</b>	E	E	E
<b>Underground Burial</b>	E	E	E

FEP = Fluorinated Ethylene-Propylene • ETFE = Ethylene Tetrafluoroethylene • PTFE = Polytetrafluoroethylene  
P = Poor • F = Fair • G = Good • E = Excellent • O = Outstanding

These ratings are based on average performance of general purpose compounds.  
Any given property can usually be improved by the use of selective compounding.

Teflon® and Tefzel® are DuPont trademarks.

## Insulations and Jackets

Table 7: Comparative Properties of **Rubber** Insulations

Properties	Rubber	Neoprene	Hypalon® (Chlorosulfonated Polyethylene)	EPDM (Ethylene-Propylene- Diene Elastomer)	Silicone
<b>Oxidation Resistance</b>	F	G	E	E	E
<b>Heat Resistance</b>	F	G	E	E	O
<b>Oil-resistance</b>	P	G	G	P	F-G
<b>Low-temperature Flexibility</b>	G	F-G	F	G-E	O
<b>Weather, Sun Resistance</b>	F	G	E	E	O
<b>Ozone Resistance</b>	P	G	E	E	O
<b>Abrasion Resistance</b>	E	G-E	G	G	P
<b>Electrical Properties</b>	G	P	G	E	G
<b>Flame Resistance</b>	P	G	G	P	F-G
<b>Nuclear Radiation Resistance</b>	F	F-G	E	G	E
<b>Water Resistance</b>	G	E	E	G-E	G-E
<b>Acid Resistance</b>	F-G	G	E	G-E	F-G
<b>Alkali Resistance</b>	F-G	G	E	G-E	F-G
<b>Aliphatic Hydrocarbons Resistance</b> (Gasoline, Kerosene, etc.)	P	G	F	P	P-F
<b>Aromatic Hydrocarbons Resistance</b> (Benzol, Toluol, etc.)	P	P-F	F	F	P
<b>Halogenated Hydrocarbons Resistance</b> (Degreaser Solvents)	P	P	P-F	P	P-G
<b>Alcohol Resistance</b>	G	F	G	P	G

P = Poor • F = Fair • G = Good • E = Excellent • O = Outstanding

These ratings are based on average performance of general purpose compounds.  
Any given property can usually be improved by the use of selective compounding.

Hypalon® is a DuPont trademark.

## Insulations and Jackets

Table 8: Nominal Temperature Range for Various Insulating and Jacketing Compounds

Compound	Normal Low	Normal High	Special Low	Special High
Chlorosulfonated Polyethylene (Hypalon®)	-20°C	90°C	-40°C	105°C
EPDM (Ethylene-Propylene-Diene Monomer)	-55°C	105°C	–	150°C
Neoprene	-20°C	60°C	-55°C	90°C
Polyethylene (Solid and Foamed)	-60°C	80°C	–	–
Polypropylene (Solid and Foamed)	-40°C	105°C	–	–
Rubber	-30°C	60°C	-55°C	75°C
FEP Teflon®	-70°C	200°C	–	–
PVC	-20°C	80°C	-55°C	105°C
Silicone	-80°C	150°C	–	200°C
Tefzel®	-65°C	150°C	–	–
PTFE Teflon®	-70°C	260°C	–	–
GPE	-35°C	90°C	-45°C	105°C

Hypalon®, Teflon® and Tefzel® are DuPont trademarks.



## Shielding and Armoring

### Overview

#### Innovative Leadership

The evolution of technology maintains steady demand for sophisticated cable shielding. Belden meets that demand with innovative shielding and shield effectiveness testing methods to supply you with high quality, dependable cable.

With the creation of trademarked shield designs and patented test methods, Belden has earned a reputation for innovation and leadership that is unequalled in the wire and cable industry. In addition, Belden offers the broadest line of shielded multi-conductor, coaxial and flat cable in the industry.

Several unique Belden innovations are utilized across a wide range of shielding applications:

- Beldfoil®**  
 The first aluminum/polyester foil developed for use as a cable shield. Provides 100% shield coverage for optimum protection.
- Duofoil®**  
 Consists of an aluminum-poly-aluminum laminate wrapped around the cable's dielectric core. Provides 100% physical coverage, and improves shield reliability and flex life.

Belden also utilizes a number of innovative techniques to apply shielding to multi-conductor and paired cables:

- “French Braid” Shields**  
 Belden's patented “French Braid” shield is a double spiral (double serve shield) with the two spirals tied together by one weave.

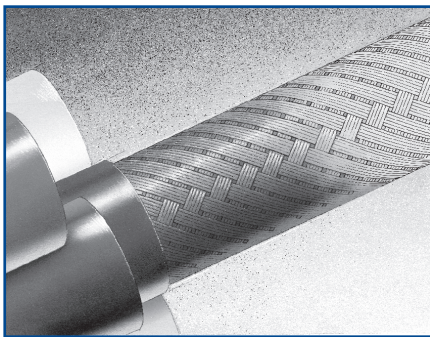

Belden's patented “French Braid” shield.

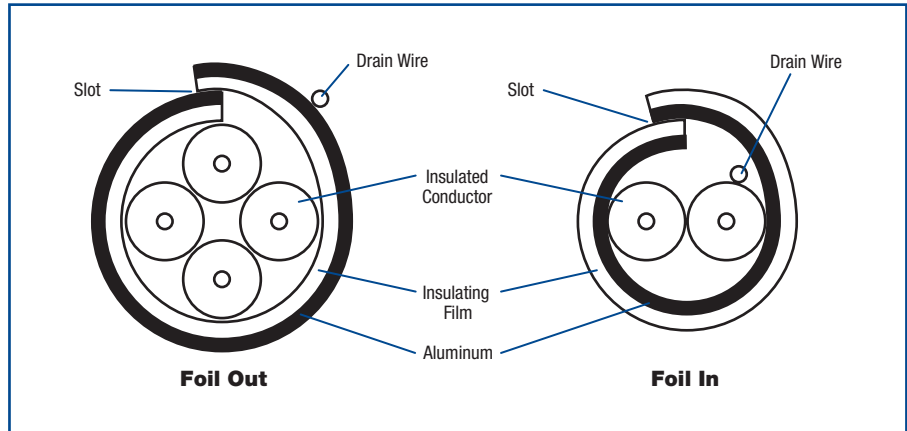

Figure 1: Foil shield configurations without shorting folds.

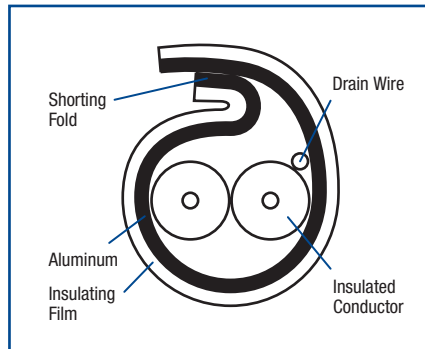

Figure 2: Foil shield configurations with shorting fold.

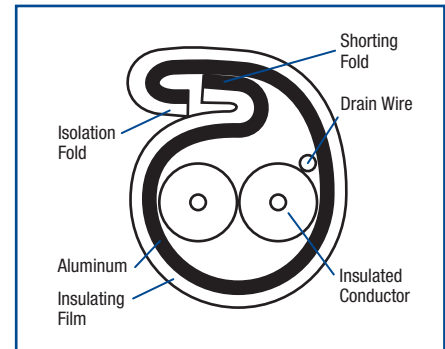

Figure 3: Foil shield with Z-fold reduces crosstalk in multi-pair applications.

- Shorting Fold**  
 Belden uses a shorting fold technique to maintain metal-to-metal contact for improved high frequency performance. Without the shorting fold, a slot is created through which signals can leak and cause interference. (See figures 1 and 2 above.)

- Z-Fold®**  
 Belden improves on the traditional shorting fold by employing a Z-Fold designed for use in multi-pair applications to reduce crosstalk. The Z-Fold (see figure 3) combines an isolation and a shorting fold. The shorting fold provides metal-to-metal contact while the isolation fold keeps shields from shorting to one another in multi-pair, individually shielded cables.

The use of either a shorting fold or a Z-Fold increases the foil shield's range of effectiveness to higher frequencies.

## Shielding and Armoring

### Characteristics of Belden Shield Types and Armor Styles

#### Foil Shields

Foil shields consist of aluminum foil laminated to a polyester or polypropylene film. The film gives the shield mechanical strength and bonus insulation. Foil shields provide 100% cable coverage, necessary for electrostatic shield protection. Because of their small size, foil shields are commonly used to shield individual pairs of multi-pair data cables to reduce crosstalk. They have less weight, bulk and cost less than spiral or braid shields and are generally more effective than braid shields in RF ranges. Foil shields are more flexible than braid but have a shorter flex life than spiral or braid.

Drain wires are used with foil shields to make termination easier and to ground electrostatic discharges. The shortcomings in using the foil shield include higher dc resistance and lower mechanical strength than braid or spiral shields.



#### Braid Shields

A braid shield consists of groups of tinned or bare copper or aluminum strands, one set woven in a clockwise direction and interwoven with another set in a counter-clockwise direction.

Braid shields provide superior structural integrity, while maintaining good flexibility and flex life. These shields are ideal for minimizing low frequency interference and have lower DC resistance than foil. Braid shields are effective at audio, as well as RF ranges. Generally, the higher the braid coverage, the more effective the shield. However, the trade-off between cost and braid coverage must be considered. Typical braid coverages are between 80% and 95%. Coverage of 100% is unattainable with a braid shield. Other features to consider when choosing a braid shield are the weave angle, strand diameter, number of carriers (strand groups) and the number of ends (strands).

Braid shields are generally bulkier and heavier than other shields and, in some cases, harder to terminate because the braid may be combed out and pigtailed.

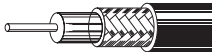

#### Spiral/Serve Shields

A spiral/serve shield consists of wire (usually copper) wrapped in a spiral around the inner cable core.

Superior flexibility and flex life, ease of termination and up to 97% coverage are the advantages of spiral shields. They are best suited for audio applications. As a rule, spiral shields are not effective above the audio frequency range due to the coil effect produced by the inductance of served wire strands.



#### “French Braid” Shields

Belden's patented “French Braid” shield is a double spiral (double serve shield) with the two spirals tied together by one weave. This construction provides improved flex life over standard spiral shields, improved flexibility over conventional braid shields, and lower levels of microphonic or triboelectric noise than either spiral or conventional braid shields.



#### Combination Shields

Combination shields consist of more than one layer of shielding. They provide maximum shield efficiency across the frequency spectrum. The combination foil/braid shield combines the advantages of 100% foil coverage, plus the strength and low DC resistance of the braid.

Belden has also developed a number of shielding configurations for use with broadband coaxial cables.

- **Duobond®**  
Duobond is essentially the same construction as Duofoil® (a laminated tape of foil/film/foil), but with an extra layer of adhesive bonding the foil shield to the dielectric core. This foil shield provides 100% coverage and insures maximum shield protection.

- **Duobond II (Foil/Braid)**

Combines Duobond with an outer braid, applied for greater protection against interference and to increase the overall tensile strength.

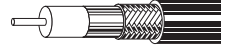

- **Duobond III (Tri-Shield)**

Utilizes the Duobond II design (foil/braid) plus a surrounding layer of Duofoil. The extra foil layer improves shield reliability and provides an additional interference barrier.



- **Duobond Plus®**

Features foil/braid/foil construction with a shorting fold in the outermost foil. This fold prevents a slot opening from being created in the shield, thereby preventing signal egress or ingress.



Shorting Fold

- **Duobond IV (Quad Shield)**

Offers an extra layer of braid shield (foil/braid/foil/braid) for improved strength and durability.



Other combination shields are available such as the foil/braid/foil/braid used on the Ethernet cables, braid/braid or foil/spiral.

#### Armoring

Belden's innovative technology delivers maximum effectiveness to meet the performance requirements of a wide range of applications.

Belden also has the capability to protect electronic, instrumentation, and control cables with interlocking steel or aluminum armor.

## Shielding and Armoring

### Shield Types Application Guide, Table 9: Relative Cost Comparison of Shield Types

### Table 10: Shield Performance Ratings

#### Shield Types Application Guide

##### Choose a Foil Shield...

- For protection against capacitive (electric field) coupling where shield coverage is more important than low DC resistance.
- When possible sources of interference include TV signals, crosstalk from other circuits, radio transmitters, fluorescent lights or computing equipment.
- For MATV, CATV, video, networking, computer I/O cables in office, industrial or commercial environments where ambient EMI levels are low.

##### Choose a Braid Shield...

- For superior performance against diffusion coupling, where low DC resistance is important, and to a lesser extent, capacitive and inductive coupling.
- When possible sources of interference exhibit low impedance characteristics, such as motor control circuits and switches which operate inductive loads.
- For computer to terminal interconnect for process, instrumentation or control applications.

##### Choose a Spiral Shield...

- For functional shielding against diffusion and capacitive coupling at audio frequencies only.
- When possible sources of interference are power lines and fluorescent lights.
- For applications when flexibility and flex life are major concerns, such as microphone and audio cables and retractile cords.

##### Choose a Combination Shield...

- For shielding against high frequency radiated emissions coupling and ESD. Combines the low resistance of braid and 100% coverage of foil shields.
- When possible sources of interference include radio transmitters, TV stations, printed circuit boards, back planes, motor control circuits and computing equipment.
- For video, CATV, MATV, networking, computer I/O cables and computer-aided manufacturing applications.

**Table 9: Relative Cost Comparison**

Relative cost comparisons are based on coaxial cable. Chart shows relative shield cost as one component of the total cost of the cable.

These cost ratings may change depending on the physical construction of the cable.

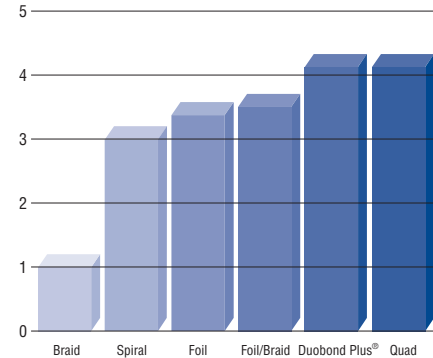

**Table 10: Shield Performance Comparison Chart**

Properties	Cable Shield Ratings*				
	Braid (95% Coverage)	Spiral	Foil	Foil/Braid	Foil/Braid/Foil Duobond Plus®
<b>Frequency: DC</b>					
Capacitive	A	AA	AAA	AAA	AAA
Diffusion	AAA	A	C	AAA	AAA
Diffusion/Inductive	–	–	–	–	–
Diffusion/Inductive/Capacitive	–	–	–	–	–
<b>Frequency: 15 kHz</b>					
Capacitive	A	AA	AAA	AAA	AAA
Diffusion	AAA	B	C	AAA	AAA
Diffusion/Inductive	AA	C	A	AA	AAA
Diffusion/Inductive/Capacitive	–	–	–	–	–
<b>Frequency: 10 MHz to 1000 MHz</b>					
Capacitive	A	AA	AAA	AAA	AAA
Diffusion	–	–	–	–	–
Diffusion/Inductive	B	C	A	AA	AAA
Diffusion/Inductive/Capacitive	B	C	A	AA	AAA

\* Although ratings shown in table 10 are based on shielded coaxial cable test results, these ratings also pertain to shielded multi-conductor and flat cable where shield types are available.

Note: Shield effectiveness decreases as frequency increases. Therefore, ratings in one frequency category do not imply equal shield effectiveness in other frequency categories.

Shield Rating Key	
AAA	Best
AA	Better
A	Good
B	Functional
C	Unsatisfactory
–	Not applicable

### Metric Conversions

Table 11: Temperature Conversion Chart and Formula

Table 12: Distance and Weight Conversion Formulas, Table 13: RG Types

**Table 11: Temperature Conversion Chart**

°C	↔	°F	°C	↔	°F	Temp. Conversion Formulas	
210		410	125		257	$^{\circ}\text{C} = \frac{5}{9} (^{\circ}\text{F} - 32)$ $^{\circ}\text{F} = \frac{9}{5} ^{\circ}\text{C} + 32$	
205		401	120		248		
200		392	115		239		
195		383	110		230		
190		374	105		221		
185		365	100		212		
180		356	95		203		
175		347	90		194		
170		338	85		185		
165		329	80		176		
160		320	75		167		
155		311	70		158		
150		302	65		149		
145		293	60		140		
140		284	55		131		
135		275	50		122		
130		266	45		113		

**Table 12: Conversion Chart**

To Convert Imperial to Metric			
inch	mm	x 25.4	#
ft.	m	: 0.3048	#
mi	km	x 1.6093	▲
lbs.	kg	x 0.4536	▲
lbs./100 ft.	kg/km	x 1.488	▲
To Convert Metric to Imperial			
mm	inch	: 25.4	#
m	ft.	x 0.3048	#
km	mi	x 0.6214	▲
kg	lbs.	x 2.204	▲
kg/km	lbs./100 ft.	x 0.67197	▲

# = Exact value  
 ▲ = Approximate value  
 x = multiply by  
 : = divide by

**Table 13: RG Types**

For example RG-59 is a common type of coaxial cable used in a wide variety of professional and commercial applications. The term RG itself is quite generic and refers to a wide variety of cable designs, which differ from one another in shielding characteristics, center conductor material, and dielectric type.

RG was originally a military spec, but is now obsolete; in practice, the term RG is generally used to refer to coaxial cables with 50, 75 or 93 Ohm characteristic impedance and a center conductor as follows:

Type	CDR (mm approx)	Impedance Ohm
RG-6	1	75
RG-8	1.5 - 2.7	75
RG-11	1.6	75
RG-58	0.7 - 1.2	75
RG-58	0.7 - 4.5	50
RG-59	0.6 - 0.8	75
RG-62	0.6	93
RG-401	1.6	50
RG-402	0.9	50
RG-405	0.5	50

### Metric Conversions

Table 14: Conductor Size Equivalents (Square Millimeters/Square Inches/Circular Mils/AWG)

mm <sup>2</sup>	sq. in.	Circular mils	AWG	mm <sup>2</sup>	sq. in.	Circular mils	AWG	mm <sup>2</sup>	sq. in.	Circular mils	AWG
1000	1.550	1974000		55	0.0853	108570		5.00	0.00775	9870	
975	1.511	1924700		—	—	105600	1/0	4.75	0.00736	9377	
950	1.472	1875300		50	0.0775	98700		4.50	0.00698	8883	
925	1.434	1826000		45	0.0698	88830		4.25	0.00659	8390	
900	1.395	1776600		—	—	83690	1	—	—	8230	11
875	1.356	1727300		40	0.0620	78960		4.00	0.00620	7896	
850	1.317	1677900		35	0.0542	69090		3.75	0.00581	7403	
825	1.279	1628600		—	—	66360	2	3.50	0.00542	6909	
800	1.240	1579200		30	0.0465	59220		—	—	6530	12
775	1.201	1529900		—	—	52620	3	3.25	0.00504	6416	
750	1.163	1480500		25	0.0388	49350		3.00	0.00465	5922	
725	1.124	1431200		—	—	41740	4	2.75	0.00426	5429	
700	1.085	1381800		20.0	0.0310	39480		2.63	—	5180	13
675	1.046	1332500		19.5	0.0302	38490		2.50	0.00388	4935	
650	1.008	1283100		19.0	0.0294	37510		2.25	0.00349	4422	
625	0.969	1233800		18.5	0.0287	36520		—	—	4110	14
600	0.930	1184400		18.0	0.0279	35530		2.00	0.00310	3948	
575	0.891	1135100		17.5	0.0271	34550		1.75	0.00271	3455	
550	0.853	1085700	1000 MCM	17.0	0.0264	33560		1.65	—	3260	15
525	0.814	1036400		—	—	33090	5	1.50	0.00233	2961	
500	0.775	987000		16.5	0.0256	32560		—	—	2580	16
475	0.736	937700		16.0	0.0248	31580		1.25	0.00194	2468	
450	0.698	888300		15.5	0.0240	30600	6	—	—	2050	17
425	0.659	839000		15.0	0.0233	29610		1.00	0.00155	1974	
400	0.620	789600	750 MCM	14.5	0.0225	28620		0.90	0.00140	1777	
375	0.581	740300		14.0	0.0217	27640		—	—	1620	18
350	0.542	690900		13.5	0.0209	26650		0.75	0.00116	1481	
325	0.504	641600	600 MCM	—	—	26420		0.70	0.00109	1382	
300	0.465	592200		13.0	0.0201	25660		0.65	—	1290	19
275	0.426	542900	500 MCM	12.5	0.0194	24680		0.60	0.00093	1184	
250	0.388	493500		12.0	0.0186	23690		—	—	1029	20
225	0.349	444200	350 MCM	11.5	0.0178	22700		0.50	0.000775	987	
200	0.310	394800		11.0	0.0171	21710					
185	—	—		—	—	20820	7				
175	0.271	345500	300 MCM	10.5	0.0163	20730					
150	0.233	296100		10.0	0.0155	19740					
125	0.1938	246800		9.5	0.01472	18753					
120	—	211600	4/0	9.0	0.01395	17766					
100	0.1550	197400		8.5	0.01317	16779					
95	0.1472	187530		—	—	16510	8				
90	0.1395	177660		8.0	0.01240	15792					
—	—	167800	3/0	7.7	0.01163	14805					
85	0.1317	167790		7.0	0.01085	13818					
80	0.1240	157920		—	—	13090	9				
75	0.1163	148050		6.5	0.01008	12831					
70	0.1085	138180		6.0	0.00930	11844					
—	—	133100	2/0	5.5	0.00853	10857					
65	0.1008	128310		—	—	10380	10				
60	0.0930	118440									

To Convert:	Multiply by:
Inches to millimeters	25.4
Millimeters to inches	0.03937

# Belden Color Code Charts

## Color Code Chart 1

Cond.	Color
1	Black
2	White
3	Red
4	Green
5	Brown
6	Blue
7	Orange
8	Yellow
9	Purple
10	Grey
11	Pink
12	Tan

18 gage conductors in cables 8446 through 8449 are black and white.

## Color Code Chart 2 and 2R – ICEA (Insulated Cable Engineers Association) Standard\*

Cond.	Color
1	Black
2	White
3	Red
4	Green
5	Brown
6	Blue
7	White/Black Stripe
8	Red/Black Stripe
9	Green/Black Stripe
10	Orange/Black Stripe
11	Blue/Black Stripe
12	Black/White Stripe
13	Red/White Stripe
14	Green/White Stripe
15	Blue/White Stripe
16	Black/Red Stripe
17	White/Red Stripe

Cond.	Color
18	Orange/Red Stripe
19	Blue/Red Stripe
20	Red/Green Stripe
21	Orange/Green Stripe
22	Black/White/Red
23	White/Black/Red
24	Red/Black/White
25	Green/Black/White
26	Orange/Black/White
27	Blue/Black/White
28	Black/Red/Green
29	White/Red/Green
30	Red/Black/Green
31	Green/Black/Orange
32	Orange/Black/Green
33	Blue/White/Orange
34	Black/White/Orange

Cond.	Color
35	White/Red/Orange
36	Orange/White/Blue
37	White/Red/Blue
38	Black/White/Green
39	White/Black/Green
40	Red/White/Green
41	Green/White/Blue
42	Orange/Red/Green
43	Blue/Red/Green
44	Black/White/Blue
45	White/Black/Blue
46	Red/White/Blue
47	Green/Orange/Red
48	Orange/Red/Blue
49	Blue/Orange/Red
50	Black/Orange/Red

\* 2= Spiral Stripe • 2R= Ring Band Stripping

## Color Code Chart 3 for Paired Cables (Belden Standard)

Cond.	Color
1	Black & Red
2	Black & White
3	Black & Green
4	Black & Blue
5	Black & Yellow
6	Black & Brown
7	Black & Orange
8	Red & White
9	Red & Green
10	Red & Blue

Cond.	Color
11	Red & Yellow
12	Red & Brown
13	Red & Orange
14	Green & White
15	Green & Blue
16	Green & Yellow
17	Green & Brown
18	Green & Orange
19	White & Blue
20	White & Yellow

Cond.	Color
21	White & Brown
22	White & Orange
23	Blue & Yellow
24	Blue & Brown
25	Blue & Orange
26	Brown & Yellow
27	Brown & Orange
28	Orange & Yellow
29	Purple & Orange
30	Purple & Red

Cond.	Color
31	Purple & White
32	Purple & Green
33	Purple & Blue
34	Purple & Yellow
35	Purple & Brown
36	Purple & Black
37	Grey & White

## Color Code Chart 4 for Paired Cables

Pair No.	Color Combination
1	White & Blue
2	White & Orange
3	White & Green
4	White & Brown
5	White & Grey
6	Red & Blue
7	Red & Orange

Pair No.	Color Combination
8	Red & Green
9	Red & Brown
10	Red & Grey
11	Black & Blue
12	Black & Orange
13	Black & Green
14	Black & Brown

Pair No.	Color Combination
15	Black & Grey
16	Yellow & Blue
17	Yellow & Orange
18	Yellow & Green
19	Yellow & Brown
20	Yellow & Grey
21	Purple & Blue

Pair No.	Color Combination
22	Purple & Orange
23	Purple & Green
24	Purple & Brown
25	Purple & Grey

## Color Code Chart 5 for Paired Cables (Western Electric Standard)

Pair No.	Color Combination
1	White/Blue Stripe & Blue/White Stripe
2	White/Orange Stripe & Orange/White Stripe
3	White/Green Stripe & Green/White Stripe
4	White/Brown Stripe & Brown/White Stripe
5	White/Grey Stripe & Grey/White Stripe
6	Red/Blue Stripe & Blue/Red Stripe
7	Red/Orange Stripe & Orange/Red Stripe

Pair No.	Color Combination
8	Red/Green Stripe & Green/Red Stripe
9	Red/Brown Stripe & Brown/Red Stripe
10	Red/Grey Stripe & Grey/Red Stripe
11	Black/Blue Stripe & Blue/Black Stripe
12	Black/Orange Stripe & Orange/Black Stripe
13	Black/Green Stripe & Green/Black Stripe
14	Black/Brown Stripe & Brown/Black Stripe

Pair No.	Color Combination
15	Black/Grey Stripe & Grey/Black Stripe
16	Yellow/Blue Stripe & Blue/Yellow Stripe
17	Yellow/Orange Stripe & Orange/Yellow Stripe
18	Yellow/Green Stripe & Green/Yellow Stripe
19	Yellow/Brown Stripe & Brown/Yellow Stripe
20	Yellow/Grey Stripe & Grey/Yellow Stripe
21	Purple/Blue Stripe & Blue/Purple Stripe

Pair No.	Color Combination
22	Purple/Orange Stripe & Orange/Purple Stripe
23	Purple/Green Stripe & Green/Purple Stripe
24	Purple/Brown Stripe & Brown/Purple Stripe
25	Purple/Grey Stripe & Grey/Purple Stripe

## Belden Color Code Charts

### Color Code Chart 6

Position No.	Color
1	Brown
2	Red
3	Orange
4	Yellow
5	Green
6	Blue
7	Purple
8	Grey
9	White
10	White/Black
11	White/Brown
12	White/Red
13	White/Orange
14	White/Yellow
15	White/Green
16	White/Blue
17	White/Purple
18	White/Grey
19	White/Black/Brown
20	White/Black/Red
21	White/Black/Orange
22	White/Black/Yellow
23	White/Black/Green
24	White/Black/Blue

### Color Code Chart 7 for Snake Cables

Pair No.	Color Combination
1	Brown
2	Red
3	Orange
4	Yellow
5	Green
6	Blue
7	Purple
8	Grey
9	White
10	Black
11	Tan
12	Pink
13	Grey/Brown Stripe
14	Grey/Red Stripe
15	Grey/Orange Stripe
16	Grey/Yellow Stripe
17	Grey/Green Stripe
18	Grey/Blue Stripe
19	Grey/Purple Stripe
20	Grey/Grey Stripe

Pair No.	Color Combination
21	Grey/White Stripe
22	Grey/Black Stripe
23	Grey/Tan Stripe
24	Grey/Pink Stripe
25	Blue/Brown Stripe
26	Blue/Red Stripe
27	Blue/Orange Stripe
28	Blue/Yellow Stripe
29	Blue/Green Stripe
30	Blue/Blue Stripe
31	Blue/Purple Stripe
32	Blue/Grey Stripe
33	Blue/White Stripe
34	Blue/Black Stripe
35	Blue/Tan Stripe
36	Blue/Pink Stripe
37	Lime/Brown Stripe
38	Lime/Red Stripe
39	Lime/Orange Stripe
40	Lime/Yellow Stripe

Pair No.	Color Combination
41	Lime/Green Stripe
42	Lime/Blue Stripe
43	Lime/Purple Stripe
44	Lime/Grey Stripe
45	Lime/White Stripe
46	Lime/Black Stripe
47	Lime/Tan Stripe
48	Lime/Pink Stripe
49	Aqua/Brown Stripe
50	Aqua/Red Stripe
51	Aqua/Orange Stripe
52	Aqua/Yellow Stripe
53	Aqua/Green Stripe
54	Aqua/Blue Stripe
55	Aqua/Purple Stripe
56	Aqua/Grey Stripe
57	Aqua/White Stripe
58	Aqua/Black Stripe
59	Aqua/Tan Stripe
60	Aqua/Pink Stripe

### Color Code Chart 8 for DataTwist® Cables (Modified Western Electric)

Pair No.	Color Combination
1	White/Blue Stripe & Blue
2	White/Orange Stripe & Orange
3	White/Green Stripe & Green
4	White/Brown Stripe & Brown
5	White/Grey Stripe & Grey
6	Red/Blue Stripe & Blue/Red Stripe
7	Red/Orange Stripe & Orange/Red Stripe
8	Red/Green Stripe & Green/Red Stripe

Pair No.	Color Combination
9	Red/Brown Stripe & Brown/Red Stripe
10	Red/Grey Stripe & Grey/Red Stripe
11	Black/Blue Stripe & Blue/Black Stripe
12	Black/Orange Stripe & Orange/Black Stripe
13	Black/Green Stripe & Green/Black Stripe
14	Black/Brown Stripe & Brown/Black Stripe

Pair No.	Color Combination
15	Black/Grey Stripe & Grey/Black Stripe
16	Yellow/Blue Stripe & Blue/Yellow Stripe
17	Yellow/Orange Stripe & Orange/Yellow Stripe
18	Yellow/Green Stripe & Green/Yellow Stripe
19	Yellow/Brown Stripe & Brown/Yellow Stripe
20	Yellow/Grey Stripe & Grey/Yellow Stripe

Pair No.	Color Combination
21	Purple/Blue Stripe & Blue/Purple Stripe
22	Purple/Orange Stripe & Orange/Purple Stripe
23	Purple/Green Stripe & Green/Purple Stripe
24	Purple/Brown Stripe & Brown/Purple Stripe
25	Purple/Grey Stripe & Grey/Purple Stripe

### Color Code Chart 9: IBM RISC System/6000

Cond.	Color
1	White over Blue
2	White over Orange
3	White over Green
4	White over Brown
5	White over Grey
6	White over Red
7	White over Yellow

Pair No.	Color Combination
1	White over Blue & Blue over White
2	White over Orange & Orange over White
3	White over Green & Green over White

### Color Code Chart 10 for Fiber Optics\*

Position No.	Color
1	Blue
2	Orange
3	Green
4	Brown
5	Grey
6	White
7	Red

Position No.	Color
8	Black
9	Yellow
10	Purple
11	Rose
12	Aqua

\* per TIA/EIA 598-A

## Belden Color Code Charts

**Chart 11: VDE 47100**

Core No.	Color	Core No.	Color	Core No.	Color
1	White	22	Brown/Blue	43	Blue/Black
2	Brown	23	White/Red	44	Red/Black
3	Green	24	Brown/Red	45	White/Brown/Black
4	Yellow	25	White/Black	46	Yellow/Green/Black
5	Grey	26	Brown/Black	47	Grey/Pink/Black
6	Pink	27	Grey/Green	48	Red/Blue/Black
7	Blue	28	Yellow/Green	49	White/Green/Black
8	Red	29	Pink/Green	50	Brown/Green/Black
9	Black	30	Yellow/Pink	51	White/Yellow/Black
10	Violet	31	Green/Blue	52	Yellow/Brown/Black
11	Grey/Pink	32	Yellow/Blue	53	White/Grey/Black
12	Red/Blue	33	Green/Red	54	Grey/Brown/Black
13	White/Grey	34	Yellow/Red	55	White/Pink/Black
14	Brown/Green	35	Green/Black	56	Pink/Brown/Black
15	White/Yellow	36	Yellow/Black	57	White/Blue/Black
16	Yellow/Brown	37	Grey/Blue	58	Brown/Blue/Black
17	White/Grey	38	Pink/Blue	59	White/Red/Black
18	Grey/Brown	39	Grey/Red	60	Brown/Red/Black
19	White/Pink	40	Pink/Red	61	Black/White
20	Pink/Brown	41	Grey/Black		
21	White/Blue	42	Pink/Black		

**Chart 12: UNEL 00722**

Core No.	Color
2	Brown, Blue
3	Brown, Blue, Green/Yellow
4	Brown, Black, Blue, Green/Yellow
5	Brown, Blue, Black, Black, Green/Yellow



## Halogen-Free Standards

Our halogen-free cables meet the most important international standards. Moreover Belden selected halogen-free jacketing materials are suitable for outdoor use like direct burial.

In comparison to products containing halogens (like PVC), these halogen-free materials offers considerable advantages in case of a fire:

- Less impairment to vision
- Minimal toxic gases
- No release of highly caustic acids
- More safety for man, nature and materials.

Belden's halogen-free cables are both FRNC (= Flame-Retardant, Non-Corrosive ) and LSNH (= Low-Smoke, Non-Halogen).

In the event of a fire, low halogen cables can burn extremely fiercely. In addition, a forced air flow intended to cool equipment can provide a continuous supply of oxygen, thus "feeding" the fire. Where this air flow has a HVAC function, fire and toxic smoke may be distributed to other parts of the building.

### Beyond Zero Halogen

Where there is a risk of fire and/or smoke being propagated and spread throughout a building, there is an additional risk of corrosive and toxic damage. Recent research has demonstrated that several cables in common use may in fact propagate fire and smoke extremely rapidly. These include cables with a fire rating, including low smoke and low halogen. In a number of actual fires, severe structural damage has occurred.

### Products Tested for Public Safety

It goes without saying that where public safety is concerned, there can be no shortcuts. Safety standards are high to ensure minimum damage to life, property and the environment. When it comes to cables, make sure you specify the best products for safety. So you can be confident of performance and quality – even in the event of a calamity.

Belden cables offer the quality and reliability consistent with your long-term needs. And to ensure top performance. Belden cables are available with extended fire ratings. Belden has developed these cables in response to the industry's growing demand for halogen free cables with acid free, non toxic and low smoke density which are also flame and fire retardant.

The test designation (and its meaning) would be one of the following:

#### IEC 60754-1

The cable must be designed with halogen-free plastics. This has an additional advantage: no formation of toxic gases.

#### IEC 60754-2

This test determines the level of corrosion by combustion of insulation-bedding and sheathing compounds. A minimum of 1000 mg ( $\pm 5$  mg) of insulating or sheathing compound should be heated in a furnace, 500 - 600 mm long, to a temperature of 935°C.

#### IEC 60332-3C (Test on Fire Behavior on Cable Bundles)

The cables should be flamed/torched from a distance of 75 mm by a propane gas burner. The test duration is 20 min. The test is passed if the flames extinguish by themselves and when no part of the samples is affected above a 2.5 m height from the burner.

#### IEC 60332-1

A sample of 600 mm is burnt with a flame of a propane gas burner. The test is passed, if the sample has not burnt or when the flames extinguish by themselves and the affected part of the sample which is located the farthest from the bottom edge of the burner has not reached the opposite edge of the sample.

#### IEC 61034-1

The measurement system (27 m<sup>3</sup> chamber) consists of a light source (a standardized 100 W halogen lamp) and a selenium or silicon photo-electric cell, both installed at a height of 2.15 m. A rectangular tray filled with 1 litre of alcohol provides the fire source. A ventilator ensures an even distribution of smoke. The number of test samples depends on the outer diameter. The light intensity is recorded by a plotter. The test is passed if the level of light transmission is not lower than 60%.

Specification	International IEC	Europe CENELEC	Germany VDE	Switzerland SEV	Spain UNE	Italy CEI	France NF	United Kingdom BS	Others
---------------	-------------------	----------------	-------------	-----------------	-----------	-----------	-----------	-------------------	--------

### Material Properties

Quantity of halogen (halogen-free)	IEC 60754-1	EN 50267-2-1	VDE 0482, Teil 267	TP 20B/3C 3.4.5	UNE EN 50267-2-1	CEI 20-37-2	NFC 20-454	-/-	-/-
Toxicity index (no toxic gases)	IEC 60754-1	EN 50305	-/-	-/-	UNE EN 50267-2-1	CEI 20-37-7	NFC 20-454	-/-	NES 713
Degree of Acidity (no corrosive gases)	IEC 60754-2	EN 50267-2-2	VDE 0482, Teil 267	TP 20B/3C 3.4.4/3.4.5	UNE EN 50267-2-3	-/-	NFC 20-454	BS 6425 Part 2	-/-

### Fire Performance

Fire retardant (no flame propagation)	IEC 60332-3C IEC 60333-3	EN 50265-2-1 (HD405.3)	VDE 0482, Teil 266-2-4	TP 20B/3C 3.4.1.3	UNE 20423-3 UNE 20427	CEI 20-22-3	NFC 32070-C1	BS 4066 Part 3	-/-
Flame retardant	IEC 60332-1	EN 50265-2-1 (HD405.1/2)	VDE 0482, Teil 265-2-1	TP 20B/3C 3.4.1.1	UNE EN 50265-2-1	-/-	-/-	BS 4066 Part 1	-/-
Low smoke density	IEC 61034-1	EN 50268-2-1	VDE 0482, Teil 268	TP 20B/3C 3.4.3	UNE EN 50268	CEI 20-37-5	-/-	BS 7622 Part 1	-/-

## Environmental Regulations and Compliance

### Heavy Metal Free, RoHS and Prop 65

Over the past several years, increased attention has been placed upon the potential environmental impacts of electronic products. Both voluntary and regulatory measures have been taken to address some of these concerns. Already in place are California Proposition 65 and the European Union End-of-Life Vehicle (ELV) and Flame Retardant Directives. Since July 2006 the European Union Restriction on Hazardous Substances (RoHS) Directive is in place and restricts the use of heavy metal substances (Lead, for example) in electronic products. There are also several states and countries currently considering their own legislation on this topic.

The use of materials that are environmentally friendly is of growing concern to Belden, its customers and to the global community since January 2006. Belden is engaged in a world-wide project to integrate into its product designs and supplier requirements a formalized program to restrict the use of these materials. The following list of materials represents examples of substances that Belden is eliminating or reducing in certain applications:

- Asbestos and its compounds
- Cadmium and its compounds
- Chromium VI and its compounds
- Lead and its compounds
- Mercury and its compounds
- Polybrominated biphenyls (PBBs) and their ethers/oxides (PBDEs, PBBEs)
- Di-(2-ethylhexyl)phthalate (DEHP)
- Penta-, Octa-BDE brominated flame retardants

As a result of this project, many of Belden's products are now, heavy metal free and meet the requirements of both RoHS and California Proposition 65. Please consult the Glossary of Terms section, contact Belden customer service or visit [www.belden-emea.com](http://www.belden-emea.com) for more specific product details and current compliance information.

### RoHS Compliance

Unless so marked, cables in this catalog do not contain any of the following restricted substances, as an intentional additive, and is therefore compliant with European Directive 2002/95/EC (RoHS), European Directive 2000/53/EC (ELV), European Directive 2003/11/EC (BFR), European Directive 2002/96/EC (WEEE), and California Proposition 65 Consent Judgement for Wire & Cable Manufacturers [San Francisco Superior Court Nos. 312962 and 320342] (Prop 65).

For customer convenience, Belden products that are in compliance with these directives contain the identification "ROHS" within the text of the jacket surface printing and also an environmentally friendly logo (as shown at right) on package labeling.



Substance	Maximum Concentration*
Lead	0.03%
Mercury	0.10%
Hexavalent Chromium	0.10%
PBB, PBDE**	0.10%
Cadmium	0.01%

\* Per homogeneous material, as trace or contaminate amount.

\*\* Some Belden cables may contain Decabromodiphenyl Oxide/Ether (PBDE) as a flame retardant. This substance is currently exempt from RoHS.

In addition, Belden products do not contain asbestos and its compounds or Di-(2-ethylhexyl)phthalate (DEHP).

This determination is based upon information obtained from sources which Belden believes are reliable, and from random sample testing at the Belden Engineering Center; however, the information is provided without any representation of warranty, expressed or implied, regarding accuracy or correctness. Belden does not specifically run any analysis on our raw materials or end product to measure for these substances.

The information provided in this catalog, and the identification of materials listed as reportable or restricted within the catalog, is correct to the best of Belden's knowledge, information and belief at the date of its publication. The information provided in the catalog is designed only as a general guide for the safe handling, storage, and any other operation of the product itself or the one that it becomes a part of. This catalog is not to be considered a warranty or quality specification. Regulatory information is for guidance purposes only. Product users are responsible for determining the applicability of legislation and regulations based on their individual usage of the product.

## Cable Packaging

Belden, a recognized leader in state-of-the-art packaging design, has introduced a variety of packaging styles and options for the convenience of our customers:

### UnReel®

A wide variety of Belden cable and plenum cable is available in Belden's UnReel cardboard dispenser.

Belden UnReel is a unique packaging/dispensing system developed to save time, cut costs and labor, and eliminate the need for dereeling equipment.

Lightweight and more economical than conventional drums or reels, UnReel dispensers have pre-punched handles for easy, individual transport as well as rectangular boxes for easy pallet delivery and storage. Unreeled cable pays out smoothly and evenly with no kinking, twisting, or backlashing. It also rolls out 60% faster per hour than conventionally packaged cable.

UnReel ships, stores and dispenses in one carton, which – since its introduction – has always been fully recyclable and biodegradable. Look for the letter “U” in the put-up (“length”) description.

### Coil Package

New Generation cables are available in a coil package. These revolutionary coils come in an easy-to handle standard package size so pallet loading is uniform. In addition, the densely packaged coil requires less shelf space, truck space or cage space. In addition, because there is no box and no spool, far less waste and clean-up are required after use.

This is the most tangle-proof package available and, because the wire pulls from the middle you only have to handle the weight of the length of wire between you and the coil. This is a great advantage over the conventional spool where it is necessary to pull the whole weight of the package to get it spinning and, once spinning, the spool does not stop. Often assistance is required to stop for payouts from tangling. With coils, no assistance is required and there is no tangling. In addition, five coils can be stacked and pulled in parallel through their common centre.

### Terms of Use of Master Catalog

#### Use of Information; Disclaimers

Although Belden makes every reasonable effort to ensure their accuracy at the time of this publication, information and specifications described in this catalog are subject to change without notice. The most current product information may be found by accessing our website at [www.belden-emea.com](http://www.belden-emea.com) or contacting Belden Technical Support at +31-77-3875-414.

Belden provides the information and specifications in this catalog on an “AS IS” basis, with no representations or warranties, whether express, statutory or implied. WITH RESPECT TO SUCH INFORMATION AND SPECIFICATIONS, BELDEN DISCLAIMS ALL WARRANTIES OF MERCHANTABILITY, FITNESS FOR INTENDED PURPOSE AND NON-INFRINGEMENT. IT ALSO EXCLUDES ANY EXPRESS OR IMPLIED WARRANTIES ARISING FROM ANY COURSE OF DEALING, USAGE, TRADE PRACTICE OR PERFORMANCE. BELDEN'S SOLE WARRANTIES ARE AS BELDEN MAY PROVIDE IN (AND SUBJECT TO THE TERMS AND LIMITATIONS OF) SEPARATE WARRANTY DOCUMENTATION.

In no event will Belden be liable for any damages (including consequential, indirect, incidental, special, punitive, or exemplary damages) whatsoever, even if Belden has been advised of the possibility of such damages, whether in an action under contract, negligence or any other theory, arising out of or in connection with the use, inability to use, or performance of the information, specifications or products described in this catalog.

#### Conversions

All conversions are from feet to metres and have been rounded off. Amounts invoiced will be for actual lengths delivered.

#### Belden's Terms and Conditions of Sale

All sales of Belden products are subject to Belden's standard terms and conditions of sale.

#### Intellectual Property Protection

All trademarks or registered trademarks mentioned in this catalog are property of their respective owners. The information contained in this catalog is protected by copyright. No part of this catalog may be reproduced by any means without the prior written permission from Belden.

#### U.S. and European Export Laws

The United States and European Export Controls laws prohibit the export of certain technical data and software to certain territories. No content from this catalog may be reproduced or otherwise exported in violation of United States or European Law.



**Table of Contents**

<b>Part Number Index</b>	<b>Page No.</b>
Index	24.2 – 24.17

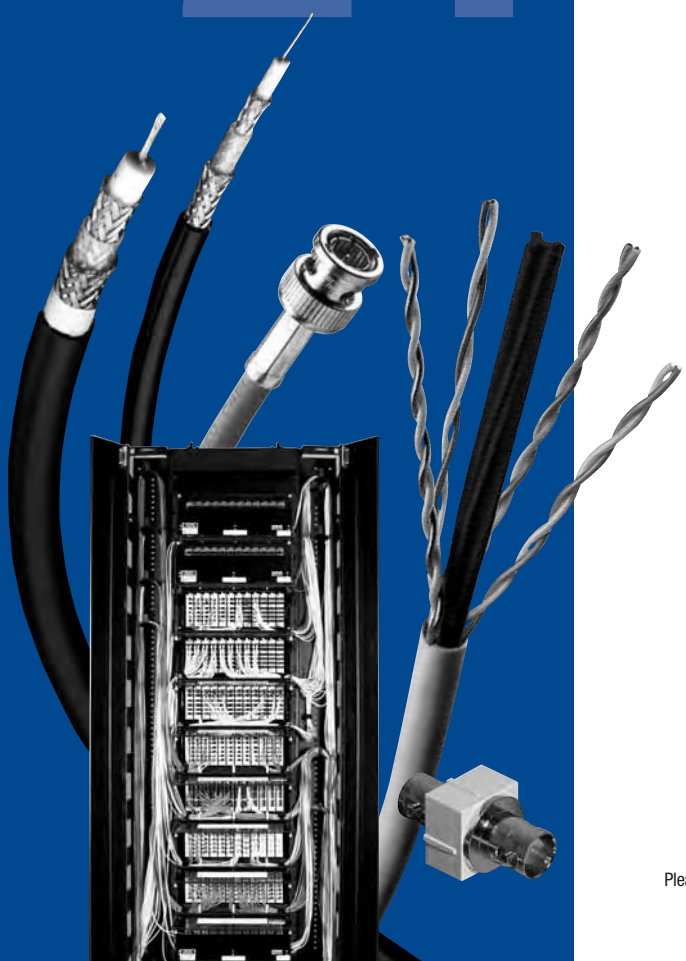

Please refer to "Terms of Use of Master Catalog" on page 23.22.

## Index

## How to use this part number index

All part numbers are listed numerically, in three sections:

- Section 1: numerical only
- Section 2: numbers followed by letters
- Section 3: letters followed by numbers

Section 1		Part No.	Page	Part No.	Page	Part No.	Page	Part No.	Page
Part No.	Page								
7805	9.27	8337	5.15	9418	4.8	9615	4.9	9874	5.23
8102	5.17	8340	5.15	9421	4.4	9616	4.9	9875	5.23
8103	5.17	8342	5.15	9423	4.4	9617	4.9	9880	15.69, 18.12
8104	5.17	8345	5.15	9430	4.4	9618	4.9	9891	15.70
8105	5.17	8348	5.15	9451	19.11	9619	4.9	9901	15.70
8106	5.17	8355	5.15	9452	19.11	9680	5.9	9903	15.70
8107	5.17	8410	19.21	9463	18.13	9681	5.9	9907	15.69, 18.12
8108	5.17	8412	19.9	9464	5.10	9682	5.9	9925	4.11
8110	5.17	8424	19.10	9501	5.7	9683	5.9	9927	4.11
8112	5.17	8442	4.4	9502	5.7	9684	5.9	9929	4.11
8115	5.17	8443	4.4	9503	5.7	9688	15.71	9931	4.11
8118	5.17	8444	4.4	9504	5.7	9689	15.72	9932	4.11
8125	5.17	8445	4.4	9505	5.7	9716	21.10	9933	4.11
8132	5.14	8451	19.11	9506	5.7	9728	5.20	9934	4.11
8133	5.14	8456	4.4	9507	5.7	9729	5.20, 18.33	9935	4.11
8134	5.14	8461	5.4	9508	5.7	9730	5.20	9936	4.11
8135	5.14	8471	5.5, 18.30, 21.8	9509	5.7	9731	5.20	9937	4.11
8138	5.14	8473	5.5	9510	5.7	9732	5.20	9938	4.11
8142	5.14	8477	5.5	9515	5.7	9733	5.20	9939	4.10
8148	5.14	8673	4.5	9519	5.7	9734	5.20	9940	4.10
8155	5.14	8675	4.5	9525	5.8	9735	5.20	9941	4.10
8162	5.25	8677	4.5	9533	4.6	9736	5.20	9942	4.10
8163	5.25	8678	4.5	9534	4.6	9737	5.20	9943	4.10
8164	5.25	8690	5.5	9535	4.6	9738	5.20	9944	4.10
8165	5.25	8718	5.11	9536	4.6	9740	5.4	9945	4.10
8166	5.25	8719	5.11, 18.31	9537	4.6	9750	5.4	9946	4.10
8167	5.25	8720	5.11	9538	4.6	9751	5.4	9947	4.10
8168	5.25	8723	5.22, 18.34	9539	4.6	9752	5.4	9948	4.10
8170	5.25	8728	19.11	9540	4.6	9755	5.4	9949	4.10
8175	5.25	8760	18.35	9541	4.7	9773	5.23	9950	4.10
8178	5.25	8761	5.10	9542	4.7	9774	5.23	82489	4.4
8185	5.25	8762	5.10	9543	4.7	9775	5.23	82502	5.8
8205	5.4	8770	4.8	9544	4.7	9804	5.13	82503	5.8
8241	19.25	8772	4.8	9545	4.7	9805	5.13	82504	5.8
8281	19.25	8774	5.22	9546	4.7	9806	5.13	82505	5.8
8302	5.18	8777	5.22, 18.33	9550	5.8	9807	5.13	82506	5.8
8303	5.18	8778	5.22	9571	4.13	9808	5.13	82509	5.8
8304	5.18	9116	9.18	9572	4.13	9809	5.13	82641	5.8
8305	5.18	9118	9.18	9574	4.13	9812	5.13	82740	5.5
8306	5.18	9154	5.10	9575	4.13	9813	5.13	82760	5.10
8307	5.18	9156	5.4	9578	4.13	9814	5.13	82777	5.22
8308	5.18	9157	5.5	9579	4.13	9819	5.13	82907	15.69
8310	5.18	9159	5.5	9580	4.14	9825	5.13	83503	4.12
8312	5.18	9167	9.26	9581	4.14	9829	5.16	83504	4.12
8315	5.18	9180	19.16	9582	4.14	9830	5.16	83506	4.12
8318	5.18	9182	18.16	9583	4.14	9831	5.16	83552	4.12
8325	5.18	9207	18.15	9608	4.9	9832	5.16	83553	4.12
8332	5.15	9248	19.25	9609	4.9	9841	18.32	83554	4.12
8333	5.15	9259	19.25	9610	4.9	9842	18.32	83556	4.12
8334	5.15	9292	19.25	9611	4.9	9843	18.32	83559	4.12
8335	5.15	9397	19.9	9612	4.9	9844	18.32	83562	4.12
8336	5.15	9398	19.9	9613	4.9	9860	18.15	83569	4.12
		9402	5.23	9614	4.9	9873	5.23	85102	18.31

# Index

## How to use this part number index

All part numbers are listed numerically, in three sections:

- Section 1: numerical only
- Section 2: numbers followed by letters
- Section 3: letters followed by numbers

Part No.	Page
88723	18.34
89182	18.16
89463	18.14
89880	15.69, 18.12
89901	15.70
89907	15.69, 18.12
129463	18.14
139463	18.14
189463	18.14
413945	20.36
433945	20.36
439945	20.39
443945	20.36
449945	20.39
451945	20.35
473945	20.35
513945	20.36
533945	20.36
539945	20.39
543945	20.35
549945	20.39
551945	20.35
573945	20.35
22208010	15.19
22208067	15.19
22208231	15.19
22208235	15.19
22208250	15.19
22208253	15.19
22208260	15.19
22208265	15.19
22208270	15.19
22214348	15.43
22214500	15.43
22214700	15.43
22214900	15.43
24566315	15.47
24566345	15.47
24566915	15.47
24566945	15.47
24567315	15.47
24567345	15.47
24567915	15.47
24567945	15.47
24568005	15.47
24568015	15.47
24568315	15.47
24568331	15.47
24570157	15.11, 15.50
24570161	15.11, 15.50
24570166	15.11, 15.50
24570452	15.50
24570460	15.50

Part No.	Page
24570521	15.13
24570800	15.11, 15.50
24570808	15.50
24570810	15.11, 15.50
24570812	15.50
24576125	15.54
24577125	15.54
24577B15	15.13
24586385	15.9, 15.45
24586985	15.9, 15.45
24587385	15.9, 15.45
24587985	15.9, 15.45
24588085	15.9, 15.45
24598301	15.11, 15.50
24598331	15.11, 15.50
24812395	15.8
24816395	15.8
24816995	15.8
24817395	15.8
24817995	15.8
24818095	15.8
24822395	15.8
24826395	15.8
24826995	15.8
24827395	15.8
24827995	15.8
24828095	15.8
25500027	15.56
25500028	15.56
70100390	16.6
70101714	16.6
70102419	16.6
70102420	16.6
70102447	16.6

Section 2	
Part No.	Page
1B25A	8.4, 21.14
1R25A	8.4, 21.14
4K20FX	20.56
4K21FX	20.56
4K22FX	20.56
4L20FX	20.56
4L21FX	20.56
4L22FX	20.56
4L25FX	20.56
4N20FX	20.56
4N21FX	20.56
4N22FX	20.56
179DT	19.27, 21.12
500PTZ	20.44
501PTZ	20.44
502PTZ	20.44
540BUE	20.13
558AFS	20.45
1172A	19.10
1192A	19.10
1215A	15.72
1227A1	15.58
1229A1	15.58
1232A1	15.58
1243A2	15.58
1245A2	15.58
1277R	19.31, 21.13
1278R	19.31, 21.13
1279R	19.31, 21.13
1280R	19.31, 21.13
1281S3	19.33, 21.13
1281S4	19.33, 21.13
1281S5	19.33, 21.13
1281S6	19.33, 21.13
1300SB	7.5
1304A	19.22
1305A	19.22
1306SB	7.5
1307A	21.10
1308A	21.10
1309A	21.11
1310A	21.11
1311A	21.11
1312A	21.11
1313A	21.11
1347A	19.21
1348A	18.29
1349A	18.29
1406B	19.26
1407B	19.26
1417B	19.26
1419A	5.9

Part No.	Page
1420A	5.9
1421A	5.9
1422A	5.9
1423A	5.9
1424A	5.9
1425A	5.9
1500A	20.42
1502R	21.7
1504A	21.10
1505A	19.28
1505ANH	19.28
1505F	19.28, 21.12
1505S3	19.34
1505S5	19.34
1505S6	19.34
1508A	19.14
1508ENH	19.14
1509C	19.14
1509ENH	19.14
1510C	19.14
1511C	19.14
1512C	19.14
1512ENH	19.14
1513C	19.14
1514C	19.14
1515C	19.14
1516C	19.14
1517C	19.14
1518C	19.14
1519C	19.14
1520A	19.26
1521A	19.26
1522A	19.26
1523A	9.13
1524AM	9.13
1525A	9.13
1583A	15.52
1583E	15.52, 20.42
1583ENH	15.52
1585A	15.53
1592A	15.65
1594A	15.52
1633E	15.62
1633ENH	15.62
1633ENS	15.63
1633ES	15.63
1634A	15.71
1667E	15.53
1667ENH	15.53
1668E	15.62
1668ENH	15.62
1668ENS	15.63
1668ES	15.63, 21.6

Part No.	Page
1671A	9.32
1673A	9.32
1674A	9.32
1675A	9.32
1694A	19.29
1694ANH	19.29
1694F	19.29
1694SB	7.4
1696A	19.16
1700A	15.49
1700E	15.49
1700ENH	15.11, 15.49
1700S6	15.55, 21.5
1701S6	15.55
1752A	15.65
1797B	15.37
1800B	19.16
1800F	19.16
1802B	19.16
1803F	19.18
1804A	19.10
1805F	19.18
1806F	19.18
1808A	21.12
1810A	19.19
1811A	19.19
1814R	19.15
1815R	19.15
1816R	19.15
1817R	19.15
1818R	19.15
1819R	19.15
1820R	19.15
1821R	19.15
1822R	19.15
1823R	19.15
1850F	19.18
1852F	19.18
1854F	19.18
1855A	19.27
1855ENH	19.27
1855S3	19.33
1855S5	19.33
1855S6	19.33
1864A	15.57
1865A	19.27
1868E	15.66
1868ENH	15.66
1871A	15.57
1872A	15.48
1874A	15.48
1875GB	15.64
1883A	19.11

## Index

## How to use this part number index

All part numbers are listed numerically, in three sections:

- Section 1: numerical only
- Section 2: numbers followed by letters
- Section 3: letters followed by numbers

Part No.	Page	Part No.	Page	Part No.	Page	Part No.	Page	Part No.	Page
1885ENH	15.60	4000UE	20.17	4445FE	20.31	5222UL	20.48	5345UE	20.29
1887ENH	15.60	4001UE	20.17	4500FE	20.21	5222UN	20.54	5347UE	20.29
1902A	19.13	4020FL	20.51	4500UE	20.12	5284UE	20.41	5399B5	20.38
1904A	19.13	4020UL	20.49	4501FE	20.21	5284US	20.41	5400F1	20.28
1906A	19.13	4100FE	20.27	4501UE	20.12	5288US	20.41	5400FE	20.22
1908A	19.13	4100UE	20.16	4502FE	20.21	5300F1	20.28	5400UE	20.13
1912A	19.13	4101UE	20.16	4502GE	20.33	5300FE	20.23	5401FE	20.22
1916A	19.13	4102UE	20.16	4502UE	20.12	5300U1	20.28	5401GE	20.33
1924A	19.13	4120FL	20.51	4504FE	20.21	5300UE	20.14	5401UE	20.13
1932A	19.13	4120UL	20.48	4504UE	20.12	5300UG	20.10	5402FE	20.22
3072F	18.17	4122UL	20.48	4506FE	20.21	5301FE	20.23	5402GE	20.33
3073F	18.17	4200FE	20.26	4506UE	20.12	5301UE	20.14	5402UE	20.13
3074F	18.17	4200UE	20.16	4508FE	20.21	5302FE	20.23	5403FE	20.22
3076ELS	18.20	4201FE	20.26	4509UE	20.12	5302GE	20.33	5403UE	20.13
3076ENH	18.20	4201UE	20.16	4541FE	20.30	5302UE	20.14	5405FE	20.22
3076F	18.20	4202FE	20.26	4542FE	20.30	5303FE	20.23	5405UE	20.13
3077ELS	18.20	4202UE	20.16	4545FE	20.30	5303UE	20.14	5406UE	20.13
3077ENH	18.20	4220FL	20.50	5000FE	20.27	5304FE	20.23	5407FE	20.22
3077F	18.20	4220UL	20.48	5000UE	20.17	5304UE	20.14	5407UE	20.13
3078F	18.21	4222UL	20.48	5001UE	20.17	5305FE	20.23	5408UE	20.13
3079A	18.21	4300FE	20.24	5020FJ	20.53	5305UE	20.14	5409UE	20.13
3079ALS	18.21	4300UE	20.15	5020FL	20.51	5306FE	20.23	5439W5	20.37
3079ANH	18.21	4301FE	20.24	5020FN	20.55	5306UE	20.14	5441FE	20.30
3079E	18.21	4301UE	20.15	5020UL	20.49	5307FE	20.23	5442FE	20.30
3082A	18.22	4302FE	20.24	5100FE	20.27	5307UE	20.14	5445FE	20.30
3082F	18.23	4302UE	20.15	5100UE	20.16	5308UE	20.14	5500F1	20.28
3082K	18.24	4303FE	20.24	5101FE	20.27	5309UE	20.14	5500FE	20.20
3082KP	18.24	4303UE	20.15	5101UE	20.16	530BUE	20.14	5500UE	20.11
3083A	18.23	4304FE	20.24	5102UE	20.16	5320FJ	20.52	5500UG	20.10
3084A	18.23	4304UE	20.15	5120FJ	20.53	5320FL	20.50	5501FE	20.20
3084F	18.23	4306FE	20.24	5120FL	20.51	5320FN	20.54	5501GE	20.33
3085A	18.24	4306UE	20.15	5120FN	20.55	5320UJ	20.52	5501UE	20.11
3086A	18.25	4307FE	20.24	5120UL	20.48	5320UL	20.46	5502FE	20.20
3087A	18.25	4308UE	20.15	5120UN	20.54	5320UN	20.54	5502GE	20.33
3092A	18.18	4309UE	20.15	5122FL	20.51	5322FJ	20.52	5502UE	20.11
3092F	18.18	4320FL	20.50	5122FN	20.55	5322FL	20.50	5502UG	20.10
3093A	18.18	4322FL	20.50	5122UL	20.48	5322FN	20.54	5503FE	20.20
3094A	15.71, 18.19	4322UL	20.47	5200FE	20.26	5322UL	20.46	5503UE	20.11
3095A	18.19	4324UL	20.47	5200UE	20.15	5322UN	20.54	5504FE	20.20
3105A	18.28	4339B5	20.38	5201FE	20.26	5324UL	20.46	5504UE	20.11
3106A	18.28	4339Q5	20.38	5201UE	20.15	5326UL	20.46	5506FE	20.20
3107A	18.28	4341FE	20.31	5202FE	20.26	5328UL	20.46	5506UE	20.11
3108A	18.28	4341UE	20.29	5202UE	20.15	5329UL	20.46	5508FE	20.20
3109A	18.28	4342FE	20.31	5205UE	20.15	5339B5	20.38	5508UE	20.11
3119A	18.27	4343FE	20.31	5220FJ	20.52	5339Q5	20.38	5509UE	20.11
3120A	18.27	4345FE	20.31	5220FL	20.50	5339W5	20.37	5522FL	20.50
3124A	18.26	4400FE	20.22	5220FN	20.55	5341FE	20.31	5522UL	20.46
3125A	18.26	4400UE	20.13	5220UJ	20.52	5341UE	20.29	5541FE	20.30
3126A	18.26	4401FE	20.22	5220UL	20.48	5342FE	20.31	5541UE	20.29
3131A	18.19	4402FE	20.22	5220UN	20.54	5342UE	20.29	5542FE	20.30
3132A	18.19	4402UE	20.13	5222FJ	20.52	5343FE	20.31	5542GE	20.33
3999E	18.28	4403FE	20.22	5222FL	20.50	5343UE	20.29	5542UE	20.29
4000FE	20.27	4441FE	20.31	5222FN	20.55	5345FE	20.31	5542UL	20.46

# Index

## How to use this part number index

All part numbers are listed numerically, in three sections:

- Section 1: numerical only
- Section 2: numbers followed by letters
- Section 3: letters followed by numbers

Part No.	Page
5543FE	20.30
5543PE	20.32
5543UE	20.29
5545FE	20.30
5547UE	20.29
5600FE	20.18
7200A	18.37
7201A	18.37
7202A	18.37
7203A	18.37
7205A	18.37
7206A	18.37
7500A	18.38
7501A	18.38
7502A	18.38
7503A	18.38
7504A	18.38
7701NH	18.30, 21.7
7702NH	18.30
7703NH	18.30
7704NH	18.30
7710A	19.32
7711A	19.32
7712A	19.32
7713A	19.32
7731A	19.30
7731ANH	19.30
7783AF	19.23
7784AF	19.23
7784ANH	19.23
7784AS	19.23
7784E	19.23
7785A	19.24
7785ANH	19.24
7787A	19.31
7788A	19.31
7789A	19.31
7790A	19.31
7791A	19.31
7792A	19.31
7794A	19.32
7795A	19.32
7796A	19.32
7798A	19.32
7804C	19.8
7804R	19.8
7805R	9.27
7806A	9.27
7807A	9.27
7808A	9.28
7809A	9.28
7810A	9.28
7812E	15.46

Part No.	Page
7812ENH	15.46
7851A	15.44
7851NH	15.44
7852A	15.9, 15.44
7860ENH	15.61
7860ENS	15.61
7876S	21.4
7878S	21.4
7880A	19.17
7881A	20.42
7883A	15.64
7884A	19.12
7885A	19.12
7886A	19.12
7887A	19.12
7888A	19.12
7889A	19.12
7890A	19.17
7891A	19.17
7892A	19.17
7893A	19.17
7895A	18.24
7896A	18.22
7897A	18.22
7900A	18.22
7911A	21.6
7918A	18.8
7919A	18.8
7921A	18.7
7922A	18.10
7923A	18.9
7924A	18.10
7927A	18.11
7928A	18.8
7929A	18.7
7931A	18.10
7933A	18.8
7952A	21.6
7965E	15.51
7965ENH	15.51
7976A	9.29
7977A	9.29
7987R	21.9
7988P	15.68
7988R	15.68, 21.9
7989P	15.67
7989R	15.67, 21.9
7997A	15.52
8471LS	18.31
8471NH	18.31
8723LS	18.34
8723NH	18.34
8723SB	7.3

Part No.	Page
8760LS	18.35
8760NH	18.35
8777LS	18.34
8777NH	18.33
8777SB	7.3
9116SB	7.4
9182NH	18.16
9207NH	18.15
9451SB	7.3
9463DB	18.13
9463F	18.13
9463LS	18.13
9463NH	18.13
9729LS	18.33
9729NH	18.33
9841LS	18.32
9841NH	18.32
9842LS	18.32
9842NH	18.32
9843NH	18.32
9860LS	18.15
9860NH	18.15
11700A	18.9
11872A	18.11
121700A	18.9
121872A	18.11

Section 3	
Part No.	Page
A0266827	15.16
A0266828	15.16
A0269923	15.16
A0269925	15.16
A0270164	15.17
A0270165	15.20
A0270166	15.20
A0270168	15.17
A0270169	15.20
A0270172	15.20
A0275511	15.18
A0275512	15.18
A0276394	15.17
A0276396	15.17
A0277853	15.17
A0277854	15.17
A0284798	15.17
A0285986	15.17
A0316446	16.14
A0318897	15.18
A0318904	16.14
A0321775	15.18
A0321776	15.18
A0325091	15.20
A0325493	15.20
A0327325	15.18
A0327326	15.18
A0330863	15.16
A0330864	15.16
A0335015	16.14
A0340836	15.17
A0340837	15.18
A0340838	15.17
A0341173	15.16
A0352331	15.20
A0390851	16.5
A0393146	15.16
A0394328	16.14
A0394330	16.14
A0394331	16.14
A0396695	12.7
A0403634	16.4
A0403641	16.4
A0403977	12.7
A0405536	15.36
A0405537	15.36
A0405538	15.36
A0405539	15.36
A0406995	15.35
A0406996	15.35
A0406997	15.35
A0406998	15.35

Part No.	Page
A0406999	15.35
A0407000	15.35
A0407001	15.35
A0407002	15.35
A0407003	15.35, 16.16
A0407004	15.35, 16.16
A0407005	15.35, 16.16
A0407006	15.35, 16.16
A0407007	15.35, 16.16
A0407008	15.35, 16.16
A0407009	15.35, 16.16
A0407010	15.35, 16.16
A0407071	15.32
A0407072	15.32
A0407073	15.32
A0407074	15.32
A0408829	16.4
A0408835	16.4
A0409651	15.32
A0409652	15.32
A0409653	15.32
A0409654	15.32
A0410469	15.19
A0410471	15.19
A0410473	15.19
A0410475	15.19
A0410493	15.19
A0410494	15.19
A0410495	15.19
A0410496	15.19
A0410497	15.19
A0643205	15.34, 16.16
A0643206	15.34, 16.16
A0643207	15.34, 16.16
A0643208	15.34, 16.16
A0644488	12.7
A0644489	12.7
A0644490	12.7
A0644492	12.7
A0644497	12.6
A0644499	12.6
A0645271	15.32
A0645272	15.32
A0645273	15.32
A0645274	15.32
A0649254	15.35, 16.16
A0649869	16.14
AC200004	16.8
AC300656	15.38
AC301215	15.38
AC301311	15.38
AC301325	15.38
AX-50	15.42, 16.17



## Index

## How to use this part number index

All part numbers are listed numerically, in three sections:

- Section 1: numerical only
- Section 2: numbers followed by letters
- Section 3: letters followed by numbers

Part No.	Page	Part No.	Page	Part No.	Page	Part No.	Page	Part No.	Page
AX-50R	15.42, 16.17	AX-8300SNCRZ30N	14.3	AX100183	15.36	AX100332	16.8	AX100697	15.21
AX-70	15.42, 16.17	AX-8300SR600101	14.3	AX100184	15.36	AX100452	15.11, 15.26	AX100698	15.21
AX-80	15.42, 16.17	AX-8310	14.3	AX100185	15.36	AX100454	15.11, 15.26	AX100699	15.21
AX-110BT	15.42, 16.17	AX-8320	14.3	AX100186	15.36	AX100462	12.7	AX100700	15.21
AX-200	15.42, 16.17	AX-8351	14.4	AX100187	15.36	AX100463	12.7	AX100701	15.22
AX-270	15.42, 16.17	AX-8351HW	14.4	AX100188	15.36	AX100464	15.26	AX100702	15.22
AX-270P4U	15.42, 16.17	AX-8400	14.3	AX100189	15.36	AX100465	15.26	AX100703	15.22
AX-270P8U	15.42, 16.17	AX-8400IQEYE3	14.3	AX100190	15.36	AX100472	15.26	AX100704	15.22
AX-280	15.42, 16.17	AX-8400M58305AP	14.3	AX100191	15.36	AX100473	15.26	AX100705	15.22
AX-509	15.42, 16.17	AX-8400MXD03	14.3	AX100192	15.36	AX100494	15.34	AX100706	15.22
AX-820Y-01	14.6	AX-8400SP400101	14.3	AX100193	15.36	AX100495	16.13	AX100707	15.21
AX-820Y-02	14.6	AX-8410	14.3	AX100194	15.36	AX100496	16.13	AX100708	15.21
AX-820Y-03	14.6	AX-8420	14.3	AX100195	15.36	AX100505	15.26	AX100709	15.23
AX-820Y-04	14.6	AX-8451	14.4	AX100196	15.36	AX100506	15.26	AX100710	15.23
AX-820Y-05	14.6	AX-8500	14.3	AX100197	15.36	AX100528	16.14	AX100711	15.23
AX-820Y-06	14.6	AX-8500HW	14.3	AX100198	15.36	AX100530	16.14	AX100721	15.22
AX-820Y-07	14.6	AX-8510	14.3	AX100199	15.36	AX100532	16.14	AX100749	15.37
AX-820Y-08	14.6	AX-8520	14.3	AX100200	15.36	AX100534	16.14	AX100781	12.10
AX-820Y-09	14.6	AX-8551	14.4	AX100201	15.36	AX100536	16.14	AX100783	12.10
AX-820Y-10	14.6	AX-8551HW	14.4	AX100202	15.36	AX100538	16.14	AX100784	12.10
AX-1912-MCR	15.42, 16.17	AX-8600	14.3	AX100203	15.36	AX100540	16.13	AX100785	12.5
AX-5270SC	15.42, 16.17	AX-8600HW	14.3	AX100204	15.36	AX100541	16.13	AX100786	12.5
AX-5270ST	15.42, 16.17	AX-8610	14.3	AX100205	15.36	AX100542	16.13	AX100788	12.7
AX-6108	14.5	AX-8620	14.3	AX100206	15.36	AX100543	16.13	AX100789	12.7
AX-6108-RM	14.5	AX-8651	14.4	AX100207	15.36	AX100577	15.29	AX100792	12.7
AX-6201	14.5	AX-8651HW	14.4	AX100208	15.36	AX100578	15.29	AX100793	12.7
AX-6208	14.5	AX-8858-01	14.6	AX100209	15.36	AX100579	15.29	AX100794	12.7
AX-6224	14.5	AX-8858-02	14.6	AX100210	15.36	AX100580	15.29	AX100795	12.7
AX-6500	14.5	AX100029	16.4	AX100211	15.36	AX100581	15.29	AX100796	12.7
AX-6500GIG	14.5	AX100041	16.12	AX100212	15.36	AX100582	15.29	AX100797	12.7
AX-6500HW4	14.5	AX100042	16.12	AX100213	15.36	AX100583	15.29	AX100798	15.16
AX-6504HW4	14.5	AX100045	16.13	AX100214	15.36	AX100584	15.29	AX100826	15.43
AX-6508	14.5	AX100046	16.13	AX100219	15.34, 16.16	AX100585	15.29	AX100827	15.43
AX-6508GIG	14.5	AX100047	16.13	AX100220	15.34, 16.16	AX100586	15.29	AX100910	16.4
AX-6508HW4	14.5	AX100066	16.14	AX100221	15.34, 16.16	AX100587	15.29	AX100919	16.5
AX-6512HW4	14.5	AX100068	16.12	AX100222	15.34, 16.16	AX100645	15.29	AX100925	15.32
AX-6516	14.5	AX100069	16.12	AX100223	15.34	AX100646	15.29	AX100926	15.32
AX-6516GIG	14.5	AX100073	16.13	AX100224	15.34	AX100647	15.29	AX100927	15.32
AX-6524	14.5	AX100074	16.13	AX100226	15.43	AX100648	15.29	AX100928	15.32
AX-6524GIG	14.5	AX100077	16.12	AX100248	12.7	AX100649	15.29	AX100929	16.5
AX-8201	14.3	AX100078	16.12	AX100249	12.7	AX100650	15.29	AX100930	12.3
AX-8202	14.3	AX100079	16.14	AX100304	15.32	AX100651	15.29	AX100931	12.3
AX-8205	14.3	AX100080	16.14	AX100305	15.32	AX100652	15.29	AX100932	12.4
AX-8206	14.3	AX100082	16.14	AX100306	15.32	AX100653	15.29	AX100933	12.4
AX-8210	14.3	AX100084	16.14	AX100307	15.32	AX100654	15.29	AX100934	16.11
AX-8210-RM	14.3	AX100088	16.14	AX100308	15.32	AX100655	15.29	AX100935	16.11
AX-8210-WM	14.3	AX100090	16.14	AX100309	15.32	AX100690	15.21	AX100936	16.11
AX-8220	14.3	AX100092	16.14	AX100310	15.32	AX100691	15.21	AX100937	16.11
AX-8300	14.3	AX100094	16.14	AX100311	15.32	AX100692	15.21	AX100943	16.11
AX-8300AXIS205	14.3	AX100098	16.14	AX100328	16.8	AX100693	15.21	AX100944	16.11
AX-8300AXIS2120	14.3	AX100115	16.12	AX100329	16.8	AX100694	15.21	AX100945	16.14
AX-8300HW	14.3	AX100116	16.12	AX100330	16.8	AX100695	15.21	AX100947	16.4
AX-8300IVC100	14.3	AX100182	15.36	AX100331	16.8	AX100696	15.21	AX100949	16.4

## Index

## How to use this part number index

All part numbers are listed numerically, in three sections:

- Section 1: numerical only
- Section 2: numbers followed by letters
- Section 3: letters followed by numbers

Part No.	Page	Part No.	Page	Part No.	Page	Part No.	Page	Part No.	Page
AX100951	16.4	AX101161	16.6	AX101407	16.14	AX101537	15.24	AX101749	15.30, 16.15
AX101044	15.28	AX101166	16.6	AX101409	16.14	AX101538	15.24	AX101750	15.30, 16.15
AX101045	15.28	AX101173	12.7	AX101411	16.5	AX101539	15.24	AX101751	15.30, 16.15
AX101046	15.11, 15.28	AX101174	12.3	AX101412	16.5	AX101540	15.24	AX101752	15.30, 16.15
AX101047	15.11, 15.28	AX101175	12.3	AX101413	15.33	AX101541	15.24	AX101753	15.30, 16.15
AX101048	15.28	AX101176	12.3	AX101414	15.33	AX101542	15.24	AX101754	15.30, 16.15
AX101049	15.28	AX101177	12.3	AX101415	15.33	AX101543	15.24	AX101755	15.30, 16.15
AX101050	15.28	AX101178	12.3	AX101416	15.33	AX101544	15.24	AX101756	15.30, 16.15
AX101051	15.28	AX101179	12.3	AX101431	15.31	AX101545	15.24	AX101757	15.30
AX101052	15.28	AX101180	12.4	AX101432	15.31	AX101546	15.24	AX101758	15.30
AX101053	15.28	AX101181	12.4	AX101433	15.31	AX101547	15.24	AX101759	15.30
AX101054	15.28	AX101182	12.4	AX101434	15.31	AX101548	15.24	AX101760	15.30
AX101063	15.27	AX101183	12.4	AX101435	15.31	AX101549	15.24	AX101761	15.30
AX101064	15.27	AX101184	12.4	AX101436	15.31	AX101550	15.24	AX101762	15.30
AX101065	15.9, 15.10, 15.27	AX101185	15.37	AX101437	15.31	AX101551	15.24	AX101763	15.30
AX101066	15.9, 15.10, 15.27	AX101186	16.11	AX101438	15.31	AX101552	15.24	AX101764	15.30
AX101067	15.27	AX101187	16.11	AX101439	15.31	AX101553	15.24	AX101765	15.30
AX101068	15.27	AX101188	16.11	AX101440	15.31	AX101554	15.24	AX101766	15.30
AX101069	15.27	AX101189	16.11	AX101441	15.31	AX101555	15.24	AX101767	15.30
AX101070	15.27	AX101190	16.11	AX101442	15.31	AX101556	15.24	AX101768	15.30
AX101071	15.27	AX101254	12.3	AX101447	15.12	AX101557	15.24	AX101769	15.30
AX101072	15.27	AX101307	15.28	AX101448	15.12	AX101558	15.24	AX101770	15.30
AX101073	15.27	AX101308	15.28	AX101456	15.26	AX101559	15.24	AX101771	15.30
AX101075	16.4	AX101309	15.11, 15.28	AX101458	15.9 – 15.11, 15.26	AX101560	15.24	AX101772	15.30
AX101077	16.4	AX101310	15.11, 15.28	AX101466	15.35, 16.16	AX101561	15.24	AX101791	16.4
AX101084	16.11	AX101311	15.28	AX101467	15.35, 16.16	AX101562	15.24	AX101792	16.4
AX101085	16.11	AX101312	15.28	AX101468	15.14	AX101563	15.24	AX101793	16.4
AX101089	16.11	AX101313	15.28	AX101469	15.14	AX101564	15.24	AX101794	16.4
AX101090	16.11	AX101314	15.28	AX101470	15.12	AX101565	15.24	AX101797	16.13
AX101091	16.11	AX101315	15.28	AX101471	15.12	AX101566	15.24	AX101798	16.13
AX101092	16.11	AX101316	15.28	AX101472	15.12	AX101567	15.24	AX101799	16.13
AX101096	16.11	AX101317	15.28	AX101474	15.31	AX101568	15.24	AX101800	16.13
AX101098	16.14	AX101318	15.27	AX101475	15.31	AX101569	15.24	AX101801	16.13
AX101100	16.14	AX101319	15.27	AX101476	15.31	AX101571	15.9 – 15.11, 15.26	AX101802	16.13
AX101101	16.14	AX101320	15.9, 15.10, 15.27	AX101477	15.31	AX101573	15.26	AX101820	15.24
AX101114	16.11	AX101321	15.9, 15.10, 15.27	AX101478	15.14	AX101581	16.11	AX101821	15.24
AX101115	16.14	AX101322	15.27	AX101483	15.12	AX101584	15.24	AX101823	15.35
AX101117	16.14	AX101323	15.27	AX101486	15.12	AX101611	15.9, 15.10, 15.25	AX101824	15.35
AX101119	16.11	AX101324	15.27	AX101520	15.14	AX101612	15.25	AX101825	15.35
AX101120	16.11	AX101325	15.27	AX101521	15.14	AX101613	15.9, 15.10, 15.25	AX101826	15.35
AX101122	16.6	AX101326	15.27	AX101524	16.11	AX101614	15.25	AX101827	15.35
AX101123	16.6	AX101327	15.27	AX101525	16.11	AX101626	15.24	AX101828	15.35
AX101125	16.6	AX101328	15.27	AX101526	16.11	AX101713	16.11	AX101829	15.35
AX101128	16.6	AX101366	16.6	AX101527	16.11	AX101714	16.11	AX101830	15.35
AX101133	16.6	AX101367	16.6	AX101528	16.11	AX101715	16.11	AX101831	15.35
AX101137	16.6	AX101368	16.6	AX101529	16.11	AX101729	16.14	AX101832	15.35
AX101138	16.6	AX101371	12.4	AX101530	16.11	AX101731	16.14	AX101833	15.35
AX101139	16.6	AX101372	15.33	AX101531	16.11	AX101741	16.14	AX101834	15.35
AX101143	16.6	AX101373	15.33	AX101532	15.24	AX101743	16.14	AX101835	15.35
AX101151	16.6	AX101374	15.33	AX101533	15.24	AX101745	16.15	AX101836	15.35
AX101155	16.6	AX101375	15.33	AX101534	15.24	AX101746	16.15	AX101837	15.35
AX101156	16.6	AX101376	15.33	AX101535	15.24	AX101747	16.15	AX101838	15.35
AX101157	16.6	AX101377	15.33	AX101536	15.24	AX101748	16.15	AX101839	15.35

## Index

## How to use this part number index

All part numbers are listed numerically, in three sections:

- Section 1: numerical only
- Section 2: numbers followed by letters
- Section 3: letters followed by numbers

Part No.	Page	Part No.	Page	Part No.	Page	Part No.	Page	Part No.	Page
AX101840	15.35	AX101976	15.13	AX102112	16.10	AX102272	15.6	AX102389	15.11, 15.40
AX101841	15.35	AX101977	15.13	AX102113	16.10	AX102274	15.6	AX102390	15.11, 15.40
AX101842	15.35	AX101978	15.13	AX102114	16.10	AX102275	15.6	AX102391	15.11, 15.40
AX101852	15.37	AX101979	15.13	AX102115	16.10	AX102276	15.6	AX102392	15.9, 15.10, 15.38
AX101869	16.15	AX101980	15.13	AX102116	16.10	AX102277	15.6	AX102393	15.9, 15.10, 15.38
AX101870	16.15	AX101981	16.4	AX102117	16.10	AX102280	15.6	AX102394	15.9, 15.10, 15.38
AX101871	16.15	AX101982	16.4	AX102118	16.10	AX102281	15.6	AX102395	15.9, 15.10, 15.38
AX101872	16.15	AX101983	16.4	AX102119	16.10	AX102282	15.6	AX102396	15.9, 15.10, 15.38
AX101873	16.15	AX101984	16.4	AX102120	16.10	AX102283	15.6	AX102397	15.9, 15.10, 15.38
AX101874	16.15	AX101985	15.12	AX102121	16.10	AX102285	15.6	AX102480	16.15
AX101875	16.15	AX101986	15.12	AX102122	16.10	AX102286	15.6	AX102481	16.15
AX101876	16.15	AX101987	15.12	AX102123	16.10	AX102287	15.6	AX102482	16.15
AX101935	16.15	AX102014	15.36	AX102124	16.10	AX102288	15.6	AX102483	16.15
AX101936	16.15	AX102015	15.36	AX102125	16.10	AX102293	15.6	AX102484	16.15
AX101937	16.15	AX102016	15.36	AX102126	16.10	AX102296	15.6	AX102485	16.15
AX101938	16.15	AX102017	15.36	AX102127	16.10	AX102305	16.11	AX102488	15.6
AX101939	16.15	AX102018	15.36	AX102128	16.10	AX102306	16.11	AX102512	12.10
AX101940	16.15	AX102019	15.36	AX102129	16.10	AX102307	16.11	AX102513	12.10
AX101941	16.15	AX102020	15.36	AX102130	16.10	AX102308	16.11	AX102514	12.5
AX101942	16.15	AX102021	15.36	AX102145	15.15	AX102309	16.11	AX102515	12.10
AX101943	16.11	AX102022	15.36	AX102146	15.14	AX102310	16.10	AX102516	12.10
AX101944	16.11	AX102023	15.36	AX102147	15.14	AX102311	16.10	AX102517	12.10
AX101945	15.13	AX102024	15.36	AX102148	15.14	AX102312	16.10	AX102526	15.11, 15.40
AX101946	15.13	AX102032	16.11	AX102149	15.14	AX102313	16.10	AX102527	15.11, 15.40
AX101947	15.13	AX102033	16.11	AX102150	15.14	AX102314	16.10	AX102528	15.11, 15.40
AX101948	15.13	AX102061	16.4	AX102151	15.14	AX102315	16.10	AX102529	15.11, 15.40
AX101949	15.13	AX102062	16.4	AX102152	15.14	AX102338	15.11, 15.40	AX102530	15.11, 15.40
AX101950	15.13	AX102063	16.4	AX102153	15.14	AX102339	15.11, 15.40	AX102531	15.11, 15.40
AX101951	15.13	AX102073	15.15	AX102154	15.14	AX102340	15.11, 15.40	AX102532	15.11, 15.40
AX101952	15.13	AX102082	15.15	AX102155	15.14	AX102341	15.11, 15.40	AX102533	15.11, 15.40
AX101953	15.13	AX102089	16.10	AX102156	15.14	AX102342	15.11, 15.40	AX102534	15.11, 15.40
AX101954	15.13	AX102090	16.10	AX102197	16.9	AX102343	15.11, 15.40	AX102535	15.11, 15.40
AX101955	15.13	AX102091	16.10	AX102198	16.9	AX102344	15.11, 15.40	AX102536	15.11, 15.40
AX101956	15.13	AX102092	16.10	AX102199	16.9	AX102345	15.11, 15.40	AX102537	15.11, 15.40
AX101957	15.13	AX102093	16.10	AX102200	16.9	AX102346	15.11, 15.40	AX102538	15.11, 15.40
AX101958	15.13	AX102094	16.10	AX102201	16.9	AX102347	15.11, 15.40	AX102539	15.11, 15.40
AX101959	15.13	AX102095	16.10	AX102202	16.9	AX102348	15.11, 15.40	AX102540	15.11, 15.40
AX101960	15.13	AX102096	16.10	AX102203	16.9	AX102349	15.11, 15.40	AX102541	15.11, 15.40
AX101961	15.13	AX102097	16.10	AX102204	16.9	AX102350	15.9, 15.10, 15.38	AX102542	15.11, 15.40
AX101962	15.13	AX102098	16.10	AX102205	16.9	AX102351	15.9, 15.10, 15.38	AX102543	15.11, 15.40
AX101963	15.13	AX102099	16.10	AX102206	16.9	AX102352	15.9, 15.10, 15.38	AX102544	15.9, 15.10, 15.38
AX101964	15.13	AX102100	16.10	AX102207	16.9	AX102353	15.9, 15.10, 15.38	AX102545	15.9, 15.10, 15.38
AX101965	15.13	AX102101	16.10	AX102208	16.9	AX102354	15.9, 15.10, 15.38	AX102546	15.9, 15.10, 15.38
AX101966	15.13	AX102102	16.10	AX102209	15.35, 16.16	AX102355	15.9, 15.10, 15.38	AX102547	15.9, 15.10, 15.38
AX101967	15.13	AX102103	16.10	AX102210	15.35, 16.16	AX102356	15.9, 15.10, 15.38	AX102548	15.9, 15.10, 15.38
AX101968	15.13	AX102104	16.10	AX102211	15.35, 16.16	AX102357	15.9, 15.10, 15.38	AX102549	15.9, 15.10, 15.38
AX101969	15.13	AX102105	16.10	AX102212	16.16	AX102358	15.9, 15.10, 15.38	AX102550	15.9, 15.10, 15.38
AX101970	15.13	AX102106	16.10	AX102213	15.35, 16.16	AX102359	15.9, 15.10, 15.38	AX102551	15.9, 15.10, 15.38
AX101971	15.13	AX102107	16.10	AX102214	15.35, 16.16	AX102360	15.9, 15.10, 15.38	AX102552	15.9, 15.10, 15.38
AX101972	15.13	AX102108	16.10	AX102215	15.35, 16.16	AX102361	15.9, 15.10, 15.38	AX102553	15.9, 15.10, 15.38
AX101973	15.13	AX102109	16.10	AX102216	15.35, 16.16	AX102386	15.11, 15.40	AX102554	15.9, 15.10, 15.38
AX101974	15.13	AX102110	16.10	AX102269	15.6	AX102387	15.11, 15.40	AX102555	15.9, 15.10, 15.38
AX101975	15.13	AX102111	16.10	AX102271	15.6	AX102388	15.11, 15.40	AX102556	15.9, 15.10, 15.38

## Index

## How to use this part number index

All part numbers are listed numerically, in three sections:

- Section 1: numerical only
- Section 2: numbers followed by letters
- Section 3: letters followed by numbers

Part No.	Page	Part No.	Page	Part No.	Page	Part No.	Page	Part No.	Page
AX102557	15.9, 15.10, 15.38	AX102628	15.35	AX200795	16.6	AX201406	16.9	AX201459	16.9
AX102558	15.9, 15.10, 15.38	AX102648	15.32	AX200797	16.6	AX201407	16.9	AX201460	16.9
AX102559	15.9, 15.10, 15.38	AX102649	16.15	AX200799	16.6	AX201408	16.9	AX201461	16.9
AX102560	15.9, 15.10, 15.38	AX102650	16.15	AX200800	16.6	AX201409	16.9	AX201462	16.9
AX102561	15.9, 15.10, 15.38	AX200056	16.6	AX200801	16.6	AX201410	16.9	AX201463	16.9
AX102562	15.6	AX200057	16.6	AX200802	16.6	AX201411	16.9	AX201464	16.9
AX102563	15.27	AX200058	16.6	AX200803	16.6	AX201412	16.9	AX201465	16.9
AX102564	15.28	AX200060	16.6	AX200809	16.6	AX201413	16.9	AX201466	16.9
AX102569	16.15	AX200082	16.6	AX200810	16.6	AX201414	16.9	AX201467	16.9
AX102570	16.15	AX200084	16.6	AX200811	16.6	AX201415	16.9	AX201468	16.9
AX102571	16.15	AX200090	16.6	AX200812	16.6	AX201416	16.9	AX201469	16.9
AX102572	15.30, 16.15	AX200091	16.6	AX200900	16.6	AX201417	16.9	AX201470	16.9
AX102573	15.30, 16.15	AX200092	16.6	AX201365	16.9	AX201418	16.9	AX201471	16.9
AX102574	15.30	AX200094	16.6	AX201366	16.9	AX201419	16.9	AX201472	16.9
AX102575	15.30	AX200095	16.6	AX201367	16.9	AX201420	16.9	AX201473	16.9
AX102576	15.30	AX200096	16.6	AX201368	16.9	AX201421	16.9	AX201474	16.9
AX102577	15.30	AX200097	16.6	AX201369	16.9	AX201422	16.9	AX201475	16.9
AX102582	15.31	AX200098	16.6	AX201370	16.9	AX201423	16.9	AX201476	16.9
AX102583	15.31	AX200192	16.6	AX201371	16.9	AX201424	16.9	AX201477	16.9
AX102584	15.31	AX200196	16.6	AX201372	16.9	AX201425	16.9	AX201478	16.9
AX102589	15.31	AX200280	16.6	AX201373	16.9	AX201426	16.9	AX201479	16.9
AX102590	15.32	AX200341	16.6	AX201374	16.9	AX201427	16.9	AX201480	16.9
AX102591	15.32	AX200413	16.6	AX201375	16.9	AX201428	16.9	AX201481	16.9
AX102592	15.32	AX200421	16.6	AX201376	16.9	AX201429	16.9	AX201482	16.9
AX102593	15.32	AX200458	16.6	AX201377	16.9	AX201430	16.9	AX201483	16.9
AX102594	15.32	AX200459	16.6	AX201378	16.9	AX201431	16.9	AX201484	16.9
AX102595	15.34	AX200507	16.6	AX201379	16.9	AX201432	16.9	AX201485	16.9
AX102596	15.35	AX200508	16.6	AX201380	16.9	AX201433	16.9	AX201486	16.9
AX102597	15.35	AX200509	16.6	AX201381	16.9	AX201434	16.9	AX201487	16.9
AX102598	15.35	AX200517	16.6	AX201382	16.9	AX201435	16.9	AX201488	16.9
AX102599	15.35	AX200518	16.6	AX201383	16.9	AX201436	16.9	AX201489	16.9
AX102600	15.36	AX200519	16.6	AX201384	16.9	AX201437	16.9	AX201490	16.9
AX102601	15.35	AX200527	16.6	AX201385	16.9	AX201438	16.9	AX201491	16.9
AX102602	15.35	AX200528	16.6	AX201386	16.9	AX201439	16.9	AX201492	16.9
AX102603	15.35	AX200529	16.6	AX201387	16.9	AX201440	16.9	AX201493	16.9
AX102604	15.35	AX200580	16.6	AX201388	16.9	AX201441	16.9	AX201494	16.9
AX102605	15.35	AX200581	16.6	AX201389	16.9	AX201442	16.9	AX201495	16.9
AX102606	15.36	AX200589	16.6	AX201390	16.9	AX201443	16.9	AX201496	16.9
AX102607	15.36	AX200603	16.6	AX201391	16.9	AX201444	16.9	AX201497	16.9
AX102608	16.15	AX200624	16.6	AX201392	16.9	AX201445	16.9	AX201498	16.9
AX102609	16.15	AX200653	16.6	AX201393	16.9	AX201446	16.9	AX201499	16.9
AX102610	13.3, 16.15	AX200657	16.6	AX201394	16.9	AX201447	16.9	AX201500	16.9
AX102611	13.3	AX200658	16.6	AX201395	16.9	AX201448	16.9	AX201501	16.9
AX102612	15.30, 16.15	AX200659	16.6	AX201396	16.9	AX201449	16.9	AX201502	16.9
AX102613	15.30, 16.15	AX200660	16.6	AX201397	16.9	AX201450	16.9	AX201503	16.9
AX102614	15.30	AX200664	16.6	AX201398	16.9	AX201451	16.9	AX201504	16.9
AX102615	15.30	AX200665	16.6	AX201399	16.9	AX201452	16.9	AX201505	16.9
AX102619	15.35, 16.15	AX200666	16.6	AX201400	16.9	AX201453	16.9	AX201506	16.9
AX102620	16.15	AX200667	16.6	AX201401	16.9	AX201454	16.9	AX201507	16.9
AX102624	15.35	AX200668	16.6	AX201402	16.9	AX201455	16.9	AX201508	16.9
AX102625	15.35	AX200695	16.6	AX201403	16.9	AX201456	16.9	AX201509	16.9
AX102626	15.35	AX200698	16.6	AX201404	16.9	AX201457	16.9	AX201510	16.9
AX102627	15.35	AX200699	16.6	AX201405	16.9	AX201458	16.9	AX201511	16.9

## Index

## How to use this part number index

All part numbers are listed numerically, in three sections:

- Section 1: numerical only
- Section 2: numbers followed by letters
- Section 3: letters followed by numbers

Part No.	Page	Part No.	Page	Part No.	Page	Part No.	Page	Part No.	Page
AX201512	16.9	AX250224	16.7	AX330024	15.41	AX350029	15.40	AX360018	15.7
AX201513	16.9	AX250345	16.7	AX330025	15.41	AX350030	15.40	AX360021	15.7
AX201514	16.9	AX250349	16.7	AX330026	15.41	AX350031	15.40	AX360022	15.7
AX201515	16.9	AX250376	16.7	AX330027	15.41	AX350032	15.40	AX360023	15.7
AX201516	16.9	AX250387	16.7	AX330028	15.41	AX350033	15.40	AX360024	15.7
AX201517	16.9	AX250412	16.7	AX330029	15.41	AX350034	15.40	AX360027	15.7
AX201518	16.9	AX250413	16.7	AX330030	15.41	AX350035	15.40	AX360028	15.7
AX201519	16.9	AX250457	16.7	AX330043	15.41	AX350036	15.40	AX360029	15.7
AX201520	16.9	AX250458	16.7	AX330044	15.41	AX350037	15.39	AX360030	15.7
AX201521	16.9	AX250459	16.8	AX330045	15.41	AX350038	15.39	AX360045	15.7
AX201522	16.9	AX250460	16.8	AX330046	15.41	AX350039	15.39	AX360046	15.7
AX201523	16.9	AX250461	16.8	AX330047	15.41	AX350040	15.39	AX360047	15.7
AX201524	16.9	AX250539	16.8	AX330048	15.41	AX350041	15.39	AX360048	15.7
AX201525	16.9	AX250540	16.8	AX330049	15.41	AX350042	15.39	AX360051	15.7
AX201526	16.9	AX250541	16.8	AX330050	15.41	AX350043	15.39	AX360052	15.7
AX201527	16.9	AX250542	16.8	AX330051	15.41	AX350044	15.39	AX360053	15.7
AX201528	16.9	AX300001	15.23	AX330052	15.41	AX350045	15.39	AX360054	15.7
AX201529	16.9	AX300002	15.23	AX330053	15.41	AX350046	15.39	AX360057	15.7
AX201530	16.9	AX300005	15.23	AX330054	15.41	AX350047	15.39	AX360058	15.7
AX201531	16.9	AX300006	15.23	AX330055	15.41	AX350048	15.39	AX360059	15.7
AX201532	16.9	AX300007	15.23	AX330056	15.41	AX350049	15.39	AX360060	15.7
AX201533	16.9	AX300008	15.23	AX330057	15.41	AX350050	15.39	AX360265	15.7
AX201534	16.9	AX300009	15.23	AX330058	15.41	AX350051	15.39	AX360266	15.7
AX201535	16.9	AX300010	15.23	AX330059	15.41	AX350052	15.39	AX360267	15.7
AX201536	16.9	AX300011	15.23	AX330060	15.41	AX350053	15.39	AX360268	15.7
AX201537	16.9	AX300012	15.23	AX350001	15.40	AX350054	15.39	AX360269	15.7
AX201538	16.9	AX300013	15.23	AX350002	15.40	AX350055	15.39	AX360270	15.7
AX201539	16.9	AX300014	15.23	AX350003	15.40	AX350056	15.39	AX360271	15.7
AX201540	16.9	AX300015	15.23	AX350004	15.40	AX350057	15.39	AX360272	15.7
AX201541	16.9	AX300017	15.23	AX350005	15.40	AX350058	15.39	AX380014	15.39
AX201542	16.9	AX300021	15.23	AX350006	15.40	AX350059	15.39	AX380015	15.39
AX201543	16.9	AX300025	15.23	AX350007	15.40	AX350060	15.39	AX380016	15.39
AX201544	16.9	AX300026	15.23	AX350008	15.40	AX350061	15.39	AX380017	15.39
AX250001	16.8	AX300027	15.23	AX350009	15.40	AX350062	15.39	AX380018	15.39
AX250005	16.8	AX300029	15.23	AX350010	15.40	AX350063	15.39	AX380026	15.39
AX250009	16.8	AX300030	15.23	AX350011	15.40	AX350064	15.39	AX380027	15.39
AX250011	16.8	AX300032	15.23	AX350012	15.40	AX350065	15.39	AX380028	15.39
AX250021	16.7	AX300034	15.23	AX350013	15.40	AX350066	15.39	AX380029	15.39
AX250052	16.8	AX300037	15.23	AX350014	15.40	AX350067	15.39	AX380030	15.39
AX250054	16.8	AX300038	15.23	AX350015	15.40	AX350068	15.39	AX380050	15.39
AX250060	16.7	AX300039	15.23	AX350016	15.40	AX350069	15.39	AX380051	15.39
AX250061	16.7	AX300040	15.23	AX350017	15.40	AX350070	15.39	AX380052	15.39
AX250065	16.7	AX330013	15.41	AX350018	15.40	AX350071	15.39	AX380053	15.39
AX250066	16.7	AX330014	15.41	AX350019	15.40	AX350072	15.39	AX380054	15.39
AX250067	16.7	AX330015	15.41	AX350020	15.40	AX350093	15.40	AX380056	15.39
AX250071	16.7	AX330016	15.41	AX350021	15.40	AX350149	15.40	AX380057	15.39
AX250072	16.7	AX330017	15.41	AX350022	15.40	AX350160	15.39	AX380058	15.39
AX250073	16.7	AX330018	15.41	AX350023	15.40	AX350161	15.39	AX380059	15.39
AX250105	16.7	AX330019	15.41	AX350024	15.40	AX350162	15.39	AX380060	15.39
AX250106	16.7	AX330020	15.41	AX350025	15.40	AX350163	15.39	B2418-TP-1-C	11.11
AX250178	16.8	AX330021	15.41	AX350026	15.40	AX360015	15.7	B2418-TP-2-C	11.11
AX250179	16.8	AX330022	15.41	AX350027	15.40	AX360016	15.7	B2418-TP-3-C	11.11
AX250180	16.8	AX330023	15.41	AX350028	15.40	AX360017	15.7	B2418-TP-4-C	11.11

## Index

## How to use this part number index

All part numbers are listed numerically, in three sections:

- Section 1: numerical only
- Section 2: numbers followed by letters
- Section 3: letters followed by numbers

Part No.	Page	Part No.	Page	Part No.	Page	Part No.	Page	Part No.	Page
B2430-TP-1-C	11.14, 11.17	B7824-VF-C	11.11	B9012-1918-16	11.20	B9610-2301	12.6	BE46205	19.18
B2430-TP-3-C	11.14, 11.17	B7824-VR-C	11.11	B9013-1930	11.20	B9611-2302	12.6	BE46207	19.18
B2430-TP-4-C	11.14, 11.17	B7829-FR-C	11.5, 11.8	B9013-1936	11.20	B9712-0100	11.24	BE46208	19.18
B2430-TP-6-C	11.14, 11.17	B7829-GF-C	11.5, 11.8	B9014-1907	11.20	B9712-0101	11.24	BE46266	19.18
B2918-TP-1-C	11.5, 11.8	B7829-PD-C	11.5, 11.8	B9015-1902	11.20	B9712-0102	11.24	BE46273	19.18
B2918-TP-2-C	11.5, 11.8	B7829-SF-C	11.5, 11.8	B9015-1909	11.20	B9712-0103	11.24	BE46305	19.12
B2918-TP-3-C	11.5, 11.8	B7829-SR-C	11.5, 11.8	B9015-1924	11.20	B9712-0106	11.24	BE46306	19.12
B2918-TP-4-C	11.5, 11.8	B7829-VF-C	11.5, 11.8	B9016-1921	11.20	B9712-0107	11.24	BE46312	19.12
B433-5114	11.17	B7829-VR-C	11.5, 11.8	B9016-1921-3	11.20	B9712-0108	11.24	BE46313	19.12
B433-5115-F	11.17	B7836-01-SP-C	11.14	B9017-0200	11.20	B9712-0109	11.24	BE46315	19.12
B433-5115-R	11.17	B7836-02-SP-C	11.14	B9110-2324	11.21	B9712-0109S	11.24	BE46349	19.9
B433-5118	11.17	B8401-SP-C	11.5, 11.8, 11.11	B9111-2318	11.21	B9713-0200	11.24	BE46379	19.20
B4801-SP-C	11.5, 11.11	B8402-SP-C	11.5, 11.8, 11.11	B9112-2318	11.21	B9713-0201	11.24	BE46380	19.20
B4802-SP-C	11.5, 11.11	B8424-DSPR-C	11.17	B9113-2324	11.21	B9713-0202	11.24	BE46381	19.20
B4824-FR-C	11.11	B8424-DSSR-C	11.17	B9114-2307	11.21	B9714-0190	11.22	BE46382	19.19
B4824-GF-C	11.11	B8424-DSVF-C	11.17	B9210-2923	11.21	B9714-0720	11.22	BE46923	19.17
B4824-PD-C	11.11	B8424-DSVR-C	11.17	B9211-2917	11.21	B9810-0100	12.6	BE46925	19.17
B4824-SF-C	11.11	B8424-FR-C	11.11	B9212-2922	11.21	B9811-0200	12.6	BE46935	19.17
B4824-SR-C	11.11	B8424-GF-C	11.11	B9309-0100	11.20	B9812-0300	12.6	BE46936	19.17
B4824-VF-C	11.11	B8424-PD-C	11.11	B9315-7200	11.14, 11.17	B9813-0400	12.6	BE46937	19.17
B4824-VR-C	11.11	B8424-SF-C	11.11	B9318-0200	11.27	B9910-0100	12.6	BE46938	19.17
B4829-FR-C	11.5	B8424-SPR-C	11.14	B9318-0300	11.27	B9911-0200	12.6	BE46948	19.12
B4829-GF-C	11.5	B8424-SR-C	11.11	B9318-0400	11.27	B9912-0300	12.6	BE46959	19.17
B4829-PD-C	11.5	B8424-SVF-C	11.14	B9411-1602	11.25	B9913-0400	12.6	BEB1212	18.7
B4829-SF-C	11.5	B8424-VF-C	11.11	B9412-0801	11.25	B9914-0200	12.6	BEB3212	18.7
B4829-SR-C	11.5	B8424-VR-C	11.11	B9413-0601	11.25	B9915-0300	12.6	BER-3UC	12.5
B4829-VF-C	11.5	B8429-FR-C	11.5, 11.8	B9414-0602	11.25	B9916-0400	12.6	BER-6UP	12.5
B4829-VR-C	11.5	B8429-GF-C	11.5, 11.8	B9415-1601	11.25	BCR-8419	12.4	BER-6X6	12.5
B7201-SP-C	11.5, 11.8, 11.11	B8429-PD-C	11.5, 11.8	B9415-1602	11.25	BCR-8419-10	12.4	BER-AS	12.5
B7202-SP-C	11.5, 11.8, 11.11	B8429-SF-C	11.5, 11.8	B9415-1603	11.25	BDP72	11.7	BFT-03SRW8	13.2
B7224-FR-C	11.11	B8429-SR-C	11.5, 11.8	B9415-1606	11.25	BDP7219-23	11.23	BFT-05SRW8	13.2
B7224-GF-C	11.11	B8429-VF-C	11.5, 11.8	B9415-1607	11.25	BDP7219-23SQ	11.23	BFT-09SRW8	13.2
B7224-PD-C	11.11	B8429-VR-C	11.5, 11.8	B9415-1608	11.25	BDP78	11.7	BFT-3T03W	13.3
B7224-SF-C	11.11	B8436-01-SP-C	11.14, 11.17	B9415-1610	11.25	BDP7819-23	11.23	BFT-3T05W	13.3
B7224-SR-C	11.11	B8436-01-SPP-C	11.17	B9416-1001	11.25	BDP8419-23	11.23	BFT-3T09W	13.3
B7224-VF-C	11.11	B8436-02-SP-C	11.14, 11.17	B9418-0801	11.26	BDP84	11.7	BFT-4T03W	13.3
B7224-VR-C	11.11	B8436-02-SPP-C	11.17	B9418-0802	11.26	BDP-ATD-0200-3	11.22	BFT-4T05W	13.3
B7229-FR-C	11.5, 11.8	B8910-0100	11.22	B9418-1201	11.26	BDR-4819	12.3	BFT-4T09W	13.3
B7229-GF-C	11.5, 11.8	B8911-0100	11.22	B9418-2401	11.26	BDR-7201	12.3	BFT-9003W	13.3
B7229-PD-C	11.5, 11.8	B8912-0100	12.3	B9418-2402	11.26	BDR-7219	12.3	BFT-9005W	13.3
B7229-SF-C	11.5, 11.8	B8912-0200-C	11.29	B9418-2403	11.26	BDR-7223	12.3	BFT-9009W	13.3
B7229-SR-C	11.5, 11.8	B8913-0100	11.22	B9418-2410	11.26	BDR-8401	12.3	BFT-CE03W	13.3
B7229-VF-C	11.5, 11.8	B8914-0100	11.22	B9418-4801	11.26	BDR-8403	12.3	BFT-CE05W	13.3
B7229-VR-C	11.5, 11.8	B8915-0100	11.22	B9418-7201	11.26	BDR-8419	12.3	BFT-CE09W	13.3
B7801-SP-C	11.5, 11.8, 11.11	B9010-1924	11.20	B9420-1905	11.24	BDR-8419-4	12.3	BFT-EC03W	13.3
B7802-SP-C	11.5, 11.8, 11.11	B9010-1924-Q	11.20	B9420-1906	11.24	BDR-8423	12.3	BFT-EC05W	13.3
B7824-FR-C	11.11	B9010-1930	11.20	B9510-1901	12.6	BE43187	19.28	BFT-EC09W	13.3
B7824-GF-C	11.11	B9010-1930-Q	11.20	B9511-1902	12.6	BE43906	19.21	BFT-F003W	13.3
B7824-PD-C	11.11	B9010-1936	11.20	B9512-1901	12.6	BE43907	19.20	BFT-F005W	13.3
B7824-SF-C	11.11	B9011-1912	11.20	B9512-1902	12.6	BE43908	19.19	BFT-F009W	13.3
B7824-SPR-C	11.14	B9011-1918	11.20	B9512-1902-FR	12.6	BE46202	19.18	BFT-IN03W	13.3
B7824-SR-C	11.11	B9011-1918-16	11.20	B9513-1902	12.6	BE46203	19.18	BFT-IN05W	13.3
B7824-SVF-C	11.14	B9012-1918	11.20	B9514-1901	12.6	BE46204	19.18	BFT-IN09W	13.3

## Index

## How to use this part number index

All part numbers are listed numerically, in three sections:

- Section 1: numerical only
- Section 2: numbers followed by letters
- Section 3: letters followed by numbers

Part No.	Page	Part No.	Page	Part No.	Page	Part No.	Page	Part No.	Page
BFT-0C03W	13.3	BWM-3601	11.29	CTI5P40BW	12.8	GED	16.56	H125A03	9.22
BFT-0C05W	13.3	BWM-3606-GD-C	11.28	CTI5P40N	12.8	GER	16.54	H125A04	9.22
BFT-0C09W	13.3	BWM-3606-SD-C	11.28	CTI11P40BW	12.8	GEW	16.58	H125A06	9.22
BFT-SC03W	13.3	BWM-3619	11.29	CTI11P40N	12.8	GIBK	16.28	H125A07	9.21
BFT-SC05W	13.3	BWM-3620-GD-C	11.28	CTI14P40BW	12.8	GIBT	16.28	H125A08	9.21
BFT-SC09W	13.3	BWM-3620-SD-C	11.28	CTI14P40N	12.8	GIMK	16.29	H125C00	9.21
BGS84	11.19	BWM-3624-GD-C	11.28	CTI6040NM	12.9	GIMT	16.29	H125C01	9.20
BRL-3006-0300	11.23	BWM-3624-SD-C	11.28	CTI8040BW	12.8	GIOK	16.25	H125C03	9.21
BRL-3012-0200	11.23	BWM-4801	11.29	CTI8040N	12.8	GIPK	16.26	H125C04	9.21
BRL-3024-0100	11.23	BWM-4806-GD-C	11.28	CTM4P18NMK	12.9	GIPS	16.25, 16.26, 16.32	H125D00	9.23
BSL/BST-ATD-0300-3	11.22	BWM-4806-SD-C	11.28	CTM5P18N	12.8	GIPT	16.27	H126A00	9.19
BSL48	11.10	BWM-4819	11.29	CTM4018N	12.8	GMMT	16.32, 18.36, 19.8	H126A02	9.20
BSL72	11.10	BWM-4820-GD-C	11.28	CTM4018NMK	12.9	GOCB	16.36	H126A03	9.20
BSL7219	11.23	BWM-4820-SD-C	11.28	CTM5018NMK	12.9	GODA	16.36	H126D00	9.19
BSL7219SQ-2	11.23	BWM-4824-GD-C	11.28	CTM8018N	12.8	GODB	16.36	H126D02	9.19
BSL78	11.10	BWM-4824-SD-C	11.28	CTM8018NMK	12.9	GOFB	16.35	H126D03	9.19
BSL7819	11.23	BWM-4830-SD-3S0001	11.28	CTS10P50NMK	12.9	GORA	16.34	H126D04	9.19
BSL8419	11.23	BWM-9312-1600	11.29	CTS11P50NM	12.9	GORB	16.34	H155A00	9.31
BSL84	11.10	BWR-1219	12.5	CTS14P50N	12.8	GOSA	16.33	H155A01	9.31
BSR-8419-24	12.4	BWR-3619-12	12.5	CTS14P50BW	12.8	GOSB	16.33	H500C00	9.30
BSR-8419-28	12.4	BWR-3619-18	12.5	CTS14P50NM	12.9	GOWA	18.36	H1000C0	9.30
BSR-8419-32	12.4	BWR-4819	12.5	CTS17P50BW	12.8	GOWB	16.35, 18.36	H1000C1	9.30
BSR-8419-36	12.4	BWR-4819-12	12.5	CTS17P50N	12.8	GUCB	16.39	H1000C3	9.30
BSR-8423-24	12.4	BWR-4819-18	12.5	CTS1150BW	12.8	GUDA	16.39	H1001C1	9.30
BSR-8423-28	12.4			CTS1150N	12.8	GUDB	16.39	HCCT	8.4, 21.14
BSR-8423-32	12.4			CTS8050BW	12.8	GUMT	16.30	HCST	8.4, 21.14
BSR-8423-36	12.4	C0039222	15.20	CTS8050N	12.8	GURA	16.38	HMC0001	4.15
BST4819-23	11.23	C0054642	15.20	CTS8050NMK	12.9	GURB	16.38	HMC0002	4.15
BST7219-23	11.23	CA00100	8.3	CX3C0	9.9	GUSA	16.37	HMC0003	4.15
BST7819-23	11.23	CA00101	8.3	CX3C1	9.9	GUSB	16.37	HMC0004	4.15
BST8419-23	11.23	CA00102	8.3	CX3C2	9.9	GUWA	18.36	HMC0005	4.15
BST8419-23SQ	11.23	CA00150	8.4	CX3C3	9.9	GUWB	16.40, 18.36	HMC0006	4.15
BST84-3-100000	11.4	CA00151	8.4	CX4C0	9.11	GUXT	16.31	HMC0007	4.15
BST84-3-122226	11.4	CA00200	8.5	CX4C1	9.11	H106T00	9.26	HMC0008	4.15
BST-ATD-0030-3	11.22	CA00201	8.5	CX4C2	9.11	H106T01	9.26	HMC0009	4.15
BSW-0100	11.29	CA00202	8.5	CX4C3	9.11	H109A00	20.34	HMC0010	4.15
BSW-0200	11.29	CA00250	8.6	E1005460	15.25	H109C00	9.20	HMC0011	4.15
BSW-8419	11.29	CA00270	8.6	GAAD	16.50	H109C02	9.20	HMC0012	4.15
BUS48	11.13	CT100C0	9.23	GALD	16.49	H121A00	9.24, 20.34	HMC0013	4.15
BUS72	11.13	CT100C1	9.23	GALH	16.49	H121A01	9.24	HMC0014	4.15
BUS78	11.13	CT100C3	9.23	GBA	16.41	H121A02	9.25	HMC0015	4.15
BUS84	11.13	CT125C0	9.16	GBD	16.45	H121A03	9.24	HMC0016	4.16
BUS-ATD-0010-C	11.22	CT125C1	9.16	GBR	16.43	H121A04	9.24	HMC0017	4.16
BUSD84	11.16	CT125C3	9.16	GBW	16.47	H121C00	9.24	HMC0018	4.16
BWAP-200	10.6	CT167C0	9.12	GCA	16.51	H122A00	9.25	HMC0019	4.16
BWM-2401	11.29	CT167C1	9.12	GCD	16.55	H123A00	9.25	HMC0020	4.16
BWM-2406-GD-C	11.28	CT167C2	9.12	GCR	16.53	H123A01	9.25	HMC0021	4.16
BWM-2406-SD-C	11.28	CT167C3	9.12	GCW	16.57	H123A02	9.25	HMC0022	4.16
BWM-2419	11.29	CTH17P175N	12.9	GDA	16.42	H124A00	9.23	HMC0023	4.16
BWM-2420-GD-C	11.28	CTH21P175N	12.9	GDD	16.46	H125A00	20.34	HMC0024	4.16
BWM-2420-SD-C	11.28	CTH36P175N	12.9	GDR	16.44	H125A00	9.22	HMC0025	4.16
BWM-2424-GD-C	11.28	CTH48P175N	12.9	GDW	16.48	H125A01	9.22	HMC0026	4.16
BWM-2424-SD-C	11.28	CTH15120N	12.8	GEA	16.52	H125A02	9.22	HMC0027	4.16

## Index

## How to use this part number index

All part numbers are listed numerically, in three sections:

- Section 1: numerical only
- Section 2: numbers followed by letters
- Section 3: letters followed by numbers

Part No.	Page	Part No.	Page	Part No.	Page	Part No.	Page	Part No.	Page
HMC0028	4.16	HMC0081	4.18	HMC0134	4.21	HMC0187	4.23	HMC0240	4.25
HMC0029	4.16	HMC0082	4.18	HMC0135	4.21	HMC0188	4.23	HMC0241	4.25
HMC0030	4.16	HMC0083	4.18	HMC0136	4.21	HMC0189	4.23	HMC0242	4.25
HMC0031	4.16	HMC0084	4.18	HMC0137	4.21	HMC0190	4.24	HMC0243	4.25
HMC0032	4.16	HMC0085	4.18	HMC0138	4.21	HMC0191	4.24	HMC0244	4.26
HMC0033	4.16	HMC0086	4.19	HMC0139	4.21	HMC0192	4.24	HMC0245	4.26
HMC0034	4.16	HMC0087	4.19	HMC0140	4.21	HMC0193	4.24	HMC0246	4.26
HMC0035	4.16	HMC0088	4.19	HMC0141	4.21	HMC0194	4.24	HMC0247	4.26
HMC0036	4.16	HMC0089	4.19	HMC0142	4.21	HMC0195	4.24	HMC0248	4.26
HMC0037	4.16	HMC0090	4.19	HMC0143	4.21	HMC0196	4.24	HMC0249	4.26
HMC0038	4.16	HMC0091	4.19	HMC0144	4.21	HMC0197	4.24	HMC0250	4.26
HMC0039	4.16	HMC0092	4.19	HMC0145	4.21	HMC0198	4.24	HMC0251	4.26
HMC0040	4.17	HMC0093	4.19	HMC0146	4.21	HMC0199	4.24	HMC0252	4.26
HMC0041	4.17	HMC0094	4.19	HMC0147	4.21	HMC0200	4.24	HMC0253	4.26
HMC0042	4.17	HMC0095	4.19	HMC0148	4.21	HMC0201	4.24	HMC0254	4.26
HMC0043	4.17	HMC0096	4.19	HMC0149	4.22	HMC0202	4.24	HMC0255	4.26
HMC0044	4.17	HMC0097	4.19	HMC0150	4.22	HMC0203	4.24	HMC0256	4.26
HMC0045	4.17	HMC0098	4.19	HMC0151	4.22	HMC0204	4.24	HMC0257	4.26
HMC0046	4.17	HMC0099	4.19	HMC0152	4.22	HMC0205	4.24	HMC0258	4.26
HMC0047	4.17	HMC0100	4.20	HMC0153	4.22	HMC0206	4.24	HMC0259	4.26
HMC0048	4.17	HMC0101	4.20	HMC0154	4.22	HMC0207	4.24	HMC0260	4.26
HMC0049	4.17	HMC0102	4.20	HMC0155	4.22	HMC0208	4.24	HMC0261	4.26
HMC0050	4.17	HMC0103	4.20	HMC0156	4.22	HMC0209	4.24	HMC0262	4.26
HMC0051	4.17	HMC0104	4.20	HMC0157	4.22	HMC0210	4.24	HMC0263	4.27
HMC0052	4.17	HMC0105	4.20	HMC0158	4.22	HMC0211	4.24	HMC0264	4.27
HMC0053	4.17	HMC0106	4.20	HMC0159	4.22	HMC0212	4.24	HMC0265	4.27
HMC0054	4.17	HMC0107	4.20	HMC0160	4.22	HMC0213	4.24	HMC0266	4.27
HMC0055	4.17	HMC0108	4.20	HMC0161	4.22	HMC0214	4.24	HMC0267	4.27
HMC0056	4.18	HMC0109	4.20	HMC0162	4.22	HMC0215	4.25	HMC0268	4.27
HMC0057	4.18	HMC0110	4.20	HMC0163	4.22	HMC0216	4.25	HMC0269	4.27
HMC0058	4.18	HMC0111	4.20	HMC0164	4.22	HMC0217	4.25	HMC0270	4.27
HMC0059	4.18	HMC0112	4.20	HMC0165	4.22	HMC0218	4.25	HMC0271	4.27
HMC0060	4.18	HMC0113	4.20	HMC0166	4.22	HMC0219	4.25	HMC0272	4.27
HMC0061	4.18	HMC0114	4.20	HMC0167	4.22	HMC0220	4.25	HMC0273	4.27
HMC0062	4.18	HMC0115	4.20	HMC0168	4.22	HMC0221	4.25	HMC0274	4.27
HMC0063	4.18	HMC0116	4.20	HMC0169	4.22	HMC0222	4.25	HMC0275	4.27
HMC0064	4.18	HMC0117	4.20	HMC0170	4.22	HMC0223	4.25	HMC0276	4.27
HMC0065	4.18	HMC0118	4.20	HMC0171	4.22	HMC0224	4.25	HMC0277	4.27
HMC0066	4.18	HMC0119	4.20	HMC0172	4.22	HMC0225	4.25	HMC0278	4.27
HMC0067	4.18	HMC0120	4.21	HMC0173	4.22	HMC0226	4.25	HMC0279	4.27
HMC0068	4.18	HMC0121	4.21	HMC0174	4.22	HMC0227	4.25	HMC0280	4.27
HMC0069	4.18	HMC0122	4.21	HMC0175	4.22	HMC0228	4.25	HMC0281	4.27
HMC0070	4.18	HMC0123	4.21	HMC0176	4.22	HMC0229	4.25	HMC0282	4.27
HMC0071	4.18	HMC0124	4.21	HMC0177	4.22	HMC0230	4.25	HMC0283	4.27
HMC0072	4.18	HMC0125	4.21	HMC0178	4.23	HMC0231	4.25	HMC0284	4.27
HMC0073	4.18	HMC0126	4.21	HMC0179	4.23	HMC0232	4.25	HMC0285	4.27
HMC0074	4.18	HMC0127	4.21	HMC0180	4.23	HMC0233	4.25	HMC0286	4.27
HMC0075	4.18	HMC0128	4.21	HMC0181	4.23	HMC0234	4.25	HMC0287	4.27
HMC0076	4.18	HMC0129	4.21	HMC0182	4.23	HMC0235	4.25	HMC0288	4.27
HMC0077	4.18	HMC0130	4.21	HMC0183	4.23	HMC0236	4.25	HMC0289	4.27
HMC0078	4.18	HMC0131	4.21	HMC0184	4.23	HMC0237	4.25	HMC0290	4.27
HMC0079	4.18	HMC0132	4.21	HMC0185	4.23	HMC0238	4.25	HMC0291	4.27
HMC0080	4.18	HMC0133	4.21	HMC0186	4.23	HMC0239	4.25	HMC0292	4.27



## Index

## How to use this part number index

All part numbers are listed numerically, in three sections:

- Section 1: numerical only
- Section 2: numbers followed by letters
- Section 3: letters followed by numbers

Part No.	Page	Part No.	Page	Part No.	Page	Part No.	Page	Part No.	Page
HMC0293	4.27	HMC0346	4.30	HMC0399	4.32	HMC0454	4.35	HMC0510	4.37
HMC0294	4.28	HMC0347	4.30	HMC0400	4.32	HMC0455	4.35	HMC0511	4.37
HMC0295	4.28	HMC0348	4.30	HMC0401	4.32	HMC0456	4.35	HMC0512	4.37
HMC0296	4.28	HMC0349	4.30	HMC0402	4.32	HMC0457	4.35	HMC0513	4.37
HMC0297	4.28	HMC0350	4.30	HMC0403	4.33	HMC0458	4.35	HMC0514	4.37
HMC0298	4.28	HMC0351	4.30	HMC0404	4.33	HMC0459	4.35	HMC0515	4.37
HMC0299	4.28	HMC0352	4.30	HMC0405	4.33	HMC0461	4.35	HMC0516	4.37
HMC0300	4.28	HMC0353	4.30	HMC0406	4.33	HMC0462	4.35	HMC0517	4.37
HMC0301	4.28	HMC0354	4.30	HMC0407	4.33	HMC0463	4.35	HMC0518	4.38
HMC0302	4.28	HMC0355	4.31	HMC0408	4.33	HMC0464	4.35	HMC0519	4.38
HMC0303	4.28	HMC0356	4.31	HMC0409	4.33	HMC0465	4.35	HMC0520	4.38
HMC0304	4.28	HMC0357	4.31	HMC0410	4.33	HMC0466	4.35	HMC0521	4.38
HMC0305	4.28	HMC0358	4.31	HMC0411	4.33	HMC0467	4.35	HMC0522	4.38
HMC0306	4.28	HMC0359	4.31	HMC0412	4.33	HMC0468	4.35	HMC0523	4.38
HMC0307	4.28	HMC0360	4.31	HMC0413	4.33	HMC0469	4.35	HMC0524	4.38
HMC0308	4.28	HMC0361	4.31	HMC0414	4.33	HMC0471	4.35	HMC0525	4.38
HMC0309	4.28	HMC0362	4.31	HMC0415	4.33	HMC0472	4.35	HMC0526	4.38
HMC0310	4.28	HMC0363	4.31	HMC0416	4.33	HMC0473	4.35	HMC0527	4.38
HMC0311	4.29	HMC0364	4.31	HMC0417	4.33	HMC0474	4.35	HMC0528	4.38
HMC0312	4.29	HMC0365	4.31	HMC0418	4.33	HMC0475	4.35	HMC0529	4.38
HMC0313	4.29	HMC0366	4.31	HMC0419	4.33	HMC0476	4.35	HMC0530	4.38
HMC0314	4.29	HMC0367	4.31	HMC0420	4.33	HMC0477	4.35	HMC0630	5.26
HMC0315	4.29	HMC0368	4.31	HMC0421	4.33	HMC0479	4.36	HMC0631	5.26
HMC0316	4.29	HMC0369	4.31	HMC0422	4.33	HMC0480	4.36	HMC0632	5.26
HMC0317	4.29	HMC0370	4.31	HMC0423	4.34	HMC0481	4.36	HMC0633	5.26
HMC0318	4.29	HMC0371	4.31	HMC0424	4.34	HMC0482	4.36	HMC0634	5.26
HMC0319	4.29	HMC0372	4.31	HMC0425	4.34	HMC0483	4.36	HMC0635	5.26
HMC0320	4.29	HMC0373	4.31	HMC0426	4.34	HMC0484	4.36	HMC0636	5.26
HMC0321	4.29	HMC0374	4.31	HMC0427	4.34	HMC0485	4.36	HMC0637	5.26
HMC0322	4.29	HMC0375	4.31	HMC0428	4.34	HMC0486	4.37	HMC0638	5.26
HMC0323	4.29	HMC0376	4.31	HMC0429	4.34	HMC0487	4.37	HMC0639	5.26
HMC0324	4.29	HMC0377	4.31	HMC0430	4.34	HMC0488	4.37	HMC0640	5.26
HMC0325	4.29	HMC0378	4.31	HMC0431	4.34	HMC0489	4.37	HMC4000	3.4
HMC0326	4.29	HMC0379	4.32	HMC0432	4.34	HMC0490	4.37	HMC4001	3.4
HMC0327	4.29	HMC0380	4.32	HMC0433	4.34	HMC0491	4.37	HMC4002	3.4
HMC0328	4.29	HMC0381	4.32	HMC0434	4.34	HMC0492	4.37	HMC4003	3.4
HMC0329	4.29	HMC0382	4.32	HMC0435	4.34	HMC0493	4.37	HMC4004	3.4
HMC0330	4.29	HMC0383	4.32	HMC0436	4.34	HMC0494	4.37	HMC4005	3.4
HMC0331	4.30	HMC0384	4.32	HMC0437	4.34	HMC0495	4.37	HMC4006	3.4
HMC0332	4.30	HMC0385	4.32	HMC0438	4.34	HMC0496	4.37	HMC4007	3.4
HMC0333	4.30	HMC0386	4.32	HMC0439	4.34	HMC0497	4.37	HMC4008	3.4
HMC0334	4.30	HMC0387	4.32	HMC0440	4.34	HMC0498	4.37	HMC4009	3.4
HMC0335	4.30	HMC0388	4.32	HMC0441	4.34	HMC0499	4.37	HMC4010	3.4
HMC0336	4.30	HMC0389	4.32	HMC0442	4.34	HMC0500	4.37	HMC4011	3.4
HMC0337	4.30	HMC0390	4.32	HMC0444	4.35	HMC0501	4.37	HMC4012	3.4
HMC0338	4.30	HMC0391	4.32	HMC0445	4.35	HMC0502	4.37	HMC4013	3.4
HMC0339	4.30	HMC0392	4.32	HMC0446	4.35	HMC0503	4.37	HMC4014	3.4
HMC0340	4.30	HMC0393	4.32	HMC0447	4.35	HMC0504	4.37	HMC4015	3.5
HMC0341	4.30	HMC0394	4.32	HMC0448	4.35	HMC0505	4.37	HMC4016	3.5
HMC0342	4.30	HMC0395	4.32	HMC0449	4.35	HMC0506	4.37	HMC4017	3.5
HMC0343	4.30	HMC0396	4.32	HMC0451	4.35	HMC0507	4.37	HMC4018	3.5
HMC0344	4.30	HMC0397	4.32	HMC0452	4.35	HMC0508	4.37	HMC4019	3.5
HMC0345	4.30	HMC0398	4.32	HMC0453	4.35	HMC0509	4.37	HMC4020	3.5

# Index

## How to use this part number index

All part numbers are listed numerically, in three sections:

- Section 1: numerical only
- Section 2: numbers followed by letters
- Section 3: letters followed by numbers

Part No.	Page	Part No.	Page	Part No.	Page	Part No.	Page	Part No.	Page
HMC4021	3.5	HMC4074	3.9	HMC4127	3.12	HMC4180	3.14	HMC4233	3.18
HMC4022	3.5	HMC4075	3.9	HMC4128	3.12	HMC4181	3.14	HMC4234	3.18
HMC4023	3.5	HMC4076	3.9	HMC4129	3.12	HMC4182	3.15	HMC4235	3.18
HMC4024	3.5	HMC4077	3.9	HMC4130	3.12	HMC4183	3.15	HMC4236	3.18
HMC4025	3.5	HMC4078	3.9	HMC4131	3.12	HMC4184	3.15	HMC4237	3.18
HMC4026	3.5	HMC4079	3.9	HMC4132	3.12	HMC4185	3.15	HMC4238	3.18
HMC4027	3.5	HMC4080	3.9	HMC4133	3.12	HMC4186	3.15	HMC4239	3.18
HMC4028	3.5	HMC4081	3.9	HMC4134	3.12	HMC4187	3.15	HMC4240	3.18
HMC4029	3.5	HMC4082	3.9	HMC4135	3.12	HMC4188	3.15	HMC4241	3.18
HMC4030	3.5	HMC4083	3.9	HMC4136	3.12	HMC4189	3.15	HMC4242	3.18
HMC4031	3.5	HMC4084	3.9	HMC4137	3.12	HMC4190	3.15	HMC4243	3.19
HMC4032	3.6	HMC4085	3.9	HMC4138	3.12	HMC4191	3.15	HMC4244	3.19
HMC4033	3.6	HMC4086	3.9	HMC4139	3.12	HMC4192	3.15	HMC4245	3.19
HMC4034	3.6	HMC4087	3.9	HMC4140	3.12	HMC4193	3.15	HMC4246	3.19
HMC4035	3.6	HMC4088	3.9	HMC4141	3.13	HMC4194	3.15	HMC4247	3.19
HMC4036	3.6	HMC4089	3.10	HMC4142	3.13	HMC4195	3.15	HMC4248	3.19
HMC4037	3.6	HMC4090	3.10	HMC4143	3.13	HMC4196	3.15	HMC4249	3.19
HMC4038	3.6	HMC4091	3.10	HMC4144	3.13	HMC4197	3.15	HMC4250	3.19
HMC4039	3.6	HMC4092	3.10	HMC4145	3.13	HMC4198	3.16	HMC4251	3.19
HMC4040	3.6	HMC4093	3.10	HMC4146	3.13	HMC4199	3.16	HMC4252	3.19
HMC4041	3.6	HMC4094	3.10	HMC4147	3.13	HMC4200	3.16	HMC4253	3.19
HMC4042	3.7	HMC4095	3.10	HMC4148	3.13	HMC4201	3.16	HMC4254	3.19
HMC4043	3.7	HMC4096	3.10	HMC4149	3.13	HMC4202	3.16	HMC4255	3.20
HMC4044	3.7	HMC4097	3.10	HMC4150	3.13	HMC4203	3.16	HMC4256	3.20
HMC4045	3.7	HMC4098	3.10	HMC4151	3.13	HMC4204	3.16	HMC4257	3.20
HMC4046	3.7	HMC4099	3.10	HMC4152	3.13	HMC4205	3.16	HMC4258	3.20
HMC4047	3.7	HMC4100	3.10	HMC4153	3.13	HMC4206	3.16	HMC4259	3.20
HMC4048	3.7	HMC4101	3.10	HMC4154	3.13	HMC4207	3.16	HMC4260	3.20
HMC4049	3.7	HMC4102	3.10	HMC4155	3.13	HMC4208	3.16	HMC4261	3.20
HMC4050	3.7	HMC4103	3.10	HMC4156	3.13	HMC4209	3.16	HMC4262	3.20
HMC4051	3.7	HMC4104	3.10	HMC4157	3.13	HMC4210	3.16	HMC4263	3.20
HMC4052	3.8	HMC4105	3.11	HMC4158	3.13	HMC4211	3.16	HMC4264	3.20
HMC4053	3.8	HMC4106	3.11	HMC4159	3.13	HMC4212	3.16	HMC4265	3.20
HMC4054	3.8	HMC4107	3.11	HMC4160	3.13	HMC4213	3.16	HMC4266	3.20
HMC4055	3.8	HMC4108	3.11	HMC4161	3.13	HMC4214	3.16	HMC4267	3.20
HMC4056	3.8	HMC4109	3.11	HMC4162	3.13	HMC4215	3.16	HMC4268	3.20
HMC4057	3.8	HMC4110	3.11	HMC4163	3.13	HMC4216	3.16	HMC4269	3.20
HMC4058	3.8	HMC4111	3.11	HMC4164	3.13	HMC4217	3.16	HMC4270	3.20
HMC4059	3.8	HMC4112	3.11	HMC4165	3.13	HMC4218	3.16	HMC4271	3.20
HMC4060	3.8	HMC4113	3.11	HMC4166	3.14	HMC4219	3.16	HMC4272	3.20
HMC4061	3.8	HMC4114	3.11	HMC4167	3.14	HMC4220	3.16	HMC4273	3.20
HMC4062	3.8	HMC4115	3.11	HMC4168	3.14	HMC4221	3.16	HMC4274	3.20
HMC4063	3.8	HMC4116	3.11	HMC4169	3.14	HMC4222	3.16	HMC4275	3.20
HMC4064	3.8	HMC4117	3.11	HMC4170	3.14	HMC4223	3.17	HMC4276	3.20
HMC4065	3.8	HMC4118	3.11	HMC4171	3.14	HMC4224	3.17	HMC4277	3.20
HMC4066	3.8	HMC4119	3.11	HMC4172	3.14	HMC4225	3.17	HMC4278	3.20
HMC4067	3.8	HMC4120	3.11	HMC4173	3.14	HMC4226	3.17	HMC4279	3.20
HMC4068	3.9	HMC4121	3.11	HMC4174	3.14	HMC4227	3.17	HMC4280	3.21
HMC4069	3.9	HMC4122	3.11	HMC4175	3.14	HMC4228	3.17	HMC4281	3.21
HMC4070	3.9	HMC4123	3.11	HMC4176	3.14	HMC4229	3.17	HMC4282	3.21
HMC4071	3.9	HMC4124	3.12	HMC4177	3.14	HMC4230	3.17	HMC4283	3.21
HMC4072	3.9	HMC4125	3.12	HMC4178	3.14	HMC4231	3.17	HMC4284	3.21
HMC4073	3.9	HMC4126	3.12	HMC4179	3.14	HMC4232	3.17	HMC4285	3.21

## Index

## How to use this part number index

All part numbers are listed numerically, in three sections:

- Section 1: numerical only
- Section 2: numbers followed by letters
- Section 3: letters followed by numbers

Part No.	Page	Part No.	Page	Part No.	Page	Part No.	Page	Part No.	Page
HMC4286	3.21	MRG178	6.3	SEC0010	20.18	SHO 0013	7.8	SHO 0066	7.11
HMC4287	3.21	MRG179	6.5	SEC0011	20.18	SHO 0014	7.8	SHO 0067	7.11
HMC4288	3.21	MRG180	6.6	SEC0012	20.18	SHO 0015	7.8	SHO 0068	7.11
HMC4289	3.21	MRG187	6.5	SEC0013	20.18	SHO 0016	7.8	SHO 0069	7.11
HMC4290	3.21	MRG188	6.3	SEC0014	20.18	SHO 0017	7.8	SHO 0070	7.11
HMC4291	3.21	MRG195	6.6	SEC0015	20.18	SHO 0018	7.8	SHO 0071	7.11
HMC4292	3.21	MRG196	6.3	SEC0016	20.18	SHO 0019	7.8	SHO 0072	7.11
HMC4293	3.21	MRG2130	9.31	SEC0017	20.18	SHO 0020	7.8	SHO 0073	7.11
HMC4294	3.21	MRG225	6.4	SEC0018	20.18	SHO 0021	7.8	SHO 0074	7.11
HMC4295	3.21	MRG302	6.5	SEC0019	20.18	SHO 0022	7.8	SHO 0075	7.11
HMC4296	3.21	MRG303	6.3	SEC0020	20.18	SHO 0023	7.8	SHO 0076	7.11
HMC4297	3.21	MRG304	6.4	SEC0021	20.18	SHO 0024	7.8	SHO 0077	7.11
HMC4298	3.21	MRG316	6.3	SEC0022	20.18	SHO 0025	7.8	SHO 0078	7.11
HMC4299	3.21	MRG5800	9.31	SEC0023	20.18	SHO 0026	7.8	SHO 0079	7.11
HMC4300	3.22	MRG5900	9.26	SEC0024	20.18	SHO 0027	7.8	SHO 0080	7.11
HMC4301	3.22	MX100154	16.8	SEC0025	20.18	SHO 0028	7.9	SHO 0081	7.11
HMC4302	3.22	NN00043	15.20	SEC0026	20.18	SHO 0029	7.9	SHO 0082	7.11
HMC4303	3.22	NN00097	15.59	SEC0027	20.19	SHO 0030	7.9	SHO 0083	7.11
HMC4304	3.22	NN00099	15.59	SEC0028	20.19	SHO 0031	7.9	SHO 0084	7.11
HMC4305	3.22	NN00101	15.59	SEC0029	20.19	SHO 0032	7.9	SHO 0085	7.11
HMC4306	3.22	NOT0651	16.4	SEC0030	20.19	SHO 0033	7.9	SHO 0086	7.11
HMC4307	3.22	PO596540	15.18	SEC0031	20.19	SHO 0034	7.9	SHO 0087	7.11
HMC4308	3.22	PO660798	15.20	SEC0032	20.19	SHO 0035	7.9	SHO 0088	7.13
HMC4309	3.22	PRG7A00	9.17	SEC0033	20.19	SHO 0036	7.9	SHO 0089	7.13
HMC4310	3.22	PRG7A01	9.17	SEC0034	20.19	SHO 0037	7.9	SHO 0090	7.13
HMC4311	3.22	PRG7C00	9.17	SEC0035	20.19	SHO 0038	7.9	SHO 0091	7.13
HMC4312	3.22	PRG7C01	9.17	SEC0036	20.19	SHO 0039	7.9	SHO 0092	7.13
HMC4313	3.22	PRG11A2	9.14	SEC0037	20.19	SHO 0040	7.9	SHO 0093	7.13
HMC4314	3.22	PRG11A3	9.14	SEC0038	20.19	SHO 0041	7.9	SHO 0094	7.13
HMC4315	3.23	PRG11C0	9.13	SEC0039	20.19	SHO 0042	7.9	SHO 0095	7.13
HMC4316	3.23	PRG11C2	9.14	SEC0040	20.19	SHO 0043	7.9	SHO 0096	7.13
HMC4317	3.23	PRG11C4	9.14	SEC0041	20.19	SHO 0044	7.9	SHO 0097	7.13
HMC4318	3.23	PRG11C6	9.13	SEC0042	20.19	SHO 0045	7.9	SHO 0098	7.12
HMC4319	3.23	PRG11D0	9.15	SEC0043	20.19	SHO 0046	7.9	SHO 0099	7.12
HMC4320	3.23	PRG11D1	9.15	SEC0044	20.19	SHO 0047	7.9	SHO 0100	7.12
HMC4321	3.23	PRG11D3	9.15	SEC0045	20.19	SHO 0048	7.9	SHO 0101	7.12
HMC4322	3.23	PX101317	16.4	SEC0046	20.19	SHO 0049	7.9	SHO 0102	7.12
HMC4323	3.23	PX101318	16.4	SEC0047	20.25	SHO 0050	7.9	SHO 0103	7.12
HMC4324	3.23	RG6A00	9.18	SEC0048	20.25	SHO 0051	7.9	SHO 0104	7.12
HMC4325	3.23	RG6D00	9.18	SEC0049	20.25	SHO 0052	7.9	SHO 0105	7.12
HMC4326	3.23	RG6D01	9.18	SEC0050	20.25	SHO 0053	7.9	SHO 0106	7.12
HMC4327	3.23	RG7C00	9.17	SHO 0001	7.8	SHO 0054	7.9	SHO 0107	7.12
HMC4328	3.23	RG7C01	9.16	SHO 0002	7.8	SHO 0055	7.10	SHO 0108	7.12
HMC4329	3.23	RG7C02	9.16	SHO 0003	7.8	SHO 0056	7.10	SHO 0109	7.12
HMC4330	3.23	SEC0001	20.40	SHO 0004	7.8	SHO 0057	7.10	SHO 0110	7.12
M9	7.6, 16.59, 16.61	SEC0002	20.40	SHO 0005	7.8	SHO 0058	7.10	SHO 0111	7.12
M9A	7.6, 16.59, 16.61 – 16.64	SEC0003	20.40	SHO 0006	7.8	SHO 0059	7.10	SHO 0112	7.12
M9B	16.61 – 16.64	SEC0004	20.40	SHO 0007	7.8	SHO 0060	7.10	SHO 0113	7.12
M9C	7.6, 16.59, 16.61 – 16.64	SEC0005	20.43	SHO 0008	7.8	SHO 0061	7.10	SHO 0114	7.12
M9W	7.6, 16.59, 16.61 – 16.64	SEC0006	20.43	SHO 0009	7.8	SHO 0062	7.10	SHO 0115	7.12
MRG140	6.5	SEC0007	20.43	SHO 0010	7.8	SHO 0063	7.11	SHO 0116	7.12
MRG142	6.3	SEC0008	20.18	SHO 0011	7.8	SHO 0064	7.11	SHO 0117	7.12
MRG165	6.4	SEC0009	20.18	SHO 0012	7.8	SHO 0065	7.11	SHO 0119	7.13

## Index

### How to use this part number index

All part numbers are listed numerically, in three sections:

- Section 1: numerical only
- Section 2: numbers followed by letters
- Section 3: letters followed by numbers

Part No.	Page	Part No.	Page
SHO0120	7.13	NXC-RPFL-PGPNNN-JBPFBN-N-01.5	16.7
SHO0121	7.13	NXC-RPFL-PGPNNN-LCPFBN-N-01.5	16.7
SHO0122	7.13	NXC-RPFL-PGPNNN-SCPFBN-N-01.5	16.7
SHO0123	7.13	NXC-RPFL-PGPNNN-STPFBN-N-01.5	16.7
SHO0124	7.13	NXC-RPML-PGPNNN-JBPFBN-N-01.5	16.7
SHO0145	7.12	NXC-RPML-PGPNNN-LCPFBN-N-01.5	16.7
SHO0146	7.12	NXC-RPML-PGPNNN-SCPFBN-N-01.5	16.7
TM1	12.9	NXC-RPML-PGPNNN-STPFBN-N-01.5	16.7
TM2	12.9	NXC-RPML-PGPNNN-JBPFBN-N-01.5	16.7
TM4	12.9	NXC-RPML-PGPNNN-LCPFBN-N-01.5	16.7
TM100S4	12.9	NXC-RPML-PGPNNN-SCPFBN-N-01.5	16.7
TM101SS2	12.9	NXC-RPML-PGPNNN-STPFBN-N-01.5	16.7
TM102	12.9	NXC-RPML-PGPNNN-JBPFBN-N-01.5	16.7
X9905753	15.43	NXC-RPML-PGPNNN-LCPFBN-N-01.5	16.7
X9905754	15.43	NXC-RPML-PGPNNN-SCPFBN-N-01.5	16.7
X9908359	15.43	NXC-RPML-PGPNNN-STPFBN-N-01.5	16.7
YE00131	9.10	NXC-RPML-PGPNNN-JBPFBN-N-01.5	16.7
YE00132	9.10	NXC-RPML-PGPNNN-LCPFBN-N-01.5	16.7
YE00193	19.17	NXC-RPML-PGPNNN-SCPFBN-N-01.5	16.7
YE00820	21.8	NXC-RPML-PGPNNN-STPFBN-N-01.5	16.7
YE00906	21.8	NXC-RPML-PGPNNN-JBPFBN-N-01.5	16.7
YR48902	21.5	NXC-RPML-PGPNNN-LCPFBN-N-01.5	16.7

**Notes**

**EUROPE/MIDDLE EAST/AFRICA****The Netherlands  
Division Headquarters –  
Europe, Middle East, Africa**

Visiting address:  
Edisonstraat 9  
5928 PG Venlo  
The Netherlands

Postal address:  
P.O. Box 9  
5900 AA Venlo  
The Netherlands

**Phone: +31-77-3878-555**  
Fax: +31-77-3878-488  
venlo.salesinfo@belden.com

**France**

Immeuble le Cesar  
20, Place Louis Pradel  
69001 Lyon  
France  
**Phone: +33-472-109-990**  
Fax: +33-478-298-409  
lyon.salesinfo@belden.com

**Germany  
HEW-KABEL**

Gewerbegebiet Klingsiepen 12  
51688 Wipperfürth  
Germany  
**Phone: +49-2267-683-0**  
Fax: +49-2267-2203  
wipperfuert.sales@hew-kabel.com

**Italy**

Centro Direzionale Colleoni  
Palazzo Cassiopea Ingr 3  
Via Paracelso, 26  
20041 Agrate Brianza (MI)  
Italy  
**Phone: +39-039-656-0911**  
Fax: +39-039-656-0929  
milano.salesinfo@belden.com

**United Kingdom**

3000 Manchester Business Park  
Aviator Way  
Manchester M22 5TG  
United Kingdom  
**Phone: +44-161-266-1115**  
Fax: +44-161-266-1339  
manchester.salesinfo@belden.com

**Africa/Middle East**

Dubai Internet City  
Building One, Office 216  
P.O. Box 500158  
Dubai  
United Arab Emirates  
**Phone: +97-14-391-0490**  
Fax: +97-14-391-8775  
dubai.salesinfo@belden.com

**UNITED STATES****Division Headquarters –  
Americas**

2200 U.S. Highway 27 South  
Richmond, IN 47374  
United States  
**Phone: +1-765-983-5200**  
Toll-Free: +1-800-235-3361  
Fax: +1-765-983-5294  
info@belden.com  
web: www.belden.com

793 Fort Mill Highway  
Fort Mill, SC 29715  
United States  
**Phone: +1-803-802-1450**  
Fax: +1-803-802-1440  
info@belden.com

**CANADA**

**Cobourg**  
130 Willmott Street  
Cobourg, Ontario K9A 4M3  
Canada  
**Phone: +1-905-372-8713**  
Fax: +1-905-372-6291  
salescobourg@belden.com

**Montreal**

2345 Boulevard des Sources  
Pointe Claire, Quebec H9R 5Z3  
Canada  
**Phone: +1-800-681-6131**  
Fax: +1-514-822-7968  
ibdn.info@belden.com

**ASIA/PACIFIC****Australia**

Level 10  
369 Royal Parade  
Parkville, Victoria 3052  
Australia  
**Phone: +61-3-9341-0900**  
Fax: +61-3-9347-8274  
australia.sales@belden.com

**Beijing**

Rm 1015  
Office Tower Beijing Capital  
Times Square  
No. 88 West Changan Ave.  
Beijing 100031  
People's Republic of China  
**Phone: +86-10-8391-5181-3**  
Fax: +86-10-8391-5186  
hongkong.sales@belden.com

**Hong Kong**

Unit 4401, 44F  
Cosco Tower  
Grand Millennium Plaza  
183 Queen's Road Central  
Hong Kong  
**Phone: +852-2955-0128**  
Fax: +852-2907-6933  
hongkong.sales@belden.com

**India**

15th Floor, Tower B  
Unitech Cyberpark  
Sector 39, Gurgaon 122001  
Haryana, India  
**Phone: +91-124-4509999**  
Fax: +91-124-4509900  
india.sales@belden.com

**Malaysia**

Suite C315, 3<sup>rd</sup> Floor  
Central Tower  
Wisma Consplant 1  
No. 2, Jalan SS 16/4  
47500 Subang Jaya  
Selangor Darul Ehsan  
Malaysia  
**Phone: +603-5638-5897**  
Fax: +603-5637-8917  
malaysia.sales@belden.com

**Shanghai**

Unit 2605  
Harbour Ring Plaza  
18 Xi Zang Zhong Road  
Shanghai 200001  
People's Republic of China  
**Phone: +86-21-5385-3355**  
Fax: +86-21-6249-0879  
hongkong.sales@belden.com

**Singapore**

101 Thomson Road  
#21-01 United Square  
Singapore 307591  
**Phone: +65-6251-8211**  
Fax: +65-6251-5010  
singapore.sales@belden.com

**MEXICO/CARIBBEAN/SOUTH AMERICA****Regional Office**

6100 Hollywood Boulevard  
Suite 110  
Hollywood, Florida 33024  
United States  
**Phone: +1-954-987-5044**  
Fax: +1-954-987-8022  
salesla@belden.com

**Mexico**

Insurgentes Sur 800, Piso 9  
Colonia del Valle  
03100 Mexico, D.F.  
Mexico  
**Phone: +52-55-5523-7733**  
Fax: +52-55-5528-8077  
salesmex@belden.com

**South America**

Av. Rebouças, 1923 - 4. Andar  
05401-300 Sao Paulo, SP  
Brasil  
**Phone: +5511-3061-3099**  
Fax: +5511-3061-3752  
salesla@belden.com

**Belden Technical Support +31-77-3875-414 or techsupport.venlo@belden.com**