

Cables, Wires and Accessories for Industrial Applications



**Be certain.
Belden.**

**Signal Transmission Solutions
for Reliable, Mission-Critical
Applications**



Keep productivity high and downtime low with Belden industrial cables. From industrial automation and process control to wind turbines and robotics, Belden has the cable that combines reliability, ruggedness, and performance.

A nighttime photograph of an industrial facility, likely a refinery or chemical plant, with a city skyline in the background. The industrial site is illuminated with bright lights, and the city skyline is visible in the distance. In the foreground, there are some buildings and a road with light trails from traffic.

**Be certain.
Belden.**



Section Index

	Page
Table of Contents	4–8
Power & Control	
■ Multi-Conductor Cables	13
■ Paired and Triads Cables	87
■ Variable Frequency Drive (VFD) Cables	151
■ Sensor & Actuator Cables	163
■ Hook-up & Lead Wire	169
■ Portable Cordage	199
Data Communication Systems	
■ Computer Cables	209
Industrial Data and Process Automation	
■ Overview and Cross Reference Guide	229
■ Serial Fieldbus	237
■ DataTuff® Industrial Ethernet Cables	263
■ RailTuff™ Railway and Bus Approved Industrial Data Cables	281
Optical Fiber	
■ Central and Multi Loose Tube	285
Patching and Termination	
■ MIPP – The Industrial-strength Patch Panel	337
Technical Information	349
Part Number Index	371

Table of Contents

	Page
Table of Contents	4–8
Trust Belden Cable to Ensure Clear, Uninterrupted Signal Transmission	9
Top of Class Performance	10–11
Bringing Added Value with Industry-leading Support	12
Power & Control	
Multi-Conductor Cables	
Overview	14
Classic Multi-Conductor Cables	15
Overview	15
Audio, Control and Instrumentation Cables	16–23
High-Temperature Control and Instrumentation Cables	24–26
Special Audio, Communication and Instrumentation Cables	27–28
Fire Alarm Power-Limited Fire Protective Signaling Circuit Cables	29–30
Plenum-Rated Fire Alarm Power-Limited	31
Circuit Integrity (CI) SAFE-T-Line® Cables	32–35
Computer, Instrumentation and Medical Electronics Cables	36
MIL-W-16878 (Type B) Conductors	37
Security Systems and Duplex Primary Wire	38
Antenna Rotor Cables	39
Rubber SO Power and Control Cables	39
MachFlex Flexible Control Cables	40
Overview and Application Guide	40–41
600 V MachFlex Super 360TC for Extreme Flexing (10 Million Flex Cycles)	42–43
600 V MachFlex 360TC for Moderate Flexing (1 Million Flex Cycles)	44–46
MachFlex 350 YY Unshielded PVC Control Cables	47
Unshielded Cable with (G) Protective Ground	47
Unshielded Cable without (G) Protective Ground	48
MachFlex 350 CY Shielded (CY) PVC Control Cables	49
Tinned Copper Braid Shielded Cable with (G) Protective Ground	49
Tinned Copper Braid Shielded Cable without (G) Protective Ground	50
MachFlex 350 SY Armored (SY) PVC Control Cables	51
Galvanized Steel Wire Braid Shield (GSWB) Cable with (G) Protective Ground	51
Galvanized Steel Wire Braid Shield (GSWB) Cable without (G) Protective Ground	52
MachFlex 375 YY Unshielded PVC Control Cables	53
Unshielded Cable with (G) Protective Ground	53
Unshielded Cable without (G) Protective Ground	54
MachFlex 375 CY Shielded (CY) PVC Control Cables	55
Tinned Copper Braid Shielded Cable with (G) Protective Ground	55
Tinned Copper Braid Shielded Cable without (G) Protective Ground	56
MachFlex 375 SY Armored (SY) PVC Control Cables	57
Galvanized Steel Wire Braid Shield (GSWB) Cable with (G) Protective Ground	57
Galvanized Steel Wire Braid Shield (GSWB) Cable without (G) Protective Ground	58
UL Control Cables	59
600 V Type TC Cables	59–65
600 V Type MC Metal Clad and Teck-Style® Cables	66–69
Dual Rated UL/CSA Control Cables	70
600 V Teck-Style® Cables: Dual-Rated Type MC/TECK 90	70–72
CSA Control and Power Cables	73
600 V and 1000 V TC/CIC Multi-Conductor Cables	73–74



Power & Control	Page
CSA Control Cables	75
600 V CIC Multi-Conductor Cables	75–76
600 V ACIC Cables and TECK 90 Cables	77–80
600 V TECK 90 Composite Cables	81
1000 V TECK 90 Cables	82–83
Technical Information	84
Paired and Triads Cables	
Overview	88
Classic Paired Cables	89
Overview and Selection Guide	89–96
Special Audio, Communication and Instrumentation Cables	97–98
Audio, Control, and Instrumentation Cables	99–115
UL Instrumentation Cables	116
300 V Power-Limited Tray Cables	116–130
Thermocouple Extension Cable and Thermocouple Wire	131–133
600 V Tray Cables	134–143
CSA Instrumentation and Thermocouple Tray Cables	144
300 V TC/CIC	144–145
CSA Instrumentation Cables	146
300 V CIC	146–147
300 V ACIC Armored Cables	148–150
Variable Frequency Drive (VFD) Cables	
Overview	152–153
Cross Reference Guide	154–156
Classic and Symmetrical VFD Cables	157–158
Low Smoke Zero Halogen VFD Cables	159–160
Armored VFD Cables	161
CSA VFD Cables	162
Sensor & Actuator Cables	
Overview	164
PVC Sensor & Actuator Cables	165
PUR Sensor & Actuator Cables	166
PUR Distribution Boxes Cables	167
Hook-up & Lead Wire	
Overview	170
Introduction: UL Style & CSA Type Listings	171
PVC	172–175
PVC Wire Dispenser Kits	176
GreenChoice™ PPO	177
TFE	178–179
EPDM	180–181
XL-DUR®	182
XL-DUR® (High-Temperature) and SIS (Switchboard) Wire	183
Chlorosulfonated Polyethylene	184–185
Neoprene	186
Silicone Rubber	187–188

Table of Contents (continued)

Power & Control	Page
Mercury Switch	189
High-Voltage Leads	189
Test Prod Wire	189
Magnet Wire	190
Shielding and Bonding Cable, Direct Burial Cable, Bus Bar, and Antenna Wire	191
Technical Information	192–198
Portable Cordage	
Overview	200
Introduction	201
2-Conductor	202–203
3-Conductor	204–205
4-, 5- and Multi-Conductor	206
UL Cordage Type: Designation, Construction and Rating	207
Data Communication Systems	
Computer Cables	
Overview	210
Multi-Conductor Computer Cables	211
Computer Cables for RS-232 Applications	211–212
Computer Cables for RS-232, RS-423, and IEEE 488	213
Low-Capacitance Computer Cables for RS-232 Applications	214
Low-Capacitance Computer Cables for RS-232 and RS-423 Applications	215
Paired Computer Cables	216
Computer Cables for RS-232 Applications	216–217
Low-Capacitance Computer Cables for RS-232 and RS-422 Applications	218
Low-Capacitance 100 Ohm Computer Cables for RS-422 and Digital Audio Applications	219–220
Low-Capacitance Computer Cables for RS-232 Applications	221
Low-Capacitance Computer Cables for RS-232 and RS-422 Applications	222–223
Low-Capacitance Computer Cables for RS-232, RS-422, and RS-485 Applications	224
Low-Capacitance Computer Cables for RS-485 Applications	225
Computer POS Cables	226
Low-Capacitance Computer Cables for RS-232, RS-422, and Digital Audio Applications	227
Industrial Data and Process Automation	
Overview	230
Introduction	230–231
PLC/DCS Cable Cross Reference Guide	232–234
Protocol Cable Cross Reference Guide	235–236
Serial Fieldbus	
Overview	238
Foundation Fieldbus Type A	239–241
Foundation Fieldbus Type B	242
PROFIBUS	243–244
CANopen RS-485	245–246
DeviceBus® for ODVA DeviceNet™	247–248
DeviceBus® for Honeywell Smart Distributed System	249
DeviceBus® for Square D/Seriplex® and Phoenix Contact INTERBUS®-S	250



Industrial Data and Process Automation		Page
ControlNet™		251
ControlBus™		252–254
MODBUS for RS-232		255
MODBUS II for RG-6 Type Coaxial Cables		255
LonWorks		256
DataTray® 600 V Twinaxial		257
CC Link		258
KNX/EIB Approved Cables		259
Coaxial Ethernet		260
MachFlex Flexible Automation Control Cables		261
300 V MachFlex Data Cables (1 Million Flex Cycles)		261
MachFlex Vision 75 Ohm Coax Cables (1 Million Flex Cycles)		261
DataTuff® Industrial Ethernet Cables		
Overview		264
Introduction and Cable Selection Guide		265–268
DataTuff® Industrial Ethernet		269
Permanent Installation Cables		269–273
Moderate Flexing Cables		274–276
Continuous Flexing Cables		277
DataTuff® PROFINET		278
Permanent Installation Cables		278
Moderate Flexing Cables		279
Continuous Flexing Cables		280
RailTuff™ Railway and Bus Approved Industrial Data Cables		
Overview		282
RailTuff™ Railway Approved Industrial Ethernet		283
Bus & Coach ECE R118.02 approved Data, Coax and Microphone		284
Optical Fiber		
Overview		286
Loose Tube Optical Characteristics		287
Construction Lookup Table		288
Part Number Coding		289
Central Loose Tube		290–315
Multi Loose Tube		316–333
Technical Information		334–336
Patching and Termination		
MIPP – The Industrial-strength Patch Panel		
Overview		338–339
MIPP Fiber Splice Box		340
Overview		340
Standard Part Number Reference Guide		341
Standard Part Number Reference List		342–343
MIPP Copper Patch Panel		344
Overview		344
Standard Part Number Reference Guide		345
Standard Part Number Reference List		345

Patching and Termination		Page
MIPP Mix		346
Overview		346
Standard Part Number Reference List		347
Accessories		348
Technical Information		
Belden Conductor Color Code Charts		350–351
Conductors		352–354
Insulations and Jackets		355–358
Shielding		359–361
Cables Standards Reference Guide		362
Cables Substitution Chart		363
Canadian Substitution Hierarchy and Catalog Terms of Use		364
Glossary		365–369
Part Number Index		
Part Number Index		372–401



Be certain of a partner who understands your industry.





Trust Belden Cable to Ensure Clear, Uninterrupted Signal Transmission

Today's industrial applications cannot afford transmission errors that cause downtime, delays, and even safety concerns. Belden quality provides the performance and reliability needed to keep your connections strong and your automation up and running, even in the harshest operating environments.

- Patented, proven technology for maximum uptime
- Broad portfolio to meet any need
- Above-and-beyond service and support

Designing Solutions for Unmatched Reliability

Noise, vibration, humidity, temperature, sunlight, flexing, chemicals and so many other factors can impact signal performance. The consequences can be significant, depending on the scope of the resulting shutdown, the mission-critical level of the application and the vertical market or industry involved. Whatever the cost, your bottom line suffers.



That's why so many project designers write Belden cables into their project specs. The experts know that when it comes to reliability, Belden has no equal.

Belden's Bonded-Pair technology, a patented cable construction that affixes the conductor insulation of the cable pairs along their longitudinal axes, ensures that no performance-robbing gaps can develop. The design also prevents noise interference with the signal in the cable.

- Conductor-to-conductor spacing, or centricity, is always uniform – no gaps
- With uniform centricity, cable delivers consistently reliable electrical performance
- Superior electrical performance, even after cable is subjected to bending, pulling and twists

Installed and manipulated Nonbonded-pairs (left) have a tendency to gap, varying the centricity of the two conductors. Belden Bonded-Pairs (right) do not gap so the physical integrity of the pair is maintained.

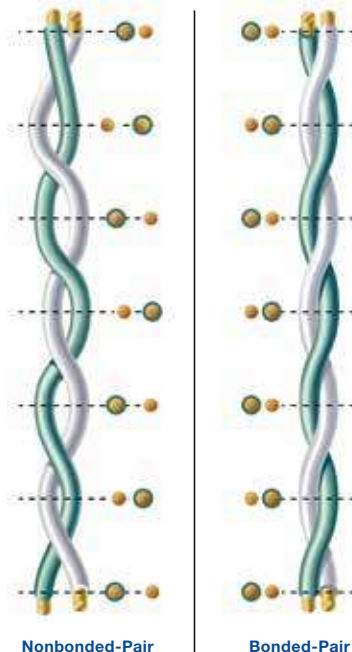

Belden is a dynamic and an innovative company with a vast product portfolio.

Top of Class Performance

Belden has developed the most comprehensive line of industrial cables, wires and accessories in the world today.



Operating as a lean enterprise, Belden puts a high priority on what you need. Our manufacturing sites and products meet or exceed the certification requirements of multiple, independent certification agencies, including:

- **UL (Underwriters Laboratories)**
UL Standards are used to assess products; test components, materials, systems and performance; and evaluate environmentally sustainable products, renewable energies, food and water products, recycling systems and other innovative technologies in order to fulfill its mission to create a safer, more sustainable world.
- **ISO (International Organization for Standardization)**
ISO Standards give world-class specifications for products, services and systems, to ensure quality, safety and efficiency. They are instrumental in facilitating international trade.
- **RoHS (Restriction on Hazard Substances)**
Nearly all Belden cables contain none of the restricted substances under the European Directives of 2002/2003 or California Proposition 65.

Plus, we've built our entire corporate culture around continuous improvement. Every action is taken to earn your trust and protect your mission-critical applications.



Delivering the Right Product for Every Application

From copper to fiber. From fieldbus to Ethernet. From unshielded to armored. From on-machine to buried underground. No matter what you need, you'll find a solution in the Belden portfolio.

In business since 1902, Belden has grown into a worldwide enterprise with more than 25 sales offices and manufacturing facilities spread across North and South America, Europe, Asia Pacific, Africa and the Middle East. That means worldwide market access and global distribution to supply any project you have.

You'll also find experience and expertise across diverse industries and vertical markets. Having introduced more than 250,000 products to the market and earned more than 600 patents for innovation, we've successfully completed projects in:

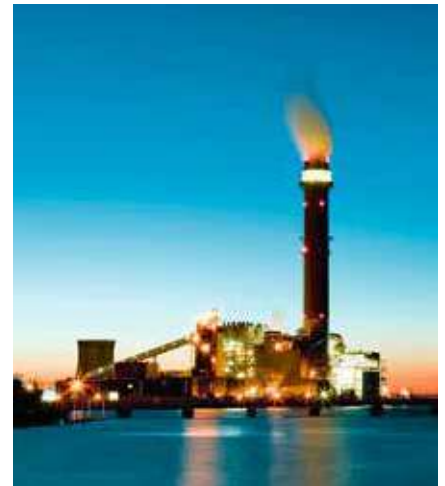

Markets	Applications
Automotive	Network/Fieldbus Infrastructure
Machine Building/Manufacturing	Sensor/Actuator Connectivity
Food & Beverage	Ethernet Automation
Consumer Packaging	Physical Security & Surveillance
Chemical & Petrochemical	Industrial Internet of Things
Transportation	Smart Factory/Industrie 4.0
Oil & Gas	Smart Grids
Power, Transmission & Distribution	Cybersecurity
Utilities/Energy	Robotics/Automation
Medical & Healthcare	Multi-protocol
& More	



Bringing Added Value with Industry-leading Support

When you choose Belden, you can operate with confidence. Our entire industrial cable portfolio is backed by our 10-year extended warranty – FREE. That's unmatched coverage you can only get from Belden.

In every region of the world, you have access to a Commercial Engineering "Coach" who can guide you through any project, from planning and design to implementation and troubleshooting. We can also connect you to certified partners and authorized systems integrators to ensure your success and satisfaction.

Plus, we invest in you. Every year, we offer countless opportunities to expand your knowledge – from our highly rated annual Design Seminar and formal certification courses to interactive webinars, a weekly blog, and a bi-monthly newsletter.

The more you know, the more you'll agree: Belden is the right choice for your industrial project.



Belden is leading the way in the transformation to a connected world.

Power & Control Multi-Conductor Cables



Section Table of Contents

Power & Control	
Multi-Conductor Cables	
Overview	14
Classic Multi-Conductor Cables	
Overview	15
Audio, Control and Instrumentation Cables	16–23
High-Temperature Control and Instrumentation Cables	24–26
Special Audio, Communication and Instrumentation Cables	27–28
Fire Alarm Power-Limited Fire Protective Signaling Circuit Cables	29–30
Plenum-Rated Fire Alarm Power-Limited	31
Circuit Integrity (CI) SAFE-T-Line® Cables	32–35
Computer, Instrumentation and Medical Electronics Cables	36
MIL-W-16878 (Type B) Conductors	37
Security Systems and Duplex Primary Wire	38
Antenna Rotor Cables	39
Rubber SO Power and Control Cables	39
MachFlex Flexible Control Cables	
Overview and Application Guide	40–41
600 V MachFlex Super 360TC for Extreme Flexing (10 Million Flex Cycles)	42–43
600 V MachFlex 360TC for Moderate Flexing (1 Million Flex Cycles)	44–46
MachFlex 350 YY Unshielded PVC Control Cables	
Unshielded Cable with (G) Protective Ground	47
Unshielded Cable without (G) Protective Ground	48
MachFlex 350 CY Shielded (CY) PVC Control Cables	
Tinned Copper Braid Shielded Cable with (G) Protective Ground	49
Tinned Copper Braid Shielded Cable without (G) Protective Ground	50
MachFlex 350 SY Armored (SY) PVC Control Cables	
Galvanized Steel Wire Braid Shield (GSWB) Cable with (G) Protective Ground	51
Galvanized Steel Wire Braid Shield (GSWB) Cable without (G) Protective Ground	52
MachFlex 375 YY Unshielded PVC Control Cables	
Unshielded Cable with (G) Protective Ground	53
Unshielded Cable without (G) Protective Ground	54
MachFlex 375 CY Shielded (CY) PVC Control Cables	
Tinned Copper Braid Shielded Cable with (G) Protective Ground	55
Tinned Copper Braid Shielded Cable without (G) Protective Ground	56
MachFlex 375 SY Armored (SY) PVC Control Cables	
Galvanized Steel Wire Braid Shield (GSWB) Cable with (G) Protective Ground	57
Galvanized Steel Wire Braid Shield (GSWB) Cable without (G) Protective Ground	58
UL Control Cables	
600 V Type TC Cables	59–65
600 V Type MC Metal Clad and Teck-Style® Cables	66–69
Dual Rated UL/CSA Control Cables	
600 V Teck-Style® Cables: Dual-Rated Type MC/TECK 90	70–72
CSA Control and Power Cables	
600 V and 1000 V TC/CIC Multi-Conductor Cables	73–74
CSA Control Cables	
600 V CIC Multi-Conductor Cables	75–76
600 V ACIC Cables and TECK 90 Cables	77–80
600 V TECK 90 Composite Cables	81
1000 V TECK 90 Cables	82–83
Technical Information	
	84



Multi-Conductor Cables



Product Features

Belden multi-conductor products deliver low voltage analog data signals within enclosures, from controllers and I/Os to devices such as temperature and pressure sensors, relays, valves, meters, thermocouples, solenoids, actuators, contacts, push buttons, and alarms. They also are applicable for computers, communications, instrumentation, sound, control, audio, data transmission, and many more applications.

- Unsurpassed quality and reliability
- Robust designs that meet or exceed UL standards
- Proven performance in installations worldwide
- Broad range of AWG sizes, shielding options, and conductor counts
- Convenient put-up options
- Polyolefin insulations provide lower capacitance performance when compared to PVC insulated cables

Applications

Belden's multi-conductor line includes a select number of high-quality, high-reliability cables that meet or exceed UL standards and have been used worldwide for decades.

Multi-conductor Computer Cable is suitable for process control networks, industrial automation and building automation systems such as heating, ventilation, air conditioning (HVAC) and security systems. It is ideal for data transmission between multiple systems and often in long distance links (up to 4,000 ft/1,219 m).

Fire protective control and circuit integrity cables ensure the continued operation of a building's EVAC systems in the event of fire are suitable for a wide range of applications, including security systems, sound and intercom systems, power-limited controls, fire and burglar alarm systems, single-line telephones, and more.

The Fire Alarm range is approved by NEC/CEC and California State Fire Marshall for commercial fire alarms, monitoring and detection systems, audio and control and notification circuits.

When the application demands highly flexible cables offering exceptional cable life and performance, Belden MachFlex offers the best solution.

For installation in wet or dry locations the UL control cables are recommended. Cable jackets are resistant to sunlight, moisture and vapor penetration. The cables can be used in raceways, outdoor applications and direct burial applications.

CSA Control cables are general-purpose cables used in the oil and gas, pulp and paper, mining, petroleum and chemical industries as well as in commercial buildings.

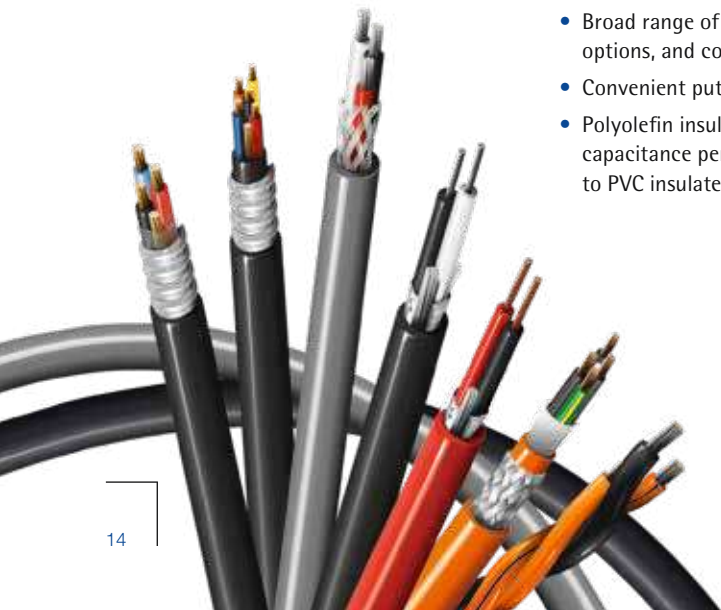

Classic Multi-Conductor Cables

Shielding

Belden meets the demand for highly effective shielding technology with innovative, EMI/RFI-protective foil and braid designs like Beldfoil®. Belden's patented Beldfoil shield is an aluminum/polyester foil construction that yields a lightweight, strong, flexible and thin shield that provides extra insulation and 100% shield coverage. Beldfoil is ideally suited for multiple-pair, individually shielded audio, communication, and data cables.

Product Consistency

By manufacturing our products in ISO-certified, state-of-the-art manufacturing facilities, Belden assures that quality is built into each and every product. Precise diameter control of insulation and jacket diameters and concentric wall thickness assures fast, reliable manufacturing in high-speed automated equipment, and ease of termination and assembly in the field.

Find the Right Product for Your Application

Belden Classic products are available from stock from Belden distributors. If the products above do not fit your application, Belden can also engineer specific constructions for your application.

Audio, Control and Instrumentation Cables

600 V, +80 °C • Unshielded



- C(UL) FT4
- VW-1

Part No.	Conductors	Color Code	OD (Nom)		Insulation Thickness		Jacket Thickness	
			Inch	mm	Inch	mm	Inch	mm

Stranded (19 x 29) TC Conductors • PVC Insulation • Cabled • Chrome PVC Jacket

16 AWG • 19 x 29 • PVC/PVC

8620	4	Chart 2	.376	9.55				
9620	5	Chart 2	.411	10.44	.031	.79	.042	1.07
8621	7	Chart 2	.458	11.63				
9721	8	Chart 2	.496	12.60	.031	.79	0.45	1.14
9621	9	Chart 2	.533	13.54				
8622	12	Chart 2	.627	15.93				
8623	15	Chart 2	.694	17.63	.031	.79	.060	1.52
8624	19	Chart 2	.740	18.80				
9622	25	Chart 2	.879	22.33	.031	.79	.065	1.65

14 AWG • 19 x 27 • PVC/PVC

8627	4	Chart 2	.490	12.45	.045	1.14	.045	1.14
9623	5	Chart 2	.573	14.55	.045	1.14	.060	1.62
8628	7	Chart 2	.623	15.82	.045	1.14	.060	1.62
8629	12	Chart 2	.824	20.93	.045	1.14	.065	1.65

Audio, Control and Instrumentation Cables

300 V, +60 °C • Unshielded



- UL AWM Style

- NEC: CM
- CEC: CM
- NEC: MP (9794 Only)

Part No.	Conductors	Color Code	OD (Nom)		Insulation Thickness		Jacket Thickness	
			Inch	mm	Inch	mm	Inch	mm

22 AWG • Polyolefin/PVC

Solid BC Conductors • Polyolefin Insulation • Cabled • Rose or Gray PVC Jacket								
8795	2	Green, Red	.168	4.27				
8794	3	Green, Red, Yellow	.178	4.52	.018	.46	.022	.56
9794	4	Green, Red, Yellow, Black	.200	5.08				
1242A	4	Green, Red, Yellow, Black	.154	3.91	.018	.46	.025	.64

300 V, +60 °C • Unshielded



- PVC/PVC
- AWM Style

- NEC: CMG
- CEC: CMG FT4

Part No.	Conductors	Color Code	OD (Nom)		Insulation Thickness		Jacket Thickness	
			Inch	mm	Inch	mm	Inch	mm

Stranded TC Conductors • PVC Insulation • Cabled • Chrome PVC Jacket

20 AWG • 7 x 28 • PVC/PVC

9444	4	Chart 1	.217	5.51				
9445	5	Chart 1	.239	6.07	.015	.38	.032	.81
9439	7	Chart 1	.260	6.60				
9455	9	Chart 1	.317	8.05				
9457	15	Chart 2R	.389	9.88	.015	.38	.035	.89

18 AWG • 19 x 30 • PVC/PVC

8489	4	Chart 1	.257	6.53	.017	.43	.032	.81
8465	5	Chart 1	.282	7.16	.017	.43	.033	.84
8467	7	Chart 1	.309	7.85	.017	.43		.94
8469	9	Chart 1	.364	9.25	.017	.43	.037	.94
8466	12	Chart 2R	.412	10.46	.017	.43	.040	1.02
8468	15	Chart 2R	.500	12.70	.017	.43		.500
8619	19	Chart 2R	.490	12.45	.017	.43	.045	.500
9626	25	Chart 2R	.612	15.54	.017	.43	.060	1.52

300 V, +80 °C • Unshielded



- Unjacketed
- AWM Style
- VW-1

Part No.	Conductors	Color Code	OD (Nom)		Insulation Thickness		Jacket Thickness	
			Inch	mm	Inch	mm	Inch	mm

16 AWG • PVC

Stranded (19 x 29) TC Conductors • PVC Insulation • Cabled								
9498	3	Orange, Black, Orange with Black Stripe	.243	6.17	.027	.69	-	-

BC = Bare Copper • TC = Tinned Copper • PVC = Polyvinyl Chloride | Belden Color Code Charts can be found at page 350/351.

Audio, Control and Instrumentation Cables

150 V, +80 °C • Unshielded



- UL AWM Style (Except 8442)
- NEC: CMG
- CEC: CMG FT4

Part No.	Conductors	Color Code	OD (Nom)		Insulation Thickness		Jacket Thickness	
			Inch	mm	Inch	mm	Inch	mm

22 AWG • PVC/PVC

Stranded (7 x 30) TC Conductors • PVC Insulation • Cabled • Chrome PVC Jacket									
8442	2	Black, Red	.170	4.32	.016	.41	0.25	.64	
8443	3	Black, Red, Green	.172	4.37					
8444	4	Chart 1	.185	4.70					
8445	5	Chart 1	.194	4.93					
9430	7	Chart 1	.214	5.44					
9421	8	Chart 1	.229	5.82	.011	.28	.032	.81	
9423	9	Chart 1	.244	6.20					
8456	10	Chart 1	.264	6.71					
8457	12	Chart 1	.272	6.91					
8458	15	Chart 1	.315	8.00					
9431	20	Chart 1	.345	8.76					
8459	25	Chart 1	.387	9.83	.011	.28	.040	1.02	
9432	30	Chart 1	.400	10.16					
9433	40	Chart 1	.455	11.56					
9434	50	Chart 1	.500	12.70	.011	.28	.045	1.14	

300 V, +60 °C • Foil Shield



- Polyolefin/PVC
- AWM Style
- NEC: CM
- CEC: CM
- NEC: CL3 (8618)
- Polyolefin/LSZH
- IEC 60332-3-24
- Smoke IEC6103

Part No.	Conductors	Color Code	OD (Nom)		Insulation Thickness		Jacket Thickness		Capacitance*	
			Inch	mm	Inch	mm	Inch	mm	pF/Ft	pF/m

Stranded TC Conductors • Polyolefin Insulation • Cabled • Overall Beldfoil® Shield • Stranded TC Drain Wire • Chrome PVC Jacket

22 AWG • 7 x 30 • 22 AWG Drain Wire • Polyolefin/PVC

8771	3	Black, Red, Clear	.199	5.05	.017	.43	.033	.84	41	134
------	---	-------------------	------	------	------	-----	------	-----	----	-----

20 AWG • 7 x 28 • 22 AWG Drain Wire • Polyolefin/PVC

8772	3	Black, Red, Clear	.218	5.54	.017	.43	.033	.84	51	167
------	---	-------------------	------	------	------	-----	------	-----	----	-----

18 AWG • 16 x 30 • 20 AWG Drain Wire • Polyolefin/PVC

8770	3	Black, Red, Clear	.246	6.25	.018	.46	.033	.84	48	157
------	---	-------------------	------	------	------	-----	------	-----	----	-----

16 AWG • 19 x 29 • 18 AWG Drain Wire • Polyolefin/PVC

8618	3	Black, Red, Clear	.327	8.3	.032	.81	.031	.79	50	164
------	---	-------------------	------	-----	------	-----	------	-----	----	-----

Stranded TC Conductors • Polyolefin Insulation • Cabled • Overall Beldfoil® Shielding • Stranded TC Drain Wire • Chrome LSZH Jacket

22 AWG • 7 x 30 • 22 AWG Drain Wire • Polyolefin/LSZH

8771NH	3	Black, Red, Clear	.210	5.30	.015	.38	.035	.89	41	134
--------	---	-------------------	------	------	------	-----	------	-----	----	-----

20 AWG • 7 x 28 • 22 AWG Drain Wire • Polyolefin/LSZH

8772NH	3	Black, Red, Clear	.220	5.65	.015	.38	.035	.89	41	134
--------	---	-------------------	------	------	------	-----	------	-----	----	-----

18 AWG • 16 x 30 • 20 AWG Drain Wire • Polyolefin/LSZH

8770NH	3	Black, Red, Clear	.250	6.25	.015	.38	.035	.89	41	134
--------	---	-------------------	------	------	------	-----	------	-----	----	-----

* One conductor to other conductors connected to shield.

TC = Tinned Copper • PVC = Polyvinyl Chloride • LSZH = Low Smoke Zero Halogen | Belden Color Code Charts can be found at page 350/351.

Audio, Control and Instrumentation Cables

300 V, +75 °C • Foil Shield

- AWM Style

- NEC: CM, CL3
- CEC: CM



Part No.	Conductors	Color Code	OD (Nom)		Insulation Thickness		Jacket Thickness		Capacitance*	
			Inch	mm	Inch	mm	Inch	mm	pF/Ft	pF/m

22 AWG • Polyolefin/PVC

Stranded (19 x 34) TC Conductors • Polyolefin Insulation • Cabled • Overall Beldfoil® Shield • Three 23 AWG and One 25 AWG Stranded TC Drain Wires • White PVC Jacket										
8729	4	Black, Red, Green, Clear	.257	6.53	.016	.41	.051	1.30	42	138

* One conductor to other conductors connected to shield.

300 V, +80 °C • Foil Shield

- AWM Style

- NEC: CMG
- CEC: CMG FT4



Part No.	Conductors	Color Code	OD (Nom)		Insulation Thickness		Jacket Thickness		Capacitance*	
			Inch	mm	Inch	mm	Inch	mm	pF/Ft	pF/m

18 AWG • SR-PVC/PVC

Stranded (19 x 30) TC Conductors • Semi-Rigid PVC Insulation • Cabled • Overall Beldfoil® Shield • 22 AWG Stranded TC Drain Wires • Chrome PVC Jacket										
9418	4	Red, Green, Black, White	.245	6.22	.010	.25	.035	.89	120	394

* One conductor to other conductors connected to shield.

300 V, +80 °C • Foil Shield

- AWM Style

- NEC: CMP
- CEC: CMP FT4



Part No.	Conductors	Color Code	OD (Nom)		Insulation Thickness		Jacket Thickness		Capacitance*	
			Inch	mm	Inch	mm	Inch	mm	pF/Ft	pF/m

18 AWG • FEP/Flamarrest

Stranded (19 x 30) • FEP Insulation • Cabled • Overall Beldfoil® Shield • 20 AWG TC Drain Wire • Natural Flamarrest Jacket										
82418	4	Black, White, Red, Green	.172	4.37	.007	.18	.015	.38	57	187

* One conductor to other conductors connected to shield.

300 V, +90 °C • Foil Shield

- NEC: CM
- CEC: CM



Part No.	Conductors	Color Code	OD (Nom)		Insulation Thickness		Jacket Thickness		Capacitance*	
			Inch	mm	Inch	mm	Inch	mm	pF/Ft	pF/m

22 AWG • Polyolefin/PVC

Stranded (7 x 30) TC Conductors • Polyolefin Insulation • Cabled • Overall Beldfoil® Shield • 22 AWG Stranded TC Drain Wire • Brown PVC Jacket										
9770	3	Black, Red, White	.145	3.68	.009	.23	.020	.51	60	197

* One conductor to other conductors connected to shield.

TC = Tinned Copper • FEP = Fluorinated Ethylene Propylene • PVC = Polyvinyl Chloride

Audio, Control and Instrumentation Cables

200 V, +105 °C • Braid Shield



Part No.	Conductors	Color Code	OD (Nom)		Insulation Thickness		Jacket Thickness		Capacitance*	
			Inch	mm	Inch	mm	Inch	mm	pF/Ft	pF/m

30 AWG • Polyolefin/PVC

Stranded (7 x 38) TC Conductors • Polyolefin Insulation • Cabled • Central Textile Strength Member • Paper Separator • 95% TC Braid Shielding • Chrome PVC Jacket										
8643	3	Black, Red, White	.096	2.44	.006	.15	.014	.36	43	141

* One conductor to other conductors connected to shield.

200 V, +80 °C • Braid Shield



Part No.	Conductors	Color Code	OD (Nom)		Insulation Thickness		Jacket Thickness		Capacitance*	
			Inch	mm	Inch	mm	Inch	mm	pF/Ft	pF/m

22 AWG • PVC/PVC

Stranded (7 x 38) TC Conductors • PVC Insulation • Cabled • 70% TC Braid Shielding • Chrome PVC Jacket										
8735	3	Black, Red, White	.202	5.13	.016	.41	.025	.64	60	197

* One conductor to other conductors connected to shield.

200 V, +80 °C • Braid Shield

• AWM Style

- NEC: CMG
- CEC: CMG FT4



Part No.	Conductors	Color Code	OD (Nom)		Insulation Thickness		Jacket Thickness		Capacitance*	
			Inch	mm	Inch	mm	Inch	mm	pF/Ft	pF/m

20 AWG • PVC/PVC

Stranded (7 x 30) TC Conductors • PVC Insulation • Cabled • 85% TC Braid Shielding • Chrome PVC Jacket										
9260	6	Chart 2R	.305	7.75	.017	.43	.032	.82	50	164
9261	12	Chart 2R	.396	10.06	.017	.43	.040	1.02	57	187

* One conductor to other conductors connected to shield.

Audio, Control and Instrumentation Cables

450 V, +80 °C • Spiral Shield



- AWM Style
- VW-1

Part No.	Conductors	Color Code	OD (Nom)		Insulation Thickness		Jacket Thickness		Capacitance*	
			Inch	mm	Inch	mm	Inch	mm	pF/Ft	pF/m

18 AWG • PVC/PVC

Stranded (7 x 26) TC Conductors • PVC Insulation • Cabled • 80% Spiral Wrap TC Shielding • Chrome PVC Jacket										
8791	3	Black, Red, White	.260	6.60	.022	.56	.028	.56	79	259

* One conductor to other conductors connected to shield.

300 V, +80 °C • Braid Shield/Unshielded



- AWM Style
- NEC: CM

Part No.	Conductors	Color Code	OD (Nom)		Insulation Thickness		Jacket Thickness	
			Inch	mm	Inch	mm	Inch	mm

22 AWG • PVC/PVC

Stranded (7 x 30) TC Conductors • PVC Insulation • Cabled • 80% TC Braid Shielding Over One Conductor • Chrome PVC Jacket										
8734	3 Total 1 Shielded 2 Unshielded	Black, Red, White	.194	4.93	.016	.41	.025	.64		

TC = Tinned Copper • PVC = Polyvinyl Chloride

Audio, Control and Instrumentation Cables

Plenum-Rated

300 V • Plenum • Unshielded



- Non-conduit
- Suitable for Outdoor and Direct Burial Applications
- NEC: CMP
- CEC: CMP FT6

Part No.	Conductors	Color Code	OD (Nom)		Insulation Thickness		Jacket Thickness	
			Inch	mm	Inch	mm	Inch	mm

Stranded TC Conductors • FEP Insulation • Cabled • Red FEP Jacket

22 AWG • 7 x 30 • FEP/FEP

88442	2	Black, Red	.102	2.59	.007	.18	.012	.30
88444	4	Black, White, Red, Green	.121	3.07	.007	.18	.010	.25

18 AWG • 19 x 30 • FEP/FEP

88489	4	Black, White, Red, Green	.161	4.09	.007	.18	.009	.23
-------	---	--------------------------	------	------	------	-----	------	-----

Stranded TC Conductors • FEP Insulation • Cabled • Natural Flamarrest® Jacket

22 AWG • 7 x 30 • FEP/Flamarrest

82442	2	Black, Red	.102	2.59	.006	.15	.015	.38
82444	4	Black, White, Red, Green	.121	3.07	.006	.15	.015	.38

18 AWG • 19 x 30 • FEP/Flamarrest

82489	4	Black, White, Red, Green	.170	4.32	.007	.18	.014	.36
-------	---	--------------------------	------	------	------	-----	------	-----

300 V • Plenum • Foil Shield



- Non-conduit
- Suitable for Outdoor and Direct Burial Applications
- NEC: CMP
- CEC: CMP FT6

Part No.	Conductors	Color Code	OD (Nom)		Insulation Thickness		Jacket Thickness		Capacitance*	
			Inch	mm	Inch	mm	Inch	mm	pF/Ft	pF/m

18 AWG • FEP/FEP

Stranded (19 x 30) TC Conductors • FEP Insulation • Overall Beldfoil® Shield • 20 AWG Stranded TC Dain Wires • Red FEP Jacket

88770	3	Black, White, Red	.155	3.94	.007	.18	.014	.36	96	315
89418	4	Black, White, Red, Green	.177	4.50	.007	.18	.014	.36	57	187

18 AWG • FEP/Flamarrest

Stranded (19 x 30) TC Conductors • FEP Insulation • Overall Beldfoil® Shield • 20 AWG Stranded TC Dain Wires • Natural Flamarrest Jacket

82418	4	Black, White, Red, Green	.176	4.47	.007	.18	.014	.36	63	207
-------	---	--------------------------	------	------	------	-----	------	-----	----	-----

* One conductor to other conductors connected to shield.

Audio, Control and Instrumentation Cables
Plenum-Rated

300 V • Plenum • Foil/Braid Shield



- Non-conduit
- Suitable for Outdoor and Direct Burial Applications
- -70 °C to +200 °C
- NEC: CMP
- CEC: CMP FT6

Part No.	Conductors	Color Code	OD (Nom)		Insulation Thickness		Jacket Thickness		Capacitance*	
			Inch	mm	Inch	mm	Inch	mm	pF/Ft	pF/m

Stranded TC Conductors • FEP Insulation • Cabled • Overall Beldfoil® + 85% TC Braid Shielding • Red FEP Jacket

24 AWG • 7 x 32 • FEP/FEP

83503	3	Chart 2	.135	3.43						
83504	4	Chart 2	.144	3.66						
83506	6	Chart 2	.165	4.19						
83509	9	Chart 2	.188	4.78	.006	.15	.014	.36	36	118
83512	12	Chart 2	.207	5.26						
83515	15	Chart 2	.227	5.77						

22 AWG • 7 x 30 • FEP/FEP

83552	2	Chart 2	.141	3.58						
83553	3	Chart 2	.148	3.76						
83554	4	Chart 2	.159	4.04	.006	.15	.014	.36		
83556	6	Chart 2	.183	4.65					40	132
83559	9	Chart 2	.209	5.31						
83562	12	Chart 2	.234	5.94						
83569	19	Chart 2	.269	6.83	.006	.15	.015	.38		

20 AWG • 7 x 28 • FEP/FEP

83602	2	Chart 2	.157	3.99						
83604	4	Chart 2	.178	4.52						
83606	6	Chart 2	.207	5.26	.006	.15	.014	.36	51	167
83609	9	Chart 2	.238	6.05						
83612	12	Chart 2	.265	6.73						

18 AWG • 19 x 30 • FEP/FEP

83652	2	Chart 2	.175	4.45						
83653	3	Chart 2	.184	4.67						
83654	4	Chart 2	.199	5.05	.007	.18	.014	.36		
83656	6	Chart 2	.234	5.94					60	197
83659	9	Chart 2	.293	7.44						
83662	12	Chart 2	.308	7.82	.007	.18	.015	.38		

16 AWG • 19 x 29 • FEP/FEP

83702	2	Chart 2	.196	4.98						
83703	3	Chart 2	.206	5.23						
83704	4	Chart 2	.223	5.66						
83706	6	Chart 2	.265	6.73						
83709	9	Chart 2	.307	7.80	.007	.18	.014	.36	63	207
83712	12	Chart 2	.344	8.74						
83715	15	Chart 2	.407	10.34						
83719	19	Chart 2	.403	10.24						

* One conductor to other conductors connected to shield.

TC = Tinned Copper • FEP = Fluorinated Ethylene Propylene | Belden Color Code Charts can be found at page 350/351.

High-Temperature Control and Instrumentation Cables

300 V, +150 °C • Unshielded

- VW-1



Part No.	Conductors	Color Code	OD (Nom)		Insulation Thickness		Jacket Thickness	
			Inch	mm	Inch	mm	Inch	mm

Stranded (7 x 28) TC Conductors • Cabled • ETFE Insulation • Clear ETFE Jacket

20 AWG • 7 x 28 • ETFE/ETFE

85220	2	Black, Red	.185	4.70	.015	.38	.020	.51
-------	---	------------	------	------	------	-----	------	-----

16 AWG • 19 x 29 • ETFE/ETFE

85221	2	Black, Red	.215	5.46	.014	.36	.020	.51
85102	2	Chart 2R	.211	5.36	.014	.36	.019	.48
85103	3	Chart 2R	.223	5.66	.014	.36		
85109	9	Chart 2R	.354	8.99	.014	.36	.024	.61

ETFE insulated and jacketed cables are particularly well suited for harsh environments due to outstanding mechanical toughness of the material, as well as its high-temperature and radiation resistant characteristics.

ETFE cables are used extensively in chemical plants, nuclear plants, and fossil fuel power plants. Typical applications are data recording, communication, telemetry, and monitoring pressure or material flow.

High-Temperature Control and Instrumentation Cables

600 V, +150 °C • Silicone Rubber • Foil Shield



- AWM Style
- -70 °C to +150 °C
- VW-1
- 2999 V DC Jacket Working Voltage (Shield to Ground)

Part No.	Conductors	Color Code	OD (Nom)		Insulation Thickness		Jacket Thickness		Capacitance*	
			Inch	mm	Inch	mm	Inch	mm	pF/Ft	pF/m

Stranded TC Conductors • FEP Insulation • Cabled • Noise-Reducing Tape • Overall Beldfoil® Shield • 22 AWG Stranded TC Drain Wire • Red Silicone Rubber Jacket

22 AWG • 7 x 30 • FEP/Silicone Rubber

83394	2	Black, White	.199	5.05	.015	.38	.030	.76	22	72
83395	3	Black, Red, White	.208	5.28	.015	.38	.031	.79	40	131
83396	4	Black, White, Red, Green	.217	5.51	.015	.38	.030	.76		

20 AWG • 7 x 28 • FEP/Silicone Rubber

83393	2	Black, Red	.242	6.15	.020	.51	.030	.76	22	72
-------	---	------------	------	------	------	-----	------	-----	----	----

* For 2-conductor cables, capacitance is measured conductor to conductor. For 3 conductors and higher, capacitance is measured as one conductor to other conductors connected to shield.

300 V, +150 °C • Foil Shield



- VW-1

Part No.	Conductors	Color Code	OD (Nom)		Insulation Thickness		Jacket Thickness		Capacitance*	
			Inch	mm	Inch	mm	Inch	mm	pF/Ft	pF/m

Stranded TC Conductors • ETFE Insulation • Cabled • Beldfoil® Shield • Stranded TC Drain Wire • Clear ETFE Jacket

20 AWG • 7 x 28 • ETFE/ETFE

85230	2	Black, Red	.182	4.62	.015	.38	.020	.51	31	102
85240	3	Black, Red, Green	.193	4.90	.015	.38	.020	.51	48	157

16 AWG • 19 x 29 • ETFE/ETFE

85231	2	Black, Red	.210	5.33	.014	.36	.020	.51	44	144
85241	3	Black, Red, Green	.223	5.66	.014	.36	.020	.51	48	157

* For 2-conductor cables, capacitance is measured conductor to conductor. For 3 conductors and higher, capacitance is measured as one conductor to other conductors connected to shield.

TC = Tinned Copper • ETFE = Ethylene/Tetrafluoroethylene • FEP = Fluorinated Ethylene Propylene

High-Temperature Control and Instrumentation Cables

MIL-W16878/4 (Type E) Conductors

600 V, +200 °C • TFE • Braid Shield

- -65 °C to +200 °C
- VW-1

- MIL-W16878/4 (Type E) Conductors



Part No.	Conductors	Color Code	OD (Nom)		Insulation Thickness		Jacket Thickness		Capacitance*	
			Inch	mm	Inch	mm	Inch	mm	pF/Ft	pF/m

Stranded Silver-Plated Conductors • Extruded TFE Insulation • Cabled • 85% Silver-Plated Braid Shielding • White Tape-Wrapped TFE Jacket

26 AWG • 7 x 34 • TFE/TFE

83303E	1	White	.076	1.93	.010	.25	.010	.25	44.6	146
83317E	2	White, Black	.121	3.07	.010	.25	.011	.28	35.5	116
83332E	3	White, Black, Red	.127	3.23	.010	.25	.011	.28	31.5	103
83347E	4	White, Black, Red, Green	.137	3.48	.010	.25	.011	.28	30.5	100

24 AWG • 19 x 36 • TFE/TFE

83304E	1	White	.085	2.16	.010	.25	.010	.25	46	151
83318E	2	White, Black	.131	3.33	.010	.25	.011	.28	42.4	139
83333E	3	White, Black, Red	.137	3.48	.010	.25	.011	.28	36.8	121
83348E	4	White, Black, Red, Green	.149	3.79	.010	.25	.011	.28	36.8	121

22 AWG • 19 x 34 • TFE/TFE

83305E	1	White	.091	2.31	.010	.25	.010	.25	57.9	190
83319E	2	White, Black	.143	3.63	.010	.25	.011	.28	49.2	161
83334E	3	White, Black, Red	.150	3.81	.010	.25	.011	.28	45.7	150
83349E	4	White, Black, Red, Green	.163	4.14	.010	.25	.011	.28	45.7	150

20 AWG • 19 x 32 • TFE/TFE

83306E	1	White	.099	2.52	.010	.25	.011	.25	69	226
83320E	2	White, Black	.159	4.04	.010	.25	.010	.28	51	167
83335E	3	White, Black, Red	.168	4.27	.010	.25	.011	.28	51	167
83350E	4	White, Black, Red, Green	.183	4.65	.011	.28	.011	.25	51	167

18 AWG • 19 x 30 • TFE/TFE

83307E	1	White	.109	2.77	.011	.28	.010	.25	71.5	135
83321E	2	White, Black	.179	4.55	.011	.28	.011	.28	52.8	173
83336E	3	White, Black, Red	.189	4.80	.010	.25	.011	.28	52.8	173
83351E	4	White, Black, Red, Green	.207	5.26	.010	.25	.011	.28	52.8	173

16 AWG • 19 x 29 • TFE/TFE

83308E	1	White	.120	3.05	.011	.28	.011	.28	72.5	238
83322E	2	White, Black	.197	5.00	.011	.28	.011	.28	60	197
83337E	3	White, Black, Red	.209	5.31	.011	.28	.011	.28	53	174
83352E	4	White, Black, Red, Green	.229	5.82	.011	.28	.011	.28	50.8	167

* One conductor to other conductors connected to shield.

TFE = Tetrafluoroethylene

Special Audio, Communication and Instrumentation Cables

300 V, +80 °C • Shielded • Triads

- VW-1

- NEC: CM
- NEC: Article 800
- CEC: CM



Part No.	Conductors	Color Code	OD (Nom)		Insulation Thickness		Jacket Thickness		Capacitance*	
			Inch	mm	Inch	mm	Inch	mm	pF/Ft	pF/m

22 AWG • Polyolefin/PVC

Stranded (7 x 30) TC Conductors • Polyolefin Insulation • White PVC Jacket Over Triads • Overall Beldfoil® Shield • 22 AWG TC Drain Wires • Overall Chrome PVC Jacket										
9772	36 (12 Triads)	Triads: Black, Red, Green	.725	18.42	.009	.23	.060	1.52	67	220

* One conductor to other conductors connected to shield.

350 V, +80 °C • Foil Shielded Quads • Unshielded Conductors

- VW-1



Part No.	Conductors	Color Code	OD (Nom)		Insulation Thickness		Jacket Thickness	
			Inch	mm	Inch	mm	Inch	mm

24 AWG and 22 AWG • Polyolefin/PVC

Stranded (7 x 32 and 7 x 30) TC Conductors • Polyolefin Insulation (24 AWG), PVC Insulation (22 AWG) • Green Beldfoil® Shield on One Quad, Red Beldfoil® Shield on One Quad • 24 AWG Stranded TC Drain Wire • Chrome PVC Jacket										
8787	10 Total 8 (24 AWG Shielded: 2 Quads) 2 (22 AWG Unshielded)	Quad 1: Gray, White, Green, Blue Quad 2: Brown, Red, Yellow, Orange Unshielded: Blue, White	.290	7.87	.012	.30	.030	.76		
					.016	.41				

TC = Tinned Copper • PVC = Polyvinyl Chloride

Special Audio, Communication and Instrumentation Cables

300 V, +60 °C • Foil Shielded and Unshielded

• VW-1

• NEC: CM



Part No.	Conductors	Color Code	OD (Nom)		Insulation Thickness		Jacket Thickness	
			Inch	mm	Inch	mm	Inch	mm

22 AWG • PVC/PVC

Stranded (7 x 30) TC Conductors • PVC Insulation • Individually Beldfoil® Shielded Conductors • Tinned Cadmium Bronze Ribbon Drain Wire • Chrome PVC Jacket

8788	5 Total 3 Shielded 2 Unshielded	Shielded: Black, Red, Green Unshielded: Yellow, Blue	.236	5.99	.016	.41	.028	.71
-------------	---------------------------------------	--	------	------	------	-----	------	-----

300 V, +90 °C • Foil Shielded and Unshielded

- NEC: CM
- NEC: Article 800
- CEC: CM



Part No.	Conductors	Color Code	OD (Nom)		Insulation Thickness		Jacket Thickness	
			Inch	mm	Inch	mm	Inch	mm

24 AWG and 22 AWG • PVC/PVC

Stranded (7 x 32 and 7 x 30) TC Conductors • PVC Insulation • Beldfoil® Shield • 22 AWG Stranded TC Drain Wire • Chrome PVC Jacket

8786	6 Total 4 (24 AWG Shielded) 2 (22 AWG Unshielded)	Shielded: Black, Green, Red, Yellow Unshielded: White, Blue	.236	5.99	.016	.41	.028	.71
-------------	---	--	------	------	------	-----	------	-----

TC = Tinned Copper • PVC = Polyvinyl Chloride

Fire Alarm Power-Limited Fire Protective Signaling Circuit Cables

Subject 1424 (NEC Article 760, Type FPLR)

300 V, +105 °C • Unshielded

- AWM Style

- NEC: MPR, FPLR
- CEC: FAS 105 FT4



Part No.	Conductors	Color Code	OD (Nom)		Insulation Thickness		Jacket Thickness	
			Inch	mm	Inch	mm	Inch	mm

22 AWG • PVC/PVC

Solid TC Conductors • PVC Insulation • Cabled • Black PVC Jacket								
9576	6	Black, White, Red, Green, Brown, Blue	.234	5.94	.013	.33	.039	.99

300 V, +105 °C • Unshielded

- AWM Style

- NEC: MPR, FPLR
- CEC: FAS 105 FT4



Part No.	Conductors	Color Code	OD (Nom)		Insulation Thickness		Jacket Thickness	
			Inch	mm	Inch	mm	Inch	mm

Solid BC Conductors • PVC Insulation • Cabled • Red PVC Jacket								
--	--	--	--	--	--	--	--	--

18 AWG • PVC/PVC

9571	2	Black, Red	.228	5.79	.017	.43	.037	.94
------	---	------------	------	------	------	-----	------	-----

16 AWG • PVC/PVC

9572	2	Black, Red	.238	6.05	0.16	.41	.036	.91
------	---	------------	------	------	------	-----	------	-----

14 AWG • PVC/PVC

9580	2	Black, Red	.303	7.70	.022	.56	.042	1.07
------	---	------------	------	------	------	-----	------	------

12 AWG • PVC/PVC

9582	2	Black, Red	.340	8.64	.022	.56	.042	1.07
------	---	------------	------	------	------	-----	------	------

BC = Bare Copper • TC = Tinned Copper • PVC = Polyvinyl Chloride

Fire Alarm Power-Limited Fire Protective Signaling Circuit Cables

Subject 1424 (NEC Article 760, Type FPLR)

300 V, +105 °C • Foil Shielded

• AWM Style

- NEC: MPR, FPLR
- CEC: FAS 105 FT4



Part No.	Conductors	Color Code	OD (Nom)		Insulation Thickness		Jacket Thickness	
			Inch	mm	Inch	mm	Inch	mm

Solid BC Conductors • PVC Insulation • Cabled • Overall Beldfoil® Shield • Red PVC Jacket

18 AWG • PVC/PVC

9574	2	Black, Red	.231	.587	.017	.43	.037	.94
9578	4	Black, Red, Yellow, Light Blue	.263	6.68				

16 AWG • PVC/PVC

9575	2	Black, Red	.241	6.12	.016	.41	.036	.91
9579	4	Black, Red, Yellow, Light Blue	.301	7.65	.018	.46	.042	1.07

14 AWG • PVC/PVC

9581	2	Black, Red	.306	7.77	.022	.56	.042	1.07
------	---	------------	------	------	------	-----	------	------

12 AWG • PVC/PVC

9583	2	Black, Red	.343	8.71	.022	.56	.042	1.07
------	---	------------	------	------	------	-----	------	------

BC = Bare Copper • PVC = Polyvinyl Chloride

**Plenum-Rated Fire Alarm Power-Limited
Fire Protective Control and Instrumentation Cables**

Subject 1424 (NEC Article 760, Type FPLR)

**300 V, +200 °C • Foil/Braid Shield •
Plenum**

• AWM Style

• NEC: FPLR, CMP
• CEC: CMP FT6



Part No.	Conductors	Color Code	OD (Nom)		Insulation Thickness		Jacket Thickness	
			Inch	mm	Inch	mm	Inch	mm

Stranded TC Conductors • FEP Insulation • Cabled • Overall Beldfoil® + 85% TC Braid Shielding • Red FEP Jacket

14 AWG • 7 x 22 • FEP/FEP

83752	2	Black, White	.267	6.78				
83753	3	Black, White, Red	.284	7.21	.016	.41	.015	.38
83754	4	Black, White, Red, Green	.311	7.90				
83756	6	Black, White, Red, Green, Orange, Blue	.376	9.55	.016	.41	.017	.43

12 AWG • 7 x 20 • FEP/FEP

83802	2	Black, White	.303	7.70				
83803	3	Black, White, Red	.323	8.20	.016	.41	.015	.38
83804	4	Black, White, Red, Green	.359	9.12				
83806	6	Black, White, Red, Green, Orange, Blue	.430	10.92	.016	.41	.017	.43

TC = Tinned Copper • FEP = Fluorinated Ethylene Propylene

Circuit Integrity (CI) SAFE-T-Line® Cables

Commercial Application, Addressable Systems

300 V, +105 °C • Unshielded



- Riser Rated
 - BS 6387 CWZ (3 hours)
 - EN 50200: PH 120 (2 hours)
 - IEC 60754-1/2 & EN 50267-2-1/2
- NEC: FPLR

Part No.	Conductors	Color Code	OD (Nom)		Insulation Thickness		Jacket Thickness		Capacitance (Nom)*	
			Inch	mm	Inch	mm	Inch	mm	pF/Ft	pF/m

Solid BC Conductors • Ceramifiable Silicone Rubber Insulation • Red Flame-Retardant Polyethylene Jacket

18 AWG • Silicone Rubber/FR-Polyethylene

5320UME	2	Black, Red	.31	7.87						
5322UME	4	Black, Numbered	.35	8.89	.045	1.14	.034	.86	17	56
5324UME	6	Black, Numbered	.42	10.67						
5326UME	8	Black, Numbered	.45	11.43						

16 AWG • Silicone Rubber/FR-Polyethylene

5220UME	2	Black, Red	.33	8.38	.045	1.14	.034	.86	19	62
5222UME	4	Black, Numbered	.38	9.65						

14 AWG • Silicone Rubber/FR-Polyethylene

5120UME	2	Black, Red	.36	9.14	.045	1.14	.034	.86	21	69
5122UME	4	Black, Numbered	.41	10.41						

12 AWG • Silicone Rubber/FR-Polyethylene

5020UME	2	Black, Red	.39	9.91	.045	1.14	.034	.86	23	75
5022UME	4	Black, Numbered	.45	11.43						

* For 2-conductor cables, capacitance is measured conductor to conductor. For 3 conductors and higher, capacitance is measured as one conductor to other conductors.

Circuit Integrity (CI) SAFE-T-Line® Cables
Commercial Application, Addressable Systems

300 V, +105 °C • Foil Shielded

- Riser Rated
- BS 6387 CWZ (3 hours)
- EN 50200: PH 120 (2 hours)
- IEC 60754-1/2 & EN 50267-2-1/2
- NEC: FPLR

Part No.	Conductors	Color Code	OD (Nom)		Insulation Thickness		Jacket Thickness		Capacitance (Nom)*	
			Inch	mm	Inch	mm	Inch	mm	pF/Ft	pF/m



18 AWG • Solid • Silicone Rubber/FR-Polyethylene

Solid BC Conductors • Ceramifiable Silicone Rubber Insulation • Overall Beldfoil® Shield • Red Flame-Retardant Polyethylene Jacket										
5320FME	2	Black, Red	.31	7.87						
5322FME	4	Black, Numbered	.36	9.14	.045	1.14	.034	.86	27	89
5324FME	6	Black, Numbered	.42	10.67						
5326FME	8	Black, Numbered	.46	11.61						



18 AWG • 7 x 26 • Silicone Rubber/FR-Polyethylene

Stranded BC Conductors • Ceramifiable Silicone Rubber Insulation • Overall Beldfoil® Shield • Red Flame-Retardant Polyethylene Jacket										
5300FME	2	Black, Red	.32	8.13						
5302FME	4	Black, Numbered	.37	9.40	.045	1.14	.034	.86	27	89
5304FME	6	Black, Numbered	.44	11.18						
5306FME	8	Black, Numbered	.47	11.94						



16 AWG • Solid • Silicone Rubber/FR-Polyethylene

Solid BC Conductors • Ceramifiable Silicone Rubber Insulation • Overall Beldfoil® Shield • Red Flame-Retardant Polyethylene Jacket										
5220FME	2	Black, Red	.33	8.38	.045	1.14	.034	.86	31	102
5222FME	4	Black, Numbered	.38	9.65						



16 AWG • 7 x 24 • Silicone Rubber/FR-Polyethylene

Stranded BC Conductors • Ceramifiable Silicone Rubber Insulation • Overall Beldfoil® Shield • Red Flame-Retardant Polyethylene Jacket										
5200FME	2	Black, Red	.35	8.89	.045	1.14	.034	.86	31	102
5202FME	4	Black, Numbered	.40	10.16						

* For 2-conductor cables, capacitance is measured conductor to conductor. For 3 conductors and higher, capacitance is measured as one conductor to other conductors connected to shield.

BC = Bare Copper

Circuit Integrity (CI) SAFE-T-Line® Cables

Commercial Application, Addressable Systems

300 V, +105 °C • Foil Shielded

- Riser Rated
- BS 6387 CWZ (3 hours)
- EN 50200: PH 120 (2 hours)
- IEC 60754-1/2 & EN 50267-2-1/2
- NEC: FPLR

Part No.	Conductors	Color Code	OD (Nom)		Insulation Thickness		Jacket Thickness		Capacitance (Nom)*	
			Inch	mm	Inch	mm	Inch	mm	pF/Ft	pF/m



14 AWG • Solid • Silicone Rubber/FR-Polyethylene

Solid BC Conductors • Ceramifiable Silicone Rubber Insulation • Overall Beldfoil® Shield • Red Flame-Retardant Polyethylene Jacket										
5120FME	2	Black, Red	.36	9.14	.045	1.14	.034	.86	33	108
5122FME	4	Black, Numbered	.41	10.41						



14 AWG • 7 x 22 • Silicone Rubber/FR-Polyethylene

Stranded BC Conductors • Ceramifiable Silicone Rubber Insulation • Overall Beldfoil® Shield • Red Flame-Retardant Polyethylene Jacket										
5100FME	2	Black, Red	.38	9.65	.045	1.14	.034	.86	33	108
5102FME	4	Black, Numbered	.44	11.18						



12 AWG • Solid • Silicone Rubber/FR-Polyethylene

Solid BC Conductors • Ceramifiable Silicone Rubber Insulation • Overall Beldfoil® Shield • Red Flame-Retardant Polyethylene Jacket										
5020FME	2	Black, Red	.39	9.91	.045	1.14	.034	.86	37	121
5022FME	4	Black, Numbered	.46	11.68						



12 AWG • 7 x 20 • Silicone Rubber/FR-Polyethylene

Stranded BC Conductors • Ceramifiable Silicone Rubber Insulation • Overall Beldfoil® Shield • Red Flame-Retardant Polyethylene Jacket										
5000FME	2	Black, Red	.42	10.67	.045	1.14	.034	.86	40	131
5002FME	4	Black, Numbered	.48	12.19						

* For 2-conductor cables, capacitance is measured conductor to conductor. For 3 conductors and higher, capacitance is measured as one conductor to other conductors connected to shield.

Circuit Integrity (CI) SAFE-T-Line® Cables

Commercial Application, Addressable Systems

300 V, +105 °C • Foil Shielded



- Riser Rated
- BS 6387 CWZ (3 hours)
- EN 50200: PH 120 (2 hours)
- IEC 60754-1/2 & EN 50267-2-1/2
- NEC: PLTC, FPLR

Part No.	Conductors	Stranding	Color Code	OD (Nom)		Insulation Thickness		Jacket Thickness		Capacitance (Nom)*	
				Inch	mm	Inch	mm	Inch	mm	pF/Ft	pF/m

16 AWG • 7 x 24 • Silicone Rubber/FR-Polyethylene

Stranded BC Conductors • Ceramifiable Silicone Rubber Insulation • Overall Beldfoil® Shield • Red Flame-Retardant Polyethylene Jacket											
5240FRE	2	7 x 24	Black, White	.35	8.89	.034	.86	.364	1.10	31	102
5201FRE	3	7 x 24	Red, White	.37	9.40						

* For 2-conductor cables, capacitance is measured conductor to conductor. For 3 conductors and higher, capacitance is measured as one conductor to other conductors connected to shield.

BC = Bare Copper

Computer, Instrumentation and Medical Electronics Cables

Data Cables AMP SDL Connectors

350 V, +80 °C • Foil Shield

- Direct Burial

- NEC:CL2X



Part No.	Conductors	Color Code	OD (Nom)		Insulation Thickness		Jacket Thickness		Capacitance*	
			Inch	mm	Inch	mm	Inch	mm	pF/Ft	pF/m

20 AWG • Polyolefin/Polyethylene

Solid TC Conductors • Polyolefin Insulation • Cabled • Overall Beldfoil® Shield • 22 AWG Solid TC Drain Wire • Black High-Density Polyethylene Jacket										
9802	2	Chart 1	.190	4.83	.013	.33	.035	.89		
9803	3	Chart 1	.205	5.21	.013	.33	.035	.89	42	138
9890	10	Chart 1	.310	7.87	.013	.33	.040	1.02		
9894	15	Chart 2R	.390	9.91	.013	.38	.045	1.14		

* One conductor to other conductors connected to shield.

300 V, +80 °C • Shielded

- AWM Style
- VW-1

- NEC: CL2X



Part No.	Conductors	Color Code	OD (Nom)		Insulation Thickness		Jacket Thickness	
			Inch	mm	Inch	mm	Inch	mm

26 AWG • PVC/PVC

Stranded (7 x 34) TC Conductors • PVC Insulation • Overall Duofoil® Shielding • 26 AWG Stranded TC Drain Wire • Black PVC Jacket										
1211A	4	White, Yellow, Orange, Green	.195	4.95	.015	.38	.036	.91		
1212A	6	Red, Blue, Green, Blue, Yellow, Orange, White	.220	5.59	.015	.38	.037	.93		
1213A	8	Black, Purple, Red, Blue, Green, Blue, Orange, Yellow, White	.239	6.07	.015	.38	.039	.98		
1214A	66	White/Red, White/Brown, White/Black, Black, Red, Brown, Purple, Blue, Green, Gray, Aqua, Tan, Pink, Orange, White, Yellow	.301	7.65	.015	.38	.035	.89		

TC = Tinned Copper • PVC = Polyvinyl Chloride | Belden Color Code Charts can be found at page 350/351.

MIL-W-16878 (Type B) Conductors

600 V, +105 °C • Braid Shield

• VW-1

• MIL-W-16878 (Type B) Conductors



Part No.	Conductors	Color Code	OD (Nom)		Insulation Thickness		Jacket Thickness		Capacitance*	
			Inch	mm	Inch	mm	Inch	mm	pF/Ft	pF/m

Stranded TC Conductors • PVC Insulation • Clear Nylon Skin Over Insulation • Cabled • 90% TC Braid Shielding • PVC Jacket

22 AWG • 19 x 34 • PVC-Nylon/PVC

9965	1	White	.100	2.54	.010/.003	.25/.08	.010	.25	100	328
9966	2	White, Black	.176	4.47	.010/.003	.25/.08	.020	.51	87	285
9967	3	White, Black, Red	.184	4.67	.010/.003	.25/.08	.020	.51	88	289
9968	4	White, Black, Red, Green	.200	5.08	.010/.003	.25/.08	.020	.51	69	226

20 AWG • 19 x 32 • PVC-Nylon/PVC

9961	1	White	.109	2.77	.011/.003	.27/.08	.010	.25	103	388
9962	2	White, Black	.192	4.88	.011/.003	.27/.08	.020	.51	91	299
9963	3	White, Black, Red	.210	5.33	.011/.003	.27/.08	.025	.64	84	276
9964	4	White, Black, Red, Green	.226	5.74	.011/.003	.27/.08	.025	.64	100	328

16 AWG • 19 x 29 • PVC-Nylon/PVC

9951	1	White	.143	3.63	.012/.003	.30/.08	.016	.41	138	453
9952	2	White, Black	.250	6.35	.012/.003	.30/.08	.025	.64	95	312
9953	3	White, Black, Red	.264	6.71	.012/.003	.30/.08	.027	.69	101	331
9954	4	White, Black, Red, Green	.291	7.39	.012/.003	.30/.08	.027	.69	94	308

* One conductor to other conductors connected to shield.

TC = Tinned Copper • PVC = Polyvinyl Chloride

Security Systems and Duplex Primary Wire

Security/Audio/Power-Limited Control Cable • 200 V, +75 °C • Unshielded

• VW-1



Part No.	Conductors	Color Code	OD (Nom)		Insulation Thickness		Jacket Thickness	
			Inch	mm	Inch	mm	Inch	mm

20 AWG • PVC/PVC

Stranded (7 x 28) BC Conductors • PVC Insulation • Parallel • Chrome PVC Jacket								
8484	4	Black, Green, Red, White	.173	4.39	.010	.25	.020	.51

Duplex Primary Wire • 300 V, +75 °C • Nonplenum • Unshielded

• VW-1



Part No.	Conductors	Color Code	OD (Nom)		Insulation Thickness		Jacket Thickness	
			Inch	mm	Inch	mm	Inch	mm

Stranded BC Conductors • PVC Insulation • Parallel • Chrome PVC Jacket								
--	--	--	--	--	--	--	--	--

16 AWG • 19 x 29 • PVC/PVC

8677	2	Brown, Red	.149 x .254	3.78 x 6.45	.024	.61	.022	.56
-------------	---	------------	-------------	-------------	------	-----	------	-----

14 AWG • 19 x 27 • PVC/PVC

8675	2	Brown, Red	.168 x .290	4.27 x 7.37	.023	.58	.023	.58
-------------	---	------------	-------------	-------------	------	-----	------	-----

12 AWG • 19 x 25 • PVC/PVC

8673	2	Brown, Red	.186 x 3.28	4.72 x 8.33	.026	.66	.022	.56
-------------	---	------------	-------------	-------------	------	-----	------	-----

10 AWG • 19 x 23 • PVC/PVC

8678	2	Brown, Red	.225 x .400	5.72 x 10.16	.032	.81	.025	.64
-------------	---	------------	-------------	--------------	------	-----	------	-----

BC = Bare Copper • PVC = Polyvinyl Chloride

Antenna Rotor Cables

300 V, +80 °C • Unshielded



- AWM Style
- VW-1
- NEC: CM

Part No.	Conductors	Color Code	OD (Nom)		Insulation Thickness		Jacket Thickness	
			Inch	mm	Inch	mm	Inch	mm

18 and 16 AWG • PVC/PVC

Stranded (16 x 30 and 19 x 28) TC Conductors • PVC Insulation • Cabled • Chrome PVC Jacket								
9405	6 (18 AWG)	Brown, Red, Yellow, Blue, Orange, Green	.345	8.76	.019	.48	.032	.81
	2 (16 AWG)	Black, White						

150 V, +80 °C • Unshielded



- AWM Style
- NEC: CMG
- CEC: CMG FT4

Part No.	Conductors	Color Code	OD (Nom)		Insulation Thickness		Jacket Thickness	
			Inch	mm	Inch	mm	Inch	mm

22 and 18 AWG • PVC/PVC

Stranded (7 x 30 and 16 x 30) TC Conductors • PVC Insulation • Cabled • Chrome PVC Jacket								
8446	4 (22 AWG)	Red, Green, Brown, Blue	.236	5.99	.011	.28	.032	.81
	2 (18 AWG)	Black, White						
8448	6 (22 AWG)	Brown, Red, Yellow, Blue, Orange, Green	.259	6.58	.011	.28	.032	.81
	2 (18 AWG)	Black, White						

Rubber SO Power and Control Cables

600 V, +60 °C • Unshielded



- Oil Res
- UL: SO
- CSA: SO
- CSA: FT2

Part No.	Conductors	Color Code	OD (Nom)		Insulation Thickness		Jacket Thickness	
			Inch	mm	Inch	mm	Inch	mm

16 AWG • EPDM/Rubber

Stranded (65 x 34) BC Conductors • EPDM Insulation • Cabled • Paper Tape Separator • Fillers Added • Black Rubber Jacket								
9420	5	Chart 2	.506	12.85	.033	8.38	.084	2.13
9422	7	Chart 2	.581	14.76	.033	8.38	0.83	2.11
9424	9	Chart 2	.720	18.29	.033	8.38	.100	2.54
9425	12	Chart 2	.720	18.29				
9427	16	Chart 2	.787	19.99				
9429	20	Chart 2	.862	21.29				

TC = Tinned Copper • PVC = Polyvinyl Chloride • BC = Bare Copper • EPDM = Ethylene-Propylene Diene Elastomer | Belden Color Code Charts can be found at page 350/351.

MachFlex Flexible Control Cables

Overview and Application Guide

Belden MachFlex is a complete line of control, data, video, and power cables specifically designed to handle the rigorous speeds and near-constant motion encountered in automated equipment such as robots, pick and place machines, automatic handling systems, multi-axis machine tools, and conveyor systems.

When the application demands highly flexible cables offering exceptional cable life and performance, specify Belden MachFlex.

Belden MachFlex Means More Performance and Longer Life

Reduced Cable Memory – Belden MachFlex's unique design and neutralized cabling results in cables that are relaxed, with almost no memory.

Greater Flex Life – Belden MachFlex cables offer superior flexibility and are able to handle the vigorous motions and high speeds encountered in automated equipment.

Greater System Uptime – Belden MachFlex cables combine specialized manufacturing techniques with precision copper stranding and rugged insulation and jacketing compounds to maximize flex life and reliability.

No Talc Problems – Unlike the potentially harmful talc used in other cables, Belden's non-toxic, non-irritating slipper compound facilitates flexing and also complies with OSHA regulations. It's safer for employees and operators and is less likely to contaminate solder joints or mechanical compounds.

CE Conformity – All Belden MachFlex cables are CE marked per the Conformité Européenne low voltage directive, allowing trade of product in Europe.

Custom Conductor Counts – Available upon request.

- Oil resistant DIN EN 50290-2-22 (TM54)
- Wider fixed temperature range (-40°C to +80°C)
- Good shield effectiveness
- Good Sunlight (UV) & Chemical Resistant
- Environmental friendly cables (RoHS)

Product Series Descriptions

- **600 V MachFlex Super 360TC for Extreme Flexing (10 Million Flex Cycles), C-TC+** – The C-TC+ series is designed for C-track and extreme flex applications up to 10 million flex cycles*. This series utilizes super fine stranding and some of the tightest lay lengths allowed by UL, providing outstanding flex life. *(at pages 42–43)*
- **600 V MachFlex 360TC for Moderate Flexing (1 Million Flex Cycles), FCC** – The FCC series is a cost-effective alternative for C-track and moderate flexing applications rated up to 1 million flex cycles. *(at pages 44–46)*
- **300 V MachFlex Data Cables (1 Million Flex Cycles), Flex Data Cables** – Belden MachFlex Data cables are designed for industrial applications where precise data transmission is combined with high-flexing. These cables are ideal for effective operation of computer controlled equipment or other automated production processes, even in harsh environments. *(at page 261)*
- **MachFlex Vision 75 Ohm Coax Cables (1 Million Flex Cycles), Flex Vision** – Belden MachFlex Vision cables are continuous flex video cables designed for machine vision applications. They are ideal for motion-controlled video and with inspection and measurement equipment. *(at page 261)*
- **MachFlex 350**
 - DIN VDE 0295, IEC 60228, BS6360
 - DIN EN 50290-2-22, DIN VDE 0207-363-4-1
 - DIN VDE 0482-332-1-2, DIN EN 60332-1-2, IEC 60332-1-2
 - DIN EN 50525-2-51
 - RoHS&REACH&CE Directives
- **MachFlex 375**
 - DIN VDE 0295, IEC 60228, BS6360
 - DIN EN 50290-2-22, DIN VDE 0207-363-4-1
 - DIN VDE 0482-332-1-2, DIN EN 60332-1-2, IEC 60332-1-2
 - RoHS&REACH&CE Directives

* Based on proper installation techniques in a C-track cable guide.

Application Guide

Belden MachFlex Series	C-Track Systems	Multi-Axis Machining	Robotics	Auto-mated Assembly Systems	Material Handling Systems	Pick & Place Systems	Auto-mated Storage Retrieval	Gantry Systems	Machine Vision	Motion-Controlled Video	Inspection & Measure Equip.	Fes-tooning	Servo	Power	Wind
FCC Oil & abrasion resistant 600 V UL & CSA rated Life Expectancy: Over 1 million flex cycles*	●	●		●	●	●	●	●			●	●	●	●	●
C-TC+ Oil & abrasion resistant 600 V UL & CSA rated Life Expectancy: Over 10 million flex cycles*	★	★	●	★	★	★	★	★			★	★	★	★	★
DATA Oil & abrasion resistant 300 V UL & CSA rated Life Expectancy: Over 1 million flex cycles*	●	●		●	●	●	●	●			●	●			
VISION 30 V UL & CSA rated Life Expectancy: Over 1 million flex cycles*	●	●		●	●	●	●	●	★	+	+	●			

● Good + Better ★ Best

* Based on proper installation techniques in a C-track cable guide.

MachFlex Flexible Control Cables

600 V MachFlex Super 360TC for Extreme Flexing (10 Million Flex Cycles)

C-TC+ Control Cables • Unshielded



- UL AWM 2587 (600 V, +90 °C)
- CSA AWM I/II A/B 600 V +105 °C
- Sunlight Res
- Oil Res I/II
- UL Direct Burial
- IEEE 1202/383 FT4
- -40 °C to +90 °C (Cold Impact)
- -5 °C to +90 °C (Flexing)

Part No.	Conductors		Pull Tension (Max)		OD (Nom)		Insulation Thickness		Jacket Thickness		Additional Features/Ratings
	Circuit	Ground (Grn/Yel)	Lbs	N	Inch	mm	Inch	mm	Inch	mm	

Stranded BC Conductors • PVC Insulation • Abrasion Resistant Orange Belflex® TPE Jacket

20 AWG • 74 x 38

7101W	2	1	45	200	.237	6.02					
7102W	3	1	59	262	.256	6.50	.015	.38	.037	.94	
7105W	8	1	130	578	.376	9.55	.015	.38	.042	1.07	UL PLTC
7106W	11	1	178	792	.417	10.59					
7107W	17	1	260	1156	.480	12.19	.015	.38	.053	1.35	
7108W	24	1	370	1645	.563	14.30					

Stranded BC Conductors • PVC/Nylon Insulation • Abrasion Resistant Orange Belflex® TPE Jacket

18 AWG • 114 x 38

7110W	2	1	69	307	.289	7.34					
7111W	3	1	92	409	.313	7.95	.020	.51	.047	1.19	
7113W	6	1	161	716	.390	9.91					
7116W	17	1	400	1779	.576	14.63	.020	.51	.063	1.60	
7117W	24	1	575	2558	.678	17.22					

16 AWG • 190 x 38

7122W	2	1	114	507	.333	8.46	.020	.51	.047	1.19	UL AWM 21486 (1000 V, +90 °C) UL TC-ER UL WTTC 1000 V C(UL) Type TC & CIC FT4
7125W	6	1	266	1183	.460	11.68					
7126W	8	1	342	1521	.561	14.25					
7127W	11	1	456	2028	.582	14.78	.020	.51	.063	1.60	
7129W	24	1	950	4226	.800	20.32					

12 AWG • 413 x 38

7145W	3	1	330	1468	.446	11.33	.020	.51	.047	1.19	
-------	---	---	-----	------	------	-------	------	-----	------	------	--

Conductor Color Coding: Black, Numbered, Green/Yellow Ground

MachFlex Flexible Control Cables

600 V MachFlex Super 360TC for Extreme Flexing (10 Million Flex Cycles)

C-TC+ Control Cables • Braid Shielded • Double Jacketed



- UL AWM 2587 (600 V, +90 °C)
- CSA AWM I/II A/B 600 V +105 °C
- Sunlight Res
- Oil Res. I/II
- UL Direct Burial
- IEEE 1202/383 FT4
- -40 °C to +90 °C (Cold Impact)
- -5 °C to +90 °C (Flexing)

Part No.	Conductors		Pull Tension (Max)		OD (Nom)		Insulation Thickness		Inner Jacket Thickness		Outer Jacket Thickness		Additional Features/Ratings
	Circuit	Ground (Grn/Yel)	Lbs	N	Inch	mm	Inch	mm	Inch	mm	Inch	mm	

Stranded BC Conductors • PVC Insulation • TPE Inner Jacket • 85% TC Braid Shield • Abrasion Resistant Orange Belflex® TPE Jacket

20 AWG • 74 x 38

7106WS	11	1	194	863	.489	12.42	.015	.38	.025	.64	.053	1.35	UL PLTC
---------------	----	---	-----	-----	------	-------	------	-----	------	-----	------	------	---------

Stranded BC Conductors • PVC/Nylon Insulation • TPE Inner Jacket • 85% TC Braid Shield • Abrasion Resistant Orange Belflex® TPE Jacket

18 AWG Stranded • 114 x 38

7111WS	3	1	92	409	.391	9.93	.021	.53	.025	.64	.047	1.19	
---------------	---	---	----	-----	------	------	------	-----	------	-----	------	------	--

16 AWG Stranded • 190 x 38

7123WS	3	1	152	676	.435	11.05	.021	.53	.025	.64	.047	1.19	UL AWM 21486 (1000 V, +90 °C) UL TC-ER UL WTTC 1000 V C(UL) Type TC & CIC FT4
7129WS	24	1	950	4226	.918	23.32	.021	.53	0.63	1.60	.083	2.11	

14 AWG Stranded • 266 x 38

7136WS	3	1	208	925	.488	12.40	.021	.53	.030	.76	.053	1.35	
---------------	---	---	-----	-----	------	-------	------	-----	------	-----	------	------	--

Conductor Color Coding: Black, Numbered, Green/Yellow Ground.

BC = Bare Copper • TC = Tinned Copper • PVC = Polyvinyl Chloride

MachFlex Flexible Control Cables

600 V MachFlex 360TC for Moderate Flexing (1 Million Flex Cycles)

FCC Control Cable • Unshielded



- UL AWM 2587 (600 V, +90 °C)
- CSA AWM I/II A/B 600 V +105 °C
- Sunlight Res
- Oil Res I/II
- UL Direct Burial
- IEEE 1202/383 FT4
- -40 °C to +90 °C (Cold Impact)
- -5 °C to +90 °C (Flexing)

Part No.	Conductors		Pull Tension (Max)		OD (Nom)		Insulation Thickness		Jacket Thickness		Additional Features/Ratings
	Circuit	Ground (Grn/Yel)	Lbs	N	Inch	mm	Inch	mm	Inch	mm	

Stranded BC Conductors • PVC Insulation • Abrasion Resistant Chrome Belflex® TPE Jacket

20 AWG • 10 x 30

7400W	2	—	26	116	.211	5.36					
7401W	2	1	39	173	.221	5.61					
7402W	3	1	52	231	.238	6.05	.015	.38	.037	.94	
7403W	4	1	65	289	.257	6.53					
7404W	6	1	91	405	.309	7.85					UL PLTC
7405W	8	1	117	520	.345	8.76	.015	.38	.042	1.07	
7406W	11	1	156	693	.363	9.22					
7407W	17	1	234	1041	.441	11.20					
7408W	24	1	325	1445	.517	13.13	.015	.38	.053	1.35	

Stranded BC Conductors • PVC/Nylon Insulation • Abrasion Resistant Chrome Belflex® TPE Jacket

18 AWG • 16 x 30

7409W	2	—	50	222	.264	6.71	.022	.56	.040	1.02	
7410W	2	1	69	307	.289	7.34					
7411W	3	1	92	409	.313	7.95					
7412W	4	1	115	511	.339	8.61	.020	.51	.047	1.19	
7413W	6	1	161	716	.390	9.91					
7414W	8	1	252	1121	.451	11.46					
7415W	11	1	276	1227	.468	11.89					
7416W	17	1	414	1841	.576	14.63					
7417W	24	1	575	2557	.678	17.22	.020	.51	.063	1.60	
7418W	33	1	782	3478	.762	19.36					

UL AWM 21486
(1000 V, +90 °C)
UL TC-ER
UL WTTC 1000 V
C(UL) Type TC & CIC FT4

16 AWG • 26 x 30

7421W	2	—	76	338	.301	7.65					
7422W	2	1	105	467	.316	8.03					
7423W	3	1	140	623	.342	8.69	.020	.51	.047	1.19	
7424W	4	1	175	778	.371	9.42					
7425W	6	1	245	1090	.434	11.02					
7426W	8	1	315	1401	.498	12.65					
7427W	11	1	420	1868	.550	13.97					
7428W	17	1	630	2802	.636	16.15	.020	.51	.063	1.60	
7429W	24	1	875	3892	.752	19.10					
7430W	33	1	1190	5293	.882	22.40	.020	.51	.085	2.16	

Conductor Color Coding: Black, Numbered, Green/Yellow Ground

BC = Bare Copper • PVC = Polyvinyl Chloride

MachFlex Flexible Control Cables

600 V MachFlex 360TC for Moderate Flexing (1 Million Flex Cycles)

FCC Control Cable • Unshielded



- UL AWM 2587 (600 V, +90 °C)
- CSA AWM I/II A/B 600 V +105 °C
- Sunlight Res
- Oil Res I/II
- UL Direct Burial
- IEEE 1202/383 FT4
- -40 °C to +90 °C (Cold Impact)
- -5 °C to +90 °C (Flexing)

Part No.	Conductors		Pull Tension (Max)		OD (Nom)		Insulation Thickness		Jacket Thickness		Additional Features/Ratings
	Circuit	Ground (Grn/Yel)	Lbs	N	Inch	mm	Inch	mm	Inch	mm	

Stranded BC Conductors • PVC/Nylon Insulation • Abrasion Resistant Chrome Belflex® TPE Jacket

14 AWG • 41 x 30

7435W	2	1	201	894	.329	8.36					
7436W	3	1	268	1192	.381	9.68	.020	.51	.047	1.19	
7438W	6	1	469	2086	.487	12.37					
7439W	8	1	603	2682	.593	15.06					
7440W	11	1	804	3576	.617	15.67	.020	.51	.063	1.60	
7442W	24	1	1675	7451	.895	22.73	.020	.51	.085	2.16	

12 AWG • 65 x 30

7444W	2	1	253	1125	.389	9.88					
7445W	3	1	338	1503	.424	10.77	.020	.51	.047	1.19	

UL AWM 21486
(1000 V, +90 °C)
UL TC-ER
UL WTTC 1000 V
C(UL) Type TC & CIC FT4

10 AWG • 105 x 30

7447W	3	1	672	2989	.546	13.87	.025	.64	.063	1.60	
-------	---	---	-----	------	------	-------	------	-----	------	------	--

6 AWG • 266 x 30

7453W	3	1	1472	6548	.875	22.23	.040	1.02	.085	2.16	
-------	---	---	------	------	------	-------	------	------	------	------	--

Conductor Color Coding: Black, Numbered, Green/Yellow Ground

BC = Bare Copper • PVC = Polyvinyl Chloride

MachFlex Flexible Control Cables

600 V MachFlex 360TC for Moderate Flexing (1 Million Flex Cycles)

FCC Control Cables • Braid Shielded • Double Jacketed



- UL AWM 2587 (600 V, +90 °C)
- CSA AWM I/II A/B 600 V +105 °C
- Sunlight Res
- Oil Res I/II
- UL Direct Burial
- IEEE 1202/383 FT4
- -40 °C to +90 °C (Cold Impact)
- -5 °C to +90 °C (Flexing)

Part No.	Conductors		Pull Tension (Max)		OD (Nom)		Insulation Thickness		Inner Jacket Thickness		Outer Jacket Thickness		Additional Features/Ratings
	Circuit	Ground (Grn/Yel)	Lbs	N	Inch	mm	Inch	mm	Inch	mm	Inch	mm	

Stranded BC Conductors • PVC Insulation • TPE Inner Jacket • 85% TC Braid Shield • Abrasion Resistant Chrome Belflex® TPE Jacket

20 AWG • 10 x 30

7401WS	2	1	39	173	.303	7.70								
7403WS	4	1	65	289	.339	8.61	.015	.38	.025	.64	.040	1.02		
7404WS	6	1	91	405	.409	10.39								
7408WS	24	1	325	1445	.595	15.11	.015	.38	.025	.64	.053	1.35	UL PLTC	

Stranded BC Conductors • PVC/Nylon Insulation • TPE Inner Jacket • 85% TC Braid Shield • Abrasion Resistant Chrome Belflex® TPE Jacket

18 AWG • 16 x 30

7410WS	2	1	69	307	.367	9.32								
7411WS	3	1	92	409	.391	9.93	.020	.51	.025	.64	.047	1.19		
7413WS	6	1	161	716	.468	11.89								
7415WS	11	1	276	1227	.578	14.68	.020	.51	.025	.64	.060	1.52		
7416WS	17	1	414	1842	.654	16.61								
7417WS	24	1	575	2557	.756	19.20	.020	.51	.025	.64	.063	1.60		

16 AWG • 26 x 30

7422WS	2	1	105	467	.394	10.01								
7423WS	3	1	140	623	.420	10.67	.020	.51	.025	.64	.047	1.19		
7427WS	11	1	420	1868	.628	15.95								
7428WS	17	1	630	2802	.714	18.14	.020	.51	.025	.64	.063	1.60	UL AWM 21486 (1000 V, +90 °C)	
7429WS	24	1	875	3892	.870	22.10	.020	.51	.025	.64	.080	2.03	CSA AWM I/II A/B	

UL AWM 21486 (1000 V, +90 °C)
 CSA AWM I/II A/B
 UL TC-ER
 UL WTTC 1000 V
 C(UL) Type TC & CIC FT4

14 AWG • 41 x 30

7435WS	2	1	201	894	.407	10.34	.020	.51	.025	.64	.047	1.19		
7438WS	6	1	469	2086	.598	15.19	.020	.51	.025	.64	.060	1.52		

12 AWG • 65 x 30

7445WS	3	1	338	1503	.544	13.82	.020	.51	.030	.76	.060	1.52		
--------	---	---	-----	------	------	-------	------	-----	------	-----	------	------	--	--

10 AWG • 105 x 30

7447WS	3	1	546	2429	.644	16.36	.025	.64	.035	.89	.063	1.60		
--------	---	---	-----	------	------	-------	------	-----	------	-----	------	------	--	--

8 AWG • 168 x 30

7450WS	3	1	872	3879	.910	23.11	.025	.64	.040	1.02	.085	2.16		
--------	---	---	-----	------	------	-------	------	-----	------	------	------	------	--	--

Conductor Color Coding: Black, Numbered, Green/Yellow Ground.

BC = Bare Copper • TC = Tinned Copper • PVC = Polyvinyl Chloride

MachFlex 350 YY Unshielded PVC Control Cables
Unshielded Cable with (G) Protective Ground



- DIN VDE 0295, IEC 60228, BS6360
- DIN EN 50290-2-22, DIN VDE 0207-363-4-1
- DIN VDE 0482-332-1-2, DIN EN 60332-1-2, IEC 60332-1-2
- DIN EN 50525-2-51
- RoHS&REACH&CE Directives

Conductor 0.50 mm²

No. of Cores	Nom. Overall Diameter (mm)	Copper Weight (kg/km)	EMEA Part Code	APAC Part Code
3	4.9	14.40	3GA	3G0.5
4	5.3	19.20	4GA	4G0.5
5	5.9	24.00	5GA	5G0.5
7	6.4	33.60	7GA	7G0.5
12	8.6	58.00	12GA	12G0.5
20	10.8	96.70	20GA	20G0.5

Conductor 0.75 mm²

No. of Cores	Nom. Overall Diameter (mm)	Copper Weight (kg/km)	EMEA Part Code	APAC Part Code
3	5.4	21.60	3GB	3G0.75
4	5.9	28.80	4GB	4G0.75
5	6.5	36.00	5GB	5G0.75
7	7.2	50.00	7GB	7G0.75
12	9.6	86.00	12GB	12G0.75
20	12.1	143.30	20GB	20G0.75

Conductor 1.00 mm²

No. of Cores	Nom. Overall Diameter (mm)	Copper Weight (kg/km)	EMEA Part Code	APAC Part Code
3	5.8	28.80	3GC	3G1.0
4	6.4	38.40	4GC	4G1.0
5	7.1	48.00	5GC	5G1.0
7	7.8	67.00	7GC	7G1.0
12	10.5	115.00	12GC	12G1.0
20	13.2	192.00	20GC	20G1.0

Conductor 1.50 mm²

No. of Cores	Nom. Overall Diameter (mm)	Copper Weight (kg/km)	EMEA Part Code	APAC Part Code
3	6.4	43.00	3GD	3G1.5
4	7.0	58.00	4GD	4G1.5
5	7.8	72.00	5GD	5G1.5
7	8.5	101.00	7GD	7G1.5
12	11.5	173.00	12GD	12G1.5
20	14.5	288.30	20GD	20G1.5

Conductor 2.50 mm²

No. of Cores	Nom. Overall Diameter (mm)	Copper Weight (kg/km)	EMEA Part Code	APAC Part Code
3	8.3	72.00	3GE	3G2.5
4	9.2	96.00	4GE	4G2.5
5	10.1	120.00	5GE	5G2.5
7	11.2	168.00	7GE	7G2.5
12	15.2	288.00	12GE	12G2.5
20	19.2	480.00	20GE	20G2.5

Conductor 4.00 mm²

No. of Cores	Nom. Overall Diameter (mm)	Copper Weight (kg/km)	EMEA Part Code	APAC Part Code
3	9.8	115.00	3GF	3G4
4	10.9	154.00	4GF	4G4
5	12.0	192.00	5GF	5G4
7	13.3	269.00	7GF	7G4
9	16.6	345.90	9GF	9G4
12	18.1	461.00	12GF	12G4

Conductor 6.00 mm²

No. of Cores	Nom. Overall Diameter (mm)	Copper Weight (kg/km)	EMEA Part Code	APAC Part Code
3	11.8	172.80	3GG	3G6
4	13.1	230.00	4GG	4G6
5	14.5	288.00	5GG	5G6
7	16.0	403.00	7GG	7G6
9	20.1	518.10	9GG	9G6

Conductor 10.00 mm²

No. of Cores	Nom. Overall Diameter (mm)	Copper Weight (kg/km)	EMEA Part Code	APAC Part Code
3	14.8	288.00	3GH	3G10
4	16.5	384.00	4GH	4G10
5	18.3	480.00	5GH	5G10
7	20.3	672.00	7GH	7G10
9	25.5	864.00	9GH	9G10

Conductor 16.00 mm²

No. of Cores	Nom. Overall Diameter (mm)	Copper Weight (kg/km)	EMEA Part Code	APAC Part Code
3	18.1	460.50	3GI	3G16
4	20.2	614.00	4GI	4G16
5	22.4	768.00	5GI	5G16
7	24.8	1,075.00	7GI	7G16

Conductor 25.00 mm²

No. of Cores	Nom. Overall Diameter (mm)	Copper Weight (kg/km)	EMEA Part Code	APAC Part Code
3	22.3	720.00	3GJ	3G25
4	24.9	960.00	4GJ	4G25
5	27.7	1,200.00	5GJ	5G25
7	30.6	1,680.00	7GJ	7G25

- Putup length & tolerance of the cables will vary depending on the construction of the cable
- MOQ will vary depending on the construction of the cable & provided at the time of quotation
- Cable requested outside the above design criteria can be reviewed and quoted

MachFlex 350 YY Unshielded PVC Control Cables

Unshielded Cable without (G) Protective Ground



- DIN VDE 0295, IEC 60228, BS6360
- DIN EN 50290-2-22, DIN VDE 0207-363-4-1
- DIN VDE 0482-332-1-2, DIN EN 60332-1-2, IEC 60332-1-2
- DIN EN 50525-2-51
- RoHS&REACH&CE Directives

Conductor 0.50 mm²

No. of Cores	Nom. Overall Diameter (mm)	Copper Weight (kg/km)	EMEA Part Code	APAC Part Code
3	4.9	14.40	3XA	3X0.5
4	5.3	19.20	4XA	4X0.5
5	5.9	24.00	5XA	5X0.5
7	6.4	33.60	7XA	7X0.5
12	8.6	58.00	12XA	12X0.5
20	10.8	96.70	20XA	20X0.5

Conductor 0.75 mm²

No. of Cores	Nom. Overall Diameter (mm)	Copper Weight (kg/km)	EMEA Part Code	APAC Part Code
3	5.4	21.60	3XB	3X0.75
4	5.9	28.80	4XB	4X0.75
5	6.5	36.00	5XB	5X0.75
7	7.2	50.00	7XB	7X0.75
12	9.6	86.00	12XB	12X0.75
20	12.1	143.30	20XB	20X0.75

Conductor 1.00 mm²

No. of Cores	Nom. Overall Diameter (mm)	Copper Weight (kg/km)	EMEA Part Code	APAC Part Code
3	5.8	28.80	3XC	3X1.0
4	6.4	38.40	4XC	4X1.0
5	7.1	48.00	5XC	5X1.0
7	7.8	67.00	7XC	7X1.0
12	10.5	115.00	12XC	12X1.0
20	13.2	192.00	20XC	20X1.0

Conductor 1.50 mm²

No. of Cores	Nom. Overall Diameter (mm)	Copper Weight (kg/km)	EMEA Part Code	APAC Part Code
3	6.4	43.00	3XD	3X1.5
4	7.0	58.00	4XD	4X1.5
5	7.8	72.00	5XD	5X1.5
7	8.5	101.00	7XD	7X1.5
12	11.5	173.00	12XD	12X1.5
20	14.5	288.30	20XD	20X1.5

Conductor 2.50 mm²

No. of Cores	Nom. Overall Diameter (mm)	Copper Weight (kg/km)	EMEA Part Code	APAC Part Code
3	8.3	72.00	3XE	3X2.5
4	9.2	96.00	4XE	4X2.5
5	10.1	120.00	5XE	5X2.5
7	11.2	168.00	7XE	7X2.5
12	15.2	288.00	12XE	12X2.5
20	19.2	480.00	20XE	20X2.5

Conductor 4.00 mm²

No. of Cores	Nom. Overall Diameter (mm)	Copper Weight (kg/km)	EMEA Part Code	APAC Part Code
3	8.3	72.00	3XE	3X2.5
4	9.2	96.00	4XE	4X2.5
5	10.1	120.00	5XE	5X2.5
7	11.2	168.00	7XE	7X2.5
12	15.2	288.00	12XE	12X2.5
20	19.2	480.00	20XE	20X2.5

Conductor 6.00 mm²

No. of Cores	Nom. Overall Diameter (mm)	Copper Weight (kg/km)	EMEA Part Code	APAC Part Code
3	11.8	172.80	3XG	3X6
4	13.1	230.00	4XG	4X6
5	14.5	288.00	5XG	5X6
7	16.0	403.00	7XG	7X6
9	20.1	518.10	9XG	9X6

Conductor 10.00 mm²

No. of Cores	Nom. Overall Diameter (mm)	Copper Weight (kg/km)	EMEA Part Code	APAC Part Code
3	14.8	288.00	3XH	3X10
4	16.5	384.00	4XH	4X10
5	18.3	480.00	5XH	5X10
7	20.3	672.00	7XH	7X10
9	25.5	864.00	9XH	9X10

Conductor 16.00 mm²

No. of Cores	Nom. Overall Diameter (mm)	Copper Weight (kg/km)	EMEA Part Code	APAC Part Code
3	18.1	460.50	3XI	3X16
4	20.2	614.00	4XI	4X16
5	22.4	768.00	5XI	5X16
7	24.8	1,075.00	7XI	7X16

Conductor 25.00 mm²

No. of Cores	Nom. Overall Diameter (mm)	Copper Weight (kg/km)	EMEA Part Code	APAC Part Code
3	22.3	720.00	3XJ	3X25
4	24.9	960.00	4XJ	4X25
5	27.7	1,200.00	5XJ	5X25
7	30.6	1,680.00	7XJ	7X25

- Putup length & tolerance of the cables will vary depending on the construction of the cable
- MOQ will vary depending on the construction of the cable & provided at the time of quotation
- Cable requested outside the above design criteria can be reviewed and quoted

MachFlex 350 CY Shielded (CY) PVC Control Cables
Tinned Copper Braid Shielded Cable with (G) Protective Ground



- DIN VDE 0295, IEC 60228, BS6360
- DIN EN 50290-2-22, DIN VDE 0207-363-4-1
- DIN VDE 0482-332-1-2, DIN EN 60332-1-2, IEC 60332-1-2
- DIN EN 50525-2-51
- RoHS&REACH&CE Directives

Conductor 0.50 mm²

No. of Cores	Nom. Overall Diameter (mm)	Copper Weight (kg/km)	EMEA Part Code	APAC Part Code
3	7.2	45.08	3GACY	3G0.5CY
4	7.7	53.90	4GACY	4G0.5CY
5	8.3	64.68	5GACY	5G0.5CY
7	9.1	78.40	7GACY	7G0.5CY
12	11.4	135.73	12GACY	12G0.5CY
20	13.7	226.25	20GACY	20G0.5CY

Conductor 0.75 mm²

No. of Cores	Nom. Overall Diameter (mm)	Copper Weight (kg/km)	EMEA Part Code	APAC Part Code
3	7.7	55.86	3GBCY	3G0.75CY
4	8.3	62.72	4GBCY	4G0.75CY
5	9.2	75.46	5GBCY	5G0.75CY
7	9.9	99.96	7GBCY	7G0.75CY
12	12.4	173.46	12GBCY	12G0.75CY
20	15.0	289.10	20GBCY	20G0.75CY

Conductor 1.00 mm²

No. of Cores	Nom. Overall Diameter (mm)	Copper Weight (kg/km)	EMEA Part Code	APAC Part Code
3	8.2	63.70	3GCCY	3G1.0CY
4	9.1	76.44	4GCCY	4G1.0CY
5	9.8	87.22	5GCCY	5G1.0CY
7	10.5	110.74	7GCCY	7G1.0CY
12	13.3	184.34	12GCCY	12G1.0CY
20	16.1	307.23	20GCCY	20G1.0CY

Conductor 1.50 mm²

No. of Cores	Nom. Overall Diameter (mm)	Copper Weight (kg/km)	EMEA Part Code	APAC Part Code
3	9.0	77.42	3GDCY	3G1.5CY
4	9.7	95.06	4GDCY	4G1.5CY
5	10.5	113.68	5GDCY	5G1.5CY
7	11.3	146.02	7GDCY	7G1.5CY
12	14.4	274.40	12GDCY	12G1.5CY
20	17.5	457.33	20GDCY	20G1.5CY

Conductor 2.50 mm²

No. of Cores	Nom. Overall Diameter (mm)	Copper Weight (kg/km)	EMEA Part Code	APAC Part Code
3	11.0	143.08	3GECY	3G2.5CY
4	11.9	163.66	4GECY	4G2.5CY
5	12.9	196.00	5GECY	5G2.5CY
7	14.0	282.24	7GECY	7G2.5CY
12	18.2	467.75	12GECY	12G2.5CY
20	22.7	779.58	20GECY	20G2.5CY

Conductor 4.00 mm²

No. of Cores	Nom. Overall Diameter (mm)	Copper Weight (kg/km)	EMEA Part Code	APAC Part Code
3	12.6	174.20	3GFCY	3G4CY
4	13.7	232.26	4GFCY	4G4CY
5	14.9	274.40	5GFCY	5G4CY
7	16.2	384.16	7GFCY	7G4CY
9	20.0	493.92	9GFCY	9G4CY
12	21.5	658.56	12GFCY	12G4CY

Conductor 6.00 mm²

No. of Cores	Nom. Overall Diameter (mm)	Copper Weight (kg/km)	EMEA Part Code	APAC Part Code
3	14.6	233.73	3GGCY	3G6CY
4	16.0	311.64	4GGCY	4G6CY
5	17.5	432.18	5GGCY	5G6CY
7	19.1	519.40	7GGCY	7G6CY
9	23.6	667.80	9GGCY	9G6CY

Conductor 10.00 mm²

No. of Cores	Nom. Overall Diameter (mm)	Copper Weight (kg/km)	EMEA Part Code	APAC Part Code
3	17.8	355.15	3GHCY	3G10CY
4	19.8	507.64	4GHCY	4G10CY
5	21.7	583.10	5GHCY	5G10CY
7	23.8	780.08	7GHCY	7G10CY
9	29.2	1,004.24	9GHCY	9G10CY

Conductor 16.00 mm²

No. of Cores	Nom. Overall Diameter (mm)	Copper Weight (kg/km)	EMEA Part Code	APAC Part Code
3	21.5	594.86	3GICY	3G16CY
4	23.6	787.92	4GICY	4G16CY
5	26.0	916.30	5GICY	5G16CY
7	28.5	1,282.82	7GICY	7G16CY

Conductor 25.00 mm²

No. of Cores	Nom. Overall Diameter (mm)	Copper Weight (kg/km)	EMEA Part Code	APAC Part Code
3	25.9	853.33	3GJCY	3G25CY
4	28.6	1,137.78	4GJCY	4G25CY
5	31.5	1,372.00	5GJCY	5G25CY
7	34.2	1,920.80	7GJCY	7G25CY

- Putup length & tolerance of the cables will vary depending on the construction of the cable
- MOQ will vary depending on the construction of the cable & provided at the time of quotation
- Cable requested outside the above design criteria can be reviewed and quoted

MachFlex 350 CY Shielded (CY) PVC Control Cables
Tinned Copper Braid Shielded Cable without (G) Protective Ground



- DIN VDE 0295, IEC 60228, BS6360
- DIN EN 50290-2-22, DIN VDE 0207-363-4-1
- DIN VDE 0482-332-1-2, DIN EN 60332-1-2, IEC 60332-1-2
- DIN EN 50525-2-51
- RoHS&REACH&CE Directives

Conductor 0.50 mm²

No. of Cores	Nom. Overall Diameter (mm)	Copper Weight (kg/km)	EMEA Part Code	APAC Part Code
3	7.2	45.08	3XACY	3X0.5CY
4	7.7	53.90	4XACY	4X0.5CY
5	8.3	64.68	5XACY	5X0.5CY
7	9.1	78.40	7XACY	7X0.5CY
12	11.4	135.73	12XACY	12X0.5CY
20	13.7	226.25	20XACY	20X0.5CY

Conductor 0.75 mm²

No. of Cores	Nom. Overall Diameter (mm)	Copper Weight (kg/km)	EMEA Part Code	APAC Part Code
3	7.7	55.86	3XBCY	3X0.75CY
4	8.3	62.72	4XBCY	4X0.75CY
5	9.2	75.46	5XBCY	5X0.75CY
7	9.9	99.96	7XBCY	7X0.75CY
12	12.4	173.46	12XBCY	12X0.75CY
20	15.0	289.10	20XBCY	20X0.75CY

Conductor 1.00 mm²

No. of Cores	Nom. Overall Diameter (mm)	Copper Weight (kg/km)	EMEA Part Code	APAC Part Code
3	8.2	63.70	3XCCY	3X1.0CY
4	9.1	76.44	4XCCY	4X1.0CY
5	9.8	87.22	5XCCY	5X1.0CY
7	10.5	110.74	7XCCY	7X1.0CY
12	13.3	184.34	12XCCY	12X1.0CY
20	16.1	307.23	20XCCY	20X1.0CY

Conductor 1.50 mm²

No. of Cores	Nom. Overall Diameter (mm)	Copper Weight (kg/km)	EMEA Part Code	APAC Part Code
3	9.0	77.42	3XDCY	3X1.5CY
4	9.7	95.06	4XDCY	4X1.5CY
5	10.5	113.68	5XDCY	5X1.5CY
7	11.3	146.02	7XDCY	7X1.5CY
12	14.4	274.40	12XDCY	12X1.5CY
20	17.5	457.33	20XDCY	20X1.5CY

Conductor 2.50 mm²

No. of Cores	Nom. Overall Diameter (mm)	Copper Weight (kg/km)	EMEA Part Code	APAC Part Code
3	11.0	143.08	3XECY	3X2.5CY
4	11.9	163.66	4XECY	4X2.5CY
5	12.9	196.00	5XECY	5X2.5CY
7	14.0	282.24	7XECY	7X2.5CY
12	18.2	467.75	12XECY	12X2.5CY
20	22.7	779.58	20XECY	20X2.5CY

Conductor 4.00 mm²

No. of Cores	Nom. Overall Diameter (mm)	Copper Weight (kg/km)	EMEA Part Code	APAC Part Code
3	12.6	174.20	3XFCY	3X4CY
4	13.7	232.26	4XFCY	4X4CY
5	14.9	274.40	5XFCY	5X4CY
7	16.2	384.16	7XFCY	7X4CY
9	20.0	493.92	9XFCY	9X4CY
12	21.5	658.56	12XFCY	12X4CY

Conductor 6.00 mm²

No. of Cores	Nom. Overall Diameter (mm)	Copper Weight (kg/km)	EMEA Part Code	APAC Part Code
3	14.6	233.73	3XGCV	3X6CY
4	16.0	311.64	4XGCV	4X6CY
5	17.5	432.18	5XGCV	5X6CY
7	19.1	519.40	7XGCV	7X6CY
9	23.6	667.80	9XGCV	9X6CY

Conductor 10.00 mm²

No. of Cores	Nom. Overall Diameter (mm)	Copper Weight (kg/km)	EMEA Part Code	APAC Part Code
3	17.8	355.15	3XHCY	3X10CY
4	19.8	507.64	4XHCY	4X10CY
5	21.7	583.10	5XHCY	5X10CY
7	23.8	780.08	7XHCY	7X10CY
9	29.2	1,004.24	9XHCY	9X10CY

Conductor 16.00 mm²

No. of Cores	Nom. Overall Diameter (mm)	Copper Weight (kg/km)	EMEA Part Code	APAC Part Code
3	21.5	594.86	3XICY	3X16CY
4	23.6	787.92	4XICY	4X16CY
5	26.0	916.30	5XICY	5X16CY
7	28.5	1,282.82	7XICY	7X16CY

Conductor 25.00 mm²

No. of Cores	Nom. Overall Diameter (mm)	Copper Weight (kg/km)	EMEA Part Code	APAC Part Code
3	25.9	853.33	3XJCY	3X25CY
4	28.6	1,137.78	4XJCY	4X25CY
5	31.5	1,372.00	5XJCY	5X25CY
7	34.2	1,920.80	7XJCY	7X25CY

- Putup length & tolerance of the cables will vary depending on the construction of the cable
- MOQ will vary depending on the construction of the cable & provided at the time of quotation
- Cable requested outside the above design criteria can be reviewed and quoted

MachFlex 350 SY Armored (SY) PVC Control Cables
Galvanized Steel Wire Braid Shield (GSWB) Cable with (G) Protective Ground



- DIN VDE 0295, IEC 60228, BS6360
- DIN EN 50290-2-22, DIN VDE 0207-363-4-1
- DIN VDE 0482-332-1-2, DIN EN 60332-1-2, IEC 60332-1-2
- DIN EN 50525-2-51
- RoHS&REACH&CE Directives

Conductor 0.50 mm²

No. of Cores	Nom. Overall Diameter (mm)	Copper Weight (kg/km)	EMEA Part Code	APAC Part Code
3	7.5	14.40	3GASY	3G0.5SY
4	8.0	19.20	4GASY	4G0.5SY
5	8.5	24.00	5GASY	5G0.5SY
7	9.1	33.60	7GASY	7G0.5SY
12	11.4	58.00	12GASY	12G0.5SY
20	13.9	96.70	20GASY	20G0.5SY

Conductor 0.75 mm²

No. of Cores	Nom. Overall Diameter (mm)	Copper Weight (kg/km)	EMEA Part Code	APAC Part Code
3	8.0	21.60	3GBSY	3G0.75SY
4	8.6	28.80	4GBSY	4G0.75SY
5	9.2	36.00	5GBSY	5G0.75SY
7	9.9	50.00	7GBSY	7G0.75SY
12	12.4	86.00	12GBSY	12G0.75SY
20	15.2	143.30	20GBSY	20G0.75SY

Conductor 1.00 mm²

No. of Cores	Nom. Overall Diameter (mm)	Copper Weight (kg/km)	EMEA Part Code	APAC Part Code
3	8.4	28.80	3GCSY	3G1.0SY
4	9.1	38.40	4GCSY	4G1.0SY
5	9.8	48.00	5GCSY	5G1.0SY
7	10.5	67.00	7GCSY	7G1.0SY
12	13.3	115.00	12GCSY	12G1.0SY
20	16.3	192.00	20GCSY	20G1.0SY

Conductor 1.50 mm²

No. of Cores	Nom. Overall Diameter (mm)	Copper Weight (kg/km)	EMEA Part Code	APAC Part Code
3	9.0	43.00	3GDSY	3G1.5SY
4	9.7	58.00	4GDSY	4G1.5SY
5	10.5	72.00	5GDSY	5G1.5SY
7	11.3	101.00	7GDSY	7G1.5SY
12	14.6	173.00	12GDSY	12G1.5SY
20	17.7	288.30	20GDSY	20G1.5SY

Conductor 2.50 mm²

No. of Cores	Nom. Overall Diameter (mm)	Copper Weight (kg/km)	EMEA Part Code	APAC Part Code
3	11.0	72.00	3GESY	3G2.5SY
4	11.9	96.00	4GESY	4G2.5SY
5	12.9	120.00	5GESY	5G2.5SY
7	14.2	168.00	7GESY	7G2.5SY
12	18.4	288.00	12GESY	12G2.5SY
20	22.6	480.00	20GESY	20G2.5SY

Conductor 4.00 mm²

No. of Cores	Nom. Overall Diameter (mm)	Copper Weight (kg/km)	EMEA Part Code	APAC Part Code
3	12.6	115.00	3GFSY	3G4SY
4	13.9	154.00	4GFSY	4G4SY
5	15.1	192.00	5GFSY	5G4SY
7	16.4	269.00	7GFSY	7G4SY
9	19.9	345.90	9GFSY	9G4SY
12	21.5	461.00	12GFSY	12G4SY

Conductor 6.00 mm²

No. of Cores	Nom. Overall Diameter (mm)	Copper Weight (kg/km)	EMEA Part Code	APAC Part Code
3	14.9	172.80	3GGSY	3G6SY
4	16.2	230.00	4GGSY	4G6SY
5	17.7	288.00	5GGSY	5G6SY
7	19.3	403.00	7GGSY	7G6SY
9	23.5	518.10	9GGSY	9G6SY

Conductor 10.00 mm²

No. of Cores	Nom. Overall Diameter (mm)	Copper Weight (kg/km)	EMEA Part Code	APAC Part Code
3	18.0	288.00	3GHSY	3G10SY
4	19.8	384.00	4GHSY	4G10SY
5	21.7	480.00	5GHSY	5G10SY
7	23.7	672.00	7GHSY	7G10SY
9	29.1	864.00	9GHSY	9G10SY

Conductor 16.00 mm²

No. of Cores	Nom. Overall Diameter (mm)	Copper Weight (kg/km)	EMEA Part Code	APAC Part Code
3	21.4	460.50	3GISY	3G16SY
4	23.6	614.00	4GISY	4G16SY
5	26.1	768.00	5GISY	5G16SY
7	28.4	1,075.00	7GISY	7G16SY

Conductor 25.00 mm²

No. of Cores	Nom. Overall Diameter (mm)	Copper Weight (kg/km)	EMEA Part Code	APAC Part Code
3	25.9	720.00	3GJSY	3G25SY
4	28.6	960.00	4GJSY	4G25SY
5	31.2	1,200.00	5GJSY	5G25SY
7	33.9	1,680.00	7GJSY	7G25SY

- Putup length & tolerance of the cables will vary depending on the construction of the cable
- MOQ will vary depending on the construction of the cable & provided at the time of quotation
- Cable requested outside the above design criteria can be reviewed and quoted

MachFlex 350 SY Armored (SY) PVC Control Cables

Galvanized Steel Wire Braid Shield (GSWB) Cable without (G) Protective Ground



- DIN VDE 0295, IEC 60228, BS6360
- DIN EN 50290-2-22, DIN VDE 0207-363-4-1
- DIN VDE 0482-332-1-2, DIN EN 60332-1-2, IEC 60332-1-2
- DIN EN 50525-2-51
- RoHS&REACH&CE Directives

Conductor 0.50 mm²

No. of Cores	Nom. Overall Diameter (mm)	Copper Weight (kg/km)	EMEA Part Code	APAC Part Code
3	7.5	14.40	3XASY	3X0.5SY
4	8.0	19.20	4XASY	4X0.5SY
5	8.5	24.00	5XASY	5X0.5SY
7	9.1	33.60	7XASY	7X0.5SY
12	11.4	58.00	12XASY	12X0.5SY
20	13.9	96.70	20XASY	20X0.5SY

Conductor 0.75 mm²

No. of Cores	Nom. Overall Diameter (mm)	Copper Weight (kg/km)	EMEA Part Code	APAC Part Code
3	8.0	21.60	3XBSY	3X0.75SY
4	8.6	28.80	4XBSY	4X0.75SY
5	9.2	36.00	5XBSY	5X0.75SY
7	9.9	50.00	7XBSY	7X0.75SY
12	12.4	86.00	12XBSY	12X0.75SY
20	15.2	143.30	20XBSY	20X0.75SY

Conductor 1.00 mm²

No. of Cores	Nom. Overall Diameter (mm)	Copper Weight (kg/km)	EMEA Part Code	APAC Part Code
3	8.4	28.80	3XCSY	3X1.0SY
4	9.1	38.40	4XCSY	4X1.0SY
5	9.8	48.00	5XCSY	5X1.0SY
7	10.5	67.00	7XCSY	7X1.0SY
12	13.3	115.00	12XCSY	12X1.0SY
20	16.3	192.00	20XCSY	20X1.0SY

Conductor 1.50 mm²

No. of Cores	Nom. Overall Diameter (mm)	Copper Weight (kg/km)	EMEA Part Code	APAC Part Code
3	9.0	43.00	3XDSY	3X1.5SY
4	9.7	58.00	4XDSY	4X1.5SY
5	10.5	72.00	5XDSY	5X1.5SY
7	11.3	101.00	7XDSY	7X1.5SY
12	14.6	173.00	12XDSY	12X1.5SY
20	17.7	288.30	20XDSY	20X1.5SY

Conductor 2.50 mm²

No. of Cores	Nom. Overall Diameter (mm)	Copper Weight (kg/km)	EMEA Part Code	APAC Part Code
3	11.0	72.00	3XESY	3X2.5SY
4	11.9	96.00	4XESY	4X2.5SY
5	12.9	120.00	5XESY	5X2.5SY
7	14.2	168.00	7XESY	7X2.5SY
12	18.4	288.00	12XESY	12X2.5SY
20	22.6	480.00	20XESY	20X2.5SY

Conductor 4.00 mm²

No. of Cores	Nom. Overall Diameter (mm)	Copper Weight (kg/km)	EMEA Part Code	APAC Part Code
3	12.6	115.00	3XFSY	3X4SY
4	13.9	154.00	4XFSY	4X4SY
5	15.1	192.00	5XFSY	5X4SY
7	16.4	269.00	7XFSY	7X4SY
9	19.9	345.90	9XFSY	9X4SY
12	21.5	461.00	12XFSY	12X4SY

Conductor 6.00 mm²

No. of Cores	Nom. Overall Diameter (mm)	Copper Weight (kg/km)	EMEA Part Code	APAC Part Code
3	14.9	172.80	3XGSY	3X6SY
4	16.2	230.00	4XGSY	4X6SY
5	17.7	288.00	5XGSY	5X6SY
7	19.3	403.00	7XGSY	7X6SY
9	23.5	518.10	9XGSY	9X6SY

Conductor 10.00 mm²

No. of Cores	Nom. Overall Diameter (mm)	Copper Weight (kg/km)	EMEA Part Code	APAC Part Code
3	18.0	288.00	3XHSY	3X10SY
4	19.8	384.00	4XHSY	4X10SY
5	21.7	480.00	5XHSY	5X10SY
7	23.7	672.00	7XHSY	7X10SY
9	29.1	864.00	9XHSY	9X10SY

Conductor 16.00 mm²

No. of Cores	Nom. Overall Diameter (mm)	Copper Weight (kg/km)	EMEA Part Code	APAC Part Code
3	21.4	460.50	3XISY	3X16SY
4	23.6	614.00	4XISY	4X16SY
5	26.1	768.00	5XISY	5X16SY
7	28.4	1,075.00	7XISY	7X16SY

Conductor 25.00 mm²

No. of Cores	Nom. Overall Diameter (mm)	Copper Weight (kg/km)	EMEA Part Code	APAC Part Code
3	25.9	720.00	3XJSY	3X25SY
4	28.6	960.00	4XJSY	4X25SY
5	31.2	1,200.00	5XJSY	5X25SY
7	33.9	1,680.00	7XJSY	7X25SY

- Putup length & tolerance of the cables will vary depending on the construction of the cable
- MOQ will vary depending on the construction of the cable & provided at the time of quotation
- Cable requested outside the above design criteria can be reviewed and quoted

MachFlex 375 YY Unshielded PVC Control Cables
Unshielded Cable with (G) Protective Ground

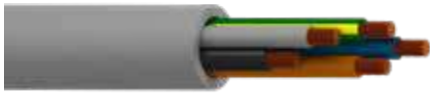

- DIN VDE 0295, IEC 60228, BS6360
- DIN EN 50290-2-22, DIN VDE 0207-363-4-1
- DIN VDE 0482-332-1-2, DIN EN 60332-1-2, IEC 60332-1-2
- RoHS&REACH&CE Directives

Conductor 0.50 mm²

No. of Cores	Nom. Overall Diameter (mm)	Copper Weight (kg/km)	EMEA Part Code	APAC Part Code
3	5.1	14.40	C3GA	C3G0.5
4	5.6	19.20	C4GA	C4G0.5
5	6.2	24.00	C5GA	C5G0.5
7	6.8	33.60	C7GA	C7G0.5
12	9.1	58.00	C12GA	C12G0.5
20	11.4	96.70	C20GA	C20G0.5

Conductor 0.75 mm²

No. of Cores	Nom. Overall Diameter (mm)	Copper Weight (kg/km)	EMEA Part Code	APAC Part Code
3	5.6	21.60	C3GB	C3G0.75
4	6.2	28.80	C4GB	C4G0.75
5	6.8	36.00	C5GB	C5G0.75
7	7.5	50.00	C7GB	C7G0.75
12	10.1	86.00	C12GB	C12G0.75
20	12.7	143.30	C20GB	C20G0.75

Conductor 1.00 mm²

No. of Cores	Nom. Overall Diameter (mm)	Copper Weight (kg/km)	EMEA Part Code	APAC Part Code
3	6.1	28.80	C3GC	C3G1.0
4	6.7	38.40	C4GC	C4G1.0
5	7.4	48.00	C5GC	C5G1.0
7	8.1	67.00	C7GC	C7G1.0
12	10.9	115.00	C12GC	C12G1.0
20	13.8	192.00	C20GC	C20G1.0

Conductor 1.50 mm²

No. of Cores	Nom. Overall Diameter (mm)	Copper Weight (kg/km)	EMEA Part Code	APAC Part Code
3	6.6	43.00	C3GD	C3G1.5
4	7.3	58.00	C4GD	C4G1.5
5	8.1	72.00	C5GD	C5G1.5
7	8.9	101.00	C7GD	C7G1.5
12	12.0	173.00	C12GD	C12G1.5
20	15.1	288.30	C20GD	C20G1.5

Conductor 2.50 mm²

No. of Cores	Nom. Overall Diameter (mm)	Copper Weight (kg/km)	EMEA Part Code	APAC Part Code
3	9.8	72.00	C3GE	C3G2.5
4	10.9	96.00	C4GE	C4G2.5
5	12.0	120.00	C5GE	C5G2.5
7	13.3	168.00	C7GE	C7G2.5
9	16.6	216.00	C9GE	C9G2.5
12	18.1	288.00	C12GE	C12G2.5

Conductor 4.00 mm²

No. of Cores	Nom. Overall Diameter (mm)	Copper Weight (kg/km)	EMEA Part Code	APAC Part Code
3	11.3	115.00	3GF	C3G4
4	12.6	154.00	4GF	C4G4
5	13.9	192.00	5GF	C5G4
7	15.4	269.00	7GF	C7G4
9	19.3	345.90	C9GF	C9G4
12	21.0	461.00	C12GF	C12G4

Conductor 6.00 mm²

No. of Cores	Nom. Overall Diameter (mm)	Copper Weight (kg/km)	EMEA Part Code	APAC Part Code
3	12.8	172.80	C3GG	C3G6
4	14.2	230.00	C4GG	C4G6
5	15.8	288.00	C5GG	C5G6
7	17.4	403.00	C7GG	C7G6
9	21.9	518.10	C9GG	C9G6

Conductor 10.00 mm²

No. of Cores	Nom. Overall Diameter (mm)	Copper Weight (kg/km)	EMEA Part Code	APAC Part Code
3	15.3	288.00	C3GH	C3G10
4	17.1	384.00	C4GH	C4G10
5	19.0	480.00	C5GH	C5G10
7	21.0	672.00	C7GH	C7G10
9	26.4	864.00	C9GH	C9G10

Conductor 16.00 mm²

No. of Cores	Nom. Overall Diameter (mm)	Copper Weight (kg/km)	EMEA Part Code	APAC Part Code
3	19.6	460.50	C3GI	C3G16
4	21.9	614.00	C4GI	C4G16
5	24.3	768.00	C5GI	C5G16

Conductor 25.00 mm²

No. of Cores	Nom. Overall Diameter (mm)	Copper Weight (kg/km)	EMEA Part Code	APAC Part Code
3	22.3	720.00	C3GJ	C3G25
4	24.9	960.00	C4GJ	C4G25
5	27.7	1,200.00	C5GJ	C5G25

- Putup length & tolerance of the cables will vary depending on the construction of the cable
- MOQ will vary depending on the construction of the cable & provided at the time of quotation
- Cable requested outside the above design criteria can be reviewed and quoted

MachFlex 375 YY Unshielded PVC Control Cables

Unshielded Cable without (G) Protective Ground



- DIN VDE 0295, IEC 60228, BS6360
- DIN EN 50290-2-22, DIN VDE 0207-363-4-1
- DIN VDE 0482-332-1-2, DIN EN 60332-1-2, IEC 60332-1-2
- RoHS&REACH&CE Directives

Conductor 0.50 mm²

No. of Cores	Nom. Overall Diameter (mm)	Copper Weight (kg/km)	EMEA Part Code	APAC Part Code
3	5.1	14.40	C3XA	C3X0.5
4	5.6	19.20	C4XA	C4X0.5
5	6.2	24.00	C5XA	C5X0.5
7	6.8	33.60	C7XA	C7X0.5
12	9.1	58.00	C12XA	C12X0.5
20	11.4	96.70	C20XA	C20X0.5

Conductor 0.75 mm²

No. of Cores	Nom. Overall Diameter (mm)	Copper Weight (kg/km)	EMEA Part Code	APAC Part Code
3	5.6	21.60	C3XB	C3X0.75
4	6.2	28.80	C4XB	C4X0.75
5	6.8	36.00	C5XB	C5X0.75
7	7.5	50.00	C7XB	C7X0.75
12	10.1	86.00	C12XB	C12X0.75
20	12.7	143.30	C20XB	C20X0.75

Conductor 1.00 mm²

No. of Cores	Nom. Overall Diameter (mm)	Copper Weight (kg/km)	EMEA Part Code	APAC Part Code
3	6.1	28.80	C3XC	C3X1.0
4	6.7	38.40	C4XC	C4X1.0
5	7.4	48.00	C5XC	C5X1.0
7	8.1	67.00	C7XC	C7X1.0
12	10.9	115.00	C12XC	C12X1.0
20	13.8	192.00	C20XC	C20X1.0

Conductor 1.50 mm²

No. of Cores	Nom. Overall Diameter (mm)	Copper Weight (kg/km)	EMEA Part Code	APAC Part Code
3	6.6	43.00	C3XD	C3X1.5
4	7.3	58.00	C4XD	C4X1.5
5	8.1	72.00	C5XD	C5X1.5
7	8.9	101.00	C7XD	C7X1.5
12	12.0	173.00	C12XD	C12X1.5
20	15.1	288.30	C20XD	C20X1.5

Conductor 2.50 mm²

No. of Cores	Nom. Overall Diameter (mm)	Copper Weight (kg/km)	EMEA Part Code	APAC Part Code
3	9.8	72.00	C3XE	C3X2.5
4	10.9	96.00	C4XE	C4X2.5
5	12.0	120.00	C5XE	C5X2.5
7	13.3	168.00	C7XE	C7X2.5
9	16.6	216.00	C9XE	C9X2.5
12	18.1	288.00	C12XE	C12X2.5

Conductor 4.00 mm²

No. of Cores	Nom. Overall Diameter (mm)	Copper Weight (kg/km)	EMEA Part Code	APAC Part Code
3	11.3	115.00	C3XF	C3X4
4	12.6	154.00	C4XF	C4X4
5	13.9	192.00	C5XF	C5X4
7	15.4	269.00	C7XF	C7X4
9	19.3	345.90	C9XF	C9X4
12	21.0	461.00	C12XF	C12X4

Conductor 6.00 mm²

No. of Cores	Nom. Overall Diameter (mm)	Copper Weight (kg/km)	EMEA Part Code	APAC Part Code
3	12.8	172.80	C3XG	C3X6
4	14.2	230.00	C4XG	C4X6
5	15.8	288.00	C5XG	C5X6
7	17.4	403.00	C7XG	C7X6
9	21.9	518.10	C9XG	C9X6

Conductor 10.00 mm²

No. of Cores	Nom. Overall Diameter (mm)	Copper Weight (kg/km)	EMEA Part Code	APAC Part Code
3	15.3	288.00	C3XH	C3X10
4	17.1	384.00	C4XH	C4X10
5	19.0	480.00	C5XH	C5X10
7	21.0	672.00	C7XH	C7X10
9	26.4	864.00	C9XH	C9X10

Conductor 16.00 mm²

No. of Cores	Nom. Overall Diameter (mm)	Copper Weight (kg/km)	EMEA Part Code	APAC Part Code
3	19.6	460.50	C3XI	C3X16
4	21.9	614.00	C4XI	C4X16
5	24.3	768.00	C5XI	C5X16

Conductor 25.00 mm²

No. of Cores	Nom. Overall Diameter (mm)	Copper Weight (kg/km)	EMEA Part Code	APAC Part Code
3	22.3	720.00	C3XJ	C3X25
4	24.9	960.00	C4XJ	C4X25
5	27.7	1,200.00	C5XJ	C5X25

- Putup length & tolerance of the cables will vary depending on the construction of the cable
- MOQ will vary depending on the construction of the cable & provided at the time of quotation
- Cable requested outside the above design criteria can be reviewed and quoted

MachFlex 375 CY Shielded (CY) PVC Control Cables
Tinned Copper Braid Shielded Cable with (G) Protective Ground



- DIN VDE 0295, IEC 60228, BS6360
- DIN EN 50290-2-22, DIN VDE 0207-363-4-1
- DIN VDE 0482-332-1-2, DIN EN 60332-1-2, IEC 60332-1-2
- RoHS&REACH&CE Directives

Conductor 0.50 mm²

No. of Cores	Nom. Overall Diameter (mm)	Copper Weight (kg/km)	EMEA Part Code	APAC Part Code
3	7.2	45.08	C3GACY	C3G0.5CY
4	7.7	53.90	C4GACY	C4G0.5CY
5	8.3	64.68	C5GACY	C5G0.5CY
7	8.9	78.40	C7GACY	C7G0.5CY
12	11.3	135.73	C12GACY	C12G0.5CY
20	13.9	226.25	C20GACY	C20G0.5CY

Conductor 0.75 mm²

No. of Cores	Nom. Overall Diameter (mm)	Copper Weight (kg/km)	EMEA Part Code	APAC Part Code
3	7.7	55.86	C3GBCY	C3G0.75CY
4	8.3	62.72	C4GBCY	C4G0.75CY
5	9.0	75.46	C5GBCY	C5G0.75CY
7	9.7	99.96	C7GBCY	C7G0.75CY
12	12.4	173.46	C12GBCY	C12G0.75CY
20	15.2	289.10	C20GBCY	C20G0.75CY

Conductor 1.00 mm²

No. of Cores	Nom. Overall Diameter (mm)	Copper Weight (kg/km)	EMEA Part Code	APAC Part Code
3	8.2	63.70	C3GCCY	C3G1.0CY
4	8.8	76.44	C4GCCY	C4G1.0CY
5	9.6	87.22	C5GCCY	C5G1.0CY
7	10.3	110.74	C7GCCY	C7G1.0CY
12	13.4	184.34	C12GCCY	C12G1.0CY
20	16.3	307.23	C20GCCY	C20G1.0CY

Conductor 1.50 mm²

No. of Cores	Nom. Overall Diameter (mm)	Copper Weight (kg/km)	EMEA Part Code	APAC Part Code
3	8.8	77.42	C3GDCY	C3G1.5CY
4	9.5	95.06	C4GDCY	C4G1.5CY
5	10.3	113.68	C5GDCY	C5G1.5CY
7	11.1	146.02	C7GDCY	C7G1.5CY
12	14.5	274.40	C12GDCY	C12G1.5CY
20	17.7	457.33	C20GDCY	C20G1.5CY

Conductor 2.50 mm²

No. of Cores	Nom. Overall Diameter (mm)	Copper Weight (kg/km)	EMEA Part Code	APAC Part Code
3	12.0	143.08	C3GECY	C3G2.5CY
4	13.3	163.66	C4GECY	C4G2.5CY
5	14.5	196.00	C5GECY	C5G2.5CY
7	15.8	282.24	C7GECY	C7G2.5CY
9	19.2	362.88	C9GECY	C9G2.5CY
12	20.8	467.75	C12GECY	C12G2.5CY

Conductor 4.00 mm²

No. of Cores	Nom. Overall Diameter (mm)	Copper Weight (kg/km)	EMEA Part Code	APAC Part Code
3	13.7	174.20	C3GFCY	C3G4CY
4	15.1	232.26	C4GFCY	C4G4CY
5	16.5	274.40	C5GFCY	C5G4CY
7	18.0	384.16	C7GFCY	C7G4CY
9	22.0	493.92	C9GFCY	C9G4CY
12	24.0	658.56	C12GFCY	C12G4CY

Conductor 6.00 mm²

No. of Cores	Nom. Overall Diameter (mm)	Copper Weight (kg/km)	EMEA Part Code	APAC Part Code
3	15.3	233.73	C3GGCY	C3G6CY
4	16.8	311.64	C4GGCY	C4G6CY
5	18.4	432.18	C5GGCY	C5G6CY
7	20.1	519.40	C7GGCY	C7G6CY
9	24.9	667.80	C9GGCY	C9G6CY

Conductor 10.00 mm²

No. of Cores	Nom. Overall Diameter (mm)	Copper Weight (kg/km)	EMEA Part Code	APAC Part Code
3	17.9	355.15	C3GHCY	C3G10CY
4	19.8	507.64	C4GHCY	C4G10CY
5	21.7	583.10	C5GHCY	C5G10CY
7	24.0	780.08	C7GHCY	C7G10CY
9	29.6	1,004.24	C9GHCY	C9G10CY

Conductor 16.00 mm²

No. of Cores	Nom. Overall Diameter (mm)	Copper Weight (kg/km)	EMEA Part Code	APAC Part Code
3	22.5	594.86	C3GICY	C3G16CY
4	24.9	787.92	C4GICY	C4G16CY
5	27.4	916.30	C5GICY	C5G16CY

Conductor 25.00 mm²

No. of Cores	Nom. Overall Diameter (mm)	Copper Weight (kg/km)	EMEA Part Code	APAC Part Code
3	25.4	853.33	C3GJCY	C3G25CY
4	28.1	1,137.78	C4GJCY	C4G25CY
5	30.8	1,372.00	C5GJCY	C5G25CY

- Putup length & tolerance of the cables will vary depending on the construction of the cable
- MOQ will vary depending on the construction of the cable & provided at the time of quotation
- Cable requested outside the above design criteria can be reviewed and quoted

MachFlex 375 CY Shielded (CY) PVC Control Cables
Tinned Copper Braid Shielded Cable without (G) Protective Ground



- DIN VDE 0295, IEC 60228, BS6360
- DIN EN 50290-2-22, DIN VDE 0207-363-4-1
- DIN VDE 0482-332-1-2, DIN EN 60332-1-2, IEC 60332-1-2
- RoHS&REACH&CE Directives

Conductor 0.50 mm²

No. of Cores	Nom. Overall Diameter (mm)	Copper Weight (kg/km)	EMEA Part Code	APAC Part Code
3	7.2	45.08	C3XACY	C3X0.5CY
4	7.7	53.90	C4XACY	C4X0.5CY
5	8.3	64.68	C5XACY	C5X0.5CY
7	8.9	78.40	C7XACY	C7X0.5CY
12	11.3	135.73	C12XACY	C12X0.5CY
20	13.9	226.25	C20XACY	C20X0.5CY

Conductor 0.75 mm²

No. of Cores	Nom. Overall Diameter (mm)	Copper Weight (kg/km)	EMEA Part Code	APAC Part Code
3	7.7	55.86	C3XBCY	C3X0.75CY
4	8.3	62.72	C4XBCY	C4X0.75CY
5	9.0	75.46	C5XBCY	C5X0.75CY
7	9.7	99.96	C7XBCY	C7X0.75CY
12	12.4	173.46	C12XBCY	C12X0.75CY
20	15.2	289.10	C20XBCY	C20X0.75CY

Conductor 1.00 mm²

No. of Cores	Nom. Overall Diameter (mm)	Copper Weight (kg/km)	EMEA Part Code	APAC Part Code
3	8.2	63.70	C3XCCY	C3X1.0CY
4	8.8	76.44	C4XCCY	C4X1.0CY
5	9.6	87.22	C5XCCY	C5X1.0CY
7	10.3	110.74	C7XCCY	C7X1.0CY
12	13.4	184.34	C12XCCY	C12X1.0CY
20	16.3	307.23	C20XCCY	C20X1.0CY

Conductor 1.50 mm²

No. of Cores	Nom. Overall Diameter (mm)	Copper Weight (kg/km)	EMEA Part Code	APAC Part Code
3	8.8	77.42	C3XDCY	C3X1.5CY
4	9.5	95.06	C4XDCY	C4X1.5CY
5	10.3	113.68	C5XDCY	C5X1.5CY
7	11.1	146.02	C7XDCY	C7X1.5CY
12	14.5	274.40	C12XDCY	C12X1.5CY
20	17.7	457.33	C20XDCY	C20X1.5CY

Conductor 2.50 mm²

No. of Cores	Nom. Overall Diameter (mm)	Copper Weight (kg/km)	EMEA Part Code	APAC Part Code
3	12.0	143.08	C3XECY	C3X2.5CY
4	13.3	163.66	C4XECY	C4X2.5CY
5	14.5	196.00	C5XECY	C5X2.5CY
7	15.8	282.24	C7XECY	C7X2.5CY
9	19.2	362.88	C9XECY	C9X2.5CY
12	20.8	467.75	C12XECY	C12X2.5CY

Conductor 4.00 mm²

No. of Cores	Nom. Overall Diameter (mm)	Copper Weight (kg/km)	EMEA Part Code	APAC Part Code
3	13.7	174.20	C3XFCY	C3X4CY
4	15.1	232.26	C4XFCY	C4X4CY
5	16.5	274.40	C5XFCY	C5X4CY
7	18.0	384.16	C7XFCY	C7X4CY
9	22.0	493.92	C9XFCY	C9X4CY
12	24.0	658.56	C12XFCY	C12X4CY

Conductor 6.00 mm²

No. of Cores	Nom. Overall Diameter (mm)	Copper Weight (kg/km)	EMEA Part Code	APAC Part Code
3	15.3	233.73	C3XGCY	C3X6CY
4	16.8	311.64	C4XGCY	C4X6CY
5	18.4	432.18	C5XGCY	C5X6CY
7	20.1	519.40	C7XGCY	C7X6CY
9	24.9	667.80	C9XGCY	C9X6CY

Conductor 10.00 mm²

No. of Cores	Nom. Overall Diameter (mm)	Copper Weight (kg/km)	EMEA Part Code	APAC Part Code
3	17.9	355.15	C3XHCY	C3X10CY
4	19.8	507.64	C4XHCY	C4X10CY
5	21.7	583.10	C5XHCY	C5X10CY
7	24.0	780.08	C7XHCY	C7X10CY
9	29.6	1,004.24	C9XHCY	C9X10CY

Conductor 16.00 mm²

No. of Cores	Nom. Overall Diameter (mm)	Copper Weight (kg/km)	EMEA Part Code	APAC Part Code
3	22.5	594.86	C3XICY	C3X16CY
4	24.9	787.92	C4XICY	C4X16CY
5	27.4	916.30	C5XICY	C5X16CY

Conductor 25.00 mm²

No. of Cores	Nom. Overall Diameter (mm)	Copper Weight (kg/km)	EMEA Part Code	APAC Part Code
3	25.4	853.33	C3XJCY	C3X25CY
4	28.1	1,137.78	C4XJCY	C4X25CY
5	30.8	1,372.00	C5XJCY	C5X25CY

- Putup length & tolerance of the cables will vary depending on the construction of the cable
- MOQ will vary depending on the construction of the cable & provided at the time of quotation
- Cable requested outside the above design criteria can be reviewed and quoted

MachFlex 375 SY Armored (SY) PVC Control Cables

Galvanized Steel Wire Braid Shield (GSWB) Cable with (G) Protective Ground



- DIN VDE 0295, IEC 60228, BS6360
- DIN EN 50290-2-22, DIN VDE 0207-363-4-1
- DIN VDE 0482-332-1-2, DIN EN 60332-1-2, IEC 60332-1-2
- RoHS&REACH&CE Directives

Conductor 0.50 mm²

No. of Cores	Nom. Overall Diameter (mm)	Copper Weight (kg/km)	EMEA Part Code	APAC Part Code
3	7.7	14.40	C3GASY	C3G0.5SY
4	8.3	19.20	C4GASY	C4G0.5SY
5	8.8	24.00	C5GASY	C5G0.5SY
7	9.5	33.60	C7GASY	C7G0.5SY
12	11.9	58.00	C12GASY	C12G0.5SY
20	14.5	96.70	C20GASY	C20G0.5SY

Conductor 0.75 mm²

No. of Cores	Nom. Overall Diameter (mm)	Copper Weight (kg/km)	EMEA Part Code	APAC Part Code
3	8.3	21.60	C3GBSY	C3G0.75SY
4	8.9	28.80	C4GBSY	C4G0.75SY
5	9.5	36.00	C5GBSY	C5G0.75SY
7	10.2	50.00	C7GBSY	C7G0.75SY
12	12.9	86.00	C12GBSY	C12G0.75SY
20	15.9	143.30	C20GBSY	C20G0.75SY

Conductor 1.00 mm²

No. of Cores	Nom. Overall Diameter (mm)	Copper Weight (kg/km)	EMEA Part Code	APAC Part Code
3	8.7	28.80	C3GCSY	C3G1.0SY
4	9.4	38.40	C4GCSY	C4G1.0SY
5	10.1	48.00	C5GCSY	C5G1.0SY
7	10.8	67.00	C7GCSY	C7G1.0SY
12	14.0	115.00	C12GCSY	C12G1.0SY
20	16.9	192.00	C20GCSY	C20G1.0SY

Conductor 1.50 mm²

No. of Cores	Nom. Overall Diameter (mm)	Copper Weight (kg/km)	EMEA Part Code	APAC Part Code
3	9.3	43.00	C3GDSY	C3G1.5SY
4	10.0	58.00	C4GDSY	C4G1.5SY
5	10.8	72.00	C5GDSY	C5G1.5SY
7	11.6	101.00	C7GDSY	C7G1.5SY
12	15.1	173.00	C12GDSY	C12G1.5SY
20	18.4	288.30	C20GDSY	C20G1.5SY

Conductor 2.50 mm²

No. of Cores	Nom. Overall Diameter (mm)	Copper Weight (kg/km)	EMEA Part Code	APAC Part Code
3	12.6	72.00	C3GESY	C3G2.5SY
4	13.9	96.00	C4GESY	C4G2.5SY
5	15.1	120.00	C5GESY	C5G2.5SY
7	16.4	168.00	C7GESY	C7G2.5SY
9	19.9	216.00	C9GESY	C9G2.5SY
12	21.4	288.00	C12GESY	C12G2.5SY

Conductor 4.00 mm²

No. of Cores	Nom. Overall Diameter (mm)	Copper Weight (kg/km)	EMEA Part Code	APAC Part Code
3	14.4	115.00	C3GFSY	C3G4SY
4	15.7	154.00	C4GFSY	C4G4SY
5	17.1	192.00	C5GFSY	C5G4SY
7	18.6	269.00	C7GFSY	C7G4SY
9	22.7	345.90	C9GFSY	C9G4SY
12	24.5	461.00	C12GFSY	C12G4SY

Conductor 6.00 mm²

No. of Cores	Nom. Overall Diameter (mm)	Copper Weight (kg/km)	EMEA Part Code	APAC Part Code
3	15.9	172.80	C3GGSY	C3G6SY
4	17.4	230.00	C4GGSY	C4G6SY
5	19.0	288.00	C5GGSY	C5G6SY
7	20.7	403.00	C7GGSY	C7G6SY
9	25.4	518.10	C9GGSY	C9G6SY

Conductor 10.00 mm²

No. of Cores	Nom. Overall Diameter (mm)	Copper Weight (kg/km)	EMEA Part Code	APAC Part Code
3	18.6	288.00	C3GHSY	C3G10SY
4	20.4	384.00	C4GHSY	C4G10SY
5	22.3	480.00	C5GHSY	C5G10SY
7	24.4	672.00	C7GHSY	C7G10SY
9	30.0	864.00	C9GHSY	C9G10SY

Conductor 16.00 mm²

No. of Cores	Nom. Overall Diameter (mm)	Copper Weight (kg/km)	EMEA Part Code	APAC Part Code
3	23.0	460.50	C3GISY	C3G16SY
4	25.3	614.00	C4GISY	C4G16SY
5	27.9	768.00	C5GISY	C5G16SY

Conductor 25.00 mm²

No. of Cores	Nom. Overall Diameter (mm)	Copper Weight (kg/km)	EMEA Part Code	APAC Part Code
3	25.9	720.00	C3GJSY	C3G25SY
4	28.6	960.00	C4GJSY	C4G25SY
5	31.2	1,200.00	C5GJSY	C5G25SY

- Putup length & tolerance of the cables will vary depending on the construction of the cable
- MOQ will vary depending on the construction of the cable & provided at the time of quotation
- Cable requested outside the above design criteria can be reviewed and quoted

MachFlex 375 SY Armored (SY) PVC Control Cables

Galvanized Steel Wire Braid Shield (GSWB) Cable without (G) Protective Ground



- DIN VDE 0295, IEC 60228, BS6360
- DIN EN 50290-2-22, DIN VDE 0207-363-4-1
- DIN VDE 0482-332-1-2, DIN EN 60332-1-2, IEC 60332-1-2
- RoHS&REACH&CE Directives

Conductor 0.50 mm²

No. of Cores	Nom. Overall Diameter (mm)	Copper Weight (kg/km)	EMEA Part Code	APAC Part Code
3	7.7	14.40	C3XASY	C3X0.5SY
4	8.3	19.20	C4XASY	C4X0.5SY
5	8.8	24.00	C5XASY	C5X0.5SY
7	9.5	33.60	C7XASY	C7X0.5SY
12	11.9	58.00	C12XASY	C12X0.5SY
20	14.5	96.70	C20XASY	C20X0.5SY

Conductor 0.75 mm²

No. of Cores	Nom. Overall Diameter (mm)	Copper Weight (kg/km)	EMEA Part Code	APAC Part Code
3	8.3	21.60	C3XBSY	C3X0.75SY
4	8.9	28.80	C4XBSY	C4X0.75SY
5	9.5	36.00	C5XBSY	C5X0.75SY
7	10.2	50.00	C7XBSY	C7X0.75SY
12	12.9	86.00	C12XBSY	C12X0.75SY
20	15.9	143.30	C20XBSY	C20X0.75SY

Conductor 1.00 mm²

No. of Cores	Nom. Overall Diameter (mm)	Copper Weight (kg/km)	EMEA Part Code	APAC Part Code
3	8.7	28.80	C3XCSY	C3X1.0SY
4	9.4	38.40	C4XCSY	C4X1.0SY
5	10.1	48.00	C5XCSY	C5X1.0SY
7	10.8	67.00	C7XCSY	C7X1.0SY
12	14.0	115.00	C12XCSY	C12X1.0SY
20	16.9	192.00	C20XCSY	C20X1.0SY

Conductor 1.50 mm²

No. of Cores	Nom. Overall Diameter (mm)	Copper Weight (kg/km)	EMEA Part Code	APAC Part Code
3	9.3	43.00	C3XDSY	C3X1.5SY
4	10.0	58.00	C4XDSY	C4X1.5SY
5	10.8	72.00	C5XDSY	C5X1.5SY
7	11.6	101.00	C7XDSY	C7X1.5SY
12	15.1	173.00	C12XDSY	C12X1.5SY
20	18.4	288.30	C20XDSY	C20X1.5SY

Conductor 2.50 mm²

No. of Cores	Nom. Overall Diameter (mm)	Copper Weight (kg/km)	EMEA Part Code	APAC Part Code
3	12.6	72.00	C3XESY	C3X2.5SY
4	13.9	96.00	C4XESY	C4X2.5SY
5	15.1	120.00	C5XESY	C5X2.5SY
7	16.4	168.00	C7XESY	C7X2.5SY
9	19.9	216.00	C9XESY	C9X2.5SY
12	21.4	288.00	C12XESY	C12X2.5SY

Conductor 4.00 mm²

No. of Cores	Nom. Overall Diameter (mm)	Copper Weight (kg/km)	EMEA Part Code	APAC Part Code
3	14.4	115.00	C3XFSY	C3X4SY
4	15.7	154.00	C4XFSY	C4X4SY
5	17.1	192.00	C5XFSY	C5X4SY
7	18.6	269.00	C7XFSY	C7X4SY
9	22.7	345.90	C9XFSY	C9X4SY
12	24.5	461.00	C12XFSY	C12X4SY

Conductor 6.00 mm²

No. of Cores	Nom. Overall Diameter (mm)	Copper Weight (kg/km)	EMEA Part Code	APAC Part Code
3	15.9	172.80	C3XGSY	C3X6SY
4	17.4	230.00	C4XGSY	C4X6SY
5	19.0	288.00	C5XGSY	C5X6SY
7	20.7	403.00	C7XGSY	C7X6SY
9	25.4	518.10	C9XGSY	C9X6SY

Conductor 10.00 mm²

No. of Cores	Nom. Overall Diameter (mm)	Copper Weight (kg/km)	EMEA Part Code	APAC Part Code
3	18.6	288.00	C3XHSY	C3X10SY
4	20.4	384.00	C4XHSY	C4X10SY
5	22.3	480.00	C5XHSY	C5X10SY
7	24.4	672.00	C7XHSY	C7X10SY
9	30.0	864.00	C9XHSY	C9X10SY

Conductor 16.00 mm²

No. of Cores	Nom. Overall Diameter (mm)	Copper Weight (kg/km)	EMEA Part Code	APAC Part Code
3	23.0	460.50	C3XISY	C3X16SY
4	25.3	614.00	C4XISY	C4X16SY
5	27.9	768.00	C5XISY	C5X16SY

Conductor 25.00 mm²

No. of Cores	Nom. Overall Diameter (mm)	Copper Weight (kg/km)	EMEA Part Code	APAC Part Code
3	25.9	720.00	C3XJSY	C3X25SY
4	28.6	960.00	C4XJSY	C4X25SY
5	31.2	1,200.00	C5XJSY	C5X25SY

- Putup length & tolerance of the cables will vary depending on the construction of the cable
- MOQ will vary depending on the construction of the cable & provided at the time of quotation
- Cable requested outside the above design criteria can be reviewed and quoted

UL Control Cables

600 V Type TC Cables – Overview

Introduction

Belden offers a wide selection of UL-rated 600 V Tray Cable for a variety of control applications.

Multi-conductor versions are available as standards from 18 to 4/0 AWG. These are unshielded and shielded versions that come with various insulation and jacket combinations.

These TC cables are installed in cable trays, ducts and conduit and can be used in direct burial applications. They are extensively used in manufacturing facilities, especially in the process industries such as petrochemical, steel, pulp and paper, cement and mining.

These flexible, space efficient cables can be substantially more economical than traditional wiring methods.

Construction

Soft annealed bare or tinned copper conductors, with various insulation and jacketing options as seen in chart below.

Application

These cables are suitable for installation in wet or dry locations. Cable jackets are resistant to sunlight, moisture and vapor penetration. The cables can be used in raceways (supported by messenger wire), outdoor applications and direct burial applications.

Unshielded

Cabled non-shielded conductors provide a minimal O.D. allowing greater tray and conduit fill. Non-shielded control cable may be utilized when recommended by the equipment manufacturer and used in a metallic conduit.

Overall Shield

Recommended for use in control applications where signals are transmitted in excess of 100 millivolts, except in areas where high voltage and current sources create excessive noise interference. The Beldfoil® shield with drain wire provides 100% coverage for maximum shield effectiveness. Copper tape shield available upon request.

Only 2-conductor round constructions can be shielded. Flat constructions cannot be shielded.

Tray Cable Construction Options

Insulation/Jacket	UL Listed for MC and TC		Flame Tests	Ratings*
	Max. Temp Rating			
	Wet	Dry		
PVC-Nylon/PVC (THHN or THWN) 14 AWG & larger	+75 °C	+90 °C	UL 1685 FT4/IEEE 1202/383 ICEA T-29-520	ICEA S-73-532 ICEA S-61-402
PVC-Nylon/PVC (TFN or TFFN) 16 & 18 AWG	+75 °C	+90 °C	UL 1685 FT4/IEEE 1202/383 ICEA T-29-520	ICEA S-73-532 ICEA S-61-402
XLP/PVC or CPE (XHHW-2) 14 AWG & larger	+90 °C	+90 °C	UL 1685 FT4/IEEE 1202/383 VW-1 rated singles ICEA T-29-520	ICEA S-73-532 ICEA S-66-524
XLP/PVC or CPE (RFH-2) 16 & 18 AWG	+90 °C	+90 °C	UL 1685 FT4/IEEE 1202/383 ICEA T-29-520	ICEA S-73-532 ICEA S-82-552
XLP/Haloarrest® (Thermoplastic) (XHHW-2) 14 AWG & larger (RFH-2) 16 & 18 AWG	+90 °C	+90 °C	UL 1685	TC-LS
XLP/HaloarrestXLink™-1 and -2 (Thermoset) (XHHW-2) 14 AWG & larger (RFH-2) 16 & 18 AWG	+90 °C	+90 °C	UL 1685 ICEA T-29-520 FT4/IEEE 1202/383	TC-ER ICEA S-73-532 T-33-655

* Applicable to TC-rated cables only.

Ground Wire

- Non-insulated, bare copper ground wires are included for constructions 8 through 4/0 AWG. Non-insulated, bare copper, full sized ground wires may be requested on other constructions.
- All shielded PVC-Nylon/PVC constructions, over three conductors, include full sized ground (drain) wires.

Color Code

Multi-conductor control cables (10 AWG to 18 AWG) are printed alpha-numerically in addition to being color coded per ICEA Table E2.

8 AWG and larger are black and numbered per ICEA Method 4.

Refer to Technical Information Section for ICEA color code charts.

Specifications

- UL Subject 1277 Type TC and TC-ER
- XLP/Haloarrest (thermoplastic) jacketed cables are UL 1277 TC-LS rated
- XLP/HaloarrestXLink™-1 and -2 are TC-ER rated
- UL Subject 1424 (per outline for NPLF requirements dated May 3, 1979)
- UL 1685 (UL 1581) Vertical Flame Test

- Approved for cable tray use in Class 1, Division 2 areas, per NEC Articles 340, 318 and 501, and for Class 1 circuits as permitted in Article 725
- PVC-Nylon/PVC, XLP/PVC and XLP/CPE constructed cables meet IEEE 1202/IEEE 383-2003/FT4 (70,000 BTU/hr) Flame Test

TC-ER Rated Cables

Belden offers all PVC-nylon/PVC, XLP/PVC and XLP/CPE jacketed tray cables with a TC-ER (Exposed Run) rating, formerly referred to as Open Wiring.

Per NEC Article 336, a TC-ER rated cable may be installed in an industrial establishment between a cable tray and the utilization equipment or device. A TC-ER rated cable must meet the crush and impact requirements of UL Type MC cable. By eliminating the need for metal conduit and/or armor, using a TC-ER rated cable results in savings in both installation and maintenance.

Standard lengths may be subject to tolerance. Custom lengths may be available upon request. Contact the Belden Electronics Division Customer Service Department for additional information.

CPE = Chlorinated Polyethylene • PVC = Polyvinyl Chloride • XLP = Cross-Linked Poly

UL Control Cables
600 V Type TC Cables



- UL TC-ER
- UL TC (2-Conductor Cables)
- UL Sunlight Res
- Oil Res
- Direct Burial
- NEC: NPLF
- ICEA S-73-532, S-61-402, T-29-520
- FT4
- IEEE 1202/383

Part No.	Conductors	Color Code	Pull Tension (Max)	Bend Radius (Min)		OD (Nom)		Jacket Thickness	
			Lbs	Inch	mm	Inch	mm	Inch	mm

18 AWG • Unshielded

Stranded (7 x 26) BC Conductors • PVC/Nylon Insulation • PVC Jacket									
27916A	2	E2	44	2.7	68.58	.180 x .266	4.57 x 6.76		
27325A	2	E2	44	2.7	68.58	.270	6.86		
28334A	3	E2	66	2.8	71.12	.280	7.11		
28326A	4	E2	88	3.1	78.74	.310	7.87		
28335A	5	E2	110	3.3	83.82	.330	8.38	.045	1.14
28600A	6	E2	132	3.5	88.90	.350	8.89		
28327A	7	E2	154	3.5	88.90	.350	8.89		
28601A	8	E2	176	3.8	96.52	.390	9.83		
28336A	9	E2	198	4.1	104.14	.410	10.41		
28328A	10	E2	220	4.5	114.30	.450	11.43		
28602A	11	E2	242	4.5	114.30	.450	11.43		
28329A	12	E2	264	4.5	114.30	.450	11.43		
28603A	13	E2	286	4.7	119.38	.470	11.94		
28604A	14	E2	308	4.8	121.92	.480	12.19		
28605A	15	E2	330	5.1	129.54	.510	12.95		
28606A	16	E2	352	5.0	127.00	.500	12.70	.060	1.52
28607A	17	E2	374	5.7	144.78	.570	14.48		
28608A	18	E2	396	5.7	144.78	.570	14.48		
28609A	19	E2	418	5.7	144.78	.570	14.48		
28610A	20	E2	440	5.9	149.86	.600	15.24		
28611A	25	E2	550	6.6	167.64	.660	16.76		
28612A	30	E2	660	6.6	167.64	.690	17.53		
28613A	37	E2	814	7.4	187.96	.740	18.80		
28614A	50	E2	1100	9.1	231.14	.910	23.11	.080	2.03
28632A	60	E2	1320	9.6	243.84	.960	24.38		

18 AWG • Overall Beldfoil® Shield

Stranded (7 x 26) BC Conductors • PVC/Nylon Insulation • PVC Jacket									
27325AS	2	E2	67	2.70	68.58	.270	6.86		
28334AS	3	E2	90	2.80	71.12	.280	7.11	.045	1.14
28326AS	4	E2	112	3.10	81.28	.300	7.62		

To Specify Conductor, Insulation and Jacket Options:		
12345	A	S
Start with Base Part No.	Add or Modify for Conductor, Insulation, and Jacket. See table at right.	Add "S" for Optional Beldfoil® Shield

Conductor		Insulation/Jacket	Conductor		Insulation/Jacket
Bare	Tinned		Bare	Tinned	
A	B	PVC-Nylon/PVC	S	T	XLP/Haloarrest®
C	D	XLP/PVC	U	V	XLP/HaloarrestXLink™-1
G	H	XLP/TPE	W	X	XLP/HaloarrestXLink-2
Q	R	XLP/CPE	Y	Z	XLP/HaloarrestXLink-2, Marine Approved

BC = Bare Copper • CPE = Chlorinated Polyethylene • PVC = Polyvinyl Chloride • TPE = Thermoplastic Elastomer • XLP = Cross-Linked Poly

UL Control Cables
600 V Type TC Cables



- UL TC-ER
- UL TC (2-Conductor Cables)
- UL Sunlight Res
- Oil Res
- Direct Burial
- NEC: NPLF
- ICEA S-73-532, S-61-402, T-29-520
- FT4
- IEEE 1202/383

Part No.	Conductors	Color Code	Pull Tension (Max)		Bend Radius (Min)		OD (Nom)		Jacket Thickness	
			Lbs		Inch	mm	Inch	mm	Inch	mm

16 AWG • Unshielded

Stranded (7 x 24) BC Conductors • PVC/Nylon Insulation • PVC Jacket										
27917A	2	E2	70	2.9	73.66	.190 x .290	4.83 x 7.37			
27337A	2	E2	70	2.9	73.66	.299	7.60			
28331A	3	E2	105	3.1	78.74	.307	7.80			
28338A	4	E2	140	3.3	83.82	.332	8.18			
28339A	5	E2	175	3.6	91.44	.360	9.14			
28615A	6	E2	210	3.9	99.06	.390	9.91			
28323A	7	E2	245	3.9	99.06	.390	9.91	.045	1.14	
28616A	8	E2	280	4.2	106.68	.420	10.67			
28340A	9	E2	315	4.5	114.30	.450	11.43			
28617A	10	E2	350	4.9	124.46	.490	12.45			
28618A	11	E2	385	4.9	124.46	.490	12.45			
28341A	12	E2	420	5.0	127.00	.500	12.70			
28619A	13	E2	455	5.7	144.78	.570	14.48			
28620A	14	E2	490	5.7	144.78	.570	14.48			
28621A	15	E2	525	5.9	149.86	.590	14.99	.060	1.52	
28330A	16	E2	560	6.0	152.40	.600	15.24	.045	1.14	
28622A	17	E2	595	6.3	160.02	.630	16.00			
28623A	18	E2	630	6.3	160.02	.630	16.00	.060	1.52	
28624A	19	E2	665	6.3	160.02	.630	16.00			
28625A	20	E2	700	6.6	167.64	.660	16.76			
28324A	25	E2	875	7.3	185.42	.730	18.54			
28626A	30	E2	1050	7.7	195.58	.770	19.56			
28627A	37	E2	1295	8.3	210.82	.830	21.08	.080	2.03	
28628A	50	E2	1750	10.0	254.00	1.000	25.40			
28633A	60	E2	2100	11.0	279.40	1.100	27.94			

16 AWG • Overall Beldfoil® Shield

Stranded (7 x 24) BC Conductors • PVC/Nylon Insulation • PVC Jacket										
27337AS	2	E2	94	3.00	76.20	.302	7.67	.045	1.14	
28331AS	3	E2	130	3.20	81.28	.320	8.13			

14 AWG • Unshielded

Stranded (7 x 22) BC Conductors • PVC/Nylon Insulation • PVC Jacket										
27080A	2	E2	108	3.5	88.90	.210 x .320	5.33 x 8.13			
27636A	2	E2	108	3.2	81.28	.320	8.13	.045	1.14	
28081A	3	E2	162	3.4	86.36	.340	8.64			

BC = Bare Copper • CPE = Chlorinated Polyethylene • PVC = Polyvinyl Chloride • TPE = Thermoplastic Elastomer • XLP = Cross-Linked Poly

UL Control Cables
600 V Type TC Cables



- UL TC-ER
- UL TC (2-Conductor Cables)
- UL Sunlight Res
- Oil Res
- Direct Burial
- NEC: NPLF
- ICEA S-73-532, S-61-402, T-29-520
- FT4
- IEEE 1202/383

Part No.	Conductors	Color Code	Pull Tension (Max)		Bend Radius (Min)		OD (Nom)		Jacket Thickness	
			Lbs		Inch	mm	Inch	mm	Inch	mm

14 AWG • Unshielded (continued)

Stranded (7 x 22) BC Conductors • PVC/Nylon Insulation • PVC Jacket										
28082A	4	E2	216		3.6	91.44	.360	9.14		
28083A	5	E2	270		3.9	99.06	.400	10.16		
28084A	6	E2	324		4.3	109.22	.434	11.02	.045	1.14
28085A	7	E2	378		4.3	109.22	.433	11.00		
28086A	8	E2	432		4.7	119.38	.480	12.19		
28087A	9	E2	486		5.1	129.54	.510	12.95		
28088A	10	E2	540		5.7	144.78	.588	14.94		
28089A	11	E2	594		5.9	149.86	.595	15.11		
28090A	12	E2	648		5.9	149.86	.595	15.11		
28091A	13	E2	702		6.3	160.02	.640	16.26		
28092A	14	E2	756		6.3	160.02	.640	16.26		
28093A	15	E2	810		6.7	170.18	.670	17.02		
28094A	16	E2	864		6.6	167.64	.671	17.04		
28095A	17	E2	918		7.0	177.80	.700	17.78		
28096A	18	E2	972		7.0	177.80	.700	17.78	.060	1.52
28097A	19	E2	1026		7.0	177.80	.705	17.91		
28098A	20	E2	1080		7.4	187.96	.735	18.67		
28099A	21	E2	1134		7.4	187.96	.740	18.80		
28100A	22	E2	1188		7.6	193.04	.760	19.30		
28101A	23	E2	1242		7.6	193.04	.760	19.30		
28102A	24	E2	1296		8.1	205.74	.810	20.57		
28103A	25	E2	1350		8.1	205.74	.810	20.57		
28104A	26	E2	1404		8.1	205.74	.810	20.57		
28105A	27	E2	1458		8.7	220.98	.870	22.10		
28106A	28	E2	1512		9.1	231.14	.910	23.11		
28107A	29	E2	1566		9.1	231.14	.910	23.11	.080	2.03
28108A	30	E2	1620		9.0	228.60	.902	22.91		
28629A	37	E2	1998		9.7	246.38	.975	24.77		
28912A	50	E2	2700		11.3	287.02	1.138	28.91		



- UL TC-ER
- UL TC (2-Conductor Cables)
- UL Sunlight Res
- Oil Res
- Direct Burial
- NEC: NPLF
- ICEA S-73-532, S-61-402, T-29-520
- FT4
- IEEE 1202/383

Part No.	Conductors	Color Code	Pull Tension (Max)		Bend Radius (Min)		OD (Nom)		Jacket Thickness	
			Lbs		Inch	mm	Inch	mm	Inch	mm

14 AWG • Overall Beldfoil® Shield

Stranded (7 x 22) BC Conductors • PVC/Nylon Insulation • PVC Jacket										
28081AS	3	E2	99		3.4	86.36	.340	8.64	.045	1.14
28082AS	4	E2	273		3.9	99.06	.391	9.93		

BC = Bare Copper • PVC = Polyvinyl Chloride

UL Control Cables
600 V Type TC Cables



- UL TC-ER
- UL TC (2-Conductor Cables)
- UL Sunlight Res
- Oil Res
- Direct Burial
- NEC: NPLF
- ICEA S-73-532, S-61-402, T-29-520
- FT4
- IEEE 1202/383

Part No.	Conductors	Color Code	Pull Tension (Max)		Bend Radius (Min)		OD (Nom)		Jacket Thickness	
			Lbs		Inch	mm	Inch	mm	Inch	mm

12 AWG • Unshielded

Stranded (7 x 20) BC Conductors • PVC/Nylon Insulation • PVC Jacket										
27109A	2	E2	172	3.5	88.90	.220 x .350	5.59 x 8.89			
27641A	2	E2	172	3.6	91.44	.360	9.14			
28110A	3	E2	258	3.7	93.98	.374	9.50			
28111A	4	E2	344	4.1	104.14	.410	10.41	.045	1.14	
28112A	5	E2	430	4.5	114.30	.450	11.43			
28113A	6	E2	516	4.8	121.92	.480	12.19			
28114A	7	E2	602	4.8	121.92	.480	12.19			
28115A	8	E2	688	5.6	142.24	.560	14.22			
28116A	9	E2	774	6.0	152.40	.600	15.24			
28117A	10	E2	860	6.6	167.64	.660	16.76			
28118A	11	E2	946	6.7	170.18	.670	17.02			
28119A	12	E2	1032	6.7	170.18	.670	17.02			
28120A	13	E2	1118	7.0	177.80	.700	17.78	.060	1.52	
28121A	14	E2	1204	7.0	177.80	.700	17.78			
28122A	15	E2	1290	7.4	187.96	.740	18.80			
28123A	16	E2	1376	7.5	190.50	.750	19.05			
28124A	17	E2	1462	7.7	195.58	.770	19.56			
28125A	18	E2	1548	7.7	195.58	.770	19.56			
28126A	19	E2	1634	7.9	200.66	.790	20.07			
28127A	20	E2	1720	8.7	220.98	.870	22.10			
28128A	21	E2	1806	8.7	220.98	.870	22.10			
28129A	22	E2	1892	8.9	226.06	.890	22.61			
28130A	23	E2	1978	8.9	226.06	.890	22.61			
28131A	24	E2	2064	9.4	238.76	.940	23.88			
28132A	25	E2	2150	9.6	243.84	.960	24.38			
28133A	26	E2	2236	9.6	243.84	.960	24.38	.080	2.03	
28134A	27	E2	2322	9.6	243.84	.960	24.38			
28135A	28	E2	2408	9.9	251.46	.990	25.15			
28136A	29	E2	2494	9.9	251.46	.990	25.15			
28137A	30	E2	2580	10.2	259.08	1.020	25.91			
28630A	37	E2	3182	10.9	276.86	1.090	27.69			
28634A	50	E2	4300	13.0	330.20	1.300	33.02			

To Specify Conductor, Insulation and Jacket Options:		
12345	A	S
Start with Base Part No.	Add or Modify for Conductor, Insulation, and Jacket. See table at right.	Add "S" for Optional Beldfoil® Shield

Conductor		Insulation/Jacket	Conductor		Insulation/Jacket
Bare	Tinned		Bare	Tinned	
A	B	PVC-Nylon/PVC	S	T	XLP/Haloarrest®
C	D	XLP/PVC	U	V	XLP/HaloarrestXLink™-1
G	H	XLP/TPE	W	X	XLP/HaloarrestXLink-2
Q	R	XLP/CPE	Y	Z	XLP/HaloarrestXLink-2, Marine Approved

BC = Bare Copper • CPE = Chlorinated Polyethylene • PVC = Polyvinyl Chloride • TPE = Thermoplastic Elastomer • XLP = Cross-Linked Poly

UL Control Cables
600 V Type TC Cables



- UL TC-ER
- UL TC (2-Conductor 10 AWG Cables)
- UL Sunlight Res
- Oil Res
- Direct Burial
- NEC: NPLF
- ICEA S-73-532, S-61-402, T-29-520
- FT4
- IEEE 1202/383

Part No.	Conductors	Color Code	Pull Tension (Max)		Bend Radius (Min)		OD (Nom)		Jacket Thickness	
			Lbs		Inch	mm	Inch	mm	Inch	mm

10 AWG • Unshielded

Stranded (7 x 18) BC Conductors • PVC/Nylon Insulation • PVC Jacket										
27138A	2	E2	296		4.2	106.68	.260 x .420	6.60 x 10.67		
27643A	2	E2	296		4.2	106.68	.420	10.67	.045	1.14
28139A	3	E2	444		4.5	114.30	.450	11.43		
28140A	4	E2	592		4.9	124.46	.490	12.45		
28141A	5	E2	740		5.7	144.78	.570	14.48		
28142A	6	E2	888		6.2	157.48	.620	15.75		
28143A	7	E2	1036		6.2	157.48	.620	15.75		
28144A	8	E2	1184		6.8	172.72	.680	17.27	.060	1.52
28145A	9	E2	1332		7.2	182.88	.720	18.29		
28146A	10	E2	1480		7.9	200.66	.790	20.07		
28147A	11	E2	1628		7.9	200.66	.790	20.07		
28148A	12	E2	1776		8.2	208.28	.820	20.83	.080	2.03

8 AWG • Unshielded • 10 AWG Uninsulated Ground Wire

Stranded (7 x 16) BC Conductors • PVC/Nylon Insulation • PVC Jacket										
28149A	2	M4	384		5.6	142.24	.560	14.22		
28150A	3	M4	576		5.9	149.86	.590	14.99	.060	1.52
28151A	4	M4	768		6.5	165.10	.650	16.51		

6 AWG • Unshielded • 8 AWG Uninsulated Ground Wire

Stranded (7 x 14) BC Conductors • PVC/Nylon Insulation • PVC Jacket										
28152A	2	M4	610		6.3	160.02	.630	16.00		
28153A	3	M4	915		6.7	170.18	.670	17.02	.060	1.52
28154A	4	M4	1220		7.3	185.42	.730	18.54		

To Specify Conductor, Insulation and Jacket Options:		
12345	A	S
Start with Base Part No.	Add or Modify for Conductor, Insulation, and Jacket. See table at right.	Add "S" for Optional Beldfoil® Shield

Conductor		Insulation/Jacket	Conductor		Insulation/Jacket
Bare	Tinned		Bare	Tinned	
A	B	PVC-Nylon/PVC	S	T	XLP/Halobarrest®
C	D		U	V	
G	H	XLP/TPE	W	X	XLP/HalobarrestXLInk-2
Q	R	XLP/CPE	Y	Z	XLP/HalobarrestXLInk-2, Marine Approved

BC = Bare Copper • CPE = Chlorinated Polyethylene • PVC = Polyvinyl Chloride • TPE = Thermoplastic Elastomer • XLP = Cross-Linked Poly

UL Control Cables
600 V Type TC Cables



- UL TC-ER
- UL Sunlight Res
- Oil Res
- Direct Burial
- NEC: NPLF
- ICEA S-73-532, S-61-402, T-29-520
- FT4
- IEEE 1202/383

Part No.	Conductors	Color Code	Pull Tension (Max)		Bend Radius (Min)		OD (Nom)		Jacket Thickness	
			Lbs		Inch	mm	Inch	mm	Inch	mm

4 AWG • Unshielded • 8 AWG Uninsulated Ground Wire

Stranded (7 x 12) BC Conductors • PVC/Nylon Insulation • PVC Jacket										
28155A	2	M4	970	7.7	195.58	.770	19.56		.060	1.52
28156A	3	M4	1455	8.2	208.28	.820	20.83		.080	2.03
28157A	4	M4	1940	9.5	241.30	.950	24.13			

2 AWG • Unshielded • 6 AWG Uninsulated Ground Wire

Stranded (7 x 10) BC Conductors • PVC/Nylon Insulation • PVC Jacket										
28158A	2	M4	1544	9.7	246.38	.970	24.64			
28159A	3	M4	2316	9.9	251.46	.990	25.15		.080	2.03
28160A	4	M4	3088	10.9	276.86	1.090	27.69			

1 AWG • Unshielded • 6 AWG Uninsulated Ground Wire

Stranded (19 x 14) BC Conductors • PVC/Nylon Insulation • PVC Jacket										
28165A	2	M4	1340	10.7	271.78	1.060	26.92		.080	2.03
28161A	3	M4	2919	11.2	284.48	1.120	28.45		.080	2.03
28166A	4	M4	2680	12.5	317.5	1.250	31.75		.080	2.03

1/0 AWG • Unshielded • 6 AWG Uninsulated Ground Wire

Stranded (19 x 12) BC Conductors • PVC/Nylon Insulation • PVC Jacket										
28167A	2	M4	1690	11.4	289.56	1.13	28.70		.080	2.03
28168A	3	M4	2535	12.1	307.34	1.21	30.73		.083	2.11
28169A	4	M4	3380	13.4	340.36	1.33	33.78			

2/0 AWG • Unshielded • 6 AWG Uninsulated Ground Wire

Stranded (19 x 11) BC Conductors • PVC/Nylon Insulation • PVC Jacket										
28170A	2	M4	2130	12.2	309.88	1.22	30.99			
28171A	3	M4	3195	13.0	330.20	1.30	33.02		.083	2.11
28172A	4	M4	4260	14.4	365.76	1.44	36.58			

3/0 AWG • Unshielded • 4 AWG Uninsulated Ground Wire

Stranded (19 x 10) BC Conductors • PVC/Nylon Insulation • PVC Jacket										
28173A	2	M4	2686	13.1	332.74	1.31	33.27			
28174A	3	M4	4029	14.2	360.68	1.42	36.07		.083	2.11
28175A	4	M4	5372	15.6	396.24	1.56	39.62			

4/0 AWG • Unshielded • 4 AWG Uninsulated Ground Wire

Stranded (19 x 9.5) BC Conductors • PVC/Nylon Insulation • PVC Jacket										
28176A	2	M4	3386	14.2	360.68	1.42	36.07			
28177A	3	M4	5078	15.4	391.16	1.54	39.12		.083	2.11
28178A	4	M4	6771	17.7	449.58	1.77	44.96		.116	2.95

To Specify Conductor, Insulation and Jacket Options:		
12345	A	S
Start with Base Part No.	Add or Modify for Conductor, Insulation, and Jacket. See table at right.	Add "S" for Optional Beldfoil® Shield

Conductor		Insulation/Jacket	Conductor		Insulation/Jacket
Bare	Tinned		Bare	Tinned	
A	B	PVC-Nylon/PVC	S	T	XLP/Haloarrest®
C	D	XLP/PVC	U	V	XLP/HaloarrestXLink™-1
G	H	XLP/TPE	W	X	XLP/HaloarrestXLink-2
Q	R	XLP/CPE	Y	Z	XLP/HaloarrestXLink-2, Marine Approved

BC = Bare Copper • CPE = Chlorinated Polyethylene • PVC = Polyvinyl Chloride • TPE = Thermoplastic Elastomer • XLP = Cross-Linked Poly

UL Control Cables

600 V Type MC Metal Clad and Teck-Style® Cables – Overview

Metal Clad

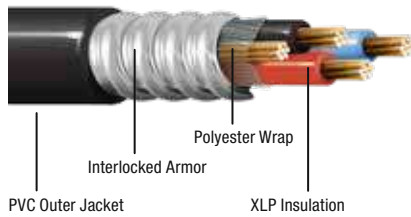

Teck-Style

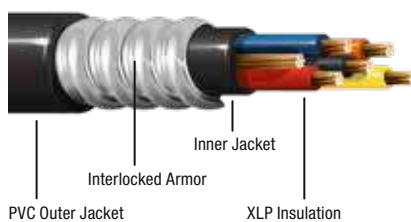

Introduction

Belden Metal Clad (MC) and Teck-Style cables are designed to meet demanding industrial needs by combining rugged durability and corrosion resistance with flexibility and easy handling.

MC and Teck-Style cables are available in a wide range of constructions for installation in demanding industrial environments including oil and gas, mining, utility, chemical, pulp and paper, and others. They are ideal for use in wet or dry areas, ventilated or non-ventilated, ladder-type cable troughs and flexible cableways. Custom cables are available to meet exacting requirements.

Belden Type MC Cable is sunlight-resistant and appropriate for outdoor use, installation in cable trays, and direct burial.

Teck-Style cables are price-competitive, high-performance, UL and CSA dual-rated cables with a flame-retardant XHHW insulated conductor and an inner PVC jacket for mechanical moisture and corrosion protection.

Construction

Class B stranded bare copper conductors, XLP insulation, bare copper ground wire, standard aluminum or optional galvanized steel interlocking armor, PVC outer jacket.

- Thermoset insulation – XHHW-2 conductors
- NEC conductor temperature +90 °C dry and +90 °C wet

Voltage Rating

14 AWG – 2 AWG: 600 Volt

Application

Type MC Cable is a general-purpose cable used in the pulp and paper, mining, petroleum and chemical industries as well as in commercial buildings.

MC Cable may be used under the following conditions:

- Exposed or concealed wiring in dry or wet conditions
- In ventilated, non-ventilated or ladder-type cable trays in dry or wet conditions
- On walls or beams
- Directly buried
- Class I and II Div. 2 and Class III Div. 1 and 2 hazardous locations

Minimum Bending Radius

12 times the overall cable diameter

Pulling Tensions

The combined use of Kellems grips and pulling eyes is recommended.

Design Advantages

Insulation Properties

- High tensile strength
- Impact- and crush-resistant
- Heat-resistant
- Excellent elongation
- Moisture-resistant
- Good low temperature properties
- +90 °C dry and +90 °C wet

Electrical Properties

- High insulation resistance
- Low dielectric loss
- High dielectric strength

Other Features

- Corrosion-resistant
- Versatile and flexible
- Provides cost savings as conduit and ducts are not required

Specifications

- UL 44
- UL 1569
- UL 1685 (UL 1581) Vertical Tray Flame Test (70,000 BTU/hr)

Teck-Style CSA Specifications

- CSA C22.2 No. 131
- FT4 Flame Test
- HAZ LOC
- CSA C22.2 No. 0.3 Clause 4.31 Low Acid Gas

UL Control Cables
600 V Type MC Metal Clad Cables

Interlocked Armor



- UL MC
- UL Sun Res
- Oil Res
- Direct Burial

Part No.		Conductors	Color Code	Armor OD		OD (Nom)		Bend Radius (Min)		Insulation Thickness		Jacket Thickness	
Aluminum	Steel			Inch	mm	Inch	mm	Inch	mm	Inch	mm	Inch	mm

Stranded (7 x 22) BC Conductors • XLP Insulation • Interlocked Armor • PVC Jacket

14 AWG • 14 AWG Uninsulated Ground Wire

27243	28243	2	E2	.48	12.19	.58	14.73	7.3	185				
27244	28244	3	E2	.50	12.70	.61	15.49	7.6	193				
27245	28245	4	E2	.54	13.72	.64	16.26	7.9	200				
27246	28246	5	E2	.57	14.48	.68	17.27	8.4	213				
27247	28247	6	E2	.62	15.75	.72	18.29	8.9	226				
27248	28248	7	E2	.62	15.75	.72	18.29	8.9	226				
27269	28269	8	E2	.69	17.53	.80	20.32	9.4	238				
27535	28535	9	E2	.70	17.78	.80	20.32	10.0	254				
27249	28249	10	E2	.75	19.05	.85	21.59	10.5	266	.030	.76	.050	1.27
27250	28250	12	E2	.77	19.56	.87	22.10	10.8	274				
27251	28251	15	E2	.87	22.10	.98	24.89	11.6	294				
27969	28969	19	E2	1.00	25.40	1.11	28.19	12.1	307				
27252	28252	20	E2	1.03	26.16	1.14	28.96	13.3	337				
27270	28270	25	E2	1.10	27.94	1.21	30.73	14.4	365				
27253	28253	30	E2	1.18	29.97	1.29	32.77	15.1	383				
27292	28292	37	E2	1.14	28.96	1.24	31.50	16.1	408				
27433	28433	40	E2	1.28	32.51	1.40	35.56	16.7	424				
27434	28434	50	E2	1.40	35.56	1.52	38.61	18.4	467				

Stranded (7 x 20) BC Conductors • XLP Insulation • Interlocked Armor • PVC Jacket

12 AWG • 12 AWG Uninsulated Ground Wire

27254	28254	2	E2	.52	13.21	.62	15.75	7.8	198				
27255	28255	3	E2	.54	13.72	.64	16.26	8.0	203				
27256	28256	4	E2	.58	14.73	.68	17.22	8.5	215				
27271	28271	5	E2	.62	15.75	.72	18.29	9.1	231				
27272	28272	6	E2	.67	17.02	.77	19.56	9.6	243				
27273	28273	7	E2	.67	17.02	.77	19.56	9.6	243				
27274	28274	8	E2	.77	19.56	.88	22.35	10.2	259				
27538	28538	9	E2	.76	19.30	.86	21.84	10.8	274				
27275	28275	10	E2	.80	20.32	.91	23.11	11.5	292	.030	.76	.050	1.27
27276	28276	12	E2	.84	21.34	.94	23.88	11.7	297				
27277	28277	15	E2	.94	23.88	1.05	26.67	13.4	340				
27539	28539	19	E2	.05	26.67	1.16	29.46	14.0	355				
27278	28278	20	E2	.16	29.46	1.27	32.26	14.6	370				
27279	28279	25	E2	.26	32.00	1.37	34.80	15.8	401				
27280	28280	30	E2	.29	32.77	1.40	35.56	16.8	426				
27540	28540	37	E2	.44	36.58	1.55	39.37	17.8	452				
27432	28432	40	E2	.50	38.10	1.63	41.40	18.4	467				

BC = Bare Copper • PVC = Polyvinyl Chloride • XLP = Cross-Linked Poly

UL Control Cables
600 V Type MC Metal Clad Cables

Interlocked Armor



- UL MC
- UL Sun Res
- Oil Res
- Direct Burial

Part No.		Conductors	Color Code	Armor OD		OD (Nom)		Bend Radius (Min)		Insulation Thickness		Jacket Thickness	
Aluminum	Steel			Inch	mm	Inch	mm	Inch	mm	Inch	mm	Inch	mm

Stranded (7 x 18) BC Conductors • XLP Insulation • Interlocked Armor • PVC Jacket

10 AWG • 10 AWG Uninsulated Ground Wire

27257	28257	2	E2	.56	14.22	.67	17.02	8.4	213				
27258	28258	3	E2	.58	14.73	.69	17.53	8.6	218				
27259	28259	4	E2	.62	15.75	.74	18.80	9.2	233				
27281	28281	5	E2	.68	17.27	.79	20.07	12.8	325				
27282	28282	6	E2	.74	18.80	.84	21.34	10.4	264				
27283	28283	7	E2	.74	18.80	.84	21.34	10.4	264	.030	.76	.050	1.27
27284	28284	8	E2	.81	20.57	.92	23.37	11.2	284				
27541	28541	9	E2	.87	22.10	.98	24.89	11.8	299				
27285	28285	10	E2	.89	22.61	1.03	26.16	13.3	337				
27286	28286	12	E2	1.01	25.65	1.12	28.45	13.7	347				
27287	28287	15	E2	1.09	27.69	1.22	30.99	14.8	375				
27288	28288	20	E2	1.22	30.99	1.35	34.29	16.2	411				
27289	28289	25	E2	1.32	33.53	1.47	37.34	17.8	452	.030	.76	.055	1.40
27290	28290	30	E2	1.42	36.07	1.55	39.37	18.6	472				

Stranded (7 x 16) BC Conductors • XLP Insulation • Interlocked Armor • PVC Jacket

8 AWG • 8 AWG Uninsulated Ground Wire

27291	28291	2	M4	.70	17.78	.81	20.57	9.8	248				
27260	28260	3	M4	.72	18.29	.82	20.83	10.2	259	.045	1.14	.050	1.27
27261	28261	4	M4	.78	19.81	.88	22.35	10.9	276				

Stranded (7 x 14) BC Conductors • XLP Insulation • Interlocked Armor • PVC Jacket

6 AWG • 8 AWG Uninsulated Ground Wire

27293	28293	2	M4	.76	19.30	.87	22.10	10.7	271				
27262	28262	3	M4	.80	20.32	.90	22.86	11.2	284	.045	1.14	.050	1.27
27263	28263	4	M4	.87	22.10	.97	24.64	12.1	307				

Stranded (7 x 12) BC Conductors • XLP Insulation • Interlocked Armor • PVC Jacket

4 AWG • 8 AWG Uninsulated Ground Wire

27264	28264	3	M4	1.90	22.86	1.00	25.40	13.1	332				
27265	28265	4	M4	1.97	50.04	1.08	27.43	14.2	360	.045	1.14	.050	1.27

Stranded (7 x 10) BC Conductors • XLP Insulation • Interlocked Armor • PVC Jacket

2 AWG • 6 AWG Uninsulated Ground Wire

27267	28267	3	M4	1.02	25.91	1.13	28.70	14.7	373				
27268	28268	4	M4	1.11	28.19	1.22	30.99	16.0	406	.045	1.14	.050	1.27

BC = Bare Copper • PVC = Polyvinyl Chloride • XLP = Cross-Linked Poly

UL Control Cables
600 V Type MC Metal Clad Cables

Interlocked Armor • Composite Cables



- UL MC
- UL Sun Res
- Oil Res
- Direct Burial

Part No.		Conductors	Color Code	Armor OD		OD (Nom)		Bend Radius (Min)		Insulation Thickness		Jacket Thickness	
Aluminum	Steel			Inch	mm	Inch	mm	Inch	mm	Inch	mm	Inch	mm

Stranded (7 x 22 and 7 x 20) BC Conductors • XLP Insulation • Interlocked Armor • PVC Jacket

14 AWG and 12 AWG • 12 AWG Uninsulated Ground Wire

27428	28428	3 + 3	Note 1	.70	17.78	.81	20.57	9.7	2468	.030	.76	.050	1.27
-------	-------	-------	--------	-----	-------	-----	-------	-----	------	------	-----	------	------

Stranded (7 x 22 and 7 x 18) BC Conductors • XLP Insulation • Interlocked Armor • PVC Jacket

14 AWG and 10 AWG • 10 AWG Uninsulated Ground Wire

27429	28429	3 + 3	Note 1	.74	18.80	.85	21.59	10.2	259	.030	.76	.050	1.27
-------	-------	-------	--------	-----	-------	-----	-------	------	-----	------	-----	------	------

Stranded (7 x 22 and 7 x 16) BC Conductors • XLP Insulation • Interlocked Armor • PVC Jacket

14 AWG and 8 AWG • 10 AWG Uninsulated Ground Wire

27430	28430	3 + 3	Note 1	.83	21.08	.94	23.88	11.2	284	.030 (14 AWG)	.76	.050	1.27
										.045 (8 AWG)	1.14		

Stranded (7 x 22 and 7 x 14) BC Conductors • XLP Insulation • Interlocked Armor • PVC Jacket

14 AWG and 6 AWG • 6 AWG Uninsulated Ground Wire

27431	28431	3 + 3	Note 1	.89	22.61	1.01	25.65	12.0	304	.030 (14 AWG)	.76	.050	1.27
										.045 (8 AWG)	1.14		

Note 1: 14, 12, and 10 AWG use ICEA Table E2 with printed numbers. 8 AWG and larger, use ICEA M4 with printed numbers.

BC = Bare Copper • PVC = Polyvinyl Chloride • XLP = Cross-Linked Poly

Dual Rated UL/CSA Control Cables

600 V Teck-Style® Cables: Dual-Rated Type MC/TECK 90

Interlocked Armor



- UL MC
- CSA C22.2 No.131 FT4 Flame Test, HAZ LOC
- CSA C22.2 No. 0.3 Clause 4.31 Low Acid Gas
- Direct Burial

Part No.		Conductors	Color Code	Inner Jacket OD		Armor OD		OD (Nom)		Pull Tension (Max)		Bend Radius (Min)		Insulation Thickness	
Aluminum	Steel			Inch	mm	Inch	mm	Inch	mm	Lbs	N	Inch	mm	Inch	mm

Stranded (7 x 22) BC Conductors • XLP Insulation • PVC Inner Jacket • Interlocked Armor • PVC Outer Jacket

14 AWG • 14 AWG Uninsulated Ground Wire

27840	28840	2	E2	.37	9.40	.56	14.22	.67	17.02	66	294	8.0	203		
27841	28841	3	E2	.39	9.91	.58	14.73	.69	17.53	98	436	8.3	211		
27842	28842	4	E2	.43	10.92	.62	15.75	.73	18.54	131	583	8.7	221		
27843	28843	5	E2	.47	11.94	.66	16.76	.77	19.56	164	730	9.2	234		
27844	28844	6	E2	.51	12.95	.70	17.78	.81	20.57	191	850	9.7	246		
27845	28845	7	E2	.51	12.95	.70	17.78	.81	20.57	225	1001	9.7	246		
27846	28846	8	E2	.58	14.73	.77	19.56	.88	22.35	260	1157	10.5	267		
27847	28847	10	E2	.67	17.02	.93	23.62	1.04	26.42	321	1428	12.5	318	.030	.76
27848	28848	12	E2	.69	17.53	.95	24.13	1.06	26.92	388	1726	10.9	277		
27849	28849	15	E2	.77	19.56	1.03	26.16	1.14	28.96	481	2140	13.7	348		
27850	28850	20	E2	.86	21.84	1.12	28.45	1.23	31.24	649	2887	15.3	389		
27851	28851	25	E2	.92	23.37	1.18	29.97	1.30	33.02	810	3603	16.3	414		
27852	28852	30	E2	.98	24.89	1.24	31.50	1.36	34.54	975	4337	17.0	432		
27885	28885	40	E2	1.09	27.69	1.35	34.29	1.47	37.34	1301	5787	18.5	470		
27886	28886	50	E2	1.19	30.23	1.45	36.83	1.57	39.88	1630	7251	19.8	503		

Stranded (7 x 20) BC Conductors • XLP Insulation • PVC Inner Jacket • Interlocked Armor • PVC Outer Jacket

12 AWG • 12 AWG Uninsulated Ground Wire

27853	28853	2	E2	.41	10.41	.60	15.24	.71	18.03	104	463	8.5	216		
27854	28854	3	E2	.43	10.92	.62	15.75	.73	18.54	156	694	8.8	224		
27855	28855	4	E2	.47	11.94	.66	16.76	.77	19.56	207	921	9.2	234		
27856	28856	5	E2	.52	13.21	.71	18.03	.82	20.83	260	1157	9.8	249		
27857	28857	6	E2	.59	14.99	.78	19.81	.89	22.61	310	1379	10.7	272		
27858	28858	7	E2	.59	14.99	.78	19.81	.89	22.61	361	1606	10.7	272		
27859	28859	8	E2	.64	16.26	.83	21.08	.94	23.88	415	1846	11.3	287		
27860	28860	10	E2	.75	19.05	1.01	25.65	1.12	28.45	520	2313	13.4	340	.030	.76
27861	28861	12	E2	.77	19.56	1.03	26.16	1.14	28.96	619	2753	13.7	348		
27862	28862	15	E2	.87	22.10	1.13	28.70	1.25	31.75	718	3194	15.0	381		
27863	28863	20	E2	.96	24.38	1.22	30.99	1.33	33.78	1040	4626	15.9	404		
27864	28864	25	E2	1.04	26.42	1.30	33.02	1.42	36.07	1301	5787	17.0	432		
27865	28865	30	E2	1.15	29.21	1.41	35.81	1.53	38.86	1560	6939	18.3	465		
27887	28887	40	E2	1.20	30.48	1.54	39.12	1.67	42.42	2020	8985	20.0	508		

BC = Bare Copper • PVC = Polyvinyl Chloride • XLP = Cross-Linked Poly

Dual Rated UL/CSA Control Cables
 600 V Teck-Style® Cables: Dual-Rated Type MC/TECK 90

Interlocked Armor



- UL MC
- CSA C22.2 No.131 FT4 Flame Test, HAZ LOC
- CSA C22.2 No. 0.3 Clause 4.31 Low Acid Gas
- Direct Burial

Part No.		Conductors	Color Code	Inner Jacket OD		Armor OD		OD (Nom)		Pull Tension (Max)		Bend Radius (Min)		Insulation Thickness	
Aluminum	Steel			Inch	mm	Inch	mm	Inch	mm	Lbs	N	Inch	mm	Inch	mm

Stranded (7 x 18) BC Conductors • XLP Insulation • PVC Inner Jacket • Interlocked Armor • PVC Outer Jacket

10 AWG • 10 AWG Uninsulated Ground Wire

27866	28866	2	E2	.46	11.68	.65	16.51	.74	18.80	166	738	9.1	231		
27867	28867	3	E2	.48	12.19	.67	17.02	.77	19.56	249	1108	9.4	239		
27868	28868	4	E2	.56	14.22	.75	19.05	.84	21.34	330	1468	10.3	262		
27869	28869	5	E2	.67	17.02	.86	21.84	.96	24.38	415	1846	11.6	295		
27870	28870	6	E2	.67	17.02	.86	21.84	.96	24.38	491	2184	11.6	295		
27877	28877	7	E2	.70	17.78	.90	22.86	1.00	25.40	560	2491	12.1	307		
27878	28878	8	E2	.75	19.05	.95	24.13	1.05	26.67	640	2847	12.7	323	.030	.76
27879	28879	10	E2	.78	19.81	1.04	26.42	1.15	29.21	801	3563	13.8	351		
27880	28880	12	E2	.89	22.61	1.15	29.21	1.26	32.00	960	4270	15.1	384		
27881	28881	15	E2	.93	23.62	1.19	30.23	1.30	33.02	1195	5316	15.6	396		
27882	28882	20	E2	1.06	26.92	1.32	33.53	1.44	36.58	1600	7117	17.3	439		
27883	28883	25	E2	1.12	28.45	1.44	36.58	1.58	40.13	1990	8852	19.0	483		
27884	28884	30	E2	1.28	32.51	1.54	39.12	1.67	42.42	2355	10476	20.0	508		

Stranded (7 x 16) BC Conductors • XLP Insulation • PVC Inner Jacket • Interlocked Armor • PVC Outer Jacket

8 AWG • 10 AWG Uninsulated Ground Wire

27871	28871	2	M4	.59	14.99	.78	19.81	.89	22.61	264	1174	10.7	272		
27872	28872	3	M4	.62	15.75	.81	20.57	.91	23.11	396	1762	10.9	277	.045	1.14
27873	28873	4	M4	.68	17.27	.94	23.88	1.05	26.67	528	2349	12.6	320		

Stranded (7 x 14) BC Conductors • XLP Insulation • PVC Inner Jacket • Interlocked Armor • PVC Outer Jacket

6 AWG • 8 AWG Uninsulated Ground Wire

27874	28874	2	M4	.71	18.03	.97	24.64	1.08	27.43	420	1868	13.0	330		
27875	28875	3	M4	.76	19.30	1.02	25.91	1.13	28.70	630	2802	13.5	343	.060	1.52
27876	28876	4	M4	.88	22.35	1.14	28.96	1.25	31.75	840	3737	15.0	381		

Stranded (7 x 12) BC Conductors • XLP Insulation • PVC Inner Jacket • Interlocked Armor • PVC Outer Jacket

4 AWG • 8 AWG Uninsulated Ground Wire

27894	28894	3	M4	.91	23.11	1.17	29.72	1.29	32.77	1002	4457	15.5	394	.060	1.52
27895	28895	4	M4	.99	25.15	1.25	31.75	1.37	34.80	1335	5938	16.4	417		

Stranded (7 x 11) BC Conductors • XLP Insulation • PVC Inner Jacket • Interlocked Armor • PVC Outer Jacket

3 AWG • 6 AWG Uninsulated Ground Wire

27896	28896	3	M4	.96	24.38	1.22	30.99	1.33	33.78	1263	5618	16.0	406	.060	1.52
-------	-------	---	----	-----	-------	------	-------	------	-------	------	------	------	-----	------	------

Stranded (7 x 10) BC Conductors • XLP Insulation • PVC Inner Jacket • Interlocked Armor • PVC Outer Jacket

2 AWG • 6 AWG Uninsulated Ground Wire

27888	28888	3	M4	1.08	27.43	1.28	32.51	1.40	35.56	1593	7086	16.8	427	.060	1.52
27889	28889	4	M4	1.12	28.45	1.38	35.05	1.50	38.10	2124	9448	18.0	457		

BC = Bare Copper • PVC = Polyvinyl Chloride • XLP = Cross-Linked Poly

Dual Rated UL/CSA Control Cables

600 V Teck-Style® Cables: Dual-Rated Type MC/TECK 90

Interlocked Armor • Composite Cables



- UL MC
- CSA C22.2 No.131 FT4 Flame Test, HAZ LOC
- CSA C22.2 No. 0.3 Clause 4.31 Low Acid Gas
- Direct Burial

Part No.		Conductors	Color Code	Inner Jacket OD		Armor OD		OD (Nom)		Pull Tension (Max)		Bend Radius (Min)		Insulation Thickness	
Aluminum	Steel			Inch	mm	Inch	mm	Inch	mm	Lbs	N	Inch	mm	Inch	mm

Stranded (7 x 22 and 7 x 20) BC Conductors • XLP Insulation • PVC Inner Jacket • Interlocked Armor • PVC Outer Jacket

14 AWG and 12 AWG • 12 AWG Uninsulated Ground Wire

27890	28890	3 + 3	Note 1:	.56	14.22	.75	19.05	.86	21.84	202	899	10.3	262	.030	.76
-------	-------	-------	---------	-----	-------	-----	-------	-----	-------	-----	-----	------	-----	------	-----

Stranded (7 x 22 and 7 x 18) BC Conductors • XLP Insulation • PVC Inner Jacket • Interlocked Armor • PVC Outer Jacket

14 AWG and 10 AWG • 10 AWG Uninsulated Ground Wire

27891	28891	3 + 3	Note 1:	.61	15.49	.80	20.32	.91	23.11	305	1357	10.9	277	.030	.76
-------	-------	-------	---------	-----	-------	-----	-------	-----	-------	-----	------	------	-----	------	-----

Stranded (7 x 22 and 7 x 16) BC Conductors • XLP Insulation • PVC Inner Jacket • Interlocked Armor • PVC Outer Jacket

14 AWG and 8 AWG • 10 AWG Uninsulated Ground Wire

27892	28892	3 + 3	Note 1:	.70	17.78	.96	24.38	1.07	27.18	435	1935	12.8	325	.030 (14 AWG)	0.76
														.045 (8 AWG)	1.14

Stranded (7 x 22 and 7 x 14) BC Conductors • XLP Insulation • PVC Inner Jacket • Interlocked Armor • PVC Outer Jacket

14 AWG and 6 AWG • 6 AWG Uninsulated Ground Wire

27893	28893	3 + 3	Note 1:	.90	22.86	1.15	29.21	1.26	32.00	655	2914	15.1	384	.030 (14 AWG)	0.76
														.060 (6 AWG)	1.52

Note 1: 14, 12, and 10 AWG use ICEA Table E2 with printed numbers. 8 AWG and larger, use ICEA M4 with printed numbers.

CSA Control and Power Cables
600 V and 1000 V TC/CIC Multi-Conductor Cables

Unshielded



- CEC Part 1, Suitable for Use in Hazardous Locations: Class 1, Zone 2 and Class 2, Division 2
- +90 °C Dry & Wet
- -40 °C Cold Bend
- -25 °C Cold Impact
- CSA C22.2 No. 230 Type TC
- CSA C22.2 No. 239 Type CIC (600 V only)
- CSA C22.2 No. 38 Type TC (1000 V only)
- CSA FT4 70,000 BTU Flame test

Conductors	Part No.					
	14 AWG		12 AWG		10 AWG	
	600 V	1000 V	600 V	1000 V	600 V	1000 V

Unshielded • For Foil Shielding, add “S” as a Suffix to the Part Number

7-Strand BC Conductors • Flame Resistant Cross-Linked Poly Insulation • Uninsulated BC Ground Conductor • Optional Foil Shielding • Flame Resistant PVC Jacket						
2	21500	21300	21550	21350	21600	21400
3	21501	21301	21551	21351	21601	21401
4	21502	21302	21552	21352	21602	21402
5	21503	21303	21553	21353	21603	21403
6	21504	21304	21554	21354	21604	21404
7	21505	21305	21555	21355	21605	21405
8	21506	21306	21556	21356	21606	21406
9	21507	21307	21557	21357	21607	21407
10	21508	21308	21558	21358	21608	21408
11	21509	21309	21559	21359	21609	21409
12	21510	21310	21560	21360	21610	21410
13	21511	21311	21561	21361	21611	21411
14	21512	21312	21562	21362	21612	21412
15	21513	21313	21563	21363	21613	21413
16	21514	21314	21564	21364	21614	21414
17	21515	21315	21565	21365	21615	21415
18	21516	21316	21566	21366	21616	21416
19	21517	21317	21567	21367	21617	21417
20	21518	21318	21568	21368	21618	21418
21	21519	21319	21569	21369	21619	21419
22	21520	21320	21570	21370	21620	21420
23	21521	21321	21571	21371	21621	21421
24	21522	21322	21572	21372	21622	21422
25	21523	21323	21573	21373	21623	21423
26	21524	21324	21574	21374	21624	21424
27	21525	21325	21575	21375	21625	21425
28	21526	21326	21576	21376	21626	21426
29	21527	21327	21577	21377	21627	21427
30	21528	21328	21578	21378	21628	21428
31	21529	21329	21579	21379	21629	21429
32	21530	21330	21580	21380	21630	21430
33	21531	21331	21581	21381	21631	21431
34	21532	21332	21582	21382	21632	21432
35	21533	21333	21583	21383	21633	21433
36	21534	21334	21584	21384	21634	21434
37	21535	21335	21585	21385	21635	21435
38	21536	21336	21586	21386	21636	21436
39	21537	21337	21587	21387	21637	21437
40	21538	21338	21588	21388	21638	21438

BC = Bare Copper • PVC = Polyvinyl Chloride

CSA Control and Power Cables (continued)
600 V and 1000 V TC/CIC Multi-Conductor Cables

Unshielded



- CEC Part 1, Suitable for Use in Hazardous Locations: Class 1, Zone 2 and Class 2, Division 2
- +90 °C Dry & Wet
- -40 °C Cold Bend
- -25 °C Cold Impact
- CSA C22.2 No. 230 Type TC
- CSA C22.2 No. 239 Type CIC (600 V only)
- CSA C22.2 No. 38 Type TC (1000 V only)
- CSA FT4 70,000 BTU Flame test

Conductors	Part No.					
	14 AWG		12 AWG		10 AWG	
	600 V	1000 V	600 V	1000 V	600 V	1000 V

Unshielded • For Foil Shielding, add "S" as a Suffix to the Part Number

7-Strand BC Conductors • Flame Resistant Cross-Linked Poly Insulation • Uninsulated BC Ground Conductor • Optional Foil Shielding • Flame Resistant PVC Jacket						
41	21539	21339	21589	21389	21639	21439
42	21540	21340	21590	21390	21640	21440
43	21541	21341	21591	21391	21641	21441
44	21542	21342	21592	21392	21642	21442
45	21543	21343	21593	21393	21643	21443
46	21544	21344	21594	21394	21644	21444
47	21545	21345	21595	21395	21645	21445
48	21546	21346	21596	21396	21646	21446
49	21547	21347	21597	21397	21647	21447
50	21548	21348	21598	21398	21648	21448

Conductors	Part No.									
	8 AWG		6 AWG		4 AWG		3 AWG		2 AWG	
	600 V	1000 V	600 V	1000 V	600 V	1000 V	600 V	1000 V	600 V	1000 V

Unshielded • For Foil Shielding, add "S" as a Suffix to the Part Number

7-Strand BC Conductors • Flame Resistant Cross-Linked Poly Insulation • Optional Foil Shielding • Flame Resistant PVC Jacket										
2	21650	21450	21653	21453	21656	21456	21659	21459	21662	21462
3	21651	21451	21654	21454	21657	21457	21660	21460	21663	21463
4	21652	21452	21655	21455	21658	21458	21661	21461	21664	21464

Conductors	Part No.									
	1 AWG		1/0 AWG		2/0 AWG		3/0 AWG		4/0 AWG	
	600 V	1000 V	600 V	1000 V	600 V	1000 V	600 V	1000 V	600 V	1000 V

Unshielded • For Foil Shielding, add "S" as a Suffix to the Part Number

19-Strand BC Conductors • Flame Resistant Cross-Linked Poly Insulation • Optional Foil Shielding • Flame Resistant PVC Jacket										
2	21665	21465	21668	21468	21671	21471	21674	21474	21677	21477
3	21666	21466	21669	21469	21672	21472	21675	21475	21678	21478
4	21667	21467	21670	21470	21673	21473	21676	21476	21679	21479

Conductor Color Codes

Conductors	Colors
2	Black, White
3	Black, White, Blue
4	Black, Red, White, Blue
5 or More	Black and Numbered

BC = Bare Copper • PVC = Polyvinyl Chloride

CSA Control Cables
600 V CIC Multi-Conductor Cables

Unshielded



- -40 °C to +90 °C Dry
- -40 °C to +90 °C Wet
- -25 °C Cold Impact
- CSA C22.2 No. 231 Type CIC
- CSA FT4 Flame Test

Part No.	Conductors	Color Code	OD (Nom)		Insulation Thickness		Jacket Thickness	
			Inch	mm	Inch	mm	Inch	mm

Stranded BC Conductors • Stranded BC Drain Wire • Cross-Linked Poly Insulation • Black PVC Jacket

14 AWG • 7 x 22 • Unshielded

22100	2	Blk, Numberd	.367	9.32				
22101	3	Blk, Numberd	.388	9.86				
22102	4	Blk, Numberd	.423	10.74				
22103	5	Blk, Numberd	.462	11.74	.030	.76	.045	1.14
22104	6	Blk, Numberd	.504	12.80				
22105	7	Blk, Numberd	.504	12.80				
22106	8	Blk, Numberd	.576	14.63				
22107	9	Blk, Numberd	.618	15.70				
22108	10	Blk, Numberd	.669	17.00	.030	.76	.060	1.52
22110	12	Blk, Numberd	.689	17.50				
22114	16	Blk, Numberd	.764	19.41				
22118	20	Blk, Numberd	.886	22.50	.030	.76	.080	2.03

12 AWG • 7 x 20 • Unshielded

22120	2	Blk, Numberd	.405	10.29				
22121	3	Blk, Numberd	.429	10.90	.030	.76	.045	1.14
22122	4	Blk, Numberd	.469	11.91				
22123	5	Blk, Numberd	.515	13.08				
22124	6	Blk, Numberd	.591	15.01				
22125	7	Blk, Numberd	.591	15.01				
22126	8	Blk, Numberd	.639	16.23	.030	.76	.060	1.52
22127	9	Blk, Numberd	.687	17.45				
22128	10	Blk, Numberd	.745	18.92				
22130	12	Blk, Numberd	.768	19.51				
22134	16	Blk, Numberd	.893	22.68	.030	.76	.080	2.03
22138	20	Blk, Numberd	.992	25.20				

10 AWG • 7 x 18 • Unshielded

22140	2	Blk, Numberd	.736	18.69	.030	.76	.045	1.14
22141	3	Blk, Numberd	.763	19.38				
22142	4	Blk, Numberd	.839	21.31				
22143	5	Blk, Numberd	.891	22.63				
22144	6	Blk, Numberd	.944	23.98				
22145	7	Blk, Numberd	.944	23.98	.030	.76	.060	1.52
22146	8	Blk, Numberd	.999	25.38				
22147	9	Blk, Numberd	1.074	27.28				
22148	10	Blk, Numberd	1.182	30.02				
22150	12	Blk, Numberd	1.209	30.71				
22152	14	Blk, Numberd	1.255	31.88	.030	.76	.080	2.03
22154	16	Blk, Numberd	1.307	33.20				

BC = Bare Copper • PVC = Polyvinyl Chloride

CSA Control Cables

600 V CIC Multi-Conductor Cables

Unshielded



- -40 °C to +90 °C Dry
- -40 °C to +90 °C Wet
- -25 °C Cold Impact

- CSA C22.2 No. 231 Type CIC
- CSA FT4 Flame Test

Part No.	Conductors	Color Code	OD (Nom)		Insulation Thickness		Jacket Thickness	
			Inch	mm	Inch	mm	Inch	mm

Stranded BC Conductors • Stranded BC Drain Wire • Cross-Linked Poly Insulation • Black PVC Jacket

8 AWG • 7 x 16 • Unshielded

22160	2	Blk, Numbered	.863	21.92				
22161	3	Blk, Numbered	.898	22.81	.045	1.14	.060	1.52
22162	4	Blk, Numbered	.957	24.31				

6 AWG • 7 x 14 • Unshielded

22170	2	Blk, Numbered	.711	18.06	.060	1.52	.060	1.52
22171	3	Blk, Numbered	.756	19.20				

4 AWG • 7 x 12 • Unshielded

22180	2	Blk, Numbered	.800	20.32	.060	1.52	.060	1.52
22181	3	Blk, Numbered	.891	22.63				

BC = Bare Copper • PVC = Polyvinyl Chloride

CSA Control Cables

600 V ACIC and TECK 90 Cables – Overview

Belden TECK 90 and ACIC cables are designed to meet demanding industrial needs by combining rugged durability and corrosion resistance with flexibility and easy handling.

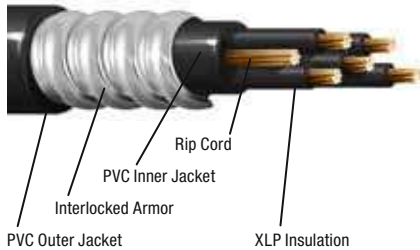

Introduction

TECK 90 and ACIC Cables are available in a wide range of standard and custom constructions to meet the needs of oil and gas, pulp and paper, chemical, petroleum and other demanding industrial and resource industry environments. They are ideal for use in wet or dry areas, ventilated or non-ventilated, ladder-type cable troughs, flexible cableways and direct burial installations.

Belden TECK 90 Cable is marked with "FT4," "HL" designations, and cable constructions are certified to CSA Standard C22.2 No. 131 and C22.2 No. 174 for use in a wide range of hazardous locations. Both inner and outer jackets meet the acid gas evolution requirement of 14% maximum required by CSA Standard C22.2 No. 0.3 Clause 4.31.

Custom cables are available upon request.

Construction

Class B stranded bare copper conductors, cross-link polyethylene insulation, bare copper ground wire, PVC inner jacket, aluminum steel interlocking armor, PVC outer jacket.

- Galvanized steel interlocking armor available as an option.

Voltage Rating

- 18 to 16 AWG – 600 V ACIC
- 14 to 8 AWG – 600 V
- 14 to 4/0 AWG – 1000 V

Temperature Rating

- -40 °C to +90 °C (Dry/Wet)
- -25 °C installed

Application

TECK 90 and ACIC are general-purpose cables used in the oil and gas, pulp and paper, mining, petroleum and chemical industries as well as in commercial buildings.

TECK 90 and ACIC may be used under the following conditions:

- Exposed or concealed wiring in dry or wet conditions
- In ventilated, non-ventilated or ladder-type cable trays in dry or wet conditions
- On walls or beams
- Directly buried
- CEC Class I, Division I locations

Minimum Bending Radius

12 times the overall cable diameter

Pulling Tensions

The combined use of Kellems grips and pulling eyes is recommended.

Design Advantages

Insulation Properties

- High tensile strength
- Impact- and crush-resistant
- Heat-resistant
- Excellent elongation
- Moisture-resistant
- Good low temperature properties

Electrical Properties

- High insulation resistance
- Low dielectric loss
- High dielectric strength

Other Features

- Corrosion-resistant
- Versatile and flexible
- Provides cost savings as conduit and ducts are not required
- ACIC has a blue jacket
- Rip cord for inner jacket

Specifications

- CSA Standard C22.2 No. 131
- CSA Standard C22.2 No. 174 "Cables and Cable Glands for Use in Hazardous Locations"
- CSA Standard C22.2 No. 0.3 Clause 4.31 "Low Acid Gas"
- CSA Standard C22.2 No. 0.3 Clause 4.11.4 "Cables with FT4 Marking"

CSA Control Cables

600 V ACIC Cables

Armored • Unshielded



- CSA C22.2 No. 239 CIC
- CSA C22.2 No. 0.3 Clause 4.31 Low Acid Gas
- HAZ LOC

Part No.	Conductors	Inner Jacket OD		Armor OD		Outer Jacket OD		Pull Tension (Max)		Bend Radius (Min)	
		Inch	mm	Inch	mm	Inch	mm	Lbs	N	Inch	mm

Stranded BC Conductors • Cross-Linked Poly Insulation • Uninsulated BC Ground Wire • PVC Inner Jacket • Armor • Blue PVC Outer Jacket

18 AWG • 7 x 26

29030	2	.32	8.13	.52	13.21	.62	15.75	44	196	7.4	187.96
29031	3	.34	8.64	.54	13.72	.64	16.26	66	294	7.6	193.04
29032	4	.37	9.40	.57	14.48	.67	17.02	88	392	8.0	203.20
29033	5	.41	10.41	.61	15.49	.71	18.03	110	490	8.5	215.90
29034	6	.45	11.43	.65	16.51	.75	19.05	132	587	9.0	228.60
29035	7	.45	11.43	.65	16.51	.75	19.05	154	685	9.0	228.60
29036	8	.48	12.19	.68	17.27	.78	19.81	176	783	9.3	236.22
29038	10	.56	14.22	.76	19.30	.87	22.10	220	979	10.6	269.24
29040	12	.62	15.75	.82	20.83	.93	23.62	264	1175	11.1	281.94
29043	15	.65	16.51	.85	21.59	.96	24.38	330	1469	11.5	292.10
29048	20	.73	18.54	.93	23.62	1.04	26.42	440	1958	12.4	314.96
29053	25	.79	20.07	1.05	26.67	1.16	29.46	550	2448	13.9	353.06
29058	30	.88	22.35	1.14	28.96	1.25	31.75	660	2937	15.0	381.00
29068	40	.97	24.64	1.23	31.24	1.35	34.29	880	3916	16.2	411.48
29078	50	1.09	27.69	1.35	34.29	1.47	37.34	1100	4895	17.6	447.04

16 AWG • 7 x 24

29017	2	.34	8.64	.54	13.72	.65	16.51	70	312	7.7	195.58
29004	3	.36	9.14	.56	14.22	.66	16.76	105	467	7.9	200.66
29018	4	.39	9.91	.59	14.99	.70	17.78	140	623	8.3	210.82
29019	5	.42	10.67	.62	15.75	.73	18.54	175	779	8.6	218.44
29005	6	.46	11.68	.66	16.76	.77	19.56	210	935	9.1	231.14
29020	7	.47	11.94	.67	17.02	.77	19.56	245	1090	9.2	233.68
29021	8	.50	12.70	.70	17.78	.80	20.32	280	1246	9.6	243.84
29022	10	.61	15.49	.81	20.57	.92	23.37	350	1558	10.9	276.86
29006	12	.63	16.00	.83	21.08	.94	23.88	420	1869	11.2	284.48
29023	15	.68	17.27	.88	22.35	1.00	25.40	525	2336	11.9	302.26
29007	20	.77	19.56	1.03	26.16	1.13	28.70	700	3115	13.7	347.98
29024	25	.89	22.61	1.15	29.21	1.26	32.00	875	3894	15.1	383.54
29008	30	.94	23.88	1.20	30.48	1.30	33.02	1050	4673	15.8	401.32
29009	40	1.06	26.92	1.32	33.53	1.41	35.81	1400	6230	17.3	439.42
29016	50	1.19	30.23	1.45	36.83	1.54	39.12	1750	7788	18.8	477.52
29025	60	1.27	32.26	1.53	38.86	1.66	42.16	2100	9345	19.9	505.46

Conductor Color Codes

Conductors	Colors
2	Black, White
3	Black, White, Blue
4	Black, Red, White, Blue
5 or More	Black and Numbered

BC = Bare Copper • PVC = Polyvinyl Chloride

CSA Control Cables
600 V TECK 90 Cables

Armored • Unshielded



- CSA C22.2 No. 239 CIC
- CSA C22.2 No. 0.3 Clause 4.31 Low Acid Gas
- HAZ LOC

Part No.	Conductors	Inner Jacket OD		Armor OD		Outer Jacket OD		Pull Tension (Max)		Bend Radius (Min)	
		Inch	mm	Inch	mm	Inch	mm	Lbs	N	Inch	mm

Stranded BC Conductors • Cross-Linked Poly Insulation • Uninsulated BC Ground Wire • PVC Inner Jacket • Armor • Black PVC Outer Jacket

14 AWG • 7 x 22

C5500	2	.36	9.14	.56	14.22	.66	16.76	108	481	7.8	198.12
C5501	3	.39	9.91	.58	14.73	.66	16.76	162	721	8.2	208.28
C5502	4	.42	10.67	.62	15.75	.71	18.03	216	961	8.5	215.90
C5503	5	.47	11.94	.66	16.76	.74	18.80	270	1202	9.0	228.60
C5504	6	.51	12.95	.70	17.78	.78	19.81	324	1442	9.5	241.30
C5505	7	.51	12.95	.70	17.78	.78	19.81	378	1682	9.5	241.30
C5506	8	.58	14.73	.77	19.56	.86	21.84	432	1922	10.4	264.16
C5508	10	.67	17.02	.93	23.62	.95	24.13	540	2403	12.3	312.42
C5510	12	.69	17.53	.95	24.13	.97	24.64	648	2884	12.6	320.04
C5513	15	.77	19.56	1.03	26.16	1.11	28.19	810	3605	14.1	358.14
C5518	20	.90	22.86	1.16	29.46	1.24	31.50	1080	4806	15.1	383.54
C5523	25	.90	22.86	1.24	31.50	1.33	33.78	1350	6008	16.1	408.94
C5528	30	1.05	26.67	1.30	33.02	1.40	35.56	1620	7209	16.8	426.72
C5529	40	1.20	30.48	1.42	36.07	1.51	38.35	2160	9612	18.3	464.82
C6064	50	1.35	34.29	1.60	40.64	1.66	42.16	2700	12,015	20.5	520.70

12 AWG • 7 x 20

C5530	2	.41	10.41	.60	15.24	.69	17.53	172	765	8.3	210.82
C5531	3	.43	10.92	.62	15.75	.70	17.78	258	1148	8.6	218.44
C5532	4	.47	11.94	.66	16.76	.73	18.54	344	1531	9.1	231.14
C5533	5	.52	13.21	.71	18.03	.78	19.81	430	1914	9.1	231.14
C5534	6	.59	14.99	.78	19.81	.86	21.84	516	2296	10.5	266.70
C5535	7	.59	14.99	.78	19.81	.86	21.84	602	2679	10.5	266.70
C5536	8	.64	16.26	.83	21.08	.92	23.37	688	3062	11.1	281.94
C5538	10	.75	19.05	1.01	25.65	1.02	25.91	860	3827	13.3	337.82
C5540	12	.77	19.56	1.03	26.16	1.12	28.45	1032	4592	13.5	342.90
C5543	15	.90	22.86	1.16	29.46	1.24	31.50	1290	5741	15.1	383.54
C5548	20	.99	25.15	1.25	31.75	1.34	34.04	1720	7654	16.5	419.10
C5553	25	1.10	27.94	1.36	34.54	1.45	36.83	2150	9568	17.6	447.04
C5558	30	1.20	30.48	1.46	37.08	1.51	38.35	2580	11,481	17.6	447.04

Conductor Color Codes

Conductors	Colors
2	Black, White
3	Black, White, Blue
4	Black, Red, White, Blue
5 or More	Black and Numbered

BC = Bare Copper • PVC = Polyvinyl Chloride

CSA Control Cables
600 V TECK 90 Cables

Armored • Unshielded



- CSA C22.2 No. 239 CIC
- CSA C22.2 No. 0.3 Clause 4.31
Low Acid Gas
- HAZ LOC

Part No.	Conductors	Inner Jacket OD		Armor OD		Outer Jacket OD		Pull Tension (Max)		Bend Radius (Min)	
		Inch	mm	Inch	mm	Inch	mm	Lbs	N	Inch	mm

Stranded BC Conductors • Cross-Linked Poly Insulation • Uninsulated BC Ground Wire • PVC Inner Jacket • Armor • Black PVC Outer Jacket

10 AWG • 7 x 18

C5560	2	.48	12.19	.66	16.76	.72	18.29	296	1317	8.9	226.06
C5561	3	.50	12.70	.70	17.78	.75	19.05	444	1976	9.2	233.68
C5562	4	.57	14.48	.77	19.56	.79	20.07	592	2634	10.1	256.64
C5563	5	.63	16.00	.83	21.08	.93	23.62	740	3293	11.5	292.10
C5564	6	.68	17.27	.88	22.35	.93	23.62	888	3952	11.5	292.10
C5565	7	.69	17.53	.89	22.61	.99	25.15	1036	4610	11.8	299.72
C5566	8	.74	18.80	.94	23.88	1.00	25.40	1184	5269	12.4	314.96
C5568	10	.84	21.34	1.10	27.94	1.24	31.50	1480	6586	14.4	365.76
C5570	12	.93	23.62	1.19	30.23	1.26	32.00	1776	7903	15.6	396.24
C5573	15	.99	25.15	1.25	31.75	1.37	34.80	2220	9879	16.3	414.02
C5578	20	1.13	28.70	1.39	35.31	1.47	37.34	2960	13,172	16.9	429.26
C5579	25	1.26	32.00	1.52	38.61	1.60	40.64	3700	16,465	19.7	500.38
C5580	30	1.34	34.04	1.60	40.64	1.66	42.16	4440	19,758	20.6	523.24

8 AWG • 7 x 16

C5583	2	.59	14.99	.78	19.81	.86	21.84	384	1709	10.6	269.24
C5581	3	.63	16.00	.83	21.08	.90	22.86	576	2563	10.8	274.32
C5582	4	.69	17.53	.89	22.61	.97	24.64	768	3418	12.5	317.50

Conductor Color Codes

Conductors	Colors
2	Black, White
3	Black, White, Blue
4	Black, Red, White, Blue
5 or More	Black and Numbered

CSA Control Cables
600 V TECK 90 Composite Cables

Composite • Armored • Unshielded



- Sunlight Res
- CSA C22.2 No. 131 Type TECK 90
- CSA C22.2 No. 0.3 Clause 4.31 Low Acid Gas
- HAZ LOC

Part No.	Conductors	Color Code	Inner Jacket OD		Armor OD		Outer Jacket OD		Pull Tension (Max)		Bend Radius (Min)	
			Inch	mm	Inch	mm	Inch	mm	Lbs	N	Inch	mm

Stranded BC Conductors • Cross-linked Poly Insulation • PVC Inner Jacket • Armor • Black PVC Outer Jacket

14 and 12 AWG • 7 x 22 and 7 x 20 • 14 AWG Uninsulated Ground Wire

6054	3 + 3	E2	.560	14.22	.75	19.05	.89	22.61	424	1886	8.4	213.36
-------------	-------	----	------	-------	-----	-------	-----	-------	-----	------	-----	--------

14 and 10 AWG • 7 x 22 and 7 x 18 • 12 AWG Uninsulated Ground Wire

6051	3 + 3	E2	.600	15.24	.82	20.83	.92	23.37	608	2705	9.0	228.60
-------------	-------	----	------	-------	-----	-------	-----	-------	-----	------	-----	--------

14 and 8 AWG • 7 x 22 and 7 x 16 • 10 AWG Uninsulated Ground Wire

6059	3 + 3	E2	.700	17.78	.89	22.51	.98	24.92	1160	5160	9.8	248.92
-------------	-------	----	------	-------	-----	-------	-----	-------	------	------	-----	--------

14 and 6 AWG • 7 x 22 and 7 x 14 • 8 AWG Uninsulated Ground Wire

6060	3 + 3	E2	.810	20.57	1.06	27.00	1.16	29.41	1700	7562	11.6	294.64
-------------	-------	----	------	-------	------	-------	------	-------	------	------	------	--------

BC = Bare Copper • PVC = Polyvinyl Chloride

CSA Control Cables
1000 V TECK 90 Cables

Armored • Unshielded



- CSA C22.2 No. 131 Type TECK 90
- CSA C22.2 No. 0.3 Clause 4.31
Low Acid Gas
- HAZ LOC

Part No.	Conductors	Inner Jacket OD		Armor OD		Outer Jacket OD		Pull Tension (Max)		Bend Radius (Min)	
		Inch	mm	Inch	mm	Inch	mm	Lbs	N	Inch	mm

Stranded BC Conductors • Cross-linked Poly Insulation • PVC Inner Jacket • Armor • Black PVC Outer Jacket

14 AWG • 7 x 22 • 14 AWG Uninsulated Ground Wire

C5701	3	.47	11.94	.67	17.02	.73	18.54	162	721	9.2	233.68
C5702	4	.51	12.95	.71	18.03	.81	20.57	216	961	9.7	246.38

12 AWG • 7 x 20 • 14 AWG Uninsulated Ground Wire

C5730	2	.48	12.19	.68	17.27	.74	18.80	172	765	9.3	236.22
C5731	3	.51	12.95	.71	18.03	.76	19.30	258	1148	9.7	246.38
C5732	4	.59	14.99	.75	19.05	.85	21.59	344	1531	10.8	274.32

10 AWG • 7 x 18 • 12 AWG Uninsulated Ground Wire

C5760	2	.56	14.22	.79	19.99	.70	17.71	296	1317	10.3	261.62
C5761	3	.59	14.99	.79	20.07	.85	21.59	444	1976	10.3	261.62
C5762	4	.65	16.51	.85	21.59	.90	22.86	592	2634	11.5	292.10

8 AWG • 7 x 16 • 10 AWG Uninsulated Ground Wire

C5583	2	.59	14.99	.78	19.81	.86	21.84	384	1709	10.6	269.24
C5581	3	.63	16.00	.83	21.08	.90	22.86	576	2563	10.8	274.32
C5582	4	.69	17.53	.89	22.61	.97	24.64	768	3418	12.5	317.50

6 AWG • 7 x 14 • 8 AWG Uninsulated Ground Wire

C5590	2	.73	18.54	.99	25.15	1.10	27.94	610	2713	12.8	325.12
C5591	3	.78	19.81	1.04	26.42	1.15	29.21	915	4072	13.4	340.36
C5592	4	.89	22.61	1.15	29.21	1.24	31.50	1220	5429	14.9	378.46

Conductor Color Codes

Conductors	Colors
2	Black, White
3	Black, White, Blue
4	Black, Red, White, Blue

BC = Bare Copper • PVC = Polyvinyl Chloride

CSA Control Cables
1000 V TECK 90 Cables

Armored • Unshielded



- CSA C22.2 No. 131 Type TECK 90
- CSA C22.2 No. 0.3 Clause 4.31 Low Acid Gas
- HAZ LOC

Part No.	Conductors	Inner Jacket OD		Armor OD		Outer Jacket OD		Pull Tension (Max)		Bend Radius (Min)	
		Inch	mm	Inch	mm	Inch	mm	Lbs	N	Inch	mm

Stranded BC Conductors • Cross-linked Poly Insulation • PVC Inner Jacket • Armor • Black PVC Outer Jacket

4 AWG • 7 x 12 • 8 AWG Uninsulated Ground Wire

C5601	3	.91	23.11	1.17	29.72	1.23	31.24	1455	6475	15.2	386.08
C5602	4	.91	23.11	1.25	31.75	1.33	33.78	1940	8633	16.2	411.48

3 AWG • 7 x 11 • 6 AWG Uninsulated Ground Wire

C5611	3	.97	24.64	1.23	31.24	1.30	33.02	1836	8170	15.8	401.32
--------------	---	-----	-------	------	-------	------	-------	------	------	------	--------

2 AWG • 7 x 10 • 6 AWG Uninsulated Ground Wire

C5621	3	1.02	25.91	1.28	32.51	1.37	34.80	2316	10,302	16.5	419.10
C5622	4	1.12	28.45	1.38	35.05	1.48	37.59	3088	13,736	17.7	449.58

1 AWG • 19 x 14 • 6 AWG Uninsulated Ground Wire

C5625	3	1.25	31.75	1.51	38.35	1.59	40.39	1980	8807	19.1	485.14
C5626	4	1.34	34.04	1.57	39.88	1.68	42.67	2680	11,921	20.2	513.08

1/0 AWG • 19 x 12 • 6 AWG Uninsulated Ground Wire

C5627	3	1.34	34.04	1.60	40.64	1.67	42.42	3582	15,940	20.0	508.0
6164	4	1.44	36.58	1.67	42.42	1.78	45.21	4700	20,906	21.4	543.56

2/0 AWG • 19 x 11 • 6 AWG Uninsulated Ground Wire

C5635	3	1.40	35.56	1.63	41.40	1.74	44.20	4200	12010	20.9	530.86
6157	4	1.55	39.37	1.84	46.74	1.95	49.53	5500	24,465	23.4	594.36

3/0 AWG • 19 x 10 • 4 AWG Uninsulated Ground Wire

6163	3	1.51	38.10	1.80	45.72	1.91	48.26	5020	11,121	22.9	579.12
6179	4	1.67	42.42	1.96	49.78	2.07	52.58	6500	28,913	24.8	629.92

4/0 AWG • 19 x 9.5 • 4 AWG Uninsulated Ground Wire

6193	3	1.63	41.40	1.92	48.77	2.03	51.56	6650	29,580	24.4	619.76
-------------	---	------	-------	------	-------	------	-------	------	--------	------	--------

Conductor Color Codes

Conductors	Colors
3	Black, White, Blue
4	Black, Red, White, Blue

BC = Bare Copper • PVC = Polyvinyl Chloride

Technical Information

Gland Information for Armored Cables

Thomas and Betts

Part No.	Hub Size NPT	Range Over Jacket			
		Minimum		Maximum	
		Inch	mm	Inch	mm
ST050-462	1/2	.525	13.34	.650	16.51
ST050-464	1/2	.600	15.24	.760	19.30
ST050-465	1/2	.725	18.42	.885	22.48
ST050-466	1/2	.825	20.96	.985	25.02
ST075-467	3/4	.880	22.35	1.065	27.05
ST075-468	3/4	1.025	26.04	1.205	30.61
ST100-469	1	1.187	30.15	1.375	34.93
ST125-470	1-1/4	1.350	34.29	1.625	41.28
ST125-550	1-1/4	1.500	38.10	1.625	41.28
ST125-471	1-1/4	1.600	40.64	1.875	47.63
ST150-472	1-1/2	1.700	43.18	1.965	49.91
ST150-473	1-1/2	1.900	48.26	2.187	55.55
ST200-551	2	1.900	48.26	2.187	55.55
ST200-474	2	2.100	53.34	2.375	60.33
ST200-475	2	2.300	58.42	2.565	65.15
ST200-476	2	2.500	63.50	2.750	69.85
ST250-477	2-1/2	2.380	60.45	2.640	67.06
ST250-478	2-1/2	2.580	65.53	2.840	72.14
ST300-479	3	2.790	70.87	3.060	77.72
ST300-480	3	3.000	76.20	3.270	83.06
ST300-481	3	3.210	81.53	3.480	88.39
ST350-482	3-1/2	3.420	86.67	3.690	93.73
ST350-483	3-1/2	3.610	91.69	3.870	98.30
ST400-484	4	3.810	96.77	4.030	102.36
ST400-485	4	3.965	100.71	4.185	106.30
ST400-486	4	4.120	104.65	4.340	110.24

Crouse Hinds

NPT Thread Size	Armor OD Range (Inch)	Non-Hazardous Part No.	Hazardous Part No.
1/2	.440 to .650	TMC165	TMCX165*
3/4	.600 to .850	TMC285	TMCX285*
1	.800 to 1.120	TMC3112	TMCX3112*
1-1/4	1.100 to 1.400	TMC4140	TMCX4140*
1-1/2	1.330 to 1.610	TMC5161	TMCX5161*
2	1.570 to 2.060	TMC6206	TMCX6206
2-1/2	1.930 to 2.470	TMC7247	TMCX7247*
3	2.450 to 3.020	TMC8302	TMCX8302
3-1/2	2.950 to 3.520	TMC9352	TMCX9352
4	3.500 to 4.020	TMC10402	TMCX10402

* TMCX Catalog numbers listed are suitable for use with Type TC tray cable in hazardous locations when installed in accordance with NEC Articles 501-5(e) and 502-5. TMCX series is not suitable for use in Class III locations when used with tray cable.

Hawke Size Ref.	Standard Seal 1348 Diameter				Alternative Seal 1498 Diameter				NPT Size
	Minimum		Maximum		Minimum		Maximum		
	Inch	mm	Inch	mm	Inch	mm	Inch	mm	
711-A	.590	14.99	.820	20.83	.470	11.94	.610	15.49	1/2
711-B	.790	20.07	.060	26.92	.630	16.00	.840	21.34	3/4
711-C	.930	23.62	1.310	33.27	.830	21.08	1.090	27.69	1
711-C2	1.260	32.00	1.690	42.93	1.100	27.94	1.340	34.04	1-1/4
711-D	1.690	42.93	2.060	52.32	1.300	33.02	1.610	40.89	2
711-E	2.050	52.07	2.560	65.02	1.810	45.97	2.160	54.86	2-1/2
711-F	2.560	65.02	3.070	77.98	2.240	56.90	2.640	67.06	3
711-H	2.990	75.95	3.520	89.41	Special Order				3-1/2
711-J	3.500	88.90	4.110	104.39	Special Order				4

Adalet - PLM

Part No.	Diameter Over Jacket				Conduit Size
	Minimum		Maximum		
	Inch	mm	Inch	mm	
PS/PSX 45-05	.350	8.89	.450	11.43	1/2
PS/PSX 55-05	.450	11.43	.550	13.97	1/2
PS/PSX 65-05	.550	13.97	.650	16.51	1/2
PS/PSX 75-05	.650	16.51	.750	19.05	1/2
PS/PSX 85-05	.750	19.05	.850	21.59	1/2
PS/PSX 95-05	.850	21.59	.950	24.13	1/2
PS/PSX 99-07	.850	21.59	.990	25.15	3/4
PS/PSX 107-07	.920	23.37	1.070	27.18	3/4
PS/PSX 113-07	.980	24.89	1.130	28.70	3/4
PS/PSX 121-07	1.070	27.18	1.210	30.73	3/4
PS/PSX 112-10	1.000	25.40	1.120	28.45	1
PS/PSX 125-10	1.120	28.45	1.250	31.25	1
PS/PSX 138-10	1.220	30.99	1.380	35.05	1
PS/PSX 138-12	1.280	32.51	1.380	35.05	1-1/4
PS/PSX 156-12	1.380	35.05	1.560	39.62	1-1/4
PS/PSX 174-12	1.560	39.62	1.740	44.20	1-1/4
PS/PSX 188-12	1.740	44.20	1.880	47.75	1-1/4
PS/PSX 174-15	1.600	40.64	1.740	44.20	1-1/2
PS/PSX 188-15	1.740	44.20	1.880	47.75	1-1/2
PS/PSX 200-15	1.880	47.75	2.000	50.80	1-1/2
PS/PSX 218-15	2.000	50.80	2.180	55.37	1-1/2
PS/PSX 219-20	2.050	52.07	2.190	55.63	2
PS/PSX 236-20	2.190	55.63	2.360	59.94	2
PS/PSX 247-20	2.350	59.69	2.470	62.74	2
PS/PSX 261-20	2.470	62.74	2.610	66.29	2
PS/PSX 263-25	2.460	62.48	2.630	66.80	2-1/2
PS/PSX 280-25	2.620	66.55	2.800	71.12	2-1/2
PS/PSX 296-25	2.800	71.12	2.960	75.18	2-1/2
PS/PSX 297-30	2.800	71.12	2.970	75.44	3
PS/PSX 311-30	2.950	74.93	3.110	78.99	3
PS/PSX 327-30	3.100	78.74	3.270	83.06	3
PS/PSX 343-30	3.260	82.80	3.430	87.12	3
PS/PSX 359-30	3.420	86.87	3.590	91.19	3
PS/PSX 375-35	3.520	89.41	3.750	95.25	3-1/2
PS/PSX 392-35	3.750	95.25	3.920	99.57	3-1/2
PS/PSX 412-35	3.900	99.06	4.120	104.65	3-1/2
PS/PSX 423-40	4.050	102.87	4.230	107.44	4
PS/PSX 437-40	4.200	106.68	4.370	111.00	4
PS/PSX 451-40	4.340	110.24	4.510	114.55	4
PS/PSX 462-40	4.430	112.52	4.620	117.35	4

** Use PS for non-hazardous locations and PSX for hazardous locations.

Technical Information

LSZH Jacketed Cables and Hazardous Locations Reference

Approvals and Standards/Performance Data for Low-Smoke, Zero-Halogen Jacketed Cable

XLP Insulation

Physical: (per UL-44)			
Tensile (min)	1500 psi	Deformation (max)	3.35
Elongation (min)	150%	LOI	27

	Haloarrest®	HaloarrestXLink-1	HaloarrestXLink-2
Physical			
Tensile (min)	1500 psi	1500 psi	1500 psi
Elongation (min)	100%	150%	150%
Tear Resistance	74 lbs/inch	—	—
LOI	38	39	45
Halogen Content			
IEC 754-1	0%	0%	0%
BS6425	0%	—	—
MIL-C-24643	<0.2%	—	—
NBS Smoke Chamber			
Flaming Mode	141 D _m corrected typical	164 D _m corrected typical	—
Smoldering Mode	311 D _m corrected typical	417 D _m corrected typical	—
Acid Gas			
IEC 754-2	4.3 pH, 28 µS/cm	4.9 pH, 0.7 µS/cm	<4.5 pH, 0.4 µS/cm
VDE 0472 Part 813	4.3 pH, 27 µS/cm	—	—
Toxicity Index			
NES 713	1	4.6	—
EN50305-2	—	—	2

Low-Smoke, Zero-Halogen Jacketed Cable Specifications

600 V, +90 °C TC-LC NEC 340/UL 1277 & 1685

Instrumentation

- 18 to 12 AWG, BC or TC
- +90 °C XLP insulation
- UL 44 XHHW-2 – +90 °C dry/wet
- Shielded or unshielded
- Haloarrest® jacket

Control or Power

- 14 to 4/0 AWG, BC or TC
- +90 °C XLP insulation
- UL 44 XHHW-2 – +90 °C dry/wet
- Shielded or unshielded
- Haloarrest® jacket

Hazardous Locations Cable Reference

Article 500

Class I Division 1 Hazards

- Locations where flammable gases or vapors may exist under normal operating conditions, under frequent repair or maintenance operations, or where break-down or faulty operation of process equipment might also cause simultaneous failure of electrical equipment.
- Use conduit or MI cable with approved termination fittings.

Class I Division 2 Hazards

- Locations where flammable gases, vapors or volatile liquids are handled either in a closed system, or confined within suitable enclosures, or where hazardous concentrations are normally prevented by positive mechanical ventilation. Areas adjacent to Division 1 areas belong in Division 2.
- Use PLTC, ITC, TC, MC, MV, MI with approved termination fittings.

Class II Division 1

- Locations where combustible dusts exist under normal conditions.
- Use conduit or MI with approved termination fittings.

Class II Division 2

- Locations where combustible dusts exist under abnormal conditions.
- Use conduit or PLTC, ITC, TC, MC with ventilated channel cable trays.
- Use conduit or MC, MI with approved termination fittings.

Class III Division 1

- Locations where easily ignitable fibers and flyings exist under normal conditions.
- Use conduit or MC, MI with approved termination fittings.

Class III Division 2

- Locations where easily ignitable fibers and flyings exist under abnormal conditions.
- Use conduit or MC, MI with approved termination fittings.

Article 504

Intrinsically Safe

- Equipment and wiring that are incapable of releasing sufficient electrical energy under normal or abnormal conditions to cause ignition of a specific hazardous atmospheric mixture in its most easily ignited concentration.
- Use CL3, CL2, PLTC, TC or CM cable, colored light blue, with approved sealing and separation.

Hazardous Location Cable Reference per Canadian Electrical Code CEC Section 18

All Armored cables printed "HL" per CSA C22.2 #174 are rated for all Hazardous Location Classes and Divisions (i.e., Class 1, Div. 1).

All Tray Cables printed "TC" per CSA C22.2 #230 are rated for all Hazardous Location Classes and Division 2 or lower. (i.e., Class 1, Div. 2 or lower).

Technical Information

UL Approved Insulation/Jacketing Options

UL Listed for MC and TC			
Insulation/Jacket	Max. Temp Rating		Flame Tests
	Wet	Dry	
PVC-Nylon/PVC (THHN or THWN) 14 AWG & larger	+75 °C	+90 °C	UL 1685 FT4/ IEEE 1202/383 ICEA T-29-520
PVC-Nylon/PVC (TFN or TFFN) 16 & 18 AWG	+75 °C	+90 °C	UL 1685 FT4/ IEEE 1202/383 ICEA T-29-520
XLP/PVC or CPE (XHHW-2) 14 AWG & larger	+90 °C	+90 °C	UL 1685 FT4/ IEEE 1202/383 VW-1 rated singles ICEA T-29-520
XLP/PVC or CPE (RFH-2) 16 & 18 AWG	+90 °C	+90 °C	UL 1685 FT4/ IEEE 1202/383 VW-1 rated singles ICEA T-29-520
FRPO/PVC 18 AWG & larger	—	+75 °C	UL 1685
FRPO/PVC	+75 °C	+90 °C	UL 1685
XLP/Haloarrest® (XHHW-2) 14 AWG & larger	+90 °C	+90 °C	UL 1685
XLP/Haloarrest (RFH-2) 16 & 18 AWG	+90 °C	+90 °C	UL 1685 ICEA T-29-520
XLP/HaloarrestXLink™-1 (XHHW-2) 18 AWG & larger	+90 °C	+90 °C	UL 1685 FT4/IEEE 1202/383 VW-1 rated singles
XLP/HaloarrestXLink-2 (XHHW-2) 18 AWG & larger	+90 °C	+90 °C	UL 1685 FT4/IEEE 1202/383 VW-1 rated singles
FEP/PVC	+90 °C	+90 °C	UL 1685

UL Listed for PLTC	
Insulation/Jacket	Max. Temp Rating
XLP/PVC	+90 °C
XLP/CPE	+90 °C
PVC/PVC	+105 °C
PVC/CPE	+105 °C
PE/PVC	+75 °C
FPE/PVC	+75 °C
XLP/Haloarrest	+90 °C
FEP/FEP	+200 °C

Abbreviations Key	
CPE	Chlorinated Polyethylene
FEP	Fluorinated Ethylene-propylene
FPE	Foam Polyethylene
FRPO	Flame-Retardant Polyolefin
PE	Polyethylene
PVC	Polyvinyl Chloride Nylon insulated singles are type THHN or THWN for conductors 14 AWG or larger. Conductor sizes 16 and 18 AWG are Type TFN or TFFN singles.
XLP	Cross-Linked Poly Cross-Linked Poly (XLP) insulated singles are type XHHW-2 for conductors 14 AWG or larger. Conductor sizes 16 and 18 AWG are RFH-2.

Vertical Tray Flame Test Comparison

Test	UL 1685 (UL 1581)	FT4/IEEE 1202/IEEE 383-2003	IEEE 383-1974	IEC 60332-3	ICEA T-29-520
Flame Test Chamber	Vertical Tray	Vertical Tray	Vertical Tray	Vertical Tray	Vertical Tray
Burner Type	Ribbon gas burner	Ribbon gas burner	Ribbon gas burner	Ribbon gas burner	Ribbon gas burner
Theoretical Heat Input	70,000 BTU/hr	70,000 BTU/hr	70,000 BTU/hr	70,000 BTU/hr	210,000 BTU/hr
Burner Positioning	horizontal 3" (8 cm) from samples 18" (46 cm) from tray base	+20 °C up from horizontal 2.95" (7.5 cm) from cable surface 11.8" (30 cm) above floor	horizontal 3" (8 cm) from samples 18" (46 cm) above tray bottom	horizontal 2.95" (7.5 cm) from cable surface 23.6" (60 cm) above floor	horizontal 8-1/4" (20-3.6 cm) from cable surface 12-1/4" (30-3.6 cm) above tray base
Tray Dimensions	8' (2.4 m) length, 12" (30 cm) width, 3" (8 cm) side flanges	9.84' (3 m) length, 11.81" (30 cm) width, 2.85" (7 cm) side flanges	8' (2.4 m) length, 12" (30 cm) width, 3" (8 cm) side flanges	11.5' (3.5 m) length, 19.7" (50 cm) width, side flanges: none	8' (2.4 m) length, 12" (30 cm) width, 3" (8 cm) side flanges
Sample Spacing	1/2 cable diameter	1/2 cable diameter	1/2 cable diameter	lesser of 1/2 cable diameter and .78" (2 cm)	1/2 cable diameter
Duration of Flame Application	20 minutes	20 minutes	20 minutes	20 minutes	20 minutes
Mode of Failure	Cable blistering or charring has reached the top of the sample after the cable has self-extinguished.	Cable char has exceeded a length of 4.92' (1.5 m).	Cable blistering or charring has reached the top of the sample after the cable has self-extinguished.	Cable charring has reached a height of 98.4" (250 cm) above the bottom of the burner.	Cable blistering or charring has reached the top of the sample after the cable has self-extinguished.



Power & Control Paired and Triads Cables

Section Table of Contents

Power & Control	Page
Paired and Triads Cables	
Overview	88
Classic Paired Cables	89
Overview and Selection Guide	89–96
Special Audio, Communication and Instrumentation Cables	97–98
Audio, Control, and Instrumentation Cables	99–115
UL Instrumentation Cables	116
300 V Power-Limited Tray Cables	116–130
Thermocouple Extension Cable and Thermocouple Wire	131–133
600 V Tray Cables	134–143
CSA Instrumentation and Thermocouple Tray Cables	144
300 V TC/CIC	144–145
CSA Instrumentation Cables	146
300 V CIC	146–147
300 V ACIC Armored Cables	148–150



Paired and Triads Cables



Belden's Paired and Triads cable line includes a select number of high quality, high-reliability cables that meet or exceed UL standards and have been used worldwide for decades.

Belden's Classic paired cables offer one of the broadest lines of UL Listed, NEC and CEC cables available from any single source. Due to the improved noise immunity of twisted pairs, these designs generally permit higher data speeds than traditional multiconductor cables.

The Belden Instrumentation product line consists of 300 V Power Limited Tray (PLTC) instrumentation cables, thermocouple instrumentation cables, thermocouple extension cables and wire, and 600 V TC instrumentation cables, which comply with ICEA standards, TC-ER and TC-LS ratings.

Product Features

- Cable jackets are resistant to sunlight, moisture and vapor penetration
- Robust designs that meet or exceed UL standards, PLTC-ER, ITC-ER, TC-ER and NFPA rated
- Broad range of AWG sizes, shielding options, and pair counts
- Constructions with PVC/PVC that have three or more conductors and 20 AWG or larger conductors
- Insulation/jacket options to include XLP/PVC, XLP/CPE, PVC/PVC, PVC/CPE, XLP/Haloarrest, FEP/FEP
- Armoring capabilities to include interlock or continuous armor and Belclad® corrugated protective metal tapes

Benefits

- Product Consistency – by manufacturing our products in ISO-certified, state-of-the-art manufacturing facilities, Belden assures that quality is built into each and every product.
- Product Reliability – even in the harshest of environments – is the hallmark of Belden Instrumentation cables. No matter what type of insulation, conductor count, gauge size, jacket, armor or rating we can meet your needs.

Applications

Belden Classics paired products deliver low voltage analog data signals within enclosures, from controllers and I/Os to devices such as temperature and pressure sensors, relays, valves, meters, actuators, and alarms. They also are applicable for computers, communications, instrumentation, sound, control, audio, data transmission, and many more applications.

The Belden Instrumentation cables are available with multiple armoring and jacketing options – making them ideal for all industries, including petrochemical, pharmaceutical, mining, power generation, wastewater treatment, pulp and paper, food processing, and transportation.



Classic Paired Cables

Belden's Classic paired cable line includes a select number of high-quality, high-reliability cables that meet or exceed UL standards and have been used worldwide for decades.

Belden paired products deliver low voltage analog data signals within enclosures, from controllers and I/Os to devices such as temperature and pressure sensors, relays, valves, meters, thermocouples, solenoids, actuators, contacts, push buttons, and alarms. They also are applicable for computers, communications, instrumentation, sound, control, audio, data transmission, and many more applications.

- Unsurpassed quality and reliability
- Robust designs that meet or exceed UL standards
- Proven performance in installations worldwide
- Broad range of AWG sizes, shielding options, and pair counts
- Convenient put-up options
- Polyolefin insulations provide lower capacitance performance when compared to cables

Shielding

Belden meets the demand for highly effective shielding technology with innovative, EMI/RFI-protective foil and braid designs like Beldfoil®. Belden's patented Beldfoil shield is an aluminum/polyester foil construction that yields a lightweight, strong, flexible and thin shield that provides extra insulation and 100% shield coverage. Beldfoil is ideally suited for multiple-pair, individually shielded audio, communication, and data cables.

Product Consistency

By manufacturing our products in ISO-certified, state-of-the-art manufacturing facilities, Belden assures that quality is built into each and every product. Precise diameter control of insulation and jacket diameters and concentric wall thickness assures fast, reliable manufacturing in high-speed automated equipment, and ease of termination and assembly in the field.

Cable Performance Benefits

Belden offers one of the broadest lines of UL Listed, NEC and CEC cables available from any single source. Paired designs allow balanced signal transmission which results in lower crosstalk through common mode rejection. Due to the improved noise immunity of twisted pairs, they generally permit higher data speeds than traditional multiconductor cables.

Find the Right Product for Your Application

Belden Classic products are available from stock from Belden distributors. If the products above do not fit your application, Belden can also engineer specific constructions for your application.

Classic Paired Cables

Paired Computer Cable

AWG	Overall Beldfoil®			Overall Foil/Braid			Individual Foil	Individual Foil + Overall Foil/Braid
	SR-PVC, PVC, [FEP]	PE	Datalene®, [FFEP]	SR-PVC	PE, PP, [FEP]	Datalene, PE, [FFEP]	Datalene, [FFEP]	Datalene
		15.5 pF/Ft (50.9 pF/m)	11.0-13.5 pF/Ft (36.1-44.3 pF/m)		15.5 pF/Ft (50.9 pF/m)	11.0-13.5 pF/Ft (36.1-44.3 pF/m)	11.0-13.5 pF/Ft (36.1-44.3 pF/m)	11.0-13.5 pF/Ft (36.1-44.3 pF/m)
28	—	—	RS-232/485	—	RS-232/422	RS-232/485	—	—
24	RS-232 [RS-232]	RS-232/422	RS-232/422 [RS-232/422]	RS-232	RS-232/423	RS-232/422 RS-485 [RS-485]	RS-422, DA [RS-232/422, DA]	RS-232/422, DA
22	—	—	—	RS-232	POS	—	—	—

DA = Digital Audio • POS = Point of Sale • [Brackets] = High-Temperature Cables.

Audio, Control, and Instrumentation Cables

AWG	Unshielded	Overall Beldfoil®	Individual Foil	Overall Braid
24	ACI	—	ACI	—
22	ACI [ACI]	ACI [ACI]	ACI [ACI]	—
20	ACI	ACI [Special Hi-Temp ACI]	ACI	—
18	ACI [ACI]	ACI [ACI]	ACI	ACI
16	ACI	ACI	—	—
14	ACI	ACI	—	—
12	ACI	ACI	—	—

AIC = Audio, Control, and Instrumentation • DA = Digital Audio • POS = Point of Sale • [Brackets] = High-Temperature Cables.

Classic Paired Cables

Selection Guide

Shielded Multi-Pair Computer Cables RS-232, RS-422, and RS-485 Applications. All Cables are UL Listed.

Specifications	9804	8132	9829	8332	9501	8102	9729	8162	9990	9841	9680	9302^	8302	8777	9873	9773	8132F0	1419A	
Conductor Size: (AWG)	28	✓	✓															✓	
	24			✓	✓	✓	✓	✓	✓	✓	✓								✓
	22											✓	✓	✓					
	20															✓			
	18																✓		
Page No.:	226	226	224	224	219	225	221	229	209	227	220	207	223	211	214	214	220	220	
Insulation:	S-R PVC				✓	✓						✓	✓	✓					
	Polyethylene			✓					✓	✓	✓				✓	✓			
	Polypropylene	✓																	
	Datalene® HDPE		✓				✓	✓	✓								✓	✓	
Shield:	Overall Foil				✓						✓	✓					✓	✓	
	Individual Foil						✓	✓	✓					✓	✓	✓			
	Overall Foil/Braid	✓	✓	✓	✓			✓	✓	✓			✓						
	Braid Coverage	90%	65%	65%	65%		65%		65%		90%			65%					
Drain Wire:	Overall	•	•	•	x	•	•	▲	▲	▲	•	•	•		▲	▲	▲	•	•
	Each Pair							•	•	•					•	•	•		
Pairs Available:	1				✓					✓									
	2	✓	✓	✓	✓	✓	✓	✓		✓		✓	✓					✓	✓
	3	✓	✓	✓	✓	✓	✓	✓	✓	✓	✓		✓	✓	✓	✓	✓	✓	✓
	4	✓	✓	✓	✓	✓	✓	✓	✓	✓	✓		✓	✓				✓	✓
	5	✓	✓	✓	✓	✓	✓		✓				✓					✓	✓
	6			✓	✓	✓	✓	✓	✓	✓		✓	✓	✓	✓	✓	✓		✓
	7	✓		✓	✓	✓	✓		✓				✓						
	8		✓			✓	✓		✓					✓					✓
	9	✓		✓		✓		✓		✓		✓	✓		✓	✓	✓		
	10			✓	✓	✓	✓		✓					✓					
	11							✓							✓	✓			
	12	✓		✓				✓		✓					✓	✓	✓		
	12.5		✓		✓		✓				✓			✓				✓	✓
	13	✓																	
	15				✓	✓	✓	✓	✓				✓	✓	✓	✓	v		✓
	17							✓							✓				
	18	✓	✓	✓	✓		✓		✓					✓					✓
	19					✓		✓					✓		✓				
	25	✓	✓	✓	✓	✓	✓		✓	✓				✓					✓
	27							✓					✓		✓				
31	✓																		
37														✓					
50					✓														
Capacitance* (pF/Ft)	15.5	11.0	15.5	30.0	30.0	12.5	12.5	12.5	25.0	12.8	15.5	35.0	35.0	30.0	30.0	30.0	11.0	13.0	
Capacitance* (pF/m)	50.9	36.1	50.9	98.4	98.4	41.0	41.0	41.0	82.0	42.0	50.9	114.8	114.8	98.4	98.4	98.4	36.1	42.7	

^ Standard PVC insulation, solid conductors.

* Capacitance may vary on some cables.

Drain Wire Key: • = Drain wire overall, ▲ = Drain wire each pair, x = No drain wire

Overall Beldfoil® Shield Cable Characteristics

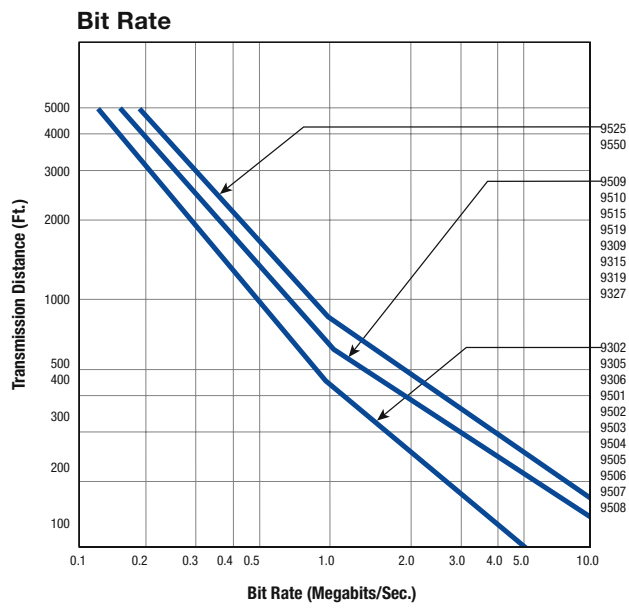
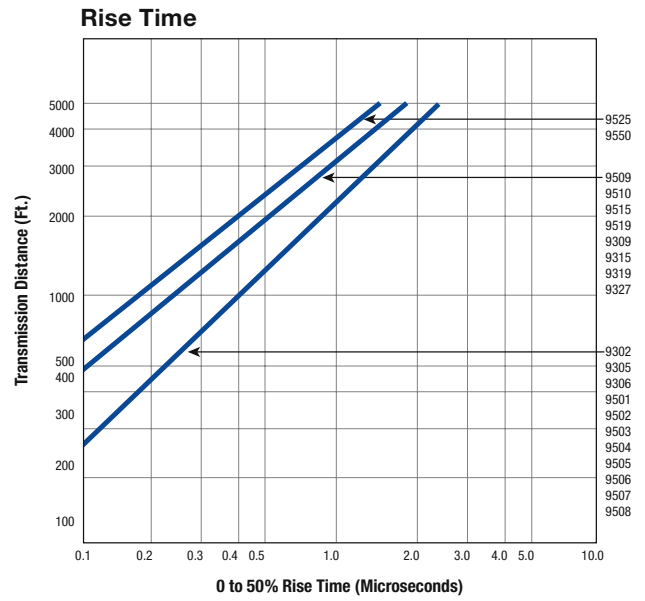
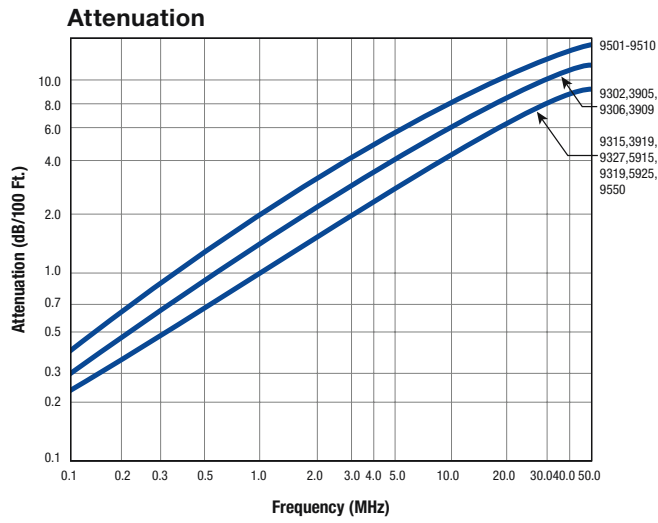

Cables are terminated in their characteristic impedance. Signal source electrical characteristics: 50 ohms and 10% to 90% rise time less than 5 nanoseconds.

Charts assume 5% peak-to-peak time jitter as determined by eye pattern measurements of pseudorandom NRZ code.

Overall Foil/Braid Shield
Cable Characteristics

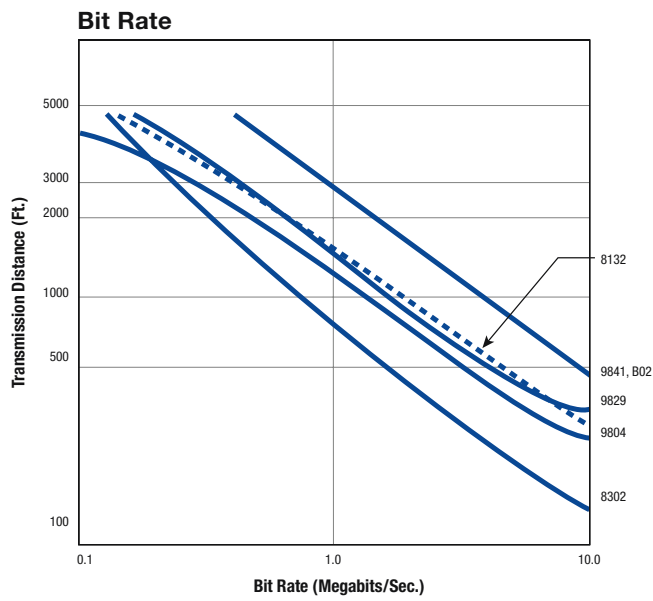
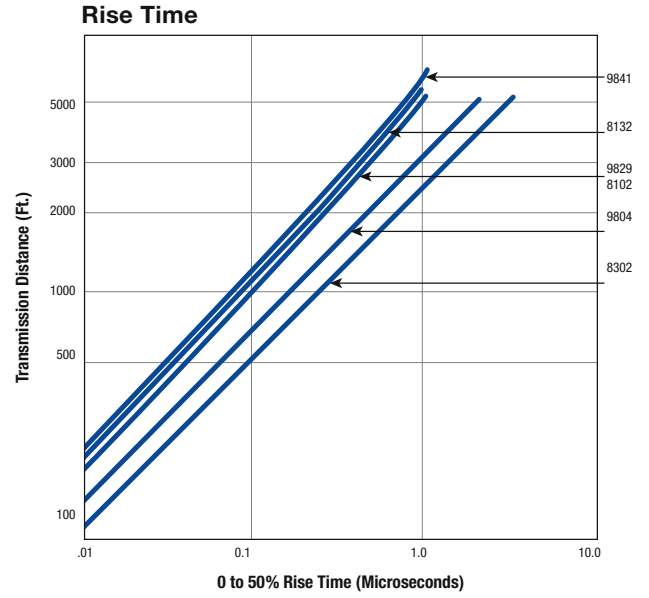
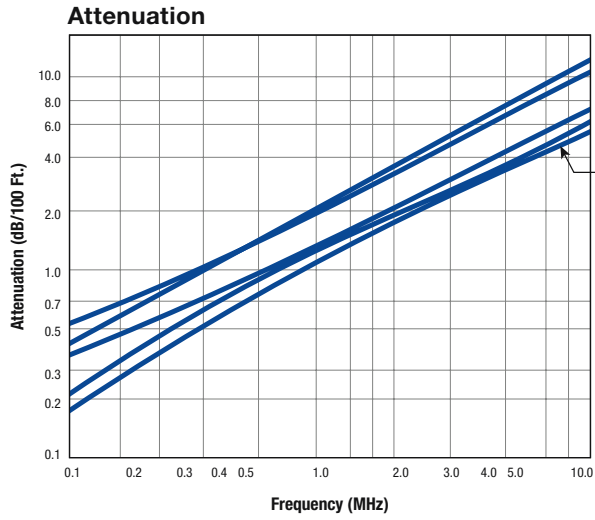

Individually Shielded

Cable Characteristics (Part No. 9728 - 9738)

Attenuation

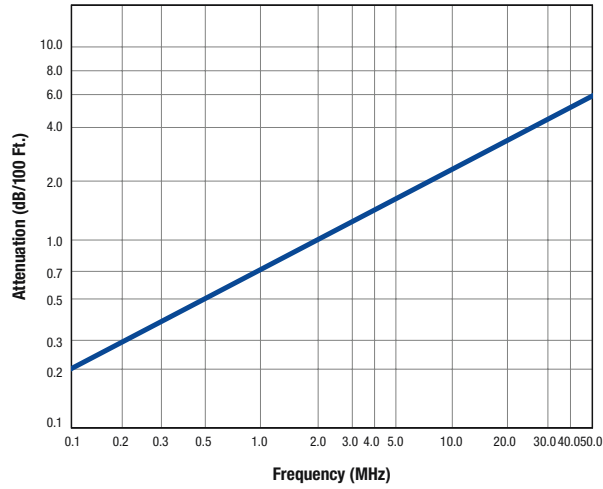

Rise Time

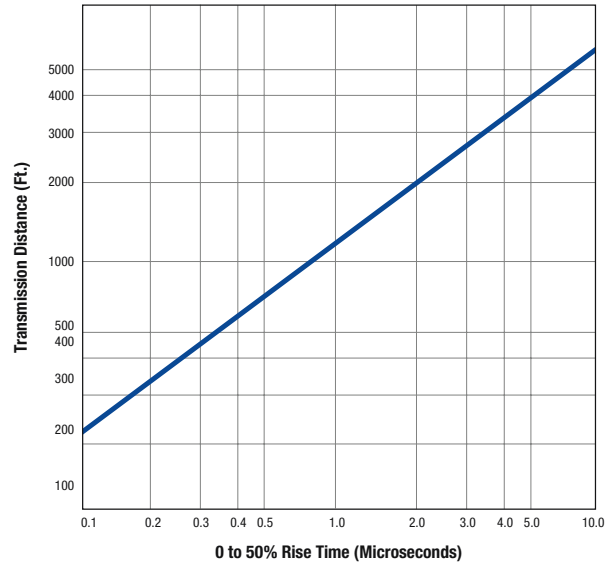

Bit Rate

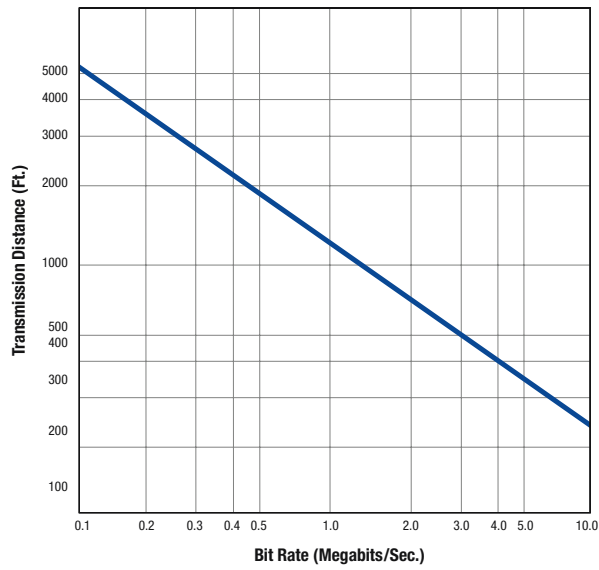

Cables are terminated in their characteristic impedance. Signal source electrical characteristics: 50 ohms and 10% to 90% rise time less than 5 nanoseconds.

Charts assume 5% peak-to-peak time jitter as determined by eye pattern measurements of pseudorandom NRZ code.

Individually Shielded

Cable Characteristics (Part No. 8777 - 9767, 9873 - 9879, 9773 - 9777)

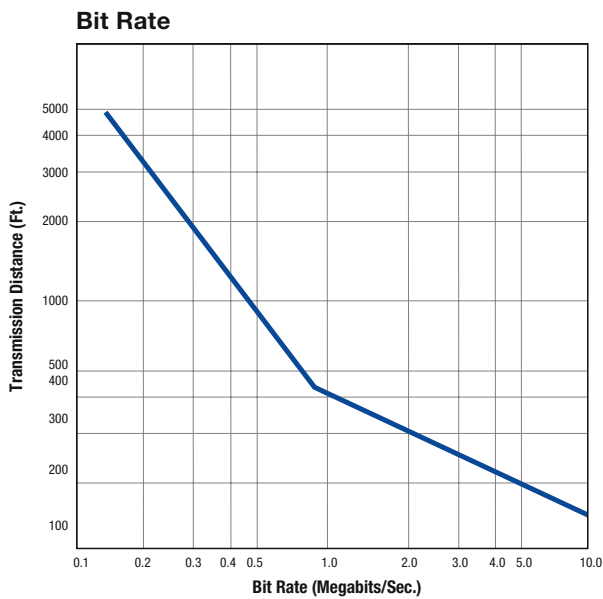
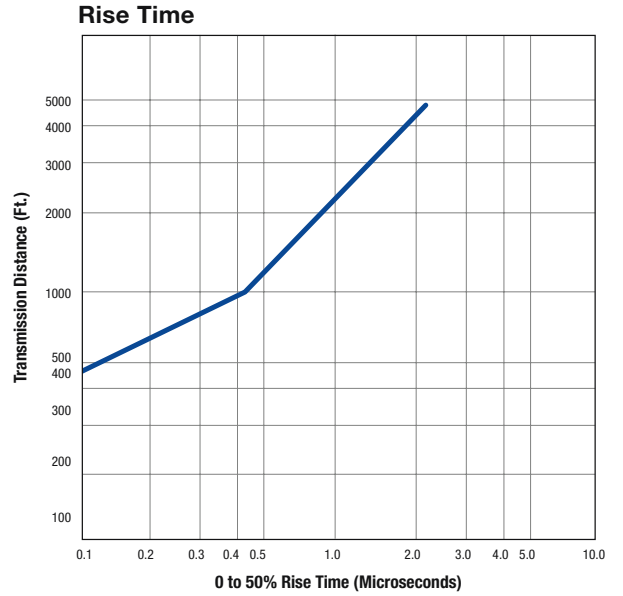
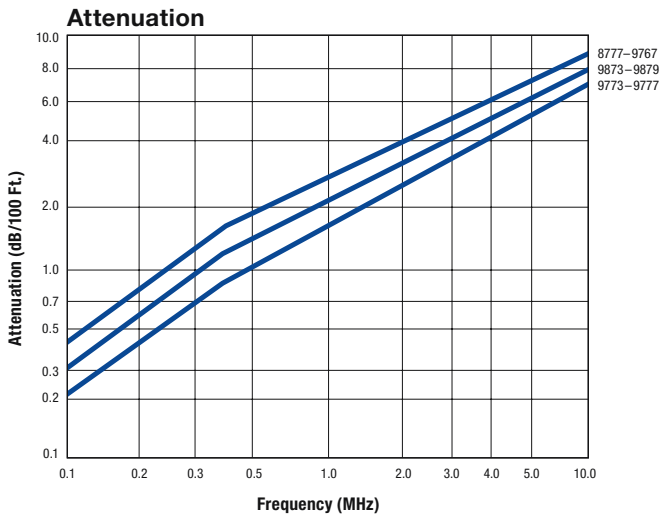

Recommended for audio, pulse, and radio frequency applications requiring superior circuit isolation.

Insulation resistance between shields:
100 megohms/1000' nom.

Capacitance between adjacent shields:
115 pf/ft. nom.

Working voltage between adjacent shields:
50 volts max.

Individually Shielded Pairs with Overall Foil/Braid Shield
Cable Characteristics

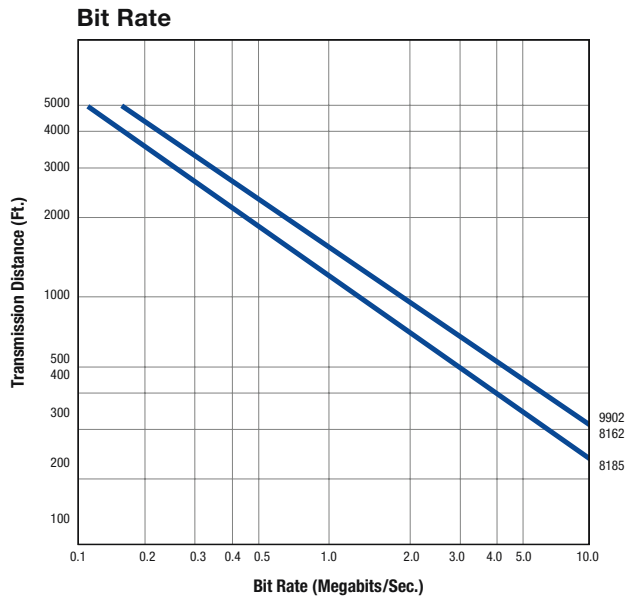
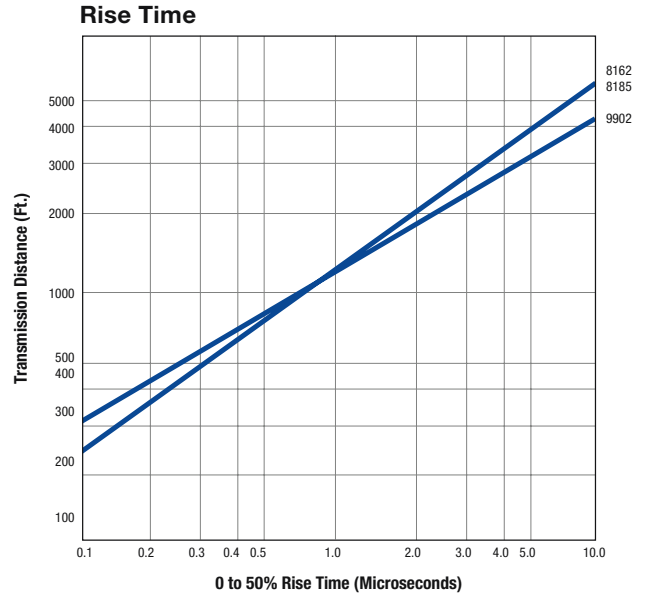
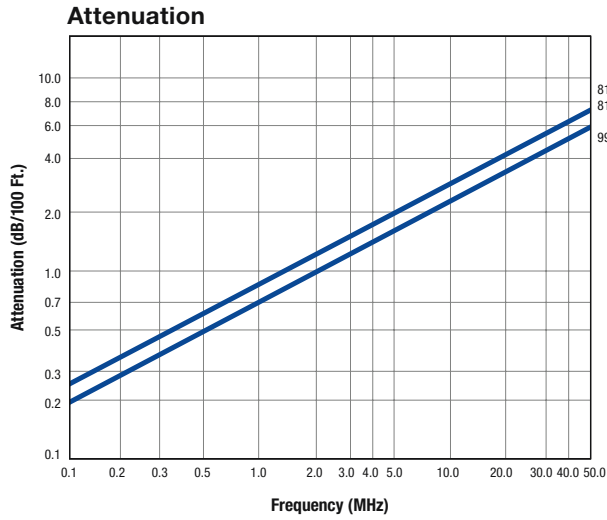

Cables are terminated in their characteristic impedance. Signal source electrical characteristics: 50 ohms and 10% to 90% rise time less than 5 nanoseconds.

Charts assume 5% peak-to-peak time jitter as determined by eye pattern measurements of pseudorandom NRZ code.

Special Audio, Communication and Instrumentation Cables

Combination and Special Shielding



Part No.	Pairs	Color Code	OD (Nom)		Insulation Thickness		Jacket Thickness		Capacitance				Additional Features/Ratings	
			Inch	mm	Inch	mm	Inch	mm	Cond. - Cond.		Cond. - Shield			
										pF/Ft	pF/m	pF/Ft	pF/m	
25 AWG • Polyethylene/PVC														
Stranded (7 x 32) TC Conductors • Polyethylene Insulation • Red-Black Pair Individually Shielded + Overall Beldfoil® Shield • 25 AWG TC Drain Wire • Chrome PVC Jacket. 3 Copper, 4 Copper-Covered Steel Strands in Each Conductor • Pairs Cables on Common Axis to Reduce Diameter.														
8434	2	Black-Red, Green-White	.165	4.19	.013	.33	.020	.51	25	82	49	131	400 V, +80 °C	
22 AWG • PVC/PVC														
Stranded (7 x 30) TC Conductors • PVC Insulation • One Unshielded Single Conductor • One Pair Beldfoil® Shielded • 22 AWG TC Drain Wire • Chrome PVC Jacket														
9685	1.5	Black-White, Brown	.199	5.05	.013	.33	.032	.81	60	197	99	325	NEC: CM Meets NEC Article 800 300 V, +80 °C	
22 AWG • Polypropylene/PVC														
Stranded (7 x 30) TC Conductors • Polypropylene Insulation • One Unshielded Pair • One Beldfoil® Shielded Pair • 24 AWG TC Drain Wire • Chrome PVC Jacket. See Technical Bulletin T/8-21 Before Planning High- And Low-Level Circuits in the Same Cable • Pairs Cables on Common Axis to Reduce Diameter.														
8730	2	Black-Red, Green-White	.205	5.21	.008	.20	.030	.76	34	113	67	220	200 V, +80 °C	
8724	2	Black-Red, Green-White	.185	4.19	.008	.20	.019	.48	34	113	67	220	NEC: CM • CEC: CM 300 V, +80 °C •VW-1	
22 AWG • Polypropylene/PVC														
Stranded (7 x 30) TC Conductors • Polypropylene Insulation • Individually Beldfoil® Shielded Pairs • Polyester Film Over Each Shield • 24 AWG TC Drain Wire for Each Pair • Chrome PVC Jacket. Pairs Cables on Common Axis to Reduce Diameter.														
8728	2	Black-Red, Green-White	.215	5.46	.010	.25	.028	.71	35	115	62	203	NEC: CM • CEC: CM UL AWM Style 2717 (+80 °C)	

TC = Tinned Copper • PVC = Polyvinyl Chloride

Special Audio, Communication and Instrumentation Cables

Combination and Special Shielding



Part No.	Pairs	Color Code	OD (Nom)		Insulation Thickness		Jacket Thickness		Capacitance				Additional Features/Ratings
			Inch	mm	Inch	mm	Inch	mm	Cond. - Cond.		Cond. - Shield		
									pF/Ft	pF/m	pF/Ft	pF/m	

20 AWG • Polyethylene/PVC

Stranded (7 x 28) TC Conductors • Polyethylene Insulation • One Unshielded Single Conductor • One Pair Beldfoil® Shielded • 20 AWG TC Drain Wire • Chrome PVC Jacket													
8763	1.5	Black-Red, Clear	.210	5.33	.014	.36	.028	.71	26	85	48	157	350 V, +80 °C

20 AWG • PVC/PVC

Stranded (7 x 28) TC Conductors • PVC Insulation • One Unshielded Pair • One Beldfoil® Shielded Pair • 22 AWG TC Drain Wire • Chrome PVC Jacket. See Technical Bulletin T/8-21 Before Planning High- And Low-Level Circuits in the Same Cable • Pairs Cables on Common Axis to Reduce Diameter.													
8722	2	Black-Red, Green-White	.226	5.74	.015	.38	.028	.71	60	197	99	325	NEC: CMG • CEC: CMG FT4 350 V, +80 °C VW-1

20 AWG • Polypropylene/PVC

Stranded (7 x 28) TC Conductors • Polypropylene Insulation • Individually Beldfoil® Shielded Pairs Polyester Film Over Each Shield • 22 AWG TC Drain Wire for Each Pair • Chrome PVC Jacket. See Technical Bulletin T/8-21 Before Planning High- And Low-Level Circuits in the Same Cable • Pairs Cables on Common Axis to Reduce Diameter.													
8725	4	Black-Red, Green-White, White/Red-White/Black, White/Green-White/Yellow	.345	8.76	.015	.38	.030	.76	27	89	49	161	NEC: CM • CEC: CM 400 V, +105 °C VW-1

20 AWG and 18 AWG • Polyethylene/PVC

Stranded (7 x 28 and 16 x 30) TC Conductors • Polyethylene Insulation • Unshielded 18 AWG Pair • Beldfoil® Shielded 20 AWG Pair • 22 AWG Stranded TC Drain Wire • Beige PVC Jacket													
9155	1 (20 AWG)	Black-Red	.262	6.65	.020	.51	.031	.79	24	79	46	151	NEC: CM • CEC: CM Meets NEC Article 800 UL AWM Style 2094 (300 V, +60 °C)
	1 (18 AWG)	Green-White			.019	.48			22	72			

TC = Tinned Copper • PVC = Polyvinyl Chloride

Audio, Control, and Instrumentation Cables

300 V +80 °C • Unshielded



Part No.	Pairs	Color Code	OD (Nom)		Insulation Thickness		Jacket Thickness		Additional Features/Ratings
			Inch	mm	Inch	mm	Inch	mm	

Stranded TC or Solid BC Conductors • PVC Insulation • Chrome PVC Jacket

20 AWG • 7 x 28 • PVC/PVC

8205	1	Chart 3	.180	4.57	.013	.33	.025	.64	NEC: CMG • CEC: CMG FT4 UL AWM Style 2464 (Except 8205)
9750	3	Chart 3	.299	7.59					
9751	6	Chart 3	.366	9.30	.013	.33	.035	.89	
9752	9	Chart 3	.429	10.90					
9755	15	Chart 3	.545	13.84	.013	.33	.040	1.02	

19 AWG • Solid • PVC/PVC

8486	1	Brown-Tan	.182	4.62	.015	.38	.025	.64	NEC: CM • CEC: CM
------	---	-----------	------	------	------	-----	------	-----	-------------------

18 AWG • 7 x 26 • PVC/PVC

8461	1	Black-White	.234	5.94	.022	.56	.028	.71	NEC: CMG • CEC: CMG FT4
------	---	-------------	------	------	------	-----	------	-----	-------------------------

18 AWG • 16 x 30 • PVC/PVC

9740	1	Chart 3	.210	5.33	.014	.36	.032	.81	NEC: CMG • CEC: CMG FT4 UL AWM Style 2464
9156	2	Chart 3	.333	8.46	.014	.36	.035	.89	
8690	3	Chart 3	.347	8.81					
9157	4	Chart 3	.381	9.68					
9159	5	Chart 3	.391	9.93	.014	.36	.032	.81	
8691	6	Chart 3	.433	11.00					
9161	8	Chart 3	.485	12.32	.014	.36	.037	.94	
8692	9	Chart 3	.524	13.31	.014	.36	.040	1.02	
9741	12	Chart 3	.600	15.24	.014	.36	.046	1.17	
9742	15	Chart 3	.677	17.20	.014	.36	.051	1.30	
9743	19	Chart 3	.721	18.31	.014	.36	.055	1.40	

20 AWG • 7 x 28 • PE/LSZH

Stranded TC Conductors • PE Insulation • Chrome LSZH Jacket

8205NH	1	Chart 3	.180	4.65	.013	.33	.035	.89	Flame IEC 60332-3-24, Smoke IEC 61034
--------	---	---------	------	------	------	-----	------	-----	--

BC = Bare Copper • TC = Tinned Copper • PVC = Polyvinyl Chloride | Belden Color Code Charts can be found at page 350/351.

Audio, Control, and Instrumentation Cables

Plenum • 300 V, +80 °C • Unshielded



Part No.	Pairs	Color Code	OD (Nom)		Insulation Thickness		Jacket Thickness		Additional Features/Ratings
			Inch	mm	Inch	mm	Inch	mm	

16 AWG • 19 x 29 • PVC/PVC

Stranded TC Conductors • PVC Insulation • Chrome PVC jacket									
8471	1	Black-White	.274	6.96	.023	.58	.032	.81	NEC: CMG • CEC: CMG FT4 UL AWM Style 2598

16 AWG • 19 x 29 • PE/LSZH

Stranded TC Conductors • PE Insulation • LSZH Jacket									
8471NH	1	Black-White	.28	7.10	.023	.58	.035	.89	Flame IEC 60332-3-24, Smoke IEC 61034
8471LS	1	Black-White	.45	11.50	.023	.58	.035/.051	.89/1.30	Flame IEC 60332-3-24, Smoke IEC 61034

14 AWG • 42 x 30 • PVC/PVC

Stranded TC Conductors • PVC Insulation • Chrome PVC jacket									
8473	1	Black-White	.340	8.64	.031	.79	.032	.81	NEC: CL3 • CEC: FAS 90 FT4 UL AWM Style 2587

12 AWG • 65 x 32 • PVC/PVC

Stranded TC Conductors • PVC Insulation • Chrome PVC jacket									
8477	1	Black-White	.386	9.80	.032	.81	.035	.89	NEC: CL3R UL AWM Style 2587

Plenum • 300 V • Unshielded



- NEC: CMP
- CEC: CMP FT6

Part No.	Pairs	Color Code	OD (Nom)		Insulation Thickness		Jacket Thickness	
			Inch	mm	Inch	mm	Inch	mm

22 AWG • FEP/FEP

Stranded (7 x 30) TC Conductors • FEP Insulation • Red FEP Jacket									
88442	1	Chart 3	.102	2.59					
88741	2	Chart 3	.169	4.29	.006	.15	.012	.30	
88757	4	Chart 3	.200	5.08	.006	.15	.019	.23	

22 AWG • FEP/Flamarrest®

Stranded (7 x 30) TC Conductors • FEP Insulation • Natural Flamarrest Jacket									
82442	1	Chart 3	.112	2.84					
82741	2	Chart 3	.179	4.55					
82742	3	Chart 3	.191	4.85	.006	.15	.014	.36	
82757	4	Chart 3	.210	5.33					
82743	6	Chart 3	.238	6.05	.006	.15	.015	.38	

TC = Tinned Copper • FEP = Fluorinated Ethylene Propylene • PVC = Polyvinyl Chloride | Belden Color Code Charts can be found at page 350/351.

Audio, Control, and Instrumentation Cables

Plenum • 300 V • Unshielded



- NEC: CMP
- CEC: CMP FT6

Part No.	Pairs	Color Code	OD (Nom)		Insulation Thickness		Jacket Thickness	
			Inch	mm	Inch	mm	Inch	mm

18 AWG • FEP/FEP

Stranded (19 x 30) TC Conductors • FEP Insulation • Red FEP Jacket								
89740	1	Black-Red	.136	3.45	.006	.17	.009	.23

18 AWG • FEP/Fluorocopolymer

Plenum • FEP Insulation • Red Fluorocopolymer Jacket								
87740	1	Black-Red	.140	3.56	.006	.17	.011	.28

18 AWG • FEP/Flamarrest®

Plenum • FEP Insulation • Natural Flamarrest Jacket								
82740	1	Black-Red	.147	3.73	.006	.17	.015	.38

150 V, +80 °C • Unshielded



- PVC/PVC
- UL AWM Style 2576
- NEC: CMG
- CEC: CMG FT4

Part No.	Pairs	Color Code	OD (Nom)		Insulation Thickness		Jacket Thickness	
			Inch	mm	Inch	mm	Inch	mm

Solid TC Conductors • PVC Insulation • Chrome PVC Jacket								
--	--	--	--	--	--	--	--	--

24 AWG • PVC/PVC

9562	2	Chart 4	.199	5.05	.010	.25	.032	.81
9566	6	Chart 4	.289	7.34				
9570	10	Chart 4	.310	7.87				
9585	25	Chart 4	.480	12.19				

22 AWG • PVC/PVC

8740	1	Chart 3	.156	3.96	.010	.25	.032	.81
8741	2	Chart 3	.230	5.84				
8742	3	Chart 3	.242	6.15				
8757	4	Chart 3	.264	6.71				
8743	6	Chart 3	.293	7.44				
9160	8	Chart 3	.323	8.20				
8744	9	Chart 3	.350	8.89				

TC = Tinned Copper • FEP = Fluorinated Ethylene Propylene • PVC = Polyvinyl Chloride | Belden Color Code Charts can be found at page 350/351.

Audio, Control, and Instrumentation Cables

150 V, +80 °C • Unshielded

• UL AWM Style 2576

- NEC: CMG
- CEC: CMG FT4



Part No.	Pairs	Color Code	OD (Nom)		Insulation Thickness		Jacket Thickness	
			Inch	mm	Inch	mm	Inch	mm

22 AWG • PVC/PVC

Stranded (7 x 30) TC Conductors • PVC Insulation • Chrome PVC Jacket								
9744	2	Chart 3	.244	6.20				
9745	3	Chart 3	.257	6.53	.010	.25	.032	.81
9746	4	Chart 3	.281	7.14				
8747	6	Chart 3	.320	8.13	.010	.25	.035	.89
8748	9	Chart 3	.389	9.88	.010	.25	.037	.94
9747	12	Chart 3	.425	10.80				
8749	15	Chart 3	.440	11.18	.010	.25	.040	1.02
9748	19	Chart 3	.505	12.83				
8750	27	Chart 3	.575	14.61	.010	.25	.045	1.14

Audio, Control, and Instrumentation Cables

Overall Beldfoil® Shield



Part No.	Pairs	Color Code	OD (Nom)		Insulation Thickness		Jacket Thickness		Capacitance				Additional Features/Ratings
			Inch	mm	Inch	mm	Inch	mm	Cond. - Cond.		Cond. - Shield		
									pF/Ft	pF/m	pF/Ft	pF/m	
22 AWG • Polypropylene/PVC													
Solid TC Conductors • Polypropylene Insulation • Overall Beldfoil® Shield • 22 AWG Solid TC Drain Wire • Gray or Black PVC Insulation													
8450	1	Black-Red	.118	3.00	.007	.18	.018	.46	40	133	76	249	NEC: CM • CEC: CM 300 V, +75 °C
22 AWG • Polypropylene/PVC													
Solid TC Conductors • Polypropylene Insulation • Overall Beldfoil® Shield • 22 AWG Stranded TC Drain Wire • Chrome PVC Insulation													
8752	38	Tech Bulletin T/8-4	.610	15.50	.008	.20	.045	1.14	17	56	24.3	80	200 V, +75 °C
22 AWG • SR-PVC/PVC													
Stranded (7 x 30) TC Conductors • Semi-Rigid PVC Insulation • Overall Beldfoil® Shield • 22 AWG Stranded TC Drain Wire • Pale Fawn Beige Striated PVC Jacket													
9414	1	White-Black	.186	4.72	.010	.25	.035	.89	50	164	95	312	NEC: CMG • CEC: CMG FT4 UL AWM Style 2464 (300 V, +80 °C)
22 AWG • PVC/PVC													
Stranded (7 x 30) TC Conductors • PVC Insulation • Overall Beldfoil® Shield • 22 AWG Stranded TC Drain Wire • Chrome PVC Jacket													
9462	1	Black-Red	.186	4.72	.013	.33	.035	.89	50	164	90	295	200 V, +75 °C
22 AWG • Polyethylene/PVC													
Stranded (7 x 30) TC Conductors • Polyethylene Insulation • Overall Beldfoil® Shield • 22 AWG Stranded TC Drain Wire • Chrome PVC Jacket													
8761	1	Black-Clear	.175	4.45	.016	.41	.025	.64	24	79	47	154	NEC: CM • CEC: CM UL AWM Style 2092 (300 V, +60 °C)
22 AWG • Polyethylene/LSZH													
Stranded (7x30) TC Conductors • Polyethylene Insulation • Overall Beldfoil® Shielding • 22 AWG Stranded TC Drain Wire • Chrome LSZH Jacket													
8761NH	1	Black-Clear	.19	4.95	.016	.41	.035	.89	24	79	47	154	Flame IEC 60332-3-24, Smoke IEC 61034
22 AWG • Polyethylene/PVC													
Stranded (7 x 30) TC Conductors • Polyethylene Insulation • Overall Beldfoil® Shield • 22 AWG Stranded TC Drain Wire • Chrome PVC Jacket Jacket and Shield Are Bonded So Both Can Be Removed on Automatic Stripping Equipment. Drain Wire Is Inside Foil Shield.													
9461	1	Black-Clear	.180	4.57	.016	.41	.026	.66	24	79	47	154	NEC: CM • CEC: CM UL AWM Style 2092 (300 V, +60 °C)
22 AWG • Polypropylene/PVC													
Stranded (7 x 30) TC Conductors • Polypropylene Insulation • Overall Beldfoil® Shield • 22 AWG Stranded TC Drain Wire • Paper Wrap (to Facilitate Stripping) • Gray or Black PVC Jacket Jacket and Shield Are Bonded So Both Can Be Removed on Automatic Stripping Equipment. Drain Wire Is Inside Foil Shield.													
8451	1	Black-Red	.138	3.51	.008	.20	.020	.51	34	112	67	220	NEC: CMR • CEC: CMG 300 V, 75°V

TC = Tinned Copper • LSZH = Low Smoke Zero Halogen • PVC = Polyvinyl Chloride

Audio, Control, and Instrumentation Cables

Overall Beldfoil® Shield



Part No.	Pairs	Color Code	OD (Nom)		Insulation Thickness		Jacket Thickness		Capacitance				Additional Features/Ratings
			Inch	mm	Inch	mm	Inch	mm	Cond. - Cond.		Cond. - Shield		
									pF/Ft	pF/m	pF/Ft	pF/m	

22 AWG • Polypropylene/PVC

Stranded (7 x 30) TC Conductors • Polypropylene Insulation • Overall Beldfoil® Shield • 22 AWG Stranded TC Drain Wire • PVC Jacket (Black, Gray, Brown, Red, Orange, Yellow, Green, Blue, Purple, White)													
9451	1	Black-Red	.135	3.43	.008	.20	.020	.51	35	115	67	220	NEC: CMR • CEC: CMG FT4 300 V, +75 °C

22 AWG • Polypropylene/LSZH

Stranded (7 x 30) TC Conductors • Polypropylene Insulation • Overall Beldfoil® Shield • 22 AWG Stranded TC Drain Wire • Black LSZH Jacket Jacket and Shield Are Bonded So Both Can Be Removed on Automatic Stripping Equipment. Drain Wire Is Inside Foil Shield.													
9451SB	1	Black-Red	.160	4.06	.008	.20	.032	.81	35	115	67	220	NEC: CMG-LS • CEC: CMG-LS FT4 300 V, +105 °C

22 AWG • Polyolefin/PVC

Stranded (7 x 30) TC Conductors • Polyolefin Insulation • Overall Beldfoil® Shield • 22 AWG Stranded TC Drain Wire • PVC Jacket (Red-Green, Red-Black, Red-Purple, Red-Gray)													
9451D	2	Black-Red	.135 x .270	3.43 x 6.86	.008	.20	.020	.51	34	112	67	220	Zipcord Construction NEC: CMR • CEC: CMR FT4 300 V, +60 °C

22 AWG • Polypropylene/PVC

Unique Design Features Lower Capacitance and Greater Flexibility Than Standard Audio Pair Constructions.

Stranded (7 x 30) TC Conductors • Polypropylene Insulation • Overall Beldfoil® Shield • 24 AWG Stranded TC Drain Wire • PVC Jacket (Black, Gray, Brown, Red, Orange, Yellow, Green, Blue, Purple, White)													
1266A	1	Black-Red	.143	3.63	.010	.25	.020	.51	30	99	54	177	NEC: CM • CEC: CM 300 V

22 AWG • PVC/PVC

Unique Design Features Lower Capacitance and Greater Flexibility Than Standard Audio Pair Constructions.

Stranded (7 x 30) TC Conductors • PVC Insulation • Overall Beldfoil® Shield • 24 AWG Stranded TC Drain Wire • PVC Jacket (Black, Gray, Brown, Red, Orange, Yellow, Green, Blue, Purple, White)													
1503A	1	Black-Red	.142	3.61	.010	.25	.020	.51	53	174	97	318	NEC: CM • CEC: CM 300 V

22 AWG • PVC/PVC

Stranded (19 x 34) TC Conductors • PVC Insulation • Overall Beldfoil® Shield • 24 AWG Stranded TC Drain Wire • PVC Jacket (Red-Green, Red-Purple, Red-Gray)													
1504A	2	Black-Red	.143 x .286	3.63 x 7.26	.010	.25	.017	.43	57	187	100	328	Stereo Audio Cable Zipcord Construction NEC: CM • CEC: CM 150 V

TC = Tinned Copper • LSZH = Low Smoke Zero Halogen • PVC = Polyvinyl Chloride

Audio, Control, and Instrumentation Cables

Overall Beldfoil® Shield



Part No.	Pairs	Color Code	OD (Nom)		Insulation Thickness		Jacket Thickness		Capacitance				Additional Features/Ratings
			Inch	mm	Inch	mm	Inch	mm	Cond. - Cond.		Cond. - Shield		
									pF/Ft	pF/m	pF/Ft	pF/m	
22 AWG • FEP/Flamarrest®													
Stranded (19 x 34) TC Conductors • FEP Insulation • Overall Beldfoil® Shield • 22 AWG Stranded TC Drain Wire • White Flamarrest Jacket Jacket and Shield Are Bonded So Both Can Be Removed on Automatic Stripping Equipment. Drain Wire Is Inside Foil Shield.													
9451DP	2	Black-Red, Black-White	.127 x .269	3.43 x 6.86	.007	.18	.017	.43	35	115	67	220	Plenum Zipcord Construction NEC: CMP • CEC: CMP FT6 300 V
22 AWG • FEP/Flamarrest®													
Stranded (7 x 30) TC Conductors • FEP Insulation • Overall Beldfoil® Shield • 22 AWG Stranded TC Drain Wire • Flamarrest Jacket (Black, Gray, Brown, Red, Orange, Yellow, Green, Blue, Purple, White)													
9451P	1	Black-Red	.127	3.23	.007	.18	.017	.43	35	115	67	220	NEC: CMP • CEC: CMP FT6
22 AWG • FEP/Flamarrest®													
Stranded (7 x 30) TC Conductors • FEP Insulation • Overall Beldfoil® Shield • 22 AWG Stranded TC Drain Wire • Natural Flamarrest Jacket													
82761	1	Black-Red	.116	2.95	.006	.15	.014	.36	35	115	67	220	NEC: CMP • CEC: CMP FT6
22 AWG • FEP/FEP													
Stranded (7 x 30) TC Conductors • FEP Insulation • Overall Beldfoil® Shield • 22 AWG Stranded TC Drain Wire • Red FEP Jacket													
88761	1	Black-Red	.119	3.02	.006	.15	.014	.36	35	115	67	220	NEC: CMP • CEC: CMP FT6
22 AWG • FEP/Fluorocopolymer													
Stranded (7 x 30) TC Conductors • FEP Insulation • Overall Beldfoil® Shield • 22 AWG Stranded TC Drain Wire • Red Fluorocopolymer Jacket													
87761	1	Black-Red	.116	2.95	.006	.15	.014	.36	35	115	67	220	NEC: CMP • CEC: CMP FT6

TC = Tinned Copper • FEP = Fluorinated Ethylene Propylene

Audio, Control, and Instrumentation Cables

Overall Beldfoil® Shield



Part No.	Pairs	Color Code	OD (Nom)		Insulation Thickness		Jacket Thickness		Capacitance				Additional Features/Ratings
			Inch	mm	Inch	mm	Inch	mm	Cond. - Cond.		Cond. - Shield		
									pF/Ft	pF/m	pF/Ft	pF/m	

20 AWG • PVC/PVC

Stranded (7 x 28) TC Conductors • PVC Insulation • Overall Beldfoil® Shield • 22 AWG Stranded TC Drain Wire • Beige PVC Jacket														
9154	1	Black, Red	.198	5.03	.014	.36	.031	.79						NEC: CMG • CEC: CMG FT4 UL AWM Style 2464 (300 V, +80 °C)

20 AWG • Polyethylene/PVC

Stranded (7 x 28) TC Conductors • Polyethylene Insulation • Overall Beldfoil® Shield • 20 AWG Stranded TC Drain Wire • Chrome PVC Jacket														
8762	1	Black-Clear	.204	5.18	.016	.41	.028	.71	27	89	49	161		NEC: CM • CEC: CM UL AWM Style 2092 (300 V, +60 °C)

20 AWG • Polyethylene/LSZH

Stranded (7 x 28) TC Conductors • Polyethylene Insulation • Overall Beldfoil® Shielding • 20 AWG Stranded TC Drain • Wire Chrome LSZH Jacket														
8762NH	1	Black-Clear	.21	5.40	.016	.41	.035	.89	27	89	49	161		Flame IEC 60332-3-24, Smoke IEC 61034

18 AWG • Polyethylene/PVC

Stranded (19 x 30) TC Conductors • Polyethylene Insulation • Overall Beldfoil® Shield • 20 AWG TC Drain Wire Chrome PVC Jacket														
8760	1	Black-Clear	.222	5.64	.019	.48	.028	.71	24	79	44	144		NEC: CM • CEC: CM UL AWM Style 2092 (300 V, +60 °C)

18 AWG • Polyethylene/LSZH

Stranded (19 x 30) TC Conductors • Polyethylene Insulation • Overall Beldfoil® Shield • 20 AWG Stranded TC Drain Wire • Chrome LSZH Jacket														
8760NH	1	Black-Clear	.24	6.00	.016	.41	.035	.89	30	98	44	144		Flame IEC 60332-3-24, Smoke IEC 61034
8760LS	1	Black-Clear	.41	10.40	.016	.41	.035/ .051	.89/ 1.30	30	98	44	144		Flame IEC 60332-3-24, Smoke IEC 61034 Steel Wire Armor

18 AWG • Polyethylene/PVC

Stranded (19 x 30) TC Conductors • Polyethylene Insulation • Overall Beldfoil® Shield • 20 AWG TC Drain Wire • Chrome PVC Jacket Jacket and Shield Are Bonded So Both Can Be Removed on Automatic Stripping Equipment. Drain Wire Is Inside Foil Shield.														
9460	1	Black-Clear	.230	5.84	.019	.48	.030	.76	24	79	44	144		NEC: CM • CEC: CM UL AWM Style 2092 (300 V, +60 °C)

18 AWG • FEP/FEP

Stranded (19 x 30) TC Conductors • FEP Insulation • Overall Beldfoil® Shield • 20 AWG TC Drain Wire • Red FEP Jacket														
88760	1	Black-Red	.150	3.81	.007	.18	.014	.36	51	167	97	318		NEC: CMP • CEC: CMP FT6 300 V

18 AWG • FEP/Fluorocopolymer

Stranded (19 x 30) TC Conductors • FEP Insulation • Overall Beldfoil® Shield • 20 AWG TC Drain Wire • Red Fluorocopolymer Jacket														
87760	1	Black-Red	.150	3.81	.007	.18	.014	.36	51	167	97	318		NEC: CMP • CEC: CMP FT6 300 V

18 AWG • FEP/Flamarrest®

Stranded (19 x 30) TC Conductors • FEP Insulation • Overall Beldfoil® Shield • 20 AWG TC Drain Wire • Natural Flamarrest Jacket														
82760	1	Black-Red	.150	3.81	.007	.18	.014	.36	51	167	97	318		NEC: CMP • CEC: CMP FT6 300 V

TC = Tinned Copper • FEP = Fluorinated Ethylene Propylene • PVC = Polyvinyl Chloride

Audio, Control, and Instrumentation Cables

Overall Beldfoil® Shield



Part No.	Pairs	Color Code	OD (Nom)		Insulation Thickness		Jacket Thickness		Capacitance				Additional Features/Ratings
			Inch	mm	Inch	mm	Inch	mm	Cond. - Cond.		Cond. - Shield		
									pF/Ft	pF/m	pF/Ft	pF/m	
16 AWG • 19 x 29 • Polyethylene/PVC													
Stranded TC Conductors • Polyethylene Insulation • Overall Beldfoil® Shield • 18 AWG Stranded TC Drain Wire • Chrome PVC Jacket													
8719	1	Black-Clear	.313	7.95	.032	.81	.032	.81	23	75	44	144	NEC: CM, CL2 • CEC: CM UL AWM Style 20253 (600 V, +80 °C)
16 AWG • 19 x 29 • Polyethylene/LSZH													
Stranded TC Conductors • Polyethylene Insulation • Overall Beldfoil® Shield • 18 AWG Stranded TC Drain Wire • Chrome LSZH Jacket													
8719NH	1	Black-Clear	.32	8.10	.032	.81	.030	.75	23	75	44	144	Flame IEC 60332-3-24, Smoke IEC 61034
14 AWG • 19 x 27 • Polyethylene/PVC													
Stranded TC Conductors • Polyethylene Insulation • Overall Beldfoil® Shield • 18 AWG Stranded TC Drain Wire • Chrome PVC Jacket													
8720	1	Black-Clear	.355	9.02	.032	.81	.035	.89	24	79	47	154	NEC: CM, CL2 UL AWM Style 20253 (600 V, +80 °C)
12 AWG • 19 x 25 • Polyethylene/PVC													
Stranded TC Conductors • Polyethylene Insulation • Overall Beldfoil® Shield • 18 AWG Stranded TC Drain Wire • Chrome PVC Jacket													
8718	1	Black-Clear	.400	10.16	.037	.94	.040	1.02	25	82	49	161	NEC: CL2 C(UL) AWM II A UL AWM Style 20253 (600 V, +80 °C)

TC = Tinned Copper • PVC = Polyvinyl Chloride

Audio, Control, and Instrumentation Cables

300 V, +60 °C • Overall Beldfoil® Shield

- NEC: CMG
- CEC: CMG FT4



Part No.	Pairs	Color Code	OD (Nom)		Insulation Thickness		Jacket Thickness		Capacitance				Additional Features/Ratings
			Inch	mm	Inch	mm	Inch	mm	Cond. - Cond.		Cond. - Shield		
									pF/Ft	pF/m	pF/Ft	pF/m	

22 AWG • PVC/PVC

Solid TC Conductors • PVC Insulation • Overall Beldfoil® Shield • 22 AWG Stranded TC Drain Wire • Chrome PVC Jacket														
9302	2	Chart 3	.244	6.20										
9305	4	Chart 3	.265	6.73	.013	.33	.032	.81						
9306	6	Chart 3	.315	8.00										
9309	9	Chart 3	.363	9.22	.013	.33	.033	.84	35	115	50	164	AWM Style 2464 (300 V, +80 °C)	
9315	15	Chart 3	.449	11.41	.013	.33	.037	.94						
9319	19	Chart 3	.495	12.57	.013	.33	.040	1.02						
9327	27	Chart 3	.615	15.62	.013	.33	.045	1.14						
8751	51	Note 1	.710	18.03	.013	.33	.050	1.27	30	98	42.8	140	300 V, +60 °C	

Note 1: See Tech Bulletin T/8-4.

300 V • Overall Duofoil® Shield

- NEC: CM
- CEC: CM



Part No.	Pairs	Color Code	OD (Nom)		Insulation Thickness		Jacket Thickness		Capacitance				Additional Features/Ratings
			Inch	mm	Inch	mm	Inch	mm	Cond. - Cond.		Cond. - Shield		
									pF/Ft	pF/m	pF/Ft	pF/m	

22 AWG • Datalene®/PVC

Solid TC Conductors • Datalene Insulation • Overall Duofoil Shielding • 22 AWG Stranded TC Drain Wire • Black PVC Jacket													
9184	2	Black-Yellow, Red-Blue	.385	9.78	.035	.89	.041	1.03	8.7	25.5	14.1	46.3	150 Ω Nom. Impedance 78% Velocity of Prop. Conductor DCR (Nom): 16.5/1000' (54.13 Ω/km)

TC = Tinned Copper • PVC = Polyvinyl Chloride | Belden Color Code Charts can be found at page 350/351.

Audio, Control, and Instrumentation Cables

300 V, +80 °C • Overall Beldfoil® Shield • Plenum and Non-Plenum



Part No.	Pairs	Color Code	OD (Nom)		Insulation Thickness		Jacket Thickness		Capacitance				Additional Features/Ratings
			Inch	mm	Inch	mm	Inch	mm	Cond. - Cond.		Cond. - Shield		
									pF/Ft	pF/m	pF/Ft	pF/m	

24 AWG • Polyolefin/PVC

Stranded (7 x 32) TC Conductors • Polyolefin Insulation • Overall Beldfoil® Shield • 24 AWG TC Drain Wire • Matte Black PVC Jacket													
1508A	1	Black-Red	.131	3.33	.008	.20	.024	.61	31	102	58	190	NEC: CM

24 AWG • Polypropylene/PVC

Stranded (7 x 32) TC Conductors • Polypropylene Insulation • Overall Beldfoil® Shield • 24 AWG TC Drain Wire • PVC Jacket (Gray, Brown, Red, Green, Light Blue, Purple, White, or Black). Jacket and Shield Are Bonded So Both Can Be Removed With Automatic Stripping Equipment. For Cross-Connect Use With 1408R Snake Cables.													
1883A	1	Black-Red	.123	3.12	.008	.29	.020	.51	31	102	58	190	NEC: CMR • CEC: CMR FT4

24 AWG • Polyethylene/PVC

Stranded (7 x 32) TC Conductors • Polyethylene Insulation • Overall Beldfoil® Shield • 24 AWG TC Drain Wire • Chrome PVC Jacket													
8641	1	Black-Clear	.168	4.27	.016	.41	.025	.64	22	72	42	138	NEC: CM • CEC: CM AWM Style 2092

24 AWG • FEP/FEP

Stranded (7 x 32) TC Conductors • FEP Insulation • Overall Beldfoil® Shield • 24 AWG TC Drain Wire • Red FEP Jacket													
88641	1	Black-Red	.106	2.69	.006	.15	.014	.36	31	102	59	194	Plenum • Non-Conduit NEC: CMP • CEC: CMP FT6

24 AWG • FEP/Flamarrest®

Stranded (7 x 32) TC Conductors • FEP Insulation • Overall Beldfoil® Shield • 24 AWG TC Drain Wire • Red Flamarrest Jacket													
82641	1	Black-Red	.106	2.69	.006	.15	.014	.36	31	102	59	194	Plenum • Non-Conduit NEC: CMP • CEC: CMP FT6

High-Temperature • 300 V, +150 °C • Overall Beldfoil® Shield



Part No.	Pairs	Color Code	OD (Nom)		Insulation Thickness		Jacket Thickness		Capacitance				Additional Features/Ratings
			Inch	mm	Inch	mm	Inch	mm	Cond. - Cond.		Cond. - Shield		
									pF/Ft	pF/m	pF/Ft	pF/m	

20 AWG • ETFE/ETFE

Stranded (7 x 28) TC Conductors • ETFE Insulation Overall Beldfoil® Shield • 22 AWG TC Drain Wire • Clear ETFE Jacket													
85164	4	Chart 3	.344	8.74	.015	.38	.025	.64	23	75	40	111	VW-1
85168	8	Chart 3	.439	11.15									

TC = Tinned Copper • ETFE = Ethylene/TFE = Tetrafluoroethylene • FEP = Fluorinated Ethylene Propylene • PVC = Polyvinyl Chloride | Belden Color Code Charts can be found at page 350/351.

Audio, Control, and Instrumentation Cables

Individually Shielded Pairs



- NEC: CM
- CEC: CM

Part No.	Pairs	Color Code	OD (Nom)		Insulation Thickness		Jacket Thickness		Capacitance				Additional Features/Ratings
			Inch	mm	Inch	mm	Inch	mm	Cond. - Cond.		Cond. - Shield		
									pF/Ft	pF/m	pF/Ft	pF/m	

24 AWG • Polyethylene/PVC

Stranded (7 x 32) TC Conductors • Polyethylene Insulation • Individually Beldfoil® Shielded Pairs • 24 AWG TC Drain Wire • Chrome PVC Jacket														
9990	3	Chart 3	.255	6.48										UL AWM Style 2919 (30 V, +80 °C) 60 Ω Nom. Impedance 66% Velocity of Prop. Conductor DCR (Nom): 24.0 Ω/1000' (78.7 Ω/km)
9991	6	Chart 3	.330	8.38										
9992	9	Chart 3	.383	9.73	.011	.28	.035	.89	25	82	47	154		
9993	12	Chart 3	.428	10.87										
9995	25	Chart 3	.636	16.15	.011	.28	.052	1.32						

Individually Shielded Pairs



- NEC: MPG, CMG
- CEC: MPG, CMG FT4

Part No.	Pairs	Color Code	OD (Nom)		Insulation Thickness		Jacket Thickness		Capacitance				Additional Features/Ratings
			Inch	mm	Inch	mm	Inch	mm	Cond. - Cond.		Cond. - Shield		
									pF/Ft	pF/m	pF/Ft	pF/m	

22 AWG • Polyethylene/PVC

Solid TC Conductors • Polyethylene Insulation • Individually Beldfoil® Shielded Pairs • 22 AWG TC Drain Wire • Chrome PVC Jacket														
8767	3	Chart 3	.279	7.10	.013	.33	.037	.94						UL AWM Style 2464 (300 V, +80 °C)
8768	6	Chart 3	.379	9.60	.013	.33	.037	.94	40	131	77	253		
8764	9	Chart 3	.425	10.80	.013	.33	.040	1.02						
8766	15	Chart 3	.525	13.30	.013	.33	.045	1.14						

TC = Tinned Copper • ETFE = Ethylene/TFE = Tetrafluoroethylene • FEP = Fluorinated Ethylene Propylene • PVC = Polyvinyl Chloride | Belden Color Code Charts can be found at page 350/351.

Audio, Control, and Instrumentation Cables

Individually Shielded Pairs • RS-485



Part No.	Pairs	Color Code	OD (Nom)		Insulation Thickness		Jacket Thickness		Capacitance				Additional Features/Ratings
			Inch	mm	Inch	mm	Inch	mm	Cond. - Cond.		Cond. - Shield		
									pF/Ft	pF/m	pF/Ft	pF/m	

22 AWG • SR-PVC/PVC

Stranded (7 x 30) TC Conductors • PVC Insulation • Individually Beldfoil® Shielded Pairs • 22 AWG TC Drain Wire • Pale Fawn Beige PVC Jacket • Pairs Parallel Under Jacket													
9406	2	Black-White Black-Yellow	.173 x .280	4.39 x 7.11	.011	.28	.033	.84	50	164	95.5	312	NEC: CMG • CEC: CMG FT4 UL AWM Style 2464 (300 V, +80 °C) 50 Ω Nom. Impedance 60% Velocity of Prop. Conductor DCR (Nom): 15.0 Ω/1000' (49.2 Ω/km)

22 AWG • Polypropylene/PVC

Stranded (7 x 30) TC Conductors • Polypropylene Insulation • Individually Beldfoil® Shielded Pairs • 22 AWG TC Drain Wire • Chrome PVC Jacket • Pairs Cabled on a Common Axis to Reduce Diameter													
8723	2	Black-Red Green-White	.160	4.06	.009	.22	.020	.51	35	115	62	203	NEC: CM • CEC: CM 300 V, +60 °C 45 Ω Nom. Impedance 66% Velocity of Prop. Conductor DCR (Nom): 14.7 Ω/1000' (48.2 Ω/km)

22 AWG • Polypropylene/LSZH

Stranded (7 x 30) TC Conductors • Polypropylene Insulation • Individually Beldfoil® Shielded Pairs • 22 AWG TC Drain Wire • Black LSZH Jacket • Pairs Cabled on a Common Axis to Reduce Diameter													
8723SB	2	Black-Red Green-White	.196	4.98	.009	.22	.034	.86	35	115	62	203	NEC: CMG-LS • CEC: CMG-LS FT4 Limited Smoke 300 V, +60 °C 45 Ω Nom. Impedance 66% Velocity of Prop. Conductor DCR (Nom): 14.7 Ω/1000' (48.2 Ω/km)

22 AWG • Polypropylene/LSZH

Stranded (7 x 30) TC Conductors • Polypropylene Insulation • Individually Beldfoil® Shielded Pairs • 22 AWG TC Drain Wire • Chrome LSZH Jacket • Pairs Cabled on Common Axis to Reduce Diameter													
8723NH	2	Black-Red Green-White	.180	4.55	.009	.22	.026	.65	17	55	35	115	Flame IEC 60332-3-24, Smoke IEC 61034, 45 Ω Nim. Impedance, 65% Velocity of Prop., Conductor DCR (Nom): 14.7 Ω/100' (48.2 Ω/km)
8723LS	2	Black-Red Green-White	.350	8.80	.009	.22	.026/ .049	.65/ 1.25	17	55	35	115	Flame IEC 60332-3-24, Smoke IEC 61034, 45 Ω Nim. Impedance, 65% Velocity of Prop., Conductor DCR (Nom): 14.7 Ω/100' (48.2 Ω/km) Steel Wire Armor

TC = Tinned Copper • LSZH = Low Smoke Zero Halogen • PVC = Polyvinyl Chloride

Audio, Control, and Instrumentation Cables

Individually Shielded Pairs • RS-485



Part No.	Pairs	Color Code	OD (Nom)		Insulation Thickness		Jacket Thickness		Capacitance				Additional Features/Ratings
			Inch	mm	Inch	mm	Inch	mm	Cond. - Cond.		Cond. - Shield		
									pF/Ft	pF/m	pF/Ft	pF/m	

22 AWG • Polypropylene/PVC

Stranded (7 x 30) TC Conductors • Polypropylene Insulation • Individually Beldfoil® Shielded Pairs • 22 AWG TC Drain Wire • Chrome PVC Jacket														
8777	3	Chart 3	.273	6.93										
8778	6	Chart 3	.362	9.19	.011	.28	.034	.86						
8774	9	Chart 3	.417	10.59										
8775	11	Chart 3	.464	11.79										
9768	12	Chart 3	.464	11.79	.011	.28	.036	.91						
8776	15	Chart 3	.548	13.92					30	98	55	180		
9769	17	Chart 3	.577	14.66	.011	.28	.052	1.32						
8769	19	Chart 3	.603	15.32										
8773	27	Chart 3	.709	18.00	.011	.28	.064	1.63						
9767	37	Chart 3	.800	20.32	.011	.28	.069	1.75						

NEC: CM • CEC: CM
UL AWM Style 2919
(30 V, +80 °C)
50 Ω Nom. Impedance
66% Velocity of Prop.
Conductor DCR (Nom):
15.0 Ω/1000' (49.2 Ω/km)

22 AWG • Polypropylene/LSZH

Stranded (7 x 30) TC Conductors • Polypropylene Insulation • Individually Beldfoil® Shielded Pairs • 22 AWG TC Drain Wire • LSZH Jacket														
8777SB	3	Chart 3	.273	6.93	.010	.25	.034	.86	30	98	55	180		

NEC: CMG-LS • CEC: CMG-LS
50 Ω Nom. Impedance
66% Velocity of Prop.
Conductor DCR (Nom):
15.0 Ω/1000' (49.2 Ω/km)

22 AWG • Polypropylene/LSZH

Stranded (7 x 30) TC Conductors • Polypropylene Insulation • Individually Beldfoil® Shielded Pairs • 22 AWG Stranded TC Drain Wire • Chrome LSZH Jacket														
8777NH	3	Chart 3	.280	7.00	.011	.28	.035	.89	30	98	55	180		Flame IEC 60332-3-24, Smoke IEC 61034, 50 Ω Nom. Impedance, 66% Velocity of Prop., Conductor DCR (Nom): 15.0 Ω/1000' (49.2 Ω/km)
8777LS	3	Chart 3	.450	11.50	.011	.28	.035/ .053	.89/ 1.35	30	98	55	180		Flame IEC 60332-3-24, Smoke IEC 61034, 50 Ω Nom. Impedance, 66% Velocity of Prop., Conductor DCR (Nom): 15.0 Ω/1000' (49.2 Ω/km) Steel Wire Armor
8778NH	6	Chart 3	.370	9.50	.011	.28	.035	.89	30	98	55	180		Flame IEC 60332-3-24, Smoke IEC 61034, 50 Ω Nom. Impedance, 66% Velocity of Prop., Conductor DCR (Nom): 15.0 Ω/1000' (49.2 Ω/km)
8778LS	6	Chart 3	.550	13.90	.011	.28	.035/ .053	.89/ 1.35	30	98	55	180		Flame IEC 60332-3-24, Smoke IEC 61034, 50 Ω Nom. Impedance, 66% Velocity of Prop., Conductor DCR (Nom): 15.0 Ω/1000' (49.2 Ω/km) Steel Wire Armor

TC = Tinned Copper • LSZH = Low Smoke Zero Halogen • PVC = Polyvinyl Chloride | Belden Color Code Charts can be found at page 350/351.

Audio, Control, and Instrumentation Cables

Individually Shielded Pairs • RS-485



Part No.	Pairs	Color Code	OD (Nom)		Insulation Thickness		Jacket Thickness		Capacitance				Additional Features/Ratings
			Inch	mm	Inch	mm	Inch	mm	Cond. - Cond.		Cond. - Shield		
									pF/Ft	pF/m	pF/Ft	pF/m	
22 AWG • FEP/Flamarrest®													
Stranded (7 x 30) TC Conductors • FEP Insulation • Individually Beldfoil® Shielded Pairs • 24 AWG TC Drain Wire • Natural Flamarrest Jacket Pairs Cabled on a Common Axis to Reduce Diameter.													
82723	2	Black-Red Green-White	.153	3.89	.007	.18	.017	.43	43	141	75	246	Plenum • Non-Conduit NEC: CMP • CEC: CMP FT6 300 V 45 Ω Nom. Impedance 66% Velocity of Prop. Conductor DCR (Nom): 14.7 Ω/1000' (48.2 Ω/km)

22 AWG • FEP/FEP

Stranded (7 x 30) TC Conductors • FEP Insulation • Individually Beldfoil® Shielded Pairs • 24 AWG TC Drain Wire • Red FEP Jacket Pairs Cabled on a Common Axis to Reduce Diameter.													
88723	2	Black-Red Green-White	.148	3.76	.007	.18	.014	.36	35	115	67	220	Plenum • Non-Conduit NEC: CMP • CEC: CMP FT6 300 V 45 Ω Nom. Impedance 66% Velocity of Prop. Conductor DCR (Nom): 14.7 Ω/1000' (48.2 Ω/km)

22 AWG • FEP/Fluorocopolymer

Stranded (7 x 30) TC Conductors • FEP Insulation • Individually Beldfoil® Shielded Pairs • 24 AWG TC Drain Wire • Red Fluorocopolymer Jacket Pairs Cabled on a Common Axis to Reduce Diameter.													
87723	2	Black-Red Green-White	.148	3.76	.007	.18	.014	.36	35	115	67	220	Plenum • Non-Conduit NEC: CMP • CEC: CMP FT6 300 V 45 Ω Nom. Impedance 66% Velocity of Prop. Conductor DCR (Nom): 14.7 Ω/1000' (48.2 Ω/km)

TC = Tinned Copper • FEP = Fluorinated Ethylene Propylene

Audio, Control, and Instrumentation Cables

Individually Shielded Pairs • Plenum



Part No.	Pairs	Color Code	OD (Nom)		Insulation Thickness		Jacket Thickness		Capacitance				Additional Features/Ratings
			Inch	mm	Inch	mm	Inch	mm	Cond. - Cond.		Cond. - Shield		
									pF/Ft	pF/m	pF/Ft	pF/m	

22 AWG • FEP/Flamarrest®

Stranded (7 x 30) TC Conductors • FEP Insulation • Individually Beldfoil® Shielded Pairs • 22 AWG TC Drain Wire • Natural Flamarrest Jacket													
82777	3	Chart 3	.237	6.02									Plenum NEC: CMP • CEC: CMP FT6 46 Ω Nom. Impedance 62% Velocity of Prop. Conductor DCR (Nom): 14.7 Ω/1000' (48.2 Ω/km)
					.011	.28	.017	.43	35	115	76	249	
82778	6	Chart 3	3.14	7.98									

22 AWG • FEP/FEP

Stranded (7 x 30) TC Conductors • FEP Insulation • Individually Beldfoil® Shielded Pairs • 22 AWG TC Drain Wire • Red FEP Jacket													
88777	3	Chart 3	.234	5.94									Plenum NEC: CMP • CEC: CMP FT6 50 Ω Nom. Impedance 62% Velocity of Prop. Conductor DCR (Nom): 14.7 Ω/1000' (48.2 Ω/km)
					.010	.25	.014	.36	31	102	67	220	
88778	6	Chart 3	.309	7.85									

22 AWG • FEP/Fluorocopolymer

Stranded (7 x 30) TC Conductors • FEP Insulation • Individually Beldfoil® Shielded Pairs • 22 AWG TC Drain Wire • Red Fluorocopolymer Jacket													
87777	3	Chart 3	.234	5.94									Plenum NEC: CMP • CEC: CMP FT6 46 Ω Nom. Impedance 50% Velocity of Prop. Conductor DCR (Nom): 14.7 Ω/1000' (48.2 Ω/km)
					.010	.25	.014	.36	31	102	67	220	
87778	6	Chart 3	.309	7.85									

TC = Tinned Copper • FEP = Fluorinated Ethylene Propylene | Belden Color Code Charts can be found at page 350/351.

Audio, Control, and Instrumentation Cables

Individually Shielded Pairs



Part No.	Pairs	Color Code	OD (Nom)		Insulation Thickness		Jacket Thickness		Capacitance				Additional Features/Ratings
			Inch	mm	Inch	mm	Inch	mm	Cond. - Cond.		Cond. - Shield		
									pF/Ft	pF/m	pF/Ft	pF/m	
20 AWG • SR-PVC/PVC													
Stranded (7 x 28) TC Conductors • Semi-Rigid PVC Insulation • Individually Beldfoil® Shielded Pairs • 22 AWG TC Drain Wire • Chrome PVC Jacket													
9402	2	Black-Red, Green-White	.300	7.62	.010	.25	.041	1.04	55	180	95	312	NEC: CMG • CEC: CMG FT4 UL AWM Style 2464 (300 V, +80 °C)
20 AWG • Polypropylene/Polyethylene													
Stranded (10 x 32) TC Conductors • Polypropylene Insulation • Individually Beldfoil® Shielded Pairs • 22 AWG TC Drain Wire • Black High-Density Polyethylene Jacket													
9883	3	Chart 3	.340	8.64	.013	.33	.040	1.02	30	98	55	180	NEC: CMG • CEC: CMP FT4 350 V 50 Ω Nom. Impedance 66% Velocity of Prop Conductor DCR (Nom): 6.4 Ω/1000' (21.0 Ω/km)
9886	6	Chart 3	.455	11.56	.013	.33	.045	1.14					
20 AWG • Polypropylene/PVC													
Stranded (7 x 28) TC Conductors • Polypropylene Insulation • Individually Beldfoil® Shielded Pairs • 22 AWG TC Drain Wire • Chrome PVC Jacket													
9873	3	Chart 3	.341	8.66	.015	.38	.035	.89	30	98	55	180	NEC: CM • CEC: CM UL AWM Style 2919 (30 V, +80 °C) 50 Ω Nom. Impedance 66% Velocity of Prop Conductor DCR (Nom): 10.5 Ω/1000' (34.4 Ω/km)
9874	6	Chart 3	.445	11.30									
9875	9	Chart 3	.555	14.10									
9876	11	Chart 3	.600	15.24									
9877	12	Chart 3	.617	15.67									
9879	15	Chart 3	.689	17.50	.015	.38	.052	1.32					
18 AWG • Polypropylene/PVC													
Stranded (19 x 30) TC Conductors • Polypropylene Insulation • Individually Beldfoil® Shielded Pairs • 20 AWG TC Drain Wire • Chrome PVC Jacket													
9773	3	Chart 3	.404	10.26	.019	.48	.035	.89	30	98	55	180	NEC: CM • CEC: CM UL AWM Style 2919 (30 V, +80 °C) 50 Ω Nom. Impedance 66% Velocity of Prop Conductor DCR (Nom): 10.5 Ω/1000' (34.4 Ω/km)
9774	6	Chart 3	.560	14.22									
9775	9	Chart 3	.655	16.64									
9776	12	Chart 3	.735	18.67									
9777	15	Chart 3	.819	20.80									

TC = Tinned Copper • PVC = Polyvinyl Chloride | Belden Color Code Charts can be found at page 350/351.

UL Instrumentation Cables

300 V Power-Limited Tray Cables – Overview

Construction

Soft annealed bare or tinned copper with PVC flame retardant insulation and jacket. Other insulation and jacket options are available (see table below). Communication wire included on all multi-pair/multi-triad 1000 and 3000 series part numbers, 22 AWG (7 x 30) bare copper, orange PVC insulation. Nylon rip cord included in all PVC/PVC instrumentation cables.

Other Construction Options:

UL Listed for PLTC	
Insulation/Jacket	Max. Temp Rating
XLP/PVC	+90 °C
XLP/CPE	+90 °C
PVC/PVC	+105 °C
PVC/CPE	+105 °C
XLP/Haloarrest®	+90 °C

Armoring Capabilities

Belden also has the capability to protect electronic, instrumentation and control cables with interlocking or continuous armor and Belclad® corrugated protective metal tapes.

Application

Cable jackets are resistant to sunlight, moisture and vapor penetration. PVC/PVC constructions, with 3 conductors or more and 20 AWG or larger, are suitable for direct burial.

Unshielded

Twisted non-shielded pairs and triads provide a minimal OD allowing greater tray and conduit fill. Non-shielded instrument pairs may be utilized when recommended by the instrument manufacturer and used in a metallic conduit.

Overall Shield

Recommended for use in instrumentation applications where signals are transmitted in excess of 100 millivolts except in areas where high voltage and current sources create excessive noise interference. The Beldfoil® shield with drain wire provides 100% coverage for maximum shield effectiveness.

Individually Shielded and Overall Shielded

Individually shielded pairs or triads with an overall shield are recommended for use in instrumentation applications where optimum noise rejection is required. Individual pair/triad shields are fully isolated from each other and contain a separate drain wire for grounding to provide maximum protection from crosstalk and common mode interference. Cables with an overall shield provide additional electrostatic noise protection.

Specifications

- UL Subject 13
- UL Subject 2250
- NEC Article 725 Class 2 and Class 3 Circuits
- NEC Type PLTC Listed, which is approved for cable tray use in Class 1, Division 2, hazardous areas and non-hazardous areas, cable trays, raceways, conduit and supported by messenger wires.
- Sunlight-resistant.
- NEC Type ITC per Article 727. ITC cables may carry up to 5 amps at 150 V, which is significantly greater than that allowed for PLTC only cables. ITC cables may also be installed in specific applications, per the NEC, in addition to those allowed for PLTC.
- UL 1685 (UL 1581) Vertical Tray Flame Test comparable to IEEE 383-1974 (70,000 BTU/hr.) Flame Test.
- PVC/PVC constructions are CMG, FT4, IEEE 1202 and IEEE 383-2003 rated, and meet ICEA T-29-520 Flame Test.
- Design options – call technical support.

PLTC-ER/ITC-ER

As an option, Belden offers all PVC insulated, PVC jacketed instrumentation cables, and several other insulation and jackets, with a PLTC-ER (Exposed Run) and ITC-ER ratings.

Per NEC Article 725, a PLTC-ER rated cable may be installed in an industrial establishment between a cable tray and the utilization equipment or device. A PLTC-ER rated cable must meet the crush and impact requirements of UL Type MC cable. By eliminating the need for metal conduit and/or armor, using a PLTC-ER rated cable results in savings in both installation and maintenance.

Armoring Options

Code		
Overall Jacket Prefix	Armor Prefix	Base Part No.
3	4	4-digit base number

Overall Jacket

Code	Material
1	PVC
3	CPE
4	TPE
5	HDPE
7	Haloarrest

Armor

Code	Material
2	Aluminum Interlock
3	Steel Interlock
4	Aluminum Belclad®
5	Steel Belclad
6	Copper Belclad
8	Continuous Armor

Example: 343016A is cable part no. 3016A with CPE outer jacket and aluminum Belclad tape.

UL Instrumentation Cables
300 V Power-Limited Tray Cables

22 AWG Pairs



- UL PLTC, ITC
- Sunlight Res
- Oil Res

- NEC: CMG
- CEC: CMG FT4
- IEEE 1202/383
- ICEA T-29-520

Part No.	Pairs	Color Code	Pull Tension (Max)		Bend Radius (Min)		OD (Nom)		Jacket Thickness	
			Lbs	N	Inch	mm	Inch	mm	Inch	mm

22 AWG • Unshielded

Stranded (7 x 30) TC Conductors • PVC Insulation • PVC Jacket										
9407	1	E2	19	85	2.00	50.80	.198	5.03	.037	.94

22 AWG • Overall Beldfoil® Shield

Stranded (7 x 30) TC Conductors • PVC Insulation • PVC Jacket										
9322	1	E2	28	125	2.00	50.80	.201	5.10	.037	.94
9512	2	E2	46	205	3.00	76.20	.310	7.82		
9513	3	E2	63	280	3.25	82.55	.324	8.23	.042	1.07
9514	4	E2	80	356	3.50	88.90	.356	9.04		
9516	6	E2	118	525	4.25	107.95	.418	10.62		
9520	9	E2	172	765	4.75	120.65	.482	12.29		
9521	11	E2	200	890	5.35	135.89	.506	12.85	.053	1.35
9524	15	E2	280	1246	6.00	152.40	.594	15.09		
9526	19	E2	350	1557	6.33	160.78	.644	16.36		
9527	27	E2	500	2224	7.50	190.50	.763	19.38	.063	1.60

22 AWG • Individually Beldfoil® Shielded Pairs

Stranded (7 x 30) TC Conductors • PVC Insulation • PVC Jacket										
9328	2	E2	54	240	3.00	76.20	.323	8.20		
9329	3	E2	54	240	3.50	88.90	.341	8.66	.042	1.07
9330	4	E2	110	489	3.50	88.90	.372	9.45		
9331	6	E2	101	449	4.33	109.98	.457	11.61		
9332	9	E2	160	712	5.00	127.00	.530	13.46	.053	1.35
9333	11	E2	160	712	5.50	139.70	.592	15.04		
9335	19	E2	264	1174	6.50	165.10	.711	18.06	.063	1.60

TC = Tinned Copper • PVC = Polyvinyl Chloride | Belden Color Code Charts can be found at page 350/351.

UL Instrumentation Cables
300 V Power-Limited Tray Cables

22 AWG Pairs



- UL PLTC, ITC
- Sunlight Res
- Oil Res
- NEC: CMG
- CEC: CMG FT4
- IEEE 1202/383
- ICEA T-29-520

Part No.	Pairs	Color Code	Pull Tension (Max)		Bend Radius (Min)		OD (Nom)		Jacket Thickness	
			Lbs	N	Inch	mm	Inch	mm	Inch	mm

22 AWG • Overall Beldfoil® Shield • 22 AWG Orange Communication Wire

Stranded (7 x 30) BC Conductors • PVC Insulation • PVC Jacket										
3000A	2	E1	46	205	3.00	76.20	.310	7.87	.043	1.09
3004A	4	E1	80	356	3.50	88.90	.357	9.01	.042	1.07
3006A	8	E1	172	765	4.75	120.65	.450	11.43		
3008A	12	E1	210	934	5.00	127.00	.536	13.61	.053	1.35
3010A	16	E1	290	1290	6.00	152.40	.594	15.09		
3012A	24	E1	440	1957	7.50	190.50	.749	19.02	.065	1.65
3014A	50	E1	915	4070	9.50	241.30	1.017	25.80	.075	1.91

22 AWG • Individually Beldfoil® Shielded Pairs and Overall Beldfoil® Shield • 22 AWG Orange Communication Wire

Stranded (7 x 30) BC Conductors • PVC Insulation • PVC Jacket										
3001A	2	E1	54	240	3.25	82.55	.324	8.23	.042	1.07
3005A	4	E1	115	512	3.50	88.90	.360	9.14	.043	1.09
3007A	8	E1	250	1112	5.25	133.35	.497	12.62		
3009A	12	E1	300	1334	5.75	146.05	.570	14.48	.053	1.35
3011A	16	E1	350	1557	6.25	158.75	.674	17.12	.064	1.63
3013A	24	E1	540	2402	8.00	203.20	.800	20.32	.065	1.65
3015A	50	E1	1330	5916	10.50	266.70	1.050	26.67	.075	1.91

To Specify Conductor, Insulation and Jacket Options:		
1234	A	E
Start with Base Part No. (1000 and 3000 Series cables only)	Add or Modify for Conductor, Insulation, and Jacket. See table at right.	Add for Exposed Run Rating

Bare	Tinned	Insulation/Jacket	Bare	Tinned	Insulation/Jacket
A	B	PVC/PVC	Q	R	XLP/CPE
C	D	XLP/PVC	S	T	XLP/Haloarrest®

BC = Bare Copper • CPE = Chlorinated Polyethylene • PVC = Polyvinyl Chloride • XLP = Cross-Linked Polyethylene | Belden Color Code Charts can be found at page 350/351.

UL Instrumentation Cables

300 V Power-Limited Tray Cables

22 AWG Triads



- UL PLTC, ITC
- Sunlight Res
- Oil Res
- NEC: CMG
- CEC: CMG FT4
- IEEE 1202/383
- ICEA T-29-520

Part No.	Triads	Color Code	Pull Tension (Max)		Bend Radius (Min)		OD (Nom)		Jacket Thickness	
			Lbs	N	Inch	mm	Inch	mm	Inch	mm

22 AWG • Unshielded

Stranded (7 x 30) TC Conductors • PVC Insulation • PVC Jacket										
9491	1	E1	29	129	2.00	50.80	.208	5.28	.037	.94

22 AWG • Beldfoil® Shield

Stranded (7 x 30) TC Conductors • PVC Insulation • PVC Jacket										
9363	1	E1	29	129	2.00	50.80	.208	5.28	.037	.94

22 AWG Triads



- UL PLTC, ITC
- Sunlight Res
- Oil Res
- NEC: CMG
- CEC: CMG FT4
- IEEE 1202/383
- ICEA T-29-520

Part No.	Triads	Color Code	Pull Tension (Max)		Bend Radius (Min)		OD (Nom)		Jacket Thickness	
			Lbs	N	Inch	mm	Inch	mm	Inch	mm

22 AWG • Overall Beldfoil® Shield • 22 AWG Orange Communication Wire

Stranded (7 x 30) BC Conductors • PVC Insulation • PVC Jacket										
3002A	2	E1	62	276	3.50	88.90	.330	8.38	.043	1.09

22 AWG • Individually Beldfoil® Shielded Triads and Overall Beldfoil® Shield • 22 AWG Orange Communication Wire

Stranded (7 x 30) BC Conductors • PVC Insulation • PVC Jacket										
3003A	2	E1	82	365	3.25	82.55	.330	8.38	.043	1.09

To Specify Conductor, Insulation and Jacket Options:

1234	A	E
Start with Base Part No. (1000 and 3000 Series cables only)	Add or Modify for Conductor, Insulation, and Jacket. See table at right.	Add for Exposed Run Rating

Bare	Tinned	Insulation/Jacket	Bare	Tinned	Insulation/Jacket
A	B	PVC/PVC	Q	R	XLP/CPE
C	D	XLP/PVC	S	T	XLP/Haloarrest®

BC = Bare Copper • TC = Tinned Copper • PVC = Polyvinyl Chloride • XLP = Cross-Linked Polyethylene | Belden Color Code Charts can be found at page 350/351.

UL Instrumentation Cables
300 V Power-Limited Tray Cables

20 AWG Pairs



- UL PLTC, ITC
- Sunlight Res
- Oil Res
- NEC: CMG
- CEC: CMG FT4
- IEEE 1202/383
- ICEA T-29-520

Part No.	Pairs	Color Code	Pull Tension (Max)		Bend Radius (Min)		OD (Nom)		Jacket Thickness	
			Lbs	N	Inch	mm	Inch	mm	Inch	mm

20 AWG • Unshielded

Stranded (19 x 32) TC Conductors • PVC Insulation • PVC Jacket										
9408	1	E2	31	138	2.0	50.80	.214	5.44	.037	.94

20 AWG • Overall Beldfoil® Shield

Stranded (19 x 32) TC Conductors • PVC Insulation • PVC Jacket										
9320	1	E2	40	178	2.0	50.80	.217	5.51	.037	.94

20 AWG Pairs



- UL PLTC, ITC
- Sunlight Res
- Oil Res
- NEC: CMG
- CEC: CMG FT4
- IEEE 1202/383
- ICEA T-29-520

Part No.	Pairs	Color Code	Pull Tension (Max)		Bend Radius (Min)		OD (Nom)		Jacket Thickness	
			Lbs	N	Inch	mm	Inch	mm	Inch	mm

20 AWG • Overall Beldfoil® Shield • 22 AWG Orange Communication Wire

Stranded (7 x 28) BC Conductors • PVC Insulation • PVC Jacket										
1033A	1	E1	42	187	2.25	57.15	.213	5.41	.037	.94
3016A	2	E1	92	409	3.75	95.25	.332	8.43	.042	1.07
1056A	4	E1	135	601	4.25	107.95	.408	10.36		
1057A	8	E1	247	1099	5.00	127.00	.472	11.99	.053	1.35
1058A	12	E1	359	1597	6.00	152.40	.564	14.33		
1059A	16	E1	232	1032	6.50	165.10	.649	16.48		
1060A	24	E1	695	3092	8.25	209.55	.786	19.96	.064	1.63
1061A	36	E1	1031	4586	10.00	254.00	.960	24.38	.074	1.88
1062A	50	E1	1423	6330	11.50	292.10	1.117	28.37		

To Specify Conductor, Insulation and Jacket Options:		
1234	A	E
Start with Base Part No. (1000 and 3000 Series cables only)	Add or Modify for Conductor, Insulation, and Jacket. See table at right.	Add for Exposed Run Rating

Bare	Tinned	Insulation/Jacket	Bare	Tinned	Insulation/Jacket
A	B	PVC/PVC	Q	R	XLP/CPE
C	D	XLP/PVC	S	T	XLP/Haloarrest®

BC = Bare Copper • TC = Tinned Copper • CPE = Chlorinated Polyethylene • PVC = Polyvinyl Chloride • XLP = Cross-Linked Polyethylene | Belden Color Code Charts can be found at page 350/351.

UL Instrumentation Cables
300 V Power-Limited Tray Cables

20 AWG Pairs



- UL PLTC, ITC
- Sunlight Res
- Oil Res
- NEC: CMG
- CEC: CMG FT4
- IEEE 1202/383
- ICEA T-29-520

Part No.	Pairs	Color Code	Pull Tension (Max)		Bend Radius (Min)		OD (Nom)		Jacket Thickness	
			Lbs	N	Inch	mm	Inch	mm	Inch	mm

20 AWG • Individually Beldfoil® Shielded Pairs and Overall Beldfoil® Shield • 22 AWG Orange Communication Wire

Stranded (7 x 28) BC Conductors • PVC Insulation • PVC Jacket										
1075A	2	E1	97	431	3.75	95.25	.337	8.56	.042	1.07
1076A	4	E1	171	761	4.50	114.30	.411	10.44	.053	1.35
1077A	8	E1	320	1423	5.50	139.70	.514	13.06		
1078A	12	E1	468	2082	6.75	171.45	.637	16.18		
1079A	16	E1	617	2745	7.50	190.50	.704	17.88	.064	1.63
1091A	20	E1	765	3403	8.25	209.55	.780	19.81		
1080A	24	E1	914	4066	9.00	228.60	.863	21.92		
1081A	36	E1	1359	6045	10.50	266.70	1.035	26.29	.074	1.88
1082A	50	E1	1878	8354	12.75	323.85	1.215	30.86		

20 AWG Triads



- UL PLTC, ITC
- Sunlight Res
- Oil Res
- NEC: CMG
- CEC: CMG FT4
- IEEE 1202/383
- ICEA T-29-520

Part No.	Triads	Color Code	Pull Tension (Max)		Bend Radius (Min)		OD (Nom)		Jacket Thickness	
			Lbs	N	Inch	mm	Inch	mm	Inch	mm

20 AWG • Unshielded

Stranded (19 x 32) TC Conductors • PVC Insulation • PVC Jacket										
9492	1	E1	46	205	2.25	57.15	.225	5.72	.037	.94

20 AWG • Beldfoil® Shield

Stranded (19 x 32) TC Conductors • PVC Insulation • PVC Jacket										
9364	1	E1	46	205	2.25	57.15	.228	5.79	.037	.94

To Specify Conductor, Insulation and Jacket Options:

1234	A	E
Start with Base Part No. (1000 and 3000 Series cables only)	Add or Modify for Conductor, Insulation, and Jacket. See table at right.	Add for Exposed Run Rating

Bare	Tinned	Insulation/Jacket	Bare	Tinned	Insulation/Jacket
A	B	PVC/PVC	Q	R	XLP/CPE
C	D	XLP/PVC	S	T	XLP/Haloarrest®

BC = Bare Copper • TC = Tinned Copper • CPE = Chlorinated Polyethylene • PVC = Polyvinyl Chloride • XLP = Cross-Linked Polyethylene | Belden Color Code Charts can be found at page 350/351.

UL Instrumentation Cables

300 V Power-Limited Tray Cables

20 AWG Triads



- UL PLTC, ITC
- Sunlight Res
- Oil Res
- NEC: CMG
- CEC: CMG FT4
- IEEE 1202/383
- ICEA T-29-520

Part No.	Triads	Color Code	Pull Tension (Max)		Bend Radius (Min)		OD (Nom)		Jacket Thickness	
			Lbs	N	Inch	mm	Inch	mm	Inch	mm

20 AWG • Beldfoil® Shield • 22 AWG Orange Communication Wire

Stranded (7 x 28) BC Conductors • PVC Insulation • PVC Jacket										
1526A	1	E1	42	187	2.20	55.88	.215	5.46	.037	.94
3017A	2	E1	97	431	3.60	91.44	.360	9.14		
3020A	4	E1	174	774	4.75	120.65	.470	11.94	.055	1.40
3021A	8	E1	330	1468	5.00	127.00	.560	14.22		
3022A	12	E1	485	2157	7.00	177.80	.710	18.03	.066	1.68
3023A	16	E1	600	2669	7.75	196.85	.821	20.85	.064	1.63
3024A	24	E1	920	4092	9.25	234.95	1.031	26.19	.074	1.88

20 AWG • Individually Beldfoil® Shielded Triads and Overall Beldfoil® Shield • 22 AWG Orange Communication Wire

Stranded (7 x 28) BC Conductors • PVC Insulation • PVC Jacket										
3018A	2	E1	102	454	3.75	95.25	.372	9.45	.055	1.40
1083A	4	E1	228	1014	4.50	114.30	.451	11.46	.053	1.35
1084A	8	E1	432	1922	5.75	146.05	.575	10.81		
1085A	12	E1	636	2929	7.15	181.61	.714	18.14	.064	1.63
1092A	16	E1	841	3741	7.90	200.66	.793	20.14		
1086A	24	E1	1250	5560	9.90	251.46	.992	25.20		
3067A	36	E1	1875	8340	13.00	330.20	1.292	32.82	.074	1.88

To Specify Conductor, Insulation and Jacket Options:

1234	A	E
Start with Base Part No. (1000 and 3000 Series cables only)	Add or Modify for Conductor, Insulation, and Jacket. See table at right.	Add for Exposed Run Rating

Bare	Tinned	Insulation/Jacket	Bare	Tinned	Insulation/Jacket
A	B	PVC/PVC	Q	R	XLP/CPE
C	D	XLP/PVC	S	T	XLP/Haloarrest®

BC = Bare Copper • TC = Tinned Copper • CPE = Chlorinated Polyethylene • PVC = Polyvinyl Chloride • XLP = Cross-Linked Polyethylene | Belden Color Code Charts can be found at page 350/351.

UL Instrumentation Cables
300 V Power-Limited Tray Cables

18 AWG Pairs



- UL PLTC, ITC
- Sunlight Res
- Oil Res
- NEC: CMG
- CEC: CMG FT4
- IEEE 1202/383
- ICEA T-29-520

Part No.	Pairs	Color Code	Pull Tension (Max)		Bend Radius (Min)		OD (Nom)		Jacket Thickness	
			Lbs	N	Inch	mm	Inch	mm	Inch	mm

18 AWG • Unshielded

Stranded (19 x 30) TC Conductors • PVC Insulation • PVC Jacket										
9409	1	E2	19	85	2.25	57.15	.230	5.84	.037	.94

18 AWG • Overall Beldfoil® Shield

Stranded (19 x 30) TC Conductors • PVC Insulation • PVC Jacket										
9318	1	E2	60	267	2.25	57.15	.233	5.92	.037	.94
9552	2	E2	65	289	3.70	93.98	.368	9.34	.042	1.07
9553	3	E2	145	645	4.10	104.14	.411	10.44		
9554	4	E2	187	832	4.50	114.30	.447	11.35		
9556	6	E2	270	1201	5.00	127.00	.497	12.62	.053	1.35
9559	9	E2	395	1757	5.80	147.32	.579	14.71		
9563	11	E2	478	2126	6.75	171.45	.665	16.89		
9565	15	E2	640	2847	7.50	190.50	.739	18.77	.063	1.60

18 AWG • Individually Beldfoil® Shielded Pairs

Stranded (19 x 30) TC Conductors • PVC Insulation • PVC Jacket										
9368	2	E2	125	556	3.75	95.25	.378	9.60	.042	1.07
9369	3	E2	220	979	4.25	107.95	.423	10.74		
3029A	4	E1	296	1317	4.50	114.30	.461	11.71		
9388	4	E2	296	1317	4.60	116.84	.461	11.71	.053	1.35
9389	6	E2	440	1957	5.25	133.35	.538	13.67		
9390	9	E2	666	2963	6.50	165.10	.652	16.56		
9391	11	E2	815	3625	7.25	184.15	.729	18.52	.064	1.63
9392	15	E2	1100	4893	8.00	203.20	.808	20.52		

TC = Tinned Copper • PVC = Polyvinyl Chloride | Belden Color Code Charts can be found at page 350/351.

UL Instrumentation Cables

300 V Power-Limited Tray Cables

18 AWG Pairs



- UL PLTC, ITC
- Sunlight Res
- Oil Res
- NEC: CMG
- CEC: CMG FT4
- IEEE 1202/383
- ICEA T-29-520

Part No.	Pairs	Color Code	Pull Tension (Max)		Bend Radius (Min)		OD (Nom)		Jacket Thickness	
			Lbs	N	Inch	mm	Inch	mm	Inch	mm

18 AWG • Overall Beldfoil® Shield • 22 AWG Orange Communication Wire

Stranded (7 x 26) BC Conductors • PVC Insulation • PVC Jacket										
1032A	1	E1	67	298	2.50	63.50	.233	5.92	.037	.94
3025A	2	E1	121	538	3.50	88.90	.375	9.53	.042	1.07
1529A	3	E1	165	734	4.25	107.95	.415	10.54		
1466A	4	E1	211	939	4.50	114.30	.452	11.48	.053	1.35
1467A	8	E1	390	1735	5.50	139.70	.523	13.28		
1468A	12	E1	560	2491	6.75	171.45	.673	17.09	.064	1.63
3034A	16	E1	640	2847	7.25	184.15	.713	18.11	.066	1.68
1471A	24	E1	1105	4915	9.25	234.95	.932	23.67		
1472A	36	E1	1644	7313	10.50	266.70	1.062	26.97	.074	1.88
3041A	50	E1	2240	9964	12.75	323.85	1.240	31.50		

18 AWG • Individually Beldfoil® Shielded Pairs and Overall Beldfoil® Shield • 22 AWG Orange Communication Wire

Stranded (7 x 26) BC Conductors • PVC Insulation • PVC Jacket										
1474A	2	E1	149	663	4.00	101.60	.408	10.16		
1475A	4	E1	267	1188	4.75	120.65	.468	11.89	.053	1.35
1476A	8	E1	501	2229	6.00	152.40	.594	15.10		
1477A	12	E1	779	3465	7.25	184.15	.737	18.72	.064	1.63
3035A	16	E1	725	3225	8.50	215.90	.836	21.20		
1480A	24	E1	1443	6419	10.25	260.35	1.019	25.88	.074	1.88
1481A	36	E1	2148	9555	11.75	298.45	1.163	29.54		
3042A	50	E1	2935	13056	14.00	355.60	1.389	35.28	.084	2.13

To Specify Conductor, Insulation and Jacket Options:		
1234	A	E
Start with Base Part No. (1000 and 3000 Series cables only)	Add or Modify for Conductor, Insulation, and Jacket. See table at right.	Add for Exposed Run Rating

Bare	Tinned	Insulation/Jacket	Bare	Tinned	Insulation/Jacket
A	B	PVC/PVC	Q	R	XLP/CPE
C	D	XLP/PVC	S	T	XLP/Haloarrest®

BC = Bare Copper • CPE = Chlorinated Polyethylene • PVC = Polyvinyl Chloride • XLP = Cross-Linked Polyethylene | Belden Color Code Charts can be found at page 350/351.

UL Instrumentation Cables
300 V Power-Limited Tray Cables

18 AWG Triads



- UL PLTC, ITC
- Sunlight Res
- Oil Res
- NEC: CMG
- CEC: CMG FT4
- IEEE 1202/383
- ICEA T-29-520

Part No.	Triads	Color Code	Pull Tension (Max)		Bend Radius (Min)		OD (Nom)		Jacket Thickness	
			Lbs	N	Inch	mm	Inch	mm	Inch	mm

18 AWG • Unshielded

Stranded (19 x 30) TC Conductors • PVC Insulation • PVC Jacket										
9493	1	E1	62	276	2.25	57.15	.242	6.15	.037	.94

18 AWG • Beldfoil® Shield

Stranded (19 x 30) TC Conductors • PVC Insulation • PVC Jacket										
9365	1	E1	74	329	2.50	63.50	.245	6.22	.037	.94

18 AWG Triads



- UL PLTC, ITC
- Sunlight Res
- Oil Res
- NEC: CMG
- CEC: CMG FT4
- IEEE 1202/383
- ICEA T-29-520

Part No.	Triads	Color Code	Pull Tension (Max)		Bend Radius (Min)		OD (Nom)		Jacket Thickness	
			Lbs	N	Inch	mm	Inch	mm	Inch	mm

18 AWG • Overall Beldfoil® Shield • 22 AWG Orange Communication Wire

Stranded (7 x 26) BC Conductors • PVC Insulation • PVC Jacket										
1036A	1	E1	90	400	2.40	60.96	.236	5.99	.037	.94
3027A	2	E1	165	734	4.25	107.95	.420	10.67	.055	1.40
3030A	4	E1	240	1068	4.50	114.30	.521	13.20	.064	1.63
3032A	8	E1	501	2229	5.75	146.05	.580	14.70	.077	1.96
3036A	16	E1	1050	4671	9.00	228.60	.900	22.86	.077	1.96
3038A	24	E1	1450	6450	10.25	260.35	1.020	25.91	.077	1.96

18 AWG • Individually Beldfoil® Shielded Triads and Overall Beldfoil® Shield • 22 AWG Orange Communication Wire

Stranded (7 x 26) BC Conductors • PVC Insulation • PVC Jacket										
3028A	2	E1	175	778	4.50	114.30	.450	11.43	.055	1.40
3031A	4	E1	255	1134	5.25	133.35	.533	13.50	.053	1.35
3033A	8	E1	560	2491	6.50	165.10	.654	16.50	.064	1.63
3068A	12	E1	800	3559	8.50	215.90	.840	21.30	.063	1.60
3037A	16	E1	1320	5872	10.50	266.70	.974	24.70	.074	1.88
3039A	24	E1	1620	7206	11.25	285.75	1.200	30.50	.074	1.88

To Specify Conductor, Insulation and Jacket Options:		
1234	A	E
Start with Base Part No. (1000 and 3000 Series cables only)	Add or Modify for Conductor, Insulation, and Jacket. See table at right.	Add for Exposed Run Rating

Bare	Tinned	Insulation/Jacket	Bare	Tinned	Insulation/Jacket
A	B	PVC/PVC	Q	R	XLP/CPE
C	D	XLP/PVC	S	T	XLP/Haloarrest®

BC = Bare Copper • TC = Tinned Copper • CPE = Chlorinated Polyethylene • PVC = Polyvinyl Chloride • XLP = Cross-Linked Polyethylene | Belden Color Code Charts can be found at page 350/351.

UL Instrumentation Cables
300 V Power-Limited Tray Cables

16 AWG Pairs



- UL PLTC, ITC
- Sunlight Res
- Oil Res
- NEC: CMG
- CEC: CMG FT4
- IEEE 1202/383
- ICEA T-29-520

Part No.	Pairs	Color Code	Pull Tension (Max)		Bend Radius (Min)		OD (Nom)		Jacket Thickness	
			Lbs	N	Inch	mm	Inch	mm	Inch	mm

16 AWG • Unshielded

Stranded (19 x 29) TC Conductors • PVC Insulation • PVC Jacket										
9410	1	E2	78	347	2.50	63.50	.254	6.45	0.37	.94
Stranded (7 x 24) BC Conductors • PVC Insulation • PVC Jacket										
1035A	1	E1	71	316	2.50	63.50	.254	6.45	0.37	.94

16 AWG • Beldfoil® Shield

Stranded (19 x 29) TC Conductors • PVC Insulation • PVC Jacket										
9316	1	E2	90	400	2.50	63.50	.256	6.50	0.37	.94

16 AWG Pairs



- UL PLTC, ITC
- Sunlight Res
- Oil Res
- NEC: CMG
- CEC: CMG FT4
- IEEE 1202/383
- ICEA T-29-520

Part No.	Pairs	Color Code	Pull Tension (Max)		Bend Radius (Min)		OD (Nom)		Jacket Thickness	
			Lbs	N	Inch	mm	Inch	mm	Inch	mm

16 AWG • Overall Beldfoil® Shield • 22 AWG Orange Communication Wire

Stranded (7 x 24) BC Conductors • PVC Insulation • PVC Jacket										
1030A	1	E1	94	418	2.50	63.50	.257	6.53	.037	.94
3043A	2	E1	83	369	4.50	114.30	.437	11.10		
1528A	3	E1	250	1112	4.75	120.65	.457	11.61	.053	1.35
1484A	4	E1	330	1468	5.00	127.00	.495	12.57		
1485A	8	E1	616	2740	6.00	152.40	.597	15.16		
1486A	12	E1	892	3966	7.50	190.50	.741	18.80	.064	1.63
3050A	16	E1	661	2940	8.50	215.90	.831	21.10		
1489A	24	E1	1749	7780	10.50	266.70	1.032	26.20	.074	1.88
1490A	36	E1	2606	11592	11.75	298.45	1.178	29.80		
3056A	50	E1	3615	16080	15.50	393.70	1.550	39.37	.088	2.24

To Specify Conductor, Insulation and Jacket Options:		
1234	A	E
Start with Base Part No. (1000 and 3000 Series cables only)	Add or Modify for Conductor, Insulation, and Jacket. See table at right.	Add for Exposed Run Rating

Bare	Tinned	Insulation/Jacket	Bare	Tinned	Insulation/Jacket
A	B	PVC/PVC	Q	R	XLP/CPE
C	D	XLP/PVC	S	T	XLP/Haloarrest®

BC = Bare Copper • TC = Tinned Copper • CPE = Chlorinated Polyethylene • PVC = Polyvinyl Chloride • XLP = Cross-Linked Polyethylene | Belden Color Code Charts can be found at page 350/351.

UL Instrumentation Cables
300 V Power-Limited Tray Cables

16 AWG Pairs



- UL PLTC, ITC
- Sunlight Res
- Oil Res
- NEC: CMG
- CEC: CMG FT4
- IEEE 1202/383
- ICEA T-29-520

Part No.	Pairs	Color Code	Pull Tension (Max)		Bend Radius (Min)		OD (Nom)		Jacket Thickness	
			Lbs	N	Inch	mm	Inch	mm	Inch	mm

16 AWG • Individually Beldfoil® Shielded Pairs and Overall Beldfoil® Shield • 22 AWG Orange Communication Wire

Stranded (7 x 24) BC Conductors • PVC Insulation • PVC Jacket										
1492A	2	E1	232	1032	4.50	114.30	.450	11.43	.053	1.35
1493A	4	E1	420	1868	5.00	127.00	.512	13.11	.055	1.40
1494A	8	E1	795	3536	7.00	177.80	.687	17.50	.066	1.68
1495A	12	E1	1170	5204	8.25	209.55	.822	20.73	.074	1.88
3051A	16	E1	661	2940	10.00	254.00	.936	23.77	.084	2.13
1498A	24	E1	2296	10213	11.50	292.10	1.149	29.18	.088	2.24
1499A	36	E1	3167	14088	13.50	342.90	1.334	33.88		
3057A	50	E1	2066	9190	16.00	406.40	1.600	40.64		

16 AWG Triads



- UL PLTC, ITC
- Sunlight Res
- Oil Res
- NEC: CMG
- CEC: CMG FT4
- IEEE 1202/383
- ICEA T-29-520

Part No.	Triads	Color Code	Pull Tension (Max)		Bend Radius (Min)		OD (Nom)		Jacket Thickness	
			Lbs	N	Inch	mm	Inch	mm	Inch	mm

16 AWG • Unshielded

Stranded (19 x 29) TC Conductors • PVC Insulation • PVC Jacket										
9494	1	E1	91	405	2.75	69.85	.268	6.81	.037	.94
Stranded (7 x 24) BC Conductors • PVC Insulation • PVC Jacket										
1034A	1	E1	107	476	2.75	69.85	.268	6.81	.037	.94

16 AWG • Beldfoil® Shield

Stranded (19 x 29) TC Conductors • PVC Insulation • PVC Jacket										
9366	1	E1	116	516	2.75	69.85	.270	6.86	.037	.94

To Specify Conductor, Insulation and Jacket Options:

1234			A			E		
Start with Base Part No. (1000 and 3000 Series cables only)			Add or Modify for Conductor, Insulation, and Jacket. See table at right.			Add for Exposed Run Rating		
Bare	Tinned	Insulation/Jacket	Bare	Tinned	Insulation/Jacket	Bare	Tinned	Insulation/Jacket
A	B	PVC/PVC	Q	R	XLP/CPE			
C	D	XLP/PVC	S	T	XLP/Haloarrest®			

BC = Bare Copper • TC = Tinned Copper • CPE = Chlorinated Polyethylene • PVC = Polyvinyl Chloride • XLP = Cross-Linked Polyethylene | Belden Color Code Charts can be found at page 350/351.

UL Instrumentation Cables

300 V Power-Limited Tray Cables

16 AWG Triads



- UL PLTC, ITC
- Sunlight Res
- Oil Res
- NEC: CMG
- CEC: CMG FT4
- IEEE 1202/383
- ICEA T-29-520

Part No.	Triads	Color Code	Pull Tension (Max)		Bend Radius (Min)		OD (Nom)		Jacket Thickness	
			Lbs	N	Inch	mm	Inch	mm	Inch	mm

16 AWG • Overall Beldfoil® Shield • 22 AWG Orange Communication Wire

Stranded (7 x 24) BC Conductors • PVC Insulation • PVC Jacket										
1031A	1	E1	130	578	2.75	69.85	.271	6.88	.037	.94
3044A	2	E1	259	1152	4.75	120.65	.483	12.27	.053	1.35
3046A	4	E1	473	2104	5.75	146.05	.570	14.40		
3048A	8	E1	902	4012	7.50	190.50	.760	19.30	.063	1.60
3052A	16	E1	1758	7820	11.25	285.75	1.032	26.21		
3054A	24	E1	2615	11632	11.75	298.45	1.180	29.90	.074	1.88

16 AWG • Individually Beldfoil® Shielded Triads and Overall Beldfoil® Shield • 22 AWG Orange Communication Wire

Stranded (7 x 24) BC Conductors • PVC Insulation • PVC Jacket										
3045A	2	E1	304	1352	5.00	127.00	.506	12.80	.053	1.35
3047A	4	E1	563	2504	6.00	152.40	.569	14.45		
3049A	8	E1	1081	4809	8.00	203.20	.764	19.41	.064	1.63
3069A	12	E1	1500	6672	10.00	254.00	.998	25.35		
3053A	16	E1	2117	9417	11.50	292.10	1.150	29.20	.074	1.88
3055A	24	E1	3153	14025	13.25	336.55	1.320	33.53	.084	2.13

To Specify Conductor, Insulation and Jacket Options:

1234	A	E
Start with Base Part No. (1000 and 3000 Series cables only)	Add or Modify for Conductor, Insulation, and Jacket. See table at right.	Add for Exposed Run Rating

Bare	Tinned	Insulation/Jacket	Bare	Tinned	Insulation/Jacket
A	B	PVC/PVC	Q	R	XLP/CPE
C	D	XLP/PVC	S	T	XLP/Haloarrest®

BC = Bare Copper • CPE = Chlorinated Polyethylene • PVC = Polyvinyl Chloride • XLP = Cross-Linked Polyethylene | Belden Color Code Charts can be found at page 350/351.

UL Instrumentation Cables
300 V Power-Limited Tray Cables

14 AWG Pairs



- UL PLTC, ITC
- Sunlight Res
- Oil Res
- NEC: CL3R
- CEC: CMG FT4
- IEEE 1202/383
- ICEA T-29-520

Part No.	Pairs	Color Code	Pull Tension (Max)		Bend Radius (Min)		OD (Nom)		Jacket Thickness	
			Lbs	N	Inch	mm	Inch	mm	Inch	mm

14 AWG • Unshielded

Stranded (42 x 30) TC Conductors • PVC Insulation • PVC Jacket										
9411	1	E2	124	552	3.25	82.55	.322	8.18	.042	1.07

14 AWG • Beldfoil® Shield

Stranded (42 x 30) TC Conductors • PVC Insulation • PVC Jacket										
9314	1	E2	140	623	3.25	82.55	.324	8.23	.042	1.07

14 AWG Triads



- UL PLTC, ITC
- Sunlight Res
- Oil Res
- NEC: CL3R
- CEC: CMG FT4
- IEEE 1202/383
- ICEA T-29-520

Part No.	Triads	Color Code	Pull Tension (Max)		Bend Radius (Min)		OD (Nom)		Jacket Thickness	
			Lbs	N	Inch	mm	Inch	mm	Inch	mm

14 AWG • Unshielded

Stranded (42 x 30) TC Conductors • PVC Insulation • PVC Jacket										
9495	1	E1	186	827	3.50	88.90	.340	8.64	.042	1.07

14 AWG • Beldfoil® Shield

Stranded (42 x 30) TC Conductors • PVC Insulation • PVC Jacket										
9367	1	E1	188	836	3.50	88.90	.343	8.71	.042	1.07

TC = Tinned Copper • PVC = Polyvinyl Chloride | Belden Color Code Charts can be found at page 350/351.

UL Instrumentation Cables
300 V Power-Limited Tray Cables

12 AWG Pairs



- UL PLTC, ITC
- Sunlight Res
- Oil Res
- NEC: CL3R
- CEC: CMG FT4
- IEEE 1202/383
- ICEA T-29-520

Part No.	Pairs	Color Code	Pull Tension (Max)		Bend Radius (Min)		OD (Nom)		Jacket Thickness	
			Lbs	N	Inch	mm	Inch	mm	Inch	mm

12 AWG • Unshielded

Stranded (65 x 30) TC Conductors • PVC Insulation • PVC Jacket										
9412	1	E2	197	876	4.25	107.95	.370	9.40	.042	1.07

12 AWG • Beldfoil® Shield

Stranded (65 x 30) TC Conductors • PVC Insulation • PVC Jacket										
9312	1	E2	225	1001	4.25	107.95	.373	9.47	.042	1.07

12 AWG Triads



- UL PLTC, ITC
- Sunlight Res
- Oil Res
- NEC: CL3R
- CEC: CMG FT4
- IEEE 1202/383
- ICEA T-29-520

Part No.	Triads	Color Code	Pull Tension (Max)		Bend Radius (Min)		OD (Nom)		Jacket Thickness	
			Lbs	N	Inch	mm	Inch	mm	Inch	mm

12 AWG • Unshielded

Stranded (7 x 20) BC Conductors • PVC Insulation • PVC Jacket										
3102A	1	E1	315	1401	3.50	88.90	.432	11.00	0.53	1.35

To Specify Conductor, Insulation and Jacket Options:		
1234	A	E
Start with Base Part No. (1000 and 3000 Series cables only)	Add or Modify for Conductor, Insulation, and Jacket. See table at right.	Add for Exposed Run Rating

Bare	Tinned	Insulation/Jacket	Bare	Tinned	Insulation/Jacket
A	B	PVC/PVC	Q	R	XLP/CPE
C	D	XLP/PVC	S	T	XLP/Haloarrest®

BC = Bare Copper • TC = Tinned Copper • CPE = Chlorinated Polyethylene • PVC = Polyvinyl Chloride • XLP = Cross-Linked Polyethylene | Belden Color Code Charts can be found at page 350/351.

UL Instrumentation Cable

Thermocouple Extension Cable and Thermocouple Wire – Overview

Construction Thermocouple Extension Cable

Conductor material determined by the thermocouple extension wire type. FEP or PVC insulated with FEP or PVC jacket. Nylon rip cord included in all PVC-jacketed thermocouple extension cables. Communication wire included on all multi-pair, PVC constructions – 22 AWG (7 x 30) bare copper orange PVC insulation.

NOTE: The temperature ranges in Table A are applicable only to the thermocouple conductors and not to the cable. The cable must never be exposed to temperatures higher than the maximum temperature ratings shown in Table B.

Table B: Other Insulation/Jacket Options

UL Listed for PLTC	
Insulation/Jacket	Max. Temp Rating
XLP/PVC	+90 °C
XLP/CPE	+90 °C
PVC/PVC	+105 °C
PVC/CPE	+105 °C
XLP/Haloarrest®	+90 °C
FEP/FEP	+200 °C

Application

Unshielded

Parallel non-shielded extension wire may be utilized in low noise environments when recommended by the instrument manufacturer.

Overall Shield

Recommended, except in areas where high voltage and current sources create excessive noise interference. The Beldfoil® shield with drain wire provides 100% coverage for maximum shield effectiveness.

Individually Shielded

Individually shielded pairs are recommended for use in applications where optimum noise rejection is required.

PVC Insulated, PVC Jacketed Cable Specifications

- UL Subject 13
- UL 1685 (UL 1581) Vertical Tray Flame Test comparable to IEEE 383-1974 (70,000 BTU) Flame Test
- ANSI/MC 96.1-1982
- NEC CMG
- NEC Type PLTC Listed, which is approved for cable tray use in Class 1, Division 2, hazardous areas and non-hazardous areas, cable trays, raceways, conduit and supported by messenger wires.

- NEC Type ITC Listed, which is approved for cable tray use, raceways hazardous locations according to Articles 501, 502, 503 and 504; or as aerial on a cable messenger, and under raised floors in control rooms and rack rooms where arranged to prevent damage to the cable. Usages are allowed based on qualified persons servicing all installations.
- PVC/PVC constructions are CMG, FT4, IEEE 1202 and IEEE 383-2003 rated, and meet ICEA T-29-520 Flame Test.
- Optional: PLTC-ER/ITC-ER
- UL 1277 TC versions approved for use in Class 1 trays available as special.

Shielded Twisted Pair (FEP insulated, FEP jacketed cable specifications)

- UL Subject 13
- NFPA 262 (UL 910 Steiner Tunnel Flame Test) comparable to FT6 Flame Test
- ANSI/MC 96.1-1982
- NEC Type CL3P/PLTC Listed, which is approved for use in ducts, plenums and other space used for environmental air.
- UL 1277 TC versions approved for use in Class 1 trays available as special.

Thermocouple Wire

Conductor material determined by the thermocouple type. FEP insulated and jacketed flat constructions.

FEP thermocouple wire is impervious to chemical attack and is flame retardant.

Table A: Thermocouple Identification and Limits of Error – Reference Junction 0 °C*

ANSI Symbol	Temperature Range (°C) (conductor only)	Limits of Error Standard (°C)	Jacket Color	Insulation Color Code		Conductor Identification	
				Positive (+)	Negative (-)	Positive (+)	Negative (-)
E	0 to 340 340 to 540	±1.7 °C ±.50%	Brown	Purple	Red	Chromel® Non-magnetic	Constantan Silver Color
J	0 to 293 293 to 480	±2.2 °C ±.75%	Brown	White	Red	Iron Magnetic	Constantan Non-magnetic
K	0 to 293 293 to 980	±2.2 °C ±.75%	Brown	Yellow	Red	Chromel Non-magnetic	Alumel® Magnetic
T	0 to 133 133 to 260	±1.0 °C ±.75%	Brown	Blue	Red	Copper Copper Color	Constantan Non-magnetic
EX	0 to 200	±1.7 °C	Purple	Purple	Red	Chromel	Constantan
JX	0 to 200	±2.2 °C	Black	White	Red	Iron	Constantan
KX	0 to 200	±2.2 °C	Yellow	Yellow	Red	Chromel	Alumel
TX	0 to 200	±1.0 °C	Blue	Blue	Red	Copper	Constantan

Limits of error per ANSI MC96.1-1982. Limits shown do not include system or installation error. Percentages refer to the temperature being measured.

* The Temperature Range and Limits of Error are for standard grade thermocouples, Reference ANSI MC96.1-1982 for special grade thermocouples.

The Temperature Ranges for type E, J, K and T thermocouple wires listed above pertain to 20 AWG wire.

Additional constructions available upon request.

CPE = Chlorinated Polyethylene • FEP = Fluorinated Ethylene Propylene • PVC = Polyvinyl Chloride • XLP = Cross-Linked Polyethylene

UL Instrumentation Cables

Thermocouple Extension Cables

Extension Cable



- UL PLTC, ITC
- Sunlight Res
- Oil Res
- +105 °C
- NEC: CMG
- CEC: CMG FT4
- IEEE 1202/383
- ICEA T-29-520

Part No.	ANSI Type	Pairs	Color Code	Jacket Color	Insulation Thickness		OD (Nom)	
					Inch	mm	Inch	mm

20 AWG Solid Conductors • Overall Beldfoil® Shield

PVC Insulation • PVC Jacket								
3111A	JX	1	White, Red	Black				
3112A	KX	1	Yellow, Red	Yellow	.016	.41	.206	5.23
3113A	TX	1	Blue, Red	Blue				

20 AWG Solid Conductors • Individually Beldfoil® Shielded Pairs + Overall Beldfoil® Shield

PVC Insulation • PVC Jacket								
3115A	JX	2	White, Red	Black	.016	.41	.332	8.43
1006A	JX	4	White, Red	Black	.016	.41	.383	9.73
1012A	KX	4	Yellow, Red	Yellow	.016	.41	.383	9.73
1013A	KX	8	Yellow, Red	Yellow	.016	.41	.503	12.78

16 AWG Solid Conductors • Overall Beldfoil® Shield

PVC Insulation • PVC Jacket								
1101A	EX	1	Purple, Red	Purple				
1000A	JX	1	White, Red	Black	.017	.43	.248	6.30
1018A	KX	1	Yellow, Red	Yellow				
1023A	TX	1	Blue, Red	Blue				

PVC = Polyvinyl Chloride

UL Instrumentation Cables

High-Temperature Thermocouple Extension Cables and Thermocouple Wire

High-Temperature Extension Cable



- UL PLTC
- Sunlight Res
- Oil Res
- +200 °C
- NEC: CL3P

Part No.	ANSI Type	Pairs/Cond.	Color Code	Jacket Color	Insulation Thickness		OD (Nom)	
					Inch	mm	Inch	mm

20 AWG Solid Conductors • Unshielded

FEP Insulation • FEP Jacket								
83932	KX	2c	Yellow, Red	Yellow	.010	.25	.076 x .128	1.93 x 3.25

20 AWG Stranded (7x28) Conductors • Unshielded

FEP Insulation • FEP Jacket								
83930	JX	2c	White, Red	Black	.010	.25	.082 x .149	2.08 x 3.56

20 AWG Stranded (7x28) Conductors • Overall Beldfoil® Shield

FEP Insulation • FEP Jacket								
83955	EX	1 pr	Purple, Red	Purple	.010	.25	.145	3.68
83950	JX	1 pr	White, Red	Black				
83952	KX	1 pr	Yellow, Red	Yellow				
83954	TX	1 pr	Blue, Red	Blue				

16 AWG Solid Conductors • Overall Beldfoil® Shield

FEP Insulation • FEP Jacket								
1114A	EX	1 pr	Purple, Red	Purple	.010	.25	.172	4.37
1115A	JX	1 pr	White, Red	Black				
1116A	KX	1 pr	Yellow, Red	Yellow				
1117A	TX	1 pr	Blue, Red	Blue				

16 AWG Stranded (7 x 24) Conductors • Overall Beldfoil® Shield

FEP Insulation • FEP Jacket								
83951	JX	1 pr	White, Red	Black	.010	.25	.189	4.80
83953	KX	1pr	Yellow, Red	Yellow	.010	.25	.187	4.75

High-Temperature Thermocouple Wire



- UL PLTC
- Sunlight Res
- Oil Res
- +200 °C
- NEC: CL3P

Part No.	ANSI Type	Conductors	Color Code	Jacket Color	Insulation Thickness		OD (Nom)	
					Inch	mm	Inch	mm

20 AWG Solid Conductors • Unshielded

FEP Insulation • FEP Jacket								
83915	E	2	Purple, Red	Brown	.010	.25	.076 x .128	1.93 x 3.25
83900	J	2	White, Red	Brown				
83905	K	2	Yellow, Red	Brown				
83910	T	2	Blue, Red	Brown				

FEP = Fluorinated Ethylene Propylene

UL Instrumentation Cables

600 V Tray Cables – Overview

Construction

Soft annealed bare or tinned copper conductors. PVC insulated with a nylon overcoat, +90 °C PVC Jacket, TFN, TFFN or THHN style singles. Nylon rip cord included in all PVC-Nylon/PVC instrumentation cables.

Application

These cables are suitable for installation in wet or dry locations. Cable jackets are resistant to sunlight, moisture and vapor penetration. The cables can be used in raceways, and (supported by messenger wire), outdoor applications and direct burial applications.

Unshielded

Twisted non-shielded instrument pairs provide a minimal OD allowing greater tray and conduit fill. Non-shielded instrument pairs may be utilized when recommended by the instrument manufacturer and used in a metallic conduit.

Overall Shield

Recommended for use in instrumentation applications where signals are transmitted in excess of 100 millivolts except in areas where high voltage and current sources creates excessive noise interference.

The Beldfoil® shield with drain wire provides 100% coverage for maximum shield effectiveness. Copper tape shield available upon request.

Individually Shielded and Overall Shielded

Individually shielded pairs or triads with an overall shield are recommended for use in instrumentation applications where optimum noise rejection is required. Individual pair/triad shields are fully isolated from each other and contain a separate drain wire for grounding to provide maximum protection from crosstalk and common mode interference. Cables with an overall shield provide additional electrostatic noise protection.

Tray Cable Construction Options

Insulation/Jacket	UL Listed for MC and TC			
	Max. Temp Rating		Flame Tests	Ratings*
	Wet	Dry		
PVC-Nylon/PVC (THHN or THWN) 14 AWG & larger	+75 °C	+90 °C	UL 1685 FT4/IEEE 1202/383 ICEA T-29-520	ICEA S-73-532 ICEA S-61-402
PVC-Nylon/PVC (TFN or TFFN) 16 & 18 AWG	+75 °C	+90 °C	UL 1685 FT4/IEEE 1202/383 ICEA T-29-520	ICEA S-73-532 ICEA S-61-402
XLP/PVC or CPE (XHHW-2) 14 AWG & larger	+90 °C	+90 °C	UL 1685 FT4/IEEE 1202/383 VW-1 rated singles ICEA T-29-520	ICEA S-73-532 ICEA S-66-524
XLP/PVC or CPE (RFH-2) 16 & 18 AWG	+90 °C	+90 °C	UL 1685 FT4/IEEE 1202/383 VW-1 rated singles ICEA T-29-520	ICEA S-73-532 ICEA S-82-552
XLP/Haloorrest® (Thermoplastic) (XHHW-2) 14 AWG & larger (RFH-2) 16 & 18 AWG	+90 °C	+90 °C	UL 1685	TC-LS
XLP/HaloorrestXLink™-1 and -2 (Thermoset) (XHHW-2) 14 AWG & larger (RFH-2) 16 & 18 AWG	+90 °C	+90 °C	UL 1685 ICEA T-29-520 FT4/IEEE 1202/383	TC-ER ICEA S-73-532 T-33-655

CPE = Chlorinated Polyethylene • PVC = Polyvinyl Chloride • XLP = Cross-linked Poly

* Applicable to TC-rated cables only.

UL Instrumentation Cables (continued)

600 V Tray Cables – Overview

Specifications

- UL Subject 1277 TC
- UL 1685 (UL 1581) Vertical Tray Flame
- NEC Type TC Listed, which is approved for cable tray use in Class 1, Division 2 areas, per NEC Articles 340, 318 and 501 and for Class 1 circuits as permitted in Article 725
- PVC-Nylon/PVC constructions are NEC Type NPLF Listed, which is approved for use in Non Power-Limited Fire Protective Signaling circuits, per NEC Article 760
- PVC-Nylon/PVC, XLP/PVC and XLP/CPE constructed cables meet IEEE 1202/IEEE 383-2003/FT4 (70,000 BTU) Flame Test
- XLP/Haloarrest® (thermoplastic) cables are UL 1277 TC-LS rated
- XLP/HaloarrestXLink™-1 and -2 are TC-ER rated

TC-ER Rated Cables

Belden offers all PVC-nylon/PVC, XLP/PVC and XLP/CPE jacketed tray cables with a TC-ER (Exposed Run) rating.

Per NEC Article 336, a TC-ER rated cable may be installed in an industrial establishment between a cable tray and the utilization equipment or device. A TC-ER rated cable must meet the crush and impact requirements of UL Type MC cable. By eliminating the need for metal conduit and/or armor, using a TC-ER rated cable results in savings in both installation and maintenance.

MC Cable Ratings Optional

Customize any 600 V TC instrumentation cable with armor and a full-sized ground. See chart below to specify.

To Specify Conductor, Insulation and Jacket Options:

1234	A	E
Start with Base Part No.	Add or replace letter code for desired Conductor, Insulation, and Jacket	Add for Exposed Run Rating if required

Conductor		Insulation/Jacket
Bare	Tinned	
A	B	PVC-Nylon/PVC
C	D	XLP/PVC
G	H	XLP/TPE
Q	R	XLP/CPE
S	T	XLP/Haloarrest
U	V	XLP/HaloarrestXLink-1
W	X	XLP/HaloarrestXLink-2
Y	Z	XLP/HaloarrestXLink-2, Marine Approved

Code		
Overall Jacket Prefix	Armor Prefix	Base Part No.
1	2	4-digit base number

Overall Jacket

Code	Material
1	PVC
3	CPE
4	TPE
5	HDPE
7	Haloarrest® (Thermoplastic LSZH)

Armor

Code	Material
2	Aluminum Interlock
3	Steel Interlock
4	Aluminum Belclad®
5	Steel Belclad
6	Copper Belclad
8	Continuous Armor

Example: 121049A is part number 1049A with PVC outer jacket and aluminum interlock armor.

UL Instrumentation Cables
600 V Tray Cables

18 AWG Pairs



- UL TC
- UL Sunlight Res
- Oil Res
- Direct Burial
- NEC: NPLF
- ICEA S-73-532, S-61-402, T-29-520
- FT4
- IEEE 1202/383

Part No.	Pairs	Color Code	Pull Tension (Max)		Bend Radius (Min)		OD (Nom)		Jacket Thickness	
			Lbs	N	Inch	mm	Inch	mm	Inch	mm

18 AWG • Unshielded

Stranded (19 x 30) TC Conductors • PVC/Nylon Insulation • PVC Jacket										
9486	1	E2	50	222	2.75	69.85	.275	6.99	.048	1.22

18 AWG • Overall Beldfoil® Shield

Stranded (19 x 30) TC Conductors • PVC/Nylon Insulation • PVC Jacket										
9341	1	E2	63	280	2.75	69.85	.276	7.01	.048	1.22

18 AWG • Overall Beldfoil® Shield

Stranded (7 x 26) BC Conductors • PVC/Nylon Insulation • PVC Jacket										
1120A	1	E2	59	262	2.80	71.12	.278	7.06		
3088A	1	E1	67	298	2.80	71.12	.278	7.06	.048	1.22
1063A	2	E1	112	498	4.10	104.14	.407	10.34		
1064A	4	E1	202	899	4.70	119.38	.470	11.94	.053	1.35
1065A	8	E1	381	1695	6.00	152.40	.599	15.21		
1066A	12	E1	560	2491	7.20	182.88	.717	18.21	.064	1.63
1067A	16	E1	739	3287	8.00	203.20	.793	20.14		
1068A	24	E1	1098	4884	10.30	261.62	1.017	25.83		
1087A	36	E1	1635	7273	11.70	297.18	1.178	29.97	.084	2.13
1088A	50	E1	2262	10062	14.50	368.30	1.446	36.73		

To Specify Conductor, Insulation and Jacket Options:		
1234	A	E
Start with Base Part No. (1000 and 3000 Series cables only)	Add or Modify for Conductor, Insulation, and Jacket. See table at right.	Add for Exposed Run Rating

Bare	Tinned	Insulation/Jacket	Bare	Tinned	Insulation/Jacket
A	B	PVC/PVC	Q	R	XLP/CPE
C	D	XLP/PVC	S	T	XLP/Haloarrest®

BC = Bare Copper • TC = Tinned Copper • CPE = Chlorinated Polyethylene • XLP = Cross-Linked Polyethylene | Belden Color Code Charts can be found at page 350/351.

UL Instrumentation Cables
600 V Tray Cables

18 AWG Pairs



- UL TC
- UL Sunlight Res
- Oil Res
- Direct Burial
- NEC: NPLF
- ICEA S-73-532, S-61-402, T-29-520
- FT4
- IEEE 1202/383

Part No.	Pairs	Color Code	Pull Tension (Max)		Bend Radius (Min)		OD (Nom)		Jacket Thickness	
			Lbs	N	Inch	mm	Inch	mm	Inch	mm

18 AWG • Individually Beldfoil® Shielded Pairs + Overall Beldfoil® Shield

Stranded (7 x 26) BC Conductors • PVC/Nylon Insulation • PVC Jacket										
1048A	2	E1	140	623	3.80	96.52	.381	9.68	.048	1.22
1049A	4	E1	258	1148	4.90	124.46	.489	12.42	.053	1.35
1050A	8	E1	350	1557	6.60	167.64	.654	16.61	.064	1.63
1051A	12	E1	728	3238	7.90	200.66	.785	19.94		
1052A	16	E1	963	4284	9.00	228.60	.898	22.81	.084	2.13
1053A	24	E1	1434	6379	11.10	281.94	1.115	28.32		
1054A	36	E1	2139	9515	13.00	330.20	1.299	32.99		
1038A	50	E1	2962	13176	15.30	388.62	1.527	38.79		

18 AWG • Overall Beldfoil® Shield • Exposed Run • Green Insulated Ground Wire

Stranded (7 x 26) BC Conductors • PVC/Nylon Insulation • PVC Jacket										
3088AE	1	E1	80	356	3.40	86.36	.340	8.64	.048	1.22

Stranded (7 x 26) BC Conductors • Cross-Linked Poly Insulation • PVC Jacket										
3088CE	1	E1	63	280	2.75	69.85	.276	7.01	.048	1.22

To Specify Conductor, Insulation and Jacket Options:

1234	A	E
Start with Base Part No. (1000 and 3000 Series cables only)	Add or Modify for Conductor, Insulation, and Jacket. See table at right.	Add for Exposed Run Rating

Bare	Tinned	Insulation/Jacket	Bare	Tinned	Insulation/Jacket
A	B	PVC/PVC	Q	R	XLP/CPE
C	D	XLP/PVC	S	T	XLP/Haloarrest®

BC = Bare Copper • CPE = Chlorinated Polyethylene • XLP = Cross-Linked Polyethylene | Belden Color Code Charts can be found at page 350/351.

UL Instrumentation Cables
600 V Tray Cables

18 AWG Triads



- UL TC
- UL Sunlight Res
- Oil Res
- Direct Burial
- NEC: NPLF
- ICEA S-73-532, S-61-402, T-29-520
- FT4
- IEEE 1202/383

Part No.	Triads	Color Code	Pull Tension (Max)		Bend Radius (Min)		OD (Nom)		Jacket Thickness	
			Lbs	N	Inch	mm	Inch	mm	Inch	mm

18 AWG • Overall Beldfoil® Shield

Stranded (7 x 26) BC Conductors • PVC/Nylon Insulation • PVC Jacket										
1121A	1	E2	81	360	2.90	73.66	.290	7.36	.047	1.22
3089A	1	E1	90	400	2.75	89.85	.282	7.16	.048	1.22

18 AWG • Individually Beldfoil® Shielded Triads + Overall Beldfoil® Shield

Stranded (7 x 26) BC Conductors • PVC/Nylon Insulation • PVC Jacket										
3064A	2	E1	185	823	4.75	120.65	.493	12.52	.048	1.22
1093A	4	E1	347	1545	6.00	152.40	.577	14.66	.063	1.60
1094A	8	E1	672	2989	7.50	190.50	.745	18.92	.084	2.13
1095A	12	E1	997	4435	9.75	247.65	.944	23.98	.084	2.13
1096A	24	E1	1971	8767	13.00	330.20	1.284	32.61	.084	2.13

To Specify Conductor, Insulation and Jacket Options:		
1234	A	E
Start with Base Part No. (1000 and 3000 Series cables only)	Add or Modify for Conductor, Insulation, and Jacket. See table at right.	Add for Exposed Run Rating

Conductor		Insulation/Jacket	Conductor		Insulation/Jacket
Bare	Tinned		Bare	Tinned	
A	B	PVC-Nylon/PVC	S	T	XLP/Haloarrest®
C	D	XLP/PVC	U	V	XLP/HaloarrestXLink™-1
G	H	XLP/TPE	W	X	XLP/HaloarrestXLink-2
Q	R	XLP/CPE	Y	Z	XLP/HaloarrestXLink-2, Marine Approved

BC = Bare Copper • CPE = Chlorinated Polyethylene • PVC = Polyvinyl Chloride • XLP = Cross-Linked Polyethylene | Belden Color Code Charts can be found at page 350/351.

UL Instrumentation Cables

600 V Tray Cables

16 AWG Pairs



- UL TC
- UL Sunlight Res
- Oil Res
- Direct Burial
- NEC: NPLF
- ICEA S-73-532, S-61-402, T-29-520
- FT4
- IEEE 1202/383

Part No.	Pairs	Color Code	Pull Tension (Max)		Bend Radius (Min)		OD (Nom)		Jacket Thickness	
			Lbs	N	Inch	mm	Inch	mm	Inch	mm

16 AWG • Unshielded

Stranded (19 x 29) TC Conductors • PVC/Nylon Insulation • PVC Jacket										
9487	1	E2	70	311	3.00	76.20	.295	7.49	.048	1.22

16 AWG • Overall Beldfoil® Shield

Stranded (19 x 29) TC Conductors • PVC/Nylon Insulation • PVC Jacket										
9342	1	E2	105	467	3.00	76.20	.296	7.52	.048	1.22

16 AWG • Overall Beldfoil® Shield

Stranded (7 x 24) BC Conductors • PVC/Nylon Insulation • PVC Jacket										
1118A	1	E2	105	467	3.00	76.20	.294	7.47		
3090A	1	E1	105	467	3.00	76.20	.295	7.49		
1069A	2	E1	179	796	4.60	116.84	.456	11.58	.047	1.19
1527A	3	E1	241	1072	4.80	121.92	.482	12.24		
1070A	4	E1	321	1428	5.60	142.24	.560	14.22		
1071A	8	E1	607	2700	6.80	172.72	.676	17.17	.063	1.60
1072A	12	E1	893	3972	8.10	205.74	.812	20.63		
1073A	16	E1	1178	5240	9.30	236.22	.946	24.03		
1074A	24	E1	1749	7780	11.60	294.64	1.158	29.41	.085	2.16
1089A	36	E1	2606	11592	13.20	335.28	1.321	33.55		
1090A	50	E1	3606	16040	15.50	393.70	1.551	39.40		

To Specify Conductor, Insulation and Jacket Options:		
1234	A	E
Start with Base Part No. (1000 and 3000 Series cables only)	Add or Modify for Conductor, Insulation, and Jacket. See table at right.	Add for Exposed Run Rating

Conductor		Insulation/Jacket	Conductor		Insulation/Jacket
Bare	Tinned		Bare	Tinned	
A	B	PVC-Nylon/PVC	S	T	XLP/Haloarrest®
C	D	XLP/PVC	U	V	XLP/HaloarrestXLink™-1
G	H	XLP/TPE	W	X	XLP/HaloarrestXLink-2
Q	R	XLP/CPE	Y	Z	XLP/HaloarrestXLink-2, Marine Approved

TC = Tinned Copper • CPE = Chlorinated Polyethylene • PVC = Polyvinyl Chloride • XLP = Cross-Linked Polyethylene | Belden Color Code Charts can be found at page 350/351.

UL Instrumentation Cables

600 V Tray Cables

16 AWG Pairs



- UL TC
- UL Sunlight Res
- Oil Res
- Direct Burial
- NEC: NPLF
- ICEA S-73-532, S-61-402, T-29-520
- FT4
- IEEE 1202/383

Part No.	Pairs	Color Code	Pull Tension (Max)		Bend Radius (Min)		OD (Nom)		Jacket Thickness	
			Lbs	N	Inch	mm	Inch	mm	Inch	mm

16 AWG • Individually Beldfoil® Shielded Pairs + Overall Beldfoil® Shield

Stranded (7 x 24) TC Conductors • PVC/Nylon Insulation • PVC Jacket										
1055A	2	E1	223	992	4.16	105.66	.476	12.09		
1037A	3	E1	290	1290	5.00	127.0	.504	12.80	.047	1.19
1039A	4	E1	411	1828	5.80	147.32	.584	14.83		
1040A	6	E1	428	1904	6.80	172.72	.682	17.32	.063	1.60
1041A	8	E1	786	3496	7.40	187.96	.738	18.75		
1042A	12	E1	1161	5164	9.40	238.76	.935	23.75		
1043A	16	E1	1537	6837	10.40	264.16	1.035	26.29		
1044A	20	E1	1912	8505	11.50	292.10	1.146	29.11	.085	2.16
1045A	24	E1	2287	10173	12.70	322.58	1.272	32.31		
1046A	36	E1	3413	15182	14.50	368.30	1.454	36.93		
1047A	50	E1	4726	21022	17.80	452.12	1.781	45.24	.120	3.05

16 AWG • Overall Beldfoil® Shield • Exposed Run • Green Insulated Ground Wire

Stranded (7 x 24) BC Conductors • PVC/Nylon Insulation • PVC Jacket										
3090AE	1	E1	130	578	3.90	99.06	.390	9.91	.048	1.22
Stranded (7 x 24) BC Conductors • Cross-Linked Poly Insulation • PVC Jacket										
3090CE	1	E1	130	578	3.90	99.06	.390	9.91	.048	1.22

To Specify Conductor, Insulation and Jacket Options:		
1234	A	E
Start with Base Part No. (1000 and 3000 Series cables only)	Add or Modify for Conductor, Insulation, and Jacket. See table at right.	Add for Exposed Run Rating

Conductor		Insulation/Jacket	Conductor		Insulation/Jacket
Bare	Tinned		Bare	Tinned	
A	B	PVC-Nylon/PVC	S	T	XLP/Haloarrest®
C	D	XLP/PVC	U	V	XLP/HaloarrestXLink™-1
G	H	XLP/TPE	W	X	XLP/HaloarrestXLink-2
Q	R	XLP/CPE	Y	Z	XLP/HaloarrestXLink-2, Marine Approved

BC = Bare Copper • TC = Tinned Copper • CPE = Chlorinated Polyethylene • PVC = Polyvinyl Chloride • TPE = Thermoplastic Elastomer • XLP = Cross-Linked Polyethylene
 Belden Color Code Charts can be found at page 350/351.

UL Instrumentation Cables

600 V Tray Cables

16 AWG Triads



- UL TC
- UL Sunlight Res
- Oil Res
- Direct Burial
- NEC: NPLF
- ICEA S-73-532, S-61-402, T-29-520
- FT4
- IEEE 1202/383

Part No.	Triads	Color Code	Pull Tension (Max)		Bend Radius (Min)		OD (Nom)		Jacket Thickness	
			Lbs	N	Inch	mm	Inch	mm	Inch	mm

16 AWG • Overall Beldfoil® Shield

Stranded (7 x 24) BC Conductors • PVC/Nylon Insulation • PVC Jacket										
1119A	1	E2	129	574	3.10	78.74	.310	7.87	.047	1.19
3091A	1	E1								

16 AWG • Individually Beldfoil® Shielded Triads + Overall Beldfoil® Shield

Stranded (7 x 24) BC Conductors • PVC/Nylon Insulation • PVC Jacket										
1097A	4	E1	554	2464	6.40	162.56	.640	16.26	.063	1.60
1098A	8	E1	1072	4768	8.70	220.98	.872	22.15	.085	2.16
1099A	12	E1	1590	7073	10.50	266.70	1.047	26.59	.085	2.16
3118A	16	E1	1771	7878	12.25	311.15	1.234	31.34	.084	2.13
1100A	24	E1	3144	13985	14.30	363.22	1.434	36.42	.085	2.16
3130A	36	E1	3600	16014	18.00	457.20	1.773	45.03	.110	2.79

To Specify Conductor, Insulation and Jacket Options:		
1234	A	E
Start with Base Part No. (1000 and 3000 Series cables only)	Add or Modify for Conductor, Insulation, and Jacket. See table at right.	Add for Exposed Run Rating

Conductor		Insulation/Jacket	Conductor		Insulation/Jacket
Bare	Tinned		Bare	Tinned	
A	B	PVC-Nylon/PVC	S	T	XLP/Haloarrest®
C	D	XLP/PVC	U	V	XLP/HaloarrestXLink™-1
G	H	XLP/TPE	W	X	XLP/HaloarrestXLink-2
Q	R	XLP/CPE	Y	Z	XLP/HaloarrestXLink-2, Marine Approved

BC = Bare Copper • CPE = Chlorinated Polyethylene • PVC = Polyvinyl Chloride • TPE = Thermoplastic Elastomer • XLP = Cross-Linked Polyethylene
 Belden Color Code Charts can be found at page 350/351.

UL Instrumentation Cables
600 V Tray Cables

14 AWG Pairs



- UL TC
- UL Sunlight Res
- Oil Res
- Direct Burial
- NEC: NPLF
- ICEA S-73-532, S-61-402, T-29-520
- FT4
- IEEE 1202/383

Part No.	Pairs	Color Code	Pull Tension (Max)		Bend Radius (Min)		OD (Nom)		Jacket Thickness	
			Lbs	N	Inch	mm	Inch	mm	Inch	mm

14 AWG • Unshielded

Stranded (42 x 30) TC Conductors • PVC/Nylon Insulation • PVC Jacket										
9488	1	E2	107	476	3.75	95.25	.359	9.12	.048	1.22

14 AWG • Overall Beldfoil® Shield

Stranded (42 x 30) TC Conductors • PVC/Nylon Insulation • PVC Jacket										
9343	1	E2	160	712	3.75	95.25	3.58	9.09	.048	1.22

14 AWG • Overall Beldfoil® Shield

Stranded (7 x 22) BC Conductors • PVC/Nylon Insulation • PVC Jacket										
3080A	1	E2	160	712	3.50	88.90	.342	8.69	.048	1.22

To Specify Conductor, Insulation and Jacket Options:		
1234	A	E
Start with Base Part No. (1000 and 3000 Series cables only)	Add or Modify for Conductor, Insulation, and Jacket. See table at right.	Add for Exposed Run Rating

Conductor		Insulation/Jacket	Conductor		Insulation/Jacket
Bare	Tinned		Bare	Tinned	
A	B	PVC-Nylon/PVC	S	T	XLP/Haloarrest®
C	D	XLP/PVC	U	V	XLP/HaloarrestXLink™-1
G	H	XLP/TPE	W	X	XLP/HaloarrestXLink-2
Q	R	XLP/CPE	Y	Z	XLP/HaloarrestXLink-2, Marine Approved

BC = Bare Copper • TC = Tinned Copper • CPE = Chlorinated Polyethylene • PVC = Polyvinyl Chloride • TPE = Thermoplastic Elastomer • XLP = Cross-Linked Polyethylene
Belden Color Code Charts can be found at page 350/351.

UL Instrumentation Cables

600 V Tray Cables

14 AWG Triads



- UL TC
- UL Sunlight Res
- Oil Res
- Direct Burial
- NEC: NPLF
- ICEA S-73-532, S-61-402, T-29-520
- FT4
- IEEE 1202/383

Part No.	Triads	Color Code	Pull Tension (Max)		Bend Radius (Min)		OD (Nom)		Jacket Thickness	
			Lbs	N	Inch	mm	Inch	mm	Inch	mm
14 AWG • Overall Beldfoil® Shield										
Stranded (7 x 22) BC Conductors • PVC/Nylon Insulation • PVC Jacket										
3081A	1	E1	200	890	3.50	88.90	.361	9.17	.048	1.22

12 AWG Pairs



- UL TC
- UL Sunlight Res
- Oil Res
- Direct Burial
- NEC: NPLF
- ICEA S-73-532, S-61-402, T-29-520
- FT4
- IEEE 1202/383

Part No.	Pairs	Color Code	Pull Tension (Max)		Bend Radius (Min)		OD (Nom)		Jacket Thickness	
			Lbs	N	Inch	mm	Inch	mm	Inch	mm
12 AWG • Unshielded										
Stranded (37 x 27) TC Conductors • PVC/Nylon Insulation • PVC Jacket										
9489	1	E2	179	796	3.75	95.25	.380	9.65	0.45	1.14

12 AWG • Overall Beldfoil® Shield

Stranded (37 x 27) TC Conductors • PVC/Nylon Insulation • PVC Jacket										
9344	1	E2	253	1125	3.75	95.25	.384	9.75	.045	1.14

12 AWG • Overall Beldfoil® Shield

Stranded (7 x 20) BC Conductors • PVC/Nylon Insulation • PVC Jacket										
3103A	1	E1	253	1125	3.80	96.52	.380	9.65	.048	1.22

12 AWG Triads



- UL TC
- UL Sunlight Res
- Oil Res
- Direct Burial
- NEC: NPLF
- ICEA S-73-532, S-61-402, T-29-520
- FT4
- IEEE 1202/383

Part No.	Pairs	Color Code	Pull Tension (Max)		Bend Radius (Min)		OD (Nom)		Jacket Thickness	
			Lbs	N	Inch	mm	Inch	mm	Inch	mm
12 AWG • Overall Beldfoil® Shield										
Stranded (7 x 20) BC Conductors • PVC/Nylon Insulation • PVC Jacket										
3104A	1	E1	315	1401	4.00	101.60	.401	10.19	.048	1.22

To Specify Conductor, Insulation and Jacket Options:		
1234	A	E
Start with Base Part No. (1000 and 3000 Series cables only)	Add or Modify for Conductor, Insulation, and Jacket. See table at right.	Add for Exposed Run Rating

Conductor		Insulation/Jacket	Conductor		Insulation/Jacket
Bare	Tinned		Bare	Tinned	
A	B	PVC-Nylon/PVC	S	T	XLP/Haloarrest®
C	D	XLP/PVC	U	V	XLP/HaloarrestXLink™-1
G	H	XLP/TPE	W	X	XLP/HaloarrestXLink-2
Q	R	XLP/CPE	Y	Z	XLP/HaloarrestXLink-2, Marine Approved

BC = Bare Copper • TC = Tinned Copper • CPE = Chlorinated Polyethylene • PVC = Polyvinyl Chloride • TPE = Thermoplastic Elastomer • XLP = Cross-Linked Polyethylene
 Belden Color Code Charts can be found at page 350/351.

CSA Instrumentation and Thermocouple Tray Cables

300 V TC/CIC

Pairs • Unshielded



- +90 °C Dry, +75 °C Wet (PVC)
- +90 °C Dry/Wet (XLP)
- Sunlight Res
- Direct Burial
- CSA C22.2 No. 239 CIC
- CSA C22.2 No. 230 Type TC
- CSA FT4 70,000 BTU Flame Test
- CEC Part 1, Suitable for Use in Hazardous Locations: Class 1, Zone 2 and Class 2, Division 2

Pairs	Part No.				
	7-Strand Copper	Solid EX Chromel/Constantan	Solid JX Iron/Constantan	Solid KX Chromel/Alumel	Solid TX Copper/Constantan
20 AWG • PVC Insulation • PVC Jacket					
1	22000	21100	21114	21128	21142
2	22001	21101	21115	21129	21143
4	22002	21102	21116	21130	21144
6	22003	21103	21117	21131	21145
8	22004	21104	21118	21132	21146
10	22005	21105	21119	21133	21147
12	22006	21106	21120	21134	21148
16	22007	21107	21121	21135	21149
20	22008	21108	21122	21136	21150
24	22009	21109	21123	21137	21151
30	22010	21110	21124	21138	21152
36	22011	21111	21125	21139	21153
40	22012	21112	21126	21140	21154
50	22013	21113	21127	21141	21155
18 AWG • PVC Insulation • PVC Jacket					
1	22027	21156	21170	21184	21198
2	22028	21157	21171	21185	21199
4	22029	21158	21172	21186	21200
6	22030	21159	21173	21187	21201
8	22031	21160	21174	21188	21202
10	22032	21161	21175	21189	21203
12	22033	21162	21176	21190	21204
16	22034	21163	21177	21191	21205
20	22035	21164	21178	21192	21206
24	22036	21165	21179	21193	21207
30	22037	21166	21180	21194	21208
36	22038	21167	21181	21195	21209
40	22039	21168	21182	21196	21210
50	22040	21169	21183	21197	21211
16 AWG • PVC Insulation • PVC Jacket					
1	22054	21212	21226	21240	21254
2	22055	21213	21227	21241	21255
4	22056	21214	21228	21242	21256
6	22057	21215	21229	21243	21257
8	22058	21216	21230	21244	21258
10	22059	21217	21231	21245	21259
12	22060	21218	21232	21246	21260
16	22061	21219	21233	21247	21261
20	22062	21220	21234	21248	21262
24	22063	21221	21235	21249	21263
30	22064	21222	21236	21250	21264
36	22065	21223	21237	21251	21265
40	22066	21224	21238	21252	21266
50	22067	21225	21239	21253	21267

PVC = Polyvinyl Chloride

CSA Instrumentation and Thermocouple Tray Cables

300 V TC/CIC

Triads • Unshielded



- +90 °C Dry, +75 °C Wet (PVC)
- +90 °C Dry/Wet (XLP)
- Sunlight Res
- Direct Burial
- CSA C22.2 No. 239 CIC
- CSA C22.2 No. 230 Type TC
- CSA FT4 70,000 BTU Flame Test
- CEC Part 1, Suitable for Use in Hazardous Locations: Class 1, Zone 2 and Class 2, Division 2

Triads	Part No.		
	20 AWG	18 AWG	16 AWG
Copper Conductors • PVC Insulation (Black, White, Red) • PVC Jacket			
1	22014	22041	22068
2	22015	22042	22069
4	22016	22043	22070
6	22017	22044	22071
8	22018	22045	22072
10	22019	22046	22073
12	22020	22047	22074
16	22021	22048	22075
20	22022	22049	22076
24	22023	22050	22077
30	22024	22051	22078
36	22025	22052	22079

To Create a Part Number

To the base part number, add a letter suffix for conductor, insulation, and, jacket, and a numeric suffix for shielding, as shown below.

Suffix	Conductor	Insulation	Jacket	Suffix	Shielding (includes Drain wire)
A	Bare Copper or Thermocouple Alloy	PVC	PVC	none	No Shielding
B	Tinned Copper	PVC	PVC	1	Overall Foil + Drain Wire
C	Bare Copper or Thermocouple Alloy	XLP	PVC	2	Individual Pairs/Triads + Overall Foil
D	Tinned Copper	XLP	PVC		

Sample Part Number: 22001B2 = 300 V, 2-pair 20 AWG tinned copper conductor cable with PVC insulation, PVC jacket, with individual and overall foil shields plus drain wire.

Thermocouple Color Codes

ANSI Type	Jacket	Insulation	
		Positive (+)	Negative (-)
EX	Purple	Purple	Red
JX	Black	White	Red
KX	Yellow	Yellow	Red
TX	Blue	Blue	Red

PVC = Polyvinyl Chloride • XLP = Cross-Linked Polyethylene

CSA Instrumentation Cables

300 V CIC

Contact Belden Customer Service for other options:

- 150 V
- XLP insulation (add D suffix to part number)
- Thermocouple alloy conductors
- Overall foil shield only
- Other pair and triad counts

Pairs • Individually Shielded Pairs + Overall Beldfoil® Shield



- -40 °C to +105 °C Dry
- -40 °C to +75 °C Wet
- -25 °C Cold Impact

- CSA C22.2 No. 239, Type CIC
- FT4 Flame Test

Part No.	Pairs	Color Code	OD (Nom)		Jacket Thickness	
			Inch	mm	Inch	mm

Stranded TC Conductors • PVC Insulation • Individually Shielded Pairs + Overall Beldfoil® Shield • Polyester Isolation Tape • PVC Jacket

20 AWG • 7 x 28

22671	1	E1	.260	6.60		
22638	2	E1	.400	10.16		
22639	4	E1	.460	11.68	.045	1.14
22640	6	E1	.570	14.48		
22641	8	E1	.610	15.49		
22676	12	E1	.730	18.54	.060	1.52
22643	16	E1	.810	20.57		
22647	24	E1	1.040	26.42	.080	2.03
22670	36	E1	1.190	30.23		

18 AWG • 7 x 26

22645	1	E1	.300	7.62		
22633	2	E1	.480	12.19	.045	1.14
22648	4	E1	.580	14.73		
22634	6	E1	.670	17.02		
22635	8	E1	.730	18.54	.060	1.52
22636	12	E1	.920	23.37		
22654	16	E1	1.020	25.91	.080	2.03
22637	24	E1	1.260	32.00		

16 AWG • 7 x 24

22646	1	E1	.320	8.13		
22628	2	E1	.520	13.21	.045	1.14
22629	4	E1	.628	15.95		
22630	6	E1	.740	18.80	.060	1.52
22631	8	E1	.800	20.32		
22632	12	E1	1.010	25.65		
22685	16	E1	1.120	28.45	.080	2.03
22686	24	E1	1.380	35.05		

TC = Tinned Copper • PVC = Polyvinyl Chloride | Belden Color Code Charts can be found at page 350/351.

CSA Instrumentation Cables
300 V CIC

**Triads • Individually Shielded Triads
+ Overall Beldfoil® Shield**



- -40 °C to +105 °C Dry
- -40 °C to +75 °C Wet
- -25 °C Cold Impact

- CSA C22.2 No . 239, Type CIC
- FT4 Flame Test

Part No.	Triads	Color Code	OD (Nom)		Jacket Thickness	
			Inch	mm	Inch	mm

Stranded TC Conductors • PVC Insulation • Individually Shielded Triads + Overall Beldfoil® Shield • Polyester Isolation Tape • Black PVC Jacket

20 AWG • 7 x 28

22660	1	E1	.270	6.86		
22662	2	E1	.420	10.67	.045	1.14
22663	4	E1	.490	12.45		
22672	8	E1	.650	16.51	.060	1.52
22673	16	E1	.910	23.11		
22674	24	E1	1.110	28.19	.080	2.03

18 AWG • 7 x 26

22677	1	E1	.303	7.70		
22678	2	E1	.480	12.19	.045	1.14
22679	4	E1	.620	15.75		
22680	8	E1	.710	18.03	.060	1.52
22681	16	E1	.770	19.56		
22682	24	E1	.980	24.89		
22683	16	E1	1.090	27.69	.080	2.03
22684	24	E1	1.340	34.04		

16 AWG • 7 x 24

22603	1	E1	.329	8.36		
22687	2	E1	.580	14.73	.045	1.14
22675	4	E1	.670	17.02		
22688	6	E1	.780	19.81	.060	1.52
22689	8	E1	.940	23.88	.080	2.03

TC = Tinned Copper • PVC = Polyvinyl Chloride | Belden Color Code Charts can be found at page 350/351.

CSA Instrumentation Cables

300 V ACIC Armored Cables

Pairs • Armored • Individually Beldfoil® Shielded Pairs + Overall Beldfoil® Shield



- -40 °C to +105 °C Dry
- -40 °C to +75 °C Wet
- -25 °C Cold Impact

- CSA C22.2 No. 239, Type ACIC
- CSA C22.2 No. 174, HLABCD
- CSA C22.2 No. 0.3 Clause 4.31 Low Acid Gas (Jacket Only)
- FT4 Flame Test

Part No.		Pairs	Color Code	Inner Jacket OD		Outer Jacket OD		Insulation Thickness	
Aluminum	Steel			Inch	mm	Inch	mm	Inch	mm

Stranded TC Conductors • PVC Insulation • Individually Beldfoil® Shielded Pairs + Overall Beldfoil® Shield • Polyester Isolation Tape • PVC Inner Jacket • Armor • Chrome PVC Outer Jacket

20 AWG • 7 x 28

23543	26530	1	E1	.26	6.6	.56	14.2		
23534	26531	2	E1	.40	10.2	.70	17.8		
23514	26532	4	E1	.46	11.7	.76	19.3		
23513	26533	6	E1	.57	14.5	.88	22.4		
23503	26534	8	E1	.63	16.0	.92	23.4		
23521	26535	12	E1	.75	19.1	1.06	26.9	.020	.51
23532	26536	16	E1	.79	20.1	1.16	29.5		
23506	26537	24	E1	1.05	26.7	1.42	36.1		
23544	26538	36	E1	1.14	29.0	1.57	39.9		
23575	26546	50	E1	1.37	34.8	1.75	44.5		

18 AWG • 7 x 26

23533	26514	1	E1	.30	7.6	.60	15.2		
23511	26515	2	E1	.48	12.2	.78	19.8		
23530	26516	4	E1	.58	14.7	.88	22.4		
23528	26517	6	E1	.67	17.0	.98	24.9		
23531	26518	8	E1	.73	18.5	1.03	26.2	.025	.64
23524	26519	12	E1	.90	22.9	1.28	32.5		
23519	26520	16	E1	.99	25.1	1.37	34.8		
23542	26521	24	E1	1.24	31.5	1.63	41.4		
23554	26555	36	E1	1.41	35.8	1.80	45.7		

16 AWG • 7 x 24

23501	26500	1	E1	.33	8.4	.62	15.8		
23527	26501	2	E1	.52	13.2	.81	20.6		
23509	26503	4	E1	.63	16.0	.93	23.6		
23500	26504	6	E1	.73	18.5	1.03	26.2		
23510	26505	8	E1	.79	20.1	1.16	29.5	.025	.64
23525	26506	12	E1	1.00	25.4	1.37	34.8		
23539	26507	16	E1	1.12	28.2	1.48	37.6		
23538	26508	24	E1	1.36	34.5	1.75	44.5		
23568	26551	36	E1	1.60	40.6	1.97	50.0		

TC = Tinned Copper • PVC = Polyvinyl Chloride | Belden Color Code Charts can be found at page 350/351.

CSA Instrumentation Cables
300 V ACIC Armored Cables

Triads • Armored • Individually Beldfoil® Shielded Triads + Overall Beldfoil® Shield



- -40 °C to +105 °C Dry
- -40 °C to +75 °C Wet
- -25 °C Cold Impact

- CSA C22.2 No. 239, Type ACIC
- CSA C22.2 No. 174, HLABCD
- CSA C22.2 No. 0.3 Clause 4.31 Low Acid Gas (Jacket Only)
- FT4 Flame Test

Part No.		Triads	Color Code	Inner Jacket OD		Outer Jacket OD		Insulation Thickness	
Aluminum	Steel			Inch	mm	Inch	mm	Inch	mm

Stranded TC Conductors • PVC Insulation • Individually Beldfoil® Shielded Triads + Overall Beldfoil® Shield • Polyester Isolation Tape • PVC Inner Jacket • Armor • Chrome PVC Outer Jacket

20 AWG • 7 x 28

23545	26539	1	E1	.27	6.9	.57	14.5		
23546	26540	2	E1	.43	10.9	.73	18.5		
23547	26541	4	E1	.50	12.7	.80	20.3		
23548	26542	8	E1	.69	17.5	1.00	25.4	.020	.51
23571	26553	12	E1	.82	20.8	1.24	31.5		
23549	26543	16	E1	.91	23.1	1.28	32.5		
23550	26544	24	E1	1.11	28.2	1.48	37.6		

18 AWG • 7 x 26

23505	26522	1	E1	.33	8.4	.61	15.5		
23516	26523	2	E1	.51	13.0	.81	20.6		
23515	26524	4	E1	.62	15.7	.93	23.6		
23508	26525	6	E1	.75	19.1	1.11	28.2	.025	.64
23523	26526	8	E1	.81	20.6	1.18	30.0		
23512	26527	12	E1	1.03	26.2	1.40	35.6		
23537	26528	16	E1	1.13	28.7	1.50	38.1		
23536	26529	24	E1	1.37	34.8	1.80	45.7		

16 AWG • 7 x 24

23507	26502	1	E1	.35	8.9	.63	16.0		
23522	26509	2	E1	.58	14.7	.90	22.9		
23520	26510	4	E1	.68	17.3	.95	24.1		
23529	26511	6	E1	.78	19.8	1.19	30.2	.025	.64
23526	26512	8	E1	.93	23.6	1.30	33.0		
23541	26513	12	E1	1.13	28.7	1.50	38.1		
23567	26545	16	E1	1.25	31.8	1.64	41.7		
23578	26547	24	E1	1.58	40.1	1.95	49.5		

TC = Tinned Copper • PVC = Polyvinyl Chloride | Belden Color Code Charts can be found at page 350/351.

CSA Instrumentation Cables
600 V ACIC Armored Cables

Pairs • Armored • Individually Beldfoil® Shielded Pairs + Overall Beldfoil® Shield



- -40 °C to +105 °C Dry
- -40 °C to +75 °C Wet
- -25 °C Cold Impact

- CSA C22.2 No. 239, Type ACIC
- CSA C22.2 No. 174, HLABCD
- CSA C22.2 No. 0.3 Clause 4.31 Low Acid Gas (Jacket Only)
- FT4 Flame Test

Part No.		Pairs	Color Code	Inner Jacket OD		Outer Jacket OD		Insulation Thickness	
Aluminum	Steel			Inch	mm	Inch	mm	Inch	mm

Stranded TC Conductors • PVC Insulation • Individually Beldfoil® Shielded Pairs + Overall Beldfoil® Shield • Polyester Isolation Tape • PVC Inner Jacket • Armor • Chrome PVC Outer Jacket

18 AWG • 7 x 26

24511	25506	1	E1	.32	8.13	.61	15.49	.030	.76
24512	25514	2	E1	.51	12.95	.82	20.83		
24513	25503	4	E1	.63	16.00	.93	23.62		
24514	25505	8	E1	.79	20.27	1.15	29.21		
24515	25501	12	E1	1.00	25.40	1.36	34.54		
24520	25517	24	E1	1.36	34.54	1.75	44.45		

16 AWG • 7 x 24

24500	25504	1	E1	.34	8.64	.64	16.26	.030	.76
24505	25510	2	E1	.59	14.99	.89	22.61		
24502	25511	4	E1	.68	17.27	.98	24.89		
24506	25512	6	E1	.79	20.07	1.16	29.46		
24503	25513	8	E1	.90	22.86	1.27	32.26		
24504	25518	12	E1	1.09	27.69	1.46	37.08		
24510	25519	24	E1	1.49	37.85	1.88	47.75		

Triads • Armored • Individually Beldfoil® Shielded Triads + Overall Beldfoil® Shield



- -40 °C to +105 °C Dry
- -40 °C to +75 °C Wet
- -25 °C Cold Impact

- CSA C22.2 No. 239, Type ACIC
- CSA C22.2 No. 174, HLABCD
- CSA C22.2 No. 0.3 Clause 4.31 Low Acid Gas (Jacket Only)
- FT4 Flame Test

Part No.		Triads	Color Code	Inner Jacket OD		Outer Jacket OD		Insulation Thickness	
Aluminum	Steel			Inch	mm	Inch	mm	Inch	mm

Stranded TC Conductors • PVC Insulation • Individually Beldfoil® Shielded Triads + Overall Beldfoil® Shield • Polyester Isolation Tape • PVC Inner Jacket • Armor • Chrome PVC Outer Jacket

18 AWG • 7 x 26

24516	25500	1	E1	.34	8.64	.63	16.00	.030	.76
24517	25522	2	E1	.58	14.73	.89	22.61		
24518	25520	4	E1	.66	16.76	.99	25.15		
24519	25523	8	E1	.88	22.35	1.29	32.77		

16 AWG • 7 x 24

24501	25502	1	E1	.36	9.14	.66	16.76	.030	.76
24507	25507	2	E1	.62	15.75	.94	23.88		
24508	25509	4	E1	.72	18.29	1.05	26.67		
24509	25508	8	E1	.96	24.38	1.33	33.78		

TC = Tinned Copper • PVC = Polyvinyl Chloride | Belden Color Code Charts can be found at page 350/351.

Power & Control Variable Frequency Drive (VFD) Cables



Section Table of Contents

Power & Control	Page
Variable Frequency Drive (VFD) Cables	
Overview	152–153
Cross Reference Guide	154–156
Classic and Symmetrical VFD Cables	157–158
Low Smoke Zero Halogen VFD Cables	159–160
Armored VFD Cables	161
CSA VFD Cables	162

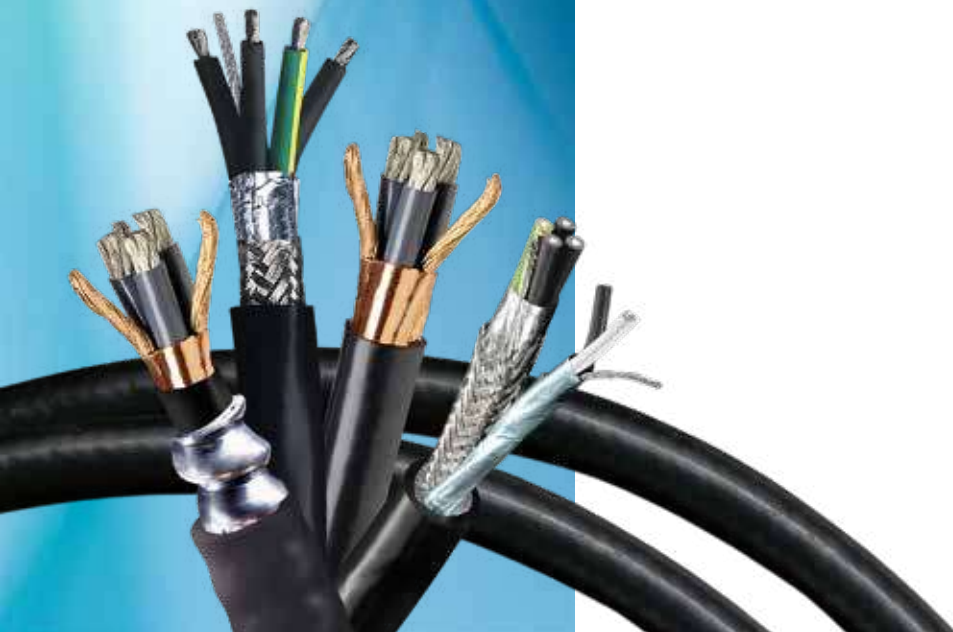

Variable Frequency Drive (VFD) Cables



Variable frequency AC motor drive output cables are subject to harsh operating environments characterized by high voltage spikes, high noise levels and adverse environmental conditions. Typical cabling solutions for this application have been unshielded tray cables, single-conductor lead wire installed in conduit or continuously-welded armored cable. These solutions suffer from complex, costly installation and potential reliability problems. Belden Variable Frequency Drive (VFD) Cables were designed and engineered to overcome these challenges.

Product Features

Jacket Options

- Industrial-grade PVC (Sunlight and oil-resistant)
- Haloarrest Jackets – Halogen-free LSZH

Insulation

- XLPE – lower capacitance resulting in reduced voltage spikes and corona discharge

Shielding

- 100% coverage foil shield along with an 80% braid shield or Dual 5 mm Copper Tape

Grounding

- Full-sized insulated ground allows lower resistance path to ground

AWG Sizes

- From 16 to 4/0 AWG

Benefits

Thicker, Industrial-grade XLPE Insulation

- Provides more stable electrical performance than PVC
- Lower capacitance resulting in
 - Longer cable runs
 - Reduced peak motor terminal voltage for extended motor life
 - Reduced likelihood of corona discharge
 - Reduced magnitude of standing waves
 - Increased efficiency of power transfer

High-strand Tinned Copper Circuit Conductors

- More flexible for ease of installation
- Better vibration resistance
- Numbered for ease of identification

Industrial-grade PVC or Haloarrest Low Smoke Zero Halogen Jackets

- Sunlight Resistant
- Oil Resistant (PVC only)

Applications

VFD drives are utilized in all industrial vertical markets and are used to:

- Run process equipment and machinery
- Power pumps to move fluids
- Drive fans to move air
- Run conveyors to transport a wide range of materials

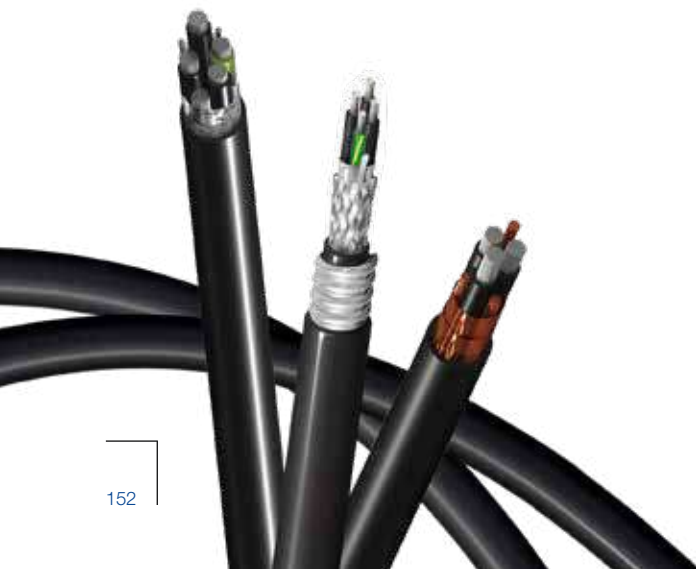

Variable Frequency Drive (VFD) Cables

Overview

Belden VFD Cables are Designed to Deliver Top Performance in Any Type of Environment

All Cables

- Thicker, industrial-grade XLP insulations provide low capacitance for extended motor life, reduced likelihood of corona discharge, reduced magnitude of standing waves, increased efficiency of power transfer
- Robust ground and shielding system to minimize radiated and conducted noise that can disrupt plant control and instrumentation systems
- Reliably carry power from AC drive systems to AC motors
- Effectively handle the overall high power levels of pulse-width modulated (PWM) signals
- Reliably handle high voltage spikes – eliminating potential damage to the cable, motors, bearings, drives and related equipment – potentially extending their life
- Industrial-grade PVC jackets provide sunlight and oil-resistance; Haloarrest® jackets are halogen-free and provide sunlight-resistance in LSZH versions
- HaloarrestXLink™ jackets are thermoset and low smoke zero halogen for exposure in harsh environments
- Resistant to adverse or harsh environments
- ER rating allows for the elimination of conduit for easier and less expensive installations
- Effectively eliminate downtime due to cable failure

Classic Foil/Braid Designs

- High-strand conductors ease installation; enable better vibration resistance
- Full-sized insulated ground allows lower resistance path to ground
- Tinned copper conductors to prevent against corrosion
- Low capacitance and low impedance of the cables closely matches the drive and electrical values
- Round configuration for reliable sealing

Classic Symmetrical Designs

- Available with high-strand conductors in large AWG sizes
- Design features a copper tape shield with segmented ground
- Smaller OD than the Classic Designs with Foil/Braid

Classic Designs with Signal Pair

- Overall jackets provide more protection for the integrated signal pair
- Easier, lower cost installation than pulling the signal pair separately

Termination Guide

See our Unarmored VFD Cable Termination Guide (Lit No. VFDCDG) for a step-by-step look at best practices for installing and terminating unarmored VFD cables, available on-line at www.belden.com.

Applicable for Use With:

- Rockwell Automation AC drives
- ABB/Baldor
- Danfoss
- Eaton/Cutler-Hammer
- Emerson
- General Electric
- Hitachi
- Magnetek
- Mitsubishi Electric Automation
- OMRON
- Robicon
- Schneider Electric
- Siemens
- Toshiba
- Vacon (TB Wood's)
- WEG
- Yaskawa

Belden VFD Cables versus Tray Cables or Single Conductor Products

- Superior radiated and conducted noise protection with robust shield and ground design
- XLP insulation provides lower capacitance resulting in reduced voltage spikes and corona discharge
- Extended motor life
- Longer cable runs

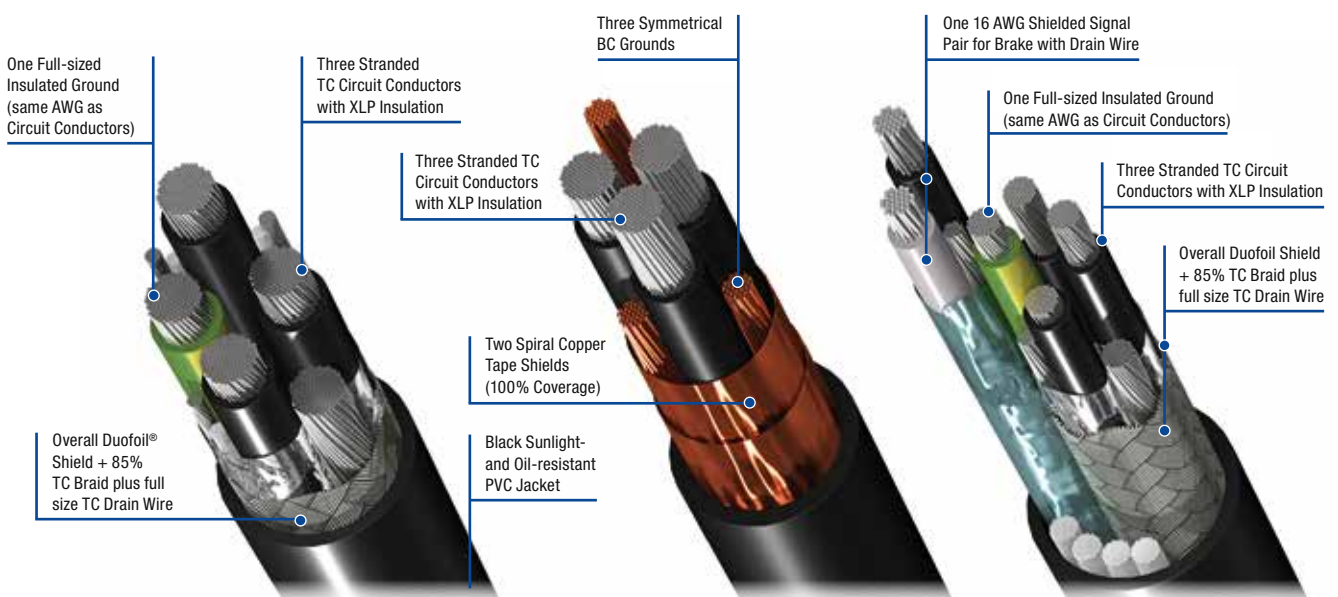

VFD Cross Reference Guide

Voltage	HP	kW	Sizes	Classic VFD Part No.	Classic with Signal Pair Part No.	2 kV VFD Part No.	CSA VFD Part No.	LSZH VFD Part No.	Thermoset LSZH VFD, Marine Approvals Part No.
230 V 3Ø	.25 to 3	0.75 to 2.2	16	29500	29510	—	—	29500T	29500X
	5	3.7	14	29501	29511	29536	29550C	29501T	29501X
			12	29502	29512	29537	29551C	29502T	29502X
	7.5	5.6	12	29502	29512	29537	29551C	29502T	29502X
	10	7.5	10	29503	29513	29538	29552C	29503T	29503X
	15	11.2	8	29504	—	29539	29553C	29504T	29504X
	20	14.9	6	29505	—	29540	29554C	29505T	29505X
	25	18.6	4	29506	—	29541	29555C	29506T	29506X
	40	29.8	2	29507	—	29542	29556C	29507T	29507X
			1	29528	—	29543	29557C	29528T	29528X
	50	37.3	1/0	29529	—	29544	29558C	29529T	29529X
			2/0	29530	—	29545	29559C	29530T	29530X
			3/0	29531	—	29546	29560C	29531T	29531X
	75	55.9	4/0	29532	—	29547	29561C	29532T	29532X
			250 MCM	—	—	29533	29533	—	—
	100	74.6	350 MCM	—	—	29534	29534	—	—
	125	93.2	500 MCM	—	—	29535	29535	—	—
460 V 3Ø	10	7.5	16	29500	29510	—	—	29500T	29500X
			14	29501	29511	29536	29550C	29501T	29501X
			12	29502	29512	29537	29551C	29502T	29502X
	15	11.2	12	29502	29512	29537	29551C	29502T	29502X
			10	29503	29513	29538	29552C	29503T	29503X
	20	14.9	10	29503	29513	29538	29552C	29503T	29503X
	30	22.4	8	29504	—	29539	29553C	29504T	29504X
	40	29.8	6	29505	—	29540	29554C	29505T	29505X
	50	37.3	4	29506	—	29541	29555C	29506T	29506X
	75	55.9	2	29507	—	29542	29556C	29507T	29507X
			1	29528	—	29543	29557C	29528T	29528X
	100	74.6	1/0	29529	—	29544	29558C	29529T	29529X
	125	93.2	2/0	29530	—	29545	29559C	29530T	29530X
			3/0	29531	—	29546	29560C	29531T	29531X
			4/0	29532	—	29547	29561C	29532T	29532X
	150	111.9	250 MCM	—	—	29533	29533	—	—
			350 MCM	—	—	29534	29534	—	—
200	149.1	500 MCM	—	—	29535	29535	—	—	

Values based on typical Full-Load Current (FLC) ratings of three-phase AC motors as published in NEC Table 430.250 (2011) multiplied by 125% per NEC article 430-22 (A) (2011). The ampacity ratings of the cables are based on NEC Table 310.15(B)(16) (2011). The VFD w/Signal ampacity values were de-rated to 80% per NEC Table 310.15 (B)(2)(a) (2011) due to the increased number of current-carrying conductors included in these cable(s).

Values based on typical Full-Load Current (FLC) ratings of three-phase AC motors as published in CEC Table 44 (2012) multiplied by 125% per CEC Section 28-112 (2012). The ampacity ratings of the cables are based on CEC Table 2 (2012). The VFD w/Signal ampacity values were de-rated to 80% per CEC Table 5C (2012) due to the increased number of current-carrying conductors included in these cable(s).

Consult drive/motor manufacturer for exact FLC ratings. Ampacity interpretations subject to user's local authority having jurisdiction.

VFD Cross Reference Guide (continued)

Voltage	HP	kW	Sizes	Classic VFD Part No.	Classic with Signal Pair Part No.	2 kV VFD Part No.	CSA VFD Part No.	LSZH VFD Part No.	Thermoset LSZH VFD, Marine Approvals Part No.
575 V 3Ø	10	7.5	16	29500	29510	—	—	29500T	29500X
			14	29501	29511	29536	29550C	29501T	29501X
	15	11.2	14	29501	29511	29536	29550C	29501T	29501X
			12	29502	29512	29537	29551C	29502T	29502X
	20	14.9	12	29502	29512	29537	29551C	29502T	29502X
			10	29503	29513	29538	29552C	29503T	29503X
	30	22.4	10	29503	29513	29538	29552C	29503T	29503X
	40	29.8	8	29504	—	29539	29553C	29504T	29504X
	50	37.3	6	29505	—	29540	29554C	29505T	29505X
	60	44.7	4	29506	—	29541	29555C	29506T	29506X
	100	74.6	2	29507	—	29542	29556C	29507T	29507X
			1	29528	—	29543	29557C	29528T	29528X
	125	93.2	1/0	29529	—	29544	29558C	29529T	29529X
			2/0	29530	—	29545	29559C	29530T	29530X
	150	111.9	3/0	29531	—	29546	29560C	29531T	29531X
			4/0	29532	—	29547	29561C	29532T	29532X
	200	149.1	250 MCM	—	—	29533	29533	—	—
	250	186.4	350 MCM	—	—	29534	29534	—	—
	350	261.0	500 MCM	—	—	29535	29535	—	—

Values based on typical Full-Load Current (FLC) ratings of three-phase AC motors as published in NEC Table 430.250 (2011) multiplied by 125% per NEC article 430-22 (A) (2011). The ampacity ratings of the cables are based on NEC Table 310.15(B)(16) (2011). The VFD w/Signal ampacity values were de-rated to 80% per NEC Table 310.15 (B)(2)(a) (2011) due to the increased number of current-carrying conductors included in these cable(s).

Values based on typical Full-Load Current (FLC) ratings of three-phase AC motors as published in CEC Table 44 (2012) multiplied by 125% per CEC Section 28-112 (2012). The ampacity ratings of the cables are based on CEC Table 2 (2012). The VFD w/Signal ampacity values were de-rated to 80% per CEC Table 5C (2012) due to the increased number of current-carrying conductors included in these cable(s).

Consult drive/motor manufacturer for exact FLC ratings. Ampacity interpretations subject to user's local authority having jurisdiction.

VFD Cross Reference Guide *(continued)*

VFD Supplier	VFD Name	VFD Supplier	VFD Name	VFD Supplier	VFD Name
ABB/Baldor	AC S	Easton/Cutler-Hammer	CFX	Rockwell/A-B	PowerFlex®
	ACH 501 (480 V AC, 208/230 V AC)		CPX		1336
	ACH550		H-Max		1305
	ACS 6000c		HVX	Schneider Electric	Altivar®
	ACQ		LCX		E-flex™
	Cascade		M-Max		M-Flex™
	Cyclo (Analog)		MVX		PowerGard™
	Cyclo (PSR)		NFX		S-Flex™
	MEGADRIVE-LCI		SC 9000	Siemens	MICROMASTER
	MEGASTAR A		SLX		SINAMICS
	SAMI MEGASTAR (W)		SPX		SED2
	TYRAK-LCI	SVX	VBA		
	VS1SP	Mitsubishi	A500 Series	WEG	CFW
	VS1GV		A700 Series		EDP
	VS1PM		A701 Series		MVW
	Danfoss		AHF	D700 Series	Yaskawa
VLT® 12-Pulse			E500 Series	AC7	
VLT 2800			E700 Series	E7	
VLT 2800			E700SC Series	F7	
VLT AQUA FC 200		F700Series	G5HHP		
VLT FC 100		S500 Series	G7		
VLT FC 300		V500 Drives	J1000		
VLT High Power		OMRON	3G3JX	P1000	
VLT Low Harmonic			3G3MX2	P7	
VLT Micro			3G3RX	V1000	
			VS mini		
			Z1000		

Encoder Cables

Belden also offers the following standard cables for encoder applications. Encoder cables help feed information to the micro-processor regarding both the speed and the position of the rotor.

Part No.	Pairs	AWG
8790	1 (Power Supply)	18
9729	2	24
9730, 89730	3	24
9728	4	24
9892	4	20
9860	1 (Signal)	16

Classic and Symmetrical VFD Cables

Classic Foil/Braid Design



- Four-Conductor Cable (3 Circuit + Ground)
- Full-Size Insulated Ground
- Foil + Braid Shield
- 1000 V UL Flexible Motor Supply Cable
- 600 V UL TC-ER
- 1000 V CSA AWM I/II A/B FT4
- C(UL) 600 V Type CIC TC

Part No.	Conductor			OD (Nom)		Pulling Tension (Max)		Bend Radius (Min)		Additional Features/Ratings
	AWG	mm ²	Stranding	Inch	mm	Lbs	N	Inch	mm	
Stranded TC Conductors • XLP Insulation (PVC for Ground) • Overall Beldfoil® + 85% TC Braid Shielding • Black PVC Jacket • TC Drain Wire (Sized Same as Conductors)										
29500	16	1.3	26 x 30	.53	13.46	128	570	4.3	109.2	+90 °C Wet/Dry Sunlight Res Oil Res UL Direct Burial IEEE 1202/383 XHHW-2, RHW-2 Conductors (16 AWG: XHHW-2 only) MSHA* P-07-KA070003
29501	14	2.0	41 x 30	.60	15.24	212	943	4.8	121.9	
29502	12	3.3	65 x 30	.65	16.51	336	1495	5.2	132.0	
29503	10	5.4	105 x 30	.69	17.53	592	2634	5.5	139.7	
29504	8	8.6	7 x 19 x 29	.93	23.61	768	3418	7.5	190.5	
29505	6	13.8	7 x 19 x 27	1.02	25.91	1220	5429	8.2	203.2	
29506	4	21.6	7 x 19 x 25	1.16	29.46	1940	8633	9.3	236.2	
29507	2	34.4	7 x 19 x 23	1.31	33.27	3088	13,742	10.8	273.1	

Conductor Color Coding: ICEA Method 4: Black and Numbered, Green/Yellow Ground.

Classic Symmetrical Design



- Three-Conductor Cable (3 Circuit + 3 Ground)
- Dual Spiral Copper Tape Shield
- 1000 V UL Flexible Motor Supply Cable
- 600 V UL 1277 Type TC-ER
- 1000 V CSA AWM I/II A/B FT4
- C(UL) 600 V Type RW90 TC

Part No.	Conductor			OD (Nom)		Pulling Tension (Max)		Bend Radius (Min)		Additional Features/Ratings
	AWG	mm ²	Stranding	Inch	mm	Lbs	N	Inch	mm	
Stranded TC Conductors • XLP Insulation (PVC for Ground) • Dual Spiral Copper Tape Shield • Black PVC Jacket • BC Drain Wire (Sized Same as Conductors)										
29528	1	43.2	7 x 19 x 22	1.20	30.48	2650	11,788	12.0	304.8	+90 °C Wet/Dry Sunlight Res Oil Res UL Direct Burial IEEE 1202/383 XHHW-2 Conductors MSHA* P-07-KA070003
29529	1/0	53.5	7 x 19 x 21	1.29	32.77	3537	15,733	12.9	327.7	
29530	2/0	69.0	7 x 19 x 20	1.40	35.56	4200	18,682	14.0	355.6	
29531	3/0	85.0	7 x 19 x 19	1.52	38.61	5025	22,352	15.2	386.1	
29532	4/0	107.2	7 x 19 x 18	1.68	42.67	6670	29,670	16.8	426.7	

Conductor Color Coding: ICEA Method 4: Black and Numbered, Green/Yellow Ground.

Classic Foil/Braid Design • Signal Pair



- Four-Conductor Cable (3 Circuit + Ground)
- Full-Size Insulated Ground
- 16 AWG Stranded (26 x 30) Shielded Signal Pair
- Foil + Braid Shield
- 1000 V UL Flexible Motor Supply Cable
- 600 V UL TC-ER
- 1000 V CSA AWM I/II A/B FT4
- C(UL) 600 V Type CIC TC

Part No.	Conductor			OD (Nom)		Pulling Tension (Max)		Bend Radius (Min)		Additional Features/Ratings
	AWG	mm ²	Stranding	Inch	mm	Lbs	N	Inch	mm	
Stranded TC Conductors • XLP Insulation (PVC for Ground) • Overall Duofoil® + 85% TC Braid Shielding • Black PVC Jacket • TC Drain Wire (Sized Same as Conductors)										
29510	16	1.3	26 x 30	.75	19.05	272	1210	7.5	190.5	IEEE 1202/383 +90 °C Wet/Dry Sunlight Res Oil Res UL Direct Burial XHHW-2, RHW-2 Conductors (16 AWG: XHHW-2 only) MSHA* P-07-KA070003
29511	14	2.1	41 x 30	.82	20.83	368	1638	8.2	208.3	
29512	12	3.3	65 x 30	.90	22.86	527	2345	9.0	228.6	
29513	10	5.4	105 x 30	.99	25.15	718	3195	9.9	251.5	

Conductor Color Coding: ICEA Method 4: Black and Numbered, Green/Yellow Ground.

BC = Bare Copper • TC = Tinned Copper • PVC = Polyvinyl Chloride • XLP = Cross-Linked Polyethylene | * MSHA = Mine Safety and Health Administration

Classic and Symmetrical VFD Cables

Classic Foil/Braid Design • 2kV



- Four-Conductor Cable (3 Circuit + Ground)
- Full-Size Insulated Ground
- Foil + Braid Shield
- 2000 V UL Flexible Motor Supply Cable
- 2000 V UL TC-ER
- 1000 V CSA AWM I/II A/B FT4
- C(UL) 600 V Type CIC TC

Part No.	Conductor			OD (Nom)		Pulling Tension (Max)		Bend Radius (Min)		Additional Features/Ratings
	AWG	mm ²	Stranding	Inch	mm	Lbs	N	Inch	mm	
Stranded TC Circuit Conductors • XLP Insulation (PVC for Ground) • Overall Duofoil + 85% TC Braid Shielding • Black PVC Jacket • TC Drain Wire (Sized Same as Conductors)										
29536	14	2.1	41 x 30	.68	17.30	212	943	6.8	172.72	
29537	12	3.3	65 x 30	.72	18.30	336	1495	7.3	185.42	+90 °C Wet/Dry Sunlight Res Oil Res UL Direct Burial IEEE 1202/3837 XHHW-2, RHW-2 Conductors MSHA* P-07-KA070003
29538	10	5.4	105 x 30	.79	20.10	592	2634	7.9	200.70	
29539	8	8.6	7 x 19 x 29	.96	24.40	768	3418	9.6	243.84	
29540	6	13.8	7 x 19 x 27	1.07	26.92	1220	5429	10.6	269.24	
29541	4	21.6	7 x 19 x 25	1.21	30.50	1940	8633	12.1	307.34	
29542	2	34.4	7 x 19 x 23	1.36	34.54	3088	13,742	13.6	345.44	

Conductor Color Coding: ICEA Method 4: Black and Numbered, Green/Yellow Ground.

Classic Symmetrical Design • 2kV



- Three-Conductor Cable (3 Circuit + 3 Ground)
- Dual Spiral Copper Tape Shield
- 2000 V UL Flexible Motor Supply Cable
- 2000 V UL TC-ER
- 1000 V CSA AWM I/II A/B FT4
- C(UL) 2000 V Type RW90 TC

Part No.	Conductor			OD (Nom)		Pulling Tension (Max)		Bend Radius (Min)		Additional Features/Ratings
	AWG	mm ²	Stranding	Inch	mm	Lbs	N	Inch	mm	
Stranded TC Conductors • XLP Insulation • Dual Spiral Copper Tape Shield • Black PVC Jacket • BC Ground Conductors										
29543	1	43.2	7 x 19 x 22	1.36	34.54	2650	11,788	13.6	345.44	IEEE 1202/383 Sunlight Res Oil Res UL Direct Burial XHHW-2, RHW-2 Conductors +90 °C Wet/Dry MSHA* P-07-KA070003
29544	1/0	53.5	7 x 19 x 21	1.45	36.83	3537	15,733	14.5	368.30	
29545	2/0	69.0	7 x 19 x 29	1.56	39.62	4200	18,682	15.6	396.24	
29546	3/0	85.0	7 x 19 x 19	1.75	44.50	5025	22,352	17.5	444.50	
29547	4/0	107.2	7 x 19 x 18	1.88	47.80	6670	29,670	18.8	477.52	

Conductor Color Coding: ICEA Method 4: Black and Numbered.

Symmetrical Design • 2kV MCM Size



- Three-Conductor Cable (3 Circuit + 3 Ground)
- Dual Spiral Copper Tape Shield
- 2000 V UL TC-ER
- 1000 V CSA 22.2 No. 230 TC

Part No.	Conductor			OD (Nom)		Pulling Tension (Max)		Bend Radius (Min)		Additional Features/Ratings
	MCM	mm ²	Stranding	Inch	mm	Lbs	N	Inch	mm	
Stranded BC Conductors • XLP Insulation • Dual Spiral Copper Tape Shield • Black PVC Jacket • BC Ground Conductors										
29533	250	125	37 x .0822	1.91	48.56	6000	26,688	34.4	873	IEEE 1202/383 Sunlight Res Oil Res UL Direct Burial CSA FT4 RHW-2, RW90 Conductors +90 °C Wet/Dry
29534	350	185	37 x .0973	2.13	54.18	8400	37,363	38.4	975	
29535	500	240	37 x .1162	2.41	61.16	12,000	53,376	43.4	1102	

Conductor Color Coding: ICEA Method 4: Black and Numbered.

BC = Bare Copper • TC = Tinned Copper • PVC = Polyvinyl Chloride • XLP = Cross-Linked Polyethylene | * MSHA = Mine Safety and Health Administration

Low Smoke Zero Halogen VFD Cables

Classic Foil/Braid Design • Low Smoke Zero Halogen



- Four-Conductor Cable (3 Circuit + Ground)
- Full-Size Insulated Ground
- Foil + Braid Shield
- 1000 V UL Flexible Motor Supply Cable
- 600 V UL TC-ER
- 1000 V CSA AWM I/II A/B FT4

Part No.	Conductor			OD (Nom)		Pulling Tension (Max)		Bend Radius (Min)		Additional Features/Ratings
	AWG	mm ²	Stranding	Inch	mm	Lbs	N	Inch	mm	
Stranded TC (Circuit), TC (Ground) Conductors • XLP Insulation • Overall Beldfoil® + 85% TC Braid Shielding • Black Haloarrest® Jacket										
29500T	16	1.3	26 x 30	.53	13.46	128	570	4.3	109.2	IEEE 1202/383 Sunlight Res UL Direct Burial XHHW-2, RHW-2 Conductors (16 AWG: XHHW-2 only) +90 °C Wet/Dry MSHA* P-07-KA070003
29501T	14	2.1	41 x 30	.60	15.24	212	943	4.8	121.9	
29502T	12	3.3	65 x 30	.65	16.51	336	1495	5.2	132.0	
29503T	10	5.4	105 x 30	.69	17.53	592	2634	5.5	139.7	
29504T	8	8.6	7 x 19 x 29	.93	23.62	768	3418	7.5	190.5	
29505T	6	13.8	7 x 19 x 27	1.02	25.91	1220	5429	8.2	203.2	
29506T	4	21.6	7 x 19 x 25	1.16	29.46	1940	8633	9.3	236.2	
29507T	2	34.4	7 x 19 x 23	1.31	33.27	3088	13,742	10.8	273.1	

Conductor Color Coding: ICEA Method 4: Black and Numbered, Green/Yellow Ground.

Classic Symmetrical Design • Low Smoke Zero Halogen



- Three-Conductor Cable (3 Circuit + 3 Ground)
- Dual Spiral Copper Tape Shield
- 1000 V UL Flexible Motor Supply Cable
- 600 V UL TC-ER
- 1000 V CSA AWM I/II A/B FT4

Part No.	Conductor			OD (Nom)		Pulling Tension (Max)		Bend Radius (Min)		Additional Features/Ratings
	AWG	mm ²	Stranding	Inch	mm	Lbs	N	Inch	mm	
Stranded TC (Circuit), BC (Ground) Conductors • XLP Insulation • Dual Spiral Copper Tape Shield • Black PVC Jacket										
29528T	1	43.2	7 x 19 x 22	1.20	30.48	2650	11,788	12.0	304.8	IEEE 1202/383 Sunlight Res UL Direct Burial XHHW-2 Conductors +90 °C Wet/Dry MSHA* P-07-KA070003
29529T	1/0	53.5	7 x 19 x 21	1.29	32.77	3537	15,733	12.9	327.7	
29530T	2/0	69.0	7 x 19 x 20	1.40	35.56	4200	18,682	14.0	355.6	
29531T	3/0	85.0	7 x 19 x 19	1.52	38.61	5025	22,352	15.2	386.1	
29532T	4/0	107.2	7 x 19 x 18	1.68	42.67	6670	29,670	16.8	426.7	

Conductor Color Coding: ICEA Method 4: Black and Numbered, Green/Yellow Ground.

BC = Bare Copper • TC = Tinned Copper • PVC = Polyvinyl Chloride • XLP = Cross-Linked Polyethylene | * MSHA = Mine Safety and Health Administration

Low Smoke Zero Halogen VFD Cables

Classic Foil/Braid Design • Thermoset Low Smoke Zero Halogen • Marine Certified



- Four-Conductor Cable (3 Circuit + Ground)
- Full-Size Insulated Ground
- Foil + Braid Shield

- 1000 V UL Flexible Motor Supply Cable
- 600 V UL TC-ER
- CSA FT4
- Marine Approvals: ABS, UL 1309, IEEE 45, IEEE 1580 Type P

Part No.	Conductor			OD (Nom)		Pulling Tension (Max)		Bend Radius (Min)		Additional Features/Ratings
	AWG	mm ²	Stranding	Inch	mm	Lbs	N	Inch	mm	
Stranded TC Conductors • XLP Insulation • Overall Beldfoil® + 85% TC Braid Shielding • Black HaloarrestXLink™-2 Jacket										
29500X	16	1.3	26 x 30	.53	13.46	128	570	4.3	109.2	IEEE 1202/383 Sunlight Res Oil Res II IEC 60811-2-1 Hydrocarbon Resistant XHHW-2, RHW-2 Conductors (16 AWG: XHHW-2 only) +90 °C Wet/Dry MSHA Approved* Suitable for Class I, II & III, Division 2 Hazardous Locations
29501X	14	2.1	41 x 30	.60	15.24	212	943	4.8	121.9	
29502X	12	3.3	65 x 30	.65	16.51	336	1495	5.2	132.0	
29503X	10	5.4	105 x 30	.69	17.53	592	2634	5.5	139.7	
29504X	8	8.6	7 x 19 x 29	.93	23.62	768	3418	7.5	190.5	
29505X	6	13.8	7 x 19 x 27	1.02	25.91	1220	5429	8.2	203.2	
29506X	4	21.6	7 x 19 x 25	1.16	29.46	1940	8633	9.3	236.2	
29507X	2	34.4	7 x 19 x 23	1.31	33.27	3088	13,742	10.8	273.1	

Conductor Color Coding: ICEA Method 4: Black and Numbered, Green/Yellow Ground.

Classic Symmetrical Design • Thermoset Low Smoke Zero Halogen • Marine Certified



- Three-Conductor Cable (3 Circuit + 3 Ground)
- Dual Spiral Copper Tape Shield

- 1000 V UL Flexible Motor Supply Cable
- 600 V UL TC-ER
- CSA FT4
- Marine approvals: ABS, UL 1309 Type, IEEE 45, IEEE 1580 Type P

Part No.	Conductor			OD (Nom)		Pulling Tension (Max)		Bend Radius (Min)		Additional Features/Ratings
	AWG	mm ²	Stranding	Inch	mm	Lbs	N	Inch	mm	
Stranded TC (Circuit), BC (Ground) Conductors • XLP Insulation • Dual Spiral Copper Tape Shield • Black HaloarrestXLink-2 Jacket										
29528X	1	43.2	7 x 19 x 22	1.20	30.48	2650	11,788	12.0	304.8	IEEE 1202/383 Sunlight Res Oil Res II IEC 60811-2-1 Hydrocarbon Resistant XHHW-2 Conductors +90 °C Wet/Dry MSHA Approved* Suitable for Class I, II & III, Division 2 hazardous locations
29529X	1/0	53.5	7 x 19 x 21	1.29	32.77	3537	15,733	12.9	327.7	
29530X	2/0	69.0	7 x 19 x 20	1.40	35.56	4200	18,682	14.0	355.6	
29531X	3/0	85.0	7 x 19 x 19	1.52	38.61	5025	22,352	15.2	386.1	
29532X	4/0	107.2	7 x 19 x 18	1.68	42.67	6670	29,670	16.8	426.7	

Conductor Color Coding: ICEA Method 4: Black and Numbered.

BC = Bare Copper • TC = Tinned Copper • PVC = Polyvinyl Chloride • XLP = Cross-Linked Polyethylene | * MSHA = Mine Safety and Health Administration

Armored VFD Cables

Interlocked Armor

Belden armored VFD cables are available in interlocked aluminum or steel type metal clad (MC) constructions. Belden MC cables are designed to meet demanding industrial needs with rugged durability and corrosion resistance with flexibility and easy handling.

The products use Belden Classic or Classic Symmetrical designs.

Classic Foil/Braid Design • Armored



- Four-Conductor Cable (3 Circuit + Ground)
- Foil + Braid Shield
- 600 V UL MC
- NEC Hazardous Location: Classes I and II, Div. II

Part No.		Conductor		Additional Features/Ratings
Aluminum	Steel	AWG	mm ²	
Stranded TC Conductors • XLP Insulation (PVC for Ground) • Overall Beldfoil® + 85% TC Braid Shielding • Black PVC Jacket				
1229500	1329500	16	1.3	IEEE 1202/383 (70,000 BTU) Sunlight Res Oil Res UL Direct Burial XHHW-2, RHW-2 Conductors (16 AWG, XHHW-2 Only) +90 °C Wet/Dry
1229501	1329501	14	2.1	
1229502	1329502	12	3.3	
1229503	1329503	10	5.4	
1229504	1329504	8	8.6	
1229505	1329505	6	13.8	
1229506	1329506	4	21.6	
1229507	1329507	2	34.4	

Conductor Color Coding: ICEA Method 4: Black and Numbered, Green/Yellow Ground.

Classic Symmetrical Design • Armored



- Three-Conductor Cable (3 Circuit + 3 Ground)
- Dual Spiral Copper Tape Shield
- 600 V UL MC
- NEC Hazardous Location: Classes I and II, Div. II

Part No.		Conductor		Additional Features/Ratings
Aluminum	Steel	AWG	mm ²	
Stranded TC (Circuit), BC (Ground) Conductors • XLP Insulation (PVC for Ground) • Dual Copper Tape Shield • Black PVC Jacket				
1229528	1329528	1	43.2	IEEE 1202/383 (70,000 BTU) Sunlight Res Oil Res UL Direct Burial XHHW-2 Rated Circuit Conductors +90 °C Wet/Dry
1229529	1329529	1/0	53.5	
1229530	1329530	2/0	69.0	
1229531	1329531	3/0	85.0	
1229532	1329532	4/0	107.2	

Conductor Color Coding: ICEA Method 4: Black and Numbered, Green/Yellow Ground.

BC = Bare Copper • TC = Tinned Copper • PVC = Polyvinyl Chloride • XLP = Cross-Linked Polyethylene

CSA VFD Cables
1000 V CSA Cables

CSA Symmetrical Design



- Three-Conductor Cable (3 Circuit + 3 Ground)
- Dual Spiral Copper Tape Shield
- 1000 V CSA TC
- CSA C22.2 #230
- CSA C22.2 #38
- CSA FT-4

Part No.	Conductor			OD (Nom)		Pulling Tension (Max)		Bend Radius (Min)		Additional Features/Ratings
	AWG	mm ²	Stranding	Inch	mm	Lbs	N	Inch	mm	
Stranded BC Conductors • XLP Insulation • Dual Spiral Copper Cable Shield • Black PVC Jacket										
29550C	14	2.1	7 x 22	0.43	10.92	162	75	4.3	109.2	
29551C	12	3.3	7 x 20	0.46	11.68	258	117	4.6	116.8	
29552C	10	5.4	7 x 18	0.51	12.95	444	201	5.1	129.5	
29553C	8	8.6	7 x 16	0.65	16.51	576	261	6.5	165.1	
29554C	6	13.8	7 x 14	0.72	18.28	915	415	7.3	185.4	
29555C	4	21.6	7 x 12	0.83	21.08	1450	658	8.3	210.8	
29556C	2	34.4	7 x 10	0.99	25.15	2300	1043	10.0	254.0	
29557C	1	43.2	19 x 14	1.13	28.70	2650	1202	11.5	292.1	
29558C	1/0	53.5	19 x 13	1.21	30.73	3537	1604	12.3	312.4	
29559C	2/0	69.0	19 x 12	1.31	33.27	4200	1905	13.3	337.8	
29560C	3/0	85.0	19 x 11	1.42	36.07	5025	2279	14.3	363.2	
29561C	4/0	107.2	19 x 10	1.54	39.12	6670	3025	15.5	393.7	

IEEE 1202/383
Sunlight Res
Oil Res
Direct Burial
RW90 Conductors
+90 °C Wet/Dry

Conductor Color Coding: ICEA Method 4: Black and Numbered.



Power & Control Sensor & Actuator Cables

Section Table of Contents

Power & Control	Page
Sensor & Actuator Cables	
Overview	164
PVC Sensor & Actuator Cables	165
PUR Sensor & Actuator Cables	166
PUR Distribution Boxes Cables	167

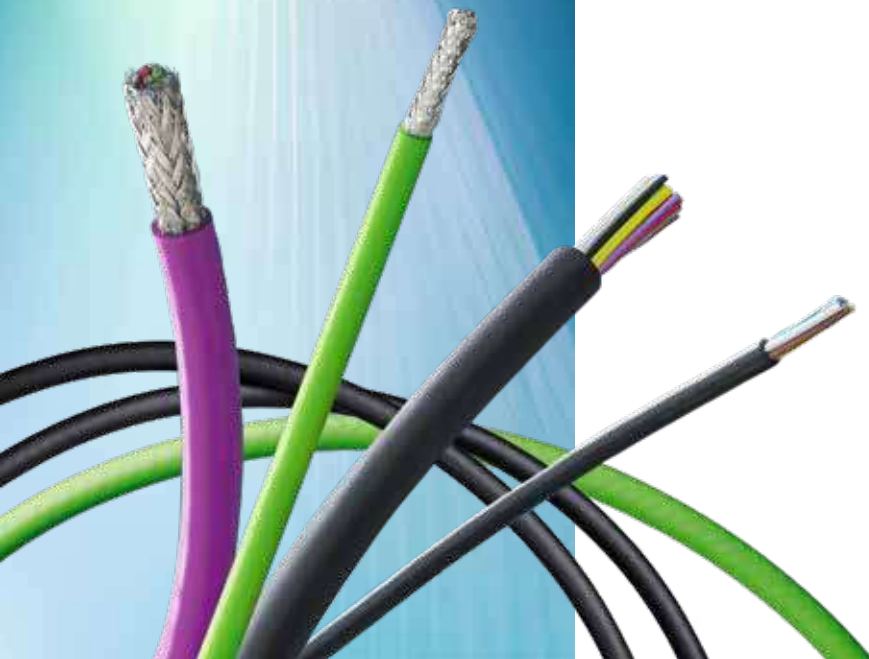

Sensor & Actuator Cables



The sensor/actuator range are signal cables, connecting automation systems end points (e.g., sensors) to the next layer (e.g. I/O devices). These applications require cables with high flexibility and resistance to tough industrial environments (e.g., oil, temperature variation, chemicals), high data rates and reliable quality.

Product Features

- Drag chain suitability/trailing-resistant
 - Bending radius 10xD
 - Acceleration 5 m/s²
 - Path feed rate 200 m/min at 5 m horizontal path
 - Guaranteed from 2 million bending cycles to 10 million bending cycles
- Torsion-resistant
 - >5 million cycles guaranteed
 - ± 360° per 1 m length
- Resistance to coolants and lubricants
 - Polyurethane outer jacket for longer service life
 - Lower maintenance costs
- UL, ROHS compliant
- No halogens, LABS free, phosphorus free
- On-machine industrial resistance requirements: flexible, oil resistant, tough cable jackets, e.g. PURs
- High temperature resistance +80 °C
- Perfectly round cable for IP67 assemblies requirements
- Multiple put-up lengths (100 m, 3000 m, 5000 m, etc.)

Benefits

- With an experience of over 110 years, Belden evolved its manufacturing sites to deliver maximum performance and total reliability. High levels of quality in centricity, roundness, strippability and consistent jacket thickness are ensured through the production quality systems, in line management, centricity control systems, stripping force testing, UL and ISO 9001:2000 certified facilities.
- Belden guarantees the quality of its cables by using high quality materials, approved by international authorities such as IEC and UL.

Applications

On-machine applications & peripheral devices to PLC controllers:

- Sensor-Actuator links
- Sensors/Actuators to I/O Distributor Boxes
- Sensors/Actuators to Field Devices

Belden Sensor & Actuator Cables

Robust Cables for Sustainable Performance

Automation technologies make things move. They sense, they control, and they inspect. Automation also means intelligent networking of control systems, sensors and actuators. High performance cables have changed the face of modern factories, manufacturing processes and the industrial infrastructure. Today's industrialists expect reliability and take long lifecycles and high performance for granted. Very often this applies under even the most rugged conditions, which means in practice that they can concentrate on their own work.

Belden offers a wide range of industrial sensor cables, UL style and tested for 1 up to 5 million cycles trailing or torsion applications, have a durable outside sheath, extremely small bending radiuses and are highly resistant to oil and chemicals. They are particularly suitable for use in metal-cutting machines and installations.

PVC Sensor/Actuator Cables

PVC (Polyvinylchloride) is a general purpose thermoplastic jacketing material, which has good mechanical strength in dry, damp or wet rooms and outdoors (fixed installations).

- Outstanding resistance to chemicals
- PVC screened
- Cu screen: Wire Ø 0.10 mm, tinned/coverage 85% +/- 5%
- Recommended for applications in food processing equipment
- Recommended for applications in packaging, assembly and automatic production lines

PVC Sensor & Actuator Cable



Part No.	Conductors	Stranding	OD (Nom)		Voltage	Temperature Fixed Installation (°C)	UL Style	Additional Features/Ratings
			Inch	mm				

Copper Section 0.25 mm²

Stranded BC Conductors • PVC Insulation • PVC Jacket • LABS Free								
70202E	3	32 x 0.10 mm	0.197	5.0	300 V	-40 to +80	UL AWM 2464	1 Million Continuous Flex Cycles, Trailing Acids and Chemical Cleaning Agents Resistant

Copper Section 0.34 mm²

Stranded BC Conductors • PVC Insulation • PVC Jacket • LABS Free								
70201E	3	42 x 0.10 mm	0.197	5.0	300 V	-40 to +80	UL AWM 2464	1 Million Continuous Flex Cycles, Trailing Acids and Chemical Cleaning Agents Resistant
70203E	4	42 x 0.10 mm	0.224	5.7	300 V	-40 to +80	UL AWM 2464	

BC = Bare Copper • PVC = Polyvinyl Chloride

Belden Sensor & Actuator Cables

PUR Sensor & Actuator Cables

Product Features

- Low outer diameter and tolerances
 - Process security during sensor production
 - Optimum processing in the sensor
- Drag chain suitability
 - Bending radius 10 x D
 - Acceleration 5 m/s²
 - Path feed rate 200 m/min at 5 m horizontal path
 - Guaranteed bending cycles 5 millions
- Free of halogen and substances detrimental to paint adhesion
 - Decrease in fire load
 - Can also be used in paint shops for example
- Resistance to coolants and lubricants
 - Polyurethane outer jacket for longer service life
 - Lower maintenance costs
- Color black – suitable for any device design
- UL approved
- Torsion-resistant
 - >5 million cycles guaranteed
 - ± 360° per 1 m length

PUR Sensor & Actuator Cable



Part No.	Conductors	Stranding	OD (Nom)		Voltage	Temperature Fixed Installation (°C)	UL Style	Additional Features/Ratings
			Inch	mm				

Copper Section 0.14 mm²

Stranded BC Conductors • PP Insulation • PUR Jacket • Halogen Free • LABS Free								
70252PU	3	72 x 0.05 mm	0.114	2.9	300 V	-50 to +80	UL AWM 20549	5 Million Continuous Flex Cycles, Trailing Sunlight and Oil Resistant
70254PU	3	72 x 0.05 mm	0.114	2.9	300 V	-50 to +80	UL AWM 20549	5 Million Continuous Flex Cycles, Trailing Weldsplatter Resistant Sunlight and Oil Resistant
70251PU	4	18 x 0.10 mm	0.138	3.5	300 V	-50 to +80	UL AWM 20549	5 Million Continuous Flex Cycles, Trailing Sunlight and Oil Resistant

Copper Section 0.25 mm²

Stranded BC Conductors • PP Insulation • PUR Jacket • Halogen Free • LABS Free								
70262PU	6	32 x 0.10 mm	0.200	5.1	300 V	-50 to +80	UL AWM 20549	2 Million Continuous Flex Cycles, Trailing Sunlight and Oil Resistant
70263PU	8	32 x 0.10 mm	0.236	6.0	300 V	-50 to +80	UL AWM 20549	
70264PU	10	32 x 0.10 mm	0.248	6.3	300 V	-50 to +80	UL AWM 20549	
70265PU	12	32 x 0.10 mm	0.251	6.4	300 V	-50 to +80	UL AWM 20549	
70268PU	14	32 x 0.10 mm	0.283	7.2	300 V	-50 to +80	UL AWM 20549	

Copper Section 0.34 mm²

Stranded BC Conductors • PP Insulation • PUR Jacket • Halogen Free • LABS Free								
70256PU	3	42 x 0.10 mm	0.169	4.3	300 V	-50 to +80	UL AWM 20549	5 Million Continuous Flex Cycles, Trailing Sunlight and Oil Resistant
70257PU	4	42 x 0.10 mm	0.185	4.7	300 V	-50 to +80	UL AWM 20549	
70261PU	6	42 x 0.10 mm	0.236	6.0	300 V	-50 to +80	UL AWM 20549	2 Million Continuous Flex Cycles, Trailing Sunlight and Oil Resistant
Stranded BC Conductors • PETE Insulation • Special PUR • Halogen Free • LABS Free								
70269PU	4	42 x 0.10 mm	0.224	5.7	300 V	-50 to +80	UL AWM 20549	5 Million Continuous Flex Cycles Robot Cable: Trailing and Torsion Weldsplatter Resistant Sunlight and Oil Resistant

Copper Section 0.50 mm²

Stranded BC Conductors • PP Insulation • PUR Jacket • Halogen Free • LABS Free								
70258PU	3	16 x 0.20 mm	0.181	4.6	300 V	-50 to +80	UL AWM 20549	5 Million Continuous Flex Cycles, Trailing Sunlight and Oil Resistant
70259PU	5	16 x 0.20 mm	0.213	5.4	300 V	-50 to +80	UL AWM 20549	

BC = Bare Copper • PP = Polypropylene • PUR = Polyurethane • PETE = Polyethylene Terephthalate

Belden Sensor & Actuator Cables

PUR Distribution Boxes Cables



Part No.	Conductors	Stranding	OD (Nom)		Voltage	Temperature Fixed Installation (°C)	UL Style	Additional Features/Ratings
			Inch	mm				

Copper Section 0.50 mm² & 1.00 mm²

Stranded BC Conductors • PP Insulation • PUR Jacket • Halogen Free • LABS Free								
70260PU	12 x 0.50 mm ² & 3 x 1.00 mm ²	64 x 0.10 mm 128 x 0.10 mm	0.358	9.1	300 V	-25 to +80	UL AWM 20549	2 Million Continuous Flex Cycles, Trailing Sunlight and Oil Resistant
70266PU	16 x 0.50 mm ² & 3 x 1.00 mm ²	64 x 0.10 mm 128 x 0.10 mm	0.457	11.6	300 V	-25 to +80	UL AWM 20549	
70267PU	8 x 0.50 mm ² & 3 x 1.00 mm ²	64 x 0.10 mm 128 x 0.10 mm	0.366	9.3	300 V	-25 to +80	UL AWM 20549	

BC = Bare Copper • PP = Polypropylene • PUR = Polyurethane

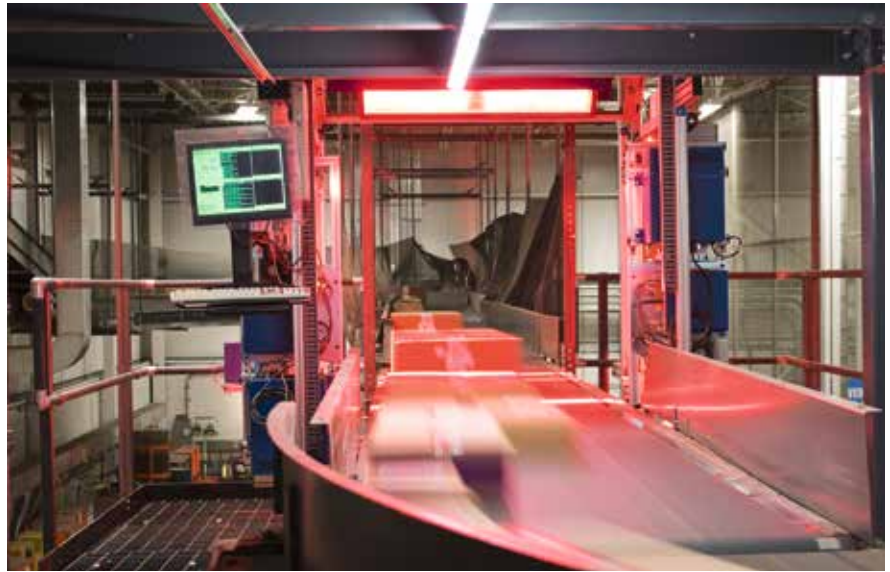

High performance cabling solutions have changed the face of modern production facilities.





Power & Control Hook-up & Lead Wire

Section Table of Contents

Power & Control	Page
Hook-up & Lead Wire	
Overview	170
Introduction: UL Style & CSA Type Listings	171
PVC	172–175
PVC Wire Dispenser Kits	176
GreenChoice™ PPO	177
TFE	178–179
EPDM	180–181
XL-DUR®	182
XL-DUR® (High-Temperature) and SIS (Switchboard) Wire	183
Chlorosulfonated Polyethylene	184–185
Neoprene	186
Silicone Rubber	187–188
Mercury Switch	189
High-Voltage Leads	189
Test Prod Wire	189
Magnet Wire	190
Shielding and Bonding Cable, Direct Burial Cable, Bus Bar, and Antenna Wire	191
Technical Information	192–198

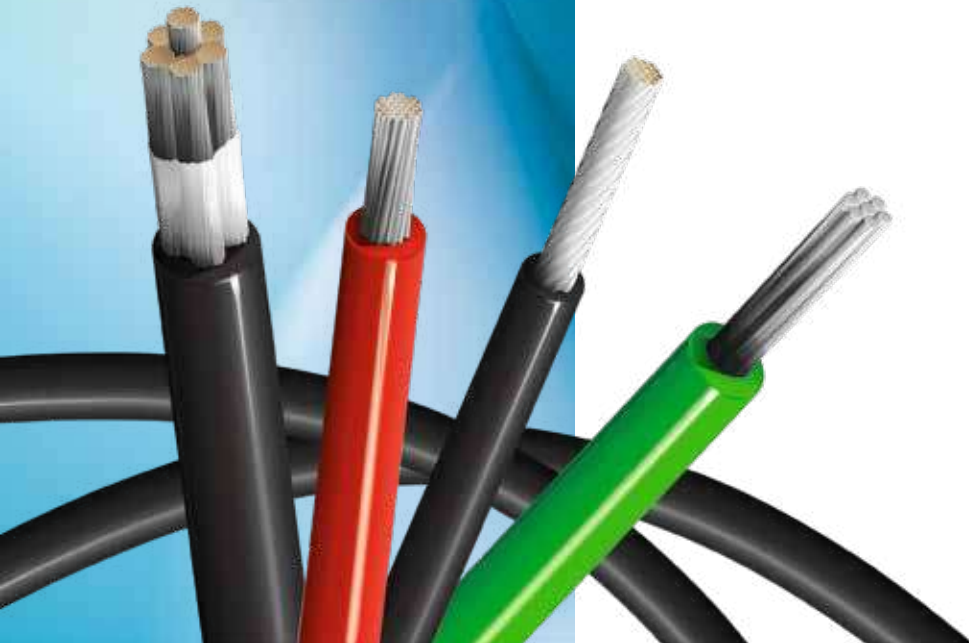

Hook-up & Lead Wire



Belden hook-up and lead wire products are manufactured in a variety of materials, sizes and designs to meet rigid industry and government specifications. Manufactured in-house, our hook-up and lead wire manufacturing process begins with copper rod.

Product Features

- Variety of jacket materials: PVC, FEP, Teflon, EPDM, XL-DUR, CSPE, Neoprene, Silicone rubber
- Temperature range up to +200 °C silicon
- Color stability
- Fast stripping
- Oil resistant
- UL approval

Benefits

Belden's rubber formulation and plastic mixing facilities give us complete control of the product from start to finish. As a result, consistent quality of these products is always assured.

Applications

Belden's hook-up and lead wire products can be used in a wealth of applications, including interconnection circuits, internal wiring of computer and data processing equipment, appliances, lighting, motor leads, heating and cooling equipment, harness fabrication, and automotive.



Introduction

CSPE and Neoprene Constructions

These constructions may require a special topcoat to facilitate printing by customers. Minimum order is 5000 feet per AWG. Please order the standard item and specify "Top-Coated" and specify color. Orders must be in multiples of standard packages.

Price and delivery information is available upon request.

Manufacturer's Identification

Identification of the hook-up and lead wire is provided by our UL and CSA file numbers or printed name on the wire jacket.

Manufacturer's Identification

UL/CSA	File Number	Style
UL	E-12683	1XXX, 2XXX, 3XXX, 4XXX, 5XXX
	E-53518	MTW
	E-6934	SF-1, SFF-1, SF-2, SFF-2
	E-3917	SIS
CSA	LL-7874	All Types

Index by UL Voltage and Temperature Rating

Hook-up & Lead Wire Section	Materials
300 V, +80 °C	PVC
300 V, +90 °C	Neoprene
300 V, +105 °C	Chlorosulfonated Polyethylene (CSPE)
	XL-DUR®
300 V, +200 °C	TFE
600 V, +90 °C	Neoprene
	SIS
600 V, +105 °C	CSPE
	PPO
	PVC
600 V, +125 °C	EPDM
	XL-DUR
600 V, +150 °C	EPDM
	Silicone Rubber, Braidless
	Silicone Rubber, Glass Braid
	Silicone Rubber, Mercury Switch Wire
	XL-DUR
600 V, +200 °C	Silicone Rubber, Braidless
	Silicone Rubber, Glass Braid
5000 V	CSPE
7500 V, +150 °C	EPDM

Appliance Wiring Material (AWM)

Appliance Wiring Material is Underwriter Laboratories, Inc.'s recognized covering of insulated wire and cable intended for internal wiring of appliances and equipment. Each construction satisfies the requirements for use in particular applications. Wiring materials recognized under this classification bear the "Underwriters' Appliance Wiring Material Label".

UL and CSA Type by Belden Series

UL Style	CSA Type	Belden Series Number	Temperature Rating, °C
1007	TR-64	328	+80
1015	TEW	327, 99, 89	+105
1028	TEW	99, 89	+105
1061	AWM	99	+80
1180	—	830	+200
1213	—	830	+105
1283	TEW	99	+105
1371	—	830	+105
1569	TRSR-64	99	+105
1855	—	—	+80
3044	CL902	315	+90
3046	CL903	315, 325	+90
3048	CL902	315	+90
3049	CL902	315	+90
3069	SEWF-2	308	+150
3070	SEWF-2	308	+150
3071	SEW-2	324	+200
3074	SEW-2	324	+200
3075	SEW-2	324	+200
3101	SEWF-2	308	+150
3123	—	340	+150
3125	SEW-2	308	+200
3126	SEW-2	308	+200
3135	—	334	+200
3173	CL1251	356	+125
3190	CL1052	349	+105
3191	CL1052	344	+105
3192	CL1052	344	+105
3193	CL1052	344	+105
3195	CL1251	356	+125
3196	CL1251	356	+125
3199	CL1054	357	+105
3212	AWM	333	+150
3213	AWM	333	+150
3214	AWM	333	+150
3239	—	—	+80
3321	AWM	354	+150
3340	CL1254	371	+150
3374	CL1254	371	+150
3436	CL1251	354	+150
3484	AWM	372	+125
3499	—	375	+150
11028	—	391	+105
SIS	—	310	+90

CSPE = Chlorosulfonated Polyethylene • EPDM = Ethylene-Propylene Diene Elastomer • PPO = Polyphenylene Oxide • PVC = Polyvinyl Chloride • PVDF = Polyvinylidene Fluoride • TFE = Tetrafluoroethylene

PVC

UL AWM Style 1061
300 V, +80 °C (UL & CSA)

- Tinned Copper Conductors
- Semi-rigid PVC Insulation
- CSA AWM



Solid conductors suitable for wire wrap applications

Part No.	AWG	Stranding	OD (Nom)		Insulation Thickness	
			Inch	mm	Inch	mm
9978	30	Solid	.030	.76	.010	.25
9987	30	7 x 38	.032	.81	.010	.25
9977	28	Solid	.033	.84	.010	.25
9986	28	7 x 36	.035	.89	.010	.25
9976	26	Solid	.036	.91	.010	.25
9985	26	7 x 34	.039	.99	.010	.25
9975	24	Solid	.040	1.02	.010	.25
9984	24	7 x 32	.044	1.12	.010	.25
9979	22	Solid	.047	1.19	.010	.25
9983	22	7 x 30	.050	1.27	.010	.25
9982	20	7 x 28	.057	1.45	.010	.25
9917	20	10 x 30	.056	1.42	.010	.25
9911	18	16 x 30	.067	1.70	.010	.25
9981	18	19 x 30	.066	1.68	.010	.25
9980	16	19 x 28	.078	1.98	.010	.25
9909	16	26 x 30	.080	2.03	.010	.25

For available colors and put-ups, see the on-line Belden Technical Data Sheet for the part number at www.belden.com

PVC

**UL AWM Style 1007
300 V, +80 °C (UL)**



- Tinned Copper Conductors
- PVC Insulation
- VW-1

Rated 2500 V peak for electronic circuits, and internal wiring of electronic and electrical equipment

Part No.	AWG	Stranding	OD (Nom)		Insulation Thickness	
			Inch	mm	Inch	mm
9930	30	7 x 38	.044	1.12	.015	.38

For available colors and put-ups, see the on-line Belden Technical Data Sheet for the part number at www.belden.com

**UL AWM Style 1007, 1569 • CSA Type TR-64, TRSR-64
Dual-Rated Wire • 300 V, +80/+105 °C (UL) • 300 V, +90/+105 °C (CSA)**



- Tinned Copper Conductors
- PVC Insulation
- VW-1

Rated 600 V peak for electronic circuits, and internal wiring of electronic and electrical equipment

Part No.	AWG	Stranding	OD (Nom)		Insulation Thickness	
			Inch	mm	Inch	mm
9928	28	7 x 36	.047	1.19	.015	.38
9926	26	7 x 34	.051	1.30	.015	.38
9923	24	7 x 32	.056	1.42	.015	.38
9921	22	7 x 30	.062	1.57	.015	.38
9919	20	7 x 28	.069	1.75	.015	.38
9920	20	10 x 30	.067	1.70	.015	.38
9918	18	16 x 30	.079	2.01	.015	.38
9916	16	26 x 30	.092	2.34	.015	.38
9989*	14	41 x 30	.110	2.79	.015	.38

* Not AWM Style 1007.

For available colors and put-ups, see the on-line Belden Technical Data Sheet for the part number at www.belden.com

**UL AWM Style 1007 • CSA Type TR-64
300 V, +80 °C (UL) • 300 V, +90 °C (CSA)**



- Uni-Strand® Tinned Copper Conductors
- PVC Insulation
- VW-1

Recommended Maximum Baking Cycles: 24 Hours @ +300 °F (+149 °C)

Part No.	AWG	Stranding	OD (Nom)		Insulation Thickness	
			Inch	mm	Inch	mm
32822	22	7 x 30	.062	1.58	.015	.38
32820	20	7 x 28	.068	1.73	.015	.38

For available colors and put-ups, see the on-line Belden Technical Data Sheet for the part number at www.belden.com

PVC = Polyvinyl Chloride

PVC

**UL AWM Style 1015 or 1230 • CSA Type TEW
600 V, +105 °C (UL & CSA)**



- Tinned Copper Conductors
- PVC Insulation
- UL Type MTW (except 9924)
- VW-1

Rated 2500 V peak for electronic circuits, and internal wiring of electronic and electrical equipment

Part No.	AWG	Stranding	OD (Nom)		Insulation Thickness	
			Inch	mm	Inch	mm
9924	24	7 x 32	.088	2.24	.030	.76
8920	22	7 x 30	.093	2.36	.030	.76
8919	20	10 x 30	.100	2.54	.030	.76
8918	18	16 x 30	.110	2.79	.030	.76
8915	18	Solid	.105	2.67	.030	.76
8917	16	26 x 30	.123	3.12	.030	.76
8916	14	41 x 30	.138	3.51	.030	.76
9912	12	65 x 30	.158	4.01	.030	.76
9910	10	65 x 28	.180	4.57	.030	.76
8910	10	105 x 30	.186	4.72	.030	.76

For available colors and put-ups, see the on-line Belden Technical Data Sheet for the part number at www.belden.com

**UL AWM Style 1015 • CSA Type TEW
600 V, +105 °C (UL & CSA)**



- Uni-Strand Tinned Copper Conductors
- PVC Insulation
- VW-1

Recommended Maximum Baking Cycles: 48 Hours @ +275 °F (+135 °C), 24 Hours @ +300 °F (+149 °C)

Part No.	AWG	Stranding	OD (Nom)		Insulation Thickness	
			Inch	mm	Inch	mm
32722	22	7 x 30	.093	2.36	.030	.76
32720	20	7 x 28	.099	2.52	.030	.76
32718	18	7 x 26	.108	2.74	.032	.80

For available colors and put-ups, see the on-line Belden Technical Data Sheet for the part number at www.belden.com

**UL AWM Style 1015, 1028 • CSA Type TEW
600 V, +105 °C (UL & CSA)**



- Tinned Copper Conductors
- PVC Insulation
- UL Type MTW
- VW-1

Part No.	AWG	Stranding	OD (Nom)		Insulation Thickness	
			Inch	mm	Inch	mm
9908	8	84 x 27	.250	6.35	.045	1.14
8908	8	133 x 29	.262	6.65	.045	1.14

For available colors and put-ups, see the on-line Belden Technical Data Sheet for the part number at www.belden.com

PVC = Polyvinyl Chloride

PVC

**UL AWM Style 1015, 1283 • CSA Type TEW
600 V, +105 °C (UL & CSA)**



- Tinned Copper Conductors
- PVC Insulation
- UL Type MTW
- VW-1

PVC insulation hook-up wire for internal wiring of meters, panels, and electrical or electronic equipment

Part No.	AWG	Stranding	OD (Nom)		Insulation Thickness	
			Inch	mm	Inch	mm
9906	6	133 x 27	.331	8.41	.060	1.52
9904	4	133 x 25	.392	9.96	.060	1.52

For available colors and put-ups, see the on-line Belden Technical Data Sheet for the part number at www.belden.com

**Type MW, MIL-W-76C-PVC
1000 V, +80 °C (MIL)**



- Tinned Copper Conductors
- PVC Insulation, Medium Wall
- Flame and Ozone Resistant
- Inert to Most Chemicals, Oils, and Solvents

PVC insulation hook-up wire for internal wiring of meters, panels, and electrical or electronic equipment

Part No.	AWG	Stranding	OD (Nom)		Insulation Thickness	
			Inch	mm	Inch	mm
8538	24	Solid	.055	1.40	.017	.43
8525	24	7 x 32	.058	1.47	.017	.43
8530	22	Solid	.059	1.50	.017	.43
8524	22	7 x 30	.064	1.63	.017	.43
8529	20	Solid	.066	1.68	.017	.43
8523	20	10 x 30	.070	1.78	.017	.43
8522	18	16 x 30	.080	2.03	.017	.43
8521	16	26 x 30	.098	2.49	.019	.48
8520	14	41 x 30	.111	2.82	.018	.46
8527	12	65 x 30	.128	3.25	.018	.46

For available colors and put-ups, see the on-line Belden Technical Data Sheet for the part number at www.belden.com

**Type B, MIL-W-16878/1-PVC
600 V, +105 °C (MIL)**



- Tinned Copper Conductors
- PVC Insulation

PVC insulation hook-up wire for internal wiring of meters, panels, and electrical or electronic equipment

Part No.	AWG	Stranding	OD (Nom)		Insulation Thickness	
			Inch	mm	Inch	mm
8597	28	7 x 32	.035	.89	.010	.035
8505	26	7 x 34	.039	.89	.010	.035
8504	24	7 x 32	.044	1.12	.010	.035
8503	22	7 x 30	.050	1.27	.010	.035
8502	20	7 x 28	.058	1.47	.010	.035
8501	18	7 x 26	.068	1.73	.010	.035
8500	16	19 x 29	.079	2.01	.010	.035

For available colors and put-ups, see the on-line Belden Technical Data Sheet for the part number at www.belden.com

PVC = Polyvinyl Chloride

PVC Wire Dispenser Kits

Wire Dispenser Kits



- Tinned Copper Conductors
- PVC Insulation

Great for R & D labs, engineers, service personnel, and hobbyists

Part No.	No. of Spools	Wire Part No.	Temp Rating	AWG	Stranding	Spool Lengths	
						Feet	Meters
8816	8	8522	+80 °C	18	16 x 30	25	7.6
8824	8	8523	+80 °C	20	10 x 30		
8825	5	8502	+105 °C	20	7 x 28	100	30.4
9531	5	8524	+80 °C	22	7 x 30		
8800	Rack Only						

For available colors and put-ups, see the on-line Belden Technical Data Sheet for the part number at www.belden.com

GreenChoice™ PPO

**UL AWM Style 11028
600 V, +105 °C**



- Stranded Tinned Copper Conductors
- Zero Halogen Polyphenylene Oxide (PPO) Insulation
- VW-1
- -40 °C

Part No.	AWG	Stranding	OD (Nom)		Insulation Thickness	
			Inch	mm	Inch	mm
39128	28	7 x 36	.039	0.99	.012	0.30
39126	26	7 x 34	.043	1.09	.012	0.30
39124	24	7 x 32	.048	1.22	.012	0.30
39122	22	7 x 30	.053	1.35	.012	0.30
39120	20	10 x 30	.061	1.55	.012	0.30
39118	18	16 x 30	.069	1.75	.012	0.30
39116	16	26 x 30	.083	2.11	.012	0.30
39114	14	41 x 30	.097	2.46	.012	0.30
39112	12	65 x 30	.111	2.82	.012	0.30
39110	10	105 x 30	.144	3.66	.012	0.30

For available colors and put-ups, see the on-line Belden Technical Data Sheet for the part number at www.belden.com

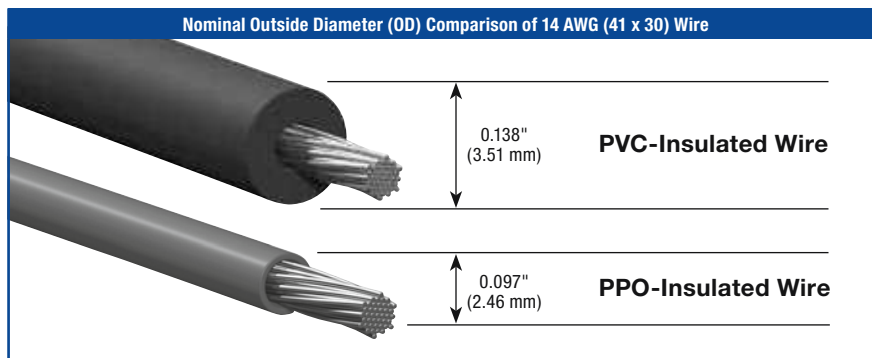

Polyphenylene oxide (PPO) insulation is nontoxic, nonpolluting, and recyclable. It has superior dielectric strength, and although it has thinner wall thickness than PVC, it provides a weight savings of up to 40%, 10 x better abrasion and pinch resistance, and a temperature rating of -40 °C to +105 °C.

PVC = Polyvinyl Chloride • PPO = Polyphenylene Oxide

TFE
High Temperature

UL AWM Style 1180 • Type EE, MIL-W-16878/5 TFE
300 V, +200 °C (UL) • 1000 V, +200 °C (MIL)



- Stranded Silver-Coated Conductors
- Extruded TFE Insulation
- VW-1

Part No.	AWG	Stranding	OD (Nom)		Insulation Thickness	
			Inch	mm	Inch	mm
83023*	24	19 x 36	.053	1.35	.015	.38
83025	22	7 x 30	.060	1.52	.015	.38
83026*	22	19 x 34	.059	1.50	.015	.38
83027*	20	19 x 32	.068	1.73	.015	.38
83028	20	7 x 28	.068	1.73	.015	.38
83029*	18	19 x 30	.077	1.96	.015	.38
83030*	16	19 x 29	.088	2.24	.015	.38

* Complies with MIL-W-16878 except stranding.
For available colors and put-ups, see the on-line Belden Technical Data Sheet for the part number at www.belden.com

UL AWM Style 1213 • Type E, MIL-W-16878/4 TFE
+105 °C (UL) • 600 V, +200 °C (MIL)



- Stranded Silver-Coated Conductors
- Extruded TFE Insulation
- VW-1

Part No.	AWG	Stranding	OD (Nom)		Insulation Thickness	
			Inch	mm	Inch	mm
83000	30	7 x 38	.032	.81	.010	.25
83001*	28	7 x 36	.035	.89	.010	.25
83002	26	7 x 34	.039	.99	.010	.25
83003*	24	19 x 36	.043	1.09	.010	.25
83004	24	7 x 32	.043	1.09	.010	.25
83005	22	7 x 30	.049	1.24	.010	.25
83006*	22	19 x 34	.048	1.22	.010	.25
83007*	20	19 x 32	.056	1.42	.010	.25
83008	20	7 x 28	.058	1.47	.010	.25

* Complies with MIL-W-16878 except stranding.
For available colors and put-ups, see the on-line Belden Technical Data Sheet for the part number at www.belden.com

TFE

High Temperature

**UL AWM Style 1371 • Type E, MIL-W-16878/4 TFE
+105 °C (UL) • 600 V, +200 °C (MIL)**



- Stranded Silver-Coated Copper Conductors
- Extruded TFE Insulation
- VW-1

Part No.	AWG	Stranding	OD (Nom)		Insulation Thickness	
			Inch	mm	Inch	mm
83009*	18	19 x 30	.068	1.73	.011	.28
83010*	16	19 x 29	.076	1.93	.012	.30

* Complies with MIL-W-16878 except stranding.
For available colors and put-ups, see the on-line Belden Technical Data Sheet for the part number at www.belden.com

**UL AWM Style 1371 • Type ET, MIL-W-16878/6 TFE
+105 °C (UL) • 250 V, +200 °C (MIL)**



- Stranded Silver-Coated Copper Conductors
- Extruded TFE Insulation
- VW-1

Part No.	AWG	Stranding	OD (Nom)		Insulation Thickness	
			Inch	mm	Inch	mm
83041	32	7 x 40	.022	.56	.006	.15
83043	30	7 x 38	.024	.61	.006	.15
83045	28	7 x 36	.027	.69	.006	.15
83046	26	7 x 34	.031	.79	.006	.15
83047	24	7 x 32	.036	.91	.006	.15
83048	24	19 x 36	.036	.91	.006	.15
83049	22	7 x 30	.042	1.07	.006	.15
83050	22	19 x 34	.042	1.07	.006	.15

For available colors and put-ups, see the on-line Belden Technical Data Sheet for the part number at www.belden.com

TFE = Tetrafluoroethylene

EPDM

High Temperature

UL AWM Style 3340, 3374**600 V, +125 °C Flex, +150 °C No Flex • CSA Type CL1254**

- Stranded Tinned Copper Conductors
- EPDM Insulation

Recommended for Class 130(B), 155(F) and also in some 180(H) systems
 Recommended maximum baking cycles: 24 hours @ +350 °F (+177 °C) • 4 hours @ +375 °F (+190 °C)

Part No.	AWG	Stranding	OD (Nom)		Insulation Thickness	
			Inch	mm	Inch	mm
37118	18	16 x 30	.142	3.61	.045	1.14
37116	16	26 x 30	.154	3.91	.045	1.14
37114	14	41 x 30	.169	4.29	.045	1.14
37112	12	65 x 30	.190	4.83	.045	1.14
37110	10	65 x 28	.240	6.10	.060	1.52
37108*	8	84 x 27	.327	8.31	.080	2.03
37106*	6	84 x 25	.383	9.73	.080	2.03
37104*	4	105 x 24	.432	10.97	.080	2.03
37103*	3	133 x 24	.453	11.51	.080	2.03
37102*	2	163 x 24	.494	12.55	.080	2.03
37101*	1	210 x 24	.583	14.81	.095	2.41
37190*	1/0	262 x 24	.633	16.08	.095	2.41
37100*	2/0	504 x 26	.698	17.73	.095	2.41
37130*	3/0	630 x 26	.758	19.25	.095	2.41
37140*	4/0	805 x 26	.849	21.57	.095	2.41

* Separator over conductor.

For available colors and put-ups, see the on-line Belden Technical Data Sheet for the part number at www.belden.com

EPDM
High Temperature

UL AWM Style 3484 • CSA Type AWM
600 V, +125 °C



- Stranded Tinned Copper Conductors
- EPDM Insulation
- Special Order

Part No.	AWG	Stranding	OD (Nom)		Insulation Thickness	
			Inch	mm	Inch	mm
37222	22	7 x 30	.093	2.36	.030	.76
37220	20	10 x 30	.102	2.59	.030	.76
37218	18	16 x 30	.109	2.77	.030	.76
37216	16	26 x 30	.123	3.12	.030	.76
37214	14	41 x 30	.138	3.51	.030	.76
37212	12	65 x 30	.158	4.01	.030	.76

For available colors and put-ups, see the on-line Belden Technical Data Sheet for the part number at www.belden.com

EPDM
High Voltage/High Temperature

UL AWM Style 3499
7500 V, +150 °C



- Stranded Tinned Copper Conductors
- EPDM Insulation
- Separator Over Conductor

Part No.	AWG	Stranding	OD (Nom)		Insulation Thickness	
			Inch	mm	Inch	mm
37508	8	84 x 27	.423	10.74	.125	3.18
37506	6	84 x 25	.470	11.94	.125	3.18
37504	4	105 x 24	.526	13.36	.125	3.18
37502	2	163 x 24	.581	14.76	.125	3.18
37501	1	210 x 24	.638	16.21	.125	3.18
37590	1/0	262 x 24	.688	17.48	.125	3.18
37500	2/0	504 x 26	.753	19.13	.125	3.18
37530	3/0	630 x 26	.813	20.65	.125	3.18
37540	4/0	805 x 26	.909	23.09	.125	3.18

Separator over conductor.

For available colors and put-ups, see the on-line Belden Technical Data Sheet for the part number at www.belden.com

EPDM = Ethylene-Propylene Diene Elastomer

XL-DUR®

XL-DUR insulation is a chemically cross-linked poly applied in a single extrusion, offering excellent thermal aging characteristics, moisture resistance, and solvent resistance. It provides an economic alternative to CSPE where extreme flexibility is not required. The insulation resists deformation when subjected to momentary high temperatures in customer assembly processes.

UL AWM Style 3199 • CSA Type CL1054 300 V, +105 °C



- Stranded Tinned Copper Conductors
- XL-DUR Insulation

Recommended maximum baking cycles: 24 hours @ +300 °F (+149 °C), 12 hours @ +325 °F (+163 °C), 8 hours @ +350 °F (+177 °C)

Part No.	AWG	Stranding	OD (Nom)		Insulation Thickness	
			Inch	mm	Inch	mm
35722	22	7 x 30	.062	1.58	.015	.38
35720	20	10 x 30	.073	1.85	.015	.38
35718	18	19 x 30.5	.078	1.98	.015	.38
35716	16	19 x 29	.091	2.31	.015	.38

For available colors and put-ups, see the on-line Belden Technical Data Sheet for the part number at www.belden.com

UL AWM Styles 3173, 3195, 3196 • CSA Type CL1251 600 V, +125 °C



- Stranded Tinned Copper Conductors
- XL-DUR Insulation

The 356 series is recommended for Class 130(B) as motor leads

Recommended maximum baking cycles: 24 hours @ +300 °F (+149 °C), 12 hours @ +325 °F (+163 °C), 8 hours @ +350 °F (+177 °C)

Part No.	AWG	Stranding	OD (Nom)		Insulation Thickness	
			Inch	mm	Inch	mm
UL AWM Style 3173						
35622	22	7 x 30	.093	2.36	.030	.76
35620	20	10 x 30	.101	2.57	.030	.76
35618	18	16 x 30	.109	2.77	.030	.76
35616	16	26 x 30	.122	3.10	.030	.76
35614	14	41 x 30	.137	3.48	.030	.76
35612	12	65 x 30	.153	3.89	.030	.76
35610	10	65 x 28	.177	4.50	.030	.76
UL AWM Style 3195 • Separator Over Conductor						
35608*	8	133 x 29	.263	6.68	.045	1.14
UL AWM Style 3196 • Separator Over Conductor						
35606*	6	133 x 27	.333	8.46	.060	1.52

* Separator over conductor.

For available colors and put-ups, see the on-line Belden Technical Data Sheet for the part number at www.belden.com

XL-DUR® (High-Temperature) and SIS (Switchboard) Wire

UL AWM Style 3436 and 3321 • CSA Type CL1251 •
CSA AWM • 600 V, +150 °C



- Stranded Tinned Copper Conductors
- XL-DUR Insulation

Part No.	AWG	Stranding	OD (Nom)		Insulation Thickness	
			Inch	mm	Inch	mm
35420	20	10 x 30	.102	2.59	.030	.76
35418	18	16 x 30	.110	2.79	.030	.76
35416	16	26 x 30	.123	3.12	.030	.76
35414	14	41 x 30	.138	3.51	.030	.76
35412	12	65 x 30	.153	3.89	.030	.76
35410	10	65 x 28	.177	4.50	.030	.76

For available colors and put-ups, see the on-line Belden Technical Data Sheet for the part number at www.belden.com

UL Type SIS
600 V, +150 °C



- Stranded Tinned Copper Conductors
- XL-DUR Insulation
- VW-1 only on 31014, 31012, 31010
- Separator Over Conductor

Part No.	AWG	Stranding	OD (Nom)		Insulation Thickness	
			Inch	mm	Inch	mm
31014	14	41 x 30	.144	3.66	.030	.76
31012	12	65 x 30	.167	4.24	.030	.76
31010	10	65 x 28	.184	4.67	.030	.76
31014N	14	41 x 30	.144	3.66	.030	.76
31012N	12	65 x 30	.167	4.24	.030	.76
31010N	10	65 x 28	.184	4.67	.030	.76
31008N	8	133 x 29	.268	6.75	.045	1.14

Separator over conductor.

For available colors and put-ups, see the on-line Belden Technical Data Sheet for the part number at www.belden.com

Chlorosulfonated Polyethylene

Chlorosulfonated polyethylene insulation has excellent heat resistance, color stability and electrical properties. CSPE is recommended for motor leads for Class 130(B) insulation systems. It may be considered as an alternative to silicone rubber to withstand +155 °C varnish baking temperatures, but is not suitable for operating temperatures above Class 130(B).

UL AWM Style 3191, 3192, 3193 CSA Type CL1053 (18–12 AWG), CL1052 (10–4/0 AWG) 600 V, +105 °C • 300 V, +105 °C (CL1052)



- Stranded Tinned Copper Conductors
- CSPE Insulation
- Separator Over Conductor (8 AWG & larger)

Recommended maximum baking cycles: 24 hours @ +300 °F (+149 °C)

Part No.	AWG	Stranding	OD (Nom)		Insulation Thickness	
			Inch	mm	Inch	mm
UL AWM Style 3191 (600 V, +105 °C) • CSA Type CL1053						
34418	18	16 x 30	.142	3.61	.045	1.14
34416	16	26 x 30	1.55	3.94	.045	1.14
34414	14	41 x 30	1.70	4.32	.045	1.14
34412	12	65 x 30	1.90	4.83	.045	1.14
UL AWM Style 3191 • CSA Type CL1052**						
34410	10	65 x 28	.209	5.31	.045	1.14
UL AWM Style 3192 • CSA Type CL1052**						
34408*	8	84 x 27	.290	7.37	.060	1.52
34406*	6	84 x 25	.343	8.71	.060	1.52
34404*	4	105 x 24	.399	10.14	.060	1.52
34403*	3	133 x 24	.420	10.69	.060	1.52
34402*	2	163 x 24	.445	11.53	.060	1.52
UL AWM Style 3193 • CSA Type CL1052**						
34401*	1	210 x 24	.557	14.15	.080	2.03
34490*	1/0	262 x 24	.607	15.42	.080	2.03
34400*	2/0	504 x 26	.668	16.97	.080	2.03
34430	3/0	630 x 26	.732	18.59	.080	2.03
34440	4/0	805 x 26	.819	20.80	.080	2.03

* Separator over conductor.

** CSA requires additional wall thickness in sizes 10 AWG and larger to meet CL1053 requirements.

For available colors and put-ups, see the on-line Belden Technical Data Sheet for the part number at www.belden.com

UL AWM Style 3190 • CSA Type CL1052 300 V, +105 °C (UL & CSA)



- Stranded Tinned Copper Conductors
- CSPE Insulation

Part No.	AWG	Stranding	OD (Nom)		Insulation Thickness	
			Inch	mm	Inch	mm
34922	22	7 x 30	.093	2.36	.030	.76
34920	20	10 x 30	.100	2.54	.030	.76
34918	18	16 x 30	.110	2.79	.030	.76
34916	16	26 x 30	.123	3.12	.030	.76
34914	14	41 x 30	.138	3.51	.030	.76

For available colors and put-ups, see the on-line Belden Technical Data Sheet for the part number at www.belden.com

CSPE = Chlorosulfonated Polyethylene

Chlorosulfonated Polyethylene

5000 V High Voltage



- Stranded Tinned Copper Conductors
- CSPE Insulation
- Separator Over Conductor

Part No.	AWG	Stranding	OD (Nom)		Insulation Thickness	
			Inch	mm	Inch	mm
36108	8	84 x 27	.480	12.19	.150	3.81
36106	6	84 x 25	.532	13.51	.150	3.81
36104	4	105 x 24	.588	14.94	.150	3.81
36102	2	163 x 24	.643	16.33	.150	3.81
36101	1	210 x 24	.700	17.78	.150	3.81
36190	1/0	262 x 24	.750	19.05	.150	3.81
36100	2/0	504 x 26	.815	20.70	.150	3.81
36140	4/0	805 x 26	.959	24.36	.150	3.81

Separator over conductor.

For available colors and put-ups, see the on-line Belden Technical Data Sheet for the part number at www.belden.com

Neoprene

UL AWM Style 3044 • CSA Type CL902 300 V, +90 °C (UL & CSA)



- Stranded Tinned Copper Conductors
- Neoprene Insulation

Recommended maximum baking cycles: 24 hours @ +300 °F (+149 °C), 8 hours @ +325 °F (+163 °C), 15 minutes @ +450 °F (+232 °C)

Part No.	AWG	Stranding	OD (Nom)		Insulation Thickness	
			Inch	mm	Inch	mm
31520	20	10 x 30	.100	2.54	.030	.76
31518	18	16 x 30	.109	2.77	.030	.76
31516	16	26 x 30	.122	3.10	.030	.76

For available colors and put-ups, see the on-line Belden Technical Data Sheet for the part number at www.belden.com

UL AWM Style 3046, 3048 • CSA Type CL903 600 V, +90 °C (UL & CSA)



- Stranded Tinned Copper Conductors
- Neoprene Insulation
- Separator Over Conductor (8 AWG and Larger)

Part No.	AWG	Stranding	OD (Nom)		Insulation Thickness	
			Inch	mm	Inch	mm
UL AWM Style 3046 • CSA Type CL903						
32518	18	16 x 30	.142	3.61	.045	1.14
32516	16	26 x 30	.155	3.94	.045	1.14
31514	14	41 x 30	.169	4.29	.045	1.14
31512	12	65 x 30	.190	4.83	.045	1.14
UL AWM Style 3046						
31510	10	65 x 28	.209	5.31	.045	1.14
UL AWM Style 3048						
31508	8	84 x 27	.285	7.24	.060	1.52
31506	6	84 x 25	.343	8.71	.060	1.52
31504	4	105 x 24	.399	10.14	.060	1.52
31502	2	163 x 24	.454	11.53	.060	1.52

For available colors and put-ups, see the on-line Belden Technical Data Sheet for the part number at www.belden.com

Silicone Rubber
Braidless

UL AWM Styles 3212, 3213, 3214 • CSA Type AWM
600 V, +150 °C (UL & CSA)



- Stranded Tinned Copper Conductors
- Silicone Rubber Insulation
- Separator Over Conductor (8 AWG and Larger)
- Easy and Clean Stripping
- Excellent Physical and Mechanical Strength

Recommended for applications requiring Class 155(F) or Class 180(H) materials and high-temperature applications in motors, lighting fixtures, clothes dryers, stoves, therapeutic and electronic devices.
Recommended maximum baking cycles: 24 hours @ +410 °F (+210 °C)

Part No.	AWG	Stranding	OD (Nom)		Insulation Thickness	
			Inch	mm	Inch	mm
UL AWM Style 3212 • CSA Type AWM						
33322**	22	7 x 30	.125	3.18	.045	1.14
33320**	20	10 x 30	.132	3.53	.045	1.14
33318	18	16 x 30	.142	3.61	.045	1.14
33316	16	26 x 30	.155	3.94	.045	1.14
33314	14	41 x 30	.170	4.32	.045	1.14
33312	12	65 x 30	.190	4.83	.045	1.14
33310	10	65 x 28	.209	5.31	.045	1.14
UL AWM Style 3213 • CSA Type AWM						
33308*	8	84 x 27	.283	7.19	.060	1.52
33306*	6	84 x 25	.334	8.48	.060	1.52
33304*	4	105 x 24	.390	9.91	.060	1.52
33302*	2	163 x 24	.457	11.61	.060	1.52
UL AWM Style 3214 • CSA Type AWM						
33390*	1/0	262 x 24	.594	15.09	.080	2.03

* Separator over conductor.

** Special Order Only.

For available colors and put-ups, see the on-line Belden Technical Data Sheet for the part number at www.belden.com

UL AWM Style 3135
600 V, +200 °C (UL)



- Stranded Tinned Copper Conductors
- Silicone Rubber Insulation
- Special Order Only

The 334 Series is for use only in totally enclosed systems.
Recommended maximum baking cycles: 24 hours @ +410 °F (+210 °C)

Part No.	AWG	Stranding	OD (Nom)		Insulation Thickness	
			Inch	mm	Inch	mm
33418	18	7 x 26	.111	2.82	.030	.76
33416	16	7 x 24	.123	3.12	.030	.76
33414	14	7 x 22	.139	3.53	.030	.76

For available colors and put-ups, see the on-line Belden Technical Data Sheet for the part number at www.belden.com

Silicone Rubber

Glass Braid

UL AWM Styles 3069, 3070, 3101 • CSA Type SEWF-2 600 V, +150 °C (UL & CSA)



- Stranded Tinned Copper Conductors
- Glass Braided Silicone Rubber Insulation
- VW-1

Recommended maximum baking cycles: 24 hours @ +410 °F (+210 °C)

Part No.	AWG	Stranding	OD (Nom)		Insulation Thickness	
			Inch	mm	Inch	mm
UL AWM Style 3069 • CSA Type SEWF-2						
30820	20	10 x 30	.122	3.10	.030	.76
UL AWM Style 3070 • CSA Type SEWF-2						
30818	18	16 x 30	.132	3.35	.030	.76
30816	16	26 x 30	.145	3.68	.030	.76
30814	14	41 x 30	.164	4.17	.030	.76
30812	12	65 x 30	.186	4.72	.030	.76
UL AWM Style 3101 • CSA Type SEWF-2						
30810	10	65 x 28	.239	6.07	.045	1.14

For available colors and put-ups, see the on-line Belden Technical Data Sheet for the part number at www.belden.com

UL AWM Styles 3071, 3074, 3075, 3125, 3126 • CSA Type SEW-2 600 V, +200 °C (UL & CSA)



- Stranded Tinned Copper Conductors
- Glass Braided Silicone Rubber Insulation
- Separator Over Conductors (8 AWG and Larger)
- VW-1
- Glass Braid Provides Additional Abrasion Resistance and Is Treated to Prevent Fraying

Recommended for high-temperature applications in motors, lighting fixtures, clothes dryers, stoves, therapeutic and electronic devices. These wires can be used with Class 130(B), 155(F) or 180(H) insulation systems. Recommended maximum baking cycles: 24 hours @ +410 °F (+210 °C)

Part No.	AWG	Stranding	OD (Nom)		Insulation Thickness	
			Inch	mm	Inch	mm
UL AWM Style 3071 • CSA Type SEW-2						
32418	18	7 x 26	.133	3.38	.030	.76
32416	16	7 x 24	.145	3.68	.030	.76
32414	14	7 x 22	.167	4.24	.030	.76
UL AWM Style 3074 • CSA Type SEW-2						
32412	12	19 x 24.5	.190	4.83	.030	.76
UL AWM Style 3075 • CSA Type SEW-2						
32410	10	19 x 22.5	.238	6.05	.045	1.14
UL AWM Style 3125 • CSA Type SEW-2						
30808	8	54 x 25	.313	7.95	.060	1.52
30806	6	84 x 25	.368	9.35	.060	1.52
30804	4	105 x 24	.424	10.77	.060	1.52
30802	2	163 x 24	.496	12.60	.060	1.52
UL AWM Style 3126 • CSA Type SEW-2						
30801	1	210 x 24	.622	15.80	.080	2.03
30890	1/0	262 x 24	.670	17.02	.080	2.03
30800	2/0	504 x 26	.727	18.47	.080	2.03
30830	3/0	630 x 26	.795	20.19	.080	2.03
30840	4/0	266 x 21	.779	19.79	.080	2.03

For available colors and put-ups, see the on-line Belden Technical Data Sheet for the part number at www.belden.com

Mercury Switch

UL AWM Style 3123 Mercury Switch • 600 V, +150 °C (UL)



- Stranded Tinned Copper Conductors
- Silicone Rubber Insulation

Part No.	AWG	Stranding	OD (Nom)		Insulation Thickness	
			Inch	mm	Inch	mm
34020	20	105 x 40	.110	2.79	.030	.76
34017	17	210 x 40	.118	3.00	.030	.76

For available colors and put-ups, see the on-line Belden Technical Data Sheet for the part number at www.belden.com

High-Voltage Leads



- Stranded Tinned Copper Conductors
- Polyethylene Insulation
- PVC Jacket, Red or Black
- Conductive Polyethylene (Korona-Guard) Over Inner Conductor Provides Uniform Distribution of Voltage Stresses
- +80 °C

Part No.	AWG	Stranding	OD (Nom)		Insulation Thickness		Suggested Working Voltage (VDC)	Breakdown Voltage (VDC)
			Inch	mm	Inch	mm		
8868	22	7 x 30	.150	3.81	.044	1.12	24,000	48,000
8869	22	7 x 30	.120	3.05	.027	.69	17,000	35,000
9867*	20	7 x 28	.191	4.85	.046	1.17	30,000	60,000
8866	18	16 x 30	.208	5.28	.057	1.45	40,000	80,000

* UL AWM Style 3239 (30,000 V DC, +80 °C), VW-1.

For available colors and put-ups, see the on-line Belden Technical Data Sheet for the part number at www.belden.com

Test Prod Wire



- Stranded Tinned Copper Conductors

Part No.	AWG	Stranding	OD (Nom)		Insulation Thickness		Suggested Working Voltage (VDC)	Breakdown Voltage (VDC)
			Inch	mm	Inch	mm		
5000 V, +90 °C • Rubber Insulation								
8899	18	65 x 36	.144	3.66	.045	1.14	5000	20,000
5000 V, +80 °C • Rubber Insulation • Manufactured for MIL-W-13169B								
8897	18	65 x 36	.144	3.66	.045	1.14	5000	20,000
5000 V, +80 °C • PVC Insulation • UL AWM Style 1855								
9899	18	65 x 36	.144	3.66	.048	1.22	5000	—
10,000 V, +90 °C • Rubber Insulation								
8898	18	65 x 36	.229	5.82	.088	2.24	10,000	29,000
1000 V, +90 °C • Rubber Insulation • Miniature Cable								
8890	24	45 x 40	.066	1.68	.019	.48	1000	10,000

For available colors and put-ups, see the on-line Belden Technical Data Sheet for the part number at www.belden.com

PVC = Polyvinyl Chloride

Magnet Wire

Class 200 • One Pound Spool



- Bare Copper Conductor
- Cross-Linked Polyester Base Coat
- Amide-imide Polymer Top Coat
- +200 °C
- LJ-W-1177/14
- MW 35-C (Heavy) or MW 74-C (Heavy)

Class 200 magnet wire offers exceptional ability to resist solvents and abuse in difficult windings

Part No.	AWG (Solid)	Approximate Length		Turns per Linear Inch	Turns per Square Inch
		Feet	Meters		
8085*	38	19,300	5882.7	206.0	42,436
8083	34	7860	2395.8	133.1	17,716
8081	30	3140	957.1	86.2	7430
8080	28	1990	606.6	69.4	4816
8079	26	1260	384.1	55.7	3102
8078	24	793	241.7	44.7	1998
8077	22	501	152.7	36.0	1296
8076	20	315	96.0	28.9	835
8075	18	199	60.7	23.2	538
8074	16	126	38.4	18.6	346
8073	14	80	24.4	14.9	222

For available colors and put-ups, see the on-line Belden Technical Data Sheet for the part number at www.belden.com

Single Beldsol™ Solderable • Half Pound Spool



- Bare Copper Conductor
- Polyurethane Base Coat
- Nylon Top Coat
- J-W-1177/9
- MW 28-C (Single)
- Rated by IEEE Tests for +270 °F Usage
- Solders without Insulation Removal at +750 °F
- Solvent Resistant

Part No.	AWG (Solid)	Approximate Length		Turns per Linear Inch	Turns per Square Inch
		Feet	Meters		
8058	36	6400	1950.7	180.0	32,400
8057	34	4060	1237.5	144.0	20,736
8056	32	2515	766.6	114.0	12,996
8055	30	1615	492.3	91.7	8409
8054	28	1020	310.9	73.8	5446
8053	26	645	196.6	59.0	3481
8052	24	404	123.1	46.9	2200
8051	22	254	77.4	37.5	1406
8050	20	160	48.8	29.9	894
8049	18	100	30.5	23.9	571

For available colors and put-ups, see the on-line Belden Technical Data Sheet for the part number at www.belden.com

Shielding and Bonding Cable, Direct Burial Cable, Bus Bar, and Antenna Wire

Shielding and Bonding Cable

- Braided Tinned Copper



Part No.	AWG	Stranding	Approximate Circular Area		Nominal ID Tubular		Recommended Max. Current (Amps)
			CMA	mm ²	Inch	mm	
8660	14.3	96 x 34	3800	1.92	.125	3.18	27.0
8668	13.3	120 x 34	4800	2.43	.172	4.37	36.0
8663	11.9	168 x 34	6700	3.40	.219	5.56	38.0
8661	11.3	192 x 34	7600	3.85	.203	5.16	46.0
8669	8.9	336 x 34	13300	6.74	.500	12.70	62.0
8662	6.6	576 x 34	22900	11.60	.781	19.84	80.0
8670	3.4	480 x 30	48000	24.32	.750 Flat Width	19.05 Flat Width	145.0

Note: Dimensions and wire gauge shown are approximate, due to pliable nature of braided cables.
For available colors and put-ups, see the on-line Belden Technical Data Sheet for the part number at www.belden.com

Direct Burial



- Stranded Tinned Copper Conductors
- High-Density Polyethylene Insulation, Black

Part No.	AWG	Stranding	OD (Nom)		Insulation Thickness		Suggested Working Voltage (VDC)
			Inch	mm	Inch	mm	
9438	14	104 x 34	.139	3.53	.032	.81	600

For available colors and put-ups, see the on-line Belden Technical Data Sheet for the part number at www.belden.com

Bus Bar Wire



- Solid Tinned Copper Conductors
- QQ-W-343G
- QQ-W-343S_S1T (on request)

Part No.	AWG	OD (Nom)		Circular Area	
		Inch	mm	CMA	mm ²
8025	30	.010	.26	102	.05
8024	28	.013	.33	164	.08
8023	26	.016	.41	262	.13
8022	24	.021	.52	424	.22
8021	22	.026	.65	650	.33
8020	20	.033	.83	1056	.54
8019	18	.041	1.03	1648	.84
8013	16	.052	1.31	2673	1.35
8012	14	.065	1.66	4251	2.15
8011	12	.083	2.11	6872	3.48

For available colors and put-ups, see the on-line Belden Technical Data Sheet for the part number at www.belden.com

Antenna Wire

- Stranded Copper-Covered Steel



Part No.	AWG	Stranding	OD (Nom)	
			Inch	mm
8000	14	7 x 22	.076	1.93

For available colors and put-ups, see the on-line Belden Technical Data Sheet for the part number at www.belden.com

Technical Information

Conductor and Insulation Materials

Tough Cables for Tough Environments

The technical information provided in this section has been expanded to include additional graphs and supplementary data as an aid in specifying the hook-up and lead wire best suited to the needs of a particular application. If you require additional technical information, contact Belden Technical Support.

The tables on the following pages are offered as a guide to assist users in selecting the correct lead wire for their application.

Conductors

Uni-Strand®

Uni-Strand tinned copper conductor. In this type of construction, the bare copper wires are stranded, then tinned to coat the strands and also to fill in the interstices between strands. This allows for easier wire stripping with no re-twisting operation.

Insulation Materials

PVC

Vinyl plastic insulation is fast stripping, and resists oil, solvents, and ozone. The colors are bright and remain distinct after processing. Applications include motors, transformers, fluorescent ballasts and fixtures, switchboards, panels, controls, rectifiers and electronic circuits. Meets VW-1 Vertical Wire Flame Test in many cases.

TFE

TFE is a fluorinated thermoplastic with outstanding thermal, physical, and electrical properties. TFE is generally restricted to applications requiring its special characteristics because its basic resin and processing costs are relatively high.

Belden Teflon wire products are highly recommended for miniature cable applications because of their superior thermal and electrical properties. Teflon is especially suitable for internal wiring-soldering applications where insulation meltback is a specific problem. Belden wiring products insulated with Teflon are outstanding in their resistance to oil, oxidation, heat, sunlight and flame; and also in their ability to remain flexible at low temperatures. They have excellent resistance to ozone, water, alcohol, gasoline, acids, alkalis, aromatic hydrocarbons and solvents.

EPDM

EPDM (ethylene-propylene diene monomer) is a chemically cross-linked elastomer with excellent flexibility at high and low temperatures (+150 °C to -60 °C). It has good insulation and dielectric strength, as well as excellent abrasion resistance and mechanical properties. EPDM also has better cut-through resistance than silicone rubber, which it replaces in some applications.

EPDM is compatible with most varnishes. After the dip and bake cycle, however, the varnish tends to adhere to the insulation because EPDM, unlike some rubber insulations, does not exude oils or waxes.

As the lead wires are pulled apart for termination or flexed, the varnish cracks, sometimes tearing the insulation.

To help this problem, a stearic solution is applied to the lead wire during the manufacturing process. However, many varnishes may still bond to the insulation unless other special coatings are applied. (Other slip coats are available at additional cost.) Because most cleaning processes will remove these coatings from the EPDM lead wire, cleaning EPDM lead wire before using in the process is not recommended.

Due to the above, it is recommended that the compatibility between the individual lead wire size, the bake/varnish process and varnish used always be checked and, if possible, do not allow any varnish to extend beyond a point where the lead wire will be flexed or bent.

XL-DUR®

XL-DUR is a lead wire insulation using thermoset, chemically XLP. Because of its excellent physical and electrical properties, XL-DUR is highly desirable for a wide variety of applications.

CSPE

Chlorosulfonated polyethylene insulation has excellent heat resistance, color stability and electrical properties.

Neoprene

Neoprene insulation has good heat aging characteristics and is an excellent motor lead wire. It may be considered for use in hazardous locations and is being used in explosion-proof motors recognized by UL.

Silicone Rubber

Braidless silicone lead wire features easy and clean stripping without the problems associated with glass braid lead wire. It has excellent physical and mechanical strength properties. It is recommended for high-temperature applications in motors, lighting fixtures, clothes dryers, stoves, therapeutic, and electronic devices. Varnish compatibility should be checked before production. Some rigid varnishes may cause cracking when the wire is severely bent.

Silicone Rubber – Glass Braid

The silicone insulation strips clean and easy. The glass braid provides additional abrasion resistance and is treated to prevent fraying. Recommended for high-temperature applications in motors, lighting fixtures, clothes dryers, stoves, therapeutic and electronic devices.

PPO

Polyphenylene oxide (PPO) has superior dielectric properties to enable a thinner wall thickness and an outside diameter that is up to 45% smaller and significantly lighter than conventional PVC-insulated wire. PPO-based wires offer the same electrical properties as PVC wires with a voltage rating of 600 V. Strong and flexible, PPO offers 10x the abrasion and pinch resistance of PVC. In addition, PPO insulation contains no halogens, phthalates, or heavy metals, allowing it to be burned or easily recycled.

Technical Information

Insulation Characteristics and Color Codes

How to Use

The choice of an appropriate conductor, with respect to current carrying capacity, usually depends on one or more factors which vary according to application. These factors include the temperature in which the lead wire operates, temperature rise of equipment, limitations of insulation, voltage drop, and location of wires as in free air or enclosed, such as formed by a compartment, tubing, or a bundle of wires.

For these reasons it is not practical to provide a general chart showing the current carrying capacity of lead wire for all conditions. Accordingly, the values shown in Table 3 are MAXIMUM for a single conductor in free air, based on ambient temperature of +30 °C. For actual use temperatures above an ambient temperature of +30 °C, reduce the maximum ampacity by use of correction factor in Table 5 to correct the values in Table 3 and Table 4.

Table 1: Insulation Characteristics

Insulation	Temperature Rating, °C	UL Voltage Rating (Volts)	Oil Resistance	Ozone Resistance	Abrasion	Flame Resistance
Neoprene	90	300/600	Good	Good	Good	Good
PVC	80	300	Good-Excellent	Good-Excellent	Good	Excellent
	105	600	Good-Excellent	Good-Excellent	Good	Excellent
CSPE	105	300/600	Good	Excellent	Good	Good
PPO	105	600	—	—	—	—
	105	300	Good	Good	Excellent	Fair-Good
XL-DUR® XLP	125	600	Good	Good	Excellent	Fair-Good
	150	600	Good	Good	Excellent	Fair-Good
EPDM	125	600	Fair-Poor	Good	Good	Fair
	150	600	Fair-Poor	Good	Good	Fair
Silicone Rubber	150	300	Fair	Good	Poor	Good
	200	600	Fair	Good	Poor	Good
Silicone Rubber Glass Braid	150	600	Fair	Excellent	Excellent	Good
	200	600	Fair	Excellent	Excellent	Good
TFE	150	300	Excellent	Excellent	Excellent	Excellent
	200	300	Excellent	Excellent	Excellent	Excellent
	260	300	Excellent	Excellent	Excellent	Excellent

For available colors and put-ups, see the on-line Belden Technical Data Sheet for the part number at www.belden.com

Table 2: Lead Wire Color Chart

Color No.	Color Combination	Color No.	Color Combination	Color No.	Color Combination
1	Brown	13	Dark Blue	25	White/Black/Yellow
2	Red	14	White/Black	26	White/Black/Blue
3	Orange	15	White/Red	27	White/Black/Brown
4	Yellow	16	White/Green	28	White/Black/Orange
5	Green	17	White/Yellow	29	White/Black/Gray
6	Light Blue	18	White/Blue	30	White/Black/Purple
7	Purple	19	White/Brown	189	Green/Yellow
8	Gray	20	White/Orange	620	Green/min 30% Yellow
9	White	21	White/Gray	876	Nickel Gray
10	Black	22	White/Purple	B02	Purple
11	Tan	23	White/Black/Red	—	—
12	Pink	24	White/Black/Green	—	—

For available colors and put-ups, see the on-line Belden Technical Data Sheet for the part number at www.belden.com

Technical Information
Current Carrying Capacity

Table 3: Lead Wire Current Carrying Capacity

AWG	+90 °C Neoprene, SIS	+105 °C Vinyl, GSPE, PPO	+125 °C XL-DUR®	+150 °C EPDM, XL-DUR®, Silicone	+200 °C Silicone
22	10	11	12	14	16
20	13	14	15	18	21
18	18	20	22	24	28
16	24	26	28	31	35
14	35	39	42	46	54
12	40	51	55	60	68
10	55	67	72	80	90
8	80	90	97	106	124
6	105	121	131	155	165
4	140	160	172	190	220
3	165	180	194	214	252
2	190	215	232	255	293
1	220	247	266	293	344
1/0	260	286	309	339	399
2/0	300	329	355	390	467
3/0	350	380	410	451	546
4/0	405	446	481	529	629

Values (amperes) shown in this table are maximum for a single conductor in free air with an assumed ambient room temperature of +30 °C (+86 °F). For available colors and put-ups, see the on-line Belden Technical Data Sheet for the part number at www.belden.com

Table 4: Current Carrying Capacity of 2 or 3 Conductors

AWG	+90 °C Neoprene, SIS	+105 °C Vinyl, GSPE, PPO	+125 °C XL-DUR	+150 °C EPDM, XL-DUR, Silicone	+200 °C Silicone
22	6	7	8	9	10
20	8	9	10	10	15
18	14	15	16	17	20
16	18	19	20	22	25
14	25	29	31	34	36
12	30	36	39	43	45
10	40	46	50	55	60
8	55	64	69	76	83
6	75	81	87	96	110
4	95	109	118	120	125
3	110	129	139	143	152
2	130	143	154	160	171
1	150	168	181	186	197
1/0	170	193	208	215	229
2/0	195	229	247	251	260
3/0	225	263	284	288	297
4/0	260	301	325	332	346

Current carrying capacity of not more than three (3) conductors in a raceway, conduit or cable. The values (amperes) shown in this table are maximum at an assumed ambient room temperature of +30 °C (+86 °F). For available colors and put-ups, see the on-line Belden Technical Data Sheet for the part number at www.belden.com

CSPE = Chlorosulfonated Polyethylene • EPDM = Ethylene Propylene Diene Monomer Rubber • PPO = P-Phenylene Oxide

Technical Information
Current Carrying Capacity

Table 5: Correction Factors for Tables 3 & 4

Ambient Temperature (°C)	Insulation Temperature Rating				
	+90 °C	+105 °C	+125 °C	+150 °C	+200 °C
31-35	.96	1.00	1.00	1.00	1.00
36-40	.91	1.00	1.00	1.00	1.00
41-45	.87	.93	.94	.95	.97
46-50	.82	.93	.94	.95	.97
51-55	.76	.85	.87	.90	.94
56-60	.71	.85	.87	.90	.94
61-70	.58	.76	.880	.85	.90
71-80	.41	.65	.73	.80	.87
81-90	—	.53	.64	.74	.83
91-100	—	.38	.54	.67	.79
101-120	—	—	.24	.52	.71
121-140	—	—	—	.30	.61
141-160	—	—	—	—	.50
161-180	—	—	—	—	.35
2/0	195	229	247	251	260
3/0	225	263	284	288	297
4/0	260	301	325	332	346

For ambient temperatures over +30 °C, multiply the ampacities shown in Table 3 or Table 4 by the appropriate correction factor to determine the maximum allowable load current. For available colors and put-ups, see the on-line Belden Technical Data Sheet for the part number at www.belden.com

Correction Factors for Table 4

Number of Conductors	Reduction Percentage	Number of Conductors	Reduction Percentage
4 thru 6	80%	21 thru 30	45%
7 thru 9	70%	31 thru 40	40%
10 thru 20	50%	41 and above	35%

For ambient temperatures over +30 °C, multiply the ampacities shown in Table 3 or Table 4 by the appropriate correction factor to determine the maximum allowable load current. For available colors and put-ups, see the on-line Belden Technical Data Sheet for the part number at www.belden.com

Technical Information
Temperature Classifications
Conductor Configurations

Table 6: Nominal Temperature Operating Ranges (°C)

-100 °C	-80 °C	-60 °C	-40 °C	-20 °C	0 °C	100 °C	20 °C	40 °C	60 °C	80 °C	100 °C	120 °C	140 °C	160 °C	180 °C	200 °C	220 °C	240 °C			
				-30 °C	Neoprene						+90 °C										
				-30 °C	CSPE						+105 °C										
				-40 °C	PPO						+105 °C										
				-60 °C	EPDM						+105 °C										
				-75 °C	Silicone Braidedless												+200 °C				
				-75 °C	Silicone Braided												+200 °C				
				-60 °C	XLP						+105 °C										
				-35 °C	PVC						+105 °C										
				-100 °C	TFE														+260 °C		

Table 7: Temperature Classification

Insulation System Class	Minimum Acceptable Lead Wire Temperature Rating	
	°C	°F
130 (B)	+90	+194
155 (F)	+125	+257
180 (H)	+150	+302
220 (R)	+200	+392

Systems of Insulating Materials – UL Standard 1446.
This is a guide intended for UL approved insulation systems connected to branch circuits of 600 V or less.
Approval required by Underwriters Laboratories when using lead wire with a temperature rating more than +5 °C under the system temperature rating.
For available colors and put-ups, see the on-line Belden Technical Data Sheet for the part number at www.belden.com

Table 8: Conductor Configurations

Typical Application	American Wire Gage							
	12	14	16	18	20	22	24	26
Fixed Services Hook-Up Wire Cable in Raceway	19 x 25	Solid or 19 x 27	Solid or 19 x 29	Solid or 7 x 26 or 16 x 30	Solid or 7 x 28 or 10 x 30	Solid or 7 x 30	Solid or 7 x 32	Solid or 7 x 34
Fixed Services Hook-Up Wire Frequently Disturbed For Maintenance	65 x 30	19 x 27 or 41 x 30	19 x 29 or 26 x 30	16 x 30 or 41 x 34	7 x 28, 10 x 30, 19 x 32, or 26 x 34	7 x 30 or 19 x 34	7 x 34 or 10 x 34	7 x 34
Severe Flexing Microphone Test Products	165 x 34	104 x 34	65 x 34 or 104 x 36	41 x 34 or 65 x 36	26 x 34 or 42 x 36	19 x 34 or 26 x 36	19 x 36 or 45 x 40	7 x 34 or 10 x 36
Most Severe Duty Mercury Switches	259 x 36 (7 x 37 Rope Lay)*	168 x 36 (7 x 24 Rope Lay)*	105 x 36 (7 x 15 Rope Lay)*	63 x 36 (7 x 9 Rope Lay)*	105 x 40 (3 x 35 Rope Lay)*	(Consider Braid or Tinsel)		

Note: For a given AWG wire size (based on equal cross-sectional area of conductor), limpness and flex life are increased by use of a large number of fine strands. The finer stranding does result in higher costs.
* Rope Lay is several stranded groups cabled together. For example: 12 AWG, 259 x 36 is 7 cords each consisting of 37 strands of 36 AWG.
For available colors and put-ups, see the on-line Belden Technical Data Sheet for the part number at www.belden.com

CSPE = Chlorosulfonated Polyethylene • EPDM = Ethylene Propylene Diene Monomer Rubber • PPO = P-Phenylene Oxide • XLP = Cross-Linked Poly • PVC = Polyvinyl Chloride • TFE = Tetrafluoroethylene

Technical Information
Packaging



Drums

Conductor is available in three drum pack sizes:

- The #15 Beldpak® is 15" high and 23" in diameter.
- The #31 Beldpak is 30.5" high and 23" in diameter.
- The #42 Beldpak (pictured) is 42" high and 23" in diameter.
- Price and delivery information is available upon request.

Packaging: Drums

OD of Wire		#15 Beldpak		#31 Beldpak		#42 Beldpak	
Inch	mm	1000	km	1000	km	1000	km
.070	1.78	35	10.7	70	21.3	85	25.9
.080	2.03	27	8.2	55	16.8	70	21.3
.090	2.29	21	6.4	43	13.1	55	16.8
.100	2.54	17	5.2	35	10.7	48	14.6
.110	2.79	12	3.7	25	7.6	40	12.2
.120	3.05	10	3.0	20	6.1	34	10.4
.130	3.30	9	2.7	18	5.5	30	9.1
.140	3.56	8	2.4	15	4.6	20	6.1
.150	3.81	7	2.1	14	4.3	18	5.5
.160	4.06	6	1.8	12	3.7	16	4.9
.170	4.32	5	1.5	10	3.0	14	4.3

For available colors and put-ups, see the on-line Belden Technical Data Sheet for the part number at www.belden.com



Reels

Reel dimensions will vary by size, determined by AWG of wire.

Special Orders

Orders for special packages must be placed for footage mentioned or for multiples for these quantities per color.

Packaging: Spools

OD of Wire		Quantity		Crate Reels	Head Diameter		Barrel Diameter		Height Transverse	
Inch	mm	1000'	km		Inch	mm	Inch	mm	Inch	mm
.080	2.03	10.0	3.05	1748	15-3/4	400	8	203	8	203
.090	2.29	8.0	2.24	1748	15-3/4	400	8	203	8	203
.100	2.54	6.5	1.98	1748	15-3/4	400	8	203	8	203
.110	2.79	5.0	1.52	1748	15-3/4	400	8	203	8	203
.120	3.05	6.0	1.83	1747	15-3/4	400	8	203	10-1/2	267
.130	3.30	5.0	1.52	1747	15-3/4	400	8	203	10-1/2	267
.140	3.56	6.0	1.83	1746	17-3/4	451	8	203	10-1/2	267
.150	3.81	5.0	1.52	1746	17-3/4	451	8	203	10-1/2	267
.160	4.06	4.5	1.37	1746	17-3/4	451	8	203	10-1/2	267
.170	4.32	7.0	2.13	1744	22	559	10	254	14-1/4	362
.180	4.57	6.0	1.83	1744	22	559	10	254	14-1/4	362
.190	4.83	5.5	1.68	1744	22	559	10	254	14-1/4	362
.200	5.08	5.0	1.52	1744	22	559	10	254	14-1/4	362
.250	6.35	5.0	1.52	1743	26	660	10	254	14-1/4	362
.300	7.62	3.5	1.07	1743	26	660	10	254	14-1/4	362
.350	8.89	2.5	.76	1743	26	660	10	254	14-1/4	362
.400	10.16	2.0	.61	1743	26	660	10	254	14-1/4	362
.450	11.43	1.5	.46	1743	26	660	10	254	14-1/4	362
.500	12.70	1.2	.37	1743	26	660	10	254	14-1/4	362
.550	13.97	1.0	.31	1743	26	660	10	254	14-1/4	362
.600	15.24	1.2	.37	1733	30	762	10	254	14-1/4	362

Crate Reel numbers are Belden's internal numbers. They are representative only to the extent of the dimensions shown. Weight of the wire may require another reel with dimensions identical to those shown. For available colors and put-ups, see the on-line Belden Technical Data Sheet for the part number at www.belden.com

Conductors

Solid Copper Wire, American Wire Gage

Gage (AWG)	Nominal OD		Nominal Circular MIL Area	Nominal Weight (Inch per 1000')	Nominal Resistance @ +68 °F (Ω/1000')
	Inches	mm			
10	.1019	2.60	10380.0	31.43	.9989
11	.0907	2.30	8234.0	24.92	1.260
12	.0808	2.05	6530.0	19.77	1.588
13	.0720	1.83	5178.0	15.68	2.003
14	.0641	1.63	4107.0	12.43	2.525
15	.0571	1.45	3260.0	9.858	3.184
16	.0508	1.29	2583.0	7.818	4.016
17	.0453	1.15	2050.0	6.200	5.064
18	.0403	1.02	1620.0	4.917	6.385
19	.0359	.912	1200.0	3.899	8.051
20	.0320	.813	1020.0	3.092	10.15
21	.0285	.724	812.1	2.452	12.80
22	.0253	.643	640.4	1.945	16.14
23	.0226	.574	511.5	1.542	20.36
24	.0201	.511	404.0	1.223	25.67
25	.0179	.455	320.4	.9699	32.37
26	.0159	.404	253.0	.7692	40.81
27	.0142	.361	201.5	.6100	51.47
28	.0126	.320	159.8	.4837	64.90
29	.0113	.287	126.7	.3836	81.83
30	.0100	.254	100.5	.3042	103.2
31	.0089	.226	79.7	.2413	130.1
32	.0080	.203	63.21	.1913	164.1
33	.0071	.180	50.13	.1517	206.9
34	.0063	.160	39.75	.1203	260.9
35	.0056	.142	31.52	.09542	331.0
36	.0050	.127	25.00	.07568	414.8
37	.0045	.114	19.83	.0613	512.1

Information from National Bureau of Standards Copper Wire Tables – Handbook 100.

Unparalleled Performance Belden is one of only a very few cable manufacturers to draw and anneal its own conductors. This is a time-consuming process, but it allows us to ensure signal integrity, as well as proper physical characteristics.

In addition, the standards under which we design and manufacture our fiber optic cabling are among the strictest in the industry. The result is a comprehensive offering of products which give unparalleled performance and can satisfy your most demanding operating and environmental challenges.

For available colors and put-ups, see the on-line Belden Technical Data Sheet for the part number at www.belden.com



Power & Control Portable Cordage

Section Table of Contents

Power & Control	Page
Portable Cordage	
Overview	200
Introduction	201
2-Conductor	202-203
3-Conductor	204-205
4-, 5- and Multi-Conductor	206
UL Cordage Type: Designation, Construction and Rating	207



Portable Cordage



Belden portable cordage products are available in a wide assortment of styles, lengths and thicknesses. Products offered include 2, 3, 4 and 5-conductor, as well as multi-conductor constructions.

Jacket options include PVC, Rubber, Oil-resistant Rubber and Belflex®. Belflex is a premium PVC jacket compound (Class 43) that is superior to standard PVC for flexibility and durability.

Product Features

- Temperature range up to +105 °C (Belflex®)
- UL/CSA approvals
- Paper tape or cotton serve separator or conductor polarity
- Shielded and unshielded options
- Jacket material PVC, Rubber, Oil-resistant Rubber, Belflex®

Benefits

Belden portable cordage is listed by Underwriters Laboratories Inc. (UL). This approval signifies that UL has approved all elements of the cordage as meeting their applicable construction and performance standards. Certain Belden portable cordage products are certified to CSA (Canadian) standards.

Applications

Belden's portable cordage portfolio can be used for power in a wide range of applications, from operating motors to power extensions, home appliances and machinery.

Can be used in:

- Building management systems
- Industrial applications
- Audio applications



Introduction

Manufacturer's Identification

Identification of the flexible cord is provided by our UL and CSA file numbers or printed name on the cord jacket.

UL/CSA File Numbers

- UL: E-3462
- CSA: LL-7874

Portable Cordage Packaging

Belden's unique UnReel® cable dispenser is available for many of the portable cordage products listed in this section.

Color Code Comparison by Function

Color Coding		Function
International	North American Standards	
Light Blue	White	N-Neutral
Brown	Black	L-Live
Green/Yellow	Green or Green/Yellow	E-Earth or Ground

2-Conductor

UL/CSA Types: SPT -1, SPT -2, SP-1, HPN

Parallel Cordage



Part No.	AWG	Stranding	OD (Nom)		Insulation Thickness	
			Inch	mm	Inch	mm

Type SPT-1 • PVC Insulation • 300 V, +60 °C • Parallel Lamp Cord

BC Conductors • Brown, Black, White, or Silver Insulation • UL/CSA Listed • One Conductor Polarity Ribbed						
19122	18	42 x 34	.110 x .207	2.79 x 5.26	.032	.81
8888*	18	42 x 34	.110 x .207	2.79 x 5.26	.032	.81

Type SPT-2 • PVC Insulation • 300 V, +60 °C • Parallel Lamp Cord

BC Conductors • Brown or Black Insulation • UL/CSA Listed • One Conductor Polarity Ribbed						
19123	18	42 x 34	.144 x .277	3.66 x 7.04	.049	1.24
19126	16	65 x 34	.155 x .299	3.94 x 7.59	.048	1.22

Type SP-1 • Rubber Insulation • 300 V, +60 °C • Parallel Lamp Cord

BC Conductors • Black Insulation • UL Listed • One Conductor Polarity Ribbed						
19115	18	41 x 34	.123 x .227	3.12 x 5.77	.035	.89

Type HPN • CPE Insulation • 300 V, +90 °C • Parallel Heater Cord

BC Conductors • Black Insulation • UL/CSA Listed						
19405	18	41 x 34	.140 x 2.76	3.56 x 7.01	.047	1.18
19404	16	105 x 36	.152 x .300	3.86 x 7.62	.047	1.18

* Not CSA listed

2-Conductor

UL/CSA Types: SJ, SJO, SJTOW, SO, STOW, SV, SVT



Part No.	AWG	Stranding	OD (Nom)		Insulation Thickness		Jacket Thickness	
			Inch	mm	Inch	mm	Inch	mm

Type SJ • Rubber Jacket • 300 V, +60 °C

BC Conductors • Paper Tape Separator • Smooth Black Jacket • UL/CSA Listed • Conductor Color Code: Black, White								
8478	18	42 x 34	.290	7.37	.032	.81	.035	.89
8472	16	65 x 34	.315	8.00	.033	.84	.035	.89

Type SJO • Oil-Resistant Rubber Jacket • 300 V, +90 °C

BC Conductors • Paper Tape Separator • Smooth Matte Black Jacket • UL/CSA Listed • Conductor Color Code: Black, White								
19227	18	16 x 30	.290	7.37	.031	.79	.035	.89
19228	16	26 x 30	.315	8.00	.031	.79	.035	.89

Type SJTOW • Belflex® Premium PVC Jacket • 300 V, +105 °C

BC Conductors • Paper Tape Separator • Smooth Matte Black Jacket • UL/CSA Listed • VW-1 • International Conductor Color Code: Light Blue, Brown								
19506	18	42 x 34	.290	7.37	.032	.81	.035	.89
19507	16	65 x 34	.319	8.10	.033	.84	.037	.94
19508	14	41 x 30	.348	8.84	.033	.84	.032	.81

Type SO • Oil-Resistant Rubber Jacket • 600 V, +90 °C

BC Conductors • Smooth Black Jacket • Cotton Server Separator or Paper Tape (12 AWG Only) • UL/CSA Listed • Conductor Color Code: Black, White								
19204	18	42 x 34	.360	9.14	.032	.81	.065	1.65
19203	16	65 x 34	.385	9.78	.033	.84	.065	1.65
19202	14	41 x 30	.523	13.28	.048	1.22	.085	2.16
19201	12	65 x 30	.610	15.49	.051	1.30	1.00	2.54

Type STOW • Belflex Premium PVC Jacket • 600 V, +105 °C

BC Conductors • Paper Tape Separator • Smooth Black Jacket • UL/CSA Listed • VW-1 • International Conductor Color Code: Light Blue, Brown								
19500	18	42 x 34	.360	9.14	.032	.81	.070	1.78
19501	16	65 x 34	.386	9.80	.033	.84	.070	1.78
19502	14	41 x 30	.524	13.31	.049	1.24	.089	2.26

Type SV • Rubber Jacket • 300 V, +60 °C • Serrated Jacket

BC Conductors • Cotton Serve Separator • Serrated Black Jacket • UL/CSA Listed • Conductor Color Code: Black, White								
8452	18	42 x 34	.245	6.22	.017	.43	.037	.94

Type SV • Rubber Jacket • 300 V, +60 °C • Smooth Jacket

BC Conductors • Cotton Serve Separator • Smooth Black Jacket • UL/CSA Listed • Conductor Color Code: Black, White								
19120	18	42 x 34	.245	6.22	.017	.43	.037	.94

Type SVT • PVC Jacket • 300 V, +60 °C

BC Conductors • Paper Tape Separator • Serrated Black Jacket • UL/CSA Listed • Conductor Color Code: Black, White								
19140	18	42 x 34	.243	6.17	.018	.46	.036	.91

BC = Bare Copper • PVC = Polyvinyl Chloride

3-Conductor

UL/CSA Types: S, SO, SJ, SJO, SJT



Part No.	AWG	Stranding	OD (Nom)		Insulation Thickness		Jacket Thickness	
			Inch	mm	Inch	mm	Inch	mm

Type S • Rubber Jacket • 600 V, +60 °C

BC Conductors • Cotton Serve (18 – 16 AWG) or Paper Tape (14 – 10 AWG) Separator • Smooth Black Jacket • UL/CSA Listed • Conductor Color Code: Black, White, Green								
19109	18	42 x 34	.380	9.65	.032	.81	.065	1.65
19108	16	65 x 34	.405	10.29	.033	.84	.065	1.65
19107	14	41 x 30	.535	13.59	.048	1.22	.085	2.16
19106	12	65 x 30	.640	16.26	.051	1.30	.099	2.51
19105	10	105 x 30	.681	17.30	.050	1.27	.099	2.51

Type SO • Oil-Resistant Rubber Jacket • 600 V, +90 °C

BC Conductors • Cotton Serve (18 – 16 AWG) or Paper Tape (14 – 10 AWG) Separator • Smooth Black Jacket • UL/CSA Listed • Conductor Color Code: Black, White, Green								
19209	18	42 x 34	.380	9.65	.032	.81	.065	1.65
19208	16	65 x 34	.400	10.16	.033	.84	.063	1.60
19207	14	41 x 30	.538	13.67	.048	1.22	.086	2.18
19206	12	65 x 30	.632	16.05	.051	1.30	.100	2.54
19205	10	105 x 30	.681	17.30	.050	1.27	.099	2.51

Type SJ • Rubber Jacket • 300 V, +60 °C

BC Conductors • Paper Tape Separator • Smooth Black Jacket • UL/CSA Listed • Conductor Color Code: Black, White, Green								
19129	18	16 x 30	.315	8.00	.031	.79	.039	.99
19125	18	42 x 34	.315	8.00	.032	.81	.038	.97
19130	16	26 x 30	.340	8.64	.031	.79	.038	.97
19124	16	65 x 34	.340	8.64	.033	.84	.038	.97
8479	14	41 x 30	.380	9.65	.031	.79	.039	.99

Type SJO • Oil-Resistant Rubber Jacket • 300 V, +90 °C

BC Conductors • Smooth Black Jacket • Paper Tape Separator • UL/CSA Listed • Conductor Color Code: Black, White								
19229	18	16 x 30	.315	8.00	.031	.79	.039	.99
19230	16	26 x 30	.340	8.64	.031	.79	.038	.97

Type SJT • PVC Jacket • 300 V, +60 °C

BC Conductors • Paper Tape Separator • Serrated Black or Gray Jacket • UL/CSA Listed • Conductor Color Code: Black, White, Green (18 AWG) or Green/Yellow (16 AWG)								
19348	18	42 x 34	.328	8.33	.032	.81	.046	1.17
19349	16	65 x 34	.340	8.84	.033	.84	.038	.97

Type SJT • PVC Jacket • 300 V, +60 °C • International Conductor Color Code

BC Conductors • Paper Tape Separator • Smooth Black or Brown Jacket • UL/CSA Listed • Conductor Color Code: Light Brown, Blue, Green/Yellow								
19352	18	42 x 34	.328	8.33	.032	.81	.046	1.17
19353	16	65 x 34	.353	8.97	.033	.84	.036	.91
19354	14	41 x 30	.380	9.65	.033	.84	.038	.97

BC = Bare Copper • PVC = Polyvinyl Chloride

3-Conductor

UL/CSA Types: SJT, SJTOW, STOW, SV, SVT



Part No.	AWG	Stranding	OD (Nom)		Insulation Thickness		Jacket Thickness	
			Inch	mm	Inch	mm	Inch	mm

Type SJT • PVC Jacket • Shielded • 300 V, +60 °C • International Conductor Color Code

BC Conductors • Beldfoil® Shield • Smooth Black Jacket • UL/CSA Listed • Conductor Color Code: Light Blue, Brown, Green/Yellow								
19362	18	42 x 34	.340	8.64	.032	.81	.050	1.27
19363	16	65 x 34	.365	9.27	.033	.84	.047	1.19
19364	14	41 x 30	.402	10.21	.033	.84	.042	1.07

Type SJT • PVC Jacket • Low Leakage • 300 V, +75 °C

BC Conductors • Paper Tape Separator • Smooth Brown Jacket • UL Listed • Conductor Color Code: Black, White, Green								
9998	16	65 x 34	.475	12.07	.033	.84	.045	1.14

Type SJTOW • Belflex® Premium PVC Jacket • 300 V, +105 °C • International Conductor Color Code

BC Conductors • Paper Tape Separator • Smooth Matte Black Jacket • UL/CSA Listed • VW1 • Conductor Color Code: Light Blue, Brown, Green/Yellow								
19509	18	42 x 34	.315	8.00	.032	.81	.038	.97
19510	16	65 x 34	.340	8.64	.033	.84	.038	.97
19511	14	41 x 30	.380	9.65	.032	.81	.040	1.02

Type STOW • Belflex® Premium PVC Jacket • 600 V, +105 °C • International Conductor Color Code

BC Conductors • Paper Tape Separator • Smooth Black Matte Jacket • UL/CSA Listed • VW1 • Conductor Color Code: Light Blue, Brown, Green/Yellow								
19503	18	42 x 34	.380	9.65	.032	.81	.070	1.78
19504	16	65 x 34	.405	10.29	.033	.84	.070	1.78
19505	14	41 x 30	.558	14.17	.049	1.24	.089	2.26

Type SV • Rubber Jacket • 300 V, +60 °C

TC Conductors • Cotton Serve Separator • Smooth Black Jacket • UL/CSA Listed • Conductor Color Code: Black, White, Green								
8453	18	41 x 34	.256	6.50	.018	.46	.036	.91

Type SVT • PVC Jacket • 300 V, +60 °C

BC Conductors • Paper Tape Separator • Serrated Gray Jacket • UL/CSA Listed • Conductor Color Code: Black, White, Green								
19350	18	42 x 34	.253	6.43	.018	.46	.038	.97

Type SVT • PVC Jacket • 300 V, +60 °C • International Conductor Code

BC Conductors • Paper Tape Separator • Smooth Black Jacket • UL/CSA Listed • Conductor Color Code: Light Blue, Brown, Green/Yellow								
19402	18	42 x 34	.253	6.43	.018	.46	.034	.86

Type SVT • PVC Jacket • Shielded • 300 V, +60 °C • International Conductor Color Codes

BC Conductors • Beldfoil® Shield • 22 AWG (7 x 30) Drain Wire • Smooth Black Jacket • UL/CSA Listed • Conductor Color Code: Light Blue, Brown, Green/Yellow								
19401	18	42 x 34	.270	6.86	.018	.46	.043	1.09

Type SVT • PVC Jacket • Shielded • 300 V, +60 °C • International Conductor Color Codes

BC Conductors • Duofoil® Shield (100% Coverage) • Braid (88% Coverage) Smooth Black Jacket • UL/CSA Listed • Conductor Code: Light Blue, Brown, Green/Yellow								
19403	18	42 x 34	.307	7.80	.018	.46	.038	.97

BC = Bare Copper • TC = Tinned Copper • PVC = Polyvinyl Chloride

4-, 5-, and Multi-Conductor

UL/CSA Type SO and UL AWM Styles 4097 and 4256



4-Conductor

Part No.	AWG	Stranding	OD (Nom)		Insulation Thickness		Jacket Thickness	
			Inch	mm	Inch	mm	Inch	mm

AWM Style 4097 • Rubber Jacket • 300 V, +60 °C

TC Conductors • Paper Tape Separator • Smooth Black Jacket • Conductor Color Code: Black, White, Brown, Red								
8454	18	41 X 34	.265	6.73	.018	.46	.036	.91

Type SO • Oil-Resistant Rubber Jacket • 600 V, +90 °C

BC Conductors • Paper Tape Separator • Smooth Black Jacket • UL/CSA Listed • Conductor Color Code: Black, White, Green, Red								
19217	14	41 x 30	.603	15.32	.048	1.22	.087	2.21
19216	12	65 x 30	.690	17.53	.051	1.30	.102	2.59

5-Conductor

Part No.	AWG	Stranding	OD (Nom)		Insulation Thickness		Jacket Thickness	
			Inch	mm	Inch	mm	Inch	mm

AWM Style 4256 • Rubber Jacket • 300 V, +60 °C

TC Conductors • Paper Tape Separator • Smooth Black Jacket • Conductor Color Code: Brown, Green, White, Black, Red								
8455	20 (3)	26 x 34	.280	7.11	.018	.46	.031	.79
	18 (2)	41 x 34						

Multi-Conductor

Part No.	Conductors	AWG	Stranding	OD (Nom)		Insulation Thickness		Jacket Thickness	
				Inch	mm	Inch	mm	Inch	mm

Type SO • 4256 • Oil-Resistant Rubber Jacket • 600 V, +60 °C

BC Conductors • Paper Tape Separator • Smooth Black Jacket • UL/CSA Listed • Conductor Color Code: Chart 2									
9420	5	16	65 x 34	.506	12.85	.033	.84	.084	2.13
9422	7	16	65 x 34	.581	14.76	.033	.84	.083	2.11
9424	9	16	65 x 34	.720	18.29	.033	.84	.100	2.54
9425	12	16	65 x 34	.720	28.29	.033	.84	.100	2.54
9427	16	16	65 x 34	.787	19.99	.033	.84	.100	2.54
9429	20	16	65 x 34	.862	21.89	.033	.84	.100	2.54

BC = Bare Copper • TC = Tinned Copper | Belden Color Code Charts can be found at page 350/351.

UL Cordage Type
Designation, Construction and Rating

Cord Type*	Description	AWG Size Range	No. of Cond.	Conductor Insulation Material and Min. Average Thickness (inches/millimeters)	Jacket Material and Min. Average Thickness** (inches/millimeters)	Temperature Rating (°C)†		Voltage Rating
						Standard	Other	
HPN	Heater Parallel Neoprene	18-12	2 or 3††	.045"/1.14 mm Rubber	—	90	105	300
HSJ	Heater Service Junior	18-12	2, 3, 4	.030"/0.76 mm Rubber††	.030"/0.76 mm Rubber	90	—	300
HSJO	HSJO with Oil-Resistant Jacket	18-12	2, 3, 4	.030"/0.76 mm Rubber ▲	.030"/0.76 mm Rubber	90	—	300
S	Service	18-2	2 or more	.030"/0.76 mm Rubber ▲	.060"/1.52 mm Rubbers	60	75, 90	600
SE	Service Elastomer	18-2	2 or more	.030"/0.76 mm Elastomer	.060"/1.52 mm Elastomer	105	—	600
SEO	SE with Oil-Resistant Jacket	18-2	2 or more	.030"/0.76 mm Elastomer	.060"/1.52 mm Elastomer	105	—	600
SJ	Service Junior	18-10	2, 3, 4, 5	.030"/0.76 mm Rubber	.030"/0.76 mm Rubber	60	75, 90	300
SJE	Service Junior Elastomer	18-10	2, 3, 4, 5	.030"/0.76 mm Elastomer††	.030"/0.76 mm Elastomer	105	—	300
SJEO	SJE with Oil-Resistant Jacket	18-10	2, 3, 4, 5	.030"/0.76 mm Elastomer	.030"/0.76 mm Elastomer	105	—	300
SJO	SJ with Oil-Resistant Jacket	18-10	2, 3, 4, 5	.030"/0.76 mm Rubber ♦	.030"/0.76 mm Rubber	60	75, 90, 105	300
SJT	Service Junior Thermoplastic	18-10	2, 3, 4, 5	.030"/0.76 mm Plastic ♦	.030"/0.76 mm Plastic	60	75, 90, 105	300
SJTO	SJT with Oil-Resistant Jacket	18-10	2, 3, 4, 5	.030"/0.76 mm Plastic ♦	.030"/0.76 mm Plastic	60	75, 90, 105	300
SO	Service with Oil-Resistant Jacket	18-2	2 or more	.030"/0.76 mm Rubber ▲	.060"/1.52 mm Rubber	60	75, 90	600
SP-1	Service Parallel, 1/32" Insulation	18	2 or 3††	.030"/0.76 mm Rubber	—	60	—	300
SP-2	Service Parallel, 3/64" Insulation	18-16	2 or 3††	.045"/1.14 mm Rubber	—	60	—	300
SP-3	Service Parallel, 1/16" Insulation	18-12	2 or 3††	.060"/1.52 mm Rubber ▲	—	60	—	300
SPT-1	Service Thermoplastic, 1/32" Insulation	18	2 or 3††	.030"/0.76 mm Plastic	—	60	75, 90, 105	300
SPT-2	Service Thermoplastic, 3/64" Insulation	18-16	2 or 3††	.045"/1.14 mm Plastic	—	60	75, 90, 105	300
SPT-3	Service Thermoplastic, 1/16" Insulation	18-10	2 or 3††	.060"/1.52 mm Plastic ▲	—	60	75, 90, 105	300
ST	Service Thermoplastic	18-2	2 or more	.030"/0.76 mm Plastic ▲	.060"/1.52 mm Plastics	60	75, 90, 105	600
STO	ST with Oil-Resistant Jacket	18-2	2 or more	.030"/0.76 mm Plastic ▲	.060"/1.52 mm Plastics	60	75, 90, 105	600
SV	Service Vacuum	18	2 or 3††	.015"/0.38 mm Rubber	.030"/0.76 mm Rubber	60	75, 90	300
SVE	Service Vacuum Elastomer	18-17	2 or 3††	.015"/0.38 mm Elastomer	.030"/0.76 mm Elastomer	105	—	300
SVEO	SVE with Oil-Resistant Jacket	18-17	2 or 3††	.015"/0.38 mm Elastomer	.030"/0.76 mm Elastomer	105	—	300
SVO	SVO with Oil-Resistant Jacket	18	2 or 3††	.015"/0.38 mm Rubber	.030"/0.76 mm Rubber	60	75, 90	300
SVT	Service Vacuum Thermoplastic	18-17	2 or 3††	.015"/0.38 mm Plastic	.030"/0.76 mm Plastic	60	75, 90, 105	300
SVTO	SVT with Oil-Resistant Jacket	18-17	2 or 3††	.015"/0.38 mm Plastic	.030"/0.76 mm Plastic	60	75, 90, 105	300
TPT	Tinsel Parallel Thermoplastic	27 (Tinsel)	2	.030"/0.76 mm Plastic	—	60	—	300
TST	Tinsel Service Thermoplastic	27 (Tinsel)	2	.015"/0.38 mm Plastic	.030"/0.76 mm Rubber	60	—	300

* Types SVO, SVTO, SJO, SJTO, SO, STO and HSJO have jackets which are also recognized for oil resistance at maximum temperature of 60°C. Types SJ, SJO, SJT, SJTO, S, SO, ST and STO may also be made for outdoor use and will be indicated by adding a "W" suffix to the cord type. Similarly, types SJ, SJTO, SJO, SJT, S, SO, ST and STO may also be made in water-resistant grades with "Water-Resistant" printed on the jacket. 3-wire SJT may be made in special low-leakage constructions for medical equipment cords.

** Where no jacket is shown, the construction is integral or flat style with insulation also serving as jacket.

† For cordage ratings higher than 60°C, the temperature limit is printed on the outside of the jacket. This does not apply to heater cordage type HPN, rated 90°C, or 105°C.

†† Recognized in three conductors when third or center conductor (with Green or Green/Yellow stripe) is used for equipment grounding.

▲ Insulation and jacket thickness depend on cordage size. Thickness as shown are for 18 and 16 AWG.

♦ Insulation and jacket thickness depend on cordage size.
No. 12 AWG requires .030" conductor insulation thickness and .045" jacket thickness.
No. 10 AWG requires .045" conductor insulation thickness and .060" jacket thickness.

The term Elastomer refers to thermoplastic elastomer.



Enjoy the benefits of
our experience and
innovations.



Data Communication Systems Computer Cables



Section Table of Contents

Data Communication Systems	Page
Computer Cables	
Overview	210
Multi-Conductor Computer Cables	211
Computer Cables for RS-232 Applications	211–212
Computer Cables for RS-232, RS-423, and IEEE 488	213
Low-Capacitance Computer Cables for RS-232 Applications	214
Low-Capacitance Computer Cables for RS-232 and RS-423 Applications	215
Paired Computer Cables	216
Computer Cables for RS-232 Applications	216–217
Low-Capacitance Computer Cables for RS-232 and RS-422 Applications	218
Low-Capacitance 100 Ohm Computer Cables for RS-422 and Digital Audio Applications	219–220
Low-Capacitance Computer Cables for RS-232 Applications	221
Low-Capacitance Computer Cables for RS-232 and RS-422 Applications	222–223
Low-Capacitance Computer Cables for RS-232, RS-422, and RS-485 Applications	224
Low-Capacitance Computer Cables for RS-485 Applications	225
Computer POS Cables	226
Low-Capacitance Computer Cables for RS-232, RS-422, and Digital Audio Applications	227

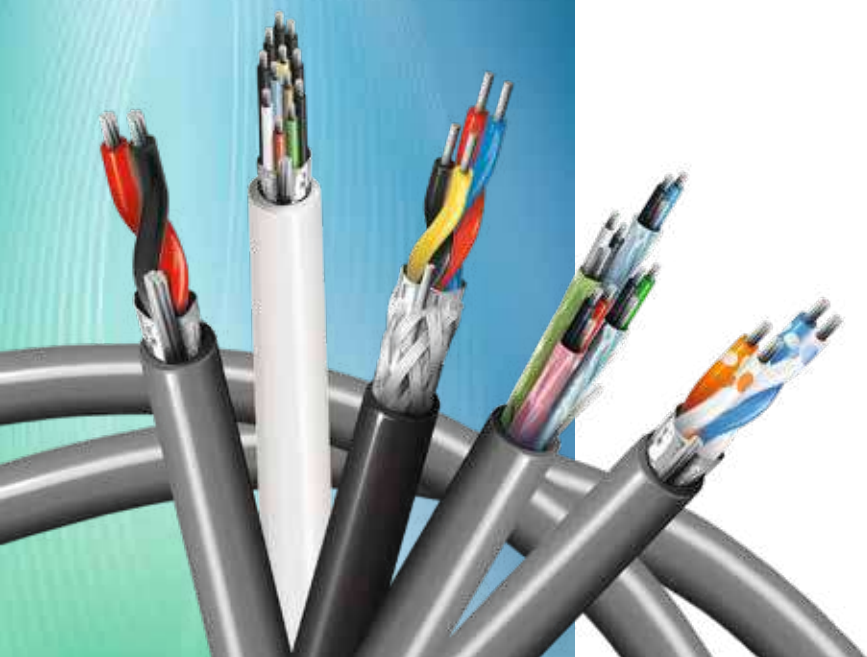

Computer Cables



Belden Computer cables are manufactured in a wide variety of gauge (AWG) sizes, insulation materials, shielding configurations, and jacking materials including Plenum versions. These cables meet the technical requirements of many different applications, with proven reliability and performance that is best in class.

Product Features

- Broad range of AWG sizes, shielding options, conductor (designs include up to 50 wires) and pair counts (up to 50)
- EMI/RFI protective foil and braid designs, such as Beldfoil®, to reduce such interferences
- PVC, LSZH, FEP, Natural Flamearrest and Fluorocopolymer jackets
- UL, AWM and IEC ratings
- MSHA approved designs

Benefits

Higher Level of Safety through:

- Certified fire-resistant characteristics preventing spreading of fire and ensuring the safety of the building
- Single and bundle flame test against flame propagation
- Limited smoke release minimizing safety hazards

Lifetime Performance:

- 10 year warranty

Unmatched Signal Performance through:

- Patented Beldfoil® shielding technology for maximum EMI and cross talk protection
- Lower Electrical capacitance ensuring system performance
- A constant performance during temperature variations ranging between -30 °C up to +90 °C without signal disruptions
- UL certified design quality

Applications

Computer cables are designed but are not limited to RS-232, RS-422/423, RS-488 & RS-485 applications, as Computer & CAD/CAM and Low speed data communication from microprocessor to device utilizing simple commands (On, Off, Stop, Start).

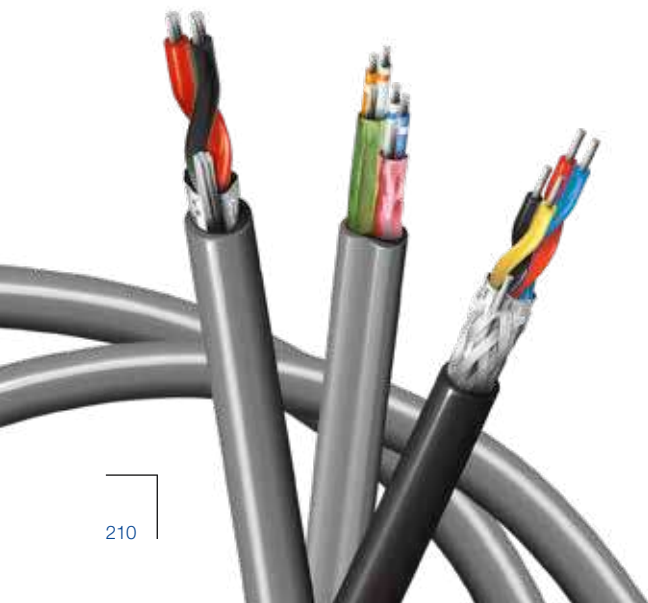

Multi-Conductor Computer Cables
Computer Cables for RS-232 Applications

300 V, +80 °C • Foil Shield



24 AWG • SR-PVC/PVC

- AWM Style
- NEC: CMG
- CEC: CMG FT4

24 AWG • PE/LSZH

- Flame IEC 60332-3-24
- Smoke IEC 61034

Part No.	Conductors	Color Code	OD (Nom)		Insulation Thickness		Jacket Thickness		Capacitance*	
			Inch	mm	Inch	mm	Inch	mm	pF/Ft	pF/m

24 AWG • SR-PVC/PVC

Stranded (7 x 32) TC Conductors • Semi-Rigid PVC Insulation • Cabled • Overall Beldfoil® Shield • 28 AWG Stranded TC Drain Wire • Chrome PVC Jacket										
9533	3	Chart 1	.162	4.11						
9534	4	Chart 1	.184	4.67						
9535	5	Chart 1	.189	4.80	.011	.28	.032	.81	65	213
9536	6	Chart 1	.209	5.31						
9537	7	Chart 1	.209	5.31						
9538	8	Chart 1	.224	5.69						
9539	9	Chart 1	.244	6.20						
9540	10	Chart 1	.244	6.20						
9541	15	Chart 2R	.284	7.21	.011	.28	.032	.81		
9542	20	Chart 2R	.314	7.98					55	180
9543	25	Chart 2R	.339	8.61						
9544	30	Chart 2R	.380	9.65	.011	.28	.040	1.02		
9545	40	Chart 2R	.406	10.31						
9546	50	Chart 2R	.490	12.45	.011	.28	.045	1.14		

24 AWG • PE/LSZH

Stranded (7 x 32) TC Conductors • PE Insulation • Cabled • Overall Beldfoil® Shielding • 28 AWG Stranded TC Drain Wire • Chrome LSZH Jacket										
9534NH	30	Chart 1	.190	4.85						
9536NH	40	Chart 1	.220	5.48	.011	.28	.035	.90	65	213
9541NH	50	Chart 2R	.290	7.40			.031	.80	55	180

* One conductor to other conductors connected to shield.

Multi-Conductor Computer Cables

Computer Cables for RS-232 Applications

300 V, +80 °C • Foil/Braid Shield



- AWM Style
- VW-1

- NEC: CMG
- CEC: CMG FT4

Part No.	Conductors	Color Code	OD (Nom)		Insulation Thickness		Jacket Thickness		Capacitance*	
			Inch	mm	Inch	mm	Inch	mm	pF/Ft	pF/m

24 AWG • SR-PVC/PVC

Stranded (7 x 32) TC Conductors • Semi-Rigid PVC Insulation • Overall Beldfoil® + 65% TC Braid Shielding • Chrome PVC Jacket										
9608	3	Chart 1	.190	4.83						
9609	4	Chart 1	.200	5.08	.011	.28	.035	.88	65	213
9610	5	Chart 1	.215	5.46						
9611	6	Chart 1	.225	5.72						
9612	7	Chart 1	.225	5.72						
9613	8	Chart 1	.240	6.10	.011	.28	.035	.88		
9614	9	Chart 1	.253	6.43						
9615	10	Chart 1	.270	6.86					55	180
9616	15	Chart 1	.300	7.62						
9617	25	Chart 1	.370	9.40	.011	.28	.037	.94		
9618	37	Chart 1	.411	10.43	.011	.28	.040	1.02		
9619	50	Chart 1	.485	12.32	.011	.28	.045	1.14		

* One conductor to other conductors connected to shield.

Multi-Conductor Computer Cables
 Computer Cables for RS-232, RS-423, and IEEE 488

300 V, +80 °C • Foil/Braid Shield



- AWM Style
- VW-1

- NEC: CL2
- CSA: AWM I B FT4

Part No.	Conductors	Color Code	OD (Nom)		Insulation Thickness		Jacket Thickness		Capacitance*	
			Inch	mm	Inch	mm	Inch	mm	pF/Ft	pF/m

28 AWG • SR-PVC/PVC

Stranded (7 x 36) TC Conductors • Semi-Rigid PVC Insulation • Overall Beldfoil® + 65% TC Braid Shielding • Chrome PVC Jacket										
9637	25	Chart 2R	.305	7.75	.010	.25	.035	.89	50	164.05

* One conductor to other conductors connected to shield.

30 V, +80 °C • Foil/Braid Shield



- AWM Style
- VW-1

- NEC: CL2
- CSA: AWM I A FT4

Part No.	Conductors	Color Code	OD (Nom)		Insulation Thickness		Jacket Thickness	
			Inch	mm	Inch	mm	Inch	mm

26 and 24 AWG • SR-PVC/PVC

Stranded (7 x 34 and 7 x 32) TC Conductors • Semi-Rigid PVC Insulation • Overall Beldfoil® + 90% TC Braid Shielding • 26 AWG Stranded TC Drain Wire • Chrome PVC Jacket										
9641	23 Total 6 (26 AWG Pairs) 10 (26 AWG Cond.) 1 (24 AWG Cond.)	Chart 1	.350	8.89	.010	.25	.035	.89		

TC = Tinned Copper • PVC = Polyvinyl Chloride | Belden Color Code Charts can be found at page 350/351.

Multi-Conductor Computer Cables

Low-Capacitance Computer Cables for RS-232 Applications

300 V, +80 °C • Low Capacitance • Foil/Braid Shield

• AWM Style

- NEC: CMG
- CEC: CMG FT4



Part No.	Conductors	Color Code	OD (Nom)		Insulation Thickness		Jacket Thickness		Capacitance*	
			Inch	mm	Inch	mm	Inch	mm	pF/Ft	pF/m

22 AWG • SR-PVC/PVC

Stranded (7 x 30) TC Conductors • Semi-Rigid PVC Insulation • Overall Beldfoil® + 65% TC Braid Shielding • Chrome PVC Jacket											
9939	3	Chart 1	.202	5.13							
9940	4	Chart 1	.215	5.46	.011	.28	.035	.89	67	220	
9941	5	Chart 1	.230	5.84							
9942	6	Chart 1	.245	6.22							
9943	7	Chart 1	.245	6.22							
9944	8	Chart 1	.264	6.71	.011	.28	.035	.89			
9945	9	Chart 1	.280	7.11							
9946	10	Chart 1	.300	7.62					63	207	
9947	15	Chart 2R	.340	8.64							
9948	25	Chart 2R	.410	10.41	0.11	.28	.040	1.02			
9949	37	Chart 2R	.460	11.68							
9950	50	Chart 2R	.555	14.10	0.11	.28	.050	1.27			

* One conductor to other conductors connected to shield.

Multi-Conductor Computer Cables

Low-Capacitance Computer Cables for RS-232 and RS-423 Applications

30 V, +80 °C • Low Capacitance • Foil/Braid Shield

• AWM Style

• NEC: CMG
• CEC: CMG FT4



Part No.	Conductors	Color Code	OD (Nom)		Insulation Thickness		Jacket Thickness		Capacitance*	
			Inch	mm	Inch	mm	Inch	mm	pF/Ft	pF/m

24 AWG • Datalene®/PVC

Stranded (7 x 32) TC Conductors • Datalene® Insulation • Overall Beldfoil® + 65% TC Braid Shielding • 24 AWG TC Drain Wire • Chrome PVC Jacket										
9925	3	Chart 1	.215	5.46						
9927	4	Chart 1	.230	5.84						
9929	5	Chart 1	.246	6.25						
9931	6	Chart 1	.265	6.73						
9932	7	Chart 1	.265	6.73	.015	.38	.035	.89		
9933	8	Chart 1	.280	7.11					22	72.2
9934	9	Chart 1	3.00	7.62						
9935	10	Chart 1	3.06	7.77						
9936	15	Chart 1	.350	8.89						
9937	25	Chart 1	.445	11.30						
9938	37	Chart 1	.500	12.70	.015	.38	.045	1.14		

* One conductor to other conductors connected to shield.

Datalene insulation features include a low dielectric constant and a low dissipation factor for high-speed, low-distortion data handling. Physical properties include good crush resistance and light weight.

TC = Tinned Copper • PVC = Polyvinyl Chloride | Belden Color Code Charts can be found at page 350/351.

Paired Computer Cables
Computer Cables for RS-232 Applications

300 V, +80 °C •
Overall Beldfoil® Shield



24 AWG • SR-PVC/PVC
• NEC: CMG
• CEC: CMG FT43

24 AWG • PE/LSZH
• Flame IEC 60332-3-24
• Smoke IEC 6103

Part No.	Pairs	Color Code	OD (Nom)		Insulation Thickness		Jacket Thickness		Capacitance				Additional Features/Ratings
			Inch	mm	Inch	mm	Inch	mm	Cond. - Cond.		Cond. - Shield		
									pF/Ft	pF/m	pF/Ft	pF/m	

24 AWG • SR-PVC/PVC

Stranded (7 x 32) TC Conductors • Semi-Rigid PVC Insulation • Overall Beldfoil® Shield • 24 AWG TC Drain Wire • Chrome PVC Jacket													
9501	1	Chart 3	.156	3.96	.011	.28	.032	.81	40	131	74	233	
9502	2	Chart 3	.222	5.64									
9503	3	Chart 3	.232	5.89									
9504	4	Chart 3	.265	6.73									
9505	5	Chart 3	.289	7.34									
9506	6	Chart 3	.289	7.34	.011	.28	.032	.81					
9507	7	Chart 3	.294	7.47									
9508	8	Chart 3	.324	8.23					30	98	50	164	
9509	9	Chart 3	.334	8.48									
9510	10	Chart 3	.368	9.34									
9515	15	Chart 3	.417	10.6	.011	.28	.034	.86					
9519	19	Chart 3	.448	11.4									
9525	25	Chart 3	.503	12.8	.011	.28	.045	1.14					
9550	50	Chart 3	.708	18.0	.011	.28	.054	1.37					

UL AWM Style 2464
CSA AWM 1A
MSHA* (9502)
75 Ω Nominal Impedance
60% Velocity of Prop.
Conductor DCR (Nom):
24.0 Ω/1000' (78.7 Ω/km)
Shield DCR (Nom):
18.0 Ω/1000' (59.1 Ω/km)

24 AWG • PE/LSZH

Stranded (7 x 32) TC Conductors • Polyethylene Insulation • Overall Beldfoil® Shield • 24 AWG Stranded TC Drain Wire • Chrome LSZH Jacket													
9501NH	1	Chart 3	.160	4.15	.011	.28	.035	.90	40	131	74	243	
9502NH	2	Chart 3	.230	5.80									
9503NH	3	Chart 3	.240	6.07									
9504NH	4	Chart 3	.270	6.88									
9505NH	5	Chart 3	.300	7.50									
9506NH	6	Chart 3	.300	7.52	.011	.28	.035	.90	30	98	50	164	
9507NH	7	Chart 3	.300	7.64									
9508NH	8	Chart 3	.330	8.40									
9510NH	10	Chart 3	.370	9.40									
9502LS	2	Chart 3	.390	10.00	.011	.28	0.035/ 0.051	0.90/ 1.30	30	98	50	164	

75 Ω Nominal Impedance,
60% Velocity of Prop.,
Conductor DCR (Nom):
24.0 Ω/1000' (78.7 Ω/km)
Shield DCR (Nom):
18.0 Ω/1000' (59.1 Ω/km)

75 Ω Nominal Impedance,
60% Velocity of Prop.,
Conductor DCR (Nom):
24.0 Ω/1000' (78.7 Ω/km)
Shield DCR (Nom):
18.0 Ω/1000' (59.1 Ω/km)
Steel Wire Armor

* MSHA = Mine Safety and Health Administration

Paired Computer Cables

Computer Cables for RS-232 Applications

Plenum • Overall Beldfoil® Shield



- Flame IEC 60332-3-24
- Smoke IEC 6103
- NEC: CMP
- CEC: CMP FT6

Part No.	Pairs	Color Code	OD (Nom)		Insulation Thickness		Jacket Thickness		Capacitance			
			Inch	mm	inch	mm	Inch	mm	Cond. - Cond.		Cond. - Shield	
									pF/Ft	pF/m	pF/Ft	pF/m

24 AWG • FEP/Flamarrest®

Stranded (7 x 32) TC Conductors • FEP Insulation • Overall Beldfoil® Shield • 24 AWG TC Drain Wire • Natural Flamarrest Jacket														
82641	1	Chart 3	.106	2.69	.006	.15	.014	.36	31	102	59	194		
82502	2	Chart 3	.162	4.11										
82503	3	Chart 3	.169	4.29										
82504	4	Chart 3	.193	4.90	.006	.15	.014	.36	25	82	45	148		
82505	5	Chart 3	.196	4.98										
82506	6	Chart 3	.209	5.31										
82509	9	Chart 3	.246	6.25	.006	.15	.015	.38	23	75	42	138		

24 AWG • FEP/FEP

Stranded (7 x 32) TC Conductors • FEP Insulation • Overall Beldfoil® Shield • 24 AWG TC Drain Wire • Red FEP Jacket														
88641	1	Chart 3	.106	2.69	.006	.15	.014	.36	31	102	59	194		
89503	3	Chart 3	.175	4.45										
89504	4	Chart 3	.192	4.88	.006	.15	.014	.36	21	69	40	131		
89505	5	Chart 3	.197	5.00										

TC = Tinned Copper • FEP = Fluorinated Ethylene Propylene • PVC = Polyvinyl Chloride | Belden Color Code Charts can be found at page 350/351.

Paired Computer Cables

Low-Capacitance Computer Cables for RS-232 and RS-422 Applications

Low Capacitance • Overall Beldfoil® Shield



Part No.	Pairs	Color Code	OD (Nom)		Insulation Thickness		Jacket Thickness		Capacitance				Additional Features/Ratings
			Inch	mm	Inch	mm	Inch	mm	Cond. - Cond.		Cond. - Shield		
									pF/Ft	pF/m	pF/Ft	pF/m	

28 AWG • Datalene®/PVC

Stranded (7 x 36) TC Conductors • Datalene Insulation • Overall Beldfoil® Shield • 28 AWG TC Drain Wire • Chrome PVC Jacket														
8132FO	2	Chart 5	.215	5.46										NEC: CL2 UL AWM Style 2919 (30 V, +80 °C) 120 Ω Nom. Impedance 78% Velocity of Prop. Conductor DCR (Nom): 65.0/1000' (213.0 Ω/km) Shield DCR (Nom): 23.1 Ω/1000' (75.8 Ω/km)
8134FO	4	Chart 5	.270	6.86										
8135FO	5	Chart 5	.280	7.11										
8138FO	8	Chart 5	.310	7.88	.015	.38	.035	.89	11.0	36.1	20.0	65.6		
8142FO	12.5	Chart 5	.385	9.78										

24 AWG • Polyethylene/PVC

Stranded (7 x 32) TC Conductors • Polyethylene Insulation • Overall Beldfoil® Shield • 24 AWG TC Drain Wire • Chrome PVC Jacket														
9680	3	Chart 5	.282	7.16										NEC: CM • CEC: CM UL AWM Style 2919 100 Ω Nom. Impedance 66% Velocity of Prop. Conductor DCR (Nom): 24.0/1000' (78.7 Ω/km)
9681	4	Chart 5	.307	7.80										
9682	6	Chart 5	.342	8.69	.016	.41	.035	.89	15.5	42.0	27.5	72.0		
9683	9	Chart 5	.397	10.10										
9684	12.5	Chart 5	.445	11.30										

24 AWG • Datalene/PVC

Stranded (7 x 32) TC Conductors • Datalene Insulation • Overall Beldfoil® Shield • 24 AWG TC Drain Wire • Chrome PVC Jacket														
1419A	2	Chart 5	.248	6.30										NEC: CM • CEC: CM CEC: FT1 (1419A) UL AWM Style 2919 100 Ω Nom. Impedance 78% Velocity of Prop. Conductor DCR (Nom): 24.0/1000' (78.7 Ω/km)
1420A	3	Chart 5	.261	6.63										
1421A	4	Chart 5	.280	7.11										
1422A	5	Chart 5	.294	7.47	.013	.33	.035	.89	15.5	42.0	27.5	72.0		
1423A	6	Chart 5	.319	8.10										
1424A	12.5	Chart 5	.418	10.62										
1425A	15	Chart 5	.473	12.01	.013	.33	.040	1.02						

TC = Tinned Copper • PVC = Polyvinyl Chloride | Belden Color Code Charts can be found at page 350/351.

Paired Computer Cables

Low-Capacitance 100 Ohm Computer Cables for RS-422 and Digital Audio Applications

Individually Shielded Pairs • RS-422 and Digital Audio



24 AWG • Datalene®/PVC
 • NEC: CM
 • CEC: CM

24 AWG • Datalene/LSZH
 • Flame IEC 60332-3-24
 • Smoke IEC 61034

Part No.	Pairs	Color Code	OD (Nom)		Insulation Thickness		Jacket Thickness		Capacitance				Additional Features/Ratings
			Inch	mm	Inch	mm	Inch	mm	Cond. - Cond.		Cond. - Shield		
									pF/Ft	pF/m	pF/Ft	pF/m	

24 AWG • Datalene®/PVC

Stranded (7 x 32) TC Conductors • Datalene Insulation • Individually Beldfoil® Shielded Pairs • Chrome PVC Jacket														
9729	2	Chart 3	.266	6.76										
9730	3	Chart 3	.334	8.48										
9728	4	Chart 3	.363	9.22	.019	.48	.048	1.22						
9731	6	Chart 3	.421	10.69										
9732	9	Chart 3	.488	12.40										
9734	12	Chart 3	.575	14.61	.019	.48	.063	1.60	12.5	41.0	23.2	76.1	UL AWM Style 2493 (300 V, +60 °C) 100 Ω Nom. Impedance 76% Velocity of Prop. Conductor DCR (Nom): 24.0 Ω/1000' (78.7 Ω/km)	
9735	15	Chart 3	.639	16.23										
9736	17	Chart 3	.671	17.04										
9737	19	Chart 3	.671	17.04	.019	.48	.065	1.65						
9738	27	Chart 3	.797	20.24										

24 AWG • Datalene/LSZH

Stranded (7 x 32) TC Conductors • Datalene Insulation • Individually Beldfoil® Shielded Pairs • Chrome LSZH Jacket													
9729NH	2	Chart 3	.310	7.90	.019	.48	.045	1.14	12	41	23	76	100 Ω Nom. Impedance, 76% Velocity of Prop., Conductor DCR (Nom): 24.0 Ω/1000' (78.7 Ω/km)
9729LS	2	Chart 3	.490	12.50	.019	.48	0.045/ 0.053	1.14/ 1.35	12	41	23	76	100 Ω Nom. Impedance, 76% Velocity of Prop., Conductor DCR (Nom): 24.0 Ω/1000' (78.7 Ω/km) Steel Wire Armor

TC = Tinned Copper • PVC = Polyvinyl Chloride • LSZH = Low Smoke Zero Halogen | Belden Color Code Charts can be found at page 350/351.

Paired Computer Cables

Low-Capacitance 100 Ohm Computer Cables for RS-422 and Digital Audio Applications

Plenum • Individually Shielded Pairs • RS-232, RS-422, and Digital Audio

- NEC: CMP
- CEC: CMP FT6



Part No.	Pairs	Color Code	OD (Nom)		Insulation Thickness		Jacket Thickness		Capacitance				Additional Features/Ratings
			Inch	mm	Inch	mm	Inch	mm	Cond. - Cond.		Cond. - Shield		
									pF/Ft	pF/m	pF/Ft	pF/m	

24 AWG • FEP/Fluorocopolymer

Stranded (7 x 32) TC Conductors • Foam FEP Insulation • Individually Beldfoil® Shielded Pairs • 24 AWG TC Drain Wire • Gray Fluorocopolymer Jacket														
89729	2	Chart 5	.261	6.63										Plenum 300 V
89730	3	Chart 5	.278	7.06	.019	.48	.017	.43						100 Ω Nom. Impedance
89728	4	Chart 5	.307	7.80					13.5	44	22.5	73.8		76% Velocity of Prop. Conductor DCR (Nom): 23.3 Ω/1000' (76.4 Ω/km)
89731	6	Chart 5	.361	9.17	.019	.48	.014	.36						
89732	9	Chart 5	.429	10.90	.019	.48	.016	.41						

24 AWG • FEP/Flamarrest®

Stranded (7 x 32) TC Conductors • Foam FEP Insulation • Individually Beldfoil® Shielded Pairs • 24 AWG TC Drain Wire • Natural Flamarrest Jacket														
82729	2	Chart 5	.255	6.48	.019	.48	.014	.36	13.5	44	22.5	73.8		300 V 100 Ω Nom. Impedance 76% Velocity of Prop. Conductor DCR (Nom): 23.3 Ω/1000' (76.4 Ω/km)

TC = Tinned Copper • FEP = Fluorinated Ethylene Propylene | Belden Color Code Charts can be found at page 350/351.

Paired Computer Cables

Low-Capacitance Computer Cables for RS-232 Applications

Overall Foil/Braid Shield • RS-232



- NEC: CMG
- CEC: CMG FT4

Part No.	Pairs	Color Code	OD (Nom)		Insulation Thickness		Jacket Thickness		Capacitance				Additional Features/Ratings
			Inch	mm	Inch	mm	Inch	mm	Cond. - Cond.		Cond. - Shield		
									pF/Ft	pF/m	pF/Ft	pF/m	

22 AWG • SR-PVC/PVC

Stranded (7 x 30) TC Conductors • Semi-Rigid Insulation • Overall Beldfoil® + 65% TC Braid Shield • Chrome PVC Jacket															
8302	2	Chart 3	.260	6.60							40	131	72	236	
8303	3	Chart 3	.270	6.86											
8304	4	Chart 3	.320	8.13											
8305	5	Chart 3	.322	8.18	.011	.28	.035	.89							
8306	6	Chart 3	.348	8.84											
8307	7	Chart 3	.348	8.84											
8308	8	Chart 3	.384	9.75						35	115	63	207		
8310	10	Chart 3	.440	11.18											
8312	12	Chart 3	.455	11.56	.011	.28	.040	1.02							
8315	15	Chart 3	.502	12.75											
8318	18	Chart 3	.535	13.59											
8325	25	Chart 3	.620	15.75	.011	.28	.045	1.14							

UL AWM Style 2464
(300 V, +80 °C)
70 Ω Nom. Impedance
60% Velocity of Prop.
Conductor DCR (Nom):
15.0 Ω/1000'
(49.2 Ω/km)

TC = Tinned Copper • PVC = Polyvinyl Chloride | Belden Color Code Charts can be found at page 350/351.

Paired Computer Cables

Low-Capacitance Computer Cables for RS-232 and RS-422 Applications

Overall Foil/Braid Shield • RS-232



- NEC: CMG
- CEC: CMG FT4

Part No.	Pairs	Color Code	OD (Nom)		Insulation Thickness		Jacket Thickness		Capacitance				Additional Features/Ratings
			Inch	mm	Inch	mm	Inch	mm	Cond. - Cond.		Cond. - Shield		
									pF/Ft	pF/m	pF/Ft	pF/m	

24 AWG • SR-PVC/PVC

Stranded (7 x 32) TC Conductors • Semi-Rigid PVC Insulation • Overall Beldfoil® + 65% TC Braid Shield • Chrome PVC Jacket														
8332	2	Chart 5	.250	6.35										
8333	3	Chart 5	.265	6.73										
8334	4	Chart 5	.288	7.32										
8335	5	Chart 5	.295	7.49	.011	.28	.035	.89						
8336	6	Chart 5	.310	7.87										
8337	7	Chart 5	.321	8.15					30	98	50	165		
8340	10	Chart 5	.385	9.78										
8342	12.5	Chart 5	.405	10.29										
8345	15	Chart 5	.445	11.30	.011	.28	.040	1.02						
8348*	18	Chart 5	.480	12.19										
8355*	25	Chart 5	.550	13.97	.011	.28	.045	1.14						

UL AWM Style 2464
(300 V, +80 °C)
CSA AWM I A
75 Ω Nom. Impedance
60% Velocity of Prop.
Conductor DCR (Nom):
24.0 Ω/1000'
(78.7 Ω/km)

* Not Rated for CSA AWM I A, 300 V, +80 °C

Overall Foil/Braid Shield • RS-232/422



- 24 AWG • Polyethylene/PVC
- NEC: CM
 - CEC: CM

- 24 AWG • Polyethylene/LSZH
- Flame IEC 60332-3-24
 - Smoke IEC 6103

Part No.	Pairs	Color Code	OD (Nom)		Insulation Thickness		Jacket Thickness		Capacitance				Additional Features/Ratings
			Inch	mm	Inch	mm	Inch	mm	Cond. - Cond.		Cond. - Shield		
									pF/Ft	pF/m	pF/Ft	pF/m	

24 AWG • Polyethylene/PVC

Stranded (7 x 32) TC Conductors • Polyethylene Insulation • Overall Beldfoil® + 65% TC Braid Shield • 24 AWG Stranded TC Drain Wire • Chrome PVC Jacket														
9829	2	Chart 5	.291	7.39										
9830	3	Chart 5	.305	7.74										
9831	4	Chart 5	.330	8.38										
9832	5	Chart 5	.338	8.59										
9839	6	Chart 5	.364	9.25	.016	.41	.035	.89	15.5	50.9	27.5	90.2		
9833	7	Chart 5	.370	9.40										
9834	9	Chart 5	.419	10.64										
9835	10	Chart 5	.451	11.46										
9836	12	Chart 5	.464	11.79										
9837	18	Chart 5	.567	14.40										

UL AWM Style 2919
(30 V, +80 °C)
100 Ω Nom. Impedance
66% Velocity of Prop.
Conductor DCR (Nom):
24.0 Ω/1000'
(78.7 Ω/km)

24 AWG • Polyethylene/LSZH

Stranded (7 x 32) TC Conductors • Polyethylene Insulation • Overall Beldfoil® + 65% TC Braid • 24 AWG • Stranded TC Drain Wire • Chrome LSZH Jacket														
9829NH	2	Chart 5	.280	7.10	.016	.41	.035	.89	16.0	50.9	27.0	90.2		

100 Ω Nom. Impedance,
66% Velocity of Prop.,
Conductor DCR (Nom):
24.0 Ω/1000'
(78.7 Ω/km)

TC = Tinned Copper • PVC = Polyvinyl Chloride • LSZH = Low Smoke Zero Halogen | Belden Color Code Charts can be found at page 350/351.

Paired Computer Cables

Low-Capacitance Computer Cables for RS-232 and RS-422 Applications

Overall Foil/Braid Shield • RS-232/422



24 AWG • Datalene®/PVC
 • NEC: CM
 • CEC: CM

24 AWG • Datalene/LSZH
 • Flame IEC 60332-3-24
 • Smoke IEC 61034

Part No.	Pairs	Color Code	OD (Nom)		Insulation Thickness		Jacket Thickness		Capacitance				Additional Features/Ratings	
			Inch	mm	Inch	mm	Inch	mm	Cond. - Cond.		Cond. - Shield			
										pF/Ft	pF/m	pF/Ft	pF/m	

24 AWG • Datalene®/PVC

Stranded (7 x 32) TC Conductors • Datalene Insulation • Overall Beldfoil® + 65% TC Braid Shield • 24 AWG Stranded TC Drain Wire • Chrome PVC Jacket														
8102	2	Chart 5	.270	6.86										
8103	3	Chart 5	.283	7.19										
8104	4	Chart 5	.302	7.67										
8105	5	Chart 5	.316	8.03										
8106	6	Chart 5	.341	8.66	.013	.33	.035	.89						
8107	7	Chart 5	.341	8.66										
8108	8	Chart 5	.370	9.40					12.5	41	22	72.2	UL AWM Style 2919 (30 V, +80 °C)	
8110	10	Chart 5	.427	10.85									100 Ω Nom. Impedance	
8112	12.5	Chart 5	.440	11.18									78% Velocity of Prop.	
8115	15	Chart 5	.495	12.57	.015	.38	.040	1.02					Conductor DCR (Nom):	
8118	18	Chart 5	.537	13.64	.015	.38	.048	1.22					24.0 Ω/1000'	
8125	25	Chart 5	.632	16.05	.015	.38	.050	1.27					(78.7 Ω/km)	

24 AWG • Datalene/LSZH

Stranded (7 x 32) TC Conductors • Datalene Insulation • Overall Beldfoil® + 65% TC Braid • 24 AWG • Stranded TC Drain Wire • Chrome LSZH Jacket														
8102NH	2	Chart 5	.270	6.90	.013	.33	.031	.80						
8110NH	10	Chart 5	.410	10.29	.013	.33	.033	.83	12.0	41	22	72.2	100 Ω Nom. Impedance,	
													78% Velocity of Prop.,	
													Conductor DCR (Nom):	
													24.0 Ω/1000'	
													(78.7 Ω/km)	

TC = Tinned Copper • PVC = Polyvinyl Chloride • LSZH = Low Smoke Zero Halogen | Belden Color Code Charts can be found at page 350/351.

Paired Computer Cables

Low-Capacitance Computer Cables for RS-232, RS-422, and RS-485 Applications

Overall Foil/Braid Shield • RS-232/422

- NEC: CL2



Part No.	Pairs	Color Code	OD (Nom)		Insulation Thickness		Jacket Thickness		Capacitance				Additional Features/Ratings
			Inch	mm	Inch	mm	Inch	mm	Cond. - Cond.		Cond. - Shield		
									pF/Ft	pF/m	pF/Ft	pF/m	

28 AWG • Polypropylene/PVC

Stranded (7 x 36) TC Conductors • Polypropylene Insulation • Overall Beldfoil® + 90% TC Braid Shield • 28 AWG Stranded TC Drain Wire • Chrome PVC Jacket														
9804	2	Chart 3	.214	5.44	.009	.23	.042	1.07						
9805	3	Chart 3	.222	5.64										
9806	4	Chart 3	.237	6.02										
9807	5	Chart 3	.240	6.10										
9808	7	Chart 3	.256	6.50										
9809	9	Chart 3	.290	7.37	.009	.23	.035	.89	15.5	50.9	27.5	90.2	UL AWM Style 2960 (30 V, +60 °C) 100 Ω Nom. Impedance 66% Velocity of Prop. Conductor DCR (Nom): 64.9 Ω/1000' (212.9 Ω/km)	
9812	12	Chart 3	.319	8.10										
9813	13	Chart 3	.336	8.53										
9819	18	Chart 3	.365	9.27										
9825	25	Chart 3	.429	10.90										
9814	31	Chart 3	.462	11.73	.009	.23	.040	1.02						

Overall Foil/Braid Shield • RS-232/485

- NEC: CL2



Part No.	Pairs	Color Code	OD (Nom)		Insulation Thickness		Jacket Thickness		Capacitance				Additional Features/Ratings
			Inch	mm	Inch	mm	Inch	mm	Cond. - Cond.		Cond. - Shield		
									pF/Ft	pF/m	pF/Ft	pF/m	

28 AWG • Datalene®/PVC

Stranded (7 x 36) TC Conductors • Datalene Insulation • Overall Beldfoil® + 65% TC Braid Shield • 28 AWG Stranded TC Drain Wire • Chrome PVC Jacket														
8132	2	Chart 5	.220	5.59										
8133	3	Chart 5	.270	6.86										
8134	4	Chart 5	.290	7.37	.015	.38	.035	.89						
8135	5	Chart 5	.300	7.62										
8138	8	Chart 5	.330	8.38	.015	.38	.039	.99	11.0	36.1	20.0	65.6	UL AWM Style 2919 (30 V, +80 °C) 120 Ω Nom. Impedance 78% Velocity of Prop. Conductor DCR (Nom): 65.0 Ω/1000' (213.0 Ω/km)	
8142	12.5	Chart 5	.375	9.53	.015	.38	.035	.89						
8148	18	Chart 5	.465	11.81	.015	.38	.045	1.14						
8155	25	Chart 5	.565	14.35	.015	.38	.044	1.12						

TC = Tinned Copper • PVC = Polyvinyl Chloride | Belden Color Code Charts can be found at page 350/351.

Paired Computer Cables

Low-Capacitance Computer Cables for RS-485 Applications

Overall Foil/Braid Shield • RS-485 • DMX512



- 24 AWG • Polyethylene/PVC
- NEC: CM
 - CEC: CM

- 24 AWG • Polyethylene/LSZH
- Flame IEC 60332-3-24
 - Smoke IEC 6103

Part No.	Pairs	Color Code	OD (Nom)		Insulation Thickness		Jacket Thickness		Capacitance				Additional Features/Ratings
			Inch	mm	Inch	mm	Inch	mm	Cond. - Cond.		Cond. - Shield		
									pF/Ft	pF/m	pF/Ft	pF/m	

24 AWG • Polyethylene/PVC

Stranded (7 x 32) TC Conductors • Polyethylene Insulation • Overall Beldfoil® + 90% TC Braid Shield • 24 AWG Stranded TC Drain Wire • Chrome PVC Jacket														
9841	1	Chart 5	.232	5.89	.023	.58	.035	.89						UL AWM Style 2919 (30 V, +80 °C) ANSI E1.11 DMX512 120 Ω Nom. Impedance 66% Velocity of Prop. Conductor DCR (Nom): 24.0 Ω/1000' (78.7 Ω/km)
9842	2	Chart 5	.340	8.64										
9843	3	Chart 5	.360	9.14					12.8	42.0	23.0	75.5		
9844	4	Chart 5	.390	9.91	.022	.56	.035	.89						

24 AWG • Polyethylene/LSZH

Stranded (7 x 32) TC Conductors • Polyethylene Insulation • Overall Beldfoil® + 90% TC Braid • 24 AWG Stranded TC Drain Wire • Chrome LSZH Jacket														
9841NH	1	Chart 5	.230	5.90										120 Ω Nom. Impedance, 66% Velocity of Prop., Conductor DCR (Nom): 24.0 Ω/1000' (78.7 Ω/km)
9842NH	2	Chart 5	.340	9.65	.023	.58	.035	.89	12.8	42.0	23.0	75.5		
9843NH	3	Chart 5	.360	9.10										
9844NH	4	Chart 5	.390	9.90										
9841LS	1	Chart 5	.410	10.30										120 Ω Nom. Impedance, 66% Velocity of Prop., Conductor DCR (Nom): 24.0 Ω/1000' (78.7 Ω/km) Steel Wire Armor
9842LS	2	Chart 5	.520	13.10	.023	.58	.035/.053	.89/1.35	12.8	42.0	23.0	75.5		
9844LS	4	Chart 5	.590	15.10										

Plenum • Overall Foil/Braid Shield • RS-485



- NEC: CMP
- CEC: CMP FT6

Part No.	Pairs	Color Code	OD (Nom)		Insulation Thickness		Jacket Thickness		Capacitance				Additional Features/Ratings
			Inch	mm	Inch	mm	Inch	mm	Cond. - Cond.		Cond. - Shield		
									pF/Ft	pF/m	pF/Ft	pF/m	

24 AWG • FEP/Flamarrest®

Stranded (7 x 32) TC Conductors • Foam FEP Insulation • Overall Beldfoil® + 90% TC Braid Shield • 24 AWG Stranded TC Drain Wire • Natural Flamarrest Jacket														
82841	1	Chart 5	.204	5.18	.025	.64	.015	.38						Plenum 300 V 120 Ω Nom. Impedance 76% Velocity of Prop. Conductor DCR (Nom): 24.0 Ω/1000' (78.7 Ω/km)
82842	2	Chart 5	.273	6.93	.019	.48	.015	.38	12	39.4	22	72.2		

24 AWG • FEP/FEP

Stranded (7 x 32) TC Conductors • Foam FEP Insulation • Overall Beldfoil® + 90% TC Braid Shield • 24 AWG Stranded TC Drain Wire • Red FEP Jacket														
89841	1	Chart 5	.202	5.13	.025	.64	.014	.36						Plenum 300 V 120 Ω Nom. Impedance 76% Velocity of Prop. Conductor DCR (Nom): 24.0 Ω/1000' (78.7 Ω/km)
89842	2	Chart 5	.305	7.75	.023	.58	.014	.36	12	39.4	22	72.2		

TC = Tinned Copper • FEP = Fluorinated Ethylene Propylene • PVC = Polyvinyl Chloride • LSZH = Low Smoke Zero Halogen | Belden Color Code Charts can be found at page 350/351.

Paired Computer Cables

Computer POS Cables

Overall Foil/Braid Shield • RS-485 • POS



Part No.	Pairs	Color Code	OD (Nom)		Insulation Thickness		Jacket Thickness		Braid	Capacitance				Additional Features/Ratings
			Inch	mm	Inch	mm	Inch	mm		Cond. - Cond.		Cond. - Shield		
										pF/Ft	pF/m	pF/Ft	pF/m	

22 AWG • Polyethylene/PVC

Solid TC or BC Conductors • Polyethylene Insulation • Overall Beldfoil® + TC Braid Shield • 22 AWG Solid TC Drain Wire • Black PVC Jacket														
1268A	2 TC	Note 1	.270	6.86	.019	.48	.033	.84	90%	15.5	50.9	27.5	90.2	NEC: CM • CEC: CM UL AWM Style 2582 (150 V, +60 °C) 66% Velocity of Prop.
9855	2 TC	Note 1	.270	6.86					58%					
9696	2 BC	Note 2	.290	7.37	.018	.44	.033	.84	58%	16.0	52.5	27.5	90.2	

22 AWG • FEP/PVC

Solid TC or BC Conductors • FEP Insulation • Overall Beldfoil® + TC Braid Shield • 22 AWG Solid TC Drain Wire • Black PVC Jacket														
1269A	2 TC	Note 1	.240	6.10	.016	.41	.016	.43	90%					Plenum • Non-conduit NEC: CMP • CEC: CMP FT6 69.5% Velocity of Prop.
89855	2 TC	Note 1	.272	6.91	.016	.41	.016	.41	58%	15.5	50.9	27.0	88.6	
89696	2 BC	Note 2	.262	6.65	.020	.51	.016	.41						

Note 1: Red-Blue, Black-Yellow

Note 2: Blue-White with Blue Stripe, Orange-White with Orange Stripe

Paired Computer Cables

Low-Capacitance Computer Cables for RS-232, RS-422, and Digital Audio Applications

Individually Shielded Pairs with Overall Foil/Braid Shield

- NEC: CM
- CEC: CM



Part No.	Pairs	Color Code	OD (Nom)		Insulation Thickness		Jacket Thickness		Capacitance				Additional Features/Ratings
			Inch	mm	Inch	mm	Inch	mm	Cond. - Cond.		Cond. - Shield		
									pF/Ft	pF/m	pF/Ft	pF/m	

24 AWG • Datalene®/PVC

Stranded (7 x 32) TC Conductors • Datalene Insulation • Individually Beldfoil® Shielded Pairs + Overall 65% TC Braid Shielding • 24 AWG TC Drain Wire • Chrome PVC Jacket														
8162	2	Chart 3	.343	8.71										
8263	3	Chart 3	.359	9.12										
8164	4	Chart 3	.388	9.86										
8165	5	Chart 3	.413	10.49	.019	.48	.048	1.22						UL AWM Style 2493 (+60 °C) VW-1 100 Ω Nom. Impedance 78% Velocity of Prop. Conductor DCR (Nom): 24.0 Ω/1000' (78.7 Ω/km)
8166	6	Chart 3	.446	11.33										
8167	7	Chart 3	.446	11.33					12.5	41	22	72.2		
8168	8	Chart 3	.479	12.17										
8170	10	Chart 3	.584	14.83	.019	.48	.063	1.60						
8175	15	Chart 3	.665	16.89										
8178	18	Chart 3	.686	17.42	.019	.48	.065	1.65						
8185	25	Chart 3	.822	20.88										

TC = Tinned Copper • PVC = Polyvinyl Chloride | Belden Color Code Charts can be found at page 350/351.



Advanced networks
need advanced
technology.





Industrial Data and Process Automation

Section Table of Contents

Industrial Data and Process Automation

Overview	230
Introduction	230–231
PLC/DCS Cable Cross Reference Guide	232–234
Protocol Cable Cross Reference Guide	235–236



Industrial Data and Process Automation



Tough Cables for Tough Environments

Today, more than ever, manufacturing productivity depends upon seamless data communication and automation systems. And both depend upon high-performance cabling solutions.

Depend on Belden

Belden has developed the world's most comprehensive line of industrial cabling solutions for applications like yours: whether you are networking your factory floor or your process equipment and devices to their controllers...and on to the control room, the engineering department, and remote manufacturing sites – or, all of the above. From your petrochemical, automotive manufacturing, pharmaceutical, power generation, pulp and paper, metals, food and beverage, or general manufacturing plant to your corporate headquarters – and everywhere in between – Belden has your cabling solution.

Most importantly you can have the peace-of-mind that is inherent with the use of Belden products since all Belden cables are manufactured in ISO 9001:2000 certified

facilities to the industry's highest standards of quality, using the most advanced equipment, systems, controls and processes available.

Belden cables give you the performance you need day after dependable day.

Innovative Technology

Bonded-Pair™ Cable

Many DataTuff® Industrial Ethernet cables feature Belden's patented bonded-pair technology. Bonded-pairs provide Installable Performance® – superior electrical performance even after the stresses of installation. Bonded-pairs exhibit the most robust and reliable electrical performance in the industry.

Shielding

Effective cable shielding for protection from noise interference remains critical with evolving industrial technology. Belden's shielding designs and testing methods ensure signal integrity and a dependable cable in the presence of electrical noise.

Belden's exclusive patented Beldfoil® design, with its aluminum/polyester foil, was the first shield to offer 100 percent cable protection against radiated emission and ingress at audio and radio frequencies.

Armoring

Belden's innovative armoring technology delivers maximum physical protection in harsh environments. Additional benefits include reduced cost of conduit, easier installation and re-routing, plus additional shielding.

Belden has the capability to protect data, electronic, instrumentation and control cables with interlocking steel or aluminum armor as well as continuous corrugated aluminum armor. Smooth or corrugated protective metal tapes are also available.



Insulation and Jacket

Belden formulates many of its own insulation and jacket compounds. As a result, they provide superior performance under a variety of hostile environmental conditions.

Intrinsically Safe Wiring

In accordance with NEC Article 504, intrinsically safe cables are colored blue for easy identification. Belden offers several industrial cables in intrinsically safe blue to meet your requirements for intrinsically safe wiring. Contact the NEC and/or your local inspector for specific guidelines.

Custom Capabilities

Most of our industrial cables are available from stock. Many of these are available off the shelf from distributors. If you have a new or unusual application or you cannot find an Industrial cable in this catalog section that meets your technical requirements, contact Technical Support at +31-77-3878-555.

Overall Jacket

Material
PUR
FRNC
PVC
CPE
TPE
HDPE

Armor

Material
Steel Wire, Aluminum Interlock
Steel Interlock
Aluminum Belclad®
Steel Belclad
Copper Belclad
Continuous Armor

PLC/DCS Cable Cross Reference Guide

PLC/DCS Manufacturer	System Name	Belden Part Number		
ABB/Bailey Controls	FOUNDATION Fieldbus	See Protocol listings on pages 235–236		
	Industrial IT 800 X A	9880	Network Trunk Cable	
	Infinet	9880	Network Trunk Cable	
		9463	Blue Hose® (Standard)	
	Masterpiece 200	9880	Network Trunk Cable	
		9907	Thin Network Trunk Cable	
	MICRO-DCI	3105A	1-Pair, RS-485	
	MICROLINK	9860	Twinax, 16 AWG, 124 Ohm	
	Modcell	3105A	1-Pair, RS-485	
	PROFIBUS DP & PA	See Protocol listings on pages 235–236		
Allen-Bradley/Rockwell Automation	ControlNet™	See Protocol listings on pages 235–236		
	DeviceNet™	See Protocol listings on pages 235–236		
	DH, DH+, Remote I/O	9463	Blue Hose (Standard)	
		9463F	Flexible Version (9463)	
		129463	Aluminum Armor (9463)	
		139463	Steel Armor (9463)	
		189463	Continuous Armor (9463)	
		9463DB	Direct Burial (9463)	
		3072F	600 V TC Rated (9463)	
		89463	FEP 200 °C, Plenum	
		DH-485	3074F	600 V Tray Cable
			3106A	1.5-Pair, RS-485 (PLTC)
	Industrial Ethernet	9842	2-Pair, RS-485	
		See pages 263–280		
	Longline Communications	8723	Interface Cable	
		88723	Plenum Version	
	Cutler-Hammer/Westinghouse	I/Q System	9463	Blue Hose (Standard)
	Emerson Process Management (Fisher/Rosemont Systems) – Delta V	DeviceNet	See Protocol listings on pages 235–236	
		FOUNDATION Fieldbus (Type SP50 ISA/IEC)	See Protocol listings on pages 235–236	
		HART	See Protocol listings on pages 235–236	
Industrial Ethernet		See pages 263–280		
MODBUS		See Protocol listings on pages 235–236		
PROFIBUS DP		See Protocol listings on pages 235–236		
Provox Plus		3094A	RG-11 Quad Shield PVC	
		3131A	RG-6 Quad Shield PVC	
RS-485	See Protocol listings on pages 235–236			
GE Fanuc – I/O Bus	DeviceNet	See Protocol listings on pages 235–236		
	9030, 9070	9182	Communications Bus	
	PAC System	89182	Plenum Version	
	INTERBUS®-S	See Protocol listings on pages 235–236		
	MODBUS®	See Protocol listings on pages 235–236		
	PROFIBUS	See Protocol listings on pages 235–236		

PLC/DCS Manufacturer	System Name	Belden Part Number	
GE Fanuc – Sensor Device Networks	DeviceNet	See Protocol listings on pages 235–236	
	SDS	See Protocol listings on pages 235–236	
Honeywell	Access 4000 System	9248	RG-6 PVC
	FOUNDATION Fieldbus (Type SP50 ISA/IEC)	See Protocol listings on pages 235–236	
	IPC 620 System I/O	9271	Twinax, 25 AWG, 124 Ohm
	IPC 620 System	9729	Up to 4000 ft. (1220 m)
	Serial Interface	9182	Up to 10,000 ft. (3050 m)
		89182	Plenum
	Series C	RS-485	FOUNDATION Fieldbus Industrial Ethernet
	3000 UCN & LCN	3131A	RG-6 Quad Shield PVC
		3094A	RG-11 Quad Shield PVC
	Honeywell Microswitch Division	Smart Distributed System	3086A
3087A			Micro
1346F			1 Pair 22 AWG, 1 Pair 24 AWG
1348A			3 20 AWG
1349A			3 20 AWG, 2 18 AWG
Invensys/Foxboro	FOUNDATION Fieldbus (Type SP50 ISA/IEC)	See Protocol listings on pages 235–236	
	I/A Series Carrier Band	8233	Small Trunk
		3095A	Plenum
		9290	Drop Cable
	I/A Series Fieldbus	9207	Twinax
		89207	200 °C, Plenum
		3073F	600 V Tray Cable
	I/A Series Node Bus	9880	Trunk Cable
		89880	Plenum Version
		Industrial Ethernet	
Limitorque	DCC100	3105A	Actuator Bus Cable, 1-Pair, RS-485
Matsushita	FP Series C-NET	9207	Twinax, 20 AWG, Stranded, 100 Ohm
		9860	Twinax, 16 AWG, Solid, 124 Ohm
	FP Series MEWNET-F	9207	Twinax, 20 AWG, Stranded, 100 Ohm
		9860	Twinax, 16 AWG, Solid, 124 Ohm
	FP Series MEWNET-H	9248	RG-6, 75 Ohm, 18 AWG
	FP Series MEWNET-TR	9207	Twinax, 20 AWG, Stranded, 100 Ohm
		9860	Twinax, 16 AWG, Solid, 124 Ohm
	FP Series MEWNET-W	9207	Twinax, 20 AWG, Stranded, 100 Ohm
		9806	4-Pair, RS-232, RS-422
	FP Series MEWNET-W2	9207	Twinax, 20 AWG, Stranded, 100 Ohm
9860		Twinax, 16 AWG, Solid, 124 Ohm	
FP Series TRNET	9207	Twinax, 20 AWG, Stranded, 100 Ohm	
	9860	Twinax, 16 AWG, Solid, 124 Ohm	

FEP = Fluorinated Ethylene-propylene
PVC = Polyvinyl Chloride
TC = Tinned Copper

PLC/DCS Manufacturer	System Name	Belden Part Number		
Mitsubishi Electric Automation	CC-Link	See Protocol listings on pages 235–236		
	DeviceNet	See Protocol listings on pages 235–236		
	Melsecnet II (10/10H)	1505A	Precision RG-59/U Coax	
		1505F	High-Flex 1505A	
		1506A	Plenum Precision RG-59/U, Outdoor, Direct Burial	
		8241	Standard RG-59/U Coax	
		8241F	High-Flex 8241F	
	MODBUS	See Protocol listings on pages 235–236		
	PROFIBUS DP	See Protocol listings on pages 235–236		
	Serial Communications	8777	Control and Instrumentation Interconnect Cable	
Modicon/Schneider AEG	Industrial Ethernet	See pages 263–280		
	MODBUS	8777	Modem Drop Cable, 22 AWG, 3-Pair	
		8777NH	22 AWG, 3-Pair, LSNH	
		8777LS	22 AWG, 3-Pair, Steel Wire Armor	
		128777	Aluminum Armor (8777)	
		138777	Steel Armor (8777)	
		88777	FEP 200 °C, Plenum	
		MODBUS II	3092A	RG-6 Quad Shield PVC
		3132A	RG-6 Quad Shield, 150 °C, Plenum	
			3092F	RG-6 Quad Shield PVC, Flexible Version
			123092A	Aluminum Armor (3092A)
			133092A	Steel Armor (3092A)
			123092F	Aluminum Armor, RG-6 Quad Shield PVC
		3132A	RG-6 Quad Shield, 150 °C, Plenum	
			3094A	RG-11 Quad Shield PVC
			123094A	Aluminum Armor (3094A)
			133094A	Steel Armor (3094A)
			3095A	RG-11 Quad Shield, 150 °C, Plenum
	Remote I/O	3092A	RG-6 Quad Shield PVC	
			3092F	RG-6 Quad Shield PVC, Flexible Version
			123092A	Aluminum Armor (3092A)
			133092A	Steel Armor (3092A)
			123092F	Aluminum Armor, RG-6 Quad Shield PVC
		3132A	RG-6 Quad Shield, 150 °C, Plenum	
			3094A	RG-11 Quad Shield PVC
			123094A	Aluminum Armor (3094A)
			133094A	Steel Armor (3094A)
3095A			RG-11 Quad Shield, 150 °C, Plenum	
Omron	ComboBus/D (DeviceNet™)	See DeviceNet Protocol listings on pages 235–236		
	ComboBus/S	9409	18 AWG, 1-Pair, 300 V PLTC Control	
		9318	18 AWG, 1-Pair, 300 V PLTC Control, Shielded	
		3073F	600 V Tray Cable, Twinax	
		89740	18 AWG, 1-Pair, 300 V, Control	

PLC/DCS Manufacturer	System Name	Belden Part Number	
Omron <i>(continued)</i>	Controller Link	9207	Twinax
		89207	Twinax, 200 °C, Plenum
		9815	Twinax, 100 Ohm, Direct Burial
		3073F	600 V Tray Cable, Twinax
		3073F	600 V Tray Cable, Twinax
	SYSBUS-2	3073F	600 V Tray Cable, Twinax
	SYSMAC BUS	9841	22 AWG, 1-Pair, RS-485
		3105A	22 AWG, 1-Pair, RS-485
	SYSMAC LINK	9231	RG-59U Coax
	Phoenix Contact	DeviceNet	See Protocol listings on pages 235–236
Industrial Ethernet		See pages 263–280	
INTERBUS®-S		See Protocol listings on pages 235–236	
PROFIBUS DP FMS & PA		See Protocol listings on pages 235–236	
Reliance/A-B	Auto Max Distributed Power	B9B012	2-Fiber Breakout
		1100255	2-Fiber Loose Tube PVC
		1100266	2-Fiber Loose Tube CPE
	R-Net	9259	RG-59 PVC
		89259	RG-59, 200 °C, Plenum
Rotork	Pakscan II E RS-485	3105A	22 AWG, 1-Pair, RS-485
Siemens/ Moore	FMC (Field Mountable Controller)	3105A	1-Pair, RS-485
		3106A	1.5-Pair, RS-485
		3107A	2-Pair, RS-485
		3108A	3-Pair, RS-485
		3109A	4-Pair, RS-485
	FOUNDATION Fieldbus (Type SP50 ISA/IEC)	See Protocol listings on pages 235–236	
	Hiway	9860	Network Trunk Cable
	Industrial Ethernet	See pages 11–14	
	MODULNET	3094A	RG-11 Quad Shield PVC
		3131A	RG-6 Quad Shield PVC
PROFIBUS DP & FMS (Purple)	See Protocol listings on pages 235–236		
PROFIBUS PA (Blue)	See Protocol listings on pages 235–236		
SINEC Series H1	9907	Thin Network Trunk Cable	
	9880	Network Trunk Cable	
SINEC Series H2B	3131A	RG-6 Quad Shield	
	3094A	RG-11 Quad Shield	
SINEC Series L1	3107A	2-Pair, RS-485	
SINEC Series L2	3079A	300 V Twinax	
Thicknet Ethernet Trunk	9880	Network Trunk Cable	
	129880	Aluminum Interlocked Armor Trunk	
	139880	Steel Interlocked Armor Trunk	
Thinnet Ethernet Trunk	9907	Thin Network Trunk Cable	

CPE = Chlorinated Polyethylene
 LSNH = Low Smoke No Halogen
 FEP = Fluorinated Ethylene-propylene
 PVC = Polyvinyl Chloride

PLC/DCS Cable Cross Reference Guide (continued)

PLC/DCS Manufacturer	System Name	Belden Part Number	
Smar	FOUNDATION Fieldbus (Type SP50 ISA/IEC)	See Protocol listings on pages 235–236	
	Industrial Ethernet	See pages 263–280	
	PROFIBUS DP FMS & PA	See Protocol listings on pages 235–236	
	RS-485	See Protocol listings on pages 235–236	
Square D/ Schneider AEG	FIP/Fieldbus	3079A	22 AWG, 1-Pair, Shielded
		123079A	Aluminum Armor (3079A)
	Industrial Ethernet	See pages 263–280	
	Model 50, RS-422 Cable	8760	18 AWG, 1-Pair, Shielded
		128760	Aluminum Armor (8760)
	Passport I/O – I/O Net	3105A	22 AWG, 1-Pair, RS-485
		123105A	Aluminum Armor (3105A)
		3106A	22 AWG, 1.5-Pair, RS-485
		123106A	Aluminum Armor (3106A)
	Power Logic	9841	24 AWG, 1-Pair, RS-485
9842		24 AWG, 2-Pair, RS-485	
Square D/ Schneider AEG	Seriplex®	3124A	CBL-1822-P20
		3125A	CBL-1622-P16
		3126A	CBL-162212-P16
		123124A	Aluminum Armor (3124A)
		123125A	Aluminum Armor (3125A)
		123126A	Aluminum Armor (3126A)
		9463	Blue Hose® (Standard)
		9463NH	20 AWG Twinax, FRNC
		9463LS	20 AWG Twinax, Steel Wire Armor, FRNC
		129463	Aluminum Armor (9463)
	139463	Steel Armor (9463)	
	189463	Continuous Armor (9463)	
	YR28826	Dual Version (9463)	
	9463DB	Direct Burial (9463)	
	YR29565	Various Color Jackets 9463)	
SY/Net Network Trunk Cable	3072F	600 V TC Rated (9463)	
	89463	FEP 200 °C, Plenum	
SY/Net TNIM Cable	9272	20 AWG, 1-Pair, Shielded	
	89272	FEP 200 °C, Plenum	

PLC/DCS Manufacturer	System Name	Belden Part Number	
Yokogawa – CENTUM	DeviceNet™	See Protocol listings on pages 235–236	
	FOUNDATION Fieldbus (Type SP50 ISA/IEC)	See Protocol listings on pages 235–236	
	HART	See Protocol listings on pages 235–236	
	Industrial Ethernet	See pages 263–280	
	PROFIBUS	See Protocol listings on pages 235–236	
	RS-485	See Protocol listings on pages 235–236	
Yokogawa – FA-M3	DeviceNet	See Protocol listings on pages 235–236	
	Industrial Ethernet	See pages 263–280	
	MODBUS	See Protocol listings on pages 235–236	
	PROFIBUS	See Protocol listings on pages 235–236	
	RS-485	See Protocol listings on pages 235–236	
Yokogawa – STARDOM	DeviceNet	See Protocol listings on pages 235–236	
	FOUNDATION Fieldbus (Type SP50 ISA/IEC)	See Protocol listings on pages 235–236	
	HART	See Protocol listings on pages 235–236	
	Industrial Ethernet	See pages 263–280	
	PROFIBUS	See Protocol listings on pages 235–236	
Westinghouse	WDPF	9292*	RG-11 PVC

FEP = Fluorinated Ethylene-Propylene.
FRNC = Fire Retardant, Non-Corrosive
TC = Tinned Copper

ControlNet is a ControlNet International, Ltd. trademark.
DeviceNet is an Open DeviceNet Vendor Association, Inc. trademark.
EtherNet/IP is a ControlNet International, Ltd. trademark, under license by Open DeviceNet Vendor Association, Inc.
HART is a HART Communication Foundation trademark.
INTERBUS is a Phoenix Contact trademark.
MODBUS is a Schneider Electric trademark.
PROFIBUS is a PROFIBUS International trademark.
PROFINET is a PROFIBUS International trademark.
SDS is a Honeywell International, Inc. trademark.
Seriplex is a Square D/Schneider AEG trademark.

Protocol Cable Cross Reference Guide

System Name	Belden Part Number
Industrial Ethernet	See pages 263–280
FOUNDATION Fieldbus (Type SP50 ISA/IEC)	See pages 239–242
	HSE Copper See Industrial Ethernet
PROFIBUS DP	3079A 22 AWG 300 V Twinax
	3079E 22 AWG 300 V Twinax, Flex Version
	3079ALS 22 AWG, Steel Wire Armored, LSNH
	3079ANH 22 AWG, LSNH
	70101E Solid Cond., PVC, IEC 60332-1, IEC 61158-2
	70101NH Solid Cond., LSNH, IEC 60332-1, IEC 61158-2
	70101LS Solid Cond., Steel Wire Armored, LSNH, IEC 60332-1, IEC 61158-2
	70102E Stranded Cond., PVC, IEC 60332-1, IEC 61158-2
	70101PE Outdoor, PE, IEC 61158-2
	70103E Fast Connect, PVC, IEC 60332-1, IEC 61158-2
	70104E Fast Connect, PVC, UL AWM 20276
	70105PU Trailing, PUR, IEC 61158-2
	183079A 22 AWG, 300 V, Twinax, Armored
PROFIBUS PA	3076F 18 AWG, 2-Conductor, PVC, CMX-Outdoor
	3076ELS 18 AWG, 2-Conductor, LSNH Inner and Outer Jacket
	3076ENH 18 AWG, 2-Conductor, LSNH
	183076F 18 AWG, 2-Conductor, Armored, PVC
	70001E 18 AWG, 2-Conductor, PVC, IEC 60332-1
	70001NH 18 AWG, 2-Conductor, LSNH, IEC 60332-1
	70001LS 18 AWG, 2-Conductor, Steel Wire Armour, LSNH, IEC 60332-1
	70200E 18 AWG, 2-Conductor, PVC, 30 V UL AWM 2464, IEC 60332-1, IEC 61158-2
	70200NH 18 AWG, 2-Conductor, LSNH, 30 V UL AWM 20851, IEC 60332-1, IEC 61158-2
	70200LS 18 AWG, 2-Conductor, Steel Wire Armor, LSNH, IEC 60332-1, IEC 61158-2
	70110E 18 AWG, 2-Conductor, PVC, IEC 60332-1, IEC 61158-2, UL 1581, AWM 2464

System Name	Belden Part Number
CANopen RS-485/HART	9841 1-Pair
	9841NH 1-Pair, LSNH
	9841LS 1-Pair, Low Smoke
	82841 1-Pair, Plenum
	89841 1-Pair, Plenum, High-Temperature
	9842 2-Pair
	9842NH 2-Pair, LSNH
	9842LS 2-Pair, Low Smoke
	82842 2-Pair, Plenum
	9843 3-Pair
	9843NH 3-Pair, LSNH
	9844 4-Pair
	9844NH 4-Pair, LSNH
	7200A 1-Pair, RS-485, Hi-Flex
	7201A 2-Pair, RS-485, Hi-Flex
	7202A 3-Pair, RS-485, Hi-Flex
	7203A 4-Pair, RS-485, Hi-Flex
	7206A 1-Pair, RS-485, Hi-Flex
	3105A 1-Pair, RS-485 (PLTC)
	3106A 1.5-Pair, RS-485 (PLTC)
	3107A 2-Pair, RS-485 (PLTC)
	3108A 3 Pair, RS-485 (PLTC)
	3109A 4 Pair, RS-485 (PLTC)
	123107A 2-Pair, RS-485, Aluminium Interlocked Armor
DeviceBus for ODVA DeviceNet	1345F CL2 TPE (Thick)
	3082A PVC (Thick)
	3082F High-Flex (Thick)
	3083A CPE (Thick)
	3084A PVC (Thin)
	3084F High-Flex (Thin)
	3085A CPE (Thin)
	7895A CL2 PVC (Cable III Mid)
	7896A CL1 PVC (Type V Trunk Cable)
	7897A CL1 PVC (Thick)
	7900A CL1 Unshielded (Drop Cable IV)

CPE = Chlorinated Polyethylene
 PE = Polyethylene
 PUR = Polyurethane
 LSNH = Low Smoke No Halogen
 PVC = Polyvinyl Chloride
 TPE = Fluorinated Ethylene-propylene

Protocol Cable Cross Reference Guide (continued)

System Name	Belden Part Number	Belden Part Number
DeviceBus for Honeywell Smart Distributed System (SDS)	3086A	1-Pair 16 AWG, 1-Pair 20 AWG
	3087A	2-Pair 22 AWG
DeviceBus for Square D/Seriplex	3124A	1-Pair 18 AWG, 1-Pair 22 AWG
	3125A	1-Pair 16 AWG, 1-Pair 22 AWG
	3126A	1-Pair 16 AWG, 1-Pair 22 AWG, 1-Pair 12 AWG
	123124A	Aluminum Armor (3124A)
	123125A	Aluminum Armor (3125A)
	123126A	Aluminum Armor (3126A)
DeviceBus for Phoenix Contact INTERBUS-S	3119A	18 AWG/3c, 24 AWG/3-Pair, Composite
	3120A	24 AWG/3-Pair
ControlNet™	3092A	RG-6 PVC Quad Shield
	3092F	RG-6 PVC Quad Shield, Flex Version, Aluminum Braid
	3093A	RG-6 FEP Quad Shield, Plenum
	123092A	Aluminum Armor (3092A)
	133092A	Steel Armor (3092A)
	183092A	Continuous Armor (3092A)
	ControlBus	3092F
3131A		RG-6 Quad Shield, Solid
3132A		RG-6 Quad Shield, Plenum, Outdoor and Direct Burial
3094A		RG-11 Quad Shield, Solid
3095A		RG-11 Quad Shield, Plenum, Outdoor and Direct Burial
ControlBus Blue Hose Industrial Twinax/DataHighway (DH) and DataHighway Plus (DH+) Remote I/O	9463	20 AWG Twinax, Blue Hose
	9463DB	Direct Burial Blue Hose
	9463NH	20 AWG Twinax, FRNC
	9463LS	20 AWG Twinax Steel Wire Armor, FRNC
	9463F	High-Flex, Blue Hose
	89463	High-Temp, Plenum Blue Hose
	129463	Aluminum Armor (9463)
	139463	Steel Armor (9463)
	189463	Continuous Armor (9463)

System Name	Belden Part Number	Belden Part Number	
ControlBus Twinax Cables	9272	20 AWG Stranded, 300 V	
	9250	18 AWG Stranded, RG-22B	
	9207	20 AWG Stranded, PVC	
	9207NH	20 AWG Stranded, LSNH	
	9271	25 AWG Stranded, 300 V	
	9860	16 AWG Solid, PVC	
	9182	22 AWG Stranded, PVC	
	9182NH	22 AWG Stranded, LSNH	
	9182LS	22 AWG Stranded, Steel Wire Armor, LSNH	
	89182	22 AWG Stranded, Plenum, FEP	
	MODBUS RS-232	8777	22 AWG, 3-Pair, Modem Drop Cable
128777		Aluminum Armor (8777)	
138777		Steel Armor (8777)	
82777		FEP 200 °C, Plenum (8777)	
8777NH		22 AWG, 3-Pair, LSNH	
8777LS		22 AWG, 3-Pair, Steel Wire Armor	
MODBUS II RG-6 Type Coaxial Cables	3092A	18 AWG Solid, PVC	
	3093A	18 AWG Solid, Plenum	
	3092F	20 AWG High Flex	
LonWorks	7701NH	22 AWG, 1-Pair, LSNH	
	7702NH	22 AWG, 2-Pair, LSNH	
	7703NH	24 AWG, 1-Pair, LSNH	
	7704NH	24 AWG, 2-Pair, LSNH	
	8471	16 AWG, 1-Pair, UL AWM 2598	
	8471LS	16 AWG, 1-Pair, LSNH, IEC 60332-1	
	8471NH	16 AWG 1-Pair, LSNH	
	85102	16 AWG, 1-Pair, Tefzel® jacket	
DataTray 600 V Twinaxial	3072F	18 AWG, MSHA, 78 Ω, PVC	
	3073F	18 AWG, 100 Ω, PVC	
	3074F	18 AWG, 124 Ω, PVC	
	CC Link	7953A	Cat 6, 600 V UL AWM, EtherNet/IP, CMX-Outdoor, Solid, LSNH
7929A		Cat 5e, MSHA, CMX-Outdoor, Solid, PVC	
7921A		Cat 5e, EtherNet/IP, CMX-Outdoor, Solid, PVC	
7939A		Cat 5e, CMX-Outdoor, Stranded, PVC	
1348A		3-Conductor, PVC Outer Jacket	
1349A		5-Conductor, PVC Inner and Outer Jacket	
KNX/EIB		YE00819	1-pair, PVC
		YE00820	2-pair, PVC
	YE00905	1-pair, LSNH	
	YE00906	2-pair, LSNH	
Coaxial Ethernet	9907	20 AWG, Stranded, PVC	
	89907	20 AWG, Stranded, Plenum	
	9880	12 AWG, Solid, PVC	
	89880	12 AWG, Solid, Plenum	

CPE = Chlorinated Polyethylene
 FEP = Fluorinated Ethylene
 FRPO = Flame Retardant Polyolefin
 FRNC = Fire Retardant, Non-Corrosive
 LSNH = Low Smoke No Halogen
 PVC = Polyvinyl Chloride
 TPE = Fluorinated Ethylene-propylene
 MSHA = Mine Safety and Health Administration

Industrial Data and Process Automation Serial Fieldbus



Section Table of Contents

Industrial Data and Process Automation	
Serial Fieldbus	
Overview	238
Foundation Fieldbus Type A	239–241
Foundation Fieldbus Type B	242
PROFIBUS	243–244
CANopen RS-485	245–246
DeviceBus® for ODVA DeviceNet™	247–248
DeviceBus® for Honeywell Smart Distributed System	249
DeviceBus® for Square D/Seriplex® and Phoenix Contact INTERBUS®-S	250
ControlNet™	251
ControlBus™	252–254
MODBUS for RS-232	255
MODBUS II for RG-6 Type Coaxial Cables	255
LonWorks	256
DataTray® 600 V Twinaxial	257
CC Link	258
KNX/EIB Approved Cables	259
Coaxial Ethernet	260
MachFlex Flexible Automation Control Cables	261
300 V MachFlex Data Cables (1 Million Flex Cycles)	261
MachFlex Vision 75 Ohm Coax Cables (1 Million Flex Cycles)	261



Serial Fieldbus



Today, more than ever, manufacturing productivity depends upon seamless data communication and automation systems. And both depend upon high-performance cabling solutions. The Serial Fieldbus range covers all key protocols in the market: Foundation Fieldbus (type A, type B, high speed), Profibus DP and PA, CanOpen RS-485, DeviceBus (for ODVA DeviceNet™, Honeywell Smart Distributed System, Square D/Seriplex® and Phoenix Contact INTERBUS®-S), ControlNet, ControlBus, MODBUS, Lonworks, DataTray® 600 V Twinaxial, CC Link, KNX/EIB and Coaxial Ethernet. The products are approved for the main PCL/DCS manufacturers in the market, such as: ABB, Siemens, Rockwell Automation, Honeywell, Emerson, Yokogawa, Mitsubishi, Schneider Electric, Omron, etc.

Product Features

- Variety of jacket materials: PVC, CPE, HDPE, FRNC/LSNH, or TPE jackets
- Versions available with Beldfoil® shields and Beldfoil® Plus Braid shields
- Twisted and bonded pairs, quad, single and multi-conductor versions
- Operation temperature from -40 °C up to +150 °C, designs suitable for hi/lo temperature installations
- UL, IEC, NFPA approvals
- Sunlight, oil, gasoline and weldsplatter resistant designs
- Suitable for CMX/outdoor applications
- PLTC listed cables
- High resistance against trailing and torsion as well continuous flooding
- Options suitable for direct burial

Benefits

- Robustness for full range of industrial applications: outdoors, trailing, oil contact
- Reliability through design robustness: steel wire armor, aluminium interlock armor, stranded conductors
- Ease of use through fast connect versions

Applications

Belden has developed the world's most comprehensive line of industrial cabling solutions for applications like yours: whether you are networking your factory floor or your process equipment and devices to their controllers, on to the control room, or relaying data between the control room, the engineering department, and remote manufacturing sites. From your petrochemical, automotive manufacturing, pharmaceutical, power generation, pulp and paper, metals, food and beverage, or general manufacturing plant to your corporate headquarters – and everywhere in between – Belden has your cabling solution.

Foundation Fieldbus Type A

Foundation Fieldbus Type A

- Impedance 100 Ohm



Part No.	AWG	Voltage	Pairs	OD (Nom)		Operating Temperature (°C)	Additional Features/Ratings
				Inch	mm		
Stranded (7 x 26) TC Conductors • Polyolefin Insulation • TC Drain Wire • Beldfoil® Shielding • Orange or Intrinsically Safe Blue PVC Jacket							
3076F*	18	300	1	.253	6.43	-40 to +105	PLTC/ITC-ER CMG CMX-Outdoor CEC: CMG FT4 Sunlight Res Oil Res IEC 60332-3-24 (Cat C)
Stranded (7 x 26) TC Conductors • Polyolefin Insulation • TC Drain Wire • Beldfoil® Shielding • LSNH Inner Jacket (Black and Blue) • Steel Wire Armour • Black LSNH Outer Jacket							
3076ELS	18	300	1	.295/.511	7.5/13	-45 to +80	NEC: CM • CEC: CM
Stranded (7 x 26) TC Conductors • Polyolefin Insulation • TC Drain Wire • Beldfoil® Shielding • LSNH Jacket							
3076ENH	18	300	1	.295	7.5	-45 to +80	NEC: CM • CEC: CM
Stranded (7 x 26) TC Conductors • Polyolefin Insulation • TC Drain Wire • Beldfoil® Shielding • PVC Inner Jacket • Armor • Orange PVC Outer Jacket							
183076F	18	300	1	.562	14.30	-40 to +105	FOUNDATION Fieldbus Type A Continuously Corrugated Aluminum Armor NEC: CMX-Outdoor Sunlight Res Oil Res
Stranded (7 x 26) TC Conductors • Polyolefin Insulation • TC Drain Wire • Individually Foil Shielded Pairs + Overall Beldfoil® Shielding • Orange PVC Jacket							
1327A	18	300	2	.44	11.18	-40 to +105	PLTC/ITC-ER CMG CMX-Outdoor CEC: CMG FT4 Sunlight Res Oil Res IEC 60332-3-24 (Cat C)
1328A			5	.55	13.87		
1329A			8	.67	17.02		
1330A			12	.81	20.57		
1331A			16	.92	23.37		
1332A			20	1.02	25.91		
1333A			24	1.14	28.96		
1359A			50	1.61	40.90		
Stranded (7 x 26) TC Conductors • Polyolefin Insulation • TC Drain Wire • Beldfoil® + 65% TC Braid Shielding • Orange or Intrinsically Safe Blue PVC Jacket							
1334A	18	300	1	.28	7.11	-50 to +105	PLTC/ITC-ER CMG CMX-Outdoor CEC: CMG FT4 Sunlight Res Oil Res IEC 60332-3-24 (Cat C)

* ABS and DNV-GL approved design also available. For more details please see Belden MarineTuff Offshore and Marine Cable Solutions brochure or consult Customer Service.

Conductor Color Code: Blue, Orange, Numbered Pairs

TC = Tinned Copper • PVC = Polyvinyl Chloride • LSNH = Low Smoke No Halogen

Foundation Fieldbus Type A

Foundation Fieldbus Type A

- Impedance 100 Ohm



Part No.	AWG	Voltage	Pairs	OD (Nom)		Operating Temperature (°C)	Additional Features/Ratings
				Inch	mm		
Stranded (7 x 26) TC Conductors • Cross-Linked Polyolefin Insulation • TC Drain Wire • Individually Shielded Pairs and Overall Beldfoil® Shielding • Orange or Intrinsically Safe Blue PVC Jacket							
2100A			1	.319	8.10		
2101A			2	.512	13.00		
2102A			5	.677	17.20		PLTC/ITC-ER CMG
2103A			8	.800	20.32		CMX-Outdoor CEC: CMG FT4
2104A	18	300	12	1.015	25.78	-55 to +90	C(UL) CIC Type TC Sunlight Res Oil Res
2105A			16	1.126	28.60		IEC 60332-3-24 (Cat C)
2106A			20	1.249	31.72		
2107A			24	1.389	35.28		
2108A			50	1.947	49.45		
Stranded (7 x 26) TC Conductors • Cross-Linked Polyolefin Insulation • TC Drain Wires • Individually Shielded Pairs and Overall Beldfoil® Shielding • Orange or Intrinsically Safe Blue PVC Jacket							
2118A*			1	.319	8.10		
2119A*			2	.512	13.00		
2120A*			5	.677	17.20		TC-ER CMG
2121A*			8	.800	20.32		CMX-Outdoor CEC: CMG FT4
2122A*	18	600	12	1.015	25.78	-55 to +90	C(UL) CIC Type TC Sunlight Res Oil Res
2123A			16	1.126	28.60		IEC 60332-3-24 (Cat C)
2124A			20	1.249	31.72		
2125A			24	1.389	35.28		
2126A			50	1.947	49.45		
Stranded (7 x 24) TC Conductors • Polyolefin Insulation • TC Drain Wires • Individually Shielded Pairs and Overall Beldfoil® Shielding • Orange PVC Jacket							
1360A			1	.40	10.16	-50 to +105	
1361A			2	.58	14.73		
1362A			5	.75	19.05		PLTC/ITC-ER CMG
1363A			8	.91	23.11		CMX-Outdoor CEC: CMG FT4
1364A	16	300	12	1.11	28.19	-40 to +105	Sunlight Res Oil Res
1365A			16	1.23	31.24		IEC 60332-3-24 (Cat C)
1366A			20	1.39	35.31		
1367A			24	1.55	39.37		
Stranded (7 x 24) TC Conductors • Cross-Linked Polyolefin Insulation • TC Drain Wire • Individually Shielded Pairs and Overall Beldfoil® Shielding • Orange or Intrinsically Safe Blue PVC Jacket							
2109A			1	.365	9.27		
2110A			2	.629	15.98		
2111A			5	.789	20.04		PLTC/ITC-ER CMG
2112A			8	.982	24.94		CMX-Outdoor CEC: CMG FT4
2113A	16	300	12	1.186	30.12	-55 to +90	C(UL) CIC Type TC Sunlight Res Oil Res
2114A			16	1.321	33.55		IEC 60332-3-24 (Cat C)
2115A			20	1.469	37.31		
2116A			24	1.638	41.61		
2117A			36	1.952	49.58		

* ABS and DNV-GL approved design also available. For more details please see Belden MarineTuff Offshore and Marine Cable Solutions brochure or consult Customer Service.

Conductor Color Code: Blue, Orange, Numbered Pairs

TC = Tinned Copper • PVC = Polyvinyl Chloride

Foundation Fieldbus Type A

Foundation Fieldbus Type A

- Impedance 100 Ohm



Part No.	AWG	Voltage	Pairs	OD (Nom)		Operating Temperature (°C)	Additional Features/Ratings
				Inch	mm		
Stranded (7 x 24) TC Conductors • Cross-Linked Polyolefin Insulation • TC Drain Wire • Individually Shielded Pairs and Overall Beldfoil® Shielding • Orange or Intrinsically Safe Blue PVC Jacket							
2127A*			1	.365	9.27		
2128A*			2	.629	15.98		
2129A*			5	.789	20.04		
2130A*			8	.982	24.94		
2131A*	16	600	12	1.186	30.12	-55 to +90	TC-ER CMG CMX-Outdoor CEC: CMG FT4 C(UL) CIC Type TC Sunlight Res Oil Res IEC 60332-3-24 (Cat C)
2132A			16	1.321	33.55		
2133A			20	1.469	37.31		
2134A			24	1.638	41.61		
2135A			36	1.952	49.58		
Stranded (7 x 24) TC Conductors • Polyolefin Insulation • TC Drain Wire • Overall Beldfoil® + 65% TC Braid Shielding • Orange or Intrinsically Safe Blue PVC Jacket							
1335A**	16	300	1	.34	8.64	-50 to +105	PLTC/ITC-ER CMG CMX-Outdoor CEC: CMG FT4 Sunlight Res Oil Res IEC 60332-3-24 (Cat C)
Stranded (7 x 22) TC Conductors • Polyolefin Insulation • TC Drain Wire • Overall Beldfoil® + 65% TC Braid Shielding • Orange or Intrinsically Safe Blue PVC Jacket							
1336A**	14	300	1	.43	10.92	-50 to +105	PLTC/ITC-ER CMG CMX-Outdoor CEC: CMG FT4 Sunlight Res Oil Res IEC 60332-3-24 (Cat C)

* ABS and DNV-GL approved design also available. For more details please see Belden MarineTuff Offshore and Marine Cable Solutions brochure or consult Customer Service.

** Although Type A specification references nominal 18 AWG, Belden 1335A and 1336A meet all other Type A requirements.

Conductor Color Code: Blue, Orange, Numbered Pairs

Foundation Fieldbus Type B

Foundation Fieldbus Type B and High Speed

- Impedance 100 Ohm or 150 Ohm



Part No.	Impedance (Ohm)	AWG	Voltage	Pairs	OD (Nom)		Operating Temperature (°C)	Additional Features/Ratings
					Inch	mm		
Stranded (7 x 30) TC Conductors • Polyolefin Insulation • TC Drain Wire • Beldfoil® Shielding • Orange PVC Jacket								
3077F	100	22	300	1	.196	4.97	-30 to +105	FOUNDATION Fieldbus Type B NEC: PLTC/ITC CM • CEC: CM FT1 Sunlight Res Oil Res
Stranded (7 x 30) TC Conductors • Foam High-Density Polyethylene Insulation • TC Drain Wire • Beldfoil® Shield • Orange PVC Jacket								
3078F	150	22	300	1	.351	8.92	-40 to +75	FOUNDATION Fieldbus High Speed NEC: CM • CEC: CM Sunlight Res Oil Res
Stranded (7 x 30) TC Conductors • Polyolefin Insulation • TC Drain Wire • Beldfoil® Shielding • Steel Wire Armour • FRNC Jacket								
3077ELS	100	22	300	1	.295/.512*	7.50/13.00*	-30 to +105	FOUNDATION Fieldbus Type B NEC: PLTC/ITC CM • CEC: CM FT1
Stranded (7 x 30) TC Conductors • Polyolefin Insulation • TC Drain Wire • Beldfoil® Shielding • FRNC Jacket								
3077ENH	100	22	300	1	.295	7.50	-30 to +105	FOUNDATION Fieldbus Type B NEC: PLTC/ITC CM • CEC: CM FT1

* Inner jacket/outer jacket

Conductor Color Code: Blue, Orange

PROFIBUS

PROFIBUS PA

- Impedance 100 Ohm
- 300 V



Part No.	Shielding	Jacket	OD (Nom)		Operating Temperature (°C)	Additional Features
			Inch	mm		
18 AWG (.891 mm²) • Stranded (7 x 26) TC Conductors • 1 Pair • Polyolefin Insulation						
3076F	Overall Beldfoil®	PVC	.253	6.43	-40 to +105	PLTC/ITC-ER CMG CMX-Outdoor CEC: CMG FT4 Sunlight Res Oil Res IEC 60332-3-24 (Cat C)
70200E			.295	7.5	-40 to +80	30 V UL AWM 2464 IEC 60332-1 • IEC 61158-2
70001E	Overall Beldfoil® + 85% Braid		.295	7.5	-45 to +80	30 V UL AWM 20276 IEC 60332-1
70110E	Overall Beldfoil® + >70% Braid		.307	7.8	-30 to +75	IEC 60332-1 • IEC 61158-2 UL 1581 • 30 V UL AWM 2464
3076ENH					-45 to +80	NEC: CM • CEC: CM
70200NH	Overall Beldfoil®	LSNH	.295	7.5	-40 to +80	30 V UL AWM 20851 IEC 60332-1 • IEC 61158-2
70001NH	Overall Beldfoil® + 85% Braid					-45 to +80
18 AWG (.891 mm²) • Stranded (7 x 26) TC Conductors • 1 Pair • Polyolefin Insulation • Continuously Corrugated Aluminium Armor						
183076F	Overall Beldfoil® + 65% Braid	PVC	.253/.562	6.43/14.3	-40 to +105	FOUNDATION Fieldbus Type A Continuously Corrugated Aluminum Armor NEC: CMX-Outdoor Sunlight Res Oil Res PVC Inner Jacket
18 AWG (.891 mm²) • Stranded (7 x 26) TC Conductors • 1 Pair • Polyolefin Insulation • Steel Wire Armor						
3076ELS					-45 to +80	Steel Wire Armor NEC: CM • CEC: CM LSNH Inner Jacket
	Overall Beldfoil®					
70200LS		LSNH	.295/.511	7.5/13	-40 to +70	Steel Wire Armor IEC 60332-1 • IEC 61158-2 LSNH Inner Jacket
70001LS	Overall Beldfoil® + 85% Braid				-45 to +70	Steel Wire Armor IEC 60332-1 LSNH Inner Jacket

Conductor Color Coding: 3076F, 3076ELS, 3076ENH, 183076F: Blue, Orange
70001E, 70001NH, 70001LS, 70200E, 70200NH, 70200LS, 70110E: Red, Green

All construction have TC Drain Wire in their design.
Colors available: Orange, Blue, Black

TC = Tinned Copper • PVC = Polyvinyl Chloride • LSNH = Low Smoke No Halogen

PROFIBUS

PROFIBUS DP

- Impedance 150 Ohm
- 300 V



Part No.	Shielding	Jacket	OD (Nom)		Operating Temperature (°C)	Additional Features
			Inch	mm		
22 AWG (.322 mm²) • Solid BC Conductors • 1 Pair • Flame Retardant Foam Polyethylene Insulation						
3079A*			.315	8.92	-30 to +75	NEC: CMG • CEC: CMG FT4 UL PLTC Sunlight Res Siemens Sinec L2 cable UL AWM 20201 (600 V, +75 °C)
70101E	Overall Beldfoil® + 65% Braid	PVC	.307	7.8	-40 to +80	30 V UL AWM 20276 IEC 60332-1 • IEC 61158-2
70103E			.323	8.2	-40 to +80	Fast Connect 30 V UL AWM 20276 IEC 60332-1 • IEC 61158-2
3079ANH			.315	8.0	-45 to +80	IEC 60332-3-24
70101NH		LSNH	.307	7.8	-40 to +80	30 V UL AWM 20851 IEC 60332-1 • IEC 61158-2
70101PE		PE	.307	7.8	-40 to +70	Outdoor IEC 61158-2
22 AWG (.352 mm²) • Stranded (7 x 30) BC Conductors • 1 Pair • Flame Retardant Foam Polyethylene Insulation						
3079E	Overall Beldfoil® + 65% Braid	PVC	.315	8.92	-30 to +75	NEC: CMG • CEC: CMG FT4 UL PLTC Sunlight Res UL AWM 20201 (600 V, +75 °C)
70102E			.307	7.8	-40 to +80	30 V UL AWM 20276 IEC 60332-1 • IEC 61158-2
24 AWG (.239 mm²) • Stranded (19 x 36) BC Conductors • 1 Pair • Flame Retardant Foam Polyethylene Insulation						
70105PU	Overall Beldfoil® + 70% Braid	PUR	.307	7.8	-40 to +80	2 Million Continuous Flex Cycles, Trailing 30 V UL AWM 21292 IEC 61158-2
22 AWG (.322 mm²) • Solid BC Conductors • 1 Pair • Flame Retardant Foam Polyethylene Insulation • Continuously Corrugated Aluminium Armor						
183079A	Overall Beldfoil® + 65% Braid	PVC	.315/.587	8.92/14.91	-30 to +60	NEC: CMG • CEC: CMG FT4 UL PLTC Continuously Corrugated Aluminum Armor 600 V AWM Sunlight Res PVC Inner Jacket
22 AWG (.322 mm²) • Solid BC Conductors • 1 Pair • Flame Retardant Foam Polyethylene Insulation • Steel Wire Armor						
3079ALS	Overall Beldfoil® + 65% Braid		.315/.488	8.00/12.40	-45 to +80	Steel Wire Armor IEC 60332-3-24 LSNH Inner Jacket
70101LS		LSNH	.307/.472	7.8/12	-40 to +70	Steel Wire Armor IEC 60332-1 • IEC 61158-2 LSNH Inner Jacket

* ABS and DNV-GL approved design also available. For more details please see Belden MarineTuff Offshore and Marine Cable Solutions brochure or consult Customer Service.

Conductor Color Coding: Red, Green

All construction have TC Drain Wire in their design.
Colors available: Chrome, Purple, Black

CANopen RS-485

Non-Plenum • Overall Foil/
Braid Shield • RS-485 • DMX512

- Impedance 120 Ohm



Part No.	Pairs	Color Code	OD (Nom)		Insulation Thickness		Jacket Thickness		Capacitance				Additional Features/Ratings
			Inch	mm	Inch	mm	Inch	mm	Cond. - Cond.		Cond. - Shield		
									pF/Ft	pF/m	pF/Ft	pF/m	

24 AWG • Polyethylene/PVC

Stranded (7 x 32) TC Conductors • Polyethylene Insulation • Overall Beldfoil® + 90% TC Braid Shield • 24 AWG Stranded TC Drain Wire • Chrome PVC Jacket													
9841	1	Chart 5	.232	5.89	.023	.58	.035	.89					NEC: CM • CEC: CM UL AWM Style 2919 (30 V, +80 °C) ANSI E1.11 DMX512 120 Ω Nom. Impedance 66% Velocity of Prop. Conductor DCR (Nom): 24.0 Ω/1000' (78.7 Ω/km)
9842	2	Chart 5	.340	8.64					12.8	42.0	23.0	75.5	
9843	3	Chart 5	.360	9.14	.022	.56	.035	.89					
9844	4	Chart 5	.390	9.91									

24 AWG • Polyethylene/LSNH

Stranded (7 x 32) TC Conductors • Polyethylene Insulation • Overall Beldfoil® + 90% TC Braid Shield • 24 AWG Stranded TC Drain Wire • Chrome FRNC/LSNH Jacket													
9841NH	1	Chart 5	.232	5.89	.023	0.58	.035	.89					IEC332-3-24 ANSI E1.11 DMX512 120 Ω Nom. Impedance 66% Velocity of Prop. Conductor DCR (Nom): 24.0 Ω/1000' (78.7 Ω/km)
9842NH	2	Chart 5	.341	8.65					12.8	42.0	23.0	75.5	
9843NH	3	Chart 5	.358	9.10	.022	0.56	.035	.89					
9844NH	4	Chart 5	.390	9.91									

24 AWG • Polyethylene/LSNH • Armored

Stranded (7 x 32) TC Conductors • Polyethylene Insulation • Chrome FRNC/LSNH Inner Jacket • Overall Beldfoil® + 90% TC Braid Shield • 24 AWG Stranded TC Drain Wire • Steel Wire Armor • Black Sunlight-Resistant FRNC/LSNH Outer Jacket														
9841LS	1	Chart 5	.405	10.30	.023	0.58							IEC332-3-24 ANSI E1.11 DMX512 120 Ω Nom. Impedance 66% Velocity of Prop. Conductor DCR (Nom): 24.0 Ω/1000' (78.7 Ω/km)	
9842LS	2	Chart 5	.516	13.10	.022	0.56			.035/.051*	.89/1.30*	12.8	42.0		23.0

* Inner jacket/outer jacket

Plenum • Overall Foil/
Braid Shield • RS-485

- Impedance 120 Ohm

- NEC: CMP
- CEC: CMP FT6



Part No.	Pairs	Color Code	OD (Nom)		Insulation Thickness		Jacket Thickness		Capacitance				Additional Features/Ratings
			Inch	mm	Inch	mm	Inch	mm	Cond. - Cond.		Cond. - Shield		
									pF/Ft	pF/m	pF/Ft	pF/m	

24 AWG • FEP/Flamarrest®

Stranded (7 x 32) TC Conductors • Foam FEP Insulation • Overall Beldfoil® + 90% TC Braid Shield • 24 AWG Stranded TC Drain Wire • Natural Flamarrest Jacket													
82841	1	Chart 5	.204	5.18	.025	.64	.015	.38					Plenum 300 V 120 Ω Nom. Impedance 76% Velocity of Prop. Conductor DCR (Nom): 24.0 Ω/1000' (78.7 Ω/km)
82842	2	Chart 5	.273	6.93	.019	.48	.015	.38	12	39.4	22	72.2	

24 AWG • FEP/FEP

Stranded (7 x 32) TC Conductors • Foam FEP Insulation • Overall Beldfoil® + 90% TC Braid Shield • 24 AWG Stranded TC Drain Wire • Red FEP Jacket													
89841	1	Chart 5	.202	5.13	.025	.64	.014	.36					Plenum 300 V 120 Ω Nom. Impedance 76% Velocity of Prop. Conductor DCR (Nom): 24.0 Ω/1000' (78.7 Ω/km)
89842	2	Chart 5	.305	7.75	.023	.58	.014	.36	12	39.4	22	72.2	

TC = Tinned Copper • FEP = Fluorinated Ethylene Propylene • FRNC/LSNH = Fire Retardant, Non-Corrosive/Low Smoke, No Halogen | Belden Color Code Charts can be found at page 350/351.

CANopen RS-485

Paired Cable • Shielded



- 24 AWG (41 x 40) BC Conductors
- Foam Polyethylene Insulation with Skin
- Overall Beldfoil® + 85% TC Braid Shield
- Green PVC Jacket
- 24 AWG (41 x 40) TC Drain Wire
- Impedance 120 Ohm
- NEC: CM
- CEC: CM
- -20 °C to +60 °C
- -5 °C to +60 °C Flexing

Part No.	Pairs	OD (Nom)		Capacitance (Max) Cond.-Cond.		Additional Features/Ratings
		Inch	mm	pF/Ft	pF/m	

120 Ohm Impedance • RS-232 and RS-485

24 AWG (41 x 40) BC Conductors • Foam Polyethylene Insulation with Skin • Overall Beldfoil® + 85% TC Braid Shield • 24 AWG (41 x 40) TC Drain Wire • Green PVC Jacket						
7200A	1	.240	6.10			
7201A	2	.322	8.18	15.0	49.2	Oil Res II
7202A	3	.347	8.81			
7203A	4	.362	9.20			

Conductor Color Coding: One-Pair Cable: White, Blue
 Multi-Pair Configurations: 1 White/Blue Stripe – Blue/White Stripe
 2 White/Orange Stripe – Orange/White Stripe
 3 White/Green Stripe – Green/White Stripe
 4 White/Brown Stripe – Brown/White Stripe

PLTC Cable



- Impedance 120 Ohm

Part No.	Pairs	OD (Nom)		Capacitance (Max) Cond.-Cond.		Operating Temperature (°C)	Additional Features/Ratings
		Inch	mm	pF/Ft	pF/m		

22 AWG (7 x 30) Stranded TC Conductors • Datalene® Insulation • TC Drain Wire • Overall Beldfoil® + 90% TC Braid Shielding • Black PVC Jacket							
3105A	1.0	.284	7.21				NEC CM • CEC CM FT1
3106A*	1.5	.300	7.62				UL PLTC
3107A*	2.0	.356	9.04				Sunlight Res
3108A*	3.0	.420	10.67	11	36.1	-20 to +60	Oil Res II 300 V
3109A*	4.0	.448	11.38				3015A and 3107A are DMX512 Type 3106A: Single conductor is under the braid shield; pair is under the Beldfoil® shield Also available with CPE jacket

22 AWG (7 x 30) Stranded TC Conductors • Datalene Insulation • TC Drain Wire • Overall Beldfoil® + 90% TC Braid Shielding • Armor • Black PVC Jacket							
123107A	2.0	.650	16.51	11	36.1	-40 to +60	Aluminum Interlocked Armor NEC CM • CEC CMG FT4 UL PLTC Sunlight Res Oil Res II 300 V

* ABS and DNV-GL approved design also available. For more details please see Belden MarineTuff Offshore and Marine Cable Solutions brochure or consult Customer Service.

DeviceBus® for ODVA DeviceNet™

DeviceNet Communications Rate Table (Impedance 120 Ohm)

Communications Rate (Kb/s)	Maximum Distance							
	3082A, 3082F, 3083A, 7897A		3082K, 7896A		7895A		3084F, 3084A, 3085A, 7900A	
	Feet	Meters	Feet	Meters	Feet	Meters	Feet	Meters
125	1640	500	1378	420	984	300	328	100
250	820	250	656	200	820	250	328	100
500	328	100	246	75	328	100	328	100

DeviceBus Cables

- Impedance 120 Ohm



Part No.	Pairs	OD (Nom)		Operating Temperature (°C)	Additional Features/Ratings
		Inch	mm		
15 (19 x 28) and 18 (19 x 30) AWG Stranded TC Conductors • FEP (Data), PVC/Nylon (Power) Insulation • Individually Foil Shielded Pairs + Overall 65% TC Braid Shielding • Gray PVC Jacket					
7897A	2 1 pair data 1 pair power	.460	11.7	-20 to +75	ODVA Class 1 Thick, High Velocity, 600 V UL TC-ER Sunlight Res Oil Res
16 (19 x 29) and 18 (19 x 30) AWG Stranded TC Conductors • FR Polypropylene (Data), PVC/Nylon (Power) Insulation • Individually Foil Shielded Pairs + Overall 65% TC Braid Shielding • Gray PVC Jacket					
7896A*	2 1 pair data 1 pair power	.525	13.34	-20 to +75	ODVA Class 1 Cable V, 600 V UL TC-ER Sunlight Res Oil Res
16 (19 x 29) and 18 (19 x 30) AWG Stranded TC Conductors • FR Polypropylene (Data), PVC/Nylon (Power) Insulation • Unshielded • Gray PVC Jacket					
7900A	2 1 pair data 1 pair power	.430	10.92	-20 to +75	ODVA Class 1 Cable IV, Drop Cable, 600 V UL TC-ER CEC: FT1 Sunlight Res Oil Res
15 (19 x 28) and 18 (19 x 30) AWG Stranded TC Conductors • Foam Polyethylene (Data), PVC (Power) Insulation • Individually Foil Shielded Pairs + Overall 65% TC Braid Shielding • Gray or Red PVC Jacket					
3082A	2 1 pair data 1 pair power	.480	12.19	-20 to +75	ODVA Class 2 Thick, 300 V NEC: CMG • CEC: CMG FT4 C(UL) AWM I/II A UL AWM 20201 (600 V) UL PLTC-ER Sunlight Res Oil Res
15 (65 x 33) and 18 (65 x 36) AWG Stranded TC Conductors • Foam Polyethylene (Data), PVC (Power) Insulation • Individually Foil Shielded Pairs + Overall 65% TC Braid Shielding • Gray or Red PVC Jacket					
3082F	2 1 pair data 1 pair power	.480	12.19	-20 to +75	ODVA Class 2 Thick, 300 V High Flex NEC: CMG • CEC: CMG FT4 C(UL) AWM I/II A UL AWM 20201 (600 V) UL PLTC-ER Sunlight Res Oil Res

* ABS and DNV-GL approved design also available. For more details please see Belden MarineTuff Offshore and Marine Cable Solutions brochure or consult Customer Service.

Conductor Color Coding: Data: Blue, White
Power: Red, Black

TC = Tinned Copper • FEP = Fluorinated Ethylene Propylene • PVC = Polyvinyl Chloride

DeviceBus® for ODVA DeviceNet™

DeviceBus Cables

- Impedance 120 Ohm



Part No.	Pairs	OD (Nom)		Operating Temperature (°C)	Additional Features/Ratings
		Inch	mm		
15 (65 x 33) and 18 (65 x 36) AWG Stranded TC Conductors • Foam Polyethylene (Data), PVC (Power) Insulation • Individually Foil Shielded Pairs + Overall 65% TC Braid Shielding • Gray TPE Jacket					
1345F	2 1 pair data 1 pair power	.480	12.19	-30 to +75	ODVA Class 2 Thick, 300 V High Flex NEC: CMG • CEC: CMG FT4 C(UL) AWM I/II A UL AWM 20201 (600 V) Sunlight Res Weldsplatter Resistant Oil Res UL PLTC-ER Sunlight Res Oil Res
22 AWG (154 x 44) and 24 AWG (105 x 44) Stranded TC Conductors • Foam Polyethylene (Data), PVC (Power) Insulation • TC Drain Wire • Individual Beldfoil® + 65% TC Braid Shielding • Gray TPE Jacket					
1346F	2 1 pair data 1 pair power	.275	6.99	-30 to +75	Class 2 Thin, 300 V NEC: CMG CL2 • CEC: CMG FT4 Sunlight Res Oil Res Weldsplatter Resistant C(UL) AWM I/II A
15 (19 x 28) and 18 (19 x 30) AWG Stranded TC Conductors • Foam Polyethylene (Data), PVC (Power) Insulation • Individually Foil Shielded Pairs + Overall 65% TC Braid Shielding • Yellow CPE Jacket					
3083A	2 1 pair data 1 pair power	.475	12.07	-30 to +75	ODVA Class 2 Thick, 300 V NEC: CMG • CEC: CMG FT4 UL PLTC Sunlight Res Oil Res
22 (19 x 34) and 24 (19 x 36) AWG Stranded TC Conductors • Foam Polyethylene (Data), PVC (Power) Insulation • Individually Foil Shielded Pairs + Overall 65% TC Braid Shielding • Gray PVC Jacket					
3084A	2 1 pair data 1 pair power	.280	7.11	-20 to +75	ODVA Class 2 Thin, 300 V NEC: CMG CL2 • CEC: CMG FT4, C(UL) AWM I/II A Sunlight Res Oil Res
22 (155 x 44) and 24 (105 x 44) AWG Stranded TC Conductors • Foam Polyethylene (Data), PVC (Power) Insulation • Individually Foil Shielded Pairs + Overall 65% TC Braid Shielding • Gray PVC Jacket					
3084F	2 1 pair data 1 pair power	.275	6.00	-20 to +75	Class 2 Thin, 300 V High Flex NEC: CMG CL2 • CEC: CMG FT4, C(UL) AWM I/II A Sunlight Res Oil Res
22 (19 x 34) and 24 (19 x 36) AWG Stranded TC Conductors • Foam Polyethylene (Data), PVC (Power) Insulation • Individually Foil Shielded Pairs + Overall 65% TC Braid Shielding • Yellow CPE Jacket					
3085A	2 1 pair data 1 pair power	.280	7.11	-30 to +75	ODVA Class 2 Thin, 300 V NEC: CL2 CMG • CEC: CMG FT4 Sunlight Res Oil Res
20 (19 x 32) and 18 AWG (19 x 30) Stranded TC Conductors • Foam Polyethylene (Data), PVC (Power) Insulation • Individually Foil Shielded Pairs + Overall 65% TC Braid Shielding • Gray PVC Jacket					
7895A	2 1 pair data 1 pair power	.378	9.60	-20 to +75	OVDA Class 2 Cable III, 300 V NEC: CMG • CEC: CMG FT4 UL AWM 20201 (600 V) UL PLTC Sunlight Res Oil Res

Conductor Color Coding: Data: Blue, White
Power: Red, Black

TC = Tinned Copper • PVC = Polyvinyl Chloride • FPE = Foam Polyethylene • TPE = Thermoplastic Elastomer • CPE = Chlorinated Polyethylene

DeviceBus® for Honeywell Smart Distributed System



- Impedance 120 Ohm

Part No.	Impedance (Ohm)	Pairs	OD (Nom)		Operating Temperature (°C)	Additional Features/Ratings
			Inch	mm		
16 AWG (19 x 29) and 20 AWG (19 x 32) Stranded TC Conductors • Foam Polyethylene (Data), PVC (Power) Insulation • TC Drain Wire • Individually Beldfoil® Shielded Pairs • Gray PVC Jacket						
3086A	120	2 1 pair data 1 pair power	.398	10.11	-40 to +80	Mini Cable, Trunk NEC: CL2 UL AWM 2464 (30 V, +60 °C) CSA AWM I/II A FT1
22 AWG (19 x 34) Stranded TC Conductors • Foam Polyethylene (Data), PVC (Power) Insulation • TC Drain Wire • Individually Beldfoil® Shielded Pairs • Gray PVC Jacket						
3087A	120	2 1 pair data 1 pair power	.290	7.37	-40 to +80	Micro Cable, Drop NEC: CL2 UL AWM 2464 (30 V, +60 °C) CSA AWM I/II A FT1

Conductor Color Code: Power Pairs: Black, White
Data Pairs: Blue, Brown

DeviceBus® for Square D/Seriplex® and Phoenix Contact INTERBUS®-S

Square D/Seriplex



Part No.	Pairs	OD (Nom)		Operating Temperature (°C)	Additional Features/Ratings
		Inch	mm		
18 AWG (16 x 30) and 22 (7 x 30) Stranded TC Conductors • Foam High-Density Polyethylene Insulation • TC Drain Wire • Overall Beldfoil® Shielding • Orange PVC Jacket					
3124A	2	.308	7.82	-20 to +75	Seriplex CBL 1822-P18 NEC: CL2 CM • CEC: CM UL AWM 20201 (600 V, +75 °C)
16 AWG (16 x 30) and 22 (7 x 30) Stranded TC Conductors • Foam High-Density Polyethylene Insulation • TC Drain Wire • Overall Beldfoil® Shielding • Orange PVC Jacket					
3125A	2	.368	10.11	-20 to +75	Seriplex CBL 1622-P1 NEC: CL2 CM • CEC: CM 300 V, +75 °C
12 AWG (65 x 30), 16 AWG (26 x 30) and 22 (7 x 30) Stranded TC Conductors • Foam High-Density Polyethylene (Data), PVC (Power) Insulation • TC Drain Wire • Overall Beldfoil® Shielding • Orange PVC Jacket					
3126A	3	.486 x .363	12.34 x 9.22	-20 to +75	Seriplex CBL 162212-P16 NEC: CL2 CM • CEC: CM 300 V, +75 °C

Conductor Color Coding: 16/18 AWG: Red, Black
 22 AWG: White, Green
 12 AWG: Black/White, Red/White

Phoenix Contact INTERBUS-S

- Impedance 100 Ohm



Part No.	Conductors	OD (Nom)		Operating Temperature (°C)	Additional Features/Ratings
		Inch	mm		
18 AWG (7 x 26) and 24 (7 x 33) Stranded TC Conductors • PE (Data), PVC (Power) Insulation • TC Drain Wire • Overall Beldfoil® + 90% TC Braid Shielding • Green Polyurethane Jacket					
3119A	3 Cond. power 3 pair data	.333	8.46	-40 to +80	UL AWM 20333 (300 V, +80 °C)
Stranded 24 AWG (7 x 32) TC Conductors • PE Insulation • Overall Beldfoil® + 90% TC Braid Shielding • Green Polyurethane Jacket					
3120A	3 pair	.277	7.04	-40 to +80	UL AWM 20333 (300 V, +80 °C)

TC = Tinned Copper • PE = Polyethylene • PVC = Polyvinyl Chloride

ControlNet™

RG6/U Type Quad Shielded Coaxial

- Impedance 75 Ohm



Part No.	Core Diameter		OD (Nom)		Operating Temperature (°C)	Additional Features/Ratings
	Inch	mm	Inch	mm		
18 AWG Solid BC-Covered Steel Conductor • Foam Polyethylene Insulation • Duobond® IV* Quad Shield • PVC Jacket (Black or Intrinsicly Safe Blue)						
3092A**	.180	4.57	.298	7.57	-30 to +75	Impedance: 75 Ω NEC: CMR CL2R • CEC: CMG FT4
18 AWG Solid BC-Covered Steel Conductor • Foam FEP Insulation • Duobond® IV* Quad Shield • Fluorocopolymer Jacket (Black or Intrinsicly Safe Blue)						
3093A	.170	4.32	.274	6.96	-20 to +150	Plenum Rated Impedance: 75 Ω NEC: CMP • CEC: CMP FT6
20 AWG Stranded (105 x 40) BC Conductor • Foam Polyethylene Insulation • Duobond® IV* Quad Shield • Black PVC Jacket						
3092F	.183	4.65	.303	7.70	-40 to +75	High Flex Impedance: 75 Ω NEC: CMR CL2R • CEC: CMG FT4
18 AWG Solid BC-Covered Steel Conductor • Foam Polyethylene Insulation • Duobond® IV* Quad Shield • PVC Inner Jacket • Armor • Black PVC Sunlight-Resistant Outer Jacket						
123092A	.180	4.57	.620	15.75	-40 to +75	Aluminum Interlocked Armor Impedance: 75 Ω NEC: CM • CEC: CMG FT4, HL
18 AWG Solid BC-Covered Steel Conductor • Foam Polyethylene Insulation • Duobond® IV* Quad Shield • PVC Inner Jacket • Armor • Black PVC Outer Jacket						
183092A	.180	4.57	.570	14.48	-30 to +75	Continuously Corrugated Aluminum Armor Impedance: 75 Ω NEC: CM CL2

* Duobond® IV is a four-layer shield: (1) Duobond II Foil, (2) Aluminium Braid (60%), (3) Duofoil® Foil, (4) Aluminium Braid (40%).

** ABS and DNV-GL approved design also available. For more details please see Belden MarineTuff Offshore and Marine Cable Solutions brochure or consult Customer Service.

ControlBus™

Quad Shielded Coaxial

- Impedance 75 Ohm



Part No.	Core Diameter		OD (Nom)		Operating Temperature (°C)	Additional Features/Ratings
	Inch	mm	Inch	mm		
20 AWG Stranded (105 x 40) BC Conductor • Foam Polyethylene Insulation • Duobond® IV* Quad Shielding • Black PVC Jacket						
3092F**	.183	4.65	.303	7.70	-40 to +75	High Flex Impedance: 75 Ω RG-6/U Type NEC: CMR CLR2 • CEC: CMG FT4 IEEE 802.4 MAP/IEEE 802.7 Mini-MAP
18 AWG Solid BC-Covered Steel Conductor • Gas-Injected Foam Polyethylene Insulation • Duobond® IV* Quad Shielding • Gray PVC Jacket						
3131A	.189	4.57	.300	7.62	-30 to +75	Impedance: 75 Ω RG-6/U Type NEC: CMR CLR2 • CEC: CMG FT4
18 AWG Solid BC-Covered Steel Conductor • Foam FEP Insulation • Duobond® IV* Quad Shielding • Gray Fluorocopolymer Jacket						
3132A	.170	4.32	.274	6.96	-20 to +150	Plenum Impedance: 75 Ω Outdoor and Direct Burial RG-6/U Type NEC: CMP • CEC: CMP FT6 IEEE 802.4 MAP/IEEE 802.7 Mini-MAP
14 AWG Solid BC-Covered Steel Conductor • Gas-Injected Foam Polyethylene Insulation • Duobond® IV* Quad Shielding • Gray PVC Jacket						
3094A	.280	7.11	.407	10.34	-30 to +80	Impedance: 75 Ω RG-11/U Type NEC: CMR CLR2 • CEC: CMG FT4 IEEE 802.4 MAP
14 AWG Solid BC-Covered Steel Conductor • Foam FEP Insulation • Duobond® IV* Quad Shielding • Gray Fluorocopolymer Jacket						
3095A	.280	7.11	.387	9.83	-20 to +150	Plenum Impedance: 75 Ω Outdoor and Direct Burial RG-11/U Type NEC: CMP • CEC: CMG FT6 IEEE 802.4 MAP

* Duobond® IV is a four-layer shield: (1) Duobond II Foil, (2) 60% Aluminium Braid, (3) Duofoil® Foil, (4) 40% Aluminium Braid.

** ABS and DNV-GL approved design also available. For more details please see Belden MarineTuff Offshore and Marine Cable Solutions brochure or consult Customer Service.

ControlBus™

Blue Hose® Industrial Twinax

- Impedance 78 Ohm



Part No.	Voltage	Nominal OD		Operating Temperature (°C)	Additional Features/Ratings
		Inch	mm		
20 AWG Stranded (7 x 28) TC Conductors • Polyethylene Insulation • Overall Beldfoil® + 55% TC Braid Shielding • Blue Sunlight-Resistant PVC Jacket					
9463	300 V	.238	6.05	-40 to +80	NEC: CM CL2 • CEC: CM UL AWM 2464 MSHA Approved*
20 AWG Stranded (42 x 36) TC Conductors • Polyethylene Insulation • Overall Beldfoil® + 85% TC Braid Shielding • Blue Sunlight-Resistant PVC Jacket					
9463F	300 V	.154	3.91	-40 to +80	High Flex NEC: CM CL2 • CEC: CM UL AWM 2464 MSHA Approved*
20 AWG Stranded (42 x 36) TC Conductors • Polyethylene Insulation • Overall Beldfoil® + 85% TC Braid Shielding • Blue Sunlight-Resistant FRNC Jacket					
9463NH	300 V	.25	6.35	-45 to +80	IEC 60332-3-24
20 AWG Stranded (42 x 36) TC Conductors • Polyethylene Insulation • Overall Beldfoil® + 85% TC Braid Shielding • Steel Wire Armor • Blue FRNC Outer and Inner Jacket					
9463LS	300 V	.42	10.75	-45 to +80	IEC 60332-3-24
20 AWG Stranded (7 x 28) TC Conductors • Polyethylene Insulation • Overall Beldfoil® + 55% TC Braid Shielding • PVC Inner Jacket • Aluminium, Steel Interlock or Corrugated Armor • Blue Sunlight-Resistant PVC Jacket					
129463		.563	14.30	-40 to +60	Aluminum Armored NEC: CM CL2 • CEC: CM, HLBCD
139463	300 V	.563	14.30	-40 to +60	Steel Armored NEC: CM CL2 • CEC: CM, HLBCD
189463		.500	12.70	-20 to +60	Corrugated Armored UL PLTC
20 AWG Stranded (7 x 28) TC Conductors • Low-Density Polyethylene Insulation • Overall Beldfoil® + 55% TC Braid Shielding • Blue Sunlight-Resistant LDPE Jacket					
9463DB	300 V	.154	3.91	-55 to +80	Continuously Flooded Direct Burial
20 AWG Stranded (7 x 28) TC Conductors • FEP Insulation • Overall Beldfoil® + 55% TC Braid Shielding • Blue Sunlight-Resistant FEP Jacket					
89463	300 V	.151	3.83	-70 to +200	Plenum NEC: CMP CL2P • CEC: CMP FT6

* MSHA = Mine Safety and Health Administration

Conductor Color Codes: Blue, Clear

TC = Tinned Copper • PVC = Polyvinyl Chloride • FEP = Fluorinated Ethylene Propylene • FRNC = Fire Retardant, Non-Corrosive • LDPE = Low-density Polyethylene

ControlBus™

Twinax Cables



Part No.	Impedance (Ohm)	Core Diameter		OD (Nom)		Operating Temperature (°C)	Additional Features/Ratings
		Inch	mm	Inch	mm		
20 AWG Stranded (7 x 28) TC Conductors • Polyethylene Insulation (Blue, Clear) • 93% TC Braid Shielding • Blue PVC Jacket							
9272	78	.156	3.96	.244	6.20	-20 to +60	Impedance: 78 Ω NEC: CM • CEC: CM UL AWM Style 2092 (300 V, +60 °C)
18 AWG Stranded (7 x 26) BC Conductors • Polyethylene Insulation (Clear, Clear) • Polyethylene Inner Jacket • 95% TC Double Braid Shielding • Black Non-contaminating PVC Outer Jacket							
9250	95	.285	7.24	.416	10.57	-40 to +80	Impedance: 95 Ω RG-22B/U Type VW-1 One Conductor Has Tinned Center Strand
20 AWG Stranded (7 x 28) One TC, One BC Conductor • Polyethylene Insulation (Natural, Natural) • Polyethylene Inner Jacket • Duofoil® + 86% TC Braid Shielding • Black PVC Outer Jacket							
9207	100	.236	5.99	.330	8.38	-30 to +75	Impedance: 100 Ω NEC: CMG CL2 • CEC: CMG FT4
20 AWG Stranded (7 x 28) One TC, One BC Conductor • Polyethylene Insulation (Natural, Natural) • Polyethylene Inner Jacket • Duofoil® + 86% TC Braid Shielding • Black FRNC Outer Jacket							
9207NH	100	0.236	5.99	.34	8.6	-45 to +80	IEC 60332-3-24
25 AWG Stranded (7 x 33) TC Conductors • Polyethylene Insulation (Blue, Clear) • Beldfoil® • Blue PVC Jacket							
9271	124	.170	4.32	.240	6.10	-20 to +60	Impedance: 124 Ω NEC: CM • CEC: CM UL AWM 2092 (300 V, +60 °C)
16 AWG Solid BC Conductors • Foam Polyethylene Insulation (Blue, Clear) • Duofoil + 90% TC Braid Shielding • Black PVC Jacket							
9860	124	.322	8.18	.440	11.18	-20 to +60	Impedance: 124 Ω NEC: CMX • CEC: CMX UL AWM 2448 (30 V, +60 °C) VW-1
22 AWG stranded (19 x 34) TC Conductors • Datalene® Insulation (Black, Yellow) • Duofoil Shielding • Black PVC Jacket • Stranded TC Drain Wire							
9182	150	.275	6.98	.345	8.76	-20 to +60	Impedance: 150 Ω NECL CL2X CMX • CEC: CMX UL AWM 2668 (30 V, +60 °C) VW-1
22 AWG Stranded (19 x 34) TC Conductors • Datalene® Insulation (Black, Yellow) • Duofoil Shielding • Black FRNC Jacket • Stranded TC Drain Wire							
9182NH	150	.275	6.98	.345	8.76	-45 to +80	IEC 60332-3-24
22 AWG Stranded (19 x 34) TC Conductors • Datalene Insulation (Black, Yellow) • Duofoil Shielding • Black FRNC Inner Jacket • Steel Wire Armor • Black FRNC Jacket • Stranded TC Drain Wire							
9182LS	150	.275	6.98	.56	14.25	-45 to +80	IEC 60332-3-24
22 AWG stranded (19 x 34) TC Conductors • Foam FEP Insulation (Black, Yellow) • Duofoil Shielding • Black FEP Jacket • Stranded TC Drain Wire							
89182	150	.278	7.06	.307	7.80	-70 to +200	Impedance: 150 Ω Plenum Rated NEC: CMP CL2P • CEC: CMP FT6

TC = Tinned Copper • BC = Bare Copper • PVC = Polyvinyl Chloride • FRNC = Fire Retardant, Non-Corrosive • FEP = Fluorinated Ethylene Propylene

MODBUS for RS-232 Applications

Shielded Twisted Pair Cables

- Impedance 50 Ohm



Part No.	Pairs	OD (Nom)		Operating Temperature (°C)	Additional Features/Ratings
		Inch	mm		

22 AWG • Polypropylene

Stranded (7 x 30) TC Conductors • Polypropylene Insulation • TC Drain Wire • Individually Beldfoil® Shielded Pairs • Chrome PVC Jacket					
8777	3	.273	6.93	-20 to +80	NEC: CM • CEC: CM UL AWM 2919 (30 V, +80 °C)
Stranded (7 x 30) TC Conductors • Polypropylene Insulation • TC Drain Wire • Individually Beldfoil® Shielded Pairs • Chrome FRNC Jacket					
8777NH	3	.273	6.93	-45 to +80	IEC 60332-3-24
Stranded (7 x 30) TC Conductors • Polypropylene Insulation • TC Drain Wire • Individually Beldfoil® Shielded Pairs • Steel Wire Armor • Black FRNC Jacket					
8777LS	3	.55	13.9	-45 to +80	IEC 60332-3-24

Conductor Color Coding: Red/Black, White/Black, Green/Black

Part No.	Pairs	Color Code	OD (Nom)		Insulation Thickness		Jacket Thickness		Capacitance				Additional Features/Ratings
			Inch	mm	Inch	mm	Inch	mm	Cond. - Cond.		Cond. - Shield		
									pF/Ft	pF/m	pF/Ft	pF/m	

22 AWG • FEP/Flamarrest®

Stranded (7 x 30) TC Conductors • FEP Insulation • Individually Beldfoil® Shielded Pairs • 22 AWG TC Drain Wire • Natural Flamarrest Jacket													
82777	3	Chart 3	.237	6.02	.011	.28	.017	.43	35	115	76	249	Plenum NEC: CMP • CEC: CMP FT6 46 Ω Nom. Impedance 62% Velocity of Prop. Conductor DCR (Nom): 14.7 Ω/1000' (48.2 Ω/km)

MODBUS II for RG-6 Type Coaxial Cables

Coaxial Cables

- Impedance 75 Ohm



Part No.	Core Diameter		OD (Nom)		Operating Temperature (°C)	Additional Features/Ratings
	Inch	mm	Inch	mm		

18 AWG Solid BC-Covered Steel Conductor • Foam Polyethylene Insulation • Duobond® IV* Quad Shield • PVC Jacket (Black or Intrinsically Safe Blue)						
3092A	.180	4.57	.298	7.57	-30 to +75	Impedance: 75 Ω NEC: CMR CL2R • CEC: CMG FT4
18 AWG Solid BC-Covered Steel Conductor • Foam FEP Insulation • Duobond® IV* Quad Shield • Fluorocopolymer Jacket (Black or Intrinsically Safe Blue)						
3093A	.170	4.32	.274	6.96	-20 to +150	Plenum Rated Impedance: 75 Ω NEC: CMP • CEC: CMP FT6
20 AWG Stranded (105 x 40) BC Conductor • Duobond® IV* Quad Shield • Foam Polyethylene Insulation • Black PVC Jacket						
3092F	.183	4.65	.303	7.70	-40 to +75	High Flex Impedance: 75 Ω NEC: CMR CL2R • CEC: CMG FT4

* Duobond® IV is a four-layer shield: (1) Duobond II Foil, (2) TC Braid (94%), (3) Duofoil® Foil, (4) TC Braid (90%).

TC = Tinned Copper • BC = Bare Copper • PVC = Polyvinyl Chloride • FRNC = Fire Retardant, Non-Corrosive • FEP = Fluorinated Ethylene Propylene
Belden Color Code Charts can be found at page 350/351.

LonWorks

Paired Cable 300 V, +80 °C



- Impedance 100 Ohm
- Level IV Cables

Part No.	Pairs	Color Code	OD (Nom)		Insulation Thickness		Jacket Thickness		Additional Features
			Inch	mm	Inch	mm	Inch	mm	

22 AWG BC Conductors • Foamed Polyethylene Insulation • White LSNH Jacket

Unshielded

7701NH	1	White/Blue, Blue/White	.138	3.5	.009	.23	.018	.45	Flame Resistance IEC 60332-3C or -24
7702NH	2	Orange/White, White/Orange	.205	5.2	.009	.23	.020	.50	

Overall Beldfoil® Shield

7703NH	1	White/Blue, Blue/White	.181	4.6	.015	.4	.018	.45	Flame Resistance IEC 60332-3C or -24
7704NH	2	Orange/White, White/Orange	.256	6.5	.011	.3	.020	.50	

Backbone Cable • Plenum • 300 V, +80 °C • Unshielded



Part No.	Pairs	Color Code	OD (Nom)		Insulation Thickness		Jacket Thickness		Additional Features/Ratings
			Inch	mm	Inch	mm	Inch	mm	

16 AWG • 19 x 29 • PVC/PVC

Stranded TC Conductors • PVC Insulation • Chrome PVC jacket

8471	1	Black/White	.274	6.96	.023	.58	.032	.81	NEC: CMG • CEC: CMG FT4 UL AWM Style 2598
------	---	-------------	------	------	------	-----	------	-----	--

16 AWG • 19 x 29 • Armored

Stranded BC Conductors • Polyethylene Insulation • Unshielded • LSNH Inner Jacket • Steel Wire Armor • Chrome LSNH Outer Jacket

8471LS	1	Black/White	.413	10.5	.022	.58	.035/.051	.89/1.3	IEC 60332-3-24
--------	---	-------------	------	------	------	-----	-----------	---------	----------------

16 AWG • 19 x 29

Stranded BC Conductors • Polyethylene Insulation • Unshielded • Chrome LSNH Outer Jacket

8471NH	1	Black/White	.28	7.1	.023	.58	.035	.89	IEC 60332-3-24
--------	---	-------------	-----	-----	------	-----	------	-----	----------------

High-Temperature Backbone Cable 300 V, +150 °C • Unshielded

- VW-1



Part No.	Conductors	Color Code	OD (Nom)		Insulation Thickness		Jacket Thickness	
			Inch	mm	Inch	mm	Inch	mm

16 AWG • 19 x 29 • ETFE/ETFE

Stranded (19 x 29) TC Conductors • Cabled • ETFE Insulation • Clear ETFE Jacket

85102	2	Chart 2R	.211	5.36	.014	.36	.019	.48
-------	---	----------	------	------	------	-----	------	-----

BC = Bare Copper • TC = Tinned Copper • PVC = Polyvinyl Chloride • LSNH = Low Smoke No Halogen • ETFE = Ethylene/Tetrafluoroethylene
Belden Color Code Charts can be found at page 350/351.

DataTray® 600 V Twinaxial

DataTray® 600 V Twinax



Part No.	Impedance (Ohm)	Core Diameter		OD (Nom)		Operating Temperature (°C)	Additional Features/Ratings
		Inch	mm	Inch	mm		
18 AWG Stranded (7 x 26) TC Conductors • Flame-retardant Polyolefin Insulation (Natural, Blue) • Overall Beldfoil® + 55%TC Braid Shield • Blue Sunlight-resistant PVC Jacket • TC Drain Wire							
3072F*	78	.192	4.88	.324	8.23	-40 to +75	Impedance: 78 Ω NEC: CMG, ITC, TC, PLTC • CEC: CMG FT4 UL TC MSHA Approved**
3073F	100	.246	6.25	.388	9.86	-40 to +75	Impedance: 100 Ω NEC: CMG, ITC, TC, PLTC • CEC: CMG FT4 UL TC
3074F	124	.328	8.33	.460	11.86	-40 to +75	Impedance: 124 Ω NEC: CMG, ITC, TC, PLTC • CEC: CMG FT4 UL TC

* ABS and DNV-GL approved design also available. For more details please see Belden MarineTuff Offshore and Marine Cable Solutions brochure or consult Customer Service.

** MSHA = Mine Safety and Health Administration

TC = Tinned Copper • PVC = Polyvinyl Chloride

CC Link



- Impedance 100 Ohm

Part No.	Category	Pairs	Conductor (Stranding)		Nominal OD (mm)	Jacket	Shielding	Operating Temperature (°C)	Additional Features/Ratings
			Solid	Stranded					
Category 6 • 4 Pair • Shielded • LSNH Outer Jacket • Bonded-Pair									
7953A	Cat 6	4	AWG 23 (1)	–	8.64	LSNH	Overall Beldfoil® Shielding	-40 to +75	600 V UL AWM Shielded EtherNet/IP Compliant NEC: CMR, CMX-Outdoor • CEC: CMR FT4 Sunlight and Oil Resistant
Category 5e • 4 Pair • Unshielded and Shielded • PVC Outer Jacket • Bonded-Pair									
7929A		4	AWG 24 (1)	–	6.73		Overall Beldfoil® Shielding		NEC: CMR, CMX-Outdoor • CEC: CMR FT4 MSHA Approved* Sunlight and Oil Resistant
7921A	Cat 5e	4	AWG 24 (1)	–	8.38	PVC	Foil Braid >70%	-40 to +75	Heavy Shielded EtherNet/IP Compliant NEC: CMR, CMX-Outdoor • CEC: CMR FT4 Sunlight and Oil Resistant
7939A		4	–	AWG 24 (7)	8.60		Overall Beldfoil® Shielding		NEC: CMR, CMX-Outdoor • CEC: CMR FT4 Sunlight and Oil Resistant

* MSHA = Mine Safety and Health Administration



- Impedance 110 Ohm

Part No.	Pairs	Conductor (Stranding)		Nominal OD (mm)	Jacket	Shielding	Operating Temperature (°C)	Additional Features/Ratings
		Solid	Stranded					
20 AWG (7 x 28) Stranded BC Conductors • Foam High-Density Polyethylene Insulation • TC Drain Wire • Overall Beldfoil® + 78% TC Braid Shielding • Red PVC Jacket								
1348A	3 Cond.	–	AWG 20 (7)	7.70	PVC	Foil Braid >78%	-30 to +60	3 Conductor, 300 V NEC: CM • CEC: CM
3 x 20 AWG (7 x 28) and 2 x 18 AWG (7 x 26) Stranded BC Conductors • Foam High-Density Polyethylene (Data), PVC (Power) Insulation • 3 Data cables: Overall Beldfoil® + 78% TC Braid Shielding, TC Drain Wire • Black PVC Inner Jacket • Red PVC Outer Jacket								
1349A	3 Cond. Data 2 Cond. Power	–	3 x 20 AWG (7) and 2 x 18 AWG (7)	13.00	PVC	Foil Braid >78%	-30 to +60	5 Conductor, 300 V NEC: CM • CEC: CM

Conductor Color Coding: Blue, Yellow, White (Data); Black, White (Power)

BC = Bare Copper • TC = Tinned Copper • PVC = Polyvinyl Chloride • LSNH = Low Smoke No Halogen

KNX/EIB Approved Cables



Part No.	Applicable Standard(s)	No. of Pairs	Color Code	Standard Lengths		Standard Unit Weight		Insulation Thickness		Outer Jacket Thickness		Nominal OD	
				ft.	m	lbs.	mm	Inch	mm	Inch	mm	Inch	mm
0.8 mm (0.5 mm² or AWG 20)													
Solid BC • PVC Insulation • 100% Foil Screen • Green PVC Jacket KNX Reg. no. 109/7253/05													
YE00819	EN 50090 CEN/TC 247	1	Red/Black	328	100	8.4	3.8	.012	.30	.043	1.10	.217	5.50
				500	500	46.3	21.0						
				3280	1000	89.3	40.5						
YE00820	EN 50090 CEN/TC 247	2	Red/Black White/Yellow	328	100	11.5	5.2	.012	.30	.043	1.10	.241	6.10
				500	500	61.7	28.0						
				3280	1000	122.3	55.5						
Solid BC • PE Insulation • 100% Foil Screen • Green LSNH Jacket KNX Reg. no. 109/7254/05													
YE00905	IEC 60189-2 IEC 60332-1	1	Red/Black	328	100	8.6	3.9	.016	.40	.043	1.10	.220	5.60
				1624	500	47.4	21.5						
				3280	1000	91.5	41.5						
YE00906	IEC 60189-2 IEC 60332-1	2	Red/Black White/Yellow	328	100	12.3	5.6	.016	.40	.043	1.10	.282	6.30
				1624	500	68.3	31.0						
				3280	1000	131.1	59.5						

BC = Bare Copper • PVC = Polyvinyl Chloride • PE = Polyethylene • LSNH = Low Smoke No Halogen

Coaxial Ethernet

Thinnet 10Base2 Ethernet

- Impedance 50 Ohm



Part No.	AWG	Core Diameter		OD (Nom)		Operating Temperature (°C)	Additional Features/Ratings
		Inch	mm	Inch	mm		
Stranded (19 x 32) TC Conductor • Foam Polyethylene Insulation • Duobond® II Foil + 93% TC Braid Shielding • Gray PVC Jacket							
9907	20	.102	2.59	.185	4.70	-40 to +80	Impedance: 50 Ω RG-58 Type NEC: CM CL2 • CEC: CM UL AWM Style 1354 (30 V, +60 °C)
Stranded (19 x 32) TC Conductor • Foam FEP Insulation • Duobond II Foil + 93% TC Braid Shielding • Gray Fluorocopolymer Jacket							
89907	20	.095	2.41	.160	4.06	-20 to +150	RG-58A/U Type Plenum Rated Impedance: 50 Ω NEC: CMP CL2P • CEC: CMP FT6 Outdoor and Direct Burial

Thicknet 10Base5 Ethernet

- Impedance 50 Ohm



Part No.	AWG	Core Diameter		OD (Nom)		Operating Temperature (°C)	Additional Features/Ratings
		Inch	mm	Inch	mm		
Solid BC Conductor • Foam Polyethylene Insulation • Duobond IV* Quad Shielding • Yellow PVC Jacket							
9880	12	.243	6.17	.405	10.29	-40 to +60	Impedance: 50 Ω NEC: CM CL2 • CEC: CM UL AWM Style 1478 (30 V, +60 °C)
Solid BC Conductor • Foam FEP Insulation • Duobond IV* Quad Shielding • Orange Fluorocopolymer Jacket							
89880	12	.245	6.22	.375	9.53	-25 to +150	Plenum Rated Impedance: 50 Ω NEC: CMP CL2P • CEC: CMP FT6 Outdoor and Direct Burial

* Duobond IV is a four-layer shield: (1) Duobond II Foil, (2) TC Braid (94%), (3) Duofoil® Foil, (4) TC Braid (90%).

MachFlex Flexible Control Cables

300 V MachFlex Data Cables (1 Million Flex Cycles)

Paired Cable • Shielded



- 24 AWG (41 x 40) BC Conductors
- Foam Polyethylene Insulation with Skin
- Overall Beldfoil® + 85% TC Braid Shield
- Green PVC Jacket
- 24 AWG (41 x 40) TC Drain Wire
- NEC: CM
- CEC: CM
- -20 °C to +60 °C
- -5 °C to +60 °C Flexing

Part No.	Pairs	OD (Nom)		Capacitance (Max)*		Additional Features/Ratings
		Inch	mm	pF/Ft	pF/m	

24 AWG (41 x 40) BC Conductors • Foam Polyethylene Insulation with Skin • Overall Beldfoil® + 85% TC Braid Shield • 24 AWG (41 x 40) TC Drain Wire • Green PVC Jacket

120 Ohm Impedance • RS-232 and RS-485

Part No.	Pairs	Core OD (Nom) Inch	Core OD (Nom) mm	Cable OD (Nom) Inch	Cable OD (Nom) mm	Capacitance (Max)* pF/Ft	Capacitance (Max)* pF/m	Additional Features/Ratings
7200A	1	.240	6.10					
7201A	2	.322	8.18			15.0	49.2	
7202A	3	.347	8.81					
7203A	4	.362	9.20					

100 Ohm Impedance • RS-232 and RS-422

7205A	1	.232	5.89			14.0	45.9	Oil Res II
-------	---	------	------	--	--	------	------	------------

150 Ohm Impedance • RS-232 and RS-485

7206A	1	.302	7.67			10.0	32.8	
-------	---	------	------	--	--	------	------	--

* One conductor to other conductors connected to shield.
Conductor Color Coding: One-Pair Cable: White, Blue

Multi-Pair Configurations: 1 White/Blue Stripe – Blue/White Stripe
 2 White/Orange Stripe – Orange/White Stripe
 3 White/Green Stripe – Green/White Stripe
 4 White/Brown Stripe – Brown/White Stripe

MachFlex Vision 75 Ohm Coax Cables (1 Million Flex Cycles)

75 Ohm Coax



- UL AWM 1354 (30 V, +80 °C)
- CSA AWM I/II A/B FT1
- -40 °C to +80 °C

Part No.	Core OD (Nom)		Cable OD (Nom)		Additional Features/Ratings
	Inch	mm	Inch	mm	

Foam Polyethylene Insulation • 95% TC "French Braid" Shield • Matte Blue Belflex Jacket

30 AWG Stranded • 7 x 38 • Tinned Copper Alloy Conductor

7500A	.056	1.42	.110	2.79	Sub-Mini Type
-------	------	------	------	------	---------------

25 AWG Stranded • 19 x 38 • BC Conductor

7501A	.090	2.29	.146	3.71	Mini Type
-------	------	------	------	------	-----------

22 AWG Stranded • 19 x 34 • BC Conductor

7502A	.146	3.71	.242	6.15	RG-59 Type
-------	------	------	------	------	------------

20 AWG Stranded • 7 x 15 x 40 • BC Conductor

7503A	.185	4.70	.275	6.99	RG-6/U Type
-------	------	------	------	------	-------------

16 AWG Stranded • 7 x 37 x 40 • BC Conductor

7504A	.285	7.24	.405	10.29	RG-11 Type
-------	------	------	------	-------	------------

BC = Bare Copper • TC = Tinned Copper • PVC = Polyvinyl Chloride



Products specifically designed to meet the full requirements of your mission critical applications.



Industrial Data and Process Automation DataTuff® Industrial Ethernet Cables

Section Table of Contents

Industrial Data and Process Automation	
DataTuff® Industrial Ethernet Cables	
Overview	264
Introduction and Cable Selection Guide	265–268
DataTuff® Industrial Ethernet	269
Permanent Installation Cables	269–273
Moderate Flexing Cables	274–276
Continuous Flexing Cables	277
DataTuff® PROFINET	278
Permanent Installation Cables	278
Moderate Flexing Cables	279
Continuous Flexing Cables	280



DataTuff® Industrial Ethernet Cables



The comprehensive DataTuff® Industrial Ethernet cable range ensures the highest level of reliability, quality and performance. Specifiers can choose from products suitable for indoor and outdoor applications, for use underground, and for other harsh conditions.

Product Features

- Industrial Ethernet and PROFINET designs
- PVC, polyethylene, FEP, FRNC/LSNH, PUR, or TPE jackets
- Twisted Pair or Bonded-Pair™ technology
- Shielded and unshielded designs
- Torsion resistant guaranteed for more than 2 million cycles
- Cables designed for trailing/drag chain applications tested for more than 2 million or up to 10 million bending cycles
- Oil, abrasion and sunlight resistant designs
- Direct burial and CMX/outdoor rated cables
- Operation temperature from -70 °C up to +150 °C, designs suitable for hi/lo temperature installations

Benefits

Broadest Portfolio on the Market

- Belden DataTuff® is EMEA's most comprehensive portfolio of Industrial Ethernet cable and connectivity products.

Reliability

- Robust design: industrial grade jackets withstand exposure to oil, chemicals, rough handling, abrasion, UV and temperature variations, etc
- Product consistency: manufactured in ISO certified manufacturing facilities, Belden's state-of-the-art processes ensure quality in each product. Product consistency for ease of termination and assembly is a mainstay of our products.

Future Proof

- Belden supports the migration of Ethernet networks to 10 Gb/s

Applications

DataTuff® range is primarily built and designed for harsh/mission-critical applications. The products are used in automation, machine building, food/beverage, petro-chemical, and many more industrial markets.



DataTuff® Industrial Ethernet Cables

Introduction

Breadth of Line: Category 5e, Category 6 and Category 7 Cables

- Twisted Pair or Bonded-Pair™ technology
- Unshielded or shielded cables
- Solid or stranded conductors
- Plenum or non-plenum
- Polyolefin or FEP insulation
- PVC, polyethylene, FEP, FRNC/LSNH, PUR, or TPE jackets
- Heavy duty, double jacketed, or aluminum armored
- Halogen-free or Low Smoke Zero Halogen constructions
- Versions suitable for burial or outdoor use, gasoline resistance, high and low temperatures Jackets sequentially marked at regular intervals (typically 2 ft)
- Performance third-party verified to ANSI/TIA-568-B.2

Field-Proven Performance for Such Conditions as:

- Oil, sunlight and gasoline
- Temperature variations
- Abrasion and crushing
- Flexing
- EMI/RFI presence
- Weldsplatter resistance

Approvals

- All RoHS approved
- Many are EtherNet/IP compliant
- Some MSHA approved for mining environments

Belden's Patented Bonded-Pair Technology

Most DataTuff cables feature Belden's Bonded-Pair technology, a patented cable construction which affixes the conductor insulation of the cable pairs along their longitudinal axes to ensure that no performance-robbing gaps can develop between the conductor pairs.

- No gaps between the conductor pairs ensures that the conductor-to-conductor spacing, or centricity, is always uniform
- With uniform centricity, the cable offers excellent and consistently reliable electrical performance
- Installable Performance® is achieved – the affixing of the insulation of the cable pairs and the uniform centricity translate to superior electrical performance, even after the cable has been subjected to the bending, pulling and twisting inherent in the installation process

Tests Prove the Post-Installation Effectiveness of Belden Bonded-Pair Cables

Belden performed tests that simulate the effects of the installation process, both on an industry-leading 350 MHz Cat 5e cable (a nonbonded-pair cable) and a Belden 350 MHz Cat 5e bonded-pair cable. For comparison, the cables were tested both right off the reel and after an installation stress test. Results showed that the nonbonded-pair cable had an RL degradation greater than 12 dB – over 15 times worse than its before-installation value. The Bonded-Pair cables showed greater integrity in maintaining RL performance.

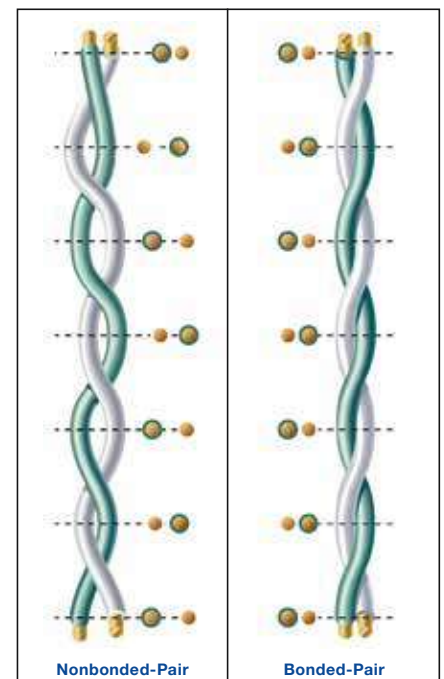

DataTuff® Industrial Ethernet Cable Selection Guide

This table is meant to help you select the proper cable.

Part No.	Conductor		Installation		Environmental										Industrial Grade Jacket		
	Solid	Stranded	Installation Stress Resistance*	Pull Tension	Oil Res.	UV Sun Res.	Weld-splatter Res.	CMX-Outdoor	Direct Burial	Gas Res.	LSZH	MSHA	Hi/Low Temp.	600 V AWM	Heavy	Upjacket	Armored
Industrial Ethernet																	
Category 7 Shielded Cable																	
74004E	•		45		•	•											
74004NH	•		45		•	•					•						
74005E		•	30		•	•											
74005NH		•	30		•	•					•						
74005PU		•	30		•	•					•						
Category 6 Shielded Cable																	
7953A <i>EtherNet/IP</i>	•		40		•	•		•					•			•	
Category 6 Unshielded Cable																	
7940A <i>EtherNet/IP</i>	•		40		•	•		•								•	
7927A	•		45		•	•										•	
11872A	•		45														•
121872A	•		200			•											•
7931A	•		40		•	•				•		•				•	
Category 5e Shielded Cable																	
7929A	•		40		•	•		•				•				•	
7958A <i>EtherNet/IP</i>	•		35		•	•							•			•	
7919A	•		25		•	•		•				•				•	
7939A		•	40		•	•										•	
7921A <i>EtherNet/IP</i>	•		75		•	•		•								•	
7957A <i>EtherNet/IP</i>	•		75		•	•		•					•			•	
7937A	•		40		•	•			•								•
7936A	•		40			•					•	•				•	
74001E	•		40		•	•											
74001NH	•		40		•	•					•						
74001PU	•		40		•	•											
74002E		•	30		•	•											
74002NH		•	30		•	•					•						
74002PU		•	30		•	•					•						
7938A High Flex		•	40		•	•	•										•
74003PU High Flex Trailing		•	30		•	•					•						
74009PU High Flex Torsion		•	30		•	•	•				•						

* Products with Bonded-Pair™ technology provide Installable Performance® advantages; refer to Belden's Bonded-Pair Cable Bulletin BP02.

Part No.	Conductor		Installation		Environmental										Industrial Grade Jacket		
	Solid	Stranded	Installation Stress Resistance*	Pull Tension	Oil Res.	UV Sun Res.	Weld-splatter Res.	CMX-Outdoor	Direct Burial	Gas Res.	LSZH	MSHA	Hi/Low Temp.	600 V AWM	Heavy	Upjacket	Armored

Industrial Ethernet

Category 5e Unshielded Cable																	
7923A <i>EtherNet/IP</i>	•		•	40	•	•		•				•				•	
7922A PLTC	•		•	40	•	•		•								•	
7918A	•			35	•	•		•				•				•	
11700A <i>EtherNet/IP</i>	•		•	40	•	•		•				•				•	
11700A2 Oil Res. 1/11	•		•	40	•	•										•	
121700A	•		•	40	•	•											•
121700R	•		•	40	•	•											•
7924A		•	•	40	•	•		•								•	
7930A		•		25	•	•		•								•	
7934A <i>EtherNet/IP</i>	•		•	40	•	•			•							•	
7935A <i>EtherNet/IP</i>	•		•	40		•					•					•	
7928A <i>EtherNet/IP</i>	•		•	40	•	•		•		•			•			•	
2-Pair Category 5e Shielded Cable																	
7933A <i>EtherNet/IP</i>	•		•	20	•	•										•	
72001E	•			30	•	•											
72001NH	•			30	•	•					•						
72002E		•		20	•	•											
72002NH		•		20	•	•					•						
72002PU		•		20	•						•						
2-Pair Category 5e Unshielded Cable																	
7932A <i>EtherNet/IP</i>	•		•	20	•	•										•	

* Products with Bonded-Pair™ technology provide Installable Performance® advantages; refer to Belden's Bonded-Pair Cable Bulletin BP02.

DataTuff® Industrial Ethernet Cable Selection Guide (continued)

Part No.	Conductor		Installation		Environmental										Industrial Grade Jacket		
	Solid	Stranded	Installation Stress Resistance*	Pull Tension	Oil Res.	UV Sun Res.	Weld-splatter Res.	CMX-Outdoor	Direct Burial	Gas Res.	LSZH	MSHA	Hi/Low Temp.	600 V AWM	Heavy	Upjacket	Armored

PROFINET

Category 6a Shielded Cable																	
74010E	•		40	•													
74010NH	•		40	•	•						•						
74010PU	•		40	•	•						•						
74011E		•	40	•													
74011NH		•	40	•	•						•						
74011PU		•	40	•	•						•						
74012PU		•	40	•	•												
74013PU		•	40	•	•												
Category 5e Shielded Cable																	
70006E	•		40	•													
70006NH	•		40	•	•						•						
7960A	•		40	•	•			•								•	
70007E		•	40	•													
7961A		•	40	•	•			•									•
70007NH		•	40	•	•						•						
70007PU		•	40	•	•												
70008PU High Flex Trailing		•	40	•	•												
7962A High Flex Trailing		•	40	•	•	•		•									•
70009PU High Flex Torsion		•	40	•	•	•											

* Products with Bonded-Pair™ technology provide Installable Performance® advantages; refer to Belden's Bonded-Pair Cable Bulletin BP02.

DataTuff® Industrial Ethernet
Permanent Installation Cables

Category 5e • 2 Pair • Unshielded and Shielded



Part No.	Data Rates	Category	Conductor (Stranding)		Nominal OD (mm)	Jacket	Shielding		Design		Operating Temperature (°C)	Additional Features/Ratings
			Solid	Stranded			Shielded	Unshielded	Twisted Pair	Bonded-Pair		
Category 5e • 2 Pair • Unshielded and Shielded • PVC Outer Jacket												
72001E					6.00		Overall Foil + 80% Braid	-	✓	-	-40 to +80	Heavy Shielded 300 V UL AWM 2464 Sunlight and Oil Resistant Flame Retardant
7933A	100 Mb/s	Cat 5e	AWG 24 (1)	-	5.77	PVC	Overall Foil	-	-	✓	-40 to +75	EtherNet/IP Compliant NEC: CMR • CEC: CMR FT4 Sunlight and Oil Resistant
7932A					5.26		-	✓	-	✓	-40 to +75	EtherNet/IP Compliant NEC: CMR • CEC: CMR FT4 Sunlight and Oil Resistant
Category 5e • 2 Pair • Shielded • LSZH Outer Jacket												
72001NH	100 Mb/s	Cat 5e	AWG 24 (1)	-	7.00	LSZH	Overall Foil + 80% Braid	-	✓	-	-40 to +80	Heavy Shielded 300 V UL AWM 21286 Sunlight and Oil Resistant Flame Retardant

Compatible with Belden Metal Body RJ45 Plugs R301601 and R301602

Conductor Color Codes: Pair 1: White/Blue Stripe & Blue
Pair 2: White/Orange Stripe & Orange

PVC = Polyvinyl Chloride • LSZH = Low Smoke Zero Halogen

DataTuff® Industrial Ethernet
Permanent Installation Cables

Category 5e • 4 Pair • Unshielded and Shielded



121700R

Part No.	Data Rates	Category	Conductor (Stranding)		Nominal OD (mm)	Jacket	Shielding		Design		Operating Temperature (°C)	Additional Features/Ratings
			Solid	Stranded			Shielded	Unshielded	Twisted Pair	Bonded-Pair		
Category 5e • 4 Pair • Unshielded and Shielded • PVC Outer Jacket												
74001E					7.00		Overall Foil + 80% Braid	-	✓	-	-40 to +80	Heavy Shielded 300 V UL AWM 2464 Sunlight and Oil Resistant Flame Retardant
7921A					8.38		Overall Foil + 70% Braid	-	-	✓		Heavy Shielded EtherNet/IP Compliant NEC: CMR, CMX-Outdoor CEC: CMR FT4 Sunlight and Oil Resistant
7957A					8.38		Overall Foil + 70% Braid	-	-	✓		Heavy Shielded 60 V UL AWM EtherNet/IP Compliant NEC: CMR, CMX-Outdoor CEC: CMR FT4 Sunlight and Oil Resistant
7923A					5.84		-	✓	-	✓		EtherNet/IP Compliant MSHA Approved* NEC: CMR, CMX-Outdoor CEC: CMR FT4 Sunlight and Oil Resistant
7918A					5.84		-	✓	✓	-		MSHA Approved* NEC: CMR, CMX-Outdoor CEC: CMR FT4
7929A					6.73		Overall Foil	-	-	✓		NEC: CMR, CMX-Outdoor CEC: CMR FT4 MSHA Approved* Sunlight and Oil Resistant
7958A	1 Gb/s	Cat 5e	AWG 24 (1)		6.73	PVC	Overall Foil	-	-	✓	-40 to +75	600 V UL AWM EtherNet/IP Compliant NEC: CMR, CMX-Outdoor CEC: CMR FT4 Sunlight and Oil Resistant
7919A					6.73		Overall Foil	-	✓	-		NEC: CMR, CMX-Outdoor CEC: CMR FT4 MSHA Approved* Sunlight and Oil Resistant CMX-Outdoor
11700A					7.24		-	✓	-	✓		Upjacketed - PVC Inner Jacket EtherNet/IP Compliant MSHA Approved* NEC: CMR, CMX-Outdoor CEC: CMR FT4 Sunlight and Oil Resistant
11700A2					7.24		-	✓	-	✓		Upjacketed – PVC Inner Jacket Outstanding Oil Res I/II NEC: CMR • CEC: CMR FT4 Sunlight and Oil Resistant
121700A					13.46		-	✓	-	✓		Interlocked Aluminium Armor Upjacketed – PVC Inner Jacket NEC: CM • CEC: HL, CMG FT4 Sunlight and Oil Resistant
121700R					13.46		-	✓	-	✓		Interlocked Aluminium Armor Upjacketed – PVC Inner Jacket -40 °C Cold Impact NEC: CM • CEC: HL, CMG FT4 Sunlight and Oil Resistant
7922A			AWG 22 (1)		7.65		-	✓	-	✓		UL PLTC NEC: CMR, CMX-Outdoor CEC: CMR FT4 Sunlight and Oil Resistant

* Pennsylvania Department of Environmental Resources and United States Mine Safety and Health Administration Certification
Compatible with Belden Metal Body RJ45 Plugs R301601 and R301602

Conductor Color Codes: Pair 1: White/Blue Stripe & Blue • Pair 2: White/Orange Stripe & Orange • Pair 3: White/Green Stripe & Green • Pair 4: White/Brown Stripe & Brown

PVC = Polyvinyl Chloride

DataTuff® Industrial Ethernet
Permanent Installation Cables

Category 5e • 4 Pair • Unshielded and Shielded (continued)



Part No.	Data Rates	Category	Conductor (Stranding)		Nominal OD (mm)	Jacket	Shielding		Design		Operating Temperature (°C)	Additional Features/Ratings
			Solid	Stranded			Shielded	Unshielded	Twisted Pair	Bonded-Pair		
Category 5e • 4 Pair • Unshielded and Shielded • LSZH Outer Jacket												
74001NH					7.00		Overall Foil + 80% Braid	-	-	-	-40 to +80	Heavy Shielded 300 V UL AWM 21286 Sunlight and Oil Resistant Flame Retardant
7935A	1 Gb/s	Cat 5e	AWG 24 (1)	-	5.84	LSZH	-	✓	-	✓	-40 to +75	EtherNet/IP Compliant NEC: CM • CEC: CM FT1 Sunlight Resistant
7936A					6.73		Overall Foil	-	-	✓		NEC: CM • CEC: CMG FT4 Sunlight Resistant
Category 5e • 4 Pair • Unshielded • PE Outer Jacket												
7934A					5.84		-	✓	-	✓		Waterblocked Burial Halogen Free EtherNet/IP Compliant Sunlight and Oil Resistant
	1 Gb/s	Cat 5e	AWG 24 (1)	-		PE					-40 to +75	
7937A					7.01		Overall Foil	-	-	✓		Waterblocked Burial Upjacketed – PE Inner Jacket Halogen Free Sunlight and Oil Resistant
Category 5e • 4 Pair • Unshielded • FEP Outer Jacket												
7928A	1 Gb/s	Cat 5e	AWG 24 (1)	-	4.75	FEP	-	✓	-	✓	-75 to +150	High and Low Temp EtherNet/IP Compliant NEC: CMP • CEC: CMP FT6 Outstanding Oil Res I/II Gas Resistant Sunlight Resistant
Category 5e • 4 Pair • Shielded • PUR Outer Jacket												
74001PU	1 Gb/s	Cat 5e	AWG 24 (1)	-	6.60	PUR	Overall Foil + 80% Braid	-	✓	-	-40 to +80	Heavy Shielded 300 V UL AWM 20549 Sunlight and Oil Resistant Flame Retardant FT2 Halogen Free

Compatible with Belden Metal Body RJ45 Plugs R301601 and R301602

Conductor Color Codes: Pair 1: White/Blue Stripe & Blue
Pair 2: White/Orange Stripe & Orange
Pair 3: White/Green Stripe & Green
Pair 4: White/Brown Stripe & Brown

LSZH = Low Smoke Zero Halogen • PE = Polyethylene • FEP = Fluorinated Ethylene Propylene • PUR = Polyurethane

DataTuff® Industrial Ethernet
Permanent Installation Cables

Category 6 • 4 Pair • Unshielded and Shielded



7953A

Part No.	Data Rates	Category	Conductor (Stranding)		Nominal OD (mm)	Jacket	Shielding		Design		Operating Temperature (°C)	Additional Features/Ratings
			Solid	Stranded			Shielded	Unshielded	Twisted Pair	Bonded-Pair		
Category 6 • 4 Pair • Unshielded and Shielded • PVC Outer Jacket												
7953A*					8.64		Overall Foil	-	-	✓		600 V UL AWM Shielded EtherNet/IP Compliant NEC: CMR, CMX-Outdoor • CEC: CMR FT4 Sunlight and Oil Resistant
7940A*					6.35		-	✓	-	✓		EtherNet/IP Compliant NEC: CMR, CMX-Outdoor • CEC: CMR FT4 Sunlight and Oil Resistant
7927A	1 Gb/s	Cat 6	AWG 23 (1)	-	6.38 x 8.61	PVC	-	✓	-	✓	-40 to +75	E-Spline Center Member for Mechanical Protection Tested to 600 MHz NEC: CMR • CEC: CMR FT4 Sunlight and Oil Resistant
11872A					12.07 x 6.73		-	✓	-	✓		Upjacketed – PVC Inner Jacket NEC: CM • CEC: CM FT1
121872A					17.37		-	✓	-	✓		Interlocked Aluminium Armor NEC: CM • CEC: HL, CMG FT4 Sunlight Resistant
Category 6 • 4 Pair • Unshielded • FEP Outer Jacket												
7931A	1 Gb/s	Cat 6	AWG 23 (1)	-	5.44	FEP	-	✓	-	✓	-75 to +150	High and Low Temp NEC: Limited Combustible FHC 25/50, CMP • CEC: CMP FT6 Outstanding Oil Res I/II Gas Resistant Sunlight Resistant

* ABS and DNV-GL approved design also available. For more details please see Belden MarineTuff Offshore and Marine Cable Solutions brochure or consult Customer Service. Compatible with Belden Metal Body RJ45 Plugs R301601 and R301602

Conductor Color Codes: Pair 1: White/Blue Stripe & Blue
Pair 2: White/Orange Stripe & Orange
Pair 3: White/Green Stripe & Green
Pair 4: White/Brown Stripe & Brown

DataTuff® Industrial Ethernet
Permanent Installation Cables

Category 7 • 4 Pair • Shielded



Part No.	Data Rates	Category	Conductor (Stranding)		Nominal OD (mm)	Jacket	Shielding		Design		Operating Temperature (°C)	Additional Features/Ratings
			Solid	Stranded			Shielded	Unshielded	Twisted Pair	Bonded-Pair		
Category 7 • 4 Pair • Shielded • PVC Outer Jacket												
74004E	10 Gb/s	Cat 7	AWG 23 (1)	–	8.00	PVC	Overall Foil + 65% Braid	–	✓	–	-40 to +80	Heavy Shielded 30 V UL AWM 20276 Sunlight and Oil Resistant Flame Retardant
Category 7 • 4 Pair • Shielded • LSZH Outer Jacket												
74004NH	10 Gb/s	Cat 7	AWG 23 (1)	–	8.00	LSZH	Overall Foil + 65% Braid	–	✓	–	-40 to +80	Heavy Shielded 30 V UL AWM 20851 Sunlight and Oil Resistant Flame Retardant – Bundle Flame Test IEC 60332-3-24 EN50266-2-4 Cat C

Compatible with Belden Metal Body RJ45 Plugs R301601 and R301602

Conductor Color Codes: Pair 1: White/Blue Stripe & Blue
 Pair 2: White/Orange Stripe & Orange
 Pair 3: White/Green Stripe & Green
 Pair 4: White/Brown Stripe & Brown

PVC = Polyvinyl Chloride • LSZH = Low Smoke Zero Halogen

DataTuff® Industrial Ethernet
Moderate Flexing Cables

Category 5e • 2 Pair • Shielded



Part No.	Data Rates	Category	Conductor (Stranding)		Nominal OD (mm)	Jacket	Shielding		Design		Operating Temperature (°C)	Additional Features/Ratings
			Solid	Stranded			Shielded	Unshielded	Twisted Pair	Bonded-Pair		
Category 5e • 2 Pair • Shielded • PVC Outer Jacket												
72002E	100 Mb/s	Cat 5e	–	AWG 26 (7)	6.00	PVC	Overall Foil + 80% Braid	–	✓	–	-40 to +80	Heavy Shielded 300 V UL AWM 2464 Sunlight and Oil Resistant Flame Retardant
Category 5e • 2 Pair • Shielded • LSZH Outer Jacket												
72002NH	100 Mb/s	Cat 5e	–	AWG 26 (7)	6.00	LSZH	Overall Foil + 80% Braid	–	✓	–	-40 to +80	Heavy Shielded 300 V UL AWM 21286 Sunlight and Oil Resistant Flame Retardant
Category 5e • 2 Pair • Shielded • PUR Outer Jacket												
72002PU	100 Mb/s	Cat 5e	–	AWG 26 (7)	6.00	PUR	Overall Foil + 80% Braid	–	✓	–	-40 to +80	Heavy Shielded 300 V UL AWM 20549 Sunlight and Oil Resistant Flame Retardant FT2 Halogen Free AWM 20549

Compatible with Belden Metal Body RJ45 Plugs R301601 and R301602

Conductor Color Codes: Pair 1: White/Blue Stripe & Blue • Pair 2: White/Orange Stripe & Orange • Pair 3: White/Green Stripe & Green • Pair 4: White/Brown Stripe & Brown

DataTuff® Industrial Ethernet
Moderate Flexing Cables

Category 5e • 4 Pair • Unshielded and Shielded



Part No.	Data Rates	Category	Conductor (Stranding)		Nominal OD (mm)	Jacket	Shielding		Design		Operating Temperature (°C)	Additional Features/Ratings
			Solid	Stranded			Shielded	Unshielded	Twisted Pair	Bonded-Pair		
Category 5e • 4 Pair • Unshielded and Shielded • PVC Outer Jacket												
74002E	1 Gb/s	Cat 5e	-	AWG 26 (7)	6.50	PVC	Overall Foil + 80% Braid	-	✓	-	-40 to +80	Heavy Shielded 300 V UL AWM 2464 Sunlight and Oil Resistant Flame Retardant AWM 2464
7939A			AWG 24 (7)	8.60	-		-	✓	-40 to +75	NEC: CMR, CMX-Outdoor CEC: CMR FT4 Sunlight and Oil Resistant		
7924A			AWG 24 (7)	5.84	-		✓	-	✓		-40 to +75	
7930A			AWG 24 (7)	5.84	-		✓	✓	-		-25 to +75	
Category 5e • 4 Pair • Shielded • LSZH Outer Jacket												
74002NH	1 Gb/s	Cat 5e	-	AWG 26 (7)	6.50	LSZH	Overall Foil + 80% Braid	-	✓	-	-40 to +80	Heavy Shielded 300 V UL AWM 21286 Sunlight and Oil Resistant Flame Retardant
Category 5e • 4 Pair • Shielded • PUR Outer Jacket												
74002PU	1 Gb/s	Cat 5e	-	AWG 26 (7)	6.50	PUR	Overall Foil + 80% Braid	-	✓	-	-40 to +80	Heavy Shielded 300 V UL AWM 20549 Sunlight and Oil Resistant Flame Retardant FT2 Halogen Free AWM 20549

Compatible with Belden Metal Body RJ45 Plugs R301601 and R301602

Conductor Color Codes: Pair 1: White/Blue Stripe & Blue • Pair 2: White/Orange Stripe & Orange • Pair 3: White/Green Stripe & Green • Pair 4: White/Brown Stripe & Brown

PVC = Polyvinyl Chloride • LSZH = Low Smoke Zero Halogen • PUR = Polyurethane

DataTuff® Industrial Ethernet
Moderate Flexing Cables

Category 7 • 4 Pair • Shielded



Part No.	Data Rates	Category	Conductor (Stranding)		Nominal OD (mm)	Jacket	Shielding		Design		Operating Temperature (°C)	Additional Features/Ratings
			Solid	Stranded			Shielded	Unshielded	Twisted Pair	Bonded-Pair		
Category 7 • 4 Pair • Shielded • PUR Outer Jacket												
74005E						PVC						Heavy Shielded 30 V UL AWM 20121 Sunlight and Oil Resistant Flame Retardant
74005NH	10 Gb/s	Cat 7	–	AWG 26 (7)	6.80	LSNH	Overall Foil + 65% Braid	–	✓	–	-40 to +80	Heavy Shielded 30 V UL AWM 20851 Sunlight and Oil Resistant Flame Retardant Halogen Free
74005PU						PUR						Heavy Shielded 30 V UL AWM 21292 Sunlight and Oil Resistant Flame Retardant FT2 Halogen Free

Compatible with Belden Metal Body RJ45 Plugs R301601 and R301602

Conductor Color Codes: Pair 1: White/Blue Stripe & Blue
 Pair 2: White/Orange Stripe & Orange
 Pair 3: White/Green Stripe & Green
 Pair 4: White/Brown Stripe & Brown

PUR = Polyurethane

DataTuff® Industrial Ethernet
Continuous Flexing Cables

Category 5e • 4 Pair • Shielded



Part No.	Data Rates	Category	Conductor (Stranding)		Nominal OD (mm)	Jacket	Shielding		Design		Operating Temperature (°C)	Additional Features/Ratings
			Solid	Stranded			Shielded	Unshielded	Twisted Pair	Bonded-Pair		
Category 5e • 4 Pair • Shielded • TPE Outer Jacket												
7938A	1 Gb/s	Cat 5e	–	AWG 24 (32)	8.74	TPE	Overall Foil + 85% Braid	–	–	✓	-40 to +80	10 Million Continuous Flex Cycles, Trailing Weldsplatter Resistant CEC: FT1 Sunlight and Oil Resistant AWM 20626
Category 5e • 4 Pair • Shielded • PUR Outer Jacket												
74003PU					6.65							2 Million Continuous Flex Cycles, Trailing 300 V UL AWM 20549 Sunlight and Oil Resistant Flame Retardant FT2 Halogen Free AWM 20549
	1 Gb/s	Cat 5e	–	AWG 26 (19)		PUR	Overall Foil + 80% Braid	–	✓	–	-40 to +80	2 Million Continuous Flex Cycles, Torsion 300 V UL AWM 20549 Weldsplatter Resistant Sunlight and Oil Resistant Flame Retardant FT2 Halogen Free
74009PU					6.40							

Compatible with Belden Metal Body RJ45 Plugs R301601 and R301602

Conductor Color Codes: Pair 1: White/Blue Stripe & Blue
Pair 2: White/Orange Stripe & Orange
Pair 3: White/Green Stripe & Green
Pair 4: White/Brown Stripe & Brown

TPE = Thermoplastic Elastomer • PUR = Polyurethane

DataTuff® PROFINET
Permanent Installation Cables

Category 5e • 2 Pair (Quad) Design • Shielded



Part No.	Data Rates	Category	Conductor (Stranding)		Nominal OD (mm)	Jacket	Shielding		Operating Temperature (°C)	Additional Features/Ratings
			Solid	Stranded			Shielded	Unshielded		
Category 5e • 2 Pair (Quad) • Shielded • PVC Outer Jacket										
70006E	100 Mbit/s	Cat 5e	AWG 22 (1)	–	6.50	PVC	Overall Foil + 85% Braid	–	-40 to +80	Heavy Shielded 300 V AWM 2464 Oil Resistant Flame Retardant
7960A										Heavy Shielded Oil Resistant, Sunlight Resistant PLTC listed 600 V AWM C(UL) CMG FT4, IEEE1202/383, VW-1 and IEC 60332-1-2 flame ratings
Category 5e • 2 Pair (Quad) • Shielded • LSZH Outer Jacket										
70006NH	100 Mbit/s	Cat 5e	AWG 22 (1)	–	6.50	FRNC	Overall Foil + 85% Braid	–	-40 to +70	Heavy Shielded 300 V UL AWM 21286 Sunlight and Oil Resistant VDE 60811-2-1 Flame Retardant

Compatible with Belden Metal Body RJ45 Plugs R301601 and R301602

Category 6a • 4 Pair • Shielded



Part No.	Data Rates	Category	Conductor (Stranding)		Nominal OD (mm)	Jacket	Shielding		Operating Temperature (°C)	Additional Features/Ratings
			Solid	Stranded			Shielded	Unshielded		
Category 6a • 4 Pair • Shielded • PVC Outer Jacket										
74010E	10 Gb/s	Cat 6a	AWG 22 (1)	–	8.70	PVC	Overall Foil + 85% Braid	–	-40 to +80	Heavy Shielded 30 V UL AWM 20276 Sunlight and Oil Resistant Flame Retardant
Category 6a • 4 Pair • Shielded • LSNH Outer Jacket										
74010NH	10 Gb/s	Cat 6a	AWG 22 (1)	–	8.70	LSZH	Overall Foil + 85% Braid	–	-40 to +80	Heavy Shielded 30 V UL AWM 20851 Sunlight and Oil Resistant Flame Retardant
Category 6a • 4 Pair • Shielded • PUR Outer Jacket										
74010PU	10 Gb/s	Cat 6a	AWG 22 (1)	–	8.70	PUR	Overall Foil + 85% Braid	–	-40 to +80	Heavy Shielded 30 V UL AWM 21292 Sunlight and Oil Resistant Flame Retardant

Compatible with Belden Metal Body RJ45 Plugs R301601 and R301602

PVC = Polyvinyl Chloride • LSZH = Low Smoke Zero Halogen • PUR = Polyurethane

DataTuff® PROFINET
Moderate Flexing Cables

Category 5e • 2 Pair (Quad) Design • Shielded



Part No.	Data Rates	Category	Conductor (Stranding)		Nominal OD (mm)	Jacket	Shielding		Operating Temperature (°C)	Additional Features/Ratings
			Solid	Stranded			Shielded	Unshielded		
Category 5e • 2 Pair (Quad) • Shielded • PVC Outer Jacket										
70007E	100 Mbit/s	Cat 5e	–	AWG 22 (7)	6.50	PVC	Overall Foil + 85% Braid	–	-40 to +80	Heavy Shielded 300 V UL AWM 2464 Oil Resistant Flame Retardant
7961A										Heavy Shielded Oil Resistant, Sunlight Resistant PLTC listed 600 V AWM C(UL) CMG FT4, IEEE1202/383, VW-1 and IEC 60332-1-2 flame ratings
Category 5e • 2 Pair (Quad) • Shielded • LSZH Outer Jacket										
70007NH	100 Mbit/s	Cat 5e	–	AWG 22 (7)	6.50	FRNC	Overall Foil + 85% Braid	–	-25 to +80	Heavy Shielded 300 V UL AWM 21286 Sunlight and Oil Resistant Flame Retardant
Category 5e • 2 Pair (Quad) • Shielded • PUR Outer Jacket										
70007PU	100 Mbit/s	Cat 5e	–	AWG 22 (7)	6.50	PUR	Overall Foil + 85% Braid	–	-40 to +80	Heavy Shielded 300 V UL AWM 20549 Sunlight and Oil Resistant Flame Retardant

Compatible with Belden Metal Body RJ45 Plugs R301601 and R301602

Category 6a • 4 Pair • Shielded



Part No.	Data Rates	Category	Conductor (Stranding)		Nominal OD (mm)	Jacket	Shielding		Operating Temperature (°C)	Additional Features/Ratings
			Solid	Stranded			Shielded	Unshielded		
Category 6a • 4 Pair • Shielded • PVC Outer Jacket										
74011E	10 Gb/s	Cat 6a	–	AWG 23 (7)	8.70	PVC	Overall Foil + 85% Braid	–	-40 to +80	Heavy Shielded 30 V UL AWM 20276 Oil Resistant Flame Retardant
Category 6a • 4 Pair • Shielded • LSZH Outer Jacket										
74011NH	10 Gb/s	Cat 6a	–	AWG 23 (7)	8.70	LSZH	Overall Foil + 85% Braid	–	-40 to +80	Heavy Shielded 30 V UL AWM 20851 Sunlight and Oil Resistant Flame Retardant
Category 6a • 4 Pair • Shielded • PUR Outer Jacket										
74011PU	10 Gb/s	Cat 6a	–	AWG 23 (7)	8.70	PUR	Overall Foil + 85% Braid	–	-40 to +80	Heavy Shielded 30 V UL AWM 21292 Sunlight and Oil Resistant Flame Retardant

Compatible with Belden Metal Body RJ45 Plugs R301601 and R301602

PVC = Polyvinyl Chloride • LSZH = Low Smoke Zero Halogen • PUR = Polyurethane

DataTuff® PROFINET
Continuous Flexing Cables

Category 5e • 2 Pair (Quad) Design • Shielded



Part No.	Data Rates	Category	Conductor (Stranding)		Nominal OD (mm)	Jacket	Shielding		Operating Temperature (°C)	Additional Features/Ratings
			Solid	Stranded			Shielded	Unshielded		
Category 5e • 2 Pair (Quad) • Shielded • PUR Outer Jacket										
70008PU				AWG 22 (19)	6.50	PUR	Overall Foil + 85% Braid	–	-40 to +80	5 Million Continuous Flex Cycles, Trailing 300 V UL AWM 20549 Sunlight and Oil Resistant Flame Retardant FT2 Halogen Free AWM 20549
70009PU	100 Mbit/s	Cat 5e	–	AWG 22 (19)	6.50	PUR	Overall Foil + 85% Braid	–	-40 to +80	2 Million Continuous Flex Cycles, Torsion 300 V UL AWM 20549 Sunlight and Oil Resistant Weldsplatter Resistant Flame Retardant FT2 Halogen Free AWM 20549
Category 5e • 2 Pair (Quad) • Shielded • TPE Outer Jacket										
7962A	100 Mbit/s	Cat 5e	–	AWG 22 (19)	6.50	TPE	Overall Foil + 85% Braid	–	-40 to +80	5 Million Continuous Flex Cycles, Trailing Heavy Shielded Oil Resistant, Sunlight Resistant Weldsplatter Resistant CMX Outdoor PLTC listed 600 V AWM C(UL) CM, FT1 flame ratings

Compatible with Belden Metal Body RJ45 Plugs R301601 and R301602

Category 6a • 4 Pair • Shielded • PUR Outer Jacket



Part No.	Data Rates	Category	Conductor (Stranding)		Nominal OD (mm)	Jacket	Shielding		Operating Temperature (°C)	Additional Features/Ratings
			Solid	Stranded			Shielded	Unshielded		
Category 6a • 4 Pair • Shielded • PUR Outer Jacket										
74012PU				AWG 24 (7)						1 Million Continuous Flex Cycles, Trailing 1 Million Continuous Flex Cycles, Torsion Heavy Shielded 30 V UL AWM 21292 Sunlight and Oil Resistant Flame Retardant
74013PU	10 Gb/s	Cat 6a	–	AWG 24 (19)	8.90	PUR	Overall Foil + 90% Braid	–	-40 to +80	2 Million Continuous Flex Cycles, Trailing 1 Million Continuous Flex Cycles, Torsion Heavy Shielded 30 V UL AWM 21292 Sunlight and Oil Resistant Flame Retardant

Compatible with Belden Metal Body RJ45 Plugs R301601 and R301602

TPE = Thermoplastic Elastomer • PUR = Polyurethane

Industrial Data and Process Automation RailTuff™ Railway and Bus Approved Industrial Data Cables



Section Table of Contents

Industrial Data and Process Automation	
RailTuff™ Railway and Bus Approved Industrial Data Cables	
Overview	282
RailTuff™ Railway Approved Industrial Ethernet	283
Bus & Coach ECE R118.02 approved Data, Coax and Microphone	284

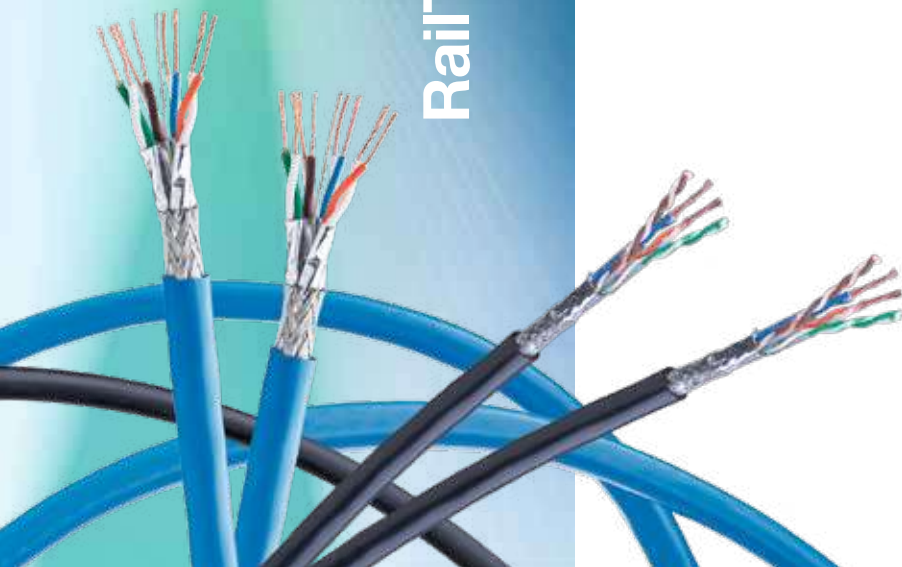

RailTuff™ Railway and Bus Approved Industrial Data Cables



Belden RailTuff™ Railway and Bus Approved Data Cables offer enhanced system performance and a greater passenger travel experience. Belden has a complete portfolio of Ethernet data communication cables in the railway and bus transportation environment, covering from 100 Mb/s, to 1 Gb/s and now also 10 Gb/s.

Product Features

- Industrial Ethernet, PROFINET and coax and microphone designs
- Approved for international railway standards: EN 50155:2007, Class TX; EN 45545-2:2013, Class R15 and R16; DIN 5510-2-ISO/IEC 11801, 2nd edition
- Compliant with ECE R118.02 standard for bus/coach systems
- Jacket material resistant to flame propagation and no harmful toxins emitted when burned
- Cat 5e 2- and 4-pair, Cat 7 cables covering from 100Mb/s to 1Gb/s and 10Gb/s
- Highly flexible 19-strand options
- Operates in temperatures from -40 °C up to +90 °C
- Halogen-free and oil-resistant options
- Shielded and unshielded designs
- Premium LSZH jacket cross-linked (by e-beam) options

Benefits

Future Proof

- Up to 10 Gb/s transmission performance (BE43802)

Safety

- Maximum operating temperatures on the market: +90 °C, exceeding the +85 °C short term temp. requirement in Class TX of the EN 50155 railway standard (BE43802)

Efficiency

- Operational efficiency with 19-strand copper conductors (BE43802)
- Small bend radius allows for easy and risk free installation within limited spaces

Full Product Range

- Complete portfolio of data communication cables in the railway and bus transportation environment: 100 Mb/s, 1 Gb/s, 10 Gb/s bandwidth

Applications

Key areas of application include:

Rolling Stock:

- Ethernet backbone
- Passenger information and entertainment
- Multimedia Services
- Networked Attached Storage systems (NAS)
- Security and surveillance and operational train controls
- Train diagnostics
- Train Consist Network (TCN)
- Communications Based Train Control (CBTC)

Bus & Coach:

- Ethernet backbone
- Passenger information and entertainment
- Multimedia services
- Networked Attached Storage systems (NAS)
- Security and surveillance and operational train controls
- Diagnostics



RailTuff™ Railway Approved Industrial Ethernet

Meeting International Railway Standards

Belden RailTuff™ data cables are designed and manufactured in accordance with the following international railway standards:

- EN 50155:2007
 - Railway applications
 - Class TX (-40 °C to +85 °C)
- EN 45545-2:2013
 - Fire protection on railway vehicles
 - Class R15 and R16 (Hazard Level 1-3)
 - IEC 60332-1-2
 - Toxicity test: EN 50305
 - Flame test: EN 50266-2-5
 - IEC 60332-3-25 Cat D
 - EN 61034-2
 - NF X70-100-1 & NF X70-100-2
- DIN 5510-2
 - Preventive fire protection in railway vehicles
 - Protection Level 1-4
 - IEC 60332-1-2
 - IEC 50266-2-5 Cat D
- ISO/IEC 11801 2nd edition IEC 61156-6
- ECE R118.02

Part No.	Data Rates	Category	Conductor (Stranding)		Nominal OD (mm)	Jacket	Shielding		Design		Operating Temperature (°C)	Additional Features/Ratings
			Solid	Stranded			Shielded	Unshielded	Twisted Pair	Quad		



PROFINET Cat 5e • 2 Pair (Quad) • Shielded • Premium X-Linked LSZH Outer Jacket												
BE43769	100 Mbit/s	Cat 5e	–	AWG 22 (19)	6.70	Premium LSZH, Insulation and Jacket cross-linked (by e-beam)	Overall Foil + 80% Braid	–	–	✓	-40 to +90	Heavy Shielded DIN 5510-2 level 1 to 4, EN 50155 Flame Resistance acc EN/TS 45545, IEC 60332-1-2, EN 50305 & IEC 60332-3-25 Cat D EN/TS 45545 (Class R15 and R16 HL3) Oil Resistance ECE R118.02



Industrial Ethernet Cat 5e • 4 Pair • Shielded • Premium X-Linked LSZH Outer Jacket												
BE43800	1 Gb/s	Cat 5e	–	AWG 26 (19)	6.70	Premium LSZH, Insulation and Jacket cross-linked (by e-beam)	Overall Foil + 85% Braid	–	✓	–	-40 to +90	Heavy Shielded DIN 5510-2 level 1 to 4, EN 50155 Flame Resistance acc EN/TS 45545, IEC 60332-1-2, EN 50305 & IEC 60332-3-25 Cat D EN/TS 45545 (Class R15 and R16 HL3) Oil Resistance ECE R118.02



Industrial Ethernet Cat 7 • 4 Pair • Shielded • Premium X-Linked LSZH Outer Jacket												
BE43802	10 Gb/s	Cat 7	–	AWG 24 (19)	8.10	Premium LSZH, Insulation and Jacket cross-linked (by e-beam)	Overall Foil + 80% Braid	–	✓	–	-40 to +80	Heavy Shielded DIN 5510-2 level 1 to 4, EN 50155 Flame Resistance acc EN/TS 45545, IEC 60332-1-2, EN 50305 & IEC 60332-3-25 Cat D EN/TS 45545 (Class R15 and R16 HL3) Oil Resistance ECE R118.02

LSZH = Low Smoke Zero Halogen

Bus & Coach ECE R118.02 approved Data, Coax and Microphone

Ethernet and PROFINET - ECE R118.02



Part No.	Data Rates	Category	Conductor (Stranding)		Nominal OD (mm)	Jacket	Shielding		Operating Temperature (°C)	Additional Features/Ratings
			Solid	Stranded			Shielded	Unshielded		
PROFINET Cat 5e, 2-pair										
BE43885	100 Mbit/s	Cat 5e	–	AWG 22 (7)	6.50	LSZH	Overall Foil + 80% Braid	–	-20 to +70	ECE R118.02 IEC 60332-1-2 IEC 60811-2-1
Ethernet Cat 5e, 4-pair										
BE43886	1 Gb/s	Cat 5e	–	AWG 26 (7)	5.40	LSZH	Overall Foil	–	-30 to +60	ECE R118.02 IEC 60332-1-2
Ethernet Cat 7, 4-pair										
BE43887	10 Gb/s	Cat 7	–	AWG 23 (1)	7.0	LSZH	> 30% Braid	–	-30 to +60	ECE R118.02 IEC 60332-1-2

Coax and Microphone - ECE R118.02

Part No.	Data Rates	Impedance	Conductor (Stranding)		Nominal OD (mm)	Jacket	Shielding		Operating Temperature (°C)	Additional Features/Ratings
			Solid	Stranded			Shielded	Unshielded		



RF transmission cable - 50 Ohm

RF transmission coaxial cable - PVC Jacket										
H155A00	–	50 Ohm	–	1.41 mm 19 x 0.28 mm	5.40	PVC	Overall Foil + 85% Braid	–	-15 to +70	EN 50117-1 IEC 60332-1-2 ECE R118.02
RF transmission coaxial cable - LSNH Jacket										
H155A02	–	50 Ohm	–	1.41 mm 19 x 0.28 mm	5.40	LSNH	Overall Foil + 85% Braid	–	-30 to +70	ECEN 50117-1 IEC 60332-1-2 ECE R118.02



Star quad microphone cable										
Y64695	–	–	–	AWG 26 (30)	–	PVC	>95% Braid	–	-20 to +60	ECE R118.02

LSZH = Low Smoke Zero Halogen



Optical Fiber Central and Multi Loose Tube

Section Table of Contents

Optical Fiber	
Overview	286
Loose Tube Optical Characteristics	287
Construction Lookup Table	288
Part Number Coding	289
Central Loose Tube	290–315
Multi Loose Tube	316–333
Technical Information	334–336



Optical Fiber – Overview



Belden's central and multi loose tube fiber cables are ideal for industrial and underground environments. Belden's fiber cabling range is the culmination of our experience and expertise in a variety of applications, including oil and gas, transportation, power transmission and generation, and many more.

Product Features

- Central loose tube and multi loose tube cables
- Available in sizes from 2 to 144 fibers
- Jelly filled (non-dripping and silicon-free) loose tubes with primary coated optical fibers ($\text{Ø } 250 \pm 15 \mu\text{m}$)
- Full dielectric construction, immune to lightning and electromagnetic interference (EMC-safe), spark-free and require no grounding
- Installation-friendly thanks to the cable core which is kept free of grease (dry interstices)
- High mechanical and full rodent protection provided by Steel Wire armor (SWA), Corrugated Steel Tape (CST) armor, Fiber Reinforced Plastic (FRP) armor, Steel Wire Braid (SWB) armor or Glass Yarn Strength Elements
- Length marking in meters for easy determination of the cable length

Benefits

Involved in the development of optical fiber components for over 40 years, Belden is a leading supplier of high-quality, cost-effective optical fiber cabling systems. Belden's fiber cables are designed to offer reduced complexity, increased flexibility, and rapid installation for maximum cost effectiveness.

Applications

Belden's fiber central and multi loose tube cables are suitable for a wide range of applications, including:

- For outdoor and indoor use in structured (data) wiring systems such as industrial backbone, campus backbone, factory backbone (riser) and/or horizontal cabling, networks within automation environments, video surveillance, cable TV and/or broadcast
- Easy to install in ducts, tunnels and trenches by means of compressed air or pulling wire
- Suitable for direct burial



Belden Optical Fiber Cables

Reduce Complexity and Increase Flexibility

Today's advanced networks are diverse and almost always complex. The right way ahead is to future-proof these networks and to take precautions to protect them against anything that will create problems, damage or disruption. That means matching the right hardware with the right cabling to guarantee performance – and that means choosing fiber optic cable. Optical fiber cables offer many benefits: high bandwidth and transmission speed, the potential for network growth, extended reach, fault tolerance, greater data security and support for Gigabit and multi-Gigabit protocols and networked applications.

Fiber Types

Loose Tube Optical Characteristics

European Part Number Coding, Position 5	Fiber-Type	Mode-Field/Cladding Diameter (µm)	Wave-length (nm)	Attenuation [®] average/max. (dB/km)	Dispersion (ps/nm-km)	PMD ^A (ps/km)	Cable Cut-off Wave-length (nm)
---	------------	-----------------------------------	------------------	---	-----------------------	--------------------------	--------------------------------

Characteristics (cabled) Single-Mode • Matched-Cladded Optical Fibers according to ITU

8	9/125	9.2 ± 0.4	1310	0.33/0.34	≤ 3.2	≤ 0.06	≤ 1260
	G.652D & G.657A1 BI OS2	125.0 ± 0.7	1550	0.18/0.19	≤ 17.0		
			1625	0.20/0.24			
7	9/125	8.4 ± 0.6	1550	0.2/0.22	≤ 4.5	≤ 0.04	≤ 1260
	G.655 C & D	125.0 ± 0.7	1625	0.21/0.24	≤ 7.9		

Note A: Link design value

Note B: Due to cabling the optical attenuation values can increase with max. 0.05 dB/km

European Part Number Coding, Position 5	Fiber-Type	Core/Cladding Diameter (µm)	Wave-length (nm)	Attenuation ^c average/max. (dB/km)	Bandwidth (MHz-km)	Ethernet Performance (m)		Num. Apert. (µm)	Refractive Index
						1 GBE	10 GBE		

Characteristics (cabled) Multi-Mode • Graded-Index Optical Fibers according to IEC 60793

1	62.5/125 OM1	62.5 ± 2.5	850	2.7/3.0	≥ 200	220	33	0.275 ± 0.015	1.495
		125.0 ± 1.0	1300	0.7/0.8	≥ 600	550	300		1.490
2	50/125 OM2	50.0 ± 2.5	850	2.3/2.5	≥ 500	600	83	0.200 ± 0.015	1.481
		125.0 ± 1.0	1300	0.5/0.6	≥ 500	600	300		1.476
D	50/125 OM3 BI	50.0 ± 2.5	850	2.3/2.5	≥ 1500	1000	300	0.200 ± 0.015	1.482
		125.0 ± 1.0	1300	0.5/0.6	≥ 500	550	300		1.477
E	50/125 OM4 BI	50.0 ± 2.5	850	2.3/2.5	≥ 3500	1100	550	0.200 ± 0.015	1.482
		125.0 ± 1.0	1300	0.5/0.6	≥ 500	550	300		1.477

Note C: Due to cabling the optical attenuation values can increase with max. 0.4 dB/km

Belden Optical Fiber Cables

Construction Lookup Table

Central Loose Tube Cables		
Construction	Description	Page
GUSN, GUSL, GURN, GUVN	CLT Universal	284
GOSN, GORN, GOVN	CLT Outdoor	286
GMSN	CLT Outdoor	288
GUCN, GUCB	CLT Universal CST	290
GOCN, GOCB	CLT Outdoor CST	292
GUDN, GUDB	CLT Universal CST	294
GODN, GODB	CLT Outdoor CST	296
GUHA	CLT Universal SWB	298
GOHN	CLT Outdoor SWB	300
GUWN, GUWB	CLT Universal SWA	302
GOWN, GOWB	CLT Outdoor SWA	304
GUFN, GUFB	CLT Universal FRP	306
GOFN, GOFB	CLT Outdoor FRP	308

Multi Loose Tube Cables		
Construction	Description	Page
GCRG, GCRD, GCRE, GCRF	MLT Universal	310
GBRG, GBRD, GBRE, GBRF	MLT Outdoor	312
GDRG, GDRD, GDRE, GDRF	MLT Outdoor	312
GCCG, GCCD, GCCE, GCCF	MLT Universal CST	314
GBCG, GBCD, GBCE, GBCF	MLT Outdoor CST	316
GDCG, GDGD, GDCE, GDGF	MLT Outdoor CST	316
GCDG, GCDD, GCDE, GCDF	MLT Universal CST	318
GBDG, GBDD, GBDE, GBDF	MLT Outdoor CST	320
GDDG, GDDD, GDDE, GDDF	MLT Outdoor CST	320
GCWG, GCWD	MLT Universal SWA	322
GBWG, GBWD	MLT Outdoor SWA	324
GDWG, GDWD	MLT Outdoor SWA	324
GAAG, GAAD, GAAE	MLT Outdoor ADSS	326

Part Number Coding

The part numbers for the European Optical Fiber cables have the following structure:

- 4 positions to describe the construction
- 1 position to describe the fiber type
- 2 positions to describe the fiber count

Example

Construction				Fiber Type	Fiber Count	
1	2	3	4	5	6	7
G	C	R	G	1	0	6

In this example the

- Construction is: **GCRG**
- Jacket type is: **2**
- Fiber type is: **1**
- Fiber count is: **6**

Jacket Type Coding on Position 2

Position 2	Jacket Type
A	Polyethylene
B	Polyethylene
C	Halogen Free
D	Polyethylene
O	Polyethylene
U	Halogen Free

For both the PE and LSZH versions Termite Protection options are available by means of adding a PA (nylon) jacket, either as an outer jacket (for PE versions) or double jackets, PA and additional LSZH outer jacket, for LSZH versions. Please contact Customer Service for more information.

**Universal Central Loose Tube Cable
with Rodent Protection, Single Jacket**

GUSN, GUSL, GURN, GUVN

A/I-DQ(ZN)BH



Applications

- For outdoor and indoor use in structured (data) wiring systems such as campus backbone
- Easy to install in ducts, tunnels and trenches by means of compressed air or pulling wire
- Suitable for direct burial

Features & Benefits

- Available in sizes from 2 to 24 fibers
- Jelly filled (non-dripping and silicon-free) loose tube with primary coated optical fibers (Ø 250 ± 15 µm)
- Full dielectric construction, no grounding required
- Rodent protected by means of Glass Yarn Strength Elements
- Halogen Free jacket
- Length marking in meters for easy determination of the cable length

Cross Section

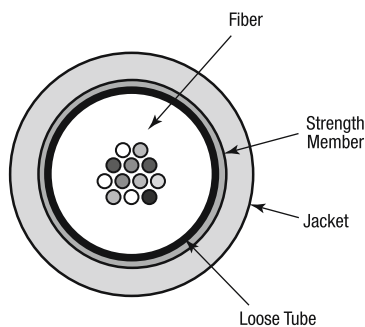

Specifications

IEC 60794-1-2	
Crush Resistance Installation (Short Term):	15 kN/m
Min. Bend Radius installation (E6):	20 x Ø
Min. Bend Radius operation (E11):	10 x Ø
Temperature Range (F1):	
– Transport/Storage	-30 °C to +70 °C
– Installation	-5 °C to +50 °C
– Operation	-30 °C to +70 °C
Watertightness (F5):	Pass
Other	
Flame Retardant:	
– GUSN, GURN, GUVN	IEC 60332-1
– GUSL	IEC 60332-3-24
Halogen Free:	IEC 60754-1
Non Corrosive:	IEC 60754-2
Smoke Density:	IEC 61034-2

Characteristics

Loose Tube	Fiber Count	Diameter (mm)	Weight (kg/km)	Tensile Strength (short term) N	Tensile Strength (permanent) N	Fire Load (kJ/m)
IEC 60794-1-2				E1	E1	
GUSN*xx	2 to 24	5.8	37	1250	420	550
GUSL*xx	2 to 24	6.5	47	1250	420	580
GURN*xx	2 to 24	7.1	55	3000	1000	755
GUVN*xx	2 to 24	7.8	67	4000	1300	928

Ordering Information

Fiber Type/Count	2	4	6	8	12	16	24	
GUSN								
62.5/125-OM1	GUSN102	GUSN104	GUSN106	GUSN108	GUSN112	GUSN116	GUSN124	
50/125-OM2	GUSN202	GUSN204	GUSN206	GUSN208	GUSN212	GUSN216	GUSN224	
50/125-OM3	GUSND02	GUSND04	GUSND06	GUSND08	GUSND12	GUSND16	GUSND24	
50/125-OM4	GUSNE02	GUSNE04	GUSNE06	GUSNE08	GUSNE12	GUSNE16	GUSNE24	
9/125 ITU G.652D	GUSN802	GUSN804	GUSN806	GUSN808	GUSN812	GUSN816	GUSN824	
9/125 ITU G.655 C & D	GUSN702	GUSN704	GUSN706	GUSN708	GUSN712	GUSN716	GUSN724	
GUSL								
62.5/125-OM1	GUSL102	GUSL104	GUSL106	GUSL108	GUSL112	GUSL116	GUSL124	
50/125-OM2	GUSL202	GUSL204	GUSL206	GUSL208	GUSL212	GUSL216	GUSL224	
50/125-OM3	GUSLD02	GUSLD04	GUSLD06	GUSLD08	GUSLD12	GUSLD16	GUSLD24	
50/125-OM4	GUSLE02	GUSLE04	GUSLE06	GUSLE08	GUSLE12	GUSLE16	GUSLE24	
9/125 ITU G.652D	GUSL802	GUSL804	GUSL806	GUSL808	GUSL812	GUSL816	GUSL824	
9/125 ITU G.655 C & D	GUSL702	GUSL704	GUSL706	GUSL708	GUSL712	GUSL716	GUSL724	
GURN								
62.5/125-OM1	GURN102	GURN104	GURN106	GURN108	GURN112	GURN116	GURN124	
50/125-OM2	GURN202	GURN204	GURN206	GURN208	GURN212	GURN216	GURN224	
50/125-OM3	GURND02	GURND04	GURND06	GURND08	GURND12	GURND16	GURND24	
50/125-OM4	GURNE02	GURNE04	GURNE06	GURNE08	GURNE12	GURNE16	GURNE24	
9/125 ITU G.652D	GURN802	GURN804	GURN806	GURN808	GURN812	GURN816	GURN824	
9/125 ITU G.655 C & D	GURN702	GURN704	GURN706	GURN708	GURN712	GURN716	GURN724	
GUVN								
62.5/125-OM1	GUVN102	GUVN104	GUVN106	GUVN108	GUVN112	GUVN116	GUVN124	
50/125-OM2	GUVN202	GUVN204	GUVN206	GUVN208	GUVN212	GUVN216	GUVN224	
50/125-OM3	GUVND02	GUVND04	GUVND06	GUVND08	GUVND12	GUVND16	GUVND24	
50/125-OM4	GUVNE02	GUVNE04	GUVNE06	GUVNE08	GUVNE12	GUVNE16	GUVNE24	
9/125 ITU G.652D	GUVN802	GUVN804	GUVN806	GUVN808	GUVN812	GUVN816	GUVN824	
9/125 ITU G.655 C & D	GUVN702	GUVN704	GUVN706	GUVN708	GUVN712	GUVN716	GUVN724	
GUSN • GURN • GUVN								
Std. plywood reel (non-returnable)			Ø 800 x 475 mm, Weight 7.65 kg and Ø 1000 x 530 mm, Weight 18.0 kg					
Std. delivery length			2100 ± 100 m and 4100 ± 100 m					

Fiber Color Coding

No.		No.		No.		No.		No.		No.	
1	Red	5	Green	9	Orange	13	Red + ring	17	Green + ring	21	Orange + ring
2	Natural	6	Violet	10	Turquoise	14	Natural + ring	18	Violet + ring	22	Turquoise + ring
3	Yellow	7	Brown	11	Pink	15	Yellow + ring	19	Brown + ring	23	Pink + ring
4	Blue	8	Black	12	White	16	Blue + ring	20	Grey + ring	24	White + ring

Outdoor Central Loose Tube Cable with Rodent Protection, Single Jacket

GOSN, GORN, GOVN

A-DQ(ZN)B2Y



Applications

- For outdoor use in structured (data) wiring systems such as campus backbone
- For outdoor use in networks for telecom, cable TV and/or broadcast
- Easy to install in ducts, tunnels and trenches by means of compressed air or pulling wire
- Suitable for direct burial

Features & Benefits

- Available in sizes from 2 to 24 fibers
- Jelly filled (non-dripping and silicon-free) loose tube with primary coated optical fibers ($\varnothing 250 \pm 15 \mu\text{m}$)
- Full dielectric construction, no grounding required
- Rodent protected by means of Glass Yarn Strength Elements
- Polyethylene jacket
- Length marking in meters for easy determination of the cable length

Cross Section

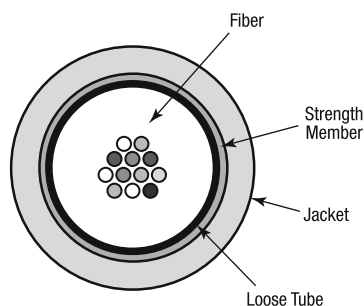

Specifications

IEC 60794-1-2	
Crush Resistance Installation (Short Term):	15 kN/m
Min. Bend Radius installation (E6):	20 x \varnothing
Min. Bend Radius operation (E11):	10 x \varnothing
Temperature Range (F1):	
– Transport/Storage	-30 °C to +70 °C
– Installation	-5 °C to +50 °C
– Operation	-30 °C to +70 °C
Watertightness (F5):	Pass

Characteristics

Loose Tube	Fiber Count	Diameter (mm)	Weight (kg/km)	Tensile Strength (short term) N	Tensile Strength (permanent) N	Fire Load (kJ/m)
IEC 60794-1-2				E1	E1	
GOSN*xx	2 to 24	5.8	28	1250	420	762
GORN*xx	2 to 24	7.1	44	3000	1000	1056
GOVN*xx	2 to 24	7.8	52	4000	1300	1350

Ordering Information

Fiber Type/Count	2	4	6	8	12	16	24
GOSN							
62.5/125-OM1	GOSN102	GOSN104	GOSN106	GOSN108	GOSN112	GOSN116	GOSN124
50/125-OM2	GOSN202	GOSN204	GOSN206	GOSN208	GOSN212	GOSN216	GOSN224
50/125-OM3	GOSND02	GOSND04	GOSND06	GOSND08	GOSND12	GOSND16	GOSND24
50/125-OM4	GOSNE02	GOSNE04	GOSNE06	GOSNE08	GOSNE12	GOSNE16	GOSNE24
9/125 ITU G.652D	GOSN802	GOSN804	GOSN806	GOSN808	GOSN812	GOSN816	GOSN824
9/125 ITU G.655 C & D	GOSN702	GOSN704	GOSN706	GOSN708	GOSN712	GOSN716	GOSN724
GORN							
62.5/125-OM1	GORN102	GORN104	GORN106	GORN108	GORN112	GORN116	GORN124
50/125-OM2	GORN202	GORN204	GORN206	GORN208	GORN212	GORN216	GORN224
50/125-OM3	GORND02	GORND04	GORND06	GORND08	GORND12	GORND16	GORND24
50/125-OM4	GORNE02	GORNE04	GORNE06	GORNE08	GORNE12	GORNE16	GORNE24
9/125 ITU G.652D	GORN802	GORN804	GORN806	GORN808	GORN812	GORN816	GORN824
9/125 ITU G.655 C & D	GORN702	GORN704	GORN706	GORN708	GORN712	GORN716	GORN724
GOVN							
62.5/125-OM1	GOVN102	GOVN104	GOVN106	GOVN108	GOVN112	GOVN116	GOVN124
50/125-OM2	GOVN202	GOVN204	GOVN206	GOVN208	GOVN212	GOVN216	GOVN224
50/125-OM3	GOVND02	GOVND04	GOVND06	GOVND08	GOVND12	GOVND16	GOVND24
50/125-OM4	GOVNE02	GOVNE04	GOVNE06	GOVNE08	GOVNE12	GOVNE16	GOVNE24
9/125 ITU G.652D	GOVN802	GOVN804	GOVN806	GOVN808	GOVN812	GOVN816	GOVN824
9/125 ITU G.655 C & D	GOVN702	GOVN704	GOVN706	GOVN708	GOVN712	GOVN716	GOVN724
GOSN • GORN • GOVN							
Std. plywood reel (non-returnable)				Ø 800 x 475 mm, Weight 7.65 kg and Ø 1000 x 530 mm, Weight 18.0 kg			
Std. delivery length				2100 ± 100 m and 4100 ± 100 m			

Fiber Color Coding

1 Red	5 Green	9 Orange	13 Red + ring	17 Green + ring	21 Orange + ring
2 Natural	6 Violet	10 Turquoise	14 Natural + ring	18 Violet + ring	22 Turquoise + ring
3 Yellow	7 Brown	11 Pink	15 Yellow + ring	19 Brown + ring	23 Pink + ring
4 Blue	8 Black	12 White	16 Blue + ring	20 Grey + ring	24 White + ring

Outdoor Central Loose Tube Cable with Rodent Protection, Single Jacket

GMSN

A/I-DQ(ZN)B11Y



Applications

- For outdoor and indoor use in structured (data) wiring systems such as campus backbone, building backbone (riser) and/or Horizontal cabling
- Support all computer network applications such as FDDI, Gigabit Ethernet and ATM
- Easy to install in ducts, tunnels and trenches. Not recommended for direct burial

Features & Benefits

- Available in sizes from 2 to 24 fibers
- Jelly filled (non-dripping and silicon-free) loose tube with primary coated optical fibers ($\varnothing 250 \pm 15 \mu\text{m}$)
- Full dielectric construction, no grounding required
- Rodent protected by means of Glass Yarn Strength Elements
- TPU Jacket
- Length marking in meters for easy determination of the cable length

Cross Section

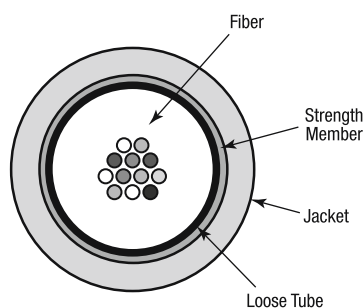

Specifications

IEC 60794-1-2	
Crush Resistance (E3):	15 kN/m
Min. Bend Radius installation (E6):	15 x \varnothing
Min. Bend Radius operation (E11):	10 x \varnothing
Temperature Range (F1):	
– Transport/Storage	-30 °C to +70 °C
– Installation	-5 °C to +50 °C
– Operation	-30 °C to +70 °C
Watertightness (F5):	Pass

Characteristics

Loose Tube	Fiber Count	Diameter (mm)	Weight (kg/km)	Tensile Strength (short term) N	Tensile Strength (permanent) N	Fire Load (kJ/m)
IEC 60794-1-2				E1	E1	
GMSN*xx	2 to 24	6.4	40	1250	420	582

Ordering Information

Fiber Type/Count	2	4	6	8	12	16	24
GMSN							
62.5/125-OM1	GMSN102	GMSN104	GMSN106	GMSN108	GMSN112	GMSN116	GMSN124
50/125-OM2 BI	GMSN202	GMSN204	GMSN206	GMSN208	GMSN212	GMSN216	GMSN224
50/125-OM3 BI	GMSND02	GMSND04	GMSND06	GMSND08	GMSND12	GMSND16	GMSND24
50/125-OM4 BI	GMSNE02	GMSNE04	GMSNE06	GMSNE08	GMSNE12	GMSNE16	GMSNE24
9/125 ITU G.655 C & D	GMSN702	GMSN704	GMSN706	GMSN708	GMSN712	GMSN716	GMSN724
9/125 ITU G.652D & G.657A1	GMSN802	GMSN804	GMSN806	GMSN808	GMSN812	GMSN816	GMSN824
9/125 ITU G.657A2 BI	GMSNF02	GMSNF04	GMSNF06	GMSNF08	GMSNF12	GMSNF16	GMSNF24
9/125 ITU G.657B3 BI	GMSNI02	GMSNI04	GMSNI06	GMSNI08	GMSNI12	GMSNI16	GMSNI24
Std. plywood reel (non-returnable)	Ø 800 x 475 mm, Weight 7.65 kg and Ø 1000 x 530 mm, Weight 18.0 kg						
Std. delivery length	2100m ± 105m						

Fiber Color Coding

No.		No.		No.		No.		No.		No.	
1	Red	5	Green	9	Orange	13	Red + ring	17	Green + ring	21	Orange + ring
2	Natural	6	Violet	10	Turquoise	14	Natural + ring	18	Violet + ring	22	Turquoise + ring
3	Yellow	7	Brown	11	Pink	15	Yellow + ring	19	Brown + ring	23	Pink + ring
4	Blue	8	Black	12	White	16	Blue + ring	20	Grey + ring	24	White + ring

Universal Central Loose Tube Cable with Corrugated Steel Tape, Single Jacket

GUCN, GUCB

A/I-DQ(ZN)(SR)H



Applications

- For outdoor and indoor use in structured (data) wiring systems such as campus backbone
- For outdoor and indoor use in networks for telecom, cable TV and/or broadcast
- Easy to install in ducts, tunnels and trenches by means of compressed air or pulling wire
- Suitable for direct burial

Features & Benefits

- Available in sizes from 4 to 24 fibers
- Jelly filled (non-dripping and silicon-free) loose tube with primary coated optical fibers ($\varnothing 250 \pm 15 \mu\text{m}$)
- High mechanical and full rodent protection provided by Corrugated Steel Tape (CST) armor
- Halogen Free jacket
- Length marking in meters for easy determination of the cable length

Cross Section

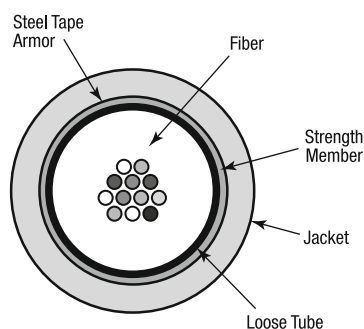

Specifications

IEC 60794-1-2	
Min. Bend Radius installation (E6):	20 x \varnothing
Min. Bend Radius operation (E11):	20 x \varnothing
Temperature Range (F1):	
– Transport/Storage	-30 °C to +70 °C
– Installation	-5 °C to +50 °C
– Operation	-30 °C to +70 °C
Watertightness (F5):	Pass
Other	
Circuit Integrity:	EN 50200, IEC 60331-25 (E120)
Flame Retardant:	IEC 60332-3-22
Halogen Free:	IEC 60754-1
Non Corrosive:	IEC 60754-2
Smoke Density:	IEC 61034-2

Characteristics

Loose Tube	Fiber Count	Diameter (mm)	Weight (kg/km)	Crush Resistance (kN/m)	Tensile Strength (short term) N	Tensile Strength (permanent) N	Fire Load (kJ/m)
IEC 60794-1-2					E1	E1	
GUCN*xx	4 to 24	9.0	103	35	1500	500	1045
GUCB*xx	4 to 24	10.6	148	40	2500	830	1308

Ordering Information

Fiber Type/Count	4	6	8	12	16	24
GUCN						
62.5/125-OM1	GUCN104	GUCN106	GUCN108	GUCN112	GUCN116	GUCN124
50/125-OM2	GUCN204	GUCN206	GUCN208	GUCN212	GUCN216	GUCN224
50/125-OM3	GUCND04	GUCND06	GUCND08	GUCND12	GUCND16	GUCND24
50/125-OM4	GUCNE04	GUCNE06	GUCNE08	GUCNE12	GUCNE16	GUCNE24
9/125 ITU G.652D	GUCN804	GUCN806	GUCN808	GUCN812	GUCN816	GUCN824
9/125 ITU G.655 C & D	GUCN704	GUCN706	GUCN708	GUCN712	GUCN716	GUCN724
GUCB						
62.5/125-OM1	GUCB104	GUCB106	GUCB108	GUCB112	GUCB116	GUCB124
50/125-OM2	GUCB204	GUCB206	GUCB208	GUCB212	GUCB216	GUCB224
50/125-OM3	GUCBD04	GUCBD06	GUCBD08	GUCBD12	GUCBD16	GUCBD24
50/125-OM4	GUCBE04	GUCBE06	GUCBE08	GUCBE12	GUCBE16	GUCBE24
9/125 ITU G.652D	GUCB804	GUCB806	GUCB808	GUCB812	GUCB816	GUCB824
9/125 ITU G.655 C & D	GUCB704	GUCB706	GUCB708	GUCB712	GUCB716	GUCB724
GUCN • GUCB						
Std. plywood reel (non-returnable)			Ø 1000 x 530 mm, Weight 18.0 kg			
Std. delivery length			2100 ± 100 m			

Fiber Color Coding

No.		No.		No.		No.		No.		No.	
1	Red	5	Green	9	Orange	13	Red + ring	17	Green + ring	21	Orange + ring
2	Natural	6	Violet	10	Turquoise	14	Natural + ring	18	Violet + ring	22	Turquoise + ring
3	Yellow	7	Brown	11	Pink	15	Yellow + ring	19	Brown + ring	23	Pink + ring
4	Blue	8	Black	12	White	16	Blue + ring	20	Grey + ring	24	White + ring

**Outdoor Central Loose Tube Cable
with Corrugated Steel Tape, Single Jacket**

GOCN, GOCB

A-DQ(ZN)(SR)2Y



Applications

- For outdoor and indoor use in structured (data) wiring systems such as campus backbone
- For outdoor and indoor use in networks for telecom, cable TV and/or broadcast
- Easy to install in ducts, tunnels and trenches by means of compressed air or pulling wire
- Suitable for direct burial

Features & Benefits

- Available in sizes from 4 to 24 fibers
- Jelly filled (non-dripping and silicon-free) loose tube with primary coated optical fibers (Ø 250 ± 15 µm)
- High mechanical and full rodent protection provided by Corrugated Steel Tape (CST) armor
- Polyethylene jacket
- Length marking in meters for easy determination of the cable length

Cross Section

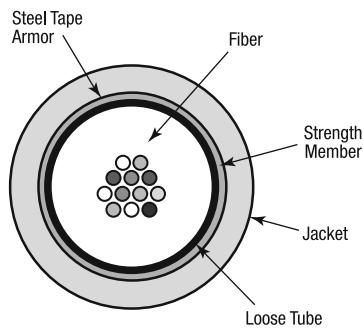

Specifications

IEC 60794-1-2	
Impact Resistance (E4):	3000 N
Min. Bend Radius installation (E6):	20 x Ø
Min. Bend Radius operation (E11):	20 x Ø
Temperature Range (F1):	
– Transport/Storage	-30 °C to +70 °C
– Installation	-5 °C to +50 °C
– Operation	-30 °C to +70 °C
Watertightness (F5):	Pass

Characteristics

Loose Tube	Fiber Count	Diameter (mm)	Weight (kg/km)	Crush Resistance (kN/m)	Tensile Strength (short term) N	Tensile Strength (permanent) N	Fire Load (kJ/m)
IEC 60794-1-2					E1	E1	
GOCN*xx	4 to 24	9.0	80	35	1500	500	1774
GOCB*xx	4 to 24	10.6	107	40	2500	830	2242

Ordering Information

Fiber Type/Count	4	6	8	12	16	24
GOCN						
62.5/125-OM1	GOCN104	GOCN106	GOCN108	GOCN112	GOCN116	GOCN124
50/125-OM2	GOCN204	GOCN206	GOCN208	GOCN212	GOCN216	GOCN224
50/125-OM3	GOCND04	GOCND06	GOCND08	GOCND12	GOCND16	GOCND24
50/125-OM4	GOCNE04	GOCNE06	GOCNE08	GOCNE12	GOCNE16	GOCNE24
9/125 ITU G.652D	GOCN804	GOCN806	GOCN808	GOCN812	GOCN816	GOCN824
9/125 ITU G.655 C & D	GOCN704	GOCN706	GOCN708	GOCN712	GOCN716	GOCN724
GOCB						
62.5/125-OM1	GOCB104	GOCB106	GOCB108	GOCB112	GOCB116	GOCB124
50/125-OM2	GOCB204	GOCB206	GOCB208	GOCB212	GOCB216	GOCB224
50/125-OM3	GOCBD04	GOCBD06	GOCBD08	GOCBD12	GOCBD16	GOCBD24
50/125-OM4	GOCBE04	GOCBE06	GOCBE08	GOCBE12	GOCBE16	GOCBE24
9/125 ITU G.652D	GOCB804	GOCB806	GOCB808	GOCB812	GOCB816	GOCB824
9/125 ITU G.655 C & D	GOCB704	GOCB706	GOCB708	GOCB712	GOCB716	GOCB724
GOCN • GOCB						
Std. plywood reel (non-returnable)			Ø 1250 x 688 mm, Weight 93.0 kg			
Std. delivery length			2100 ± 100 m			

Fiber Color Coding

No.		No.		No.		No.		No.		No.	
1	Red	5	Green	9	Orange	13	Red + ring	17	Green + ring	21	Orange + ring
2	Natural	6	Violet	10	Turquoise	14	Natural + ring	18	Violet + ring	22	Turquoise + ring
3	Yellow	7	Brown	11	Pink	15	Yellow + ring	19	Brown + ring	23	Pink + ring
4	Blue	8	Black	12	White	16	Blue + ring	20	Grey + ring	24	White + ring

Universal Central Loose Tube Cable with Corrugated Steel Tape, Double Jacket

GUDN, GUDB

A/I-DQ(ZN)H(SR)H



Applications

- For outdoor and indoor use in structured (data) wiring systems such as campus backbone
- For outdoor and indoor use in networks for telecom, cable TV and/or broadcast
- Easy to install in ducts, tunnels and trenches by means of compressed air or pulling wire
- Suitable for direct burial

Features & Benefits

- Available in sizes from 4 to 24 fibers
- Jelly filled (non-dripping and silicon-free) loose tube with primary coated optical fibers ($\varnothing 250 \pm 15 \mu\text{m}$)
- High mechanical and full rodent protection provided by Corrugated Steel Tape (CST) armor
- Halogen Free jacket
- Length marking in meters for easy determination of the cable length

Cross Section

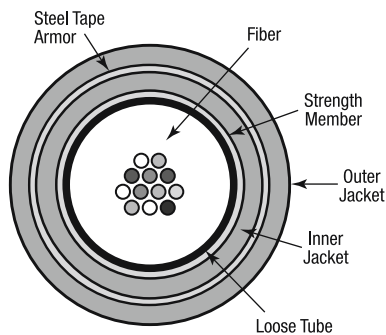

Specifications

IEC 60794-1-2

Min. Bend Radius installation (E6):	20 x \varnothing
Min. Bend Radius operation (E11):	20 x \varnothing
Temperature Range (F1):	
– Transport/Storage	-30 °C to +70 °C
– Installation	-5 °C to +50 °C
– Operation	-30 °C to +70 °C

Watertightness (F5): Pass

Other

Flame Retardant:	
– GUDN	IEC 60332-3-22
– GUDB	IEC 60332-3-22
Halogen Free:	IEC 60754-1
Non Corrosive:	IEC 60754-2
Smoke Density:	IEC 61034-2

Characteristics

Loose Tube	Fiber Count	Diameter (mm)	Weight (kg/km)	Crush Resistance (kN/m)	Tensile Strength (short term) N	Tensile Strength (permanent) N	Fire Load (kJ/m)
IEC 60794-1-2					E1	E1	
GUDN*xx	4 to 24	11.0	180	35	1500	500	1550
GUDB*xx	4 to 24	13.0	233	40	2500	830	2919

Ordering Information

Fiber Type/Count	4	6	8	12	16	24
GUDN						
62.5/125-OM1	GUDN104	GUDN106	GUDN108	GUDN112	GUDN116	GUDN124
50/125-OM2	GUDN204	GUDN206	GUDN208	GUDN212	GUDN216	GUDN224
50/125-OM3	GUDND04	GUDND06	GUDND08	GUDND12	GUDND16	GUDND24
50/125-OM4	GUDNE04	GUDNE06	GUDNE08	GUDNE12	GUDNE16	GUDNE24
9/125 ITU G.652D	GUDN804	GUDN806	GUDN808	GUDN812	GUDN816	GUDN824
9/125 ITU G.655 C & D	GUDN704	GUDN706	GUDN708	GUDN712	GUDN716	GUDN724
GUDB						
62.5/125-OM1	GUDB104	GUDB106	GUDB108	GUDB112	GUDB116	GUDB124
50/125-OM2	GUDB204	GUDB206	GUDB208	GUDB212	GUDB216	GUDB224
50/125-OM3	GUDBD04	GUDBD06	GUDBD08	GUDBD12	GUDBD16	GUDBD24
50/125-OM4	GUDBE04	GUDBE06	GUDBE08	GUDBE12	GUDBE16	GUDBE24
9/125 ITU G.652D	GUDB804	GUDB806	GUDB808	GUDB812	GUDB816	GUDB824
9/125 ITU G.655 C & D	GUDB704	GUDB706	GUDB708	GUDB712	GUDB716	GUDB724
GUDN • GUDB						
Std. plywood reel (non-returnable)			Ø 1250 x 688 mm, Weight 93.0 kg			
Std. delivery length			2100 ± 100 m			

Fiber Color Coding

No.		No.		No.		No.		No.		No.	
1	Red	5	Green	9	Orange	13	Red + ring	17	Green + ring	21	Orange + ring
2	Natural	6	Violet	10	Turquoise	14	Natural + ring	18	Violet + ring	22	Turquoise + ring
3	Yellow	7	Brown	11	Pink	15	Yellow + ring	19	Brown + ring	23	Pink + ring
4	Blue	8	Black	12	White	16	Blue + ring	20	Grey + ring	24	White + ring

**Outdoor Central Loose Tube Cable
with Corrugated Steel Tape, Double Jacket**

GODN, GODB

A-DQ(ZN)2Y(SR)2Y



Applications

- For outdoor and indoor use in structured (data) wiring systems such as campus backbone
- For outdoor and indoor use in networks for telecom, cable TV and/or broadcast
- Easy to install in ducts, tunnels and trenches by means of compressed air or pulling wire
- Suitable for direct burial

Features & Benefits

- Available in sizes from 4 to 24 fibers
- Jelly filled (non-dripping and silicon-free) loose tube with primary coated optical fibers (Ø 250 ± 15 µm)
- High mechanical and full rodent protection provided by Corrugated Steel Tape (CST) armor
- Polyethylene jacket
- Length marking in meters for easy determination of the cable length

Cross Section

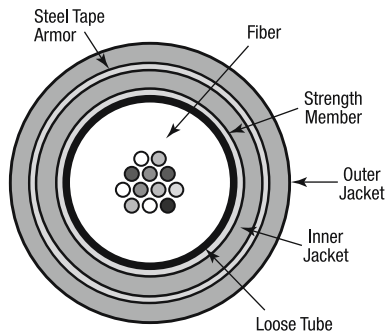

Specifications

IEC 60794-1-2	
Min. Bend Radius installation (E6):	20 x Ø
Min. Bend Radius operation (E11):	20 x Ø
Temperature Range (F1):	
- Transport/Storage	-30 °C to +70 °C
- Installation	-5 °C to +50 °C
- Operation	-30 °C to +70 °C
Watertightness (F5):	Pass

Characteristics

Loose Tube	Fiber Count	Diameter (mm)	Weight (kg/km)	Crush Resistance (kN/m)	Tensile Strength (short term) N	Tensile Strength (permanent) N	Fire Load (kJ/m)
IEC 60794-1-2					E1	E1	
GODN*xx	4 to 24	11.0	144	35	1500	500	2596
GODB*xx	4 to 24	13.0	178	40	2500	830	4980

Ordering Information

Fiber Type/Count	4	6	8	12	16	24
GODN						
62.5/125-OM1	GODN104	GODN106	GODN108	GODN112	GODN116	GODN124
50/125-OM2	GODN204	GODN206	GODN208	GODN212	GODN216	GODN224
50/125-OM3	GODND04	GODND06	GODND08	GODND12	GODND16	GODND24
50/125-OM4	GODNE04	GODNE06	GODNE08	GODNE12	GODNE16	GODNE24
9/125 ITU G.652D	GODN804	GODN806	GODN808	GODN812	GODN816	GODN824
9/125 ITU G.655 C & D	GODN704	GODN706	GODN708	GODN712	GODN716	GODN724
GODB						
62.5/125-OM1	GODB104	GODB106	GODB108	GODB112	GODB116	GODB124
50/125-OM2	GODB204	GODB206	GODB208	GODB212	GODB216	GODB224
50/125-OM3	GOSBD04	GOSBD06	GOSBD08	GOSBD12	GOSBD16	GOSBD24
50/125-OM4	GOSBE04	GOSBE06	GOSBE08	GOSBE12	GOSBE16	GOSBE24
9/125 ITU G.652D	GOSB804	GOSB806	GOSB808	GOSB812	GOSB816	GOSB824
9/125 ITU G.655 C & D	GOSB704	GOSB706	GOSB708	GOSB712	GOSB716	GOSB724
GODN • GODB						
Std. plywood reel (non-returnable)			Ø 1250 x 688 mm, Weight 93.0 kg			
Std. delivery length			2100 ± 100 m			

Fiber Color Coding

No.		No.		No.		No.		No.		No.	
1	Red	5	Green	9	Orange	13	Red + ring	17	Green + ring	21	Orange + ring
2	Natural	6	Violet	10	Turquoise	14	Natural + ring	18	Violet + ring	22	Turquoise + ring
3	Yellow	7	Brown	11	Pink	15	Yellow + ring	19	Brown + ring	23	Pink + ring
4	Blue	8	Black	12	White	16	Blue + ring	20	Grey + ring	24	White + ring

Universal Central Loose Tube Cable with Steel Wire Braid, Double Jacket

GUHA

A/I-DQ(ZN)H(SR)H



Applications

- For outdoor and indoor use in structured (data) wiring systems such as campus backbone
- For outdoor and indoor use in networks for telecom, cable TV and/or broadcast
- Easy to install in ducts, tunnels and trenches by means of compressed air or pulling wire
- Suitable for direct burial

Features & Benefits

- Available in sizes from 4 to 24 fibers
- Jelly filled (non-dripping and silicon-free) loose tube with primary coated optical fibers ($\varnothing 250 \pm 15 \mu\text{m}$)
- High mechanical and full rodent protection provided by Steel Wire Braid (SWB) armor
- Halogen Free jacket
- Length marking in meters for easy determination of the cable length

Cross Section

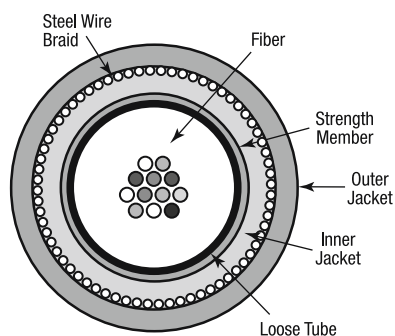

Specifications

IEC 60794-1-2	
Min. Bend Radius installation (E6):	20 x \varnothing
Min. Bend Radius operation (E11):	20 x \varnothing
Temperature Range (F1):	
- Transport/Storage	-30 °C to +70 °C
- Installation	-5 °C to +50 °C
- Operation	-30 °C to +70 °C
Watertightness (F5):	Pass
Other	
Flame Retardant:	IEC 60332-3-25
Halogen Free:	IEC 60754-1
Non Corrosive:	IEC 60754-2
Smoke Density:	IEC 61034-2

Characteristics

Loose Tube	Fiber Count	Diameter (mm)	Weight (kg/km)	Crush Resistance (kN/m)	Tensile Strength (short term) N	Tensile Strength (permanent) N	Fire Load (kJ/m)
IEC 60794-1-2					E1	E1	
GUHA*xx	4 to 24	10.0	127	25	1250	420	1509

Ordering Information

Fiber Type/Count	4	6	8	12	16	24
62.5/125-OM1	GUHA104	GUHA106	GUHA108	GUHA112	GUHA116	GUHA124
50/125-OM2	GUHA204	GUHA206	GUHA208	GUHA212	GUHA216	GUHA224
50/125-OM3	GUHAD04	GUHAD06	GUHAD08	GUHAD12	GUHAD16	GUHAD24
50/125-OM4	GUHAE04	GUHAE06	GUHAE08	GUHAE12	GUHAE16	GUHAE24
9/125 ITU G.652D	GUHA804	GUHA806	GUHA808	GUHA812	GUHA816	GUHA824
9/125 ITU G.655 C & D	GUHA704	GUHA706	GUHA708	GUHA712	GUHA716	GUHA724
Std. plywood reel (non-returnable)	Ø 1000 x 588 mm, Weight 50.0 kg					
Std. delivery length	2100 ± 100 m					

Fiber Color Coding

No.		No.		No.		No.		No.		No.	
1	Red	5	Green	9	Orange	13	Red + ring	17	Green + ring	21	Orange + ring
2	Natural	6	Violet	10	Turquoise	14	Natural + ring	18	Violet + ring	22	Turquoise + ring
3	Yellow	7	Brown	11	Pink	15	Yellow + ring	19	Brown + ring	23	Pink + ring
4	Blue	8	Black	12	White	16	Blue + ring	20	Grey + ring	24	White + ring

Outdoor Central Loose Tube Cable with Steel Wire Braid, Double Jacket

GOHN

A-DQ(ZN)2Y(SR)2Y



Applications

- For outdoor and indoor use in structured (data) wiring systems such as campus backbone
- For outdoor and indoor use in networks for telecom, cable TV and/or broadcast
- Easy to install in ducts, tunnels and trenches by means of compressed air or pulling wire
- Suitable for direct burial

Features & Benefits

- Available in sizes from 4 to 24 fibers
- Jelly filled (non-dripping and silicon-free) loose tube with primary coated optical fibers ($\varnothing 250 \pm 15 \mu\text{m}$)
- High mechanical and full rodent protection provided by Steel Wire Braid (SWB) armor
- Polyethylene jacket
- Length marking in meters for easy determination of the cable length

Cross Section

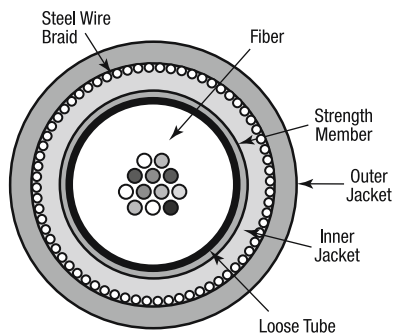

Specifications

IEC 60794-1-2	
Min. Bend Radius installation (E6):	20 x \varnothing
Min. Bend Radius operation (E11):	10 x \varnothing
Temperature Range (F1):	
– Transport/Storage	-30 °C to +70 °C
– Installation	-5 °C to +50 °C
– Operation	-30 °C to +70 °C
Watertightness (F5):	Pass

Characteristics

Loose Tube	Fiber Count	Diameter (mm)	Weight (kg/km)	Crush Resistance (kN/m)	Tensile Strength (short term) N	Tensile Strength (permanent) N	Fire Load (kJ/m)
IEC 60794-1-2					E1	E1	
GOHN*xx	4 to 24	10.0	98	25	1250	420	2503

Ordering Information

Fiber Type/Count	4	6	8	12	16	24
62.5/125-OM1	GOHN104	GOHN106	GOHN108	GOHN112	GOHN116	GOHN124
50/125-OM2	GOHN204	GOHN206	GOHN208	GOHN212	GOHN216	GOHN224
50/125-OM3	GOHND04	GOHND06	GOHND08	GOHND12	GOHND16	GOHND24
50/125-OM4	GOHNE04	GOHNE06	GOHNE08	GOHNE12	GOHNE16	GOHNE24
9/125 ITU G.652D	GOHN804	GOHN806	GOHN808	GOHN812	GOHN816	GOHN824
9/125 ITU G.655 C & D	GOHN704	GOHN706	GOHN708	GOHN712	GOHN716	GOHN724
Std. plywood reel (non-returnable)	Ø 1000 x 588 mm, Weight 50.0 kg					
Std. delivery length	2100 ± 100 m					

Fiber Color Coding

No.		No.		No.		No.		No.		No.	
1	Red	5	Green	9	Orange	13	Red + ring	17	Green + ring	21	Orange + ring
2	Natural	6	Violet	10	Turquoise	14	Natural + ring	18	Violet + ring	22	Turquoise + ring
3	Yellow	7	Brown	11	Pink	15	Yellow + ring	19	Brown + ring	23	Pink + ring
4	Blue	8	Black	12	White	16	Blue + ring	20	Grey + ring	24	White + ring

Universal Central Loose Tube Cable with Steel Wire Armor, Double Jacket

GUWN, GUWB

A/I-DQ(ZN)H(SR)H

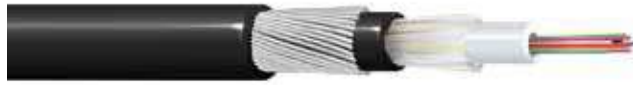

Applications

- For outdoor and indoor use in structured (data) wiring systems such as industrial backbone, campus backbone, building backbone (riser) and/or horizontal cabling
- For outdoor and indoor use in networks for industrial, telecom, cable TV and/or broadcast
- Easy to install in ducts, tunnels and trenches by means of compressed air or pulling wire
- Suitable for direct burial

Features & Benefits

- Available in sizes from 4 to 24 fibers
- Jelly filled (non-dripping and silicon-free) loose tube with primary coated optical fibers ($\varnothing 250 \pm 15 \mu\text{m}$)
- High mechanical and full rodent protection provided by Steel Wire Armor (SWA)
- Halogen Free jacket
- Length marking in meters for easy determination of the cable length

Cross Section

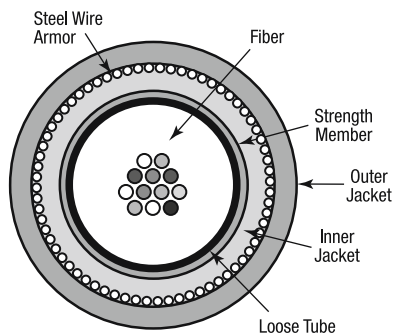

Specifications

IEC 60794-1-2	
Min. Bend Radius installation (E6):	20 x \varnothing
Min. Bend Radius operation (E11):	20 x \varnothing
Temperature Range (F1):	
– Transport/Storage	-30 °C to +70 °C
– Installation	-5 °C to +50 °C
– Operation	-30 °C to +70 °C
Watertightness (F5):	Pass
Other	
Flame Retardant:	
– GUWN	IEC 60332-3-25
– GUWB	IEC 60332-3-24
Halogen Free:	IEC 60754-1
Non Corrosive:	IEC 60754-2
Smoke Density:	IEC 61034-2

Characteristics

Loose Tube	Fiber Count	Diameter (mm)	Steel Wire Diameter (mm)	Weight (kg/km)	Crush Resistance (kN/m)	Tensile Strength (short term) N	Tensile Strength (permanent) N	Fire Load (kJ/m)
IEC 60794-1-2						E1	E1	
GUWN*xx	4 to 24	9.6	0.6	155	45	1250	420	1500
GUWB*xx	4 to 24	13.8	0.9	325	50	3750	1250	2625

Ordering Information

Fiber Type/Count	4	6	8	12	16	24
GUWN						
62.5/125-OM1	GUWN104	GUWN106	GUWN108	GUWN112	GUWN116	GUWN124
50/125-OM2	GUWN204	GUWN206	GUWN208	GUWN212	GUWN216	GUWN224
50/125-OM3	GUWND04	GUWND06	GUWND08	GUWND12	GUWND16	GUWND24
50/125-OM4	GUWNE04	GUWNE06	GUWNE08	GUWNE12	GUWNE16	GUWNE24
9/125 ITU G.652D	GUWN804	GUWN806	GUWN808	GUWN812	GUWN816	GUWN824
9/125 ITU G.655 C & D	GUWN704	GUWN706	GUWN708	GUWN712	GUWN716	GUWN724
Std. plywood reel (non-returnable)	Ø 1000 x 588 mm, Weight 50.0 kg					
Std. delivery length	2100 ± 100 m					
GUWB						
62.5/125-OM1	GUWB104	GUWB106	GUWB108	GUWB112	GUWB116	GUWB124
50/125-OM2	GUWB204	GUWB206	GUWB208	GUWB212	GUWB216	GUWB224
50/125-OM3	GUWBD04	GUWBD06	GUWBD08	GUWBD12	GUWBD16	GUWBD24
50/125-OM4	GUWBE04	GUWBE06	GUWBE08	GUWBE12	GUWBE16	GUWBE24
9/125 ITU G.652D	GUWB804	GUWB806	GUWB808	GUWB812	GUWB816	GUWB824
9/125 ITU G.655 C & D	GUWB704	GUWB706	GUWB708	GUWB712	GUWB716	GUWB724
Std. plywood reel (non-returnable)	Ø 1250 x 688 mm, Weight 93.0 kg					
Std. delivery length	2100 ± 100 m					

Fiber Color Coding

No.		No.		No.		No.		No.		No.	
1	Red	5	Green	9	Orange	13	Red + ring	17	Green + ring	21	Orange + ring
2	Natural	6	Violet	10	Turquoise	14	Natural + ring	18	Violet + ring	22	Turquoise + ring
3	Yellow	7	Brown	11	Pink	15	Yellow + ring	19	Brown + ring	23	Pink + ring
4	Blue	8	Black	12	White	16	Blue + ring	20	Grey + ring	24	White + ring

Outdoor Central Loose Tube Cable with Steel Wire Armor, Double Jacket

GOWN, GOWB

A-DQ(ZN)2Y(SR)2Y

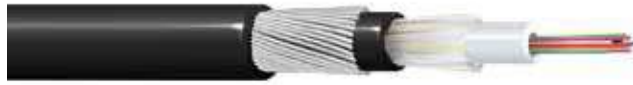

Applications

- For outdoor and indoor use in structured (data) wiring systems such as industrial backbone, campus backbone, building backbone (riser) and/or horizontal cabling
- For outdoor and indoor use in networks for industrial, telecom, cable TV and/or broadcast
- Easy to install in ducts, tunnels and trenches by means of compressed air or pulling wire
- Suitable for direct burial

Features & Benefits

- Available in sizes from 4 to 24 fibers
- Jelly filled (non-dripping and silicon-free) loose tube with primary coated optical fibers ($\text{Ø } 250 \pm 15 \mu\text{m}$)
- High mechanical and full rodent protection provided by Steel Wire Armor (SWA)
- Polyethylene jacket
- Length marking in meters for easy determination of the cable length

Cross Section

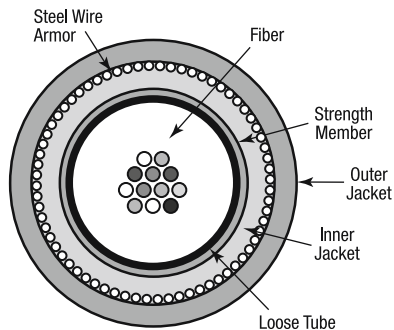

Specifications

IEC 60794-1-2

Min. Bend Radius installation (E6):	20 x Ø
Min. Bend Radius operation (E11):	10 x Ø
Temperature Range (F1):	
– Transport/Storage	-30 °C to +70 °C
– Installation	-5 °C to +50 °C
– Operation	-30 °C to +70 °C
Watertightness (F5):	Pass

Characteristics

Loose Tube	Fiber Count	Diameter (mm)	Steel Wire Diameter (mm)	Weight (kg/km)	Crush Resistance (kN/m)	Tensile Strength (short term) N	Tensile Strength (permanent) N	Fire Load (kJ/m)
IEC 60794-1-2						E1	E1	
GOWN*xx	4 to 24	9.6	0.6	125	45	1250	420	2505
GOWB*xx	4 to 24	13.5	0.9	270	50	3750	1250	2625

Ordering Information

Fiber Type/Count	4	6	8	12	16	24
GOWN						
62.5/125-OM1	GOWN104	GOWN106	GOWN108	GOWN112	GOWN116	GOWN124
50/125-OM2	GOWN204	GOWN206	GOWN208	GOWN212	GOWN216	GOWN224
50/125-OM3	GOWND04	GOWND06	GOWND08	GOWND12	GOWND16	GOWND24
50/125-OM4	GOWNE04	GOWNE06	GOWNE08	GOWNE12	GOWNE16	GOWNE24
9/125 ITU G.652D	GOWN804	GOWN806	GOWN808	GOWN812	GOWN816	GOWN824
9/125 ITU G.655 C & D	GOWN704	GOWN706	GOWN708	GOWN712	GOWN716	GOWN724
Std. plywood reel (non-returnable)	Ø 1000 x 588 mm, Weight 50.0 kg					
Std. delivery length	2100 ± 100 m					
GOWB						
62.5/125-OM1	GOWB104	GOWB106	GOWB108	GOWB112	GOWB116	GOWB124
50/125-OM2	GOWB204	GOWB206	GOWB208	GOWB212	GOWB216	GOWB224
50/125-OM3	GOWBD04	GOWBD06	GOWBD08	GOWBD12	GOWBD16	GOWBD24
50/125-OM4	GOWBE04	GOWBE06	GOWBE08	GOWBE12	GOWBE16	GOWBE24
9/125 ITU G.652D	GOWB804	GOWB806	GOWB808	GOWB812	GOWB816	GOWB824
9/125 ITU G.655 C & D	GOWB704	GOWB706	GOWB708	GOWB712	GOWB716	GOWB724
Std. plywood reel (non-returnable)	Ø 1250 x 688 mm, Weight 93.0 kg					
Std. delivery length	2100 ± 100 m					

Fiber Color Coding

No.		No.		No.		No.		No.		No.	
1	Red	5	Green	9	Orange	13	Red + ring	17	Green + ring	21	Orange + ring
2	Natural	6	Violet	10	Turquoise	14	Natural + ring	18	Violet + ring	22	Turquoise + ring
3	Yellow	7	Brown	11	Pink	15	Yellow + ring	19	Brown + ring	23	Pink + ring
4	Blue	8	Black	12	White	16	Blue + ring	20	Grey + ring	24	White + ring

**Universal Central Loose Tube Cable
with Fiber Reinforced Plastic Armor, Single Jacket**

GUFN, GUFB

A/I-DQBH



Applications

- For outdoor and indoor use in structured (data) wiring systems such as industrial backbone, campus backbone, building backbone (riser) and/or horizontal cabling
- For outdoor and indoor use in networks for industrial, telecom, cable TV and/or broadcast
- Easy to install in ducts, tunnels and trenches by means of compressed air or pulling wire
- Suitable for direct burial

Features & Benefits

- Available in sizes from 4 to 24 fibers
- Jelly filled (non-dripping and silicon-free) loose tube with primary coated optical fibers (Ø 250 ± 15 µm)
- High mechanical and full rodent protection provided by Fiber Reinforced Plastic (FRP) armor
- These cables are all dielectric and therefore immune to lightning and electromagnetic interference (EMC-safe), spark-free and require no grounding
- Halogen Free jacket
- Length marking in meters for easy determination of the cable length

Cross Section

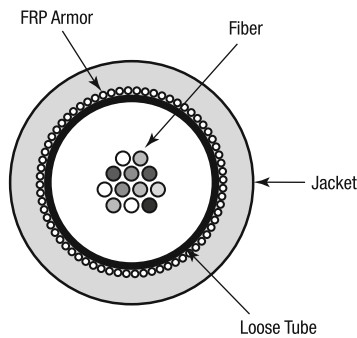

Specifications

IEC 60794-1-2	
Min. Bend Radius installation (E6):	20 x Ø
Min. Bend Radius operation (E11):	20 x Ø
Temperature Range (F1):	
– Transport/Storage	-30 °C to +70 °C
– Installation	-5 °C to +50 °C
– Operation	-30 °C to +70 °C
Watertightness (F5):	Pass
Other	
Flame Retardant:	
– GUFN	IEC 60332-1
– GUFB	IEC 60332-3-24
Halogen Free:	IEC 60754-1
Non Corrosive:	IEC 60754-2
Smoke Density:	IEC 61034-2

Characteristics

Loose Tube	Fiber Count	Diameter (mm)	FRP Diameter (mm)	Weight (kg/km)	Crush Resistance (kN/m)	Tensile Strength (short term) N	Tensile Strength (permanent) N	Fire Load (kJ/m)
IEC 60794-1-2						E1	E1	
GUFN*xx	4 to 24	7.4	1.0	62	45	3250	1100	1030
GUFB*xx	4 to 24	9.0	1.0	110	50	4000	1300	1370

Ordering Information

Fiber Type/Count	4	6	8	12	16	24
GUFN						
62.5/125-OM1	GUFN104	GUFN106	GUFN108	GUFN112	GUFN116	GUFN124
50/125-OM2	GUFN204	GUFN206	GUFN208	GUFN212	GUFN216	GUFN224
50/125-OM3	GUFND04	GUFND06	GUFND08	GUFND12	GUFND16	GUFND24
50/125-OM4	GUFNE04	GUFNE06	GUFNE08	GUFNE12	GUFNE16	GUFNE24
9/125 ITU G.652D	GUFN804	GUFN806	GUFN808	GUFN812	GUFN816	GUFN824
9/125 ITU G.655 C & D	GUFN704	GUFN706	GUFN708	GUFN712	GUFN716	GUFN724
Std. plywood reel (non-returnable)	Ø 1000 x 588 mm, Weight 50.0 kg					
Std. delivery length	2100 ± 100 m					
GUFB						
62.5/125-OM1	GUFB104	GUFB106	GUFB108	GUFB112	GUFB116	GUFB124
50/125-OM2	GUFB204	GUFB206	GUFB208	GUFB212	GUFB216	GUFB224
50/125-OM3	GUFBD04	GUFBD06	GUFBD08	GUFBD12	GUFBD16	GUFBD24
50/125-OM4	GUFBE04	GUFBE06	GUFBE08	GUFBE12	GUFBE16	GUFBE24
9/125 ITU G.652D	GUFB804	GUFB806	GUFB808	GUFB812	GUFB816	GUFB824
9/125 ITU G.655 C & D	GUFB704	GUFB706	GUFB708	GUFB712	GUFB716	GUFB724
Std. plywood reel (non-returnable)	Ø 1250 x 688 mm, Weight 93.0 kg					
Std. delivery length	2100 ± 100 m					

Fiber Color Coding

No.		No.		No.		No.		No.		No.	
1	Red	5	Green	9	Orange	13	Red + ring	17	Green + ring	21	Orange + ring
2	Natural	6	Violet	10	Turquoise	14	Natural + ring	18	Violet + ring	22	Turquoise + ring
3	Yellow	7	Brown	11	Pink	15	Yellow + ring	19	Brown + ring	23	Pink + ring
4	Blue	8	Black	12	White	16	Blue + ring	20	Grey + ring	24	White + ring

Outdoor Central Loose Tube Cable with Fiber Reinforced Plastic Armor, Single Jacket

GOFN, GOFB

A-DQB2Y



Applications

- For outdoor and indoor use in structured (data) wiring systems such as industrial backbone, campus backbone, building backbone (riser) and/or horizontal cabling
- For outdoor and indoor use in networks for industrial, telecom, cable TV and/or broadcast
- Easy to install in ducts, tunnels and trenches by means of compressed air or pulling wire
- Suitable for direct burial

Features & Benefits

- Available in sizes from 4 to 24 fibers
- Jelly filled (non-dripping and silicon-free) loose tube with primary coated optical fibers ($\text{Ø } 250 \pm 15 \mu\text{m}$)
- High mechanical and full rodent protection provided by Fiber Reinforced Plastic (FRP) armor
- Polyethylene jacket
- Length marking in meters for easy determination of the cable length

Cross Section

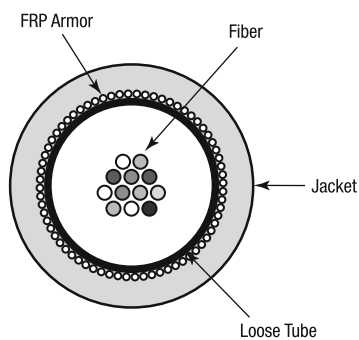

Specifications

IEC 60794-1-2	
Min. Bend Radius installation (E6):	20 x Ø
Min. Bend Radius operation (E11):	20 x Ø
Temperature Range (F1):	
– Transport/Storage	-30 °C to +70 °C
– Installation	-5 °C to +50 °C
– Operation	-30 °C to +70 °C
Watertightness (F5):	Pass

Characteristics

Loose Tube	Fiber Count	Diameter (mm)	FRP Diameter (mm)	Weight (kg/km)	Crush Resistance (kN/m)	Tensile Strength (short term) N	Tensile Strength (permanent) N	Fire Load (kJ/m)
IEC 60794-1-2						E1	E1	
GOFN*xx	4 to 24	7.4	1.0	51	45	3250	1100	1430
GOFB*xx	4 to 24	9.0	1.0	76	50	4000	1300	2410

Ordering Information

Fiber Type/Count	4	6	8	12	16	24
GOFN						
62.5/125-OM1	GOFN104	GOFN106	GOFN108	GOFN112	GOFN116	GOFN124
50/125-OM2	GOFN204	GOFN206	GOFN208	GOFN212	GOFN216	GOFN224
50/125-OM3	GOFND04	GOFND06	GOFND08	GOFND12	GOFND16	GOFND24
50/125-OM4	GOFNE04	GOFNE06	GOFNE08	GOFNE12	GOFNE16	GOFNE24
9/125 ITU G.652D	GOFN804	GOFN806	GOFN808	GOFN812	GOFN816	GOFN824
9/125 ITU G.655 C & D	GOFN704	GOFN706	GOFN708	GOFN712	GOFN716	GOFN724
Std. plywood reel (non-returnable)	Ø 1000 x 588 mm, Weight 50.0 kg					
Std. delivery length	2100 ± 100 m					
GOFB						
62.5/125-OM1	GOFB104	GOFB106	GOFB108	GOFB112	GOFB116	GOFB124
50/125-OM2	GOFB204	GOFB206	GOFB208	GOFB212	GOFB216	GOFB224
50/125-OM3	GOFBD04	GOFBD06	GOFBD08	GOFBD12	GOFBD16	GOFBD24
50/125-OM4	GOFBE04	GOFBE06	GOFBE08	GOFBE12	GOFBE16	GOFBE24
9/125 ITU G.652D	GOFB804	GOFB806	GOFB808	GOFB812	GOFB816	GOFB824
9/125 ITU G.655 C & D	GOFB704	GOFB706	GOFB708	GOFB712	GOFB716	GOFB724
Std. plywood reel (non-returnable)	Ø 1250 x 688 mm, Weight 93.0 kg					
Std. delivery length	2100 ± 100 m					

Fiber Color Coding

No.		No.		No.		No.		No.		No.	
1	Red	5	Green	9	Orange	13	Red + ring	17	Green + ring	21	Orange + ring
2	Natural	6	Violet	10	Turquoise	14	Natural + ring	18	Violet + ring	22	Turquoise + ring
3	Yellow	7	Brown	11	Pink	15	Yellow + ring	19	Brown + ring	23	Pink + ring
4	Blue	8	Black	12	White	16	Blue + ring	20	Grey + ring	24	White + ring

Universal Multi Loose Tube Cable with Rodent Protection, Single Jacket

GCRG, GCRD, GCRE, GCRF

A/I-DQ(ZN)BH



Applications

- For outdoor and indoor use in structured (data) wiring systems such as campus backbone
- For outdoor and indoor use in networks for telecom, cable TV and/or broadcast
- Easy to install in ducts, tunnels and trenches by means of compressed air or pulling wire
- Suitable for direct burial

Features & Benefits

- Available in sizes from 2 to 144 fibers
- Jelly filled (non-dripping and silicon-free) loose tubes with primary coated optical fibers ($\varnothing 250 \pm 15 \mu\text{m}$)
- Full dielectric construction, no grounding required
- Installation-friendly thanks to the cable core which is kept free of grease (dry interstices)
- Rodent protected by means of Glass Yarn Strength Elements
- Halogen Free jacket
- Length marking in meters for easy determination of the cable length

Cross Section

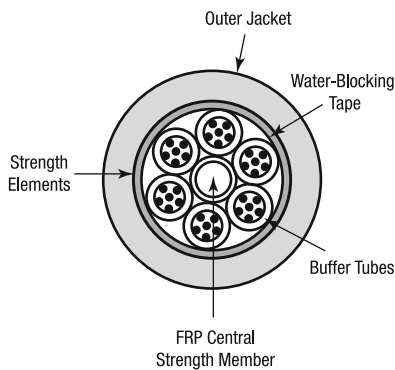

Specifications

IEC 60794-1-2	
Crush Resistance (E3):	15 kN/m
Min. Bend Radius installation (E6):	20 x \varnothing
Min. Bend Radius operation (E11):	20 x \varnothing
Temperature Range (F1):	
- Transport/Storage	-30 °C to +70 °C
- Installation	-5 °C to +50 °C
- Operation	-30 °C to +70 °C
Watertightness (F5):	Pass
Other	
Flame Retardant:	IEC 60332-3-24
Halogen Free:	IEC 60754-1
Non Corrosive:	IEC 60754-2
Smoke Density:	IEC 61034-2

Characteristics

Loose Tube	Fiber Count	Diameter Tube (mm)	Max. Fibers per Tube	Watertightness in Core	Diameter (mm)	Weight (kg/km)	Tensile Strength (short term) N	Tensile Strength (permanent) N	Fire Load (kJ/m)
IEC 60794-1-2							E1	E1	
GCRG*xx	6 to 36	1.9	6	Dry	11.8	159	6000	2000	2500
GCRD*xx	12 to 72	2.5	12	Dry	13.7	169	6600	2200	3000
GCRE*xx	84 to 96	2.5	12	Dry	15.3	215	8000	2650	3200
GCRF*xx	108 to 144	2.5	12	Dry	18.5	276	8000	3200	5900

Ordering Information

Fiber Type/Count	Dry Core				
	6	12	18	24	36
62.5/125-OM1	GCRG106	GCRG112	GCRG118	GCRG124	GCRG136
50/125-OM2	GCRG206	GCRG212	GCRG218	GCRG224	GCRG236
50/125-OM3	GCRGD06	GCRGD12	GCRGD18	GCRGD24	GCRGD36
50/125-OM4	GCRGE06	GCRGE12	GCRGE18	GCRGE24	GCRGE36
9/125 ITU G.652D	GCRG806	GCRG812	GCRG818	GCRG824	GCRG836
9/125 ITU G.655 C & D	GCRG706	GCRG712	GCRG718	GCRG724	GCRG736
Std. plywood reel (non-returnable)	Ø 1250 x 688 mm, Weight 93.0 kg				
Std. delivery length	2100 ± 100 m				

Fiber Type/Count	Dry Core					
	12	24	36	48	60	72
62.5/125-OM1	GCRD112	GCRD124	GCRD136	GCRD148	GCRD160	GCRD172
50/125-OM2	GCRD212	GCRD224	GCRD236	GCRD248	GCRD260	GCRD272
50/125-OM3	GCRDD12	GCRDD24	GCRDD36	GCRDD48	GCRDD60	GCRDD72
50/125-OM4	GCRDE12	GCRDE24	GCRDE36	GCRDE48	GCRDE60	GCRDE72
9/125 ITU G.652D	GCRD812	GCRD824	GCRD836	GCRD848	GCRD860	GCRD872
9/125 ITU G.655 C & D	GCRD712	GCRD724	GCRD736	GCRD748	GCRD760	GCRD772
Std. plywood reel (non-returnable)	Ø 1250 x 688 mm, Weight 93.0 kg					
Std. delivery length	2100 ± 100 m					

Ordering Information

Fiber Type/Count	Dry Core	
	96	144
62.5/125-OM1	GCRE196	GCRE144
50/125-OM2	GCRE296	GCRE244
50/125-OM3	GCRE96	GCRFD44
50/125-OM4	GCREE96	GCRFE44
9/125 ITU G.652D	GCRE896	GCRF844
9/125 ITU G.655 C & D	GCRE796	GCRF744
Std. plywood reel (non-returnable)	Ø 1400 x 900 mm, Weight 120.0 kg	
Std. delivery length	2100 ± 100 m	

Fiber Color Coding

No.		No.		No.	
1	Red	11	White	21	Grey + ring
2	Green	12	Aqua	22	Brown + ring
3	Blue	13	Red + ring	23	White + ring
4	Yellow	14	Green + ring	24	Aqua + ring
5	Violet	15	Blue + ring		
6	Pink	16	Yellow + ring		
7	Orange	17	Violet + ring		
8	Black	18	Pink + ring		
9	Grey	19	Orange + ring		
10	Brown	20	Black + ring		

Tube Color Coding	
No.	
1	Red
2	Green
3 to 12	White

Outdoor Multi Loose Tube Cable with Rodent Protection, Single Jacket

GBRG, GBRD, GBRE, GBRF
GDRG, GDRD, GDRE, GDRF

A-DQ(ZN)B2Y
A-DF(ZN)B2Y



Applications

- For outdoor and indoor use in structured (data) wiring systems such as campus backbone
- For outdoor and indoor use in networks for telecom, cable TV and/or broadcast
- Easy to install in ducts, tunnels and trenches by means of compressed air or pulling wire
- Suitable for direct burial

Features & Benefits

- Available in sizes from 2 to 144 fibers
- Jelly filled (non-dripping and silicon-free) loose tubes with primary coated optical fibers ($\varnothing 250 \pm 15 \mu\text{m}$)
- Full dielectric construction, no grounding required
- Installation-friendly thanks to the cable core which is kept free of grease (dry interstices) for GBR types
- Rodent protected by means of Glass Yarn Strength Elements
- Polyethylene jacket
- Length marking in meters for easy determination of the cable length

Specifications

IEC 60794-1-2	
Crush Resistance (E3):	15 kN/m
Min. Bend Radius installation (E6):	20 x \varnothing
Min. Bend Radius operation (E11):	20 x \varnothing
Temperature Range (F1):	
- Transport/Storage	-30 °C to +70 °C
- Installation	-5 °C to +50 °C
- Operation	-30 °C to +70 °C
Watertightness (F5):	Pass

Cross Section

GBR

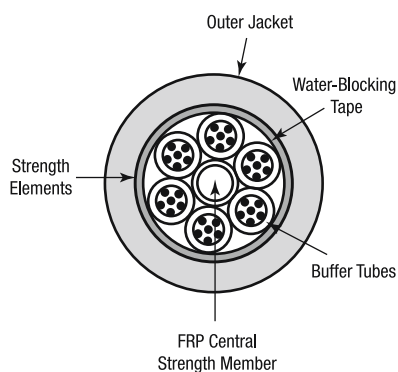

GDR

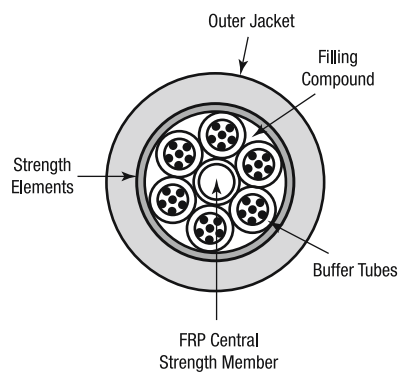

Characteristics

Loose Tube	Fiber Count	Diameter Tube (mm)	Max. Fibers per Tube	Watertightness in Core	Diameter (mm)	Weight (kg/km)	Tensile Strength (short term) N	Tensile Strength (permanent) N	Fire Load (kJ/m)
IEC 60794-1-2							E1	E1	
GBRG*xx	6 to 36	1.9	6	Dry	11.8	105	6000	2000	3200
GDRG*xx	6 to 36	1.9	6	Filled	11.8	107	6000	2000	3600
GBRD*xx	12 to 72	2.5	12	Dry	13.7	145	6600	2200	4600
GDRD*xx	12 to 72	2.5	12	Filled	13.7	147	6600	2200	5000
GBRE*xx	84 to 96	2.5	12	Dry	15.3	170	8000	2650	4900
GDRE*xx	84 to 96	2.5	12	Filled	15.3	174	8000	2650	5500
GBRF*xx	108 to 144	2.5	12	Dry	18.5	248	8000	3200	7700
GDRF*xx	108 to 144	2.5	12	Filled	18.5	254	8000	2670	8600

Ordering Information

Fiber Type/Count	Dry Core					Filled Core				
	6	12	18	24	36	6	12	18	24	36
62.5/125-OM1	GBRG106	GBRG112	GBRG118	GBRG124	GBRG136	GDRG106	GDRG112	GDRG118	GDRG124	GDRG136
50/125-OM2	GBRG206	GBRG212	GBRG218	GBRG224	GBRG236	GDRG206	GDRG212	GDRG218	GDRG224	GDRG236
50/125-OM3	GBRGD06	GBRGD12	GBRGD18	GBRGD24	GBRGD36	GDRGD06	GDRGD12	GDRGD18	GDRGD24	GDRGD36
50/125-OM4	GBRGE06	GBRGE12	GBRGE18	GBRGE24	GBRGE36	GDRGE06	GDRGE12	GDRGE18	GDRGE24	GDRGE36
9/125 ITU G.652D	GBRG806	GBRG812	GBRG818	GBRG824	GBRG836	GDRG806	GDRG812	GDRG818	GDRG824	GDRG836
9/125 ITU G.655 C & D	GBRG706	GBRG712	GBRG718	GBRG724	GBRG736	GDRG706	GDRG712	GDRG718	GDRG724	GDRG736
Std. plywood reel (non-returnable)	Ø 1250 x 688 mm, Weight 93.0 kg					Ø 1250 x 688 mm, Weight 93.0 kg				
Std. delivery length	2100 ± 100 m					2100 ± 100 m				

Fiber Type/Count	Dry Core						Filled Core					
	12	24	36	48	60	72	12	24	36	48	60	72
62.5/125-OM1	GBRD112	GBRD124	GBRD136	GBRD148	GBRD160	GBRD172	GDRD112	GDRD124	GDRD136	GDRD148	GDRD160	GDRD172
50/125-OM2	GBRD212	GBRD224	GBRD236	GBRD248	GBRD260	GBRD272	GDRD212	GDRD224	GDRD236	GDRD248	GDRD260	GDRD272
50/125-OM3	GBRDD12	GBRDD24	GBRDD36	GBRDD48	GBRDD60	GBRDD72	GDRDD12	GDRDD24	GDRDD36	GDRDD48	GDRDD60	GDRDD72
50/125-OM4	GBRDE12	GBRDE24	GBRDE36	GBRDE48	GBRDE60	GBRDE72	GDRDE12	GDRDE24	GDRDE36	GDRDE48	GDRDE60	GDRDE72
9/125 ITU G.652D	GBRD812	GBRD824	GBRD836	GBRD848	GBRD860	GBRD872	GDRD812	GDRD824	GDRD836	GDRD848	GDRD860	GDRD872
9/125 ITU G.655 C & D	GBRD712	GBRD724	GBRD736	GBRD748	GBRD760	GBRD772	GDRD712	GDRD724	GDRD736	GDRD748	GDRD760	GDRD772
Std. plywood reel (non-returnable)	Ø 1250 x 688 mm, Weight 93.0 kg						Ø 1250 x 688 mm, Weight 93.0 kg					
Std. delivery length	2100 ± 100 m						2100 ± 100 m					

Ordering Information

Fiber Type/Count	Dry Core		Filled Core	
	96	144	96	144
62.5/125-OM1	GBRE196	GBRF144	GDRE196	GDRF144
50/125-OM2	GBRE296	GBRF244	GDRE296	GDRF244
50/125-OM3	GBRED96	GBRFD44	GDRED96	GDRFD44
50/125-OM4	GBREE96	GBRFE44	GDREE96	GDRFE44
9/125 ITU G.652D	GBRE896	GBRF844	GDRE896	GDRF844
9/125 ITU G.655 C & D	GBRE796	GBRF744	GDRE796	GDRF744
Std. plywood reel (non-returnable)	Ø 1400 x 900 mm, Weight 120.0 kg			
Std. delivery length	2100 ± 100 m			

Fiber Color Coding

No.		No.		No.	
1	Red	11	White	21	Grey + ring
2	Green	12	Aqua	22	Brown + ring
3	Blue	13	Red + ring	23	White + ring
4	Yellow	14	Green + ring	24	Aqua + ring
5	Violet	15	Blue + ring		
6	Pink	16	Yellow + ring		
7	Orange	17	Violet + ring		
8	Black	18	Pink + ring		
9	Grey	19	Orange + ring		
10	Brown	20	Black + ring		

Tube Color Coding

No.	
1	Red
2	Green
3 to 12	White

Universal Multi Loose Tube Cable with Corrugated Steel Tape, Single Jacket

GCCG, GCCD, GCCE, GCCF

A/I-DQ(ZN)(SR)H



Applications

- For outdoor and indoor use in structured (data) wiring systems such as (campus backbone)
- For outdoor and indoor use in networks for telecom, cable TV and/or broadcast
- Easy to install in ducts, tunnels and trenches by means of compressed air or pulling wire
- Suitable for direct burial

Features & Benefits

- Available in sizes from 2 to 144 fibers
- Jelly filled (non-dripping and silicon-free) loose tubes with primary coated optical fibers ($\varnothing 250 \pm 15 \mu\text{m}$)
- Installation-friendly thanks to the cable core which is kept free of grease (dry interstices)
- High mechanical and full rodent protection provided by Corrugated Steel Tape (CST) armor
- Halogen Free jacket
- Length marking in meters for easy determination of the cable length

Cross Section

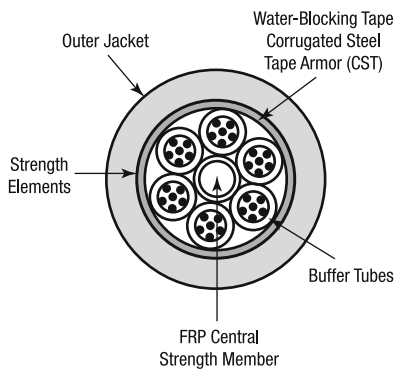

Specifications

IEC 60794-1-2	
Crush Resistance (E3):	22 kN/m
Min. Bend Radius installation (E6):	20 x \varnothing
Min. Bend Radius operation (E11):	20 x \varnothing
Temperature Range (F1):	
- Transport/Storage	-30 °C to +70 °C
- Installation	-5 °C to +50 °C
- Operation	-30 °C to +70 °C
Watertightness (F5):	Pass
Other	
Flame Retardant:	IEC 60332-3-22
Circuit Integrity:	IEC 60332-25, EN 50200
Halogen Free:	IEC 60754-1
Non Corrosive:	IEC 60754-2
Smoke Density:	IEC 61034-2

Characteristics

Loose Tube	Fiber Count	Diameter Tube (mm)	Max. Fibers per Tube	Watertightness in Core	Diameter (mm)	Weight (kg/km)	Tensile Strength (short term) N	Tensile Strength (permanent) N	Fire Load (kJ/m)
IEC 60794-1-2							E1	E1	
GCCG*xx	6 to 36	1.9	6	Dry	10.5	160	1750	580	2100
GCCD*xx	12 to 72	2.5	12	Dry	12.0	200	2400	800	2900
GCCE*xx	84 to 96	2.5	12	Dry	15.4	250	2500	830	3100
GCCF*xx	108 to 144	2.5	12	Dry	18.5	330	4000	1300	6000

Ordering Information

Fiber Type/Count	Dry Core				
	6	12	18	24	36
62.5/125-OM1	GCCG106	GCCG112	GCCG118	GCCG124	GCCG136
50/125-OM2	GCCG206	GCCG212	GCCG218	GCCG224	GCCG236
50/125-OM3	GCCGD06	GCCGD12	GCCGD18	GCCGD24	GCCGD36
50/125-OM4	GCCGE06	GCCGE12	GCCGE18	GCCGE24	GCCGE36
9/125 ITU G.652D	GCCG806	GCCG812	GCCG818	GCCG824	GCCG836
9/125 ITU G.655 C & D	GCCG706	GCCG712	GCCG718	GCCG724	GCCG736
Std. plywood reel (non-returnable)	Ø 1250 x 688 mm, Weight 93.0 kg				
Std. delivery length	2100 ± 100 m				

Fiber Type/Count	Dry Core					
	12	24	36	48	60	72
62.5/125-OM1	GCCD112	GCCD124	GCCD136	GCCD148	GCCD160	GCCD172
50/125-OM2	GCCD212	GCCD224	GCCD236	GCCD248	GCCD260	GCCD272
50/125-OM3	GCCDD12	GCCDD24	GCCDD36	GCCDD48	GCCDD60	GCCDD72
50/125-OM4	GCCDE12	GCCDE24	GCCDE36	GCCDE48	GCCDE60	GCCDE72
9/125 ITU G.652D	GCCD812	GCCD824	GCCD836	GCCD848	GCCD860	GCCD872
9/125 ITU G.655 C & D	GCCD712	GCCD724	GCCD736	GCCD748	GCCD760	GCCD772
Std. plywood reel (non-returnable)	Ø 1250 x 688 mm, Weight 93.0 kg					
Std. delivery length	2100 ± 100 m					

Ordering Information

Fiber Type/Count	Dry Core	
	96	144
62.5/125-OM1	GCCE196	GCCF144
50/125-OM2	GCCE296	GCCF244
50/125-OM3	GCCE996	GCCF444
50/125-OM4	GCCEE96	GCCFE44
9/125 ITU G.652D	GCCE896	GCCF844
9/125 ITU G.655 C & D	GCCE796	GCCF744
Std. plywood reel (non-returnable)	Ø 1400 x 900 mm, Weight 120.0 kg	
Std. delivery length	2100 ± 100 m	

Fiber Color Coding

No.		No.		No.	
1	Red	11	White	21	Grey + ring
2	Green	12	Aqua	22	Brown + ring
3	Blue	13	Red + ring	23	White + ring
4	Yellow	14	Green + ring	24	Aqua + ring
5	Violet	15	Blue + ring		
6	Pink	16	Yellow + ring		
7	Orange	17	Violet + ring		
8	Black	18	Pink + ring		
9	Grey	19	Orange + ring		
10	Brown	20	Black + ring		

Tube Color Coding	
No.	
1	Red
2	Green
3 to 12	White

Outdoor Multi Loose Tube Cable with Corrugated Steel Tape, Single Jacket

GBCG, GBCD, GBCE, GBCF
GDCG, GDCE, GDCE, GDCF

A-DQ(ZN)(SR)2Y
A-DF(ZN)(SR)2Y



Applications

- For outdoor and indoor use in structured (data) wiring systems such as campus backbone
- For outdoor and indoor use in networks for telecom, cable TV and/or broadcast
- Easy to install in ducts, tunnels and trenches by means of compressed air or pulling wire
- Suitable for direct burial

Features & Benefits

- Available in sizes from 2 to 144 fibers
- Jelly filled (non-dripping and silicon-free) loose tubes with primary coated optical fibers ($\varnothing 250 \pm 15 \mu\text{m}$)
- Installation-friendly thanks to the cable core which is kept free of grease (dry interstices) for GBC types
- High mechanical and full rodent protection provided by Corrugated Steel Tape (CST) armor
- Polyethylene jacket
- Length marking in meters for easy determination of the cable length

Specifications

IEC 60794-1-2

Crush Resistance (E3):	22 kN/m
Min. Bend Radius installation (E6):	20 x \varnothing
Min. Bend Radius operation (E11):	20 x \varnothing
Temperature Range (F1):	
- Transport/Storage	-30 °C to +70 °C
- Installation	-5 °C to +50 °C
- Operation	-30 °C to +70 °C
Watertightness (F5):	Pass

Cross Section

GBC

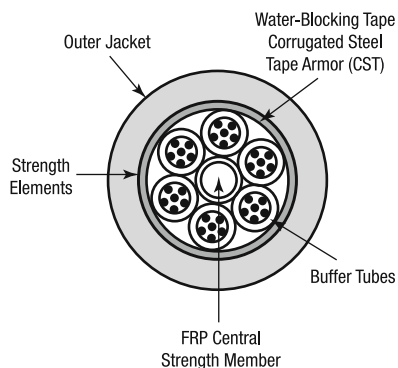

GDC

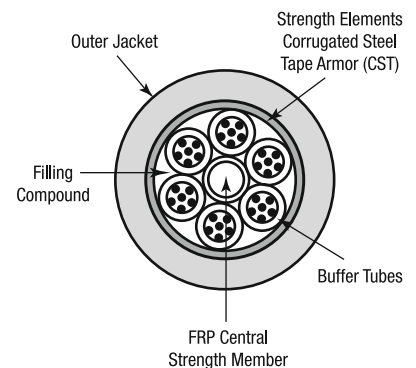

Characteristics

Loose Tube	Fiber Count	Diameter Tube (mm)	Max. Fibers per Tube	Watertightness in Core	Diameter (mm)	Weight (kg/km)	Tensile Strength (short term) N	Tensile Strength (permanent) N	Fire Load (kJ/m)
IEC 60794-1-2							E1	E1	
GBCG*xx	6 to 36	1.9	6	Dry	10.5	105	1750	550	3000
GDCG*xx	6 to 36	1.9	6	Filled	10.5	115	1750	580	3400
GBCD*xx	12 to 72	2.5	12	Dry	12.0	175	2400	800	4000
GDGD*xx	12 to 72	2.5	12	Filled	12.0	180	7000	800	4400
GBCE*xx	84 to 96	2.5	12	Dry	15.4	230	2500	830	4400
GDCE*xx	84 to 96	2.5	12	Filled	15.4	240	2500	830	4900
GBCF*xx	108 to 144	2.5	12	Dry	18.5	310	4000	1300	8000
GDCF*xx	108 to 144	2.5	12	Filled	18.5	325	4000	1300	8900

Ordering Information

Fiber Type/Count	Dry Core					Filled Core				
	6	12	18	24	36	6	12	18	24	36
62.5/125-OM1	GBCG106	GBCG112	GBCG118	GBCG124	GBCG136	GDCG106	GDCG112	GDCG118	GDCG124	GDCG136
50/125-OM2	GBCG206	GBCG212	GBCG218	GBCG224	GBCG236	GDCG206	GDCG212	GDCG218	GDCG224	GDCG236
50/125-OM3	GBCGD06	GBCGD12	GBCGD18	GBCGD24	GBCGD36	GDCGD06	GDCGD12	GDCGD18	GDCGD24	GDCGD36
50/125-OM4	GBCGE06	GBCGE12	GBCGE18	GBCGE24	GBCGE36	GDCGE06	GDCGE12	GDCGE18	GDCGE24	GDCGE36
9/125 ITU G.652D	GBCG806	GBCG812	GBCG818	GBCG824	GBCG836	GDCG806	GDCG812	GDCG818	GDCG824	GDCG836
9/125 ITU G.655 C & D	GBCG706	GBCG712	GBCG718	GBCG724	GBCG736	GDCG706	GDCG712	GDCG718	GDCG724	GDCG736
Std. plywood reel (non-returnable)	Ø 1250 x 688 mm, Weight 93.0 kg					Ø 1250 x 688 mm, Weight 93.0 kg				
Std. delivery length	2100 ± 100 m					2100 ± 100 m				

Fiber Type/Count	Dry Core						Filled Core					
	12	24	36	48	60	72	12	24	36	48	60	72
62.5/125-OM1	GBCD112	GBCD124	GBCD136	GBCD148	GBCD160	GBCD172	GDGD112	GDGD124	GDGD136	GDGD148	GDGD160	GDGD172
50/125-OM2	GBCD212	GBCD224	GBCD236	GBCD248	GBCD260	GBCD272	GDGD212	GDGD224	GDGD236	GDGD248	GDGD260	GDGD272
50/125-OM3	GBDD12	GBDD24	GBDD36	GBDD48	GBDD60	GBDD72	GDGD12	GDGD24	GDGD36	GDGD48	GDGD60	GDGD72
50/125-OM4	GBCE12	GBCE24	GBCE36	GBCE48	GBCE60	GBCE72	GDCE12	GDCE24	GDCE36	GDCE48	GDCE60	GDCE72
9/125 ITU G.652D	GBCD812	GBCD824	GBCD836	GBCD848	GBCD860	GBCD872	GDGD812	GDGD824	GDGD836	GDGD848	GDGD860	GDGD872
9/125 ITU G.655 C & D	GBCD712	GBCD724	GBCD736	GBCD748	GBCD760	GBCD772	GDGD712	GDGD724	GDGD736	GDGD748	GDGD760	GDGD772
Std. plywood reel (non-returnable)	Ø 1250 x 688 mm, Weight 93.0 kg						Ø 1250 x 688 mm, Weight 93.0 kg					
Std. delivery length	2100 ± 100 m						2100 ± 100 m					

Ordering Information

Fiber Type/Count	Dry Core		Filled Core	
	96	144	96	144
62.5/125-OM1	GBCE196	GBCF144	GDCE196	GDCF144
50/125-OM2	GBCE296	GBCF244	GDCE296	GDCF244
50/125-OM3	GBCED96	GBCFD44	GDCE96	GDCF44
50/125-OM4	GBCEE96	GBCFE44	GDCEE96	GDCF44
9/125 ITU G.652D	GBCE896	GBCF844	GDCE896	GDCF844
9/125 ITU G.655 C & D	GBCE796	GBCF744	GDCE796	GDCF744
Std. plywood reel (non-returnable)	Ø 1400 x 900 mm, Weight 120.0 kg			
Std. delivery length	2100 ± 100 m			

Fiber Color Coding

No.		No.		No.	
1	Red	11	White	21	Grey + ring
2	Green	12	Aqua	22	Brown + ring
3	Blue	13	Red + ring	23	White + ring
4	Yellow	14	Green + ring	24	Aqua + ring
5	Violet	15	Blue + ring		
6	Pink	16	Yellow + ring		
7	Orange	17	Violet + ring		
8	Black	18	Pink + ring		
9	Grey	19	Orange + ring		
10	Brown	20	Black + ring		

Tube Color Coding	
No.	
1	Red
2	Green
3 to 12	White

Universal Multi Loose Tube Cable with Corrugated Steel Tape, Double Jacket

GCDG, GCDD, GCDE, GCDF

A/I-DQ(ZN)H(SR)H



Applications

- For outdoor and indoor use in structured (data) wiring systems such as campus backbone
- For outdoor and indoor use in networks for telecom, cable TV and/or broadcast
- Easy to install in ducts, tunnels and trenches by means of compressed air or pulling wire
- Suitable for direct burial

Features & Benefits

- Available in sizes from 2 to 144 fibers
- Jelly filled (non-dripping and silicon-free) loose tubes with primary coated optical fibers ($\varnothing 250 \pm 15 \mu\text{m}$)
- Installation-friendly thanks to the cable core which is kept free of grease (dry interstices)
- High mechanical and full rodent protection provided by Corrugated Steel Tape (CST) armor
- Halogen Free jacket
- Length marking in meters for easy determination of the cable length

Cross Section

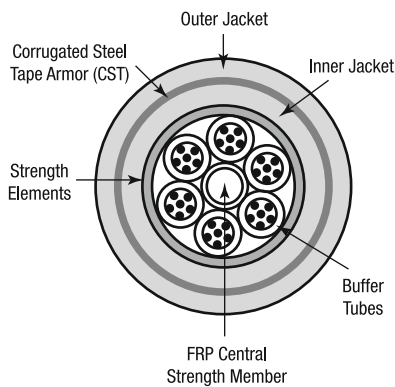

Specifications

IEC 60794-1-2	
Crush Resistance (E3):	22 kN/m
Min. Bend Radius installation (E6):	20 x \varnothing
Min. Bend Radius operation (E11):	20 x \varnothing
Temperature Range (F1):	
- Transport/Storage	-30 °C to +70 °C
- Installation	-5 °C to +50 °C
- Operation	-30 °C to +70 °C
Watertightness (F5):	Pass
Other	
Flame Retardant:	IEC 60332-3-22
Circuit Integrity:	EN 50200
Halogen Free:	IEC 60754-1
Non Corrosive:	IEC 60754-2
Smoke Density:	IEC 61034-2

Characteristics

Loose Tube	Fiber Count	Diameter Tube (mm)	Max. Fibers per Tube	Watertightness in Core	Diameter (mm)	Weight (kg/km)	Tensile Strength (short term) N	Tensile Strength (permanent) N	Fire Load (kJ/m)
IEC 60794-1-2							E1	E1	
GCDG*xx	6 to 36	1.9	6	Dry	13.2	195	1750	580	2800
GCDD*xx	12 to 72	2.5	12	Dry	15.2	280	2300	750	3900
GCDE*xx	84 to 96	2.5	12	Dry	17.4	340	2900	950	4700
GCDF*xx	108 to 144	2.5	12	Dry	20.5	430	3450	1150	7300

Ordering Information

Fiber Type/Count	Dry Core				
	6	12	18	24	36
62.5/125-OM1	GCDG106	GCDG112	GCDG118	GCDG124	GCDG136
50/125-OM2	GCDG206	GCDG212	GCDG218	GCDG224	GCDG236
50/125-OM3	GCDGD06	GCDGD12	GCDGD18	GCDGD24	GCDGD36
50/125-OM4	GCDGE06	GCDGE12	GCDGE18	GCDGE24	GCDGE36
9/125 ITU G.652D	GCDG806	GCDG812	GCDG818	GCDG824	GCDG836
9/125 ITU G.655 C & D	GCDG706	GCDG712	GCDG718	GCDG724	GCDG736
Std. plywood reel (non-returnable)	Ø 1250 x 688 mm, Weight 93.0 kg				
Std. delivery length	2100 ± 100 m				

Fiber Type/Count	Dry Core					
	12	24	36	48	60	72
62.5/125-OM1	GCDD112	GCDD124	GCDD136	GCDD148	GCDD160	GCDD172
50/125-OM2	GCDD212	GCDD224	GCDD236	GCDD248	GCDD260	GCDD272
50/125-OM3	GCDDD12	GCDDD24	GCDDD36	GCDDD48	GCDDD60	GCDDD72
50/125-OM4	GCDD12	GCDD24	GCDD36	GCDD48	GCDD60	GCDD72
9/125 ITU G.652D	GCDD812	GCDD824	GCDD836	GCDD848	GCDD860	GCDD872
9/125 ITU G.655 C & D	GCDD712	GCDD724	GCDD736	GCDD748	GCDD760	GCDD772
Std. plywood reel (non-returnable)	Ø 1250 x 688 mm, Weight 93.0 kg					
Std. delivery length	2100 ± 100 m					

Ordering Information

Fiber Type/Count	Dry Core	
	96	144
62.5/125-OM1	GCDE196	GCDF144
50/125-OM2	GCDE296	GCDF244
50/125-OM3	GCDED96	GCDFD44
50/125-OM4	GCDEE96	GCDFE44
9/125 ITU G.652D	GCDE896	GCDF844
9/125 ITU G.655 C & D	GCDE796	GCDF744
Std. plywood reel (non-returnable)	Ø 1400 x 900 mm, Weight 120.0 kg	
Std. delivery length	2100 ± 100 m	

Fiber Color Coding

No.		No.		No.	
1	Red	11	White	21	Grey + ring
2	Green	12	Aqua	22	Brown + ring
3	Blue	13	Red + ring	23	White + ring
4	Yellow	14	Green + ring	24	Aqua + ring
5	Violet	15	Blue + ring		
6	Pink	16	Yellow + ring		
7	Orange	17	Violet + ring		
8	Black	18	Pink + ring		
9	Grey	19	Orange + ring		
10	Brown	20	Black + ring		

Tube Color Coding

No.	
1	Red
2	Green
3 to 12	White

Outdoor Multi Loose Tube Cable with Corrugated Steel Tape, Double Jacket

GBDG, GBDD, GBDE, GBDF
GDDG, GDDD, GDDE, GDDF

A-DQ(ZN)2Y(SR)2Y
A-DF(ZN)2Y(SR)2Y



Applications

- For outdoor and indoor use in structured (data) wiring systems such as campus backbone
- For outdoor and indoor use in networks for telecom, cable TV and/or broadcast
- Easy to install in ducts, tunnels and trenches by means of compressed air or pulling wire
- Suitable for direct burial

Features & Benefits

- Available in sizes from 2 to 144 fibers
- Jelly filled (non-dripping and silicon-free) loose tubes with primary coated optical fibers ($\varnothing 250 \pm 15 \mu\text{m}$)
- Installation-friendly thanks to the cable core which is kept free of grease (dry interstices) for GBD types
- High mechanical and full rodent protection provided by Corrugated Steel Tape (CST) armor
- Polyethylene jacket
- Length marking in meters for easy determination of the cable length

Specifications

IEC 60794-1-2

Crush Resistance (E3):	22 kN/m
Min. Bend Radius installation (E6):	20 x \varnothing
Min. Bend Radius operation (E11):	20 x \varnothing
Temperature Range (F1):	
- Transport/Storage	-30 °C to +70 °C
- Installation	-5 °C to +50 °C
- Operation	-30 °C to +70 °C
Watertightness (F5):	Pass

Cross Section

GBD

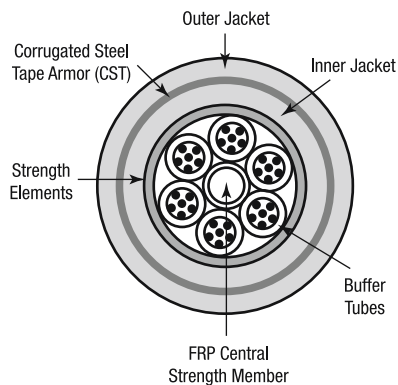

GDD

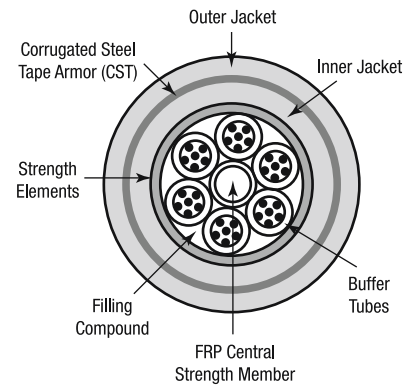

Characteristics

Tight Buffer	Fiber Count	Diameter Tube (mm)	Max. Fibers per Tube	Watertightness in Core	Diameter (mm)	Weight (kg/km)	Tensile Strength (short term) N	Tensile Strength (permanent) N	Fire Load (kJ/m)
IEC 60794-1-2							E1	E1	
GBDG*xx	6 to 36	1.9	6	Dry	13.2	155	1750	550	4700
GDDG*xx	6 to 36	1.9	6	Filled	13.0	160	1750	580	4900
GBDD*xx	12 to 72	2.5	12	Dry	15.2	200	2300	750	6100
GDDD*xx	12 to 72	2.5	12	Filled	15.0	205	2300	750	6500
GBDE*xx	84 to 96	2.5	12	Dry	17.4	310	2900	950	7600
GDDE*xx	84 to 96	2.5	12	Filled	17.1	285	2900	950	8100
GBDF*xx	108 to 144	2.5	12	Dry	20.5	310	3450	1150	8000
GDDF*xx	108 to 144	2.5	12	Filled	20.5	377	3450	1150	11400

Ordering Information

Fiber Type/Count	Dry Core					Filled Core				
	6	12	18	24	36	6	12	18	24	36
62.5/125-OM1	GBDG106	GBDG112	GBDG118	GBDG124	GBDG136	GDDG106	GDDG112	GDDG118	GDDG124	GDDG136
50/125-OM2	GBDG206	GBDG212	GBDG218	GBDG224	GBDG236	GDDG206	GDDG212	GDDG218	GDDG224	GDDG236
50/125-OM3	GBDGD06	GBDGD12	GBDGD18	GBDGD24	GBDGD36	GDDGD06	GDDGD12	GDDGD18	GDDGD24	GDDGD36
50/125-OM4	GBDGE06	GBDGE12	GBDGE18	GBDGE24	GBDGE36	GDDGE06	GDDGE12	GDDGE18	GDDGE24	GDDGE36
9/125 ITU G.652D	GBDG806	GBDG812	GBDG818	GBDG824	GBDG836	GDDG806	GDDG812	GDDG818	GDDG824	GDDG836
9/125 ITU G.655 C & D	GBDG706	GBDG712	GBDG718	GBDG724	GBDG736	GDDG706	GDDG712	GDDG718	GDDG724	GDDG736
Std. plywood reel (non-returnable)	Ø 1250 x 688 mm, Weight 93.0 kg					Ø 1250 x 688 mm, Weight 93.0 kg				
Std. delivery length	2100 ± 100 m					2100 ± 100 m				

Fiber Type/Count	Dry Core						Filled Core					
	12	24	36	48	60	72	12	24	36	48	60	72
62.5/125-OM1	GBDD112	GBDD124	GBDD136	GBDD148	GBDD160	GBDD172	GDDD112	GDDD124	GDDD136	GDDD148	GDDD160	GDDD172
50/125-OM2	GBDD212	GBDD224	GBDD236	GBDD248	GBDD260	GBDD272	GDDD212	GDDD224	GDDD236	GDDD248	GDDD260	GDDD272
50/125-OM3	GBDDD12	GBDDD24	GBDDD36	GBDDD48	GBDDD60	GBDDD72	GDDDD12	GDDDD24	GDDDD36	GDDDD48	GDDDD60	GDDDD72
50/125-OM4	GBDDE12	GBDDE24	GBDDE36	GBDDE48	GBDDE60	GBDDE72	GDDDE12	GDDDE24	GDDDE36	GDDDE48	GDDDE60	GDDDE72
9/125 ITU G.652D	GBDD812	GBDD824	GBDD836	GBDD848	GBDD860	GBDD872	GDDD812	GDDD824	GDDD836	GDDD848	GDDD860	GDDD872
9/125 ITU G.655 C & D	GBDD712	GBDD724	GBDD736	GBDD748	GBDD760	GBDD772	GDDD712	GDDD724	GDDD736	GDDD748	GDDD760	GDDD772
Std. plywood reel (non-returnable)	Ø 1250 x 688 mm, Weight 93.0 kg						Ø 1250 x 688 mm, Weight 93.0 kg					
Std. delivery length	2100 ± 100 m						2100 ± 100 m					

Ordering Information

Fiber Type/Count	Dry Core		Filled Core	
	96	144	96	144
62.5/125-OM1	GBDE196	GBDF144	GDDE196	GDDF144
50/125-OM2	GBDE296	GBDF244	GDDE296	GDDF244
50/125-OM3	GBDED96	GBDFD44	GDDED96	GDDFD44
50/125-OM4	GBDEE96	GBDFE44	GDDEE96	GDDFE44
9/125 ITU G.652D	GBDE896	GBDF844	GDDE896	GDDF844
9/125 ITU G.655 C & D	GBDE796	GBDF744	GDDE796	GDDF744
Std. plywood reel (non-returnable)	Ø 1400 x 900 mm, Weight 120.0 kg			
Std. delivery length	2100 ± 100 m			

Fiber Color Coding

No.		No.		No.	
1	Red	11	White	21	Grey + ring
2	Green	12	Aqua	22	Brown + ring
3	Blue	13	Red + ring	23	White + ring
4	Yellow	14	Green + ring	24	Aqua + ring
5	Violet	15	Blue + ring		
6	Pink	16	Yellow + ring		
7	Orange	17	Violet + ring		
8	Black	18	Pink + ring		
9	Grey	19	Orange + ring		
10	Brown	20	Black + ring		

Tube Color Coding	
No.	
1	Red
2	Green
3 to 12	White

Universal Multi Loose Tube Cable with Steel Wire Armor, Double Jacket

GCWG, GCWD

A/I-DQ(ZN)HBH



Applications

- For outdoor and indoor use in structured (data) wiring systems such as campus backbone
- For outdoor and indoor use in networks for telecom, cable TV and/or broadcast
- Easy to install in ducts, tunnels and trenches by means of compressed air or pulling wire
- Suitable for direct burial

Features & Benefits

- Available in sizes from 2 to 144 fibers
- Jelly filled (non-dripping and silicon-free) loose tubes with primary coated optical fibers ($\varnothing 250 \pm 15 \mu\text{m}$)
- Installation-friendly thanks to the cable core which is kept free of grease (dry interstices)
- High mechanical and full rodent protection provided by Steel Wire Armor (SWA)
- Halogen Free jacket
- Length marking in meters for easy determination of the cable length

Cross Section

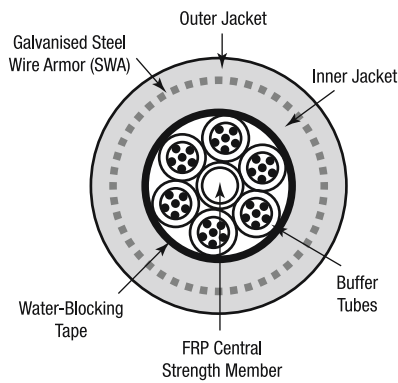

Specifications

IEC 60794-1-2	
Crush Resistance (E3):	22 kN/m
Min. Bend Radius installation (E6):	20 x \varnothing
Min. Bend Radius operation (E11):	20 x \varnothing
Temperature Range (F1):	
- Transport/Storage	-30 °C to +70 °C
- Installation	-5 °C to +50 °C
- Operation	-30 °C to +70 °C
Watertightness (F5):	Pass
Other	
Flame Retardant:	IEC 60332-3-22
Halogen Free:	IEC 60754-1
Non Corrosive:	IEC 60754-2
Smoke Density:	IEC 61034-2

Characteristics

Loose Tube	Fiber Count	Diameter Tube (mm)	Max. Fibers per Tube	Watertightness in Core	Steel Wire Diameter (mm)	Diameter (mm)	Weight (kg/km)	Tensile Strength (short term) N	Tensile Strength (permanent) N	Fire Load (kJ/m)
IEC 60794-1-2								E1	E1	
GCWG*xx	6 to 36	1.9	6	Dry	0.9	13.5	325	1750	580	3000
GCWD*xx	12 to 72	2.5	12	Dry	0.9	15.5	390	2300	750	4100

Ordering Information

Fiber Type/Count	Dry Core				
	6	12	18	24	36
62.5/125-OM1	GCWG106	GCWG112	GCWG118	GCWG124	GCWG136
50/125-OM2	GCWG206	GCWG212	GCWG218	GCWG224	GCWG236
50/125-OM3	GCWGD06	GCWGD12	GCWGD18	GCWGD24	GCWGD36
50/125-OM4	GCWGE06	GCWGE12	GCWGE18	GCWGE24	GCWGE36
9/125 ITU G.652D	GCWG806	GCWG812	GCWG818	GCWG824	GCWG836
9/125 ITU G.655 C & D	GCWG706	GCWG712	GCWG718	GCWG724	GCWG736
Std. plywood reel (non-returnable)	Ø 1250 x 688 mm, Weight 93.0 kg				
Std. delivery length	2100 ± 100 m				

Fiber Type/Count	Dry Core					
	12	24	36	48	60	72
62.5/125-OM1	GCWD112	GCWD124	GCWD136	GCWD148	GCWD160	GCWD172
50/125-OM2	GCWD212	GCWD224	GCWD236	GCWD248	GCWD260	GCWD272
50/125-OM3	GCWDD12	GCWDD24	GCWDD36	GCWDD48	GCWDD60	GCWDD72
50/125-OM4	GCWDE12	GCWDE24	GCWDE36	GCWDE48	GCWDE60	GCWDE72
9/125 ITU G.652D	GCWD812	GCWD824	GCWD836	GCWD848	GCWD860	GCWD872
9/125 ITU G.655 C & D	GCWD712	GCWD724	GCWD736	GCWD748	GCWD760	GCWD772
Std. plywood reel (non-returnable)	Ø 1250 x 688 mm, Weight 93.0 kg					
Std. delivery length	2100 ± 100 m					

Fiber Color Coding

No.	
1	Red
2	Green
3	Blue
4	Yellow
5	Violet

No.	
6	Pink
7	Orange
8	Black
9	Grey
10	Brown

No.	
11	White
12	Aqua
13	Red + ring
14	Green + ring
15	Blue + ring

No.	
16	Yellow + ring
17	Violet + ring
18	Pink + ring
19	Orange + ring
20	Black + ring

No.	
21	Grey + ring
22	Brown + ring
23	White + ring
24	Aqua + ring

Tube Color Coding

No.	
1	Red
2	Green
3 to 12	White

Outdoor Multi Loose Tube Cable with Steel Wire Armor, Double Jacket

GBWG, GBWD
GDWG, GDWD

A-DQ(ZN)2YB2Y
A-DF(ZN)2YB2Y



Applications

- For outdoor and indoor use in structured (data) wiring systems such as campus backbone
- For outdoor and indoor use in networks for telecom, cable TV and/or broadcast
- Easy to install in ducts, tunnels and trenches by means of compressed air or pulling wire
- Suitable for direct burial

Features & Benefits

- Available in sizes from 2 to 144 fibers
- Jelly filled (non-dripping and silicon-free) loose tubes with primary coated optical fibers ($\varnothing 250 \pm 15 \mu\text{m}$)
- Installation-friendly thanks to the cable core which is kept free of grease (dry interstices) for GBD types
- High mechanical and full rodent protection provided by Steel Wire Armor (SWA)
- Polyethylene jacket
- Length marking in meters for easy determination of the cable length

Specifications

IEC 60794-1-2

Crush Resistance (E3):	22 kN/m
Min. Bend Radius installation (E6):	20 x \varnothing
Min. Bend Radius operation (E11):	20 x \varnothing
Temperature Range (F1):	
- Transport/Storage	-30 °C to +70 °C
- Installation	-5 °C to +50 °C
- Operation	-30 °C to +70 °C
Watertightness (F5):	Pass

Cross Section

GBW

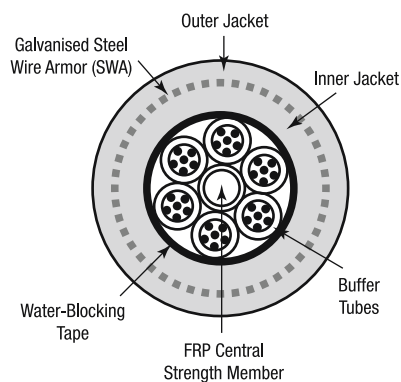

GDW

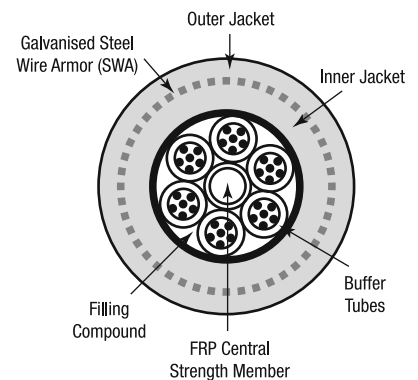

Characteristics

Loose Tube	Fiber Count	Diameter Tube (mm)	Max. Fibers per Tube	Watertightness in Core	Steel Wire Diameter (mm)	Diameter (mm)	Weight (kg/km)	Tensile Strength (short term) N	Tensile Strength (permanent) N	Fire Load (kJ/m)
IEC 60794-1-2								E1	E1	
GBWG*xx	6 to 36	1.9	6	Dry	0.9	13.5	255	1750	580	4900
GDWG*xx	6 to 36	1.9	6	Filled	0.9	13.5	260	1750	580	5100
GBWD*xx	12 to 72	2.5	12	Dry	0.9	15.5	300	2300	750	6300
GDWD*xx	12 to 72	2.5	12	Filled	0.9	15.5	320	2300	750	6700

Ordering Information

Fiber Type/Count	Dry Core					Filled Core				
	6	12	18	24	36	6	12	18	24	36
62.5/125-OM1	GBWG106	GBWG112	GBWG118	GBWG124	GBWG136	GDWG106	GDWG112	GDWG118	GDWG124	GDWG136
50/125-OM2	GBWG206	GBWG212	GBWG218	GBWG224	GBWG236	GDWG206	GDWG212	GDWG218	GDWG224	GDWG236
50/125-OM3	GBWGD06	GBWGD12	GBWGD18	GBWGD24	GBWGD36	GDWGD06	GDWGD12	GDWGD18	GDWGD24	GDWGD36
50/125-OM4	GBWGE06	GBWGE12	GBWGE18	GBWGE24	GBWGE36	GDWGE06	GDWGE12	GDWGE18	GDWGE24	GDWGE36
9/125 ITU G.652D	GBWG806	GBWG812	GBWG818	GBWG824	GBWG836	GDWG806	GDWG812	GDWG818	GDWG824	GDWG836
9/125 ITU G.655 C & D	GBWG706	GBWG712	GBWG718	GBWG724	GBWG736	GDWG706	GDWG712	GDWG718	GDWG724	GDWG736
Std. plywood reel (non-returnable)	Ø 1250 x 688 mm, Weight 93.0 kg					Ø 1250 x 688 mm, Weight 93.0 kg				
Std. delivery length	2100 ± 100 m					2100 ± 100 m				

Fiber Type/Count	Dry Core						Filled Core					
	12	24	36	48	60	72	12	24	36	48	60	72
62.5/125-OM1	GBWD112	GBWD124	GBWD136	GBWD148	GBWD160	GBWD172	GDWD112	GDWD124	GDWD136	GDWD148	GDWD160	GDWD172
50/125-OM2	GBWD212	GBWD224	GBWD236	GBWD248	GBWD260	GBWD272	GDWD212	GDWD224	GDWD236	GDWD248	GDWD260	GDWD272
50/125-OM3	GBWDD12	GBWDD24	GBWDD36	GBWDD48	GBWDD60	GBWDD72	GDWDD12	GDWDD24	GDWDD36	GDWDD48	GDWDD60	GDWDD72
50/125-OM4	GBWDE12	GBWDE24	GBWDE36	GBWDE48	GBWDE60	GBWDE72	GDWDE12	GDWDE24	GDWDE36	GDWDE48	GDWDE60	GDWDE72
9/125 ITU G.652D	GBWD812	GBWD824	GBWD836	GBWD848	GBWD860	GBWD872	GDWD812	GDWD824	GDWD836	GDWD848	GDWD860	GDWD872
9/125 ITU G.655 C & D	GBWD712	GBWD724	GBWD736	GBWD748	GBWD760	GBWD772	GDWD712	GDWD724	GDWD736	GDWD748	GDWD760	GDWD772
Std. plywood reel (non-returnable)	Ø 1250 x 688 mm, Weight 93.0 kg						Ø 1250 x 688 mm, Weight 93.0 kg					
Std. delivery length	2100 ± 100 m						2100 ± 100 m					

Fiber Color Coding

No.		No.		No.		No.		No.		No.		No.	
1	Red	6	Pink	11	White	16	Yellow + ring	21	Grey + ring	1	Red		
2	Green	7	Orange	12	Aqua	17	Violet + ring	22	Brown + ring	2	Green		
3	Blue	8	Black	13	Red + ring	18	Pink + ring	23	White + ring	3 to 12	White		
4	Yellow	9	Grey	14	Green + ring	19	Orange + ring	24	Aqua + ring				
5	Violet	10	Brown	15	Blue + ring	20	Black + ring						

Tube Color Coding

Outdoor Multi Loose Tube Cable with All Dielectric Self Supporting, Single Jacket

GAAG, GAAD, GAAE

A-DQ(ZN)2Y(T)



Applications

- All Dielectric Self Supporting cable (ADSS) for Outdoor use
- Suitable for installation between poles with a maximum span of 150 meters for GAAG, GAAD and GAAE, and 110 meter for GAAG
- Initial sag at +20 °C: 1% of span

Features & Benefits

- Available in sizes from 6 to 144 fibers
- Jelly filled (non-dripping and silicon-free) loose tubes with primary coated optical fibres ($\varnothing 250 \pm 15 \mu\text{m}$)
- Aramid yarns for tensile strength
- Installation-friendly because of the cable core kept free of grease (dry interstices)
- Polyethylene jacket
- Length marking in meters for easy determination of the cable length

Cross Section

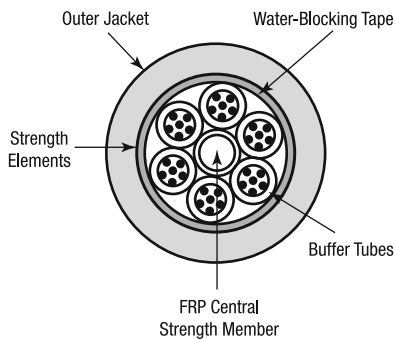

Specifications

IEC 60794-1-2	
Crush Resistance (E3):	15 kN/m
Min. Bend Radius installation (E6):	20 x \varnothing
Min. Bend Radius operation (E11):	20 x \varnothing
Temperature Range (F1):	
- Transport/Storage	-30 °C to +70 °C
- Installation	-5 °C to +50 °C
- Operation	-30 °C to +70 °C
Watertightness (F5):	Pass

Characteristics

Loose Tube	Fiber Count	Diameter Tube (mm)	Max. Fibers per Tube	Watertightness in Core	Diameter (mm)	Weight (kg/km)	Tensile Strength (short term) N	Tensile Strength (permanent) N	Fire Load (kJ/m)
IEC 60794-1-2							E1	E1	
GAAG*xx	6 to 36	1.9	6	Dry	10.3	72	2450	800	3000
GAAD*xx	12 to 72	2.5	12	Dry	12.2	99	2700	900	4000
GAAE*xx	84 to 96	2.5	12	Dry	13.8	132	3450	1150	4400

Ordering Information

Fiber Type/Count	Dry Core				
	6	12	18	24	36
62.5/125-OM1	GAAG106	GAAG112	GAAG118	GAAG124	GAAG136
50/125-OM2 BW 600/1200	GAAG206	GAAG212	GAAG218	GAAG224	GAAG236
50/125-OM3	GAAGD06	GAAGD12	GAAGD18	GAAGD24	GAAGD36
50/125-OM4	GAAGE06	GAAGE12	GAAGE18	GAAGE24	GAAGE36
9/125 ITU G.652D	GAAG806	GAAG812	GAAG818	GAAG824	GAAG836
9/125 ITU G.655 C&D	GAAG706	GAAG712	GAAG718	GAAG724	GAAG736
Std. plywood reel (non-returnable)	Ø 1250 x 688 mm, Weight 93.0 kg				
Std. delivery length	2100 ± 100 m				

Fiber Type/Count	Dry Core					
	12	24	36	48	60	72
62.5/125-OM1	GAAD112	GAAD124	GAAD136	GAAD148	GAAD160	GAAD172
50/125-OM2 BW 600/1200	GAAD212	GAAD224	GAAD236	GAAD248	GAAD260	GAAD272
50/125-OM3	GAADD12	GAADD24	GAADD36	GAADD48	GAADD60	GAADD72
50/125-OM4	GAADE12	GAADE24	GAADE36	GAADE48	GAADE60	GAADE72
9/125 ITU G.652D	GAAD812	GAAD824	GAAD836	GAAD848	GAAD860	GAAD872
9/125 ITU G.655 C & D	GAAD712	GAAD724	GAAD736	GAAD748	GAAD760	GAAD772
Std. plywood reel (non-returnable)	Ø 1250 x 688 mm, Weight 93.0 kg					
Std. delivery length	2100 ± 100 m					

Ordering Information

Fiber Type/Count	Dry Core	
	84	96
62.5/125-OM1	GAAE184	GAAE196
50/125-OM2 BW 600/1200	GAAE284	GAAE296
50/125-OM3	GAAED84	GAAED96
50/125-OM4	GAAEE84	GAAEE96
9/125 ITU G.652D	GAAE884	GAAE896
9/125 ITU G.655 C & D	GAAE784	GAAE796
Std. plywood reel (non-returnable)	Ø 1400 x 900 mm, Weight 120.0 kg	
Std. delivery length	2100 ± 100 m	

Fiber Color Coding

No.		No.		No.	
1	Red	5	Violet	9	Grey
2	Green	6	Pink	10	Brown
3	Blue	7	Orange	11	White
4	Yellow	8	Black	12	Aqua

Tube Color Coding

1	Red
2	Green
3 to 12	White

Mechanical Test Procedures

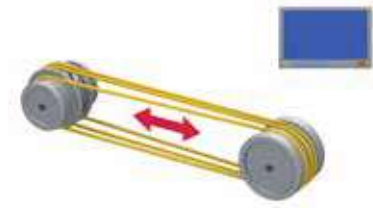

Tensile Performance

The tensile performance method monitors the attenuation variation and evaluates elongation of the cable which is subject to an increasing traction load during installation and operation.

- Standards: IEC 60794-1-2 E1 (Future IEC 60794-1-21 E1)

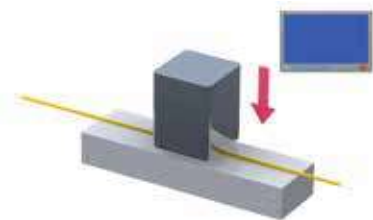

Crush Resistance

This test aims to verify the behavior of the cable and the fibers that are subject to compression during operation and/or installation. During the test, a cable sample is compressed (in a transverse direction) between a fixed and a mobile base, where an even force is applied on a cable section.

- Standards: IEC 60794-1-2 E3 (Future IEC 60794-1-21 E3)

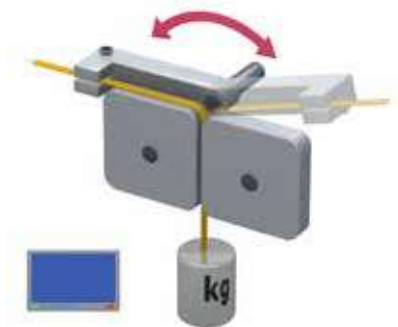

Repeated Bending

The test evaluates the ability of an optical fiber cable to withstand repeated bending. The cable is repeatedly bent at 90° to reproduce working conditions and to create stress.

- Standards: IEC 60794-1-2 E6 (Future IEC 60794-1-21 E3)

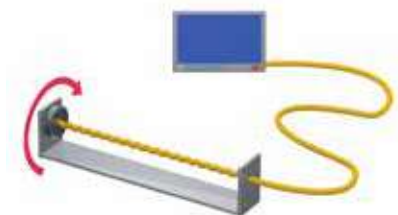

Torsion

The torsion test is aimed at evaluating the ability of an optical fiber cable to withstand mechanical twisting. The test is carried out on a cable sample anchored to a fixed support and to a rotating support and by applying a sample load. The cable is then twisted in clockwise and anti-clockwise rotations to examine the possibility of physical damage.

- Standards: IEC 60794-1-2 E7 (Future IEC 60794-1-21 E7)

Environmental Test Procedures

Temperature Cycling

The temperature cycling test measures the ability of an optical fiber cable to provide stable operations during exposure to changing temperatures. Test conditions are regulated to simulate the worst conditions for such temperature changes to measure the possible effects on the optical and mechanical performance of a cable.

- Standards: IEC 60794-1-2 F1 (Future IEC 60794-1-22 F1)

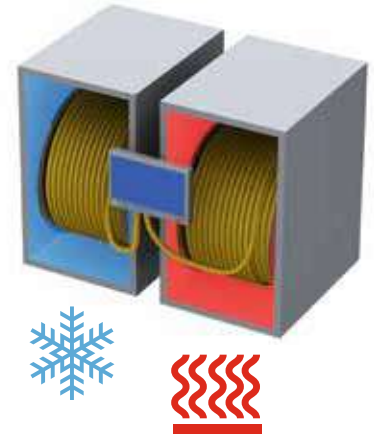

Water Penetration

Water penetration test examines the effectiveness of use of water blocking materials in fiber optic cable. This test is used as assurance criteria for the cable's resistance to longitudinal water penetration.

- Standards: IEC 60794-1-2 F5B (future IEC 60794-1-22 F5B/C)



Fire Performance Test Procedures



Fire Propagation on a Vertical Single Cable

This test evaluates the flame retardant characteristics of a single cable. Depending on the cable diameter and weight, a regulated flame is continuously applied for a certain amount of time to the cable. The cable needs to extinguish itself and the burnt portion of the cable should not reach the top of the sample for the cable to pass the test.

- Standard: IEC 60332-1



Fire Propagation on a Vertical Cable Bundle

This test examines the flame retardant characteristics of a group of bundled cables (depending on the volume of flammable materials) fixed on a vertical 3.5m ladder and flame is applied to the bundle for 20 or 40 minutes. The height of the fire damage should not exceed 2.5 m for the bundled cables to pass the test.

- Standard: IEC 60332-3



Smoke Emission

Smoke emissions considerably reduce the visibility in case of fires. This test measures the density of smoke emitted from burning cables and this is determined with an optical transmission measurement.

- Standard: IEC 61034



Fire Test with Circuit Integrity

It is vital for some circuits to maintain the power supply for the activation of safety equipment in case of fires. This test determines the circuit integrity of a cable during and after a prolonged fire. The cable passes the test when there is continuous circuit integrity during and after the test.

- Standard: IEC 60331-25



Patching and Termination MIPP – The Industrial-strength Patch Panel



Section Table of Contents

Patching and Termination	
MIPP – The Industrial-strength Patch Panel	
Overview	338–339
MIPP Fiber Splice Box	340
Overview	340
Standard Part Number Reference Guide	341
Standard Part Number Reference List	342–343
MIPP Copper Patch Panel	344
Overview	344
Standard Part Number Reference Guide	345
Standard Part Number Reference List	345
MIPP Mix	346
Overview	346
Standard Part Number Reference List	347
Accessories	348

MIPP – The Industrial-strength Patch Panel



Belden's Modular Industrial Patch Panel (MIPP™) is a robust and versatile termination panel for both fiber and copper cables that need to be connected from operating environment to active equipment. Easily installed on any standard 35 mm DIN rail, MIPP features high port-density to meet expanding network connectivity needs within limited space. MIPP is Belden's high-quality solution for performance-critical Industrial Ethernet Applications.

Product Features

Robust Quality

- Lightweight, high strength aluminium housing, able to withstand temperatures from -20 °C to +70 °C
- UL approval (UL 1863)

Fiber Splice Box, Copper Patch Panel or Combination Applications

- MIPP comes as either a Fiber Splice Box, Copper Patch Panel, or a mix of both
- LC, SC, ST, SC and ST metal and E-2000 fiber duplex adapters multimode (OM1, OM2, OM3 and OM4) and singlemode (OS2 and OS2/APC)
- RJ45 copper keystone jacks (Shielded and Unshielded, Cat 5e, Cat 6, Cat 6A) and RJ45 copper coupler (shielded and unshielded, Cat 6A)

Easy Installation and Maintenance

- Splice tray and multiple fingers for easy fiber management
- Cable entry in two places (top or bottom) for ease of use and choice of placement in cabinet
- Three cable entries for single fiber module, for ring topology applications
- Double fiber module accommodates hybrid fiber cables, with single mode and multi mode fibers

Best Fit

- Available as part of a system with market leading Hirschmann switches and high performance Belden cabling for optimum reliability in Industrial Ethernet networks

Applications

The MIPP is ideal for use in a wide range of industrial applications requiring maximum system reliability and flexibility. The industrial design makes it highly suited for use in Machine Building, Transportation, Alternative Power Generation, Power Transmission & Distribution, and Oil & Gas markets, as well as for general use in enterprise, buildings and other applications.

MIPP – The Industrial-strength Patch Panel

The market shows a clear trend in the growing use of both Industrial Ethernet and fiber infrastructures in industrial networks. The Modular Industrial Patch Panel (MIPP) is the efficient termination and patching tool for an efficient, low maintenance and secure connection between cables and switches in performance critical applications.

Robust Quality

The durable MIPP panels are constructed of lightweight, high strength aluminium, securely protecting copper and optical fiber connections under the harshest industrial conditions. The housing is able to withstand temperatures from -20 °C to +70 °C and is resistant to shocks and vibrations. The patch panel's industrial quality guarantees a secure termination point for reliable industrial Ethernet connectivity.

Fiber, Copper, Both

MIPP comes as either a Fiber Splice Box, Copper Patch Panel, or a combination. Where both fiber and copper cables are needed together the design enables simply connecting both to a single panel. MIPP allows flexible network design for network engineers and flexible patching for system installers.

Easy Installation and Maintenance

The smart housing design allows quick and flexible installation of the MIPP on a DIN rail or a wall. Maintenance is equally easy, since the modules can be individually removed without dismantling the MIPP from the DIN rail or wall mount. Just take out the modules that need work and save precious time.

Future Proof

As network design may change over time, MIPP allows for modifications by simply swapping modules to meet the new design required. Installing a MIPP with blind* modules readies the solution for any extensions or modifications to come. MIPP is the future proof termination and patching solution for dynamic industries.

Save Space

Belden knows the importance of cabinet space in industrial sites. Continuous growth of system networks requires smart use of the existing space. MIPP is designed to fit. Thanks to its narrow housing design the required space is kept to a minimum. With three cable entry points (top and bottom) there is no need for special cabinet design or positioning.

Best Fit

MIPP is the reliable solution for connecting Belden cables and Hirschmann switches.



Benefits

- 1. Robustness:** durable UL certified (UL 1863) solution for linking Hirschmann switches to Belden cabling with a guaranteed lifetime of well over 10 years.
- 2. Versatility:** suitable in nearly any industrial application where fiber splicing, copper termination or both are required. A single MIPP allows for termination and patching of:
 - Up to 72 fiber cables: MIPP Fiber Splice Box
 - Up to 24 copper cables: MIPP Copper Patch Panel
- 3. Ease of use:** mounted on a DIN rail or wall, any module can be individually extracted from the housing for maintenance actions.
- 4. Future proof:** simply swap modules to meet new network demands or add blind modules at initial installation.
- 5. Save space and cost:** high port density and multiple cable entry points.

MIPP Fiber Splice Box

Save cost and space: high port density and multiple cable entry points minimize required cabinet space.

MIPP Fiber Splice Box guarantees efficient fiber termination and is designed for use in a wide range of industrial applications. MIPP Fiber Splice Box accommodates various fiber types and connectors: LC, SC, SC metal, ST, ST metal and E-2000 fiber duplex adapters.

MIPP Fiber Splice Box gives you everything you need

- Splice tray and multiple fingers for easy fiber management
- Up to three cable entries for single fiber module, ideal for ring topology applications
- High port density with up to 72 fiber counts (for a single MIPP) for efficient usage of space

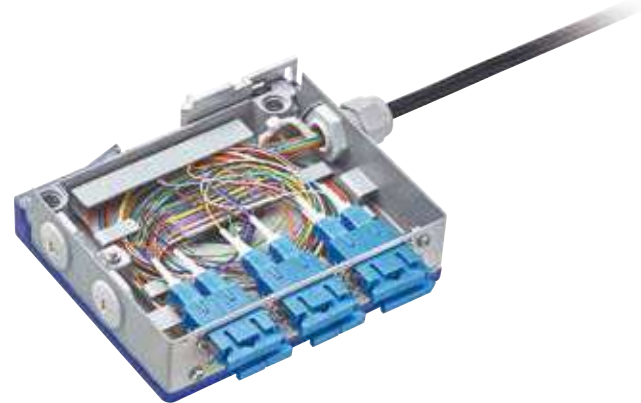

Accessories for the MIPP Fiber Splice Box
Brilliance connectors

Type of Adapters

Single Fiber Modules (up to 12 fiber connections)

- 6 x SC duplex adapters
- 6 x SC metal duplex adapters
- 6 x LC duplex adapters
- 6 x ST duplex adapters
- 6 x ST metal duplex adapters
- 6 x E-2000 duplex adapters

Double Fiber Modules (up to 24 fiber connections)

- 12 x SC duplex adapters
- 12 x SC metal duplex adapters
- 12 x LC duplex adapters
- 12 x ST duplex adapters
- 12 x ST metal duplex adapters
- 12 x E-2000 duplex adapters

Fiber Applications

- Multimode: OM1, OM2, OM3 and OM4
- Singlemode: OS2 and OS2/APC

MIPP Fiber Splice Box is UL certified (UL 1863).

MIPP Fiber Splice Box Single Module
Standard Part Number Reference Guide

1	System build-up	MIPP Fiber Splice Box
----------	------------------------	------------------------------

2	Number of Fibers	Single Module (Fiber count up to 12)
----------	-------------------------	---

3	Mounting Type	DIN rail (wall mount also available)
----------	----------------------	---

4	Adapter	LC *	SC *
----------	----------------	-------------	-------------

5	Application	OM1	OM2	OM3	OS2	OM1	OM2	OM3	OS2
	Color	Beige	Beige	Aqua	Blue	Beige	Beige	Aqua	Blue
	Adapter sleeve material	Phosphor Bronze			Ceramic		Phosphor Bronze		Ceramic
	Part Number	MIPP-01-030	MIPP-01-033	MIPP-01-003	MIPP-01-005	MIPP-01-007	MIPP-01-010	MIPP-01-012	MIPP-01-013

Accessories

Pigtails	Part Number	MIPP-01-031	MIPP-01-002	MIPP-01-004	MIPP-01-006	MIPP-01-008	MIPP-01-011	MIPP-01-037	MIPP-01-014
Brilliance Connectors	Part Number	MIPP-01-032	MIPP-01-001	MIPP-01-034	MIPP-01-035	MIPP-01-036	MIPP-01-009	MIPP-01-038	MIPP-01-039

4	Adapter	ST *
----------	----------------	-------------

* SC and ST available also in metal adapters via Customer Service
* E-2000 adapters available via Customer Service
* OM4 fibers available via Customer Service

5	Application	OM1	OM2	OM3	OS2
	Color	Beige	Beige	Aqua	Blue
	Adapter sleeve material	Phosphor Bronze		Ceramic	
	Part Number	MIPP-01-015	MIPP-01-042	MIPP-01-017	MIPP-01-019

Accessories

Pigtails	Part Number	MIPP-01-040	MIPP-01-016	MIPP-01-018	MIPP-01-045
Brilliance Connectors	Part Number	MIPP-01-041	MIPP-01-043	MIPP-01-044	MIPP-01-046

Material	Steel (powder coated)
Weight (gr)	560
Protection Class	IP40
Cable Entry	<ul style="list-style-type: none"> • 3 possible cable entries • 1 M16 Gland installed • 1 extra M16 Gland supplied
Diameter Cable	3 to 10 mm
Cable Types	loose-tube, mini-breakout or breakout cables of up to 12 fibers
Mating Cycles	500 cycles (E-2000 1000 cycles)

MIPP Fiber Splice Box
Standard Part Number Reference List

Part No.	Max Number Fibers	Type of Module	Mounting Type		Adapter Type				Application					Accessories		
			DIN Rail	Wall Mount	LC	SC	ST	E-2000™	Multimode			Singlemode		Pigtails	Brilliance Connectors	
									OM1	OM2	OM3	OS2	OS2/A PC			
MIPP-00-001	–	No Housing – Blind Module														
MIPP-00-002	12	No Housing Single			•					•						
MIPP-00-003	12	No Housing Single				•				•						
MIPP-00-004	12	No Housing Single				•					•					
MIPP-01-030	12	1 x Single	•		•					•						
MIPP-01-031	12	1 x Single	•		•					•				•		
MIPP-01-032	12	1 x Single	•		•					•					•	
MIPP-01-033	12	1 x Single	•		•					•						
MIPP-01-002	12	1 x Single	•		•					•				•		
MIPP-01-001	12	1 x Single	•		•					•					•	
MIPP-01-003	12	1 x Single	•		•						•					
MIPP-01-004	12	1 x Single	•		•						•			•		
MIPP-01-034	12	1 x Single	•		•						•				•	
MIPP-01-005	12	1 x Single	•		•							•				
MIPP-01-006	12	1 x Single	•		•							•		•		
MIPP-01-035	12	1 x Single	•		•							•			•	
MIPP-01-007	12	1 x Single	•			•				•						
MIPP-01-008	12	1 x Single	•			•				•				•		
MIPP-01-036	12	1 x Single	•			•				•					•	
MIPP-01-010	12	1 x Single	•			•				•						
MIPP-01-011	12	1 x Single	•			•				•				•		
MIPP-01-009	12	1 x Single	•			•				•					•	
MIPP-01-012	12	1 x Single	•			•					•					
MIPP-01-037	12	1 x Single	•			•					•			•		
MIPP-01-038	12	1 x Single	•			•					•				•	
MIPP-01-013	12	1 x Single	•			•						•				
MIPP-01-014	12	1 x Single	•			•						•		•		
MIPP-01-039	12	1 x Single	•			•						•			•	
MIPP-01-015	12	1 x Single	•				•			•						
MIPP-01-040	12	1 x Single	•				•			•				•		
MIPP-01-041	12	1 x Single	•				•			•					•	
MIPP-01-042	12	1 x Single	•				•			•						
MIPP-01-016	12	1 x Single	•				•			•				•		
MIPP-01-043	12	1 x Single	•				•			•					•	
MIPP-01-017	12	1 x Single	•				•				•					
MIPP-01-018	12	1 x Single	•				•				•			•		
MIPP-01-044	12	1 x Single	•				•				•				•	
MIPP-01-019	12	1 x Single	•				•					•				
MIPP-01-045	12	1 x Single	•				•					•		•		
MIPP-01-046	12	1 x Single	•				•					•			•	

MIPP Fiber Splice Box

Standard Part Number Reference List (continued)

Part No.	Max Number Fibers	Type of Module	Mounting Type		Adapter Type				Application					Accessories	
			DIN Rail	Wall Mount	LC	SC	ST	E-2000™	Multimode			Singlemode		Pigtails	Brilliance Connectors
									OM1	OM2	OM3	OS2	OS2/A PC		
MIPP-10-001	1 x 24	1 x Double	•					•						•	
MIPP-10-002	1 x 24	1 x Double	•		•					•					
MIPP-10-003	1 x 24	1 x Double	•		•						•				
MIPP-10-004	1 x 24	1 x Double	•		•							•			
MIPP-10-005	1 x 24	1 x Double	•		•							•		•	
MIPP-10-006	1 x 24	1 x Double	•			•			•						
MIPP-10-007	1 x 24	1 x Double	•			•			•					•	
MIPP-10-008	1 x 24	1 x Double	•			•					•				
MIPP-10-012	1 x 24	1 x Double	•			•						•			
MIPP-10-009	1 x 24	1 x Double	•			•						•		•	
MIPP-10-010	1 x 24	1 x Double	•				•		•					•	
MIPP-10-011	1 x 24	1 x Double		•		•			•						
MIPP-02-001	1 x 24	2 x Single	•		2x					2x					
MIPP-02-002	1 x 24	2 x Single	•		2x					2x				2x	
MIPP-02-003	1 x 24	2 x Single	•			2x			2x						
MIPP-02-004	1 x 24	2 x Single	•			2x			2x					2x	
MIPP-02-006	1 x 24	2 x Single	•			2x			2x						
MIPP-02-008	1 x 24	2 x Single	•			2x					2x				
MIPP-20-001	48	2 x Double	•		2x						2x				
MIPP-04-001	48	4 x Single	•		4x					4x					

MIPP Copper Patch Panel

Perfect fit to the Belden cables and Hirschmann product families.

MIPP Copper Patch Panel ensures maximum reliability for Industrial Ethernet and PROFINET networks. The MIPP Copper Patch Panel compliments the market leading Hirschmann switches and high performance Belden cabling solutions by enabling cables to be terminated and linked to active equipment using DataTuff patch cords, in an organised and structured manner.

MIPP Copper Patch Panel covers all your copper termination and patching needs

- High variety of media and connectors:
 - RJ45 copper keystone jacks (unshielded and shielded, Cat 5e, Cat 6, Cat 6A)
 - RJ45 copper coupler (unshielded and shielded, Cat 6A)
- Suitable in nearly any industrial application thanks to the robust aluminium housing (resisting an operating temperature range of -20 °C to +70 °C)



Accessories for the MIPP Copper Patch Panel DataTuff for cables and patch cords

Type of Keystones

Single Copper Modules

- 2 or 4 x RJ45 keystone unshielded
- 2 or 4 x RJ45 keystone shielded
- 2 or 4 x RJ45 coupler unshielded
- 2 or 4 x RJ45 coupler shielded

Type of Cable Categories

- Cat 5e unshielded and shielded
- Cat 6 unshielded and shielded
- Cat 6A unshielded and shielded

MIPP Copper Patch Panel is UL certified (UL 1863).

MIPP Copper Patch Panel Single Module
Standard Part Number Reference Guide

1	System build-up	MIPP Copper Patch Panel								
2	Number of Copper Cables	Single Module (Copper cables up to 4)								
3	Mounting Type	DIN rail (wall mount also available)								
4	Keystone	Unshielded KeyConnect			Shielded KeyConnect			Unshielded Couplers	Shielded Couplers	
5	Category	CAT 5e	CAT 6	Cat 6_A	CAT 5e	CAT 6	Cat 6_A	Cat 6_A	Cat 6_A	
	Weight (gr)	515			640			515	640	
	Connector Part Number	AX101310	AX101321	AX102283	AX104595	AX104596	AX104562	AX104024	AX104501	
	4 Keystone*	Part Number	MIPP-01-021	MIPP-01-020	MIPP-01-022	MIPP-01-023	MIPP-01-024	MIPP-01-025	MIPP-01-026	MIPP-01-027

* Available also with 2 keystones via Customer Service

Material	Steel (powder coated)
Protection Class	IP20
Cable Entry	<ul style="list-style-type: none"> • 1 cable entry point • with tie wrap fixing latch
Diameter Cable	4 x 7.5 mm
Mating Cycles	750 cycles

Standard Part Number Reference List

Part No.	Max Number Fibers	Type of Module	Mounting Type	Keystone Type				Cable Type		
			DIN Rail	KeyConnect		Couplers		Cat 5e	Cat 6	Cat 6 _A
				Unshielded	Shielded	Unshielded	Shielded			
MIPP-00-001	-	No Housing – Blind Module								
MIPP-00-005	4	No Housing Single			•			•		
MIPP-00-006	4	No Housing Single			•				•	
MIPP-01-021	4	1 x Single	•		•			•		
MIPP-01-020	4	1 x Single	•		•				•	
MIPP-01-022	4	1 x Single	•		•					•
MIPP-01-023	4	1 x Single	•			•		•		
MIPP-01-024	4	1 x Single	•			•			•	
MIPP-01-025	4	1 x Single	•			•				•
MIPP-01-026	4	1 x Single	•				•			•
MIPP-01-027	4	1 x Single	•						•	•
MIPP-02-010	8	2 x Single	•		•				•	
MIPP-04-002	16	4 x Single	•							4x

MIPP Mix



Scan to view the MIPP Mix Video

The market shows a clear trend in the growing use of both Industrial Ethernet and fiber infrastructures in industrial networks. MIPP™ addresses this by allowing the connection of both fiber and copper cables in a single solution*. Specifically designed for industrial use, MIPP™'s functionality and reliability can make a significant contribution to the uptime and availability of performancecritical systems.

MIPP Fiber Splice Box and Copper Patch Panel for varying industrial networking needs.



* Up to 6 single modules, 3 double modules or a combination can be used in one MIPP™



MIPP Mix

Standard Part Number Reference List

Part No.	Type of Module	Mounting Type	Module 1	Module 2	Module 3	Module 4	Module 5
		DIN Rail					
MIPP-00-001	No Housing - Blind Module						
MIPP-02-011	2 x Single	•	Fiber: LC OM2 with Pigtailed	Blind Module			
MIPP-02-005	2 x Single	•	Fiber: SC OM1 with Pigtailed	Copper: Unshielded Keystones Cat 5e			
MIPP-02-007	2 x Single	•	Fiber: SC OS2	Copper: Unshielded Keystones Cat 6			
MIPP-02-009	2 x Single	•	Fiber: SC OS2 with Pigtailed	Copper: Unshielded Keystones Cat 5e			
MIPP-03-001	3 x Single	•	Copper: Unshielded Coupler, Cat 6	Copper: Unshielded Coupler, Cat 6	Fiber: SC OM3		
MIPP-21-001	3 x Single	•	Copper: Unshielded Coupler, Cat 5e	Fiber Double Module: ST OM2	Fiber Double Module: ST OM2		
MIPP-05-001	5 x Single	•	Fiber: LC OS2 with Pigtailed	Copper: Unshielded Coupler, Cat 6	Blind Module	Blind Module	Blind Module

Accessories

MIPP Fiber Splice Box Accessories

Pigtails			
SC	LC	ST	E-2000
1 or 2 packs of 12 pigtails, 900 micron, 0.6 mtr in 12 different colours: <ul style="list-style-type: none"> • SC/UPC SM 9/125, OS2 • SC/APC SM 9/125, OS2 • SC/PC MM 62.5/125, OM1 • SC/PC MM 50/125, OM2 • SC/PC MM 50/125, OM3 • SC/PC MM 50/125, OM4 	1 or 2 packs of 12 pigtails, 900 micron, 0.6 mtr in 12 different colours: <ul style="list-style-type: none"> • LC/UPC SM 9/125, OS2 • LC/APC SM 9/125, OS2 • LC/PC MM 62.5/125, OM1 • LC/PC MM 50/125, OM2 • LC/PC MM 50/125, OM3 • LC/PC MM 50/125, OM4 	1 or 2 packs of 12 pigtails, 900 micron, 0.6 mtr in 12 different colours: <ul style="list-style-type: none"> • ST/UPC SM 9/125, OS2 • ST/PC MM 62.5/125, OM1 • ST/PC MM 50/125, OM2 • ST/PC MM 50/125, OM3 • ST/PC MM 50/125, OM4 	1 or 2 packs of 12 pigtails, 900 micron, 0.6 mtr in 12 different colours: <ul style="list-style-type: none"> • E-2000/UPC SM 9/125, OS2 • E-2000/APC SM 9/125, OS2 • E-2000/PC MM 62.5 ,OM1 • E-2000/PC MM 50/125,OM2 • E-2000/PC MM 50/125,OM3 • E-2000/PC MM 50/125,OM4
Brilliance Field Installable Connectors			
12 or 24 brilliance connectors SC, 900 micron: <ul style="list-style-type: none"> • OS2 Blue – AX105208 • OM1 Beige – AX105205 • OM2 Black – AX105206 • OM3/4 Aqua – AX105207 	12 or 24 brilliance connectors LC, 900 micron: <ul style="list-style-type: none"> • OS2 Blue – AX105203 • OM1 Beige – AX105200 • OM2 Black – AX105201 • OM3/4 Aqua – AX105202 	12 or 24 brilliance connectors ST, 900 micron: <ul style="list-style-type: none"> • OS2 Blue – AX105213 • OM1 Beige – AX105210 • OM2 Black – AX105211 • OM3/4 Aqua – AX105212 	–

MIPP Copper Panel Accessories

Industrial Ethernet DataTuff Patch Cords

- Cat 5e 2 or 4 pairs
- Cat 6 4 pairs
- Cat 6A 4 pairs
- Shielded or Unshielded
- Twisted Pair, Quad or Bonded-Pair
- PVC, FRNC, TPE or PUR jackets



Section Table of Contents

Technical Information	Page
Belden Conductor Color Code Charts	350–351
Conductors	352–354
Insulations and Jackets	355–358
Shielding	359–361
Cables Standards Reference Guide	362
Cables Substitution Chart	363
Canadian Substitution Hierarchy and Catalog Terms of Use	364
Glossary	365–369

Belden Conductor Color Code Charts

Color Code Chart 1

Cond. No.	Color
1	Black
2	White
3	Red
4	Green
5	Brown
6	Blue
7	Orange
8	Yellow
9	Purple
10	Gray
11	Pink
12	Tan

Color Code Chart 2 and 2R: 2 = Spiral Stripe, 2R = Ring Band Stripe

Cond. No.	Color
1	Black
2	White
3	Red
4	Green
5	Orange
6	Blue
7	White/Black Stripe
8	Red/Black Stripe
9	Green/Black Stripe
10	Orange/Black Stripe
11	Blue/Black Stripe
12	Black/White Stripe
13	Red/White Stripe

Cond. No.	Color
14	Green/White Stripe
15	Blue/White Stripe
16	Black/Red Stripe
17	White/Red Stripe
18	Orange/Red Stripe
19	Blue/Red Stripe
20	Red/Green Stripe
21	Orange/Green Stripe
22	Black/White/Red
23	White/Black/Red
24	Red/Black/White
25	Green/Black/White
26	Orange/Black/White

Cond. No.	Color
27	Blue/Black/White
28	Black/Red/Green
29	White/Red/Green
30	Red/Black/Green
31	Green/Black/Orange
32	Orange/Black/Green
33	Blue/White/Orange
34	Black/White/Orange
35	White/Red/Orange
36	Orange/White/Blue
37	White/Red/Blue
38	Black/White/Green
39	White/Black/Green

Cond. No.	Color
40	Red/White/Green
41	Green/White/Blue
42	Orange/Red/Green
43	Blue/Red/Green
44	Black/White/Blue
45	White/Black/Blue
46	Red/White/Blue
47	Green/Orange/Red
48	Orange/Red/Blue
49	Blue/Orange/Red
50	Black/Orange/Red

Color Code Chart 3: Belden Standard for Paired Cable

Pair	Color
1	Black & Red
2	Black & White
3	Black & Green
4	Black & Blue
5	Black & Yellow
6	Black & Brown
7	Black & Orange
8	Red & White
9	Red & Green
10	Red & Blue

Pair	Color
11	Red & Yellow
12	Red & Brown
13	Red & Orange
14	Green & White
15	Green & Blue
16	Green & Yellow
17	Green & Brown
18	Green & Orange
19	White & Blue
20	White & Yellow

Pair	Color
21	White & Brown
22	White & Orange
23	Blue & Yellow
24	Blue & Brown
25	Blue & Orange
26	Brown & Yellow
27	Brown & Orange
28	Orange & Yellow
29	Purple & Orange
30	Purple & Red

Pair	Color
31	Purple & White
32	Purple & Green
33	Purple & Blue
34	Purple & Yellow
35	Purple & Brown
36	Purple & Black
37	Gray & White

Color Code Chart 4: Belden Standard for Paired Cable

Pair	Color
1	White & Blue
2	White & Orange
3	White & Green
4	White & Brown
5	White & Gray
6	Red & Blue
7	Red & Orange

Pair	Color
8	Red & Green
9	Red & Brown
10	Red & Gray
11	Black & Blue
12	Black & Orange
13	Black & Green
14	Black & Brown

Pair	Color
15	Black & Gray
16	Yellow & Blue
17	Yellow & Orange
18	Yellow & Green
19	Yellow & Brown
20	Yellow & Gray
21	Purple & Blue

Pair	Color
22	Purple & Orange
23	Purple & Green
24	Purple & Brown
25	Purple & Gray

Color Code Chart 5: Western Electric Standard for Paired Cable

Pair	Color
1	White/Blue Stripe & Blue/White Stripe
2	White/Orange Stripe & Orange/White Stripe
3	White/Green Stripe & Green/White Stripe
4	White/Brown Stripe & Brown/White Stripe
5	White/Gray Stripe & Gray/White Stripe
6	Red/Blue Stripe & Blue/Red Stripe
7	Red/Orange Stripe & Orange/Red Stripe

Pair	Color
8	Red/Green Stripe & Green/Red Stripe
9	Red/Brown Stripe & Brown/Red Stripe
10	Red/Gray Stripe & Gray/Red Stripe
11	Black/Blue Stripe & Blue/Black Stripe
12	Black/Orange Stripe & Orange/Black Stripe
13	Black/Green Stripe & Green/Black Stripe
14	Black/Brown Stripe & Brown/Black Stripe

Pair	Color
15	Black/Gray Stripe & Gray/Black Stripe
16	Yellow/Blue Stripe & Blue/Yellow Stripe
17	Yellow/Orange Stripe & Orange/Yellow Stripe
18	Yellow/Green Stripe & Green/Yellow Stripe
19	Yellow/Brown Stripe & Brown/Yellow Stripe
20	Yellow/Gray Stripe & Gray/Yellow Stripe
21	Purple/Blue Stripe & Blue/Purple Stripe

Pair	Color
22	Purple/Orange Stripe & Orange/Purple Stripe
23	Purple/Green Stripe & Green/Purple Stripe
24	Purple/Brown Stripe & Brown/Purple Stripe
25	Purple/Gray Stripe & Gray/Purple Stripe

Color Code Chart E1 ICEA S-73-532

Cond. No.	Base Color	Tracer	Tracer
1	Black	-	-
2	White	-	-
3	Red	-	-
4	Green	-	-
5	Orange	-	-
6	Blue	-	-
7	White	Black	-
8	Red	Black	-
9	Green	Black	-
10	Orange	Black	-
11	Blue	Black	-
12	Black	White	-
13	Red	White	-

Cond. No.	Base Color	Tracer	Tracer
14	Green	White	-
15	Blue	White	-
16	Black	Red	-
17	White	Red	-
18	Orange	Red	-
19	Blue	Red	-
20	Red	Green	-
21	Orange	Green	-
22	Black	White	Red
23	White	Black	Red
24	Red	Black	White
25	Green	Black	White
26	Orange	Black	White

Cond. No.	Base Color	Tracer	Tracer
27	Blue	Black	White
28	Black	Red	Green
29	White	Red	Green
30	Red	Black	Green
31	Green	Black	Orange
32	Orange	Black	Green
33	Blue	White	Orange
34	Black	White	Orange
35	White	Red	Orange
36	Orange	White	Blue
37	White	Red	Blue
38	Black	White	Green
39	White	Black	Green

Cond. No.	Base Color	Tracer	Tracer
40	Red	White	Green
41	Green	White	Blue
42	Orange	Red	Green
43	Blue	Red	Green
44	Black	White	Blue
45	White	Black	Blue
46	Red	White	Blue
47	Green	Orange	Red
48	Orange	Red	Blue
49	Blue	Red	Orange
50	Black	Orange	Red

Pair cables are Black, White, and Numbered.
Triad cables are Black, White, Red, and Numbered.

Color Code Chart E2 ICEA S-73-532

Cond. No.	Base Color	Tracer
1	Black	-
2	Red	-
3	Blue	-
4	Orange	-
5	Yellow	-
6	Brown	-
7	Red	Black
8	Blue	Black
9	Orange	Black
10	Yellow	Black

Cond. No.	Base Color	Tracer
11	Brown	Black
12	Black	Red
13	Blue	Red
14	Orange	Red
15	Yellow	Red
16	Brown	Red
17	Black	Blue
18	Red	Blue
19	Orange	Blue
20	Yellow	Blue

Cond. No.	Base Color	Tracer
21	Brown	Blue
22	Black	Orange
23	Red	Orange
24	Blue	Orange
25	Yellow	Orange
26	Brown	Orange
27	Black	Yellow
28	Red	Yellow
29	Blue	Yellow
30	Orange	Yellow

Cond. No.	Base Color	Tracer
31	Brown	Yellow
32	Black	Brown
33	Red	Brown
34	Blue	Brown
35	Orange	Brown
36	Yellow	Brown

Pair cables are Black, Red, and Numbered.
Triad cables are Black, Red, Blue and Numbered.
Colors repeat after 36 conductors.
There are no Green or White conductors or stripes.

**Color Code Chart M4
ICEA Method 4: All Conductors Black and Numbered ICEA S-73-532**

Cond. No.	Conductor Printing
1	"1-ONE-1"
2	"2-TWO-2"
3	"3-THREE-3"
4	"4-FOUR-4"
5	"5-FIVE-5"
6	"6-SIX-6"
7	"7-SEVEN-7"
8	"8-EIGHT-8"
9	"9-NINE-9"
10	"10-TEN-10"
11	"11-ELEVEN-11"
12	"12-TWELVE-12"
13	"13-THRITTEEN-13"

Cond. No.	Conductor Printing
14	"14-FOURTEEN-14"
15	"15-FIFTEEN-15"
16	"16-SIXTEEN-16"
17	"17-SEVENTEEN-17"
18	"18-EIGHTEEN-18"
19	"19-NINETEEN-19"
20	"20-TWENTY-20"
21	"21-TWENTY-ONE-21"
22	"22-TWENTY-TWO-22"
23	"23-TWENTY-THREE-23"
24	"24-TWENTY-FOUR-24"
25	"25-TWENTY-FIVE-25"
26	"26-TWENTY-SIX-26"

Cond. No.	Conductor Printing
27	"27-TWENTY-SEVEN-27"
28	"28-TWENTY-EIGHT-28"
29	"29-TWENTY-NINE-29"
30	"30-THIRTY-30"
31	"31-THIRTY-ONE-31"
32	"32-THIRTY-TWO-32"
33	"33-THIRTY-THREE-33"
34	"34-THIRTY-FOUR-34"
35	"35-THIRTY-FIVE-35"
36	"36-THIRTY-SIX-36"
37	"37-THIRTY-SEVEN-37"
38	"38-THIRTY-EIGHT-38"
39	"39-THIRTY-NINE-39"

Cond. No.	Conductor Printing
40	"40-FORTY-40"
41	"41-FORTY-ONE-41"
42	"42-FORTY-TWO-42"
43	"43-FORTY-THREE-43"
44	"44-FORTY-FOUR-44"
45	"45-FORTY-FIVE-45"
46	"46-FORTY-SIX-46"
47	"47-FORTY-SEVEN-47"
48	"48-FORTY-EIGHT-48"
49	"49-FORTY-NINE-49"
50	"50-FIFTY-50"

Conductors

Solid Copper Wire, American Wire Gage

Gage (AWG)	Nominal OD		Nominal Circular MIL Area	Nominal Weight (Lbs. per 1000')	Nominal Resistance @ 68°F (Ω/1000')
	Inches	mm			
10	.1019	2.60	10,380.0	31.43	.9989
11	.0907	2.30	8234.0	24.92	1.260
12	.0808	2.05	6530.0	19.77	1.588
13	.0720	1.83	5178.0	15.68	2.003
14	.0641	1.63	4107.0	12.43	2.525
15	.0571	1.45	3260.0	9.858	3.184
16	.0508	1.29	2583.0	7.818	4.016
17	.0453	1.15	2050.0	6.200	5.064
18	.0403	1.02	1620.0	4.917	6.385
19	.0359	.912	1200.0	3.899	8.051
20	.0320	.813	1020.0	3.092	10.15
21	.0285	.724	812.1	2.452	12.80
22	.0253	.643	640.4	1.945	16.14
23	.0226	.574	511.5	1.542	20.36
24	.0201	.511	404.0	1.223	25.67
25	.0179	.455	320.4	.9699	32.37
26	.0159	.404	253.0	.7692	40.81
27	.0142	.361	201.5	.6100	51.47
28	.0126	.320	159.8	.4837	64.90
29	.0113	.287	126.7	.3836	81.83
30	.0100	.254	100.5	.3042	103.2
31	.0089	.226	79.7	.2413	130.1
32	.0080	.203	63.21	.1913	164.1
33	.0071	.180	50.13	.1517	206.9
34	.0063	.160	39.75	.1203	260.9
35	.0056	.142	31.52	.09542	331.0
36	.0050	.127	25.00	.07568	414.8
37	.0045	.114	19.83	.0613	512.1
38	.0040	.102	15.72	.04759	648.6
39	.0035	.089	12.20	.03774	847.8
40	.0031	.079	9.61	.02993	1080.0

Information from National Bureau of Standards Copper Wire Tables – Handbook 100.

Unparalleled Performance

Belden is one of only a very few cable manufacturers to draw and anneal its own conductors. This is a time-consuming process, but it allows us to ensure signal integrity, as well as proper physical characteristics.

In addition, the standards under which we design and manufacture our fiber optic cabling are among the strictest in the industry. The result is a comprehensive offering of products which give unparalleled performance and can satisfy your most demanding operating and environmental challenges.

Conductors
Stranded Copper Wire, American Wire Gage

Gage (AWG)	Stranding (Nom. AWG)	Min. Average OD of Strand	Approximate OD		ASTM Min. Circular MIL Area	Min. Weight (Lbs./1000')	Max. Resistance* @ 68°F (Ω/1000')
			Inch	mm			
36	7 x 44	.0019	.006	.152	25	.076	414.8
34	7 x 42	.0024	.0075	.191	39.7	.121	260.9
32	7 x 40	.0030	.0093	.236	64	.195	164.1
32	19 x 44	.0018	.010	.254	64	.195	164.1
30♦	7 x 38	.0038	.012	.305	100	.304	112.0
30	19 x 42	.0023	.012	.305	100	.304	112.0
28♦	7 x 36	.0048	.015	.381	159	.484	70.7
28♦	19 x 40	.0029	.016	.406	159	.484	70.7
27	7 x 35	.0054	.017	.432	202	.614	55.6
26♦	7 x 34	.0060	.019	.483	253	.770	44.4
26	10 x 36	.0050	.021	.533	253	.770	44.4
26♦	19 x 38	.0036	.020	.508	253	.770	44.4
24♦	7 x 32	.0076	.024	.610	404	1.229	27.7
24	10 x 34	.0064	.024	.610	404	1.229	27.7
24♦	19 x 36	.0046	.024	.610	404	1.229	27.7
24♦	42 x 40	.0031	.023	.584	404	1.229	27.7
22♦	7 x 30	.0096	.030	.762	640	1.947	17.5
22♦	19 x 34	.0058	.031	.787	640	1.947	17.5
22	26 x 36	.0050	.030	.762	640	1.947	17.5
20♦	7 x 28	.0126	.038	.965	1020	3.103	10.9
20	10 x 30	.0101	.037	.940	1020	3.103	10.9
20♦	19 x 32	.0073	.037	.940	1020	3.103	10.9
20	26 x 34	.0063	.036	.914	1020	3.103	10.9
20♦	42 x 36	.0049	.038	.965	1020	3.103	10.9
18♦	7 x 26	.0152	.048	1.22	1620	4.93	6.92
18	16 x 30	.0101	.047	1.19	1620	4.93	6.92
18♦	19 x 30	.0092	.049	1.24	1620	4.93	6.92
18♦	42 x 34	.0062	.047	1.19	1620	4.93	6.92
18♦	65 x 36	.0050	.047	1.19	1620	4.93	6.92
16♦	7 x 24	.0192	.060	1.52	2580	7.85	4.35
16♦	19 x 29	.0117	.058	1.47	2580	7.85	4.35
16	26 x 30	.0100	.059	1.50	2580	7.85	4.35
16♦	65 x 34	.0063	.059	1.50	2580	7.85	4.35
16	105 x 36	.0050	.059	1.50	2580	7.85	4.35
14♦	7 x 22	.0242	.076	1.93	4110	12.50	2.73
14♦	19 x 26	.0147	.071	1.80	4110	12.50	2.73
14♦	42 x 30	.0099	.075	1.91	4110	12.50	2.73
14	105 x 34	.0063	.075	1.91	4110	12.50	2.73
12♦	7 x 20	.0305	.096	2.44	6530	19.86	1.71
12♦	19 x 25	.0185	.093	2.36	6530	19.86	1.71
12♦	65 x 30	.0100	.095	2.41	6530	19.86	1.71
12	165 x 34	.0063	.095	2.41	6530	19.86	1.71
10	37 x 26	.0167	.115	2.92	10380	31.58	1.08
10	65 x 28	.0126	.120	3.05	10380	31.58	1.08
10	105 x 30	.0099	.118	3.00	10380	31.58	1.08

* AWG 10 through 30 per UL Subject 13.

Belden has standardized on the stranded conductors used in the design of all Belden products. These preferred constructions, based on standard industry practices, are marked with a ♦ symbol.

Conductors

Metric/Imperial/AWG Equivalentents (Square Millimeters/Square Inches/Circular Mills/AWG)

Sq. mm	Sq. In.	Cir. Mills	AWG
1000	1.550	1974000	
975	1.511	1924700	
950	1.472	1875300	
925	1.434	1826000	
900	1.395	1776600	
875	1.356	1727300	
850	1.317	1677900	
825	1.279	1628600	
800	1.240	1579200	
775	1.201	1529900	
750	1.163	1480500	
725	1.124	1431200	
700	1.085	1381800	
675	1.046	1332500	
650	1.008	1283100	
625	.969	1233800	
600	.930	1184400	
575	.891	1135100	
550	.853	1085700	
525	.814	1036400	
500	.775	987000	
475	.736	937700	
450	.698	888300	
425	.659	839000	
400	.620	789600	
375	.581	740300	
350	.542	690900	
325	.504	641600	
300	.465	592200	
275	.426	542900	
250	.388	493500	
225	.349	444200	
200	.310	394800	
175	.271	345500	
150	.233	296100	
125	.1938	246800	
-	-	211600	4/0
100	.1550	197400	
95	.1472	187530	
90	.1395	177660	
-	-	167800	3/0
85	.1317	167790	
80	.1240	157920	

Sq. mm	Sq. In.	Cir. Mills	AWG
75	.1163	148050	
70	.1085	138180	
-	-	133100	2/0
65	.1008	128310	
60	.0930	118440	
55	.0853	108570	
-	-	105600	1/0
50	.0775	98700	
45	.0698	88830	
-	-	83690	1
40	.0620	78960	
35	.0542	69090	
-	-	66360	2
30	.0465	59220	
-	-	52620	3
25	.0388	49350	
-	-	41740	4
20.0	.0310	39480	
19.5	.0302	38490	
19.0	.0294	37510	
18.5	.0287	36520	
18.0	.0279	35530	
17.5	.0271	34550	
17.0	.0264	33560	
-	-	33090	5
16.5	.0256	32560	
16.0	.0248	31580	
15.5	.0240	30600	
15.0	.0233	29610	
14.5	.0225	28620	
14.0	.0217	27640	
13.5	.0209	26650	
-	-	26420	6
13.0	.0201	25660	
12.5	.0194	24680	
12.0	.0186	23690	
11.5	.0178	22700	
11.0	.0171	21710	
-	-	20820	7
10.5	.0163	20730	
10.0	.0155	19740	
9.5	.01472	18753	
9.0	.01395	17766	

Sq. mm	Sq. In.	Cir. Mills	AWG
8.5	.01317	16779	
-	-	16510	8
8.0	.01240	15792	
7.5	.01163	14805	
7.0	.01085	13818	
-	-	13090	9
6.5	.01008	12831	
6.0	.00930	11844	
5.5	.00853	10857	
-	-	10380	10
5.00	.00775	9870	
4.75	.00736	9377	
4.50	.00698	8883	
4.25	.00659	8390	
-	-	8230	11
4.00	.00620	7896	
3.75	.00581	7403	
3.50	.00542	6909	
-	-	6530	12
3.25	.00504	6416	
3.00	.00465	5922	
2.75	.00426	5429	
-	-	5180	13
2.50	.00388	4935	
2.25	.00349	4422	
-	-	4110	14
2.00	.00310	3948	
1.75	.00271	3455	
-	-	3260	15
1.50	.00233	2961	
-	-	2580	16
1.25	.00194	2468	
-	-	2050	17
1.00	.00155	1974	
.90	.00140	1777	
-	-	1620	18
.80	.00124	1579	
.75	.00116	1481	
.70	.00109	1382	
-	-	1290	19
.60	.00093	1184	
-	-	1029	20
.50	.000775	987	

To Convert	Multiply By
Inches to millimeters	25.4
Millimeters to inches	.03937

Insulations and Jackets

Overview

Insulations

Because we formulate our own insulations, they provide superior performance under a variety of hostile environmental conditions. Belden cables are available in UL Listed and CSA Approved insulation compounds.

Among the insulations we offer:

- Polyethylene
- Polyvinyl chloride (PVC)
- Polypropylene

Also available are:

- **Datalene®** – For computer and data transmission, Datalene is crush resistant, lightweight, and offers good performance characteristics over a wide range of temperatures.
- **FEP Insulated Plenum & High-Temperature Cables** – For data communications, instrumentation/control, and other commercial and industrial applications. Plenum cables eliminate the need for conduit and reduce installation time.

Jackets

Belden electronic cables are manufactured in a wide selection of jacketing materials.

- **Flamarrest®** – A Belden jacketing innovation, Flamarrest is a low-smoke, flame retardant compound that is five times more flexible than fluorocopolymer. Cables jacketed with Flamarrest are cost efficient and easy to install.

Also included in our wide selection of jacketing compounds are:

- Polyvinyl chloride
- Polyethylene
- Polyurethane
- FEP
- ETFE
- E-CTFE
- Neoprene
- EPDM
- CSPE
- Silicone rubber
- Natural rubber

Special compounds and variations of standard compounds are used as well.

Insulations and Jackets

Overview (continued)

Typical Characteristics of Popular Insulation and Jacketing Compounds

EPDM

EPDM (ethylene-propylene-diene elastomer) is a chemically cross-linked elastomer with excellent flexibility at high and low temperatures (+150°C to -55 °C). It has good insulation resistance and dielectric strength, as well as excellent abrasion resistance and mechanical properties. EPDM also has better cut-through resistance than Silicone rubber, which it replaces in some applications.

EPDM is compatible with most varnishes, but after the dip and bake cycle varnish tends to adhere to the insulation (because EPDM, unlike some rubber insulations, does not exude oils or waxes). As lead wires are pulled apart for termination, the varnish cracks, sometimes breaking the insulation.

To resolve this problem, a stearic solution is applied to the lead wire during the put-up process. This ensures that rigid varnish does not cause EPDM insulation to rupture when the wire is terminated.

Field evaluations by numerous users reveal that the coated EPDM has excellent varnish resistance at least equal to synthetic elastomers, cross-link polyethylene, or silicone glass braid in dip and bake systems.

Flamarrest®

Flamarrest is a plenum grade chloride-based jacketing material with low smoke and low flame spread properties. Cables jacketed with Flamarrest meet the ANSI/NFPA Standard 262-1985 (U L910), Plenum Cable Flame Test.

E-CTFE

Thermoplastic fluoropolymer material with excellent chemical resistance, electrical properties, thermal characteristics, and impact resistance. The temperature rating is -70 °C to +150 °C.

Neoprene

The temperature range of this material can vary from -55 °C to +90 °C. The actual range would depend on the formulation used. Neoprene is both oil-resistant and sunlight-resistant, making it ideal for many outdoor applications. The most stable colors are

black, dark brown, and gray. The electrical properties are not as good as other insulation materials. Because of this, thicker insulation should be used. Typical designs where this material is used are lead wire insulation and cable jackets.

Polyethylene (Solid and Foamed)

A very good insulation in terms of electrical properties. Low dielectric constant, a stable dielectric constant over all frequencies, very high insulation resistance. In terms of flexibility, polyethylene can be rated stiff to very hard, depending on molecular weight and density – low density being the most flexible, with high-density, high-molecular weight formulation being very hard. Moisture resistance is rated excellent. Black and specially formulated colored versions have excellent weather resistance. The dielectric constant is 2.3 for solid insulation and typically 1.64 for foam designs.

Flame retardant formulations are available with dielectric constants ranging from about 1.7 for foam flame retardant to 2.58 for solid flame retardant polyethylene.

Polypropylene (Solid and Foam)

Similar in electrical properties to polyethylene. This material is primarily used as an insulation material. Typically, it is harder than polyethylene. This makes it suitable for thin wall insulations. UL maximum temperature rating may be +60 °C, +80 °C or +105 °C. The dielectric constant is 2.25 for solid and typically 1.55 for foam designs.

Polyurethane

This material is used primarily as a cable jacket material. It has excellent oxidation, oil, and ozone resistance. Some formations also have good flame resistance. It is a hard material with excellent abrasion resistance. It has outstanding "memory" properties, making it an ideal jacket material for retractile cords.

PVC

Sometimes referred to as vinyl or polyvinyl-chloride. Extremely high or low temperature properties cannot be found in one formulation. Certain formulations may have -55 °C to +105 °C rating. Other common vinyls may

have -20 °C to +60 °C. There are many formulations for the variety of different applications. The many varieties of PVC also differ in pliability and electrical properties. The price range can vary accordingly. Typical dielectric constant values can vary from 3.5 to 6.5.

Rubber

The description of rubber normally includes natural rubber and SBR compounds. Both of these materials can be used for insulations and jackets. There are many formulations of these basic materials. Each formulation is for a specific application. Some formulations are suitable for -55 °C minimum, while others are suitable for +75 °C maximum.

Silicone

This is a very soft insulation which has a temperature range from -80 °C to +200 °C. It has excellent electrical properties plus ozone resistance, low moisture absorption, weather resistance, and radiation resistance. It typically has low mechanical strength and poor scuff resistance.

FEP/TFE

This material has excellent electrical properties, temperature range, and chemical resistance. It is not suitable where subjected to nuclear radiation and does not have good high voltage characteristics. FEP is extrudable in a manner similar to PVC and polyethylene. This means that long wire and cable lengths are available. TFE is extrudable in a hydraulic ram type process. Lengths are limited due to amount of material in the ram, thickness of the insulation, and preform size. TFE must be extruded over a silver- or nickel-coated wire. The nickel- and silver-coated designs are rated +260 °C and +200 °C maximum, respectively. The cost of FEP/TFE is approximately 8 to 10 times more per pound than PVC compounds.

ETFE

Fluorocopolymer thermoplastic material having excellent electrical properties, heat resistance, chemical resistance, toughness, radiation resistance, and flame resistance. The temperature rating is -65 °C to +150 °C.

Insulations and Jackets

Comparative Properties of Plastic Insulating and Jacketing Compounds

Properties	PVC	LDPE	Cellular Polyethylene	HDPE	Polypropylene	Cellular Polypropylene	PUR	Nylon	CPE	Flamarrest®
Oxidation Resistance	E	E	E	E	E	E	E	E	E	E
Heat Resistance	G-E	G	G	E	E	E	G	E	E	G-E
Oil Resistance	F	G-E	G	G-E	F	F	E	E	E	F
Low-Temperature Flexibility	P-G	E	E	E	P	P	G	G	E	P-G
Weather, Sun Resistance	G-E	E	E	E	E	E	G	E	E	G
Ozone Resistance	E	E	E	E	E	E	E	E	E	E
Abrasion Resistance	F-G	G	F	E	F-G	F-G	O	E	E-O	F-G
Electrical Properties	F-G	E	E	E	E	E	P	P	E	G
Flame Resistance	E	P	P	P	P	P	P	P	E	E
Nuclear Radiation Resistance	F	G-E	G	G-E	F	F	G	F-G	O	F
Water Resistance	F-G	E	E	E	E	E	P-G	P-F	O	F
Acid Resistance	G-E	G-E	G-E	E	E	E	F	P-F	E	G
Alkali Resistance	G-E	G-E	G-E	E	E	E	F	E	E	G
Aliphatic Hydrocarbons Resistance (Gasoline, Kerosene, etc.)	P	G-E	G	G-E	P-F	P	P-G	G	E	P
Aromatic Hydrocarbons Resistance (Benzol, Toluol, etc.)	P-F	P	P	P	P-F	P	P-G	G	G-E	P-F
Halogenated Hydrocarbons Resistance (Degreaser Solvents)	P-F	G	G	G	P	P	P-G	G	E	P-F
Alcohol Resistance	P-F	E	E	E	E	E	P-G	P	E	G
Underground Burial	P-G	G	N/A	E	N/A	N/A	G	P	E-O	P

These ratings are based on average performance of general purpose compounds. Any given property can usually be improved by the use of selective compounding.

Comparative Properties of Fluoropolymer and Rubber Insulating and Jacketing Compounds

Properties	Fluoropolymers					Rubber				
	FEP	ETFE	PTFE	PVDF/PVF	E-CTFE	Rubber	Neoprene	CSPE	EPDM	Silicone
Oxidation Resistance	O	E	O	O	O	F	G	E	E	E
Heat Resistance	O	E	O	O	O	F	G	E	E	O
Oil Resistance	O	E	E-O	E	O	P	G	G	P	F-G
Low-Temperature Flexibility	O	E	O	F	O	G	F-G	F	G-E	O
Weather, Sun Resistance	O	E	O	E-O	O	F	G	E	E	O
Ozone Resistance	E	E	O	E	E	P	G	E	E	O
Abrasion Resistance	E	E	O	E	E	E	G-E	G	G	P
Electrical Properties	E	E	E	G-E	E	G	P	G	E	G
Flame Resistance	O	G	E	E	E-O	P	G	G	P	F-G
Nuclear Radiation Resistance	P-G	E	P	E	E	F	F-G	E	G	E
Water Resistance	E	E	E	E	E	G	E	E	G-E	G-E
Acid Resistance	E	E	E	G-E	E	F-G	G	E	G-E	F-G
Alkali Resistance	E	E	E	E	E	F-G	G	E	G-E	F-G
Aliphatic Hydrocarbons Resistance (Gasoline, Kerosene, etc.)	E	E	E	E	E	P	G	F	P	P-F
Aromatic Hydrocarbons Resistance (Benzol, Toluol, etc.)	E	E	E	G-E	E	P	P-F	F	F	P
Halogenated Hydrocarbons Resistance (Degreaser Solvents)	E	E	E	G	E	P	P	P-F	P	P-G
Alcohol Resistance	E	E	E	E	E	G	F	G	P	G
Underground Burial	E	E	E	E	E	N/A	N/A	N/A	N/A	N/A

These ratings are based on average performance of general purpose compounds. Any given property can usually be improved by the use of selective compounding

CPE = Chlorinated Polyethylene • HDPE = High-density Polyethylene • LDPE = Low-density Polyethylene • PUR = Polyurethane

Insulations and Jackets

Nominal Temperature Range for Various Insulating and Jacketing Compounds

Compound	Normal Low	Normal High	Special Low	Special High
CSPE	-20 °C	+90 °C	-40 °C	+105 °C
EPDM	-55 °C	+105 °C	–	+150 °C
Neoprene	-20 °C	+60 °C	-55 °C	+90 °C
Polyethylene (Solid and Foamed)	-60 °C	+80 °C	–	–
Polypropylene (Solid and Foamed)	-40 °C	+105 °C	–	–
Rubber	-30 °C	+60 °C	-55 °C	+75 °C
FEP	-70 °C	+200 °C	—	–
PVC	-20 °C	+80 °C	-55 °C	+105 °C
Silicone	-80 °C	+150 °C	–	+200 °C
E-CTFE	-70 °C	+150 °C	–	–
ETFE	-65 °C	+150 °C	–	–
PTFE	-70 °C	+260 °C	–	–
CPE	-35 °C	+90 °C	-45 °C	+105 °C
PVDF/PVF	-20 °C	+150 °C/+125 °C	-40 °C	+150 °C/+150 °C
Flamarrest®	-20 °C	+75 °C	–	–

Shielding Overview

Innovative Leadership

The evolution of technology maintains steady demand for sophisticated cable shielding. Belden meets that demand with innovative shielding and shield effectiveness testing methods to supply you with high quality, dependable cable.

With the creation of trademarked shield designs and patented test methods, Belden has earned a reputation for innovation and leadership that is unequaled in the wire and cable industry. In addition, Belden offers the broadest line of shielded multi-conductor, coaxial and flat cable in the industry.

Several unique Belden innovations are utilized across a wide range of shielding applications:

- **Beldfoil®** – The first aluminum/polyester foil developed for use as a cable shield. Provides 100% shield coverage for optimum protection.
- **Duofoil®** – Consists of an aluminum-poly-aluminum laminate wrapped around the cable's dielectric core. Provides 100% physical coverage, and improves shield reliability and flex life.

Belden also uses a number of innovative techniques to apply shielding to multi-conductor and paired cables:

- **"French Braid" Shields** – Belden's patented "French Braid" shield is a double spiral (double serve shield) with the two spirals tied together by one weave.

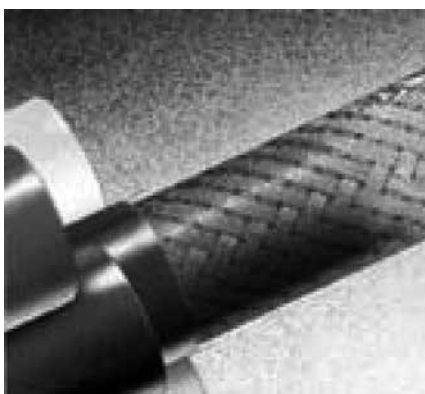

Belden's patented "French Braid" shield.

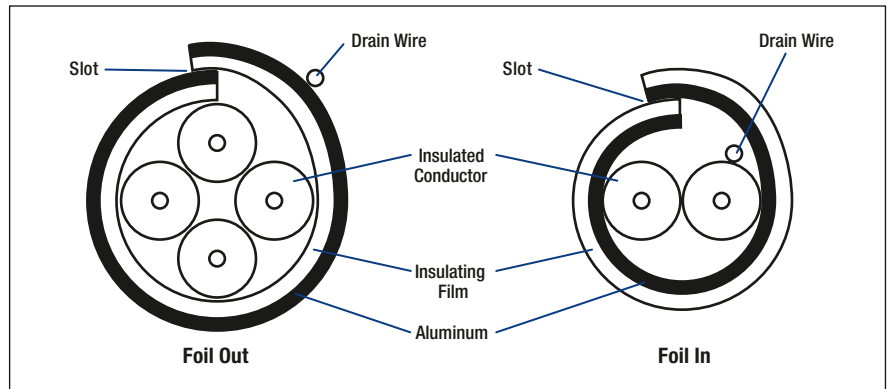

Figure 1: Foil shield configurations without shorting folds.

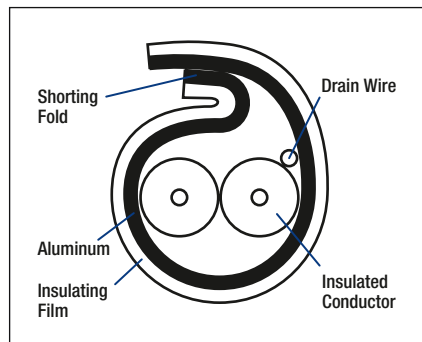

Figure 2: Foil shield configuration with shorting fold.

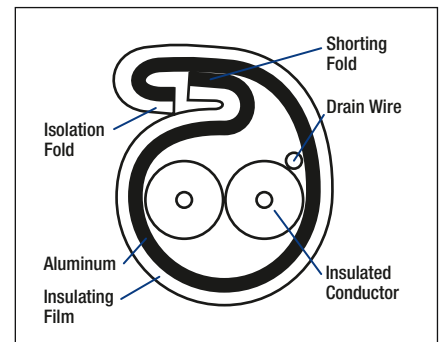

Figure 3: Foil shield with Z-Fold reduces crosstalk in multi-pair applications.

- **Shorting Fold** – Belden uses a shorting fold technique to maintain metal-to-metal contact for improved high frequency performance. Without the shorting fold, a slot is created through which signals can leak and cause interference. (See Figures 1 and 2.)

- **Z-Fold®** – Belden improves on the traditional shorting fold by employing a Z-Fold designed for use in multi-pair applications to reduce crosstalk. The Z-Fold (see Figure 3) combines an isolation and a shorting fold. The shorting fold provides metal-to-metal contact while the isolation fold keeps shields from shorting to one another in multi-pair, individually shielded cables.

The use of either a shorting fold or a Z-Fold increases the foil shield's range of effectiveness to higher frequencies.

Shielding

Characteristics of Belden Shield Types

Foil Shields

Foil shields consist of aluminum foil laminated to a polyester or polypropylene film. The film gives the shield mechanical strength and bonus insulation. Foil shields provide 100% cable coverage, necessary for electrostatic shield protection. Because of their small size, foil shields are commonly used to shield individual pairs of multi-pair data cables to reduce crosstalk. They have less weight, bulk and cost less than spiral or braid shields and are generally more effective than braid shields in RF ranges. Foil shields are more flexible than braid but have a shorter flex life than spiral or braid.



Drain wires are used with foil shields to make termination easier and to ground electrostatic discharges. The shortcomings in using the foil shield include higher DC resistance and lower mechanical strength than braid or spiral shields.

Braid Shields

A braid shield consists of groups of tinned or bare copper or aluminum strands, one set woven in a clockwise direction and interwoven with another set in a counterclockwise direction.



Braid shields provide superior structural integrity, while maintaining good flexibility and flex life. These shields are ideal for minimizing low frequency interference and have lower DC resistance than foil. Braid shields are effective at audio, as well as RF ranges.

Generally, the higher the braid coverage, the more effective the shield. However, the trade-off between cost and braid coverage must be considered. Typical braid coverages are between 80% and 95%. Coverage of 100% is unattainable with a braid shield. Other features to consider when choosing a braid shield are the weave angle, strand diameter, number of carriers (strand groups) and the number of ends (strands).

Braid shields are generally bulkier and heavier than other shields and, in some cases, harder to terminate because the braid may be combed out and pigtailed.

Spiral/Serve Shields

A spiral/serve shield consists of wire (usually copper) wrapped in a spiral around the inner cable core.



Superior flexibility and flex life, ease of termination and

up to 97% coverage are the advantages of spiral shields. They are best suited for audio applications. As a rule, spiral shields are not effective above the audio frequency range due to the coil effect produced by the inductance of served wire strands.

"French Braid" Shields

Belden's patented "French Braid" shield is a double spiral (double serve shield) with the two spirals tied together by one weave. This construction provides improved flex life over standard spiral shields, improved flexibility over conventional braid shields, and lower levels of microphonic or triboelectric noise than either spiral or conventional braid shields.



Combination Shields

Combination shields consist of more than one layer of shielding. They provide maximum shield efficiency across the frequency spectrum. The combination foil/braid shield combines the advantages of 100% foil coverage, plus the strength and low DC resistance of the braid.

Belden has also developed a number of shielding configurations for use with broadband coaxial cables.

- **Duobond®** – Duobond is essentially the same construction as Duofoil® (a laminated tape of foil/film/foil), but with an extra layer of adhesive bonding the foil shield to the dielectric core. This foil shield provides 100% coverage and insures maximum shield protection.

- **Duobond II (Foil/Braid)** – Combines Duobond with an outer braid, applied for greater protection against interference and to increase the overall tensile strength.



- **Duobond III (Tri-Shield)** – Uses the Duobond II design (foil/braid) plus a surrounding layer of Duofoil. The extra foil layer improves shield reliability and provides an additional interference barrier.



- **Duobond Plus®** – Features foil/braid/foil construction with a shorting fold in the outermost foil. This fold prevents a slot opening from being created in the shield, thereby preventing signal egress or ingress.



- **Duobond IV (Quad Shield)** – Offers an extra layer of braid shield (foil/braid/foil/braid) for improved strength and durability.



Other combination shields are available such as the foil/braid/foil/braid used on the Ethernet cables, braid/braid or foil/spiral.

Shielding

Shield Types Application Guide, Relative Cost Comparison of Shield Types Shield Performance Ratings

Shield Types Application Guide

Choose a Foil Shield...

- For protection against capacitive (electric field) coupling where shield coverage is more important than low DC resistance.
- When possible sources of interference include TV signals, crosstalk from other circuits, radio transmitters, fluorescent lights or computing equipment.
- For MATV, CATV, video, networking, computer I/O cables in office, industrial or commercial environments where ambient EMI levels are low.

Choose a Braid Shield...

- For superior performance against diffusion coupling, where low DC resistance is important, and to a lesser extent, capacitive and inductive coupling.
- When possible sources of interference exhibit low impedance characteristics, such as motor control circuits and switches which operate inductive loads.
- For computer to terminal interconnect for process, instrumentation or control applications.

Choose a Spiral Shield...

- For functional shielding against diffusion and capacitive coupling at audio frequencies only.
- When possible sources of interference are power lines and fluorescent lights.
- For applications when flexibility and flex life are major concerns, such as microphone and audio cables and retractile cords.

Choose a Combination Shield...

- For shielding against high frequency radiated emissions coupling and ESD. Combines the low resistance of braid and 100% coverage of foil shields.
- When possible sources of interference include radio transmitters, TV stations, printed circuit boards, back planes, motor control circuits and computing equipment.
- For Video, CATV, MATV, networking, computer I/O cables and computer-aided manufacturing applications.

Relative Cost Comparison

Relative cost comparisons are based on coaxial cable. Chart shows relative shield cost as one component of the total cost of the cable. These cost ratings may change depending on the physical construction of the cable.

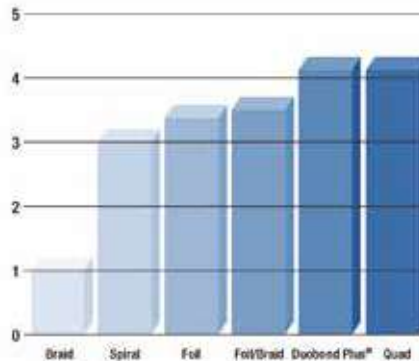

Shield Performance Comparison Chart

Frequency Range and Types of Interference Anticipated	Cable Shield Rating [®]				
	Braid 95% Coverage	Spiral	Foil	Foil/Braid	Foil/Braid/Foil Duobond Plus [®]
Frequency: DC					
Capacitive	A	AA	AAA	AAA	AAA
Diffusion	AAA	A	C	AAA	AAA
Diffusion/Inductive	-	-	-	-	-
Diffusion/Inductive/Capacitive	-	-	-	-	-
Frequency: 15 kHz					
Capacitive	A	AA	AAA	AAA	AAA
Diffusion	AAA	B	C	AAA	AAA
Diffusion/Inductive	AA	C	A	AA	AAA
Diffusion/Inductive/Capacitive	-	-	-	-	-
Frequency: 10 MHz to 1000 MHz					
Capacitive	A	AA	AAA	AAA	AAA
Diffusion	-	-	-	-	-
Diffusion/Inductive	B	C	A	AA	AAA
Diffusion/Inductive/Capacitive	B	C	A	AA	AAA

* Although ratings shown above are based on shielded coaxial cable test results, these ratings also pertain to shielded multi-conductor and flat cable where shield types are available.

Note: Shield effectiveness decreases as frequency increases. Therefore, ratings in one frequency category do not imply equal shield effectiveness in other frequency categories.

Shield Rating Key	
AAA	Best
AA	Better
A	Good
B	Functional
C	Unsatisfactory
-	Not Applicable

Cables Standards Reference Guide

National Electrical Code (NEC)[®] Catalog Reference Information

The National Electrical Code is a set of guidelines describing procedures which minimize the hazards of electrical shock, fires, and explosions caused by electrical installation. The text of the NEC is contained in nine chapters, each chapter broken into individual articles.

NEC types are acronyms consisting of a prefix describing cable type (e.g. coax, CATV, fiber optic) and a suffix indicating the type of flame test it has passed and where it can be installed. Articles describing wire and cable products – including required cable markings – are listed in the chart to the right.

Impact of the NEC

Almost everyone involved with wire and cable is affected by the National Electrical Code. In particular, the following groups must incorporate NEC guidelines into their work: OEM engineers, wire and cable product engineers, distributors, installers, and architects.

Although NEC covers wire and cable installed in factories, office buildings, hotels, motels, apartment buildings, residences, and all cables which pass through any floor, wall, ceiling, or which travel in ducts, plenums, and other air handling spaces, each individual municipality, city, county, or state can decide whether or not they wish to adopt the NEC as law. Local authorities having jurisdiction enforce their own codes. They have the right to accept or refuse any installation in accordance with their own local laws. One of the organizations local inspectors rely on to test wire and cable is Underwriters Laboratories (UL).

Intended Uses of Appliance Wiring Materials (AWM)

In the past, AWM cable was incorrectly used to wire buildings – this was never its intended use.

AWM cable is intended for internal wiring of factory-assembled, listed appliances such as computers, business machines, ranges, washers, dryers, radios, and televisions.

In some cases, AWM cable may be used for external connection. In these situations, the user should be aware that AWM cable temperatures and voltage ratings may differ from NEC ratings.

NEC Article/Type	Description	Installation Type			
		Plenum	Riser	Commercial	Residential
CL2	Class 2 cables	CL2P	CL2R	CL2	CL2X*
CL3	Class 3 cables	CL3P	CL3R	CL3	CL2X*
725 PLTC	A stand-alone class. This is a power limited tray cable – a CL3-type cable which can be used outdoors, is sunlight- and moisture-resistant and must pass the Vertical Tray flame test.	(none)	(none)	PLTC	(none)
760 FPL	Power limited, fire protective signaling circuit cable	FPLP	FPLR	FPL	(none)
770	OFN Fiber cable also containing metallic conductors	OFNP	OFNR	OFNG, OFN	(none)
	OFN Fiber cable only containing optical fibers	OFNP	OFNR	OFNG, OFN	(none)
800 CM	Communications	CMP	CMR	CMG, CM	CMX*
820 CATV	Community antenna television and radio distribution system	CATVP	CATVR	CATV	CATVX**
830 BM	Network-powered broadband communications cable	BLP	BMR	BM	BLX

* Cable diameter must be less than 0.250".

** Cable diameter must be less than 0.375".

C(UL) Certifications

UL/NEC-Approved cables may also be C(UL)/CEC-Approved as communications cables meeting the requirements of the Bi-National Standard CSA C22.2 No. 214/UL 444 and Section 60 of the Canadian Electrical Code, Part I (CEC). The C(UL) cable designation (and its meaning) would be one of the following:

1. **CMP** – Cable meeting CSA FT6 or NFPA 262 (UL 910);
2. **CMR** – Cable meeting UL 1666;
3. **CMG** – Cable meeting CSA FT4 or FT4/IEEE 1202 type of flames exposure (without smoke measurements) in UL 1685;
4. **CM** – Cable meeting UL 1685 (without smoke measurement) (UL 1581, Sec. 1160) Vertical-Tray;
5. **CMX or CMUC** – Meeting UL 1581, Sec. 1080 (VW-1);
6. **CMH** – Cable meeting CSA FT1.

NOTE: The CSA flame tests are defined in CSA C22.2 No. 0.3 as follows:

FT1 Vertical Flame Test – per C.S.A. C22.2 No. 0.3-92 Para 4.11.1

A finished cable shall not propagate a flame or continue to burn for more than 1 minute after five 15-second applications of the test flame. There is an interval of 15 seconds between flame applications. The flame test shall be performed in accordance with Para 4.11.1 of Canadian Standards Association (CSA) Standard C22.2 No. 0.3. In addition, if more than 25% of the indicator flag is burned, the test cable fails.

FT4 Vertical Flame Test – Cables in Cable Trays per C.S.A. C22.2 No. 0.3-92 Para 4.11.4

The FT4 Vertical Flame Test – Cables in Cable Trays is similar to the UL-1685 Vertical Tray Flame Test, but is more severe. The FT4 test has its burner mounted at 20° from the horizontal with the burner ports facing up. The UL-1685 Vertical Tray has its burner at 0° from the horizontal. The FT4 samples must be larger than 13 mm (.512") in diameter.

If not, then the cable samples are grouped in units of at least three (3) to obtain a grouped overall diameter of 13mm. The UL-1581 Vertical Tray does not distinguish on cable size. The FT4 has a maximum char height of 1.5 m (59") measured from the lower edge of the burner face. The UL-1685 has a flame height allowable up to approximately 78" measured from the burner.

FT6 Horizontal Flame & Smoke Test – per C.S.A. C22.2 No. 0.3-92 Appendix B

Belden products passing the FT6 Horizontal Flame and Smoke Test are designated FT6 in the column where the trade number appears. This test is for cables which must pass a Horizontal Flame and Smoke Test in accordance with ANSI/NFPA Standard 262-1985 (UL-910). The maximum flame spread shall be 1.50 meters (4.92 ft.). The smoke density shall be 0.5 at peak optical density and 0.15 at maximum average optical density.

Cables Substitution Chart

Per 2005 NEC®

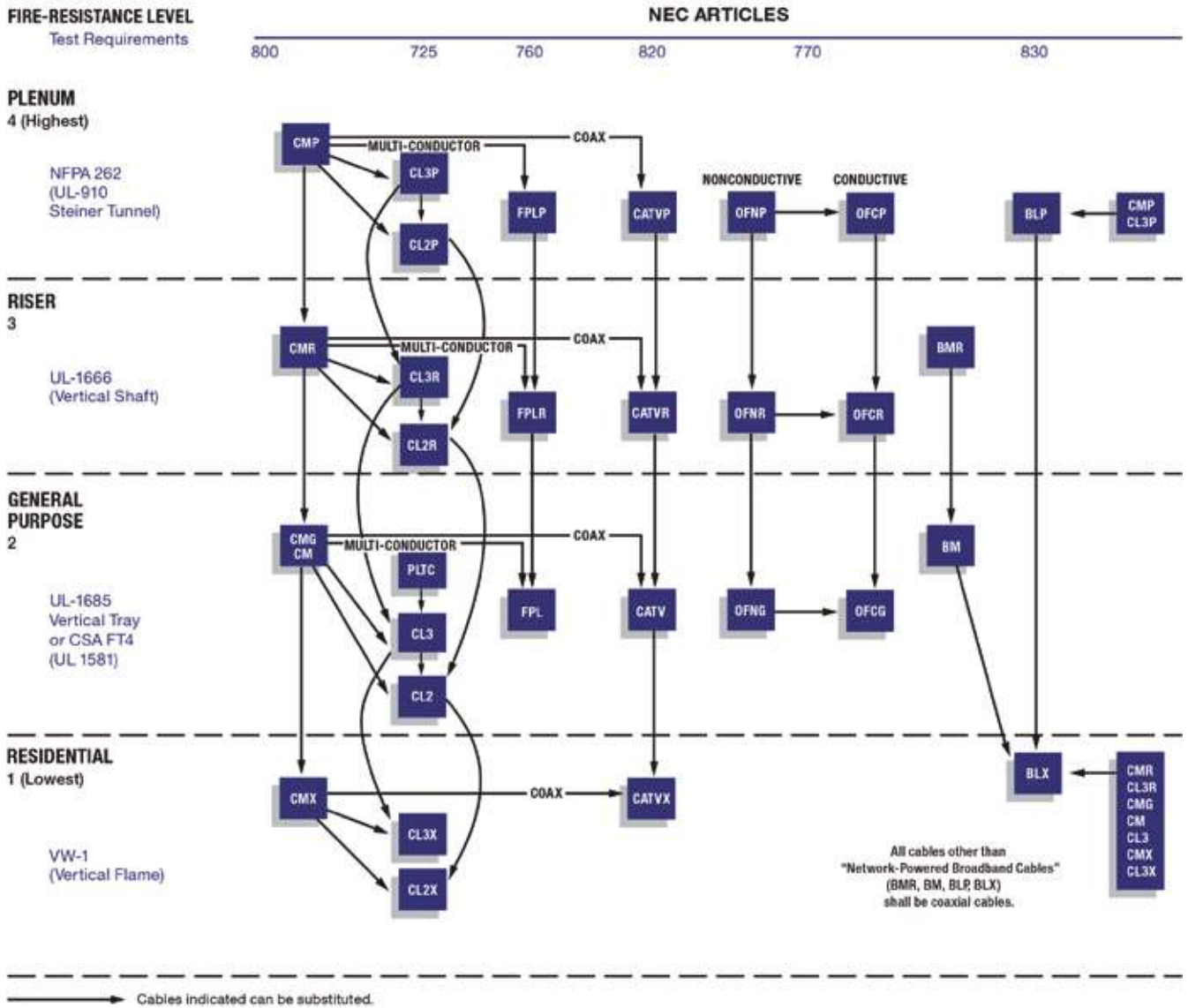

NEC Type	Definition
CMP, CMR, CMG, CM, CMX	Communications Cables
CL3P, CL3R, CL3, CL3X, CL2P, CL2R, CL2, CL2X	Class 2 and Class 3 Remote-Control, Signaling and Power Limited Cables
FPLP, FPLR, FPL	Power Limited Fire Alarm Cables
CATVP, CATVR, CATV, CATVX	Community Antenna Television and Radio Distribution Cables
OFNP, OFNR, OFNG, OFN	Nonconductive Optical Fiber Cables
OFCP, OFCR, OFCG, OFC	Conductive Optical Fiber Cables
PLTC	Power Limited Tray Cables
BMR, BM, BLP, BLX	Network-powered Broadband Communications Cable

National Electrical Code and NEC are registered trademarks of the National Fire Protection Association, Inc., Quincy, MA.

Canadian Substitution Hierarchy and Catalog Terms of Use

Cable Substitution Hierarchy as per C22.2 #214 – Communication Cables

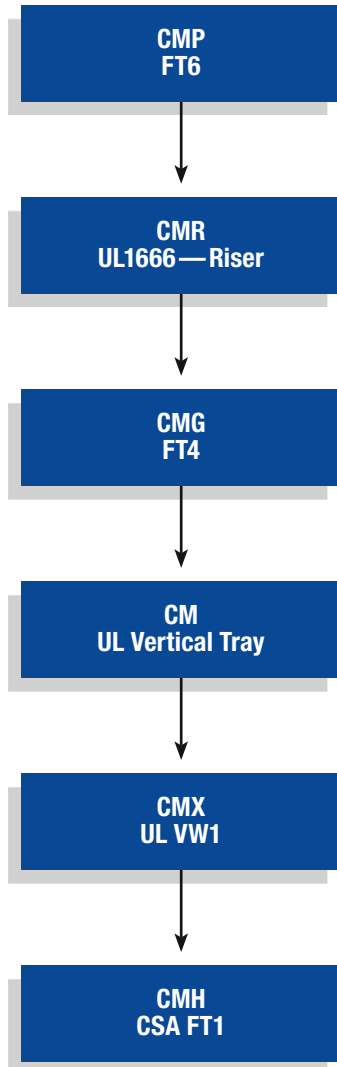

Canadian Electrical Code, Part 1, Table 19, Note 21:

The following cable substitution may be used:

- a. Communication cables marked CMP, CMR, CMG, CM, CMX, CMH, FT6, and FT4/IEEE 1202 have been found to meet the standard criteria for FT1.
- b. Communication cables marked CMP, CMR, CMG, and FT6 have been found to meet the standard criteria for FT4/IEEE 1202.
- c. Communication cables marked CMP have been found to meet the standard criteria for FT6.

Terms of Use

Use of Information; Disclaimers

Although Belden Electronics Division ("Belden") makes every reasonable effort to ensure their accuracy at the time of this publication, information and specifications described in this catalog are subject to change without notice. The most current product information may be found by accessing our Website at www.belden.com or contacting Belden Technical Support.

Belden provides the information and specifications in this catalog on an "AS IS" basis, with no representations or warranties, whether express, statutory or implied. WITH RESPECT TO SUCH INFORMATION AND SPECIFICATIONS, BELDEN DISCLAIMS ALL WARRANTIES OF MERCHANTABILITY, FITNESS FOR INTENDED PURPOSE AND NON-INFRINGEMENT. IT ALSO EXCLUDES ANY EXPRESS OR IMPLIED WARRANTIES ARISING FROM ANY COURSE OF DEALING, USAGE, TRADE PRACTICE OR PERFORMANCE. BELDEN'S SOLE WARRANTIES ARE AS BELDEN MAY PROVIDE IN (AND SUBJECT TO THE TERMS AND LIMITATIONS OF) SEPARATE WARRANTY DOCUMENTATION.

In no event will Belden be liable for any damages (including consequential, indirect, incidental, special, punitive, or exemplary damages) whatsoever, even if Belden has been advised of the possibility of such damages, whether in an action under contract, negligence or any other theory, arising out of or in connection with the use, inability to use, or performance of the information, specifications or products described in this catalog.

Belden's Terms and Conditions of Sale

All sales of Belden® products are subject to Belden's standard terms and conditions of sale.

Intellectual Property Protection

All trademarks or registered trademarks mentioned in this catalog are property of their respective owners. The information contained in this catalog is protected by copyright. No part of this catalog may be reproduced by any means without the prior written permission from Belden.

U.S. Export Laws

The United States Export Controls laws prohibit the export of certain technical data and software to certain territories. No content from this catalog may be reproduced or otherwise exported in violation of United States Law.

Glossary

Abrasion Resistance – Ability of a wire, cable or material to resist surface wear.

Accelerated Aging – A test that simulates long time environmental conditions in a relatively short time.

ACR – Attenuation to Crosstalk Ratio. The difference between attenuation and crosstalk, measured in dB, at a given frequency. Important characteristic in networking transmission to assure that signal sent down a twisted pair is stronger at the receiving end of the cable than are any interference signals imposed on that same pair by crosstalk from other pairs.

Alien Crosstalk – A measure of the unwanted signal coupling between cabling or components in close proximity.

American Wire Gage (AWG) – A standard for expressing wire diameter. As the AWG number gets smaller, the wire diameter gets larger.

Ampacity – Current handling capability expressed in amperes. The maximum current a conductor can carry without being heated beyond a safe limit.

Ampere – A standard unit of current. Defined as the amount of current that flows when one volt of electromotive force (EMF) is applied across one ohm of resistance. One ampere of current is produced by one coulomb of charge passing a point in one second.

Analog Signal – An electrical signal which varies continuously, not having discrete values. Analog signals are copies or representations of other waves in nature. An analog audio signal, for instance, is a representation of the pressure waves which make up audible sound.

Attenuation – The decrease in magnitude of a signal as it travels through any transmitting medium, such as a cable or circuitry. Attenuation is usually expressed logarithmically as the ratio of the original and decreased signal amplitudes. It is usually expressed in decibels (dB).

AWG – American Wire Gage. A wire diameter specification. The smaller the AWG number, the larger the wire diameter.

AWM – Appliance Wiring Material. A UL designation for a type of wire.

Balanced Line – A cable having two identical conductors which carry voltages opposite in polarity, but equal in magnitude with respect to ground, suitable for differential signal transmission.

Bandwidth – The difference between the upper and lower limits of a given band of frequencies. It is expressed in Hertz. The range of frequencies that a transmitted communications signal occupies or that a receiving system can accept. For example, it takes more bandwidth to download a photograph in a second than to download a page of text. Virtual reality and three-dimensional audio/visual presentations require even more.

Baud – Rate of digital transmission equal to the reciprocal of the time of one output signaling element.

Bel – A unit that represents the logarithm of the ratio of two levels. One bel equals the base 10 logarithm of the ratio of two power levels. It is also equal to the base 10 logarithm of square of the ratio of two voltage or current levels, provided the impedances are the same at the two levels. (See dB.)

Belflex® – A premium hybrid matte-finish jacket material that exhibits superior flexibility at low temperatures along with resistance compared to standard PVC jacketing materials.

Beldfoil® – Belden trademark for highly effective electrostatic shield of reinforced metallic foil.

Beldsol™ – Solderable Belden magnet wire combining insulating films of polyurethane for excellent dielectric characteristics and nylon for mechanical protection.

Bend Radius – Radius of curvature that a flat, round fiber optic or metallic cable can bend without any adverse effects.

Binder – A tape or thread used for holding assembled cable components in place.

Bit Error Rate – The number of errors occurring in a system per unit of time (e.g. bits per second).

Bonded Pairs™ – A patented method of providing uniform electrical characteristics in twisted pairs in which the insulations of the pair are bonded so that they maintain consistent geometry of twisting when bent or otherwise stressed during and after installation.

Braid – A group of textile or metallic filaments interwoven to form a tubular flexible structure which may be applied over one or more wires or flattened to form a strap.

Braid Angle – The angle between a strand of wire in a braid shield and the longitudinal axis (i.e., axis along the length of the center) of the cable it is wound around.

Breakdown Voltage – The voltage at which the insulation between two conductors will fail and allow electricity to conduct or “arc.”

Breakout – The point at which elements of a cable are separated from a multiconductor or fiber optic cable. Also called fanout.

Broadband – The technique used to multiplex multiple networks on a single cable without interfering with each other. Technologies that allow you to transmit or receive higher volumes of data at higher speeds.

Buffer – A protective coating over an optical fiber.

Bunch Strand – Conductors twisted together with the same lay and direction without regard to geometric pattern.

Buried – Cables that are required to go underground.

Bus-bar Wire – Uninsulated tinned copper wire used as a common lead.

Butyl Rubber – A synthetic rubber with good electrical insulating properties.

Cable – A group of electrically or optically conductive subcomponents twisted helically.

Cabling – The grouping or twisting together of two or more insulated conductors or subcomponents to form a cable.

Glossary (continued)

Capacitance – The ability of a dielectric material between conductors to store energy when a difference of potential exists between the conductors. The unit of measurement is the farad. Cable capacitance is usually measured in picofarads (pF).

Capacitive Crosstalk – Cable crosstalk or interference resulting from the coupling of the electrostatic field of one conductor upon one or more others.

Capacitive Reactance – The opposition to alternating current due to the capacitance of a capacitor, cable or circuit. It is measured in ohms and is equal to $1/(2\pi fC)$ where pi is approximately 3.1416, f is the frequency in Hz and C is the capacitance in farads.

Capacitor – Two conducting surfaces separated by a dielectric material. The capacitance is determined by the area of the surfaces, type of dielectric and spacing between the conducting surfaces.

Cellular Polyethylene – Expanded or “foam” polyethylene, consists of individual closed cells of inert gas suspended in a polyethylene medium. The result is a desirable reduction of the dielectric constant compared to solid polyethylene, which decreases attenuation and increases the velocity of propagation.

Center-to-Center Distance – Also called pitch. Nominal distance from center-to-center of adjacent conductors within a cable. When conductors are flat, pitch is usually measured from the reference edge of a conductor to the reference edge of the adjacent conductor.

Characteristic Impedance – In a transmission cable of infinite length, the ratio of the applied voltage to the resultant current at the point the voltage is applied. Or the impedance which makes a transmission cable seem infinitely long, when connected across the cable’s output terminals.

Circular Mil – Area of a wire that is one-thousandth of an inch (.001 inch, one mil) in diameter. This area is $\pi/4$ of a square mil. The circular mil area (CMA, cmil) equals the diameter in mils squared. By knowing the CMA of various conductors, they can be used to determine what conductivity and gage size various combinations will produce.

Cladding – A low refractive index material that surrounds the core of an optical fiber causing the transmitted light to travel down the core and protects against surface contaminant scattering or a layer of metal applied over another. Cladding is often chosen to improve conductivity or to resist corrosion.

Coaxial Cable – A cylindrical transmission line composed of a conductor centered inside a metallic tube or shield, separated by a dielectric material, and usually covered by an insulating jacket.

Coil Effect – The inductive effect exhibited by a spiral-wrapped shield, especially above audio frequencies.

Color Code – A system of different colors or stripes used to identify components of cables such as individual conductors or groups of conductors.

Composite Cable – Cable having conductors with two or more AWG sizes or more than one cable type.

Concentric Stranding – A group of uninsulated wires twisted together and containing a center core with subsequent layers spirally wrapped around the core with alternating lay directions to form a single conductor.

Conductivity – The ability of a material to allow electrons to flow, measured by the current per unit of voltage applied. It is the reciprocal of resistivity and is measured in siemens (S) or mhos.

Conductor – A substance, usually metal, used to transfer electrical energy from point to point.

Conduit – A tube of metal or plastic through which wire or cable can be run. Used to protect the wire or cable and, in the case of metal conduit, to contain the fire of a burning wire or cable.

Connector – A device designed to allow electrical flow from one wire or cable to a device on another cable. A connector will allow interruption of the circuit or the transfer to another circuit without any cutting of wire or cable or other preparation.

Cord – A very flexible insulated cable.

Core – The light conducting central portion of an optical fiber with a refractive index higher than that of the cladding. The center of a cable construction. Most often applies to a coaxial cable, where the core is the center conductor and the dielectric material applied to it.

Corona – The ionization of gasses about a conductor that results when the potential gradient reaches a certain value.

Coupling – The transfer of energy (without direct electrical contact) between two or more cables or components of a circuit.

Coverage – The extent to which a metal shield covers an underlying surface. Measured in percent.

CPE – Chlorinated polyethylene can be used as either a thermoplastic or thermoset. It is a tough chemical- and oil-resistant material and makes an excellent jacket for industrial control cable. As a thermoset, it can be used as an oil-resistant cord jacket. Other outstanding properties include low water absorption and superior crush resistance, which are important attributes in industrial control applications.

Crosstalk – A type of interference caused by signals from one pair or cable being coupled into adjacent pairs or cables. Can occur with audio, data or RF signals.

Datalene® – Belden trademark for foam polyolefin.

dB – Decibel

Decibel (dB) – A decibel is one-tenth of a bel and is equal to 10 times the logarithm of the power ratio, 20 times the log of the voltage ratio, or 20 times the log of the current ratio. Decibels are also used to express acoustic power, such as the apparent level of a sound. The decibel can express an actual level only when comparing with some definite reference level that is assumed to be zero dB.

Derating Factor – A multiplier used to reduce the current carrying capacity of conductors in more adverse environments, such as higher temperature, or where multiple conductors are together in one conduit.

Dielectric – An insulating (nonconducting) medium. It is the insulating material between conductors carrying a signal in a cable. In coaxial cables it is between the center conductor and the outer conductor. In twisted pair cables it is the insulation between conductors plus any surrounding air or other material.

Dielectric Breakdown – Any change in the properties of a dielectric that causes it to become conductive. Normally a catastrophic failure of an insulation because of excessive voltage. See Breakdown Voltage.

Dielectric Constant – Also called relative permittivity. That property of a dielectric which determines the amount of electrostatic energy that can be stored by the material when a given voltage is applied to it. Actually, the ratio of the capacitance of a capacitor using the dielectric to the capacitance of an identical capacitor using a vacuum (which has a dielectric constant of 1) as a dielectric. A number which indicates the quality of a material to resist holding an electrical charge when placed between two conductors.

Dielectric Heating – The heating of an insulating material when placed in a radio-frequency field, caused by internal losses during the rapid polarization reversal of molecules in the material.

Dielectric Loss – The power dissipated in a dielectric as the result of the friction produced by molecular motion when an alternating electric field is applied.

Dielectric Strength – The voltage an insulation can withstand before it breaks down. Usually expressed as volts per mil.

Dielectric Withstand Voltage – The voltage an insulation can withstand before it breaks down. Usually expressed as volts per mil.

Dispersion – The cause of bandwidth limitations in an optical fiber. Dispersion causes a broadening of input pulses along the length of the fiber. Two major types are (a) mode dispersion caused by differential optical path lengths in a multimode fiber, and (b) material dispersion caused by a differential delay of various wavelengths of light in a wave guide material.

Distortion – Any undesired change in a waveform or signal.

Drain Wire – A non-insulated wire in contact with parts of a cable, usually the shield, and used in the termination to that shield and as a ground connection.

Duobond® II – Belden trademark for a laminated shielding tape consisting of heat sensitive adhesive, aluminum foil, polyester or polypropylene and aluminum foil.

Duobond® IV – Belden trademark for a four-layer shield: (1) Duobond II foil, (2) tinned copper braid with 94% coverage, (3) Duofoil foil, (4) tinned copper braid with 90% coverage.

Duobond Plus® – Belden trademark for a foil/braid/foil connection with a shorting fold in the outermost shield.

Duofoil® – Belden trademark for a shield in which metallic foil is applied to both sides of a supporting plastic film.

Electromagnetic Coupling – The transfer of energy by means of a varying magnetic field. Inductive coupling.

Energy Dissipation – Loss of energy from a system due to the conversion of work energy into an undesirable form, usually heat. Dissipation of electrical energy occurs when current flows through a resistance.

EPDM – Ethylene-propylene-diene monomer rubber. A chemically cross-linked elastomer with good electrical insulating properties and excellent flexibility at high and low temperatures. It has good insulation resistance and dielectric strength, as well as excellent abrasion resistance and mechanical properties. EPDM has better cut-through resistance than silicone rubber, which it replaces in some applications.

Equilay – More than one layer of helically laid wires with the length of the lay in each layer.

Expanded Polyethylene – Expanded or "foam" polyethylene, consists of individual closed cells of inert gas suspended in a polyethylene medium, resulting in a desirable reduction of the dielectric constant.

Extruded Cable – Conductors are simultaneously insulated and the cable is formed by a continuous extrusion process.

FEP – Fluorinated ethylene-propylene. A thermoplastic material with good electrical insulating properties and chemical and heat resistance.

FEXT – Far End Crosstalk. Crosstalk induced on the pairs, measured at the far end of the cable, referenced to the near end input signal. Usually expressed in decibels (dB).

Fiber – A single, separate optical transmission element characterized by core and cladding.

Fiber Optics – Light transmission through optical fibers for communication and signaling. A technology that transmits information as light pulses along a glass or plastic fiber. Optical fiber carries much more information than conventional copper wire and is generally not subject to interference. Most telephone company long-distance lines are optical fiber.

Field – An area through which electric and/or magnetic lines of force pass.

Filled – Cables that are gel filled to improve waterblocking properties.

Fillers – Non-conducting components cabled with the insulated conductors or optical fibers to impart roundness and/or tensile strength to the cable.

Flamarrest® – Belden trademark for a plenum grade chloride-based thermoplastic jacketing material with low smoke and low flame spread properties; more flexible than traditional fluorocopolymer jacket materials. Cables jacketed with Flamarrest meet the ANSI/ NFPA Standard 2621-985 (UL-910) Flame Test.

Flame Resistance – The ability of a material to resist the spread of an applied flame.

Flex Life – The qualification of the number of times a cable may bend before breaking.

Flexibility – The ability of a cable to bend in a short radius. The ability of a cable to lay flat or conform to a surface as with microphone cables.

Glossary (continued)

Fluorocopolymer – Generic term for PVDF.

Foam Polyethylene – Expanded or “foam” polyethylene, consists of individual closed cells of inert gas suspended in a polyethylene medium, resulting in a desirable reduction of the dielectric constant.

FR-TPE – Flame retarded thermoplastic elastomer is a rubber-like plastic that has properties similar to rubber yet is processed as a thermoplastic. It is used as the insulation and jacket in an all TPE constructions which meets UL 13 and 1277 industrial cable requirements. It has good electrical properties, abrasion resistance, colorability, and flame retardance. This compound is ideal for cold weather applications.

Ground Conductor – A conductor in a transmission cable or line that is grounded.

Haloarrest® – Haloarrest is a non-halogenated flame retarding thermoplastic polyolefin with excellent low smoke and flame properties. It is often used as a jacket over the XLP insulated singles (non-XHHW), and the entire construction meets the UL 13 and 1277 specifications as a non-halogenated PLTC/TC cable. Haloarrest meets the European Specifications on acid gas evolution and % halogen content. This jacket can also be used with XHHW conductors for wet ratings.

HaloarrestXLink™ – HaloarrestXLink is a non-halogenated flame retarding thermoset compound with excellent low smoke and flame properties. The highly oil-resistant material is used as a jacket material in control, communication, and instrumentation applications and is suited for indoor and outdoor applications. The entire construction meets the UL 13 and 1277 specifications as a non-halogenated PLTC/TC cable. HaloarrestXLink meets the European Specifications on acid gas evolution and % halogen content.

Hook-Up Wire – Single conductor wire with various types of insulation.

Impedance Match – A condition whereby the impedance of a particular circuit, cable or component is the same as the impedance of the circuit, cable or device to which it is connected.

Impedance Matching Stub – A section of transmission line or pair of conductors cut to match the impedance of a load. Also called matching stub.

Insulation Stress – The molecule separation pressure caused by a potential difference across an insulator. The practical stress on insulation is expressed in volts per mil.

Interference – Disturbances of an electrical or electromagnetic nature that introduce undesirable responses into other electronic equipment.

Ionization – The formation of ions. Ions are produced when polar compounds are dissolved in a solvent and when a liquid, gas, or solid is caused to lose or gain electrons due to the passage of an electric current.

Ionization Voltage – The potential at which a material ionizes. The potential at which an atom gives up an electron.

Jacket – Pertaining to wire and cable, the outer protective covering that may also provide additional insulation.

Matte Finish PVC – A special formulation of PVC which very closely looks and feels like rubber. See Belflex®.

Mutual Capacitance – Effective capacitance between two conductors when the effects of the other conductors and shield, if present, are removed.

Neoprene – A synthetic rubber with good resistance to oil, chemical, and flame. Also called polychloroprene.

NEXT – Near-end Crosstalk. Crosstalk induced on the pairs, measured at the end near the transmitter. Usually expressed in decibels (dB).

NFPA – National Fire Protection Association.

Noise – In a cable or circuit, any extraneous signal which tends to interfere with the signal normally present in or passing through the system.

Non-Plenum – A description for a cable that does not meet the requirements of NFPA 262 (UL 910) CMP flame test. Such a cable cannot be installed in an area that is used for air return (plenum).

Nylon – An abrasion-resistant thermoplastic with good chemical resistance.

Ozone – Extremely reactive form of oxygen, normally occurring around electrical discharges and present in the atmosphere in small but active quantities. In sufficient concentrations it can break down certain rubber insulations under tension (such as a bent cable).

Plastic – High polymeric substances, including both natural and synthetic products that are capable of flowing under heat and pressure, called thermoplastics. Unlike rubber and other thermoset compounds, plastics can be remelted and reused.

Plasticizer – A chemical added to plastics to make them softer and more flexible.

Plenum – A compartment or chamber to which one or more air ducts are connected and that forms part of the air distribution system. A description for a cable that passes the NFPA 262 (UL-910) CMP flame test requirements.

Polyethylene (PE) – A thermoplastic material having excellent electrical properties. Low dielectric constant, a stable dielectric constant over all frequencies, very high insulation resistance. In terms of flexibility, polyethylene can be rated stiff to very hard, depending on molecular weight and density – low density being the most flexible and the high-density, high-molecular weight formulation being very hard. Moisture resistance is rated excellent.

Polymer – A substance made of many repeating chemical units or molecules. The term polymer is often used in place of plastic, rubber or elastomer.

Polyolefin – Any of the polymers and copolymers of the ethylene family of hydrocarbons, such as polyethylene and polypropylene.

Polypropylene (PP) – A thermoplastic similar to polyethylene but stiffer and having a higher softening point (temperature). This material is primarily used as an insulation material. Typically, it is harder than polyethylene. This makes it suitable for thin wall insulations. The dielectric constant is 2.25 for solid and 1.55 for cellular designs. Also called thermoplastic urethane (TPU).

Polyurethane (PUR or TPU) – Broad class of polymers noted for good abrasion and solvent resistance. Can be in solid or cellular form. This thermoplastic material is used primarily as a cable jacket material. It has excellent oxidation, oil, and ozone resistance. Some formulations also have good flame resistance. It is a hard material with excellent abrasion resistance. It has outstanding memory properties, making it an ideal jacket material for retractile cords.

Polyvinyl Chloride (PVC) – A general purpose thermoplastic used for wire and cable insulation and jackets.

Portable Cordage – Cable with two or more twisted conductors for flexible applications. Also called flexible cord.

PP – Polypropylene

Rated Temperature – The maximum temperature at which an electric component can operate for extended periods without loss of its basic properties.

Rated Voltage – The maximum voltage at which an electric component can operate for extended periods without undue degradation or safety hazard.

RG/U – RG is the abbreviation for radio guide, a military designation for a coaxial cable, and U stands for universal.

Rubber (Wire Insulation) – A general term used to describe wire insulations made of thermosetting elastomers, such as natural or synthetic rubbers, neoprene, butyl rubber and others.

Self-extinguishing – The characteristic of a material that extinguishes its own flame after the igniting flame is removed.

Separator – Pertaining to wire and cable, a layer of insulating material such as textile, paper, Mylar®, etc., which is placed between a conductor and its dielectric, between a cable jacket and the components it covers, or between various components of a multiple-conductor cable. It can be used to improve stripping qualities, flexibility or can offer additional mechanical or electrical protection to the components it separates.

Sheath – Pertaining to wire and cable, the outer protective covering, also called jacket, that may also provide additional insulation.

Shield – A tape, serve or braid (usually copper, aluminum or other conductive material) placed around or between electric circuits or cables or their components, to prevent signal leakage or interference.

Shield Coverage – The optical percentage of a cable actually covered by shielding material.

Shield Effectiveness – The relative ability of a shield to screen out undesirable interference or prevent signal leakage out of the cable. Frequently confused with the term shield coverage.

Shield Percentage – The percentage of physical area of a circuit or cable actually covered by shielding material.

Signal – Any visible or audible indication which can convey information. Also, the information conveyed through a communication system.

Silicone – A material made from silicon and oxygen. Can be in thermosetting elastomer or liquid form. The thermosetting elastomer form is noted for high heat resistance. This is a very soft thermoset insulation. It has excellent electrical properties plus ozone resistance, low moisture absorption, weather resistance, and radiation resistance. It typically has low mechanical strength and poor scuff resistance.

Single-mode Fiber – An optical fiber waveguide in which only one mode will propagate. The fiber has a very small core diameter of approximately 8 micro meters. It permits signal transmission at extremely high bandwidths and is generally used with laser diodes.

Thermoplastic – A material which will soften, flow or distort appreciably when subjected to sufficient heat and pressure. Examples are polyvinyl chloride and polyethylene.

Thermoset – A material which will not soften, flow or distort appreciably when subjected to heat and pressure. Vulcanizable. Examples are rubber and neoprene.

Triaxial Cable – A cable construction having a conductor and two isolated braid shields, all insulated from each other. A coaxial cable with a second braid applied over an inner jacket and an outer jacket applied over the outer braid. Commonly used in television camera systems.

Twinax Cable – Cable with two twisted conductors with established electrical properties (one pair = two conductors sharing a common axis = twinax).

Twisted Pair – Two lengths of insulated conductors twisted together. Gets its name because two insulated copper wires are twisted together, both of which are needed for each connection.

VW-1 – A flammability rating established by Underwriters Laboratories for wires and cables that pass a specially designed vertical flame test, formerly designed FR-1.

XLPE – Cross-linked poly is a thermoset and is cross linked by radiation, thermally, or by moisture. XLP offers a wide range of operating temperatures, excellent deformation, abrasion, and flame resistance. XLP can be formulated with halogenated or non-halogenated flame retardant packages. Some grades are also rated XHHW-2 which offers excellent wet electrical properties.



Belden – Wire and Cable solutions for high quality, top performance and total reliability.





Part Number Index

Section Table of Contents

Part Number Index

Part Number Index

372-401

Part Number Index

Part Number	Part Number	Part Number			
3GA	47	4GBCY	49	5GCSY	51
3GACY	49	4GBSY	51	5GD	47
3GASY	51	4GC	47	5GDCY	49
3GB	47	4GCCY	49	5GDSY	51
3GBCY	49	4GCSY	51	5GE	47
3GBSY	51	4GD	47	5GECY	49
3GC	47	4GDCY	49	5GESY	51
3GCCY	49	4GDSY	51	5GF	47
3GCSY	51	4GE	47	5GF	53
3GD	47	4GECY	49	5GFCY	49
3GDCY	49	4GESY	51	5GFSY	51
3GDSY	51	4GF	47	5GG	47
3GE	47	4GF	53	5GGCY	49
3GECY	49	4GFCY	49	5GGSY	51
3GESY	51	4GFSY	51	5GH	47
3GF	47	4GG	47	5GHCY	49
3GF	53	4GGCY	49	5GHSY	51
3GFCY	49	4GGSY	51	5GI	47
3GFSY	51	4GH	47	5GICY	49
3GG	47	4GHCY	49	5GISY	51
3GGCY	49	4GHSY	51	5GJ	47
3GGSY	51	4GI	47	5GJCY	49
3GH	47	4GICY	49	5GJSY	51
3GHCY	49	4GISY	51	5XA	48
3GHSY	51	4GJ	47	5XACY	50
3GI	47	4GJCY	49	5XASY	52
3GICY	49	4GJSY	51	5XB	48
3GISY	51	4XA	48	5XBCY	50
3GJ	47	4XACY	50	5XBSY	52
3GJCY	49	4XASY	52	5XC	48
3GJSY	51	4XB	48	5XCCY	50
3XA	48	4XBCY	50	5XCSY	52
3XACY	50	4XBSY	52	5XD	48
3XASY	52	4XC	48	5XDCY	50
3XB	48	4XCCY	50	5XDSY	52
3XBCY	50	4XCSY	52	5XE	48
3XBSY	52	4XD	48	5XE	48
3XC	48	4XDCY	50	5XECY	50
3XCCY	50	4XDSY	52	5XESY	52
3XCSY	52	4XE	48	5XFCY	50
3XD	48	4XE	48	5XFSY	52
3XDCY	50	4XECY	50	5XG	48
3XDSY	52	4XESY	52	5XGCV	50
3XE	48	4XFCY	50	5XGSY	52
3XE	48	4XFSY	52	5XH	48
3XECY	50	4XG	48	5XHCV	50
3XESY	52	4XGCV	50	5XHSY	52
3XFCY	50	4XGSY	52	5XI	48
3XFSY	52	4XH	48	5XICY	50
3XG	48	4XHCV	50	5XISY	52
3XGCV	50	4XHSY	52	5XJ	48
3XGSY	52	4XI	48	5XJCY	50
3XH	48	4XICY	50	5XJSY	52
3XHCV	50	4XISY	52	7GA	47
3XHSY	52	4XJ	48	7GACY	49
3XI	48	4XJCY	50	7GASY	51
3XICY	50	4XJSY	52	7GB	47
3XISY	52	5GA	47	7GBCY	49
3XJ	48	5GACY	49	7GBSY	51
3XJCY	50	5GASY	51	7GC	47
3XJSY	52	5GB	47	7GCCY	49
4GA	47	5GBCY	49	7GCSY	51
4GACY	49	5GBSY	51	7GD	47
4GASY	51	5GC	47	7GDCY	49
4GB	47	5GCCY	49	7GDSY	51

Part Number		Part Number		Part Number	
7GE	47	9XHSY	52	20XE	48
7GECY	49	12GA	47	20XECY	50
7GESY	51	12GACY	49	20XESY	52
7GF	47	12GASY	51	1000A	132
7GF	53	12GB	47	1006A	132
7GFCY	49	12GBCY	49	1012A	132
7GFSY	51	12GBSY	51	1013A	132
7GG	47	12GC	47	1018A	132
7GGCY	49	12GCCY	49	1023A	132
7GGSY	51	12GCSY	51	1030A	126
7GH	47	12GD	47	1031A	128
7GHCY	49	12GDCY	49	1032A	124
7GHSY	51	12GDSY	51	1033A	120
7GI	47	12GE	47	1034A	127
7GICY	49	12GECY	49	1035A	126
7GISY	51	12GESY	51	1036A	125
7GJ	47	12GF	47	1037A	140
7GJCY	49	12GFCY	49	1038A	137
7GJSY	51	12GFSY	51	1039A	140
7XA	48	12XA	48	1040A	140
7XACY	50	12XACY	50	1041A	140
7XASY	52	12XASY	52	1042A	140
7XB	48	12XB	48	1043A	140
7XBCY	50	12XBCY	50	1044A	140
7XBSY	52	12XBSY	52	1045A	140
7XC	48	12XC	48	1046A	140
7XCCY	50	12XCCY	50	1047A	140
7XCSY	52	12XCSY	52	1048A	137
7XD	48	12XD	48	1049A	137
7XDCY	50	12XDCY	50	1050A	137
7XDSY	52	12XDSY	52	1051A	137
7XE	48	12XE	48	1052A	137
7XE	48	12XE	48	1053A	137
7XECY	50	12XECY	50	1054A	137
7XESY	52	12XESY	52	1055A	140
7XFCY	50	12XFCY	50	1056A	120
7XFSY	52	12XFSY	52	1057A	120
7XG	48	20GA	47	1058A	120
7XGCV	50	20GACY	49	1059A	120
7XGSY	52	20GASY	51	1060A	120
7XH	48	20GB	47	1061A	120
7XHCY	50	20GBCY	49	1062A	120
7XHSY	52	20GBSY	51	1063A	136
7XI	48	20GC	47	1064A	136
7XICY	50	20GCCY	49	1065A	136
7XISY	52	20GCSY	51	1066A	136
7XJ	48	20GD	47	1067A	136
7XJCY	50	20GDCY	49	1068A	136
7XJSY	52	20GDSY	51	1069A	139
9GF	47	20GE	47	1070A	139
9GFCY	49	20GECY	49	1071A	139
9GFSY	51	20GESY	51	1072A	139
9GG	47	20XA	48	1073A	139
9GGCY	49	20XACY	50	1074A	139
9GGSY	51	20XASY	52	1075A	121
9GH	47	20XB	48	1076A	121
9GHCV	49	20XBCY	50	1077A	121
9GHSY	51	20XBSY	52	1078A	121
9XFCY	50	20XC	48	1079A	121
9XFSY	52	20XCCY	50	1080A	121
9XG	48	20XCSY	52	1081A	121
9XGCV	50	20XD	48	1082A	121
9XGSY	52	20XDCY	50	1083A	122
9XH	48	20XDSY	52	1084A	122
9XHCY	50	20XE	48	1085A	122

Part Number Index

Part Number		Part Number		Part Number	
1086A	122	1476A	124	3015A	118
1087A	136	1477A	124	3016A	120
1088A	136	1480A	124	3017A	122
1089A	139	1481A	124	3018A	122
1090A	139	1484A	126	3020A	122
1091A	121	1485A	126	3021A	122
1092A	122	1486A	126	3022A	122
1093A	138	1489A	126	3023A	122
1094A	138	1490A	126	3024A	122
1095A	138	1492A	127	3025A	124
1096A	138	1493A	127	3027A	125
1097A	141	1494A	127	3028A	125
1098A	141	1495A	127	3029A	123
1099A	141	1498A	127	3030A	125
1100A	141	1499A	127	3031A	125
1101A	132	1503A	104	3032A	125
1118A	139	1504A	104	3033A	125
1119A	141	1508A	109	3034A	124
1120A	136	1526A	122	3035A	124
1121A	138	1527A	139	3036A	125
1211A	36	1528A	126	3037A	125
1212A	36	1529A	124	3038A	125
1213A	36	1883A	109	3039A	125
1214A	36	2109A	240	3041A	124
1242A	17	2110A	240	3042A	124
1266A	104	2111A	240	3043A	126
1268A	226	2112A	240	3044A	128
1269A	226	2113A	240	3045A	128
1327A	239	2114A	240	3046A	128
1328A	239	2115A	240	3047A	128
1329A	239	2116A	240	3048A	128
1330A	239	2117A	240	3049A	128
1331A	239	2118A	240	3050A	126
1332A	239	2119A	240	3051A	127
1333A	239	2120A	240	3052A	128
1334A	239	2121A	240	3053A	128
1335A	241	2122A	240	3054A	128
1336A	241	2123A	240	3055A	128
1345F	248	2124A	240	3056A	126
1346F	248	2125A	240	3057A	127
1348A	258	2126A	240	3064A	138
1349A	258	2127A	241	3067A	122
1359A	239	2128A	241	3068A	125
1360A	240	2129A	241	3069A	128
1361A	240	2130A	241	3072F	257
1362A	240	2131A	241	3073F	257
1363A	240	2132A	241	3074F	257
1364A	240	2133A	241	3076ELS	239
1365A	240	2134A	241	3076ELS	243
1366A	240	2135A	241	3076ENH	239
1367A	240	3000A	118	3076ENH	243
1419A	218	3001A	118	3076F	243
1420A	218	3002A	119	3076F	239
1421A	218	3003A	119	3077ELS	242
1422A	218	3004A	118	3077ENH	242
1423A	218	3005A	118	3077F	242
1424A	218	3006A	118	3078F	242
1425A	218	3007A	118	3079A	244
1466A	124	3008A	118	3079ALS	244
1467A	124	3009A	118	3079ANH	244
1468A	124	3010A	118	3079E	244
1471A	124	3011A	118	3080A	142
1472A	124	3012A	118	3081A	143
1474A	124	3013A	118	3082A	247
1475A	124	3014A	118	3082F	247

Part Number	Part Number	Part Number			
3083A	248	5302FME	33	7410WS	46
3084A	248	5304FME	33	7411W	44
3084F	248	5306FME	33	7411WS	46
3085A	248	5320FME	33	7412W	44
3086A	249	5320UME	32	7413W	44
3087A	249	5322FME	33	7413WS	46
3088A	136	5322UME	32	7414W	44
3088AE	137	5324FME	33	7415W	44
3088CE	137	5324UME	32	7415WS	46
3089A	138	5326FME	33	7416W	44
3090A	139	5326UME	32	7416WS	46
3090AE	140	6051	81	7417W	44
3090CE	140	6054	81	7417WS	46
3091A	141	6059	81	7418W	44
3092A	255	6060	81	7421W	44
3092A	251	6163	83	7422W	44
3092F	251	6179	83	7422WS	46
3092F	255	6193	83	7423W	44
3092F	252	7101W	42	7423WS	46
3093A	251	7102W	42	7424W	44
3093A	255	7105W	42	7425W	44
3094A	252	7106W	42	7426W	44
3095A	252	7106WS	43	7427W	44
3102A	130	7107W	42	7427WS	46
3103A	143	7108W	42	7428W	44
3104A	143	7110W	42	7428WS	46
3105A	246	7111W	42	7429W	44
3106A	246	7111WS	43	7429WS	46
3107A	246	7113W	42	7430W	44
3108A	246	7116W	42	7435W	45
3109A	246	7117W	42	7435WS	46
3111A	132	7122W	42	7436W	45
3112A	132	7123WS	43	7438W	45
3113A	132	7125W	42	7438WS	46
3115A	132	7126W	42	7439W	45
3118A	141	7127W	42	7440W	45
3119A	250	7129W	42	7442W	45
3120A	250	7129WS	43	7444W	45
3124A	250	7136WS	43	7445W	45
3125A	250	7145W	42	7445WS	46
3126A	250	7200A	246	7447W	45
3130A	141	7200A	261	7447WS	46
3131A	252	7201A	246	7450WS	46
3132A	252	7201A	261	7453W	45
5000FME	34	7202A	246	7500A	261
5002FME	34	7202A	261	7501A	261
5020FME	34	7203A	246	7502A	261
5020UME	32	7203A	261	7503A	261
5022FME	34	7205A	261	7504A	261
5022UME	32	7206A	261	7701NH	256
5100FME	34	7400W	44	7702NH	256
5102FME	34	7401W	44	7703NH	256
5120FME	34	7401WS	46	7704NH	256
5120UME	32	7402W	44	7895A	248
5122FME	34	7403W	44	7896A	247
5122UME	32	7403WS	46	7897A	247
5200FME	33	7404W	44	7900A	247
5201FRE	35	7404WS	46	7918A	270
5202FME	33	7405W	44	7919A	270
5220FME	33	7406W	44	7921A	258
5220UME	32	7407W	44	7921A	270
5222FME	33	7408W	44	7922A	270
5222UME	32	7408WS	46	7923A	270
5240FRE	35	7409W	44	7924A	275
5300FME	33	7410W	44	7927A	272

Part Number Index

Part Number		Part Number		Part Number	
7928A	271	8148	224	8501	175
7929A	258	8155	224	8502	175
7929A	270	8205	99	8503	175
7930A	275	8205NH	99	8504	175
7931A	272	8302	221	8505	175
7932A	269	8303	221	8520	175
7933A	269	8304	221	8521	175
7934A	271	8305	221	8522	175
7935A	271	8306	221	8523	175
7936A	271	8307	221	8524	175
7937A	271	8308	221	8525	175
7938A	277	8310	221	8527	175
7939A	258	8312	221	8529	175
7939A	275	8315	221	8530	175
7940A	272	8318	221	8538	175
7953A	258	8325	221	8597	175
7953A	272	8332	222	8618	18
7957A	270	8333	222	8619	17
7958A	270	8334	222	8620	16
7960A	278	8335	222	8621	16
7961A	279	8336	222	8622	16
7962A	280	8337	222	8623	16
8000	191	8340	222	8624	16
8011	191	8342	222	8627	16
8012	191	8345	222	8628	16
8013	191	8348	222	8629	16
8019	191	8355	222	8641	109
8020	191	8434	97	8643	20
8021	191	8442	18	8660	191
8022	191	8443	18	8661	191
8023	191	8444	18	8662	191
8024	191	8445	18	8663	191
8025	191	8446	39	8668	191
8049	190	8448	39	8669	191
8050	190	8450	103	8670	191
8051	190	8451	103	8673	38
8052	190	8452	203	8675	38
8053	190	8453	205	8677	38
8054	190	8454	206	8678	38
8055	190	8455	206	8690	99
8056	190	8456	18	8691	99
8057	190	8457	18	8692	99
8058	190	8458	18	8718	107
8073	190	8459	18	8719	107
8074	190	8461	99	8719NH	107
8075	190	8465	17	8720	107
8076	190	8466	17	8722	98
8077	190	8467	17	8723	111
8078	190	8468	17	8723LS	111
8079	190	8469	17	8723NH	111
8080	190	8471	100	8723SB	111
8081	190	8471	256	8724	97
8083	190	8471LS	100	8725	98
8085	190	8471LS	256	8728	97
8132	224	8471NH	100	8729	19
8132FO	218	8471NH	256	8730	97
8133	224	8472	203	8734	21
8134	224	8473	100	8735	20
8134FO	218	8477	100	8740	101
8135	224	8478	203	8741	101
8135FO	218	8479	204	8742	101
8138	224	8484	38	8743	101
8138FO	218	8486	99	8744	101
8142	224	8489	17	8747	102
8142FO	218	8500	175	8748	102

Part Number		Part Number		Part Number	
8749	102	9155	98	9420	206
8750	102	9156	99	9421	18
8751	108	9157	99	9422	39
8752	103	9159	99	9422	206
8757	101	9160	101	9423	18
8760	106	9161	99	9424	39
8760LS	106	9182	254	9424	206
8760NH	106	9182LS	254	9425	39
8761	103	9182NH	254	9425	206
8761NH	103	9184	108	9427	39
8762	106	9207	254	9427	206
8762NH	106	9207NH	254	9429	39
8763	98	9250	254	9429	206
8764	110	9260	20	9430	18
8766	110	9261	20	9431	18
8767	110	9271	254	9432	18
8768	110	9272	254	9433	18
8769	112	9302	108	9434	18
8770	18	9305	108	9438	191
8770NH	18	9306	108	9439	17
8771	18	9309	108	9444	17
8771NH	18	9312	130	9445	17
8772	18	9314	129	9451	104
8772NH	18	9315	108	9451D	104
8773	112	9316	126	9451DP	105
8774	112	9318	123	9451P	105
8775	112	9319	108	9451SB	104
8776	112	9320	120	9455	17
8777	112	9322	117	9457	17
8777	255	9327	108	9460	106
8777LS	112	9328	117	9461	103
8777LS	255	9329	117	9462	103
8777NH	112	9330	117	9463	253
8777NH	255	9331	117	9463DB	253
8777SB	112	9332	117	9463F	253
8778	112	9333	117	9463LS	253
8778LS	112	9335	117	9463NH	253
8778NH	112	9341	136	9486	136
8786	28	9342	139	9487	139
8787	27	9343	142	9488	142
8788	28	9344	143	9489	143
8791	21	9363	119	9491	119
8794	17	9364	121	9492	121
8795	17	9365	125	9493	125
8800	176	9366	127	9494	127
8816	176	9367	129	9495	129
8824	176	9368	123	9498	17
8825	176	9369	123	9501	216
8866	189	9388	123	9501NH	216
8868	189	9389	123	9502	216
8869	189	9390	123	9502LS	216
8888	202	9391	123	9502NH	216
8890	189	9392	123	9503	216
8897	189	9402	115	9503NH	216
8898	189	9405	39	9504	216
8899	189	9406	111	9504NH	216
8908	174	9407	117	9505	216
8910	174	9408	120	9505NH	216
8915	174	9409	123	9506	216
8916	174	9410	126	9506NH	216
8917	174	9411	129	9507	216
8918	174	9412	130	9507NH	216
8919	174	9414	103	9508	216
8920	174	9418	19	9508NH	216
9154	106	9420	39	9509	216

Part Number Index

Part Number		Part Number		Part Number	
9510	216	9618	212	9825	224
9510NH	216	9619	212	9829NH	222
9512	117	9620	16	9841	225
9513	117	9621	16	9841	245
9514	117	9622	16	9841LS	225
9515	216	9623	16	9841LS	245
9516	117	9626	17	9841NH	225
9519	216	9637	213	9841NH	245
9520	117	9641	213	9842	225
9521	117	9680	218	9842	245
9524	117	9681	218	9842LS	225
9525	216	9682	218	9842LS	245
9526	117	9683	218	9842NH	225
9527	117	9684	218	9842NH	245
9531	176	9685	97	9843	225
9533	211	9696	226	9843	245
9534	211	9721	16	9843NH	225
9534NH	211	9728	219	9843NH	245
9535	211	9729	219	9844	225
9536	211	9729LS	219	9844	245
9536NH	211	9729NH	219	9844LS	225
9537	211	9730	219	9844NH	225
9538	211	9731	219	9844NH	245
9539	211	9732	219	9855	226
9540	211	9734	219	9860	254
9541	211	9735	219	9867	189
9541NH	211	9736	219	9873	115
9542	211	9737	219	9874	115
9543	211	9738	219	9875	115
9544	211	9740	99	9876	115
9545	211	9741	99	9877	115
9546	211	9742	99	9879	115
9550	216	9743	99	9880	260
9552	123	9744	102	9883	115
9553	123	9745	102	9886	115
9554	123	9746	102	9890	36
9556	123	9747	102	9894	36
9559	123	9748	102	9899	189
9562	101	9750	99	9904	175
9563	123	9751	99	9906	175
9565	123	9752	99	9907	260
9566	101	9755	99	9908	174
9570	101	9767	112	9909	172
9571	29	9768	112	9910	174
9572	29	9769	112	9911	172
9574	30	9770	19	9912	174
9575	30	9772	27	9916	173
9576	29	9773	115	9917	172
9578	30	9774	115	9918	173
9579	30	9775	115	9919	173
9580	29	9776	115	9920	173
9581	30	9777	115	9921	173
9582	29	9794	17	9923	173
9583	30	9802	36	9924	174
9585	101	9803	36	9925	215
9608	212	9804	224	9926	173
9609	212	9805	224	9927	215
9610	212	9806	224	9928	173
9611	212	9807	224	9929	215
9612	212	9808	224	9930	173
9613	212	9809	224	9931	215
9614	212	9812	224	9932	215
9615	212	9813	224	9933	215
9616	212	9814	224	9934	215
9617	212	9819	224	9935	215

Part Number	Part Number	Part Number			
9936	215	19201	203	21127	144
9937	215	19202	203	21128	144
9938	215	19203	203	21129	144
9939	214	19204	203	21130	144
9940	214	19205	204	21131	144
9941	214	19206	204	21132	144
9942	214	19207	204	21133	144
9943	214	19208	204	21134	144
9944	214	19209	204	21135	144
9945	214	19216	206	21136	144
9946	214	19217	206	21137	144
9947	214	19227	203	21138	144
9948	214	19228	203	21139	144
9949	214	19229	204	21140	144
9950	214	19230	204	21141	144
9951	37	19348	204	21142	144
9952	37	19349	204	21143	144
9953	37	19350	205	21144	144
9954	37	19352	204	21145	144
9961	37	19353	204	21146	144
9962	37	19354	204	21147	144
9963	37	19362	205	21148	144
9964	37	19363	205	21149	144
9965	37	19364	205	21150	144
9966	37	19401	205	21151	144
9967	37	19402	205	21152	144
9968	37	19403	205	21153	144
9975	172	19404	202	21154	144
9976	172	19405	202	21155	144
9977	172	19500	203	21212	144
9978	172	19501	203	21213	144
9979	172	19502	203	21214	144
9980	172	19503	205	21215	144
9981	172	19504	205	21216	144
9982	172	19505	205	21217	144
9983	172	19506	203	21218	144
9984	172	19507	203	21219	144
9985	172	19508	203	21220	144
9986	172	21100	144	21221	144
9987	172	21101	144	21222	144
9989	173	21102	144	21223	144
9990	110	21103	144	21224	144
9991	110	21104	144	21225	144
9992	110	21105	144	21226	144
9993	110	21106	144	21227	144
9995	110	21107	144	21228	144
9998	205	21108	144	21229	144
11700A	270	21109	144	21230	144
11700A2	270	21110	144	21231	144
11872A	272	21111	144	21232	144
19105	204	21112	144	21233	144
19106	204	21113	144	21234	144
19107	204	21114	144	21235	144
19108	204	21115	144	21236	144
19109	204	21116	144	21237	144
19115	202	21117	144	21238	144
19120	203	21118	144	21239	144
19122	202	21119	144	21240	144
19123	202	21120	144	21241	144
19124	204	21121	144	21242	144
19125	204	21122	144	21243	144
19126	202	21123	144	21244	144
19129	204	21124	144	21245	144
19130	204	21125	144	21246	144
19140	203	21126	144	21247	144

Part Number Index

Part Number		Part Number		Part Number	
21248	144	21345	74	21412	73
21249	144	21346	74	21413	73
21250	144	21347	74	21414	73
21251	144	21348	74	21415	73
21252	144	21350	73	21416	73
21253	144	21351	73	21417	73
21254	144	21352	73	21418	73
21255	144	21353	73	21419	73
21256	144	21354	73	21420	73
21257	144	21355	73	21421	73
21258	144	21356	73	21422	73
21259	144	21357	73	21423	73
21260	144	21358	73	21424	73
21261	144	21359	73	21425	73
21262	144	21360	73	21426	73
21263	144	21361	73	21427	73
21264	144	21362	73	21428	73
21265	144	21363	73	21429	73
21266	144	21364	73	21430	73
21267	144	21365	73	21431	73
21300	73	21366	73	21432	73
21301	73	21367	73	21433	73
21302	73	21368	73	21434	73
21303	73	21369	73	21435	73
21304	73	21370	73	21436	73
21305	73	21371	73	21437	73
21306	73	21372	73	21438	73
21307	73	21373	73	21439	74
21308	73	21374	73	21440	74
21309	73	21375	73	21441	74
21310	73	21376	73	21442	74
21311	73	21377	73	21443	74
21312	73	21378	73	21444	74
21313	73	21379	73	21445	74
21314	73	21380	73	21446	74
21315	73	21381	73	21447	74
21316	73	21382	73	21448	74
21317	73	21383	73	21450	74
21318	73	21384	73	21451	74
21319	73	21385	73	21452	74
21320	73	21386	73	21453	74
21321	73	21387	73	21454	74
21322	73	21388	73	21455	74
21323	73	21389	74	21456	74
21324	73	21390	74	21457	74
21325	73	21391	74	21458	74
21326	73	21392	74	21459	74
21327	73	21393	74	21460	74
21328	73	21394	74	21461	74
21329	73	21395	74	21462	74
21330	73	21396	74	21463	74
21331	73	21397	74	21464	74
21332	73	21398	74	21465	74
21333	73	21400	73	21466	74
21334	73	21401	73	21467	74
21335	73	21402	73	21468	74
21336	73	21403	73	21469	74
21337	73	21404	73	21470	74
21338	73	21405	73	21471	74
21339	74	21406	73	21472	74
21340	74	21407	73	21473	74
21341	74	21408	73	21474	74
21342	74	21409	73	21475	74
21343	74	21410	73	21476	74
21344	74	21411	73	21477	74

Part Number		Part Number		Part Number	
21478	74	21564	73	21630	73
21479	74	21565	73	21631	73
21500	73	21566	73	21632	73
21501	73	21567	73	21633	73
21502	73	21568	73	21634	73
21503	73	21569	73	21635	73
21504	73	21570	73	21636	73
21505	73	21571	73	21637	73
21506	73	21572	73	21638	73
21507	73	21573	73	21639	74
21508	73	21574	73	21640	74
21509	73	21575	73	21641	74
21510	73	21576	73	21642	74
21511	73	21577	73	21643	74
21512	73	21578	73	21644	74
21513	73	21579	73	21645	74
21514	73	21580	73	21646	74
21515	73	21581	73	21647	74
21516	73	21582	73	21648	74
21517	73	21583	73	21650	74
21518	73	21584	73	21651	74
21519	73	21585	73	21652	74
21520	73	21586	73	21653	74
21521	73	21587	73	21654	74
21522	73	21588	73	21655	74
21523	73	21589	74	21656	74
21524	73	21590	74	21657	74
21525	73	21591	74	21658	74
21526	73	21592	74	21659	74
21527	73	21593	74	21660	74
21528	73	21594	74	21661	74
21529	73	21595	74	21662	74
21530	73	21596	74	21663	74
21531	73	21597	74	21664	74
21532	73	21598	74	21665	74
21533	73	21600	73	21666	74
21534	73	21601	73	21667	74
21535	73	21602	73	21668	74
21536	73	21603	73	21669	74
21537	73	21604	73	21670	74
21538	73	21605	73	21671	74
21539	74	21606	73	21672	74
21540	74	21607	73	21673	74
21541	74	21608	73	21674	74
21542	74	21609	73	21675	74
21543	74	21610	73	21676	74
21544	74	21611	73	21677	74
21545	74	21612	73	21678	74
21546	74	21613	73	21679	74
21547	74	21614	73	22000	144
21548	74	21615	73	22001	144
21550	73	21616	73	22002	144
21551	73	21617	73	22003	144
21552	73	21618	73	22004	144
21553	73	21619	73	22005	144
21554	73	21620	73	22006	144
21555	73	21621	73	22007	144
21556	73	21622	73	22008	144
21557	73	21623	73	22009	144
21558	73	21624	73	22010	144
21559	73	21625	73	22011	144
21560	73	21626	73	22012	144
21561	73	21627	73	22013	144
21562	73	21628	73	22014	145
21563	73	21629	73	22015	145

Part Number Index

Part Number		Part Number		Part Number	
22016	145	22125	75	22685	146
22017	145	22126	75	22686	146
22018	145	22127	75	22687	147
22019	145	22128	75	22688	147
22020	145	22130	75	22689	147
22021	145	22134	75	23500	148
22022	145	22138	75	23501	148
22023	145	22140	75	23503	148
22024	145	22141	75	23505	149
22025	145	22142	75	23506	148
22041	145	22143	75	23507	149
22042	145	22144	75	23508	149
22043	145	22145	75	23509	148
22044	145	22146	75	23510	148
22045	145	22147	75	23511	148
22046	145	22148	75	23512	149
22047	145	22150	75	23513	148
22048	145	22152	75	23514	148
22049	145	22154	75	23515	149
22050	145	22160	76	23516	149
22051	145	22161	76	23519	148
22052	145	22162	76	23520	149
22054	144	22170	76	23521	148
22055	144	22171	76	23522	149
22056	144	22180	76	23523	149
22057	144	22181	76	23524	148
22058	144	22603	147	23525	148
22059	144	22628	146	23526	149
22060	144	22629	146	23527	148
22061	144	22630	146	23528	148
22062	144	22631	146	23529	149
22063	144	22632	146	23530	148
22064	144	22633	146	23531	148
22065	144	22634	146	23532	148
22066	144	22635	146	23533	148
22067	144	22636	146	23534	148
22068	145	22637	146	23536	149
22069	145	22638	146	23537	149
22070	145	22639	146	23538	148
22071	145	22640	146	23539	148
22072	145	22641	146	23541	149
22073	145	22643	146	23542	148
22074	145	22645	146	23543	148
22075	145	22646	146	23544	148
22076	145	22647	146	23545	149
22077	145	22648	146	23546	149
22078	145	22654	146	23547	149
22079	145	22660	147	23548	149
22100	75	22662	147	23549	149
22101	75	22663	147	23550	149
22102	75	22670	146	23554	148
22103	75	22671	146	23567	149
22104	75	22672	147	23568	148
22105	75	22673	147	23571	149
22106	75	22674	147	23575	148
22107	75	22675	147	23578	149
22108	75	22676	146	24500	150
22110	75	22677	147	24501	150
22114	75	22678	147	24502	150
22118	75	22679	147	24503	150
22120	75	22680	147	24504	150
22121	75	22681	147	24505	150
22122	75	22682	147	24506	150
22123	75	22683	147	24507	150
22124	75	22684	147	24508	150

Part Number		Part Number		Part Number	
24509	150	26532	148	27287	68
24510	150	26533	148	27288	68
24511	150	26534	148	27289	68
24512	150	26535	148	27290	68
24513	150	26536	148	27291	68
24514	150	26537	148	27292	67
24515	150	26538	148	27293	68
24516	150	26539	149	27325A	60
24517	150	26540	149	27325AS	60
24518	150	26541	149	27337A	61
24519	150	26542	149	27337AS	61
24520	150	26543	149	27428	69
25500	150	26544	149	27429	69
25501	150	26545	149	27430	69
25502	150	26546	148	27431	69
25503	150	26547	149	27432	67
25504	150	26551	148	27433	67
25505	150	26553	149	27434	67
25506	150	26555	148	27535	67
25507	150	27080A	61	27538	67
25508	150	27109A	63	27539	67
25509	150	27138A	64	27540	67
25510	150	27243	67	27541	68
25511	150	27244	67	27636A	61
25512	150	27245	67	27641A	63
25513	150	27246	67	27643A	64
25514	150	27247	67	27840	70
25517	150	27248	67	27841	70
25518	150	27249	67	27842	70
25519	150	27250	67	27843	70
25520	150	27251	67	27844	70
25522	150	27252	67	27845	70
25523	150	27253	67	27846	70
26500	148	27254	67	27847	70
26501	148	27255	67	27848	70
26502	149	27256	67	27849	70
26503	148	27257	68	27850	70
26504	148	27258	68	27851	70
26505	148	27259	68	27852	70
26506	148	27260	68	27853	70
26507	148	27261	68	27854	70
26508	148	27262	68	27855	70
26509	149	27263	68	27856	70
26510	149	27264	68	27857	70
26511	149	27265	68	27858	70
26512	149	27267	68	27859	70
26513	149	27268	68	27860	70
26514	148	27269	67	27861	70
26515	148	27270	67	27862	70
26516	148	27271	67	27863	70
26517	148	27272	67	27864	70
26518	148	27273	67	27865	70
26519	148	27274	67	27866	71
26520	148	27275	67	27867	71
26521	148	27276	67	27868	71
26522	149	27277	67	27869	71
26523	149	27278	67	27870	71
26524	149	27279	67	27871	71
26525	149	27280	67	27872	71
26526	149	27281	68	27873	71
26527	149	27282	68	27874	71
26528	149	27283	68	27875	71
26529	149	27284	68	27876	71
26530	148	27285	68	27877	71
26531	148	27286	68	27878	71

Part Number Index

Part Number		Part Number		Part Number	
27879	71	28124A	63	28257	68
27880	71	28125A	63	28258	68
27881	71	28126A	63	28259	68
27882	71	28127A	63	28260	68
27883	71	28128A	63	28261	68
27884	71	28129A	63	28262	68
27885	70	28130A	63	28263	68
27886	70	28131A	63	28264	68
27887	70	28132A	63	28265	68
27888	71	28133A	63	28267	68
27889	71	28134A	63	28268	68
27890	72	28135A	63	28269	67
27891	72	28136A	63	28270	67
27892	72	28137A	63	28271	67
27893	72	28139A	64	28272	67
27894	71	28140A	64	28273	67
27895	71	28141A	64	28274	67
27896	71	28142A	64	28275	67
27916A	60	28143A	64	28276	67
27917A	61	28144A	64	28277	67
27969	67	28145A	64	28278	67
28081A	61	28146A	64	28279	67
28081AS	62	28147A	64	28280	67
28082A	62	28148A	64	28281	68
28082AS	62	28149A	64	28282	68
28083A	62	28150A	64	28283	68
28084A	62	28151A	64	28284	68
28085A	62	28152A	64	28285	68
28086A	62	28153A	64	28286	68
28087A	62	28154A	64	28287	68
28088A	62	28155A	65	28288	68
28089A	62	28156A	65	28289	68
28090A	62	28157A	65	28290	68
28091A	62	28158A	65	28291	68
28092A	62	28159A	65	28292	67
28093A	62	28160A	65	28293	68
28094A	62	28161A	65	28323A	61
28095A	62	28165A	65	28324A	61
28096A	62	28166A	65	28326A	60
28097A	62	28167A	65	28326AS	60
28098A	62	28168A	65	28327A	60
28099A	62	28169A	65	28328A	60
28100A	62	28170A	65	28329A	60
28101A	62	28171A	65	28330A	61
28102A	62	28172A	65	28331A	61
28103A	62	28173A	65	28331AS	61
28104A	62	28174A	65	28334A	60
28105A	62	28175A	65	28334AS	60
28106A	62	28176A	65	28335A	60
28107A	62	28177A	65	28336A	60
28108A	62	28178A	65	28338A	61
28110A	63	28243	67	28339A	61
28111A	63	28244	67	28340A	61
28112A	63	28245	67	28341A	61
28113A	63	28246	67	28428	69
28114A	63	28247	67	28429	69
28115A	63	28248	67	28430	69
28116A	63	28249	67	28431	69
28117A	63	28250	67	28432	67
28118A	63	28251	67	28433	67
28119A	63	28252	67	28434	67
28120A	63	28253	67	28535	67
28121A	63	28254	67	28538	67
28122A	63	28255	67	28539	67
28123A	63	28256	67	28540	67

Part Number	Part Number	Part Number			
28541	68	28870	71	29501X	160
28600A	60	28871	71	29502	157
28601A	60	28872	71	29502T	159
28602A	60	28873	71	29502X	160
28603A	60	28874	71	29503	157
28604A	60	28875	71	29503T	159
28605A	60	28876	71	29503X	160
28606A	60	28877	71	29504	157
28607A	60	28878	71	29504T	159
28608A	60	28879	71	29504X	160
28609A	60	28880	71	29505	157
28610A	60	28881	71	29505T	159
28611A	60	28882	71	29505X	160
28612A	60	28883	71	29506	157
28613A	60	28884	71	29506T	159
28614A	60	28885	70	29506X	160
28615A	61	28886	70	29507	157
28616A	61	28887	70	29507T	159
28617A	61	28888	71	29507X	160
28618A	61	28889	71	29510	157
28619A	61	28890	72	29511	157
28620A	61	28891	72	29512	157
28621A	61	28892	72	29513	157
28622A	61	28893	72	29528	157
28623A	61	28894	71	29528T	159
28624A	61	28895	71	29528X	160
28625A	61	28896	71	29529	157
28626A	61	28912A	62	29529T	159
28627A	61	28969	67	29529X	160
28628A	61	29004	78	29530	157
28629A	62	29005	78	29530T	159
28630A	63	29006	78	29530X	160
28632A	60	29007	78	29531	157
28633A	61	29008	78	29531T	159
28634A	63	29009	78	29531X	160
28840	70	29016	78	29532	157
28841	70	29017	78	29532T	159
28842	70	29018	78	29532X	160
28843	70	29019	78	29533	158
28844	70	29020	78	29534	158
28845	70	29021	78	29535	158
28846	70	29022	78	29536	158
28847	70	29023	78	29537	158
28848	70	29024	78	29538	158
28849	70	29025	78	29539	158
28850	70	29030	78	29540	158
28851	70	29031	78	29541	158
28852	70	29032	78	29542	158
28853	70	29033	78	29543	158
28854	70	29034	78	29544	158
28855	70	29035	78	29545	158
28856	70	29036	78	29546	158
28857	70	29038	78	29547	158
28858	70	29040	78	29550C	162
28859	70	29043	78	29551C	162
28860	70	29048	78	29552C	162
28861	70	29053	78	29553C	162
28862	70	29058	78	29554C	162
28863	70	29068	78	29555C	162
28864	70	29078	78	29556C	162
28865	70	29500	157	29557C	162
28866	71	29500T	159	29558C	162
28867	71	29500X	160	29559C	162
28868	71	29501	157	29560C	162
28869	71	29501T	159	29561C	162

Part Number Index

Part Number		Part Number		Part Number	
30800	188	34404	184	37501	181
30801	188	34406	184	37502	181
30802	188	34408	184	37504	181
30804	188	34410	184	37506	181
30806	188	34412	184	37508	181
30808	188	34414	184	37530	181
30810	188	34416	184	37540	181
30812	188	34418	184	37590	181
30814	188	34430	184	39110	177
30816	188	34440	184	39112	177
30818	188	34490	184	39114	177
30820	188	34914	184	39116	177
30830	188	34916	184	39118	177
30840	188	34918	184	39120	177
30890	188	34920	184	39122	177
31008N	183	34922	184	39124	177
31010	183	35410	183	39126	177
31010N	183	35412	183	39128	177
31012	183	35414	183	70001E	243
31012N	183	35416	183	70001LS	243
31014	183	35418	183	70001NH	243
31014N	183	35420	183	70006E	278
31502	186	35606	182	70006NH	278
31504	186	35608	182	70007E	279
31506	186	35610	182	70007NH	279
31508	186	35612	182	70007PU	279
31510	186	35614	182	70008PU	280
31512	186	35616	182	70009PU	280
31514	186	35618	182	70101E	244
31516	186	35620	182	70101LS	244
31518	186	35622	182	70101NH	244
31520	186	35716	182	70101PE	244
32410	188	35718	182	70102E	244
32412	188	35720	182	70103E	244
32414	188	35722	182	70105PU	244
32416	188	36100	185	70110E	243
32418	188	36101	185	70200E	243
32516	186	36102	185	70200LS	243
32518	186	36104	185	70200NH	243
32718	174	36106	185	70201E	165
32720	174	36108	185	70202E	165
32722	174	36140	185	70203E	165
32820	173	36190	185	70251PU	166
32822	173	37100	180	70252PU	166
33302	187	37101	180	70254PU	166
33304	187	37102	180	70256PU	166
33306	187	37103	180	70257PU	166
33308	187	37104	180	70258PU	166
33310	187	37106	180	70259PU	166
33312	187	37108	180	70260PU	167
33314	187	37110	180	70261PU	166
33316	187	37112	180	70262PU	166
33318	187	37114	180	70263PU	166
33320	187	37116	180	70264PU	166
33322	187	37118	180	70265PU	166
33390	187	37130	180	70266PU	167
33414	187	37140	180	70267PU	167
33416	187	37190	180	70268PU	166
33418	187	37212	181	70269PU	166
34017	189	37214	181	72001E	269
34020	189	37216	181	72001NH	269
34400	184	37218	181	72002E	274
34401	184	37220	181	72002NH	274
34402	184	37222	181	72002PU	274
34403	184	37500	181	74001E	270

Part Number		Part Number		Part Number	
74001NH	271	83028	178	83704	23
74001PU	271	83029	178	83706	23
74002E	275	83030	178	83709	23
74002NH	275	83041	179	83712	23
74002PU	275	83043	179	83715	23
74003PU	277	83045	179	83719	23
74004E	273	83046	179	83752	31
74004NH	273	83047	179	83753	31
74005E	276	83048	179	83754	31
74005NH	276	83049	179	83756	31
74005PU	276	83050	179	83802	31
74009PU	277	83303E	26	83803	31
74010E	278	83304E	26	83804	31
74010NH	278	83305E	26	83806	31
74010PU	278	83306E	26	83900	133
74011E	279	83307E	26	83905	133
74011NH	279	83308E	26	83910	133
74011PU	279	83317E	26	83915	133
74012PU	280	83318E	26	83930	133
74013PU	280	83319E	26	83932	133
82418	19	83320E	26	83950	133
82418	22	83321E	26	83951	133
82442	22	83322E	26	83952	133
82442	100	83332E	26	83953	133
82444	22	83333E	26	83954	133
82489	22	83334E	26	83955	133
82502	217	83335E	26	85102	24
82503	217	83336E	26	85102	256
82504	217	83337E	26	85103	24
82505	217	83347E	26	85109	24
82506	217	83348E	26	85164	109
82509	217	83349E	26	85168	109
82641	109	83350E	26	85220	24
82641	217	83351E	26	85221	24
82723	113	83352E	26	85230	25
82729	220	83393	25	85231	25
82740	101	83394	25	85240	25
82741	100	83395	25	85241	25
82742	100	83396	25	87723	113
82743	100	83503	23	87740	101
82757	100	83504	23	87760	106
82760	106	83506	23	87761	105
82761	105	83509	23	87777	114
82777	114	83512	23	87778	114
82777	255	83515	23	88442	22
82778	114	83552	23	88442	100
82841	225	83553	23	88444	22
82841	245	83554	23	88489	22
82842	225	83556	23	88641	109
82842	245	83559	23	88641	217
83000	178	83562	23	88723	113
83001	178	83569	23	88741	100
83002	178	83602	23	88757	100
83003	178	83604	23	88760	106
83004	178	83606	23	88761	105
83005	178	83609	23	88770	22
83006	178	83612	23	88777	114
83007	178	83652	23	88778	114
83008	178	83653	23	89182	254
83009	179	83654	23	89418	22
83010	179	83656	23	89463	253
83023	178	83659	23	89503	217
83025	178	83662	23	89504	217
83026	178	83702	23	89505	217
83027	178	83703	23	89696	226

Part Number Index

Part Number	Part Number	Part Number			
89728	220	C3GCSY	57	C4GESY	57
89729	220	C3GD	53	C4GFCY	55
89730	220	C3GDY	55	C4GFSY	57
89731	220	C3GDSY	57	C4GG	53
89732	220	C3GE	53	C4GGCY	55
89740	101	C3GECY	55	C4GGSY	57
89841	225	C3GESY	57	C4GH	53
89841	245	C3GFCY	55	C4GHY	55
89842	225	C3GFSY	57	C4GHSY	57
89842	245	C3GG	53	C4GI	53
89855	226	C3GGCY	55	C4GICY	55
89880	260	C3GGSY	57	C4GISY	57
89907	260	C3GH	53	C4GJ	53
121700A	270	C3GHY	55	C4GJCY	55
121700R	270	C3GHSY	57	C4GJSY	57
121872A	272	C3GI	53	C4XA	54
123092A	251	C3GICY	55	C4XACY	56
123107A	246	C3GISY	57	C4XASY	58
129463	253	C3GJ	53	C4XB	54
139463	253	C3GJCY	55	C4XBCY	56
183076F	239	C3GJSY	57	C4XBSY	58
183076F	243	C3XA	54	C4XC	54
183079A	244	C3XACY	56	C4XCCY	56
183092A	251	C3XASY	58	C4XCSY	58
189463	253	C3XB	54	C4XD	54
1229500	161	C3XBCY	56	C4XDCY	56
1229501	161	C3XBSY	58	C4XDSY	58
1229502	161	C3XC	54	C4XE	54
1229503	161	C3XCCY	56	C4XECY	56
1229504	161	C3XCSY	58	C4XESY	58
1229505	161	C3XD	54	C4XF	54
1229506	161	C3XDCY	56	C4XFCY	56
1229507	161	C3XDSY	58	C4XFSY	58
1229528	161	C3XE	54	C4XG	54
1229529	161	C3XECY	56	C4XGCY	56
1229530	161	C3XESY	58	C4XGSY	58
1229531	161	C3XF	54	C4XH	54
1229532	161	C3XFCY	56	C4XHCY	56
1329500	161	C3XFSY	58	C4XHSY	58
1329501	161	C3XG	54	C4XI	54
1329502	161	C3XGCY	56	C4XICY	56
1329503	161	C3XGSY	58	C4XISY	58
1329504	161	C3XH	54	C4XJ	54
1329505	161	C3XHCY	56	C4XJCY	56
1329506	161	C3XHSY	58	C4XJSY	58
1329507	161	C3XI	54	C5GA	53
1329528	161	C3XICY	56	C5GACY	55
1329529	161	C3XISY	58	C5GASY	57
1329530	161	C3XJ	54	C5GB	53
1329531	161	C3XJCY	56	C5GBCY	55
1329532	161	C3XJSY	58	C5GBSY	57
BE43769	283	C4GA	53	C5GC	53
BE43800	283	C4GACY	55	C5GCCY	55
BE43802	283	C4GASY	57	C5GCSY	57
BE43885	284	C4GB	53	C5GD	53
BE43886	284	C4GBCY	55	C5GDCY	55
BE43887	284	C4GBSY	57	C5GDSY	57
C3GA	53	C4GC	53	C5GE	53
C3GACY	55	C4GCCY	55	C5GECY	55
C3GASY	57	C4GCSY	57	C5GESY	57
C3GB	53	C4GD	53	C5GFCY	55
C3GBCY	55	C4GDCY	55	C5GFSY	57
C3GBSY	57	C4GDSY	57	C5GG	53
C3GC	53	C4GE	53	C5GGCY	55
C3GCCY	55	C4GECY	55	C5GGSY	57

Part Number	Part Number	Part Number	
C5GH	53	C12XASY	58
C5GHCY	55	C12XB	54
C5GHSY	57	C12XBCY	56
C5GI	53	C12XBSY	58
C5GICY	55	C12XC	54
C5GISY	57	C12XCCY	56
C5GJ	53	C12XCSY	58
C5GJCY	55	C12XD	54
C5GJSY	57	C12XDCY	56
C5XA	54	C12XDSY	58
C5XACY	56	C12XE	54
C5XASY	58	C12XECY	56
C5XB	54	C12XESY	58
C5XBCY	56	C12XF	54
C5XBSY	58	C12XFCY	56
C5XC	54	C12XFSY	58
C5XCCY	56	C20GA	53
C5XCSY	58	C20GACY	55
C5XD	54	C20GASY	57
C5XDCY	56	C20GB	53
C5XDSY	58	C20GBCY	55
C5XE	54	C20GBSY	57
C5XECY	56	C20GC	53
C5XESY	58	C20GCCY	55
C5XF	54	C20GCSY	57
C5XFCY	56	C20GD	53
C5XFSY	58	C20GDCY	55
C5XG	54	C20GDSY	57
C5XGCY	56	C20XA	54
C5XGSY	58	C20XACY	56
C5XH	54	C20XASY	58
C5XHCY	56	C20XB	54
C5XHSY	58	C20XBCY	56
C5XI	54	C20XBSY	58
C5XICY	56	C20XC	54
C5XISY	58	C20XCCY	56
C5XJ	54	C20XCSY	58
C5XJCY	56	C20XD	54
C5XJSY	58	C20XDCY	56
C7GA	53	C20XDSY	58
C7GACY	55	C5500	79
C7GASY	57	C5501	79
C7GB	53	C5502	79
C7GBCY	55	C5503	79
C7GBSY	57	C5504	79
C7GC	53	C5505	79
C7GCCY	55	C5506	79
C7GCSY	57	C5508	79
C7GD	53	C5510	79
C7GDCY	55	C5513	79
C7GDSY	57	C5518	79
C7GE	53	C5523	79
C7GECY	55	C5528	79
C7GESY	57	C5529	79
C7GFCY	55	C5530	79
C7GFSY	57	C5531	79
C7GG	53	C5532	79
C7GGCY	55	C5533	79
C7GGSY	57	C5534	79
C7GH	53	C5535	79
C7GHCY	55	C5536	79
C7GHSY	57	C5538	79
C7XA	54	C5540	79
C7XACY	56	C5543	79
C7XASY	58	C5548	79
C7XB	54		
C7XBCY	56		
C7XBSY	58		
C7XC	54		
C7XCCY	56		
C7XCSY	58		
C7XD	54		
C7XDCY	56		
C7XDSY	58		
C7XE	54		
C7XECY	56		
C7XESY	58		
C7XF	54		
C7XFCY	56		
C7XFSY	58		
C7XG	54		
C7XGCY	56		
C7XGSY	58		
C7XH	54		
C7XHCY	56		
C7XHSY	58		
C9GE	53		
C9GECY	55		
C9GESY	57		
C9GF	53		
C9GFCY	55		
C9GFSY	57		
C9GG	53		
C9GGCY	55		
C9GGSY	57		
C9GH	53		
C9GHCY	55		
C9GHSY	57		
C9XE	54		
C9XECY	56		
C9XESY	58		
C9XF	54		
C9XFCY	56		
C9XFSY	58		
C9XG	54		
C9XGCY	56		
C9XGSY	58		
C9XH	54		
C9XHCY	56		
C9XHSY	58		
C12GA	53		
C12GACY	55		
C12GASY	57		
C12GB	53		
C12GBCY	55		
C12GBSY	57		
C12GC	53		
C12GCCY	55		
C12GCSY	57		
C12GD	53		
C12GDCY	55		
C12GDSY	57		
C12GE	53		
C12GECY	55		
C12GESY	57		
C12GF	53		
C12GFCY	55		
C12GFSY	57		
C12XA	54		
C12XACY	56		

Part Number Index

Part Number		Part Number		Part Number	
C5553	79	GAADD60	333	GBCD748	323
C5558	79	GAADD72	333	GBCD760	323
C5560	80	GAADE12	333	GBCD772	323
C5561	80	GAADE24	333	GBCD812	323
C5562	80	GAADE36	333	GBCD824	323
C5563	80	GAADE48	333	GBCD836	323
C5564	80	GAADE60	333	GBCD848	323
C5565	80	GAADE72	333	GBCD860	323
C5566	80	GAAE184	333	GBCD872	323
C5568	80	GAAE196	333	GBCDD12	323
C5570	80	GAAE284	333	GBCDD24	323
C5573	80	GAAE296	333	GBCDD36	323
C5578	80	GAAE784	333	GBCDD48	323
C5579	80	GAAE796	333	GBCDD60	323
C5580	80	GAAE884	333	GBCDD72	323
C5581	80	GAAE896	333	GBCDE12	323
C5582	80	GAAED84	333	GBCDE24	323
C5583	80	GAAED96	333	GBCDE36	323
C5590	82	GAAEE84	333	GBCDE48	323
C5591	82	GAAEE96	333	GBCDE60	323
C5592	82	GAAG106	333	GBCDE72	323
C5601	83	GAAG112	333	GBCE196	323
C5602	83	GAAG118	333	GBCE296	323
C5611	83	GAAG124	333	GBCE896	323
C5621	83	GAAG136	333	GBCED96	323
C5622	83	GAAG206	333	GBCEE96	323
C5625	83	GAAG212	333	GBCF144	323
C5626	83	GAAG218	333	GBCF244	323
C5701	82	GAAG224	333	GBCF844	323
C5702	82	GAAG236	333	GBCFD44	323
C5730	82	GAAG706	333	GBCFE44	323
C5731	82	GAAG712	333	GBCG106	323
C5732	82	GAAG718	333	GBCG112	323
C5760	82	GAAG724	333	GBCG118	323
C5761	82	GAAG736	333	GBCG124	323
C5762	82	GAAG806	333	GBCG136	323
C6064	79	GAAG812	333	GBCG206	323
GAAD112	333	GAAG818	333	GBCG212	323
GAAD124	333	GAAG824	333	GBCG218	323
GAAD136	333	GAAG836	333	GBCG224	323
GAAD148	333	GAAGD06	333	GBCG236	323
GAAD160	333	GAAGD12	333	GBCG706	323
GAAD172	333	GAAGD18	333	GBCG712	323
GAAD212	333	GAAGD24	333	GBCG718	323
GAAD224	333	GAAGD36	333	GBCG724	323
GAAD236	333	GAAGE06	333	GBCG736	323
GAAD248	333	GAAGE12	333	GBCG806	323
GAAD260	333	GAAGE18	333	GBCG812	323
GAAD272	333	GAAGE24	333	GBCG818	323
GAAD712	333	GAAGE36	333	GBCG824	323
GAAD724	333	GBCD112	323	GBCG836	323
GAAD736	333	GBCD124	323	GBCGD06	323
GAAD748	333	GBCD136	323	GBCGD12	323
GAAD760	333	GBCD148	323	GBCGD18	323
GAAD772	333	GBCD160	323	GBCGD24	323
GAAD812	333	GBCD172	323	GBCGD36	323
GAAD824	333	GBCD212	323	GBCGE06	323
GAAD836	333	GBCD224	323	GBCGE12	323
GAAD848	333	GBCD236	323	GBCGE18	323
GAAD860	333	GBCD248	323	GBCGE24	323
GAAD872	333	GBCD260	323	GBCGE36	323
GAADD12	333	GBCD272	323	GBDD112	327
GAADD24	333	GBCD712	323	GBDD124	327
GAADD36	333	GBCD724	323	GBDD136	327
GAADD48	333	GBCD736	323	GBDD148	327

Part Number	Part Number	Part Number	
GBDD160	327	GBRG224	319
GBDD172	327	GBRG236	319
GBDD212	327	GBRG706	319
GBDD224	327	GBRG712	319
GBDD236	327	GBRG718	319
GBDD248	327	GBRG724	319
GBDD260	327	GBRG736	319
GBDD272	327	GBRG806	319
GBDD712	327	GBRG812	319
GBDD724	327	GBRG818	319
GBDD736	327	GBRG824	319
GBDD748	327	GBRG836	319
GBDD760	327	GBRGD06	319
GBDD772	327	GBRGD12	319
GBDD812	327	GBRGD18	319
GBDD824	327	GBRGD24	319
GBDD836	327	GBRGD36	319
GBDD848	327	GBRGE06	319
GBDD860	327	GBRGE12	319
GBDD872	327	GBRGE18	319
GBDDD12	327	GBRGE24	319
GBDDD24	327	GBRGE36	319
GBDDD36	327	GBWD112	331
GBDDD48	327	GBWD124	331
GBDDD60	327	GBWD136	331
GBDDD72	327	GBWD148	331
GBDDE12	327	GBWD160	331
GBDDE24	327	GBWD172	331
GBDDE36	327	GBWD212	331
GBDDE48	327	GBWD224	331
GBDDE60	327	GBWD236	331
GBDDE72	327	GBWD248	331
GBDE196	327	GBWD260	331
GBDE296	327	GBWD272	331
GBDE796	327	GBWD712	331
GBDE896	327	GBWD724	331
GBDED96	327	GBWD736	331
GBDEE96	327	GBWD748	331
GBDF144	327	GBWD760	331
GBDF244	327	GBWD772	331
GBDF744	327	GBWD812	331
GBDF844	327	GBWD824	331
GBDFD44	327	GBWD836	331
GBDFE44	327	GBWD848	331
GBDG106	327	GBWD860	331
GBDG112	327	GBWD872	331
GBDG118	327	GBWDD12	331
GBDG124	327	GBWDD24	331
GBDG136	327	GBWDD36	331
GBDG206	327	GBWDD48	331
GBDG212	327	GBWDD60	331
GBDG218	327	GBWDD72	331
GBDG224	327	GBWDE12	331
GBDG236	327	GBWDE24	331
GBDG706	327	GBWDE36	331
GBDG712	327	GBWDE48	331
GBDG718	327	GBWDE60	331
GBDG724	327	GBWDE72	331
GBDG736	327	GBWG106	331
GBDG806	327	GBWG112	331
GBDG812	327	GBWG118	331
GBDG818	327	GBWG124	331
GBDG824	327	GBWG136	331
GBDG836	327	GBWG206	331
GBDGD06	327	GBWG212	331
GBDGD12	327		
GBDGD18	327		
GBDGD24	327		
GBDGD36	327		
GBDGE06	327		
GBDGE12	327		
GBDGE18	327		
GBDGE24	327		
GBDGE36	327		
GBRD112	319		
GBRD124	319		
GBRD136	319		
GBRD148	319		
GBRD160	319		
GBRD172	319		
GBRD212	319		
GBRD224	319		
GBRD236	319		
GBRD248	319		
GBRD260	319		
GBRD272	319		
GBRD712	319		
GBRD724	319		
GBRD736	319		
GBRD748	319		
GBRD760	319		
GBRD772	319		
GBRD812	319		
GBRD824	319		
GBRD836	319		
GBRD848	319		
GBRD860	319		
GBRD872	319		
GBRDD12	319		
GBRDD24	319		
GBRDD36	319		
GBRDD48	319		
GBRDD60	319		
GBRDD72	319		
GBRDE12	319		
GBRDE24	319		
GBRDE36	319		
GBRDE48	319		
GBRDE60	319		
GBRDE72	319		
GBRE196	319		
GBRE296	319		
GBRE796	319		
GBRE896	319		
GBRED96	319		
GBREE96	319		
GBRF144	319		
GBRF244	319		
GBRF744	319		
GBRF844	319		
GBRFD44	319		
GBRFE44	319		
GBRG106	319		
GBRG112	319		
GBRG118	319		
GBRG124	319		
GBRG136	319		
GBRG206	319		
GBRG212	319		
GBRG218	319		

Part Number Index

Part Number	Part Number	Part Number			
GBWG218	331	GCCF144	321	GCDD72	325
GBWG224	331	GCCF244	321	GCDE12	325
GBWG236	331	GCCF744	321	GCDE24	325
GBWG706	331	GCCF844	321	GCDE36	325
GBWG712	331	GCCFD44	321	GCDE48	325
GBWG718	331	GCCFE44	321	GCDE60	325
GBWG724	331	GCCG106	321	GCDE72	325
GBWG736	331	GCCG112	321	GCDE196	325
GBWG806	331	GCCG118	321	GCDE296	325
GBWG812	331	GCCG124	321	GCDE796	325
GBWG818	331	GCCG136	321	GCDE896	325
GBWG824	331	GCCG206	321	GCDED96	325
GBWG836	331	GCCG212	321	GCDEE96	325
GBWGD06	331	GCCG218	321	GCDF144	325
GBWGD12	331	GCCG224	321	GCDF244	325
GBWGD18	331	GCCG236	321	GCDF744	325
GBWGD24	331	GCCG706	321	GCDF844	325
GBWGD36	331	GCCG712	321	GCDFD44	325
GBWGE06	331	GCCG718	321	GCDFE44	325
GBWGE12	331	GCCG724	321	GC DG106	325
GBWGE18	331	GCCG736	321	GC DG112	325
GBWGE24	331	GCCG806	321	GC DG118	325
GBWGE36	331	GCCG812	321	GC DG124	325
GCCD112	321	GCCG818	321	GC DG136	325
GCCD124	321	GCCG824	321	GC DG206	325
GCCD136	321	GCCG836	321	GC DG212	325
GCCD148	321	GCCGD06	321	GC DG218	325
GCCD160	321	GCCGD12	321	GC DG224	325
GCCD172	321	GCCGD18	321	GC DG236	325
GCCD212	321	GCCGD24	321	GC DG706	325
GCCD224	321	GCCGD36	321	GC DG712	325
GCCD236	321	GCCGE06	321	GC DG718	325
GCCD248	321	GCCGE12	321	GC DG724	325
GCCD260	321	GCCGE18	321	GC DG736	325
GCCD272	321	GCCGE24	321	GC DG806	325
GCCD712	321	GCCGE36	321	GC DG812	325
GCCD724	321	GCDD112	325	GC DG818	325
GCCD736	321	GCDD124	325	GC DG824	325
GCCD748	321	GCDD136	325	GC DG836	325
GCCD760	321	GCDD148	325	GC DGD06	325
GCCD772	321	GCDD160	325	GC DGD12	325
GCCD812	321	GCDD172	325	GC DGD18	325
GCCD824	321	GCDD212	325	GC DGD24	325
GCCD836	321	GCDD224	325	GC DGD36	325
GCCD848	321	GCDD236	325	GC DGE06	325
GCCD860	321	GCDD248	325	GC DGE12	325
GCCD872	321	GCDD260	325	GC DGE18	325
GCCDD12	321	GCDD272	325	GC DGE24	325
GCCDD24	321	GCDD712	325	GC DGE36	325
GCCDD36	321	GCDD724	325	GCRD112	317
GCCDD48	321	GCDD736	325	GCRD124	317
GCCDD60	321	GCDD748	325	GCRD136	317
GCCDD72	321	GCDD760	325	GCRD148	317
GCCDE12	321	GCDD772	325	GCRD160	317
GCCDE24	321	GCDD812	325	GCRD172	317
GCCDE36	321	GCDD824	325	GCRD212	317
GCCDE48	321	GCDD836	325	GCRD224	317
GCCDE60	321	GCDD848	325	GCRD236	317
GCCDE72	321	GCDD860	325	GCRD248	317
GCCE196	321	GCDD872	325	GCRD260	317
GCCE296	321	GCDDD12	325	GCRD272	317
GCCE796	321	GCDDD24	325	GCRD712	317
GCCE896	321	GCDDD36	325	GCRD724	317
GCCED96	321	GCDDD48	325	GCRD736	317
GCCEE96	321	GCDDD60	325	GCRD748	317

Part Number	Part Number	Part Number			
GCRD760	317	GCWD148	329	GDCD136	323
GCRD772	317	GCWD160	329	GDCD148	323
GCRD812	317	GCWD172	329	GDCD160	323
GCRD824	317	GCWD212	329	GDCD172	323
GCRD836	317	GCWD224	329	GDCD212	323
GCRD848	317	GCWD236	329	GDCD224	323
GCRD860	317	GCWD248	329	GDCD236	323
GCRD872	317	GCWD260	329	GDCD248	323
GCRDD12	317	GCWD272	329	GDCD260	323
GCRDD24	317	GCWD712	329	GDCD272	323
GCRDD36	317	GCWD724	329	GDCD712	323
GCRDD48	317	GCWD736	329	GDCD724	323
GCRDD60	317	GCWD748	329	GDCD736	323
GCRDD72	317	GCWD760	329	GDCD748	323
GCRDE12	317	GCWD772	329	GDCD760	323
GCRDE24	317	GCWD812	329	GDCD772	323
GCRDE36	317	GCWD824	329	GDCD812	323
GCRDE48	317	GCWD836	329	GDCD824	323
GCRDE60	317	GCWD848	329	GDCD836	323
GCRDE72	317	GCWD860	329	GDCD848	323
GCRE144	317	GCWD872	329	GDCD860	323
GCRE196	317	GCWDD12	329	GDCD872	323
GCRE244	317	GCWDD24	329	GDCDD12	323
GCRE296	317	GCWDD36	329	GDCDD24	323
GCRE796	317	GCWDD48	329	GDCDD36	323
GCRE896	317	GCWDD60	329	GDCDD48	323
GCRE96	317	GCWDD72	329	GDCDD60	323
GCRF744	317	GCWDE12	329	GDCDD72	323
GCRF844	317	GCWDE24	329	GDCDE12	323
GCRFD44	317	GCWDE36	329	GDCDE24	323
GCRFE44	317	GCWDE48	329	GDCDE36	323
GCRG106	317	GCWDE60	329	GDCDE48	323
GCRG112	317	GCWDE72	329	GDCDE60	323
GCRG118	317	GCWG106	329	GDCDE72	323
GCRG124	317	GCWG118	329	GDCE196	323
GCRG136	317	GCWG124	329	GDCE296	323
GCRG206	317	GCWG136	329	GDCE896	323
GCRG212	317	GCWG206	329	GDCED96	323
GCRG218	317	GCWG212	329	GDCEE96	323
GCRG224	317	GCWG218	329	GDCF144	323
GCRG236	317	GCWG224	329	GDCF244	323
GCRG706	317	GCWG236	329	GDCF844	323
GCRG712	317	GCWG706	329	GDCFD44	323
GCRG718	317	GCWG712	329	GDCFE44	323
GCRG724	317	GCWG718	329	GDCG106	323
GCRG736	317	GCWG724	329	GDCG112	323
GCRG806	317	GCWG736	329	GDCG118	323
GCRG812	317	GCWG806	329	GDCG124	323
GCRG818	317	GCWG812	329	GDCG136	323
GCRG824	317	GCWG818	329	GDCG206	323
GCRG836	317	GCWG824	329	GDCG212	323
GCRGD06	317	GCWG836	329	GDCG218	323
GCRGD12	317	GCWGD06	329	GDCG224	323
GCRGD18	317	GCWGD12	329	GDCG236	323
GCRGD24	317	GCWGD18	329	GDCG706	323
GCRGD36	317	GCWGD24	329	GDCG712	323
GCRGE06	317	GCWGD36	329	GDCG718	323
GCRGE12	317	GCWGE06	329	GDCG724	323
GCRGE18	317	GCWGE12	329	GDCG736	323
GCRGE24	317	GCWGE18	329	GDCG806	323
GCRGE36	317	GCWGE24	329	GDCG812	323
GCWD112	329	GCWGE36	329	GDCG818	323
GCWD124	329	GDCD112	323	GDCG824	323
GCWD136	329	GDCD124	323	GDCG836	323
				GDCGD06	323

Part Number Index

Part Number	Part Number	Part Number			
GDCGD12	323	GDDG224	327	GDRF244	319
GDCGD18	323	GDDG236	327	GDRF744	319
GDCGD24	323	GDDG706	327	GDRF844	319
GDCGD36	323	GDDG712	327	GDRFD44	319
GDCGE06	323	GDDG718	327	GDRFE44	319
GDCGE12	323	GDDG724	327	GDRG106	319
GDCGE18	323	GDDG736	327	GDRG112	319
GDCGE24	323	GDDG806	327	GDRG118	319
GDCGE36	323	GDDG812	327	GDRG124	319
GDDD112	327	GDDG818	327	GDRG136	319
GDDD124	327	GDDG824	327	GDRG206	319
GDDD136	327	GDDG836	327	GDRG212	319
GDDD148	327	GDDGD06	327	GDRG218	319
GDDD160	327	GDDGD12	327	GDRG224	319
GDDD172	327	GDDGD18	327	GDRG236	319
GDDD212	327	GDDGD24	327	GDRG706	319
GDDD224	327	GDDGD36	327	GDRG712	319
GDDD236	327	GDDGE06	327	GDRG718	319
GDDD248	327	GDDGE12	327	GDRG724	319
GDDD260	327	GDDGE18	327	GDRG736	319
GDDD272	327	GDDGE24	327	GDRG806	319
GDDD712	327	GDDGE36	327	GDRG812	319
GDDD724	327	GDRD112	319	GDRG818	319
GDDD736	327	GDRD124	319	GDRG824	319
GDDD748	327	GDRD136	319	GDRG836	319
GDDD760	327	GDRD148	319	GDRGD06	319
GDDD772	327	GDRD160	319	GDRGD12	319
GDDD812	327	GDRD172	319	GDRGD18	319
GDDD824	327	GDRD212	319	GDRGD24	319
GDDD836	327	GDRD224	319	GDRGD36	319
GDDD848	327	GDRD236	319	GDRGE06	319
GDDD860	327	GDRD248	319	GDRGE12	319
GDDD872	327	GDRD260	319	GDRGE18	319
GDDDD12	327	GDRD272	319	GDRGE24	319
GDDDD24	327	GDRD712	319	GDRGE36	319
GDDDD36	327	GDRD724	319	GDWD112	331
GDDDD48	327	GDRD736	319	GDWD124	331
GDDDD60	327	GDRD748	319	GDWD136	331
GDDDD72	327	GDRD760	319	GDWD148	331
GDDDE12	327	GDRD772	319	GDWD160	331
GDDDE24	327	GDRD812	319	GDWD172	331
GDDDE36	327	GDRD824	319	GDWD212	331
GDDDE48	327	GDRD836	319	GDWD224	331
GDDDE60	327	GDRD848	319	GDWD236	331
GDDDE72	327	GDRD860	319	GDWD248	331
GDDE196	327	GDRD872	319	GDWD260	331
GDDE296	327	GDRDD12	319	GDWD272	331
GDDE796	327	GDRDD24	319	GDWD712	331
GDDE896	327	GDRDD36	319	GDWD724	331
GDDED96	327	GDRDD48	319	GDWD736	331
GDDEE96	327	GDRDD60	319	GDWD748	331
GDDF144	327	GDRDD72	319	GDWD760	331
GDDF244	327	GDRDE12	319	GDWD772	331
GDDF744	327	GDRDE24	319	GDWD812	331
GDDF844	327	GDRDE36	319	GDWD824	331
GDDFD44	327	GDRDE48	319	GDWD836	331
GDDFE44	327	GDRDE60	319	GDWD848	331
GDDG106	327	GDRDE72	319	GDWD860	331
GDDG112	327	GDRE196	319	GDWD872	331
GDDG118	327	GDRE296	319	GDWDD12	331
GDDG124	327	GDRE796	319	GDWDD24	331
GDDG136	327	GDRE896	319	GDWDD36	331
GDDG206	327	GDRED96	319	GDWDD48	331
GDDG212	327	GDREE96	319	GDWDD60	331
GDDG218	327	GDRF144	319	GDWDD72	331

Part Number	Part Number	Part Number			
GDWDE12	331	GMSND04	295	GOCN108	299
GDWDE24	331	GMSND06	295	GOCN112	299
GDWDE36	331	GMSND08	295	GOCN116	299
GDWDE48	331	GMSND12	295	GOCN124	299
GDWDE60	331	GMSND16	295	GOCN204	299
GDWDE72	331	GMSND24	295	GOCN206	299
GDWG106	331	GMSNE02	295	GOCN208	299
GDWG112	331	GMSNE04	295	GOCN212	299
GDWG118	331	GMSNE06	295	GOCN216	299
GDWG124	331	GMSNE08	295	GOCN224	299
GDWG136	331	GMSNE12	295	GOCN704	299
GDWG206	331	GMSNE16	295	GOCN706	299
GDWG212	331	GMSNE24	295	GOCN708	299
GDWG218	331	GMSNF02	295	GOCN712	299
GDWG224	331	GMSNF04	295	GOCN716	299
GDWG236	331	GMSNF06	295	GOCN724	299
GDWG706	331	GMSNF08	295	GOCN804	299
GDWG712	331	GMSNF12	295	GOCN806	299
GDWG718	331	GMSNF16	295	GOCN808	299
GDWG724	331	GMSNF24	295	GOCN812	299
GDWG736	331	GMSNI02	295	GOCN816	299
GDWG806	331	GMSNI04	295	GOCN824	299
GDWG812	331	GMSNI06	295	GOCND04	299
GDWG818	331	GMSNI08	295	GOCND06	299
GDWG824	331	GMSNI12	295	GOCND08	299
GDWG836	331	GMSNI16	295	GOCND12	299
GDWGD06	331	GMSNI24	295	GOCND16	299
GDWGD12	331	GOCB104	299	GOCND24	299
GDWGD18	331	GOCB106	299	GOCNE04	299
GDWGD24	331	GOCB108	299	GOCNE06	299
GDWGD36	331	GOCB112	299	GOCNE08	299
GDWGE06	331	GOCB116	299	GOCNE12	299
GDWGE12	331	GOCB124	299	GOCNE16	299
GDWGE18	331	GOCB204	299	GOCNE24	299
GDWGE24	331	GOCB206	299	GODB104	303
GDWGE36	331	GOCB208	299	GODB106	303
GMSN102	295	GOCB212	299	GODB108	303
GMSN104	295	GOCB216	299	GODB112	303
GMSN106	295	GOCB224	299	GODB116	303
GMSN108	295	GOCB704	299	GODB124	303
GMSN112	295	GOCB706	299	GODB204	303
GMSN116	295	GOCB708	299	GODB206	303
GMSN124	295	GOCB712	299	GODB208	303
GMSN202	295	GOCB716	299	GODB212	303
GMSN204	295	GOCB724	299	GODB216	303
GMSN206	295	GOCB804	299	GODB224	303
GMSN208	295	GOCB806	299	GODB704	303
GMSN212	295	GOCB808	299	GODB706	303
GMSN216	295	GOCB812	299	GODB708	303
GMSN224	295	GOCB816	299	GODB712	303
GMSN702	295	GOCB824	299	GODB716	303
GMSN704	295	GOCBD04	299	GODB724	303
GMSN706	295	GOCBD06	299	GODB804	303
GMSN708	295	GOCBD08	299	GODB806	303
GMSN712	295	GOCBD12	299	GODB808	303
GMSN716	295	GOCBD16	299	GODB812	303
GMSN724	295	GOCBD24	299	GODB816	303
GMSN802	295	GOCBE04	299	GODB824	303
GMSN804	295	GOCBE06	299	GODBD04	303
GMSN806	295	GOCBE08	299	GODBD06	303
GMSN808	295	GOCBE12	299	GODBD08	303
GMSN812	295	GOCBE16	299	GODBD12	303
GMSN816	295	GOCBE24	299	GODBD16	303
GMSN824	295	GOCN104	299	GODBD24	303
GMSND02	295	GOCN106	299	GODBE04	303

Part Number Index

Part Number	Part Number	Part Number			
GODBE06	303	GOFBD04	315	GOHN724	307
GODBE08	303	GOFBD06	315	GOHN804	307
GODBE12	303	GOFBD08	315	GOHN806	307
GODBE16	303	GOFBD12	315	GOHN808	307
GODBE24	303	GOFBD16	315	GOHN812	307
GODN104	303	GOFBD24	315	GOHN816	307
GODN106	303	GOFBE04	315	GOHN824	307
GODN108	303	GOFBE06	315	GOHND04	307
GODN112	303	GOFBE08	315	GOHND06	307
GODN116	303	GOFBE12	315	GOHND08	307
GODN124	303	GOFBE16	315	GOHND12	307
GODN204	303	GOFBE24	315	GOHND16	307
GODN206	303	GOFN104	315	GOHND24	307
GODN208	303	GOFN106	315	GOHNE04	307
GODN212	303	GOFN108	315	GOHNE06	307
GODN216	303	GOFN112	315	GOHNE08	307
GODN224	303	GOFN116	315	GOHNE12	307
GODN704	303	GOFN124	315	GOHNE16	307
GODN706	303	GOFN204	315	GOHNE24	307
GODN708	303	GOFN206	315	GORN102	293
GODN712	303	GOFN208	315	GORN104	293
GODN716	303	GOFN212	315	GORN106	293
GODN724	303	GOFN216	315	GORN108	293
GODN804	303	GOFN224	315	GORN112	293
GODN806	303	GOFN704	315	GORN116	293
GODN808	303	GOFN706	315	GORN124	293
GODN812	303	GOFN708	315	GORN202	293
GODN816	303	GOFN712	315	GORN204	293
GODN824	303	GOFN716	315	GORN206	293
GODND04	303	GOFN724	315	GORN208	293
GODND06	303	GOFN804	315	GORN212	293
GODND08	303	GOFN806	315	GORN216	293
GODND12	303	GOFN808	315	GORN224	293
GODND16	303	GOFN812	315	GORN702	293
GODND24	303	GOFN816	315	GORN704	293
GODNE04	303	GOFN824	315	GORN706	293
GODNE06	303	GOFND04	315	GORN708	293
GODNE08	303	GOFND06	315	GORN712	293
GODNE12	303	GOFND08	315	GORN716	293
GODNE16	303	GOFND12	315	GORN724	293
GODNE24	303	GOFND16	315	GORN802	293
GOFB104	315	GOFND24	315	GORN804	293
GOFB106	315	GOFNE04	315	GORN806	293
GOFB108	315	GOFNE06	315	GORN808	293
GOFB112	315	GOFNE08	315	GORN812	293
GOFB116	315	GOFNE12	315	GORN816	293
GOFB124	315	GOFNE16	315	GORN824	293
GOFB204	315	GOFNE24	315	GORND02	293
GOFB206	315	GOHN104	307	GORND04	293
GOFB208	315	GOHN106	307	GORND06	293
GOFB212	315	GOHN108	307	GORND08	293
GOFB216	315	GOHN112	307	GORND12	293
GOFB224	315	GOHN116	307	GORND16	293
GOFB704	315	GOHN124	307	GORND24	293
GOFB706	315	GOHN204	307	GORNE02	293
GOFB708	315	GOHN206	307	GORNE04	293
GOFB712	315	GOHN208	307	GORNE06	293
GOFB716	315	GOHN212	307	GORNE08	293
GOFB724	315	GOHN216	307	GORNE12	293
GOFB804	315	GOHN224	307	GORNE16	293
GOFB806	315	GOHN704	307	GORNE24	293
GOFB808	315	GOHN706	307	GOSN102	293
GOFB812	315	GOHN708	307	GOSN104	293
GOFB816	315	GOHN712	307	GOSN106	293
GOFB824	315	GOHN716	307	GOSN108	293

Part Number	Part Number	Part Number	
GOSN112	293	GOWN708	311
GOSN116	293	GOWN712	311
GOSN124	293	GOWN716	311
GOSN202	293	GOWN724	311
GOSN204	293	GOWN804	311
GOSN206	293	GOWN806	311
GOSN208	293	GOWN808	311
GOSN212	293	GOWN812	311
GOSN216	293	GOWN816	311
GOSN224	293	GOWN824	311
GOSN702	293	GOWND04	311
GOSN704	293	GOWND06	311
GOSN706	293	GOWND08	311
GOSN708	293	GOWND12	311
GOSN712	293	GOWND16	311
GOSN716	293	GOWND24	311
GOSN724	293	GOWNE04	311
GOSN802	293	GOWNE06	311
GOSN804	293	GOWNE08	311
GOSN806	293	GOWNE12	311
GOSN808	293	GOWNE16	311
GOSN812	293	GOWNE24	311
GOSN816	293	GUCB104	297
GOSN824	293	GUCB106	297
GOSND02	293	GUCB108	297
GOSND04	293	GUCB112	297
GOSND06	293	GUCB116	297
GOSND08	293	GUCB124	297
GOSND12	293	GUCB204	297
GOSND16	293	GUCB206	297
GOSND24	293	GUCB208	297
GOSNE02	293	GUCB212	297
GOSNE04	293	GUCB216	297
GOSNE06	293	GUCB224	297
GOSNE08	293	GUCB704	297
GOSNE12	293	GUCB706	297
GOSNE16	293	GUCB708	297
GOSNE24	293	GUCB712	297
GOVN102	293	GUCB716	297
GOVN104	293	GUCB724	297
GOVN106	293	GUCB804	297
GOVN108	293	GUCB806	297
GOVN112	293	GUCB808	297
GOVN116	293	GUCB812	297
GOVN124	293	GUCB816	297
GOVN202	293	GUCB824	297
GOVN204	293	GUCBD04	297
GOVN206	293	GUCBD06	297
GOVN208	293	GUCBD08	297
GOVN212	293	GUCBD12	297
GOVN216	293	GUCBD16	297
GOVN224	293	GUCBD24	297
GOVN702	293	GUCBE04	297
GOVN704	293	GUCBE06	297
GOVN706	293	GUCBE08	297
GOVN708	293	GUCBE12	297
GOVN712	293	GUCBE16	297
GOVN716	293	GUCBE24	297
GOVN724	293	GUCN104	297
GOVN802	293	GUCN106	297
GOVN804	293	GUCN108	297
GOVN806	293	GUCN112	297
GOVN808	293	GUCN116	297
GOVN812	293	GUCN124	297
GOVN816	293	GUCN204	297
GOVN824	293		
GOVND02	293		
GOVND04	293		
GOVND06	293		
GOVND08	293		
GOVND12	293		
GOVND16	293		
GOVND24	293		
GOVNE02	293		
GOVNE04	293		
GOVNE06	293		
GOVNE08	293		
GOVNE12	293		
GOVNE16	293		
GOVNE24	293		
GOWB104	311		
GOWB106	311		
GOWB108	311		
GOWB112	311		
GOWB116	311		
GOWB124	311		
GOWB204	311		
GOWB206	311		
GOWB208	311		
GOWB212	311		
GOWB216	311		
GOWB224	311		
GOWB704	311		
GOWB706	311		
GOWB708	311		
GOWB712	311		
GOWB716	311		
GOWB724	311		
GOWB804	311		
GOWB806	311		
GOWB808	311		
GOWB812	311		
GOWB816	311		
GOWB824	311		
GOWBD04	311		
GOWBD06	311		
GOWBD08	311		
GOWBD12	311		
GOWBD16	311		
GOWBD24	311		
GOWBE04	311		
GOWBE06	311		
GOWBE08	311		
GOWBE12	311		
GOWBE16	311		
GOWBE24	311		
GOWN104	311		
GOWN106	311		
GOWN108	311		
GOWN112	311		
GOWN116	311		
GOWN124	311		
GOWN204	311		
GOWN206	311		
GOWN208	311		
GOWN212	311		
GOWN216	311		
GOWN224	311		
GOWN704	311		
GOWN706	311		

Part Number Index

Part Number	Part Number	Part Number			
GUCN206	297	GUDN104	301	GUFBD24	313
GUCN208	297	GUDN106	301	GUFBE04	313
GUCN212	297	GUDN108	301	GUFBE06	313
GUCN216	297	GUDN112	301	GUFBE08	313
GUCN224	297	GUDN116	301	GUFBE12	313
GUCN704	297	GUDN124	301	GUFBE16	313
GUCN706	297	GUDN204	301	GUFBE24	313
GUCN708	297	GUDN206	301	GUFN104	313
GUCN712	297	GUDN208	301	GUFN106	313
GUCN716	297	GUDN212	301	GUFN108	313
GUCN724	297	GUDN216	301	GUFN112	313
GUCN804	297	GUDN224	301	GUFN116	313
GUCN806	297	GUDN704	301	GUFN124	313
GUCN808	297	GUDN706	301	GUFN204	313
GUCN812	297	GUDN708	301	GUFN206	313
GUCN816	297	GUDN712	301	GUFN208	313
GUCN824	297	GUDN716	301	GUFN212	313
GUCND04	297	GUDN724	301	GUFN216	313
GUCND06	297	GUDN804	301	GUFN224	313
GUCND08	297	GUDN806	301	GUFN704	313
GUCND12	297	GUDN808	301	GUFN706	313
GUCND16	297	GUDN812	301	GUFN708	313
GUCND24	297	GUDN816	301	GUFN712	313
GUCNE04	297	GUDN824	301	GUFN716	313
GUCNE06	297	GUDND04	301	GUFN724	313
GUCNE08	297	GUDND06	301	GUFN804	313
GUCNE12	297	GUDND08	301	GUFN806	313
GUCNE16	297	GUDND12	301	GUFN808	313
GUCNE24	297	GUDND16	301	GUFN812	313
GUDB104	301	GUDND24	301	GUFN816	313
GUDB106	301	GUDNE04	301	GUFN824	313
GUDB108	301	GUDNE06	301	GUFND04	313
GUDB112	301	GUDNE08	301	GUFND06	313
GUDB116	301	GUDNE12	301	GUFND08	313
GUDB124	301	GUDNE16	301	GUFND12	313
GUDB204	301	GUDNE24	301	GUFND16	313
GUDB206	301	GUFB104	313	GUFND24	313
GUDB208	301	GUFB106	313	GUFNE04	313
GUDB212	301	GUFB108	313	GUFNE06	313
GUDB216	301	GUFB112	313	GUFNE08	313
GUDB224	301	GUFB116	313	GUFNE12	313
GUDB704	301	GUFB124	313	GUFNE16	313
GUDB706	301	GUFB204	313	GUFNE24	313
GUDB708	301	GUFB206	313	GUHA104	305
GUDB712	301	GUFB208	313	GUHA106	305
GUDB716	301	GUFB212	313	GUHA108	305
GUDB724	301	GUFB216	313	GUHA112	305
GUDB804	301	GUFB224	313	GUHA116	305
GUDB806	301	GUFB704	313	GUHA124	305
GUDB808	301	GUFB706	313	GUHA204	305
GUDB812	301	GUFB708	313	GUHA206	305
GUDB816	301	GUFB712	313	GUHA208	305
GUDB824	301	GUFB716	313	GUHA212	305
GUDBD04	301	GUFB724	313	GUHA216	305
GUDBD06	301	GUFB804	313	GUHA224	305
GUDBD08	301	GUFB806	313	GUHA704	305
GUDBD12	301	GUFB808	313	GUHA706	305
GUDBD16	301	GUFB812	313	GUHA708	305
GUDBD24	301	GUFB816	313	GUHA712	305
GUDBE04	301	GUFB824	313	GUHA716	305
GUDBE06	301	GUFBD04	313	GUHA724	305
GUDBE08	301	GUFBD06	313	GUHA804	305
GUDBE12	301	GUFBD08	313	GUHA806	305
GUDBE16	301	GUFBD12	313	GUHA808	305
GUDBE24	301	GUFBD16	313	GUHA812	305

Part Number	Part Number	Part Number			
GUHA816	305	GUSL206	291	GUSND12	291
GUHA824	305	GUSL208	291	GUSND16	291
GUHAD04	305	GUSL212	291	GUSND24	291
GUHAD06	305	GUSL216	291	GUSNE02	291
GUHAD08	305	GUSL224	291	GUSNE04	291
GUHAD12	305	GUSL702	291	GUSNE06	291
GUHAD16	305	GUSL704	291	GUSNE08	291
GUHAD24	305	GUSL706	291	GUSNE12	291
GUHAE04	305	GUSL708	291	GUSNE16	291
GUHAE06	305	GUSL712	291	GUSNE24	291
GUHAE08	305	GUSL716	291	GUVN102	291
GUHAE12	305	GUSL724	291	GUVN104	291
GUHAE16	305	GUSL802	291	GUVN106	291
GUHAE24	305	GUSL804	291	GUVN108	291
GURN102	291	GUSL806	291	GUVN112	291
GURN104	291	GUSL808	291	GUVN116	291
GURN106	291	GUSL812	291	GUVN124	291
GURN108	291	GUSL816	291	GUVN202	291
GURN112	291	GUSL824	291	GUVN204	291
GURN116	291	GUSLD02	291	GUVN206	291
GURN124	291	GUSLD04	291	GUVN208	291
GURN202	291	GUSLD06	291	GUVN212	291
GURN204	291	GUSLD08	291	GUVN216	291
GURN206	291	GUSLD12	291	GUVN224	291
GURN208	291	GUSLD16	291	GUVN702	291
GURN212	291	GUSLD24	291	GUVN704	291
GURN216	291	GUSLE02	291	GUVN706	291
GURN224	291	GUSLE04	291	GUVN708	291
GURN702	291	GUSLE06	291	GUVN712	291
GURN704	291	GUSLE08	291	GUVN716	291
GURN706	291	GUSLE12	291	GUVN724	291
GURN708	291	GUSLE16	291	GUVN802	291
GURN712	291	GUSLE24	291	GUVN804	291
GURN716	291	GUSN102	291	GUVN806	291
GURN724	291	GUSN104	291	GUVN808	291
GURN802	291	GUSN106	291	GUVN812	291
GURN804	291	GUSN108	291	GUVN816	291
GURN806	291	GUSN112	291	GUVN824	291
GURN808	291	GUSN116	291	GUVND02	291
GURN812	291	GUSN124	291	GUVND04	291
GURN816	291	GUSN202	291	GUVND06	291
GURN824	291	GUSN204	291	GUVND08	291
GURND02	291	GUSN206	291	GUVND12	291
GURND04	291	GUSN208	291	GUVND16	291
GURND06	291	GUSN212	291	GUVND24	291
GURND08	291	GUSN216	291	GUVNE02	291
GURND12	291	GUSN224	291	GUVNE04	291
GURND16	291	GUSN702	291	GUVNE06	291
GURND24	291	GUSN704	291	GUVNE08	291
GURNE02	291	GUSN706	291	GUVNE12	291
GURNE04	291	GUSN708	291	GUVNE16	291
GURNE06	291	GUSN712	291	GUVNE24	291
GURNE08	291	GUSN716	291	GUWB104	309
GURNE12	291	GUSN724	291	GUWB106	309
GURNE16	291	GUSN802	291	GUWB108	309
GURNE24	291	GUSN804	291	GUWB112	309
GUSL102	291	GUSN806	291	GUWB116	309
GUSL104	291	GUSN808	291	GUWB124	309
GUSL106	291	GUSN812	291	GUWB204	309
GUSL108	291	GUSN816	291	GUWB206	309
GUSL112	291	GUSN824	291	GUWB208	309
GUSL116	291	GUSND02	291	GUWB212	309
GUSL124	291	GUSND04	291	GUWB216	309
GUSL202	291	GUSND06	291	GUWB224	309
GUSL204	291	GUSND08	291	GUWB704	309

Part Number Index

Part Number	Part Number	Part Number			
GUWB706	309	MIPP-00-003	342	MIPP-10-003	343
GUWB708	309	MIPP-00-004	342	MIPP-10-004	343
GUWB712	309	MIPP-00-005	345	MIPP-10-005	343
GUWB716	309	MIPP-00-006	345	MIPP-10-006	343
GUWB724	309	MIPP-01-001	342	MIPP-10-007	343
GUWB804	309	MIPP-01-002	342	MIPP-10-008	343
GUWB806	309	MIPP-01-003	342	MIPP-10-009	343
GUWB808	309	MIPP-01-004	342	MIPP-10-010	343
GUWB812	309	MIPP-01-005	342	MIPP-10-011	343
GUWB816	309	MIPP-01-006	342	MIPP-10-012	343
GUWB824	309	MIPP-01-007	342	MIPP-20-001	343
GUWBD04	309	MIPP-01-008	342	MIPP-21-001	347
GUWBD06	309	MIPP-01-009	342	PS/PSX 45-05	84
GUWBD08	309	MIPP-01-010	342	PS/PSX 55-05	84
GUWBD12	309	MIPP-01-011	342	PS/PSX 65-05	84
GUWBD16	309	MIPP-01-012	342	PS/PSX 75-05	84
GUWBD24	309	MIPP-01-013	342	PS/PSX 85-05	84
GUWBE04	309	MIPP-01-014	342	PS/PSX 95-05	84
GUWBE06	309	MIPP-01-015	342	PS/PSX 99-07	84
GUWBE08	309	MIPP-01-016	342	PS/PSX 107-07	84
GUWBE12	309	MIPP-01-017	342	PS/PSX 112-10	84
GUWBE16	309	MIPP-01-018	342	PS/PSX 113-07	84
GUWBE24	309	MIPP-01-019	342	PS/PSX 121-07	84
GUWN104	309	MIPP-01-020	345	PS/PSX 125-10	84
GUWN106	309	MIPP-01-021	345	PS/PSX 138-10	84
GUWN108	309	MIPP-01-022	345	PS/PSX 138-12	84
GUWN112	309	MIPP-01-023	345	PS/PSX 156-12	84
GUWN116	309	MIPP-01-024	345	PS/PSX 174-12	84
GUWN124	309	MIPP-01-025	345	PS/PSX 174-15	84
GUWN204	309	MIPP-01-026	345	PS/PSX 188-12	84
GUWN206	309	MIPP-01-027	345	PS/PSX 188-15	84
GUWN208	309	MIPP-01-030	342	PS/PSX 200-15	84
GUWN212	309	MIPP-01-031	342	PS/PSX 218-15	84
GUWN216	309	MIPP-01-032	342	PS/PSX 219-20	84
GUWN224	309	MIPP-01-033	342	PS/PSX 236-20	84
GUWN704	309	MIPP-01-034	342	PS/PSX 247-20	84
GUWN706	309	MIPP-01-035	342	PS/PSX 261-20	84
GUWN708	309	MIPP-01-036	342	PS/PSX 263-25	84
GUWN712	309	MIPP-01-037	342	PS/PSX 280-25	84
GUWN716	309	MIPP-01-038	342	PS/PSX 296-25	84
GUWN724	309	MIPP-01-039	342	PS/PSX 297-30	84
GUWN804	309	MIPP-01-040	342	PS/PSX 311-30	84
GUWN806	309	MIPP-01-041	342	PS/PSX 327-30	84
GUWN808	309	MIPP-01-042	342	PS/PSX 343-30	84
GUWN812	309	MIPP-01-043	342	PS/PSX 359-30	84
GUWN816	309	MIPP-01-044	342	PS/PSX 375-35	84
GUWN824	309	MIPP-01-045	342	PS/PSX 392-35	84
GUWND04	309	MIPP-01-046	342	PS/PSX 412-35	84
GUWND06	309	MIPP-02-001	343	PS/PSX 423-40	84
GUWND08	309	MIPP-02-002	343	PS/PSX 437-40	84
GUWND12	309	MIPP-02-003	343	PS/PSX 451-40	84
GUWND16	309	MIPP-02-004	343	PS/PSX 462-40	84
GUWND24	309	MIPP-02-005	347	ST050-462	84
GUWNE04	309	MIPP-02-006	343	ST050-464	84
GUWNE06	309	MIPP-02-007	347	ST050-465	84
GUWNE08	309	MIPP-02-008	343	ST050-466	84
GUWNE12	309	MIPP-02-009	347	ST075-467	84
GUWNE16	309	MIPP-02-010	345	ST075-468	84
GUWNE24	309	MIPP-02-011	347	ST100-469	84
H155A00	284	MIPP-03-001	347	ST125-470	84
H155A02	284	MIPP-04-001	343	ST125-471	84
MIPP-00-001	342	MIPP-04-002	345	ST125-550	84
MIPP-00-001	345	MIPP-05-001	347	ST150-472	84
MIPP-00-001	347	MIPP-10-001	343	ST150-473	84
MIPP-00-002	342	MIPP-10-002	343	ST200-474	84

Part Number	
ST200-475	84
ST200-476	84
ST200-551	84
ST250-477	84
ST250-478	84
ST300-479	84
ST300-480	84
ST300-481	84
ST350-482	84
ST350-483	84
ST400-484	84
ST400-485	84
ST400-486	84
TMC165	84
TMC285	84
TMC3112	84
TMC4140	84
TMC5161	84
TMC6206	84
TMC7247	84
TMC8302	84
TMC9352	84
TMC10402	84
TMCX165	84
TMCX285	84
TMCX3112	84
TMCX4140	84
TMCX5161	84
TMCX6206	84
TMCX7247	84
TMCX8302	84
TMCX9352	84
TMCX10402	84
YE00819	259
YE00820	259
YE00905	259
YE00906	259
Y64695	284

GLOBAL LOCATIONS

For more information, please visit us at:
www.beldensolutions.com



**Be certain
you stay
in touch.**

EUROPE/MIDDLE EAST/AFRICA

**The Netherlands –
Head Office**
Phone: +31-773-878-555
venlo.salesinfo@belden.com

France
Phone: +33-472-109-990
lyon.salesinfo@belden.com

Germany
Phone: +49-7127-14-0
inet-sales@belden.com

Italy
Phone: +39-039-5965-250
info.milano@belden.com

Russia
Phone: +7-495-287-1391
info@belden.ru

Spain
Phone: +34-91-746-17-30
madrid.salesinfo@belden.com

Sweden
Phone: +46-40-699-88-60
inet-sales@belden.com

United Arab Emirates
Phone: +971-4-391-0490
dubai.salesinfo@belden.com

United Kingdom
Phone: +44 161 4983749
manchester.salesinfo@belden.com

Americas

USA
Phone: +1-855-400-9071
inetsalesops@belden.com

Asia/Pacific

Singapore
Phone: +65-6879-9800
singapore.sales@belden.com

China
Phone: +86-21-5445-2353
China.Marketing@belden.com