



MEACON MIK-PH6.0

---

pH/ORP Controller

---

---

## **Preface**

Thank you for purchasing pH/ORP controller. Please read this manual carefully before operating and using it correctly to avoid unnecessary losses caused by false operation.

### **Note**

- Modification of this manual's contents will not be notified as a result of some factors, such as function upgrading.
- We try our best to guarantee that the manual content is accurate, if you find something wrong or incorrect, please contact us.
- This product is forbidden to use in explosion-proof occasions.

### **Version**

U-PH6-MYEN2

---

## **Safety Precautions**

In order to use this product safely, be sure to follow the safety precautions described.

### **About this manual**

- Please submit this manual to the operator for reading.
- Please read the operation manual carefully before applying the instrument. On the precondition of full understanding.
- This manual only describes the functions of the product. The company does not guarantee that the product will be suitable for a particular use by the user.

### **Precautions for protection, safety and modification of this product**

- To ensure safe use of this product and the systems it controls, Please read carefully the operation manual and understand the correct application methods before putting into operation, to avoid unnecessary losses due to operation mistakes. If the instrument is operated in other ways not described in the manual, the protections that the instrument give may be destroyed, and the failures and accidents incurred due to violation of precautions shall not be borne by our company.
- When installing lightning protection devices for this product and its control system, or designing and installing separate safety protection circuits for this product and its control system, it needs to be implemented by other devices.
- If you need to replace parts of the product, please use the model specifications specified by the company.
- This product is not intended for use in systems that are directly related to personal safety. Such as nuclear power equipment, equipment using radioactivity, railway systems, aviation equipment, marine equipment, aviation equipment and medical equipment. If applied, it is the responsibility of the user to use additional equipment or systems to ensure personal safety.

- 
- Do not modify this product.
  - The following safety signs are used in this manual:



Hazard, if not taken with appropriate precautions, will result in serious personal injury, product damage or major property damage.



Warning: Pay special attention to the important information linked to product or particular part in the operation manual.



- Confirm if the supply voltage is consistent with the rated voltage before operation.
- Don't use the instrument in a flammable and combustible or steam area.
- To prevent from electric shock, operation mistake, a good grounding protection must be made.
- Thunder prevention engineering facilities must be well managed: the shared grounding network shall be grounded at is-electric level, shielded, wires shall be located rationally, SPD surge protector shall be applied properly.
- Some inner parts may carry high voltage. Do not open the square panel in the front except our company personnel or maintenance personnel acknowledged by our company, to avoid electric shock.
- Cut off electric powers before making any checks, to avoid electric shock.
- Check the condition of the terminal screws regularly. If it is loose, please tighten it before use.
- It is not allowed to disassemble, process, modify or repair the product without authorization, otherwise it may cause abnormal operation, electric shock or fire accident.
- Wipe the product with a dry cotton cloth. Do not use alcohol, benzine or

---

other organic solvents. Prevent all kinds of liquid from splashing on the product. If the product falls into the water, please cut off the power immediately, otherwise there will be leakage, electric shock or even a fire accident.

- Please check the grounding protection status regularly. Do not operate if you think that the protection measures such as grounding protection and fuses are not perfect.
- Ventilation holes on the product housing must be kept clear to avoid malfunctions due to high temperatures, abnormal operation, shortened life and fire.
- Please strictly follow the instructions in this manual, otherwise the product's protective device may be damaged.



- Don't use the instrument if it is found damaged or deformed at opening of package.
- Prevent dust, wire end, iron fines or other objects from entering the instrument during installation, otherwise, it will cause abnormal movement or failure.
- During operation, to modify configuration, signal output, startup, stop, operation safety shall be fully considered. Operation mistakes may lead to failure and even destruction of the instrument and controlled equipment.
- Each part of the instrument has a certain lifetime, which must be maintained and repaired on a regular basis for long-time use.
- The product shall be scrapped as industrial wastes, to prevent environment pollution.
- When not using this product, be sure to turn off the power switch.
- If you find smoke from the product, smell odor, abnormal noise, etc., please turn off the power switch immediately and contact the company in time.

---

## Disclaimer

- The company does not make any guarantees for the terms outside the scope of this product warranty.
- This company is not responsible for damage to the instrument or loss of parts or unpredictable damage caused directly or indirectly by improper operation of the user.

No.	Name	Quantity	Note
1	pH/ORP controller	1	
2	Manual	1	
3	Certificate	1	

After opening the box, please confirm the package contents before starting the operation. If you find that the model and quantity are incorrect or there is physical damage in appearance, please contact us.

---

# Contents

Chapter 1 Introduction.....	1
1.1 Characteristics.....	1
1.2 Parameter.....	2
Chapter 2 Installation.....	3
2.1 Instrument installation.....	3
2.2 Electrode installation.....	5
2.3 Wiring.....	6
Chapter 3 Navigation keys.....	7
3.1 Button display.....	7
Chapter 4 System menu & operating.....	8
4.1 Monitoring page.....	8
4.2 Password verification page.....	9
4.3 Main menu.....	9
Chapter 5 Setting.....	10
5.1 System setting.....	10
5.2 Signal Setting.....	10
5.3 Online calibration.....	11
5.4 Remote transmission setting.....	11
5.5 Alarm setting.....	12
5.6 Information inquiry.....	12
Chapter 6 Communication.....	13
Chapter 7 Maintenance.....	15
Chapter 8 Troubleshooting.....	17

## Chapter 1 Introduction

Independent research and development of electronic online monitoring pH / ORP value, through the RS485 or current transmission remote access to the monitoring room for record and save.

pH / ORP tester is one of the intelligent online chemical analysis equipment, is a widely used in thermal power, chemical fertilizer, metallurgy, environmental protection, Pharmaceutical, biochemical, food and tap water solution pH value or ORP value and temperature of the continuous monitor.

Continuous monitoring data through the transmission output connection recorder to achieve remote monitoring and recording, you can also connect the RS485 interface through the MODBUS-RTU protocol can be easily connected to the computer to achieve monitoring and recording.

### 1.1 Characteristics

- Design of board card modularity, for convenience of assembly and configuration.
- 2.4 inches 12864 lattice screen.
- Isolating transmitting output, with little interference.
- Isolating RS485 communication.
- Can be pH / ORP measurement, temperature measurement, upper and lower limit control, transmission output, RS485 communication.
- Configurable manual and auto temperature offset function.
- Configurable upper/lower limit warning and delay.
- Configurable hummer and LCD backlight switch.



## 1.2 Parameter

Screen size	2.8 inch monochrome LCD(liquid crystal display) with a resolution of 128*64
Overall dimension:	100mm×100mm×150mm
Cutout dimension	92.5mm×92.5mm
Weight	0.58Kg
Ingress protection	IP65
Measure variables	pH/ORP
Measure range	pH: 0.00 ~ 14.00pH
	ORP: -1000 ~+1000mV -2000~+2000mV (optical)
Accuracy	pH: ±0.02pH
	ORP: ±1mV
Input resistance	≥10 <sup>12</sup> Ω
Temperature compensation	NTC10K: -10~60℃ Accuracy ±0.3℃ 60-130℃ Accuracy ±2℃
	PT1000: Accuracy ±0.3℃ -10-130℃ manual/automatic
Output	4~20mA output, maximum loop is 750Ω,±0.2%FS
RS485 output	Isolated, MODBUS-RTU RS485
Alarm relay	2channels, Pickup/Breakaway AC250V/3A
Relative humidity	10~85%RH(No condensation)
Operating temperature	0 ~ 60℃
Power supply	AC: 220V±10%, 50Hz/60Hz
Storage conditions	Temperature: -15~65℃
	Relative humidity: 5~95%RH(No condensation)
	Altitude:<2000m

## **Chapter 2 Installation**

### **2.1 Instrument installation**

Please read the instruction of installation location and method of instrument as described during installation.

#### **2.1.1 Installation precautions**

- This product is tray mounted.
- Please install it indoors, avoiding wind, rain and direct sunlight.
- In order to prevent the internal temperature of this product from rising, please install it in a well-ventilated place.
- When installing this product, please do not tilt it to the left and right, try to install it horizontally (it can be tilted back  $<30^\circ$ ).

#### **2.1.2 Installation should be kept away from the following site**

- In direct exposure to sunlight and near thermal equipment.
- With ambient temperature over 60 degrees in operation.
- With humidity over 85% in operation.
- Nearby electromagnetic source.
- In strong mechanical vibration.
- With varying temperature and dew condensation.
- With oil smoke, steam, humidity, dust and corrosive gases.

### 2.1.3 Installation methods

Install a 92.5 \* 92.5 mounting hole on the instrument cabinet or mounting panel.the thickness of the mounting panel is 1.5mm~13mm.

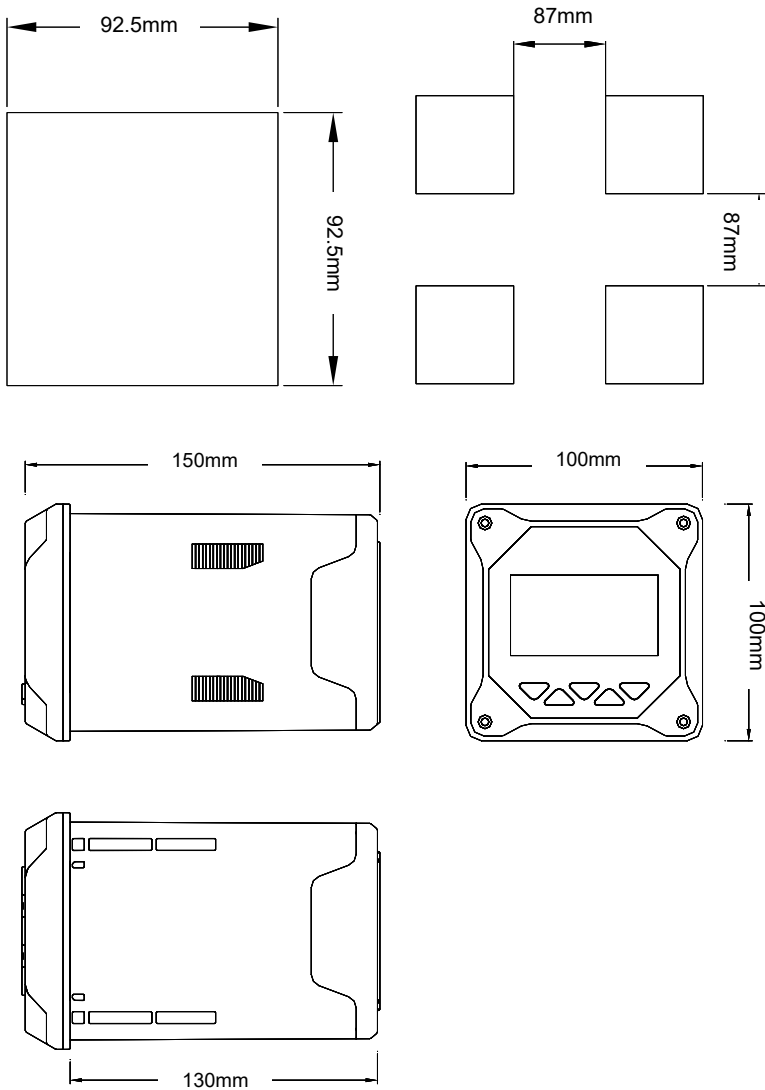

The instrument into the mounting hole and then buckle on the Snap, as shown below

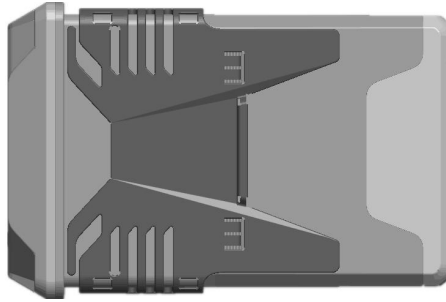

## 2.2 Electrode installation

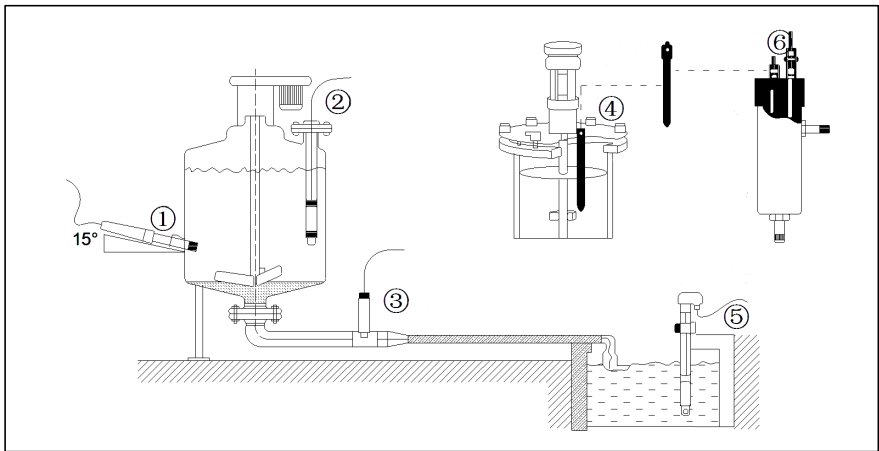

Schematic diagram of common installation method

- ①Side wall installation    ②Flange mounted at the top    ③Pipe installation    ④Top installation    ⑤Submersible installation    ⑥Flow-through installation

The interface must be in 15° oblique angle, or it will affect the normal test and use of the electrode. We won't be responsible for any results due to this.

## 2.3 Wiring

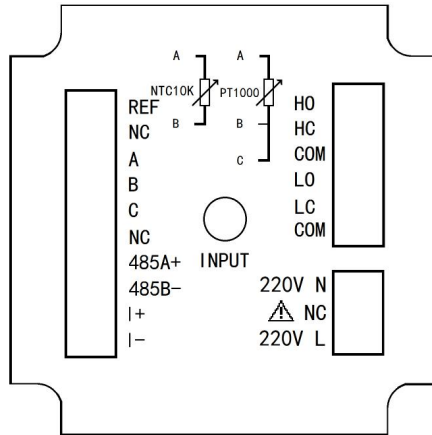

Wiring diagram

### 2.3.1 Identification of terminal

- INPUT: Measuring terminal of the electrode
- REF: Reference terminal of the electrode
- NC: Unidentified
- A: Temperature compensation terminal A, NTC10K and PT1000 connect here
- B: Temperature compensation terminal B, NTC10K and PT1000 connect here
- C: Temperature compensation terminal C, PT1000 three-wire temperature grounding, PT1000 two-wire need to be short-connected to TEMPB, not NTC10K.
- NC: Unidentified
- RS485 (A +): RS485 communication interface A +
- RS485 (B -): RS485 communication interface B-
- I (+): 4-20mA output end+
- I (-): 4-20mA output end-
- AC220V (L): AC220V FireWire
- AC220V (N): AC220V zero line
- HO: High alarm normally open relay
- HC: High alarm normally closed relay





- LO: Low alarm normally open relay
- LC: Low alarm normally closed relay
- COM: Common

## Chapter 3 Navigation keys

### 3.1 Button display



#### 3.1.1 Definition of buttons

Sign	Button name	Key function
	ESC	Under "Monitoring page" - Alarm view Under "Menu page" - Return to the previous page Under "Calibration page" - Skip this item
	RIGHT	Make a recurrent selection of digit of parameters modify the original indication value
	MENU	Under "Monitoring page" - Enter the MENU Under "Menu page" - Exit the MENU
	DOWN	Under "menu page" - Select the related menu Modify the values in the configuration state
	ENTER	Under "Menu page" - Enter the sub-menu or confirm modification

## Chapter 4 System menu & operating

### 4.1 Monitoring page

The instrument is equipped with monochrome lattice LCD, 128\*64 resolution.

- Push [MENU] to enter password verification page; input password to enter the home page.
- Push [EXIT] to enter alarm inquiry page, to inquire the current warning configuration information.



pH monitoring page

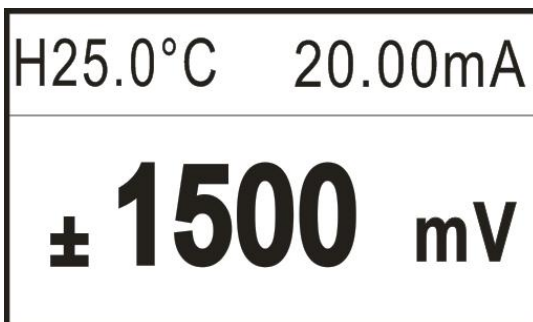

ORP monitoring page

## 4.2 Password verification page

-----User Password-----

Password: 0000

- Input password and push [CONFIRM] to enter home page.
- Initial password is 0000, which can be modified via password modification function.
- Please contact us if you forget your password.

## 4.3 Main menu

----- Main Menu -----

- ➡ 1.System Setting
- 2.Signal Setting
- 3.Online Calibrtion
- 4.Remote Setting
- 5.Alarm Setting
- 6.Information Inquiry

- System Setting: settings of language, buzzer and backlight, modification of password and factory settings
- Signal Setting: Toggle electrode type and automatic/manual temperature compensation.
- Online Calibration: Calibrate or correct pH and ORP signal.
- Remote Setting: settings of RS485 parameters and current transmission output.
- Alarm Setting: settings of parameters of high and low warning.
- Information Inquiry: current version number.



## Chapter 5 Setting

### 5.1 System setting

#### ----- System Setting -----

- ➡ 1. Language
- 2. Buzzer
- 3. Backlight
- 4. Change Password
- 5. Factory Setting

- Language: language type, Chinese or English.
- Buzzer: settings of switch of buzzer during warning.
- Backlight setting: settings of LCD backlight.
- Password modification: password modification and log-in with new password.
- Factory setting: return to factory settings

### 5.2 Signal Setting

#### ----- Signal Setting -----

- ➡ 1. Electrode Type
- 2. Temp Compensation

- Electrode type: set the electrode type, pH electrode and ORP electrode two types.
- Temperature compensation: set the automatic warming or manual temperature compensation, the temperature range of -10-130 °C. Temp Switch: auto temperature offset NTC10K or PT1000 or manual temperature compensation, temperature range: -10°C-130.0°C.

### 5.3 Online calibration

#### -----Online Calibrtion-----

- ▶ 1.PH Calibration
- 2.PH Modification
- 3.ORP Calibration
- 4.ORP Modification
- 5.Temp. Modification

- pH Calibration: Enter the pH calibration screen, the first pH electrode into the 4.00pH standard solution, standing for a moment, to be stable after the show, press the **【ENT】**, then the pH electrode into the 6.86pH standard solution Set the pH electrode into the 9.18pH standard solution, put it aside for a moment, after the test is stable, press **【ENT】**, the display shows the success of the calibration, the whole process of pH calibration completes.
- pH Modification: The measured pH can be modified between 2 pH values.
- ORP Calibration: enter the ORP calibration screen, the first ORP electrode into the 86mV standard solution, standing for a moment, to be shown after the stability, press the **【ENT】**, then the ORP electrode into the 256mV standard solution, static Set a moment, after the display is stable, press the **【ENT】** display calibration is successful, ORP calibration process is over.
- ORP Modification: The measured ORP can be modified between 300mV.
- Temp. Modification: You can correct the temperature of the automatic temperature compensation, the correction range is  $\pm 20.0$  °C.

### 5.4 Remote transmission setting

#### -----Remote Setting-----

- ▶ 1.RS485
- 2.Current Transmission

- RS485 setting: settings of 485 communication address and baud rate.

- Current transmission: settings of 4mA corresponding value and 20mA corresponding value of 4-20mA output.

## 5.5 Alarm setting

### ----- Alarm Setting -----

- ➡ 1.PH High Alarm
- 2.PH Low Alarm
- 3. ORP High Alarm
- 4. ORP Low Alarm

- pH High Alarm: when the measured value is greater than the high reported pull value, the high reported relay pull, when the measured value is less than the high reported off value, the high news relay disconnect.
- pH Low Alarm: when the measured value is less than the low pull-in value, the lower newspaper relay pull, when the measured value is greater than the low reported off value, the low alarm relay off.
- ORP High Alarm: when the measured value is greater than the high reported pull value, the high reported relay pull, when the measured value is less than the high reported off value, the high reported relay disconnect.
- ORP Low Alarm: When the measured value is less than the low pull-in value, the low relay relays, when the measured value is greater than the low reported off value, the low alarm relay off.

## 5.6 Information inquiry

### ----- Information Inquiry ----- ► 1. Version Information

Information inquiry: inquire the current hard software version, high traceability.

## Chapter 6 Communication

The instrument is provided with standard RS485 series communication interface, in accordance with international universal standard MODBUS-RTU communication protocol, supporting No.03 register reading and holding command.

MODBUS standard format (No.03 register reading and holding command)

### Command format:

Definition	Address	Function code	Register address	Number of data	CRC check
Data	ADDR	0x03	M	N	CRC 16
Number of bytes	1	1	2	2	2

### Return format:

Definition	Address	Function code	Data size	Data	CRC check
Data	ADDR	0x 03	2*N	Data	CRC 16
Number of bytes	1	1	1	2*N	2

**Register address description:**

Address	Data type	Date size	Function code	Description	Access authority
0x0000	Unsigned long	4 bytes	0x03	pH value (default two decimal places)	Read only
0x0002	Short	2 bytes	0x03	Temperature (default 1 decimal)	Read only
0x0003	Unsigned long	4 bytes	0x03	ORP value (signed integer)	Read only

**Communication case:**

The computer sends: 00 03 00 00 00 01 85 DB

pH / ORP Table Returns: 00 03 02 02 AE 05 58

Return command comment:

00 is 485 address;

03 is the function code;

02 is the data length of the return pH value: 2 bytes;

02 for the return of the pH value of 686 (hex high byte);

AE for the return of the pH value of 686 (hex low byte);

05 58 is the CRC check value;

**Example of temperature reading:**

Computer sends: 00 03 00 02 00 01 24 1B

Conductivity meter returns: 00 03 02 00 FA 05 C7

Return command annotation:

00 is the address of slave, which can be configured in the instrument;

03 is function code, reading and holding register;

02 is the length of data of returned temperature value, 2 bytes;

00 FA is the returned temperature value, 25.0°C, unit: °C.

The value obtained shall be divided by 10 to get the current temperature value. The range: -10.0-130.0°C.

05 C7 is the CRC16 check code, which is varying depending on different data;

## Chapter 7 Maintenance

1. The storage of pH glass electrode, short-term:  
stored in the pH = 4 buffer solution;  
long-term: stored in the pH = 7 buffer solution.
2. pH glass electrode cleaning  
pH glass electrode cleaning glass electrode bulb contamination may make the electrode response time longer. CCl<sub>4</sub> or soap can be used to wipe the dirt, and then immersed in distilled water a day and night to continue to use. When the pollution is serious, can be 5% HF solution for 10 to 20 minutes, immediately rinse with water, and then immersed in 0.1N HCl solution for a day and night to continue to use.
3. Glass electrode aging treatment  
The aging of the glass electrode and the gradual change in the structure of the glue layer. Old electrode response is slow, film resistance is high, slope is low. Exfoliation of the outer layer with hydrofluoric acid can often improve electrode performance. If this method can be used to regularly remove the inner and outer layers, the electrode life is almost unlimited.
4. The storage of the reference electrode  
Silver - silver chloride electrode The best storage solution is saturated potassium chloride solution, high concentration of potassium chloride solution can prevent the silver chloride in the liquid junction precipitation, and maintain the liquid junction in the work status. This method also applies to the storage of composite electrodes.
5. The reference electrode regeneration reference electrode problems caused by the vast majority of liquid junction caused by blockage, the following methods can be resolved:
  - Soaking fluid interface: 10% saturated potassium chloride solution and 90% distilled water mixture, heated to 60 ~ 70 °C, the electrode immersed in about 5cm, soak for 20 minutes to 1 hour. This method dissolves the crystallization of the electrode tip.

- Ammonia Soaking: When the liquid interface is blocked by silver chloride can be leaching with concentrated ammonia. The specific method is to clean the electrode, the liquid vent after immersion in ammonia 10 to 20 minutes, but do not let ammonia into the electrode inside. Remove the electrode with distilled water to wash, re-add the internal liquid and continue to use.
- Vacuum method: the hose to match the reference electrode fluid interface, the use of water suction pump, suction part of the liquid through the fluid interface, remove the mechanical blockage.
- Boiling fluid junction: silver - silver chloride reference electrode liquid interface immersed in boiling water for 10 to 20 seconds. Note that the next time you boil, the electrode should be cooled to room temperature.
- When the above methods are invalid, sandpaper grinding can be used to remove the mechanical method of grinding. This method may cause the sand under the grinding into the liquid interface. Causing permanent clogging.

## Chapter 8 Troubleshooting

- No display on controller?  
A: Check if the power cable is correctly connected, power is on.
- Number in display is jumping up and down?  
A: Check if there is any interference equipment such as frequency converter is nearby. The instrument should be kept away from such interference equipment or protected with good shielding measures.
- Conductivity instrument can not be calibrated?  
A: The standard solution is not mixed in a correct way or the electrode is damaged.
- The instrument can not measure accurately after calibration with a standard solution of conductivity of 1413us/cm?  
A: Check if the standard solution is polluted. Replace the solution and calibrate again.
- The response of number is slow?  
A: If the electrode is covered by dirt, the response would be slow. Clean the pollutant in a corresponding method. A slow response is normal in winter.