

ETCR

Earth Resistance Tester

ETCR2000+
ETCR2000A+
ETCR2000C+
ETCR2100+
ETCR2100A+
ETCR2100C+

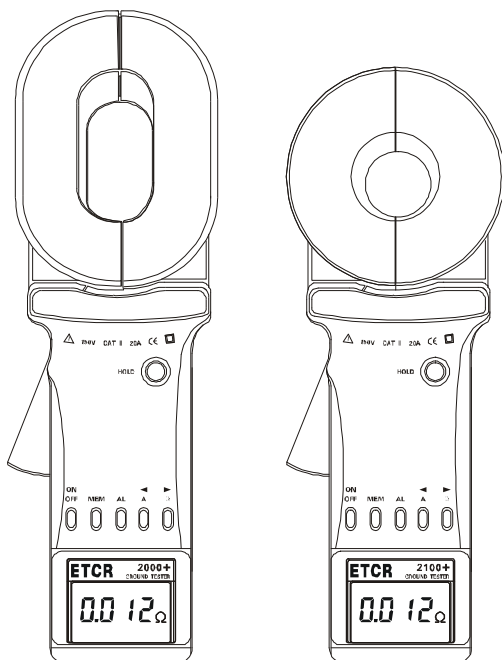

MANUAL

Guangzhou ETCR Electronic Technology Co.,Ltd

CONTENT

I. Attention.....	1
II. Brief Introduction	3
III. Specification	5
1. Model of Series.....	5
2. Ranges and Accuracy of Measurement.....	5
3. Specifications	6
IV. Structure of Meter	7
V. Liquid Crystal Display	8
1. LCD Screen.....	8
2. Description of Special Symbols.....	9
3. Examples Illustrated.....	10
VI. Operating Method	11
1.Boot up	11
2. Shutdown.....	12
3. Resistance Measurement.....	13
*4. Current Measurement	14
5. Date Lock/Release/Storage.....	15
6. Data Access	16
7. Alarm Settings	16
8. Access to Alarm Critical Value.....	17
9. Clear Data.....	17
VII. Measurement Principle	18
1. Principle of Resistance Measurement	18
2. Principle of Current Measurement	18
VIII. Measurement Method of Earth Resistance	19

1. Multi-Point Grounding System	19
2. Limited Point Grounding System	20
3. Single-Point Grounding System.....	21
IX. Bill of Loading.....	24
X. Parts List and Assembly Details.....	25
1. Parts List	25
2. Assembly Details	26
XI. Trouble shooting	27

I. Attention

Thank you for purchasing this pincers earth tester from ETCR Electronic Technology Company. In order to make better use of the product, please be certain:

----To read this user manual carefully.

----To comply with the operating cautions presented in this manual.

- 1 Under any circumstances, use the Meter should pay special attention to safety.
- 2 Pay attention to the measurement range of the Meter and the using environment provided.
- 3 Pay attention to the text labeled on the panel and back plane of the Meter.
- 4 Before booting up, the trigger should be pressed for 1-2 times to ensure the jaws are well closed.
- 5 At Boot time, DO NOT press the trigger, nor clamp any wire.
- 6 Before the auto inspection is completed and the "OL Ω" symbols are showed, the measured objects cannot be clamped on.
- 7 The jaw planes contact must be maintained clean, and should not be polished with corrosive and rough materials.
- 8 Avoid any impact onto this Meter, especially the Jaw contact surface.
- 9 This Meter will have some buzzing sound in measurement

process, and it is normal.

- 10 The measurement current of the wire should not exceed the upper limit of the Meter.
- 11 Please take out the batteries in the case of the Meter being idle for a long time.
- 12 The dismantling, calibration and maintenance the Meter shall be operated by the authorized staff.
- 13 If the continuing use of it would be dangerous, the Meter should be stopped using immediately, and immediately sealed for the treatment by the authorized agencies.
- 14 The contents in this user manual marked with "*" are limited to **C+**.

II. Brief Introduction

This instrument was designed by technical department of ETCR Electronic Technology Company. Its performance is mainly reflected in:

- u Breakthrough in self-test the boot a long time to wait, start immediately into the test.
- u Breakthrough relay self-test mode, using the most advanced processing algorithms and digital integration technology, a fully intelligent.
- u Break the old product to heavy issues, more in line with characteristics of handheld devices.
- u New design, panel operation with 6 buttons, better performance.
- u An increase of sound and light alarm, "beep—beep--beep --" alarm sound.
- u Increase the interference signal recognition indicator.
- u Improved anti-jamming capability and test stability.
- u Stored data: 99 Units.
- u Wider range: 0.01Ω-1200Ω
- u Lower power consumption: Maximum operating current not exceeding 50mA.

ETCR series of Pincers Earth Tester is widely used in the grounding resistance measurement of the power, telecommunications, meteorology, oilfield, construction and the

industrial and electrical equipment.

ETCR series of Pincers Earth Tester, in the measurement of a grounding system with loop current, does not require breaking down the grounding wire, and need no auxiliary electrode. It is safe, fast and simple in use.

ETCR series of Pincers Earth Tester can measure out the faults beyond the reach of the traditional methods, and can be applied in the occasions not in the range of the traditional methods.

ETCR series of Pincers Earth Tester can measure the integrated value of the grounding body resistance and the grounding lead resistance.

ETCR series of Pincers Earth Tester is equipped with a long jaw, as indicated in the figure below. A long jaw is particularly suitable for the occasion of grounding with the flat steel.

In addition,

C+ Pincers Earth Tester is also able to measure the leakage current and the neutral current in the grounding system.

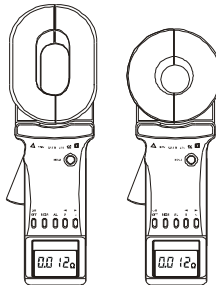

III. Specification

1. Model of Series

Model	Jaw Size (mm)	Range of Resistance (Ω)	Range of Current (A)	Storage Function	Alarm Function
ETCR2000+	65×32	0.01--1200	--	99 Units	√
ETCR2000A+	65×32	0.01--200	--	99 Units	√
ETCR2000C+	65×32	0.01--1200	0.0--20.0	99 Units	√
ETCR2100+	φ32	0.01--1200	--	99 Units	√
ETCR2100A+	φ32	0.01--200	--	99 Units	√
ETCR2100C+	φ32	0.01--1200	0.0--20.0	99 Units	√

Note: “√” means available.

2. Ranges and Accuracy of Measurement

Mode	Range	Resolution	Accuracy
Resistance	0.010 Ω -0.099 Ω	0.001 Ω	± (1%+0.01 Ω)
	0.10 Ω -0.99 Ω	0.01 Ω	± (1%+0.01 Ω)
	1.0 Ω -49.9 Ω	0.1 Ω	± (1%+0.1 Ω)
	50.0 Ω -99.5 Ω	0.5 Ω	± (1.5%+0.5 Ω)
	100 Ω -199 Ω	1 Ω	± (2%+1 Ω)
	200 Ω -395 Ω	5 Ω	± (5%+5 Ω)
	400-590 Ω	10 Ω	± (10%+10 Ω)
	600 Ω -880 Ω	20 Ω	± (20%+20 Ω)
	900 Ω -1200 Ω	30 Ω	± (25%+30 Ω)
* Current (True-RMS)	0.00mA -9.00mA	0.05mA	± (2.5%+2mA)
	10.0mA -99.0mA	0.1mA	± (2.5%+10mA)
	100mA -300mA	1mA	± (2.5%+20mA)
	0.30A-2.99A	0.01A	± (2.5%+0.1A)
	3.0A-9.9A	0.1A	± (2.5%+0.5A)
	10.0A-20.0A	0.1 A	± (2.5%+1 A)

Resistance Measurement Frequency: >1KHz

Measured Current Frequency: 50Hz/60Hz

Setting Range of Resistance Alarm Critical Value: 1 Ω -199 Ω

*Setting Range of Current Alarm Critical Value: 1mA -499mA

3. Specifications

Instrument safety: IEC/EN61010-1, IEC/EN6010-2-032

Insulation: double insulation

Pollution degree: class II

Overvoltage category: CAT III 150V to ground, Max 20A

Degrees of protection:

-IP30, Group III equipment as per EN 60529 Ed 92

-IK04, as per EN 50102 Ed 95

Dimensions(L×W×H):

-Long elliptic jaw: 285mm×90mm×66mm; (11×4×3 inches)

-Round jaw: 260mm×90mm×66mm;(10×4×3 inches)

Span of Jaw: Long elliptic jaw 35mm; round jaw 32mm

Weight (including batteries): Long elliptic jaw-1160g, Round jaw-1120g

Battery type: 4 ×1.5V alkaline LR6 AA battery

Low battery indication:  is displayed

Internal consumption: <50mA

Auto Power off: after 5 minutes of idleness

Display: 4 LCD, sign, decimal point and backlight

Memory size: 99 Units of Reading

Environment (Temperature & Relative Humidity):

-Working: -10°C~55°C, 10%RH-90%RH

-Storage: -20°C ~60°C, below 70%RH

Range shift: Full range automatic shifting

External magnetic field: <40A/m

External electric field: <1V/m

Data upload interface: RS232 (Optional)

IV. Structure of Meter

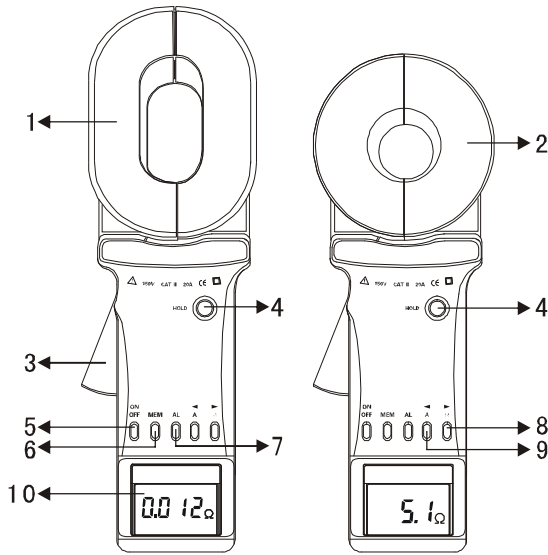

- 1. Long Pincers Jaw** : 65mmx32mm
- 2. Round Pincer Jaw** : $\phi 32$ mm
- 3. Trigger**: to control opening and closing of jaw
- 4. HOLD Key**: lock / Release display / Storage
- 5. POWER Key**: Boot Up / Shutdown /*Quit /Clear Data
- 6. MEM Key**: Data Access / Clear Data
- 7. AL Alarm Function Key**: Alarm Open / Turn Off / Alarm Critical Value Setting
- 8. Resistance Measure Switch Key Ω (Right Arrow Key)**
- 9. * Current Measure Switch Key A (Left Arrow Key)**
- 10. Liquid Crystal Display (LCD)**

Note: "*" is limited to C+.

V. Liquid Crystal Display



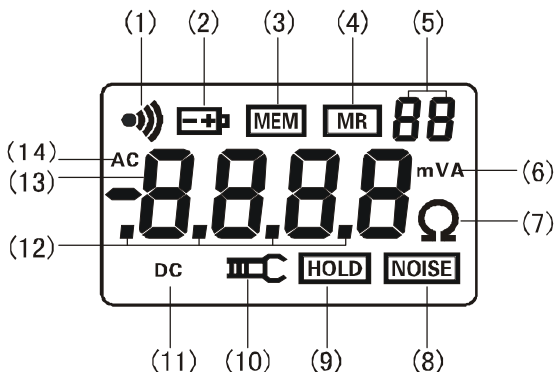



1. LCD Screen



- (1). Alarm Symbol
- (2). Symbol of low battery & voltage
- (3). Symbol of full data storage
- (4). Symbol of data access
- (5). 2-Digital No. Of Data Storage Unit
- (6). Current unit
- (7). Resistance unit
- (8). Noise signal
- (9). Data lock symbol
- (10). Symbol of an open jaw
- (11). Symbol of DC
- (12). Metrication decimal point
- (13). 4-digit LCD figures display
- (14). Symbol of AC

2. Description of Special Symbols

Note: "*" is limited to C+.

- (1).  Symbol of an open jaw: As a jaw is in the open state, the symbol shows. At this point, trigger may be artificially pressed, or the jaws have been seriously polluted, and can no longer continue to measure.
- (2). "Er" Boot error symbol, May be pressing trigger when boot or jaw has been opened.
- (3).  Symbol of low battery & voltage: when the battery voltage is lower than 5.3V, the symbol shows. At this time, it cannot guarantee accuracy of the measurements. Batteries should be replaced.
- (4). "OL Ω" symbol indicates that the measured resistance has exceeded the upper limit of the Meter.
- (5). "L0.01Ω" symbol indicates that the measured resistance has exceeded the lower limit of the Meter.
- * (6). "OL A" symbol indicates that the measured current has exceeded the upper limit of the Meter.
- (7).  Alarm symbol: when the measured value is greater than the critical value of alarm setting, the symbol flashes, and the meter issued by intermittent "beep--beep --beep--" sound.
- (8).  Symbol of full data storage: memory is full of data units of 99, and can no longer continue to store data.  symbol flashes.
- (9).  Symbol of access to data: to display in an access to data, also including the number of data.

- (10). **NOISE** signal: when the symbol flashes, in the measurement of grounding resistance at a greater interference current in the loop. At this time it cannot guarantee accuracy of the measurements.

3. Examples Illustrated

Note: "*" is limited to C+.

- (1). ---Jaw is in open state, and cannot measure

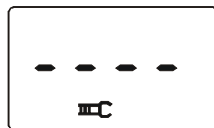

- (2). ---Boot error instructions Er (Error)

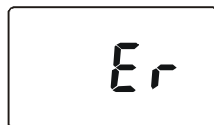

- (3). ---Measured loop resistance is less than 0.01Ω

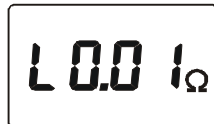

- (4). ---Measured loop resistance is 5.1Ω

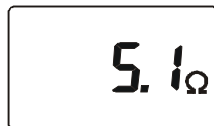

- (5). ---Measured loop resistance is 2.1Ω

---Lock the current measurement value: 2.1Ω



---Auto storage as 08 set data

- (6). ---Access to the stored data of Unit No.26

---Measured loop resistance is 0.028Ω

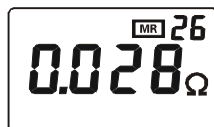

- * (7). ---Alarm function activated, the measured current exceeded

the critical value of alarm setting

---Low battery & voltage is displayed. At this time, it not guarantee the accuracy of the measurements

---Measured current is 8.40A

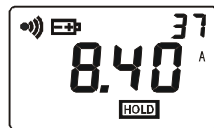

---Lock the current value displayed

---Store the current value as the data

Unit No.37

(8). --- Access to the stored data unit No.8

--- Measured resistance is 30Ω

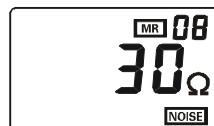

--- This data is measured in a lot of signals interference

VI. Operating Method

1.Boot up

	Boot , DO NOT press the trigger, don't open jaws, nor clamp any wire
	Boot complete, show "OL Ω", then press the trigger, open jaws, clamp the measured wire
	Before booting up, the trigger should be pressed for a couple of times to ensure the jaws are well closed.
	Boot, must maintain clamp meter natural resting state, don't flip Clamp, don't be imposed outside force on the jaw, otherwise can not guarantee the accuracy of measurement

Press **POWER** Key to Boot, first, automated testing LCD,

show all of its symbols (Figure 1). Meanwhile the instrument auto-calibration, after boot displayed "OL Ω ", automatically enter the resistance measurement mode (Figure 2). If there is no normal boot self-calibration, instrument will show "Er" symbol, said boot error. need to check the cause and reboot (Figure 3).

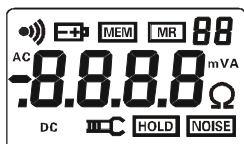

Figure 1



Figure 2

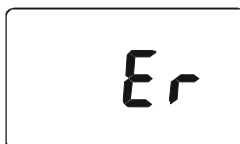

Figure 3

After Power On and Self Test if not appear "OL Ω ", but shows a large resistance (Figure 4).



Figure 4

However, when measured with the test ring, still gives the correct result, indicating Clamp measured only in the high-value (for example, more than 100 Ω) has large errors, When measuring a small resistance retains the original Accuracy, the user can rest assured use.

2. Shutdown

Press **POWER** Key to Shutdown.

5 minutes after boot, LCD display into the blinking state. To reduce battery consumption, blinking state for 30 seconds automatically shut down. In the blinking state press **POWER** key to delay shutdown, Clamp continue to work.

In the **HOLD** state, need to press **HOLD** key to exit the **HOLD** state, then press **POWER** key to shut down.

In setting Alarm Critical Value state, need to press the

POWER key or press the **AL** key for 3 seconds, exit Alarm Critical Value state, then press **POWER** key to shut down.

3. Resistance Measurement

After the booting auto-inspection is completed, it shows "OL Ω " and will be able to proceed with resistance measurement. At this point, press the trigger and open the jaws, clamp the target loop, reading to get the resistance value.

If the user thinks it necessary, the test can be done with the ring as shown in the following figure 5. Its show value should be consistent with the normal value on the test ring (5.1 Ω).

The normal value on the test ring is the value at a temperature of 20°C.

It is normal to find the difference of numerical 1 word between the show value and the nominal value,

For instance: If the nominal value of test ring is 5.1 Ω , it would be normal showing 5.0 Ω or 5.2 Ω .

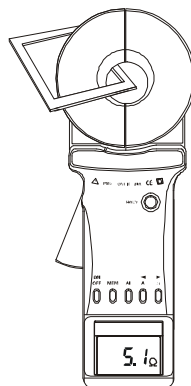

Figure 5

It shows "OL Ω ", indicating that the measured resistance value exceeded the upper limit of Meter, see Figure 2.

It shows "L0.01 Ω ", indicating that the measured resistance value exceeded the lower limit of Meter, see Figure 6.



Figure 6

Flashing display symbols $\bullet\bullet\bullet$, go with intermittent "beep--beep--beep--" sound, indicating the measured resistance

exceeds the resistance of Alarm Critical Value.

In the **HOLD** state, need to press **HOLD** key to exit the **HOLD** state, then continue measurement.

In the **MR** state, need to press **MEM** key to exit the **MR** state, then continue to measurement.

In setting Alarm Critical Value state, need to press the **POWER** key or press the **AL** key for 3 seconds, exit Alarm Critical Value state, then continue to measurement.

*In the current test mode, press **Ω** key to switch to resistance test mode.

*4. Current Measurement

After the booting auto-inspection is completed, the Meter automatically enter the resistance measurement mode. Upon showing "**OL Ω**", press **A** key, and the Meter enter the current measurement mode, showing "**AC 0.00mA**", see Figure 7. At this point, press the trigger and open the jaws, clamp the target wire, reading to get

the current value.

It shows "**OL A**", indicating



Figure 7



Figure 8

that the measured current value exceeded the upper limit of Meter, see Figure 8.

Flashing display symbols **••))** , go with intermittent "beep --beep--beep--" sound, indicating the measured current exceeds the current of Alarm Critical Value.

In the **HOLD** state, need to press **HOLD** key to exit the **HOLD** state, then continue measurement.

In the **MR** state, need to press **MEM** key to exit the **MR** state, then continue to measurement.

In setting Alarm Critical Value state, need to press the **POWER** key or press the **AL** key for 3 seconds, exit Alarm Critical Value state, then continue to measurement.

In the resistance test model, press **A** key to switch to current test model.

5. Date Lock/Release/Storage

In test model, press **HOLD** key to Lock currently displayed value and **HOLD** symbol. At the same time, this lock-values as a set of data followed by auto-ID and store, and then press **HOLD** key to cancel the lock, **HOLD** symbol disappeared, can continue to measure. Loop operation, can store 99 sets of data. If the memory is full, blinking display **MEM** symbol.

Figure 9, Lock measured resistance 0.016Ω, at the same time as the first 01 sets of data storage.

*As indicated in Figure 10, lock the measured current 278mA, and save it as data unit No.99.

And the memory is full now.

blinking display **MEM** symbol.



Figure 9

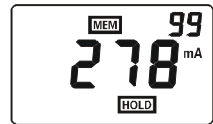

Figure 10

In the Date Access Model, press **MEM** key to exit, then can lock and storage the data.

In setting Alarm Critical Value state, need to press the **POWER** key or press the **AL** key for 3 seconds, exit Alarm Critical Value state, then can lock and storage the data.

Shutdown and then boot up, don't lose stored data.

6. Data Access

Press **MEM** key to enter Data Access Model, the default display stored in the first 01 Units of data, shown in Figure 11. Then the right arrow keys, up, read the data stored, press the left arrow key, scroll down to the data stored. If not store data, display shown in Figure 12.

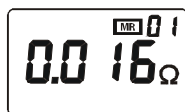

Figure 11

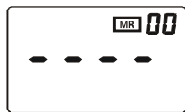

Figure 12

In setting Alarm Critical Value state, need to press the **POWER** key or press the **AL** key for 3 seconds, exit Alarm Critical Value state, then press **MEM** key to enter data storage model.

7. Alarm Settings

In the test model, press **AL** key to turn on or shutdown alarm function.

In test model, press **AL** key for 3 seconds, then enter to set alarm critical value function, temporality, the highest-digit flashing, first set a maximum bit, shown in Figure 13, Figure 14. Press **AL** key to switch to the low number, in the current digit flashing, press the left/right arrow keys to change the "0,1, ... 9" figures, after the number finished setting, press the **AL** key for 3 seconds to confirm the current set alarm critical value, when set the alarm function successful, opening alarm function, then automatically return to measurement mode. If the load bigger than the alarm critical, meter will be flashing an

alarm symbol, also issued intermittent "beep--beep--beep--" sound.

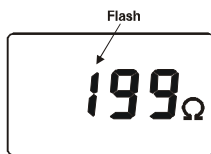

Figure 13

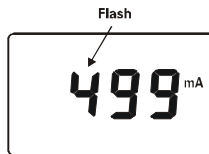

Figure 14

Setting process, press **POWER** key to exit Alarm Critical Value setting function, return to measurement status, does not change the previous settings.

In data access model, press **MEM** key to exit, then setting Alarm Critical Value.

8. Access to Alarm Critical Value

Press **AL** key to enter the mode of resistance or current measurement. Press down **AL** key for 3 sec, you can access to check the alarm critical value, which would flashes in high-digit. The value accessed was set in the last time. And again press down **AL** key for 3 sec or **POWER** key to quit from the access state and return to the measuring state.

As indicated in Figure 15, the alarm critical value of resistance set in the last time is 20Ω.

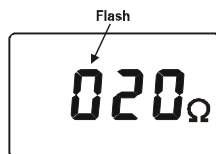

Figure 15

9. Clear Data

In the data access model, press **MEM+POWER**, automatism clear all the stored data. After clearing display show in Figure 12. The data can't be restore after clear.

Note: "*" is limited to C+.

VII. Measurement Principle

1. Principle of Resistance Measurement

The basic principle of **ETCR** in the measurement of resistance is to measure the loop resistance, as shown in the figure below. The jaw part of the Meter is comprised of voltage coil and current coil. The voltage coil provides excitation signal, and will induce a potential E on the measured loop. Under the effects of the potential E , the current I can generate on the measured loop. The Meter will measure E & I , and the measured resistance R can be obtained by the following formula.

$$R = \frac{E}{I}$$

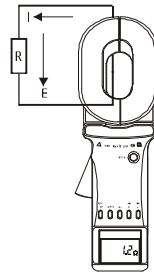

2. Principle of Current Measurement

The basic principle of **C+** in the measurement of current is the same with that of the measurement of resistance, as shown in the figure below. The AC current on the measured wire, through the current magnetic loop and coil, can generate a induction current I_1 ; The Meter will measure I_1 , and the measured current I can be obtained by the following formula.

$$I = n \cdot I_1$$

Where: n is the turn ratio of the secondary side vs. primary side.

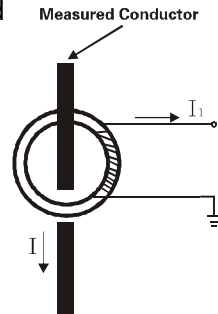

VIII. Measurement Method of Earth Resistance

1. Multi-Point Grounding System

As for the multi-point grounding system (such as electricity transmission tower grounding system, grounding cable communications systems, certain buildings, etc.), They usually pass the overhead ground wire (cable shielding layer) connected to form a grounding system.

As the Meter is in the above measurement, its equivalent electric circuit is shown in the figure below:

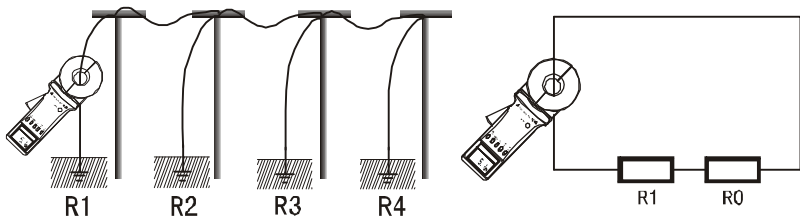

Where: R_1 is the target grounding resistance.

R_0 is the equivalent resistance of the other entire tower grounding resistances paralleled.

Although strictly on the theoretical grounding, because of the existence of so-called "mutual resistance", R_0 is not the usual parallel value in the sense of electrical engineering (slightly higher than its IEC parallel output value). But because a tower-grounding hemisphere was much smaller than the distance between the towers, and with a great number of locations after all, R_0 is much smaller than R_1 . Therefore, it can be justified to assume $R_0=0$ from an engineering perspective. In this way, the resistance we

measured should be R_1 .

Times of comparing tests in different environments and different occasions with the traditional method proved that the above assumption is entirely reasonable.

2. Limited Point Grounding System

This is also quite common. For example, in some towers, five towers are linked with each other through overhead ground wire; Besides, the grounding of some of the buildings is not an independent grounding grid, but several grounding bodies connected with each other through the wire.

Under such circumstances, the above R_0 regarded as 0, will yield more error on the results of the measurement.

Due to the same reasons mentioned above, we may ignore the impact of the mutual resistance; and the equivalent resistance of the grounding resistance paralleled is calculated by the usual sense. Thus, for the grounding system of N (N is smaller, but larger than 2) grounding bodies, it can offer N equations:

$$R_1 + \frac{1}{\frac{1}{R_2} + \frac{1}{R_3} + \dots + \frac{1}{R_N}} = R_{1T}$$

$$R_2 + \frac{1}{\frac{1}{R_1} + \frac{1}{R_3} + \dots + \frac{1}{R_N}} = R_{2T}$$

.

.

$$R_N + \frac{1}{\frac{1}{R_1} + \frac{1}{R_2} + \dots + \frac{1}{R_{(N-1)}}} = R_{NT}$$

Where: R1、 R2、RN are grounding resistances of N grounding bodies.

R1T、 R2T、RNT are the resistances measured with the Meter in the different grounding branches.

It is nonlinear equations with N unknown numbers and N equations. It indeed has a definite solution, but it is very difficult to solve the issue artificially, even impossible when N is larger.

Therefore, you're expected to buy the Limited-Point Grounding System Solution software produced by this Company. Users can use the office computer or notebook computer to carry out solutions.

In principle, in addition to ignoring the mutual resistance, this method does not have the measurement error caused by neglecting R0.

However, users need to pay attention to that: in response to the number of the grounding bodies mutually linked in your grounding system, it is necessary to measure the same number of the testing values for calculating of the program, not more or less. And the program would output the same number of grounding resistance values.

3. Single-Point Grounding System

From the measuring principle, ETCR series Meter can only

measure the loop resistance, and the single-point grounding is not measured. However, users will be able to use a testing line very near to the earth electrode of the grounding system to artificially create a loop for testing. The following presented is two kinds of methods for the single-point grounding measurement by use of the Meter. These two methods can be applied to the occasions beyond the reach of the traditional voltage-current testing methods.

(1).Two-Point Method

As shown in the figure below, in the vicinity of the measured grounding body R_A , find an independent grounding body of better grounding state R_B (for example, near a water pipe or a building). R_A and R_B line will connect to each other using a single testing line.

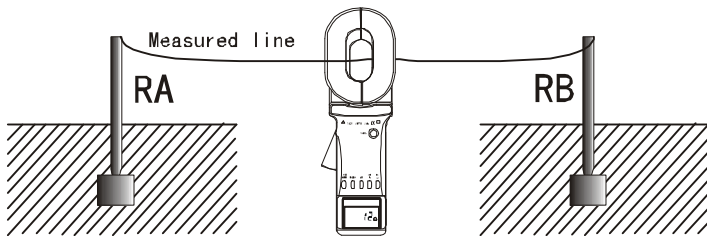

As the resistance value measured by the Meter is the value of the series resistance from the testing line and two grounding resistances.

$$R_T = R_A + R_B + R_L$$

Where: R_T is the resistance value measured with the Meter.

R_L is the resistance value of the testing line. Meter can measure out the resistance value by connecting the test lines with both ends.

So, if the measurement value of the Meter is smaller than the allowable value of the grounding resistance, then the two grounding bodies are qualified for grounding resistance.

(2) Three-Point Method

As shown in the figure below, in the vicinity of the measured grounding body R_A , find two independent grounding bodies of better grounding state R_B and R_C .

First, link R_A and R_B with a test line; use the Meter to get the first reading R_1 .

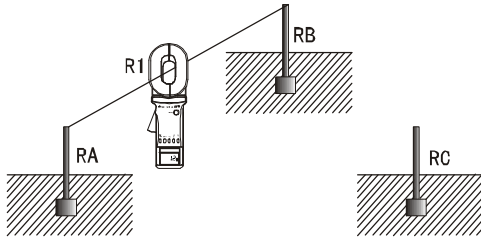

Second, have R_B and R_C linked up, as shown in the following figure. Use the Meter to get the second reading R_2 .

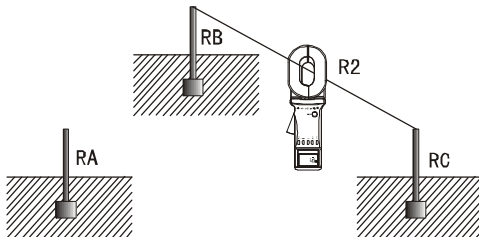

Third, have R_C and R_A linked up, as shown in the following figure. Use the Meter to get the third reading R_3 .

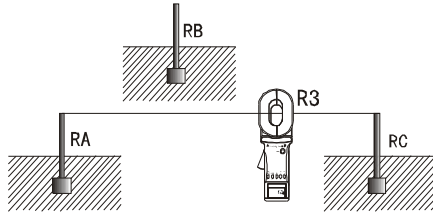

In the above three steps, the reading measured in each step is the value of the two series grounding resistance. In this way, we can easily calculate the value of each grounding resistance:

$$\text{From: } R_1 = R_A + R_B \quad R_2 = R_B + R_C \quad R_3 = R_C + R_A$$

$$\text{We get: } R_A = (R_1 + R_3 - R_2) \div 2$$

This is the grounding resistance value of the grounding body R_A . To facilitate the memory of the above formula, these three grounding bodies can be viewed as a triangle; then the measured resistance is equivalent to the value of the resistance values of the adjacent edges plus or minus resistance value of the opposite sides, and divided by 2.

As the reference points, the grounding resistance values of the other two grounding bodies are:

$$R_B = R_1 - R_A$$

$$R_C = R_3 - R_A$$

IX. Bill of Loading

Earth Tester	1 piece
Test Loop	1 piece
Carrying Case	1 piece
User's Manual	1 piece

X. Parts List and Assembly Details

1. Parts List

NO.	NAME	Part	Quantity/PCS	Remark
1	Screws of battery cover	DS01	1	M3X8
2	AA alkaline batteries	DS02	4	
3	Battery cover	DS03	1	
4	Upper shell	DS04	1	
5	Subjacent shell	DS 05	1	
6	Tension spring	DS 06	2	
7	Clamp	DS 07	1	
8	LCD	DS 08	1	
9	HOLD key	DS09	1	
10	LCD cover	DS10	1	
11	PCB	DS11	1	
12	Connect screws of shells	DS12	3	ST2.9X10
13	Clamp screws	DS13	2	ST2.9X25
14	Shaft	DS14	1	
15	Push button	DS15	5	
16	Screws for PCB fix	DS16	2	ST2.2X6
17	Screws for LCD fix	DS17	2	ST2.2X6

2. Assembly Details

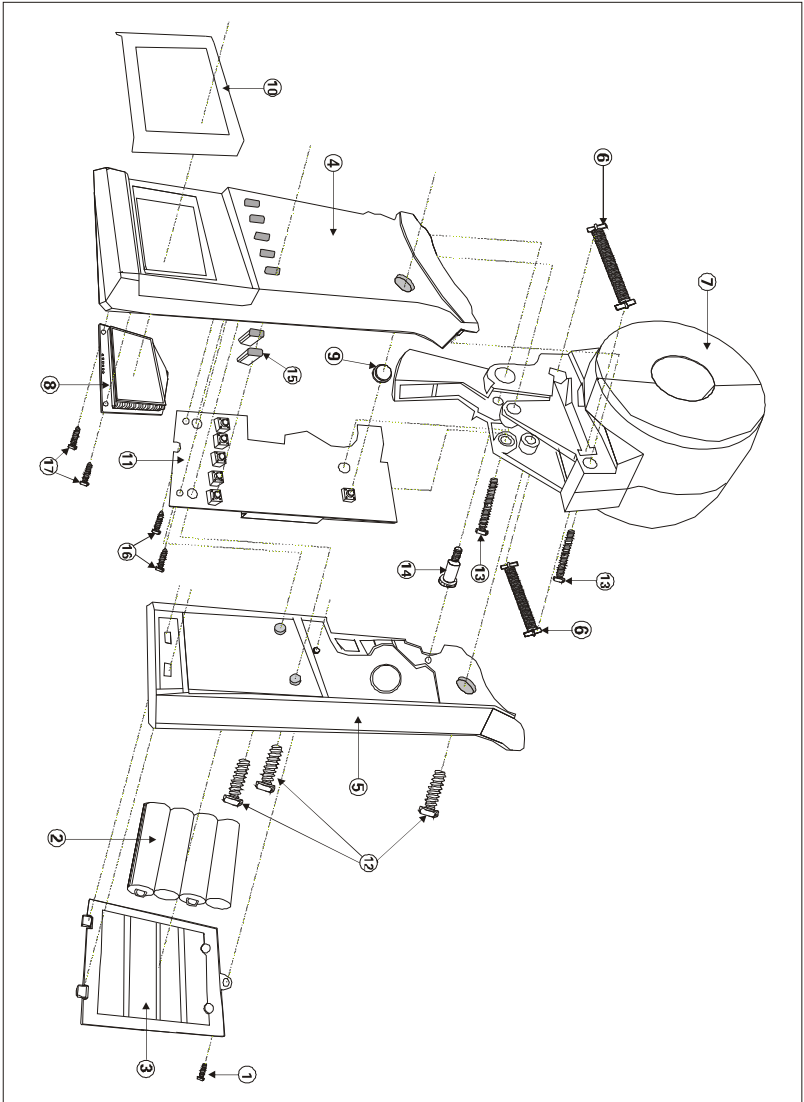

XI.Trouble shooting

Symptoms	Possible Causes	Remedies
The instrument cannot be buttoned on.	No batteries.	Set the batteries.
	Faulty battery polarity	Install batteries in correct polarity.
	Insufficient capacity of battery	Replace the batteries.
	Poor contact of battery contacts	Replace the battery contacts.
	Wrong battery type	Replace with right type.
	A break in a battery harness	Make a continuity test of test lead. If there is no continuity, replace the battery harness.
	Departure of the POWER button	Re-assemble the button.
	Poor contact of power plug	Re-plug or replace a plug.
	Defect of circuit component	Defect of PCB; when current consumption is about 100mA or more at 6V of battery voltage. Replace the PCB.
Indicating ERROR (Display “Err”, big error results or results unstable)	Insufficient capacity of battery	Replace the batteries.
	Contact surface of jaw is polluted by dust, oil etc.	Clean the surface.
	Poor enclose of jaw	Trigger the clamp several times and then re-boot.
	Defect of circuit component	Replace the PCB.
	Measure in wrong steps	Study the manual and follow it.
Incapable measurement of resistance	Insufficient capacity of battery	Replace the battery when “Low battery” mark is displayed on the LCD.
	Poor enclose of jaw, indicating “jaw-open” symbol on LCD	Trigger the clamp several times and then re-boot.
	Contact surface of jaw is polluted by dust, oil etc.	Clean the surface.
	Without self-calibration before test	Re-boot follow the manual, conduct measurement after self-calibration finished.
	Defect of circuit component	Check above points first. If there is no problem, replace the PCB, and do re-adjustment.

Symptoms	Possible Causes	Remedies
LCD Indication error (chip of segment, arithmetic point, unit and so on)	Poor contact of LCD connection wire	Re-plug the LCD connect plug or replace the plug.
	Defect of LCD	Replace the LCD.
	Insufficient capacity of battery	Replace the batteries.
	Defect of circuit component	Replace the PCB.
Incapable to hold reading	HOLD button Depart from the position	Re- assemble the button.
	Defect of circuit component	Replace the PCB.

 **Manufactured by**

ETCR Electronic Technology Company

Address: F-3F, No.4 Pengshang Zhifu Road, Jiahe, Baiyun District, Guangzhou, Guangdong, China

Post Code: 510440

Tel: (86-20)62199556 62199554

Fax: (86-20)62199550

E-mail: info@etcr.cc

Website: www.etcr.cc