

**SMART  
SENSOR®**

**Model AC63A**

## Vibration Meter User's Manual



Version Number: SZ63A-0

## Precaution

- Thank you for purchasing our company's Vibration Meter.
- This manual provides relative information on how to use the unit and warnings in operation.
- To make the best use of this product's functions, read this manual thoroughly before use. Please keep this manual for quick reference.
- Please make some simple test measurement to ensure proper performance of the unit.

## Warranty

- 1). About relative warranties please read warranty card.
- 2). We disclaim any liability due to: client's transportation damages; incorrect use or operation; manipulation, alterations or repair attempts; without warranty card, invoice.



### Statement

- a. We reserve the rights of upgrading and amending the design of the product as well as the manual updating, and the product is subject to change without any further notification.
- b. Dispose of battery should be in accordance with local laws and regulations.



## Contents

### 1. Before use

- Check-up-----(01)
- Introduction-----(02)
- Features -----(02)
- Specifications -----(03)
- Diagram of the product ----- (04)
- LCD displays ----- (06)

### 2. Operation

- Selecting measurement way----- (07)
- Battery installment----- (08)
- Starting the unit and check-up battery -----(09)
- Selecting measurement mode----- (10)
- Selecting high/low frequency----- (11)
- Measurement t----- (12)
- Vibration conversion chart----- (14)
- Contact resonance in acceleration measurement -----(15)

### 3. Other items

- Attentions -----(17)
- Maintenance and warranty -----(18)
- Statement----- (19)

# 1. Before use

## Check-up

Carefully unpack your kit and ensure that you have the following items. In case that any item is missing or if you find any mismatch or damage, promptly contact your dealer.

➤ Vibration meter	1 PCS
➤ 9V battery	1 PCS
➤ English user's manual	1 PCS
➤ Warranty card	1 PCS
➤ Long probe	1 PCS
➤ Pouch	1 PCS
➤ Aluminum packing box	1 PCS

## Maintenance and warranty

Maintenance:

- 1). Replacement and upkeep of battery:
  - a. After power on, if an icon  appears on the LCD, you need to replace the battery immediately, for details please refer figures and contents on page 9 of this manual.
  - b. Remove the battery from the unit if it is not required for extended periods of time in order to avoid damage to the battery compartment and the erosion resulting from a battery leakage.
2. Do not store or use the unit in following circumstances:
  - a. Splashes of water or high levels of dust.
  - b. Air of high salt or sulphur content.
  - c. Air mixed with other gases or contents.
  - d. High temperature or humidity (above 50°C, 90%,) or direct sunlight.
3. Do not disassemble the unit or attempt any internal alterations.
4. Never use alcohol or diluents to clean the housing for doing that will especially erode the LCD surface; just clean the unit lightly as needed with little clean water.

### 3.Other items

#### Attentions

 Warning

When making measurements on exposed rotating parts or power train parts of machinery, proceed with utmost care to prevent accidents due to getting caught in the machinery.

 Caution

If the unit shook excessively, the receiver may produce extremely high sound pressure that hurts human ear , be careful in process of using the signal output plug.

#### Introduction

This product adopts piezoelectric effect of artificial polarized ceramic for design. It is suitable for monitoring of all kinds of vibrating mechanical facility, specially the vibration measurement of rotating and reciprocating machinery. The unit can measure acceleration, velocity and displacement, which is widely used in mechanical manufacture, electric power metallurgy and general aviation etc. Field.

#### Features

- Visually displays measurement value and state
- Acceleration, velocity and displacement measurement
- Different vibration frequency selection
- High sensitivity probe for accurate measurement
- Provides long and short probe head ,each one is suitable for different situation measurement.
- Equipped with AC signal output interface
- Low power indication function
- Auto power-off function
- LCD backlight
- Simple to use, the structure is compact, portable for carrying along with measurement.

## Specifications

Technical parameter	Technical specification
Vibration pickup	Piezoelectric ceramic accelerometer (shear-type)
Measurement range of acceleration	0.1~199.9m/s <sup>2</sup> peak
Measurement range of velocity	0.1~199.9mm/s rms
Measurement range of displacement	0.001~1.999mm p-p Velocity and displacement range is limited by acceleration199.9m/s <sup>2</sup>
Measurement accuracy	±5%±2digits
Measurement frequency range of acceleration	10Hz~1KHz (LO) 1KHz~15KHz (HI)
Measurement frequency range of velocity	10Hz~1KHz (LO)
Measurement frequency range of displacement	10Hz~1KHz (LO)
Displays update cycle	1 seconds
LCD display	3 1/2 digits display
Single output	AC output 2 V peak (display full scale) Load impedance 10KΩor more earphones can be connected
Power supply	9V battery
Static current	≤20μA
Operating current	≤25mA
Battery life	20 H continuous use
Auto power-off function	Turns off automatically after 60 seconds
LCD backlight function	7 seconds
Operating temperature range	0~40°C
Operating humidity range	30~90%RH
Low battery indication	6.9V±0.2V
Dimensions	67x30x183mm
Weight	147g (not including battery)

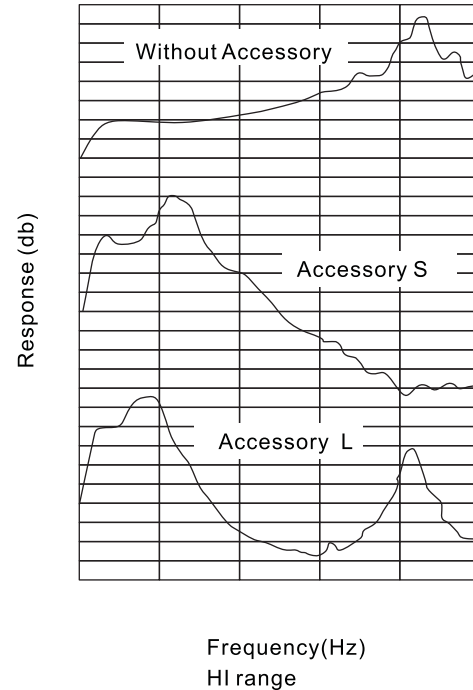

8. Contact resonance in acceleration measurement:  
(worked with FFT signal analyzer)

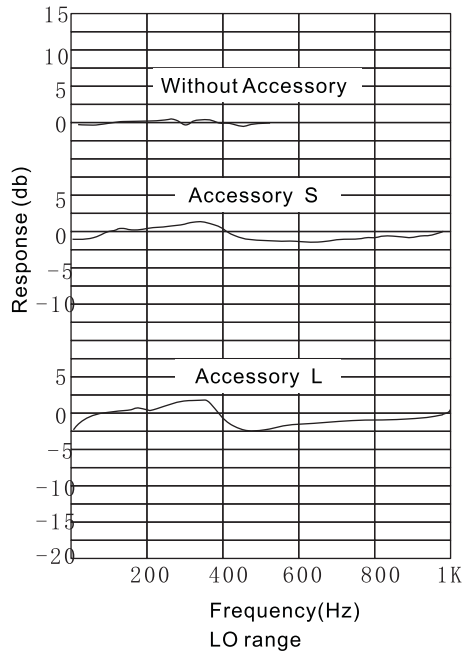
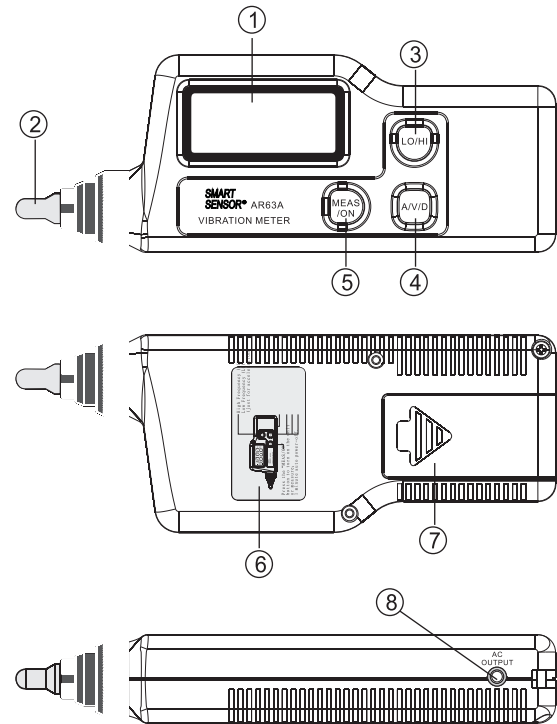





Diagram of the main unit



Need To Know  
Before Use

- 1). LCD screen
- 2). Probe
- 3).  Frequency feature selection key (only in acceleration measurement)
- 4).  Measurement mode (acceleration / velocity / displacement) selection key
- 5).  Power on and measurement key, press once to start the unit , you should keep pressing during the measuring process, release to hold the data.
- 6). Quick instruction label
- 7). Battery door
- 8). AC signal output jack



**Note:**

Above key function descriptions just are simply introduction, for details please read operation instructions part in this manual.

7. Vibration conversion chart

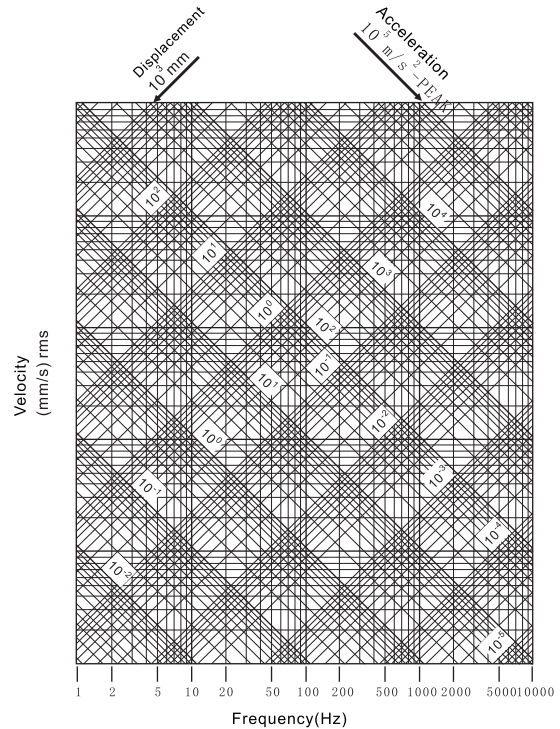





- b. When the  key is pressed again, the current value will be canceled, and a new measurement can be preformed.







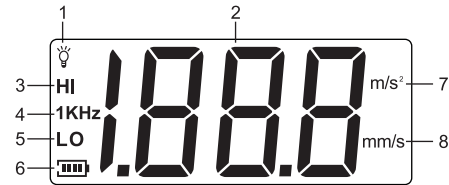

Note:

- Using short Probe (S) can take measurement of vibration both in high(HI) and low(LO) frequency.
- Long Probe (L) is only suitable for low frequency measurement. When taking velocity measurement, also the frequency is over 1KHZ, please replace with the short probe.
- When switching acceleration (HI high frequency) measurement mode to velocity or displacement mode, the high frequency (HI) will be changed to low frequency (LO) automatically.
- Power turns off automatically after 60 seconds without any operation.
- The backlight closes down after 7 seconds without any operation.

## LCD Displays



-  Backlight indication, the backlight will be activated for 7 seconds upon the button operations.
- Measurement data
- HI** High frequency indication
- 1KHz** 1KHZ indication
- LO** Low frequency indication
-  Battery mark shows current residual battery power. Has following 5 levels:
  -  :battery is sufficient
  -  :battery is comparative sufficient
  -  :battery is nearly deficient
  -  :battery is nearly exhausted, need to have a replacement
  -  :battery is exhausted completely.
- $m/s^2$  When taking measurement of acceleration, the LCD displays the acceleration unit:  $m/s^2$
- $mm/s$  When taking measurement of velocity, the LCD displays the velocity unit:  $mm/s$ ;  
When taking measurement of displacement, the LCD displays the displacement unit:  $mm$ .

## 2. Operation

### 1). Selecting measurement probe tip:

Measurement tip is used as following 3 conditions, please select according to actual condition:

- a. Measurement with short (S) probe tip: this probe head is factory default installment, adapts in wide scope vibration measurement, and obtains good response value, as shown in following figure:

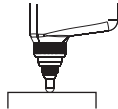

- b. Measurement with long (L) probe tip: this probe tip is packing inside the carry box, mainly adapts in narrow objects or special objects field, the unit will response quickly, as shown in following figure:

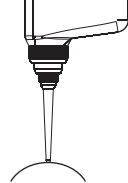

- c. Measurement without probe tip: adapts in smooth object surface measurement to get stable value, as shown in following figure:

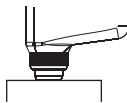

-07-

## 6. Measurement

As per the to-be-measured and frequency of vibration structure, select corresponding measurement mode (Acceleration/ Velocity/ Displacement) and frequency (HI/LO frequency). Keep the "MEAS/ON" key depressed with your right thumb, press the vibration meter against the measurement object at a force of 500g to 1kg, the result is displayed on the LCD screen. Release the key and the result is kept on the LCD screen. As shown in following figure:



-12-

5. Selecting high/low frequency: (high frequency HI is only for acceleration measurement mode)

a. press the  key select high frequency (HI) measurement or low frequency (LO) measurement, as shown in following figure:

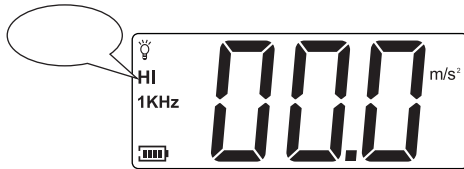

Note:

High/low frequency selection is only available in acceleration measurement

## 2. Battery installment

a. Grip tightly the unit body with your left hand; hold down the battery door with your right hand thumb to open it according to the arrow referring direction, as shown in following figure:



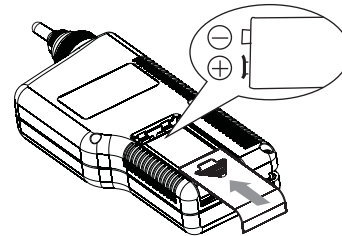

b. Insert the 9V battery into battery compartment, note the battery polarity, and then close the battery door, as shown in following figure:

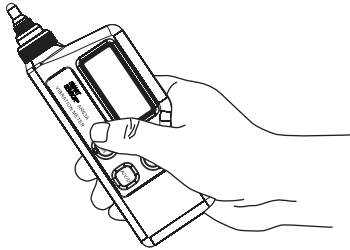

### 3. Turn on the unit and check-up battery

- a. Press the **MEAS/ON** key to turn on the unit, as shown in following figure:



- b. After the entire screen displays for 1 second, the default state is acceleration mode, if on the LCD displays the symbol  or , please promptly replace the battery, as shown in following figure:

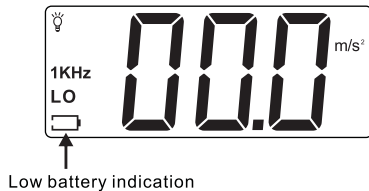

### 4. Selecting measurement mode:

- a. Press the **A/V/D** key select measurement mode, the default state is acceleration mode upon turn on, as shown in following figure:



- b. Press the **A/V/D** key enter velocity measurement mode, as shown in following figure:



- c. Press again the key enter displacement measurement mode, as shown in following figure:

