

CP12280 12V 28Ah (20hr) Sealed Lead Acid (SLA) Battery

The rechargeable batteries are lead-lead dioxide systems. The dilute sulfuric acid electrolyte is absorbed by separators and plates and thus immobilized. Should the battery be accidentally overcharged producing hydrogen and oxygen, special one-way valves allow the gases to escape thus avoiding excessive pressure build-up. Otherwise, the battery is completely sealed and is, therefore, maintenance-free, leak proof and usable in any position.



Battery Construction

Component	Positive plate	Negative plate	Container	Cover	Safety valve	Terminal	Separator	Electrolyte
Raw material	Lead dioxide	Lead	ABS	ABS	Rubber	Pb	Fiberglass	Sulfuric acid

General Features

- Absorbent Glass Mat (AGM) technology for efficient gas recombination of up to 99% and freedom from electrolyte maintenance or water adding.
- Not restricted for air transport-complies with IATA/ICAO Special Provision A67.
- UL-recognized component.
- Can be mounted in any orientation.
- Computer designed lead, calcium tin alloy grid for high power density.
- Long service life, float or cyclic applications.
- Maintenance-free operation.
- Low self discharge.
- Valve Regulated Lead Acid (VRLA) battery

Dimensions and Weight

Length(mm / inch)	165 / 6.50
Width(mm / inch)	125 / 4.92
Height(mm / inch)	175 / 6.89
Total Height(mm / inch)	182 / 7.17
Approx. Weight(Kg / lbs)	9.30 / 20.5

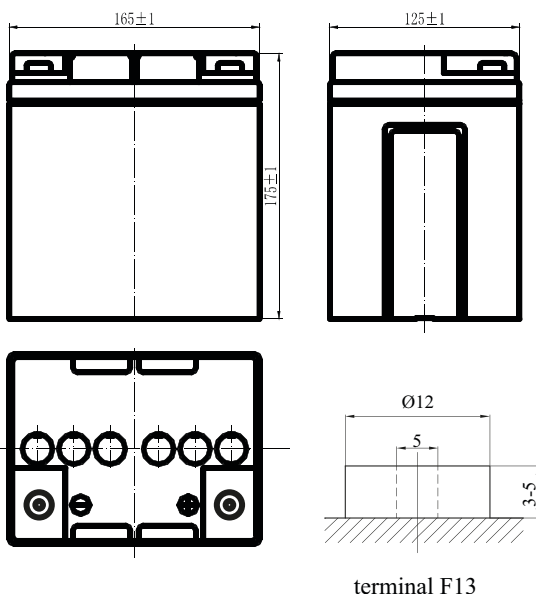

Performance Characteristics

Nominal Voltage	12V
Number of cell	6
Design Life	5 years
Nominal Capacity 77°F(25°C)	
20 hour rate (1.4A, 10.5V)	28Ah
10 hour rate (2.65A, 10.5V)	26.5Ah
5 hour rate (4.8A, 10.5V)	24Ah
1 hour rate (19.6A, 9.6V)	19.6Ah
Internal Resistance	
Fully Charged battery 77°F(25°C)	≤12mOhms
Self-Discharge	
3% of capacity declined per month at 20°C(average)	
Operating Temperature Range	
Discharge	-20~60°C
Charge	-10~60°C
Storage	-20~60°C
Max. Discharge Current 77°F(25°C)	310A(5s)
Short Circuit Current	1400A
Charge Methods: Constant Voltage Charge 77°F(25°C)	
Cycle use	14.4-14.8V
Maximum charging current	11.2A
Temperature compensation	-30mV/°C
Standby use	13.5-13.8V
Temperature compensation	-20mV/°C

Discharge Constant Current (Amperes at 77°F25°C)

End Point Volts/Cell	5min	10min	15min	30min	1h	3h	5h	10h	20h
1.60V	112	73.0	55.0	32.0	19.6	8.02	5.20	2.81	1.45
1.65V	106	69.5	52.6	30.7	18.9	7.77	5.08	2.77	1.44
1.70V	100	65.9	50.1	29.4	18.1	7.50	4.95	2.71	1.42
1.75V	93.9	62.2	47.5	28.0	17.3	7.20	4.80	2.65	1.40
1.80V	87.6	58.5	44.8	26.5	16.5	6.88	4.63	2.58	1.38

Discharge Constant Power (Watts at 77°F25°C)

End Point Volts/Cell	5min	10min	15min	30min	45min	1h	2h	3h	5h
1.60V	208	135	105	61.7	46.7	36.7	24.0	16.0	10.4
1.65V	195	127	99.3	58.6	44.5	35.1	23.3	15.6	10.2
1.70V	183	119	93.6	55.4	42.3	33.5	22.5	15.2	10.0
1.75V	170	111	87.8	52.2	40.0	31.8	21.6	14.4	9.9
1.80V	157	104	82.0	49.0	37.7	30.1	20.7	13.8	9.8

(Note)The above characteristics data are average values obtained within three charge/discharge cycles not the minimum values.

DENA ENGINEERING CO.,LTD.

185/1 Wongsawang Road, Wongsawang, Bangsue, Bangkok 10800 THAILAND

Tel. 02-587-7780, 02-910-9600 Fax. 02-587-1624, 02-910-9142 e-mail: d@dena.co.th www.dena.co.th

CP12280 12V 28Ah (20hr) Sealed Lead Acid (SLA) Battery

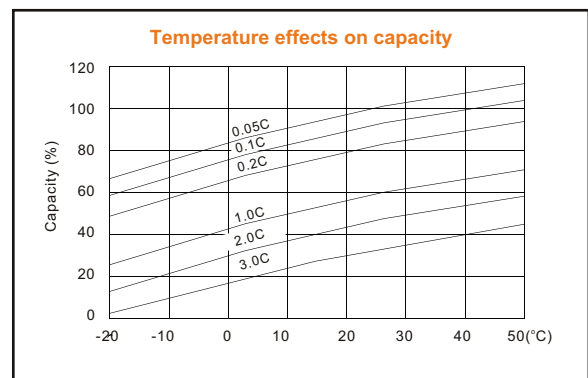
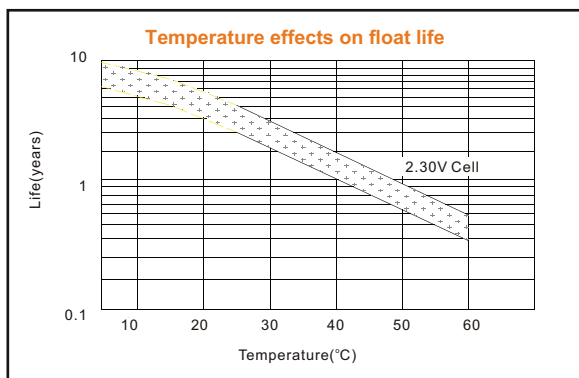
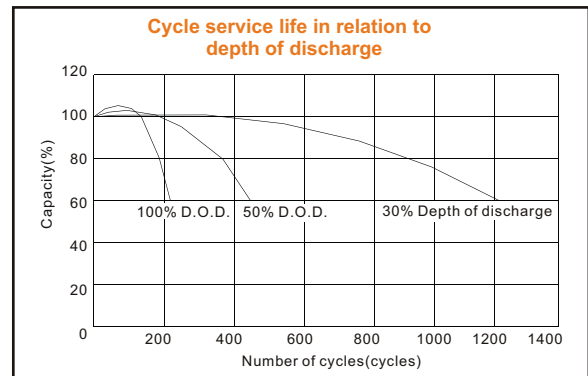
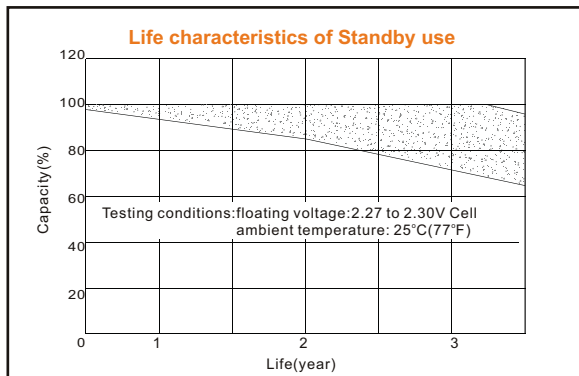
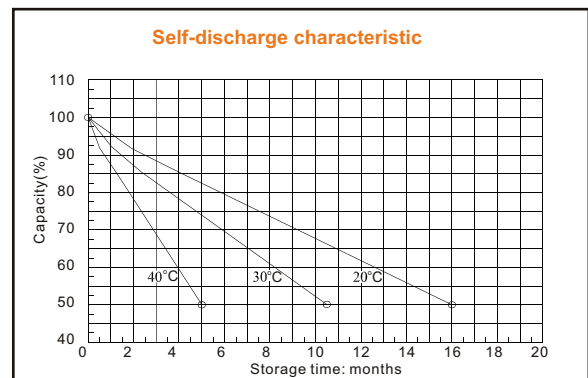
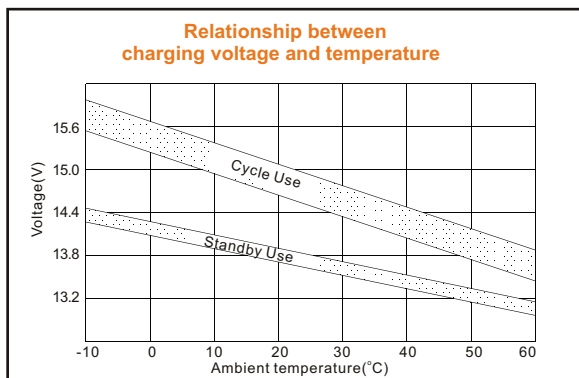
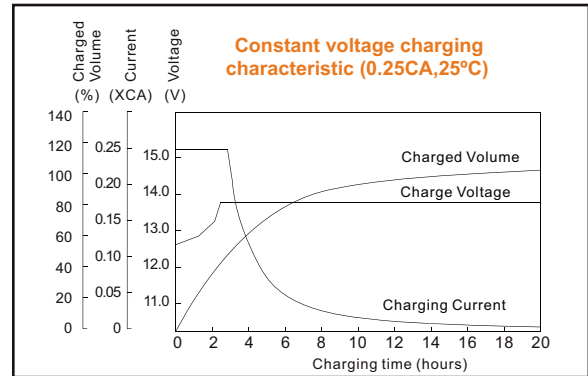
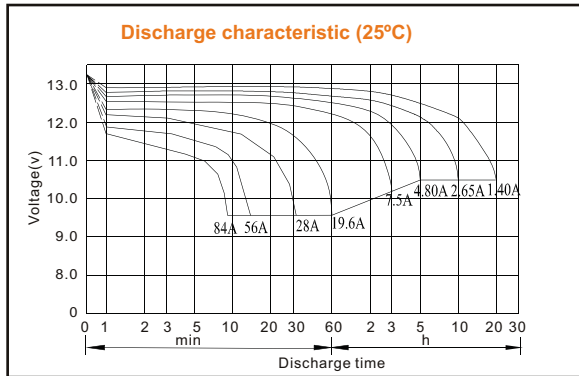

DENA ENGINEERING CO.,LTD.

185/1 Wongsawang Road, Wongsawang, Bangsue, Bangkok 10800 THAILAND

Tel. 02-587-7780, 02-910-9600 Fax. 02-587-1624, 02-910-9142 e-mail: d@dena.co.th www.dena.co.th