



# SAMWHA

[www.samwha.com](http://www.samwha.com) | [www.samwha.com/fc](http://www.samwha.com/fc)



Creative Technology Provider



**SAMWHA CAPACITOR Co.,Ltd.**  
[www.samwha.com](http://www.samwha.com) / [www.samwha.com/fc](http://www.samwha.com/fc)



**Samwha Capacitor Co., Ltd.**

*The Symbol 'Samwha' Means 'Toward Better Future'  
The inner circle denotes the SAMWHA spirit for Advanced Technology Development.  
And the outer circle shows the intention of Samwha to Extend Toward the World.*

A composite image featuring a blue sky with binary code (0s and 1s) falling like rain. In the foreground, there are modern buildings on the left, a green field, and two trees on the right. Three birds are flying in the sky.

## Passion for Challenges SAMWHA CAPACITOR GROUP

### *Affiliated Companies*

Samwha Thailand	PT.SAMCON	Samwha Electric	Tianjin Samwha Electric
Samwha Electronics	Qingdao Samwha Eletronics	Samwha Tecom	PT.SI
Korea JCC	Samwha Enterprise	Samwha Trading	Samwha U.S.A
Samwha Europe Gmbh	Samwha Hongkong	Tianjin Samwha Hi-Tech Intl	Samwha Poland
Samwha India			



# History

- 1950** 1956.08. Ohan Industry founded
- 1960** 1963.10. Company name changed into Samwha Electrical Industry, Inc.  
Began production of High Voltage & Low Voltage Power Capacitor at first in Korea  
1964.04. Began Motor Capacitor production at first in Korea  
1968.08. Company name changed to Samwha Capacitor
- 1970** 1970.01. Certified KS Mark for Low Voltage Power Capacitor at first in Korea [C4801 No.423]  
1976.06. Listed on Stock Market and opened Initial Public Offering  
1977.01. Certified KS Mark for High and Extra High Voltage Power Capacitor [C4802 No.1524]  
1979.09. Certified KS Mark for Motor Capacitor [C4805 No.1827]
- 1980** 1984.12. Moved factory from Seoul to Yongin in Geanggido  
1985.07. Began production of Multilayer Ceramic Capacitor  
Certified UL [E91154] and CSA [LR60366] for Disc Ceramic Capacitor [DCC]  
1986.10. Certified UL [106435] for Film Motor Capacitor  
1987.02. Established our own Research & Development Institute in Factory  
1987.07. Certified TUV [R76500] for Microwave Oven Capacitor
- 1990** 1992.02. Began PTC Thermistor production  
1999.10. Certified ISO 9003 for Quality Control System  
[KS A 3002-1992 / ISO9002-1987]
- 2000** 2002.07. Certified ISO 9002 for Quality Control System  
[KS A 9001-2001]  
2004.10. Certified ISO14001 for Environment Management System  
[KS A 14001-2001]  
2006.10. Certified ISO / TS 16949 for Quality Management System  
[ISO / TS 16949-2002]

## II. Main Products

### 1. Power Capacitor

#### 1-1. Capacitor Unit

- ① High Voltage Power Capacitor
  - A. Single Phase
  - B. Three Phase
- ② Low Voltage Power Capacitor
  - A. Oil Type
  - B. Dry Type



#### 1-2. Capacitor Bank

- ① Capacitor Bank
  - A. Capacitor Bank
  - B. Harmonic Filter Bank
- ② Capacitor Bank Type
  - A. Cubicle Capacitor Bank
  - B. Open-rack Capacitor Bank
  - C. Pole Mounted Capacitor Bank
- ③ Capacitor Bank Protection
  - A. NVS [Neutral Voltage Sensor]
  - B. NCT [Neutral Current Transformer]



#### 1-3. SVC [Static Var Compensator]

#### 1-4. Special Capacitor

- ① AC Harmonic Filter
- ② Zero Sequence Filter(ZSF)
- ③ Hybrid Harmonic Filter(HHF)
- ④ L-C Complex Harmonic Filter(LCF)
- ⑤ Active Power Harmonic Filter(APF)
- ⑥ Intelligent Var Compensator(IVC)
- ⑦ Low Frequency Induction Furnace Capacitor
- ⑧ Water Cooling Capacitor
- ⑨ Surge Absorbing Capacitor
- ⑩ Grounding Capacitor
- ⑪ Pulse Power Capacitor



### 2. Disc Ceramic Capacitor [DCC]

### 3. EMI Filter

### 4. Multilayer Ceramic Capacitor [MLCC]



## II. Contents

<b>1. Capacitor</b> .....	<b>4</b>
<b>1-1. High Voltage Power Capacitor</b>	
① Single Phase	
② Three Phase	
<b>1-2. Low Voltage Power Capacitor</b>	
① Oil Type	
② Dry Type	
<b>2. Capacitor Bank</b> .....	<b>19</b>
<b>2-1. Capacitor Bank [Purpose]</b>	
① General Capacitor Bank	
② Harmonic Filter Capacitor Bank	
<b>2-2. Capacitor Bank Type</b>	
① Cubicle Capacitor Bank	
② Open-rack Capacitor Bank	
③ Pole Mounted Capacitor Bank	
<b>2-3. Capacitor Bank Protection</b>	
① NVS [Neutral Voltage Sensor]	
② NCT [Neutral Current Transformer]	
<b>3.SVC</b> .....	<b>26</b>
<b>4.Special Capacitor</b> .....	<b>28</b>
4-1. AC Harmonic Filter	
4-2. Zero Sequence Filter(ZSF)	
4-3. Hybrid Harmonic Filter(HHF)	
4-4. L-C Complex Harmonic Filter(LCF)	
4-5. Active Power Harmonic Filter(APF)	
4-6. Intelligent Var Compensator(IVC)	
4-7. Low Frequency Induction Furnace Capacitor	
4-8. Water Cooling Capacitor	
4-9. Surge Absorbing Capacitor	
4-10. Grounding Capacitor	
4-11. Pulse Power Capacitor	
<b>5. Reactor</b> .....	<b>47</b>
5-1. Series Reactor	
5-2. Discharging Coil	
<b>6.Appendix</b> .....	<b>56</b>
6-1. Capacity Calculation	
6-2. Tips for Handling Capacitor	
6-3. Maintenance	
6-4. Certificate and Test Report	
6-5. Order Form	





## 1. Capacitor

### ➤ Application

The capacitors are designed for power factor correction and Harmonic filtration in power network. They are all-film dielectric and impregnated with an environmentally friendly, Non-PCB biodegradable insulating oil.

In addition each capacitor is provided with an internal discharge resistor.

All SAMWHA capacitors comply with most national and international capacitor standards.

- Capacitor benefits to
- Improve Power Factor
  - Reduce Line Losses
  - Decrease Voltage Drop

Through that it helps greater **Energy Efficiency**

### ➤ Product Scope

- **Power Range**      Single Phase 25kvar to 1000kvar  
                            Three Phase 50kvar to 500kvar
- **Voltage Range**    Single Phase 1000V to 22000V  
                            Three Phase 1000V to 11000V
- **Frequency**            50Hz / 60Hz
- **Applicable Standards**    IEC, ANSI / IEEE, NEMA



### ➤ Technical Data

Capacitor Loss [Under Stabilized Condition]	0.2W/kvar or Less with Internal fuse 0.15W/kvar or Less without Internal fuse	
Ambient Temperature	-40°C / A [+40°C], B [+45°C], C [+50°C], D [+55°C]	
Max overvoltage	$U_{max}$	$U_N + 10%$ [up to 8 hours daily]
		$U_N + 15%$ [up to 30 minutes daily]
		$U_N + 20%$ [up to 5 minutes]
		$U_N + 30%$ [up to 1 minute]
Max overcurrent	$I_s$	$1.3 \times I_N$
Painting Color	Munsell No. 5Y 7/1	
Reference Standard	IEC 60871	

### ➤ Bushings Characteristics

BIL [kV]	Creepage Distance [mm]	Strike Distance [mm]	Total Height [mm]	60Hz Withstand		Weight [kg]
				Dry Test [kV]	Wet Test [kV]	
60	191	109.2	188.1	60	45	0.87
75	191	109.2	188.1	60	45	0.87
95	318	162.6	235.6	70	55	1.23
150	438	193.0	266.8	80	60	1.75
175	635	223.5	287.9	90	70	2.14
200	720	302.4	388.9	100	80	2.79

\* The standard terminal size is M12, but M16 could be applied according to rated voltage.

\* Same Bushing is used on 60 and 75kV BIL of capacitor units.

\* Bird Cap and Parallel-groove connector with all bushings are supplied, and it is applicable to Copper or Aluminum conductor [14~100mm<sup>2</sup> 2line]

\* Applied bushing could be changed by special requirements



# 1-1 High Voltage Power Capacitor

## ① Single Phase Capacitor

### ➤ Insulation Level 36kV [50/150]

#### • Capacitor without Internal Fuse

System Voltage [V]

33000, 30000

Capacitor Rated Voltage [V]

19050/9530, 17320/8660

Rated Power [kvar]

Capacity [kvar]	Dimension [mm]					Weight [kg]
	A	B	C	D	E	
100	130	260	530	430	145	27
200	130	430	700	430	145	42
300	180	580	850	430	145	55
400	220	630	900	430	175	69
500	220	760	1030	430	175	82
600	220	880	1150	430	175	94
700	220	1030	1300	430	175	109
800	220	1180	1450	430	175	123
900	220	1200	1470	430	175	126
1000	220	1280	1550	430	175	134

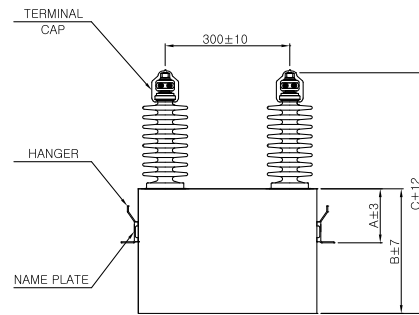
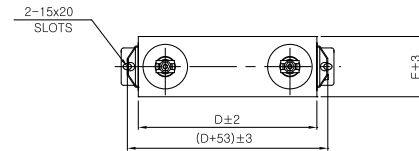

#### • Capacitor with Internal Fuse

System Voltage [V]

33000, 30000

Capacitor Rated Voltage [V]

9530, 8660

Rated Power [kvar]

Capacity [kvar]	Dimension [mm]					Weight [kg]
	A	B	C	D	E	
300	220	630	900	430	145	59
400	220	830	1100	430	145	76
500	220	830	1100	430	175	89
600	220	980	1250	430	175	104
700	220	1130	1400	430	175	120
800	220	1160	1430	430	175	123
900	220	1300	1570	430	175	138
1000	220	1430	1700	430	175	151

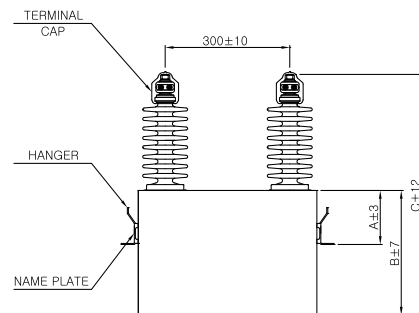
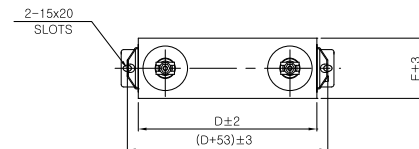

\* Single-Bushing Capacitor also could be provided.

\* Applied bushing could be changed by special requirements [See Table under Bushing Characteristics]

\* Approximate dimensions and weights are given above. Please contact to factory for exact dimensions of a particular unit before order.



## 1-1 High Voltage Power Capacitor

### ① Single Phase Capacitor

#### > Insulation Level 24kV [50/125]

##### • Capacitor without Internal Fuse

System Voltage [V]

24000

Capacitor Rated Voltage [V]

13860/6930

Rated Power [kvar]

Capacity [kvar]	Dimension [mm]					Weight [kg]
	A	B	C	D	E	
100	130	260	530	430	145	28
200	130	430	700	430	145	42
300	180	600	870	430	145	57
400	220	660	930	430	175	72
500	220	800	1070	430	175	87
600	220	960	1230	430	175	102
700	220	1080	1350	430	175	115
800	220	1130	1400	430	175	120
900	220	1160	1430	430	175	123
1000	220	1260	1530	430	175	134

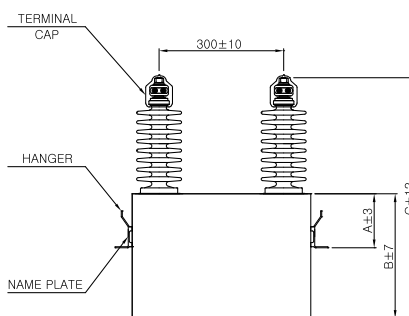
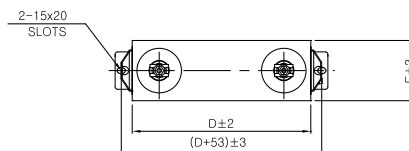

##### • Capacitor with Internal Fuse

System Voltage [V]

24000

Capacitor Rated Voltage [V]

13860/6930

Rated Power [kvar]

Capacity [kvar]	Dimension [mm]					Weight [kg]
	A	B	C	D	E	
200	180	600	870	430	115	47
300	220	660	930	430	145	62
400	220	860	1130	430	145	79
500	220	860	1130	430	175	93
600	220	1030	1300	430	175	111
700	220	1180	1450	430	175	126
800	220	1200	1470	430	175	130
900	220	1260	1530	430	175	135
1000	220	1400	1670	430	175	149

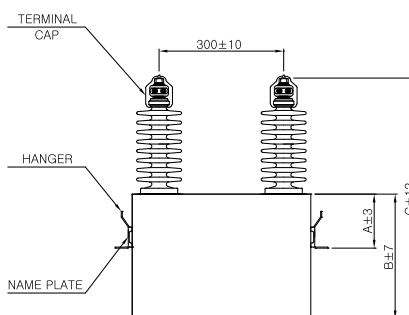
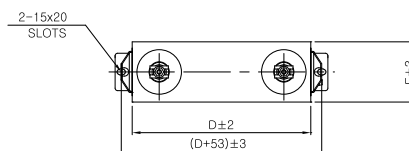

\* Single-Bushing Capacitor also could be provided.

\* Applied bushing could be changed by special requirements [See Table under Bushing Characteristics]

\* Approximate dimensions and weights are given above. Please contact to factory for exact dimensions of a particular unit before order.





# 1-1 High Voltage Power Capacitor

## ① Single Phase Capacitor

### > Insulation Level 17.5kV [38/95]

#### • Capacitor without Internal Fuse

System Voltage [V]

15000

Capacitor Rated Voltage [V]

8660

Rated Power [kvar]

Capacity [kvar]	Dimension [mm]					Weight [kg]
	A	B	C	D	E	
100	130	260	530	430	145	28
200	130	430	700	430	145	42
300	180	600	870	430	145	57
400	220	660	930	430	175	72
500	220	800	1070	430	175	87
600	220	960	1230	430	175	102
700	220	1080	1350	430	175	115
800	220	1130	1400	430	175	120
900	220	1160	1430	430	175	123
1000	220	1260	1530	430	175	134

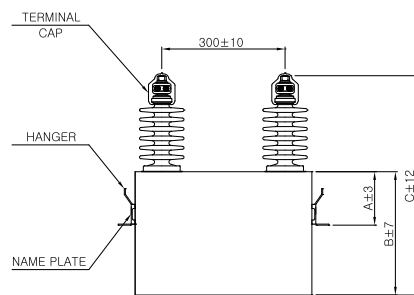
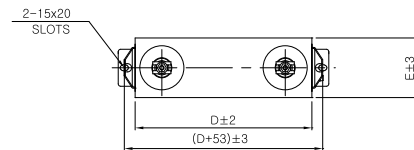

#### • Capacitor with Internal Fuse

System Voltage [V]

15000, 13800

Capacitor Rated Voltage [V]

8660, 7970

Rated Power [kvar]

Capacity [kvar]	Dimension [mm]					Weight [kg]
	A	B	C	D	E	
300	220	660	890	430	145	61
400	220	830	1060	430	145	75
500	220	830	1060	430	175	88
600	220	1000	1230	430	175	106
700	220	1160	1390	430	175	122
800	220	1200	1430	430	175	127
900	220	1300	1530	430	175	140
1000	220	1460	1690	430	175	153

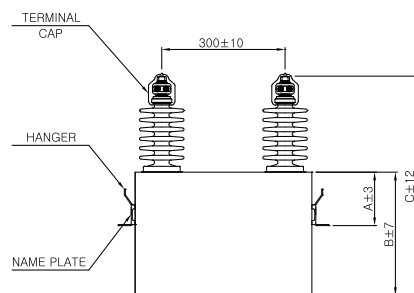
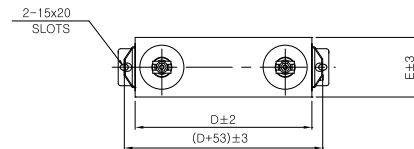

\* Single-Bushing Capacitor also could be provided.

\* Applied bushing could be changed by special requirements [See Table under Bushing Characteristics]

\* Approximate dimensions and weights are given above. Please contact to factory for exact dimensions of a particular unit before order.



## 1-1 High Voltage Power Capacitor

### ① Single Phase Capacitor

#### > Insulation Level 12kV [28/75]

#### • Capacitor without Internal Fuse

##### System Voltage [V]

12000, 11000

##### Capacitor Rated Voltage [V]

6930, 6350

##### Rated Power [kvar]

Capacity [kvar]	Dimension [mm]					Weight [kg]
	A	B	C	D	E	
100	130	260	445	430	145	27
200	130	430	615	430	145	42
300	180	580	765	430	145	55
400	180	630	815	430	175	69
500	220	780	965	430	175	84
600	220	930	1115	430	175	99
700	220	1060	1245	430	175	113
800	220	1180	1365	430	175	125
900	220	1200	1385	430	175	127
1000	220	1300	1485	430	175	134

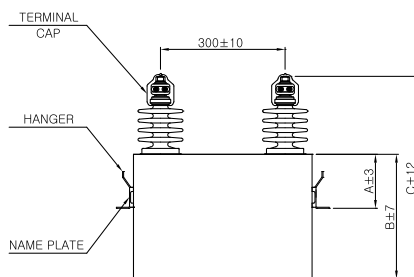
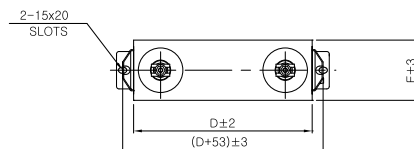

#### • Capacitor with Internal Fuse

##### System Voltage [V]

12000, 11000

##### Capacitor Rated Voltage [V]

6930, 6350

##### Rated Power [kvar]

Capacity [kvar]	Dimension [mm]					Weight [kg]
	A	B	C	D	E	
200	180	580	765	430	115	45
300	220	630	815	430	145	59
400	220	830	1015	430	145	76
500	220	830	1015	430	175	90
600	220	980	1165	430	175	105
700	220	1160	1345	430	175	123
800	220	1180	1365	430	175	126
900	220	1300	1485	430	175	135
1000	220	1430	1615	430	175	148

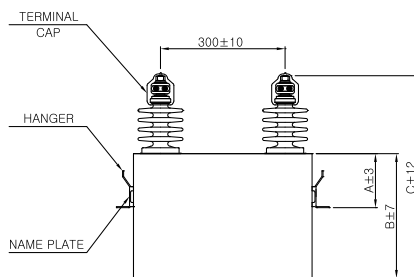
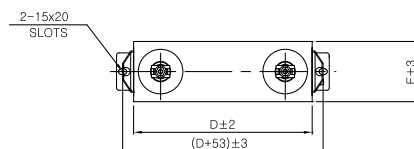

\* Single-Bushing Capacitor also could be provided.

\* Applied bushing could be changed by special requirements [See Table under Bushing Characteristics]

\* Approximate dimensions and weights are given above. Please contact to factory for exact dimensions of a particular unit before order.



# 1-1 High Voltage Power Capacitor

## ① Single Phase Capacitor

### > Insulation Level 7.2kV [20/60]

#### • Capacitor without Internal Fuse

##### System Voltage [V]

7200, 6600, 6300, 6000

##### Capacitor Rated Voltage [V]

4160, 3800, 3640, 3460

##### Rated Power [kvar]

Capacity [kvar]	Dimension [mm]					Weight [kg]
	A	B	C	D	E	
100	130	260	445	430	145	27
200	130	430	615	430	145	41
300	180	560	745	430	145	52
400	220	630	815	430	175	68
500	220	760	945	430	175	81

#### • Capacitor with Internal Fuse

##### System Voltage [V]

7200, 6600, 6300, 6000

##### Capacitor Rated Voltage [V]

4160, 3800, 3640, 3460

##### Rated Power [kvar]

Capacity [kvar]	Dimension [mm]					Weight [kg]
	A	B	C	D	E	
200	180	560	745	430	115	43
300	220	630	815	430	145	57
400	220	800	985	430	145	72
500	220	800	985	430	175	85

\* Applied bushing could be changed by special requirements [See Table under Bushing Characteristics]

\* Approximate dimensions and weights are given above. Please contact to factory for exact dimensions of a particular unit before order.

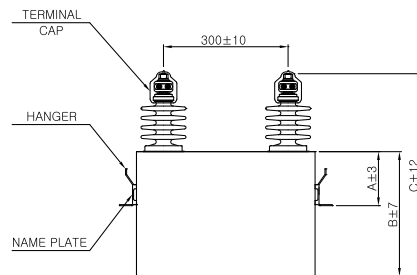
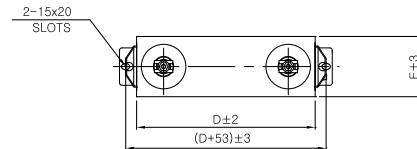
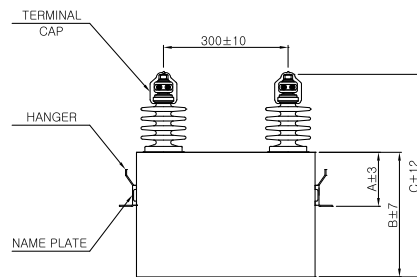
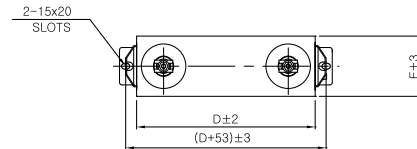



## 1-1 High Voltage Power Capacitor

### ② Three Phase Capacitor

#### > Insulation Level 12kV [28/75]

##### • Capacitor

**System Voltage [V]**

11000

**Capacitor Rated Voltage [V]**

11000

**Rated Power [kvar]**

Capacity [kvar]	Dimension [mm]					Weight [kg]
	A	B	C	D	E	
100	130	280	465	430	145	30
200	130	450	635	430	145	44
300	180	620	805	430	145	59
400	220	680	865	430	175	74
500	220	810	995	430	175	87

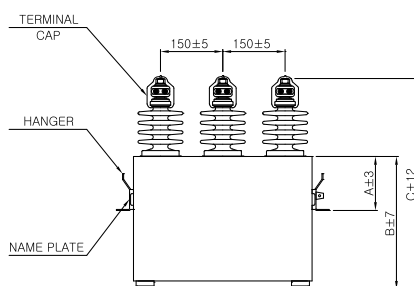
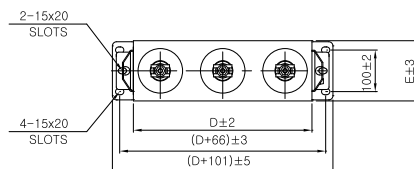

#### > Insulation Level 7.2kV [20/60]

##### • Capacitor

**System Voltage [V]**

7200, 6600, 6300, 6000

**Capacitor Rated Voltage [V]**

7200, 6600, 6300, 6000

**Rated Power [kvar]**

Capacity [kvar]	Dimension [mm]					Weight [kg]
	A	B	C	D	E	
100	130	280	465	430	145	29
200	130	420	605	430	145	41
300	180	600	785	430	145	56
400	220	620	805	430	175	67
500	220	790	975	430	175	83

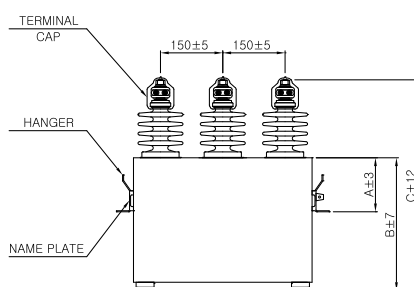
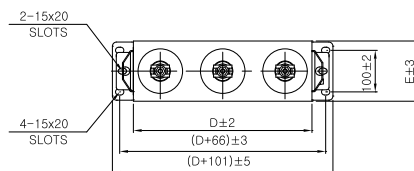

\* Applied bushing could be changed by special requirements [See Table under Bushing Characteristics]

\* Approximate dimensions and weights are given above. Please contact to factory for exact dimensions of a particular unit before order.

\* Brackets are optional



## 1-1 High Voltage Power Capacitor

### • Capacitor with NCS (Neutral Current Sensor)

#### System Voltage [V]

7200, 6600, 6300, 6000

#### Capacitor Rated Voltage [V]

7200, 6600, 6300, 6000

#### Rated Power [kvar]

Capacity [kvar]	Dimension [mm]					Weight [kg]
	A	B	C	D	E	
150	220	380	565	430	145	37
200	220	480	665	430	145	43
300	220	620	805	430	145	56
400	220	700	885	430	175	69
500	220	830	1015	430	175	82

\* Applied bushing could be changed by special requirements [See Table under Bushing Characteristics]

\* Approximate dimensions and weights are given above. Please contact to factory for exact dimensions of a particular unit before order.

\* Brackets are optional

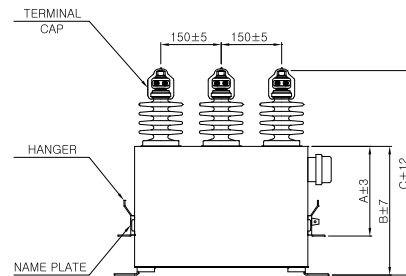
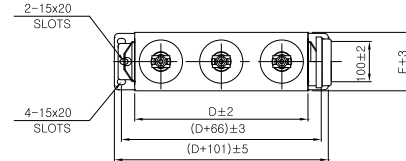



## 1-2 Low Voltage Power Capacitor

### ① Oil Type

#### > Application

Capacitors are intended for the improvement of Power Factor in low voltage power networks. Used advanced technology consists of metallized PP film with extremely low loss factor and dielectric system is self-healing.

The dielectric system is self-healing and biodegradable and environmentally friendly.

The capacitors have overpressure protection to disconnect it from the supply in the event of internal failure and at the end of its operational life.

The construction described above and the use of high quality materials ensure reliability and longevity.

Capacitor benefits to

- Improve Power Factor
- Reduce Line Losses
- Decrease Voltage Drop

Through that it helps greater **Energy Efficiency**

#### > Product Scope

- **Power Range** 0.2kvar to 150kvar
- **Voltage Range** 220V to 1000V
- **Frequency** 50Hz / 60Hz
- **Applicable Standards** IEC, AISI / IEEE, NEMA



#### > Technical Data

Location	Indoor	
Capacitor Loss [Under stabilized Condition]	0.5W/kvar	
Ambient Temperature	-25°C / A [+40°C], B [+45°C], C [+50°C], D [+55°C]	
Max overvoltage	U <sub>max</sub>	U <sub>N</sub> + 10% [up to 8 hours daily]
		U <sub>N</sub> + 15% [up to 30 minutes daily]
		U <sub>N</sub> + 20% [up to 5 minutes]
		U <sub>N</sub> + 30% [up to 1 minute]
Max overcurrent	I <sub>s</sub>	1.3 × I <sub>N</sub>
Painting Color	Munsell No. 5Y 7/1	
Reference Standard	IEC 60831-1	



## 1-2 Low Voltage Power Capacitor

### > 220V 50Hz Single Phase, Three Phase Capacitor

#### • Ratings and Dimensions

Type		Capacity		Current [A]		Dimension [mm]						Figure	
Single Phase	Three Phase	[μF]	[kvar]	Single Phase	Three Phase	A		B		W	F		D
						Single Phase	Three Phase	Single Phase	Three Phase				
QMM-2010S	QMM-2010T	10	0.2	0.7	0.4	(65)	65	(85)	85	63	77	63	1
QMM-2015S	QMM-2015T	15	0.2	1.0	0.6	(65)	65	(85)	85	63	77	63	
QMM-2020S	QMM-2020T	20	0.3	1.4	0.8	(65)	65	(85)	85	63	77	63	
QMM-2030S	QMM-2030T	30	0.5	2.1	1.2	(65)	110	(85)	130	63	77	63	
QMM-2040S	QMM-2040T	40	0.6	2.8	1.6	(65)	110	(85)	130	63	77	63	
QMM-2050S	QMM-2050T	50	0.8	3.5	2.0	(110)	110	(130)	130	63	77	63	
QMM-2075S	QMM-2075T	75	1.1	5.2	3.0	(110)	110	(130)	130	63	77	63	
QMM-2100S	QMM-2100T	100	1.5	6.9	4.0	(110)	135	(155)	135	63	77	63	
SMS-2150ST		150	2.3	10.4	6.0	105		125		170	190	60	
SMS-2175ST		175	2.7	12.1	7.0	105		125		170	190	60	
SMS-2200ST		200	3.0	13.8	8.0	105		125		170	190	60	
SMS-2250ST		250	3.8	17.3	10.0	115		135		170	190	60	
SMS-2300ST		300	4.6	20.7	12.0	130		150		170	190	60	
SMS-2400ST		400	6.1	27.6	16.0	155		175		170	190	60	
SMS-2500ST		500	7.6	34.6	20.0	175		195		170	190	60	
SMS-2600ST		600	9.1	41.5	23.9	205		225		170	190	60	
SMS-2700ST		700	10.6	48.4	27.9	255		275		170	190	60	
SMS-2750ST		750	11.4	51.8	29.9	255		275		170	190	60	
SMB-2800S	SMB-2800T	800	12.2	55.3	31.9	170		235		200	170	120	3
SMB-2900S	SMB-2900T	900	13.7	62.2	35.9	170		235		200	170	120	
SMB-21000S	SMB-21000T	1000	15.2	69.1	39.9	180		245		200	170	120	2
SMB-25010KST		657.7	10	45.5	26.2	255		275		170	190	60	
SMB-25015KS	SMB-25015KT	986.5	15	68.2	39.4	180		245		200	170	120	3
SMB-25020KS	SMB-25020KT	1315.3	20	90.9	52.5	220		285		200	170	120	
SMB-25025KS	SMB-25025KT	1644.2	25	113.6	65.6	280		345		200	170	120	
SMB-25030KS	SMB-25030KT	1973.0	30	136.4	78.7	300		365		200	170	120	
SMB-25040KS	SMB-25040KT	2630.7	40	181.8	105.0	380		445		200	170	120	
SMB-25050KS	SMB-25050KT	3288.3	50	227.3	131.2	280		355		343	409	153	

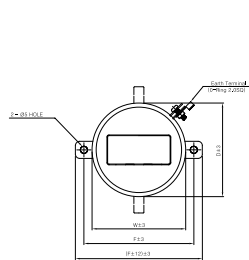

Figure 1

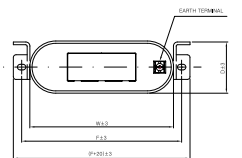

Figure 2

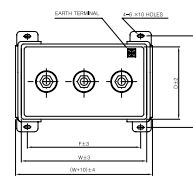

Figure 3

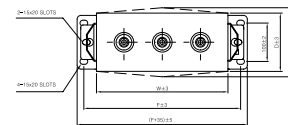

Figure 4

\* Approximate dimensions and weights are given above. Please contact to factory for exact dimensions of a particular unit before order.



## 1-2 Low Voltage Power Capacitor

### > 380V 50Hz Single Phase, Three Phase Capacitor

#### • Ratings and Dimensions

Type		Capacity		Current [A]		Dimension [mm]						Figure	
Single Phase	Three Phase	[μF]	[kvar]	Single Phase	Three Phase	A		B		W	F		D
						Single Phase	Three Phase	Single Phase	Three Phase				
QMM-3010S	QMM-3010T	10	0.5	1.2	0.7	(65)	65	(85)	85	63	77	63	1
QMM-3015S	QMM-3015T	15	0.7	1.8	1.0	(65)	110	(85)	130	63	77	63	
QMM-3020S	QMM-3020T	20	0.9	2.4	1.4	(65)	110	(85)	130	63	77	63	
QMM-3025S	QMM-3025T	25	1.1	3.0	1.7	(110)	110	(130)	130	63	77	63	
QMM-3030S	QMM-3030T	30	1.4	3.6	2.1	(110)	110	(130)	130	63	77	63	
QMM-3040S	QMM-3040T	40	1.8	4.8	2.8	(110)	110	(130)	130	63	77	63	
QMM-3050S	QMM-3050T	50	2.3	6.0	3.4	(110)	135	(130)	155	63	77	63	2
SMS-3075ST		75	3.4	9.0	5.2		105		125	170	190	60	
SMS-3100ST		100	4.5	11.9	6.9		105		125	170	190	60	
SMS-3150ST		150	6.8	17.9	10.3		130		150	170	190	60	
SMS-3200ST		200	9.1	23.9	13.8		155		175	170	190	60	
SMS-3250ST		250	11.3	29.8	17.2		175		195	170	190	60	
SMS-3300ST		300	13.6	35.8	20.7		205		225	170	190	60	
SMS-3400ST		400	18.1	47.8	27.6		255		275	170	190	60	
SMB-3500S	SMB-3500T	500	22.7	59.7	34.5		180		245	200	170	120	3(M12)
SMS-35010KST		220.4	10	26.3	15.2		155		175	170	190	60	2
SMS-35015KST		330.7	15	39.5	22.8		205		225	170	190	60	
SMB-35020KS	SMB-35020KT	440.9	20	52.6	30.4		170		235	200	170	120	3(M12)
SMB-35025KS	SMB-35025KT	551.1	25	65.8	38.0		180		245	200	170	120	
SMB-35030KS	SMB-35030KT	661.3	30	78.9	45.6		220		285	200	170	120	
SMB-35040KS	SMB-35040KT	881.7	40	105.3	60.8		280		345	200	170	120	
SMB-35050KS	SMB-35050KT	1102.2	50	131.6	76.0		340		405	200	170	120	
SMB-35075KS	SMB-35075KT	1653.3	75	197.4	114.0		300		375	343	409	153	
SMF-35100KS	SMF-35100KT	2204.4	100	263.2	151.9		320		395	343	409	153	4(M12)
SMF-35150KS	SMF-35150KT	3306.5	150	394.7	227.9		440		515	343	409	153	

### > 400V 50Hz Single Phase, Three Phase Capacitor

#### • Ratings and Dimensions

Type		Capacity		Current [A]		Dimension [mm]						Figure	
Single Phase	Three Phase	[μF]	[kvar]	Single Phase	Three Phase	A		B		W	F		D
						Single Phase	Three Phase	Single Phase	Three Phase				
QMM-4010S	QMM-4010T	10	0.5	1.3	0.7	(65)	110	(85)	130	63	77	63	1
QMM-4015S	QMM-4015T	15	0.8	1.9	1.1	(65)	110	(85)	130	63	77	63	
QMM-4020S	QMM-4020T	20	1.0	2.5	1.5	(110)	110	(130)	130	63	77	63	
QMM-4025S	QMM-4025T	25	1.3	3.1	1.8	(110)	135	(130)	155	63	77	63	
QMM-4030S	QMM-4030T	30	1.5	3.8	2.2	(110)	135	(130)	155	63	77	63	
QMM-4040S	QMM-4040T	40	2.0	5.0	2.9	(110)	135	(130)	155	63	77	63	
SMS-4050ST		50	2.5	6.3	3.6		105		125	63	77	63	2
SMS-4075ST		75	3.8	9.4	5.4		105		125	170	190	60	
SMS-4100ST		100	5.0	12.6	7.3		130		150	170	190	60	
SMS-4150ST		150	7.5	18.8	10.9		155		175	170	190	60	
SMS-4200ST		200	10.1	25.1	14.5		175		195	170	190	60	
SMS-4250ST		250	12.6	31.4	18.1		205		225	170	190	60	
SMS-4300ST		300	15.1	37.7	21.8		255		275	170	190	60	
SMB-4400S	SMB-4400T	400	20.1	50.3	29.0		180		245	200	170	120	3(M12)
SMB-4500S	SMB-4500T	500	25.1	62.8	36.3		220		285	200	170	120	
SMS-45010KST		198.9	10	25.0	14.4		155		175	170	190	60	2
SMS-45015KST		298.4	15	37.5	21.7		205		225	170	190	60	
SMB-45020KS	SMB-45020KT	397.9	20	50.0	28.9		180		245	200	170	120	3(M12)
SMB-45025KS	SMB-45025KT	497.4	25	62.5	36.1		220		285	200	170	120	
SMB-45030KS	SMB-45030KT	596.8	30	75.0	43.3		240		305	200	170	120	
SMB-45040KS	SMB-45040KT	795.8	40	100.0	57.7		300		365	200	170	120	
SMB-45050KS	SMB-45050KT	994.7	50	125.0	72.2		360		425	200	170	120	
SMB-45075KS	SMB-45075KT	1492.1	75	187.5	108.3		320		395	343	409	153	
SMF-45100KS	SMF-45100KT	1989.4	100	250.0	144.3		340		415	343	409	153	4(M12)
SMF-45150KS	SMF-45150KT	2984.2	150	375.0	216.5		480		555	343	409	153	

\* Approximate dimensions and weights are given above. Please contact to factory for exact dimensions of a particular unit before order.





## 1-2 Low Voltage Power Capacitor

### > 415V 50Hz Single Phase, Three Phase Capacitor

#### • Ratings and Dimensions

Type		Capacity		Current [A]		Dimension [mm]						Figure	
Single Phase	Three Phase	[μF]	[kvar]	Single Phase	Three Phase	A		B		W	F		D
						Single Phase	Three Phase	Single Phase	Three Phase				
QMM-4010S	QMM-4010T	10	0.5	1.3	0.8	(65)	110	(85)	130	63	77	63	1
QMM-4015S	QMM-4015T	15	0.8	2.0	1.1	(65)	110	(85)	130	63	77	63	
QMM-4020S	QMM-4020T	20	1.1	2.6	1.5	(110)	110	(130)	130	63	77	63	
QMM-4025S	QMM-4025T	25	1.4	3.3	1.9	(110)	135	(130)	155	63	77	63	
QMM-4030S	QMM-4030T	30	1.6	3.9	2.3	(110)	135	(130)	155	63	77	63	
QMM-4040S	QMM-4040T	40	2.2	5.2	3.0	(110)	135	(130)	155	63	77	63	
SMS-4050ST		50	2.7	6.5	3.8	105		125		170	190	60	2
SMS-4075ST		75	4.1	9.8	5.6	105		125		170	190	60	
SMS-4100ST		100	5.4	13.0	7.5	130		150		170	190	60	
SMS-4150ST		150	8.1	19.6	11.3	155		175		170	190	60	
SMS-4200ST		200	10.8	26.1	15.1	175		195		170	190	60	
SMS-4250ST		250	13.5	32.6	18.8	205		225		170	190	60	
SMS-4300ST		300	16.2	39.1	22.6	255		275		170	190	60	
SMB-4400S	SMB-4400T	400	21.6	52.2	30.1	180		245		200	170	120	3(M12)
SMB-4500S	SMB-4500T	500	27.1	65.2	37.6	220		285		200	170	120	
SMS-45010KST		184.8	10	24.1	13.9	205		225		170	190	60	2
SMS-45015KST		277.2	15	36.1	20.9	255		275		170	190	60	
SMB-45020KS	SMB-45020KT	369.6	20	48.2	27.8	180		245		200	170	120	3(M12)
SMB-45025KS	SMB-45025KT	462.1	25	60.2	34.8	220		285		200	170	120	
SMB-45030KS	SMB-45030KT	554.5	30	72.3	41.7	240		305		200	170	120	
SMB-45040KS	SMB-45040KT	739.3	40	96.4	55.6	280		245		200	170	120	
SMB-45050KS	SMB-45050KT	924.1	50	120.5	69.6	340		405		200	170	120	
SMB-45075KS	SMB-45075KT	1386.2	75	180.7	104.3	320		295		343	409	153	
SMF-45100KS	SMF-45100KT	1848.2	100	241.0	139.1	360		435		343	409	153	4(M12)
SMF-45150KS	SMF-45150KT	2772.3	150	361.4	208.7	480		555		343	496	153	

### > 440V 50Hz Single Phase, Three Phase Capacitor

#### • Ratings and Dimensions

Type		Capacity		Current [A]		Dimension [mm]						Figure	
Single Phase	Three Phase	[μF]	[kvar]	Single Phase	Three Phase	A		B		W	F		D
						Single Phase	Three Phase	Single Phase	Three Phase				
QMM-4010S	QMM-4010T	10	0.6	1.4	0.8	(65)	110	(85)	130	63	77	63	1
QMM-4015S	QMM-4015T	15	0.9	2.1	1.2	(65)	110	(85)	130	63	77	63	
QMM-4020S	QMM-4020T	20	1.2	2.8	1.6	(110)	110	(130)	130	63	77	63	
QMM-4025S	QMM-4025T	25	1.5	3.5	2.0	(110)	135	(130)	155	63	77	63	
QMM-4030S	QMM-4030T	30	1.8	4.1	2.4	(110)	135	(130)	155	63	77	63	
QMM-4040S	QMM-4040T	40	2.4	5.5	3.2	(110)	135	(130)	155	63	77	63	
SMS-4050ST		50	3.0	6.9	4.0	105		125		170	190	60	2
SMS-4075ST		75	4.6	10.4	6.0	105		125		170	190	60	
SMS-4100ST		100	6.1	13.8	8.0	130		150		170	190	60	
SMS-4150ST		150	9.1	20.7	12.0	155		175		170	190	60	
SMS-4200ST		200	12.2	27.6	16.0	175		195		170	190	60	
SMS-4250ST		250	15.2	34.6	20.0	205		225		170	190	60	
SMS-4300ST		300	18.2	41.5	23.9	255		275		170	170	60	
SMB-4400S	SMB-4400T	400	24.3	55.3	31.9	180		245		200	170	120	3(M12)
SMB-4500S	SMB-4500T	500	30.4	69.1	39.9	220		285		200	170	120	
SMS-45010KST		164.4	10	22.7	13.1	205		225		170	190	60	2
SMS-45015KST		246.6	15	34.1	19.7	205		225		170	190	60	
SMB-45020KS	SMB-45020KT	328.8	20	45.5	26.2	160		225		200	190	120	3(M12)
SMB-45025KS	SMB-45025KT	411.0	25	56.8	32.8	180		245		200	170	120	
SMB-45030KS	SMB-45030KT	493.2	30	68.2	39.4	220		285		200	170	120	
SMB-45040KS	SMB-45040KT	657.7	40	90.9	52.5	280		345		200	170	120	
SMB-45050KS	SMB-45050KT	822.1	50	113.6	65.6	320		385		200	170	120	
SMB-45075KS	SMB-45075KT	1233.1	75	170.5	98.4	280		355		343	409	153	
SMF-45100KS	SMF-45100KT	1644.2	100	227.3	131.2	320		395		343	409	153	4(M12)
SMF-45150KS	SMF-45150KT	2466.2	150	340.9	196.8	430		505		343	409	153	

\* Approximate dimensions and weights are given above. Please contact to factory for exact dimensions of a particular unit before order.



## 1-2 Low Voltage Power Capacitor

### ② Dry Type

#### > Application

Capacitors are intended for the improvement of Power Factor in low voltage power networks. Used advanced technology consists of metallized PP film with extremely low loss factor. The dielectric system is self-healing and has no liquid impregnant. The capacitor is enclosed in cylindrical aluminium cases. The capacitors have overpressure protection to disconnect it from the supply in the event of internal failure and at the end of its operational life. The construction described above and the use of high quality materials ensure reliability and longevity.

#### > Product Scope

- **Power Range**                    0.2kvar to 50kvar
- **Voltage Range**                220V to 1000V
- **Frequency**                     50Hz / 60Hz
- **Applicable Standards**        IEC, ANSI / IEEE, NEMA



#### > Technical Data

Location	Indoor	
Capacitor Loss [Under Stabilized Condition]	1.5W/kvar	
Ambient Temperature	-25°C / A [+40°C], B [+45°C], C [+50°C], D [+55°C]	
Max overvoltage	U <sub>max</sub>	U <sub>N</sub> + 10% [up to 8 hours daily]
		U <sub>N</sub> + 15% [up to 30 minutes daily]
		U <sub>N</sub> + 20% [up to 5 minutes]
		U <sub>N</sub> + 30% [up to 1 minute]
Max overcurrent	I <sub>s</sub>	1.3 × I <sub>N</sub>
Reference Standard	IEC 60831-1	

#### > Disconnecter Function

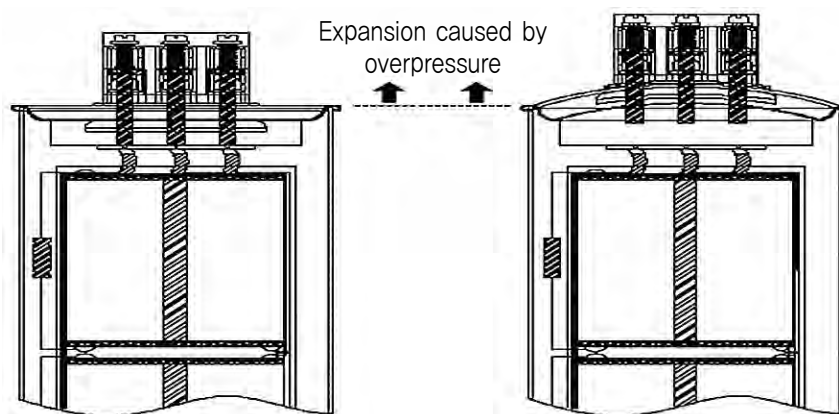



## 1-2 Low Voltage Power Capacitor

### > 220V 50Hz Three Phase Capacitor

#### • Raitngs and Dimesnions

Type	Capacity		Current [A]	Dimension [mm]		Remark
	[ $\mu$ F]	[kvar]		D	H	
RMC-225010KT	65.8	1	2.6	63	135	M12
RMC-225015KT	98.6	1.5	3.9	63	135	M12
RMC-225025KT	164.4	2.5	6.6	63	165	M12
RMC-225050KT	328.8	5	13.1	86	170	M12
RMC-225075KT	493.2	7.5	19.7	86	230	M12
RMC-225100KT	657.7	10	26.2	86	275	M12
RMC-225125KT	822.1	12.5	32.8	86	350	M12
RMC-225150KT	986.5	15	39.4	86	350	M12

### > 380V 50Hz Three Phase Capacitor

#### • Raitngs and Dimesnions

Type	Capacity		Current [A]	Dimension [mm]		Remark
	[ $\mu$ F]	[kvar]		D	H	
RMC-385025KT	55.1	2.5	3.8	63	135	M12
RMC-385050KT	110.2	5	7.6	86	140	M12
RMC-385075KT	165.3	7.5	11.4	86	170	M12
RMC-385100KT	220.4	10	15.2	86	230	M12
RMC-385125KT	275.5	12.5	19.0	86	230	M12
RMC-385150KT	330.7	15	22.8	86	275	M12
RMC-385200KT	440.9	20	30.4	86	350	M12
RMC-385250KT	551.1	25	38.0	96	350	M16

### > 400V 50Hz Three Phase Capacitor

#### • Raitngs and Dimesnions

Type	Capacity		Current [A]	Dimension [mm]		Remark
	[ $\mu$ F]	[kvar]		D	H	
RMC-405025KT	49.7	2.5	3.6	63	135	M12
RMC-405050KT	99.5	5	7.2	86	140	M12
RMC-405075KT	149.2	7.5	10.8	86	170	M12
RMC-405100KT	198.9	10	14.4	86	230	M12
RMC-405125KT	248.7	12.5	18.0	86	230	M12
RMC-405150KT	298.4	15	21.7	86	275	M12
RMC-405200KT	397.9	20	28.9	86	350	M12
RMC-405250KT	497.4	25	36.1	96	350	M16

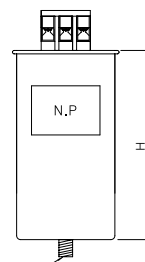
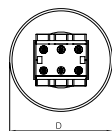

M12(FOR 63 $\phi$ , 85 $\phi$ )  
M15(FOR 96 $\phi$ )

\* Approximate dimensions and weights are given above. Please contact to factory for exact dimensions of a particular unit before order.



## 1-2 Low Voltage Power Capacitor

### > 415V 50Hz Three Phase Capacitor

#### • Raitngs and Dimesnions

Type	Capacity		Current [A]	Dimension [mm]		Remark
	[ $\mu$ F]	[kvar]		D	H	
RMC-415025KT	46.2	2.5	3.5	63	135	M12
RMC-415050KT	92.4	5	7.0	63	165	M12
RMC-415075KT	138.6	7.5	10.4	86	170	M12
RMC-415100KT	184.8	10	13.9	86	230	M12
RMC-415125KT	231.0	12.5	17.4	86	230	M12
RMC-415150KT	277.2	15	20.9	86	275	M12
RMC-415200KT	369.6	20	27.8	86	350	M12
RMC-415250KT	462.1	25	34.8	86	350	M12

### > 440V 50Hz Three Phase Capacitor

#### • Raitngs and Dimesnions

Type	Capacity		Current [A]	Dimension [mm]		Remark
	[ $\mu$ F]	[kvar]		D	H	
RMC-445025KT	41.1	2.5	3.3	63	135	M12
RMC-445050KT	82.2	5	6.6	63	165	M12
RMC-445075KT	123.3	7.5	9.8	86	170	M12
RMC-445100KT	164.4	10	13.1	86	170	M12
RMC-445125KT	205.5	12.5	16.4	86	230	M12
RMC-445150KT	246.6	15	19.7	86	230	M12
RMC-445200KT	328.8	20	26.2	86	275	M12
RMC-445250KT	411.0	25	32.8	86	350	M12
RMC-445300KT	493.2	30	39.4	96	350	M16

### > 460V 50Hz Three Phase Capacitor

#### • Raitngs and Dimesnions

Type	Capacity		Current [A]	Dimension [mm]		Remark
	[ $\mu$ F]	[kvar]		D	H	
RMC-465025KT	37.6	2.5	3.1	63	135	M12
RMC-465050KT	75.2	5	6.3	86	140	M12
RMC-465075KT	112.8	7.5	9.4	86	170	M12
RMC-465100KT	150.4	10	12.6	86	230	M12
RMC-465125KT	188.0	12.5	15.7	86	230	M12
RMC-465150KT	225.6	15	18.8	86	275	M12
RMC-465200KT	300.9	20	25.1	86	350	M12

### > 480V 50Hz Three Phase Capacitor

#### • Raitngs and Dimesnions

Type	Capacity		Current [A]	Dimension [mm]		Remark
	[ $\mu$ F]	[kvar]		D	H	
RMC-485025KT	34.5	2.5	3.0	63	135	M12
RMC-485050KT	69.1	5	6.0	86	140	M12
RMC-485075KT	103.6	7.5	9.0	86	170	M12
RMC-485100KT	138.2	10	12.0	86	230	M12
RMC-485125KT	172.7	12.5	15.0	86	230	M12
RMC-485150KT	207.2	15	18.0	86	275	M12
RMC-485200KT	276.3	20	24.1	86	350	M12

### > 525V 50Hz Three Phase Capacitor

#### • Raitngs and Dimesnions

Type	Capacity		Current [A]	Dimension [mm]		Remark
	[ $\mu$ F]	[kvar]		D	H	
RMC-525025KT	28.9	2.5	2.7	63	135	M12
RMC-525050KT	57.7	5	5.5	86	140	M12
RMC-525075KT	86.6	7.5	8.2	86	170	M12
RMC-525100KT	115.5	10	11.0	86	230	M12
RMC-525125KT	144.4	12.5	13.7	86	230	M12
RMC-525150KT	173.2	15	16.5	86	275	M12
RMC-525200KT	231.0	20	22.0	86	350	M12

\* Approximate dimensions and weights are given above. Please contact to factory for exact dimensions of a particular unit before order.



## 2. Capacitor Bank

### ① General Capacitor Bank

#### ➤ Application

Capacitor Bank is an economical method of reducing High reactance of high and extra high voltage lines. And It controls the voltage level supplied by reducing or eliminating the voltage drop and increase power transfer Power system.

Capacitor Bank is relatively inexpensive and can be easily installed with all accessories anywhere on the network.

#### ➤ Capacitor Bank benefits to

- Increase power transmission capability
- Improve system stability
- Reduce system losses
- Improve voltage profile on the lines
- Optimize power flow between parallel lines



《Capacitor Bank 150kV 25Mvar – GI Duri substation in Indonesia》



## 2-1 Capacitor Bank

### ② Harmonic Filter Capacitor Bank

#### ➤ Application

Most type of equipment in electrical systems generate harmonics. Harmonics is not only found in industrial networks, It can spread into the distribution system and cause problems for other customers.

Each plant is unique and needs its own special technical solution to prevent it.

Harmonic Filter Bank usually consists of a capacitor which is connected in series with a reactor.

The components are dimensioned to create a series resonance circuit for a required frequency.

We can help you to calculate and design filters which will reduce interference and interruption on your network.

#### ➤ Harmonic Filter Bank benefits to

- Improve power factor, voltage stability
- Reduce line loss
- Filter harmonics in the system
- Avoid resonance problems and amplification of electrical disturbances



《Harmonic Filter Bank 22.9kV 63Mvar – Doosan Heavy Industrial, Korea》



## 2-2 Capacitor Bank Type

### ① Cubicle Capacitor Bank

#### > Application & Construction

This is a fixed reactive compensation system for individual motor compensation.

There is a range of metal enclosed capacitor banks for a variety of medium voltage applications.

The product range consists of indoor and outdoor solutions, which can be single step fixed or multi-step switched.

According to the requirement, it is possible to include also inrush current reactors or other protections and measuring elements

It will automatically compensate the network to maintain a preset level of power factor.

#### > Available options

- Circuit Breaker
- Disconnect Switch
- Earthing Switch
- Inrush or Detuning reactor
- Discharge Coil
- Unbalance Protection
- Automatic Power Factor Controller



《《3.3kV 3P 50Hz 300kvar》》



《《10kV 3P 50Hz 700kvar》》



《《APFCR with Dry Type Capacitor》》



## 2-2 Capacitor Bank Type

### ② Open-rack Capacitor Bank

#### > Application & Construction

The Samwha Open-rack Capacitor Banks are primarily used to improve the power factor in the network. Improving the power factor also means a higher power transmission capability and increased control of the power flow.

They will also improve the voltage stability and reduce network losses. The installation of capacitors in a transmission or distribution network.

#### > Open-rack Capacitor Bank benefits to

- Reduce network losses
- Increase voltage stability
- Improve power quality
- Limit or reduce charges for excess reactive power consumption.
- Increase load possibility on existing transmission lines and transformers

The Samwha Open-rack Capacitor Bank type is the most common capacitor bank and available with internally fused capacitor units.

Range	Internal Fuse Type
Voltage	Up to 250kV
Location	Outdoor



《110kV 3P 50Hz 50Mvar Open-rack Capacitor Bank》





## 2-2 Capacitor Bank Type

### ③ Pole Mounted Capacitor Bank

#### ➤ Application & Construction

The Samwha Pole Mounted Capacitor Bank provide voltage support, reduce system losses, improve power factor in the distribution systems.

The installation is in distribution systems.

#### ➤ Composition equipments

- Cut-off Switch
- Capacitor Switch
- Surge Arrester
- Voltage Transformer
- Controller
- Capacitors

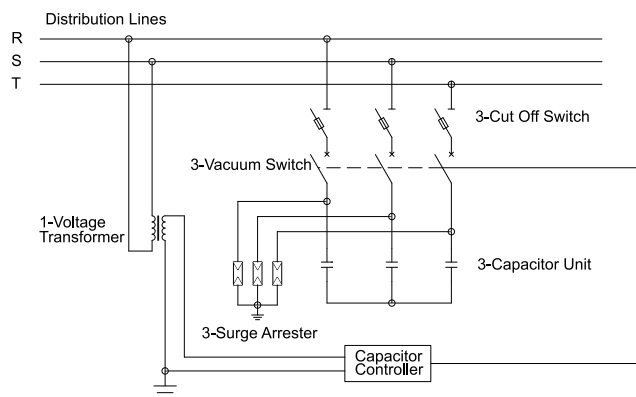
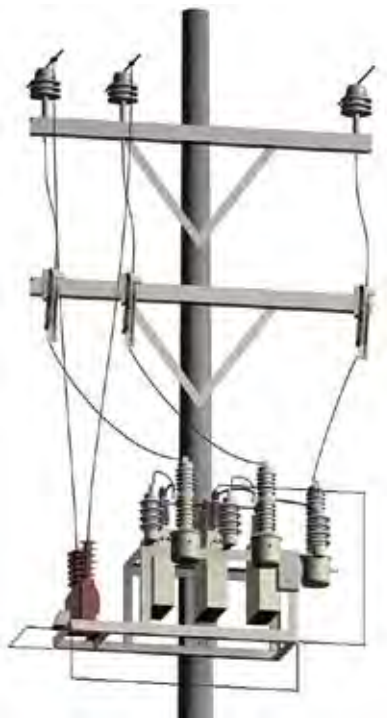

System Voltage [kV]	Frequency [Hz]	Capacity [kvar]	Number of Capacitor unit	Dimension [mm]		
				A	B	C
12	50 / 60	1000	334kvar x 3EA	575	1600	990
		1500	500kvar x 3EA	575	1600	1100
		2000	334kvar x 6EA	575	2185	990
		2500	417kvar x 6EA	575	2275	990
24		1000	334kvar x 3EA	575	1600	990
		1500	500kvar x 3EA	575	1600	1100
		2000	334kvar x 6EA	575	2185	990
		2500	417kvar x 6EA	575	2275	990

\* Approximate Dimensions and Capacities are given above. Please contact factory for your projects.



## 2-3 Capacitor Bank Protection

### ① NVS [Neutral Voltage Sensor]

#### > General

Capacitor Bank is needed to set proper protection systems to protect capacitor bank against faults occurring within the bank including those inside the capacitor units, and to protect capacitor bank against system disturbances and faults.

Generally, the method of detecting neutral value [voltage or current] is selected as the protection for capacitor bank system.

#### > Application

NVS is the protection system using voltage unbalance signals to alarm or shut down the capacitor bank in case of faults that may lead to significant damages.

To measure the unbalance of voltage, the neutral voltage-sensing device[NVS] is used.

#### • Ungrounded Single Wye Banks

It detects the unbalance voltage between capacitor neutral and resistance which is connected with capacitor.

NVS of defecting voltage is changeable according to the number of internal series in capacitor.

#### • Ungrounded Double Wye Banks

It is the same protection method as ungrounded single Wye Bank.

The difference is that it detects the unbalanced voltage between the two neutrals and it needs to use overvoltage relay.

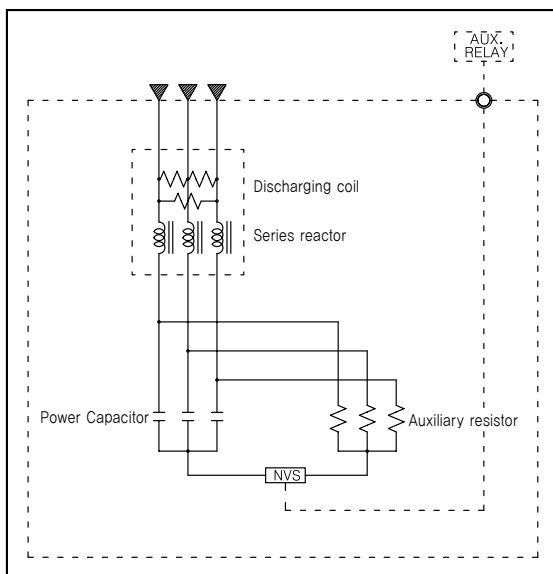

<<Ungrounded Single Wye Bank>>

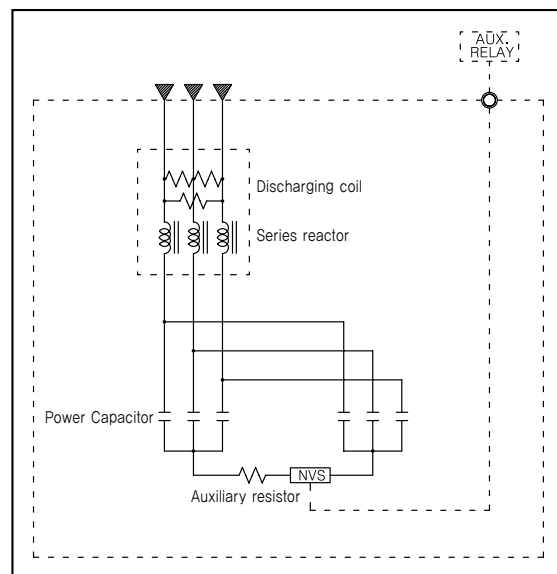

<<Ungrounded Double Wye Bank>>



## 2-3 Capacitor Bank Protection

### ② NCT [Neutral Current Transformer]

#### > Application

NCT is the protection system using unbalanced current on neutrals composed in Double Wye Capacitor Banks signals to alarm or shut down the banks.

To measure the unbalance of current, the current transformer with low current value is used.

The current transformer ratio and relay rating are selected for the desired sensitivity.

NCT protection system is normally used on wide range of level from high to extra voltage capacitor banks, and can detect faults in all kinds of capacitor units.

Current Transformer with rated current value 1 is manufactured,

therefore it is useful to protect Capacitor Bank with internal fuse which has low fault current on neutral.

#### • 36kV CAPACITOR BANK with NCT Protection System

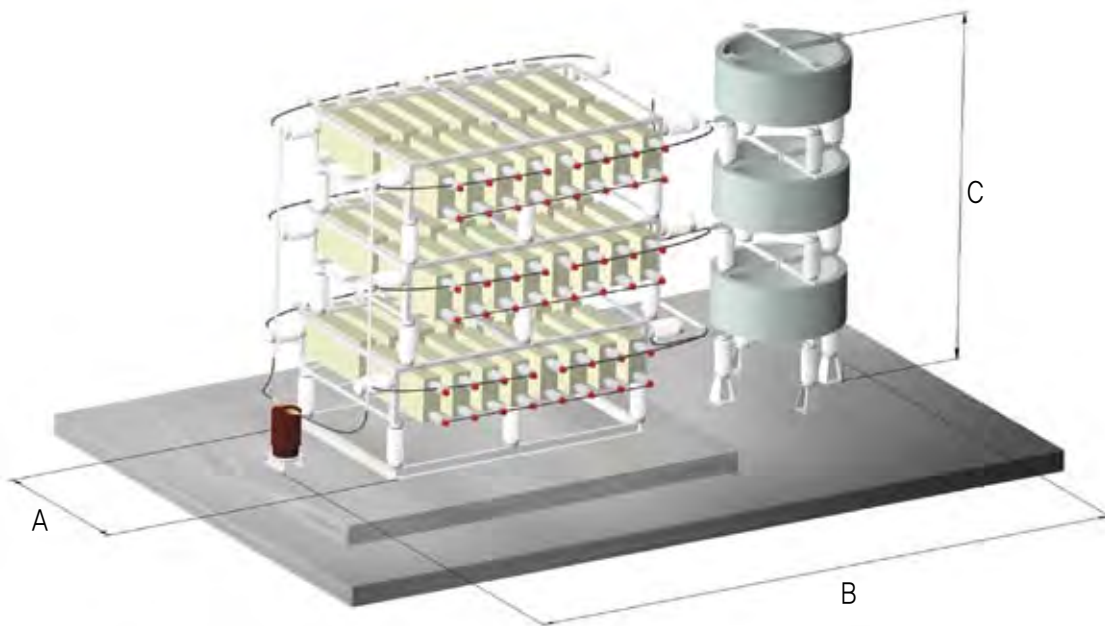

System voltage [Max] [kV]	Frequency [Hz]	Capacity [kvar]	Number of Capacitor unit	Dimension [mm]		
				A	B	C
36	50 / 60	5000	417kvar x 12EA	980	4700	4000
		7500	417kvar x 18EA	980	4990	4000
		10000	556kvar x 18EA	1340	4990	4000
		12500	521kvar x 24EA	1270	5280	4000
		15000	500kvar x 30EA	1200	5570	4000
		20000	556kvar x 36EA	1340	5860	4000
		25000	595kvar x 42EA	1500	6150	4000
		30000	500kvar x 60EA	1340	7000	4000

\* Approximate Dimensions and Capacities are given above. Please contact factory for your projects.



## 3. SVC

### > Application

SVC [Static Var Compensator] is an advanced capacitor bank using thyristor for providing fast-acting reactive power compensation on high-voltage electricity transmission networks.

SVC is an automated impedance matching device and designed to bring the system closer to unity power factor. For example, reactive load of power system is capacitive [leading], the SVC will use reactors to consume VARs from the system, lowering the system voltage. However under inductive[lagging] conditions, the capacitor banks are automatically switched in, thus providing a higher system voltage.

Therefore, SVC is mainly installed near high and rapidly varying loads, such as arc furnaces, chemical plants where need to smooth flicker voltage.



### > SVC benefits to

- Near-instantaneous response to changes in the system voltage
- Maximize power compensation
- Remove Harmonic and reduce distortion of voltage through filter capacitors connected in parallel
- Keep balanced three-phase loads
- Make smooth flicker voltage
- Maximize customer's economic benefits

### • SVC for 160ton Ac Consteel Electric Arc Furnace • SVC for 170ton Ac Consteel Electric Arc Furnace

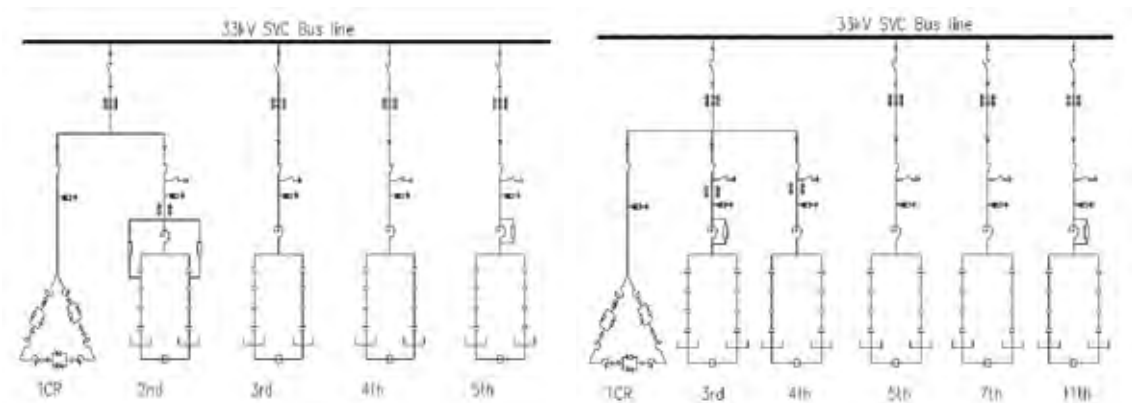



## 3. SVC

### › Feature of Samwha SVC

- MOU [Memorandum Of Understanding] with CEPRI [China Electric Power Research Institute]
- Verifying Power supply network, designated SVC system, Harmonics, designated function etc
- Using digital control method, active responding time is fast with precision.
- Extremely speedy responding of thyristor controller [10 ~ 15ms]
- Thyristor valve was designed as horizontal type, so operation is safety and repair is convenience
- Water cooling system perceives total 13 variables, such as perceives temperature, pressure, water level and resistance rate etc to make sure safety operation.
- Drainage system connected paralld with water conduit makes high reliability of Thyristor valve throgh well temperature control
- Remote control and automatic system interface

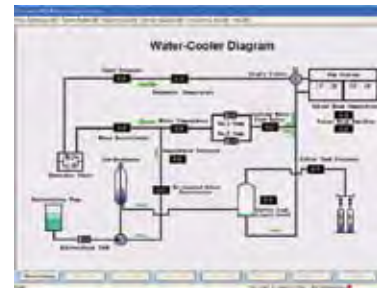
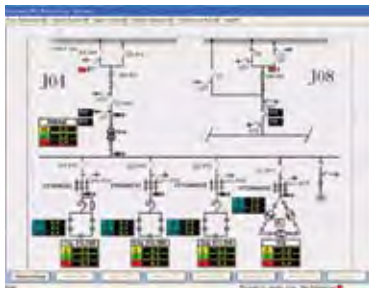

### › SVC installation

Before installing SVC, 22kV current wave

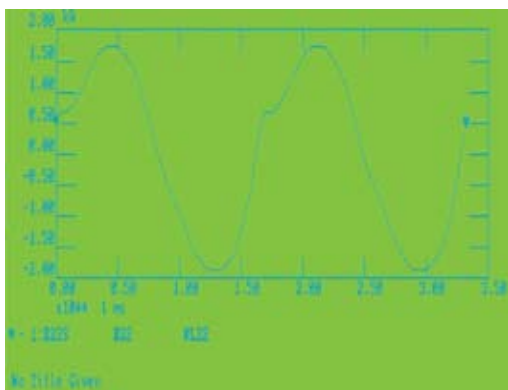

#### Before installing SVC

1. Voltage fluctuation : 2.44%
2. Voltage flicker : Pst = 1.12
3. Voltage distorted waveform : 7.17%
4. Power factor : 78%

After installing SVC, 22kV current wave

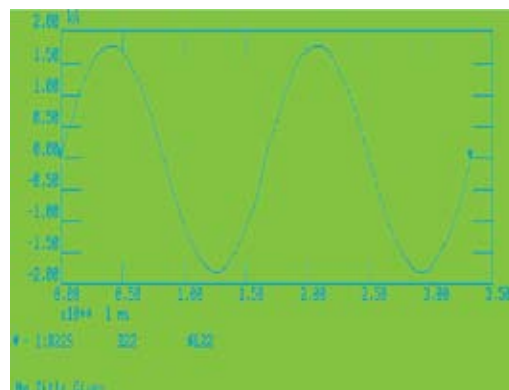

#### After installing SVC

1. Voltage fluctuation : 0.92%
2. Voltage flicker : Pst = 0.92
3. Voltage distorted waveform : 1.64%
4. Power factor : 95%

SVC dedicates to Power quality of Electric furnace improvement, Power factor improvement, Safety operation on transmission lines.



## 4. Special Capacitor

### > Application

Harmonics is commonly generated in electricity system due to devices using Thyristor. It can cause electricity accidents and interference in Power system. Therefore, the application of filter facilities is essential to prevent the effect of Harmonics in Power system and use electricity more efficiently.

### > What is harmonic

Cyclic distortion wave is expressed as the sum of sine wave [50Hz], the integral number frequency and major sine wave, integral number [50Hz] frequency.

This integral number frequency is called harmonic wave and according to the amplitude change and phase, wave form is changed resulting in synthetic distortion.

Combined distortion wave is manifested in distorted sine wave form. This form can be analyzed into one fundamental wave [50Hz] which has random cycle and major sine wave which has integral number frequency or subharmonic frequency.

If the frequency of it is higher than the fundamental frequency, it is called harmonics and if the frequency of it is lower, it is called fractional harmonic wave or subharmonic.

For example, an distorted wave form comprising sine wave type [50Hz] and 5th [250Hz] and 7th [350Hz] wave form is analyzed as following :

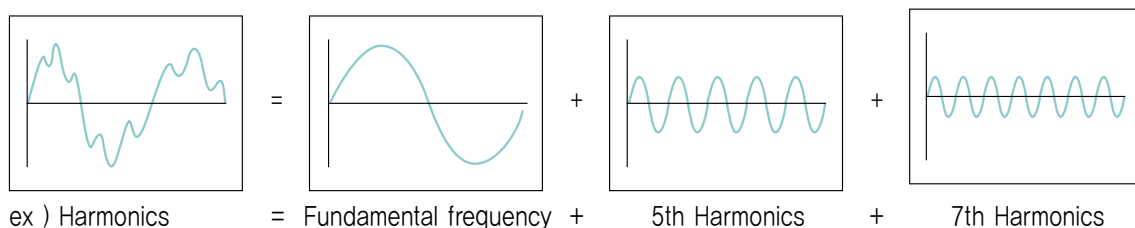

### > Harmonic Generator

- Thyristor controller
- Speed controller
- Low speed starter
- Power factor compensator
- Rectifier
- Arc furnace
- Transformer, Reactor
- Non-linear loads such as rotating devices changing the wave form of the current which generates harmonics.

### > Process of Harmonic Filter Engineering

- Collecting data [system condition, harmonic spectrum, THD limit]
- Drawing system impedance map
- Calculating harmonic impedance and determining filtering order
- Harmonic flow calculation
- Simulation
- Checking abnormal resonance in the system and the possibility of harmonic extension
- Designing Switcher PNL, Structure
- Testing the operation after installation
- Test report



## 4-1 AC Harmonic Filter

### › Disturbance by Harmonics

Once Harmonic is generated in system, it moves around and affects on the connected other electricity facilities.

- Overheating and loss of transformer
- Influx of over current of capacitor and noise
- Instability of control system
- Voltage variation
- Overload of rotator
- Errors on the operation of circuit breaker
- Impediment in communication and interfering OA functions
- Overload current in neutral and low voltage between phase and earthing

### › What is Harmonic Filter?

Harmonic filter is a device which represses and absorbs the outflow of harmonics generated in the electricity system. It consists of resistor, reactor and capacitor.

Basic harmonic filter consists of lower order [5–13th order] single shunt filter which is synchronized with the harmonic current generated in Power system.

For other higher order frequency, higher order filter shall be installed, if necessary.

### › Effects of Harmonic Filter

- Improvement of power factor [invalid power in the electricity system is removed, resulting in the improvement of economics]
- Absorption and removal of harmonics
- Resolving the problem of resonance between inductive and capacitive in the system.
- Keeping the performance and lifetime of the facility high by keeping normal voltage

The effects of contained harmonic current by filter can be expressed as following :

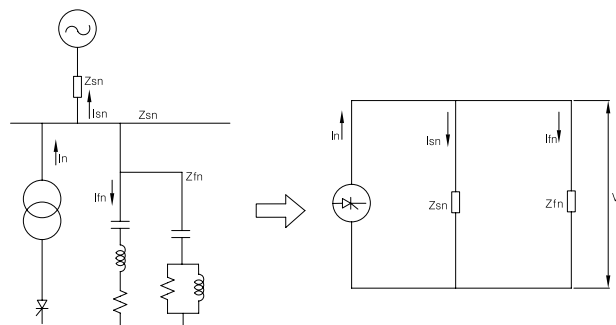

$$V_n = \frac{Z_{fn} \cdot Z_{sn}}{Z_{fn} + Z_{sn}} \cdot I_n = \frac{I_n}{Y_{fn} + Y_{sn}}$$

$$V_n = \frac{Z_{fn}}{Z_{fn} + Z_{sn}} \cdot I_n = \frac{Y_{sn}}{Y_{fn} + Y_{sn}} \cdot I_n, \quad I_{fn} = \frac{Z_{sn}}{Z_{fn} + Z_{sn}} \cdot I_n = \frac{Y_{sn}}{Y_{fn} + Y_{sn}} \cdot I_n$$



## 4-1 AC Harmonic Filter

### > Current Distortion Limits for General Distribution Systems [IEEE Std 519-1991]

Maximum Harmonic Current Distortion in Percent of  $I_L$   
Individual Harmonic Order [Odd Harmonics]

$I_{sc} / I_L$	$h < 11$	$11 \leq h < 17$	$17 \leq h < 23$	$23 \leq h < 35$	$35 \leq h$	TDD
$< 20$	4	2	1.5	0.6	0.3	5
$20 < 50$	7	3.5	2.5	1	0.5	8
$50 < 100$	10	4.5	4	1.5	0.7	12
$100 < 1000$	12	5.5	5	2	1	15
$> 1000$	15	7	6	2.5	1.4	20

Even harmonics are limited to 25% of the odd harmonic limits above

Current distortions that result in a dc offset, e.g., half wave converters are not allowed.

\* All power generation equipment is limited to these values of current distortion regardless of actual  $I_{sc} / I_L$  where

$I_{sc}$  = maximum short circuit current at PCC (point of common coupling)

$I_L$  = maximum demand load current [fundamental frequency component] at PCC

### > Voltage Distortion Limits [IEEE Std 519-1992]

Bus Voltage at PCC	Individual Voltage Distortion [%]	Total Voltage Distortion THD [%]
69kV or less	3.0	5.0
Over 69kV and less 161kV	1.5	2.5
Over 161kV	1.0	1.5





## 4-2. Zero Sequence Filter(ZSF)

### > General

#### 1. General

Increasing use of computer and electric home appliance, the neutral current zero sequence harmonic in line make variety types of disturbances in system.

ZSF(Zero Sequence Filter) is easy to install with electric accessories and it can reduce this large neutral current up to 90% depending on the installed position.

#### 2. The problems of Zero Sequence harmonics

- Trip the circuit breaker due to overcurrent
- Heat deterioration on transformer
- Malfunction of electric protector
- Overheat / Fire on the neutral line
- Communication disturbance

#### 3. Application

- Applicable load : Computer, OA appliance, Electronic fluorescent lamp, Single Phase SCR heater and UPS etc
- Applicable system : Single phase nonlinear loads on Three phase four wire system
- Applicable place : Office/Commercial Building, School, Apartment, Department, Factory, Medical center etc.

### > Features

- Neutral impedance adjuster upon request
- Ammeter displaying the neutral current in option
- Easy to Install
- Easy to select
- Increasing power quality

### > Effects

- Protect heating and loss of line and neutral cable that is effected by zero sequence harmonic current
- Reduce unbalance of line current
- Reduce system loss
- Protect overinvestment by increasing capacity
- Reduce K-factor rating of load current at main transformer.

### > Standard specification

(Rated Voltage : 220V)

Type	Currents in Neutral [A]	Dimensions [mm]		
		W	D	H
ZSF22030	30	350	500	500
ZSF22060	60	350	500	500
ZSF22100	100	600	400	850
ZSF22150	150	650	450	900
ZSF22300	300	800	450	1000
ZSF22450	450	800	500	1200
ZSF22600	600	800	1500	2350
ZSF221000	1000	1100	1500	2350
ZSF223000	3000	1100	1500	2350

\* Approximate dimensions and weights are given above.  
Please contact to factory for exact dimensions.

### > External Shape

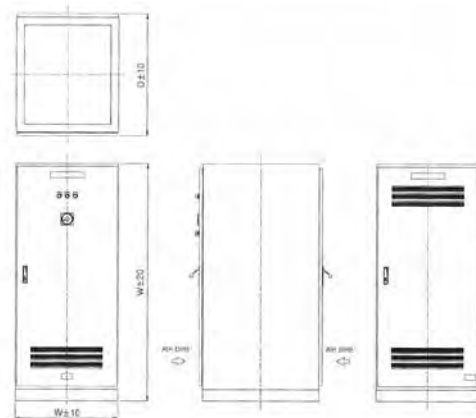



## 4-3. Hybrid Harmonic Filter(HHF)

### > General

#### 1. General

The Hybrid Harmonic Filter(HHF) enable most three phase non-linear load to comply with both the voltage and current distortion limits of IEEE Std.519-1992 and other international limits such as AS-2279, EN61000-3-4, and BS G5/4.

Comparing with the classical broad band harmonic filter, the HHF have only 30% of capacitance with better filtering. Less capacitance can minimize leading current at light loading condition.

#### 2. Harmonic Problems

- Resonance at Power
- Trip the Relay or cut fuse
- Over voltage trip and malfunction of Drive

#### 3. Application

- Applicable loads : Inverter, UPS, Elevator, AC/DC motor drive, Diode/SCR Rectifier, Induction heater, DC power supply, HVAC system, Fan and Pumps etc.
- Applicable place : Office/Commercial building, School, Shopping Mall, Department store, Apartment, Hospital, Factory etc
- Applicable system : Low Voltage 3P nonlinear loads

### > Features

- Patent No.0383791 as Hybrid Harmonic Filter
- Qualified as Excellent Product by the ministry of commerce, industry and energy
- Compact and easy-to-install.
- Standardized up to 1000HP (based on load capacity)
- Quite operation and proper ventilation.
- Special voltage available upon request.

### > Effects

- Protect loss and reduce capacity effected by harmonic current at transformer.
- Protect heating and loss of line cable that is effected by harmonic current.
- Protect burning of reactor and capacitor by harmonic current injection.
- Improve power factor and reduce system loss.
- Improve system voltage/current waveform.
- Prevent nuisance tripping of fuse and circuit breakers which can result from the presence of harmonics.
- Minimize interference with other equipment.

### > Standard specification

(Rated Voltage : 380V)

Type	Currents in Neutral [A]	Dimensions [mm]		
		W	D	H
HHF38005	5	350	500	500
HHF38010	10	500	800	1000
HHF38020	20	600	1000	1200
HHF38040	40	600	1200	1600
HHF38060	60	800	1400	1600
HHF38100	100	800	1500	1600
HHF38200	200	900	1500	2350
HHF38300	300	1100	1500	2350
HHF38400	400	1100	1500	2350

\* Rated Voltage 220V or 440V is also available

\* Approximate dimensions and weights are given above. Please contact to factory for exact dimensions.

### > External Shape

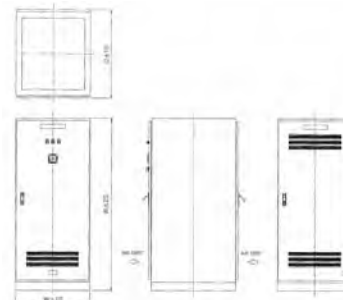



## 4-4. L-C Complex Harmonic Filter(LCF)

### > General

#### 1. General

The motor using inverter is causing ruffle wave form on voltage, and it causes many problems on the system like breaking down dielectric.

LCF can convert PWM wave form to sine wave form making more safe operation in the system.

#### 2. Harmonic Problems

- Destroying dielectric in Motor by spike
- Damage on Cable
- Damage on Voltage raising transformer
- Decreasing productivity
- Malfunction and reduced life span of Inverter by inversed voltage.
- Instantaneous Over voltage phenomenon by distorted voltage wave form
- Malfunction of precision apparatus
- Over heat on distribution line

#### 3. Application

- Applicable load : Motor and machines using inverter(Between inverter and motor)
- Applicable system: 220V, 380V, 440V, 1000HP
- Applicable place : Plants, Steel Mills, power plant, sewage disposal plants, Garbage dumps etc

### > Features

- Make smooth voltage and current wave form
- Reduce voltage reflection and surge impedance
- Reduce peak voltage of motor

### > Effects

- Prevent dielectric destruction
- Increase productivity and quality
- Increase system communication quality and life span

### > Standard specification

(Rated Voltage : 380V)

Type	Currents in Neutral [A]	Dimensions [mm]		
		W	D	H
LCF38005	3.7	350	500	500
LCF38008	5.6	350	500	500
LCF38010	7.5	420	730	1000
LCF38015	11	420	730	1000
LCF38020	15	420	730	1000
LCF38025	19	600	900	1200
LCF38030	22	600	900	1200
LCF38040	30	600	900	1200
LCF38050	37	600	900	1200
LCF38060	45	600	900	1200
LCF38100	75	600	900	1200
LCF38150	112	900	900	2150
LCF38200	149	900	900	2150
LCF38400	298	900	900	2150

\* Rated Voltage 220V or 440V is also available

\* Approximate dimensions and weights are given above. Please contact to factory for exact dimensions.

### > Wave form with LCF

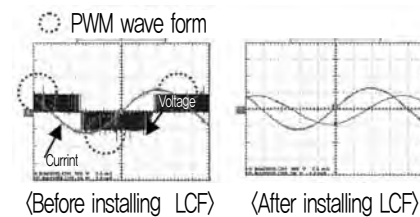

### > External Shape

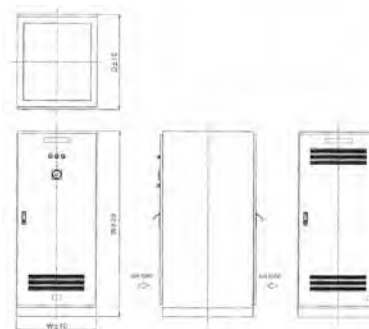



## 4-5. Active Power Harmonic Filter(APF)

### > General

#### 1. General

The proliferation of nonlinear loads such as static power converters and arc furnaces results in variety of undesirable phenomena in the operation of power systems.

The most important among these are harmonic contamination, increased reactive power demand and power system voltage fluctuations.

Harmonic currents increase power systems losses, excessive heating in rotating machinery, can create significant interference with the power line communication.

The harmonic is a growing problem for both electricity suppliers and consumers.

#### 2. Harmonic Problems

- Malfunction of precision control
- High current in neutral conductors
- Damage to sensitive equipment
- Frequent tripping of circuit breakers
- Capacitor overloading and failures
- Excitation of network resonance
- Overheating of transformer, motor and cables

#### 3. Application

- Applicable load : Welding Machine, Electrolyzer in Chemical Factory, Electrolytic machine of ceramic plastic, Arc furnace, Crain etc
- Applicable system : 380V, 440V, 50-300A
- Applicable place : Steel Mills, Chemical Plants, Metal mills, Harbors etc

### > Features

- Patent No.0459000 as Three Phase fourwire active power filter control device
- Meet IEEE standard 519-1992
- Parallel connection allows easy retrofit for large system
- Solve Power Quality Problems
- Curtailment of maintenance fee

### > Installation Effect

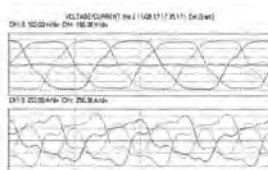

<Before installing APF>

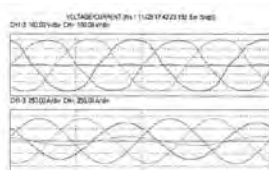

<After installing APF>



<Before installing APF>

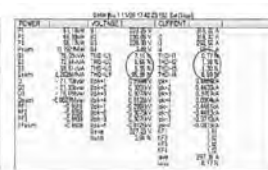

<After installing APF>

### > Standard specification

(Rated Voltage : 380V)

Type	Rating Current [A]	Dimensions [mm]		
		W	D	H
APF38050	50A	600	600	1670
APF38100	100A	750	600	2000
APF38200	200A	900	600	2000
APF38300	300A	1200	6850	2000

\* Approximate dimension is given above.

Please contact to factory for exact dimension and application.

### > External Shape

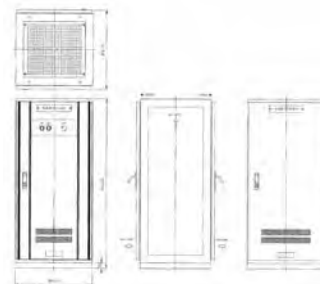



## 4-6. Intelligent Var Compensator(IVC)

### ➤ General

#### 1. General

Intelligent Var Compensator(IVC) is the product designed to improve power quality in the systems with welding, crane and many unspecified loads which is generating reactive power.

#### 2. Application

- Applicable loads : Welding machines, Arc furnace, unspecified loads generating reactive power,
- Applicable system: 380V, 440V, 30~1800kvar
- Applicable place : Steel mills, Chemical plants, Metal mills, Harbors etc.

### ➤ Features

- Patent No.0459000
- 3Phase 4Wire reactive power compensation system with linear response characteristics.
- Prevent the voltage drop and flicker with 5~20ms response speed.
- Control the reactive power using power switching sockets without transient
- Protect sensitive electric machines and save energy
- Exact and fast power factor improvement
- Long life span of switching sockets and capacitors

### ➤ Effects

- Power factor on the secondary side of transformer is improved at 98%
- Average current is decreased to 30%
- Allowance capacity of transformer is increased.
- Prevent voltage flicker phenomenon through resolving reactive power in real-time

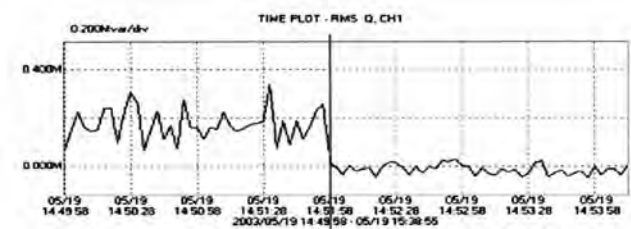

⟨Before installing IVC⟩

⟨After installing IVC⟩

### ➤ Standard specification

(Rated Voltage : 380V)

Type	Capacity [kvar]	Step [kvar]	Ratio	Dimension [mm]		
				W	D	H
IVC38100	100	20	1:2:2	800	800	2000
IVC38120	120	40	1:1:1	800	800	2000
IVC38140	140	20	1:2:4	800	800	2000
IVC38200	200	40	1:2:2	800	800	2000
IVC38240	240	80	1:1:1	800	800	2000
IVC38280	280	40	1:2:4	800	800	2000
IVC38400	400	80	1:1:1	1000	800	2000
IVC38480	480	160	1:1:1	1000	800	2000
IVC38560	560	80	1:2:4	1600	800	2000
IVC38800	800	160	1:2:2	2400	800	2000
IVC381120	1120	160	1:2:4	3200	800	2000

\* Rated Voltage 220V or 440V is also available

\* Approximate dimensions and weights are given above. Please contact to factory for exact dimensions.

### ➤ External Shape

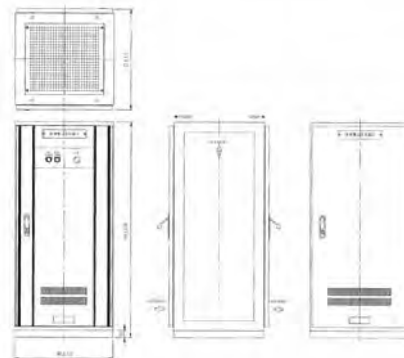



## 4-7 Low Frequency Induction Furnace Capacitor

### > Application

This product was developed in 1977 with the purpose of rationalizing power supply by improving heat efficiency and power factor of Low Frequency Induction Furnace. This product consists of polypropylene film, aluminum thin film or metalized film which has excellent voltage resistance. It contains specially produced composite oil, resulting in high reliability.

### > Product Scope

- Installation Place : Indoor
- Ambient Temperature for use :  $-20^{\circ}\text{C} \sim +40^{\circ}\text{C}$  [below  $35^{\circ}\text{C}$  average for 24 hours]

### > Technical Data

Tolerance	$-5 \sim +15\%$ [at $20^{\circ}\text{C}$ ]
Withstand Voltage	10 seconds of 2.0 times of rated voltage between mutual terminals
Insulation Level	$2U_N + 2\text{kV}$ or $3\text{kV}$ , whichever is the higher, for 10s
Max Overtoltage	Less than 105% of rated voltage : within 12hours per day
Max overcurrent	120% of rated capacity [less than 60Hz], 115% of rated capacity [more than 60Hz] or less
Capacitor Loss [Under stabilized condition]	0.35% [rated voltage, $20^{\circ}\text{C}$ ] or less

### > Diagram

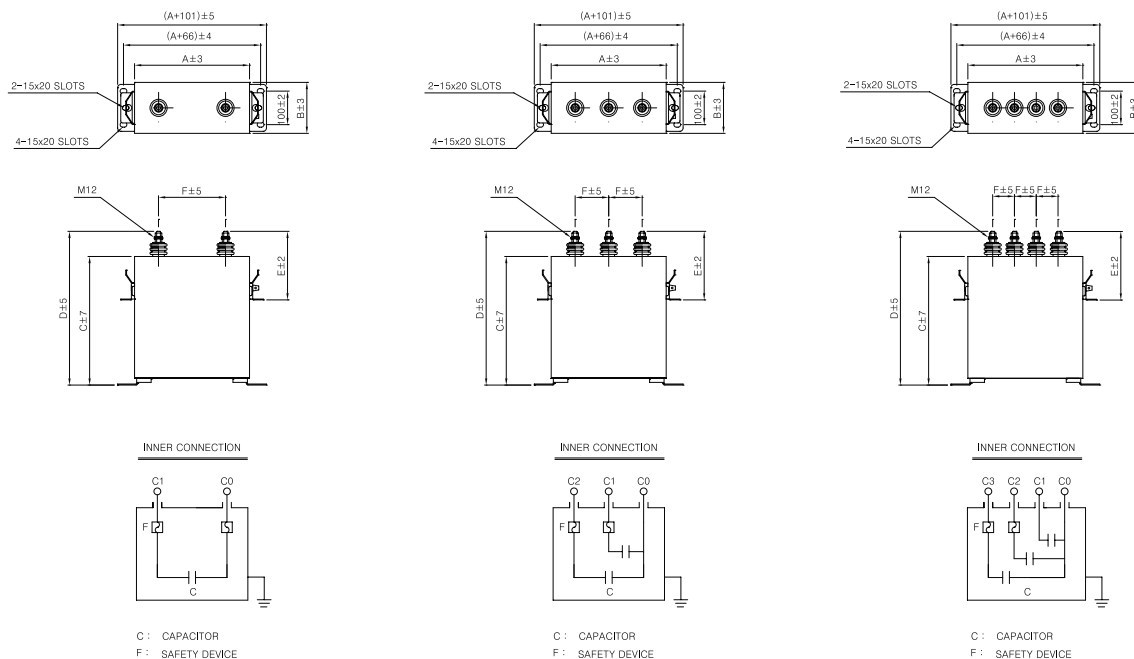

Figure 1

Figure 2

Figure 3



## 4-7 Low Frequency Induction Furnace Capacitor

### > Ratings and Dimensions

Capacity [kvar]	Voltage [V]	Phase	Frequency [Hz]	Rated Capacity [kvar]	Type	Dimension [mm]						Figure
						A	B	C	D	E	F	
50	630	1	60	50	SMFL-66050KS	343	153	280	355	205	200	1
	440	1	60	11.1+22.2+66.7	SMFL-46100KS	343	153	390	465	205	65	3
100	600	1	60	50+50	SMFL-66100KS	630	135	380	455	205	100	2
	630	1	60	100	SMFL-66100KS	343	153	380	455	205	200	1
	800	1	60	100	SMFL-86100KS	343	153	470	545	205	200	1
150	600	1	60	50+100	SMFL-66150KS	630	135	500	575	205	100	2
	800	1	60	150	SMFL-86150KS	343	153	640	715	295	200	1
	600	1	60	200	SMFL-66200KS	343	153	660	735	255	200	1
200	750	1	60	25+40+135	SMFL-76200KS	343	153	580	655	255	65	3
	1000	1	60	30+60+110	T AFL-106200KS	343	153	840	915	295	65	3
	1000	1	60	100+100	T AFL-106200KS	530	135	610	685	295	100	2
	1200	1	60	25+25+150	T AFL-126200KS	530	170	480	555	205	65	3
	1200	1	60	50+50+100	T AFL-126200KS	530	170	480	555	205	65	3

\* Approximate Dimensions and ratings are given above. Please contact factory to check it before order.





## 4-8 Water Cooling Capacitor

### > Application

This product is specially designed to accommodate high capacity to be easily used for matching circuit of high frequency induction furnace device.

For dielectric, polypropylene film and capacitor paper were used together and aluminium foil electrode of non induction method was used. For insulating oil, non PCB dielectric was impregnation resulting in stable and excellent feature.

For cooling method, it was designed that cooling water can absorb the heat generated from the inner dielectric loss.

To make matching circuit easily when inductive load is changed, capacity was divided into proper capacity and lead bushing was treated.

The material of case is non magnetic aluminum to minimize induction loss due to high frequency electric filed. The loss of capacitor itself is about 0.1%. Maximum Water temperature rise should not exceed 4deg [5l/min] on the standard of maxim capacitance.

Permissible load power is 1.05 times of rated voltage [within 1 hour per day] and maximum permissible current is 1.35 times of rated current.

High frequency water cooling capacitor does not contain discharging resistor since it is connected to high capacity coil circuit in paralleled.

When capacitor is input into circuit again, the permissible limit of residual voltage should be within 10% of rated voltage and nuts with DC voltage.

Tightening strength on nuts at terminal is 200kg · cm or less.



### > Technical data

Installation place	Only for Indoor
Temperature of Cooling Water	Cooling water exit temperature less than 45°C
Ambient Temperature	More than 0°C
Tolerance	Within ± 10% of rated capacity
Withstand Voltage	2.15 times of rated voltage, 10 seconds
Flux of Cooling Water	More than 5l per minute
Pressure of Cooling Water	Less than 10kg/cm <sup>2</sup>
Safety Device	Thermostat contact capacity [250VAC, 7.5A]
Case	Aluminium non painted product

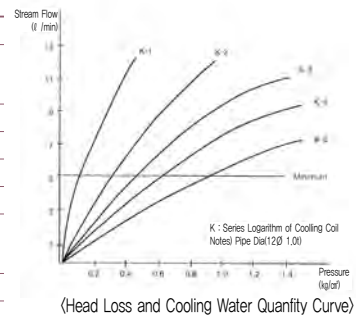

### > Caution

Since the outer case of capacitor is unilateral electrode, please be sure to use the insulated rack in installation.

When more than 2 capacitors are connected in paralleled, there should be space at least 35mm.

The flow quantity of cooling water shall be more than 5l /min.

In case when capacitor is kept at subzero temperature, remove the water entirely from copper pipe





## 4-8 Water Cooling Capacitor

### > Diagram

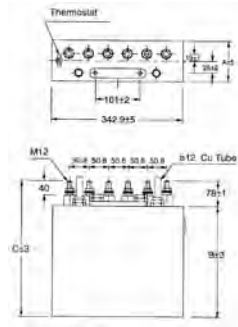

Figure 1

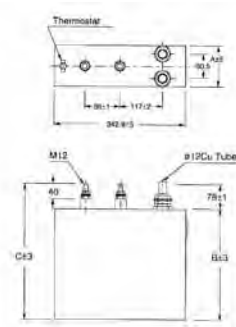

Figure 2

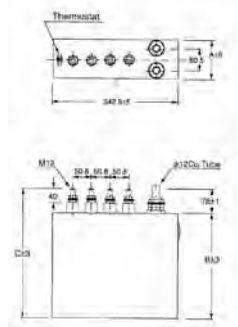

Figure 3

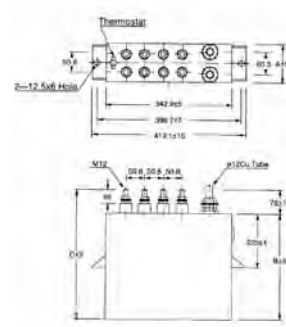

Figure 4

### > Ratings and Dimensions

Frequency [Hz]	Rated Voltage [V]	Rated Capacity [kvar]	Total [ $\mu$ F]	$\mu$ F Per Section								Dimension [mm]			Figure
				1	2	3	4	5	6	7	8	A	B	C	
960	800	450	117	5	8	16	44	44	-	-	-	136.7	330.2	398.2	1
960	1000	480	80	13	13	27	27	-	-	-	-	104.6	330.2	398.2	3
1000	1250	750	76	3	3	3	3	13	13	19	19	104.6	360.2	428.0	4
1200	1250	1200	102	-	-	17	17	17	17	17	17	104.6	330.2	398.2	4
2000	1250	300	15	7.6	7.6	-	-	-	-	-	-	136.7	200.0	368.0	2
3000	400	300	100	7	13	27	53	-	-	-	-	104.6	200.0	268.0	3
3000	800	1000	84	21	21	21	21	-	-	-	-	104.6	330.2	398.2	3
3000	1250	1200	40	3	3	3	3	7	7	7	7	104.6	330.2	398.2	4
3000	1250	1200	40	2	2	2	2	6	10	10	10	104.6	330.2	398.2	4

\* Approximate Dimensions and ratings are given above. Please contact factory to check it before order.



## 4-9 Surge Absorbing Capacitor

### > Application

This product was developed by our company in 1976 to absorb and reduce surge which may be generated when the breaker is open or close and lighting surge by connecting transmission line and, closed and lightning surge which may be delivered by connecting transmission line and ground.

Its dielectric is polypropylene film which has excellent withstand voltage and good quality capacitor paper and it also contains specially produced composite oil.

The Capacitor with series resistance was developed to improve electric feature.

### > Product Scope

- Installation Place : Indoor / Outdoor
- Ambient Temperature :  $-20^{\circ}\text{C} \sim +40^{\circ}\text{C}$  [below average  $35^{\circ}\text{C}$  per day, below  $25^{\circ}\text{C}$  average per year]

### > Technical Data

Tolerance	$-5\% \sim +15\%$ [at $20^{\circ}\text{C}$ ], less than 108% of unbalanced ratio between phases		
Max overvoltage	Below 110% of rated voltage : within 8 hours per day		
	Below 115% of rated voltage : within 30 minutes per day		
	Below 120% of rated voltage [less than 2 times of 5 min. per month]		
Max overcurrent	Below 130% of rated voltage [less than 2 times of 1 min. per month]		
	Transient current 130% of rated current allowed		
Withstand Voltage	Between case and all of terminals		
		Line voltage	Test voltage
		3300V	16kVAC [1 min.]      45kVDC [10 sec.]
		6600V	22kVAC [1 min.]      60kVDC [10 sec.]
		11000V	28kVAC [1 min.]      90kVDC [10 sec.]
	22000V	50kVAC [1 min.]      150kVDC [10 sec.]	
Capacitor Loss [Under stabilized condition]	Less than 0.5% [at rated voltage, $20^{\circ}\text{C}$ ], in case C-R type less than 0.6%		
Reference Standard	JEM1362 [1999]		

### > Diagram

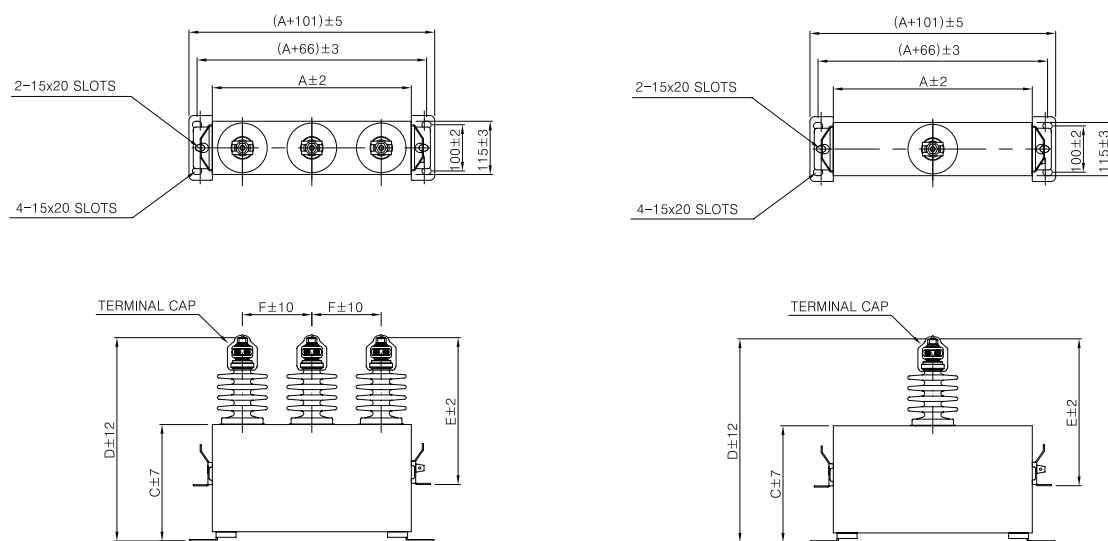

Figure 1

Figure 2



## 4-9 Surge Absorbing Capacitor

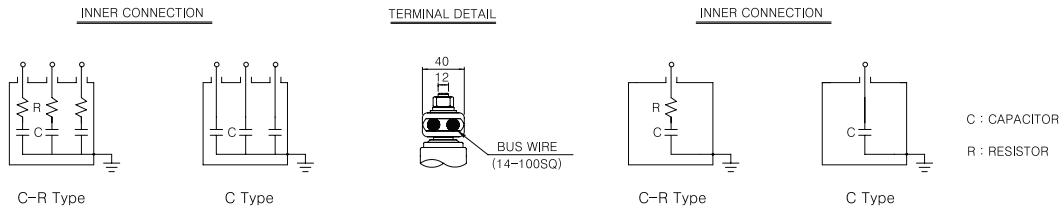

Figure 1

Figure 2

### > Ratings and Dimensions

Rated Voltage [V]	Rated Capacity [ $\mu\text{F}$ ]	Type	Dimension [mm]						Figure
			A	B	C	D	E	F	
$3300/\sqrt{3}$	$0.05 \mu\text{F} \times 3$	THF-T30015T [CR]	430	115	250	435	315	150	1
$3300/\sqrt{3}$	$0.1 \mu\text{F} \times 3$	THF-T3003T [CR]	430	115	220	435	315	150	
$3300/\sqrt{3}$	$0.5 \mu\text{F} \times 3$	THF-T305T	430	115	270	455	315	150	
$3300/\sqrt{3}$	$0.8 \mu\text{F} \times 3$	THF-T3024T	430	115	270	455	315	150	
$6600/\sqrt{3}$	$0.05 \mu\text{F} \times 3$	THF-T60015T [CR]	430	115	250	435	315	150	
$6600/\sqrt{3}$	$0.1 \mu\text{F} \times 3$	THF-T6003T [CR]	430	115	250	435	315	150	2
$22900/\sqrt{3}$	$0.1 \mu\text{F}$	THF-T23001S	430	145	250	520	400	-	
$13800/\sqrt{3}$	$0.3 \mu\text{F}$	THF-T13003S	430	145	280	510	360	-	
$24000/\sqrt{3}$	$0.2 \mu\text{F}$	THF-T24002S	430	145	350	620	400	-	
$24000/\sqrt{3}$	$0.4 \mu\text{F}$	THF-T24004S	530	135	450	720	400	-	

\* Approximate Ratings and Dimensions are given above. Please contact factory before order.

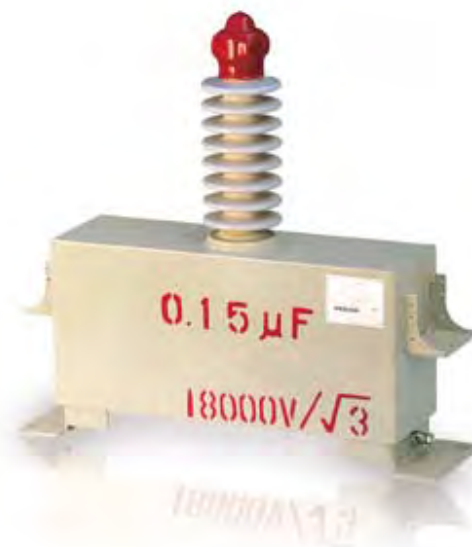



## 4-9 Surge Absorbing Capacitor

### > Operation principle

To explain the effect of surge absorbing capacitor, the rotator is expressed as intensive equivalent resistance R as in the figure A.

In parallel with this, on the circuit to which the protecting Capacitor is connected,

$V_0 = E_0H[t]$  travelling wave invaded from line of surge impedance Z.

Then terminal voltage of R and C is  $V_c$ , the current  $I_p$  at P point  $I_s$

$$I_p = C \frac{dV_c}{dt} + \frac{1}{R} V_c = \frac{1}{Z} [2V_0 - V_0]$$

To rearrange the expression  $\frac{d}{dt} = P$ ,  $V_0 = E_0H[t]$

$$P V_c = \left( \frac{R+Z}{CRZ} \right) V_c = \frac{2E_0}{CZ} H[t]$$

$$\left( \frac{R+Z}{CRZ} \right) = \alpha$$

$$V_c = \frac{2E_0}{CZ} \times \frac{1}{P+\alpha} H[t] = \frac{2E_0}{\alpha CZ} [1-e^{-\alpha t}] H[t]$$

When Z and R is constant and C is changed, the terminal voltage of the rotator  $V_c$  is as in the figure B.

From this, it can be seen that the wave height value is reduced

according to the value of C or R. When  $R = \infty$  and  $C = 0.3\mu F$ , the terminal voltage of the rotator is reduced to 1/2 of invasion wave, which shows the effects of surge absorbing capacitor.

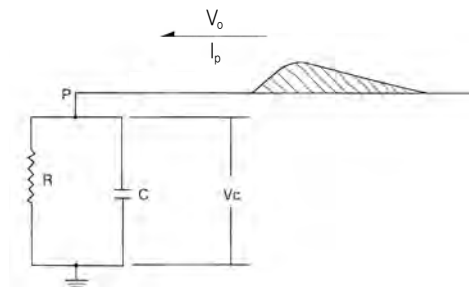

Figure A

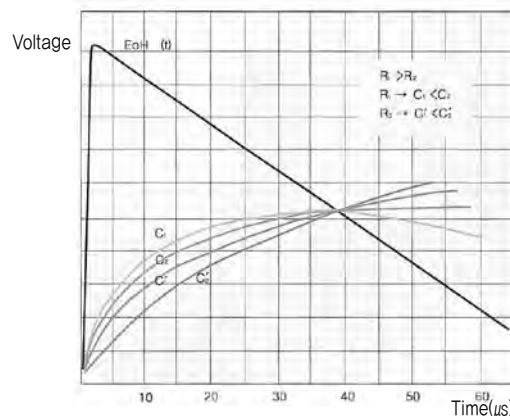

Figure B



## 4-10 Grounding Capacitor

### > Application

This product was developed by our company in 1975 to improve capacity between distribution lines and earth by connecting the 2nd winding distribution lines of insulation transformer and earth. It uses polypropylene film which has excellent insulation ability and good quality capacitor paper as dielectric and contains specially produced composite oil to improve electric feature.

### > Product Scope

- Installation Place : Indoor / Outdoor
- Ambient Temperature :  $-20^{\circ}\text{C} \sim +40^{\circ}\text{C}$  [below  $35^{\circ}\text{C}$  average per day, below  $25^{\circ}\text{C}$  average per year]

### > Technical Data

Tolerance	$-5\% \sim +15\%$ [at $20^{\circ}\text{C}$ ], less than 108% of unbalanced ratio between phases		
Max overvoltage	Below 110% of rated voltage : within 12 hours per day		
	Below 115% of rated voltage : within 30 minutes per day		
	Below 120% of rated voltage : within 5 minutes		
	Below 130% of rated voltage : within 1 minute		
Max overcurrent	Below 182% of rated voltage : within 2 seconds		
	Transient current 130% of rated current allowed		
Withstand Voltage	Between case and all of terminals		
	Line voltage	Test voltage	
	3300V	10kVAC [1 min.]	30kVDC [10 sec.]
	6600V	16kVAC [1 min.]	45kVDC [10 sec.]
Capacitor Loss	Less than 0.35% [at rated voltage, $20^{\circ}\text{C}$ ]		
Painting Color	Munsell no. 5Y 7/1		
Reference Standard	JEM1362 [1999]		

### > Diagram

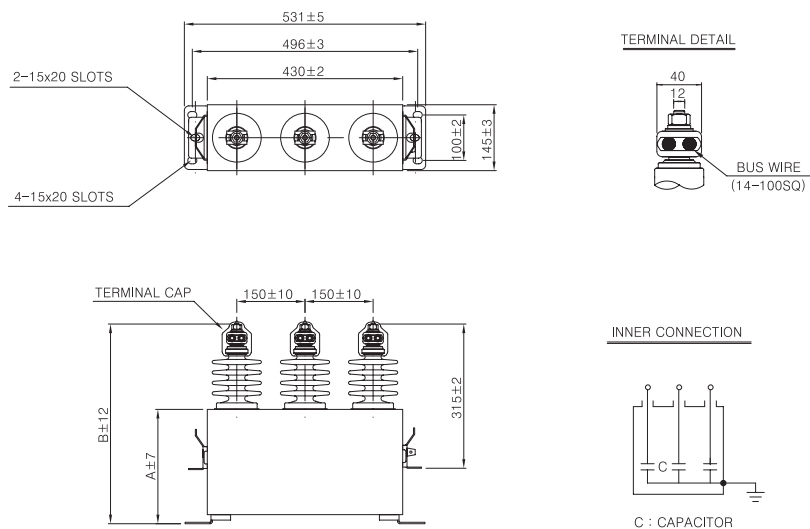



## 4-10 Grounding Capacitor

### > Ratings and Dimensions

Line Voltage [V]	Rated Capacity [kvar]	Type	Dimension [mm]	
			A	B
3300	10	TBF-T36010Y	490	675
6600	10	TBF-T66010Y	290	475

\* Approximate Dimensions are give above. Please contact factory for exact deimensions of a particular capacitor

### > Operation Principle

In 3 phase circuit, for 1 line grounding current is calculated from the following formula.

$$I_g = 3j\omega CEa = j\sqrt{3}E \times 2\pi f C$$

$I_g$  : Grounding Current [A]

E : Line Voltage [V]

Ea : Phase Voltage [V]

C : Equivalent Ground Capacitance [ $C = C_1 + C_2$ ]

$I_{c1}$  [Ground fault current  $I_g$  in figure A – charged current after zero phase current transformer [ZCT]] passes the zero phase current transformer. Therefore, ground fault current  $I_{g1}$  passing ZCT can be calculated from the following formula.

$$I_{g1} = \sqrt{3}E \times 2\pi f \times C_1$$

When the distance between transformer and ZCT is small, ground capacity in line is small and penetration ground fault current  $I_{g1}$  is not enough to move circuit breaker. Therefore, use capacitor for earthing to improve ground capacity in line.

For example, when  $E = 3300V$ ,  $C_1 = 0.5\mu F$ , and  $f = 50Hz$  in figure B, ZCT penetration ground fault current is as following :

$$I_{g1} = \sqrt{3} \times 3300 \times 2\pi \times 60 \times 0.5 \times 10^{-6} = 1.08A$$

Since detecting current of grounding breaker is selected to be  $0.1 \sim 0.8A$ , it is good to select the value of  $C_1$  to be more than this value

[ $C_1$  is equivalent to 1 phase and in case of  $C_1 = 0.5\mu F$ , capacitor for grounding of  $0.5\mu F \times 3$  is to be selected]

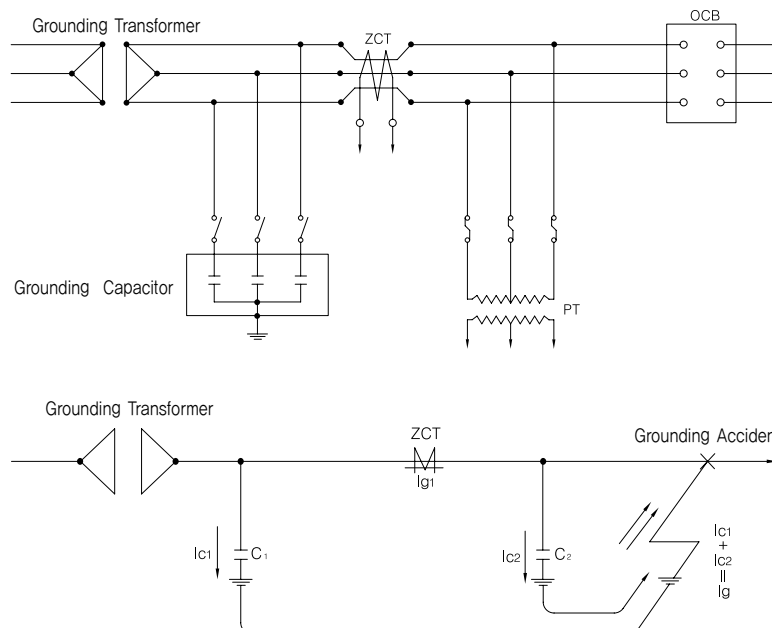



## 4-11 Pulse Power Capacitor

### ➤ Application

It is normally used in the area of power supply device for tests, for example IVG, ICG, Mark Generator, Power Supply for L-C resonance circuit and small scale power supply for fusion study and Power supply pulse power[state of art medical instruments, rock destruction and pulse laser] and recently, households which use this capacitor have been rapidly increased.

Since high energy density capacitor for pulse power is the key part of aircrafts [fighter, artificial satellite and passenger airplane], electronic / electric heat chemical gun, high efficiency laser and high efficiency munitions such as radar, the supply of this product was difficult since the industrialized countries regulated the outflow of technology. But, recently our company mass produced the capacitor resulting in smooth supply of the product. In 1997, 11kVDC 150 $\mu$ F 9kJ rated capacitor for energy storage was developed with our own technology and delivered them for power supply of simple composite test facility and its performance has been recognized.

Several capacitors were also installed at heavy electro mechanics manufacturers in Korea and are used for test facilities.

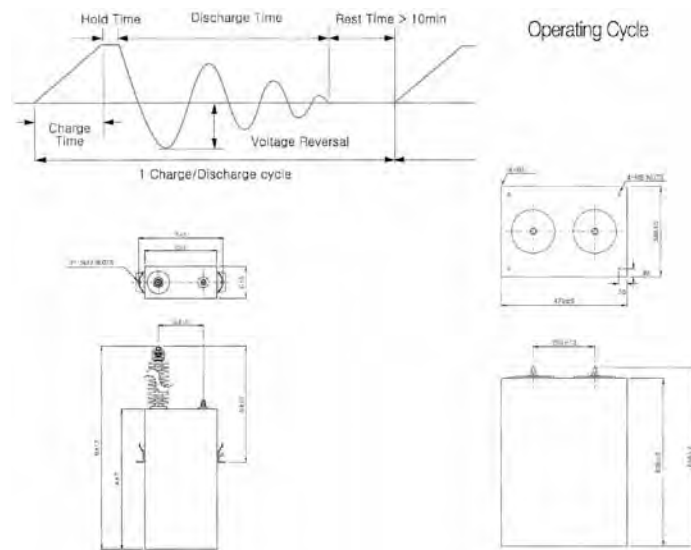

Figure 1

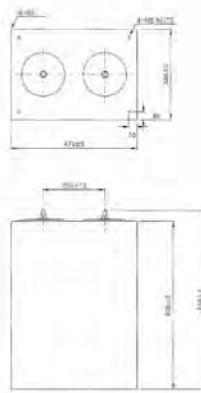

Figure 2

### ➤ PulsePower Low Capacitor

This product uses polypropylene film which has excellent withstand voltage and good quality capacitor paper as dielectric and contains refined impregnation oil, resulting in high reliability. To minimize inner inductance, it employs non inductive solder for reducing self inductance.

- Installation Place : Indoor
- Ambient Temperature : -10°C ~ +40°C [Average 35°C or less per day]
- Technical Data

Tolerance	-10% ~ +10% [at 20°C]
Insulation Resistance	More than 1000M $\Omega$ between batch terminal and case [below 20°C]
Withstand Voltage	Rated voltage $\times$ 1.2 times, for 60 seconds between terminal and case
Painting Color	Munsell no. 5Y 7/1
Self Inductance	Max. 150nH
Duty Cycle	Pause for more than 10 min. per charging / discharging
Voltage Reversal	20% ~ 90%



## 4-11 Pulse Power Capacitor

### ► Ratings and Dimensions

Rated Voltage [kVDC]	Capacity [ $\mu$ F]	Joule [kJ]	Type	Dimension [mm]								Weight [kg]	Figure	Remarks
				A	B	C	D	E	F	F				
11	150	9.08	TFT-T11150S	810	995	160	315	370	424	228	70.7	1	Steel Case	
40	0.01	0.01	TFT-T40001S	190	375	115	315	430	496	300	20.8			
	11	8.80	TFT-T40011S	560	745	170	530	530	583	300	71.8			
100	0.5	2.50	TFT-T100001S	390	660	135	530	530	583	380	42.6			
	1.0	5.00	TFT-T100001S	690	690	135	530	530	583	380	73.4			
25	0.3	0.09	TAE-25001S	-	-	-	-	-	-	-	6.7	2	Plastic Case	
100	0.1	0.50	THE-100001S	-	-	-	-	-	-	-	7.5			

\* Approximate Ratings and Dimensions are given above. Please contact factory before order.

### ► High Energy Density Pulse Power Capacitor

With metalized polypropylene film made through metalized technology and good quality capacitor paper as dielectric, this product realized high energy density, high reliability and long life span.

- Installation Place : Indoor
- Ambient Temperature for Use :  $-10^{\circ}\text{C} \sim +40^{\circ}\text{C}$  [below  $35^{\circ}\text{C}$  average per day]
- Technical Data

Tolerance	$-10\% \sim +10\%$ [at $20^{\circ}\text{C}$ ]
Insulation Resistance	More than $1000\text{M}\Omega$ between batch terminal and case [below $20^{\circ}\text{C}$ ]
Withstand Voltage	Rated voltage $\times 1.2$ times, for 60 seconds between terminal and case
Painting Color	Munsell no. 5Y 7/1
Self Inductance	Max. $150\text{nH}$
Duty Cycle	Pause for more than 10 min. per charging / discharging
Voltage Reversal	$20\% \sim 90\%$



### ► Ratings and Dimension

Rated Voltage [kVDC]	Capacity [ $\mu$ F]	Energy Density [kJ/kg]	Type	Dimension [mm]			Weight [kg]	Figure
				A	B	C		
20	200	0.33	SDF-T20200S	620	660	340	120	2

### ► Basic Information for Order

- Capacity and tolerance on capacitance
- Rated voltage and voltage reversal [%]
- Required life span and 1 time charging / discharging cycle
- Charging time and hold time
- Maximum current [kA] in discharging and discharge time





## 5. Reactor

### ➤ Application

Reactor is used in conjunction with capacitor banks in series.  
Its main function is to compensative or produce reactive power.  
According to the purpose of use, reactor helps to limit inrush or short-circuit current, filter out harmonics.

### • Product scope

Installation Place : Indoor / Outdoor

Ambient Temperature for Use : -20°C ~ +40°C [below 35°C average per day]

Technical Data

Max overcurrent	Less than rated current 120% of effective value of resultant
Temperature Rise	Oil type : winding 55°C [resistance method], impregnant 50°C [thermometer method]
Insulation resistance	More than 500M $\Omega$ [1000VDC : Oil type]
Reference standard	IEC 289

### ➤ Check points for the connection of Capacitor&Reactor

Check the followed points before operating series reactors with capacitor

1. Check status of bolts and nuts on connecting terminals
2. Check status of insulated oil surface and the oil regularly per 6 months
3. After stoping the operation, check point no1 & 2 should be checked before re-operation
4. Noise is supposed to be generated but if noise is so harsh [including that harmonic is 35%], contact to us
5. When shut off from power supply, residual voltage at terminal should be checked on reactor with D.C
6. Arrange capacitors and reactors, be careful not to lean leading power factor for preventing overheats
7. For dry type reactors, check noise and status of outside insulation.

### ➤ Adjustment capacitance with reactor

1. Decreasing capacitance of capacitor

If it needs to reduce capacitance of capacitor, it makes increasing reactance of capacitor and decreasing the reactance ratio on capacitor versus reactor. So there is high possibility to cause Harmonic enlargement.

2. Increasing capacitance of capacitor

If it needs to increase capacitance of capacitor, it makes increasing the reactance ratio on capacitor versus reactor.

So, it needs to change series reactor.

### ➤ Rated voltage according to line voltage

\* 3Phase reactor 6%

Line Voltage [V]	220	380	440	3300	6600	11400	22000	22900
Rated Voltage [V]	7.6	13.2	15.2	114	229	395	762	793



## 5-1 Series Reactor

### > Series Reactor Oil Type for Extra High Voltage

#### • Diagram

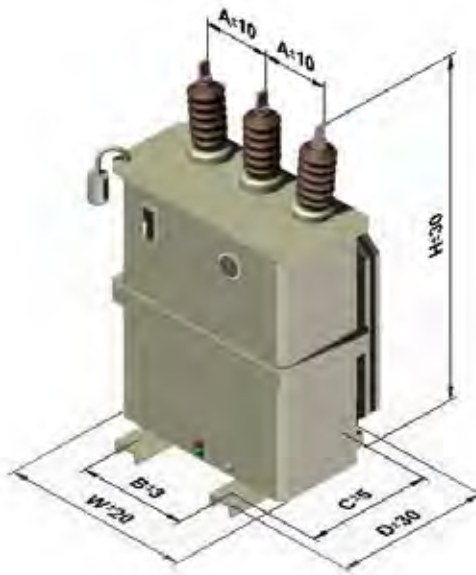

Figure 1

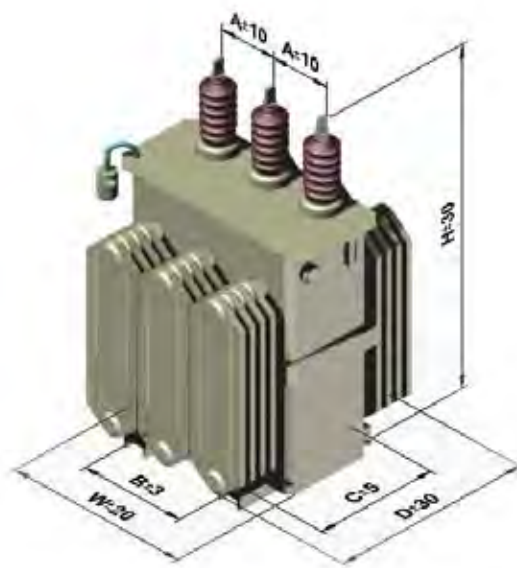

Figure 2

#### • Ratings and Dimensions

\* Bracket Hole : 4-15 × 20slots

Line Voltage[V]	Reactor Capacity [kvar]	Capacitor Capacity [kvar]	Rated Current [A]	Type	Dimension [mm]						Oil [ℓ]	Weight [kg]	Figure
					H	W	D	A	B	C			
22900	9	150	3.8	HSR20KA-9	1300	700	530	300	360	450	120	245	1
	18	300	7.8	HSR20KA-18	1400	770	620	300	360	450	135	385	
	36	600	15.1	HSR20KA-36	1400	820	780	300	400	450	200	435	
	60	1000	25.2	HSR20KA-60	1500	900	800	300	500	525	320	650	
	72	1200	30.3	HSR20KA-72	1500	960	850	300	500	525	360	730	
	90	1500	37.8	HSR20KA-92	1600	1100	850	300	560	525	400	950	
	120	2000	50.4	HSR20KA-120	1720	1100	850	300	560	550	400	1000	2
	150	2500	63.0	HSR20KA-150	1720	1150	960	320	560	550	470	1080	
	180	3000	75.6	HSR20KA-180	1720	1150	960	320	560	550	550	1220	
	240	4000	100.8	HSR20KA-240	1720	1250	1120	320	700	650	580	1450	
	300	5000	126.0	HSR20KA-300	1800	1350	1220	350	800	650	700	2100	
	360	6000	151.2	HSR20KA-360	1800	1350	1220	350	800	650	780	2200	
	450	7500	189.0	HSR20KA-450	1900	1500	1550	400	800	750	850	2500	
	540	9000	226.9	HSR20KA-540	2000	1600	1600	400	1000	750	900	2600	
	720	12000	302.5	HSR20KA-720	2100	1600	1700	400	1000	750	1200	3500	
	900	15000	378.1	HSR20KA-900	2100	1600	1800	400	1000	750	1850	4300	
1200	20000	504.2	HSR20KA-1200	2200	1650	2000	400	1000	800	2200	5100		

\* Approximate Ratings and Dimensions are given above. Please contact factory before order.



## 5-1 Series Reactor

### ► Series Reactor Oil Type for High Voltage

#### • Diagram



Figure 1

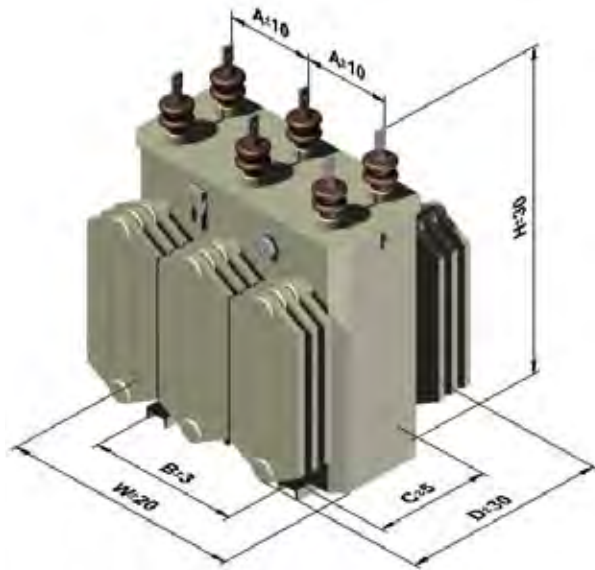

Figure 2

#### • Ratings and Dimensions

\* Bracket Hole : 4-15 × 20slots

\* 3300V Type No, HSR30A-Reactance

Line Voltage [V]	Reactor Capacity [kvar]	Capacitor Capacity [kvar]	Type [6600V]	Rated Voltage [V]		Rated Current [A]		Dimension [mm]						Oil [L]	Weight [kg]	Figure
				6600V	3300V	6600V	3300V	H	W	D	A	B	C			
6600 & 3300	3	50	HSR-60A-3	229	114	4.37	8.75	920	530	380	150	300	325	70	125	1
	4.5	75	HSR-60A-4.5			6.58	13.10	920	530	380	150	300	325	80	130	
	6	100	HSR-60A-6			8.75	17.50	920	580	380	180	300	325	80	150	
	9	150	HSR-60A-9			13.10	26.20	920	580	380	180	300	325	90	160	
	12	200	HSR-60A-12			17.50	34.90	1030	580	530	180	360	375	100	200	
	15	250	HSR-60A-15			21.90	43.70	1030	630	560	180	360	375	120	220	
	18	300	HSR-60A-18			26.20	52.50	1030	630	560	180	360	375	120	240	
	21	350	HSR-60A-21			30.60	61.20	1030	630	560	180	360	375	140	260	
	24	400	HSR-60A-24			35.00	70.00	1150	680	640	180	360	375	165	300	
	30	500	HSR-60A-30			43.70	87.50	1200	680	640	200	400	400	180	370	
	36	600	HSR-60A-36	52.40	104.80	1200	730	680	220	400	400	190	390			
	42	700	HSR-60A-42	61.20	122.40	1200	730	730	220	400	400	210	420			
	45	750	HSR-60A-45	65.30	131.20	1200	730	730	220	400	400	210	430			
	48	800	HSR-60A-48	70.00	140.00	1280	730	770	220	400	450	210	440			
	54	900	HSR-60A-54	78.70	157.40	1280	730	770	220	400	450	260	450			
	60	1000	HSR-60A-60	87.50	175.00	1280	760	770	220	400	450	260	550			
	72	1200	HSR-60A-72	105.00	210.00	1280	760	770	220	400	450	340	600			
	90	1500	HSR-60A-90	131.00	262.00	1350	1050	800	250	560	525	500	650			
	120	2000	HSR-60A-120	175.00	349.00	1500	1050	880	300	560	525	550	1100			
	150	2500	HSR-60A-150	219.00	437.00	1550	1150	950	300	660	525	560	1200			
180	3000	HSR-60A-180	262.00	535.00	1550	1150	1000	300	660	525	600	1400				
240	4000	HSR-60A-240	350.00	700.00	1700	1200	1100	300	660	600	700	1600				

\* Approximate Ratings and Dimensions are given above. Please contact factory before order.



## 5-1 Series Reactor

### > Series Reactor Dry Type for Extra High Voltage

• Diagram

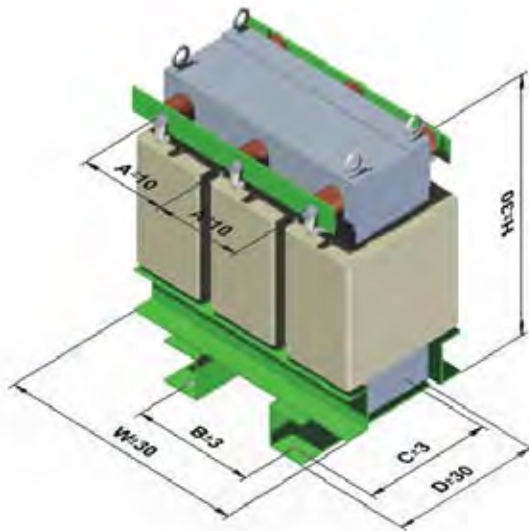

Figure 1

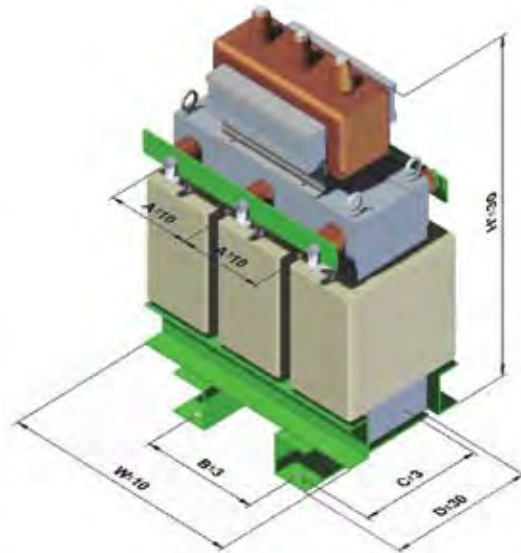

Figure 2

• Ratings and Dimensions

\* Bracket Hole : 4-15 × 20slots

\* 3300V Type No. HSR-30B-Reactance

Line Voltage [V]	Reactor Capacity [kvar]	Capacitor Capacity [kvar]	Type [6600V]	Rated Voltage [V]		Rated Current [A]		Dimension [mm]						Weight [kg]	W/DC H'	Figure
				6600V	3300V	6600V	3300V	H	W	D	A	B	C			
6600 & 3300	1.8	30	HSR-60B-1.8	229	114	2.62	5.25	380	450	320	130	260	225	50	670	1 or 2
	3	50	HSR-60B-3			4.37	8.75	410	450	330	130	260	225	60	670	
	4.5	75	HSR-60B-4.5			6.56	13.10	430	500	330	130	260	225	70	670	
	6	100	HSR-60B-6			8.75	17.50	460	500	340	130	260	225	80	700	
	9	150	HSR-60B-9			13.10	26.20	480	500	350	130	260	225	100	700	
	12	200	HSR-60B-12			17.50	34.90	490	550	350	150	260	225	120	700	
	15	250	HSR-60B-15			21.90	43.70	500	550	360	150	260	225	150	720	
	18	300	HSR-60B-18			26.20	52.50	500	550	370	150	260	225	160	735	
	21	350	HSR-60B-21			60.60	61.20	510	550	370	150	260	225	170	770	
	24	400	HSR-60B-24			35.00	70.00	550	600	380	170	360	250	180	770	
	30	500	HSR-60B-30			43.70	87.50	550	600	380	170	360	250	220	780	
	36	600	HSR-60B-36			52.40	104.80	570	600	380	170	360	250	240	800	
	42	700	HSR-60B-42			61.20	122.40	590	650	400	180	400	300	280	800	
	45	750	HSR-60B-45			65.60	131.20	590	650	400	180	400	300	300	800	
	48	800	HSR-60B-48			70.00	140.00	590	650	430	180	400	300	320	800	
	54	900	HSR-60B-54			78.70	157.50	570	700	430	200	400	300	350	720	
	60	1000	HSR-60B-60			87.50	175.00	570	700	430	200	400	300	400	720	
	72	1200	HSR-60B-72			105.00	210.00	730	800	470	250	460	300	420	880	
90	1500	HSR-60B-90	131.20	262.40	770	850	880	250	460	300	550	920				

\* Approximate Ratings and Dimensions are given above. Please contact factory before order.



## 5-1 Series Reactor

### ► Series Reactor Oil Type for Low Voltage

• Diagram

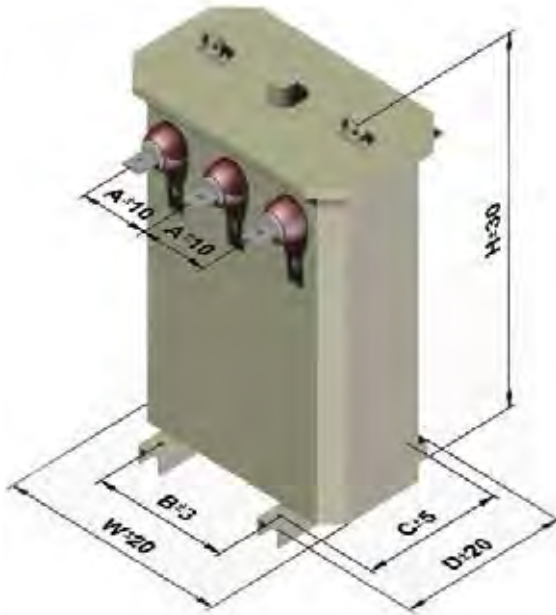

Figure 1

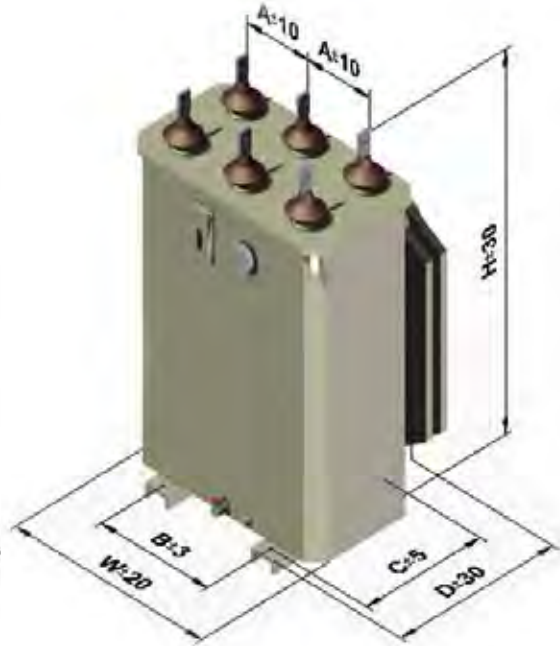

Figure 2

• Ratings and Dimensions

\* Bracket Hole : 4-15 × 20slots  
 \* 220V Type No. HSR-02B-Reactance

Line Voltage [V]	Reactor Capacity [kvar]	Capacitor Capacity [kvar]	Type [440V]	Rated Voltage [V]		Rated Current [A]		Dimension [mm]					Oil [ℓ]	Weight [kg]	Figure	
				440V	220V	440V	220V	H	W	D	A	B				C
220 & 440	1.5	25	HSR-04A-1.5	15.2	7.62	32.60	65.60	750	530	420	120	260	300	35	90	1
	3	50	HSR-04A-3			65.60	131.20	750	530	420	120	260	300	35	100	
	4.5	75	HSR-04A-4.5			98.40	196.80	750	530	420	120	260	300	48	115	
	6	100	HSR-04A-6			131.20	262.40	750	580	450	140	300	325	60	150	
	9	150	HSR-04A-9			196.80	393.60	750	580	450	140	300	325	60	170	
	12	200	HSR-04A-12			262.40	524.80	900	580	480	180	300	375	90	200	
	15	250	HSR-04A-15			328.00	656.00	950	630	530	180	300	375	100	220	2
	18	300	HSR-04A-18			393.60	787.30	950	630	530	180	300	375	110	230	
	24	400	HSR-04A-24			524.80	1049.70	1050	650	550	200	360	375	130	280	
	30	500	HSR-04A-30			656.00	1312.20	1220	680	640	200	400	400	150	350	

\* Approximate Ratings and Dimensions are given above. Please contact factory before order.



## 5-1 Series Reactor

### > Series Reactor Dry Type for Low Voltage

#### • Diagram

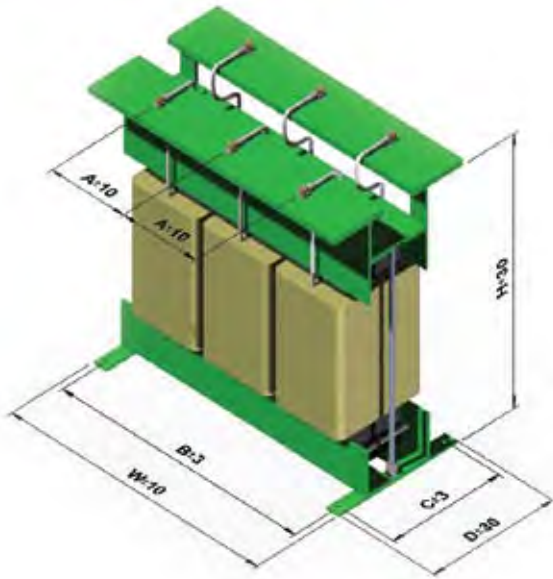

Figure 1

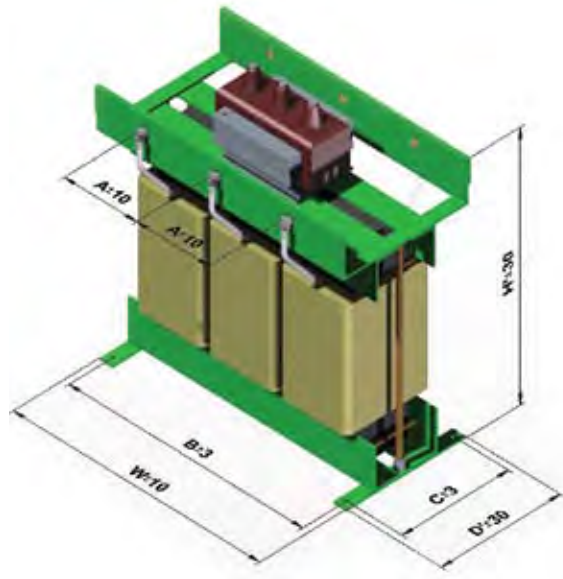

Figure 2

#### • Ratings and Dimensions

\* Bracket Hole : 4-15 × 20slots

\* 220V Type No. HSR-02B-Reactance

Line Voltage [V]	Reactor Capacity [kvar]	Capacitor Capacity [kvar]	Type [440V]	Rated Voltage [V]		Rated Current [A]		Dimension [mm]						Weight [kg]	W/DC		Figure
				440V	220V	440V	220V	H	W	D	A	B	C		H'	D'	
440 & 220	0.6	10	HSR-04B-0.6	15.2	7.62	13.10	26.20	290	300	200	90	260	125	19	390	260	1 or 2
	0.9	15	HSR-04B-0.9			19.70	39.30	290	300	200	90	260	125	20	390	260	
	1.2	20	HSR-04B-1.2			26.20	52.40	300	300	200	90	260	125	22	400	260	
	1.5	25	HSR-04B-1.5			32.80	65.60	300	300	200	90	260	125	25	400	260	
	1.8	30	HSR-04B-1.8			39.30	78.70	300	300	200	90	260	125	26	400	260	
	2.4	40	HSR-04B-2.4			52.40	104.90	300	350	200	100	320	125	32	400	260	
	3	50	HSR-04B-3			65.60	131.20	300	350	200	100	320	125	34	400	260	
	4.5	75	HSR-04B-4.5			98.40	196.80	370	350	220	100	320	150	50	470	260	
	6	100	HSR-04B-6			131.20	262.40	370	380	220	120	340	150	65	470	260	
	9	150	HSR-04B-9			196.80	393.60	385	400	220	120	360	150	80	485	270	
	12	200	HSR-04B-12			262.40	524.80	430	450	220	130	400	175	100	500	280	
	15	250	HSR-04B-15			328.00	656.00	400	450	300	130	400	175	115	530	280	
	18	300	HSR-04B-18			393.60	787.30	500	500	300	150	460	175	125	560	280	
	24	400	HSR-04B-24			524.80	1049.70	550	550	300	180	500	200	160	610	450	
	30	500	HSR-04B-30			656.00	1312.20	550	600	300	180	500	200	200	600	450	

\* Approximate Ratings and Dimensions are given above. Please contact factory before order.



## 5-2 Discharge Coil

### ➤ Application

Discharge coil are normally connected to the capacitor units or capacitor banks, based on the intention of discharging residual electricity in short time when the capacitors or capacitor banks cut out from the circuit.

Therefore it helps more safety operation of capacitor and capacitor bank.

### ➤ Product Scope

- Installation Place : Indoor[Dry type] or Outdoor[Oil type]
- Technical Data

Altitude	Up to 1000m
Ambient Temperature	-20°C ~ +40°C [Not exceed average 35°C]
Discharge Voltage	50V or Lesser in 5seconds
Max overvoltage	110% rated voltage or Less

### ➤ Connection

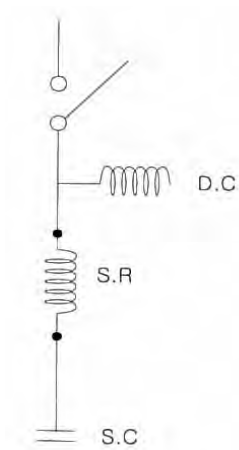

⟨Normal Discharge Coil⟩

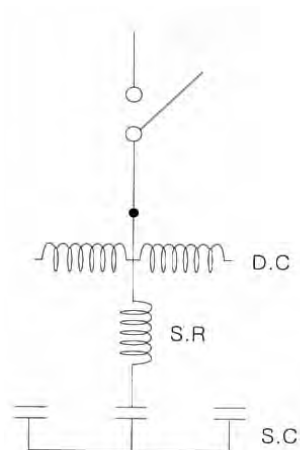

⟨Discharge coil with internal reactor⟩

SC : Shunt Capacitor  
 SR : Shunt Reactor  
 DC : Discharge Coil



## 5-2 Discharge Coil

### > Discharge Coil Oil Type • Diagram

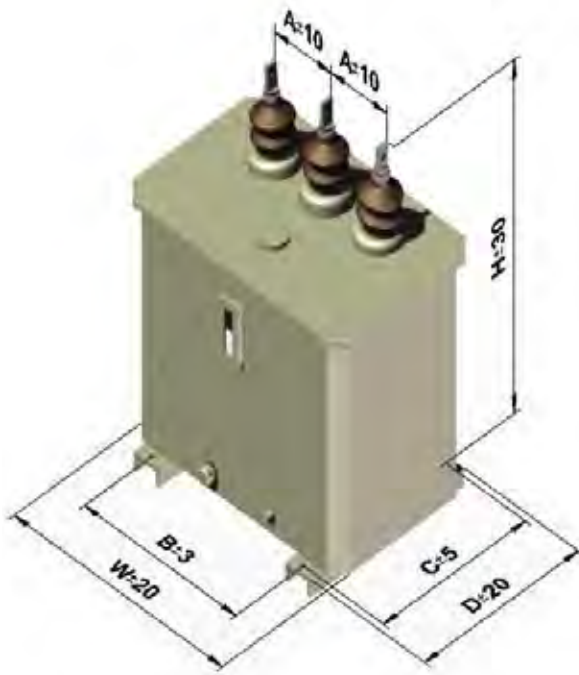

Figure 1

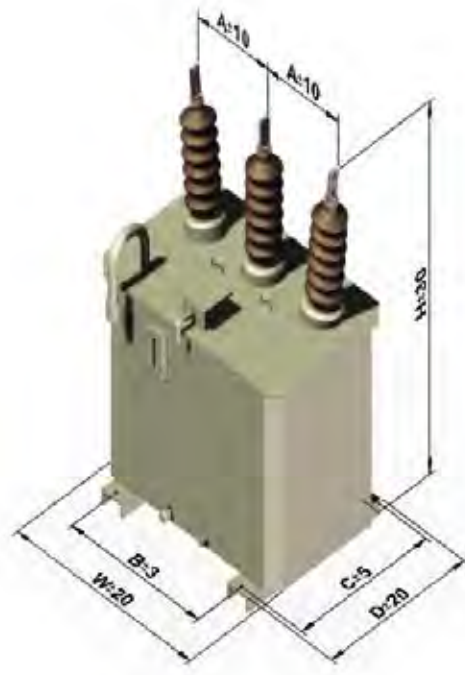

Figure 2

\* Bracket Hole : 4-15 × 20slots

\* 220V Type No. HDC-02A-03

\* 3300V Type No. HDC-30A-04, 05

### • Ratings and Dimensions

Line Voltage [V]	Discharge Capacity [kvar]	Type [440V/22900V]	Dimension [mm]						Oil [ℓ]	Weight [kg]	Figure
			H	W	D	A	B	C			
440/220	10~1000	HDC-04A-01	350	350	235	100	200	225	15	45	1
6600/3300	10~3000	HDC-60A-02	700	520	350	230	300	325	30	80	
22900/13200 1∅	10~3000	HDC-20KA-03	950	580	450	300	360	400	55	120	2
22900/6600 1∅	100~2000	HDC-20KA-04	950	700	450	300	400	400	75	160	

\* Approximate Ratings and Dimensions are given above. Please contact factory before order.





## 5-2 Discharge Coil

### > Discharge Coil Dry Type

#### • Diagram

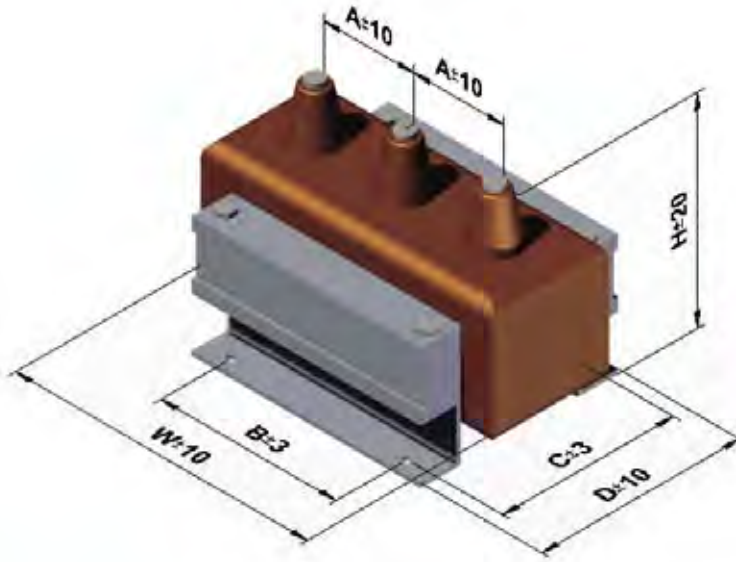

#### • Ratings and Dimensions

\* Bracket Hole : 4-15 × 20slots

\* 220V Type No. HDC-02B-Capacity

\* 3300V Type No. HDC-30A-0.4, 0.5

Line Voltage [V]	Discharge Capacity [kvar]	Type [440V/22900V]	Dimension [mm]						Weight [kg]	Figure
			H	W	D	A	B	C		
440/220	10~1000	HDC-04B-Capacity	130	195	130	55	90	100	7	1
6600/3300	10~1500	HDC-04B-Capacity	260	360	200	130	200	160	30	2

\* Approximate Ratings and Dimensions are given above. Please contact factory before order.



## 6. Appendix

### < Capacity Table >

\* Use this table to calculate necessary capacity according load quantity and present power factor.

		Power Factor After Improvemnet = cos $\phi_2$																				
		1.00	0.99	0.98	0.97	0.96	0.95	0.94	0.93	0.92	0.91	0.90	0.89	0.88	0.87	0.86	0.85	0.84	0.83	0.82	0.81	0.80
Power Factor Before Improvement = cos $\phi_1$	0.50	173	159	153	148	144	140	137	134	131	128	125	122	119	117	114	111	109	106	103	101	98
	0.51	169	154	148	144	140	136	132	129	126	123	120	118	115	112	109	107	104	102	99	96	94
	0.52	164	150	144	139	135	131	128	125	122	119	116	113	110	108	105	102	100	97	95	92	89
	0.53	160	146	140	135	131	127	124	121	117	114	112	109	106	103	101	98	95	93	90	88	85
	0.54	156	142	136	131	127	123	120	116	113	110	108	105	102	99	97	94	91	89	86	84	81
	0.55	152	138	132	127	123	119	116	112	109	106	104	101	98	95	93	90	87	85	82	80	77
	0.56	148	134	128	123	119	115	112	109	105	102	100	97	94	91	89	86	83	81	78	76	73
	0.57	144	130	124	119	115	111	108	105	102	99	96	93	90	88	85	82	80	77	74	72	69
	0.58	141	126	120	115	111	108	104	101	98	95	92	89	87	84	81	79	76	73	71	68	66
	0.59	137	123	117	112	108	104	101	97	94	91	89	86	83	80	78	75	72	70	67	65	62
	0.60	133	119	113	108	104	100	97	94	91	88	85	82	79	77	74	71	69	66	64	61	58
	0.61	130	116	110	105	101	97	94	90	87	84	82	79	76	73	71	68	65	63	60	58	55
	0.62	127	112	106	102	97	94	90	87	84	81	78	75	73	70	67	65	62	59	57	54	52
	0.63	123	109	103	98	94	90	87	84	81	78	75	72	69	67	64	61	59	56	54	51	48
	0.64	120	106	100	95	91	87	84	81	78	75	72	69	66	63	61	58	56	53	50	48	45
	0.65	117	103	97	92	88	84	81	77	74	71	69	66	63	60	58	55	52	50	47	45	42
	0.66	114	100	94	89	85	81	78	74	71	68	65	63	60	57	55	52	49	47	44	41	39
	0.67	111	97	91	86	82	78	75	71	68	65	62	60	57	54	52	49	46	44	41	38	36
	0.68	108	94	88	83	79	75	72	68	65	62	59	57	54	51	49	46	43	41	38	35	33
	0.69	105	91	85	80	76	72	69	65	62	59	57	54	51	48	46	43	40	38	35	33	30
	0.70	102	88	82	77	73	69	66	63	59	56	54	51	48	45	43	40	38	35	32	30	27
	0.71	99	85	79	74	70	66	63	60	57	54	51	48	45	43	40	37	35	32	29	27	24
	0.72	96	82	76	71	67	64	60	57	54	51	48	45	42	40	37	34	32	29	27	24	21
	0.73	94	79	73	69	64	61	57	54	51	48	45	43	40	37	34	32	29	26	24	21	19
	0.74	91	77	71	66	62	58	55	51	48	45	43	40	37	34	32	29	26	24	21	19	16
	0.75	88	74	68	63	59	55	52	49	46	43	40	37	34	32	29	26	24	21	18	16	13
	0.76	86	71	65	60	56	53	49	46	43	40	37	34	32	29	26	24	21	18	16	13	11
	0.77	83	69	63	58	54	50	47	43	40	37	35	32	29	26	24	21	18	16	13	11	8
	0.78	80	66	60	55	51	47	44	41	38	35	32	29	26	24	21	18	16	13	10	8	5
	0.79	78	63	57	53	48	45	41	38	35	32	29	26	24	21	18	16	13	10	8	5	2.6
	0.80	75	61	55	50	46	42	39	36	32	29	27	24	21	18	16	13	10	8	5	2.6	
	0.81	72	58	52	47	43	40	36	33	30	27	24	21	18	16	13	10	8	5	2.6		
	0.82	70	56	50	45	41	37	34	30	27	24	21	19	16	13	11	8	5	2.6			
	0.83	67	53	47	42	38	34	31	28	25	22	19	16	13	11	8	5	2.6				
	0.84	65	50	44	40	35	32	28	25	22	19	16	13	11	8	5	2.6					
	0.85	62	48	42	37	33	29	26	23	19	16	14	11	8	5	2.7						
	0.86	59	45	39	34	30	26	23	20	17	14	11	8	5	2.6							
	0.87	57	42	36	32	28	24	20	17	14	11	8	6	2.7								
	0.88	54	40	34	29	25	21	18	15	11	8	6	2.8									
	0.89	51	37	31	26	22	18	15	12	9	6	2.8										
0.90	48	34	28	23	19	16	12	9	6	2.8												
0.91	46	31	25	21	16	13	9	6	3													
0.92	43	28	22	18	13	10	6	3.1														
0.93	40	25	19	14	10	7	3.2															
0.94	36	22	16	11	7	3.4																
0.95	33	19	13	8	3.7																	
0.96	29	15	9	4.1																		
0.97	25	11	4.8																			
0.98	20	6																				
0.99	14																					



## 6-1 Capacitor Calculation

### < Guid for Capacitor Selection >

1. Before choosing capacitors

Consider the quality and after service of capacitors

Access power capacitors as the aspect of power compensation to use energy more efficiently

2. Knowing Capacity you may need

To know the necessary capacity, follow the under steps

Step 1. What is the value of full load power being operated in kW?

Step 2. What is the value of power factor [ $\cos\theta_1$ ] at present?

In case of New factory, power factor of each load might be changed, so it needs to be investigated.

Step 3. Set the value of target power factor [ $\cos\theta_2$ ]

Step 4. Using aboved values, calculate the necessary capacity using formula or capacity table offered.

For example >> The value of load power is 1000[kW] with power factor 0.75. But your target power factor is 0.95.

① The formula to get the value of capacity

$$Q_c = P \times \left( \frac{\sqrt{1 - \cos^2 \theta_1}}{\cos \theta_1} \right) - \left( \frac{\sqrt{1 - \cos^2 \theta_2}}{\cos \theta_2} \right)$$

$$= P \times (\tan \theta_1 - \tan \theta_2)$$

$$= P \times \{ \tan \cdot \cos^{-1}(\cos \theta_1) - \tan \cdot \cos^{-1}(\cos \theta_2) \}$$

$$= 1000 \times (\tan \cdot \cos^{-1} 0.75 - \tan \cdot \cos^{-1} 0.95)$$

$$= 553[\text{kvar}]$$

$Q_c$  : Capacity [kvar]

$P$  : Load [kW]

$\cos\theta_1$  : Power factor at present

$\cos\theta_2$  : Target power factor setting

② Using Capacity Table offered

Find the value of crossing point on the table between power factor at present and the target power factor.

In this case, the value of crossing point between power factor 0.75 and target power factor 0.95 is 55%

And multiply load value and the corrossing point value together.

$$Q_c = 1000 \times 0.55 = 550[\text{kvar}]$$

Notes >

1. With the value of Capacity more than 300kvar on high voltage and more than 50kvar on low voltage, capacitors can not prevent harmonics and inrush current themselves.

Therefore, series reactor needs to be installed together with capacitor.

Also it is recommended installing discharging coil to make sure perfect discharging performance.

2. The units to express capacity are 'kvar' or ' $\mu\text{F}$ '. Following formula is for conversion of those two units ;

$$Q_c = 2 \times \pi \times f \times C \times V^2 \times 10^{-9}[\text{kvar}]$$

$$C = \frac{Q_c \times 10^9}{2 \times \pi \times f \times V^2} [\mu\text{F}]$$

$C$  : Capacity [ $\mu\text{F}$ ]

$Q_c$  : Capacity [kvar]

$f$  : Frequency [Hz]

$V$  : Rated voltage [V]

$\pi$  : Integer [3.141592654]



## 6-2 Tips for Handling Capacitor

### < Installation Place >

Installation place shall be dry and well ventilated. Avoid the places such as where corrosive gases or dust are much or agitation occurs. Capacitor rack shall be installed on the base of concrete and tightened with bolt

### < Ambient Temperature >

Ambient temperature shall not exceed Temperature Class A [average temperature per day shall be less than 35°C]

### < Earthing >

Earth of capacitor shall be grounded with No.1 type grounding

be more than 5.5mm<sup>2</sup>.

### < Cooperation for protection >

When Y type connected unit capacitor is used, the ratio of current transformer and OCR tap adjustment shall be done as in the table.

### < Electric Wire >

Use twisted wire for connecting to capacitor. The square of wire shall be more than 1.35 times of rated current of capacitor.

### < Wire Connection >

To connect the wires, remove 30mm of the covering material from the wire and tighten them. Torque in tightening shall be less than 250kgf · cm

### < Attachment of Amperemeter >

It is desirable to attach amperemeter to capacitor circuit and distinguish the current of each phase using ampere select switch. If not so, defective phase due to current from harmonics or bad switch contact may not be found.

Capacity [kvar]	330V			6600V		
	Rated Current [A]	CT Ratio [A / A]	OCRtab [A]	Rated Current [A]	CT Ratio [A / A]	OCRtab [A]
50	8.75	15/5	4	4.37	10/5	3
75	13.1	20/5	4	6.55	10/5	4
100	17.5	30/5	4	8.75	15/5	4
150	26.2	40/5	4	13.1	20/5	4
200	35.0	60/5	4	17.5	30/5	4
250	43.7	75/5	4	21.9	30/5	5
300	52.5	75/5	5	26.2	40/5	4
400	70.0	95/5	5	35.0	50/5	5
500	87.5	110/5	5	43.7	60/5	5

### < Opening/Closing of Capacitor Circuit >

Capacitor has been produced with built-in discharge resistance so that when it is opened from the circuit, the residual voltage can be reduced to less than 75V within 10 min. If the switch is turned on again when the residual voltage is not discharged enough, DC voltage becomes double and can be the cause of damage to capacitor.

When it is turned on/off within short time [within 5 seconds], it is recommended to install discharging coil together.

### < Capacitor Transportation >

To transport capacitor, use the handle attached. Be sure not to grasp the bushing during the transportation.



## 6-3 Maintenance

### < Attentions for Installed Place >

- 1] Ambient temperature shall not exceed  $-25^{\circ}\text{C} \sim +45^{\circ}\text{C}$  [average temperature per day shall be less than  $35^{\circ}\text{C}$ ]
- 2] Installation place shall be dry and well ventilated. Avoid the place such as where corrosive gases or dust are much or agitation occurs. Capacitor rack shall be installed on the base of concrete and tightened with bolts
- 3] When it is used as a part of group, the space between capacitors shall be more than 30mm for 220V 10 ~ 500 $\mu\text{F}$ , 40mm for 600 ~ 1000 $\mu\text{F}$ , 30mm for 380 ~ 480V 10kVA, 40mm for 15 ~ 25kVA and 60mm for 50kVA considering the rise of temperature for air circulation.  
The cubicle shall not sealed tightly and ambient temperature of the Capacitor shall be less than  $40^{\circ}\text{C}$  in summer.
- 4] Use the brackets attached to the body for transportation and be sure not to grasp the bushing.
- 5] Use twisted wire for connecting to capacitor. The square of wire shall be more than 1.35 times of rated current of capacitor.
- 6] Earth of capacitor shall be grounded with No.1 type grounding construction [less than  $10\Omega$ ]
- 7] Capacitor has been produced with built in discharge resistance so that when it is opened from the circuit, the residual voltage can be reduced to less than 75V within 3 min. If the switch is turn on again when the residual voltage is not discharged enough, DC voltage becomes double and can be the cause of damage to capacitor.  
When it turns on/off within short time [within 5 seconds], discharging coil is desirable.
- 8] If the capacitor is connected in series to induction motor as in the picture below, select the capacity to be the same with non load exciting current when capacitor current  $\leq IM$ . [to prevent voltage rise against magnetic excitation.]

### < General maintenance check points >

- 1] Maximum permissible voltage is within 110% of rated voltage. Confirm of the equilibrium on each phase. Please be careful of circuit voltage rise in slight load at night. If over voltage is applied to capacitor continuously, kvar quantity is increased relative to 2 square voltage rise which results in the increase of loss and rise of temperature leading to shortening of life span.
- 2] Confirm that current of capacitor is within 130% of rated current.
- 3] When more than 120% of rated current flows on capacitor, please check the current wave form with oscilloscope to know which harmonics current is the cause and install series reactor to control harmonics.
- 4] The temperature of capacitor case is designed to be less than  $65^{\circ}\text{C}$  in mid summer [ambient temperature  $45^{\circ}\text{C}$ ]
- 5] Always check the current and voltage of capacitor circuit [3 phase equilibrium], clean bushings : more than once per 6 months [according to the state of contamination], measure capacity and insulation resistance : once per year.  
But, for measurement of insulation resistance, confirm that DC mega measurement shall be more than  $1000\text{M}\Omega$  [per unit] between terminal and case
- 6] Check the connection part of the electronic switch used in capacitor circuit once per year to a minimum.  
If the connection is not perfect, single phase operation or harmonics agitation voltage may be applied to the capacitor and it will reduce the normal life span
- 7] Open the capacitor from the circuit when leading power factor in slight load at night.



## 6-3 Maintenance

### < Maintenance points to Prevent Accidents >

To contact capacitor terminal for examination, open the switch on the side of power supply and leave it for 5 minutes as it is until the residual voltage goes below 50V. Then, use earth stick to discharge the residual voltage entirely and check the charging part.

- 1] The maximum permissible voltage of capacitor is less than 110% of rated voltage [within 12 hours per day]. Confirm that each phase is in equilibrium. Especially at night or afternoon, be careful to check the rise of circuit voltage. When over voltage is applied to capacitor, kvar is increased relatively 2 square of the voltage rise resulting in excessive increase of temperature of capacitor, leading to shorten life span. Therefore, it is desirable to separate the capacitor from the circuit in slight load.
- 2] The maximum temperature of capacitor case is designed to be 40°C to 60°C. If this limit is exceeded, forced wind cooling shall be employed to reduce the ambient temperature.
- 3] Capacitor expands or contracts according to the change of temperature and the bend of case surface absorbs this expansion or contraction. In operation, case expands about 15mm on the side by the inner insulation oil. If the expansion is below 15mm, it is normal. If the case expands about 15mm and abnormal function is suspicious, should check the current.  
The current of each phase is within permissible limit of rated current and in 3 phase equilibrium, then capacitor is normal.
- 4] Always check the current of capacitor.
- 5] Check the contact part of breaker or switch used in capacitor circuit once per year. If the contact is bad, capacitor would be operated in single phase or abnormal noise may be heard due to bad connection. High frequency agitation voltage is applied to capacitor leading to notable shortening of life span.

### < Routine maintenance check points of capacitor >

Check Points	Problems	Solutions
Leakage of Oil and Damage	Oil leakage at bushing	If oil leaks, change the capacitor. [Being left for a long time, it may be led to destruction of insulation]
	Oil leakage at case welding parts	If oil leaks, change the capacitor. [clean the part where oil leaks and check there after several days]
	Damage or rust on the side of outer case	Clean the damage and rust and treat for rust proofing.
Expansion of Case	Expansion on the side of case	Change the capacitor when it exceeds the standard expansion limit.
Temperature Rise Bad Connection	Overheat due to bad connection of terminal parts	Tighten the terminal. [avoid the agitated place]
	The limit of temperature rise of outer case when ambient temperature is 35°C is less than 30 deg.[for High Voltage]	Use ordinary thermometer for measurement. [avoid closed place] Investigate the cause of excessive temperature rise. [transient current or bad connection]
Insulation Resistance	Insulation resistance shall be more than 1000MΩ between terminal batch and earth terminal.	Clean the bushing with dry dust cloth and measure the resistance. Change the one which is below the standard. For low voltage [500VDC], for high voltage [1000VDC]



## 6-4 Certificate and Test Report

### < Certificates for Quality and Environmental Management >



ISO 14001



ISO 9001



ISO/TS 16949

### < Type Test Reports >



GB 11024-1



FGH Type Test



IEH Type Test



CESI Type Test

### < Test Reports of Non -PCB in Insulated Oil >



Jarylec-C



PXE [Phenyl-Xylyl-Ethane]



Sun-Ohm C



Polybutene+Micro WAX



## 6-5 Order Form

### > General Information

Company	
Person who is in charge of	
Contact Number	
Address	
E-mail Address	
Others	

### > Specification

Type	<input type="checkbox"/> Capacitor Unit	<input type="checkbox"/> Capacitor Bank
Line Voltage[V]		
Rated Voltage[V]		
Rated Capacity[Kvar]		
Frequency[Hz]	<input type="checkbox"/> 50Hz	<input type="checkbox"/> 60Hz
Number of Phase	<input type="checkbox"/> One Phase	<input type="checkbox"/> Three Phase <input type="checkbox"/> Special requirements[ ]
Quantity	<input type="checkbox"/> EA[Capacitor Unit]	<input type="checkbox"/> Bank[Capacitor Bank]
Dimension[mm]	W :	D: H:
Color	<input type="checkbox"/> Munsell No 5Y 7/1	<input type="checkbox"/> Special requirements : Munsell No

### > Installation Condition

Installation Place	<input type="checkbox"/> Indoor	<input type="checkbox"/> Outdoor
Installation Method	<input type="checkbox"/> Cubicle	<input type="checkbox"/> Open Rack <input type="checkbox"/> Pole mounted
Installation Area	[ ]mm x [ ]mm	
Ambient Temperature	<input type="checkbox"/> A [Max +40°C]	<input type="checkbox"/> B [Max +45°C] <input type="checkbox"/> C [Max+50°C] <input type="checkbox"/> D [Max +55°C]

### > Protection Methods

Protection Methods	<input type="checkbox"/> NVS	<input type="checkbox"/> NCS
Special requirements		

### > Attached Facilities

Series Reactor	<input type="checkbox"/> %L=6%	<input type="checkbox"/> %L=8%	<input type="checkbox"/> %L=13%
	<input type="checkbox"/> Oil Type	<input type="checkbox"/> Dry Type	<input type="checkbox"/> with Discharge Coil
Discharge Device	<input type="checkbox"/> Coil	<input type="checkbox"/> Resistance	<input type="checkbox"/> Others
APFCR	Step		

\* Please contact SAMWHA Capacitor, if you have any questions about us and products.





## Memo



## Memo



### Head Office

124, Buk-Ri, Namsa-Myun, Cheoin-Gu, Yongin-Si,  
Kyoungki-Do, Korea  
Tel.+82-31-330-5812~7 / Fax.+82-31-339-0413  
eungjin@samwha.com / jypaek@samwha.com

### SAMWHA USA (San Diego Office)

2555 Melksee street, San Diego, Ca92154, USA  
Tel.+1-619-671-0870 / Fax.+1-619-671-0874  
moseslee@samwhausa.com

### SAMWHA USA (Chicago Office)

Inc.200 Fairway Drive,  
Suite 170 Vernon Hills, IL 60061  
Tel.+1-847-294-0081 / Fax.+1-847-294-0082  
robertcheon@samwhausa.com

### SAMWHA Hongkong

Unit 3 to 9, 5th Floor, Hi-Tech Center,  
9choi Yuen Road Sheungshui, New Territories  
Hongkong  
Tel.+852-2668-2460 / Fax.+852-2668-2420  
docjin@samwha.com

### Tianjin Samwha Hi-Tech Intl Trading

No.22 Xinghua Street Xiqing Economic  
Development Zone, Tianjin China  
Tel.+86-22-238-8501 / Fax.+86-22-2388-8505  
leeyj@samwha.com

### SAMWHA Europe GmbH

Lyoner Strasse 44-4B D-60528  
Frankfurt am main Germany  
Tel.+49-69-963-765-0  
(as representative number in 6lines)  
Fax.+49-69-963-765-65  
shimjt@samwha.com

### P.T SAMCON

Jl.raya Subang Cikumapay Campaka  
Purwakatra Jawa-Barat Indonesia  
Tel.+62-264-216-881~3 / Fax.+62-264-216-901  
ytcho@samwha.com

### SAMWHA Thailand

66.MOO 4T. Takai A.Mung Chachoengsao 24000.  
Thailand  
Tel.+66-38-847571~3 / Fax.+66-38-847575,847616  
chrislee@samwha.com

### SAMWHA India

703, 7th floor, Kailash Building, Kasturba Gandhi Marg, New Delhi 110001  
TEL) 91-11-4355-3460~1 / FAX) 91-11-4355-3462  
swindia1@samwha.com