

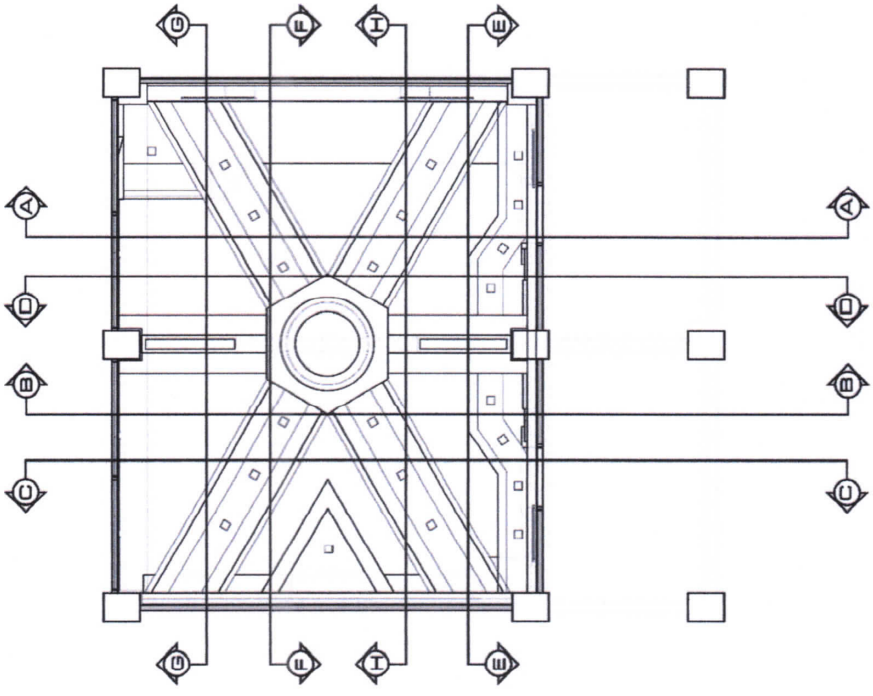



แบบใช้เฉพาะห้อง 1704 1705

 <p>กระทรวงศึกษาธิการ กรมส่งเสริมการศึกษานอกระบบ และตามอัธยาศัย</p>	<p><b>NOTE :</b> 1. THIS DRAWING IS THE PROPERTY OF THE ARCHITECT AND SHOULD BE KEPT IN THE ARCHITECT'S OFFICE. IT IS TO BE USED ONLY FOR THE PROJECT AND SITE SPECIFICALLY MENTIONED HEREIN. IT IS NOT TO BE REPRODUCED OR TRANSMITTED IN ANY FORM OR BY ANY MEANS, ELECTRONIC OR MECHANICAL, INCLUDING PHOTOCOPYING, RECORDING, OR BY ANY INFORMATION STORAGE AND RETRIEVAL SYSTEM, WITHOUT THE WRITTEN CONSENT OF THE ARCHITECT.</p>	<p><b>OWNER:</b> โรงเรียนวัฒนาวิทยาลัย ห้อง 1704 1705</p>																																	
		<p><b>PROJECT:</b> เปลี่ยนจุดจอดรถ</p>																																	
<p><b>ARCHITECT:</b></p>		<p><b>INTERIOR DESIGNER:</b></p>																																	
<p><b>STRUCTURAL DESIGNER:</b></p>		<p><b>SANITARY ENGINEER:</b></p>																																	
<p><b>ELECTRICAL ENGINEER:</b></p>		<table border="1"> <thead> <tr> <th>REV.</th> <th>STAGE</th> <th>DATE</th> </tr> </thead> <tbody> <tr><td> </td><td> </td><td> </td></tr> <tr><td> </td><td> </td><td> </td></tr> <tr><td> </td><td> </td><td> </td></tr> <tr><td> </td><td> </td><td> </td></tr> <tr><td> </td><td> </td><td> </td></tr> <tr><td> </td><td> </td><td> </td></tr> <tr><td> </td><td> </td><td> </td></tr> <tr><td> </td><td> </td><td> </td></tr> <tr><td> </td><td> </td><td> </td></tr> <tr><td> </td><td> </td><td> </td></tr> </tbody> </table>	REV.	STAGE	DATE																														
REV.	STAGE	DATE																																	
<p><b>DRAWING TITLE</b></p>																																			
<p><b>DRAWING NUMBER</b> <b>C 1</b></p>																																			
<p><b>SCALE</b></p>	<p><b>DATE</b></p>	<p><b>DRAWN BY</b></p>																																	
<p><b>JOB NUMBER</b></p>	<p><b>DRAWN BY</b></p>																																		

**SECTION**  
Scale : M.

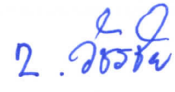



1.  2.  3. 

แบบใช้เฉพาะห้อง 1704 1705

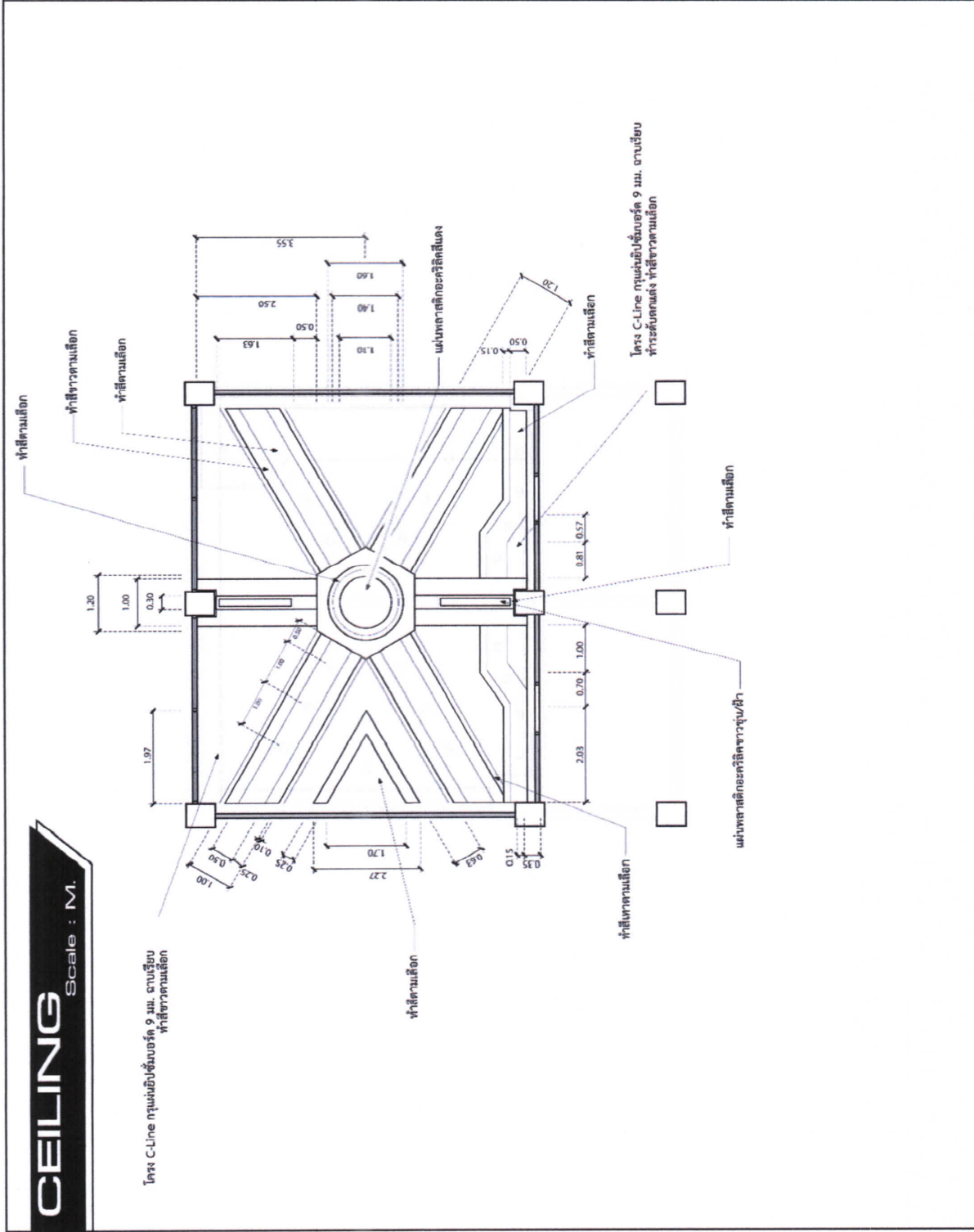
	<b>NOTE:</b> THE ABOVE DRAWING INFORMATION IS FOR INFORMATION ONLY. THE CONTRACTOR SHALL BE RESPONSIBLE FOR THE ACCURACY OF THE INFORMATION AND THE CONTRACTOR SHALL BE RESPONSIBLE FOR THE ACCURACY OF THE INFORMATION AND THE CONTRACTOR SHALL BE RESPONSIBLE FOR THE ACCURACY OF THE INFORMATION.
	<b>OWNER:</b> โรงเรียนอนุบาลราชบุรีภาค พะงัน หนองปรือ
<b>PROJECT:</b> ปรับปรุงห้องเรียน	<b>ARCHITECT:</b>
<b>INTERIOR DESIGNER:</b>	<b>STRUCTURAL DESIGNER:</b>
<b>SANITARY ENGINEER:</b>	<b>ELECTRICAL ENGINEER:</b>
REV.    STAGE    DATE	DRAWING TITLE
DRAWING NUMBER <b>C 2</b>	SCALE DATE DRAWN BY

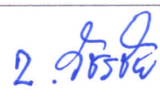

1.  2.  3. 

แบบใช้เฉพาะห้อง 1704 1705



**NOTE:**  
 THIS DRAWING IS THE PROPERTY OF THE ARCHITECT AND IS NOT TO BE REPRODUCED OR COPIED IN ANY MANNER WITHOUT THE WRITTEN PERMISSION OF THE ARCHITECT. THE ARCHITECT ASSUMES NO LIABILITY FOR ANY DAMAGE OR LOSS OF ANY KIND ARISING FROM THE USE OF THIS DRAWING. THE ARCHITECT IS NOT RESPONSIBLE FOR ANY CONSTRUCTION DEFECTS OR OMISSIONS. THE ARCHITECT IS NOT RESPONSIBLE FOR ANY DELAYS OR INTERUPTIONS IN THE CONSTRUCTION OF THE PROJECT. THE ARCHITECT IS NOT RESPONSIBLE FOR ANY INJURY OR DEATH OF ANY PERSON OR DAMAGE TO ANY PROPERTY ARISING FROM THE USE OF THIS DRAWING. THE ARCHITECT IS NOT RESPONSIBLE FOR ANY VIOLATION OF ANY LAW OR REGULATION. THE ARCHITECT IS NOT RESPONSIBLE FOR ANY BREACH OF CONTRACT. THE ARCHITECT IS NOT RESPONSIBLE FOR ANY BREACH OF WARRANTY. THE ARCHITECT IS NOT RESPONSIBLE FOR ANY BREACH OF GUARANTEE. THE ARCHITECT IS NOT RESPONSIBLE FOR ANY BREACH OF INDEMNITY. THE ARCHITECT IS NOT RESPONSIBLE FOR ANY BREACH OF RELEASE. THE ARCHITECT IS NOT RESPONSIBLE FOR ANY BREACH OF HOLD HARMLESS. THE ARCHITECT IS NOT RESPONSIBLE FOR ANY BREACH OF ASSIGNMENT. THE ARCHITECT IS NOT RESPONSIBLE FOR ANY BREACH OF SUBROGATION. THE ARCHITECT IS NOT RESPONSIBLE FOR ANY BREACH OF CONTRIBUTION. THE ARCHITECT IS NOT RESPONSIBLE FOR ANY BREACH OF JOINT AND SEVERAL LIABILITY. THE ARCHITECT IS NOT RESPONSIBLE FOR ANY BREACH OF SOLIDARITY. THE ARCHITECT IS NOT RESPONSIBLE FOR ANY BREACH OF JOINT AND SEVERAL LIABILITY. THE ARCHITECT IS NOT RESPONSIBLE FOR ANY BREACH OF SOLIDARITY. THE ARCHITECT IS NOT RESPONSIBLE FOR ANY BREACH OF JOINT AND SEVERAL LIABILITY. THE ARCHITECT IS NOT RESPONSIBLE FOR ANY BREACH OF SOLIDARITY.

<b>OWNER:</b> โรงเรียนวัฒนธรรมบึงกุ่ม บึงจันทบุรี	
<b>PROJECT:</b> เปลี่ยนห้องโถงโถง	
<b>ARCHITECT:</b>	
<b>INTERIOR DESIGNER:</b>	
<b>STRUCTURAL DESIGNER:</b>	
<b>SANITARY ENGINEER:</b>	
<b>ELECTRICAL ENGINEER:</b>	
<b>REV.</b>	<b>DATE</b>
<b>DRAWING TITLE</b>	
<b>DRAWING NUMBER</b> <b>C 3</b>	
<b>SCALE</b>	<b>DATE</b>
<b>JOB NUMBER</b>	<b>DRAWN BY</b>

**ELECTRIC & LIGHT**  
Scale : M.

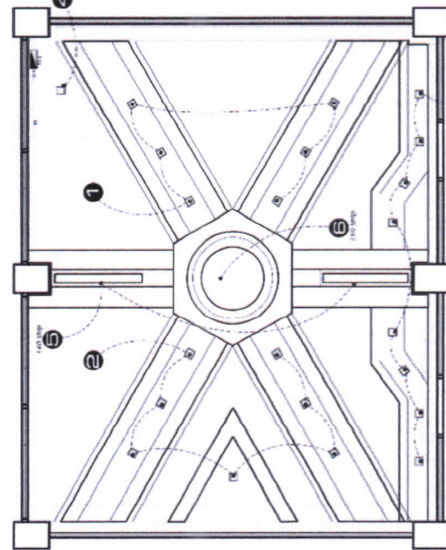

**สัญลักษณ์**

MAIN MAIN

☺ สวิตช์

☼ บั๊นไฟ 3 ตา

☐ หลอดไฟ LED แสงขาว โคมสี่เหลี่ยม 4 ทิศ 5 นิ้ว

☐ หลอดไฟ LED Strip แสงขาว

1. 2. 3.

# แบบใช้เฉพาะห้อง 1704 1705



**NOTE:**  
 1. ALL DIMENSIONS ARE IN METERS UNLESS OTHERWISE SPECIFIED.  
 2. ALL DIMENSIONS ARE TO FACE UNLESS OTHERWISE SPECIFIED.  
 3. ALL DIMENSIONS ARE TO CENTERLINE UNLESS OTHERWISE SPECIFIED.  
 4. ALL DIMENSIONS ARE TO THE CENTERLINE OF THE MEMBER UNLESS OTHERWISE SPECIFIED.  
 5. ALL DIMENSIONS ARE TO THE CENTERLINE OF THE MEMBER UNLESS OTHERWISE SPECIFIED.

**OWNER:**  
โครงการพัฒนาระบบ  
โครงสร้าง

**PROJECT:**  
ปรับปรุงห้องเรียน

**ARCHITECT:**

**INTERIOR DESIGNER:**

**STRUCTURAL DESIGNER:**

**SANITARY ENGINEER:**

**ELECTRICAL ENGINEER:**

REV.	STAGE	DATE

บริษัท วิศวกรที่ปรึกษา  
โครงสร้างและสถาปัตย์  
วิศวกรรม จำกัด

**DRAWING TITLE**

**DRAWING NUMBER**  
**C 4**

**SCALE**  
**DATE**

**JOB NUMBER**  
**DRAWN BY**

**ELEVATION**  
Scale : M.

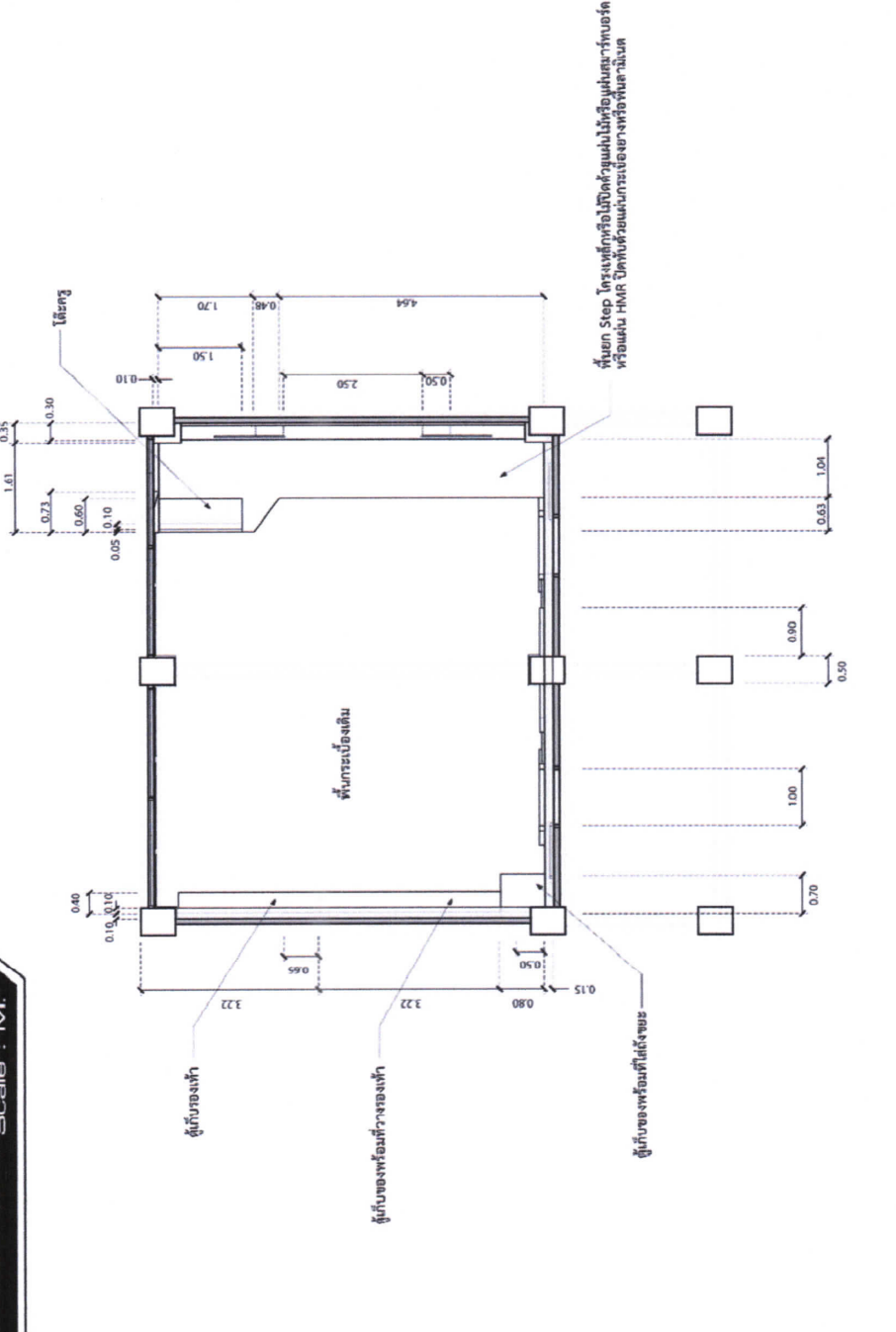

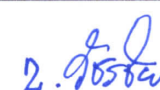
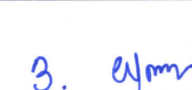
1.  2.  3. 

# แบบใช้เฉพาะห้อง 1704 1705

	<p><b>NOTE:</b>          THIS DRAWING IS THE PROPERTY OF THE ARCHITECT AND IS TO BE USED ONLY FOR THE PROJECT AND SITE SPECIFICALLY IDENTIFIED HEREON. IT IS NOT TO BE REPRODUCED OR TRANSMITTED IN ANY FORM OR BY ANY MEANS, ELECTRONIC OR MECHANICAL, INCLUDING PHOTOCOPYING, RECORDING, OR BY ANY INFORMATION STORAGE AND RETRIEVAL SYSTEM, WITHOUT THE WRITTEN PERMISSION OF THE ARCHITECT. ANY UNAUTHORIZED USE OR REUSE OF THIS DRAWING SHALL BE AT THE USER'S SOLE RISK AND WITHOUT LIABILITY TO THE ARCHITECT.</p>												
<p><b>OWNER:</b>          โรงเรียนนวมินทราชินูทิศ          หอวัง นนทบุรี</p>	<p><b>DRAWING TITLE:</b></p>												
<p><b>PROJECT:</b>          ปรับปรุงห้องเรียน</p>													
<p><b>ARCHITECT:</b></p>	<table border="1" style="width: 100%; border-collapse: collapse;"> <thead> <tr> <th>REV.</th> <th>STAGE</th> <th>DATE</th> </tr> </thead> <tbody> <tr><td> </td><td> </td><td> </td></tr> <tr><td> </td><td> </td><td> </td></tr> <tr><td> </td><td> </td><td> </td></tr> </tbody> </table>	REV.	STAGE	DATE									
REV.		STAGE	DATE										
<p><b>INTERIOR DESIGNER:</b></p>													
<p><b>STRUCTURAL DESIGNER:</b></p>													
<p><b>SANITARY ENGINEER:</b></p>													
<p><b>ELECTRICAL ENGINEER:</b></p>	<p><b>DRAWING NUMBER:</b>  <b>C 5</b></p>												
<p><b>SCALE:</b></p>													
<p><b>DRAWN BY:</b></p>													



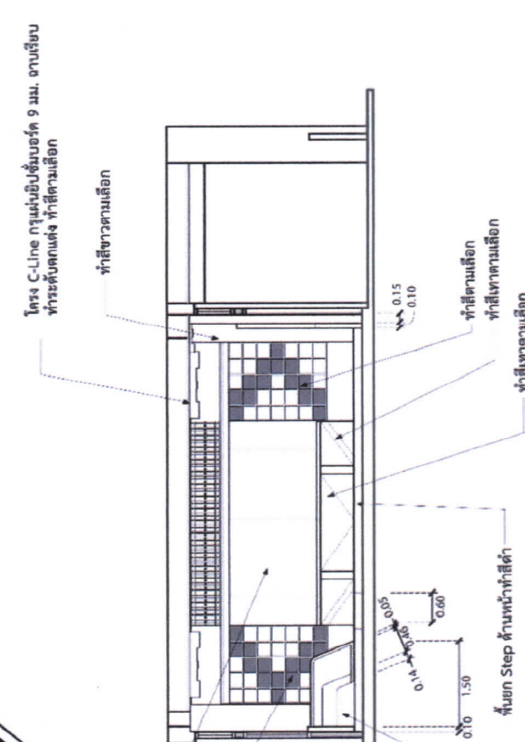

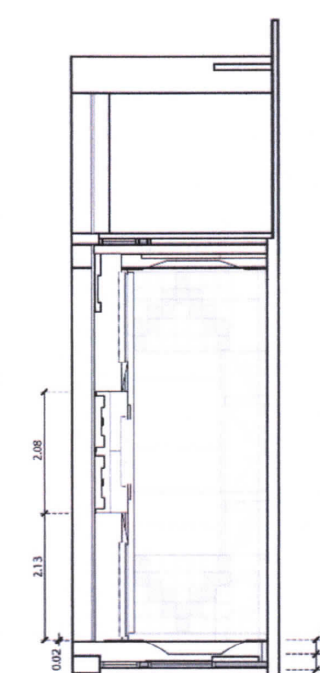

**SECTION : A**  
Scale : M.



**SECTION : B**  
Scale : M.

1.  2.  3. 



แบบใช้เฉพาะห้อง 1704 1705

	<p><b>NOTE :</b>                  THIS DRAWING IS THE PROPERTY OF ARCHITECTS ASSOCIATION OF THAILAND. IT IS NOT TO BE REPRODUCED, COPIED, EITHER WHOLLY OR PARTIALLY, IN ANY FORM OR BY ANY MEANS, WITHOUT THE WRITTEN CONSENT OF THE ARCHITECTS ASSOCIATION OF THAILAND.</p>	<b>OWNER :</b> โรงเรียนบดินทรเดชา(สิงห์ สิงหเสนี) เขตวัง อนุบาลบุรี
		<b>PROJECT :</b> บดินทรเดชาห้องเรียน
<b>ARCHITECT :</b>		<b>INTERIOR DESIGNER :</b>
<b>STRUCTURAL DESIGNER :</b>		<b>SANITARY ENGINEER :</b>
<b>ELECTRICAL ENGINEER :</b>		<b>REVISIONS :</b>
<b>DRAWING TITLE :</b>		<b>NO. OF SHEETS :</b>
<b>DRAWING NUMBER :</b> <b>C 6</b>		<b>SCALE :</b>
<b>DATE :</b>		<b>DRAWN BY :</b>

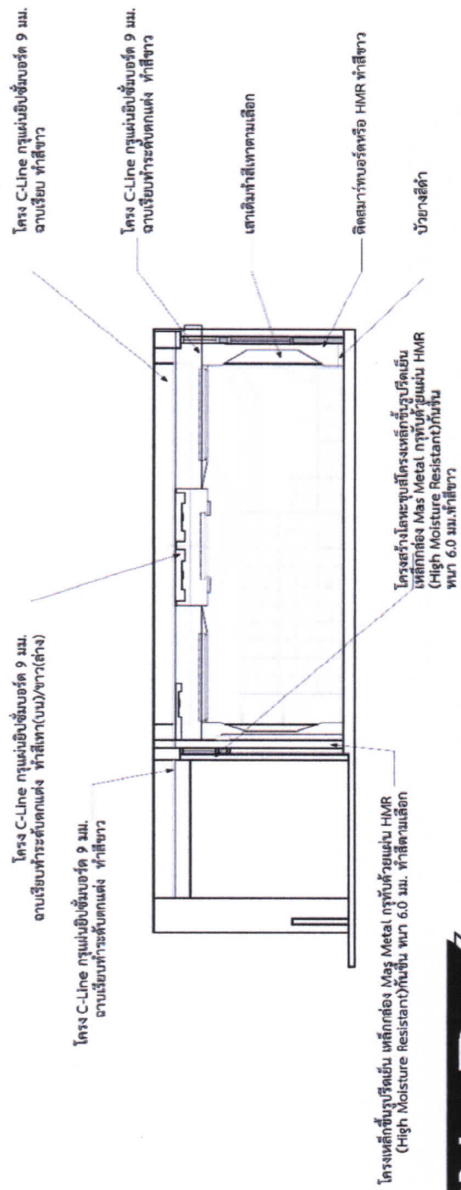
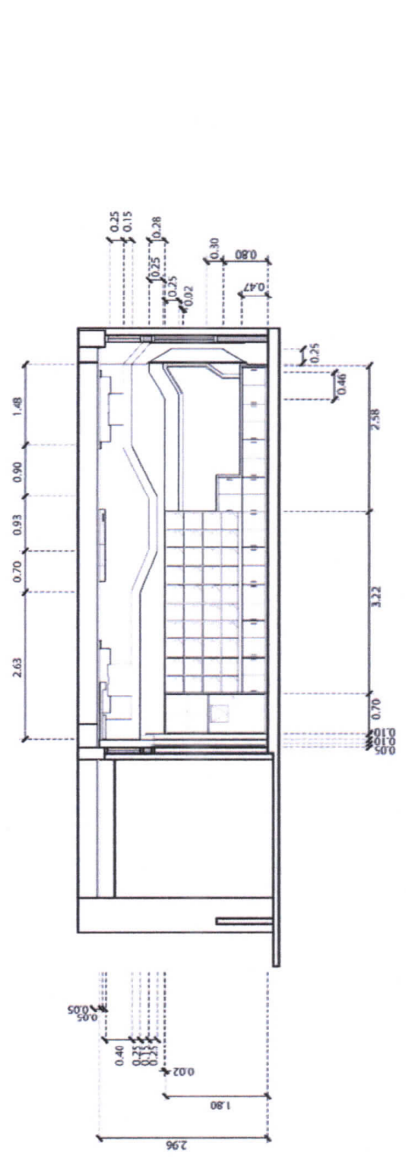
**SECTION : C**  
Scale : M.

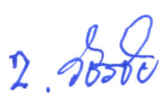

**SECTION : D**  
Scale : M.

1.  2.  3. 

# แบบใช้เฉพาะห้อง 1704 1705

**NOTE :**  
 1. ALL DIMENSIONS ARE IN MILLIMETERS UNLESS OTHERWISE SPECIFIED.  
 2. ALL DIMENSIONS ARE TO FACE UNLESS OTHERWISE SPECIFIED.  
 3. ALL DIMENSIONS ARE TO BE TAKEN FROM THE FINISHED SURFACE UNLESS OTHERWISE SPECIFIED.  
 4. ALL DIMENSIONS ARE TO BE TAKEN FROM THE FINISHED SURFACE UNLESS OTHERWISE SPECIFIED.  
 5. ALL DIMENSIONS ARE TO BE TAKEN FROM THE FINISHED SURFACE UNLESS OTHERWISE SPECIFIED.

**OWNER:**  
 โรงเรียนบดินทรเดชา (สิงห์ สิงหเสนี) วิทยาลัยอาชีวศึกษา  
 100 หมู่ 10 ถนนพหลโยธิน แขวงสามยุค เขตพญาไท กรุงเทพมหานคร 10600

**PROJECT:**  
 เบรินปรุงห้องเรียน

**ARCHITECT:**

**INTERIOR DESIGNER:**

**STRUCTURAL DESIGNER:**

**SANITARY ENGINEER:**

**ELECTRICAL ENGINEER:**

REV.	STAGE	DATE

DRAWING TITLE

DRAWING NUMBER **C 7**

SCALE

JOB NUMBER

DATE

DRAWN BY

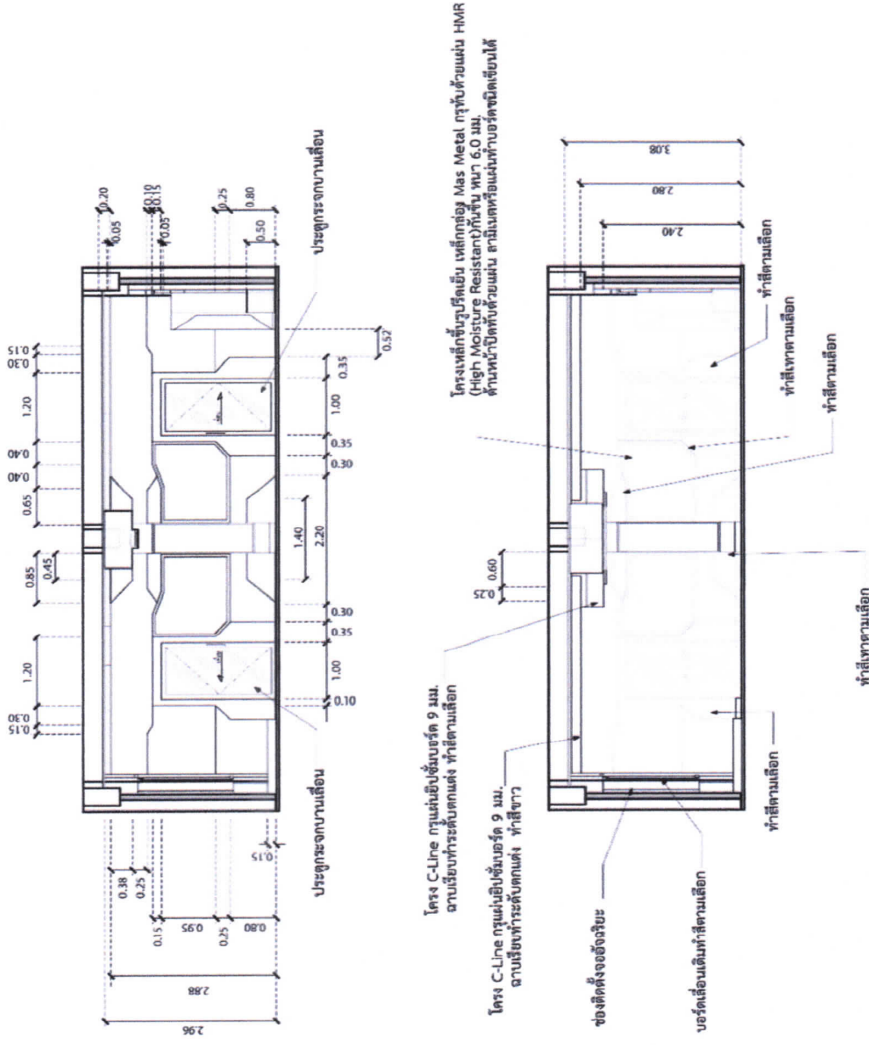

**SECTION : E**  
Scale : M.

**SECTION : F**  
Scale : M.

1.

2.

3.

แบบใช้เฉพาะห้อง 1704 1705

**SECTION : G**  
Scale : M.

**SECTION : H**  
Scale : M.

	<p><b>NOTE:</b> THIS DRAWING IS PREPARED AND ISSUED BY THE ARCHITECT AND HIS ASSOCIATES. THE CONTRACTOR SHALL BE RESPONSIBLE FOR THE ACCURACY OF THE DIMENSIONS AND MATERIALS SHOWN ON THIS DRAWING. THE CONTRACTOR SHALL BE RESPONSIBLE FOR THE ACCURACY OF THE DIMENSIONS AND MATERIALS SHOWN ON THIS DRAWING.</p>															
<p><b>OWNER:</b> โรงเรียนเวินกลางภูเก็ต พ.อ.ฉวี นนทบุรี</p>	<p><b>PROJECT:</b> บ่อน้ำร้อนห้องเรียน</p>															
<p><b>ARCHITECT:</b></p>	<p><b>INTERIOR DESIGNER:</b></p>															
<p><b>STRUCTURAL DESIGNER:</b></p>	<p><b>SANITARY ENGINEER:</b></p>															
<p><b>ELECTRICAL ENGINEER:</b></p>	<table border="1" style="width: 100%; border-collapse: collapse;"> <thead> <tr> <th>REV.</th> <th>STAGE</th> <th>DATE</th> </tr> </thead> <tbody> <tr><td> </td><td> </td><td> </td></tr> <tr><td> </td><td> </td><td> </td></tr> <tr><td> </td><td> </td><td> </td></tr> <tr><td> </td><td> </td><td> </td></tr> </tbody> </table>	REV.	STAGE	DATE												
REV.	STAGE	DATE														
<p><b>DRAWING TITLE</b></p>																
<p><b>DRAWING NUMBER</b> <b>C 8</b></p>																
<p><b>SCALE</b></p>	<p><b>DATE</b></p>															
<p><b>JOB NUMBER</b></p>	<p><b>DRAWN BY</b></p>															

1. *[Signature]* 2. *[Signature]* 3. *[Signature]*



แบบใช้เฉพาะห้อง 1704 1705

### ตู้เก็บของ

**NOTE:**  
 THIS DRAWING IS THE PROPERTY OF THE ARCHITECT AND IS TO BE USED ONLY FOR THE PROJECT AND SITE SPECIFICALLY IDENTIFIED HEREON. IT IS NOT TO BE REPRODUCED, COPIED, OR TRANSMITTED IN ANY FORM OR BY ANY MEANS, ELECTRONIC OR MECHANICAL, INCLUDING PHOTOCOPYING, RECORDING, OR BY ANY INFORMATION STORAGE AND RETRIEVAL SYSTEM, WITHOUT THE WRITTEN PERMISSION OF THE ARCHITECT. THE ARCHITECT ASSUMES NO LIABILITY FOR THE CONSTRUCTION OF THE PROJECT OR FOR THE PERFORMANCE OF THE CONTRACTOR'S OBLIGATIONS UNDER THE CONTRACT.

**OWNER:**  
 โรงเรียนเบญจมราชูทิศ  
 หนอง นนทบุรี

**PROJECT:**  
 ปรับปรุงห้องเรียน

**ARCHITECT:**

**INTERIOR DESIGNER:**

**STRUCTURAL DESIGNER:**

**SANITARY ENGINEER:**

**ELECTRICAL ENGINEER:**

REV.	STAGE	DATE

**DRAWING TITLE**

**DRAWING NUMBER**  
C 9

**SCALE**

**DATE**

**JOB NUMBER**

**DRAWN BY**

### โต๊ะครู

**SECTION TOP**

**TOP VIEW**

**FRONT VIEW**

**BACK VIEW**

**SIDE VIEW**



**SECTION SIDE**

**DETAIL**

1. 2. 3.

แบบใช้เฉพาะห้อง 1704 1705

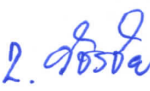

- 1. 
- 2. 
- 3. 

แบบใช้เฉพาะห้อง 1704 1705

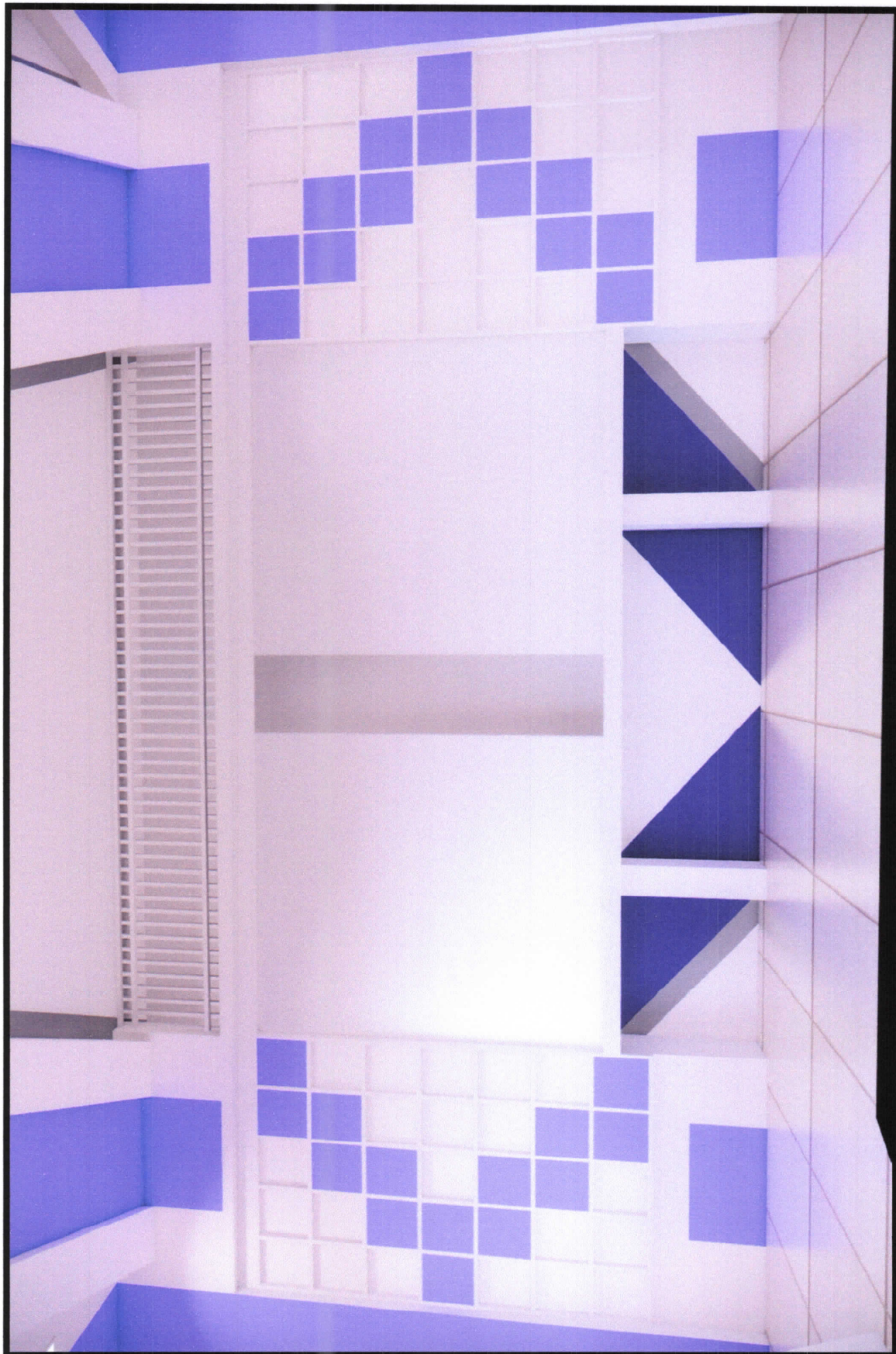

1. 
2. วิชา
3. อภิ

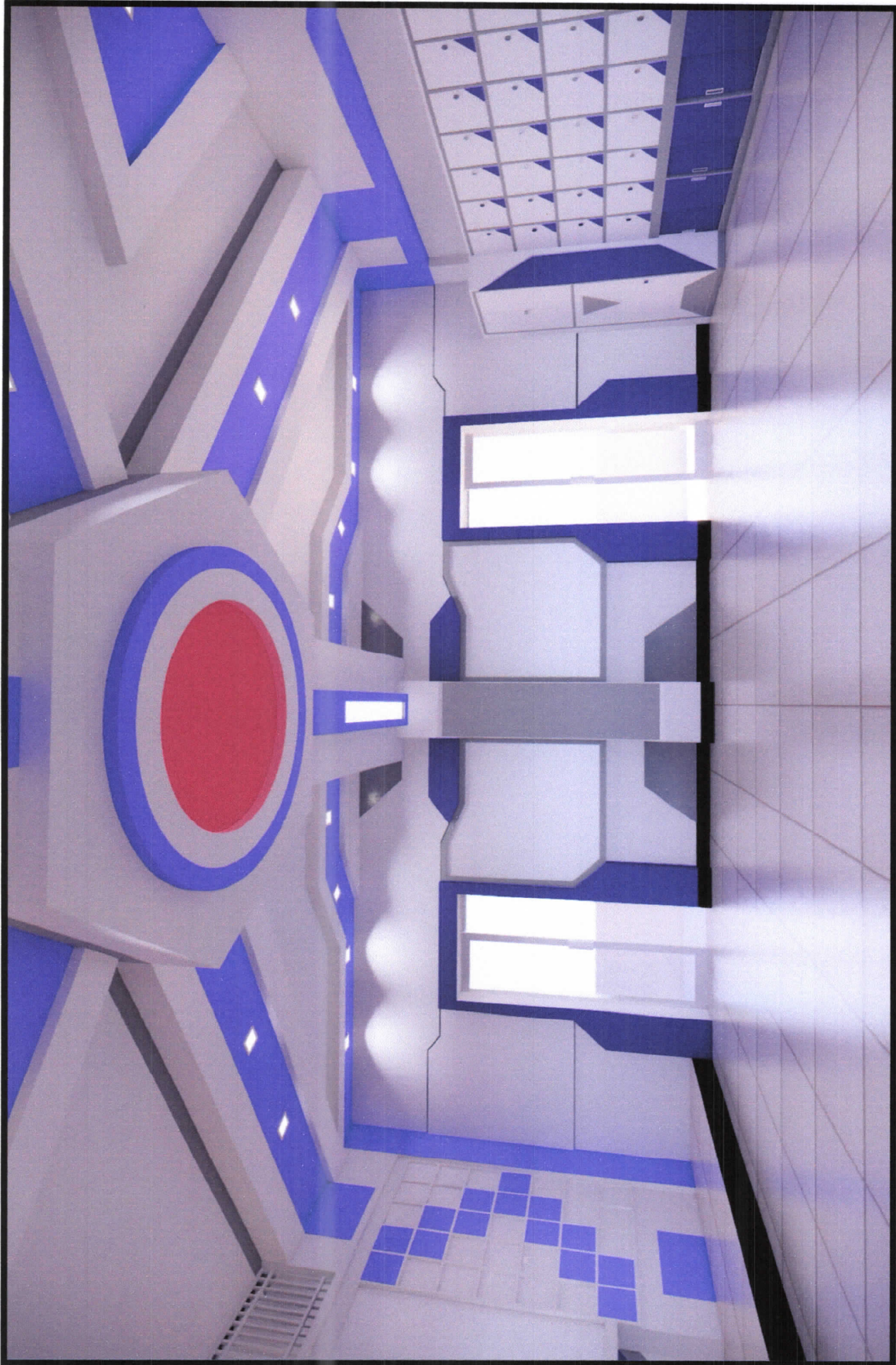

## แบบใช้เฉพาะห้อง 1704 1705

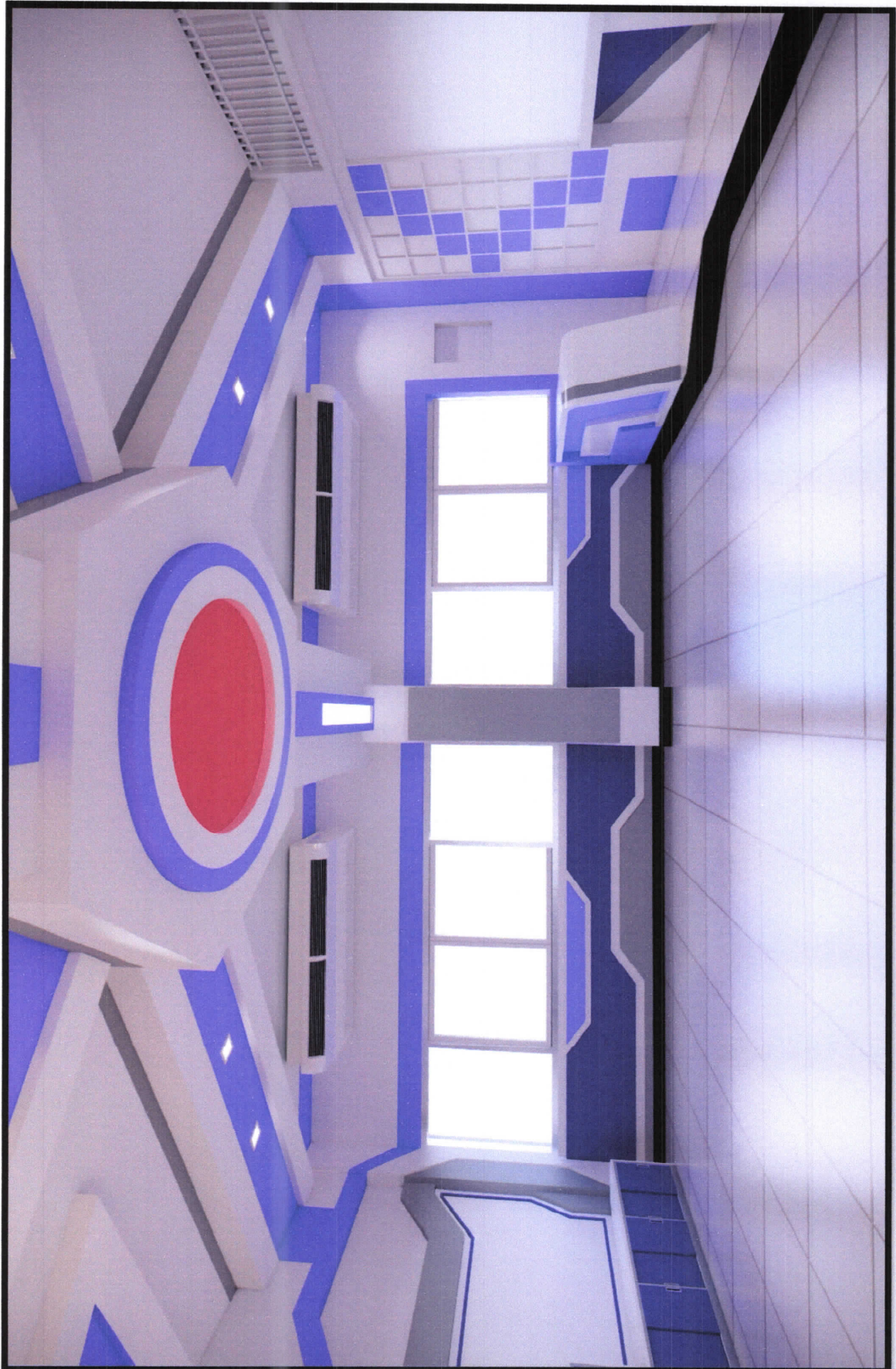

1. *Chin*
2. *Krista*
3. *epmi*

## แบบใช้เฉพาะห้อง 1704 1705



1.  2.  3. 

แบบใช้เฉพาะห้อง 1704 1705

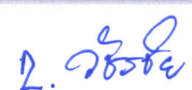
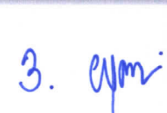

1.  2.  3. 

แบบใช้เฉพาะห้อง 1704 1705



1. *[Handwritten signature]* 2. *[Handwritten signature]* 3. *[Handwritten signature]*