

# Strain Gauges

First choice for strain measurements





# Strain Gauges

First choice for strain measurements



# Table of contents

<b>Introduction</b>	<b>6</b>
Explanations of specifications	6
From measured strain to mechanical stress	12
How to easily find the right strain gauge	14
Type coding	16
<b>Strain gauges – Y series</b>	<b>18</b>
Specifications – Y series	19
with one measuring grid/linear strain gauge	20
with two measuring grids/double linear strain gauge	25
with two measuring grids/T rosette/double SG	26
with two measuring grids/T rosette	27
with two measuring grids/torsion-shear strain gauge	29
with three measuring grids/strain gauge rosettes	30
with four measuring grids/full bridge circuits	34
with four measuring grids/diaphragm rosettes	35
Strain gauge chains	36
<b>Strain gauges with connection cable</b>	
<b>K-CLY.../K-CDY.../K-CXY.../K-CRY...</b>	<b>40</b>
Specifications – K-CLY.../K-CDY.../K-CXY.../K-CRY...	41
(incl. fluoropolymer-insulated connection wire) with one measuring grid	42
(incl. fluoropolymer-insulated connection wire) with two measuring grids	43
(incl. fluoropolymer-insulated connection wire) with three measuring grids	45
SG with connection cable and RJ11 connector	47
<b>Strain gauges – C series</b>	<b>48</b>
Specifications – C series	49
with one measuring grid	50
with two measuring grids, with three measuring grids	51
<b>Strain gauges – M series</b>	<b>52</b>
Specifications – M series	53
with one measuring grid	54
with two measuring grids	55
with three measuring grids	57

<b>Strain gauges – G series</b>	<b>58</b>
Specifications – G series	59
with one measuring grid, with two measuring grids	60
<b>Special strain gauges</b>	<b>62</b>
Encapsulated strain gauges with stranded wire	63
Weldable strain gauges	64
Strain gauges for high strains	65
Strain gauges for measurements in load pins	66
Strain gauges for measurements on PCBs	68
Strain gauges for integration in fiber composites	70
Pressure measuring gauges	71
Crack propagation gauges	72
Temperature sensor	74
Strain gauges for determination of residual stress	75
System for determination of residual stress based on the hole drilling method	79
<b>Strain gauge accessories</b>	<b>80</b>
SG bonding material	80
SG covering agents	82
Cleaning agents, bonding and soldering materials	85
Solder terminals	86
Cables and stranded wires	87
SG installation case	90
Bridge completions, resin-cored solder, lead-free solder	91
<b>Optical strain gauges</b>	<b>92</b>
<b>Customer-specific strain gauges</b>	<b>93</b>
<b>Seminars</b>	<b>94</b>

# Explanations of specifications

## Strain gauge series

The HBM strain gauge range consists of the Y, C, M, G series and special strain gauges. There are different type series within each strain gauge series. Many specifications are identical for one strain gauge series; therefore, in this catalog, the specifications of a series are given on the pages preceding the list of individual strain gauges. Where the specifications of individual strain gauges differ from those stated for the other strain gauges of a series, these strain gauges are provided with a relevant note. The specifications and their tolerances are stated in compliance with OIML directive IR62, which is essentially identical to the VDI/VDE directive 2635.

## The specifications

have been determined according to OIML directive IR62. The tolerances are stated per OIML with double standard deviation. If the specified tolerance values of the gauge factor, transverse sensitivity, temperature coefficients and temperature response are halved, the data complies with VDI/VDE directive 2635. Below you will find further explanations regarding the terms used in the specifications tables.

## Connection configuration

HBM supplies strain gauges with different connection configurations. Choose the configuration that best fits your application and personal preferences – the right connection for everyone.

### Integrated solder tabs, e.g. LY4

- Allow direct soldering on the strain gauge



### Solder tabs with strain relief, e.g. LY6

- Allow for easy soldering directly on the SG with nearly complete mechanical decoupling of solder tabs and SG

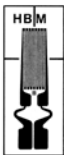

### Leads: Ni-plated copper leads; non-insulated; 30 mm long, e.g. LY1

- No direct soldering on the strain gauge
- For complete mechanical decoupling of cables and strain gauge
- Use of separate solder terminals directly on the strain gauge required

### Fluoropolymer-insulated connection wires (50 mm long), e.g. K-CLY4

- No soldering on the strain gauge
- Fluoropolymer insulation prevents the cable from sticking during installation
- Solder terminals near the strain gauge are required and are also used for the bridge circuit

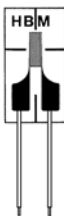

### TPE-insulated ribbon cable, alternatively with 3- or 4-wire connection, e.g. K-CLY4

- Cable length as required (0.5 to 10 m)
- Soldering at measurement point not required at all
- Fluoropolymer-insulated connection wire on the strain gauge prevents the cable from sticking during installation

## Strain gauge dimensions

The specified active measuring grid length “a” is the net length of the grid without the end loops (transverse bridges). If the following facts are taken into account, it is possible to cut the SG carrier foil: Cutting the foil in parallel to the measuring grid has only minor effects. Shortening the carrier foil perpendicular to the measuring grid influences the way the strain is applied, thereby also changing essential properties of the strain gauge. A minimum distance of 1 mm between the measuring grid and the end of the carrier foil should therefore be maintained.

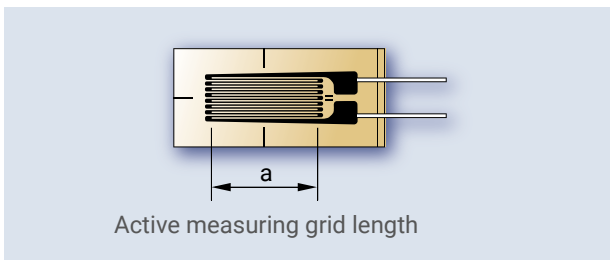

Diagrammatic view of a strain gauge

## Strain gauge resistance

The electric resistance between the two metal leads, solder tabs or cable ends for connecting the measuring cable is called the resistance of a strain gauge.<sup>(1)</sup> Please note that the nominal resistance for strain gauges <sup>(2)</sup> with connection cables is specified without the cable.

HBM strain gauges are available with 120 ohm, 350 ohm, 700 ohm or 1,000 ohm resistance. The nominal (rated) resistance is stated on each strain gauge package including the resistance tolerance per package. HBM strain gauges are 100% resistance checked.

## Gauge factor (strain sensitivity)

The gauge factor  $k$  of a strain gauge is the proportionality factor between the relative change in resistance  $\Delta R/R_0$  and the strain to be measured  $\varepsilon$ :  $\Delta R/R_0 = k \cdot \varepsilon$

The gauge factor, a dimensionless number, is sometimes also called the  $k$  factor.

This gauge factor is determined for each production batch by measuring and is specified on each strain gauge package as a nominal value complete with tolerance. The gauge factors vary between production batches by just a few thousandths.

## Temperature coefficient of the gauge factor

The specified gauge factor applies at room temperature. It changes as the temperature changes; however, with an excellent approximation, this correlation is linear. In the case of constantan measuring grid material (series G, Y), the gauge factor rises with the temperature; for chromium nickel measuring grid foils (series C, M) the gauge factor decreases as the temperature rises. The temperature coefficient of the gauge factor and its tolerance are stated on each strain gauge package.

<sup>(1)</sup> SG LE11

<sup>(2)</sup> See page 40

## Maximum electrical excitation voltage on the individual SG for high-precision strain measurements

The specified excitation voltages refer to the voltage drop on the indicated strain gauge. If the SG is used in a Wheatstone-bridge circuit in quarter, half or full bridge configuration, the selected bridge excitation voltage within the circuit is also distributed according to the configuration and thus the converted power as well.

A strain gauge can be considered as a resistor that converts electrical power into heat.

The influencing quantities – resistance of the strain gauge, SG grid surface and basic layout (for example the effect of a stacked grid) as well as the electrical voltage drop on the SG – affect the production of heat which flows through the measuring body with its specific heat conductance.

In the static case, the temperature of the measuring point increases until production and dissipation of heat are in thermal equilibrium. An accurate and stable measurement is not possible until this has occurred.

The maximum excitation voltage of every HBM SG at which the temperature increase of the measuring point does not exceed 5°C, thus resulting in a lowest possible measurement error of less than 5µm/m, is specified on the data sheet included with delivery.

The calculation assumes heat dissipation directly beneath the SG surface, taking into consideration heat conductance of the materials to which the SG has been matched.

Exceeding the maximum excitation voltage will not result in damage to the strain gauge and is far removed from the maximum voltage load, which is many hundreds of volts.

Maximum excitation voltage values for ferritic steel are indicated in the catalog. The table contains correction factors in comparison to steel if strain gauges with other temperature response matchings are used for the measurement. The best way to compensate for the extremely poor heat conductance of plastic is with a high-resistance SG, reduced voltage or switching on/off cycles.

Measuring body material	HBM code	Correction factor for ferr. steel
Ferritic steel	1	1
Aluminum	3	2.17
Austenitic steel	5	0.55
Silica / composite	6	0.12
Titanium / gray cast iron	7	0.66
Plastic	8	0.03
Molybdenum	9	1.65

Each SG package also contains the correct values for the respective material in terms of temperature response matching.

Additional tips and tricks on this topic can be found on our website.



## Reference temperature

The reference temperature is the ambient temperature to which the specifications of the SG refers if no temperature ranges are indicated. The specifications for the strain gauges are based on the reference temperature of 23 °C.

## Transverse sensitivity

The transverse sensitivity is the ratio of the sensitivity of a strain gauge transverse to the measuring grid direction to its sensitivity in the measuring grid direction. The transverse sensitivity is stated on each strain gauge package.

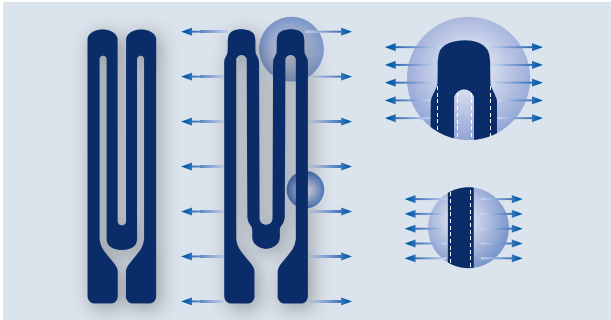

*Diagrammatic view of the transverse sensitivity of a measuring grid*

## Operating temperature range

The operating temperature range is the range of ambient temperatures in which the strain gauge can be used without lasting changes in measurement properties occurring. There are different operating temperature ranges for static (zero-point related) or dynamic (non zero-point related) measurements.

## Temperature response in a quarter bridge circuit

Strain gauges that are connected individually show an output signal if the temperature changes. This signal is called “apparent strain” or “thermal output” or “temperature response of a measuring point” and is independent of the mechanical load on the measurement object.

However, it is possible to adjust a strain gauge to the thermal expansion coefficient of a specific material so that the output signal is very small when the temperature changes. Strain gauges of this type are referred to as having “matched temperature response” or being “self-compensated” SGs. All HBM strain gauges, with the exception of the LD20 high-strain gauge, are self-compensated.

To benefit from their temperature response matching, strain gauges must be selected according to the thermal expansion coefficient  $\alpha$  of the test material. HBM therefore offers strain gauges for different materials. The code number for the temperature response matching is part of the SG type designation.

1	for ferritic steel	with $\alpha = 10.8 \cdot 10^{-6}/K$
3	for aluminum	with $\alpha = 23 \cdot 10^{-6}/K$
5	for austenitic steel	with $\alpha = 16 \cdot 10^{-6}/K$
6	for silica	with $\alpha = 0.5 \cdot 10^{-6}/K$
7	for titanium / gray cast iron	with $\alpha = 9 \cdot 10^{-6}/K$
8	for plastic	with $\alpha = 65 \cdot 10^{-6}/K$
9	for molybdenum	with $\alpha = 5.4 \cdot 10^{-6}/K$

Thus, for example, types LY21 or RY31 (code number 1) have been matched to ferritic steel. Despite this measure, a small residual error remains, which is printed on the package in the form of a mathematical function and a graphical realization – the apparent strain. The polynomial for apparent strain included with delivery refers to the strain gauge as well as the connecting cables (if fitted). If 2-wire circuits are used, the temperature effect of the conductors should be taken into consideration. With 3- and 4-wire circuits, the additional correction for the effect of the conductors is not needed.

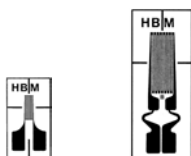

#### Strain gauges with integrated solder tabs or solder tabs with strain relief

- The polynomial for apparent strain specified on the data sheet included with delivery applies exclusively to temperature changes of the strain gauge.

#### Strain gauges with lead (Ni-plated copper lead) / with fluoropolymer-insulated connection wire (e.g. 1-LE11-3/350ZE) / with paint-insulated copper wires / pre-wired SG (e.g. K-CLY4, K-CLY9,...)

- The polynomial for apparent strain specified on the data sheet included with delivery applies to temperature changes of the strain gauge, including the connections. If the connections are shortened by  $L'$  [in mm], that value must be corrected accordingly in the formula.

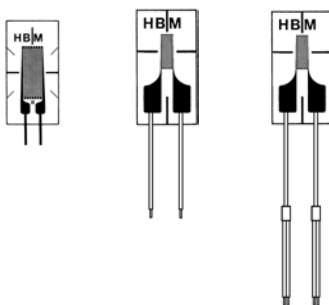

## Mechanical hysteresis

The mechanical hysteresis of a strain gauge is defined as the difference between the measured value displayed for increasing and decreasing strain loadings with the same strain value on the test specimen. The hysteresis is dependent not only on the strain gauge, but also to a major extent on application parameters such as type and layer thickness of the adhesive, etc. For this reason, the specifications include hysteresis values for different installation parameters.

## Maximum elongation

The maximum elongation of a strain gauge is the strain at which the characteristic curve (resistance change strain characteristic) deviates by more than  $\pm 5\%$  from the mean characteristic curve of the type. This is often the case if the installation or the strain gauge has been damaged.

## Minimum radius of curvature

The flexibility of a strain gauge is indicated by the minimum radius of curvature it is able to maintain in one direction without auxiliary measures. The polyimide carriers of Y and C series strain gauges are flexible to an extent that they can be bonded around edges. The carrier materials of the other strain gauge series are more brittle.

## Fatigue life

If a strain gauge is subjected to an alternating strain which can be superimposed over a static mean strain, an increase in the number of load cycles may create changes with regard to the zero point. The fatigue life is dependent on the number of strain cycles and their amplitude and is independent of applied strain duration.

The achievable numbers of load cycles depend on the various parameters of the specific installation and are therefore stated for representative examples only.

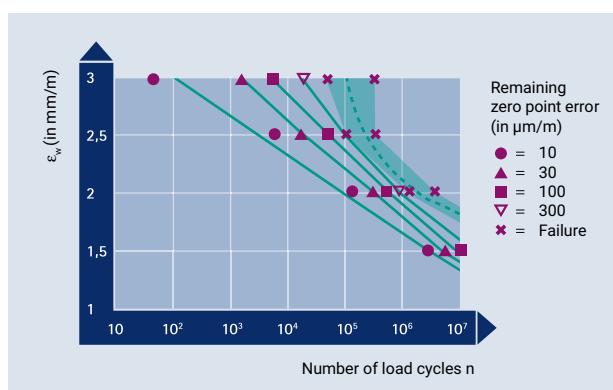

Sample realization of the fatigue life of strain gauges

## Applicable bonding materials

For each strain gauge series, the relevant bonding materials are specified. With regards to bonding technique, the HBM range of accessories distinguishes between cold and hot curing adhesives as well as spot welding methods. One of the most important selection criteria is the application temperature range of the individual bonding materials.

# From measured strain to mechanical stress

## Analysis of the biaxial stress state with unknown principal directions

The principle of experimental stress analysis using strain gauges (SG) consists in using strain gauges to measure strains on the component surface. From these measured strains and the known material properties (modulus of elasticity and Poisson's ratio), the absolute value and the direction of these mechanical stresses are determined. These calculations are based on Hooke's Law, which applies to the elastic deformation range of linear-elastic materials.

In experimental stress analysis, so-called 3-grid rosettes are used for strain measurements. These are available in 0°/45°/90° and 0°/60°/120° versions. Both forms have a historical background. It is up to the user to choose which version to use.

The three measuring grids of the rosettes are designated with the letters a, b and c. The three strains  $\varepsilon_a$ ,  $\varepsilon_b$ , and  $\varepsilon_c$  are measured accordingly using a rosette with 3 measuring grids.

The principal normal stresses  $\sigma_1$  and  $\sigma_2$  are calculated for the 0°/45°/90° strain gauge rosette using the formula:

$$\sigma_{1/2} = \frac{E}{1-\nu} \cdot \frac{\varepsilon_a + \varepsilon_c}{2} \pm \frac{E}{\sqrt{2}(1+\nu)} \cdot \sqrt{(\varepsilon_a - \varepsilon_b)^2 + (\varepsilon_c - \varepsilon_b)^2}$$

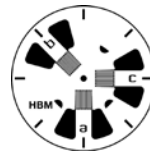

0°/45°/90° strain gauge rosette  
e.g. RY3x

and for the 0°/60°/120° rosette:

$$\sigma_{1/2} = \frac{E}{1-\nu} \cdot \frac{\varepsilon_a + \varepsilon_b + \varepsilon_c}{3} \pm \frac{E}{1+\nu} \cdot \sqrt{\left(\frac{2\varepsilon_a - \varepsilon_b - \varepsilon_c}{3}\right)^2 + \frac{1}{3}(\varepsilon_b - \varepsilon_c)^2}$$

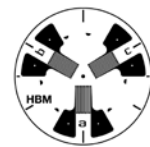

0°/60°/120° strain gauge rosette  
e.g. RY7x

The principal directions are determined below. First the tangent of an auxiliary angle  $\psi$  is calculated.

For the  $0^\circ/45^\circ/90^\circ$  rosette using the formula:

$$\tan \psi = \frac{2\varepsilon_b - \varepsilon_a - \varepsilon_c}{\varepsilon_a - \varepsilon_c} \quad \left| \quad \frac{Z}{N} \right.$$

and for the  $0^\circ/60^\circ/120^\circ$  rosette according to the formula:

$$\tan \psi = \frac{\sqrt{3}(\varepsilon_b - \varepsilon_c)}{2\varepsilon_a - \varepsilon_b - \varepsilon_c} \quad \left| \quad \frac{Z}{N} \right.$$

Comment: The tangent of an angle in a right-angled triangle is the ratio of the opposite side (= numerator N) to the adjacent side (= denominator D):

$$\tan \psi = \frac{\text{Opposite side}}{\text{Adjacent side}} = \frac{Z}{N}$$

This ambiguity of the tangent makes it necessary to determine the signs of the numerator (N) and denominator (D) before carrying out the final calculation of the two above mentioned quotients. It is important to determine the sign because that is the only way to know which quadrant of the circle the angle  $\psi$  will be found in.

From the value of the tan, the absolute value of the intermediate angle  $\psi$  must first be determined:

$$|\psi| = \arctan [^\circ]$$

Then the angle  $\varphi$  should be determined using the following scheme:

$$\left. \begin{array}{l} Z \geq 0 (+) \\ N > 0 (+) \end{array} \right\} \varphi = \frac{1}{2}(0^\circ + |\psi|)$$

$$\left. \begin{array}{l} Z > 0 (+) \\ N \leq 0 (-) \end{array} \right\} \varphi = \frac{1}{2}(180^\circ - |\psi|)$$

$$\left. \begin{array}{l} Z \leq 0 (-) \\ N < 0 (-) \end{array} \right\} \varphi = \frac{1}{2}(180^\circ + |\psi|)$$

$$\left. \begin{array}{l} Z < 0 (-) \\ N \geq 0 (+) \end{array} \right\} \varphi = \frac{1}{2}(360^\circ - |\psi|)$$

Apply the angle  $\varphi$  that is found in this manner starting from the axis of the reference grid a in a mathematically positive direction (counterclockwise). The axis of the measuring grid a forms one arm of the angle  $\varphi$ . The other arm represents the first principal direction. This is the direction of the principal normal stress  $\sigma_1$  (identical with principal strain direction  $\varepsilon_1$ ). The vertex is located at the intersection of the measuring grid axes. The second principal direction (direction of the principal normal stress  $\sigma_2$ ) has the angle  $\varphi + 90^\circ$ .

# How to easily find the right strain gauge

## Geometry of the SG

The geometry of the strain gauge depends on the measurement task to be accomplished.

### Linear strain gauges (e.g. LY1), one measuring grid

Application:

- Strain measurement in one direction

### T rosettes with two measuring grids (e.g. XY1) that are arranged offset 90° from each other

Applications:

- Analysis of the biaxial stress state with known principal directions
- Measurements on tension/compression bars

For more detailed information see 1) and 2)

### Shear / torsion strain gauges (e.g. XY2), two measuring grids, arranged at ±45° relative to the SG axis

Applications:

- Measurements on torsion bars
- Determination of shear stresses occurring in shear beams around the neutral fiber

For more detailed information see 1) and 2)

### 3-grid rosettes, arranged at 0°/45°/90° (e.g. RY8) or 0°/60°/120° (e.g. RY4)

Application:

- Analysis of the biaxial stress state with unknown principal stress directions
- The three measuring grids are arranged in a so-called quarter bridge circuit. The absolute value and the direction of the first and second principal stress are computed as described on page 12.

For more detailed information see 2)

### Double linear strain gauges (e.g. DY1) with two measuring grids

arranged in parallel

Application:

- Measurements on bending beams

For more detailed information see 1) and 2)

### Full bridge strain gauges (e.g. VY4), offset by 90° relative to each other

Applications:

- Measurements on tension/compression bars
- Measurements on torsion bars
- Determination of shear stresses occurring in shear beams around the neutral fiber

For more detailed information see 1) and 2)

### Strain gauge chains (e.g. KY1), 10 or 15 very small measuring grids spaced equidistantly on a common carrier plus one compensating strain gauge

Application:

- Determination of strain gradients.

HBM also supplies strain gauge chains complete with several strain gauge rosettes and

alternating measuring grid directions so that it is even possible to determine the gradient of a biaxial stress state.

For more detailed information see 2)

### Diaphragm rosettes (e.g. MY1), four measuring grids

Applications:

- Manufacture of diaphragm pressure transducers

1) Brochure "Using the Wheatstone bridge circuit"

2) Book: "An Introduction to Measurements Using Strain Gauges"

## Strain gauge measuring grid length

The **SG measuring grid length** depends on the aim of measurement, since the result of a measurement with strain gauges (SGs) will be determined as the average of strains underneath the measuring grid. In general, measuring grid lengths of 3 or 6 mm represent a good solution.

**Long measuring grids** are recommended where there is an inhomogeneous material such as concrete or wood, etc. A long strain gauge will bridge the inhomogeneities of the workpiece and, as a measurement result, will supply the strain underneath the measuring grid.

**Short measuring grids** are suitable for acquiring a local strain state. They are therefore suitable for determining strain gradients (see strain gauge chains), the maximum point of notch stresses and similar stresses.

## Strain gauge series

The HBM strain gauge range comprises various type series for the following typical applications:

**Y strain gauges:** The universal strain gauge for experimental stress analysis and simple transducers. Easy to handle, robust, flexible, many geometries and nominal (rated) resistances available.

Measuring grid: Constantan; Measuring grid carrier: Polyimide

**C strain gauges:** For measurements at extreme temperatures; operating temperature range from -269 ... up to +250°C; temperature response with matching in the range of -200 ... +250°C.

Measuring grid: Cr-Ni alloy; Measuring grid carrier: Polyimide

**M strain gauges:** Feature excellent fatigue life and are used for measurements at extreme temperatures, with temperature application range from -200 ... to +250°C, briefly up to 300°C; temperature response matched in the range from -200 ... +250°C.

Measuring grid: Cr-Ni alloy; Measuring grid carrier: phenolic resin, glass-fiber reinforced

**G strain gauges:** For special applications and transducer construction; available with nominal (rated) resistances 120Ω and 350Ω

Measuring grid: Constantan; Measuring grid carrier: phenolic resin, glass fiber reinforced.

## Strain gauge resistance

HBM strain gauges are available in 120, 350, 700 and 1,000 ohm versions. The selection of the resistance depends on the constraints of the measurement task. Other resistances on request.

### 120 Ω SG:

- + Relative insensitivity to variations in insulation resistance, e.g. caused by effects of humidity.

### High ohm strain gauges:

- + Less specific heat because of the lower measurement current
- + Less sensitive to ohmic resistances in the connection lines to the measuring amplifier.
- Better antennas for reception of noise pulses

## Selecting a strain gauge for experimental stress analysis

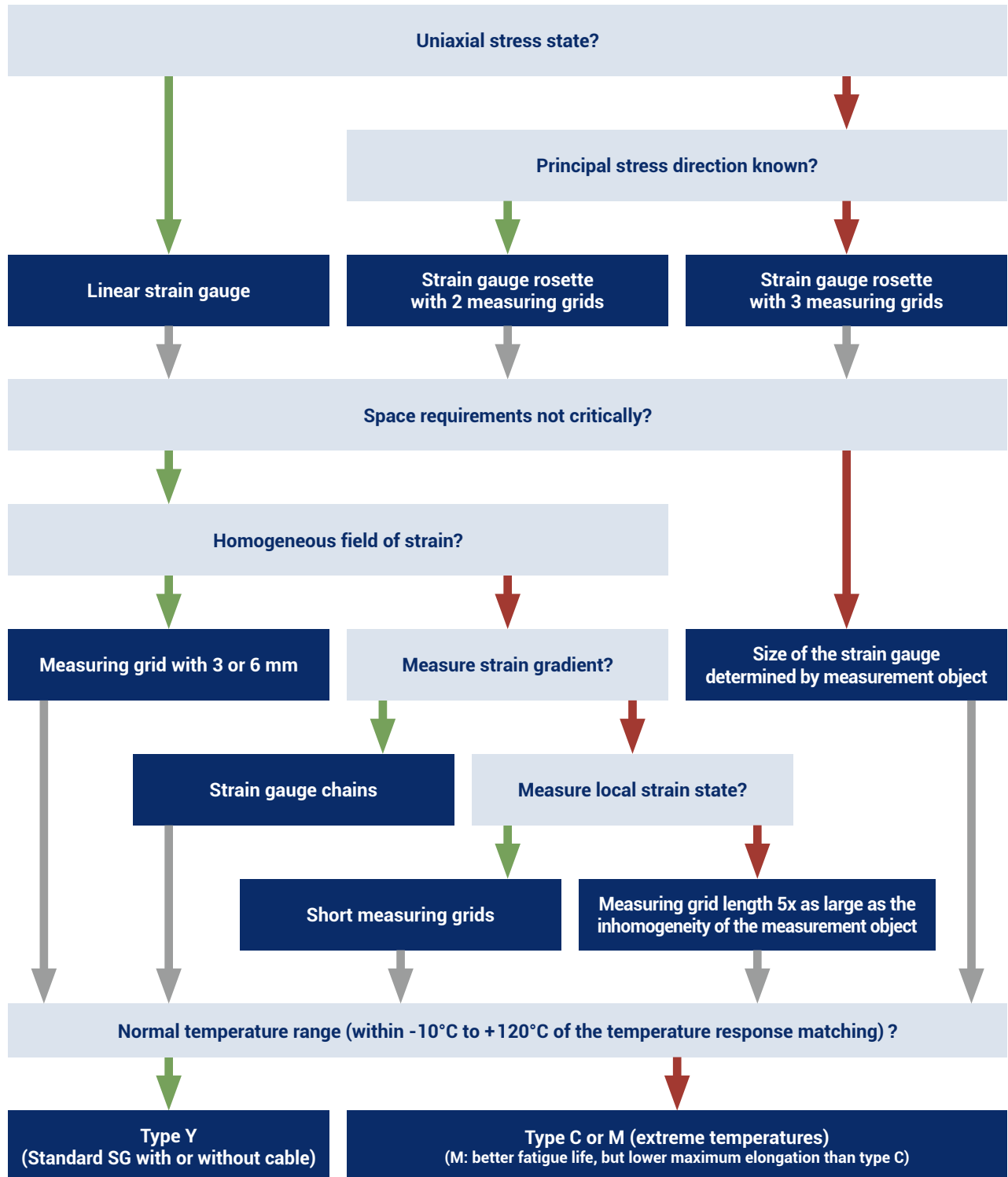

**Note:** If you are looking for strain gauges for transducer construction, we recommend our catalog "Strain Gauges for Manufacturers of Transducers" with SG series designed especially for this purpose.

↓ **YES**
↓ **NO**

# Type coding

## 1 - L Y 1 1 - 3 / 120 A

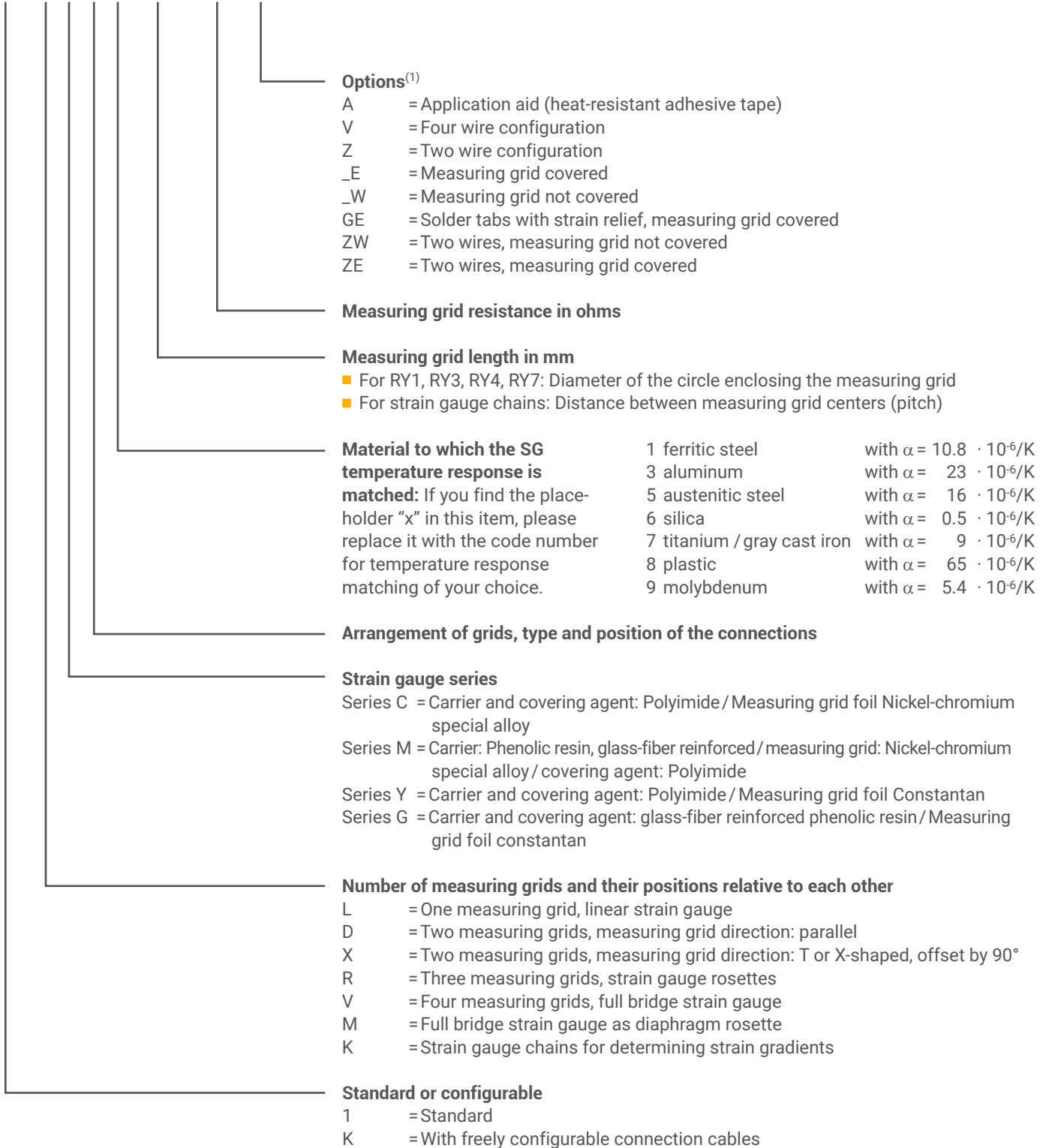

<sup>(1)</sup> Only available for selected SG types; letter code is used to differentiate for strain gauges with determination of residual stress



## An even greater range of types – easy to order

The current catalog offers a great selection of strain gauges (SG). In addition to our wide range of preferential strain gauges (available from stock), we keep a comprehensive choice of variants available for you.

## This is how easily you can order our strain gauges

Types available from stock are printed on a shaded background in our price list. Strain gauge variants do not have a shaded background and are not always available from stock. We will be pleased to provide information on current availability if requested. The minimum order quantity for these strain gauges is 3 packages.

## What does the “x” in the type designation of the strain gauges in the “Variants” column stand for?

Types available from stock		Variants	Nom-resistance	Dimensions (mm)				Max. perm. effective bridge ex. voltage	Solder terminals
Steel	Aluminum			Measuring grid		Meas. grid carrier			
		Other	Ω	a	b	c	d	V	
1-LY11-0.6/120	1-LY13-0.6/120		120	0.6	1	5	3.2	1.5	LS 7
1-LY11-1.5/120	1-LY13-1.5/120	1-LY1x-1.5/120	120	1.5	1.2	6.5	4.7	2.5	LS 7
1-LY11-3/120	1-LY13-3/120	1-LY1x-3/120	120	3	1.4	8.5	4.5	4	LS 7
1-LY11-3/120A		1-LY1x-3/120A	120	3	1.4	8.5	4.5	4	LS 7
1-LY11-6/120	1-LY13-6/120	1-LY1x-6/120	120	6	2.8	13	6	8	LS 5
1-LY11-6/120A		1-LY1x-6/120A	120	6	2.8	13	6	8	LS 5
1-LY11-10/120	1-LY13-10/120	1-LY1x-10/120	120	10	4.9	18.5	9.5	13	LS 5
1-LY11-10/120A		1-LY1x-10/120A	120	10	4.9	18.5	9.5	13	LS 5
1-LY11-1.5/350	1-LY13-1.5/350		350	1.5	1.2	5.7	4.7	4.5	LS 212
1-LY11-3/350	1-LY13-3/350	1-LY1x-3/350	350	3	1.5	8.5	4.5	7	LS 7
		1-LY1x-3/350A	350	3	1.5	8.5	4.5	7	LS 7
1-LY11-6/350	1-LY13-6/350	1-LY1x-6/350	350	6	2.9	13	6	14	LS 5
1-LY11-6/350A		1-LY1x-6/350A	350	6	2.9	13	6	14	LS 5
1-LY11-10/350		1-LY1x-10/350	350	10	5	18.5	9.5	23	LS 5
1-LY11-10/350A		1-LY1x-10/350A	350	10	5	18.5	9.5	23	LS 5

Instead of the placeholder “x” in the type coding of strain gauges in the “Other” column, please enter the code number for the appropriate temperature response compensation.

### Example:

You would like matching of type 1-LY1x-10/120 to plastic. Then enter an “8” instead of the placeholder “x” when ordering; the exact order designation will then be 1-LY18-10/120.

The preferential strain gauges are matched to steel or aluminum.

Please note the exceptions in the case of identified types!

For easy ordering please use our HBM online shop [www.hbm.com/HBMshop](http://www.hbm.com/HBMshop)

# Strain gauges – Y series

- The universal SG
- Excellent measuring characteristics
- Different connection configurations
- Strain gauge with connection cable (Page 40)
- Flexible, therefore easy to handle
- Wide range of geometries available from stock
- Many geometries are available in different nominal (rated) resistances (120, 350, 700, 1,000 $\Omega$ )



## Specifications – Y series

SG construction		Foil SG with embedded measuring grid
Measuring grid		
Material		Constantan foil
Thickness	µm	approx. 3.8 or 5, depending on SG type
Carrier		
Material		Polyimide
Thickness	µm	55 ± 5
Covering agent		
Material		Polyimide
Total thickness SG	µm	81 ± 22
Connections for SG without lead		Ni-plated copper leads, approx. 30 mm long Integrated solder tabs, approx. 1.5 mm long, approx. 1.6 ... 2.2 mm wide Copper-beryllium solder tabs with strain relief
Nominal resistance	Ω	120, 350, 700 or 1,000, depending on SG type
Resistance tolerance <sup>(2)</sup>	%	± 0.3 without ± 0.35 with leads
Gauge factor		approx. 2
Nominal (rated) value of the gauge factor		Specified on each package
Gauge factor tolerance for % measuring grid length of 1.5 mm	%	± 1.5
with measuring grid length of ≥ 3 mm	%	± 1
Temperature coefficient of the gauge factor	1/K	approx. (115 ± 10) · 10 <sup>-6</sup>
Nominal (rated) value of the temperature coefficient of the gauge factor		Specified on each package
Reference temperature	°C	23
Application temperature range		
for static, i.e. zero-point related measurements	°C	-70 ... +200
for dynamic, non zero-point related measurements	°C	-200 ... +200
Transverse sensitivity at reference temperature using adhesive Z 70 on SG type LY11-6/120	%	Specified on each package -0.1
Temperature response		Specified on each package
Temperature response matched to choice of expansion coefficient		
α for ferritic steel	1/K	10.8 · 10 <sup>-6</sup>
α for aluminum	1/K	23 · 10 <sup>-6</sup>
α for plastic	1/K	65 · 10 <sup>-6</sup>
α for austenitic steel	1/K	16 · 10 <sup>-6</sup>
α for titanium	1/K	9 · 10 <sup>-6</sup>
α for molybdenum	1/K	5.4 · 10 <sup>-6</sup>
α for silica	1/K	0.5 · 10 <sup>-6</sup>
Tolerance of temperature response	1/K	± 0.3 · 10 <sup>-6</sup>
Temperature response with matching in the range of <sup>(3)</sup>	°C	-10 ... +120
Mechanical hysteresis <sup>(1)</sup> at reference temperature and strain ε = ± 1,000 µm/m on SG type LY11-6/120		
at 1st load cycle and adhesive Z 70	µm/m	1
at 3rd load cycle and adhesive Z 70	µm/m	0.5
at 1st load cycle and adhesive X 60	µm/m	2.5
at 3rd load cycle and adhesive X 60	µm/m	1
Maximum elongation <sup>(1)</sup> at reference temperature using adhesive Z 70 on SG type LY11-6/120		
Absolute strain value ε for positive direction	µm/m	50,000 (Δ 5%)
Absolute strain value ε for negative direction	µm/m	50,000 (Δ 5%)
Fatigue life <sup>(1)</sup> at reference temperature using adhesive X 60 on SG type LY61-6/120		
Achievable number of load cycles L <sub>w</sub> with alternating strain ε <sub>w</sub> = ± 1,000 µm/m and variation of zero point ε <sub>m</sub> Δ ≤ 300 µm/m ε <sub>m</sub> Δ ≤ 30 µm/m		>> 10 <sup>7</sup> (test was interrupted at 10 <sup>7</sup> ) > 10 <sup>7</sup> (test was interrupted at 10 <sup>7</sup> )
Minimum radius of curvature, longitudinal and transverse, at reference temperature for strain gauges with leads	mm	0.3
for strain gauges with integrated solder tabs		
within measuring grid area	mm	0.3
within solder tabs area	mm	2
Applicable bonding materials		
Cold curing adhesives		Z 70; X 60; X 280
Hot curing adhesives		EP 150; EP 310N

(1) The data depend on the various parameters of the specific installation and are therefore stated for representative examples only.

(2) With measuring grid lengths of 0.3 and 0.6 mm, the nominal resistance may deviate by ± 1 %. For types LY51 / LY5x the deviation is ± 0.75 %.

For XY9x, RY9x and the KY types (per chain) it is ± 0.5 %

(3) Matching to plastic (code number 8) is only possible in the temperature range of -10 ... +50 °C

# Y series

with one measuring grid / linear strain gauge

## LY11

**Linear strain gauge**  
Temperature response matched to steel  
with  $\alpha = 10.8 \cdot 10^{-6}/K$

## LY13

Temperature response matched to aluminum  
with  $\alpha = 23 \cdot 10^{-6}/K$

## LY1x

Temperature response matched to customer's choice  
see page 16

Illustrations show actual size  
(indicated: grid length in mm)

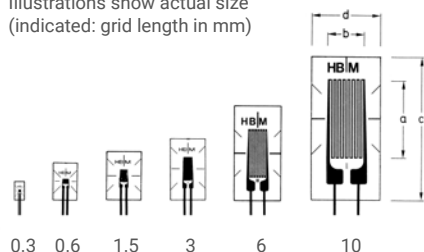

Contents per package: 10 pcs.

Types available from stock		Variants	Noml. resistance	Dimensions (mm)				Maximum excitation voltage (*)	Sldr. terminals
Steel	Aluminum			Measuring grid		Meas. grid carrier			
		Other	$\Omega$	a	b	c	d	V	
1-LY11-0.3/120		1-LY1x-0.3/120 <sup>(#)</sup>	120	0.3	0.9	2	1.2	0.6	LS 7
1-LY11-0.6/120	1-LY13-0.6/120	1-LY1x-0.6/120 <sup>(#)</sup>	120	0.6	1	5	3.2	1.5	LS 7
1-LY11-1.5/120	1-LY13-1.5/120	1-LY1x-1.5/120	120	1.5	1.2	6.5	4.7	2.5	LS 7
1-LY11-3/120	1-LY13-3/120	1-LY1x-3/120	120	3	1.6	8.5	4.5	4	LS 7
1-LY11-3/120A		1-LY1x-3/120A	120	3	1.6	8.5	4.5	4	LS 7
1-LY11-6/120	1-LY13-6/120	1-LY1x-6/120	120	6	2.7	13	6	8	LS 5
1-LY11-6/120A		1-LY1x-6/120A	120	6	2.7	13	6	8	LS 5
1-LY11-10/120	1-LY13-10/120	1-LY1x-10/120	120	10	4.6	18.5	9.5	13	LS 5
1-LY11-10/120A		1-LY1x-10/120A	120	10	4.6	18.5	9.5	13	LS 5
1-LY11-1.5/350	1-LY13-1.5/350	1-LY1x-1.5/350 <sup>(#)</sup>	350	1.5	1.2	5.7	4.7	4.5	LS 7
1-LY11-3/350	1-LY13-3/350	1-LY1x-3/350	350	3	1.6	8.5	4.5	7	LS 7
		1-LY1x-3/350A	350	3	1.6	8.5	4.5	7	LS 7
1-LY11-6/350	1-LY13-6/350	1-LY1x-6/350	350	6	2.8	13	6	13	LS 5
		1-LY1x-6/350A	350	6	2.8	13	6	13	LS 5
1-LY11-10/350		1-LY1x-10/350	350	10	5.0	18.5	9.5	23	LS 5
		1-LY1x-10/350A	350	10	5.0	18.5	9.5	23	LS 5

(\*) Maximum excitation voltage for ferritic steel. For other temperature response matchings, the corresponding value is printed on the data sheet included with delivery.

<sup>(#)</sup> Types are only available with matching to aluminum, ferritic or austenitic steel

## LY21

**Linear strain gauge**  
Temperature response matched to steel  
with  $\alpha = 10.8 \cdot 10^{-6}/K$

## LY2x

Temperature response matched to customer's choice  
see page 16

Illustrations show actual size  
(indicated: grid length in mm)

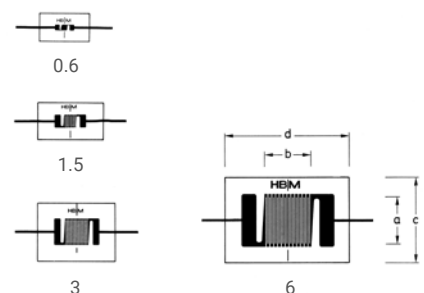

Contents per package: 10 pcs.

Types available from stock		Variants	Noml. resistance	Dimensions (mm)				Maximum excitation voltage (*)	Sldr. terminals
Steel	Aluminum			Measuring grid		Meas. grid carrier			
		Other	$\Omega$	a	b	c	d	V	
1-LY21-0.6/120		1-LY2x-0.6/120 <sup>(#)</sup>	120	0.6	0.6	3.5	6.4	1	LS 7
		1-LY2x-1.5/120	120	1.5	1.5	4.7	8.3	2	LS 5
1-LY21-3/120		1-LY2x-3/120	120	3	2.8	7.5	10	6	LS 5
		1-LY2x-6/120	120	6	6	11	16	12	LS 4

(\*) Maximum excitation voltage for ferritic steel. For other temperature response matchings, the corresponding value is printed on the data sheet included with delivery.

<sup>(#)</sup> Types are only available with matching to aluminum, ferritic or austenitic steel

# Y series

with one measuring grid / linear strain gauge

## LY41

**Linear strain gauge**  
Temperature response matched to steel  
with  $\alpha = 10.8 \cdot 10^{-6}/K$

## LY43

Temperature response matched to aluminum  
with  $\alpha = 23 \cdot 10^{-6}/K$

## LY4x

Temperature response matched to customer's choice  
see page 16

Illustrations show actual size  
(indicated: grid length in mm)

Contents per package: 10 pcs.

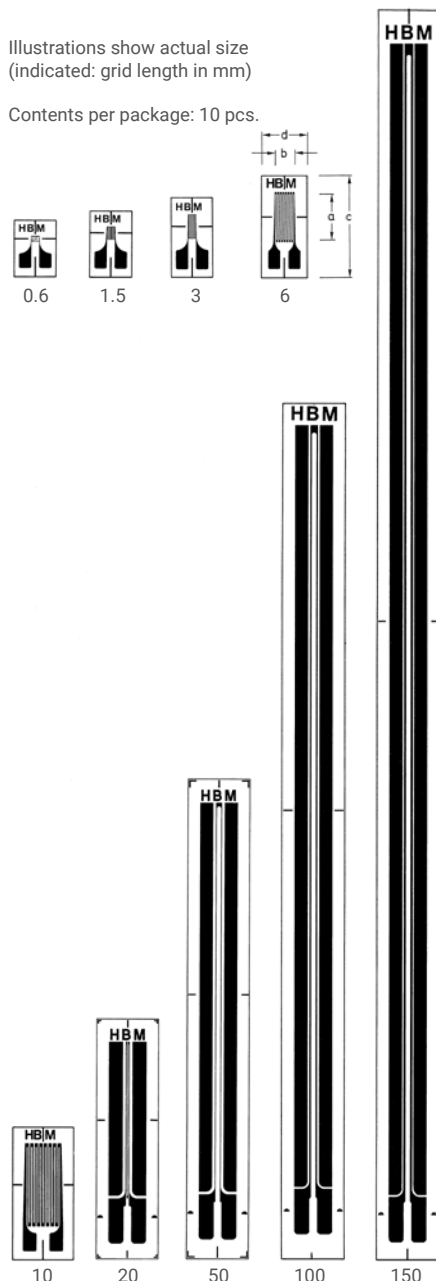

Types available from stock		Variants	Noml. resistance $\Omega$	Dimensions (mm)				Maximum excitation voltage (*) V	Sldr. terminals (1)
Steel	Aluminum			Measuring grid		Meas. grid carrier			
		Other		a	b	c	d		
1-LY41-0.6/120		1-LY4x-0.6/120 <sup>(#)</sup>	120	0.6	1.1	6	4	1.5	LS 7
1-LY41-1.5/120	1-LY43-1.5/120	1-LY4x-1.5/120	120	1.5	1.2	7	5	2.5	LS 5
1-LY41-3/120	1-LY43-3/120	1-LY4x-3/120	120	3	1.2	8	5	3.5	LS 5
		1-LY4x-3/120A	120	3	1.2	8	5	3.5	LS 5
1-LY41-6/120	1-LY43-6/120	1-LY4x-6/120	120	6	2.7	13.9	5.9	8	LS 5
1-LY41-6/120A		1-LY4x-6/120A	120	6	2.7	13.9	5.9	8	LS 5
1-LY41-10/120		1-LY4x-10/120	120	10	5	18	8	14	LS 5
		1-LY4x-10/120A	120	10	5	18	8	14	LS 5
1-LY41-20/120		1-LY4x-20/120	120	20	0.5	31.8	8.2	6.5	LS 5
1-LY41-50/120		1-LY4x-50/120	120	50	0.8	63.6	8.2	12	LS 5
1-LY41-100/120		1-LY4x-100/120	120	100	1	114.8	8.2	19	LS 5
1-LY41-150/120		1-LY4x-150/120	120	150	1.2	165.6	8.2	25	LS 5
1-LY41-1.5/350		1-LY4x-1.5/350 <sup>(#)</sup>	350	1.5	2.3	9.2	5.9	6.5	LS 5
1-LY41-3/350	1-LY43-3/350	1-LY4x-3/350	350	3	2.5	10.9	5.9	9	LS 5
1-LY41-3/350A		1-LY4x-3/350A	350	3	2.5	10.9	5.9	9	LS 5
1-LY41-6/350	1-LY43-6/350	1-LY4x-6/350 <sup>(2)</sup>	350	6	2.8	13.9	5.9	15	LS 5
		1-LY4x-6/350A	350	6	2.8	13.9	5.9	15	LS 5
1-LY41-10/350		1-LY4x-10/350	350	10	5	18	8	24	LS 5
		1-LY4x-10/350A	350	10	5	18	8	24	LS 5
		1-LY4x-20/350	350	20	0.5	31.8	8.2	10	LS 5
1-LY41-3/700	1-LY43-3/700	1-LY4x-3/700	700	3	2.7	10.9	5.9	13	LS 5
1-LY41-6/700		1-LY4x-6/700	700	6	4.1	13.9	5.9	23	LS 5
		1-LY4x-10/700	700	10	5	18	8	33	LS 5
		1-LY4x-3/1000 <sup>(#)</sup>	1,000	3	2.7	10.9	5.9	16	LS 5
1-LY41-6/1000		1-LY4x-6/1000	1,000	6	4.2	13.9	5.9	27	LS 5
		1-LY4x-10/1000	1,000	10	5	18	8	40	LS 5

(\*) Maximum excitation voltage for ferritic steel. For other temperature response matchings, the corresponding value is printed on the data sheet included with delivery.  
 (1) Solder terminals are not mandatory  
 (2) With temperature response matching to silica (i.e. x = 6) also available as preferred type (available from stock)  
 (#) Types are only available with matching to aluminum, ferritic or austenitic steel

# Y series

with one measuring grid / linear strain gauge

## LY5x

Temperature response matched to customer's choice see page 16

Illustrations show actual size (indicated: grid length in mm)

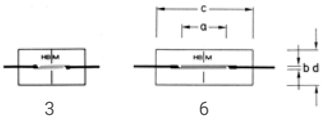

Contents per package: 10 pcs.

Types available from stock		Variants	Noml. resistance $\Omega$	Dimensions (mm)				Maximum excitation voltage (*) V	Sldr. terminals
Steel	Aluminum			Measuring grid		Meas. grid carrier			
		Other		a	b	c	d		
		1-LY5x-3/120	120	3	0.4	9	4.7	2	LS 7
		1-LY5x-6/120	120	6	0.4	13	4.7	3	LS 7

(\*) Maximum excitation voltage for ferritic steel. For other temperature response matchings, the corresponding value is printed on the data sheet included with delivery.

## LY61

### Linear strain gauge

Temperature response matched to steel with  $\alpha = 10.8 \cdot 10^{-6}/K$

## LY63

Temperature response matched to aluminum with  $\alpha = 23 \cdot 10^{-6}/K$

## LY6x

Temperature response matched to customer's choice see page 16

Illustrations show actual size (indicated: grid length in mm)

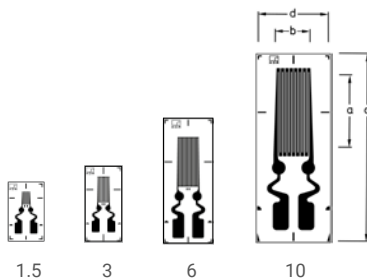

Contents per package: 10 pcs.

Types available from stock		Variants	Noml. resistance $\Omega$	Dimensions (mm)				Maximum excitation voltage (*) V	Sldr. terminals
Steel	Aluminum			Measuring grid		Meas. grid carrier			
		Other		a	b	c	d		
1-LY61-1.5/120		1-LY6x-1.5/120	120	1.5	1.0	7.8	4.7	2.5	–
1-LY61-3/120		1-LY6x-3/120	120	3	1.5	9.8	4.7	4	–
1-LY61-6/120	1-LY63-6/120	1-LY6x-6/120	120	6	2.7	16	6.3	8	–
1-LY61-10/120		1-LY6x-10/120	120	10	4.6	23.5	9.3	13	–
1-LY61-3/350		1-LY6x-3/350	350	3	1.6	9.8	4.7	7	–
1-LY61-6/350	1-LY63-6/350	1-LY6x-6/350 <sup>(1)</sup>	350	6	2.7	16	6.3	13	–
1-LY61-6/350A		1-LY6x-6/350A	350	6	2.7	16	6.3	13	–
1-LY61-10/350		1-LY6x-10/350	350	10	5	23.5	9.3	21	–

(\*) Maximum excitation voltage for ferritic steel. For other temperature response matchings, the corresponding value is printed on the data sheet included with delivery.

<sup>(1)</sup> With temperature response matching to silica (i.e. x=6) also available as preferred type (available from stock)

# Y series

with one measuring grid / linear strain gauge

## LY71

**Linear strain gauge**  
Temperature response matched to steel  
with  $a = 10.8 \cdot 10^{-6}/K$

## LY73

Temperature response matched to aluminum  
with  $a = 23 \cdot 10^{-6}/K$

## LY7x

Temperature response matched to customer's choice  
see page 16

Illustrations show actual size  
(indicated: grid length in mm)

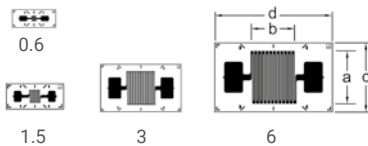

Contents per package: 10 pcs.

Types available from stock		Variants	Noml. resistance	Dimensions (mm)				Maximum excitation voltage (*)	Sldr. terminals (1)
Steel	Aluminum			Measuring grid		Meas. grid carrier			
		Other	$\Omega$	a	b	c	d	V	
		1-LY7x-0.6/120(#)	120	0.6	1	2.3	5.6	1	LS7
1-LY71-0.6/120			120	1.5	1.5	3.4	7.5	2.5	LS5
1-LY71-1.5/120		1-LY7x-3/120	120	3	2.8	5.5	10.5	5	LS4
		1-LY7x-6/120	120	6	6	9	15.5	10	LS4
1-LY71-1.5/350	1-LY73-1.5/350	1-LY7x-1.5/350(#)	350	1.5	1.6	3.4	7.5	5	LS5
1-LY71-3/350		1-LY7x-3/350	350	3	2.7	5.5	10.5	8.5	LS4
		1-LY7x-6/350	350	6	5.6	9	15.5	18	LS4

(\*) Maximum excitation voltage for ferritic steel. For other temperature response matchings, the corresponding value is printed on the data sheet included with delivery.

(1) Solder terminals are not mandatory

(#) Types are only available with matching to aluminum, ferritic or austenitic steel

## LY81

**Linear strain gauge**  
Temperature response matched to steel  
with  $a = 10.8 \cdot 10^{-6}/K$

## LY8x

Temperature response matched to customer's choice  
see page 16

Illustrations show actual size  
(indicated: grid length in mm)

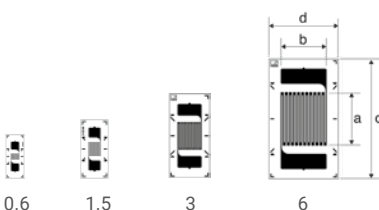

Contents per package: 10 pcs.

Types available from stock		Variants	Noml. resistance	Dimensions (mm)				Maximum excitation voltage (*)	Sldr. terminals (1)
Steel	Aluminum			Measuring grid		Meas. grid carrier			
		Other	$\Omega$	a	b	c	d	V	
		1-LY8x-0.6/120(#)	120	0.6	1	5.6	2.3	1	LS7
1-LY81-0.6/120			120	1.5	1.5	7.5	3.4	2.5	LS5
1-LY81-1.5/120		1-LY8x-3/120	120	3	3	10.5	5.5	5	LS4
		1-LY8x-6/120	120	6	6	15.5	9	10	LS4
1-LY81-1.5/350		1-LY8x-1.5/350(#)	350	1.5	1.5	7.5	3.4	5	LS5
		1-LY8x-3/350	350	3	3	10.5	5.5	8.5	LS4
1-LY81-3/350		1-LY8x-6/350	350	6	5.6	15.5	9	18	LS4

(\*) Maximum excitation voltage for ferritic steel. For other temperature response matchings, the corresponding value is printed on the data sheet included with delivery.

(1) Solder terminals are not mandatory

(#) Types are only available with matching to aluminum, ferritic or austenitic steel

# Y series

with one measuring grid / linear strain gauge

## LY91

### Linear strain gauge

Temperature response matched to steel  
with  $\alpha = 10.8 \cdot 10^{-6}/K$

## LY9x

Temperature response matched to customer's choice  
see page 16

Illustrations show actual size  
(indicated: grid length in mm)

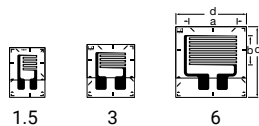

Contents per package: 10 pcs.

Types available from stock		Variants	Noml. resistance $\Omega$	Dimensions (mm)				Maximum excitation voltage (*) V	Sldr. terminals
Steel	Aluminum			Measuring grid		Meas. grid carrier			
		Other		a	b	c	d		
		1-LY9x-1.5/120_E	120	1.5	2	6.6	4.7	3.5	LS 5
		1-LY9x-3/120_E	120	3	2	6.3	7	4.5	LS 5
		1-LY9x-6/120_E	120	6	4	9.5	9.5	9	LS 5
1-LY91-1.5/350_E		1-LY9x-1.5/350_E(#)	350	1.5	2	6.6	4.7	5.5	LS 7
1-LY91-3/350_E		1-LY9x-3/350_E	350	3	2	7	6.3	8	LS 5
1-LY91-6/350_E		1-LY9x-6/350_E	350	6	4	9.5	9.5	15.5	LS 5

(\*) Maximum excitation voltage for ferritic steel. For other temperature response matchings, the corresponding value is printed on the data sheet included with delivery.

(#) Types are only available with matching to aluminum, ferritic or austenitic steel



# Y series

with two measuring grids / double linear strain gauge

## DY11

### Double linear strain gauge

Temperature response matched to steel with  $\alpha = 10.8 \cdot 10^{-6}/K$

## DY13

Temperature response matched to aluminum with  $\alpha = 23 \cdot 10^{-6}/K$

## DY1x

Temperature response matched to customer's choice see page 16

Illustrations show actual size (indicated: grid length in mm)

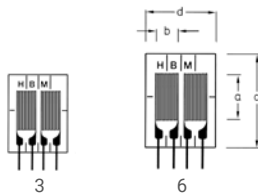

Contents per package: 5 pcs.

Types available from stock		Variants	Noml. resistance	Dimensions (mm)				Maximum excitation voltage (*)	Sldr. terminals
Steel	Aluminum			Measuring grid		Meas. grid carrier			
		Other	$\Omega$	a	b	c	d	V	
1-DY11-3/350	1-DY13-3/350	1-DY1x-3/350	350	3	2.7	9	8	9	LS 7
1-DY11-6/350	1-DY13-6/350	1-DY1x-6/350	350	6	3.2	12.5	9.4	14	LS 7

(\*) Maximum excitation voltage for ferritic steel. For other temperature response matchings, the corresponding value is printed on the data sheet included with delivery.

## DY41

### Double linear strain gauge

Temperature response matched to steel with  $\alpha = 10.8 \cdot 10^{-6}/K$

## DY43

Temperature response matched to aluminum with  $\alpha = 23 \cdot 10^{-6}/K$

## DY4x

Temperature response matched to customer's choice see page 16

Illustrations show actual size (indicated: grid length in mm)

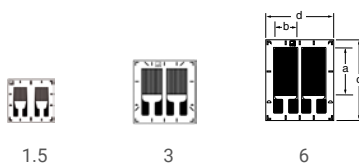

Contents per package: 5 pcs.

Types available from stock		Variants	Noml. resistance	Dimensions (mm)				Maximum excitation voltage (*)	Sldr. terminals (1)
Steel	Aluminum			Measuring grid		Meas. grid carrier			
		Other	$\Omega$	a	b	c	d	V	
1-DY41-1.5/350		1-DY4x-1.5/350(#)	350	1.5	1.8	5.5	6	5	LS 7
1-DY41-3/350	1-DY43-3/350	1-DY4x-3/350	350	3	2.7	8.2	8	8.5	LS 7
1-DY41-6/350		1-DY4x-6/350	350	6	3.2	10.7	9	13	LS 7

(\*) Maximum excitation voltage for ferritic steel. For other temperature response matchings, the corresponding value is printed on the data sheet included with delivery.

(1) Solder terminals are not mandatory

(#) Types are only available with matching to aluminum, ferritic or austenitic steel

# Y series

with two measuring grids / T rosette / double SG

## XY11

**0°/90° T rosette**  
Temperature response matched to steel  
with  $\alpha = 10.8 \cdot 10^{-6}/K$

## XY13

Temperature response matched to aluminum  
with  $\alpha = 23 \cdot 10^{-6}/K$

## XY1x

Temperature response matched to customer's choice  
see page 16

Illustrations show actual size  
(indicated: grid length in mm)

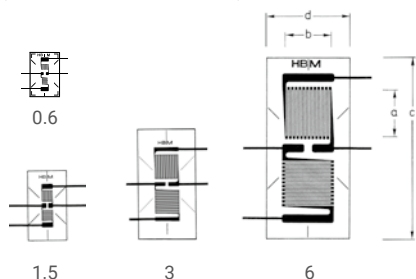

Contents per package: 5 pcs.

Types available from stock		Variants	Noml. resistance	Dimensions (mm)				Maximum excitation voltage (*)	Sldr. terminals
Steel	Aluminum			Measuring grid		Meas. grid carrier			
		Other	$\Omega$	a	b	c	d	V	
1-XY11-0.6/120		1-XY1x-0.6/120 <sup>(#)</sup>	120	0.6	1.1	6	4	1.5	LS 7
1-XY11-1.5/120	1-XY13-1.5/120	1-XY1x-1.5/120	120	1.5	1.5	9	5	3	LS 5
1-XY11-3/120	1-XY13-3/120	1-XY1x-3/120	120	3	3.2	14.5	7.5	6	LS 4
1-XY11-6/120		1-XY1x-6/120	120	6	6.5	23.5	11	12	LS 4
1-XY11-1.5/350		1-XY1x-1.5/350 <sup>(#)</sup>	350	1.5	1.5	9	5	5	LS 5
1-XY11-3/350	1-XY13-3/350	1-XY1x-3/350	350	3	3.1	14.4	7.3	10	LS 4
1-XY11-6/350		1-XY1x-6/350	350	6	6.3	23.3	10.5	20	LS 4

(\*) Maximum excitation voltage for ferritic steel. For other temperature response matchings, the corresponding value is printed on the data sheet included with delivery.

(#) Types are only available with matching to aluminum, ferritic or austenitic steel

## XY11\_E

**Double strain gauge**  
Temperature response matched to steel  
with  $\alpha = 10.8 \cdot 10^{-6}/K$

## XY1x

Temperature response matched to customer's choice  
see page 16

Illustrations show actual size  
(indicated: grid length in mm)

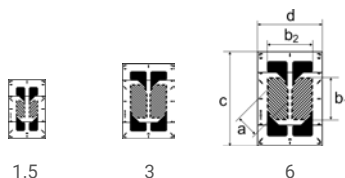

Contents per package: 5 pcs.

Types available from stock		Variants	Noml. resistance	Dimensions (mm)					Maximum excitation voltage (*)	Sldr. terminals
Steel	Aluminum			Measuring grid			Meas. grid carrier			
		Other	$\Omega$	a	b <sub>1</sub>	b <sub>2</sub>	c	d	V	
1-XY11-1.5/350_E		1-XY1x-1.5/350_E <sup>(#)</sup>	350	1.5	2.2	2.9	7.8	4.9	3.5	LS 7
1-XY11-3/350_E		1-XY1x-3/350_E	350	3	4.4	4.9	10	6.9	10.5	LS 5
		1-XY1x-6/350_E	350	6	6.5	10.2	12.3	11.7	15.5	LS 4

(\*) Maximum excitation voltage for ferritic steel. For other temperature response matchings, the corresponding value is printed on the data sheet included with delivery.

(#) Types are only available with matching to aluminum, ferritic or austenitic steel

# Y series

with two measuring grids / T rosette

## XY31

**0°/90° T rosette**  
Temperature response matched to steel  
with  $\alpha = 10.8 \cdot 10^{-6}/K$

## XY33

Temperature response matched to aluminum  
with  $\alpha = 23 \cdot 10^{-6}/K$

## XY3x

Temperature response matched to customer's choice  
see page 16

Illustrations show actual size  
(indicated: grid length in mm)

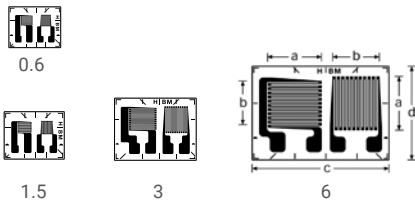

Contents per package: 5 pcs.

Types available from stock		Variants	Noml. resistance	Dimensions (mm)				Maximum excitation voltage (*)	Sldr. terminals (1)
Steel	Aluminum			Measuring grid		Meas. grid carrier			
		Other	$\Omega$	a	b	c	d	V	
1-XY31-0.6/120		1-XY3x-0.6/120(¶)	120	0.6	1	7	6	1.5	LS7
1-XY31-1.5/120	1-XY33-1.5/120	1-XY3x-1.5/120	120	1.5	1.6	8	6.3	3	LS7
1-XY31-3/120		1-XY3x-3/120	120	3	3.2	10.5	8	5.5	LS7
1-XY31-6/120		1-XY3x-6/120	120	6	6.3	17.5	12	11	LS4
1-XY31-1.5/350		1-XY3x-1.5/350(¶)	350	1.5	1.7	7.7	6.3	5	LS7
1-XY31-3/350	1-XY33-3/350	1-XY3x-3/350	350	3	3.3	10.9	7.6	10	LS5
1-XY31-6/350	1-XY33-6/350	1-XY3x-6/350(2)	350	6	6.5	18	12	20	LS4

(\*) Maximum excitation voltage for ferritic steel. For other temperature response matchings, the corresponding value is printed on the data sheet included with delivery.

(1) Solder terminals are not mandatory

(2) With temperature response matching to silica/composite (i.e. x=6) also available as preferred type (available from stock)

(¶) Types are only available with matching to aluminum, ferritic or austenitic steel

## XY71

**0°/90° T rosette**  
Temperature response matched to steel  
with  $\alpha = 10.8 \cdot 10^{-6}/K$

## XY73

Temperature response matched to aluminum  
with  $\alpha = 23 \cdot 10^{-6}/K$

## XY7x

Temperature response matched to customer's choice  
see page 16

Illustrations show actual size  
(indicated: grid length in mm)

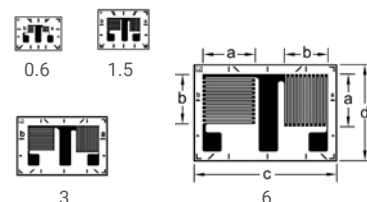

Contents per package: 5 pcs.

Types available from stock		Variants	Noml. resistance	Dimensions (mm)				Maximum excitation voltage (*)	Sldr. terminals (1)
Steel	Aluminum			Measuring grid		Meas. grid carrier			
		Other	$\Omega$	a	b	c	d	V	
		1-XY7x-0.6/120(¶)	120	0.6	0.8	5.7	4.3	1	LS7
		1-XY7x-1.5/120	120	1.5	1.4	6.5	5.3	2.5	LS7
		1-XY7x-3/120	120	3	3	9.9	7.3	5.5	LS7
1-XY71-6/120		1-XY7x-6/120	120	6	5.7	16.2	11	11	LS4
1-XY71-1.5/350	1-XY73-1.5/350	1-XY7x-1.5/350(¶)	350	1.5	1.4	6.5	5.3	4.5	LS7
1-XY71-3/350	1-XY73-3/350	1-XY7x-3/350	350	3	3	9.9	7.3	9.5	LS5
		1-XY7x-6/350	350	6	5.7	16.2	11	18.5	LS4

(\*) Maximum excitation voltage for ferritic steel. For other temperature response matchings, the corresponding value is printed on the data sheet included with delivery.

(1) Solder terminals are not mandatory

(¶) Types are only available with matching to aluminum, ferritic or austenitic steel

# Y series

with two measuring grids / T rosette

## XY91

**0°/90° T rosette with stacked measuring grids**  
 Temperature response matched to steel  
 with  $\alpha = 10.8 \cdot 10^{-6}/K$

## XY93

Temperature response matched to aluminum  
 with  $\alpha = 23 \cdot 10^{-6}/K$

## XY9x

Temperature response matched to customer's choice  
 see page 16

Illustrations show actual size  
 (indicated: grid length in mm)

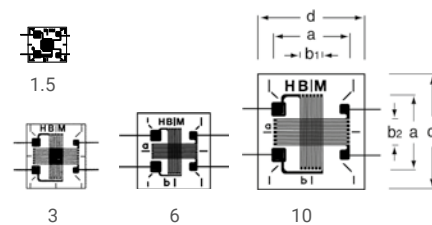

Contents per package: 5 pcs.

Types available from stock		Variants	Noml. resistance	Dimensions (mm)					Maximum excitation voltage (*)	Sldr. terminals
Steel	Aluminum			Measuring grid			Meas. grid carrier			
		Other	$\Omega$	a	b1	b2	c	d	V	
1-XY91-1.5/120	1-XY93-1.5/120	1-XY9x-1.5/120	120	1.5	1.2	1.2	4.7	6.7	1	LS 5
1-XY91-3/120	1-XY93-3/120	1-XY9x-3/120	120	3	1.4	1.3	6.2	7.9	2	LS 5
1-XY91-6/120	1-XY93-6/120	1-XY9x-6/120	120	6	1.9	2.2	10	9.6	3.5	LS 4
1-XY91-10/120		1-XY9x-10/120	120	10	3.2	3.8	15.2	14.0	6.5	LS 212
1-XY91-1.5/350		1-XY9x-1.5/350 <sup>(#)</sup>	350	1.5	1.5	1.5	4.7	6.7	2.5	LS 5
1-XY91-3/350	1-XY93-3/350	1-XY9x-3/350	350	3	1.5	1.4	6.2	7.9	3.5	LS 5
1-XY91-6/350	1-XY93-6/350	1-XY9x-6/350	350	6	2	2.2	10	9.6	6	LS 4
		1-XY9x-10/350	350	10	3.4	3.7	15.2	14	11.5	LS 212

(\*) Maximum excitation voltage for ferritic steel. For other temperature response matchings, the corresponding value is printed on the data sheet included with delivery.  
 (#) Types are only available with matching to aluminum, ferritic or austenitic steel

## XY101

**0°/90° T rosette**  
 Temperature response matched to steel  
 with  $\alpha = 10.8 \cdot 10^{-6}/K$

## XY103

Temperature response matched to aluminum  
 with  $\alpha = 23 \cdot 10^{-6}/K$

## XY10x

Temperature response matched to customer's choice  
 see page 16

Illustrations show actual size  
 (indicated: grid length in mm)

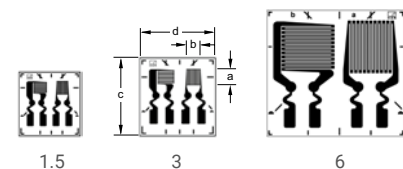

Contents per package: 5 pcs.

Types available from stock		Variants	Noml. resistance	Dimensions (mm)				Maximum excitation voltage (*)	Sldr. terminals <sup>(1)</sup>
Steel	Aluminum			Measuring grid		Meas. grid carrier			
		Other	$\Omega$	a	b	c	d	V	
		1-XY10x-1.5/120	120	1.5	1.6	8.3	8	1.5	LS7
1-XY101-3/120		1-XY10x-3/120	120	3	3.2	9.8	10.6	3	LS5
		1-XY10x-6/120	120	6	6.5	16.5	18	5.5	LS4
1-XY101-3/350	1-XY103-3/350	1-XY10x-3/350	350	3	3.3	9.8	10.6	11	LS5
		1-XY10x-6/350	350	6	6	16.5	18	10	LS4

(\*) Maximum excitation voltage for ferritic steel. For other temperature response matchings, the corresponding value is printed on the data sheet included with delivery.  
 (1) Solder terminals are not mandatory

# Y series

with two measuring grids / torsion-shear strain gauge

## XY21

**Shear / torsion half bridge**  
 Temperature response matched to steel  
 with  $\alpha = 10.8 \cdot 10^{-6}/K$

## XY2x

Temperature response matched to customer's choice  
 see page 16

Illustrations show actual size  
 (indicated: grid length in mm)

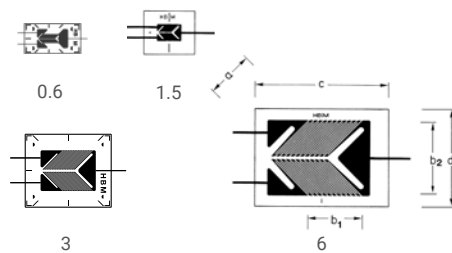

Contents per package: 5 pcs.

Types available from stock		Variants	Noml. resistance $\Omega$	Dimensions (mm)					Maximum excitation voltage (*) V	Sldr. terminals
Steel	Aluminum			Measuring grid			Meas. grid carrier			
		Other		a	b1	b2	c	d		
		1-XY2x-0.6/120 <sup>(#)</sup>	120	0.6	2.2	1.1	7.5	4	2.5	LS 7
1-XY21-1.5/120		1-XY2x-1.5/120	120	1.5	1.7	2.5	6.8	4.5	4.5	LS 7
1-XY21-3/120		1-XY2x-3/120	120	3	3.7	5.3	11.2	9.5	6	LS 4
1-XY21-6/120		1-XY2x-6/120	120	6	8	10	17.5	12.7	11	LS 4
1-XY21-1.5/350		1-XY2x-1.5/350 <sup>(#)</sup>	350	1.5	2.2	2.5	7.4	4.5	5	LS 7
1-XY21-3/350		1-XY2x-3/350	350	3	4.2	5.3	11.2	9.5	10	LS 4
1-XY21-6/350		1-XY2x-6/350	350	6	8	10	17.5	12.7	19	LS 4
		1-XY2x-3/700 <sup>(#)</sup>	700	3	4.0	4.7	11.2	9.5	14	LS 5
		1-XY2x-6/700	700	6	7.8	9.2	17.5	12.7	27	LS 4

(\*) Maximum excitation voltage for ferritic steel. For other temperature response matchings, the corresponding value is printed on the data sheet included with delivery.  
 (#) Types are only available with matching to aluminum, ferritic or austenitic steel

## XY41

**Shear / torsion half bridge**  
 Temperature response matched to steel  
 with  $\alpha = 10.8 \cdot 10^{-6}/K$

## XY43

Temperature response matched to aluminum  
 with  $\alpha = 23 \cdot 10^{-6}/K$

## XY4x

Temperature response matched to customer's choice  
 see page 16

Illustrations show actual size  
 (indicated: grid length in mm)

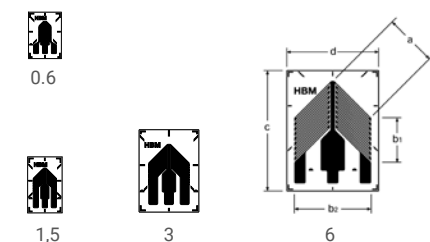

Contents per package: 5 pcs.

Types available from stock		Variants	Noml. resistance $\Omega$	Dimensions (mm)					Maximum excitation voltage (*) V	Sldr. terminals (1)
Steel	Aluminum			Measuring grid			Meas. grid carrier			
		Other		a	b1	b2	c	d		
1-XY41-0.6/120		1-XY4x-0.6/120 <sup>(#)</sup>	120	0.6	2.2	1.6	6.5	4.6	1.5	LS 7
1-XY41-1.5/120		1-XY4x-1.5/120	120	1.5	1.8	3.1	7.5	4.6	2.5	LS 7
1-XY41-3/120		1-XY4x-3/120	120	3	3	5.4	11	8	5	LS 7
1-XY41-6/120		1-XY4x-6/120	120	6	6	10.2	16	12.2	9.5	LS 4
1-XY41-1.5/350		1-XY4x-1.5/350 <sup>(#)</sup>	350	1.5	2.1	3.1	7.5	4.5	4	LS 7
1-XY41-3/350	1-XY43-3/350	1-XY4x-3/350	350	3	4.2	5.6	11	8	9.5	LS 7
1-XY41-6/350		1-XY4x-6/350	350	6	6	10	16	12.2	16	LS 4
1-XY41-3/700		1-XY4x-3/700	700	3	4.2	5.6	11	8	13.5	LS 7
		1-XY4x-6/700	700	6	6.1	9.9	16	12.2	23	LS 4

(\*) Maximum excitation voltage for ferritic steel. For other temperature response matchings, the corresponding value is printed on the data sheet included with delivery.  
 (1) Solder terminals are not mandatory  
 (#) Types are only available with matching to aluminum, ferritic or austenitic steel

# Y series

with three measuring grids / strain gauge rosettes

## RY11

**0°/45°/90° strain gauge rosette**  
Temperature response matched to steel  
with  $\alpha = 10.8 \cdot 10^{-6}/K$

## RY13

Temperature response matched to aluminum  
with  $\alpha = 23 \cdot 10^{-6}/K$

## RY1x

Temperature response matched to customer's choice  
see page 16

Illustrations show actual size  
(indicated: dimension a2 in mm)

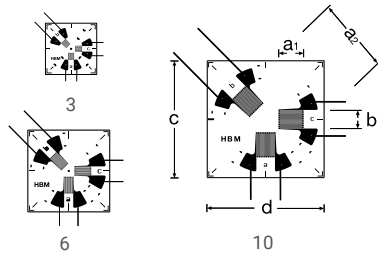

Contents per package: 5 pcs.

Types available from stock		Variants	Noml. resistance	Dimensions (mm)					Maximum excitation voltage (*)	Sldr. terminals
Steel	Aluminum			Measuring grid		Meas. grid carrier		V		
		Other	$\Omega$	a1	a2	b	c	d		
1-RY11-3/120		1-RY1x-3/120 <sup>(#)</sup>	120	0.8	3	0.8	7	7	1.5	LS7
1-RY11-6/120	1-RY13-6/120	1-RY1x-6/120	120	2	6	1.4	11	11	3	LS5
1-RY11-10/120		1-RY1x-10/120	120	2.9	10	2.7	15.4	15.4	5	LS4

(\*) Maximum excitation voltage for ferritic steel. For other temperature response matchings, the corresponding value is printed on the data sheet included with delivery.

(#) Types are only available with matching to aluminum, ferritic or austenitic steel

## RY31

**0°/45°/90° strain gauge rosette**  
Temperature response matched to steel  
with  $\alpha = 10.8 \cdot 10^{-6}/K$

## RY33

Temperature response matched to aluminum  
with  $\alpha = 23 \cdot 10^{-6}/K$

## RY3x

Temperature response matched to customer's choice  
see page 16

Illustrations show actual size  
(indicated: Dimension a2 in mm)

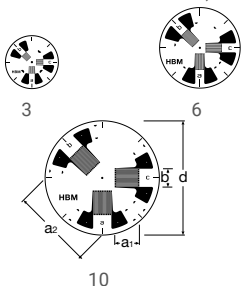

Contents per package: 5 pcs.

Types available from stock		Variants	Noml. resistance	Dimensions (mm)				Maximum excitation voltage (*)	Sldr. terminals <sup>(1)</sup>
Steel	Aluminum			Measuring grid		Meas. grid carrier			
		Other	$\Omega$	a1	a2	b	d		
1-RY31-3/120		1-RY3x-3/120 <sup>(#)</sup>	120	0.8	3	0.8	6.9	1.5	LS7
1-RY31-6/120	1-RY33-6/120	1-RY3x-6/120	120	2	6	1.4	11	3	LS5
1-RY31-10/120		1-RY3x-10/120	120	2.9	10	2.7	15.4	5	LS4

(\*) Maximum excitation voltage for ferritic steel. For other temperature response matchings, the corresponding value is printed on the data sheet included with delivery.

(1) Solder terminals are not mandatory

(#) Types are only available with matching to aluminum, ferritic or austenitic steel

# Y series

with three measuring grids / strain gauge rosettes

## Ry41

**0°/60°/120° strain gauge rosette**  
 Temperature response matched to steel  
 with  $\alpha = 10.8 \cdot 10^{-6}/K$

## Ry4x

Temperature response matched to customer's choice  
 see page 16

Illustrations show actual size  
 (indicated: dimension a2 in mm)

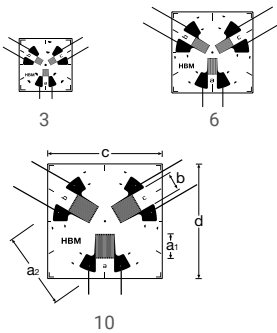

Contents per package: 5 pcs.

Types available from stock		Variants	Noml. resistance	Dimensions (mm)				Maximum excitation voltage (*)	Sldr. terminals	
Steel	Aluminum			Measuring grid		Meas. grid carrier				
		Other	$\Omega$	a1	a2	b	c	d	V	
		1-RY4x-3/120(#)	120			0.8	7	7	1.5	LS 7
1-RY41-6/120		1-RY4x-6/120	120	2	6	1.4	11	11	3	LS 5
1-RY41-10/120		1-RY4x-10/120	120	2.9	10	2.7	15.4	15.4	5	LS 4

(\*) Maximum excitation voltage for ferritic steel. For other temperature response matchings, the corresponding value is printed on the data sheet included with delivery.  
 (#) Types are only available with matching to aluminum, ferritic or austenitic steel

## Ry7x

**0°/60°/120° strain gauge rosette**  
 Temperature response matched to customer's choice  
 see page 16

Illustrations show actual size  
 (indicated: dimension a2 in mm)

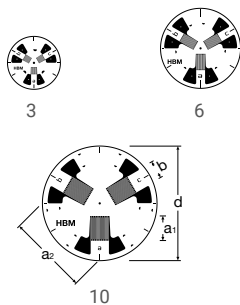

Contents per package: 5 pcs.

Types available from stock		Variants	Noml. resistance	Dimensions (mm)				Maximum excitation voltage (*)	Sldr. terminals (1)	
Steel	Aluminum			Measuring grid		Meas. grid carrier				
		Other	$\Omega$	a1	a2	b	c	d	V	
		1-RY7x-3/120(#)	120	0.8	3	0.8		6.9	1.5	LS 7
		1-RY7x-6/120	120	2	6	1.3		11	3	LS 5
		1-RY7x-10/120	120	2.9	10	2.7		15.4	5	LS 4

(\*) Maximum excitation voltage for ferritic steel. For other temperature response matchings, the corresponding value is printed on the data sheet included with delivery.  
 (1) Solder terminals are not mandatory  
 (#) Types are only available with matching to aluminum, ferritic or austenitic steel

# Y series

with three measuring grids / strain gauge rosettes

## RY81

**0°/45°/90° rectangular rosette**  
Temperature response matched to steel  
with  $\alpha = 10.8 \cdot 10^{-6}/K$

## RY83

Temperature response matched to aluminum  
with  $\alpha = 23 \cdot 10^{-6}/K$

## RY8x

Temperature response matched to customer's choice  
see page 16

Illustrations show actual size  
(indicated: grid length in mm)

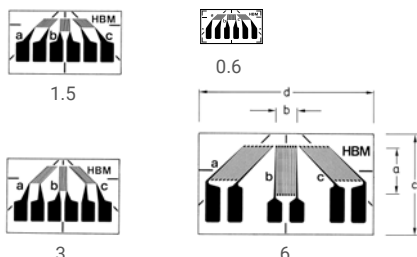

Contents per package: 5 pcs.

## RY91

**0°/45°/90° strain gauge rosette, stacked measuring grids**  
Temperature response matched to steel  
with  $\alpha = 10.8 \cdot 10^{-6}/K$

## RY93

Temperature response matched to aluminum  
with  $\alpha = 23 \cdot 10^{-6}/K$

## RY9x

Temperature response matched to customer's choice  
see page 16

Illustrations show actual size  
(indicated: grid length in mm)

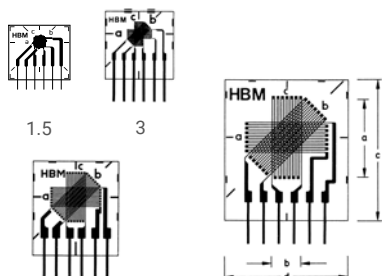

Contents per package: 5 pcs.

Types available from stock		Variants	Noml. resistance	Dimensions (mm)				Maximum excitation voltage (*)	Sldr. terminals (1)
Steel	Aluminum			Measuring grid		Meas. grid carrier			
		Other	$\Omega$	a	b	c	d	V	
		1-RY8x-0.6/120(4)	120	0.6	1.1	4.8	8.7	1.6	LS 7
1-RY81-1.5/120		1-RY8x-1.5/120	120	1.5	1.2	8.2	14.6	2.5	LS 7
1-RY81-3/120	1-RY83-3/120	1-RY8x-3/120	120	3	1.1	9.7	14.6	3	LS 7
1-RY81-6/120		1-RY8x-6/120	120	6	3	13	22.9	7.5	LS 7
		1-RY8x-1.5/350(4)	350	1.5	1.6	8.2	14.6	5	LS 7
		1-RY8x-3/350	350	3	1.2	9.7	14.6	5.5	LS 7
1-RY81-6/350		1-RY8x-6/350	350	6	2.8	13.1	22.9	13	LS 5

(\*) Maximum excitation voltage for ferritic steel. For other temperature response matchings, the corresponding value is printed on the data sheet included with delivery.

(1) Solder terminals are not mandatory

(4) Types are only available with matching to aluminum, ferritic or austenitic steel

Types available from stock		Variants	Noml. resistance	Dimensions (mm)				Maximum excitation voltage (*)	Sldr. terminals
Steel	Aluminum			Measuring grid		Meas. grid carrier			
		Other	$\Omega$	a	b	c	d	V	
1-RY91-1.5/120		1-RY9x-1.5/120	120	1.5	1.3	9	8	1.5	LS 7
1-RY91-3/120	1-RY93-3/120	1-RY9x-3/120	120	3	1.3	9	9	2	LS 7
1-RY91-6/120	1-RY93-6/120	1-RY9x-6/120	120	6	2.6	12.5	11.4	4.5	LS 7
1-RY91-10/120	1-RY93-10/120	1-RY9x-10/120	120	10	4	17.5	16	7	LS 7
1-RY91-1.5/350		1-RY9x-1.5/350(4)	350	1.5	1.5	8	9	2.5	LS 7
1-RY91-3/350	1-RY93-3/350	1-RY9x-3/350	350	3	1.5	9	9	3.5	LS 7
1-RY91-6/350		1-RY9x-6/350	350	6	2.6	12.5	11.4	6	LS 7
		1-RY9x-10/350	350	10	4	17.6	16	11.5	LS 7

(\*) Maximum excitation voltage for ferritic steel. For other temperature response matchings, the corresponding value is printed on the data sheet included with delivery.

(4) Types are only available with matching to aluminum, ferritic or austenitic steel



# Y series

with three measuring grids / strain gauge rosettes

## R Y101

Temperature response matched to steel  
with  $\alpha = 10.8 \cdot 10^{-6}/K$

## R Y103

Temperature response matched to aluminum  
with  $\alpha = 23 \cdot 10^{-6}/K$

## R Y10x

Temperature response matched to customer's choice  
see page 16

Illustrations show actual size  
(indicated: grid length in mm)



1.5

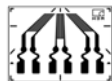

3

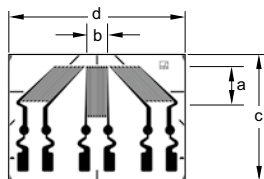

6

Contents per package: 5 pcs.

Types available from stock		Variants	Noml. resistance $\Omega$	Dimensions (mm)				Maximum excitation voltage (*) V	Sldr. terminals (1)
Steel	Aluminum			Measuring grid		Meas. grid carrier			
		Other		a	b	c	d		
		1-RY10x-1.5/120	120	1.5	1.4	8.2	13.5	2.5	LS 7
1-RY101-3/120	1-RY103-3/120	1-RY10x-3/120	120	3	1.1	9.7	13.5	3	LS 7
		1-RY10x-6/120	120	6	3	16.4	22.9	7.5	LS 4
1-RY101-1.5/350	1-RY103-1.5/350	1-RY10x-1.5/350(*)	350	1.5	1.4	8.2	13.5	5	LS 7
1-RY101-3/350	1-RY103-3/350	1-RY10x-3/350	350	3	1.2	9.7	13.5	5.5	LS 7
1-RY101-6/350	1-RY103-6/350	1-RY10x-6/350(2)	350	6	2.8	16.4	22.9	12	LS 4

(\*) Maximum excitation voltage for ferritic steel. For other temperature response matchings, the corresponding value is printed on the data sheet included with delivery.  
 (1) Solder terminals are not mandatory  
 (2) With temperature response matching to silica/composite (i.e. x=6) also available as preferred type (available from stock)  
 (#) Types are only available with matching to aluminum, ferritic or austenitic steel

# Y series

with four measuring grids / full bridge circuits

## VY11

**0°/90° full bridge strain gauge**  
 Temperature response matched to steel  
 with  $\alpha = 10.8 \cdot 10^{-6}/K$

## VY1x

Temperature response matched to customer's choice  
 see page 16

Illustrations show actual size  
 (indicated: grid length in mm)

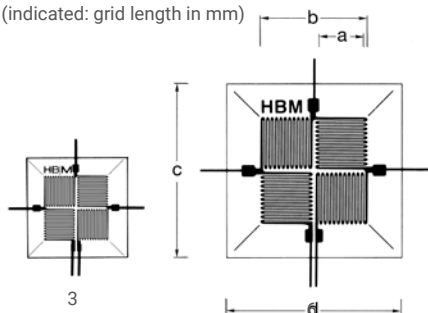

Contents per package: 5 pcs.

Types available from stock		Variants	Noml. resistance $\Omega$	Dimensions (mm)				Maximum excitation voltage (*) V	Sldr. terminals
Steel	Aluminum			Measuring grid		Meas. grid carrier			
		Other		a	b	c	d		
1-VY11-3/120		1-VY1x-3/120	120	3	7	13.5	13.5	6	LS 5/7
1-VY11-6/120		1-VY1x-6/120	120	6	14	23	23	12	LS 5/7

(\*) Maximum excitation voltage for ferritic steel. For other temperature response matchings, the corresponding value is printed on the data sheet included with delivery.

## VY41

**Shear / torsion full bridge**  
 Temperature response matched to steel  
 with  $\alpha = 10.8 \cdot 10^{-6}/K$

## VY43

Temperature response matched to aluminum  
 with  $\alpha = 23 \cdot 10^{-6}/K$

## VY4x

Temperature response matched to customer's choice  
 see page 16

Illustrations show actual size  
 (indicated: grid length in mm)

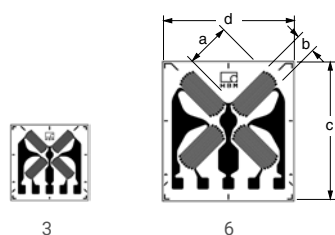

Contents per package: 5 pcs.

Types available from stock		Variants	Noml. resistance $\Omega$	Dimensions (mm)				Maximum excitation voltage (*) V	Sldr. terminals (1)
Steel	Aluminum			Measuring grid		Meas. grid carrier			
		Other		a	b	c	d		
1-VY41-3/120		1-VY4x-3/120	120	3	1.3	9.8	10	3.5	LS7
		1-VY4x-6/120	120	6	2.7	18	17	7.5	LS4
1-VY41-3/350	1-VY43-3/350	1-VY4x-3/350	350	3	1.3	9.8	10	6	LS7
		1-VY4x-6/350	350	6	2.7	18	17	13	LS4

(\*) Maximum excitation voltage for ferritic steel. For other temperature response matchings, the corresponding value is printed on the data sheet included with delivery.

(1) Solder terminals are not mandatory

# Y series

with four measuring grids / diaphragm rosettes

## MY21

### Diaphragm rosette

Temperature response matched to steel  
with  $\alpha = 10.8 \cdot 10^{-6}/K$

## MY2x

Temperature response matched to customer's choice  
see page 16

Illustrations show actual size  
(indicated: dimension a in mm)

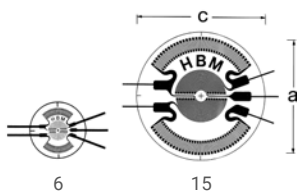

Contents per package: 5 pcs.

Types available from stock		Variants	Noml. resistance $\Omega$	Dimensions (mm)				Maximum excitation voltage (*) V	Sldr. terminals
Steel	Aluminum			Measuring grid		Meas. grid carrier			
		Other		a	b	c	d		
		1-MY2x-6/120	120	6	-	7.3	-	3.5	LS 7
1-MY21-15/350		1-MY2x-15/350	350	15	-	17	-	13	LS 5

(\*) Maximum excitation voltage for ferritic steel. For other temperature response matchings, the corresponding value is printed on the data sheet included with delivery.

# Y series

## Strain gauge chains

### KY11

**Strain gauge chain**

Consisting of ten measuring grids **parallel** to the chain axis and one compensating strain gauge. Temperature response matched to steel with  $\alpha = 10.8 \cdot 10^{-6}/K$

### KY1x

Temperature response matched to customer's choice see page 16

Illustration shows actual size (indicated: Pitch t in mm)

Contents per package 1 pc.

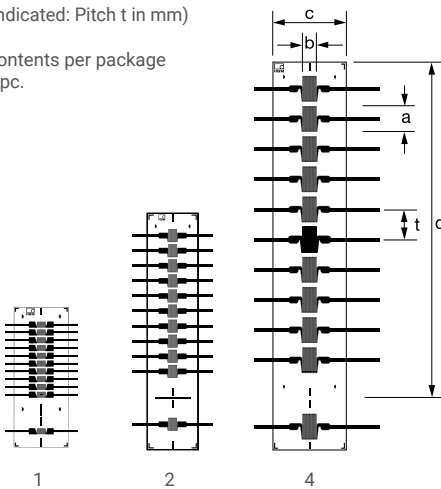

Types available from stock		Variants	Noml. resistance	Dimensions (mm)					Maximum excitation voltage (*)	Slr. terminals
Steel	Aluminum			Other	Measuring grid		Meas. grid carrier	Pitch		
			$\Omega$	a	b	c	d	t	V	
1-KY11-1/120		1-KY1x-1/120(*)	120	0.6	1	7.2	14.5	1	2	LS 7
1-KY11-2/120		1-KY1x-2/120	120	1.5	1.3	6.7	24.5	2	2.5	LS 7
1-KY11-4/120		1-KY1x-4/120	120	3	2.1	9.7	44.5	4	5	LS 7

(\*) Maximum excitation voltage for ferritic steel. For other temperature response matchings, the corresponding value is printed on the data sheet included with delivery.

(#) Types are only available with matching to aluminum, ferritic or austenitic steel

### KY21

**Strain gauge chain**

Consisting of ten measuring grids **perpendicular** to the chain axis and one compensating strain gauge. Temperature response matched to steel with  $\alpha = 10.8 \cdot 10^{-6}/K$

### KY2x

Temperature response matched to customer's choice see page 16

Illustration shows actual size (indicated: Pitch t in mm)

Contents per package 1 pc.

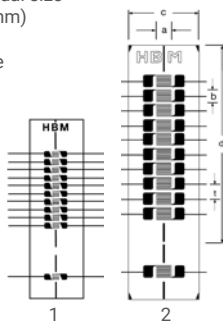

Types available from stock		Variants	Noml. resistance	Dimensions (mm)					Maximum excitation voltage (*)	Slr. terminals
Steel	Aluminum			Other	Measuring grid		Meas. grid carrier	Pitch		
			$\Omega$	a	b	c	d	t	V	
1-KY21-1/120		1-KY2x-1/120(*)	120	0.8	0.8	6.9	15	1	1.5	LS 7
1-KY21-2/120		1-KY2x-2/120	120	1.7	1.7	9.5	27	2	3.5	LS 7

(\*) Maximum excitation voltage for ferritic steel. For other temperature response matchings, the corresponding value is printed on the data sheet included with delivery.

(#) Types are only available with matching to aluminum, ferritic or austenitic steel

# Y series

## Strain gauge chains

### KY41

#### Strain gauge chain

Consisting of ten measuring grids (**alternating five parallel, five perpendicular to the chain axis**) and one compensating SG. Temperature response matched to steel with  $\alpha = 10.8 \cdot 10^{-6}/K$ .

### KY4x

Temperature response matched to customer's choice see page 16

Illustration shows actual size (indicated: Pitch t in mm)

Contents per package  
1 pc.

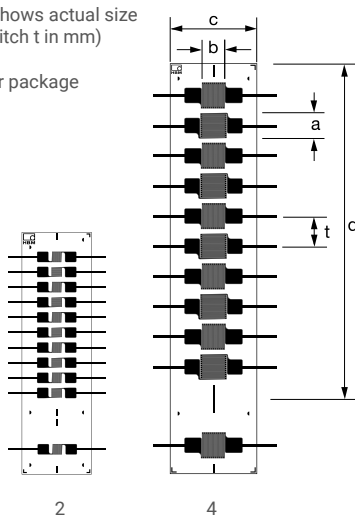

Types available from stock		Variants	Noml. resistance	Dimensions (mm)					Maximum excitation voltage (*)	Slr. terminals
Steel	Aluminum			Measuring grid		Meas. grid carrier		Pitch		
		Other	$\Omega$	a	b	c	d	t	V	
		1-KY4x-2/120	120	1.2	1.3	9.2	24.5	2	2.5	LS 7
1-KY41-4/120		1-KY4x-4/120	120	3	3	11.5	44.5	4	6	LS 5

(\*) Maximum excitation voltage for ferritic steel. For other temperature response matchings, the corresponding value is printed on the data sheet included with delivery.

### KY3x

#### Strain gauge rosette chain

Consisting of **five strain gauge rosettes** with three 0°/60°/120° measuring grids each and one compensating strain gauge. Temperature response matched to customer's choice see page 16

Illustration shows actual size (indicated: Pitch t in mm)

Contents per package: 1 pc.

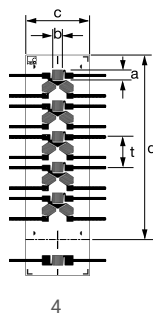

Types available from stock		Variants	Noml. resistance	Dimensions (mm)					Maximum excitation voltage (*)	Slr. terminals
Steel	Aluminum			Measuring grid		Meas. grid carrier		Pitch		
		Other	$\Omega$	a	b	c	d	t	V	
		1-KY3x-4/120	120	1.2	1.3	8.3	24	4	2.5	LS 7

(\*) Maximum excitation voltage for ferritic steel. For other temperature response matchings, the corresponding value is printed on the data sheet included with delivery.

# Y series

## Strain gauge chains

### KY5x

#### Strain gauge chain

Consisting of ten measuring grids with a common connection **parallel** to the chain axis and one compensating strain gauge. Temperature response matched to customer's choice see page 16

Illustration shows actual size (indicated: Pitch t in mm)

Contents per package: 5 pcs.

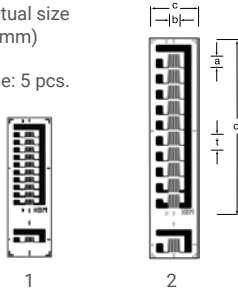

Types available from stock		Variants	Noml. resistance $\Omega$	Dimensions (mm)				Maximum excitation voltage (*) V	Sldr. terminals	
Steel	Aluminum			Measuring grid		Meas. grid carrier	Pitch			
		Other		a	b	c	d	t		
		1-KY5x-1/120 <sup>(#)</sup>	120	0.6	1.2	5.6	12.8	1	1.5	–
		1-KY5x-2/120	120	1.5	1.4	6	22.8	2	2.5	–

(\*) Maximum excitation voltage for ferritic steel. For other temperature response matchings, the corresponding value is printed on the data sheet included with delivery.

<sup>(#)</sup> Types are only available with matching to aluminum, ferritic or austenitic steel

### KY6x

#### SG chain

Consisting of ten measuring grids with a common connection **perpendicular** to the chain axis and one compensating strain gauge. Temperature response matched to customer's choice see page 16

Illustration shows actual size (indicated: Pitch t in mm)

Contents per package: 5 pcs.

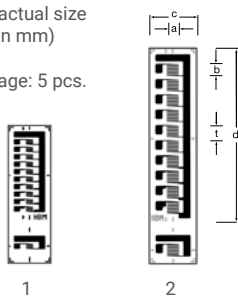

Types available from stock		Variants	Noml. resistance $\Omega$	Dimensions (mm)				Maximum excitation voltage (*) V	Sldr. terminals	
Steel	Aluminum			Measuring grid		Meas. grid carrier	Pitch			
		Other		a	b	c	d	t		
		1-KY6x-1/120 <sup>(#)</sup>	120	0.8	0.7	5.6	12.8	1	1.2	–
		1-KY6x-2/120	120	1.3	1.6	6	22.8	2	2.5	–

(\*) Maximum excitation voltage for ferritic steel. For other temperature response matchings, the corresponding value is printed on the data sheet included with delivery.

<sup>(#)</sup> Types are only available with matching to aluminum, ferritic or austenitic steel

# Y series

## Strain gauge chains

### KY7x

#### Strain gauge chain

Consisting of ten measuring grids with a common connection, (alternating five parallel, five perpendicular to the chain axis) and one compensating strain gauge.

Temperature response matched to customer's choice see page 16

Illustration shows actual size (indicated: Pitch t in mm)

Contents per package: 5 pcs.

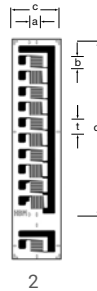

2

Types available from stock		Variants	Noml. resistance	Dimensions (mm)					Maximum excitation voltage (*)	Slr. terminals
Steel	Aluminum			Measuring grid	Meas. grid carrier	Pitch				
		Other	$\Omega$	a	b	c	d	t	V	
		1-KY7x-2/120	120	1.3	1.5	6	22.8	2	2.5	-

(\*) Maximum excitation voltage for ferritic steel. For other temperature response matchings, the corresponding value is printed on the data sheet included with delivery.

### KY81

#### Strain gauge chain

Consisting of ten measuring grids parallel to the chain axis and one compensating strain gauge. Temperature response matched to steel with  $\alpha = 10.8 \cdot 10^{-6}/K$ .

### KY8x

Temperature response matched to customer's choice see page 16

Illustration shows actual size (indicated: Pitch t in mm)

Contents per package: 5 pcs.

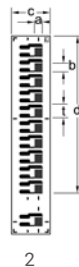

2

Types available from stock		Variants	Noml. resistance	Dimensions (mm)					Maximum excitation voltage (*)	Slr. terminals
Steel	Aluminum			Measuring grid	Meas. grid carrier	Pitch				
		Other	$\Omega$	a	b	c	d	t	V	
		1-KY8x-2/120	120	1	1	5	21.7	2	2	-

(\*) Maximum excitation voltage for ferritic steel. For other temperature response matchings, the corresponding value is printed on the data sheet included with delivery.

### KY91

#### Strain gauge chain

Consisting of 10 measuring grid perpendicular to the chain axis and 1 compensating strain gauge. Temperature response matched to steel with  $\alpha = 10.8 \cdot 10^{-6}/K$ .

### KY9x

Temperature response matched to customer's choice see page 16

Illustration shows actual size (indicated: Pitch t in mm)

Contents per package: 5 pcs.



2

Types available from stock		Variants	Noml. resistance	Dimensions (mm)					Maximum excitation voltage (*)	Slr. terminals
Steel	Aluminum			Measuring grid	Meas. grid carrier	Pitch				
		Other	$\Omega$	a	b	c	d	t	V	
		1-KY9x-2/120	120	1.2	1.2	5	21.7	2	2	-

(\*) Maximum excitation voltage for ferritic steel. For other temperature response matchings, the corresponding value is printed on the data sheet included with delivery.

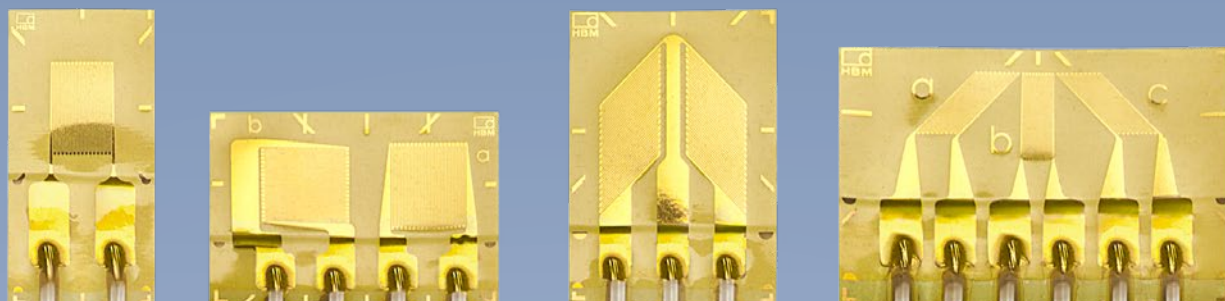

## Strain gauges with connection cable K-CLY.../K-CDY.../K-CXY.../K-CRY...

and RJ11 connector (optional)

- Soldering at measurement point not required
- Proven strain gauge quality of the Y series, now also with pre-wired TPE ribbon cable
- 50mm fluoropolymer-insulated stranded wire, optional cable lengths from 0.5m up to 10m
- 3- and 4-wire versions
- Linear strain gauges, double linear strain gauges, T rosettes, shear/torsion strain gauges and 3-grid rosettes
- Fluoropolymer-insulated stranded wire on the strain gauge prevents the cable from sticking during installation



## Specifications – K-CLY... / K-CDY... / K-CXY... / K-CRY...

SG construction		Foil SG with embedded measuring grid
Measuring grid		
Material		Constantan
Thickness	μm	3.8 or 5, depending on SG type
Carrier		
Material		Polyimide
Thickness	μm	55 ± 5
Covering agent		
Material		Polyimide
Total thickness SG	μm	81 ± 22
Connections		Fluoropolymer-insulated stranded wire, cross-section 0.06 mm <sup>2</sup> , approx. 50 mm long, outside diameter 0.6 mm, connected via crimp connection to AWG28 ribbon cables (TPE-insulated) in 3- or 4-wire configuration, in various lengths, cross-section 0.09 mm <sup>2</sup> and outside diameter of approx. 0.95 mm per core
Nominal resistance <sup>(1)</sup>	Ω	120, 350, 700 or 1,000, depending on SZ type
Resistance tolerance <sup>(1)</sup>	%	± 0.35
for measuring grid length of 0.6 mm and 1.5 mm	%	± 1
Gauge factor		approx. 2 (stated on the packaging)
Gauge factor tolerance <sup>(1)</sup>	%	± 1
for measuring grid length of 0.6 mm and 1.5 mm	%	± 1.5
Temperature coefficient of the gauge factor <sup>(1)</sup>	1/K	(115 ± 10) · 10 <sup>-6</sup>
Nominal (rated) value of the temperature coefficient of the gauge factor		Specified on each package
Reference temperature	°C	23
Application temperature range		
for static measurements (zero-point related)	°C	with cable: -40 ... +150 without cable: -40 ... +155
for dynamic measurements (non zero-point related)	°C	-10 ... +150 -10 ... +155
Transverse sensitivity		Specified on each package;
at reference temperature using adhesive Z 70		
on SG type LY41-3/120	%	+ 0.2
Temperature response		Specified on each package
Temperature response matched to choice of expansion coefficient		
α for ferritic steel	1/K	10.8 · 10 <sup>-6</sup>
α for aluminum	1/K	23 · 10 <sup>-6</sup>
α for plastic	1/K	65 · 10 <sup>-6</sup>
α for austenitic steel	1/K	16 · 10 <sup>-6</sup>
α for titanium	1/K	9 · 10 <sup>-6</sup>
α for molybdenum	1/K	5.4 · 10 <sup>-6</sup>
α for silica	1/K	0.5 · 10 <sup>-6</sup>
Tolerance of temperature response <sup>(1)</sup>	1/K	± 0.3 · 10 <sup>-6</sup>
Temperature response with matching in the range of <sup>(2)</sup>	°C	-10 ... +120
Mechanical hysteresis		
at reference temperature and strain ε = ± 1,000 μm/m		
on SG type LY41-3/120		
at 1st load cycle and adhesive Z 70	μm/m	1
at 3rd load cycle and adhesive Z 70	μm/m	0.5
at 1st load cycle and adhesive X 60	μm/m	2.5
at 3rd load cycle and adhesive X 60	μm/m	1
Maximum elongation		
at reference temperature using adhesive Z 70		
on SG type LY41-3/120		
Absolute strain value for positive direction	μm/m	20,000 (Δ 2%)
Absolute strain value for negative direction	μm/m	25,000 (Δ 2.5%)
Fatigue life		
at reference temperature using adhesive Z70		
on SG type LY41-3/120		
Achievable number of load cycles L <sub>w</sub> with		
alternating strain ε <sub>w</sub> = ± 1,000 μm/m and		
variation of zero point ε <sub>m</sub> Δ ≤ 300	μm/m	> 1 · 10 <sup>7</sup> (test was inspection at 1 · 10 <sup>7</sup> )
Variation of zero point ε <sub>m</sub> Δ ≤ 30	μm/m	5 · 10 <sup>6</sup>
Minimum radius of curvature, longitudinal and transverse, at reference temperature		
within measuring grid area	mm	0.3
within solder tabs area	mm	10
Applicable bonding materials		
Cold curing adhesives		Z70; X60; X280
Hot curing adhesives <sup>(3)</sup>		EP150, EP310N

<sup>(1)</sup> Properties of strain gauges without flat ribbon cable (incl. fluoropolymer-insulated connection wire)

<sup>(2)</sup> Matching to plastic (code number 8) is only possible in the temperature range of -10 ... +50°C

<sup>(3)</sup> Note the application temperature range of the strain gauges

# SGs with connection cables

(incl. fluoropolymer-insulated connection wire)  
with one measuring grid

## K-CLY41

**Linear strain gauge**  
Temperature response matched to steel  
with  $\alpha = 10.8 \cdot 10^{-6}/K$

## K-CLY43

Temperature response matched to aluminum  
with  $\alpha = 23 \cdot 10^{-6}/K$

## K-CLY4x

Temperature response matched to  
customer's choice, see page 16

Illustrations show actual size  
(indicated: grid length in mm)

Contents per package: 10 pcs.

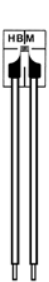
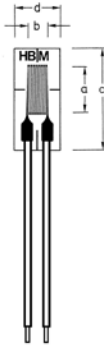
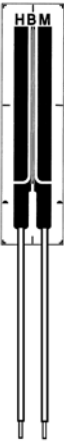
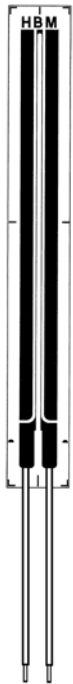

150 100 50 20 10 6 3 1.5 0.6

Types available on short notice		Variants	Noml. resistance $\Omega$	Dimensions (mm)				Maximum excitation voltage (*) V	Sldr. terminals  Not required
Steel	Aluminum			Measuring grid		Meas. grid carrier			
		Other		a	b	c	d		
		K-CLY4x-0.6/120 <sup>(#)</sup>	120	0.6	1.1	6	4	1.5	
		K-CLY4x-1.5/120	120	1.5	1.2	7	5	2.5	
K-CLY41-3/120		K-CLY4x-3/120	120	3	1.2	8	5	3.5	
K-CLY41-6/120	K-CLY43-6/120	K-CLY4x-6/120	120	6	2.7	13.9	5.9	8	
K-CLY41-10/120		K-CLY4x-10/120	120	10	4.9	18	8	14	
K-CLY41-20/120		K-CLY4x-20/120	120	20	0.5	31.8	8.2	6.5	
K-CLY41-50/120		K-CLY4x-50/120	120	50	0.8	63.6	8.2	12	
		K-CLY4x-100/120	120	100	1	114.8	8.2	19	
		K-CLY4x-150/120	120	150	1.2	165.6	8.2	25	
		K-CLY4x-1.5/350 <sup>(#)</sup>	350	1.5	2.3	9.2	5.9	6.5	
		K-CLY4x-3/350	350	3	2.5	10.9	5.9	9	
K-CLY41-6/350		K-CLY4x-6/350	350	6	2.8	13.9	5.9	15	
		K-CLY4x-10/350	350	10	5	18	8	24	
		K-CLY4x-3/700	700	3	2.7	10.9	5.9	13	
		K-CLY4x-6/700	700	6	4.1	13.9	5.9	23	
		K-CLY4x-10/700	700	10	5	18	8	33	
		K-CLY4x-3/1000 <sup>(#)</sup>	1,000	3	2.7	10.9	5.9	16	
		K-CLY4x-6/1000	1,000	6	4.2	13.9	5.9	27	
		K-CLY4x-10/1000	1,000	10	5	18	8	40	

(\*) Maximum excitation voltage for ferritic steel. For other temperature response matchings, the corresponding value is printed on the data sheet included with delivery.

(#) Only available with temperature response matching to ferritic steel, austenitic steel and aluminum

Available cable lengths  
see page 47

# SGs with connection cables

(incl. fluoropolymer-insulated connection wire)  
with one measuring grid, with two measuring grids

## K-CLY91

**Linear strain gauge**  
Temperature response matched to steel  
with  $\alpha = 10.8 \cdot 10^{-6}/K$

## K-CLY9x

Temperature response matched to customer's choice  
see page 16

Illustrations show actual size

Contents per package  
10 pcs.

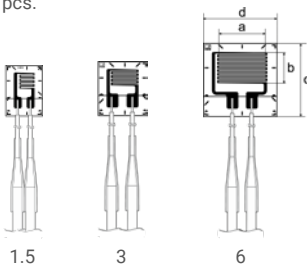

Types available on short notice		Variants	Noml. resistance $\Omega$	Dimensions (mm)				Maximum excitation voltage (*) V	Sldr. terminals Not required
Steel	Aluminum			Measuring grid		Meas. grid carrier			
		Other		a	b	c	d		
		K-CLY9x-1.5/120_E	120	1.5	2	6.6	7	3.5	
K-CLY91-3/120_E		K-CLY9x-3/120_E	120	3	2	7	6.3	4.5	
		K-CLY9x-6/120_E	120	6	4	9.5	9.5	9	
		K-CLY9x-1.5/350_E	350	1.5	2	6.6	4.7	5	
K-CLY91-3/350_E		K-CLY9x-3/350_E	350	3	2	7	6.3	7.5	
		K-CLY9x-6/350_E	350	6	3.8	9.5	9.5	15	

(\*) Maximum excitation voltage for ferritic steel. For other temperature response matchings, the corresponding value is printed on the data sheet included with delivery.

## K-CDY41

**Double linear strain gauge**  
Temperature response matched to steel  
with  $\alpha = 10.8 \cdot 10^{-6}/K$

## K-CDY4x

Temperature response matched to customer's choice  
see page 16

Illustrations show actual size

Contents per package  
5 pcs.

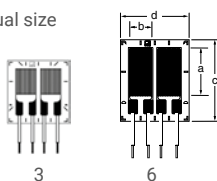

Types available on short notice		Variants	Noml. resistance $\Omega$	Dimensions (mm)				Maximum excitation voltage (*) V	Sldr. terminals Not required
Steel	Aluminum			Measuring grid		Meas. grid carrier			
		Other		a	b	c	d		
		K-CDY4x-3/350	350	3	2.7	8.2	8	8.5	
K-CDY41-6/350		K-CDY4x-6/350	350	6	3.2	10.7	9	13	

(\*) Maximum excitation voltage for ferritic steel. For other temperature response matchings, the corresponding value is printed on the data sheet included with delivery.

# SGs with connection cables

(incl. fluoropolymer-insulated connection wire)  
with two measuring grids

## K-CXY31

**0°/90° T rosette**  
Temperature response matched to steel  
with  $\alpha = 10.8 \cdot 10^{-6}/K$

## K-CXY33

Temperature response matched to aluminum  
with  $\alpha = 23 \cdot 10^{-6}/K$

## K-CXY3x

Temperature response matched to customer's choice  
see page 16

Illustrations show actual size



0.6



1.5

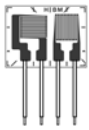

3

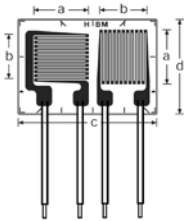

6

Contents per package: 5 pcs.

Types available on short notice		Variants	Noml. resistance	Dimensions (mm)				Maximum excitation voltage (*)	Sldr. terminals
Steel	Aluminum			Measuring grid		Meas. grid carrier			
		Other	$\Omega$	a	b	c	d	V	Not required
		K-CXY3x-0.6/120 <sup>(#)</sup>	120	0.6	1	7	6	1.5	
		K-CXY3x-1.5/120	120	1.5	1.6	8	6.3	3	
		K-CXY3x-3/120	120	3	3.2	10.5	8	5.5	
K-CXY31-6/120		K-CXY3x-6/120	120	6	6.3	17.5	12	11	
		K-CXY3x-1.5/350 <sup>(#)</sup>	350	1.5	1.7	7.7	6.3	5	
K-CXY31-3/350		K-CXY3x-3/350	350	3	3.3	10.9	7.6	10	
	K-CXY33-6/350	K-CXY3x-6/350	350	6	6.5	18	12	20	

(\*) Maximum excitation voltage for ferritic steel. For other temperature response matchings, the corresponding value is printed on the data sheet included with delivery.

(#) Only available with temperature response matching to ferritic steel, austenitic steel and aluminum

## K-CXY4x

**Shear / torsion half bridge**  
Temperature response matched to customer's choice  
see page 16

Illustrations show actual size

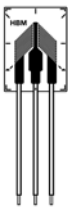

3

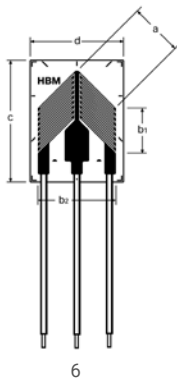

6

Contents per package: 5 pcs.

Types available on short notice		Variants	Noml. resistance	Dimensions (mm)					Maximum excitation voltage (*)	Sldr. terminals
Steel	Aluminum			Measuring grid			Meas. grid carrier			
		Other	$\Omega$	a	b1	b2	c	d	V	Not required
		K-CXY4x-3/120	120	3	3	5.4	11	8	5	
		K-CXY4x-6/120	120	6	6	10.2	16	12.2	9.5	
		K-CXY4x-3/350	350	3	4.2	5.6	11	8	9.5	
		K-CXY4x-6/350	350	6	6	10	16	12.2	16	
		K-CXY4x-3/700	700	3	4.2	5.6	11	8	13.5	
		K-CXY4x-6/700	700	6	6.1	9.9	16	12.2	23	

(\*) Maximum excitation voltage for ferritic steel. For other temperature response matchings, the corresponding value is printed on the data sheet included with delivery.

# SGs with connection cables

(incl. fluoropolymer-insulated connection wire)  
with three measuring grids

## K-CRY6xK

**0°/45°/90° rectangular hole drilling rosette**

Temperature response matched to customer's choice  
see page 16

Illustrations show  
actual size

Contents per package  
5 pcs.

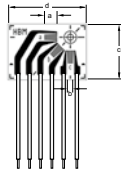

1.5

Types available on short notice		Variants	Noml. resistance $\Omega$	Dimensions (mm)				Maximum excitation voltage (*) V	Slr. terminals Not required
Steel	Aluminum			Measuring grid		Meas. grid carrier			
		Other		a	b	c	d		
		K-CRY6x-1.5/120K <sup>(1)</sup>	120	1.5	0.8	7.2	10.2	2	

(\*) Maximum excitation voltage for ferritic steel. For other temperature response matchings, the corresponding value is printed on the data sheet included with delivery.

<sup>(1)</sup> Only available with temperature response matched to ferritic steel

## K-CRY6xR

**0°/45°/90° rectangular hole drilling rosette**

Temperature response matched to customer's choice  
see page 16

Illustrations show  
actual size

Contents per package  
5 pcs.

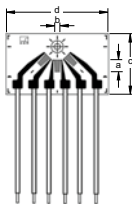

1.5

Types available on short notice		Variants	Noml. resistance $\Omega$	Dimensions (mm)				Maximum excitation voltage (*) V	Slr. terminals Not required
Steel	Aluminum			Measuring grid		Meas. grid carrier			
		Other		a	b	c	d		
		K-CRY6x-1.5/120R <sup>(1)</sup>	120	1.5	0.8	8	13.5	2	

(\*) Maximum excitation voltage for ferritic steel. For other temperature response matchings, the corresponding value is printed on the data sheet included with delivery.

<sup>(1)</sup> Only available with temperature response matched to ferritic steel

# SGs with connection cables

(incl. fluoropolymer-insulated connection wire)  
with three measuring grids

## K-CRY81

0°/45°/90° rectangular rosette  
Temperature response matched to steel  
with  $\alpha = 10.8 \cdot 10^{-6}/K$

## K-CRY83

Temperature response matched to aluminum  
with  $\alpha = 23 \cdot 10^{-6}/K$

## K-CRY8x

Temperature response matched to customer's choice  
see page 16

Illustrations show actual size

Contents per package: 5 pcs.

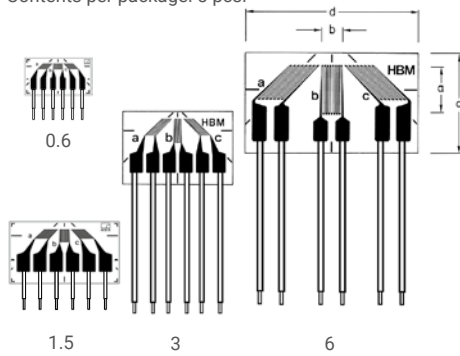

Types available on short notice		Variants	Noml. resistance $\Omega$	Dimensions (mm)				Maximum excitation voltage (*) V	Sldr. terminals Not required
Steel	Aluminum			Measuring grid		Meas. grid carrier			
		Other		a	b	c	d		
		K-CRY8x-0.6/120 <sup>(#)</sup>	120	0.6	1.1	4.8	8.7	1.6	
		K-CRY8x-1.5/120	120	1.5	1.2	8.2	14.6	2.5	
K-CRY81-3/120		K-CRY8x-3/120	120	3	1.1	9.7	14.6	3	
K-CRY81-6/120	K-CRY83-6/120	K-CRY8x-6/120	120	6	3	13	22.9	7.5	
		K-CRY8x-1.5/350 <sup>(#)</sup>	350	1.5	1.6	8.2	14.6	5	
		K-CRY8x-3/350	350	3	1.2	9.7	14.6	5.5	
		K-CRY8x-6/350	350	6	2.8	13.1	22.9	13	

(\*) Maximum excitation voltage for ferritic steel. For other temperature response matchings, the corresponding value is printed on the data sheet included with delivery.

(#) Only available with temperature response matching to ferritic steel, austenitic steel and aluminum

# SG with connection cable and RJ11 connector

Available cable lengths  
(fitted TPE ribbon cable)

K-CLY4... / K-CLY9... / K-CDY4... / K-CXY3...			
Cable length	3-wire version	4-wire version	4-wire version +RJ11
0.5 m	✓	✓	✓
1 m	✓	✓	✓
2 m	✓	✓	✓
3 m	✓	✓	✓
5 m	✓	✓	✓
7.5 m	✓	✓	✓
10 m	✓	✓	✓

K-CXY4...			
Cable length	3-wire version	4-wire version	4-wire version +RJ11
0.5 m	✓	-	-
1 m	✓	-	-
2 m	✓	-	-
3 m	✓	-	-
5 m	✓	-	-
7.5 m	✓	-	-
10 m	✓	-	-

K-CRY6... <sup>(1)</sup> / K-CRY8...			
Cable length	3-wire version	4-wire version	4-wire version +RJ11 <sup>(1)</sup>
0.5 m	✓	✓	✓
1 m	✓	✓	✓
2 m	✓	✓	✓
3 m	✓	✓	✓
5 m	✓	✓	✓
7.5 m	✓	✓	✓
10 m	✓	✓	✓

<sup>(1)</sup> Option "Connection cable in four-wire configuration with RJ11 plug" is not available for K-CRY6...

# Strain gauges – C series

- The specialist for extreme temperatures (-269 ... +250°C)
- Temperature response with matching in the range of -200 ... +250°C
- Flexible, therefore easy to handle

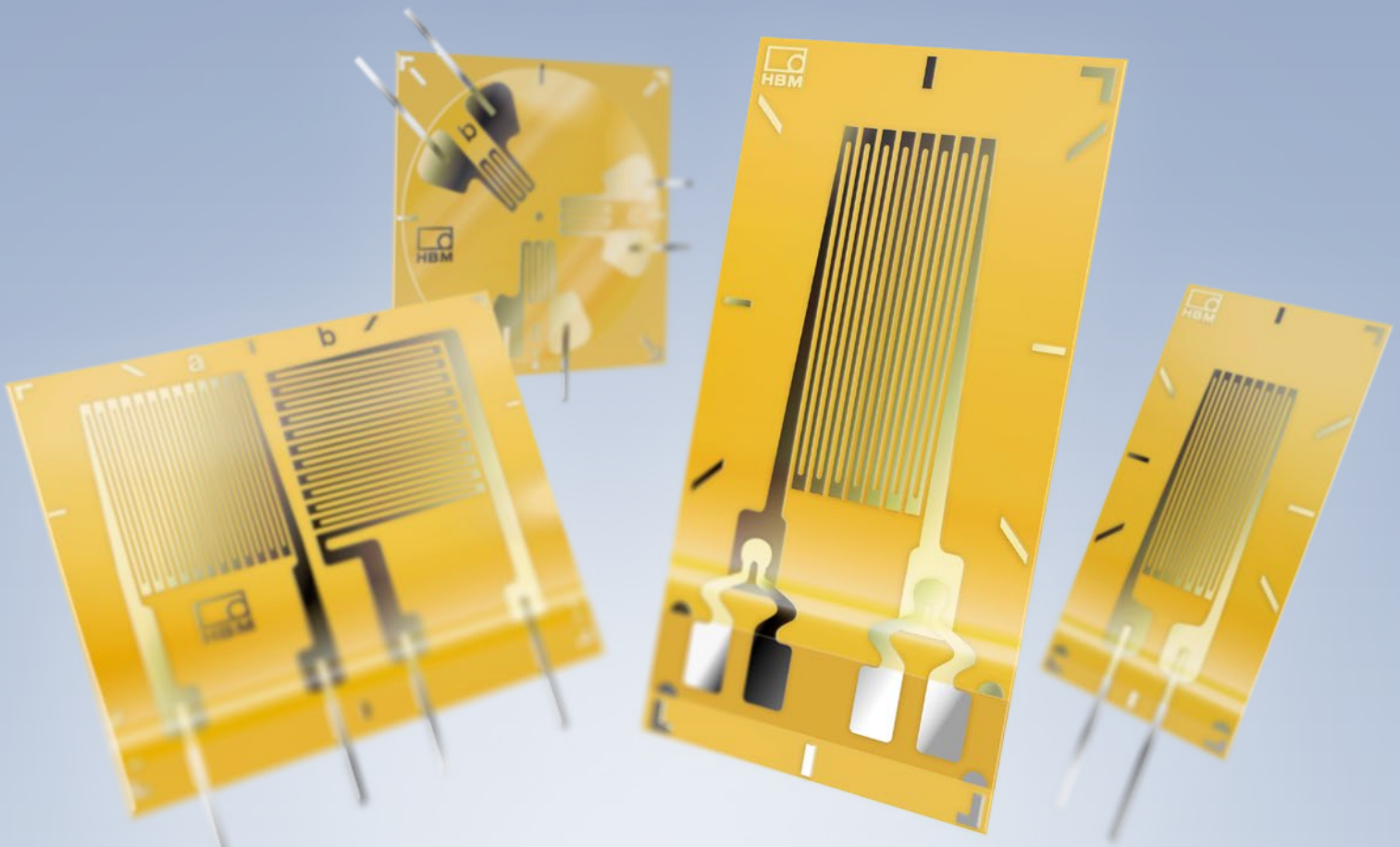



## Specifications – C series

SG construction		Foil SG with embedded measuring grid
Measuring grid		
Material	$\mu\text{m}$	Cr-Ni special alloy
Thickness		5
Carrier		
Material	$\mu\text{m}$	Polyimide
Thickness		55 ± 5
Covering agent		
Material	$\mu\text{m}$	Polyimide
Total thickness SG		81 ± 12
Connections		Nickel-plated copper leads, approx. 30 mm long
for SG without lead		solder tabs with strain relief, four-wire, copper-beryllium
Nominal resistance	$\Omega$	120, 350 depending on SG type
Resistance tolerance	%	± 0.3 without; ± 0.35 with lead
Gauge factor		approx. 2.2
Nominal (rated) value of the gauge factor		Specified on each package
Gauge factor tolerance	%	± 1
Temperature coefficient of the gauge factor		Specified on each package
Reference temperature	$^{\circ}\text{C}$	23
Application temperature range		
for static, i.e. zero-point related measurements	$^{\circ}\text{C}$	-200 ... +200
for dynamic, i.e. non zero-point related measurements	$^{\circ}\text{C}$	-269 ... +250
Transverse sensitivity		Specified on each package
at reference temperature using adhesive Z 70	%	-0.15
on SG type LC11-6/120		
Temperature response		Specified on each package
Temperature response matched to expansion coefficient		
$\alpha$ for ferritic steel	1/K	$10.8 \cdot 10^{-6}$
$\alpha$ for aluminum	1/K	$23 \cdot 10^{-6}$
Tolerance of temperature response	1/K	$\pm 0.6 \cdot 10^{-6}$
Temperature response with matching in the range of	$^{\circ}\text{C}$	-200 ... +250
Mechanical hysteresis <sup>(1)</sup>		
at reference temperature and strain $\varepsilon = \pm 1,000 \mu\text{m}/\text{m}$		
on SG type LC11-6/120		
at 1st load cycle and adhesive Z 70	$\mu\text{m}/\text{m}$	1.25
at 3rd load cycle and adhesive Z 70	$\mu\text{m}/\text{m}$	0.75
Maximum elongation <sup>(1)</sup>		
at reference temperature using adhesive Z 70		
on SG type LC11-6/120		
Absolute strain value $\varepsilon$ for positive direction	$\mu\text{m}/\text{m}$	20,000 ( $\Delta \pm 2\%$ )
Absolute strain value $\varepsilon$ for negative direction	$\mu\text{m}/\text{m}$	100,000 ( $\Delta \pm 10\%$ )
Fatigue life <sup>(1)</sup>		
at reference temperature using adhesive Z 70		
on SG type LC11-6/120		
Achievable number of load cycles $L_W$ with		
alternating strain $\varepsilon_W = \pm 1,000 \mu\text{m}/\text{m}$ and		
variation of zero point $\varepsilon_m \Delta \leq 300 \mu\text{m}/\text{m}$		$>> 10^7$ (test was interrupted at $10^7$ )
$\varepsilon_m \Delta \leq 30 \mu\text{m}/\text{m}$		$> 10^7$ (test was interrupted at $10^7$ )
Minimum radius of curvature, longitudinal and transverse, at reference temperature		
within the measuring grid area	mm	0.3
within the solder tabs area	mm	2
Applicable bonding materials		
Cold curing adhesives		Z 70; X 60; X 280
Hot curing adhesives		EP 150; EP 310N

<sup>(1)</sup> The data depend on the various parameters of the specific application and are therefore stated for representative examples only.

# C series

with one measuring grid

## LC11

### Linear strain gauge

Temperature response matched to steel  
with  $\alpha = 10.8 \cdot 10^{-6}/K$

## LC1x

Temperature response matched to customer's choice  
see page 16

Illustrations show actual size  
(indicated: grid length in mm)

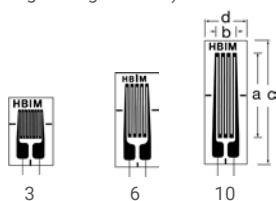

Contents per package: 10 pcs.

Types available from stock		Variants	Noml. resistance	Dimensions (mm)				Maximum excitation voltage (*)	Sldr. terminals
Steel	Aluminum			Measuring grid		Meas. grid carrier			
		Other <sup>(1)</sup>	$\Omega$	a	b	c	d	V	
1-LC11-3/120			120	3	3.3	8.5	5.5	6	LS 5
1-LC11-6/120			120	6	3.2	12	5.5	9	LS 5
		1-LC1x-10/120	120	10	3.2	16	5.5	11	LS 5
1-LC11-1.5/350		1-LC1x-1.5/350	350	1.5	3.3	6.4	5.5	6	LS 5
1-LC11-3/350		1-LC1x-3/350	350	3	3.4	8.5	5.5	10	LS 5
1-LC11-6/350		1-LC1x-6/350	350	6	3.3	12	5.5	14	LS 5
1-LC11-10/350		1-LC1x-10/350	350	10	3.3	16	5.5	18	LS 5

(\*) Maximum excitation voltage for ferritic steel. For other temperature response matchings, the corresponding value is printed on the data sheet included with delivery.

<sup>(1)</sup> Only available with matching to aluminum or ferritic steel

## LC6x

Temperature response matched to customer's choice  
see page 16

Illustrations show actual size  
(indicated: grid length in mm)

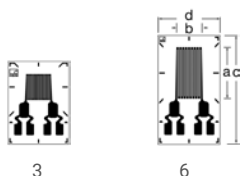

Contents per package: 10 pcs.

Types available from stock		Variants	Noml. resistance	Dimensions (mm)				Maximum excitation voltage (*)	Sldr. terminals
Steel	Aluminum			Measuring grid		Meas. grid carrier			
		Other <sup>(1)</sup>	$\Omega$	a	b	c	d	V	
		1-LC6x-3/350	350	3	3.4	11	8	9.5	-
		1-LC6x-6/350	350	6	3.4	14	8	16	-

(\*) Maximum excitation voltage for ferritic steel. For other temperature response matchings, the corresponding value is printed on the data sheet included with delivery.

<sup>(1)</sup> Only available with matching to aluminum or ferritic steel

Maximum elongation <sup>(2)</sup> at reference temperature using adhesive Z 70 on SG type LC61-3/350 Absolute strain value $\epsilon$ for positive direction Absolute strain value $\epsilon$ for negative direction Minimum radius of curvature, longitudinal and transverse, at reference temperature within measuring grid area within solder tabs area	$\mu\text{m}/\text{m}$ $\mu\text{m}/\text{m}$       mm mm	25,000 ( $\pm 2.5\%$ ) 50,000 ( $\pm 5\%$ )       0.5 10
--	--	---

<sup>(2)</sup> The data depend on the various parameters of the specific installation and are therefore stated for representative examples only.

... other specifications  
as on page 49

# C series

with two measuring grids, with three measuring grids

## XC11

**0°/90° T rosette**  
 Temperature response matched to steel  
 with  $\alpha = 10.8 \cdot 10^{-6}/K$

## XC1x

Temperature response matched to customer's choice  
 see page 16

Illustrations show actual size  
 (indicated: grid length in mm)

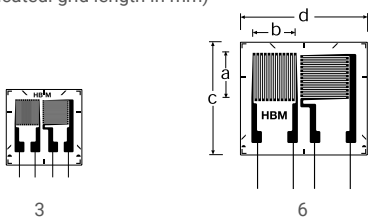

Contents per package: 5 pcs.

Types available from stock		Variants	Noml. resistance	Dimensions (mm)				Maximum excitation voltage (*)	Sldr. terminals
Steel	Aluminum			Measuring grid		Meas. grid carrier			
		Other <sup>(1)</sup>	$\Omega$	a	b	c	d	V	
		1-XY1x-1.5/350 <sup>(2)</sup>	350	1.5	1.5	6	8.4	6	LS 5
1-XC11-3/350		1-XC1x-3/350	350	3	3.3	10	10	10	LS 7
		1-XC1x-6/350	350	6	6.4	16	18	20	LS 4

(\*) Maximum excitation voltage for ferritic steel. For other temperature response matchings, the corresponding value is printed on the data sheet included with delivery.

<sup>(1)</sup> Only available with matching to aluminum or ferritic steel  
<sup>(2)</sup> Only available with matching to ferritic steel

## RC11

**0°/45°/90° strain gauge rosette**  
 Temperature response matched to steel  
 with  $\alpha = 10.8 \cdot 10^{-6}/K$

## RC1x

Temperature response matched to customer's choice  
 see page 16

Illustrations show actual size  
 (indicated: Dimension a2 in mm)

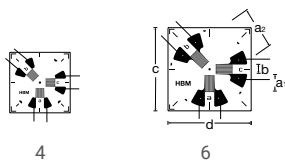

Contents per package: 5 pcs.

Types available from stock		Variants	Noml. resistance	Dimensions (mm)					Maximum excitation voltage (*)	Sldr. terminals
Steel	Aluminum			Measuring grid		Meas. grid carrier				
		Other <sup>(1)</sup>	$\Omega$	a1	a2	b	c	d	V	
1-RC11-4/350		1-RC1x-4/350	350	1.2	4	1.1	8	8	3.5	LS 7
		1-RC1x-6/350	350	2	6	1.3	11	11	5	LS 5

(\*) Maximum excitation voltage for ferritic steel. For other temperature response matchings, the corresponding value is printed on the data sheet included with delivery.

<sup>(1)</sup> Only available with matching to aluminum or ferritic steel

# Strain gauges – M series

- High resistance to alternating loads
- All strain gauges have large solder tabs with strain relief
- For high-temperature range (+300°C)
- Wide spectrum of different types

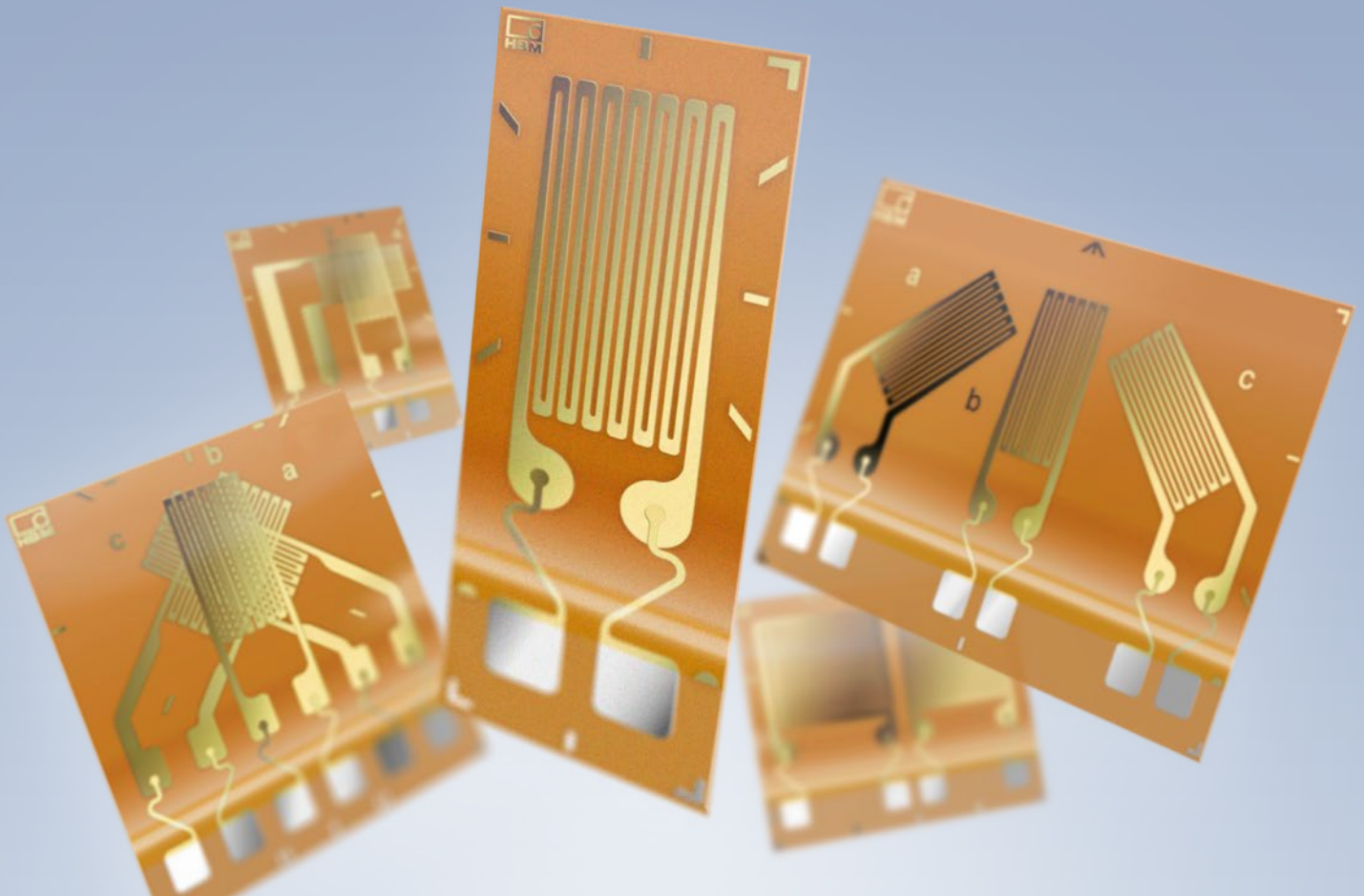

## Specifications – M series

SG construction		Foil SG with embedded measuring grid
Measuring grid		
Material	$\mu\text{m}$	Cr-Ni special alloy
Thickness		5
Carrier		
Material	$\mu\text{m}$	Glass-fiber reinforced phenolic resin
Thickness		$35 \pm 10$
Covering agent		
Material	$\mu\text{m}$	Polyimide foil
Total thickness		$65 \pm 15$
Connections		Copper-beryllium solder tabs with strain relief
Nominal resistance	$\Omega$	350 or 1,000, depending on SG type
Resistance tolerance <sup>(2)</sup>	%	$\pm 0.3$
Gauge factor		approx. 2.2
Nominal (rated) value of the gauge factor		Specified on each package
Gauge factor tolerance for measuring grid length < 3 mm	%	$\pm 1.5$
with measuring grid length $\geq 3$ mm	5	$\pm 0.7$
Temperature coefficient of the gauge factor		Specified on each package
Reference temperature	$^{\circ}\text{C}$	23
Application temperature range		
for static, i.e. zero-point related measurements	$^{\circ}\text{C}$	-200 ... +250
for dynamic, i.e. non zero-point related measurements <sup>(3)</sup>	$^{\circ}\text{C}$	-200 ... +300
Transverse sensitivity		Specified on each package;
at reference temperature using adhesive Z 70		
on SG type LM11-6/350GE	%	-4
Temperature response		Specified on each package
Temperature response matched to choice of expansion coefficient		
$\alpha$ for ferritic steel	1/K	$10.8 \cdot 10^{-6}$
$\alpha$ for aluminum	1/K	$23 \cdot 10^{-6}$
$\alpha$ for austenitic steel	1/K	$16 \cdot 10^{-6}$
$\alpha$ for titanium	1/K	$9 \cdot 10^{-6}$
$\alpha$ for molybdenum	1/K	$5.4 \cdot 10^{-6}$
$\alpha$ for silica	1/K	$0.5 \cdot 10^{-6}$
Tolerance of temperature response	1/K	$\pm 0.6 \cdot 10^{-6}$
Temperature response with matching in the range of	$^{\circ}\text{C}$	-200 ... +250
Mechanical hysteresis <sup>(1)</sup>		
at reference temperature using adhesive EP310N		
on SG type LM11-6/350GE		
at 1st load cycle and adhesive EP310N	$\mu\text{m}/\text{m}$	$\pm 0.5$
at 3rd load cycle and adhesive EP310N	$\mu\text{m}/\text{m}$	$\pm 0.5$
Maximum elongation <sup>(1)</sup>		
at reference temperature using adhesive Z70		
on SG type LM11-6/350GE		
Absolute strain value $\varepsilon$ for positive direction	$\mu\text{m}/\text{m}$	10,000 (1%)
Absolute strain value $\varepsilon$ for negative direction	$\mu\text{m}/\text{m}$	15,000 (1.5%)
Fatigue life <sup>(1)</sup>		
at reference temperature using adhesive EP310N		
on SG type LM11-6/350GE until failure criterion		
Achievable number of load cycles $L_W$ with alternating strain		
$\varepsilon_W = \pm 2,000 \mu\text{m}/\text{m}$ and variation of zero point $\varepsilon_m \Delta \leq 100 \mu\text{m}/\text{m}$		$1 \cdot 10^7$
$\varepsilon_W = \pm 2,600 \mu\text{m}/\text{m}$ and variation of zero point $\varepsilon_m \Delta \leq 100 \mu\text{m}/\text{m}$		$2 \cdot 10^5$
$\varepsilon_W = \pm 3,100 \mu\text{m}/\text{m}$ and variation of zero point $\varepsilon_m \Delta \leq 100 \mu\text{m}/\text{m}$		$1 \cdot 10^4$
Minimum radius of curvature, longitudinal and transverse, at reference temperature		
LM1, TM1, XM4, RM8	mm	5
TM9, RM9	mm	10
Applicable bonding materials		
Cold curing adhesives		Z 70; X 60; X 280
Hot curing adhesives		EP 150; EP 310N

<sup>(1)</sup> The data depend on the various parameters of the specific installation and are therefore stated for representative examples only.

<sup>(2)</sup> For TM9 and RM9 the deviation is  $\pm 0.5\%$ .

<sup>(3)</sup> 300°C only briefly; < 5 h under air

# M series

with one measuring grid

## LM11

### Linear strain gauge

Temperature response matched to steel  
with  $\alpha = 10.8 \cdot 10^{-6}/K$

## LM1x

Temperature response matched to customer's choice  
see page 16

Illustrations show actual size  
(indicated: grid length in mm)

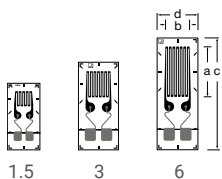

Contents per package: 10 pcs.

Types available from stock		Variants	Noml. resistance $\Omega$	Dimensions (mm)				Maximum excitation voltage (*) V	Sldr. terminals
Steel	Aluminum			Measuring grid		Meas. grid carrier			
		Other <sup>(1)</sup>		a	b	c	d		
1-LM11-1.5/350GE		1-LM1x-1.5/350GE	350	1.5	2.5	9	4.4	6	
1-LM11-3/350GE		1-LM1x-3/350GE	350	3	3.4	11.8	5.4	10	
1-LM11-6/350GE		1-LM1x-6/350GE	350	6	3.4	14.8	5.4	14	
1-LM11-1.5/1K0GE		1-LM1x-1.5/1K0GE	1000	1.5	2.5	9	4.4	11	
1-LM11-3/1K0GE		1-LM1x-3/1K0GE	1000	3	3.4	11.8	5.4	17	
1-LM11-6/1K0GE		1-LM1x-6/1K0GE	1000	6	3.4	14.8	5.4	14	

(\*) Maximum excitation voltage for ferritic steel. For other temperature response matchings, the corresponding value is printed on the data sheet included with delivery.

<sup>(1)</sup> Not available matched to plastic

# M series

with two measuring grids

## TM11

### T rosette

Temperature response matched to steel  
with  $\alpha = 10.8 \cdot 10^{-6}/K$

## TM1x

Temperature response matched to customer's choice  
see page 16

Illustrations show actual size  
(indicated: grid length in mm)

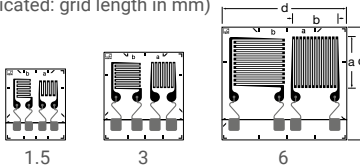

Contents per package: 5 pcs.

Types available from stock		Variants	Noml. resistance $\Omega$	Dimensions (mm)				Maximum excitation voltage (*) V	Sldr. terminals
Steel	Aluminum			Measuring grid		Meas. grid carrier			
		Other <sup>(1)</sup>		a	b	c	d		
1-TM11-1.5/350GE		1-TM1x-1.5/350GE	350	1.5	2.6	9.5	8	6	
1-TM11-3/350GE		1-TM1x-3/350GE	350	3	3.4	11.7	10.6	10	
1-TM11-6/350GE		1-TM1x-6/350GE	350	6	6.3	15	16.6	19.5	
1-TM11-1.5/1K0GE		1-TM1x-1.5/1K0GE	1000	1.5	2.5	9.5	8	11	
1-TM11-3/1K0GE		1-TM1x-3/1K0GE	1000	3	3.4	11.7	10.6	17	
1-TM11-6/1K0GE		1-TM1x-6/1K0GE	1000	6	6.3	15	16.6	33	

(\*) Maximum excitation voltage for ferritic steel. For other temperature response matchings, the corresponding value is printed on the data sheet included with delivery.

(1) Not available matched to plastic

## TM91

### Stacked T rosette

Temperature response matched to steel  
with  $\alpha = 10.8 \cdot 10^{-6}/K$

## TM9x

Temperature response matched to customer's choice  
see page 16

Illustrations show actual size  
(indicated: grid length in mm)

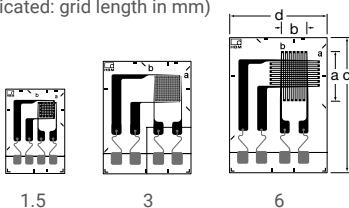

Contents per package: 5 pcs.

Types available from stock		Variants	Noml. resistance $\Omega$	Dimensions (mm)				Maximum excitation voltage (*) V	Sldr. terminals
Steel	Aluminum			Measuring grid		Meas. grid carrier			
		Other <sup>(1)</sup>		a	b	c	d		
1-TM91-1.5/350GE		1-TM9x-1.5/350GE	350	1.5	2.5	11.3	7.9	4.5	
1-TM91-3/350GE		1-TM9x-3/350GE	350	3	3.7	15	11.7	7	
1-TM91-6/350GE		1-TM9x-6/350GE	350	6	3.7	18	13	10	
1-TM91-1.5/1K0GE		1-TM9x-1.5/1K0GE	1000	1.5	2.5	11.3	7.9	7	
1-TM91-3/1K0GE		1-TM9x-3/1K0GE	1000	3	3.7	15	11.7	13	
1-TM91-6/1K0GE		1-TM9x-6/1K0GE	1000	6	3.7	18	13	18	

(\*) Maximum excitation voltage for ferritic steel. For other temperature response matchings, the corresponding value is printed on the data sheet included with delivery.

(1) Not available matched to plastic

# M series

with two measuring grids

## XM41

**Shear / torsion strain gauge**  
Temperature response matched to steel  
with  $\alpha = 10.8 \cdot 10^{-6}/K$

## XM4x

Temperature response matched to customer's choice  
see page 16

Illustrations show actual size  
(indicated: grid length in mm)

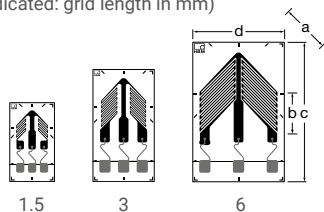

Contents per package: 5 pcs.

Types available from stock		Variants	Noml. resistance $\Omega$	Dimensions (mm)				Maximum excitation voltage (*) V	Sldr. terminals
Steel	Aluminum			Measuring grid		Meas. grid carrier			
		Other <sup>(1)</sup>		a	b	c	d		
1-XM41-1.5/350GE		1-XM4x-1.5/350GE	350	1.5	1.5	10.6	6	5	
1-XM41-3/350GE		1-XM4x-3/350GE	350	3	3	15	8.2	10	
1-XM41-6/350GE		1-XM4x-6/350GE	350	6	4	18.6	12.2	16	
1-XM41-1.5/1K0GE		1-XM4x-1.5/1K0GE	1000	1.5	1.5	10.6	6	8	
1-XM41-3/1K0GE		1-XM4x-3/1K0GE	1000	3	2.9	15	8.2	16	
1-XM41-6/1K0GE		1-XM4x-6/1K0GE	1000	6	4	18.6	12.2	26	

(\*) Maximum excitation voltage for ferritic steel. For other temperature response matchings, the corresponding value is printed on the data sheet included with delivery.

<sup>(1)</sup> Not available matched to plastic



# M series

with three measuring grids

## RM81

### Rectangular rosette

Temperature response matched to steel  
with  $\alpha = 10.8 \cdot 10^{-6}/K$

## RM8x

Temperature response matched to customer's choice  
see page 16

Illustrations show actual size  
(indicated: grid length in mm)

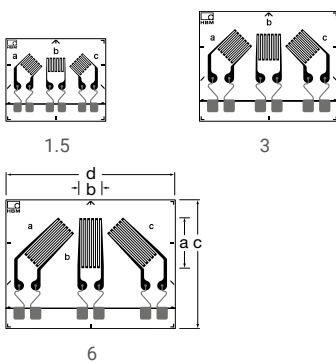

Contents per package: 5 pcs.

## RM91

### Stacked strain gauge rosette

Temperature response matched to steel  
with  $\alpha = 10.8 \cdot 10^{-6}/K$

## RM9x

Temperature response matched to customer's choice  
see page 16

Illustrations show actual size  
(indicated: grid length in mm)

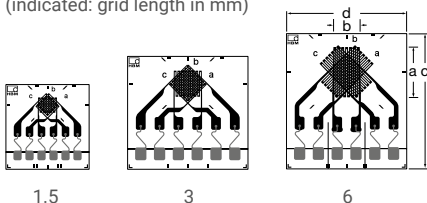

Contents per package: 5 pcs.

Types available from stock		Variants	Noml. resistance	Dimensions (mm)				Maximum excitation voltage (*)	Sldr. terminals
Steel	Aluminum			Measuring grid		Meas. grid carrier			
		Other <sup>(1)</sup>	$\Omega$	a	b	c	d	V	
1-RM81-1.5/350GE		1-RM8x-1.5/350GE	350	1.5	2.5	11	13.3	6	
1-RM81-3/350GE		1-RM8x-3/350GE	350	3	3.4	14.6	18.4	10	
1-RM81-6/350GE		1-RM8x-6/350GE	350	6	3.4	17.1	22.5	14	
1-RM81-1.5/1K0GE		1-RM8x-1.5/350GE	1000	1.5	2.5	11	13.3	11	
1-RM81-3/1K0GE		1-RM8x-3/350GE	1000	3	3.4	14.6	18.4	17	
1-RM81-6/1K0GE		1-RM8x-6/350GE	1000	6	3.4	17.1	22.5	24	

(\*) Maximum excitation voltage for ferritic steel. For other temperature response matchings, the corresponding value is printed on the data sheet included with delivery.

<sup>(1)</sup> Not available matched to plastic

Types available from stock		Variants	Noml. resistance	Dimensions (mm)				Maximum excitation voltage (*)	Sldr. terminals
Steel	Aluminum			Measuring grid		Meas. grid carrier			
		Other <sup>(1)</sup>	$\Omega$	a	b	c	d	V	
1-RM91-1.5/350GE		1-RM9x-1.5/350GE	350	1.5	2.5	11.3	11.1	6	
1-RM91-3/350GE		1-RM9x-3/350GE	350	3	3.7	15	16	11	
1-RM91-6/350GE		1-RM9x-6/350GE	350	6	3.7	18	16	9	
1-RM91-1.5/1K0GE		1-RM9x-1.5/350GE	1000	1.5	2.6	11.3	11.1	6	
1-RM91-3/1K0GE		1-RM9x-3/350GE	1000	3	3.7	15	16	11	
1-RM91-6/1K0GE		1-RM9x-6/350GE	1000	6	3.7	18	16	15	

(\*) Maximum excitation voltage for ferritic steel. For other temperature response matchings, the corresponding value is printed on the data sheet included with delivery.

<sup>(1)</sup> Not available matched to plastic

# Strain gauges – G series

- Strain gauges for special applications and transducer construction
- Nominal resistance 120  $\Omega$  and 350  $\Omega$  available
- Leads: fitted as standard

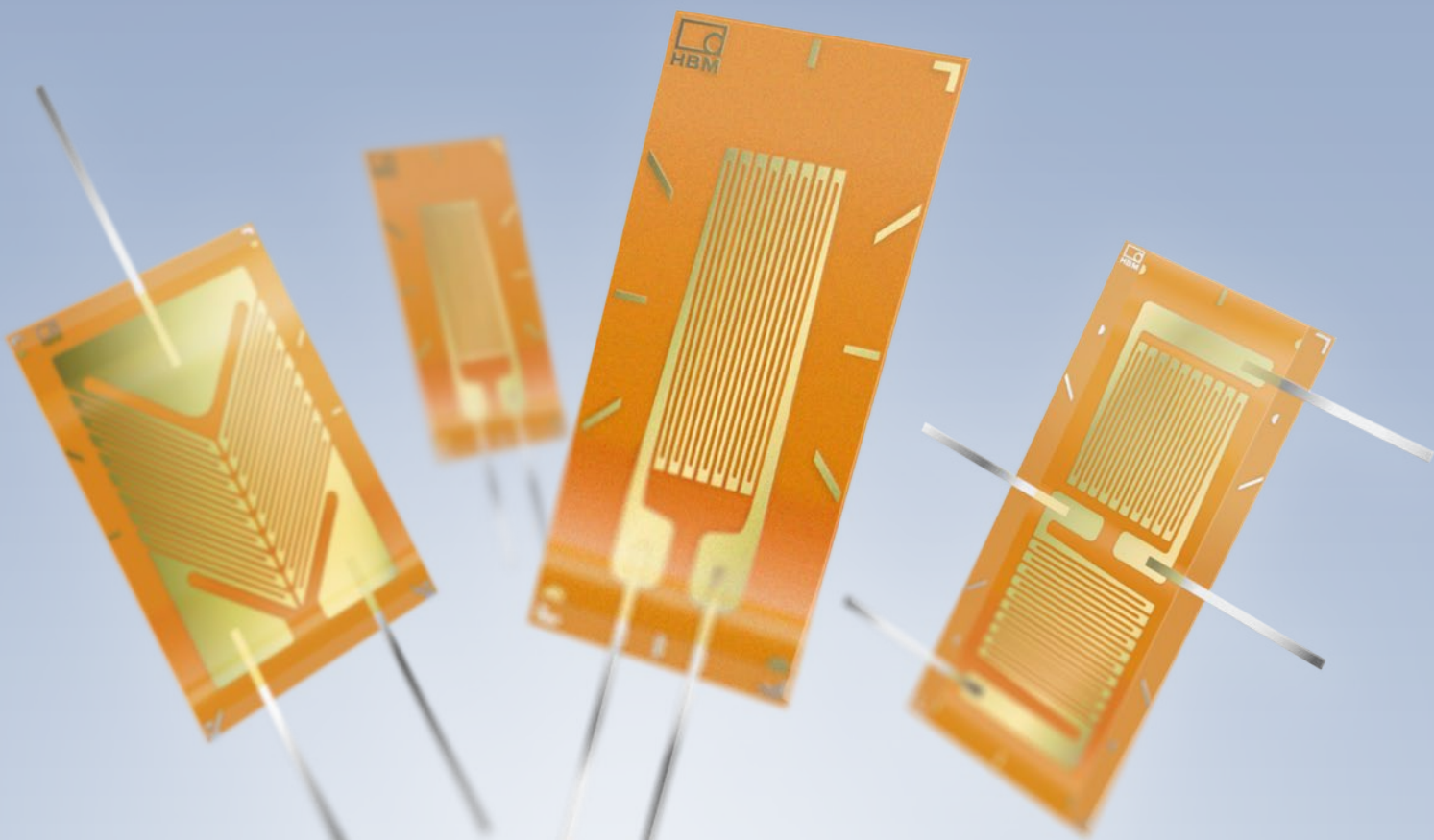

## Specifications – G series

SG construction Measuring grid Material Thickness Carrier Material Thickness Covering agent Material Total thickness SG Connections	µm           µm           µm	Foil SG with embedded measuring grid  Constantan foil 3.8 or 5, depending on SG type  Phenolic resin, glass-fiber reinforced 35±10  Phenolic resin, glass-fiber reinforced 65±15 Nickel-plated copper leads, 0.2 or 0.3 x 0.06 x 30 mm
Nominal resistance Resistance tolerance <sup>(1)</sup> Gauge factor Nominal (rated) value of the gauge factor Gauge factor tolerance for measuring grid length of 0.6 mm and 1.5 mm with measuring grid length of $\geq 3$ mm Temperature coefficient of the gauge factor Nominal (rated) value of the temperature coefficient of the gauge factor	Ω %           % % 1/K 1/K	120 or 350, depending on SG type ±0.35 approx. 2 Specified on each package ±1.5 ±0.7 approx. $(115 \pm 10) \cdot 10^{-6}$ Specified on each package
Reference temperature Application temperature range for static, i.e. zero-point related measurements for dynamic, i.e. non zero-point related measurements	°C  °C °C	23  -70 ... +200 -200 ... +200
Transverse sensitivity at reference temperature using adhesive Z 70 on SG type LG11-6/120	%	Specified on each package  +0.1
Temperature response Temperature response as required, adapted to coefficients of thermal expansion α for ferritic steel α for aluminum α for austenitic steel Other adaptation available on request Tolerance of temperature response Temperature range of temperature response matching	1/K 1/K 1/K      1/K °C	Specified on each package  10.8 · 10 <sup>-6</sup> 23 · 10 <sup>-6</sup> 16 · 10 <sup>-6</sup>      ±0.3 · 10 <sup>-6</sup> -10 ... +120
Mechanical hysteresis <sup>(2)</sup> at reference temperature and strain $\varepsilon = \pm 1,000 \mu\text{m/m}$ on SG type LG11-6/120 at 1st load cycle and adhesive EP 250 at 3rd load cycle and adhesive EP 250 at 1st load cycle and adhesive X 60 at 3rd load cycle and adhesive X 60 on SG type LG11-3/350 at 1st load cycle and adhesive Z 70 at 3rd load cycle and adhesive Z 70	µm/m µm/m µm/m µm/m      µm/m µm/m	0.5 0.5 3 1.5      1.6 0.8
Maximum elongation <sup>(2)</sup> at reference temperature using adhesive Z 70 on SG type LG11-6/120 Absolute strain value $\varepsilon$ for positive direction Absolute strain value $\varepsilon$ for negative direction	µm/m µm/m	20,000 ( $\Delta 2\%$ ) 50,000 ( $\Delta 5\%$ )
Fatigue life <sup>(2)</sup> at reference temperature using adhesive Z 70 on SG type LG11-6/120 Achievable number of load cycles $L_W$ with alternating strain $\varepsilon_w = \pm 1,000 \mu\text{m/m}$ and variation of zero point $\varepsilon_m \Delta \leq 300 \mu\text{m/m}$ $\varepsilon_m \Delta \leq 30 \mu\text{m/m}$ on SG type LG11-6/350 $\varepsilon_m \Delta \leq 300 \mu\text{m/m}$ $\varepsilon_m \Delta \leq 30 \mu\text{m/m}$	>> 10 <sup>7</sup> 3 · 10 <sup>6</sup>      >> 10 <sup>7</sup> 3 · 10 <sup>6</sup>	
Minimum radius of curvature, longitudinal and transverse, at reference temperature Applicable bonding materials Cold curing adhesives Hot curing adhesives	mm	3  Z 70; X 60; X 280 EP 150; EP 310N

(1) With measuring grid lengths of 0.6 mm, the nominal resistance may deviate by  $\pm 1\%$

(2) The data depend on the various parameters of the specific installation and are therefore stated for representative examples only.

# G series

with one measuring grid, with two measuring grids

## LG11

### Linear strain gauge

Temperature response matched to steel  
with  $\alpha = 10.8 \cdot 10^{-6}/K$

## LG13

Temperature response matched to aluminum  
with  $\alpha = 23 \cdot 10^{-6}/K$

## LG1x

Temperature response matched to customer's choice  
see page 16

Illustrations show actual size  
(indicated: grid length in mm)

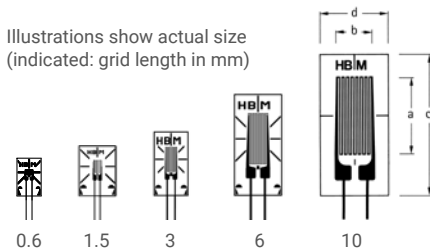

Contents per package: 10 pcs.

Types available from stock		Variants	Noml. resistance $\Omega$	Dimensions (mm)				Maximum excitation voltage (*) V	Sldr. terminals
Steel	Aluminum			Measuring grid		Meas. grid carrier			
		Other		a	b	c	d		
		1-LG1x-0.6/120 <sup>(#)</sup>	120	0.6	1	5	3.2	1.5	LS 7
		1-LG1x-1.5/120	120	1.5	1.2	6.5	4.7	2.5	LS 7
1-LG11-3/120		1-LG1x-3/120	120	3	1.6	8.5	4.5	4	LS 7
1-LG11-6/120		1-LG1x-6/120	120	6	2.8	13	6	8	LS 5
1-LG11-10/120		1-LG1x-10/120	120	10	4.6	18.5	9.5	13	LS 5
1-LG11-3/350		1-LG1x-3/350	350	3	1.6	8.5	4.5	7	LS 7
1-LG11-6/350	1-LG13-6/350	1-LG1x-6/350	350	6	2.8	13	6	13	LS 5
1-LG11-10/350		1-LG1x-10/350	350	10	5	18.5	9.5	23	LS 5

(\*) Maximum excitation voltage for ferritic steel. For other temperature response matchings, the corresponding value is printed on the data sheet included with delivery.

(#) Only available with temperature response matching to ferritic steel, austenitic steel and aluminum

## XG11

### T rosette

Temperature response matched to steel  
with  $\alpha = 10.8 \cdot 10^{-6}/K$

## XG13

Temperature response matched to aluminum  
with  $\alpha = 23 \cdot 10^{-6}/K$

## XG1x

Temperature response matched to customer's choice  
see page 16

Illustrations show actual size  
(indicated: grid length in mm)

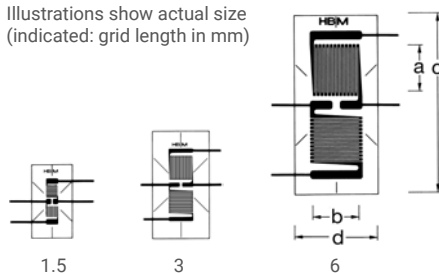

Contents per package: 5 pcs.

Types available from stock		Variants	Noml. resistance $\Omega$	Dimensions (mm)				Maximum excitation voltage (*) V	Sldr. terminals
Steel	Aluminum			Measuring grid		Meas. grid carrier			
		Other		a	b	c	d		
		1-XG1x-1.5/120	120	1.5	1.5	9	5	3	LS 5
1-XG11-3/120		1-XG1x-3/120	120	3	3.2	14.5	7.5	6	LS 4
1-XG11-6/120		1-XG1x-6/120	120	6	6.5	23.5	11	12	LS 5
1-XG11-3/350	1-XG13-3/350	1-XG1x-3/350	350	3	3.1	14.4	7.3	10	LS 4
1-XG11-6/350		1-XG1x-6/350	350	6	6.3	23.3	10.5	20	LS 5

(\*) Maximum excitation voltage for ferritic steel. For other temperature response matchings, the corresponding value is printed on the data sheet included with delivery.

# G series

with two measuring grids

## XG21

**Shear / torsion half bridge**  
 Temperature response matched to steel  
 with  $\alpha = 10.8 \cdot 10^{-6}/K$

## XG2x

Temperature response matched to customer's choice  
 see page 16

Illustrations show actual size  
 (indicated: grid length in mm)



1.5

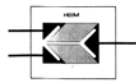

3

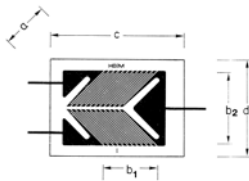

6

Contents per package: 5 pcs.

Types available from stock		Variants	Noml. resistance $\Omega$	Dimensions (mm)					Maximum excitation voltage (*) V	Sldr. terminals
Steel	Aluminum			Measuring grid			Meas. grid carrier			
		Other		a	b1	b2	c	d		
		1-XG2x-1.5/120	120	1.5	1.7	2.5	6.8	4.5	2.5	LS7
		1-XG2x-3/120	120	3	3.7	5.3	11.2	9.5	6	LS5
		1-XG2x-6/120	120	6	7.9	10	17.5	12.7	11	LS4
1-XG21-3/350		1-XG2x-3/350	350	3	4.5	5.3	11.2	9.5	10	LS4
1-XG21-6/350		1-XG2x-6/350	350	6	7.9	10	17.5	12.7	19	LS5

(\*) Maximum excitation voltage for ferritic steel. For other temperature response matchings, the corresponding value is printed on the data sheet included with delivery.

# Special strain gauges

- Encapsulated strain gauges with equipment protection level IP67 for challenging applications
- Weldable strain gauge for alternative bonding method
- Strain gauges for very high strains
- Strain gauges for measurements in load pins
- Miniature strain gauge rosette for use on PCBs
- Strain gauges for integration in fiber composites
- Strain gauges for transient pressure measurements
- Strain gauges for determination of crack propagation
- Temperature sensor for installation as strain gauge
- Strain gauges for determination of residual stress

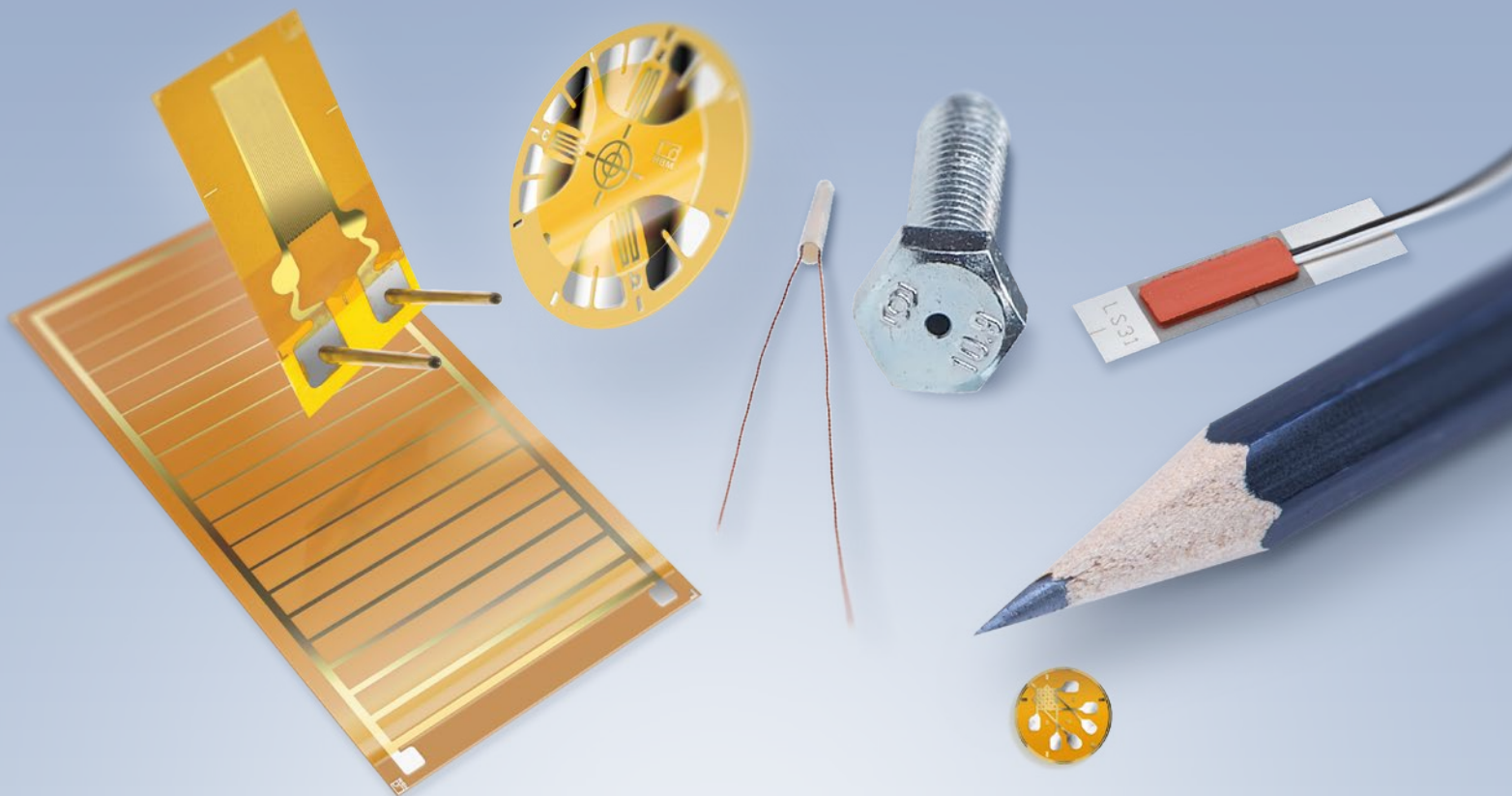

# Encapsulated strain gauges with stranded wire

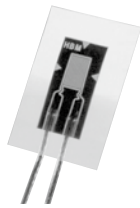

- To equipment protection level IP 67<sup>(1)</sup>
- With 1m fluoropolymer-insulated connection wire
- Moisture proof and resistant against chemicals<sup>(2)</sup> because it is encapsulated on all sides in a special plastic material
- Excellent zero signal stability with changing moisture
- Choice of two wire or four wire configuration

## LE11

**Encapsulated linear strain gauge,**  
Temperature response matched to steel  
 $\alpha = 10.8 \cdot 10^{-6} / K$

Illustrations show actual size

Contents per package  
5 pc.

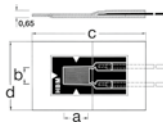

Types available from stock	Noml. resistance $\Omega$	Dimensions (mm)				Maximum excitation voltage (*) V
		Measuring grid		Meas. grid carrier		
Steel		a	b	c	d	
1-LE11-3/350ZE (2-wire circuit)	350	3	2	15	9	6
1-LE11-3/350VE (4-wire circuit)	350	3	2	15	9	6

(\*) Maximum excitation voltage for ferritic steel. For other temperature response matchings, the corresponding value is printed on the data sheet included with delivery.

## Specifications – LE11

Type		LE11-3/350
Strain gauge construction		Foil SG, IP 67, resistant against chemicals <sup>(2)</sup>
Measuring grid material		Constantan foil
Measuring grid length	mm	3
Carrier		
Material		Special plastic material
Thickness	$\mu m$	$30 \pm 5$
Covering agent		Special plastic material, 25 $\mu m$ thick
Total Thickness SG	$\mu m$	$50 \pm 15$
Connection cable, 1 m long		2 or 4 fluoropolymer-insulated stranded connection wires
Nominal resistance	$\Omega$	350
Resistance tolerance per package	%	$\pm 0.5$
Gauge factor		approx. 2
Nominal (rated) value of the gauge factor		Specified on each package
Gauge factor tolerance	%	$\pm 1$
Reference temperature	$^{\circ}C$	+23
Application temperature range		
for installation with Z 70	$^{\circ}C$	-70 ... +120
for installation with EP 150/EP 310N/X 280	$^{\circ}C$	-200 ... +180
Temperature response matched to coefficient of thermal expansion $\alpha$ for ferritic steel	1/K	$10.8 \cdot 10^{-6}$
Temperature range of temperature response matching	$^{\circ}C$	-10 ... +120
Transverse sensitivity at reference temperature when using adhesive Z 70	%	0.25
Minimum radius of curvature, longitudinal and transverse	mm	3
Maximum elongation at reference temperature	$\mu m/m$	$\pm 50,000 (\Delta \pm 5\%)$
Fatigue life at reference temperature when using adhesive Z 70		
Achievable number of load cycles $L_w$ with alternating strain $\epsilon_w = \pm 1,000 \mu m/m$ and variation of zero point $\epsilon_m \Delta \leq 300 \mu m/m$ $\epsilon_m \Delta \cong 30 \mu m/m$		$\gg 10^7$ (test was interrupted at $10^7$ ) $> 10^7$ (test was interrupted at $10^7$ )
Bonding material used		Z 70, EP 150, EP 310N, X 280

<sup>(1)</sup> Please note the resistance of the adhesives used.

<sup>(2)</sup> Only concentrated acids (sulfuric acid, nitric acid) will destroy this special plastic material.  
High resistance against fuels and engine oils.



# Weldable strain gauges

**Field of application:** Strain measurements at increased temperatures on weldable components on which – due to their size – strain gauge installation using hot curing adhesive is not possible. Use of strain gauges on site where the cleanliness required for bonding cannot be guaranteed (construction sites, production plants, etc.).

**Bonding:** Spot welding is a simple bonding method for strain gauges, as hardly any preparations are necessary and very little practical experience is required of users.

**Version:** Y series foil strain gauge on carrier plate, covered with transparent silicone rubber; fitted with 0.5 m stranded connection wires

## LS31 HT

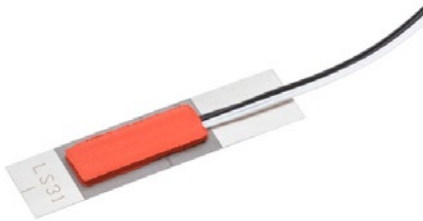

We recommend the mobile impulse welding device C33 from Walter Heller GmbH.

For further information go to:  
[www.heller-schweisstechnik.de](http://www.heller-schweisstechnik.de)

Contents per package: 5 pcs. <sup>(1)</sup>

Specifications – LS31 HT		
Type	1-LS31HT-6/350	
Strain gauge construction		Foil strain gauge (quarter bridge circuit) with glass-fiber reinforced phenolic resin and constantan measuring grid hot installed on carrier plate
Measuring grid length	mm	6
Carrier plate		
l x b	mm	40 x 10
Thickness	mm	0.1
Material		X 8 Cr 17 (1.4016)
Total thickness SG	mm	1.1
Measuring grid foil		CrNi
Covering agent		silicone, red
Maximum permissible excitation voltage	V	12
Connection		4 x 0.5 m fluoropolymer stranded connection wire
Nominal resistance	$\Omega$	350
Resistance tolerance per package	%	$\pm 1$ ; measured at end of cable
Gauge factor		approx. 2
Nominal (rated) value of the gauge factor		Specified on each package
Temperature coefficient of the gauge factor		Specified on each package
Transverse sensitivity		Specified on each package
Reference temperature	$^{\circ}\text{C}$	+23
Application temperature range	$^{\circ}\text{C}$	-50 ... +250 (briefly: 300 $^{\circ}\text{C}$ )
Temperature response matched to thermal expansion coefficient $\alpha$ for ferritic steel	1/K	$10.8 \cdot 10^{-6}$
Temperature response with matching in the range of	$^{\circ}\text{C}$	-50 ... +250
Minimum radius of curvature, longitudinal and transverse	mm	75
Maximum elongation at reference temperature	$\mu\text{m}/\text{m}$	$\pm 3,000 (\Delta \pm 0.3\%)$
Strain related restoring force	N 1,000 $\mu\text{m}/\text{m}$	< 250
Fatigue life		
At reference temperature (spot welding) alternating strain $\epsilon_w = \pm 500 \mu\text{m}/\text{m}$ Variation of zero point $\epsilon_m \Delta \leq 300 \mu\text{m}/\text{m}$ $\epsilon_m \Delta \leq 30 \mu\text{m}/\text{m}$		>> 10 <sup>7</sup> (test was interrupted at 10 <sup>7</sup> )
Bonding method		Spot welding method

<sup>(1)</sup> Each package is supplied with two plates for welding exercises



# Strain gauges for high strains

**Field of application:** all applications where they are extended or shortened by > 5%.

**Specifications:** Maximum elongation  $\pm 100,000 \mu\text{m/m}$  ( $= \pm 10\%$ ).

**Fatigue life:** Less resistance to alternating loads than with Y series strain gauges.

**More specifications:** see page 19

## LD20

**Linear strain gauges for high strains**  
Temperature response not matched

Illustrations show actual size  
(indicated: grid length in mm)

Contents per package  
10 pc.

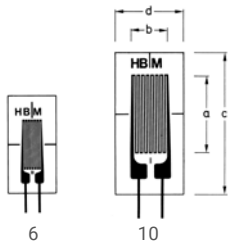

Types available from stock	Variants	Noml. resistance $\Omega$	Dimensions (mm)				Maximum excitation voltage (*) V	Sldr. terminals
			Measuring grid		Meas. grid carrier			
			a	b	c	d		
1-LD20-6/120		120	6	2.8	13	6	8	LS 7
	1-LD20-10/120	120	10	4.6	18.5	9.5	13	LS 5
1-LD20-6/350		350	6	2.8	13	6	13	LS 7
	1-LD20-10/350	350	10	5	18.5	9.5	23	LS 5

(\*) Maximum excitation voltage for ferritic steel. For other temperature response matchings, the corresponding value is printed on the data sheet included with delivery.

# Strain gauges for measurements in load pins

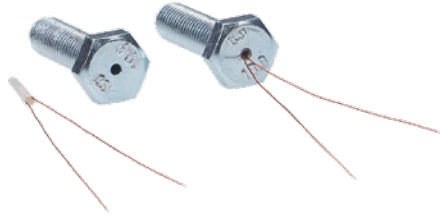

**Field of application:** Measurements of axial forces, vibrations and strains in load pins, screws and similar construction elements

**Properties:** Cylindrically shaped, preformed strain gauge for applications in load pins, screws and similar construction elements.

**Specifications:** 60 mm paint-insulated copper wires are already soldered onto the cylindrically shaped strain gauges. The strain gauge has a cylinder height of 11.5 mm and is designed for a nominal diameter of 2 mm.

## LB11

### Linear strain gauge

Temperature response matched to steel  
 $\alpha = 10.8 \cdot 10^{-6} / K$

Illustrations show actual size

Contents per package  
 5 pc.

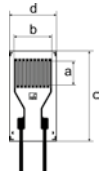

Types available from stock		Variants	Noml. resistance $\Omega$	Dimensions (mm)				Maximum excitation voltage V
Steel	Aluminum			Other	Measuring grid		Meas. grid carrier <sup>(*)</sup>	
				a	b	c	d	
1-LB11-3/120ZW			120	3	5	11.5	6	7

(\*) Preformed with outside diameter  $1.9 \pm 0.15$  mm

## Applications

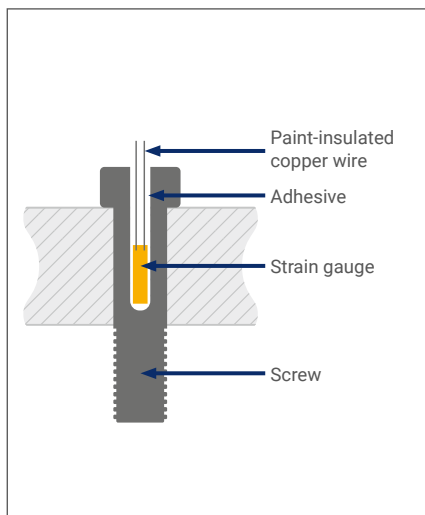

Realization of cross-section

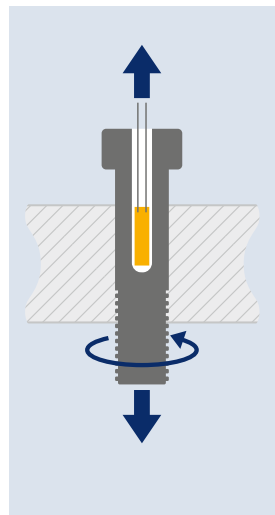

Axial forces

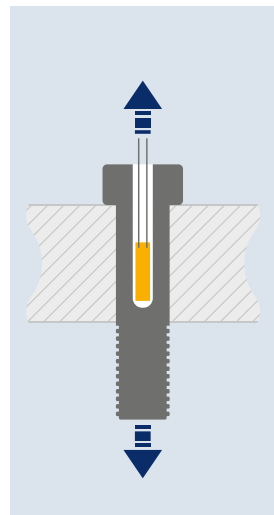

Dynamic loads

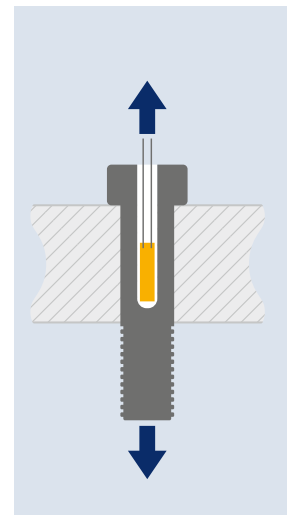

Strain

## Specifications – LB11

Type		LB11-3/120ZW
SG construction		Foil SG with embedded measuring grid
Measuring grid		
Material		Constantan
Thickness		µm5
Carrier		
Material	µm	Special plastic material
Thickness		35±10
Connections		Paint-insulated copper wire red, 60 mm
Nominal diameter	mm	1.9±0.1
Nominal resistance	Ω	120
Resistance tolerance	%	±0.3
Gauge factor		approx. 2
Nominal (rated) value of the gauge factor		Specified on each package
Gauge factor tolerance	%	±1
Temperature coefficient of the gauge factor		Specified on each package
Reference temperature	°C	23
Application temperature range		
for static, i.e. zero-point related measurements	°C	-70 ... +140
for dynamic, i.e. non zero-point related measurements	°C	-200 ... +140
Transverse sensitivity		Specified on each package;
at reference temperature using adhesive Z70		
on SG type 1-LB11-3/120ZW (not preformed)	%	1.6
Temperature response		Specified on each package
Temperature response matched to coefficient of thermal expansion $\alpha$ for ferritic steel	1/K	$10.8 \cdot 10^{-6}$
Tolerance of temperature response	1/K	$\pm 0.3 \cdot 10^{-6}$
Temperature response with matching in the range of	°C	-10 ... +120
Maximum elongation <sup>(1)</sup>		
at reference temperature using adhesive Z70		
on SG type 1-LB11-3/120ZW (not preformed)		
Absolute strain value $\varepsilon$ for positive direction	µm/m	50,000 (5%)
Absolute strain value $\varepsilon$ for negative direction	µm/m	50,000 (5%)
Applicable bonding materials		EP150

<sup>(1)</sup> The data have been determined on a flat strain gauge (not preformed)

# Strain gauges for measurements on PCBs

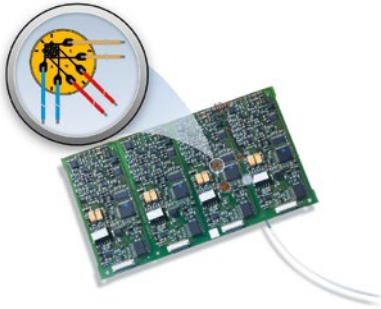

## RF91

**0°/45°/90° miniature rosette**  
 Temperature response matched to steel  
 with  $\alpha = 10.8 \cdot 10^{-6}/K$

## RF9x

Temperature response matched to customer's choice  
 see page 16

Illustrations show actual size



1-RF91-0.8\_ZE      1-RF91-0.8\_W

Contents per package  
 5 pc.

**Field of application:** Strain measurements and experimental stress analysis on PCBs and other very small components

**Properties:** Small strain gauge rosette with paint-insulated copper wire ("ZE") and stacked measuring grids with a diameter of 5 mm; available as variant with measuring grid covered ("ZE") and measuring grid not covered with very small integrated solder tabs ("\_W")

Types available from stock		Variants	Noml. resistance $\Omega$	Dimensions (mm)			Maximum excitation voltage (*) V	Sldr. terminals
Steel	Aluminum			Measuring grid		Meas. grid carrier		
		Other		a	b	c		
1-RF91-0.8/120ZE		1-RF9x-0.8/120ZE <sup>(#)</sup>	120	0.8	0.9	5	1	-
1-RF91-0.8/120_W		1-RF9x-0.8/120_W <sup>(#)</sup>	120	0.8	0.9	5	1	-

(\*) Maximum excitation voltage for ferritic steel. For other temperature response matchings, the corresponding value is printed on the data sheet included with delivery.

(#) Types are only available with matching to aluminum, ferritic or austenitic steel

# Available for you on site: HBM engineers come to you



HBM has been supporting manufacturers of printed circuit boards for many years by performing strain measurements on PCBs using strain gauges.

You benefit from seamless documentation, reliable measurement data and greater reliability in mobile applications for printed circuit boards.

### Advantages

- Follows guidelines and customer requirements
- Current international guidelines (e.g. IPC JEDEC 9804), industrial standards
- Reliable, robust results with definitive and independent test reports
- Avoid measurement errors by using our experienced service engineers
- The fast and efficient way to measurement results, without having to invest in your own equipment
- As global as your company: We perform measurements worldwide

**Speak with your personal HBM sales partner!**

## Specifications – RF9

Type		Type 1-RF91-0.8/120ZE / 1-RF91.00/120_W
Strain gauge construction		Foil strain gauge with embedded measuring grid (ZE) or measuring grid not covered (_W)
Measuring grid		
Material		Constantan
Thickness	μm	3.8
Carrier		
Material		Special plastic material
Thickness	μm	18±3
Covering agent; only with option _W		
Material		Polyimide foil
Total thickness SG	μm	95±15
Connections		Paint-insulated copper wire, 500 mm, Ø 0.2 mm (2x blue [measuring grid a], 2x red [measuring grid b], 2x golden [measuring grid c]) integrated solder tabs, approx. 0.8 mm long, approx. 0.6 mm wide
Option _W		
Nominal resistance	Ω	120
Resistance tolerance	%	±1
Gauge factor		approx. 2
Nominal (rated) value of the gauge factor		Specified on each package
Gauge factor tolerance	%	±1.5
Temperature coefficient of the gauge factor		Specified on each package
Reference temperature	°C	23
Application temperature range		
for static, i.e. zero-point related measurements	°C	-40 ... +140
for dynamic, i.e. non zero-point related measurements	°C	-75 ... +140
Transverse sensitivity		Specified on each package
Temperature response		Specified on each package
Temperature response matched to expansion coefficient		
α for ferritic steel	1/K	10.8 · 10 <sup>-6</sup>
α for aluminum	1/K	23 · 10 <sup>-6</sup>
α for austenitic steel	1/K	16 · 10 <sup>-6</sup>
Tolerance of temperature response	1/K	±0.3 · 10 <sup>-6</sup>
Temperature response with matching in the range of	°C	-10 ... +120
Maximum elongation <sup>(1)</sup>		
at reference temperature using adhesive Z70		
on SG type 1-RF91-0.8/120ZE		
Absolute strain value ε for positive direction	μm/m	50,000 (5%)
Absolute strain value ε for negative direction	μm/m	50,000 (5%)
Fatigue life <sup>(1)</sup>		
at reference temperature using adhesive Z70		
on SG type 1-RF91-0.8/120ZE		
Achievable number of load cycles L <sub>w</sub> with alternating strain		
ε <sub>w</sub> = ±1,000 μm/m and variation of zero point ε <sub>m</sub> Δ% 300 μm/m		> 10 <sup>4</sup>
Minimum radius of curvature, longitudinal and transverse, at reference temperature	mm	10
Applicable bonding materials		
Cold curing adhesives		Z70, X280
Hot curing adhesives		EP150, EP310N

<sup>(1)</sup> The data depend on the various parameters of the specific installation and are therefore stated for representative examples only

# Strain gauges for integration in fiber composites

## LI66

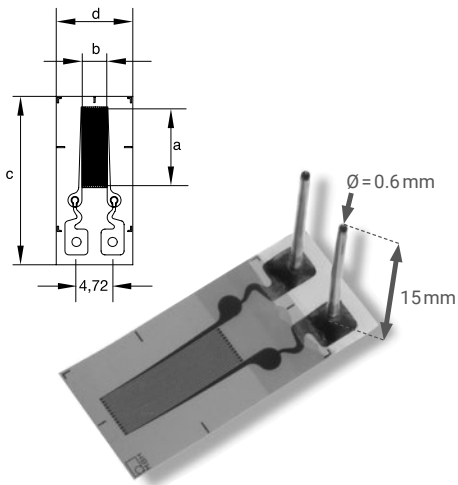

Types available from stock	Noml. resistance	Dimensions (mm)				Maximum excitation voltage
		Measuring grid		Meas. grid carrier		
Quartz	$\Omega$	a	b	c	d	V
1-LI66-10/350	350	10	3.8	22	10	2.5

## Specifications – LI66-10/350<sup>(1)</sup>

Structure		Foil strain gauge with measuring grid covered, application of strain via carrier foil
Connections		mounted, solder tabs with strain relief, connected in turn to vertically positioned connection pins 15mm high, each 0.6 mm in diameter
Measuring grid	$\Omega$	Constantan
Material	$\mu\text{m}$	5
Thickness		
Carrier material	$\mu\text{m}$	Polyimide
Material		55 ± 5
Thickness		
Base foil		Polyimide
Material		95 ± 15
Total thickness SG	$\mu\text{m}$	
Nominal resistance	$\Omega$	350
Resistance tolerance	%	± 0.35
Gauge factor		approx. 2, specified on each package
Gauge factor tolerance	%	± 1
Temperature coefficient of the gauge factor, approx.	1/K	$(115 \pm 10) \cdot 10^{-6}$
Nominal (rated) value of the temperature coefficient of the gauge factor		Specified on each package
Transverse sensitivity		Specified on each package
Reference temperature	$^{\circ}\text{C}$	23
Application temperature range		
for static, measurements (zero-point related)	$^{\circ}\text{C}$	-40 ... +180
for dynamic measurements (non zero-point related)	$^{\circ}\text{C}$	-40 ... +180
Temperature response		Specified on each package
Temperature response matched to coefficient of thermal expansion		
$\alpha$ for silica/composite	1/K	$0.5 \cdot 10^{-6}$
Tolerance of the temperature response	1/K	$\pm 0.3 \cdot 10^{-6}$
Temperature response with matching in the range of	$^{\circ}\text{C}$	-10 ... +120
Max. elongation		
Absolute strain value for positive direction	$\mu\text{m}/\text{m}$	± 50,000 ( $\Delta$ 5%)
Absolute strain value for negative direction	$\mu\text{m}/\text{m}$	± 50,000 ( $\Delta$ 5%)
Fatigue life,		
at reference temperature using a multi-directional CFP probe		
Ach. number of load cycles $L_W$ with alternating strain $\epsilon_w = \pm 1,000 \mu\text{m}/\text{m}$ and variation of zero point $\epsilon_m \Delta < 100 \mu\text{m}/\text{m}$		5,000,000
variation of zero point $\epsilon_m \Delta < 300 \mu\text{m}/\text{m}$		10,000,000
Minimum radius of curvature, longitudinal and transverse,		
at reference temperature		
within measuring grid area	mm	0.3
within solder tab area	mm	8
Applicable bonding materials		Matrix resin

<sup>(1)</sup> All data according to OIML guideline IR62

# Pressure measuring gauges

## PMS40

Contents per package  
10 pcs.

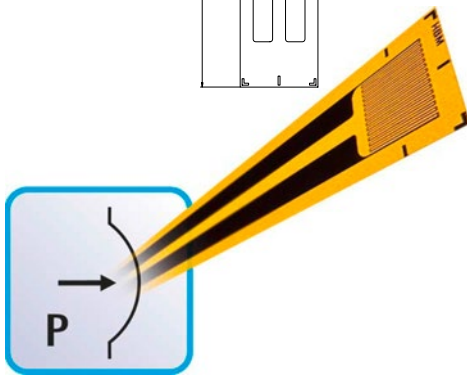
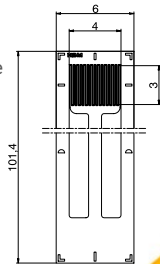

## Special features

- Transient pressure measurement
- Short rise time
- Bonded and non-bonded application

Types available from stock	Noml. resistance $\Omega$	Dimensions (mm)			
		Measuring grid		Meas. grid carrier	
		a	b	c	d
1-PMS40-3/120_E	120	3	4	101.4	6

## Specifications – PMS40-3/120

SG construction		SG with embedded measuring grid
Measuring grid		
Material		Manganin
Thickness, approx.	$\mu\text{m}$	10
Carrier material		
Material		Polyimide
Thickness	$\mu\text{m}$	$35 \pm 5$
Covering agent		
Material		Polyimide
Total thickness	$\mu\text{m}$	$70 \pm 12$
Connections		Solder tabs, two wire configuration
Nominal resistance	$\Omega$	120
Resistance tolerance	%	$\pm 2$
PMS output signal ( $\Delta R/R$ )		$a \cdot \Delta p + k \cdot \varepsilon + k \varepsilon_s(T)$
Pressure sensitivity <sup>(1)</sup> a ( $\Delta R/R = a \cdot \Delta p$ )		$2.50 \cdot 10^{-6}/\text{bar}$
Pressure-sensitivity tolerance	%	$\pm 2$
Gauge factor <sup>(2)</sup> ( $\Delta R/R = k \cdot \varepsilon$ )		0.57
Gauge factor tolerance	%	$\pm 4$
Temperature response $\varepsilon_s(T)$	$\mu\text{m}/\text{m}$	$-619.4 + 50.1 \cdot T - 1.1 \cdot T^2 + 0.003 \cdot T^3 \pm (T - 20)$ [T in °C]
Rise time $\tau$		$\geq 50 \text{ ns}$
Maximum permissible effective bridge excitation voltage	V	3.5
Reference temperature	°C	20
Application temperature range	°C	-50 ... +180
Applicable bonding materials <sup>(3)</sup>		
Cold curing adhesives		Z70, X60, X280
Hot curing adhesives		EP150, EP310N

(1) Tested under hydrostatic conditions up to 200 bar. Further, non-calibrated tests were run up to 2 kbar.

(2) Specified up to 1,000  $\mu\text{m}/\text{m}$  strain.

(3) The gauge factor must be taken into consideration for bonded applications. Non-bonded installation of the PMS is possible.

# Crack propagation gauges

These strain gauges are used to determine the crack propagation on a component. HBM offers four different types: Types RDS20 and RDS40 consist of electrically isolated resistors. In this case individual circuits are interrupted as the crack propagates.

Types RDS22 and RDS17.8 consist of conductor tracks connected in parallel which will tear if the crack grows under the crack propagation gauge. This will gradually increase the electrical resistance of the strain gauge as the crack continues to extend.

This change in resistance can be measured using a resistance meter or a strain gauge amplifier (see connection diagram).

## RDS20, RDS22, RDS40

### Crack propagation gauges

Illustrations show actual size (indicated: grid length in mm)

#### Design:

Carrier:  
Phenolic resin, glass fiber reinforced  
Thickness (35±10) µm

Grid foil:  
Constantan foil,  
thickness 5 µm

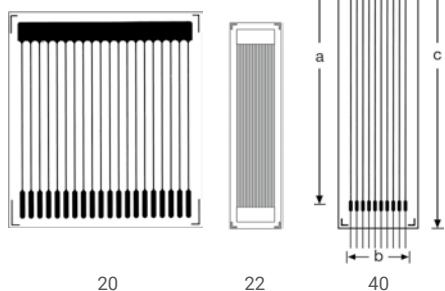

Product number of standard types	Resistance per link $\Omega$	Dimensions (mm)				Pitch link center/link center (mm) t	Number of torn links	Max. perm. effective excitation voltage
		Link length a	Meas. grid width b	Meas. grid carrier c   d				
1-RDS 20	13	20	22.5	28	25	1.15	20	–
1-RDS 22	44	22	5	27.8	6.8	0.1	50	–
1-RDS 40	28	40	8.4	47	10	0.85	10	–

Resistance tolerance ± 20 %

Contents per package: 5 pcs.

## RDS17.8

### Crack propagation gauges

Illustrations show actual size (indicated: grid length in mm)

#### Design:

Carrier:  
Phenolic resin, glass-fiber reinforced,  
thickness (35±10) µm

Grid foil:  
Constantan foil,  
thickness 5 µm

Contents per package 5 pc.

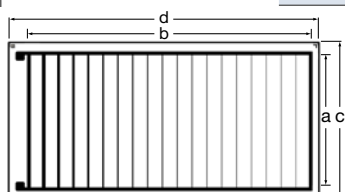

Product number of standard types	Resistance per link $\Omega$	Dimensions (mm)				Pitch link center/link center (mm) t	Number of torn links	Max. perm. effective excitation voltage
		Link length a	Meas. grid width b	Meas. grid carrier c   d				
1-RDS17.8	3.5	17.8	38.75	21	41.6	2	20	–



## Connecting a crack propagation gauge

There are two different types of crack propagation gauges: Types RDS22 and RDS17.8 consist of conductor tracks connected in parallel which will tear if the crack grows under the crack propagation gauge. This will gradually increase the electrical resistance of the strain gauge as the crack continues to extend.

Types RDS20 and RDS40 consist of electrically separated resistor lines, i.e. as the crack grows, individual circuits will be interrupted. If the circuits are contacted individually, the direction in which the gap is extending can be detected.

The easiest way to detect the signals of crack propagation gauges (RDS) is with a resistance measurement. Many HBM amplifiers allow for a direct resistance measurement of this type.

The resulting resistance (R) of the RDS is dependent on the number of torn links and can easily be calculated. In this case n identical resistors (Ri) are connected in parallel:

$$R_n = \frac{R_i}{n}$$

If a grid line is interrupted, this is described by

$$R_{(n-1)} = \frac{R_i}{(n-1)}$$

However, the measurement can be performed just as well with a measuring amplifier for SG measurements. The connection diagram shows how the RDS has to be complemented to obtain a resistance change that is inside the measuring range of an amplifier for strain gauge quarter bridges.

Temperature effects can be minimized using temperature stable fixed resistors or strain gauges as completion resistors. A higher sensitivity can be obtained by selecting a parallel resistor with a higher resistance value.

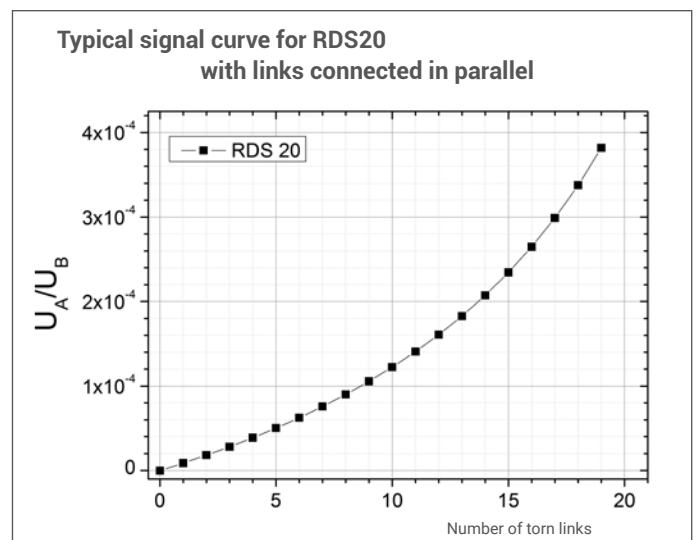
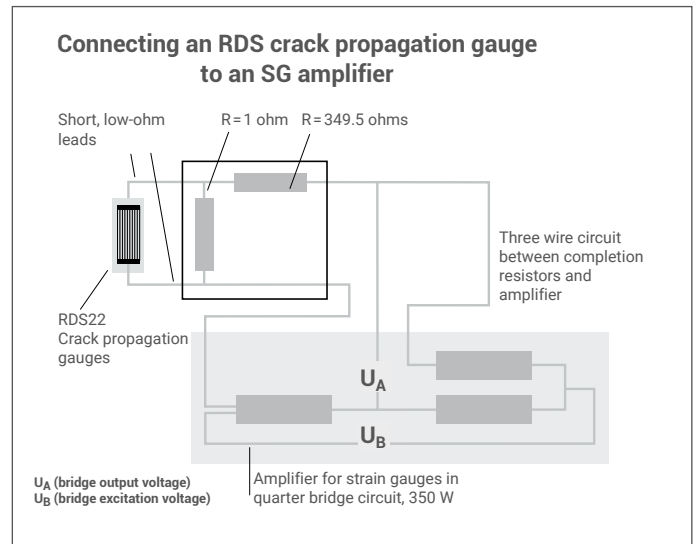

# Temperature sensor

TT

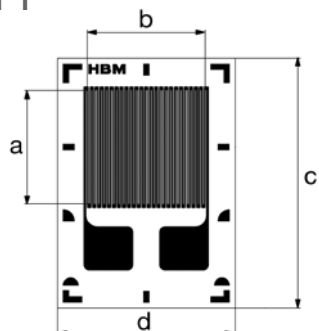

Original size

Contents per package  
5 pcs.

## Special features

- Short response time due to good thermal contact with the component and very low thermal capacity
- Can be installed like metallic strain gauges
- Can also be installed on curved surfaces
- Any resistance meter suitable for measured value acquisition

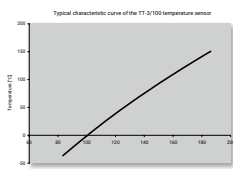

Types available from stock	Noml. resistance (at 0°C) Ω	Dimensions (mm)			
		Measuring grid		Meas. grid carrier	
		a	b	c	d
1-TT-3/100	100	3	3.3	6.6	4.7

## Specifications – TT-3/100<sup>(1)</sup>

Strain gauge construction		Nickel temperature sensor (embedded)
Meas. grid		Nickel
Material	μm	5
Thickness		
Carrier material		Polyimide
Material	μm	40 ± 5
Thickness		
Covering agent		Polyimide
Material	μm	25 ± 12
Thickness		
Connections		Integrated solder tabs
Nominal resistance (at 0°C)	Ω	100
Resistance tolerance of nominal resistance	%	± 1
Specification of nominal resistance	Ω	stated on packaging
Specification of resistance tolerance	%	± 0.3
Characteristic curve of the sensor		stated on the packaging
Sensitivity error	%	0.5 (at reference temperature)
Temperature range	°C	-50 ... +180
Minimum radius of curvature, longitudinal and transverse, at reference temperature	mm	2, within measuring grid area 5
Applicable bonding materials		Z70, X60, X280
Cold curing adhesives		EP150, EP310N
Hot curing adhesives		

<sup>(1)</sup> All data according to OIML guideline IR62

# Strain gauges for determination of residual stress

The hole drilling method is frequently used to determine residual stress. In this method, after installation of the strain gauge rosette onto the workpiece, the residual stress state is disturbed by a suitable action.

Following this action, residual stresses cause strains on the surface of the workpiece, which are detected by the strain gauge and then used to calculate the residual stress state.

## Hole drilling method, based on the integral method

The RY21 or RY61 can be used to determine residual stresses based on the integral method.

The result is the integral mean value of the residual stresses over the entire drilling depth.

### RY21

**0°/45°/90° hole drilling rosette**  
 Temperature response matched to steel  
 with  $\alpha = 10.8 \cdot 10^{-6}/K$

Illustrations show actual size

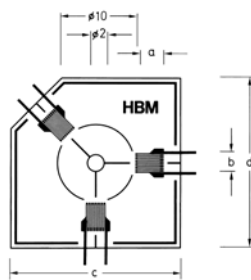

Contents per package: 5 pcs.

Types available from stock		Variants	Noml. resistance	Dimensions (mm)				Maximum excitation voltage	Sldr. terminals
Steel	Aluminum			Other	Measuring grid		Meas. grid carrier		
			$\Omega$	a	b	c	d	V	
1-RY21-3/120			120	3	2.5	22.1	22.1	4.5	LS 5

Distance drilling center to measurement grid middle: 6.78 mm

### RY61

**0°/45°/90° hole drilling rosette**  
 for use with HBM drilling device RY 61  
 Temperature response matched to steel  
 with  $\alpha = 10.8 \cdot 10^{-6}/K$   
 Application temperature range: +10°... +60°C

Illustrations show actual size

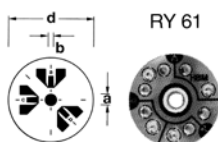

Contents per package: 5 pcs.

Types available from stock		Variants	Noml. resistance	Dimensions (mm)				Maximum excitation voltage	Sldr. terminals <sup>(1)</sup>
Steel	Aluminum			Other	Measuring grid		Meas. grid carrier		
			$\Omega$	a	b	c	d	V	
1-RY61-1.5/120			120	1.5	0.8	-	12	2	LS 5

<sup>(1)</sup> Solder terminals are not mandatory

#### Specifications:

Resistance tolerance  $\pm 1\%$   
 Minimum radius of curvature 1,000 mm  
 More specifications: see page 19

As these strain gauges are covered by a printed board, they can be used on level or weakly curved surfaces only.

Distance drilling center to measurement grid middle: 2.55 mm

# Strain gauges for determination of residual stress

## Hole drilling method based on the high-speed drilling method

Residual stresses can be determined with the high-speed drilling method using strain gauges RY61K and RY61R, the two variants RY61S, VY61S, and RY61M. MTS3000 is the drilling device required for this method.

The results are the residual stresses resolved over the set drilling depth.

### RY61K

**0°/45°/90° rectangular hole drilling rosette**  
Strain gauge with integrated solder tabs  
Temperature response matched to steel with  $\alpha = 10.8 \cdot 10^{-6}/K$

Illustrations show actual size

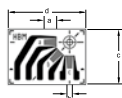

Contents per package: 5 pcs.

Types available from stock		Variants	Noml. resistance $\Omega$	Dimensions (mm)				Maximum excitation voltage V	Sldr. terminals <sup>(1)</sup>
Steel	Aluminum			Measuring grid		Meas. grid carrier			
		Other		a	b	c	d		
1-RY61-1.5/120K			120	1.5	0.8	7.2	10.2	2	LS 7

<sup>(1)</sup> Solder terminals are not mandatory

Distance drilling center to measurement grid middle: 2.55 mm

### RY61R

**0°/45°/90° hole drilling rosette**  
Temperature response matched to steel with  $\alpha = 10.8 \cdot 10^{-6}/K$

Illustrations show actual size

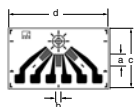

Contents per package: 5 pcs.

Types available from stock		Variants	Noml. resistance $\Omega$	Dimensions (mm)				Maximum excitation voltage V	Sldr. terminals <sup>(1)</sup>
Steel	Aluminum			Measuring grid		Meas. grid carrier			
		Other		a	b	c	d		
1-RY61-1.5/120R			120	1.5	0.8	8	13.5	2	LS 7

<sup>(1)</sup> Solder terminals are not mandatory

Distance drilling center to measurement grid middle: 2.55 mm

# Strain gauges for determination of residual stress

## R Y61S

**0°/45°/90° hole drilling rosette**  
 Temperature response matched to steel  
 with  $\alpha = 10.8 \cdot 10^{-6}/K$

Illustrations show actual size



Contents per package: 5 pcs.

Types available from stock		Variants	Noml. resistance	Dimensions (mm)				Maximum excitation voltage	Sldr. terminals <sup>(1)</sup>
Steel	Aluminum			Measuring grid		Meas. grid carrier			
		Other	$\Omega$	a	b	c	d	V	
1-RY61-1.5/120S			120	1.5	0.8	-	10.2	2	LS 5

<sup>(1)</sup> Solder terminals are not mandatory

Distance drilling center to measurement grid middle: 2.55 mm

## R Y61-3,2/120S

**0°/45°/90° hole drilling rosette**  
 Temperature response matched to steel  
 with  $\alpha = 10.8 \cdot 10^{-6}/K$

Illustrations show actual size

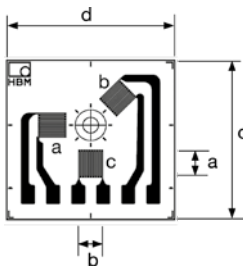

Contents per package: 5 pcs.

Types available from stock		Variants	Noml. resistance	Dimensions (mm)				Maximum excitation voltage	Sldr. terminals <sup>(1)</sup>
Steel	Aluminum			Measuring grid		Meas. grid carrier			
		Other	$\Omega$	a	b	c	d	V	
1-RY61-3.2/120S			120	3.2	3.2	20.9	22	10	LS 5

<sup>(1)</sup> Solder terminals are not mandatory

Distance drilling center to measurement grid middle: 5.07 mm

## V Y61S

**0°/45°/90°/135° hole drilling rosette**  
 Temperature response matched to steel  
 with  $\alpha = 10.8 \cdot 10^{-6}/K$   
 Illustrations show actual size

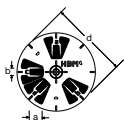

Contents per package: 5 pcs.

Types available from stock		Variants	Noml. resistance	Dimensions (mm)				Maximum excitation voltage	Sldr. terminals <sup>(1)</sup>
Steel	Aluminum			Measuring grid		Meas. grid carrier			
		Other	$\Omega$	a	b	c	d	V	
1-VY61-1.5/120S			120	1.5	0.8	-	10.2	2	LS 5

<sup>(1)</sup> Solder terminals are not mandatory

Distance drilling center to measurement grid middle: 2.55 mm

# Strain gauges for determination of residual stress

## RX61M

**0°/45°/90° hole drilling rosette, symmetrical**  
 Temperature response matched to steel  
 with  $\alpha = 10.8 \cdot 10^{-6}/K$

Illustrations show actual size

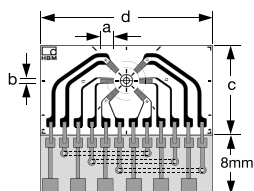

Contents per package: 5 pcs.

Types available from stock		Variants	Noml. resistance	Dimensions (mm)				Maximum excitation voltage	Sldr. terminals
Steel	Aluminum			Other	Measuring grid		Meas. grid carrier <sup>(1)</sup>		
			$\Omega$	a	b	c	d	V	
1-RX61-1.5/120M			120	1.5	0.77	11.7	22.5	2.5	-
1-RX61-1.5/350M			350	1.5	0.77	11.7	22.5	4.5	-

<sup>(1)</sup> Dimensions of SG without printed circuit board

Even minor eccentricities can cause major measurement errors in residual stress analysis based on the hole drilling method.

The advantage of the RX61M symmetrical hole drilling rosette with 6 measuring grids is that due to the opposing radially arranged measurement grids, any measurement errors in a common measuring grid direction can be almost completely compensated for.

Distance drilling center to measurement grid middle: 2.55 mm

## Special features

- Self-compensated
- Less cabling outlay

# System for determination of residual stress based on the hole drilling method

## MTS 3000

SINT Technology, an HBM partner, offers the measurement chain MTS 3000, which can be used for easy implementation of the hole drilling method.

To create the hole, a cutter with a speed of 400,000 rpm is used, driven by a stepper motor. The strain changes created by the incremental creation of the bore in the measurement object are recorded by a strain gauge rosette developed specially for this procedure (see pages 75-78).



# SG bonding material



Z 70

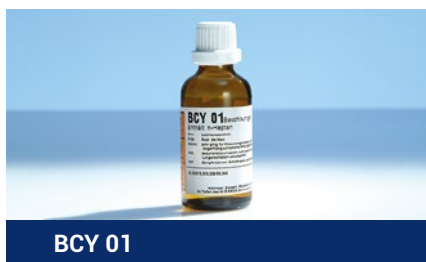

BCY 01



X 60



X 280



EP 150



EP 310 N

The most usual way to connect strain gauges to the measurement object is to glue them on. Only adhesives that are specially developed for these applications, and which meet the following requirements, should be used:

- Loss-free transfer of deformation of the measurement object to the strain gauge
- Stable behavior across a temperature and strain range which is as wide as possible
- The strain gauge and measurement object must not be attacked

All adhesive packages from HBM include the adhesive and the accessories (such as fluoropolymer release film) required for bonding. The criteria for selecting an adhesive should be:

- Application temperature
- Material of the measuring body and recommendations for the relevant strain gauge
- Requirements for long-term stability and reproducibility
- Surface roughness

## Hot curing adhesives

Hot curing adhesives can be used where the measurement object can be brought up to the curing temperature. This is generally possible in the manufacture of transducers, but also for example when strain gauges can be installed on machine parts before installation or can be removed for SG installation. Hot curing adhesives meet higher quality demands and can be used within a greater temperature range than cold curing adhesives.

Adhesive	Description	Suitable SGs	Pot life at room temperature (RT)
<b>Cold curing</b> Z 70 Ordering no.: 1-Z70 for optional use with Z 70 1-BCY01	cyanoacrylate adhesive, low-viscosity, Accelerator for Z 70	Optimal: Y, C, M, LD, LE residual stress SG Good: G	–
X 60 Ordering no.: 1-X60	methylmetacrylate Two-component adhesive pasty, also for suitable for absorbent or uneven surfaces	Optimal: Y, C, M, LD Residual stress SG Good: G, LS	approx. 5 minutes
X 280 Ordering no.: 1-X280	two-component Epoxy adhesive for smooth and absorbent surfaces	optimal: Y, C, M, LD, LE Good: G	30 minutes
<b>Hot curing</b> EP 150 Ordering no.: 1-EP150	One-component Epoxy adhesive low-viscosity	Optimal: Y, C, M, G, LD, LE Good: Residual stress strain gauge	–
EP 310 N Ordering no.: 1-EP310N	Two-component Epoxy adhesive low-viscosity,	Optimal: Y, C, M, G, LD, LE Good: Residual stress strain gauge	1 month (at RT) 6 months (at +2°C)
P250 Ordering no.: 1-P250	One-component Adhesive low-viscosity	Optimal: Y, C, M, G, LD, LE, A, U	
P250-R Ordering no.: 1-P250-R	One-component Adhesive low-viscosity	Optimal: Y, C, M, G, LD, LE, A, U	



## Cold curing adhesives

Cold curing adhesives are easy to use and can be processed at minimum cost and effort, as they cure under normal ambient conditions. Adhesives with very short reaction times are also called “superglues”. The preferred field of application is in experimental stress analysis. However, if the temperature around the measuring point is higher than about 80°C, we recommend using a hot curing adhesive or a heat resistant or cold curing epoxy resin adhesive (X280).



P250

## Spot weld joints

Spot weld joints are only possible with the special strain gauge type LS31, and if the measurement object is made of a weldable material. This method is especially suitable for applications where the level of cleanliness required for bonding cannot be achieved. Hardly any preparations or experience are necessary. However, it is essential to follow the process instructions supplied with the strain gauges.



P250-R

Strain gauge dry	Curing temperature	Curing time <sup>(3)</sup>	Contact pressure (N/mm <sup>2</sup> )	Temperature limits			Delivery qty.
				Lower	Upper Static <sup>(1)</sup>	Upper Dynamic <sup>(2)</sup>	
6 months (residual stress)	5°C <sup>(3)</sup> 20°C 30°C	10 minutes 1 minute 0.5 minutes	thumb pressure	-55°C (briefly -70°C)	+100°C	+120°C	10 ml ≈ 150 – 200 SG
12 months (room temperature)	0°C 20°C 35°C	60 minutes 10 minutes 2 minutes	thumb pressure	-200°C	+60°C	+60°C	component A = 0.1 kg B = 80 ml  Other container sizes, see price list
6 months (refrigerator)	RT...95°C	8 h...1 h	0.05...0.5	-200°C	+200°C	+280°C	6 double bags w. 10 g = 60 g
12 months (refrigerator)	160 ... 190 °C	6 h... 1 h	0.3...0.5	-70°C	+150°C	+150°C	2 bottles, each 20 ml
6 months (room temperature)	120 ... 200°C	6 h... 0.5 h	0.1 ... 0.5	-270°C	+260°C	+310°C	Component A = 50 g B = 22 g
12 months (room temperature)	160°C (subsequent curing at 180°C recommended)	4.5 hours 1 hour (subsequent curing)	10-50 N/cm <sup>2</sup>	-196°C	+250°C		2 bottles, each 15g ready mixed adhesive
12 months (room temperature)	160°C (subsequent curing at 180°C recommended)	4.5 hours 1 hour (subsequent curing)	10-50 N/cm <sup>2</sup>	-196°C	+250°C		2 bottles, each 6g Phenolic resin for mixing with ethanol

<sup>(1)</sup> Zero-point related measurement

<sup>(2)</sup> Non zero-point related measurement

<sup>(3)</sup> Curing condition: relative humidity of 30 – 80 %

# SG covering agents

The quality of a strain gauge measuring point depends not only on the SG itself, but also and primarily on the type of installation and its design. A properly functioning measuring point requires thorough preparation of the installation area, careful bonding, correct connections and also a protective covering agent. It is therefore important to provide the user with all necessary aids. The HBM strain gauge accessory product range offers everything necessary for good strain gauge installation.

## SG covering agents

In general, it is recommended that strain gauges be protected against external effects such as humidity or mechanical damage since even small fluctuations in the atmospheric humidity affect the measured signal of a strain gauge.

Suitable covering agents should have only minimum effects on the measuring point. The strain gauge and measurement object must not be attacked. Criteria for selecting the appropriate covering agent should be:

- Application temperature
- Media surrounding the measuring point

The following table will help in the selection of a suitable means of measuring point protection, which for special requirements can also be carried out in several layers. For instance, it would make sense to apply AK22, and in extremely humid environments to provide additional sealing with ABM 75. Attention: NG 150 cannot be combined with PU 140.

Please ensure, in the case of multi-layer covering, that the second layer may only be applied after full curing of the first layer and that it should overlap on all sides. All HBM covering agents are supplied with a safety data sheet.

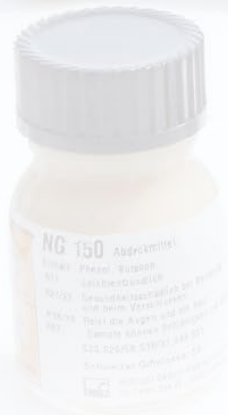
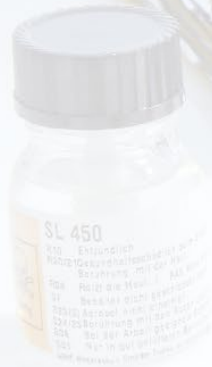
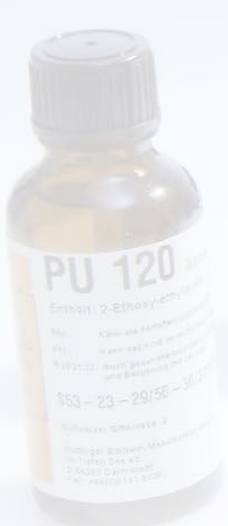

SG covering agent	Temperature range of resistance in air in °C	Package contents	One Package sufficient for approx.	Application method	Curing conditions	Storage life at room temperature	Ingredients
<b>AK 22</b> viscous putty Ord. no.: 1-AK22	-30 ... +120	1 kg	30 SG	Kneading by hand	–	2 years	viscous, kneadable, Sticky putty
<b>ABM 75</b> aluminum foil with kneading compd. Ordering no.: 1-ABM75	-196 ... +75	11 pcs. 205 mm x 100 mm	200 SG	Pressing on by hand	–	2 years	0.05 mm thick Aluminum foil coated with 3 mm thick kneading compd.
<b>NG 150<sup>(1)</sup></b> nitrile rubber Ordering no.: 1-NG150	-269 ... +150	3 bottles each with 25 cm <sup>3</sup>	35 SG	Brush application	Air drying at Room temperature	1 year	Solvent-containing one-component Nitrile rubber
<b>SG 250</b> Transparent Silicone rubber Ordering no.: 1-SG250	-70 ... +200 (briefly +250)*	Tube with 85 g	20 SG	Application from tube	Room temperature	6 months	Transparent, solvent free one-component Silicone rubber
<b>PU 140<sup>(1)</sup></b> Polyurethane paint Ordering no.: 1-PU140	-40 ... +140	3 bottles each with 30 ml	250 SG	Brush application	Room temperature ... +80°C	9 months	Solvent-containing one component Polyurethane paint
<b>SL 450</b> Transparent silicone resin Ordering no.: 1-SL450	-50 ... +450	3 bottles with 25 g each	90 SG	Brush Application	In temperature levels from 95°C bis 315°C	6 months	transparent, solvent-containing silicone resin

<sup>(1)</sup> Caution: PU 140 and NG 150 cannot be combined

\* briefly, < 24 h



## Chemical resistance of HBM covering agents

Chemical	AK 22	ABM 75	NG 150	SG 250	PU 140	SL 450
<b>Weather</b>	yes	yes	yes	yes	yes	yes
<b>Water:</b>	yes	yes	yes	yes	yes	yes
Pressurized water (400 bar)	-	-	-	-	-	-
Condensation	-	-	-	-	yes	-
Tropical climate	-	-	-	-	yes	-
Water vapor	no	condtl.	no	no	no	no
<b>Oil:</b>	no	no	yes	yes	yes	-
Engine oil (RT/70°C)	-	-	yes	-	-	-
Mineral oil (RT/70°C)	-	-	yes	-	-	-
Hydraulic oil (RT/70°C)	-	-	yes	-	-	-
<b>Greases</b>	-	-	-	-	yes	-
<b>Solvents in general</b>	no	condtl.	condtl.	no	-	condtl.
<b>Fuels:</b>	no	no	yes	no	-	-
Gasoline	no	no	yes	no	-	-
Kerosene	-	-	yes	-	-	-
<b>Aromatic /Aliphatic mixtures</b>	-	-	condtl.	-	-	-
<b>Aromatics:</b>	no	no	condtl.	no	no	no
Benzene	-	-	no	-	-	-
Toluene	no	no	condtl.	no	-	no
Xylene	no	no	condtl.	no	no	no
<b>Chlorinated solvents:</b>	no	no	no	no	no	no
Dichloromethane	no	no	no	no	no	no
Carbon tetrachloride	-	-	no	-	-	-
Perchloroethylene	-	-	no	-	-	-
1,2-Dichloroethane	-	-	no	-	-	-
o-Dichlorobenzene	-	-	no	-	-	-
<b>Alcohols:</b>	condtl.	yes	condtl.	condtl.	no	yes
Ethyl alcohol	condtl.	yes	condtl.	condtl.	no	yes
Methyl glycol	-	-	no	-	-	-
Butyl alcohol	-	-	condtl.	-	-	-
Isopropyl alcohol	-	-	condtl.	-	-	-
Ethylene glycol	-	-	yes	-	-	-
<b>Ketones:</b>	condtl.	condtl.	no	no	no	condtl.
Acetone	condtl.	condtl.	no	no	no	yes
Methyl ethyl ketone (MEK)	no	no	no	no	no	condtl.
<b>Terpenes:</b>	-	-	condtl.	-	-	-
Dipentenes	-	-	condtl.	-	-	-
Turpentine	-	-	yes	-	-	-
<b>Acids:</b>	no	condtl. <sup>(1)</sup>	condtl.	yes	no	yes
Hydrochloric acid conc.	no	-	condtl.	yes	no	yes
Sulfuric acid 50 %	no	-	yes	yes	no	yes
Acetic acid 50 %	no	-	no	yes	no	condtl.
Nitric acid 50 %	no	-	no	yes	no	yes
Oleic acid conc.	-	-	yes	-	-	-
Lactic acid conc.	-	-	condtl.	-	-	-
Air containing acids	-	-	-	-	yes	-
<b>Alkalis:</b>	condtl.	condtl. <sup>(1)</sup>	condtl.	no	condtl.	yes
Sodium hydroxide 10 %	condtl.	-	no	no	no	yes
Potassium hydroxide 10 %	-	-	no	-	-	-
Ammonia 28 %	-	-	condtl.	-	-	-
Air containing alkalis	-	-	-	-	yes	-
<b>Liquefied gases (excluding oxygen)</b>	-	-	yes	-	-	-
<b>UV resistance</b>	yes	yes	yes	yes	yes	-

<sup>(1)</sup> Up to 5 % (destruction of aluminum foil!)

condtl. = Conditionally resistant (at least 10 days at RT)

**Chemical resistance**

Unless identified specifically, the resistance refers to room temperature. No information can be provided on long term effects. The data is based on our own experience or was taken from literature. Since the specific conditions vary with each user, it is recommended that individual users carry out their own tests on resistance. Some covering agents become milky when in contact with some chemicals.

# Cleaning agents, bonding and soldering materials

## Cleaning agent RMS1

Environmentally-friendly solvent mixture that dissolves all normal contamination. One packing unit contains 1 l cleaning agent and 450 cleaning pads.  
Ordering number: 1-RMS1

## Cleaning agent RMS1 SPRAY

Environmentally-friendly solvent mixture. Contains 5 spray cans with 200 ml cleaning agent each and 450 cleaning pads.  
Ordering number: 1-RMS1-SPRAY

## Fluoropolymer release film

33 m fluoropolymer release film on a reel, suitable for cold and hot curing. The fluoropolymer release film prevents materials other than the strain gauge from bonding to the component. Thickness: 0.05 mm, width: 60 mm  
Temperature application range: -200°C to +260 °C.  
ordering number: 1-RELEASEFILM

## Flux pen

Soldering aid in felt pen format for production of smaller soldering connections. Suitable for soldering with melting points up to approx. 350°C. The flux pen contains non-corrosive flux without chloride. Package contents: 5 pcs.  
Ordering number: 1-FS01

## Polyimide tape

33 m heat resistant adhesive tape, 19mm wide, approx. 70 µm total thickness. Temperature application range: -70°C to +260 °C.  
ordering number: 1-KLEBEBAND

## Cleaning pads

Cellulose pads for cleaning measurement objects before strain gauge installation. Format 5 cm x 5 cm.  
Package contents: 450 pcs.  
Ordering number: 1-8402.0026

## Cleaning agent dispenser

In order to avoid contamination of the solvent over time, we recommend using cleaning agent dispenser "RSP 120".  
Ordering number: 1-RSP120



Cleaning agent RMS1 SPRAY



Flux pen



Cleaning agent dispenser

# Solder terminals

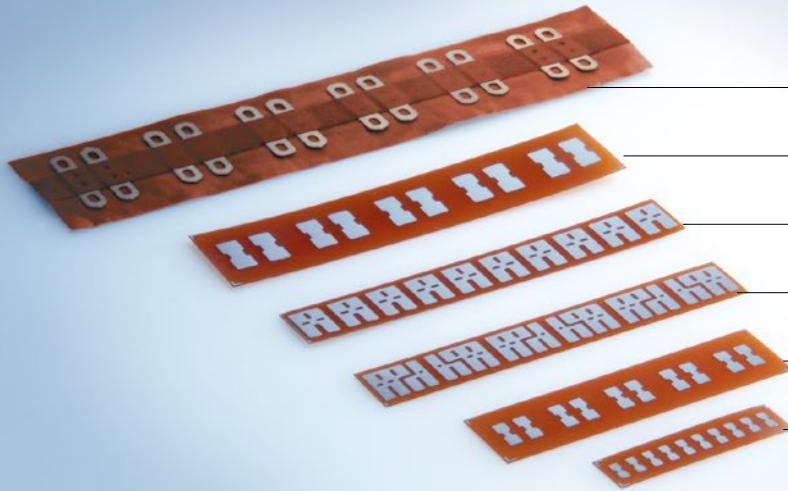

For strain gauges with leads or wires, solder terminals should be installed between the connection cables and the strain gauge itself. This will facilitate the execution of a perfect solder joint and provide strain relief for the SG connections. The solder terminals are installed in the same way on the measurement object as on the SG and all HBM adhesives can be used. HBM offers solder terminals in various versions and dimensions.

## LS2

Bronze soldering tags on polyimide carrier suitable for dynamic stress  
Bonding on measurement object: Bonding  
Can be used from -200°C up to 180°C, briefly up to 260°C

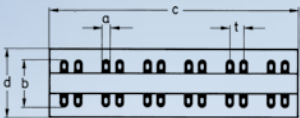

Product number	Dimensions (mm)				Spacing	Contents per package
	Solder tag		Carrier			
Steel	a	b	c	d	t	
1-LS 2	2.6	13.5	72	20	4	36 pairs (6 strips)

## LS7/5/4

Nickel-plated copper on polyimide  
Bonding on measurement object: Bonding  
Can be used from -200°C up to 180°C, briefly up to 260°C

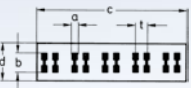

Product number	Dimensions (mm)				Spacing	Contents per package
	Solder tag		Carrier			
Steel	a	b	c	d	t	
1-LS 7	1	3	21	6	2	125 pairs
1-LS 5	1.5	4.5	35	10	2.5	125 pairs
1-LS 4	2.5	6.5	50.1	13	4	125 pairs (25 strips each)

## LS212

Nickel-plated copper on polyimide  
Bonding on measurement object: Bonding  
Can be used from -200°C up to 180°C, briefly up to 260°C

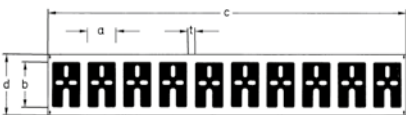

Product number	Dimensions (mm)				Spacing	Contents per package
	Solder tag		Carrier			
Steel	a	b	c	d	t	
1-LS 212	3.7	6	47.5	8	1	125 pairs (25 strips)

## LS224

Nickel-plated copper on polyimide  
Bonding on measurement object: Bonding  
Can be used from -200°C up to 180°C, briefly up to 260°C



Product number	Dimensions (mm)				Spacing	Contents per package
	Solder tag		Carrier			
Steel	a	b	c	d	t	
1-LS 224	6.5	6	45	8	1	150 pairs (25 strips)



# Cables and stranded wires

## PVC ribbon cable

PVC insulated ribbon cable, consisting of six wires with a cross-section of 0.14 mm<sup>2</sup>, 50 m per reel, resistance 0.131 Ω/m.  
Ordering number: 1-3133.0034

## Paint-insulated copper wire

Polyurethane-insulated copper wire with a cross-section of 0.04 mm<sup>2</sup>, 25 m long.  
Ordering number: 1-CULD01

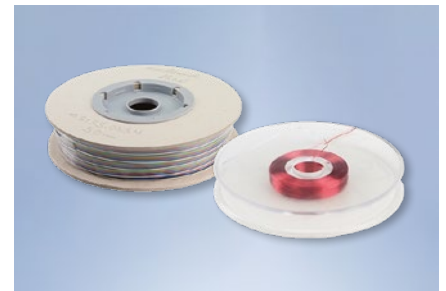

PVC ribbon cable and paint-insulated copper wire

## Jumper wire

Fluoropolymer-insulated jumper wire with a cross-section of 0.05 mm<sup>2</sup>, yellow, 100 m per reel, resistance 0.34 Ω/m.  
Ordering number: 1-3130.0239-G



Jumper wire and very flexible stranded wire

## Very flexible stranded wire

for internal, exposed wiring of transducers;  
cross-section 0.04 mm<sup>2</sup> (multi-wire), 0.6 mm outside diameter,  
resistance 0.417 Ω/m, permissible temperature +70 °C, 25 m per reel, PVC insulation.  
Ordering number: 1-SLI 01

## Flexible stranded wire

Fluoropolymer-insulated flexible stranded wire with a cross-section of 0.24 mm<sup>2</sup> (multi-wire), outside diameter of 0.9 mm, 100 m per reel, resistance 0.0741 Ω/m.

blue Ordering no.: 1-3301.0092-B  
green Ordering number: 1-3301.0091-GR  
white Ordering number: 1-3301.0094-W  
black Ordering number: 1-3301.0088-S  
red Ordering number: 1-3301.0089-R



Flexible stranded wire, available in colors Blue, Green, White, Black and Red

Name	Insulation	Thermal resistance	Chemical resistance	Typ. application
<b>Flexible stranded wire</b> 1-3301.0088-S 1-3301.0089-R 1-3301.0091-GR 1-3301.0092-B 1-3301.0094-W	Fluoropolymer	-200 ... +260 °C	not resistant against: elementary fluorine, chlorotrifluoride, molten alkaline metals. Otherwise resistant against all chemicals	For internal connection of SG bridge circuits for contacting from SG to solder terminal
<b>Jumper wire</b> 1-3130.0239-G	Fluoropolymer	-200 ... +260 °C	see flexible stranded wire	see jumper wire
<b>Very flexible stranded wire</b> 1-SLI 01	PVC	briefly 105 °C continuously ... 70 °C	not resistant against: Esters, chlorinated hydrocarbons, ketones, aromatics, benzene, liquid halogens, conc. nitric acid, depending on the plasticizer also aqueous solutions	For internal connection of SG in transducer
<b>PVC ribbon cable</b> 1-3133.0034	PVC	briefly 105 °C	see Very flexible stranded wire continuously ... 90 °C	see Flexible stranded wire
<b>Paint-insulated copper wire</b> 1-CULD 01	Polyurethane	briefly 175 °C continuously -40 ... 155 °C	not resistant against: strong acids, strong alkalis, alcohols, aromatics, saturated vapor, hot water	For internal connection of SG in transducer

## Shielded measurement cables

Type	CABP4/20	CABP1/20	
Remarks	Very thin, shielded measurement cable (AWG 32) for shorter distances. Much wider temperature application range. As a 20 m reel.	Very thin, shielded measurement cable (AWG 32) for shorter distances. Much wider temperature application range. As a 20 m reel.	
Sheath color	white	white	
Number of cores	4	6	
Outside diameter [mm]	1.6	1.6	
Wire cross-section [mm <sup>2</sup> ]	0.16	0.16	
Insulation material (core)	PFA	PFA	
Sheath material	PFA	PFA	
Resistance [ $\Omega$ /m]	0.492	0.492	
Insulation resistance (core-core) [ $\Omega$ /m]	n.d.s.	n.d.s.	
Capacitance (core-core) [pF/m]	43	43	
Capacitance (core-shield) [pF/m]	n.d.s.	n.d.s.	
Temperature range [°C]	-200 ... +200	-200 ... +200	
Quarter bridge circuit in three wire configuration; half bridge circuits without sense lead connected	x		
Quarter bridge circuit in four wire configuration; full bridge circuits without sense lead connected	x		
Half bridge circuits; full bridge circuits with sense lead connected		x	
Ordering number	1-CABP4/20	1-CABP1/20	

Minimum order quantity: 10m;  
CABP4/20 and CABP1/20, 20 m reel

Further information can be found in the price list (load cells, transducers, amplifiers, data acquisition and software)



	KAB5/00-4	KAB5.4/00-6	KAB5.4/00-6-TPE	KAB7.5/00-2/2/2
	Low-capacitance, therefore also suitable for CF amplifiers and longer distances. Very thin, therefore ideally suited for geometrically critical conditions	Economical six-wire cable for non-critical applications (TF 600 Hz < 50 m TF 4.8 kHz < 20 m)	TPE six-wire cable for non-critical applications (TF 600 Hz < 50 m TF 4.8 kHz < 20 m)	Quad-shielded cable twisted in pairs, also suitable for longer distances and higher frequency CF amplifiers
	gray	gray	blood orange	gray
	4	6	6	6
	5	5.4	5.4	7.5
	0.17	0.14	0.14	0.14
	PE	PE	TPE	PE-A
	PVC	PVC	TPE	PVC
	0.106	0.13	0.13	0.138
	10 <sup>12</sup>	10 <sup>12</sup>	10 <sup>12</sup>	10 <sup>12</sup>
	80	82	78	80
	80	82	78	130
	-35 ... +80	-30 ... +85	-50 ... +120	-30 ... +70
	x			
	x			
		x	x	x
	4-3133.0002	4-3131.0071	4-3301.0152	4-3301.0071

# SG installation case

## SG starter kit DAK 1

This handy case contains all the equipment needed for installing strain gauges for the first time. It provides an easy introduction to strain gauge technology.

Comprehensive know-how around installation and wiring of strain gauges, and evaluation of measured values is provided by the specialized book written by Karl Hoffmann, an experienced specialist in strain gauge technology.

For the first practical steps, containing:

- Strain gauges
- Solder terminals
- Cleaning agents and cleaning pads
- Emery cloth
- Cold-curing adhesives X60 and Z70
- Leads
- 2 agents for measuring point protection: AK22 and ABM75

Because DAK1 has been used for many years in company-internal SG and instrumentation seminars, the contents have been continuously optimized.

Ordering number: 1-DAK1



### DAK 1 contents

10 pcs.	SG 1-LY11-6/120A
10 pcs.	SG 1-LY61-6/350A
5 pcs.	SG K-CLY41-6/120 with 1 m TPE connection cable
1 package each	Solder terminals LS5, LS212, LS224
1 package	Z70 adhesive
1 package	X60 adhesive
1 pc.	Covering agent AK 22
1 pc.	Covering agent ABM 75
6 pcs.	Stranded connection wire, 30 cm
1 sheet	Emery cloth K180
200 ml	Cleaning agent RMS1
1 set	Cleaning pads
1 reel	Solder, lead-free
1 pc.	Petri dish
1 pc.	Reference book "Eine Einführung in die Technik des Messens mit Dehnungsmessstreifen" (An introduction to measurement using strain gauges)

## SG installation case DAK 2

The DAK 2 strain gauge installation case contains all tools and aids required for strain gauge installations. It is portable and lockable. In the bottom part of the DAK 2 there is space for various adhesives and other uses, below the removable insert.

Dimensions: 470 x 170 x 360 mm

Weight: approx. 6 kg

(incl. standard scope of delivery)

Ordering no.: 1-DAK2

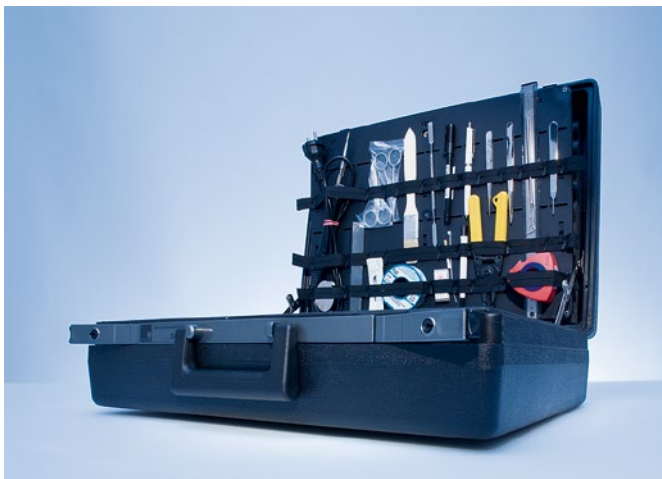

### DAK 2 contents

1 pc.	Flat brush
1 pc.	Folding magnifying glass (6x)
1 pc.	Graduated ruler, 150 mm
1 pc.	Eraser pencil
1 pc.	Scissors, toothed
1 pc.	Pointed scissors
1 pc.	Tweezers, wide
1 pc.	Tweezers, pointed
1 pc.	Flexible ruler, 300 mm
1 pc.	Dental probe with bent tip
1 pc.	Cement spatula
1 pc.	Cutting and stripping pliers
1 pc.	Petri dish 60/15
10 m	Ribbon cable 6 x 0.14 mm <sup>2</sup> , various colors
25 g	Soldering wire Ø 1 mm, lead-free
1 pc.	Flux pen
1 pc.	Roll of Scotch tape
1 pc.	Rubber
1 pc.	HBM ballpoint pen
1 each	Corundum cloth sheets, grain size 180/220/360
100 cm <sup>3</sup>	Cleaning agent RMS 1
200 pcs.	Cleaning pads, 50 x 50 mm

# Bridge completions, resin-cored solder, lead-free solder

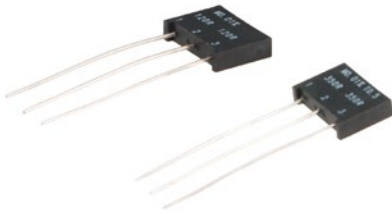

## Bridge completions

Bridge completion resistors are connected to the strain gauges of a measuring point to form the Wheatstone bridge circuit. HBM offers various resistance values in line with the nominal strain gauge resistances.

2 x 120  $\Omega$  ordering number: 3-3054.0334

2 x 350  $\Omega$  ordering number: 3-3054.0282



## Lead-free solder

Lead-free resin cored solder for SG applications. Diameter: 0.5mm; Sn95.5Ag3.8Cu0.7 ("no clean"). Melting range: 217 °C to 219 °C. Delivery form: 500g on reel, ordering no.: 1-LOT-LF

## Bibliography

SG reference book:

“Eine Einführung in die Technik des Messens mit Dehnungsmessstreifen”  
(An introduction to measurement using strain gauges)

A practical introduction into this specialist area of measurement technology with a focus on how to avoid or correct measuring errors.

Ordering number: 1-Hoffm. Buch-D (German)  
1-Hoffm. Buch-E (English)



# Optical strain gauges



Strain measurement fiber



Strain gauge



Strain rosette

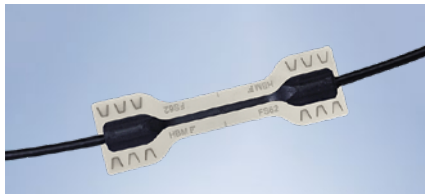

Weldable strain sensor



Composite strain sensor



Embedded strain sensor

## Bringing light to measurement

You will also find sensors based on fiber Bragg gratings here for strain measurements. These optical strain gauges are designed for use in many different applications.

## Special features

- Measurements without drift with guaranteed absolute reference
- Insensitive to electromagnetic fields and passive for use in potentially explosive atmospheres
- Extremely resistant against high strain levels and fatigue
- Rugged, optimized construction for easy installation, even in challenging environments

## Sample applications

- Strain sensors from HBM FiberSensing for various materials and bonding methods (adhesive bonding, welding, embedding or screw connections)
- Sensor arrangements with definable distances and wavelengths, connected via fusion splices and ready for installation
- Use of existing temperature sensors for temperature compensation and / or supplementary measurements
- Bare fibers with multiple FBG sensors with configurable wavelengths and distances for hard to reach measurement points, installation in small components or embedding in composites

## All-in-one solutions

Combine the optical strain gauges with other types of optical strain gauge sensors for different measurands and acquire data with reliable optical interrogators from HBM FiberSensing.

Create true hybrid systems by combining fiber Bragg grating measurements with various data acquisition and software solutions from HBM.

For further information go to:  
[www.hbm.com/fibersensing](http://www.hbm.com/fibersensing)



# Customer-specific strain gauges

- Do you have special requirements that are not adequately covered by any of the strain gauges in our standard program?
- Are you looking for a strain gauge equivalent to the one you are using now?
- Have you designed your own strain gauge?

Contact us, we will produce customized strain gauges according to your requirements!

Send your request or layout directly via e-mail to:  
[info@hbm.com](mailto:info@hbm.com)



Diaphragm rosette strain gauges

## Checklist for your strain gauge request

Strain gauge specifications					
Grid geometry	<input type="checkbox"/> Linear	<input type="checkbox"/> Rosette with two measuring grids	<input type="checkbox"/> Rosette with three measuring grids	<input type="checkbox"/> Shear / torsion	
	<input type="checkbox"/> Full bridge strain gauge	<input type="checkbox"/> Chain	<input type="checkbox"/> Diaphragm rosette		
Resistance	<input type="checkbox"/> 120 Ω	<input type="checkbox"/> 350 Ω	<input type="checkbox"/> 700 Ω	<input type="checkbox"/> 1,000 Ω	<input type="text"/> Ω
Grid length	<input type="checkbox"/> 1.5 mm	<input type="checkbox"/> 3 mm	<input type="checkbox"/> 6 mm	<input type="checkbox"/> 10 mm	<input type="text"/> mm
Grid width	<input type="text"/> mm	<input type="text"/> mm			
Carrier dimensions	<input type="text"/> mm (length)	<input type="text"/> mm (width)			
Type of connection	<input type="checkbox"/> Lead	<input type="checkbox"/> Integrated solder terminals	<input type="checkbox"/> with connection cable		
Temperature matching	<input type="checkbox"/> Ferritic steel	<input type="checkbox"/> Aluminum	<input type="checkbox"/> Austenitic steel	<input type="checkbox"/> Silica	
	<input type="checkbox"/> Titanium	<input type="checkbox"/> Plastic	<input type="checkbox"/> Molybdenum		
Temperature application range	<input type="text"/>				
Order quantity	<input type="text"/>	Pieces			
Sketch					

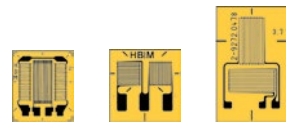

T strain gauges

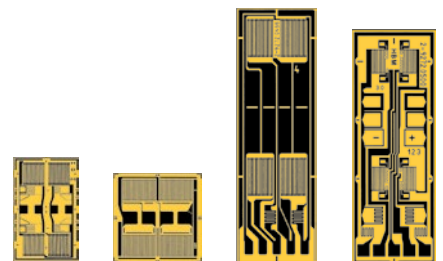

Full bridge strain gauges

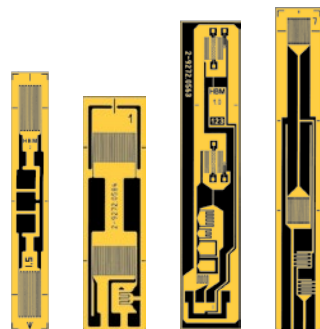

Half bridge strain gauges

Please see also our catalog  
 "Strain Gauges for Manufacturers of Transducers"

# Seminars



Measured data are the key to advanced development of your products. In HBM Academy seminars you will follow our trainers and measurement technology experts along the way to the right results. From selecting and installing the sensor system to reliable data acquisition and on to analysis and evaluation of your results.

## From the fundamentals to professional seminars

**Fundamentals sessions** in which we examine the most important “basics” again. Fundamental, but important!

**Advanced seminars** for individual measurands and sensor technologies. This is where we get into detail.

**Professional seminars** for use of the entire measurement chain from sensor to software, also complex special applications. For experts!

## Seminars related to strain gauges

- Basics principles of strain gauge installation and strain gauge measurement technology (DK)
- Measuring with strain gauges - planning, connecting and analyzing (DM)
- SG installation on plastic materials and fiber composites and PCBs (DK-F) / advanced seminar
- Experimental stress analysis for evaluating parts
- Individual seminars as requested – at the customer's site or at ours

To see our complete range of seminars together with detailed information on contents and dates, go to:  
[www.hbm.com/Seminare](http://www.hbm.com/Seminare)





© Hottinger Baldwin Messtechnik GmbH. All rights reserved.  
All details describe our products in general form only.  
They are not to be understood as express warranty and do  
not constitute and liability whatsoever.

[www.hbm.com](http://www.hbm.com)

**HBM Test and Measurement**

Tel. +49 6151 803-0

Fax +49 6151 803-9100

[info@hbm.com](mailto:info@hbm.com)

measure and predict with confidence

