

SIEMENS



SIMOTICS Motors

SIMOTICS GP, SD, XP, DP Low-Voltage Motors

Type series 1FP1, 1LE1, 1LE5, 1MB1, 1MB5 and 1PC1







Frame sizes 63 to 450 · Power range 0.09 to 1000 kW

Catalog
D 81.1

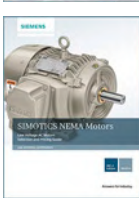
Edition
06/2020

[siemens.com/drives](https://www.siemens.com/drives)

Related catalogs

| | | | |
|---|--------|---|---|
| <p>SIMOTICS FD Low-Voltage Motors Frame sizes 315 to 450 Power range 200 to 1800 kW</p> <p>PDF (E86060-K5581-A181-A5-7600)</p> | D 81.8 |  | <p>All catalogs and other information material, such as brochures, manuals and operating instructions for standard drive systems are available up-to-date on the Internet at the following address: www.siemens.com/drives/catalogs</p> <p>The listed documentation can be ordered here or it is available in commonly used file formats (PDF, ZIP) for downloading.</p> <p>SinaSave energy saving/energy efficiency tool</p> <p>Further information on the subject of energy saving and the SinaSave energy efficiency tool is available at the following address: www.sinasave.siemens.com</p> <p>Drive Technology Configurator</p> <p>The DT Configurator can be used on the Internet without requiring any installation. The DT Configurator can be found in the Industry Mall at the following address: www.siemens.com/dt-configurator</p> <p>The Drive Technology Configurator for gear units, motors, mechanical components, converters, connection systems, control and licenses and system configuration can be found in the Industry Mall main menu, under drive systems, selection and engineering tools.</p> <ul style="list-style-type: none"> • Data sheets in up to 7 languages in PDF or RTF format • 2D/3D dimensional drawings in various formats • Terminal box drawing and terminal connection diagram • Operating instructions • Certificates • Start-up calculation for SIMOTICS motors • EPLAN macros <p>Copper surcharges</p> <p>The metal factors that are applicable for the copper surcharges are specified in the headers of the current Price List D 81.1 P. Further information about "Metal surcharges" can be found in the appendix to this catalog.</p> |
| <p>SIMOTICS NEMA Motors Low Voltage AC Motors Selection and Pricing Guide</p> <p>Further details available on the Internet at: www.usa.siemens.com/motors</p> | D 81.2 |  | |
| <p>SINAMICS G130 Drive Converter Chassis Units SINAMICS G150 Drive Converter Cabinet Units</p> <p>E86060-K5511-A101-A6-7600</p> | D 11 |  | |
| <p>Motion Control Drives SINAMICS S120 and SIMOTICS</p> <p>E86060-K5521-A141-A1-7600</p> | D 21.4 |  | |
| <p>SINAMICS S120 Chassis Format Converter Units Chassis-2 Format Converter Units Cabinet Modules, Cabinet Modules-2 SINAMICS S150 Converter Cabinet Units</p> <p>E86060-K5521-A131-A7-7600</p> | D 21.3 |  | |
| <p>Motion Control Drives SINAMICS Inverters for Single-Axis Drives Built-In Units</p> <p>E86060-K5531-A111-A1-7600</p> | D 31.1 |  | |
| <p>Industrial Controls SIRIUS</p> <p>E86060-K1010-A101-B1-7600</p> | IC 10 |  | |
| <p>Industry Mall Information and Ordering Platform on the Internet:</p> <p>www.siemens.com/industrymall</p> | |  | |



SIMOTICS GP, SD, XP, DP Low-Voltage Motors

Type series 1FP1, 1LE1, 1LE5, 1MB1, 1MB5 and 1PC1
Frame sizes 63 to 450, power range 0.09 to 1000 kW
Catalog D 81.1 · 06/2020

Dear Customer,

We are pleased to present you with the new Catalog D 81.1 · 06/2020.
The new catalog replaces the old Catalog D 81.1 · 07/2019:

In the catalog, numerous new products have been included, which are marked with "▲" to indicate a brand new listing.

■ For the SIMOTICS GP/SD standard motors:

- Inclusion of the new SIMOTICS GP 1LE1083 aluminum series with IE3 Premium Efficiency, 2- to 8-pole, frame sizes 100 to 200
- Inclusion of the new SIMOTICS SD 1LE1583 cast-iron series with IE3 Premium Efficiency, 2- to 8-pole, frame sizes 100 to 315

■ For the SIMOTICS XP explosion-protected motors:

- Inclusion of the new 1MB55.4 cast-iron series with IE4 Super Premium Efficiency, 2- to 8-pole, frame sizes 400 and 450
- Expansion of the 1MB55.3 cast-iron series with IE3 Premium Efficiency, 2- to 8-pole to include frame sizes 400 and 450
- Inclusion of the new 1MB58.3 cast-iron series with IE3 Premium Efficiency, 2- to 8-pole, frame sizes 400 and 450

By clicking on the article numbers in each chapter of the catalog PDF, you can go directly to our "Industry Mall".

The products listed in this catalog are also included in the "Industry Mall".

The "Drive Technology Configurator" is updated daily in the Internet at
www.siemens.com/dt-configurator

Up-to-date information about low-voltage motors is available online at:
www.siemens.com/lowvoltagegators

You can access our "Industry Mall" online at
www.siemens.com/industrymall

Your personal contact will be glad to receive your suggestions and recommendations for improvement. You can find your representative in our contact person database at www.siemens.com/automation-contact

We hope that you will often enjoy using Catalog D 81.1 · 06/2020 as a selection and ordering reference document and wish you every success with our products and solutions.

With kind regards,



Christoph Nöth
Head of Product Portfolio Management
Siemens AG, Motion Control, Low Voltage Motors, Europe

SIMOTICS GP, SD, XP, DP Low-Voltage Motors

Type series 1FP1, 1LE1, 1LE5, 1MB1, 1MB5 and 1PC1

Motors

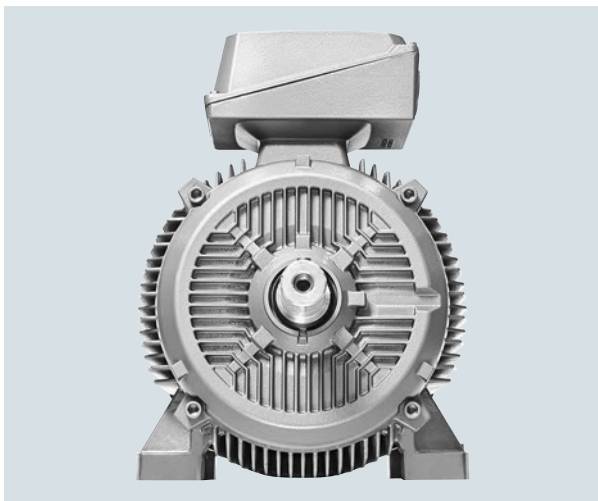

Catalog D 81.1 · 06/2020

Supersedes:
Catalog D 81.1 · 07/2019

Refer to the Industry Mall for current updates of
this catalog:

www.siemens.com/industrymall

Please contact your local Siemens branch.

© Siemens 2020

NEW

By clicking on an Article No., you can access the DT
Configurator to complete the configuration and then you
can get product information and order in the Industry Mall.

Article No.

1LE1504-1AB4

1LE1504-1AB5



Or directly on the Internet in the Industry Mall, e.g. by entering
www.siemens.com/product?1LE1504-1AB4



The products and systems described in
this catalog are manufactured/distributed
under application of a certified quality
management system in accordance with
EN ISO 9001 (04-31-1267 Certified Regis-
tration No. DE-000357 QM). The certificate
is recognized by all IQNet countries.

Introduction

Information regarding efficiency in accordance with
International Efficiency,
Guide to selecting and ordering the motors,
General information, Electrical design, Mechanical version,
Mounting technology

1

SIMOTICS GP and SIMOTICS SD standard motors

2

SIMOTICS SD standard motors next generation

3

SIMOTICS VSD motors for converter operation

4

SIMOTICS XP explosion-protected motors

5

SIMOTICS DP application-specific motors

- Marine motors

6

Appendix

NEMA motors, Industry Services, Partner at Siemens,
Tools and engineering, Index of order codes,
Conversion tables, Metal surcharges,
Conditions of sale and delivery

7

Digital Enterprise

The building blocks that ensure everything works together perfectly in the digital enterprise

Digitalization is already changing all areas of life and existing business models. It is placing greater pressure on industry while at the same time creating new business opportunities. Today, thanks to scalable solutions from Siemens, companies can already become a digital enterprise and ensure their competitiveness.



Industry faces tremendous challenges



Reduce time-to-market

Today manufacturers have to bring products to market at an ever-increasing pace despite the growing complexity of these products. In the past, a major manufacturer would push aside a small one, but now it is a fast manufacturer that overtakes a slow one.



Boost flexibility

Consumers want customized products, but at a price they would pay for a mass-produced item. That only works if production is more flexible than ever before.



Improve quality

To ensure a high level of quality while meeting legal requirements, companies have to establish closed quality loops and enable the traceability of products.



Boost efficiency

Today the product itself needs to be sustainable and environmentally friendly, while energy efficiency in production has become a competitive advantage.



Increase security

Increasing networking escalates the threat to production facilities of cyberattacks. Today more than ever, companies need suitable security measures.



The digital enterprise has already become a reality

To fully benefit from all the advantages of digitalization, companies first have to achieve complete consistency of their data. Fully digitally integrated business processes, including those of suppliers, can help to create a digital representation of the entire value chain. This requires

- the integration of industrial software and automation,
- expansion of the communication networks,
- security in automation,
- and the use of business-specific industrial services.

MindSphere

The cloud-based open IoT operating system from Siemens

With MindSphere, Siemens offers a cost-effective and scalable cloud platform as a service (PaaS) for the development of applications. The platform, designed as an open operating system for the Internet of Things, makes it possible to improve the efficiency of plants by collecting and analyzing large volumes of production data.

Totally Integrated Automation (TIA) Where digitalization becomes reality

Totally Integrated Automation (TIA) ensures the seamless transition from the virtual to the real world. It already encompasses all the necessary conditions for transforming the benefits of digitalization into true added value. The data that will form the digital twin for actual production is generated from a common base.

Digital Plant

Learn more about the digital enterprise for the process industry
www.siemens.com/digitalplant

Digital Enterprise Suite

Learn more about the digital enterprise for the discrete industry
www.siemens.com/digital-enterprise-suite

Integrated Drive Systems

Faster on the market and in the black with Integrated Drive Systems

Integrated Drive Systems are Siemens' trendsetting answer to the high degree of complexity that characterizes drive and automation technology today. The world's only true one-stop solution for entire drive systems is characterized in particular by its threefold integration: Horizontal, vertical, and lifecycle integration ensure that every drive system component fits seamlessly into the whole system, into any automation environment, and even into the entire lifecycle of a plant.

The outcome is an optimal workflow – from engineering all the way to service that entails more productivity, increased efficiency, and better availability. That's how Integrated Drive Systems reduce time to market and time to profit.

Horizontal integration

Integrated drive portfolio: The core elements of a fully integrated drive portfolio are frequency converters, motors, couplings, and gear units. At Siemens, they're all available from a single source. Perfectly integrated, perfectly interacting. For all power and performance classes. As standard solutions or fully customized. No other player in the market can offer a comparable portfolio. Moreover, all Siemens drive components are perfectly matched, so they are optimally interacting.

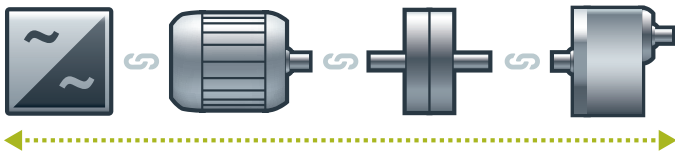

You can boost the availability of your application or plant to up to

99%*
*e.g., conveyor application

Vertical integration

Thanks to **vertical integration**, the complete drive train is seamlessly integrated in the entire automation environment – an important prerequisite for production with maximum value added. Integrated Drive Systems are part of Totally Integrated Automation (TIA), which means that they are perfectly embedded into the system architecture of the entire industrial production process. This enables optimal processes through maximum communication and control.

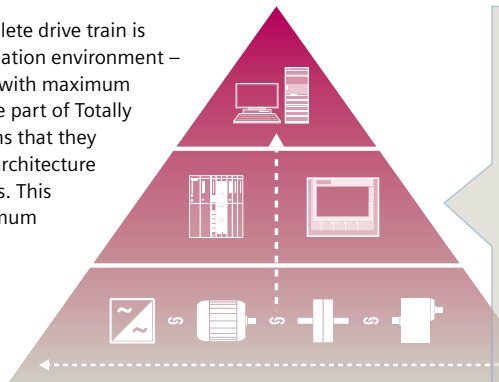

With TIA Portal you can cut your engineering time by up to

30%

Lifecycle integration

Lifecycle integration adds the factor of time: Software and service are available for the entire lifecycle of an Integrated Drive System. That way, important optimization potential for maximum productivity, increased efficiency, and highest availability can be leveraged throughout the system's lifecycle – from planning, design, and engineering to operation, maintenance, and all the way even to modernization.

With Integrated Drive Systems, assets become important success factors. They ensure shorter time to market, maximum productivity and efficiency in operation, and shorter time to profit.

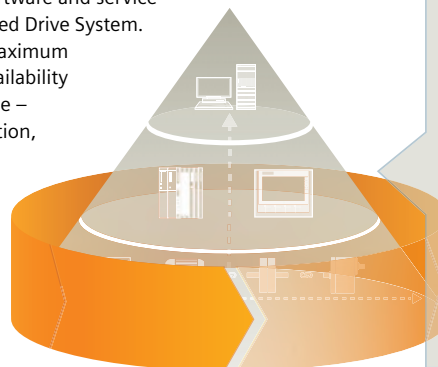

With Integrated Drive Systems you can reduce your maintenance costs by up to

15%

Introduction

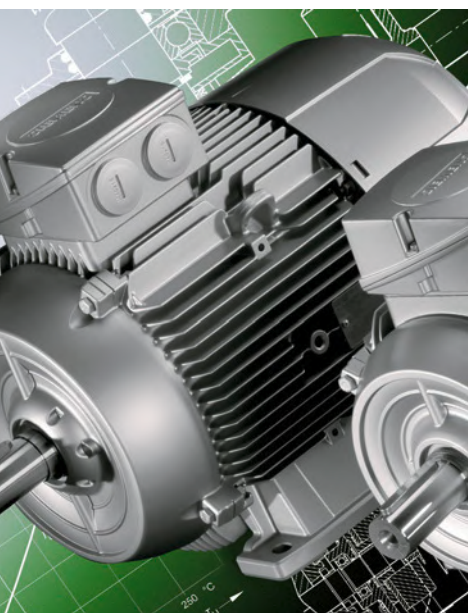

| | | | |
|-------------|---|-------------|--|
| 1/2 | SIMOTICS motors | 1/45 | Mechanical version |
| 1/2 | Innovative drive technology for all industries, applications and power classes | 1/45 | Types of construction |
| 1/4 | SIMOTICS Digital Data App | 1/47 | Flange dimensions |
| 1/5 | Information regarding efficiency in accordance with International Efficiency | 1/48 | Shaft and rotor |
| 1/5 | Efficiency classes and efficiencies according to IEC 60034-30-1 | 1/49 | Measures for gear mounting |
| 1/7 | Guide to selecting and ordering the motors | 1/50 | Balance and vibration severity |
| 1/7 | Catalog orientation and drive selection | 1/51 | Noise levels for line operation |
| 1/13 | General information | 1/52 | Bearings and lubrication |
| 1/13 | Cut-away diagram of a low-voltage motor | 1/74 | T-Drain – adjustable drainage of condensed water |
| 1/14 | Colors and paint finish | 1/75 | Lifting eyes and transport |
| 1/17 | Packaging and dispatch | 1/76 | Mounting technology |
| 1/17 | Safety notes and documentation | 1/76 | Preparation for mountings |
| 1/17 | Test certificates | 1/77 | Modular technology |
| 1/18 | Extension of the liability for defects | 1/77 | • Separately driven fan |
| 1/19 | Versions in accordance with standards and specifications | 1/78 | • Brakes |
| 1/23 | Electrical design | 1/79 | • BFK458 spring-operated disk brake |
| 1/23 | Voltages, currents and frequencies | 1/83 | • KFB spring-operated brake |
| 1/23 | Powers | 1/86 | • SFB-SH solenoid double-disk spring-operated brake |
| 1/24 | Rating plate and additional rating plates | 1/89 | • Configuration of motors with brakes |
| 1/25 | Efficiency and power factor | 1/90 | • FDX spring-operated brake |
| 1/25 | Rated speed and direction of rotation, rated torque | 1/95 | Special technology |
| 1/26 | Converter operation | 1/95 | • LL 861 900 220 rotary pulse encoder |
| 1/27 | Windings and insulation | 1/96 | • HOG 9 DN 1024 I rotary pulse encoder |
| 1/29 | Coolant temperature and installation altitude | 1/97 | • POG 9 rotary pulse encoder |
| 1/30 | Heating and ventilation | 1/98 | • POG 10 DN rotary pulse encoder |
| 1/32 | Motor protection | 1/99 | • HOG 10 D 1024 I rotary pulse encoder |
| 1/35 | Connection, circuit and terminal boxes | 1/100 | • Sendix 5020 rotary pulse encoder |
| 1/44 | Degrees of protection | 1/101 | • Rotary pulse encoders for SIL2, SIL3 safety applications |
| | | 1/101 | - Sendix 5834 FS2/FS3 rotary pulse encoder |
| | | 1/102 | - HOGS 100 S rotary pulse encoder |
| | | 1/102 | - FSI 862 rotary pulse encoder |
| | | 1/103 | • Backstop, protective cover |
| | | 1/104 | Dimensions and weights of the mountings |

Introduction

SIMOTICS motors

Innovative drive technology for all industries, applications and power classes

Overview

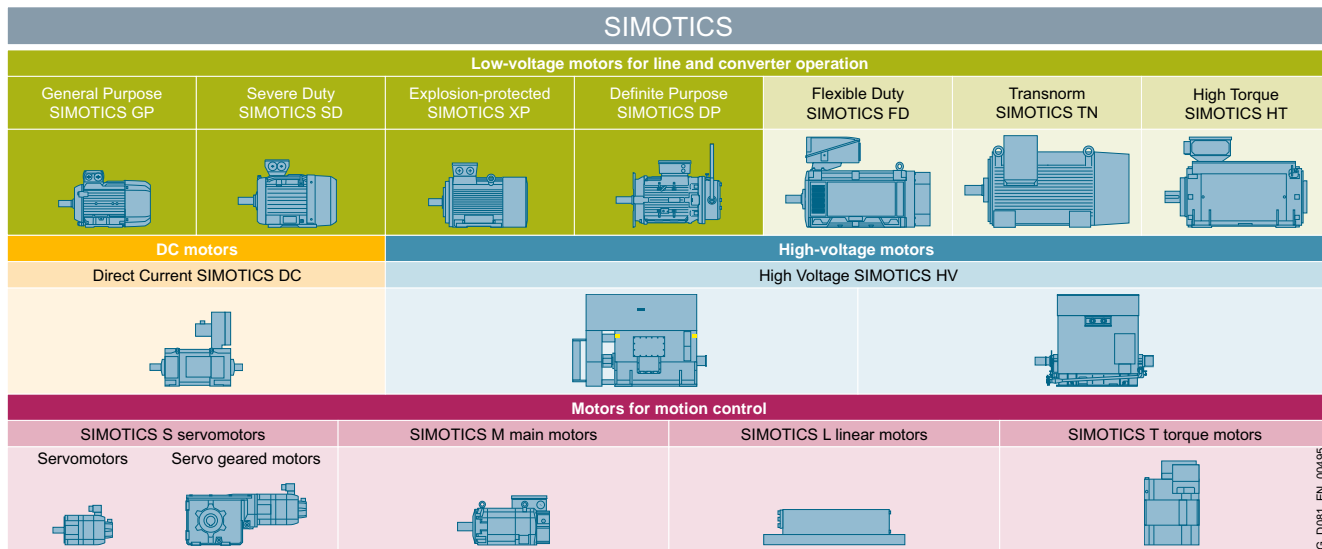

G_D081_EN_00495

SIMOTICS motors

With SIMOTICS, Siemens has the most comprehensive portfolio of electric motors worldwide. From energy-efficient, low-voltage motors through servomotors with high dynamic performance up to well-proven DC motors and powerful high-voltage motors. Innovative drive technology for all industries, applications and power classes.

Outstanding performance, quality, efficiency, and compactness.

The SIMOTICS motor portfolio:

- SIMOTICS Low-Voltage Motors for line and converter operation:
For standard applications with low to high motor power ratings
- SIMOTICS Motion Control motors:
For highly dynamic and extremely precise applications in mechanical engineering
- SIMOTICS DC motors:
For DC applications
- SIMOTICS High-Voltage Motors:
For line and converter operation in standard applications with high to very high motor power ratings.

SIMOTICS Low-Voltage Motors for line and converter operation

SIMOTICS Low-Voltage Motors are the right choice for solving drive tasks efficiently and reliably. In contrast to Motion Control motors, which are additionally characterized by very high dynamic response and precision, the more favorably priced low-voltage motors are predestined for continuous or periodic, as well as powerful motions with fixed or variable speed, such as in pumps, fans, compressors, conveyor belts, lifts, hoisting and traversing gear, winders, mixers, kneaders and centrifuges.

SIMOTICS Low-Voltage Motors are characterized by very high reliability, ruggedness, and efficiency in operation.

They are available in diverse series and versions, which means that the appropriate motor can always be found for any application in an industrial or commercial environment, as well as in building management systems, shipbuilding and infrastructure.

SIMOTICS Low-Voltage Motors comply with the most important relevant standards and guidelines and are available in IEC, NEMA, and APAC versions. They can be used all over the world, and have a global, long-term spare parts service. For these reasons, they provide a sustainable basis for export-oriented, globally operating companies to enable them to conduct their international business efficiently.

Overview

SIMOTICS GP – General Purpose motors are the most economical solution for use under standard environmental conditions. Typically, these motors have an aluminum housing and are characterized by their low weight. SIMOTICS GP motors are available in the power range from 0.09 to 45 kW.

Available motor variants:

- Induction motors, optimized for line operation
 - in efficiency classes IE4, IE3, IE2, IE1
 - as a standards-compliant version or compact version with increased power (IE3, IE2, IE1)
 - as a 2-, 4-, 6-, 8-pole version
 - as pole-changing motors
 - as an APAC version for use in the ASEAN Pacific region (IE3, IE2)
 - as a NEMA version for use in the NAFTA area
 - electrically (mechanically acc. to IEC): Eagle Line
 - electrically and mechanically
 - can optionally be run on a converter
- Motors optimized for operation on frequency converters
 - as a SIMOTICS GP – VSD10 line induction motor
 - as a SIMOTICS GP – VSD4000 line synchronous reluctance motor for particularly efficient operation in conjunction with SINAMICS converters.
- Different types of construction, voltage versions, and a wide variety of options/add-ons for precise adaptation of the motors to application and customer-specific requirements.

SIMOTICS SD – Severe Duty motors have a rugged cast-iron housing, which means that they are also suitable for use in harsh to very harsh environments. With a wide power range from 0.09 to 1000 kW, SIMOTICS SD motors are the basis for machine and plant builders and owners who require a universal motor for flexible requirements and conditions of use.

Available motor variants:

- Induction motors, optimized for line operation
 - in efficiency classes IE4, IE3, IE2, IE1
 - standards-compliant version or compact version with increased power (IE3, IE2, IE1)
 - as a 2-, 4-, 6-, 8-pole version
 - as an APAC version for use in the ASEAN Pacific region (IE3, IE2)
 - as a NEMA version for use in the NAFTA area
 - electrically (mechanically acc. to IEC): Eagle Line
 - electrically and mechanically
 - can optionally be run on a converter
- Motors optimized for operation on frequency converters
 - as a SIMOTICS SD – VSD10 line induction motor
 - as a SIMOTICS SD – VSD4000 line synchronous reluctance motor for particularly efficient operation in conjunction with SINAMICS converters.
- Basic Line and particularly rugged Performance Line
- Different types of construction, voltage versions, and a very wide variety of options/add-ons for precise adaptation of the motors to application and customer-specific requirements.

SIMOTICS – next generation is the next innovation step in low-voltage motors.

In particular, these motors offer the following advantages for customers:

- More efficiency in the engineering process due to the Digital Twin Concept.
- Further increase in availability due to the Smart Motor Concept.

SIMOTICS XP – Explosion Proof motors are designed for use in hazardous environments. For all conditions of use and hazard zones, e.g. in explosive gas atmospheres of the chemical/petrochemical sector or in explosive dust atmospheres in the mining or food and beverage sectors, there are suitable motor versions in aluminum and cast iron that ensure maximum safety and satisfy the relevant standards and regulations.

SIMOTICS XP motors are available in the power range from 0.09 to 460 kW.

Available motor variants:

- Motors for use in Zones 1, 2, 21 and 22
- Induction motors optimized for line operation
 - in efficiency classes IE3, IE2, IE1
 - as a 2-, 4-, 6-, 8-pole version
 - as a NEMA version for use in the NAFTA area
- For motors suitable for line and converter operation
- Basic Line and particularly rugged Performance Line in a cast-iron housing
- Different types of construction, voltage versions, and a wide variety of options/add-ons for precise adaptation of the motors to application and customer-specific requirements.

SIMOTICS DP – Definite Purpose motors are low-voltage motors for application-specific, customized and industry-specific use.

They have the required respective industry-specific properties and certificates.

SIMOTICS DP motors:

- Crane motors for use in cranes (primarily for hoisting gear)
- Marine motors for use on ships
- Steel plant motors for use in the steel industry
- Roller table motors for roller table applications in the steel industry

SIMOTICS FD – Flexible Duty motors have been optimized for converter operation to flexibly address applications in power ranges extending from 200 to over 1600 kW. These are available with various cooling methods (air cooling, water cooling).

SIMOTICS TN – Transnorm motors are low-voltage motors for line and converter operation in a cast-iron housing with higher power ratings up to 5000 kW from shaft height 315. In non-standard (Transnorm) motors, the assignment of the power rating and shaft extensions to frame size is not standardized.

SIMOTICS HT – High Torque motors are permanent-magnet synchronous motors and are used in applications that require extremely powerful drives without gear units, even at low speeds.

Introduction

SIMOTICS motors

1

SIMOTICS Digital Data App

Overview

The SIMOTICS Digital Data App provides access to technical data, spare part information, and operating instructions for SIMOTICS GP/SD motors any time any place. This gives our customers quick access to important contents of the digital twin. This simplifies our customers' processes.

By scanning the data matrix code on the additional rating plate of the motor, the relevant electrical and mechanical data can be displayed for this motor.

- Electronic and mechanical rating plate data
- Additional motor data
- Service information, e.g. display of the spare part list
- Display of the ordering options installed
- Documentation and manuals

The SIMOTICS Digital Data App is available for Apple and Android devices and can be installed from the respective stores. To do this, please scan the appropriate QR code.

Benefits

- Shorter commissioning and service times
- Fast access to relevant service information
- Online availability of the motor data for integration into ERP systems

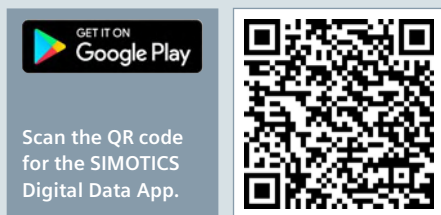

Overview

Harmonization of the efficiency classes

Various energy efficiency standards exist worldwide for induction motors. To promote global standardization, the international standard IEC 60034-30-1:2014 (Rotating electrical machines – Part 30-1: Efficiency classes of single-speed, three-phase, cage-induction motors (IE code) were defined and are used as the basis for local standards in most countries. Only the NAFTA countries USA, Canada, and Mexico use the differing standards of NEMA MG1. Standard IEC 60034-30-1:2014 divides low-voltage induction motors into new efficiency classes IE1 to IE4, which supersede the efficiency classes EFF2 and EFF1 previously valid in the EU.

Applicability (excerpt)

- Low-voltage motors up to 1000 V (50/60 Hz in line operation)
- Power rating: 0.12 to 1000 kW; with 2, 4, 6, or 8 poles
- Operating mode: S1

The efficiencies in IEC 60034-30-1 are based on the method for determining losses according to IEC 60034-2-1:2014.

IE efficiency classes

The efficiency classes are grouped according to the following nomenclature (IE = International Efficiency):

- IE1 (Standard Efficiency)
- IE2 (High Efficiency)
- IE3 (Premium Efficiency)
- IE4 (Super Premium Efficiency)

| IEC 60034-30-1 EU and other countries | NEMA MG1 NAFTA (USA, Canada, Mexico) | GB 18613-2012 China |
|--|---|------------------------|
| IE4 ¹⁾ | | Grade 1 (IE4) |
| IE3 | Premium Efficient (60 Hz) | Grade 2 (IE3) |
| IE2 | Energy Efficient (60 Hz) | Grade 3 (IE2) |

Comparison of IE efficiency classes

Note:

All efficiency classes are stated with reference to 50 Hz data (unless specified otherwise).

Measuring method according to IEC 60034-2-1:2014 for determining the efficiency

With this measuring method, motor losses are no longer applied as a percentage, but are determined by standard methods. The nominal efficiencies are therefore reduced from EFF1 to IE2 and from EFF2 to IE1, even though there have been no technical or physical changes to the motors.

Previously: $P_{LL} = 0.5\%$ of P_1 (power drawn; IEC 60034-2)

Now: P_{LL} = individual measurement (IEC 60034-1)

P_{LL} = additional load losses

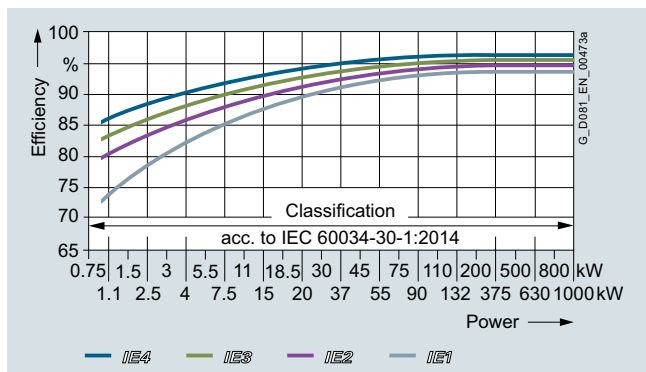

IE1-IE4 efficiencies, 4-pole, 50 Hz, depending on the power

Minimum efficiencies according to IEC 60034-30-1:2014

| Rated power $P_{rated, 50 Hz}$ kW | Efficiency η in % IEC IE class | | | | | | | |
|---|--|--------|--------|--------|-----------------------|--------|--------|--------|
| | IE1 – Standard Efficiency | | | | IE2 – High Efficiency | | | |
| | 2-pole | 4-pole | 6-pole | 8-pole | 2-pole | 4-pole | 6-pole | 8-pole |
| 0.18 | 52.8 | 57.0 | 45.5 | 38.0 | 60.4 | 64.7 | 56.6 | 45.9 |
| 0.20 | 54.6 | 58.5 | 47.6 | 39.7 | 61.9 | 65.9 | 58.2 | 47.4 |
| 0.25 | 58.2 | 61.5 | 52.1 | 43.4 | 64.8 | 68.5 | 61.6 | 50.6 |
| 0.37 | 63.9 | 66.0 | 59.7 | 49.7 | 69.5 | 72.7 | 67.6 | 56.1 |
| 0.40 | 64.9 | 66.8 | 61.1 | 50.9 | 70.4 | 73.5 | 68.8 | 57.2 |
| 0.55 | 69.0 | 70.0 | 65.8 | 56.1 | 74.1 | 77.1 | 73.1 | 61.7 |
| 0.75 | 72.1 | 72.1 | 70.0 | 61.2 | 77.4 | 79.6 | 75.9 | 66.2 |
| 1.1 | 75.0 | 75.0 | 72.9 | 66.5 | 79.6 | 81.4 | 78.1 | 70.8 |
| 1.5 | 77.2 | 77.2 | 75.2 | 70.2 | 81.3 | 82.8 | 79.8 | 74.1 |
| 2.2 | 79.7 | 79.7 | 77.7 | 74.2 | 83.2 | 84.3 | 81.8 | 77.6 |
| 3 | 81.5 | 81.5 | 79.7 | 77.0 | 84.6 | 85.5 | 83.3 | 80.0 |
| 4 | 83.1 | 83.1 | 81.4 | 79.2 | 85.8 | 86.6 | 84.6 | 81.9 |
| 5.5 | 84.7 | 84.7 | 83.1 | 81.4 | 87.0 | 87.7 | 86.0 | 83.8 |
| 7.5 | 86.0 | 86.0 | 84.7 | 83.1 | 88.1 | 88.7 | 87.2 | 85.3 |
| 11 | 87.6 | 87.6 | 86.4 | 85.0 | 89.4 | 89.8 | 88.7 | 86.9 |
| 15 | 88.7 | 88.7 | 87.7 | 86.2 | 90.3 | 90.6 | 89.7 | 88.0 |
| 18.5 | 89.3 | 89.3 | 88.6 | 86.9 | 90.9 | 91.2 | 90.4 | 88.6 |
| 22 | 89.9 | 89.9 | 89.2 | 87.4 | 91.3 | 91.6 | 90.9 | 89.1 |
| 30 | 90.7 | 90.7 | 90.2 | 88.3 | 92.0 | 92.3 | 91.7 | 89.8 |
| 37 | 91.2 | 91.2 | 90.8 | 88.8 | 92.5 | 92.7 | 92.2 | 90.3 |
| 45 | 91.7 | 91.7 | 91.4 | 89.2 | 92.9 | 93.1 | 92.7 | 90.7 |
| 55 | 92.1 | 92.1 | 91.9 | 89.7 | 93.2 | 93.5 | 93.1 | 91.0 |
| 75 | 92.7 | 92.7 | 92.6 | 90.3 | 93.8 | 94.0 | 93.7 | 91.6 |
| 90 | 93.0 | 93.0 | 92.9 | 90.7 | 94.1 | 94.2 | 94.0 | 91.9 |
| 110 | 93.3 | 93.3 | 93.3 | 91.1 | 94.3 | 94.5 | 94.3 | 92.3 |
| 132 | 93.5 | 93.5 | 93.5 | 91.5 | 94.6 | 94.7 | 94.6 | 92.6 |
| 160 | 93.8 | 93.8 | 93.8 | 91.9 | 94.8 | 94.9 | 94.8 | 93.0 |
| 200 ... 1000 | 94.0 | 94.0 | 94.0 | 92.5 | 95.0 | 95.1 | 95.0 | 93.5 |

| Rated power $P_{rated, 50 Hz}$ kW | Efficiency η in % IEC IE class | | | | | | | |
|---|--|--------|--------|--------|--------------------------------|--------|--------|--------|
| | IE3 – Premium Efficiency | | | | IE4 – Super Premium Efficiency | | | |
| | 2-pole | 4-pole | 6-pole | 8-pole | 2-pole | 4-pole | 6-pole | 8-pole |
| 0.18 | 65.9 | 69.9 | 63.9 | 58.7 | 70.8 | 74.7 | 70.1 | 67.2 |
| 0.20 | 67.2 | 71.1 | 65.4 | 60.6 | 71.9 | 75.8 | 71.4 | 68.4 |
| 0.25 | 69.7 | 73.5 | 68.6 | 64.1 | 74.3 | 77.9 | 74.1 | 70.8 |
| 0.37 | 73.8 | 77.3 | 73.5 | 69.3 | 78.1 | 81.1 | 78.0 | 74.3 |
| 0.40 | 74.6 | 78.0 | 74.4 | 70.1 | 78.9 | 81.7 | 78.7 | 74.9 |
| 0.55 | 77.8 | 80.8 | 77.2 | 73.0 | 81.5 | 83.9 | 80.9 | 77.0 |
| 0.75 | 80.7 | 82.5 | 78.9 | 75.0 | 83.5 | 85.7 | 82.7 | 78.4 |
| 1.1 | 82.7 | 84.1 | 81.0 | 77.7 | 85.2 | 87.2 | 84.5 | 80.8 |
| 1.5 | 84.2 | 85.3 | 82.5 | 79.7 | 86.5 | 88.2 | 85.9 | 82.6 |
| 2.2 | 85.9 | 86.7 | 84.3 | 81.9 | 88.0 | 89.5 | 87.4 | 84.5 |
| 3 | 87.1 | 87.7 | 85.6 | 83.5 | 89.1 | 90.4 | 88.6 | 85.9 |
| 4 | 88.1 | 88.6 | 86.8 | 84.8 | 90.0 | 91.1 | 89.5 | 87.1 |
| 5.5 | 89.2 | 89.6 | 88.0 | 86.2 | 90.9 | 91.9 | 90.5 | 88.3 |
| 7.5 | 90.1 | 90.4 | 89.1 | 87.3 | 91.7 | 92.6 | 91.3 | 89.3 |
| 11 | 91.2 | 91.4 | 90.3 | 88.6 | 92.6 | 93.3 | 92.3 | 90.4 |
| 15 | 91.9 | 92.1 | 91.2 | 89.6 | 93.3 | 93.9 | 92.9 | 91.2 |
| 18.5 | 92.4 | 92.6 | 91.7 | 90.1 | 93.7 | 94.2 | 93.4 | 91.7 |
| 22 | 92.7 | 93.0 | 92.2 | 90.6 | 94.0 | 94.5 | 93.7 | 92.1 |
| 30 | 93.3 | 93.6 | 92.9 | 91.3 | 94.5 | 94.9 | 94.2 | 92.7 |
| 37 | 93.7 | 93.9 | 93.3 | 91.8 | 94.8 | 95.2 | 94.5 | 93.1 |
| 45 | 94.0 | 94.2 | 93.7 | 92.2 | 95.0 | 95.4 | 94.8 | 93.4 |
| 55 | 94.3 | 94.6 | 94.1 | 92.5 | 95.3 | 95.7 | 95.1 | 93.7 |
| 75 | 94.7 | 95.0 | 94.6 | 93.1 | 95.6 | 96.0 | 95.4 | 94.2 |
| 90 | 95.0 | 95.2 | 94.9 | 93.4 | 95.8 | 96.1 | 95.6 | 94.4 |
| 110 | 95.2 | 95.4 | 95.1 | 93.7 | 96.0 | 96.3 | 95.8 | 94.7 |
| 132 | 95.4 | 95.6 | 95.4 | 94.0 | 96.2 | 96.4 | 96.0 | 94.9 |
| 160 | 95.6 | 95.8 | 95.6 | 94.3 | 96.3 | 96.6 | 96.2 | 95.1 |
| 200 | 95.8 | 96.0 | 95.8 | 94.6 | 96.5 | 96.7 | 96.3 | 95.4 |
| 250 | 95.8 | 96.0 | 95.8 | 94.6 | 96.5 | 96.7 | 96.5 | 95.4 |
| 315 ... 1000 | 95.8 | 96.0 | 95.8 | 94.6 | 96.5 | 96.7 | 96.6 | 95.4 |

¹⁾ Defined in IEC 60034-30-1.

Introduction

Information regarding efficiency in accordance with International Efficiency

Efficiency classes and efficiencies according to IEC 60034-30-1

1

Overview

Background information

Comprehensive laws have been introduced in the European Union with the objective of reducing energy consumption and therefore CO₂ emissions. EU Regulations 640/2009 and 2019/1781 concern the energy consumption or efficiency of induction motors in the industrial environment. This regulation is in force in every country of the European Economic Area until June 30, 2021.

Effective July 1, 2021, the new regulation (EU) 2019/1781 will come into force. The main contents of and exceptions to both regulations are explained below.

For more information on internationally applicable standards and legal requirements, visit:

www.siemens.com/international-efficiency

Regulation (EC) 640/2009

Exceptions

- Motors that are designed to be operated totally submerged in a liquid;
- Motors fully integrated into a product (e.g. a gear unit, pump, fan or compressor) whose energy efficiency cannot be measured independently of the product;
- Motors that are specially designed for operation under the following conditions:
 - At altitudes greater than 4000 meters above sea level;
 - At ambient temperatures above 60 °C;
 - At maximum operating temperatures above 400 °C;
 - At ambient temperatures below -30 °C
 - With cooling liquid temperatures at the product intake of below 0 °C or above 32 °C;
 - In hazardous areas in the context of Directive 2014/34/EU of the European Parliament and Council;
- Brake motors

The following motors are not affected:

- Pole-changing motors
- Synchronous motors
- Motors for intermittent duty S2 to S9
- Single-phase motors
- Motors specially developed for converter operation in accordance with IEC 60034-25

The following changes came into effect on the dates below:

From January 1, 2015:

Compliance with the legally required minimum efficiency class IE3 for a power range from 7.5 to 375 kW (2-, 4-, 6-pole) or, as an alternative, IE2 motor plus frequency converter.

From January 1, 2017:

Compliance with the legally required minimum efficiency class IE3 for a power range from 0.75 to 375 kW (2-, 4-, 6-pole) or, as an alternative, IE2 motor plus frequency converter.

From July 1, 2021:

Compliance with the legally required minimum efficiency class IE2 for a power range from 0.12 to 0.75 kW (2-, 4-, 6-, and 8-pole), exception: Ex eb motors

Compliance with the legally required minimum efficiency class IE3 for a power range from 0.75 to 1000 kW (2-, 4-, 6- and 8-pole), exception: Ex eb motors

From July 1, 2023:

Compliance with the legally required minimum efficiency class IE2 for a power range from 0.12 to 1000 kW (2-, 4-, 6- and 8-pole) of Ex eb motors with increased safety and of single-phase motors with a rated output power of at least 0.12 kW.

Compliance with the legally required minimum efficiency class IE4 for a power range of 75 kW to 200 kW (2-, 4-, 6-pole). Exception: Motors with a brake, Ex eb motors with increased safety or other explosion-protected motors.

Changes according to EU motor regulation 640/2009

Low-voltage motors with a power range from 0.75 kW to < 7.5 kW have been labeled as follows since January 1, 2017, and low-voltage motors with a power range from 7.5 kW to 375 kW with efficiency class IE2 have been labeled as follows since January 1, 2015:



This obligation applies only within the European Economic Area. Correct application is the sole responsibility of the customer.

Motor series SIMOTICS VSD10 (1LE1092/1LE1592), VSD4000 (1FP10/1FP15) and SIMOTICS FD (1LH1) are the preferred motor types for converter operation.

New regulation (EU) 2019/1781

Exceptions

- Motors that are designed to be operated totally submerged in a liquid
- Motors fully integrated into a product (e.g. a gear unit, pump, fan or compressor) whose energy efficiency cannot be measured independently of the product
- Motors that are specially designed for operation under the following conditions:
 - At altitudes greater than 4000 meters above sea level
 - Where ambient temperatures exceed 60 °C
 - At maximum operating temperatures above 400 °C
 - At ambient temperatures below -30 °C
 - With cooling liquid temperatures at the product intake of below 0 °C or above 32 °C
- In hazardous areas as defined in Directive 2014/34/EU of the European Parliament and Council that are designed and certified for underground mining applications
- Motors with an integrated brake that is an integral part of the interior motor structure and can neither be removed or powered from a separate source during motor efficiency testing.
- Motors with an integrated speed control (compact drives), whose energy efficiency cannot be tested independently of the speed control

The following motors are not affected:

- Pole-changing motors
- Synchronous motors
- Totally enclosed, naturally ventilated motors (TENV motors);
- Motors specially developed for converter operation in accordance with IEC 60034-25

Other potential restrictions as described in the technical documentation may apply to converter operation and must be taken into account!

The following are generally recommended for converter operation:

- Motor temperature detection by embedded temperature sensor
- Bearing insulation with frame size 225 and larger

Note:

Different minimum efficiency class requirements apply in China, Korea, and Australia. Other countries will be available soon.

Motors for the North American market

The Energy Policy Act (EPAct) was superseded in December 2010 by the Energy Independence Security Act (EISA). The following motors must fulfill the NEMA Premium Efficient Level:

- 1 hp (0.75 kW) ... 500 hp (373 kW): 2-, 4-pole
- 1 hp (0.75 kW) ... 350 hp (261 kW): 6-pole
- 1 hp (0.75 kW) ... 250 hp (186 kW): 8-pole
- 2-, 4-, 6- and 8-pole
- ≤ 600 V

• NEMA Design A, B, or C. IEC Design N or H
For details, see NEMA MG1, Table 12-11 and Table 12-12.

Abbreviations

NEMA: National Electrical Manufacturers Association

IEC: International Electrotechnical Commission

EEA: European Economic Area

Overview

Steps for drive selection

| | | | |
|---|--|--|--|
| Step 1 | Orientation and general technical information | | |
| Technical requirements for the motor | Rated frequency and rated voltage | 3 AC 50/60 Hz, 400, 500 or 690 V | |
| | Operating mode | Standard duty (continuous duty S1 according to EN 60034-1) | |
| | Degree of protection or type of explosion protection required | IP.. | |
| | Rated speed (No. of poles) | $n = \dots\dots\dots$ rpm | |
| | Rated power | $P = \dots\dots\dots$ kW | |
| | Rated torque | $T = P \cdot 9550/n = \dots\dots\dots$ Nm | |
| | Type of construction | IM.. | |
| Step 2 | Preselection in accordance with the application | | |
| Determination of the installation conditions and definition of the application, if necessary | Ambient temperature | ≤ 40 °C | > 40 °C |
| | Installation altitude | ≤ 1000 m | > 1000 m |
| | Factors for derating | None | Determine the factor for derating (for reduction factor, see "Coolant temperature and installation altitude" on page 1/29) |
| Cross-reference to other motors | These include motors for special requirements in the area of explosion protection and applications or motors according to the NEMA standard. | | |
| Step 3 | Preliminary selection of the motor | | |
| Determination of the range of possible motors | Select the frame size and therefore the possible motors on the basis of the following parameters: efficiency class, cooling method, degree of protection, rated power, rated speed and rated torque range. | | |
| | Note: The standard temperature range of the motors is from -20 to +40 °C. | | |

Layout of the selection and ordering tables and description of the columns of the table headers

Power, frame size, temperature class

Operating values at rated power

Article No., add. data

| Table header – Meaning | | | | | | | | | | | | | | | | | | | | |
|-----------------------------|-----------------------------|-----------------------------|------------|-----------------------------|-----------------------------|--|---------------|-------------------------------------|-------------------------------------|-------------------------------------|---|------------------------------------|---|---|--|---|----------------------------|----------------|--|-------------------|
| P_{rated} 50 Hz | P_{rated} 60 Hz | P_{rated} 60 Hz | Frame size | n_{rated} 50 Hz | T_{rated} 50 Hz | Different IE class | CC No. CC032A | η_{rated} 50 Hz, 4/4 | η_{rated} 50 Hz, 3/4 | η_{rated} 50 Hz, 2/4 | $\cos\phi_{\text{rated}}$ 50 Hz, 4/4 | I_{rated} 50 Hz, 400 V | $T_{\text{LR}}/T_{\text{rated}}$ | $I_{\text{LR}}/I_{\text{rated}}$ | T_B/T_{rated} | L_{pFA} 50 Hz | L_{WA} 50 Hz | Article No. | m IM B3 | J |
| kW | kW | hp | FS | rpm | Nm | | | % | % | % | | A | | | | dB (A) | dB (A) | | kg | kgm ² |
| Rated power at 50 Hz | Rated power at 60 Hz | Rated power at 60 Hz | Frame size | Rated speed at 50 Hz | Rated torque at 50 Hz | Efficiency class according to IEC 60034-30-1 | CC No. CC032A | Efficiency at 50 Hz, 4/4-load | Efficiency at 50 Hz, 3/4-load | Efficiency at 50 Hz, 2/4-load | Power factor at 50 Hz, 4/4-load | Rated current at 400 V, 50 Hz | Locked-rotor torque on direct switch-on as a multiple of the rated torque | Locked-rotor current on direct switch-on as a multiple of the rated current | Breakdown torque on direct switch-on as a multiple of the rated torque | Measuring-surface sound pressure level at 50 Hz | Sound power level at 50 Hz | Article number | Weight for type of construction IM B3, approx. | Moment of inertia |

Legend:

| |
|---|
| Primary key |
| Standard values for all motors |
| Specially for NEMA Energy Efficient MG1 motors, Table 12-11 or NEMA Premium Efficient MG1 motors, Table 12-12 |

Note on pole-changing motors:

The operating values are specified here for the rated power for the two different pole numbers.

| | | | |
|--|---|--|--|
| Step 4 | Detailed selection of the motor in the selection and ordering data tables | | |
| Determination of the basic Article No. of the motor | Determine the motor Article No. according to the following parameters: rated power, rated speed, rated torque and rated current from the "Selection and ordering data" for the motors that have already been identified as possibilities. | | |
| Step 5 | Selection of the special versions or options | | |
| Completing the motor Article No. | Determine special versions and the associated order codes (e.g. special voltages and types of construction, motor protection and degrees of protection, windings and insulation, colors and paint finish, mountings and mounting technology, etc.). | | |
| Step 6 | Additional information for motor selection | | |
| Checking the required dimensions | The dimensions are specified in each catalog section under the heading of "Dimensions". | | |
| Selection of the frequency converter, if required | Article No. of the converter as well as its selection, see Catalogs D 11, D 18.1, D 21.3, D 31.1, D 31.2 and D 31.5. | | |

Introduction

Guide to selecting and ordering the motors

Catalog orientation and drive selection

1

Overview

Steps for drive selection in the catalog

| Step 1 | Step 2 | Step 3 | Step 4 | Step 5 | Step 6 | Catalog section/ page |
|---|--------|--------|--------|--------|--------|--------------------------|
| Introduction | | | | | | 1 |
| SIMOTICS GP and SIMOTICS SD standard motors | | | | | | 2 |
| Orientation | | | | | | 2/2 |
| IE4 Super Premium Efficiency | | | | | | 2/8 |
| • Aluminum series SIMOTICS GP 1LE1004 – self-ventilated or forced-air cooled | | | | | | 2/8 |
| • Cast-iron series SIMOTICS SD 1LE1504 Basic Line – self-ventilated or forced-air cooled | | | | | | 2/9 |
| • Cast-iron series SIMOTICS SD 1LE1604 Performance Line – self-ventilated or forced-air cooled | | | | | | 2/11 |
| IE3 Premium Efficiency | | | | | | 2/13 |
| • Aluminum series SIMOTICS GP 1LE1003 – self-ventilated | | | | | | 2/13 |
| • Aluminum series SIMOTICS GP 1LE1003 with increased power – self-ventilated | | | | | | 2/16 |
| • Aluminum series SIMOTICS GP 1LE1083 – self-ventilated | | | | | | 2/17 |
| • Cast-iron series SIMOTICS SD 1LE1503 Basic Line – self-ventilated or forced-air cooled | | | | | | 2/18 |
| • Cast-iron series SIMOTICS SD 1LE1603 Performance Line – self-ventilated or forced-air cooled | | | | | | 2/21 |
| • Cast-iron series SIMOTICS SD 1LE1503 Basic Line with increased power – self-ventilated | | | | | | 2/25 |
| • Cast-iron series SIMOTICS SD 1LE1603 Performance Line with increased power – self-ventilated | | | | | | 2/26 |
| • Cast-iron series SIMOTICS SD 1LE1583 – self-ventilated | | | | | | 2/27 |
| IE2 High Efficiency | | | | | | 2/30 |
| • Aluminum series SIMOTICS GP 1LE1001 – self-ventilated or forced-air cooled | | | | | | 2/30 |
| • Aluminum series SIMOTICS GP 1LE1001 with increased power – self-ventilated | | | | | | 2/34 |
| • Cast-iron series SIMOTICS SD 1LE1501 Basic Line – self-ventilated or forced-air cooled | | | | | | 2/36 |
| • Cast-iron series SIMOTICS SD 1LE1601 Performance Line – self-ventilated or forced-air cooled | | | | | | 2/40 |
| • Cast-iron series SIMOTICS SD 1LE1501 Basic Line with increased power – self-ventilated | | | | | | 2/44 |
| • Cast-iron series SIMOTICS SD 1LE1601 Performance Line with increased power – self-ventilated | | | | | | 2/46 |
| IE1 Standard Efficiency | | | | | | 2/48 |
| • Aluminum series SIMOTICS GP 1LE1002 – self-ventilated or forced-air cooled | | | | | | 2/48 |
| • Aluminum series SIMOTICS GP 1LE1002 with increased power – self-ventilated | | | | | | 2/51 |
| • Cast-iron series SIMOTICS SD 1LE1502 Basic Line – self-ventilated or forced-air cooled | | | | | | 2/52 |
| • Cast-iron series SIMOTICS SD 1LE1502 Basic Line with increased power – self-ventilated or forced-air cooled | | | | | | 2/56 |
| APAC Line · IE3 Premium Efficiency | | | | | | 2/58 |
| • Aluminum series SIMOTICS GP 1LE1043 – self-ventilated or forced-air cooled | | | | | | 2/58 |
| • Aluminum series SIMOTICS GP 1LE1043 with increased power – self-ventilated or forced-air cooled | | | | | | 2/60 |
| • Cast-iron series SIMOTICS SD 1LE1543 Basic Line – self-ventilated or forced-air cooled | | | | | | 2/61 |
| • Cast-iron series SIMOTICS SD 1LE1643 Performance Line – self-ventilated or forced-air cooled | | | | | | 2/64 |
| • Cast-iron series SIMOTICS SD 1LE1543 Basic Line with increased power – self-ventilated | | | | | | 2/67 |
| • Cast-iron series SIMOTICS SD 1LE1643 Performance Line with increased power – self-ventilated | | | | | | 2/68 |
| APAC Line · IE2 High Efficiency | | | | | | 2/69 |
| • Aluminum series SIMOTICS GP 1LE1041 – self-ventilated or forced-air cooled | | | | | | 2/69 |
| • Aluminum series SIMOTICS GP 1LE1041 with increased power – self-ventilated or forced-air cooled | | | | | | 2/71 |
| • Cast-iron series SIMOTICS SD 1LE1541 Basic Line – self-ventilated or forced-air cooled | | | | | | 2/72 |
| • Cast-iron series SIMOTICS SD 1LE1541 Basic Line with increased power – self-ventilated or forced-air cooled | | | | | | 2/74 |
| ABNT Line · IR3 Rendimento Premium | | | | | | 2/75 |
| • Aluminum series SIMOTICS GP 1LE1073 – self-ventilated or forced-air cooled | | | | | | 2/75 |
| • Cast-iron series SIMOTICS SD 1LE1573, 1LE5773 – self-ventilated or forced-air cooled | | | | | | 2/77 |
| Eagle Line · NEMA Premium Efficient MG1 Table 12-12 | | | | | | 2/79 |
| • Aluminum series SIMOTICS GP 1LE1023 – self-ventilated or forced-air cooled | | | | | | 2/79 |
| • Cast-iron series SIMOTICS SD 1LE1523 Basic Line – self-ventilated or forced-air cooled | | | | | | 2/81 |
| • Cast-iron series SIMOTICS SD 1LE1623 Performance Line – self-ventilated or forced-air cooled | | | | | | 2/84 |
| Eagle Line · NEMA Energy Efficient MG1 Table 12-11 | | | | | | 2/88 |
| • Aluminum series SIMOTICS GP 1LE1021 – self-ventilated or forced-air cooled | | | | | | 2/88 |
| • Cast-iron series SIMOTICS SD 1LE1521 Basic Line – self-ventilated or forced-air cooled | | | | | | 2/89 |
| Pole-changing | | | | | | 2/90 |
| • Aluminum series SIMOTICS GP 1LE1011 for constant load torque – self-ventilated | | | | | | 2/90 |
| • Aluminum series SIMOTICS GP 1LE1011/1LE1012 for square-law load torque – self-ventilated | | | | | | 2/91 |
| Article No. supplements and special versions | | | | | | 2/93 |
| Dimensions | | | | | | 2/141 |
| SIMOTICS SD standard motors next generation | | | | | | 3 |
| Orientation | | | | | | 3/2 |
| IE4 Super Premium Efficiency | | | | | | 3/8 |
| • Cast-iron series SIMOTICS SD 1LE5504 Basic Line – self-ventilated or forced-air cooled | | | | | | 3/8 |
| • Cast-iron series SIMOTICS SD 1LE5604 Performance Line – self-ventilated or forced-air cooled | | | | | | 3/9 |
| • Cast-iron series SIMOTICS SD Add 1LE5534 Basic Line – self-ventilated or forced-air cooled | | | | | | 3/10 |
| • Cast-iron series SIMOTICS SD Add 1LE5634 Performance Line – self-ventilated or forced-air cooled | | | | | | 3/11 |
| • Cast-iron series SIMOTICS SD Add 1LE5534 (frame sizes 400 and 450) – self-ventilated or forced-air cooled | | | | | | 3/12 |
| IE3 Premium Efficiency | | | | | | 3/13 |
| • Cast-iron series SIMOTICS SD 1LE5503 Basic Line – self-ventilated or forced-air cooled | | | | | | 3/13 |
| • Cast-iron series SIMOTICS SD 1LE5603 Performance Line – self-ventilated or forced-air cooled | | | | | | 3/14 |
| • Cast-iron series SIMOTICS SD Add 1LE5533 Basic Line – self-ventilated or forced-air cooled | | | | | | 3/15 |
| • Cast-iron series SIMOTICS SD Add 1LE5633 Performance Line – self-ventilated or forced-air cooled | | | | | | 3/16 |
| • Cast-iron series SIMOTICS SD Add 1LE5533 (frame sizes 400 and 450) – self-ventilated or forced-air cooled | | | | | | 3/17 |
| • Cast-iron series SIMOTICS SD Pro 1LE5583 Basic Line – self-ventilated or forced-air cooled | | | | | | 3/18 |
| • Cast-iron series SIMOTICS SD Pro 1LE5683 Performance Line – self-ventilated or forced-air cooled | | | | | | 3/19 |
| • Cast-iron series SIMOTICS SD Pro 1LE5583 (frame sizes 400 and 450) – self-ventilated or forced-air cooled | | | | | | 3/20 |
| Article No. supplements and special versions | | | | | | 3/21 |
| Dimensions | | | | | | 3/36 |

Overview

| Step 1 | Step 2 | Step 3 | Step 4 | Step 5 | Step 6 | Catalog section/ page |
|---|--------|--------|--------|--------|--------|--------------------------|
| Introduction | | | | | | 1 |
| SIMOTICS VSD motors for converter operation · Introduction | | | | | | 4 |
| Synchronous reluctance motors for SINAMICS converters – VSD4000 line · Orientation | | | | | | 4/4 |
| Super Premium Efficiency | | | | | | 4/46 |
| • Aluminum series SIMOTICS GP 1FP1014, line voltage 400 V, 50 Hz/480 V, 60 Hz/400 V, 87 Hz – self-ventilated, enclosed | | | | | | 4/46 |
| • Cast-iron series SIMOTICS SD 1FP1514, line voltage 400 V, 50 Hz/460 V, 60 Hz/400 V, 87 Hz – self-ventilated, enclosed | | | | | | 4/48 |
| Article No. supplements and special versions | | | | | | 4/52 |
| Dimensions | | | | | | 4/74 |
| Standard induction motors optimized for converter operation – VSD10 line · Orientation | | | | | | 4/82 |
| Standard Efficiency | | | | | | 4/92 |
| • Aluminum series SIMOTICS GP 1LE1092, line voltage 400 V, 50 Hz/460 V, 60 Hz/400 V, 87 Hz – self-ventilated, enclosed | | | | | | 4/92 |
| • Aluminum series SIMOTICS GP 1LE1092, line voltage 500 V, 50 Hz/575 V, 60 Hz/500 V, 87 Hz – self-ventilated, enclosed | | | | | | 4/94 |
| • Aluminum series SIMOTICS GP 1LE1092, line voltage 690 V, 50 Hz/690 V, 87 Hz – self-ventilated, enclosed | | | | | | 4/96 |
| • Cast-iron series SIMOTICS SD 1LE1592, line voltage 400 V, 50 Hz/460 V, 60 Hz/400 V, 87 Hz – self-ventilated, enclosed | | | | | | 4/98 |
| • Cast-iron series SIMOTICS SD 1LE1592, line voltage 500 V, 50 Hz/575 V, 60 Hz/500 V, 87 Hz – self-ventilated, enclosed | | | | | | 4/102 |
| • Cast-iron series SIMOTICS SD 1LE1592, line voltage 690 V, 50 Hz/690 V, 87 Hz – self-ventilated, enclosed | | | | | | 4/106 |
| Article No. supplements and special versions | | | | | | 4/108 |
| Dimensions | | | | | | 4/133 |
| SIMOTICS XP explosion-protected motors | | | | | | 5 |
| Orientation | | | | | | 5/2 |
| Zones 21, 22, and 2 with types of protection Ex tb, Ex tc, Ex ec · IE4 Super Premium Efficiency | | | | | | 5/26 |
| • Cast-iron series 1MB55 – self-ventilated | | | | | | 5/26 |
| Zones 21, 22, and 2 with types of protection Ex tb, Ex tc, Ex ec · IE3 Premium Efficiency | | | | | | 5/27 |
| • Aluminum series 1MB10 – self-ventilated | | | | | | 5/27 |
| • Cast-iron series 1MB15, 1MB16 – self-ventilated | | | | | | 5/28 |
| • Cast-iron series 1MB55, 1MB58 – self-ventilated | | | | | | 5/31 |
| Zones 21, 22, and 2 with types of protection Ex tb, Ex tc, Ex ec · IE2 High Efficiency | | | | | | 5/33 |
| • Aluminum series 1MB10 – self-ventilated | | | | | | 5/33 |
| • Cast-iron series 1MB15, 1MB16 – self-ventilated | | | | | | 5/35 |
| Zones 21, 22, and 2 with types of protection Ex tb, Ex tc, Ex ec · with IE1 Standard Efficiency | | | | | | 5/39 |
| • Aluminum series 1MB10 – self-ventilated | | | | | | 5/39 |
| Zone 1 with type of protection Ex eb · IE3 Premium Efficiency | | | | | | 5/41 |
| • Cast-iron series 1MB1543, 1MB1643, 1MB5543, 1MB5643 – self-ventilated | | | | | | 5/41 |
| Zone 1 with types of protection Ex db, Ex db eb · IE3 Premium Efficiency | | | | | | 5/47 |
| • Cast-iron series 1MB15/1MB55 – self-ventilated | | | | | | 5/47 |
| Article No. supplements and special versions | | | | | | 5/51 |
| Dimensions | | | | | | 5/102 |
| SIMOTICS DP application-specific motors · Introduction | | | | | | 6 |
| SIMOTICS DP application-specific motors – Marine motors · Orientation | | | | | | 6/3 |
| Special designs · Options | | | | | | 6/9 |
| • Aluminum series 1LE10 | | | | | | 6/9 |
| • Cast-iron series 1LE15/1LE16 Basic/Performance Line | | | | | | 6/10 |
| • Cast-iron series 1LE55/1LE56 Basic/Performance Line | | | | | | 6/11 |
| • Aluminum series 1MB10, cast-iron series 1MB15/1MB16/1MB5 | | | | | | 6/12 |

Introduction

Guide to selecting and ordering the motors

Catalog orientation and drive selection

1

Overview

SIMOTICS GP/SD 1LE1 standard motors

| Motor version | Efficiency class | Rated power at 50 Hz (values in kW) or 60 Hz (values in hp) | Frame size – motor type | | | | | | | | | | | | | Page | | | |
|--------------------------------------|------------------------------|---|--------------------------------------|----|----|----|-----|-----|-----|-----|-----|-----|-----|-----|-----|------|-----|-------------------------------|------|
| | | | 63 | 71 | 80 | 90 | 100 | 112 | 132 | 160 | 180 | 200 | 225 | 250 | 280 | | 315 | | |
| SIMOTICS GP aluminum housing | | | | | | | | | | | | | | | | | | | |
| IEC | IE4 Super Premium Efficiency | 2.2 ... 37 kW | | | | | | | | | | | | | | | | 1LE1004 | 2/8 |
| | IE3 Premium Efficiency | 0.37 ... 45 kW | | | | | | | | | | | | | | | | 1LE1003 | 2/13 |
| | | 2.2 ... 37 kW | | | | | | | | | | | | | | | | 1LE1083 | 2/17 |
| | IE2 High Efficiency | 0.12 ... 45 kW | | | | | | | | | | | | | | | | 1LE1001 | 2/30 |
| | IE1 Standard Efficiency | 0.09 ... 37 kW | | | | | | | | | | | | | | | | 1LE1002 | 2/48 |
| APAC Line | IE3 Premium Efficiency | 0.75 ... 45 kW | | | | | | | | | | | | | | | | 1LE1043 | 2/58 |
| | IE2 High Efficiency | 0.75 ... 22 kW | | | | | | | | | | | | | | | | 1LE1041 | 2/69 |
| ABNT Line | IR3 Rendimento Premium | 0.25 ... 22 kW | | | | | | | | | | | | | | | | 1LE1073 | 2/75 |
| Eagle Line | NEMA Premium Efficient | 0.37 ... 37 kW 0.5 ... 50 hp | | | | | | | | | | | | | | | | 1LE1023 | 2/79 |
| | NEMA Energy Efficient | 0.37 ... 0.55 kW 0.5 ... 0.75 hp | | | | | | | | | | | | | | | | 1LE1021 | 2/88 |
| Pole-changing | – For a constant load torque | 0.55 ... 16 kW | | | | | | | | | | | | | | | | 1LE1011 4/2-pole, 8/4-pole | 2/90 |
| | | 0.5 ... 28 kW | | | | | | | | | | | | | | | | 1LE1011 4/2-pole, 8/4-pole | 2/91 |
| | | 0.6 ... 26 kW | | | | | | | | | | | | | | | | 1LE1012 6/4-pole | 2/91 |
| SIMOTICS SD cast-iron housing | | | | | | | | | | | | | | | | | | | |
| IEC | IE4 Super Premium Efficiency | – Basic Line | 2.2 ... 200 kW | | | | | | | | | | | | | | | 1LE1504 | 2/9 |
| | | – Performance Line | 2.2 ... 200 kW | | | | | | | | | | | | | | | 1LE1604 | 2/11 |
| | IE3 Premium Efficiency | – Basic Line | 0.18 ... 200 kW | | | | | | | | | | | | | | | 1LE1503 | 2/18 |
| | | – Performance Line | 1.5 ... 200 kW | | | | | | | | | | | | | | | 1LE1603 | 2/21 |
| | | | 2.2 ... 200 kW | | | | | | | | | | | | | | | 1LE1583 | 2/27 |
| | IE2 High Efficiency | – Basic Line | 0.09 ... 200 kW | | | | | | | | | | | | | | | 1LE1501 | 2/36 |
| | | – Performance Line | 0.75 ... 200 kW | | | | | | | | | | | | | | | 1LE1601 | 2/40 |
| | IE1 Standard Efficiency | – Basic Line | 0.75 ... 200 kW | | | | | | | | | | | | | | | 1LE1502 | 2/52 |
| | | – Performance Line | 0.75 ... 200 kW | | | | | | | | | | | | | | | 1LE1543 | 2/61 |
| APAC Line | IE3 Premium Efficiency | – Basic Line | 0.75 ... 200 kW | | | | | | | | | | | | | | | 1LE1643 | 2/64 |
| | | – Performance Line | 0.75 ... 200 kW | | | | | | | | | | | | | | | 1LE1541 | 2/72 |
| | IE2 High Efficiency | – Basic Line | 15 ... 200 kW | | | | | | | | | | | | | | | 1LE1541 | 2/72 |
| ABNT Line | IR3 Rendimento Premium | – Basic Line | 9.2 ... 300 kW | | | | | | | | | | | | | | | 1LE1573 | 2/74 |
| Eagle Line | NEMA Premium Efficient | – Basic Line | 0.18 ... 185 kW 0.25 ... 250 hp | | | | | | | | | | | | | | | 1LE1523 | 2/81 |
| | | – Performance Line | 2.2 ... 185 kW 3 ... 250 hp | | | | | | | | | | | | | | | 1LE1623 | 2/84 |
| | NEMA Energy Efficient | – Basic Line | 0.09 ... 0.55 kW 0.12 ... 0.75 hp | | | | | | | | | | | | | | | 1LE1521 | 2/89 |

SIMOTICS SD 1LE5 standard motors – next generation

| Motor version | Efficiency class | Rated power at 50 Hz | Frame size – motor type | | | | | | | | | | | | | Page | | | | |
|--|------------------------------|----------------------|-------------------------|----|----|----|-----|-----|-----|-----|-----|-----|-----|-----|-----|------|-----|---------|---------|------|
| | | | 63 | 71 | 80 | 90 | 100 | 112 | 132 | 160 | 180 | 200 | 225 | 250 | 280 | | 315 | 355 | 400 | 450 |
| SIMOTICS SD cast-iron housing | | | | | | | | | | | | | | | | | | | | |
| IEC | IE4 Super Premium Efficiency | – Basic Line | 160 ... 315 kW | | | | | | | | | | | | | | | | 1LE5504 | 3/8 |
| | | – Performance Line | 160 ... 500 kW | | | | | | | | | | | | | | | | 1LE5604 | 3/9 |
| | IE3 Premium Efficiency | – Basic Line | 160 ... 315 kW | | | | | | | | | | | | | | | | 1LE5503 | 3/13 |
| | | – Performance Line | 160 ... 500 kW | | | | | | | | | | | | | | | | 1LE5603 | 3/14 |
| SIMOTICS SD Add cast-iron housing | | | | | | | | | | | | | | | | | | | | |
| IEC | IE4 Super Premium Efficiency | – Basic Line | 160 ... 315 kW | | | | | | | | | | | | | | | | 1LE5534 | 3/10 |
| | | – Performance Line | 160 ... 500 kW | | | | | | | | | | | | | | | | 1LE5634 | 3/11 |
| | | | 355 ... 1000 kW | | | | | | | | | | | | | | | 1LE5534 | 3/12 | |
| | IE3 Premium Efficiency | – Basic Line | 160 ... 315 kW | | | | | | | | | | | | | | | | 1LE5533 | 3/15 |
| | | – Performance Line | 160 ... 500 kW | | | | | | | | | | | | | | | | 1LE5633 | 3/16 |
| | | | 355 ... 1000 kW | | | | | | | | | | | | | | | 1LE5533 | 3/17 | |
| SIMOTICS SD Pro cast iron housing | | | | | | | | | | | | | | | | | | | | |
| IEC | IE3 Premium Efficiency | – Basic Line | 200 ... 315 kW | | | | | | | | | | | | | | | | 1LE5583 | 3/18 |
| | | – Performance Line | 200 ... 500 kW | | | | | | | | | | | | | | | | 1LE5683 | 3/19 |
| | | | 335 ... 980 kW | | | | | | | | | | | | | | | 1LE5583 | 3/20 | |

Overview

SIMOTICS VSD motors for converter operation

SIMOTICS GP/SD VSD4000 line reluctance motors for SINAMICS converters,
SIMOTICS GP/SD VSD10 line standard motors for converter operation

| Motor version | Efficiency class | Rated power | Frame size – motor type | | | | | | | | | | | Page | | |
|--------------------------------------|--------------------------|-----------------|-------------------------|----|----|----|-----|-----|-----|-----|-----|-----|-----|------|-----|------|
| | | | 63 | 71 | 80 | 90 | 100 | 112 | 132 | 160 | 180 | 200 | 225 | | 250 | 280 |
| SIMOTICS GP aluminum housing | | | | | | | | | | | | | | | | |
| VSD4000 line | Super Premium Efficiency | 0.55 ... 30 kW | | | | | | | | | | | | | | 4/46 |
| VSD10 line | Standard Efficiency | 2.2 ... 18.5 kW | | | | | | | | | | | | | | 4/92 |
| SIMOTICS SD cast-iron housing | | | | | | | | | | | | | | | | |
| VSD4000 line | Super Premium Efficiency | 0.55 ... 45 kW | | | | | | | | | | | | | | 4/48 |
| VSD10 line | Standard Efficiency | 2.2 ... 200 kW | | | | | | | | | | | | | | 4/98 |

SIMOTICS XP explosion-protected motors

| Motor version | Efficiency class | Rated power | Frame size – motor type | | | | | | | | | | | | | | Page |
|--|------------------------------|--|-------------------------|----|----|----|-----|-----|-----|-----|-----|-----|-----|-----|-----|---------|------|
| | | | 63 | 71 | 80 | 90 | 100 | 112 | 132 | 160 | 180 | 200 | 225 | 250 | 280 | 315 | |
| Motors for Zones 21, 22, and 2 with types of protection Ex tb, Ex tc, Ex ec - aluminum housing SIMOTICS XP | | | | | | | | | | | | | | | | | |
| IEC | IE3 Premium Efficiency | 0.37 ... 18.5 kW | | | | | | | | | | | | | | | 5/27 |
| | IE2 High Efficiency | 0.37 ... 18.5 kW | | | | | | | | | | | | | | | 5/33 |
| | IE1 Standard Efficiency | 0.75 ... 18.5 kW | | | | | | | | | | | | | | | 5/39 |
| Motors for Zones 21, 22, and 2 with types of protection Ex tb, Ex tc, Ex ec - cast-iron housing SIMOTICS XP | | | | | | | | | | | | | | | | | |
| IEC | IE4 Super Premium Efficiency | 355 ... 1000 kW | | | | | | | | | | | | | | 1MB55.4 | 5/26 |
| | IE3 Premium Efficiency | – Basic Line 0.18 ... 200 kW | | | | | | | | | | | | | | 1MB15.3 | 5/28 |
| | | – Performance Line 1.5 ... 200 kW | | | | | | | | | | | | | | 1MB16.3 | 5/28 |
| | | – Advanced insulation system 355 ... 1000 kW | | | | | | | | | | | | | | 1MB55.3 | 5/31 |
| | | – Premium insulation system 335 ... 980 kW | | | | | | | | | | | | | | 1MB58.3 | 5/31 |
| | IE2 High Efficiency | – Basic Line 0.09 ... 200 kW | | | | | | | | | | | | | | 1MB15.1 | 5/35 |
| | | – Performance Line 0.75 ... 200 kW | | | | | | | | | | | | | | 1MB16.1 | 5/35 |
| Motors for Zone 1 with type of protection Ex eb - cast-iron housing SIMOTICS XP | | | | | | | | | | | | | | | | | |
| IEC | IE3 Premium Efficiency | – Basic Line 0.25 ... 80 kW | | | | | | | | | | | | | | 1MB1543 | 5/41 |
| | | – Performance Line 1.3 ... 80 kW | | | | | | | | | | | | | | 1MB1643 | 5/41 |
| | | – Basic Line 64 ... 165 kW | | | | | | | | | | | | | | 1MB5543 | 5/41 |
| | | – Performance Line 64 ... 165 kW | | | | | | | | | | | | | | 1MB5643 | 5/41 |
| Motors for Zone 1 with types of protection Ex db, Ex db eb - cast-iron housing SIMOTICS XP | | | | | | | | | | | | | | | | | |
| IEC | IE3 Premium Efficiency | 0.09 ... 90 kW | | | | | | | | | | | | | | 1MB1553 | 5/47 |
| | | 55 ... 460 kW | | | | | | | | | | | | | | 1MB5553 | 5/47 |

Introduction

Guide to selecting and ordering the motors

Catalog orientation and drive selection

1

Overview

SIMOTICS DP application-specific motors

| Motor version | Efficiency class | Rated power at 50 Hz (values in kW) or 60 Hz (values in hp) | Frame size – motor type | | | | | | | | | | | | | Page | | |
|--|------------------------------|---|--------------------------------------|----|----|----|-----|-----|-----|-----|-----|-----|-----|-----|-----|------|------|------|
| | | | 63 | 71 | 80 | 90 | 100 | 112 | 132 | 160 | 180 | 200 | 225 | 250 | 280 | | 315 | 355 |
| Marine motors – aluminum housing | | | | | | | | | | | | | | | | | | |
| IEC | IE4 Super Premium Efficiency | 2.2 ... 37 kW | | | | | | | | | | | | | | | 6/9 | |
| | IE3 Premium Efficiency | 0.37 ... 45 kW | | | | | | | | | | | | | | | 6/9 | |
| | IE2 High Efficiency | 0.12 ... 45 kW | | | | | | | | | | | | | | | 6/9 | |
| | IE1 Standard Efficiency | 0.09 ... 37 kW | | | | | | | | | | | | | | | 6/9 | |
| IEC – with explosion protection | IE3 Premium Efficiency | 0.37 ... 18.5 kW | | | | | | | | | | | | | | | 6/12 | |
| | IE2 High Efficiency | 0.37 ... 18.5 kW | | | | | | | | | | | | | | | 6/12 | |
| | IE1 Standard Efficiency | 0.75 ... 18.5 kW | | | | | | | | | | | | | | | 6/12 | |
| Eagle Line | NEMA Premium Efficient | 0.37 ... 37 kW 0.5 ... 50 hp | | | | | | | | | | | | | | | 6/9 | |
| | NEMA Energy Efficient | 0.37 ... 0.55 kW 0.5 ... 0.75 hp | | | | | | | | | | | | | | | 6/9 | |
| Pole-changing | – | 0.5 ... 28 kW | | | | | | | | | | | | | | | 6/9 | |
| | – | 0.6 ... 26 kW | | | | | | | | | | | | | | | 6/9 | |
| Marine motors – cast-iron housing | | | | | | | | | | | | | | | | | | |
| IEC | IE4 Super Premium Efficiency | – Basic Line | 2.2 ... 200 kW | | | | | | | | | | | | | | 6/10 | |
| | | | 160 ... 315 kW | | | | | | | | | | | | | | 6/11 | |
| | – Performance Line | 2.2 ... 200 kW | | | | | | | | | | | | | | | 6/10 | |
| | | 160 ... 500 kW | | | | | | | | | | | | | | | 6/11 | |
| IE3 Premium Efficiency | – Basic Line | 0.18 ... 200 kW | | | | | | | | | | | | | | | 6/10 | |
| | | 160 ... 315 kW | | | | | | | | | | | | | | | 6/11 | |
| | – Performance Line | 1.5 ... 200 kW | | | | | | | | | | | | | | | 6/10 | |
| | | 160 ... 500 kW | | | | | | | | | | | | | | | 6/11 | |
| IE2 High Efficiency | – Basic Line | 0.09 ... 200 kW | | | | | | | | | | | | | | | 6/10 | |
| | – Performance Line | 0.75 ... 200 kW | | | | | | | | | | | | | | | 6/10 | |
| IEC – with explosion protection | IE3 Premium Efficiency | – Basic Line | 0.18 ... 200 kW | | | | | | | | | | | | | | 6/12 | |
| | | – Performance Line | 1.5 ... 200 kW | | | | | | | | | | | | | | 6/12 | |
| | | | 0.09 ... 90 kW | | | | | | | | | | | | | | 6/12 | |
| | | 55 ... 460 kW | | | | | | | | | | | | | | 6/12 | | |
| | IE2 High Efficiency | – Basic Line | 0.09 ... 200 kW | | | | | | | | | | | | | | | 6/12 |
| | | – Performance Line | 0.75 ... 200 kW | | | | | | | | | | | | | | | 6/12 |
| Eagle Line | NEMA Premium Efficient | – Basic Line | 0.18 ... 185 kW 0.25 ... 250 hp | | | | | | | | | | | | | | 6/10 | |
| | | – Performance Line | 2.2 ... 185 kW 3 ... 250 hp | | | | | | | | | | | | | | 6/10 | |
| | NEMA Energy Efficient | – Basic Line | 0.09 ... 0.55 kW 0.12 ... 0.75 hp | | | | | | | | | | | | | | 6/10 | |

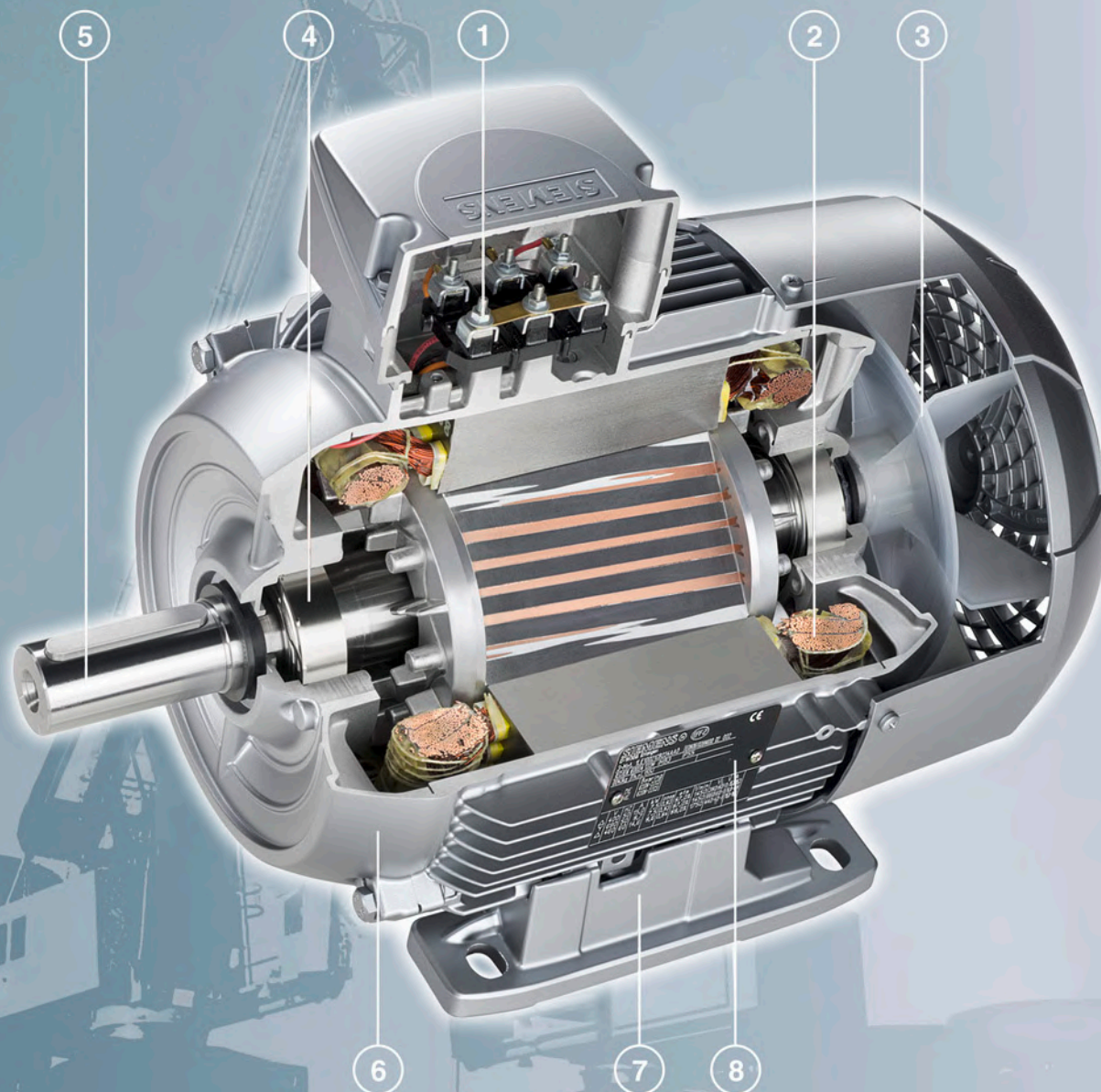
Overview

- ① Motor protection page 1/32
 Motor connection and terminal box page 1/35
 Voltages, currents and frequencies page 1/23
- ② Windings and insulation page 1/27
 Coolant temperature and installation altitude page 1/29
- ③ Heating and ventilation page 1/30
 Mechanical version page 1/45
 Degrees of protection page 1/44
 Modular technology page 1/77
 Special technology page 1/95

- ④ Bearings and lubrication page 1/52
- ⑤ Shaft and rotor page 1/48
 Balance and vibration severity page 1/50
- ⑥ Colors and paint finish page 1/14
- ⑦ Types of construction page 1/45
- ⑧ Rating plate and additional rating plates page 1/24

Introduction

General information

Colors and paint finish

Overview

To protect the drives against corrosion and external influences, high-quality paint systems are available in various colors.

| Standard version ⁸⁾ | Additional identification code -Z with order code | | | | | | |
|--|---|--|---|---|--|---|---|
| | S00 ⁹⁾ | S01 ⁸⁾ | S02 | S03 ^{8) 10)} | S04 ⁸⁾ | S05 | S06 ^{8) 10) 11)} |
| Paint finish, suitability of paint finish for climate group in accordance with IEC 60721-2-1 | | | | | | | |
| Standard paint finish C2 | Unpainted, but unfinished cast-iron surfaces are primed | Unpainted, motor primed | Special paint finish C3 | Special paint finish system "sea air resistant" C4 | Special paint finish system "offshore" C5 | Interior paint finish, all bare internal components primed with rust inhibitor ¹⁾ | Polyurethane-based top coat, can only be ordered with S03 or S04 |
| Use | | | | | | | |
| Moderate (extended) for indoor and outdoor installation under a roof not directly exposed to weather conditions. | The motors can be supplied unpainted on request. | The motors can be supplied with just a primer coat on request. | Worldwide (global) for outdoor installation in direct sunlight and/or exposed to weather conditions. | Recommended for indoor or outdoor installation directly exposed to weather conditions, industrial climate with moderate SO ₂ exposure, VIK requirements, inshore maritime climate, but not offshore maritime climate, e.g. for crane drives and in the paper industry. | Recommended for outdoor installations exposed to direct weather conditions, industrial climate with moderate SO ₂ exposure, and offshore maritime climate, e.g. for crane drives. | The motors can be supplied with internal paint finish on request. Recommended when there is a risk of heavy condensate formation. | Exposure to direct sunlight (UV light) may cause a change in color. When color stability is a requirement, a polyurethane-based paint system is recommended for the top coat (RAL 7030). Colors other than RAL 7030 are available on request. |
| Test requirements according to EN ISO 12944-2 Corrosivity Category | | | | | | | |
| C2 | – | – | C3 | C4 | C5 | – | – |
| Total film thickness – nominal film thickness in µm ^{2) 3)} | | | | | | | |
| Motors in aluminum version | | | | | | | |
| 2-comp. epoxy resin 30 ^{4) 5)} | – | 30 | 60 | 120 | – | – | – |
| Polyurethane/S06 | – | – | – | 120 | – | – | Film thickness similar to S03/S04 |
| Motors in cast-iron version | | | | | | | |
| 2-comp. epoxy resin 60 | 30 | 60 | 90 | 150 | 170 ⁶⁾ | – | – |
| Polyurethane/S06 | – | – | – | 150 | 170 ⁶⁾ | – | Film thickness similar to S03/S04 |
| Motors in cast-iron version 1LE5, 1MB5 (only valid for frame sizes 400 and 450) | | | | | | | |
| Water-based 2-comp. polyurethane | Synth. resin | Water-based 2-comp. polyurethane primer | Water-based 2-comp. polyurethane | Water-based 2-comp. polyurethane | Water-based 2-comp. polyurethane | 2-comp. epoxy resin/ 2-comp. polyurethane primer | Water-based 2-comp. polyurethane |
| 120 | 60 | 120 | 180 | 240 | 320 | 60 | Film thickness similar to S03/S04 |
| Resistance | | | | | | | |
| | | | For corrosive atmospheres up to 1 % acid and alkali concentration or permanent dampness in sheltered rooms. | Chemical exposure up to 5 % acid and alkali concentration. | Chemical exposure up to 5 % acid and alkali concentration. | | Sunlight |
| Temperature range | | | | | | | |
| Up to 120 °C for brief periods | – | – | Up to 140 °C for brief periods | –40 ... 140 °C | –40 ... 140 °C | | |
| Up to 100 °C continuously | | | Up to 120 °C continuously | | | | |
| Rel. air humidity at (temperature) | | | | | | | |
| 60 % (40 °C) | – | – | 100 % (40 °C) | 75 % (50 °C) | 75 % (60 °C) | | |

Table continues on the next page.

Overview

| Standard version ⁸⁾ | Additional identification code -Z with order code | | | | | | |
|--|--|--------------------------|------------|---|--------------------------|------------|--|
| | S00 ⁹⁾ | S01 ⁸⁾ | S02 | S03 ⁸⁾ ¹⁰⁾ | S04 ⁸⁾ | S05 | S06 ⁸⁾ ¹⁰⁾ ¹¹⁾ |
| Suitability for recoating ⁷⁾ | Can be recoated within 1 week | | | | | | |
| Pre-treatment of parts | All parts cleaned and degreased, steel and cast-iron parts sandblasted | | | | | | |
| Drying | All layers oven-dried | | | | | | |
| Top coat colors | RAL 7030 (stone gray) | | | | | | |
| Standard version | RAL 7030 (stone gray) | | | | | | |
| Available colors | Alternative standard and special RAL colors must be ordered with order code Y53 or Y56 and specification in plain text of the required RAL number (see tables for order codes Y53 and Y56 on the following page for selection of available RAL numbers/RAL colors). S06 is available only in standard RAL 7030 | | | | | | |
| Treatment of bare metal areas of shaft extensions and flanges | Coated with anti-corrosion agent that repels water and palm sweat | | | | | | |

Note:

For transport, the bare parts are coated with anti-corrosion paint which will last for a limited amount of time.

- 1) Machined laminated rotor core, shaft, inner diameter of cast-iron housing, interior surfaces of cast-iron bearing plates.
- 2) Total film thickness:
 - The specified film thickness represents average values for the external motor surfaces
 - Unpainted or one layer of paint (30 µm) less beneath the fan cover
 - The film thickness may differ at inaccessible locations (pockets/recesses or bases of ribs)

The film thickness specified for aluminum/cast-iron versions refers not only to motors, but also to components such as the bearing plate and housing. Motors are also available in an aluminum/cast-iron composite design.
- 3) The paint coat can become electrostatically charged where there is a thick film. Electrostatic discharges can occur. There is a risk of explosion if potentially explosive mixtures are also present at this moment. This can result in death, serious injury or material damage. When painted surfaces are recoated, one of the following conditions must be fulfilled:
 - Limit the total paint film thickness according to the explosion protection group:
 - IIA, IIB: Total paint film thickness ≤ 2 mm
 - IIC: Total paint film thickness ≤ 0.2 mm for motors of group II (gas)
 - Limit the surface resistance of the paint used:
 - Surface resistance ≤ 1 GΩ for motors of groups II and III (gas and dust)
 - Charge transfer limit:
 - 60 nC for Group I or Group IIA devices
 - 25 nC for Group IIB devices
 - 10 nC for Group IIC devices
 - 200 nC for Group III devices
 - Breakdown voltage ≤ 4 kV for explosion group III (dust only)

Note:
Paints for IIC with film thickness exceeding 200 µm are optionally available. Paints with film thickness exceeding 200 µm have been tested for electrostatic charging. Motors with a coating thickness exceeding 200 µm may only be painted over if the conditions mentioned above are complied with.
- 4) Aluminum motors/components without a paint finish already meet the requirements for corrosivity class C2. It is not therefore necessary to apply paint to components that are not visible. The paint finish is therefore applied only for the purpose of coloring.
- 5) Aluminum motors with cast-iron components (e.g. DE bearing plate) have a primer coat of > 30 µm on cast-iron components.
- 6) 50 µm zinc galvanized layer + 120 µm paint film thickness.
- 7) Primers, water-based 2-K epoxy resin paints and polyurethane-based paints can be overpainted with paints of the same kind if the motors are in the original packaging and are still covered by the warranty. A suitability test should be conducted before any recoating work is undertaken if the customer intends to use a coating of a different kind to overpaint the motor. Alternatively, a test in accordance with EN ISO 16927 "Determination of the overcoatability and recoatability of a coating" can be requested and ordered.
- 8) For SIMOTICS XP cast-iron motors that are suitable for operation in dust hazardous areas, some color restrictions apply to conductive paints.
- 9) Not permitted for SIMOTICS XP cast-iron motors that are suitable for operation in dust hazardous areas.
- 10) For SIMOTICS XP aluminum motors that are suitable for operation in dust hazardous areas, some color restrictions apply to conductive paints.
- 11) For SIMOTICS XP cast-iron motors that are suitable for operation in gas hazardous areas, some color restrictions apply to conductive paints.

Introduction

General information

Colors and paint finish

1

Overview

Paint finish in other standard RAL colors –

Order code Y53

(RAL number is required in plain text)

| RAL No. | Color name | RAL No. | Color name |
|---------|------------------|---------|-----------------|
| 3007 | Black red | 7 000 | Squirrel gray |
| 5002 | Ultramarine blue | 7001 | Silver gray |
| 5007 | Brilliant blue | 7004 | Signal gray |
| 5009 | Azure blue | 7011 | Iron gray |
| 5010 | Gentian blue | 7016 | Anthracite gray |
| 5015 | Sky blue | 7022 | Umbra gray |
| 5017 | Traffic blue | 7031 | Blue gray |
| 5018 | Turquoise blue | 7032 | Pebble gray |
| 5019 | Capri blue | 7033 | Cement gray |
| 6011 | Reseda green | 7035 | Light gray |
| 6021 | Pale green | 9005 | Jet black |

The following paints must be applied at least twice owing to their poor opacity. The standard paint finish for these colors is not possible and must be ordered with **S02**, **S03**, or **S04**.

| RAL No. | Color name |
|---------|---------------|
| 1002 | Sand yellow |
| 1013 | Oyster white |
| 1015 | Light ivory |
| 1019 | Gray beige |
| 2003 | Pastel orange |
| 2004 | Pure orange |
| 3000 | Flame red |
| 5012 | Light blue |
| 6019 | Pastel green |
| 9001 | Cream white |
| 9002 | Gray white |

The following colors are not permitted in combination with conductive paints that are suitable for hazardous areas.

| RAL No. | Color name | RAL No. | Color name |
|---------|-------------------|---------|----------------|
| 1003 | Signal yellow | 2009 | Traffic orange |
| 1018 | Zinc yellow | 3002 | Carmine red |
| 1021 | Rape yellow | 3015 | Light pink |
| 1023 | Traffic yellow | 3020 | Traffic red |
| 1028 | Melon yellow | 6018 | Yellow green |
| 1033 | Dahlia yellow | 9003 | Signal white |
| 2003 | Pastel orange | 9010 | Pure white |
| 2004 | Pure orange | 9016 | Traffic white |
| 2008 | Bright red orange | | |

Paint finish in special RAL colors –

Order code Y56

(RAL number is required in plain text)

| RAL No. | Color name | RAL No. | Color name |
|---------|-----------------|---------|------------------|
| 3004 | Purple red | 6034 | Pastel turquoise |
| 3011 | Brown red | 7005 | Mouse gray |
| 3015 | Light pink | 7009 | Green gray |
| 3020 | Traffic red | 7012 | Basalt gray |
| 4005 | Blue lilac | 7015 | Slate gray |
| 5000 | Violet blue | 7023 | Concrete gray |
| 5001 | Green blue | 7036 | Platinum gray |
| 5003 | Sapphire blue | 7037 | Dusty gray |
| 5005 | Signal blue | 7038 | Agate gray |
| 5011 | Steel blue | 7039 | Quartz gray |
| 5013 | Cobalt blue | 7040 | Window gray |
| 5014 | Pigeon blue | 7042 | Traffic gray A |
| 5020 | Ocean blue | 7044 | Silk gray |
| 5021 | Water blue | 7045 | Telegray 1 |
| 5022 | Night blue | 7046 | Telegray 2 |
| 5023 | Distant blue | 7047 | Telegray 4 |
| 6000 | Patina green | 8012 | Red brown |
| 6001 | Emerald green | 8025 | Pale brown |
| 6002 | Leaf green | 8028 | Terra brown |
| 6005 | Moss green | 9003 | Signal white |
| 6009 | Fir green | 9004 | Signal black |
| 6010 | Grass green | 9006 | White aluminum |
| 6016 | Turquoise green | 9007 | Gray aluminum |
| 6017 | May green | 9010 | Pure white |
| 6018 | Yellow green | 9011 | Graphite black |
| 6024 | Traffic green | 9016 | Traffic white |
| 6026 | Opal green | 9017 | Traffic black |
| 6029 | Mint green | 9018 | Papyrus white |
| 6032 | Signal green | | |

The following paints must be applied at least twice owing to their poor opacity. The standard paint finish for these colors is not possible and must be ordered with **S02**, **S03**, or **S04**.

| RAL No. | Color name |
|---------|-------------------|
| 1003 | Signal yellow |
| 1004 | Golden yellow |
| 1006 | Maize yellow |
| 1007 | Daffodil yellow |
| 1012 | Lemon yellow |
| 1014 | Ivory |
| 1018 | Zinc yellow |
| 1021 | Rape yellow |
| 1023 | Traffic yellow |
| 1028 | Melon yellow |
| 1032 | Broom yellow |
| 1033 | Dahlia yellow |
| 2008 | Bright red orange |
| 2009 | Traffic orange |
| 2010 | Signal orange |
| 3002 | Carmine red |
| 5024 | Pastel blue |
| 6027 | Light green |

Coating structure and colors not specified in the catalog are available on request.

Overview

Connected in star for dispatch – Order code M01

The terminal board of the motor is connected in star for dispatch.

Connected in delta for dispatch – Order code M02

The terminal board of the motor is connected in delta for dispatch.

Packing weights

| For motors Frame size | Type 1LE1...- 1PC1...- 1MB1...- | For land transport | | | Types of construction IM B5, IM V1 | | | | |
|--------------------------|---|----------------------------|---|----------------------|------------------------------------|-------------|---|----------------------|---------------|
| | | Type of construction IM B3 | | | in | in | on ISPM wooden | on | in |
| | | in box Tare | on ISPM wooden base board with telescopic box Tare | on pallet Tare | crate Tare | box Tare | on ISPM wooden base board with telescopic box Tare | on pallet Tare | crate Tare |
| | | kg | kg | kg | kg | kg | kg | kg | kg |
| 63 M | 0B.2 | 0.65 | – | – | – | 0.65 | – | – | – |
| 71 M | 0C.2 | 0.65 | – | – | – | 0.65 | – | – | – |
| 80 M | 0D.2 | 0.65 | – | – | – | 0.65 | – | – | – |
| 90 S | 0E.0 | 0.65 | – | – | – | 0.65 | – | – | – |
| 100 L | 1A.4 | – | 5.0 | – | – | – | 5.0 | – | – |
| | 1A.5 | – | 5.0 | – | – | – | 5.0 | – | – |
| | 1A.6 | – | 5.0 | – | – | – | 5.0 | – | – |
| 112 M | 1B.2 | – | 5.0 | – | – | – | 5.0 | – | – |
| | 1B.6 | – | 5.0 | – | – | – | 5.0 | – | – |
| 132 S | 1C.0 | 4.7 | – | – | – | 5.2 | – | – | – |
| | 1C.1 | 4.7 | – | – | – | 5.2 | – | – | – |
| 132 M | 1C.2 | 4.7 | – | – | – | 5.2 | – | – | – |
| | 1C.3 | 4.7 | – | – | – | 5.2 | – | – | – |
| | 1C.6 | 8.7 | – | – | – | 9.2 | – | – | – |
| 160 M | 1D.2 | 4.8 | – | – | – | 5.7 | – | – | – |
| | 1D.3 | 4.8 | – | – | – | 5.7 | – | – | – |
| 160 L | 1D.4 | 4.8 | – | – | – | 5.7 | – | – | – |
| | 1D.6 | 8.8 | – | – | – | 9.7 | – | – | – |
| 180 | | – | – | 8.0 | – | – | – | 10.0 | – |
| 200 | | – | – | 11.0 | – | – | – | 13.0 | – |
| 225 | | – | – | 14.0 | – | – | – | 17.0 | – |
| 250 | | – | – | 22.0 | – | – | – | 25.0 | – |
| 280 | | – | – | 24.0 | – | – | – | 27.0 | – |
| 315 | | – | – | 28.0 | – | – | – | 32.0 | – |
| 315 | 1LE5, 1MB5 | – | – | 32.0 | – | – | – | 46.0 | – |
| 355 | 1LE5, 1MB5 | – | – | 58.0 | – | – | – | 78.0 | – |
| 315 | 1LE5, 1MB5 | – | – | 50.0 | – | – | – | 40.0 | – |
| 355 | 1LE5, 1MB5 | – | – | 60.0 | – | – | – | 50.0 | – |

Data apply for individual packaging. Wire-lattice pallets can be used, order code **B99**.

Safety notes

Printed safety notes in German/English and safety notes in the language of the country of use are supplied as standard with each motor

Operating instructions

Operating instructions for all official EU languages as well as Norwegian, Russian, Turkish, and Chinese are provided in PDF format only at

<https://support.automation.siemens.com/WWW/view/en/10803948/13330>

Test certificates

Inspection certificate 3.1 in accordance with **EN 10204** – Order code **B02**

An inspection certificate 3.1 in accordance with EN 10204 can be supplied for most motors.

Type test with temperature-rise run for horizontal motors

- **With acceptance** – Order code **B83**
- **Without acceptance** – Order code **B82**

During the type test, a temperature-rise test is performed; no-load, short-circuit, and load characteristics are recorded; the iron losses and friction losses are determined and the efficiency is calculated from the summed losses. This option is only applicable to motors with a horizontal type of construction. Acceptance testing is performed by an external representative (e.g. customer, classification society). No acceptance test is performed when order code **B82** is stated.

Introduction

General information

Period of liability for defects

1

Overview

Standard warranty and extension of liability for defects

The standard warranty period is quoted in the standard conditions of supply and delivery and is 12 months.

This is valid if nothing else is stated. It is possible to obtain an extension of the liability for defects beyond the standard liability period.

| Motors | Series | Standard warranty | Extension of the liability for defects |
|---------------------|---|-------------------|---|
| SIMOTICS GP | 1LE10 | 12 months | Not available |
| SIMOTICS SD | 1LE15 / 1LE55 Basic Line | 12 months | 1LE1 see page 2/131 1LE5 see page 3/32 |
| SIMOTICS SD | 1LE16 / 1LE56 Performance Line | 36 months | 1LE1 not available 1LE5 see page 3/32 |
| SIMOTICS GP VSD4000 | 1FP10 | 36 months | Not available |
| SIMOTICS SD VSD4000 | 1FP15 | 36 months | Not available |
| SIMOTICS GP VSD10 | 1LE109 | 12 months | Not available |
| SIMOTICS SD VSD10 | 1LE159 | 12 months | see page 4/129 |
| SIMOTICS XP | 1MB10 | 12 months | Not available |
| SIMOTICS XP | 1MB151 / 1MB551 / 1MB581 Basic Line (Ex tb), 1MB152 / 1MB552 / 1MB582 Basic Line (Ex tc), 1MB153 / 1MB553 / 1MB583 Basic Line (Ex ec) | 12 months | 1MB1 not available 1MB5 see page 5/99 |
| SIMOTICS XP | 1MB161 / 1MB561 Performance Line (Ex tb), 1MB162 / 1MB562 Performance Line (Ex tc), 1MB163 / 1MB563 Performance Line (Ex ec) | 36 months | 1MB1 not available 1MB5 see page 5/99 |
| SIMOTICS XP | 1MB154 / 1MB554 Basic Line (Ex eb) | 12 months | see page 5/89 |
| SIMOTICS XP | 1MB164 / 1MB564 Performance Line (Ex eb) | 36 months | Not available |
| SIMOTICS XP | 1MB155 / 1MB555 (Ex db, Ex db eb) | 12 months | see page 5/94 |

For the case of a new product order

With the following optional order suffixes listed in the table, extension of the liability for defects beyond the standard liability period is possible in conjunction with a new order for a product.

The markup on the product price is graded according to the duration of the extension.

| Extension of the liability for defects for 1LE15, 1MB15, 1LE5, and 1MB5 motors | |
|--|--|
| Additional identification code -Z with order code | Description |
| Q80 | Extension of the liability for defects period by 12 months to a total of 24 months (2 years) from delivery |
| Q81 | Extension of the liability for defects period by 18 months to a total of 30 months (2.5 years) from delivery |
| Q82 | Extension of the liability for defects period by 24 months to a total of 36 months (3 years) from delivery |
| Q83 | Extension of the liability for defects period by 30 months to a total of 42 months (3.5 years) from delivery |
| Q84 | Extension of the liability for defects period by 36 months to a total of 48 months (4 years) from delivery |
| Q85 | Extension of the liability for defects period by 48 months to a total of 60 months (5 years) from delivery |

Overview

Applicable standards and specifications

The 1LE motors comply with the IEC 60034 series of international product standards for rotating electrical machines and, in particular, those parts that are listed in the table below.

| Title | IEC/EN | DIN EN |
|--|---|--|
| General specifications for rotating electrical machines | IEC 60034-1, IEC 60085 | EN 60034-1 |
| Specification of the losses and efficiency of rotating electrical machines | IEC 60034-2-1 | EN 60034-2-1 |
| General-purpose three-phase induction motors having standard dimensions and powers | IEC 60072 Mounting dimensions and power series only (no assignment of frame size to power) | EN 50347 Mounting dimensions according to IEC 60072 and power assignment for Europe |
| Starting performance of rotating electrical machines | IEC 60034-12 | EN 60034-12 |
| Terminal designations and direction of rotation for electrical machines | IEC 60034-8 | EN 60034-8 |
| Designation for types of construction, mounting, and terminal box position (IM code) | IEC 60034-7 | EN 60034-7 |
| Terminal box cable entries | – | DIN 42925 |
| Built-in thermal protection | IEC 60034-11 | EN 60034-11 |
| Noise limits of rotating electrical machines | IEC 60034-9 | EN 60034-9 |
| IEC standard voltages | IEC 60038 | IEC 60038 |
| Cooling methods of rotating electrical machines (IC code) | IEC 60034-6 | EN 60034-6 |
| Vibration severity of rotating electrical machines | IEC 60034-14 | EN 60034-14 |
| Vibration limits | – | ISO 10816 |
| Degrees of protection for rotating electrical machines (IP code) | IEC 60034-5 | EN 60034-5 |
| International efficiency classes for rotating electrical machines (IE code) | IEC 60034-30-1 | EN 60034-30 |
| In addition, the following applies to Ex motors: | | |
| General provisions | IEC/EN 60079-0 | EN 60079-0 |
| Flameproof enclosure "d" | IEC/EN 60079-1 | EN 60079-1 |
| Increased safety "e" | IEC/EN 60079-7 | EN 60079-7 |
| Type of protection "n" (non-sparking) | IEC/EN 60079-15 | EN 60079-15 |
| Areas containing flammable dust | IEC/EN 60079-31 | EN 60079-31 |

The following applies to explosion-protected motors:

Since the requirements of explosion-protected motors comply with the European standards EN 60079-0, EN 60079-1, EN 60079-7, EN 60079-15, EN 60079-31 and Directive 2014/34/EU (ATEX 95), the certificates issued by authorized testing agencies (PTB, FTZU, etc.) are accepted by all member states of the EU. The remaining members of CENELEC, Switzerland in particular, also accept the certificates.

Tolerances for electrical data

According to EN 60034, the following tolerances are permitted: Motors that comply with EN 60034-1 must have a voltage tolerance according to Area A (see diagram on page 1/23). If this is fully utilized, the admissible limit temperature of the temperature class may be exceeded by 10 K.

Efficiency η at

$$P_{\text{rated}} \leq 150 \text{ kW: } -0.15 \cdot (1 - \eta)$$

$$P_{\text{rated}} > 150 \text{ kW: } -0.1 \cdot (1 - \eta)$$

Where η is a decimal number.

$$\text{Power factor} = \frac{1 - \cos \phi}{6}$$

- Minimum absolute value: 0.02
- Maximum absolute value: 0.07

Slip $\pm 20\%$ (for motors $< 1 \text{ kW}$ $\pm 30\%$ is admissible)

Locked-rotor current $+20\%$

Locked-rotor torque -15% to $+25\%$

Breakdown torque -10%

Moment of inertia $\pm 10\%$

For more details, see section "Voltages, currents and frequencies" on page 1/23.

Certifications

Product certifications are differentiated in terms of safety-related certificates and efficiency certificates.

Since 2011, it has been obligatory for low-voltage motors with power ratings in the range of 0.75 to 375 kW (2-, 4-, and 6-pole) to be classified in accordance with the IEC 60034-30-1 efficiency standard and to be marked with the corresponding IE code (International Efficiency IE1, IE2, or IE3). The efficiency is determined using the summed losses method in accordance with IEC 60034-2-1.

Introduction

General information

Versions in accordance with standards and specifications

Overview

Energy-saving motors for the European Economic Area in accordance with EU Regulation 640/2009 – valid until June 30, 2021 (from July 1, 2021, EU Regulation 2019/1781 comes into force)

Since January 2017, all low-voltage motors that fall within the scope of the EU Regulation must fulfill the specifications of international efficiency class IE3.

- Line voltage ≤ 1000 V
- Line frequency 50 or 50/60 Hz
- Power range 0.75 to 375 kW
- Pole number 2-, 4- and 6-pole
- Continuous duty S1

IE2 motors are only admissible if they are speed-controlled via converters.

Energy-saving motors for the North-American economic area in accordance with EISA

In accordance with EISA, modified conditions have been in effect since June 1, 2016.

This law stipulates that all motors must comply with the requirements stated in NEMA MG1 Table 12-12 (NPE = Nema Premium Efficient).

From this date onwards, therefore, motors previously covered by the EPAAct must also comply with NPE. The NPE requirements apply to motors with the following characteristics / operating conditions:

- Line voltage ≤ 600 V
- Line frequency 60 Hz
- Power range 1 hp to 500 hp
- Number of poles: 2-, 4-, 6-, 8-pole motors and geared motors
- Continuous duty S1

Explosion-protected motors are also included.

Exclusions from the EISA efficiency requirements:

- Brake motors
- Converter motors

Note:

Option **D30**: el. acc. to NEMA

Option **D31**: UL version

These options can be ordered for motors that are not subject to the EISA specifications (e.g. for use outside North America).

Options **D30** and **D31** do not authorize operation within North America.



The logo NEMA Premium is a registered trademark. It is only permitted to be used by companies that voluntarily submit to the control of the NEMA organization.

Approval for the USA: UL safety and DoE listing

For the USA, the motor series **1LE1.21** (NEE) and **1LE1.23** (NPE) are listed at the Department of Energy (DoE) and marked with the certification number **CC032A**.

Additional specifications to NEMA MG1: Nominal efficiency acc. to NEMA MG1 Table 12-11 or Table 12-12, design letter, code letter, CONT, CC No. CC 032A (Siemens) and service factor SF 1.15.

Motor series 1LE1.21 and 1LE1.23 remain certified up to a rated voltage of 600 V from Underwriters Laboratories Inc. and are marked accordingly ("Recognition Mark" = R/C).



UL approval does not apply to motors for Zones 1, 2, 21, 22 or marine motors.

Approval for Canada: CSA safety and CSA Energy Efficiency Verification

In April 2012, the EISA requirements were implemented in Canada; in this case, all powers are subject to certification without the restrictions applicable to the NEMA frame sizes. Motor series 1LE1.21 and 1LE1.23 are certified for Canada through the Canadian Standard Association (CSA), listed by the Office of Energy Efficiency (OEE) and marked with both the CSA safety logo and the CSA efficiency label. These motors comply with the efficiency requirements of the new CSA standard C390-10. The efficiency is determined in the same manner as with IEC 60034-2-1.



Externally or internally mounted components which are used are listed by CSA or are used by manufacturers in accordance with regulations. Suitability in the final application must be verified. Approval does not apply to 1MB1 motors for Zones 1, 2, 21 and 22 or marine motors.

Approval for Mexico:

The EISA regulations are applicable for Mexico.

Korea certification – Order code **D33**

Minimum efficiencies required by law

According to a legislative amendment with reference to the MKE-2015-28 (Ministry of Knowledge Economy Korea) dated February 12, 2015, Minimum Efficiency IE3 became obligatory in Korea on the following dates:

- October 1, 2015 for motors ranging from 37 to 200 kW
- October 1, 2016 for motors ranging from 200 to 375 kW
- October 1, 2018 for motors ranging from 0.75 to 37 kW

For this reason, the SIMOTICS GP/SD APAC series (Asia/Pacific) with efficiency class IE3, which complies with the IE3 energy efficiency requirements for line frequencies 50 Hz and 60 Hz (P50), was launched onto the market:

- SIMOTICS GP, 2-, 4-, and 6-pole motors of the 1LE1043 motor series
- SIMOTICS SD, 2-, 4-, and 6-pole motors of the 1LE1543 and 1LE1643 motor series

Scope of Korean standard KS C 60034-2-1

This Korean standard is applicable to three-phase asynchronous motors with the following parameters:

- Voltage: ≤ 600 V
- Power supply: 60 Hz three-phase
- Rated power: 0.75 ... 375 kW
- Number of poles: 2, 4, 6 and 8
- Speed: Constant
- Coolant temperature: ≤ 40 °C
- Mounting method: Foot or flange-mounted

Overview

Korea Energy Label

Option **D33** KEMCO (Korea Energy Management Cooperation KEMCO) Korea Energy Efficiency Label can be ordered only for those motors which comply with Korean efficiency requirements. Confirmation that the motor efficiency and power factor comply with KS C 60034-2-1 is provided by certification.

The Korea Energy Label includes the following information:

- Full-load efficiency
- Motor Type (MT)
- Rated output power
- No. of poles
- CO₂ emissions per hour
- Energy costs per annum



Rating plate

KEMCO-certified motors with option code **D33** are fitted with a modified rating plate that indicates the admissible minimum energy efficiency value (P50 for 60 Hz) in accordance with the Korean Energy Efficiency Ordinance with reference to Korean Standard KS C 60034-2-1.

The energy efficiency values stipulated by KS C 60034 are identical to the international efficiency values IE (IEC 60034-30).

| SIEMENS | | IE3 | | CE | | | |
|--------------------------------------|---------|-----------------|-----|--|---------|-------|-------|
| Made in Czech. Rep. D-90441 Nürnberg | | 3~Mot. 1CV3314B | | 1LE15433AB434AA4-Z UC 1701/1234567 001 001 | | | |
| IEC/EN 60034 315L IMB3 IP55 | | 990kg | | Th.Cl. 155(F) -20°C ≤TAMB≤40°C | | | |
| Bearing | | UNIREX-N3 | | INTERVAL: 6000h | | | |
| DE | 6319-C3 | 40g | | | | | |
| NE | 6319-C3 | 40g | | | | | |
| KS C 60034-2-1 | | | | | | | |
| V | Hz | A | kW | cosφ | NOM.EFF | 1/min | IE-CL |
| 400 Δ | 50 | 275 | 160 | 0.87 | 95.8 | 1490 | IE3 |
| 690 Y | 50 | 161 | 160 | 0.87 | 95.8 | 1490 | IE3 |
| 460 Δ | 60 | 275 | 184 | 0.88 | 96.2 | 1788 | IE3 |
| 460 Δ | 60 | 240 | 160 | 0.87 | 96.2 | 1791 | IE3 |

You will find a complete list of KEMCO-certified motors (APAC Line) on the selection tables in Chapter 2.

1PC3 motors: 1PC3 motors are also covered by certification provided that the electrical design complies with local requirements as stipulated in standard KS C 60034-2-1. Please contact QC for further clarification if required.

Motors from the APAC Line can be ordered with or without option **D33** depending on the final destination region.

Energy-saving motors for China: China Energy Label

In 2012, the directive for the China Energy Label was redefined. Applicability was extended to explosion-protected motors.

- Line voltage ≤ 1000 V
- Line frequency 50 Hz
- Power range 0.75 kW to 375 kW
- Number of poles: 2-, 4-, 6-pole
- Continuous duty S1

The minimum requirements for the efficiency classes previously defined in the Chinese standard GB 18613-2006 were classified in the new standard GB 18613-2012 (Minimum Allowable Values of Energy Efficiency and Energy Efficiency Grades for Small and Medium Three-Phase Asynchronous Motors) in accordance with International Efficiency IE2-4.



| IEC IE class | GB 18613-2012 |
|--------------|---------------|
| IE4 | Grade 1 |
| IE3 | Grade 2 |
| IE2 | Grade 3 |
| IE1 | |

The 1LE1 motor series for IE2 and IE3, plus order code **D34** were previously certified for China Energy Label 2012.

CCC safety certification is also required for motors with lower powers.

CCC – China Compulsory Certification – Order code **D01**

Motors with small powers (small power motors) that are exported to China must be certified up to a rated power of:

- 2-pole: ≤ 2.2 kW
- 4-pole: ≤ 1.1 kW
- 6-pole: ≤ 0.75 kW
- 8-pole: ≤ 0.55 kW

Notes:

Chinese customs checks the need for certification of imported products by means of the commodity code.

The following do not need to be certified:

- Explosion-protected motors
- Multi-voltage motors
- Multi-speed motors with powers higher than those listed above
- Repair parts

Introduction

General information

Versions in accordance with standards and specifications

Overview

VIK version

VIK = Verband der Industriellen Energie- und Kraftwirtschaft e.V. (German Association of the Energy and Power Supply Industry)

- **VIK standard version** – 1LE1, 1LE5 frame sizes 400 and 450 + order code **C02**
"VIK" identification on rating plate.
→ Product range in Catalog Section 2.
- **VIK-Ex ec version** – 1MB1.3, 1MB5.3 + order code **C02**
"VIK" and "Ex ec IIC T3 Gc" marking on the rating plate according to Directive 2014/34/EU (ATEX).
→ Product range in catalog section 5.

Both versions include technology for Zone 2 with type of protection Ex ec IIC T3 Gc. Motors up to frame size 355 can be supplied in accordance with the technical requirements of the VIK recommendation.

Minimum efficiency class:

- VIK standard version:
IE3 in accordance with legal specifications.
- VIK-Ex ec version:
At least IE3 according to the VIK recommendation of January 2018.

Notes:

- 8-pole motors or all motors < 0.75 kW are still possible as these motors are outside the power range specified for IE stamping.
- Motors in VIK version with mounted technology (brake, rotary pulse encoder and separately driven fan) are not compatible with Zone 2.
Versions for Zone 21/22 are not possible.
- Motors in VIK standard version with externally mounted components (brake, rotary pulse encoder and separately driven fan) are not suitable for use in Zone 2. Versions for Zone 21/22 are not possible.

TR CU product safety certificate EAC for the Eurasian Customs Union (Russia, Belarus, Kazakhstan, Armenia, Kyrgyzstan)

TR CU = Technical Regulation Customs Union
EAC = Eurasian Conformity

The TR CU product safety certificate is required in order to import motors into the Eurasian Customs Union area.

"TR CU product safety certificate EAC for Eurasian Customs Union" – order code **D47**

When motors are ordered with order code **D47**, the motor rating plate and packaging are marked with the logo "EAC".

The motor must have a "TR CU product safety certificate EAC", although the certificate does not generally have to be shipped with the motor. The customs authorities use the motor article number to check the motor certification.

The following are available in the SIOS (Siemens Industry Online Support)

<https://support.industry.siemens.com/cs/ww/en>
and the Drive Technology Configurator
www.siemens.com/dt-configurator

- TR CU product safety certificate in accordance with the Low-Voltage Directive
- Additional TR CU product certificate in accordance with the EMC Directive.

Train-compatible version

Train-compatible version IC418, EN IEC 60349, acc. to EN 45545, without external fan and without fan cover (1LE10 aluminum motors in frame sizes 80 to 200) – Order code **L92** for cooling method IC418

- Electrical design in accordance with EN IEC 60349;
 $U_{rated} \leq 500$ V AC.
- DC-link voltage: $U_{dc} \leq 700$ V; $du/dt \leq 5$ kV/ μ s
- Vibration resistance to Class 3M4 according to IEC 60721-3-3
- Metal cable gland
- Including external grounding depending on construction type (corresponds to order code **H04**).
- Standard paint finish certified according to EN 45545 (Polyurethane-based paint, order code **S06**, not possible as not certified)

Train-compatible version IC411, EN IEC 60349, with EN 45545, with external fan and fan cover in metal – order code **L91** for cooling method IC411

- 1LE10 aluminum motors in frame sizes 80 to 200
- Electrical design in accordance with EN IEC 60349;
 $U_{rated} \leq 500$ V AC.
- DC-link voltage: $U_{dc} \leq 700$ V; $du/dt \leq 5$ kV/ μ s
- Vibration resistance to Class 3M4 according to IEC 60721-3-3
- Metal cable gland
- Including external grounding depending on construction type (corresponds to order code **H04**).
- Standard paint finish certified according to EN 45545 (Polyurethane-based paint, order code **S06**, not possible as not certified)
- Including metal fan cover

Train-compatible version IC411, EN IEC 60349, without EN 45545, with external fan and fan cover in plastic – Order code **L90** for cooling method IC411

- 1LE10 aluminum motors in frame sizes 80 to 200
- Electrical design in accordance with EN IEC 60349;
 $U_{rated} \leq 500$ V AC
- DC-link voltage: $U_{dc} \leq 700$ V; $du/dt \leq 5$ kV/ μ s
- Vibration resistance to Class 3M4 according to IEC 60721-3-3
- Metal cable gland
- Including external grounding depending on construction type (corresponds to order code **H04**).
- Standard paint finish, without EN 45545 (Polyurethane-based paint, order code **S06**, not possible as not certified)
- Including plastic fan cover

Recommended supplementary options:

- Located bearing DE (order code **L20**)
- Temperature class 155 (F), utilized according to 130 (B), coolant temperature 55 C, derating approx. 13 % (order code **N07**)
- Coolant temperature –30 to +40 °C (order code **D04**)
- Coolant temperature –40 to +40 °C (order code **D03**)

Overview

Voltages, currents and frequencies

Standard voltages

EN 60034-1 differentiates between Category A (combination of voltage deviation $\pm 5\%$ and frequency deviation $\pm 2\%$) and Category B (combination of voltage deviation $\pm 10\%$ and frequency deviation $+3/-5\%$) for voltage and frequency fluctuations. The motors can supply their rated torque in both Category A and Category B. In Category A, the temperature rise is approx. 10 K higher than during rated operation.

| Standard | Category | Category |
|--|--|--|
| IEC 60034-1 | A | B |
| Voltage deviation | $\pm 5\%$ | $\pm 10\%$ |
| Frequency deviation | $\pm 2\%$ | $+3\%/-5\%$ |
| Rating plate data stamped with rated voltage a (e.g. a=400 V) | a $\pm 5\%$ (e.g. 400 V $\pm 5\%$) | a $\pm 10\%$ (e.g. 400 $\pm 10\%$) |
| Rating plate data stamped with rated voltage ranges b to c (e.g. b=380 V to c=420 V) | b -5% to c $+5\%$ (e.g. 380 -5% to 420 $+5\%$) | b -10% to c $+10\%$ (e.g. 380 -10% to 420 $+10\%$) |

For further details, see EN 60034-1.

According to the standard, longer operation is not recommended for Category B. See "Rating plates and additional rating plates" for details of the rating plate inscriptions and corresponding examples. The selection and ordering data give the rated current at 460 V, 60 Hz. The IEC 60038 standard specifies a tolerance of $\pm 10\%$ for line voltages of 230 V, 400 V, and 690 V.

| Line voltages | Voltage code |
|-------------------------------|--------------|
| 1LE1 motors | |
| 230 V Δ /400 VY, 50 Hz | 22 |
| 460 VY, 60 Hz | |
| 400 V Δ /690 VY, 50 Hz | 34 |
| 460 V Δ , 60 Hz | |
| 500 VY, 50 Hz | 27 |
| 575 VY, 60 Hz | |
| 500 V Δ , 50 Hz | 40 |
| 575 V Δ , 60 Hz | |

Non-standard voltages and/or frequencies

The tolerance laid down by EN 60034-1 applies to all non-standard voltages.

For some non-standard voltages at 50 or 60 Hz, order codes are specified. They are ordered by specifying the code digit **9** for voltage in the 12th position of the Article No. as well as the code digit **0** in the 13th position of the Article No. and the corresponding order code.

The lowest rated voltage for **M1Y** that can be delivered depends on factors including the circuit (delta connection 200 V/star (wye) connection 250 V) and frame size. The defined order codes for further rated voltages provide an indication of the lowest rated voltage for **M1Y**.

Order codes for other rated voltages are listed under "Order suffixes" in the "Selection and ordering data" as well as "Special versions" under "Voltages".

Line voltages according to NEMA

Assignment of rated voltage of the motor to that of the line:

| Line voltage | Motor voltage |
|--------------|---------------|
| 208 V | 200 V |
| 240 V | 230 V |
| 480 V | 460 V |
| 600 V | 575 V |

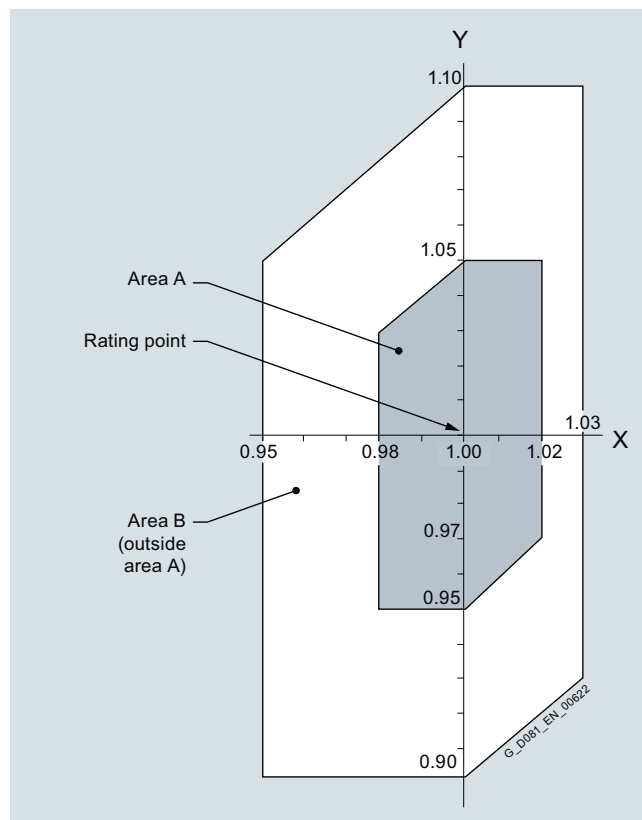

Y-axis: Voltage tolerance
X-axis: Frequency tolerance

Powers

The powers or rated powers are listed in the selection tables for both 50 Hz and 60 Hz. For 60 Hz, the rated power values must, in some cases, be increased, e.g. for pole-changing motors.

Assignment of standard powers kW-hp in accordance with IEC 60072-1

The values specified for kW and hp are not precise conversion values. They are the approximate relationship between the values generally applied in the countries in which both units are used.

| P_{rated} kW | P_{rated} hp | P_{rated} kW | P_{rated} hp | P_{rated} kW | P_{rated} hp | P_{rated} kW | P_{rated} hp | P_{rated} kW | P_{rated} hp | P_{rated} kW | P_{rated} hp |
|-------------------|-------------------|-------------------|-------------------|-------------------|-------------------|-------------------|-------------------|-------------------|-------------------|-------------------|-------------------|
| 0.06 | 0.08 | 2.2 | 3 | 37 | 50 | 200 | 270 | 450 | 603 | 800 | 1072 |
| 0.09 | 0.12 | 3 | 3.7 | 45 | 60 | 220 | 300 | 475 | 637 | 850 | 1139 |
| 0.12 | 0.16 | 4 | 5 | 55 | 75 | 250 | 350 | 500 | 670 | 900 | 1206 |
| 0.18 | 0.25 | 5.5 | 7.5 | 75 | 100 | 280 | 375 | 530 | 710 | 950 | 1273 |
| 0.25 | 0.33 | 7.5 | 10 | 90 | 125 | 300 | 402 | 560 | 750 | 1000 | 1340 |
| 0.37 | 0.5 | 11 | 15 | 110 | 150 | 315 | 422 | 600 | 804 | | |
| 0.55 | 0.75 | 15 | 20 | 132 | 175 | 335 | 476 | 630 | 845 | | |
| 0.75 | 1 | 18.5 | 25 | 150 | 200 | 375 | 503 | 670 | 898 | | |
| 1.1 | 1.5 | 22 | 30 | 160 | 220 | 400 | 536 | 710 | 952 | | |
| 1.5 | 2 | 30 | 40 | 185 | 250 | 425 | 570 | 750 | 1005 | | |

Introduction

Electrical design

Rating plate and additional rating plates

Overview

In accordance with EN 60034-1, the approximate total weight is specified on the rating plate for all motors.

Supplementary data (maximum of 20 characters) can be indicated on the rating plate or additional rating plate and on the packaging label.

Order code **Y84**

An additional rating plate for customer specifications is also possible, additional text: 9 lines of 40 characters each.

Order code **Y82**

An adhesive label can also be supplied loose.

Order code **Y85**

An additional rating plate for customer specifications is also possible, additional text: 9 lines of 40 characters each.

Order code **Y82**

An additional rating plate with deviating rating plate data can also be ordered (only for ratings such as voltage, power, speed). Order code **Y80**.

An "additional rating plate for voltage tolerance" can also be ordered.

Can be ordered for 230 VΔ/400 VY or 400 VΔ/690 VY (voltage code "22" or "34"). Not possible for pole-changing motors, naturally cooled 1PC1 motors, 8-pole motors and in combination with order code D34.

Order code **B07**

(voltage range plate is always provided in the form of an adhesive label)

The number of rating plates and/or the material quality of the rating plate including additional rating plates can be ordered using order codes Y82, Y84 and Y80. Does not apply to order code B07, rotational direction arrows, PTC thermistor plates, other notices.

- Extra (rating) plate(s) – Order code **M10**
- Plate(s) with resistance to scratches, heat, cold and acid – Order code **M11**

As standard, the normal version of the rating plate is international (in English).

Other languages on request.

Examples of rating plates

| SIEMENS | | Made in Germany | | IEC/EN 60034 | | CE | |
|---|----|-----------------|------|--------------|------|--------|-------|
| 3-MOT 1AV2092A 1LE10010EA422AA0 TH.CL.155(F) IP55 | | | | | | | |
| F no E1701/1234567 01 001 FS 90L IMB3 WT 13kg | | | | | | | |
| V | Hz | kW | A | PF | RPM | EFF-CL | ETA % |
| 230 Δ | 50 | 2.2 | 7.8 | 0.85 | 2890 | IE2 | 83.2 |
| 400 Y | 50 | 2.2 | 4.50 | 0.85 | 2890 | IE2 | 83.2 |
| 460 Y | 60 | 2.55 | 4.35 | 0.86 | 3485 | IE2 | 85.5 |

Adhesive rating plate up to frame size 90

| SIEMENS | | Made in Czech Rep. | | D-90441 Nürnberg | | IE3 H CE | |
|--|---------------|---------------------|-----|------------------|---------|----------|-------|
| 3-Mot. 1AV3114B 1LE15433AB434AA4-Z UC 1701/1234567 001 001 | | | | | | | |
| IEC/EN 60034 315L IMB3 IP55 | | | | | | | |
| 990kg | Th.Cl. 155(F) | -20°C ≤ TAMB ≤ 40°C | | | | | |
| Bearing | | UNIREX-N3 | | | | | |
| DE | 6319-C3 | 40g | | INTERVAL: 6000h | | | |
| NE | 6319-C3 | 40g | | | | | |
| KS C 60034-2-1 | | | | | | | |
| V | Hz | A | kW | cosφ | NOM.EFF | 1/min | IE-CL |
| 400 Δ | 50 | 275 | 160 | 0.87 | 95.8 | 1490 | IE3 |
| 690 Y | 50 | 161 | 160 | 0.87 | 95.8 | 1490 | IE3 |
| 460 Δ | 60 | 275 | 184 | 0.88 | 96.2 | 1788 | IE3 |
| 460 Δ | 60 | 240 | 160 | 0.87 | 96.2 | 1791 | IE3 |

Rating plate for motor with KEMCO certification

| SIEMENS | | Made in Germany | | D-90441 Nürnberg | | IE3 H CE | |
|---|---------------|---------------------|------|------------------|---------|----------------------|-------|
| 3-Mot. 1AV3164A 1LE10431DA434AA0-Z E 1701/1410842 001 001 | | | | | | | |
| IEC/EN 60034 160L IMB3 IP10=FAN COVER/IP55 | | | | | | | |
| 94kg | Th.Cl. 155(F) | -20°C ≤ TAMB ≤ 45°C | | 2000M | | Brake: 2LM8040-5NA10 | |
| Bearing | | UNIREX-N3 | | | | | |
| DE | 6209-2ZC3 | 20g | | INTERVAL: 2000h | | | |
| NE | 6209-2ZC3 | 20g | | | | | |
| Vibration B SF 1.1 CONT KS C 60034-2-1 | | | | | | | |
| V | Hz | A | kW | cosφ | NOM.EFF | 1/min | IE-CL |
| 400 Δ | 50 | 32.0 | 18.5 | 0.90 | 92.4 | 2955 | IE3 |
| 690 Y | 50 | 18.6 | 18.5 | 0.90 | 92.4 | 2955 | IE3 |
| 460 Δ | 60 | 32.0 | 21.3 | 0.91 | 91.7 | 3550 | IE3 |
| 460 Δ | 60 | 28.0 | 18.5 | 0.90 | 91.7 | 3560 | IE3 |
| KDN. 12345678999111 MATNo. 12345678 Space Heater 230V | | | | | | | |

Rating plate (metal) for IEC motors (APAC Line) – maximum characteristics

| SIEMENS | | Made in Germany | | D-90441 Nürnberg | | IE3 H CE | |
|---|---------------|---------------------|------|------------------|---------|----------------------|-------|
| 3-Mot. 1AV3164A 1LE10231DA434AA0-Z E 1701/1410842 001 001 | | | | | | | |
| IEC/EN 60034 160L IMB3 IP55 | | | | | | | |
| 94kg | Th.Cl. 155(F) | -20°C ≤ TAMB ≤ 45°C | | 2000M | | Brake: 2LM8040-5NA10 | |
| Bearing | | UNIREX-N3 | | | | | |
| DE | 6209-2ZC3 | 20g | | INTERVAL: 2000h | | | |
| NE | 6209-2ZC3 | 20g | | | | | |
| Vibration B 60Hz: SF 1.1 CONT NEMA MG1 12-12 TEFC DES A 25.0 HP | | | | | | | |
| V | Hz | A | kW | PF | NOM.EFF | rpm | IE-CL |
| 400 Δ | 50 | 32.0 | 18.5 | 0.90 | 92.4 | 2955 | IE3 |
| 690 Y | 50 | 18.6 | 18.5 | 0.90 | 92.4 | 2955 | IE3 |
| 460 Δ | 60 | 32.0 | 21.3 | 0.91 | 91.7 | 3550 | IE3 |
| 460 Δ | 60 | 28.0 | 18.5 | 0.90 | 91.7 | 3560 | IE3 |
| KDN. 12345678999111 MATNo. 12345678 Space Heater 230V | | | | | | | |

Standard rating plate (metal) for NEMA motors – maximum characteristics

Overview

| | | | | | | | | | | |
|----|---|--------------------|------------------------|------|-------------------|------|-----------------|-----|--|----|
| 1 | 3-Mot. 1AV3164A | 1LE10231DA434AA0-Z | E 1701/1410842 001 001 | | | | | | | |
| 14 | IEC/EN 60034 160L IMB3 | IP55 | Brake: | | | | | | | |
| 15 | 94kg | Th.Cl. 155(F) | -20°C ≤ TAMB ≤ 45°C | | | | | | | |
| 31 | RINA | Bearing | UNIREX-N3 | | | | | | | |
| 16 | DE 6209/2ZC3 | 20g | INTERVAL: 2000h | | | | | | | |
| 33 | NE 6209/2ZC3 | 20g | | | | | | | | |
| 34 | Vibration B 60Hz: SF 1.1 CONT NEMA MG1 12-12 TEFC DES A 25.0 HP | | | | | | | | | |
| 26 | 400 Δ | 50 | 32.0 | 18.5 | 0.90 | 92.4 | 2955 | IE3 | | CL |
| 27 | 690 Y | 50 | 18.6 | 18.5 | 0.90 | 92.4 | 2955 | IE3 | | M |
| 28 | 460 Δ | 60 | 32.0 | 21.3 | 0.91 | 91.7 | 3550 | IE3 | | M |
| 29 | 460 Δ | 60 | 28.0 | 18.5 | 0.90 | 91.7 | 3560 | IE3 | | N |
| | KDNo. 12345678999111 | | MATNo. 12345678 | | Space Heater 230V | | G_D081_EN_00891 | | | |

1 Machine type: Three-phase low-voltage motor
 2 Article No.
 3 Factory serial number (Ident.-no., serial number)
 4 Type of construction
 5 Degree of protection
 6 Rated voltage [V] and winding connections
 7 Frequency [Hz]
 8 Rated current [A]
 9 Rated power [kW]
 10 Power factor (cos φ)
 11 Efficiency
 12 Rated speed [rpm]
 13 IE efficiency class
 14 Standards and specifications
 15 Weight of machine [kg]
 16 Temperature class
 17 Frame size
 18 Supplementary data (optional)
 19 Operating temperature range (only if it deviates from standard)
 20 Installation altitude (only when higher than 1000 m)
 21 Customer data (optional)
 22 Date of manufacture YYYYMM
 23 Half-key balancing
 24 Code letter "CL"
 25 Motor type number (MT)
 26 IEC standard series, power 50 Hz (P50/50 Hz) 400 Δ
 27 IEC standard series, power 50 Hz (P50/50 Hz) 690 Δ
 28 Equivalent power 60 Hz at the same utilization as IEC standard series 50 Hz
 29 IEC standard series power 60 Hz (P50/60 Hz)
 30 Manufacturer's address
 31 Marine certificates
 32 Optional information
 33 Bearing size
 34 Relubrication data optional

Explanation of the standard rating plate

Efficiency, power factor, rated speed, direction of rotation, rated torque

Overview

Efficiency and power factor

The efficiency η for 4/4, 3/4 and 1/2 load and the power factor $\cos \varphi$ for each rated power are listed in the selection tables in the individual sections of this catalog. See page 1/5 for minimum efficiencies.

Rated speed and direction of rotation

The rated speeds are applicable for the rated data. The synchronous speed changes proportionally with the line frequency. The motors are suitable for clockwise and counterclockwise rotation.

When U1, V1, W1 are connected to L1, L2, L3 the motor rotates clockwise when viewing the drive shaft extension. Counterclockwise rotation is achieved by swapping two phases (see also "Heating and ventilation" on page 1/30).

Rated torque

The rated torque T in Nm delivered at the motor shaft is

$$T = \frac{9.55 \cdot P \cdot 1000}{n}$$

P Rated power in kW
 n Speed in rpm

Note:

If the voltage deviates from its rated value within the admissible limits, the locked-rotor torque, the pull-up torque and the breakdown torque vary with the approximate square of the value, but the locked-rotor current varies approximately linearly.

In the case of squirrel-cage motors, the locked-rotor torque and breakdown torque are listed in the selection tables as multiples of the rated torque.

Preferred practice is to start squirrel-cage motors directly on line. The torque class indicates that with direct-on-line starting, even if there is an undervoltage of -5 %, it is possible to start up the motor against a load torque of

- 160 % for CL 16
- 130 % for CL 13
- 100 % for CL 10
- 70 % for CL 7
- 50 % for CL 5

of the rated torque.

Introduction

Electrical design

Converter operation

1

Overview

All motors in the SIMOTICS generation are equipped with innovative insulation systems, consisting of high-quality enamel wires and insulating sheet materials in conjunction with highly temperature-resistant impregnations.

The motors can be operated with SINAMICS G and SINAMICS S converters (controlled and uncontrolled infeed) while adhering to the admissible voltage peaks in accordance with the adjacent table.

Continuous operation while fully utilizing the admissible voltage tolerances must be avoided and is not recommended in accordance with IEC 60034-1 2011 Chapter 7.3.

The preferred supply system configurations are TT systems and TN systems with neutral-point grounding. We do not recommend operation in TN systems because of the higher voltage load.

Operation on non-grounded IT systems is also possible. However, in a ground fault, the insulation is excessively stressed. In the case of a ground fault, the process should be terminated as quickly as possible ($t < 2$ h), and the fault resolved.

For motors with protruding connection cables (order codes **R20**, **R21**, **R22**, **R23**, and **R24**), please inquire in the case of converter operation.

Impulse Voltage Insulation Class (IVIC) – category C (strong)

The insulation system of SIMOTICS motors significantly exceeds the requirements of stress category C (IVIC C = high stress). If voltage peaks higher than those specified according to IVIC C can occur, observe the data in the following table.

- For a line voltage (converter input voltage) up to max. 480 V and operation connected to a SINAMICS G/SINAMICS S converter with uncontrolled infeed (BLM, SLM), the relevant guidelines for the motor and converter configuration must be observed.
- For a line voltage (converter input voltage) up to max. 480 V and operation connected to a SINAMICS S converter with controlled infeed (ALM), the relevant guidelines for the motor and converter configuration must be observed.
- For line voltages (converter input voltages) higher than those stated above (max. 690 V), motors that are ordered for converter operation must have a suitable insulation system.
- For operation of a converter of another manufacturer, the permissible voltage peaks according to IEC 60034-18-41 in accordance with stress category C (see table below) must be observed, depending on the particular line voltage (converter input voltage) and the motor insulation system.

| | Line voltage U_{rated} | | | | | | |
|---------------------------------|--------------------------|---------|--------|---------|--------|---------|------|
| | 400 V | | 480 V | | 500 V | | |
| Standard | IVIC C | Siemens | IVIC C | Siemens | IVIC C | Siemens | |
| $U_{phase} U_{phase-to-ground}$ | $V_{pk/pk}$ | 1680 | 2200 | 2016 | 2200 | 2100 | 2200 |
| $\hat{U}_{phase-to-ground}$ | V_{pk} | 840 | 1100 | 1008 | 1100 | 1050 | 1100 |
| $U_{phase} U_{phase-to-phase}$ | $V_{pk/pk}$ | 2360 | 3000 | 2832 | 3000 | 2950 | 3000 |
| $\hat{U}_{phase-to-phase}$ | V_{pk} | 1180 | 1500 | 1416 | 1500 | 1475 | 1500 |

| | Line voltage U_{rated} | | | | |
|---------------------------------|--------------------------|---------|--------|---------|------|
| | 500 V | | 690 V | | |
| PREMIUM | IVIC C | Siemens | IVIV C | Siemens | |
| $U_{phase} U_{phase-to-ground}$ | $V_{pk/pk}$ | 2100 | 3000 | 2898 | 3000 |
| $\hat{U}_{phase-to-ground}$ | V_{pk} | 1050 | 1500 | 1499 | 1500 |
| $U_{phase} U_{phase-to-phase}$ | $V_{pk/pk}$ | 2950 | 4400 | 4070 | 4400 |
| $\hat{U}_{phase-to-phase}$ | V_{pk} | 1475 | 2200 | 2035 | 2200 |

The following applies for the voltage rise time: $T_a > 0.3 \mu s$.

The voltages according to EN 60034-18-41/IVIC C are specified as peak-to-peak values ($V_{pk/pk}$). For information, the conventional peak values (V_{pk}) are also stated.

Insulation systems for converter operation > 480 V/500 V

The SIMOTICS motors can be operated in their standard version on SINAMICS converters without an additional filter up to a maximum converter input voltage of 480 V 3 AC on uncontrolled infeeds (SINAMICS G/S/V, BLM/SLM) and up to 480 V 3 AC on controlled infeeds (SINAMICS S, ALM). The specific configuration guidelines for motors and converters must be observed.

For higher converter input voltages, > 480 V/500 V 3 AC (max. 690 V), a special insulation system of the motor (PREMIUM) is required.

This is available for converter motors, such as SIMOTICS GP/SD VSD10, SIMOTICS DP crane motors, SIMOTICS FD, and the converter-capable SIMOTICS SD Pro motors.

For IE3 standard motors, the PREMIUM insulation system is available depending on the type.

Bearing insulation/shaft grounding brushes

To avoid damage to bearings due to bearing currents, we recommend bearing insulation at the non-drive end (NDE) for frame size 225 and larger (order code **L51**).

For converter operation and for frame size 315 and larger, bearing insulation at the non-drive end (NDE) is always provided (order code **L51**).

When rotary encoders are used, it must be ensured that these do not bypass the bearing insulation. The rotary encoders in this catalog meet this requirement except for type 1XP8.

In most cases, NDE bearing insulation provides sufficient protection against damage to bearings due to bearing currents.

In rare cases, depending on the application and system, it may be necessary to take further measures on the converter or motor. On the motor side, bearing insulation is provided on the drive end (DE) (order code **L50** on frame size 225 and larger) and shaft grounding brushes (order code **L52** as of frame size 280).

When NDE bearing insulation is used together with DE bearing insulation, the "shaft grounding brush" option (order code **L52**) must also be selected to maintain the shaft at a defined potential. In this constellation, to avoid damage to the bearings of the driven machine due to bearing currents, it is also necessary to insulate the coupling between the motor and the driven machine.

The EMC guidelines must always be complied with when the drive system is installed.

Thermal utilization of the motor

When motors are operated on a converter, additional losses occur due to the harmonics in the motor currents, which, depending on the permissible winding temperature, can make it necessary to reduce the torque. For operation on SINAMICS converters, the permissible torque values can be obtained from the SIZER engineering tool.

For operation on SINAMICS converters with the power ratings specified in the catalog, the motors are used according to temperature class 155 (F), i.e. in this case neither a service factor > 1 nor an increased coolant temperature is possible (order codes **N01**, **N02** and **N03** cannot be ordered).

Overview**Explosion-protected motors**

For converter operation of Ex motors, special measures must be considered, see Chapter 5.

DURIGNIT IR 2000 insulation system

The DURIGNIT IR 2000 insulation system consists of high-quality enamel wires and insulating sheet materials in conjunction with temperature-resistant resin impregnation.

This ensures that these motors will have a high mechanical and electrical strength, high service value, and a long lifetime. The insulation system protects the winding to a large degree against aggressive gases, vapors, dusts, oils and increased air humidity. It can withstand the usual vibration stressing. The insulation is suitable up to an absolute air humidity of 30 g water per m³ of air. Moisture condensation should be prevented from forming on the winding. For higher values, the **N30** and **N31** options are available – see page 1/28.

Please inquire about extreme applications.

Restarting against residual field and opposite phase

All motors can be restarted against 100 % residual field after a line voltage failure.

Winding and insulation version with regard to temperature class

At rated power in line operation, the 1LE5/1MB5 motor series can be utilized in the following temperature class:

- For SIMOTICS SD Add ¹⁾: Temperature class 130 (B)
- For SIMOTICS XP ¹⁾: Temperature class 130 (B)
- For SIMOTICS SD Pro and SIMOTICS XP 1MB58: Temperature class 155 (F)

All motors are designed with temperature class 155 (F).

For details of derating for utilization in temperature class 155 (F), see "DURIGNIT IR 2000 insulation system".

Temperature class 155 (F), utilized according to 155 (F), with service factor (SF)

According to the selection table, at rated power and rated voltage, all 1LE./1PC1 motors in line operation have a service factor of 1.15. An exception are IE1 motors, which have a service factor of 1.1.

For the line operation, all motors with frame sizes 400 and 450 have a service factor of 1.05 at rated power.

Order code **N01**

Temperature class 155 (F), utilized according to 155 (F), for higher power

When utilized according to temperature class 155 (F), the rated power specified in the selection and ordering data can be increased by 15 %. Exception for IE1 motors – can be increased by 10 %. For motors of frame sizes 400 and 450, for line operation, when utilized according to temperature class 155 (F), the rated power listed in the selection and ordering data can be increased by 5 %. In this case, the service factor is 1.0.

Order code **N02**

Temperature class 155 (F), utilized acc. to 155 (F), with increased coolant temperature

With power as defined in the catalog and line operation, the coolant temperature is permitted to rise to 55 °C and, for motors of frame sizes 400 and 450, to 45 °C.

In this case, the service factor is 1.0.

Order code **N03**

The service factor (SF) is not indicated on the rating plate for order codes **N02** and **N03**.

For converter operation at the power specified in the catalog, the motors are utilized according to temperature class 155 (F). Order codes **N01**, **N02**, and **N03** are not possible.

Temperature class 155 (F), utilized acc. to 130 (B), coolant temperature 45 °C, derating approx. 4 %

For motor series 1LE1, 1MB. ¹⁾, SIMOTICS SD Add ¹⁾, a version can be ordered according to temperature class 155 (F) for utilization according to temperature class 130 (B) and a maximum coolant temperature of 45 °C with derating of 4 %.

Order code **N05**

Temperature class 155 (F), utilized acc. to 130 (B), coolant temperature 50 °C, derating approx. 8 %

For motor series 1LE1, 1MB. ¹⁾, SIMOTICS SD Add ¹⁾ a version can be ordered according to temperature class 155 (F) for utilization according to temperature class 130 (B) and a maximum coolant temperature of 50 °C with derating of 8 %.

Order code **N06**

Temperature class 155 (F), utilized acc. to 130 (B), coolant temperature 55 °C, derating approx. 13 %

For motor series 1LE1, 1MB. ¹⁾, SIMOTICS SD Add ¹⁾ a version can be ordered according to temperature class 155 (F) for utilization according to temperature class 130 (B) and a maximum coolant temperature of 55 °C with derating of 13 %.

Order code **N07**

Temperature class 155 (F), utilized acc. to 130 (B), coolant temperature 60 °C, derating approx. 18 %

For motor series 1LE1, 1MB. ¹⁾, SIMOTICS SD Add ¹⁾ a version can be ordered according to temperature class 155 (F) for utilization according to temperature class 130 (B) and a maximum coolant temperature of 60 °C with derating of 18 %.

Order code **N08**

Temperature class 180 (H)

With motor series 1LE., 1MB., and 1PC1, utilization according to temperature class 180 (H) is permitted.

For the SIMOTICS SD Add / SD Pro motor series, the rated power is increased by 5 %.

Rating plate data for SIMOTICS SD Add / SD Pro:

- Line operation (DOL): PN·1.05 + SF 1.05
- Converter operation (VSD): PN·1.05

Order code **N10** ²⁾

Temperature class 180 (H) at rated power and max. CT 60 °C

With motor series 1LE1, and 1PC1, utilization according to temperature class 180 (H) is permitted at rated power and a maximum coolant temperature of 60 °C (for the SIMOTICS SD Add / SD Pro motor series on request).

Order code **N11** ¹⁾ (not possible for 1LE15 and 1LE16 motors with increased power).

The grease lifetime specified is valid for a coolant temperature of 40 °C. If the coolant temperature is increased by 10 K, the grease lifetime and regreasing interval are halved.

¹⁾ Not applicable for 8-pole motors, frame size 450. Utilization in accordance with temperature class 130 (B) only possible on request, specifying order code Y50.

²⁾ Order code for Ex motors of the 1MB5, SIMOTICS XP motor series not available.

Introduction

Electrical design

Windings and insulation

1

Overview

Temperature class 155 (F), utilized acc. to 130 (B), with higher coolant temperature and/or installation altitude

The motors can be ordered according to temperature class 155 (F) for utilization according to temperature class 130 (B) with other customized requirements if they are specified in plain text in the order.

Order code **Y50**

Temperature class 155 (F), utilized according to 155 (F), other requirements

The motors can be ordered according to temperature class 155 (F) for utilization according to temperature class 155 (F) with other customized requirements if they are specified in plain text in the order.

Order code **Y52**

Temperature class 180 (H), utilized according to 155 (F)

The motors can be ordered according to temperature class 180 (H) for utilization according to temperature class 155 (F) with other customized requirements if they are specified in plain text in the order.

Order code **Y75**¹⁾

Increased air humidity/temperature with 30 to 60 g water per m³ of air

With motor series 1LE1, 1LE5, 1MB1, 1MB5 and 1PC1, motors are available in a version designed for increased air humidity in the range of 30 to 60 g water per m³ of air, depending on the temperature, as shown in the table below. This version has condensation drainage holes (sealed). Not possible for 1MB...5 Ex db motors. Order code **N30** (includes order code **H03**²⁾, **M11**, stainless bolts in the terminal box cover, and **S02** standard/special paint finish for Performance Line cast-iron motors).

Please inquire before combining order code **N30** with mountings (e.g. rotary pulse encoder, brakes)!

Increased air humidity/temperature with over 60 to 100 g water per m³ air

With motor series 1LE1, 1LE5, 1MB1, 1MB5 and 1PC1, motors are available in a version designed for increased air humidity of over 60 to 100 g water per m³ of air, depending on the temperature, as shown in the table below. This version has condensation drainage holes. Not possible for 1MB...5 Ex db motors.

Order code **N31** (includes order code **H03**²⁾, **M11**, stainless bolts in the terminal box cover, and either the **S02** special paint finish or the **S03** "sea air resistant" special paint finish for Performance Line cast-iron motors).

Please inquire before combining order code **N31** with mountings (e.g. rotary pulse encoder, brakes)!

Absolute/relative conversion of air humidity

| Relative humidity | Temperature | | | | | | | |
|-------------------|-------------|-------------|-------------|-------------|-------------|-------------|-------------|-------------|
| | up to 20 °C | up to 30 °C | up to 40 °C | up to 50 °C | up to 60 °C | up to 70 °C | up to 80 °C | up to 90 °C |
| 10 % | 2 | 3 | 5 | 8 | 13 | 20 | 29 | 42 |
| 15 % | 3 | 5 | 8 | 12 | 19 | 30 | 44 | 63 |
| 20 % | 3 | 6 | 10 | 17 | 26 | 39 | 58 | 84 |
| 25 % | 4 | 8 | 13 | 21 | 32 | 49 | 73 | 105 |
| 30 % | 5 | 9 | 15 | 25 | 39 | 59 | 87 | 126 |
| 35 % | 6 | 11 | 18 | 29 | 45 | 69 | 102 | 146 |
| 40 % | 7 | 12 | 20 | 33 | 52 | 79 | 116 | 167 |
| 45 % | 8 | 14 | 23 | 37 | 58 | 89 | 131 | 188 |
| 50 % | 9 | 15 | 26 | 41 | 65 | 98 | 145 | 209 |
| 55 % | 10 | 17 | 28 | 46 | 71 | 108 | 160 | 230 |
| 60 % | 10 | 19 | 31 | 50 | 78 | 118 | 174 | 251 |
| 65 % | 11 | 20 | 33 | 54 | 84 | 128 | 189 | 272 |
| 70 % | 12 | 21 | 36 | 58 | 91 | 138 | 203 | 293 |
| 75 % | 13 | 23 | 38 | 62 | 97 | 148 | 218 | 314 |
| 80 % | 14 | 24 | 41 | 66 | 104 | 157 | 233 | 335 |
| 85 % | 15 | 26 | 43 | 70 | 110 | 167 | 247 | 356 |
| 90 % | 16 | 27 | 46 | 74 | 117 | 177 | 262 | 377 |
| 95 % | 16 | 29 | 49 | 79 | 123 | 187 | 276 | 398 |
| 100 % | 17 | 30 | 51 | 83 | 130 | 197 | 291 | 419 |

The values in the table with a blue background are covered by the standard version (up to < 30 g water per m³ of air).

The values in the table with a light gray background are covered by order code **N30** (30 to < 60 g of water per m³ of air).

The values in the table with a dark gray background are covered by order code **N31** (60 to < 100 g of water per m³ of air).

Note:

- The coolant temperature and installation altitude can be found from page 1/29 onwards!
- The metal fan cover is available in combination with order code **F74** (not standard). For 1LE5/1MB5 motors with frame sizes 400 and 450 and for cast-iron motors of the Performance Line (1LE16), the metal fan cover is always standard.
- In case of increased thermal stress, please combine with the order codes **N05** to **N08**.
- In conjunction with more stringent requirements for the paint finish or corrosion protection stress (offshore, sea air, etc.), the corresponding order codes **S02**, **S03**, **S04**, and potentially **H07**, must be combined!
- Order code **N31** requires additional specifications for the ambient temperature CT 50 °C to CT 90 °C.

¹⁾ Order code for Ex motors of the 1MB5, SIMOTICS XP motor series not available.

²⁾ Order code for Ex motors of the 1MB.553, SIMOTICS XP motor series not available.

Overview

The specified rated power is applicable for continuous duty in accordance with IEC 60034-1 at the frequency of 50 Hz, a coolant temperature (CT) or ambient temperature of 40 °C and an installation altitude (IA) up to 1000 m above sea level. 1LE1, 1LE5, 1MB1, 1MB5 and 1PC1 motors for ambient temperatures exceeding 40 °C are equipped with various types of seal. Mountings such as brake, terminal box at NDE, flange-mounted motors can sometimes exceed utilization in accordance with temperature class 130 (B).

For higher coolant temperatures and/or installation altitudes greater than 1000 m above sea level, the specified motor power must be reduced using the factor k_{HT} .

Depending on the frame size of the motor or the number of poles, special windings may be added to the motors for the different operating conditions.

This results in an admissible motor power of:

$$P_{adm} = P_{rated} \cdot k_{HT}$$

If the admissible motor power is no longer adequate for the drive, it should be checked whether the motor with the next highest rated power fulfills the requirements.

| Abbreviation | Description | Unit |
|--------------|--|------|
| P_{adm} | Admissible motor power | kW |
| P_{rated} | Rated power | kW |
| k_{HT} | Factor for abnormal coolant temperature and/or installation altitude | |

The motors are designed for temperature class 155 (F) and utilized in temperature class 130 (B). Under non-standard operating conditions, if they are to be used in this class, the admissible power rating must be determined from the table below.

Reduction factor k_{HT} for different installation altitudes and/or coolant temperatures

| Installation altitude above sea level m | Coolant temperature | | | | | |
|--|---------------------|--------------|-------|-------|-------|-------|
| | < 30 °C | 30 ... 40 °C | 45 °C | 50 °C | 55 °C | 60 °C |
| 1000 | 1.07 | 1.00 | 0.96 | 0.92 | 0.87 | 0.82 |
| 1500 | 1.04 | 0.97 | 0.93 | 0.89 | 0.84 | 0.79 |
| 2000 | 1.00 | 0.94 | 0.90 | 0.86 | 0.82 | 0.77 |
| 2500 | 0.96 | 0.90 | 0.86 | 0.83 | 0.78 | 0.74 |
| 3000 | 0.92 | 0.86 | 0.82 | 0.79 | 0.75 | 0.70 |
| 3500 | 0.88 | 0.82 | 0.79 | 0.75 | 0.71 | 0.67 |
| 4000 | 0.82 | 0.77 | 0.74 | 0.71 | 0.67 | 0.63 |

Coolant temperature and installation altitude are rounded to 5 °C and 500 m respectively.

Motors for coolant temperatures other than 40 °C or installation altitudes higher than 1000 m above sea level for utilization in temperature class 130 (B) must always be ordered with the additional identification code "-Z" and plain text. In the case of extreme derating, the operating data for the motors, i.e. efficiency and power factor, will also be less favorable due to partial utilization.

The following special versions are possible for 1LE1 and 1PC1 motors:

- Motors for coolant temperatures from -40 to +40 °C order code **D03**
- Motors for coolant temperatures from -30 to +40 °C order code **D04**

When ordering with order codes **D03** or **D04** in combination with mountings, the respective technical specifications have to be observed and it is necessary to inquire.

For details of order codes for use in temperature class 155 (F), see "DURIGNIT IR 2000 insulation system" under "Windings and insulation" on page 1/27.

Ambient temperature:

All motors can be used in the standard version at ambient temperatures between -20 and +40 °C. Exposure to direct sunlight can result in uncontrollable rises in motor temperature. To prevent this, appropriate shading measures such as a sun-protective cover are recommended.

Motors can be utilized in temperature class 155 (F)

- at 40 °C with service factor 1.1, i.e. the motor can be continuously overloaded with 10 % of the rated power in the case of IE1 motors
- at 40 °C with service factor 1.15, i.e. the motor can be continuously overloaded with 15 % of the rated power in the case of IE2 motors and higher efficiency classes
- above 40 °C at rated power.
- 1LE5/1MB5 motors are used in accordance with temperature class 155 (F) up to 40 °C occurs with a service factor of 1.05, i.e. the motor can be continuously overloaded with 5 % of the rated power.

When motors are used in temperature class 130 (B) for higher ambient temperatures and/or installation altitudes, derating occurs in accordance with the Table "Reduction factor k_{HT} for different installation altitudes and/or coolant temperatures".

For motors ex stock, the service factor is indicated on the rating plate.

For other temperatures, special measures are necessary.

When brakes are to be mounted on motors intended for operation at temperatures below freezing, please inquire.

Introduction

Electrical design

Heating and ventilation

1

Overview

Anti-condensation heating

Supply voltage 230 V (1AC)
Order code **Q02**

Supply voltage 115 V (1AC)
Order code **Q03**

Supply voltage 400 V (1AC)
Order code **Q06**

For motors with windings at risk of condensation due to the climatic conditions, e.g. inactive motors in humid atmospheres or motors that are subjected to widely fluctuating temperatures, anti-condensation heaters must be used.

An additional cable entry is provided for the connecting cable in the terminal box.

| Motor series | Frame size | Cable entry |
|-----------------------|-------------|---------------|
| Aluminum motors (GP) | ≤ 200 | 1 × M16 × 1.5 |
| Cast-iron motors (SD) | ≤ 180 | 1 × M16 × 1.5 |
| | 200 | 1 × M20 × 1.5 |
| | 225 ... 315 | 2 × M20 × 1.5 |
| | 355 ... 450 | 2 × M20 × 1.5 |

Anti-condensation heating must not be switched on during operation.

| Frame size | Heat power of the anti-condensation heating | | |
|------------------------------|---|-----------------------|-----------------------|
| | Supply voltage at | | |
| | 230 V | 115 V (110 V) | 400 V (1AC) |
| | Order code Q02 | Order code Q03 | Order code Q06 |
| | W | W | W |
| 1LE1/1LE5/1PC1 motors | | | |
| 63 ... 80 | 12.5 | 12.5 | – |
| 90 ... 112 | 25 | 25 | – |
| 132 ... 200 | 50 | 50 | – |
| 225 ... 250 | 92 | 92 | – |
| 280 ... 315 | 109 | 109 | – |
| 315 ... 355 | 218 | 218 | 200 |
| 400 ... 450 | 240 | 240 | 370 |
| 1MB1, 1MB5 motors | | | |
| 80 ... 112 | 7 | 7 | – |
| 132 ... 160 | 12 | 12 | – |
| 180 ... 200 | 57 | 57 | – |
| 225 ... 250 | 92 | 92 | – |
| 280 ... 315 | 109 | 109 | – |
| 355 | 218 | 218 | 200 |
| 400 ... 450 | 240 | 240 | 370 |

Instead of an anti-condensation heater, another possibility is to connect a voltage that is approximately 4 to 10 % of the rated motor voltage to stator terminals U1 and V1; 20 to 30 % of rated motor current is sufficient to heat the motor.

Fans/separately driven fans

1LE1 and 1MB1 motors of frame size 71 to 315 and 1LE5 and 1MB5 motors with 4 poles or more have radial-flow fans in the standard version (with the exception of option **F90** – version "Forced-air cooled motors without external fan and fan cover") that cool regardless of the direction of rotation of the motor (cooling method IC411 acc. to EN 60034-6). In the standard version, 1LE5 motors with 2 poles are cooled with unidirectional axial-flow fans. The air flow is forced from the non-drive-end (NDE) to the drive end (DE).

For details of separately driven fans for frame size 63 to 450, see also "Separately driven fans" on page 1/77.

Supply voltage of separately driven fan for 1LE1 motors:
The supply voltage tolerance of the separately driven fan is ±5 %. For voltage ranges, see page 1/77.

In confined spaces, it must be ensured that the minimum spacing is maintained between the fan cover and the wall. This also applies to adjacent parts, such as large handwheels and flywheels on the second shaft extension.

| Clearance from wall/fan grilles | |
|---------------------------------|-----|
| Frame size | mm |
| 63, 71 | 15 |
| 80, 90, 100 | 20 |
| 112 | 25 |
| 132 | 30 |
| 160 | 40 |
| 180, 200 | 90 |
| 225, 250 | 100 |
| 280, 315 | 110 |
| 355 | 140 |
| 400 ... 450 | 150 |

For version of the fan and the fan cover, see the table below.

| Motor series | Frame size | Fan material | Fan cover material |
|--------------|--------------------------|--------------|-----------------------|
| 1LE10 | 63 ... 71 | Plastic | Metal |
| | 80 ... 200 | | Plastic ¹⁾ |
| 1LE15 | 71 ... 90 | Plastic | Metal |
| | 100 ... 315 | | Plastic |
| 1LE16 | 100 ... 315 | Plastic | Metal |
| 1LE55 | 315 | Metal | Plastic |
| 1LE55 | 400 ... 450 2-pole | Metal | Metal |
| | 400 ... 450 4-... 8-pole | | Plastic |
| 1LE56 | 315 ... 355 | Metal | Metal |

Metal external fan impeller

The standard fan impeller made of plastic can be replaced with a fan impeller made of metal. This version is available for the motors (with the exception of 1LE1 with option **F90** – version "Forced-air cooled motors without external fan and fan cover").

In versions with a unidirectional axial-flow fan, the metal external fan is already included. Up to frame size 160 and for the 1LE5/1MB5 motor series, the metal external fan impeller is made of aluminum.

Order code **F76**

Fan cover for textile industry

For 1LE1 motors (with the exception of 1LE1 with option **F90** – version "Forced-air cooled motors without external fan and fan cover") the standard version of the fan cover cannot be used in the textile industry.

For the motor series 1LE1 (with the exception of 1LE1 with option **F90** – version "Forced-air cooled motors without external fan and fan cover") a special version of the fan cover is available for the textile industry. This has a protective cover and is made of non-corrosive sheet steel.

The motor length increases when the fan cover for the textile industry is mounted, see page 1/109, Figure 12.

Order code **F75**

¹⁾ For the frame size codes **A, D, F, H, J, K, L, N, T, U,** and **V,** a screwed-on cover (plastic or metal) is used in conjunction with the option **H03** (condensation drainage holes). Mounted separately driven fans or brakes are only available in sheet metal version.

Overview

Sheet metal fan cover

In place of the plastic fan cover, a sheet metal fan cover can be ordered for motor series 1LE1 (with the exception of 1LE1 with option **F90** – version "Forced-air cooled motors without external fan and fan cover").

Order code **F74**

The sheet metal fan cover is supplied as standard with 1LE16 (Performance Line), 1LE5, and 1MB5 motors.

Necessary minimum cooling air flow for forced-air cooled motors in standard duty

The cooling air flow specified in the selection table applies to continuous duty according to EN 60034-1 at a coolant temperature (CT) or ambient temperature of 40 °C respectively and an installation altitude (IA) up to 1000 m above sea level.

In the 1LE1/1LE5 motor version without external fan and fan cover, order code **F90**, the motor is located in the air flow of the driven fan that must drive the minimum cooling air flow over the motor housing. The minimum air flow must pass closely over the housing (comparable to self-ventilation of the motor). Otherwise higher air flows are required to comply with admissible motor heating levels.

1LE1 motors

| Frame size | Required cooling air flow for number of poles | | | | | | | | | |
|------------|---|------------------------------|------------------------------|------------------------------|------------------------------|------------------------------|------------------------------|------------------------------|------------------------------|------------------------------|
| | 2 | | 4 | | | | 6 | | 8 | |
| | IE2 | | | | | | | | | |
| | 50 Hz m ³ /min | 60 Hz m ³ /min | 50 Hz m ³ /min | 60 Hz m ³ /min | 50 Hz m ³ /min | 60 Hz m ³ /min | 50 Hz m ³ /min | 60 Hz m ³ /min | 50 Hz m ³ /min | 60 Hz m ³ /min |
| 63 | 0.83 | 1.02 | 0.41 | 0.48 | 0.27 | 0.32 | – | – | – | – |
| 71 | 1.49/1.73 | 1.81/2.08 | 0.75/0.86 | 0.87/1.02 | 0.49/0.58 | 0.58/0.71 | 0.36/0.42 | 0.43/0.54 | – | – |
| 80 | 1.82 | 2.18 | 0.9 | 1.1 | 0.6 | 0.73 | 0.44 | 0.53 | – | – |
| 90 | 3.3 | 4.03 | 1.64 | 2.01 | 1.11 | 1.31 | 0.76 | 0.94 | – | – |
| | IE2/IE1 | | IE2 | | IE1 | | IE2/IE1 | | IE2/IE1 | |
| | 50 Hz m ³ /min | 60 Hz m ³ /min | 50 Hz m ³ /min | 60 Hz m ³ /min | 50 Hz m ³ /min | 60 Hz m ³ /min | 50 Hz m ³ /min | 60 Hz m ³ /min | 50 Hz m ³ /min | 60 Hz m ³ /min |
| 100 | 3.8 | 4.4 | 2.1 | 2.6 | 2.3 | 2.8 | 1.5 | 1.8 | 1.2 | 1.3 |
| 112 | 5.0/5.4 ¹⁾ | 5.7/6.1 ¹⁾ | 2.9 | 3.5 | 2.9 | 3.5 | 1.9 | 2.3 | 1.4 | 1.6 |
| 132 | 6.3 | 7.2 | 4.6 | 5.7 | 4.6 | 5.7 | 3.1 | 3.8 | 2.4 | 2.9 |
| 160 | 10.9 | 13.3 | 6.7 | 8.1 | 7.6 | 9.1 | 5 | 6.1 | 3.8 | 4.5 |
| 180 | 12.4 | 14.8 | 7.8 | 9.4 | 7.8 | 9.4 | 5.2 | 6.2 | 4.8 | 5.8 |
| 200 | 14.3 | 17.2 | 10.4 | 12.5 | 10.4 | 12.5 | 7.9 | 9.5 | 6 | 7.2 |
| | IE2 | | | | | | | | | |
| | 50 Hz m ³ /min | 60 Hz m ³ /min | 50 Hz m ³ /min | 60 Hz m ³ /min | 50 Hz m ³ /min | 60 Hz m ³ /min | 50 Hz m ³ /min | 60 Hz m ³ /min | 50 Hz m ³ /min | 60 Hz m ³ /min |
| 225 | 22 | 26 | 19 | 23 | 15 | 17.5 | 11.5 | 13.5 | – | – |
| 250 | 28 | 33 | 21 | 24.5 | 19 | 22.5 | 14.5 | 16.3 | – | – |
| 280 | 32 | 37.5 | 32.5 | 39 | 24 | 29.5 | 18 | 22 | – | – |
| 315 | 48 | 58 | 49 | 58 | 34 | 40 | 25 | 30.5 | – | – |
| | IE4/IE3 | | | | | | | | | |
| | 50 Hz m ³ /min | 60 Hz m ³ /min | 50 Hz m ³ /min | 60 Hz m ³ /min | 50 Hz m ³ /min | 60 Hz m ³ /min | 50 Hz m ³ /min | 60 Hz m ³ /min | 50 Hz m ³ /min | 60 Hz m ³ /min |
| 180 | 10.3 | 12.3 | 7 | 8.3 | 5.2 | 6.2 | – | – | – | – |
| 200 | 10.4 | 12.5 | 7.6 | 9.1 | 6.5 | 7.8 | – | – | – | – |
| 225 | 14 | 17.5 | 12 | 15 | 15.5 | 18 | 11.5 | 12.5 | – | – |
| 250 | 18.5 | 22 | 12 | 15 | 16 | 20 | 12 | 13.5 | – | – |
| 280 | 26 | 30.5 | 27.5 | 32.5 | 22.5 | 26.5 | 18 | 21.5 | – | – |
| 315 | 40 | 48.5 | 32.5 | 39 | 31 | 37 | 25 | 30.5 | – | – |
| | IE3/IE2 | | | | | | | | | |
| | 50 Hz m ³ /min | 60 Hz m ³ /min | 50 Hz m ³ /min | 60 Hz m ³ /min | 50 Hz m ³ /min | 60 Hz m ³ /min | 50 Hz m ³ /min | 60 Hz m ³ /min | 50 Hz m ³ /min | 60 Hz m ³ /min |
| 80 | 1.36 | 1.66 | 0.66 | 0.8 | 0.42 | 0.51 | 0.3 | 0.38 | – | – |
| 90 | 2.86 | 3.41 | 1.34 | 1.7 | 0.87 | 1.06 | 0.65 | 0.8 | – | – |

1LE5 motors

| Frame size | Required cooling air flow for number of poles | | | | | | | | |
|------------|---|------------------------------|------------------------------|------------------------------|------------------------------|------------------------------|------------------------------|------------------------------|---|
| | 2 | | 4 | | | | 6 | | 8 |
| | IE3/IE4 | | | | | | | | |
| | 50 Hz m ³ /min | 60 Hz m ³ /min | 50 Hz m ³ /min | 60 Hz m ³ /min | 50 Hz m ³ /min | 60 Hz m ³ /min | 50 Hz m ³ /min | 60 Hz m ³ /min | |
| 315 | 46/44 | 56/53 | 38.5/38 | 46/46 | 26.5/– | 31/– | – | – | |
| 355 | 44/– | 53/– | 63/63 | 75/75 | 40.5/– | 48.5/– | – | – | |
| 400 | 72 | 84 | 78 | 96 | 102 | 120 | 78 | 96 | |
| 450 | 90 | 108 | 126 | 150 | 90 | 108 | 72 | 84 | |

¹⁾ Value: IE2/IE1

Introduction

Electrical design

Motor protection

1

Overview

The order variants for motor protection are coded with letters in the 15th position of the Article No. and, if necessary, using order codes.

In the standard version, the motor is designed without motor protection.

15th position of the Article No. letter **A**.

A distinction is made between current-dependent and motor-temperature-dependent protection devices.

The following applies to all motors:

The motors can withstand 1.5 times the rated current at rated voltage and frequency for two minutes (EN 60034).

Note:

Electrically protective separation of the built-in winding components for low-voltage motors is the insulation of the sensors for winding protection.

All sensors for winding protection, which can be selected under the Article No. supplements and options for motor protection meet the requirements of basic insulation.

The basic insulation is tested in accordance with Siemens Product Standard 60034-1 and 60034-18-41 and relates to all sensors and built-in components that are installed in the winding, such as PTC, NTC, KTY, Pt100 and bimetal switch.

For example, by ordering with letter **B** in the 15th position of the Article No or as an option with order code **Q11** "1 or 3 PTC thermistors – for tripping".

The Pt1000 already meets the requirements for electrically protective separation according to IEC 61800-5-1.

Current dependent protection devices

Fuses are only used to protect power cables in the event of a short-circuit. They are not suitable for overload protection of the motor.

The motors are usually protected by thermally delayed overload protection devices (circuit breakers for motor protection or overload relays), e.g. with SIRIUS industrial controls and protection relays. For further details, see Catalog IC 10.

This protection is current-dependent and is particularly effective in the case of a locked rotor.

For standard duty with short start-up times and starting currents not too excessive and for low numbers of switching operations, motor protection switches provide adequate protection. Motor protection switches are not suitable for heavy starting duty or large numbers of switching operations. Differences in the thermal time constants for the protection equipment and the motor result in unnecessary early tripping when the protection switch is set to rated current.

Motor-temperature-dependent protective devices and motor temperature detection with converter operation

Depending on the specific requirements, various different components can be built into the motor winding for switching off the motor before it overheats and for monitoring the winding temperature and motor temperature.

Temperature detectors – Bimetal switches

Bimetal switches operate on the principle of mechanical deformation as a result of long-term heating. Bimetal strips bent as a result of such heating have a spring action that results in sudden reversal of the curvature (concave to convex or vice-versa).

When a limit temperature is reached, these temperature detectors (NC contacts) can deactivate an auxiliary circuit. The circuit can only be reclosed following a considerable fall in temperature. Bimetal switches are suitable protection devices in the case of slowly rising motor temperatures. When the motor current rises quickly (e.g. with a locked rotor), these switches are not suitable due to their large thermal time constants.

Temperature detectors for tripping:

15th position of the Article No. letter **Z** and order code **Q3A**.

The temperature detectors have the following current-carrying capacity and switching capacity:

230 V, AC: 2.5 A

24 V, DC: 1.6 A

PTC thermistors – Thermistor motor protection

PTC thermistors provide the most comprehensive protection against thermal overloading of the motor. A rise in the winding temperature over the admissible value can be accurately detected thanks to the low heat capacity of these PTC (Positive Temperature Coefficient) thermistors and their excellent heat contact with the winding. When the limit temperature is reached (rated tripping temperature), the PTC thermistors undergo a sudden change in resistance. This is evaluated by tripping units and can be used to open auxiliary circuits. PTC thermistors cannot themselves be subjected to high currents and voltages. This results in the destruction of the semiconductor. The switching hysteresis of the PTC thermistor and tripping unit is low, which supports fast restarting of the drive. Motor protection of this type is recommended for heavy duty starting, switching duty, extreme changes in load, high ambient temperatures or fluctuating supply systems.

Motor protection with PTC thermistor for tripping. In the terminal box, two auxiliary terminals are required.

15th position of the Article No. letter **B**.

Two temperature sensor circuits are used if a warning is required before the motor is shut down (tripped).

The warning is normally set to 10 K below the tripping temperature.

Motor protection with PTC thermistor for alarm and tripping.

In the terminal box, 4 auxiliary terminals are required.

15th position of the Article No. letter **C**.

The following applies to 1LE1 motors:

Motor protection for frame sizes 80 and 90 is implemented with the 15th position of the Article No. letter **B**, and with the order code **Q11** with a PTC thermistor.

Motor protection for frame sizes 80 and 90 is implemented with the 15th position of the Article No. letter **C**, and with the order code **Q12** with two PTC thermistors.

The following applies to 1MB1 motors:

The motor protection is implemented with the 15th position of the Article No. letter **B** with three PTC thermistors.

The motor protection is implemented with the 15th position of the Article No. letter **C** with six PTC thermistors.

In order to achieve full thermal protection, it is necessary to combine a thermally delayed overcurrent release and a PTC thermistor. For full motor protection implemented only with PTC thermistors, please inquire.

The SIRIUS 3RN2 thermistor motor protection device for protecting motors against overheating by means of direct temperature measurement, also for a hazardous area with ATEX approval, can be ordered separately. For further details, see Catalog IC 10 or www.siemens.com/product?3RN2.

OverviewPTC thermistor characteristic

The PTC thermistor is a temperature-dependent component. At the smallest changes in temperature in the region of the rated shutdown temperature, the resistance of the PTC increases steeply.

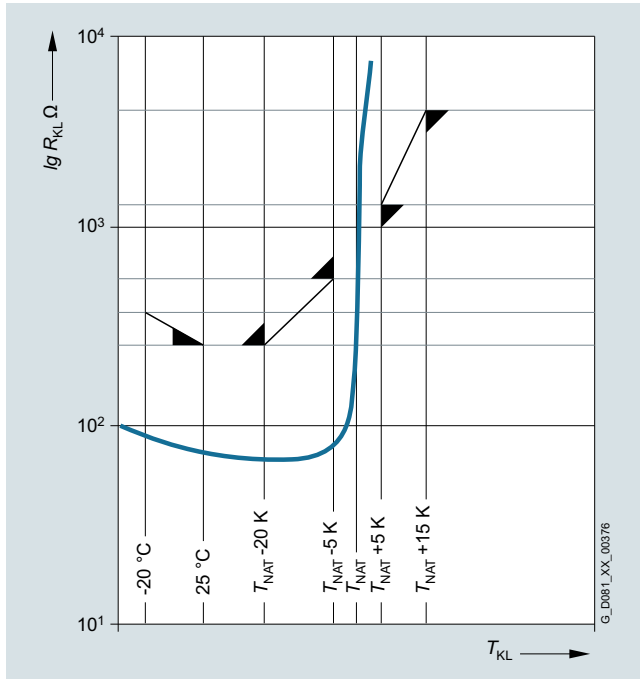

PTC sensor characteristic

NTC thermistor

NTC thermistors have a negative temperature coefficient and conduct current at higher temperatures better than at lower temperatures.

NTC thermistors are typically used for temperature compensation of electronic circuits, or to limit inrush currents, to achieve the soft starting of electrical machines, for example.

Motor temperature monitoring and shutdown using NTC thermistors is unusual, but it is technically possible. The tripping temperature can be set when using suitable tripping devices of this type.

NTC thermistors for tripping: 15th position of the Article No. letter **Z** and order code **Q2A**.

For line operation, the SIRIUS 3RS1, 3RS2 temperature monitoring relay, which forms part of the protection equipment, can be ordered separately.

For further details, see Catalog IC 10 or www.siemens.com/product?3RS1.

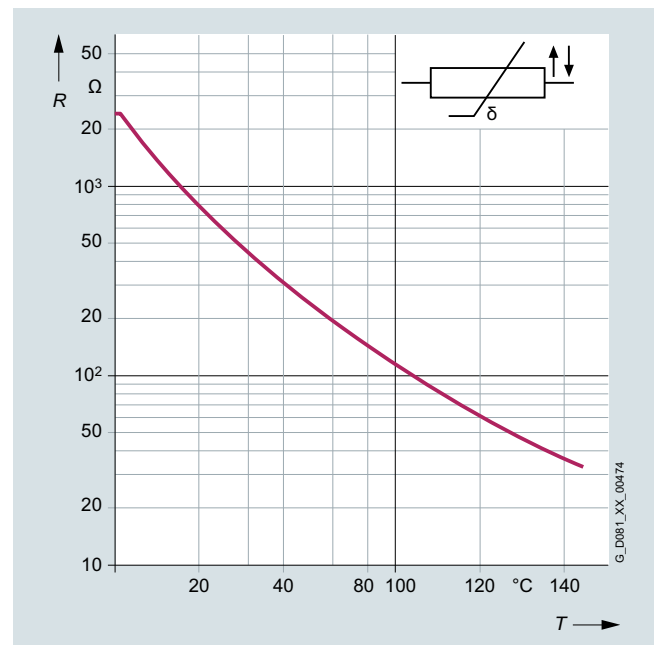
NTC thermistor characteristic

Introduction

Electrical design

Motor protection

Overview

KTY 84-130 temperature sensor

This temperature sensor is a semiconductor which, in a similar manner to a PTC thermistor, changes its resistance as a function of its temperature at a defined rate. Within the measuring range, however, the KTY 84-130 characteristic rises almost linearly. The temperature sensor is embedded in the winding overhang of the motor in the same way as the components mentioned above. It is characterized by its outstanding precision, high reliability, and temperature stability, as well as a fast response time. Thanks to these properties, which permit the almost analog monitoring of winding temperature, the KTY 84-130 is preferred for converter operation.

Motor temperature detection with embedded KTY 84-130 temperature sensor: In the terminal box, two auxiliary terminals are required.

15th position of the Article No. letter **F**.

Temperatures for alarm and tripping can be set as required when using converters from Siemens that determine the motor temperature in accordance with the measuring principle described above. With these devices, the measured signal is evaluated directly in the converter.

For line operation, the SIRIUS 3RS1, 3RS2 temperature monitoring relay, which forms part of the protection equipment, can be ordered separately.

For further details, see [Catalog IC 10](#) or www.siemens.com/product?3RS1.

KTY 84-130 temperature sensor characteristic

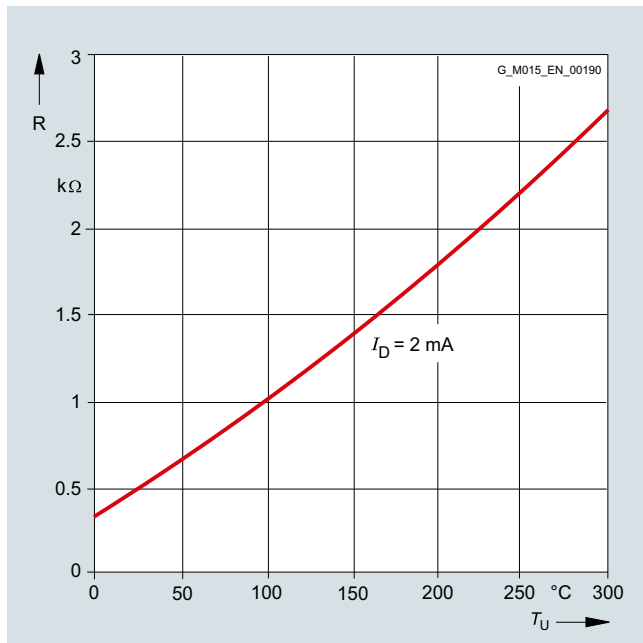

Pt100/Pt1000 resistance thermometer

The resistance thermometer has a chip for a temperature sensor, the resistance of which changes in relation to temperature according to a series of reproducible basic values. The changes in resistance are transferred as changes in current. At 0 °C, the measurement resistances are adjusted to 100 Ω for the Pt100 and 1000 Ω for the Pt1000, and correspond to the accuracy class B (i.e. the relationship between resistance and temperature). The limit deviation is ± 0.3 °C, and the admissible deviations are defined in EN 60751.

The Pt1000 resistance thermometer will, in the future, gradually replace the KTY84-130 temperature sensors available today. Similar to the method of operation of the Pt100, the relationship between the temperature and the electrical resistance of conductors is utilized in the Pt1000 to measure the temperature, just like with the additional resistance thermometers described above.

Pure metals undergo larger changes in resistance than alloys and have a relatively constant temperature coefficient.

The order options for the Pt100/Pt1000 temperature sensors are described in Chapter 2 (15th position of the Article No.: **H, J, K, L, P, Q, or R**, or order codes **Q35, Q36, Q60, Q61, Q62, Q63, Q64, Q72, Q78, or Q79**).

Temperatures for alarm and tripping can be set as required when using converters from Siemens that determine the motor temperature in accordance with the measuring principle described above. With these devices, the measured signal is evaluated directly in the converter.

In line operation, the SIRIUS 3RS1, 3RS2 temperature monitoring relay can be ordered separately for the protection equipment.

For further details, see [Catalog IC 10](#) or www.siemens.com/product?3RS1.

Pt100/Pt1000 resistance thermometer characteristics

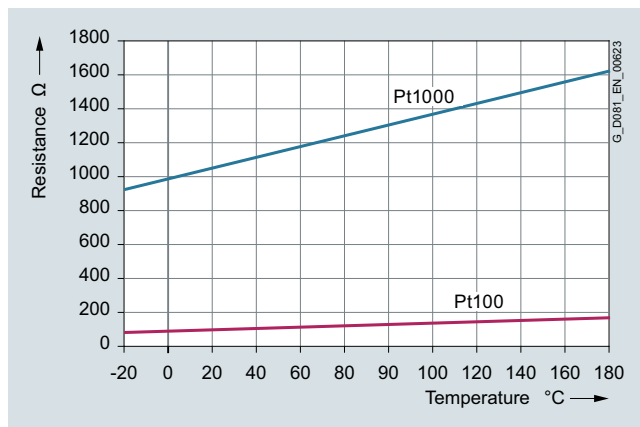

OverviewLocation of the terminal box

The terminal box of the motor can be mounted in four different locations or positions. For the motors of the 1LE10 aluminum series, frame sizes 63 and 71, the terminal box can only be mounted on the top (16th position of the Article No. **4**).

The position of the terminal box is coded using the 16th position of the motor Article No.

When defining the position of the terminal box, please observe the following:

- Motors with feet must always be viewed looking onto the drive end with the shaft in the horizontal position. The feet are then always at "6 o'clock". This is especially important with construction types IM B6, IM B7, and IM B8, and also applies to combined construction types such as IM B35.
- Flange-mounted motors (e.g. IM B5) whose drive-end flange has a condensation drainage hole must always be viewed looking onto the drive end with the shaft in the horizontal position. The condensation drainage hole is then always at "6 o'clock".

The aluminum series motors 1LE10 and 1PC10 with feet and standard power range have cast feet in the standard version in frame sizes up to 160, e.g. IM B3, IM B6, etc. (applies only to IE3 and IE4 motors with standard housing; IE3 and IE4 motors with long housing always have screwed-on feet). Motors from frame size 180 upwards have screwed-on feet. If rotation of the terminal box is to be possible in the future, the "Screwed-on feet" option, order code **H01**, must be ordered. In accordance with the type of construction, spare holes that are not used for mounting the feet can be used by the customer. If the customer would like this option, it is advisable to include order code **H10** "Housing with screw mounting" in the order – possible only for frame sizes 80, 90, 180 and 200. Responsibility for any strength calculations required for this type of customer mounting lies with the customer.

For all motors with increased power and with feet, the feet are screwed-on as standard. The terminal box can be rotated later. Motors with frame sizes 225 to 315 are supplied as standard with cast feet.

Terminal box on right-hand side:
16th position of the Article No. digit **5**

Terminal box on left-hand side:
16th position of the Article No. digit **6**

Terminal box below:
16th position of the Article No. digit **7**

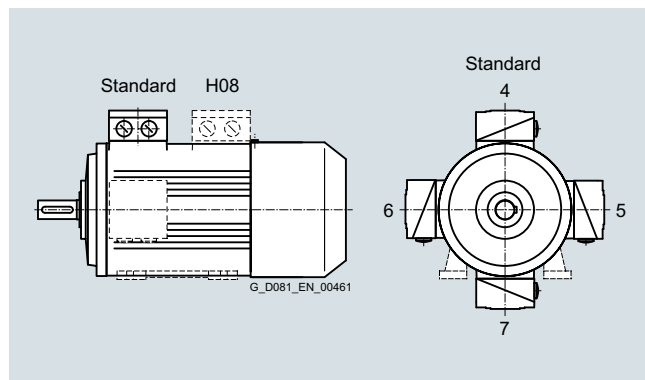

Location of the terminal box with the corresponding digits in the 16th position of the Article No.

The number of winding ends depends on the winding design. Three-phase motors are connected to the three phase conductors L1, L2 and L3 of a three-phase system. The rated voltage of the motor in the running connection must match the phase conductor voltages of the network.

When the three phases are operating in a time sequence and are connected to the terminals of the motor in alphabetical order U1, V1 and W1, clockwise rotation of the motor shaft is established as viewed onto the drive end. The direction of rotation of the motor can be changed to counterclockwise if two connecting leads are interchanged.

Labeled terminals are provided to connect the protective conductor.

A PE terminal is provided in the terminal box for grounding. A grounding terminal is provided on the outside of the motor housing – special version for 1LE1/1PC1 motors.

Order code **H04**

External grounding terminal/external grounding is standard for 1LE15/16 motors from frame size 180 upwards and for 1LE5/1MB5 motors of frame sizes 400 and 450.

A second external grounding connection can also be ordered. Order code **H70** (must be ordered in combination with option **H04**)

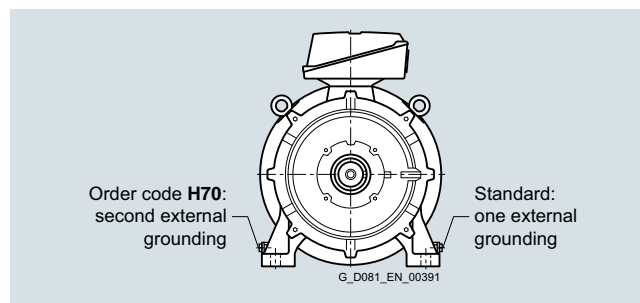

If a brake control system or thermal protection is installed, the connections will also be in the terminal box. The motors are suitable for direct connection to the line supply.

Design of the terminal box

The number of terminals and the size of the terminal box are designed for standard requirements.

For special requirements, or on customer request, a larger terminal box can be supplied.

For motors with frame sizes 71 up to 90, the following constraints apply:

For configuration, note that, when the terminal box is located on the left or right-hand sides, the customer must not align the cable entry towards the housing feet, because this can cause collisions between the motor connection cables and the foundations.

Larger terminal box

Order code **R50**

If the necessary installation angle of the motor would cause machine components to collide with the terminal box, the terminal box can be moved from the drive end (DE) to the non-drive end (NDE). Only use according to temperature class 155 (F). When the terminal box is rotated to the non-drive end (NDE) of the motor, it is important to note that dimensions "C" and "CA" will not comply with the values specified by EN 50347. Dimensional drawings can be requested via DT Configurator.

Order code **H08**

Introduction

Electrical design

Connection, circuit and terminal boxes

Overview

Motor connection

Line feeder cables

The line feeder cables must be dimensioned acc. to DIN VDE 0298. The number of required feeder cables, if necessary in parallel, is defined by:

- The max. cable cross-section which can be connected,
- The cable type,
- The cable routing,
- The ambient temperature and the corresponding admissible current in accordance with DIN VDE 0298,
- The requirements according to IEC/EN 60204-1,
- The requirements according to IEC/EN 60079-14 for 1MB motors.

For motors with auxiliary terminals (e.g. 15th position of the Article No. letter **B**), additional cable entry holes are provided (M16 × 1.5 or M20 × 1.5 depending on frame size).

For further details, see the data sheet function in the DT Configurator.

The terminal box is located on the housing and bolted in place. The terminal box can be turned by 4 × 90° degrees on the terminal base of the machine housing in the case of a terminal board with 6 terminal studs (standard version).

Order code **R09**

Parallel feeders

Some motors must be fitted with parallel feeders due to the maximum permissible current per terminal. These motors are indicated in the selection and ordering data in the respective chapter.

The temperature rises in the terminal box must be taken into account when selecting the connection cable or individual connections.

These approximate temperature rises are as follows:

- Range of ambient temperature (T_{amb}) +50 K for motors with temperature class Th.Cl.155 (F).
- Range of ambient temperature (T_{amb}) +60 K for motors with temperature class Th.Cl.180 (H).
- Without any specifications in field 19 (T_{amb}) on the rating plate, T_{amb} is equal to 40 °C.

Location of the cable entries with the corresponding order codes

| Motor | Frame size | Terminal box | Terminal box position | | | | Bottom | Retrofitting possible | Rotation of the terminal box and cable entry | | | Retrofitting possible |
|---------------------------------------|-------------|-------------------|-----------------------|-----------------|----------------|--------|--------|------------------------------------|--|------------|------------|-----------------------|
| | | | Top | Right-hand side | Left-hand side | Bottom | | | -90° | +90° | 180° | |
| Type | Type | Type | 4 | 5 | 6 | 7 | 4 | Article No. with -Z and order code | | | | |
| | | | | | | | | H01 | R10 | R11 | R12 | |
| 1FP10, 1LE10, 1MB10, 1PC10 | 63 ... 71 | TB1B00, TB1B10 | ✓ | – | – | – | – | – | ✓ | ✓ | ✓ | Yes |
| | 80 ... 90 | TB1E00, TB1E10 | ✓ | ✓ | ✓ | – | – | – | ✓ | ✓ | ✓ | Yes |
| | 100, 112 | TB1F00, TB1F10 | ✓ | ✓ | ✓ | – | – | – | ✓ | ✓ | ✓ | Yes |
| | 132 | TB1H00, TB1H10 | ✓ | ✓ | ✓ | – | – | – | ✓ | ✓ | ✓ | Yes |
| | 160 | TB1J00, TB1J10 | ✓ | ✓ | ✓ | – | – | – | ✓ | ✓ | ✓ | Yes |
| | 180 | – | ✓ | ✓ | ✓ | – | – | – | ✓ | ✓ | ✓ | Yes |
| 1FP15, 1LE15, 1MB15 ⁶⁾ | 71 | TB1D01 | ✓ | ✓ | ✓ | – | – | – | ✓ | ✓ | ✓ | Yes |
| | 80, 90 | – | ✓ | ✓ | ✓ | – | – | – | ✓ | ✓ | ✓ | Yes |
| 1FP15, 1LE15/6, 1MB15/6 ⁶⁾ | 100 ... 160 | TB1F01 ... TB1R01 | ✓ | ✓ | ✓ | – | – | – | ✓ | ✓ | ✓ | Yes |
| | 180 ... 315 | – | ✓ | ✓ | ✓ | – | – | – | ✓ | ✓ | ✓ | Yes |
| 1PC13 | 80, 90 | – | ✓ | ✓ | ✓ | – | – | – | ✓ | ✓ | ✓ | Yes |
| | 100 ... 160 | – | ✓ | ✓ | ✓ | – | – | – | ✓ | ✓ | ✓ | Yes |
| | 180 ... 315 | – | ✓ | ✓ | ✓ | – | – | – | ✓ | ✓ | ✓ | Yes |

| Motor | Frame size | Terminal box | Terminal box position | | | | | | Bottom | Rotation of the terminal box and cable entry | | | Retrofitting possible |
|--------------------------|-------------|--------------|-----------------------|-----------|----------|-----------|-----------|----------|--------------------|--|------------|------------|-----------------------|
| | | | Top left | Top right | 45° left | 45° right | 90° right | 90° left | | -90° | +90° | 180° | |
| Type | Type | Type | 0 | 1 | 2 | 3 | 5 | 6 | 9 ^{1) 2)} | Article No. with -Z and order code | | | |
| | | | | | | | | | | R10 | R11 | R12 | |
| 1LE5, 1MB5 ⁶⁾ | 315 | TB3Q01 | ✓ | ✓ | ✓ | ✓ | ✓ | ✓ | ✓ | ✓ | ✓ | ✓ | Yes |
| | 355 | TB3R01 | ✓ | ✓ | ✓ | ✓ | ✓ | ✓ | ✓ | ✓ ³⁾ | ✓ | ✓ | Yes |
| | 400 ... 450 | TB3R61 | ✓ | ✓ | ✓ | ✓ | ✓ | ✓ | ✓ | ✓ ⁵⁾ | ✓ | ✓ | No ⁴⁾ |

- ¹⁾ Article No with the following order code:
R5L – terminal box on left-hand side (base below)
R6R – terminal box on right-hand side (base below)
R7L – terminal box bottom left
R7R – terminal box bottom right

- ²⁾ Only possible in combination with type of construction IM B5.

Cable entry on the terminal box

With a view onto the drive end of the motor with the shaft in the horizontal position and the terminal box on the top, the cable entry is always on the right-hand side of the motor, as shown in the figure below – standard position 0°.

The terminal box can be rotated on the base of the motor housing such that the cable entry is located in the positions given below:

- Towards the drive end (DE)
(rotation of terminal box by 90°, entry from DE) for B5 types of constructions only with order code **H08!**

With B14 construction types, the customer must ensure that sufficient space is available for cable outlet.

Order code **R10**

- Towards the fan end (NDE)
(rotation of terminal box by 90°, entry from NDE)
Order code **R11**

- Opposite the standard position 0°
(rotation of terminal box by 180°, entry opposite the standard position 0°)
Order code **R12**

The dimensions of the terminal box are listed in the section "Dimensions" on pages 2/142 to 2/181 in accordance with the frame size and the "Dimensional drawings".

If the position of the terminal box (right-hand side, left-hand side, or top) is changed, the position of the cable entry must be checked and, if necessary, ordered with the corresponding order codes (**R10**, **R11**, and **R12**).

Overview



Terminal box in standard position, detailed view

Ordering example:

Terminal box on right-hand side (16th position of the Article No. digit **5**):

Cable entry is from below unless another order code is specified.

Cable entry from drive end (DE) – Article No. with **-Z** and order code **R10**.

For cable entry to a standard terminal box, a metal cable gland can be ordered for motor connection.

One metal cable gland – Article No. with **-Z** and order code **R15**.

For special requirements for which standard holes for the cable entries are inadequate for the UK market, reduction pieces for M cable glands in accordance with British Standard that are mounted on both cable entries can be supplied (only up to frame size 160).

Order code **R30**

| Frame size | Cable entry acc. to | |
|------------|---------------------|------------------|
| | IEC | British Standard |
| 100 | 2 × M32 | 2 × M20 |
| 112/132 | 2 × M32 | 2 × M25 |
| 160 | 2 × M40 | 2 × M32 |

Motor connectors

Motors of frame sizes 63 to 132 can be supplied with a motor connector.

The motor connectors are mounted on the specially designed terminal box at the factory and are aligned towards NDE in the basic version. The terminal boxes can be rotated by $4 \times 90^\circ$ on the base of the motor housing (order codes **R10**, **R12**, and **R13**).

The following motor connector variants are available:

- Motor connector HAN10B-10E
Order code **R70**
- Motor connector HAN10B-10E EMC
Order code **R71**
- Motor connector HAN3A-Q12 EMC
Order code **R72**
- Motor connector HAN3A-Q12
Order code **R73**

Motor connector assignment

| Motor Type | Frame size | Motor connectors Type | Size of the terminal box |
|-----------------|-------------|------------------------------|---|
| 1LE10 | 63 ... 70 | HAN10B-10E HAN10B-10E EMC | TB1B60 |
| | 80 ... 90 | HAN3A-Q12 HAN3A-Q12 EMC | TB1E00 with mounted brake TB1E10 |
| | 80 ... 90 | HAN10B-10E HAN10B-10E EMC | Only possible with TB1E10 |
| 1LE10, 1PC10 | 100 ... 132 | HAN10B-10E HAN10B-10E EMC | Currently only available with TB1F10 (frame sizes 100 and 112) or TB1H10 (frame size 132) |

Technical characteristic values of motor connectors according to EN 60664-1 and EN 61984

| Characteristic value | Motor connectors | | | |
|------------------------------|------------------|-----------|------------|-----------|
| | HAN3A-Q12 | | HAN10B-10E | |
| Degree of pollution | 3 | | 2 | |
| Rated current | 10 A | | 16 A | |
| Rated voltage | 400 V | 400/690 V | 500 V | 400/690 V |
| Rated voltage acc. to UL/CSA | 600 V | | 600 V | |

For further technical specifications of the motor connectors, refer to the catalog of Harting Deutschland GmbH & Co. at www.harting.com

or
<https://b2b.harting.com/ebusiness/de/industrie-steckverbinder-han/100382>.

Protruding cable ends

For confined spaces, protruding cable ends can be ordered without a terminal box with cover plate.

The following lengths of protruding cables can be ordered as standard using order codes:

- 3 cables protruding, 0.5 m long ¹⁾
Order code **R20**
- 3 cables protruding, 1.5 m long ¹⁾
Order code **R21**
- 6 cables protruding, 0.5 m long
Order code **R22**
- 6 cables protruding, 1.5 m long
Order code **R23**
- 6 cables protruding, 3.0 m long
Order code **R24**

The cross-section of the named cable refers to a coolant temperature of up to CT 40 °C.

¹⁾ For 3 protruding cables only, it must be specified in plain text whether star or delta connection is required (voltage code **90** and **M1Y**).

Introduction

Electrical design

Connection, circuit and terminal boxes

1

Overview

Terminal box type TB1B00

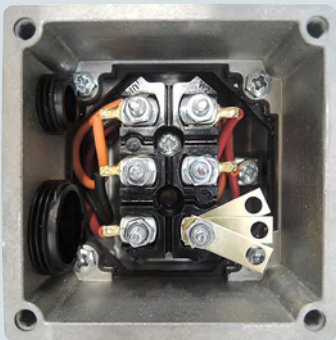

Terminal box type TB1B10

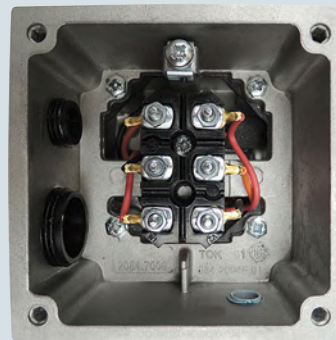

Terminal box type TB1E00

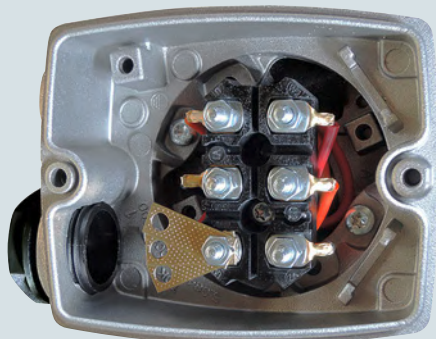

Terminal box type TB1E10 – order code **R50**

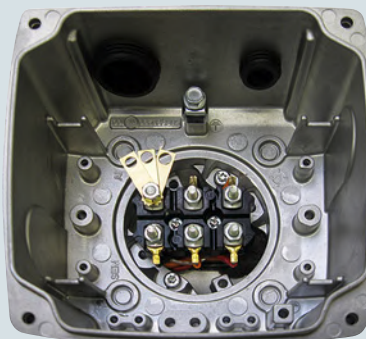

Terminal box types TB1F00, TB1H00, TB1J00

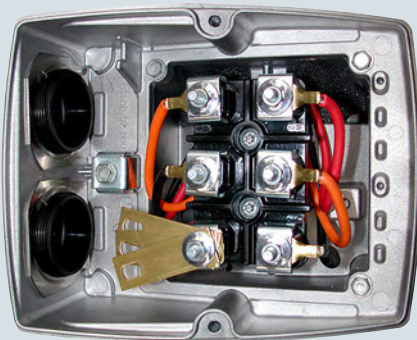

Terminal box types TB1F10, TB1H10, TB1J10 – order code **R50**

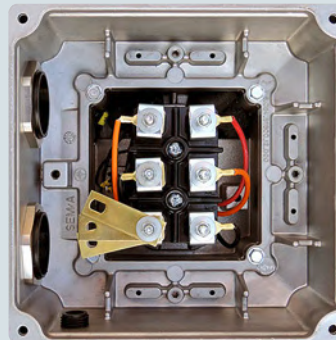

Terminal box type TB1L00



Terminal box type TB1L10 – order code **R50**

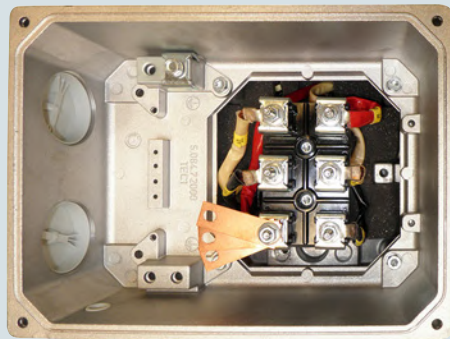

Overview

Terminal box type TB1J01



Terminal box type TB1L01



Terminal box type TB1N01



Terminal box type TB1Q01



Motor connector type HAN3A-Q12

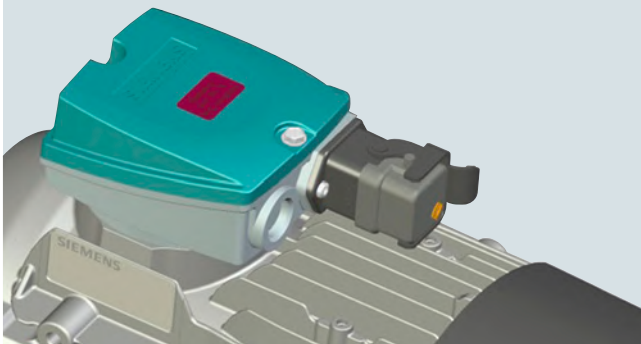

Motor connector type HAN10B-10E

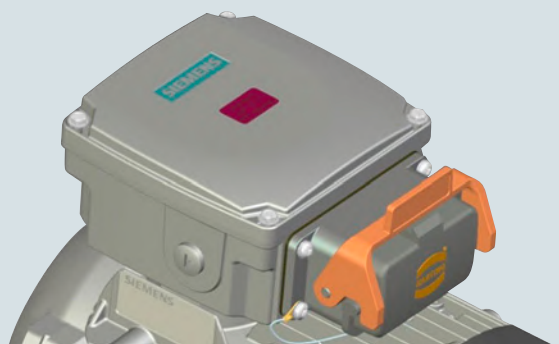

Terminal box type TB3R61

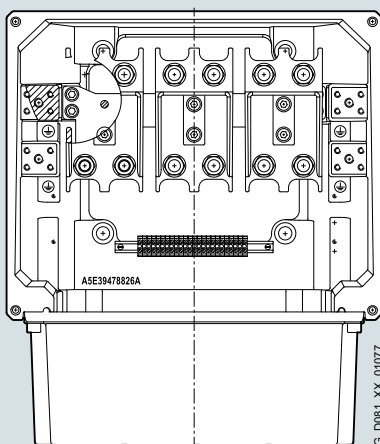

Terminal box type 1XB1631

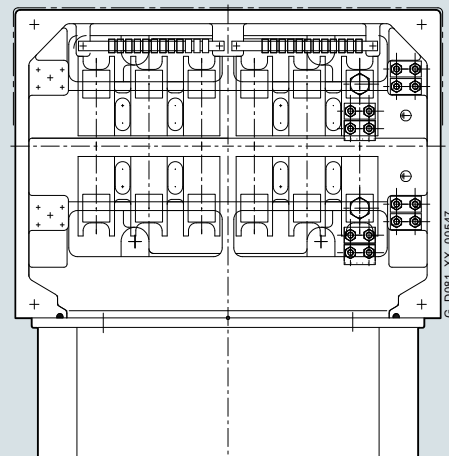

Introduction

Electrical design

Connection, circuit and terminal boxes

1

Overview

Terminal box type 1XB7750

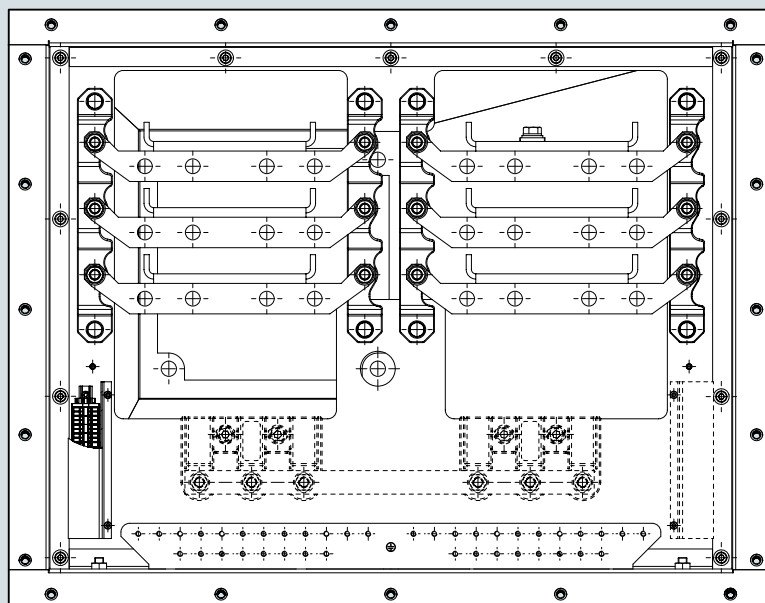

Basic data for terminal boxes for 1LE1, 1MB1, 1PC1, 1LE5, and 1MB5 motors

| Motor | Frame size | Terminal box | Cable entries/locking | Terminal box material | Feeder connection |
|---|--|--|--|-----------------------|--|
| 1LE10/1MB10/1PC10 | | | | | |
| 1LE10 | 63 ... 71 | TB1B00 TB1B10 | 2 entries complete with sealing plugs, thread in terminal box, terminal box mounted and screwed in place | Aluminum alloy | <ul style="list-style-type: none"> • Cable lug • Rigid cable, no cable lug |
| 1LE10 | 80 ... 90 | TB1E00 | 1 entry complete with sealing plugs, thread in terminal box (2 entries with additional mounting components in the winding), terminal box mounted and screwed in place | Aluminum alloy | <ul style="list-style-type: none"> • Cable lug • Rigid cable, no cable lug |
| 1LE10/ 1MB10 | 80 ... 90 | TB1E10 | 2 entries complete with sealing plugs, thread in terminal box, terminal box mounted and screwed in place | Aluminum alloy | <ul style="list-style-type: none"> • Cable lug • Rigid cable, no cable lug |
| 1LE10 1MB10 ¹⁾ 1PC10 | 100 ... 180 80 ... 160 100 ... 160 | TB1F00 TB1H00 TB1J00 TB1F10 TB1H10 TB1J10 | 2 entries complete with sealing plugs and locknuts, terminal box mounted and screwed in place | Aluminum alloy | <ul style="list-style-type: none"> • Cable lug • Rigid cable, no cable lug |
| 1LE10 | 200 | TB1L00 TB1L10 | 2 entries complete with sealing plugs, thread in terminal box, terminal box mounted and screwed in place | Aluminum alloy | <ul style="list-style-type: none"> • Cable lug • Rigid cable, no cable lug |
| 1LE15/1LE16/1LE5/1MB15/1MB16/1MB5 | | | | | |
| 1LE15/ 1MB15 ¹⁾ | 71 ... 90 | TB1D01 | 2 entries complete with sealing plugs, thread in terminal box, terminal box mounted and screwed in place | Cast iron | <ul style="list-style-type: none"> • Cable lug • Rigid cable, no cable lug |
| 1LE15/ 1LE16/ 1MB15/ 1MB16 ¹⁾ 2) | 100 ... 315 | TB1F01 ... TB1R01 | 2 entries complete with sealing plugs, thread in terminal box, terminal box mounted and screwed in place | Cast iron | <ul style="list-style-type: none"> • Cable lug • Rigid cable, no cable lug |
| 1LE5, 1MB5 ²⁾ | 315 ... 355 | TB3Q01 TB3R01 | 2 entries complete with sealing plugs, thread in terminal box, terminal box mounted and screwed in place | Cast iron | <ul style="list-style-type: none"> • Cable lug • Rigid cable, no cable lug |
| 1LE5, 1MB5 ²⁾ | 355 (500 kW) | TB3R01 | 4 entries complete with sealing plugs, thread in terminal box, terminal box mounted and screwed in place | Cast iron | <ul style="list-style-type: none"> • Cable lug • Rigid cable, no cable lug |
| 1LE5/ 1MB5 | 400 ... 450 | TB3R61 1XB1631 1XB7750 | 4 entries complete with sealing plugs, thread in terminal box, terminal box mounted and screwed in place 8 entries complete with sealing plugs, thread in terminal box, terminal box mounted and screwed in place | Sheet steel | <ul style="list-style-type: none"> • Cable lug • Rigid cable, no cable lug |

¹⁾ The certified cable entries are supplied as standard for explosion-protected motors.
 - Frame sizes 63 to 200: One certified metric cable gland and one certified metric sealing plug
 - Frame sizes 225 to 315: Two certified metric cable glands

²⁾ 1MB15/1MB16 also applies to 1MB154, 1MB164, and 1MB155; 1MB5 also applies to 1MB554 and 1MB555.

Overview

Technical specifications for terminal boxes for 1LE1, 1LE5, 1MB1, 1MB5, and 1PC1 motors

| Frame size | Terminal box ¹⁾ Standard/larger (order code R50) | Number of terminals | Thread of the contact screw | Max. connect- able cable mm ² | Outer cable diameter (sealing range) mm | Cable entry ^{2) 3)} |
|--------------------------------|---|---------------------------|-----------------------------------|--|---|---|
| 1LE10/1MB10/1PC1 | | | | | | |
| 63 ... 71 | TB1B00/TB1B10 | 6 | M4 | 1.5/2.5 with cable lug | M16 × 1.5: 4.5 ... 10; M25 × 1.5: 9 ... 17 | 1 × M25 × 1.5/ 1 × M16 × 1.5 + 1 × M25 × 1.5 |
| 80 and 90 | TB1E00/TB1E10 ⁴⁾ | 6 | M4 | 1.5/2.5 with cable lug | M16 × 1.5: 4.5 ... 10; M25 × 1.5: 9 ... 17 | 1 × M25 × 1.5/ 1 × M16 × 1.5 + 1 × M25 × 1.5 |
| 100 112 | TB1F00/TB1F10 | 6 | M4 | 4 | 11 ... 21 | 2 × M32 × 1.5 |
| 132 | TB1H00/TB1H10 | 6 | M4 | 6 | 11 ... 21 | 2 × M32 × 1.5 |
| 160 | TB1J00/TB1J10 | 6 | M5 | 16 | 19 ... 28 | 2 × M40 × 1.5 |
| 180 | | | | | | |
| 200 | TB1L00/TB1L10 | 6 | M6 | 25 | 27 ... 35 | 2 × M50 × 1.5 |
| 1LE15/1MB15 | | | | | | |
| 71 ... 90 | TB1D01 | 6 | M4 | 1.5/2.5 with cable lug | M16 × 1.5: 4.5 ... 10 M25 × 1.5: 9 ... 17 | 1 × M16 × 1.5 + 1 × M25 × 1.5 |
| 1LE15/1LE16/1MB15/1MB16 | | | | | | |
| 100 112 | TB1F01/TB1J01 | 6 | M4 | 4 | 11 ... 21 | 2 × M32 × 1.5/ 2 × M40 × 1.5 |
| 132 | TB1H01/TB1J01 | 6 | M4 | 6 | 11 ... 21 | 2 × M32 × 1.5 |
| 160 | TB1J01/TB1K01 | 6 | M5 | 16 | 19 ... 28 | 2 × M40 × 1.5 |
| 180 | TB1J01/TB1K01 | 6 | M5/M6 | 16/25 | 19 ... 28/ 27 ... 35 | 2 × M40 × 1.5/ 2 × M50 × 1.5 |
| 200 | TB1L01/TB1L01 | 6 | M6/M8 | 25/35 | 27 ... 35/ 27 ... 35 | 2 × M50 × 1.5/ 2 × M50 × 1.5 |
| 225 | TB1L01/TB1N01 | 6 | M8/M10 | 35/120 | 27 ... 35/ 34 ... 42 | 2 × M50 × 1.5/ 2 × M63 × 1.5 |
| 250 280 | TB1N01/TB1Q01 | 6 | M10/M12 | 120/240 | 34 ... 42/ 38 ... 45 | 2 × M63 × 1.5 2 × M63 × 1.5 |
| 315 | TB1Q01/TB1R01 | 6 | M12/M16 | 240 | 38 ... 45/ 44 ... 54 | 2 × M63 × 1.5 2 × M63 × 1.5 |
| | TB3Q01 | 6 | M12 | 185 | 38 ... 45 | 2 × M63 × 1.5 |
| | TB3Q61 | | | 240 | 42 ... 54 | 2 × M63 × 1.5 |
| 355 | TB1R01 | 6 | M16 | 240 | 56 ... 68.5 | 2 × M80 × 2 |
| | | 12 | 2 × M16 | | | 4 × M80 × 2 |
| 1LE55/1LE56/1MB5 | | | | | | |
| 315 | TB3Q01/TB3R01 | 6 | M12/M16 | 185/240 | 38 ... 45/ 42 ... 54 | 2 × M63 × 1.5 4 × M80 × 2 |
| 355 | TB3R01/TB3R61 | 12 | M16/2 × M16 | 300 | 56 ... 68.5/ 56 ... 68.5 | 2 × M80 × 2 4 × M80 × 2 |
| 400 ... 450 | TB3R61/1XB7750 | 12 | M16 | 240 | 56 ... 64.5 | 4 × M80 × 2 |
| | 1XB1631/1XB7750 | | M16 | 300 | 56 ... 64.5 | 4 × M80 × 2 |
| | -/1XB7750 | 48 | M12 | 300 | 41 ... 57 | 8 × M72 × 2 |
| – not available | | | | | | |

Terminal connection

The terminal board accommodates the terminals that are connected to the leads to the motor windings. The terminals are designed so that for frame sizes 71 to 315, the external (line) connections can be made without the need for cable lugs.

¹⁾ In addition to the exact part designation, please specify the machine type and the serial number in all orders for spare parts and repair parts.

²⁾ Designed for cable glands with O-ring.

³⁾ NPT threads can be ordered with order code **Y61**.

⁴⁾ For 1LE1021, 1LE1023, and 1MB10, terminal box TB1E10 normal version.

Introduction

Electrical design

Connection, circuit and terminal boxes

1

Overview

Maximum number of auxiliary terminal boxes for main terminal box

| Maximum number of auxiliary terminal boxes TB2J01, TB2N01 (order codes R62, R63) in combination with standard terminal box | | | | | | | | | | | | |
|--|------------|--------------|--------|--------|-----|--------|-----|--------|-----|--------|--------|--------|
| | | Frame size | | | | | | | | | | |
| | | 100, 112 | 132 | 160 | 180 | 200 | 225 | 250 | 280 | 315 | 355 | |
| | | Terminal box | | | | | | | | | | |
| | | Type | | | | | | | | | | |
| Auxiliary terminal box Type | Order code | TB1F01 | TB1H01 | TB1J01 | | TB1L01 | | TB1N01 | | TB1Q01 | TB3Q01 | TB3R01 |
| TB2J01 | R62 | – | – | 2 | | 2 | | 2 | | 2 | 4 | 4 |
| TB2N01 | R63 | – | – | – | | – | | – | | – | 2 | 2 |

| Maximum number of auxiliary terminal boxes TB2J01, TB2N01 (order codes R62, R63) in combination with large terminal box (order code R50) | | | | | | | | | | | | |
|--|------------|--------------|-----|--------|-----|--------|--------|--------|-----|--------|--------|---|
| | | Frame size | | | | | | | | | | |
| | | 100, 112 | 132 | 160 | 180 | 200 | 225 | 250 | 280 | 315 | 355 | |
| | | Terminal box | | | | | | | | | | |
| | | Type | | | | | | | | | | |
| Auxiliary terminal box Type | Order code | TB1J01 | | TB1K01 | | TB1L01 | TB1N01 | TB1Q01 | | TB1R01 | TB3R01 | |
| TB2J01 | R62 | 2 | 2 | 2 | | 2 | 2 | 2 | | 2 | 4 | 4 |
| TB2N01 | R63 | – | – | – | | – | – | – | | – | 2 | 2 |

| Maximum number of auxiliary terminal boxes TB2J01, TB2N01 (order codes R62, R63) in combination with universal terminal box (order code R52 or R53) | | | | | | | | | | | |
|---|------------|---------------|--|--------|--------|-----|--------|-----|--------|--------|--------|
| | | Frame size | | | | | | | | | |
| | | 100 ... 160 | | | 180 | 200 | 225 | 250 | 280 | 315 | 355 |
| | | Terminal box | | | | | | | | | |
| | | Type | | | | | | | | | |
| Auxiliary terminal box Type | Order code | | | TB1J61 | TB1L61 | | TB1N61 | | TB1Q61 | TB3Q41 | TB3R41 |
| TB2J01 | R62 | Not available | | 2 | 2 | | 2 | | 2 | 4 | 4 |
| TB2N01 | R63 | – | | – | – | | – | | – | 2 | 2 |

Position of auxiliary terminal box in relation to position of TB1J01, TB1L01, TB1N01, TB1Q01, TB1K01 main terminal box

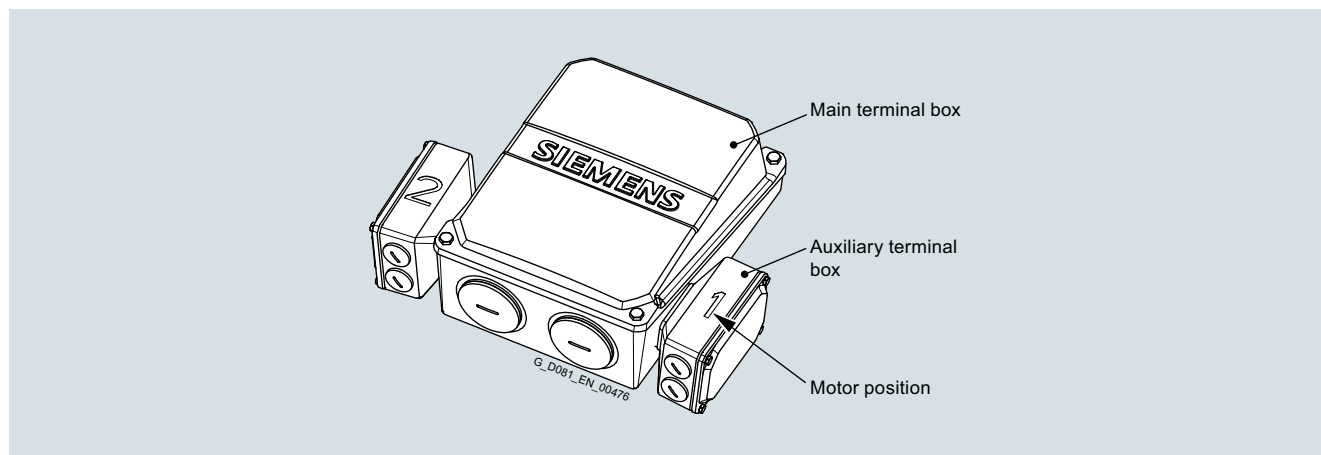

| Auxiliary terminal box TB2J01 (order code R62) in combination with TB1J01, TB1L01, TB1N01, TB1Q01, TB1K01 main terminal box | | | | | | | | | | | | | |
|---|-------|--|-------|-------|-------|--------------------|-----|----------------|-------|---------------------|-----|-------|------|
| Position of the main terminal box | | Right-hand side | | | | | | Left-hand side | | | | | |
| Top | | 4 | | | | | | 5 | | | | | |
| 16th position of Article No. and when ordering with order code, Article No. with -Z | | 4 | | | | | | 5 | | | | | |
| Rotation of terminal box | | 90°, entry from DE | | | 180° | 90°, entry from DE | | | 180° | 90°, entry from NDE | | | 180° |
| Order code | | R10 | R11 | R12 | – | R10 | R11 | R12 | – | R10 | R11 | R12 | |
| Number of auxiliary terminal boxes | | Positions of auxiliary terminal boxes – see Figure | | | | | | | | | | | |
| 1 | 1 | 1 | 1 | 2 | 1 | 2 | 1 | 2 | 2 | 1 | 2 | 1 | |
| 2 | 1 + 2 | 1 + 2 | 1 + 2 | 1 + 2 | 1 + 2 | – | – | 1 + 2 | 1 + 2 | – | – | 1 + 2 | |

Overview

Position of auxiliary terminal box in relation to position of TB1R01, TB1J61, TB1L61, TB1N61, TB1Q61 main terminal box

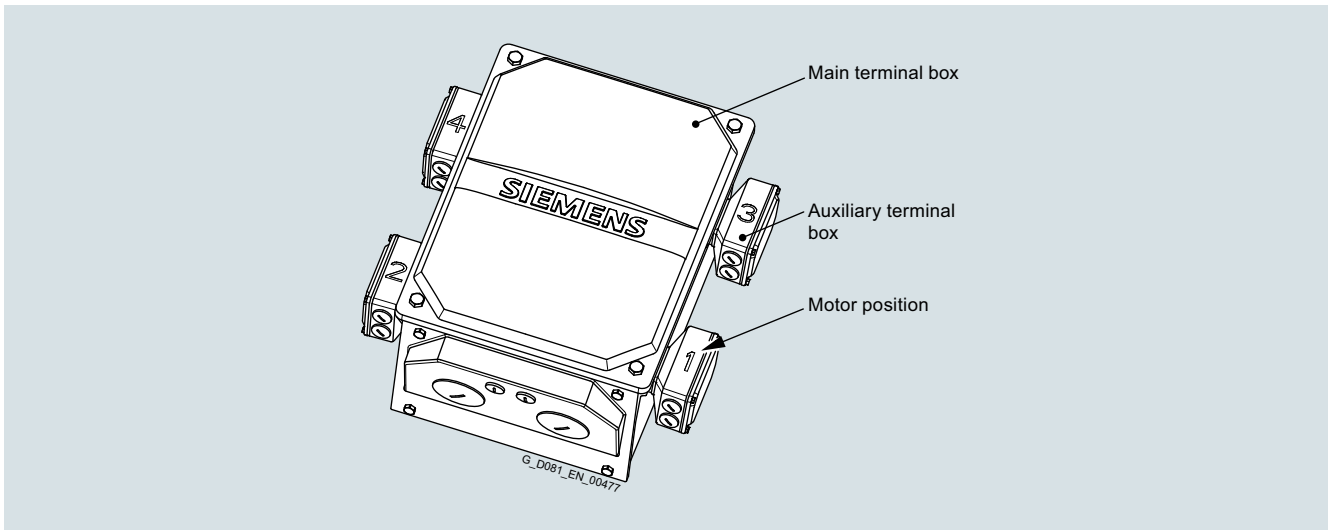

Auxiliary terminal box TB2J01 (order code R62) in combination with TB1R01, TB1J61, TB1L61, TB1N61, TB1Q61 main terminal box

Position of the main terminal box

Top

Right-hand side

Left-hand side

16th position of Article No. and when ordering with order code, Article No. with -Z

4

5

6

Rotation of terminal box

0°
(default)90°,
entry from
DE90°,
entry from
NDE

180°

0°
(default)90°,
entry from
DE90°,
entry from
NDE

180°

0°
(default)90°,
entry from
DE90°,
entry from
NDE

180°

Order code

-

R10

R11

R12

-

R10

R11

R12

-

R10

R11

R12

Number of
Auxiliary terminal
boxes

Positions of auxiliary terminal boxes – see Figure

| | 4 | | | | 5 | | | | 6 | | | |
|--------------|-------------|-------------|-------------|-------------|-------------|-----|-----|-------------|-------------|-----|-----|-------------|
| | 1 | 1 | 1 | 2 | 1 | 2 | 1 | 2 | 2 | 1 | 2 | 1 |
| 1 | 1 | 1 | 1 | 2 | 1 | 2 | 1 | 2 | 2 | 1 | 2 | 1 |
| 2 | 1+3 | 1+3 | 1+3 | 2+4 | 1+3 | 2+4 | 1+3 | 2+4 | 2+4 | 1+3 | 2+4 | 1+3 |
| (3 on requ.) | 1+2+3 | 1+2+3 | 1+2+3 | 1+2+4 | 1+2+3 | - | - | 1+2+4 | 1+2+4 | - | - | 1+2+3 |
| (4 on requ.) | 1+2+3+ 4 | 1+2+3+ 4 | 1+2+3+ 4 | 1+2+3+ 4 | 1+2+3+ 4 | - | - | 1+2+3+ 4 | 1+2+3+ 4 | - | - | 1+2+3+ 4 |

Introduction

Electrical design

Degrees of protection

1

Overview

All motors are designed to IP55 degree of protection. They can be installed in dusty or humid environments. The motors are suitable for operation in tropical climates. Guide value < 60 % relative air humidity at CT 40 °C. Other requirements are available on request (see table on page 1/28).

Brief explanation of the degree of protection

IP54:

- Protection against harmful dust deposits
- Protected against spray water

IP55:

- Protection against harmful dust deposits
- Protection against water jets from any direction

IP56:

- Protection against harmful dust deposits
- Protection against powerful water jets from any direction

Order code **H22**

Important: Note that submersion by waves or total immersion, even temporarily, is not permitted especially in the case of motors with fans. This corresponds to IP67 or IP68 degree of protection (please inquire).

EN 60034-5 defines protection level 6 for water protection as: "Protection against water due to heavy seas or water in a powerful jet". IP56 degree of protection can only be used with the requirement "Protection against a powerful jet" and not for the requirement "Protection against heavy sea".

Not possible in combination with brake BFK458 (order code **F01**).

IP65:

- Complete protection against dust deposits
- Protection against water jets from any direction

Order code **H20**

In EN 60034-5, the code 6 for protection against the ingress of foreign bodies and touch hazard protection for electrical machines is not listed – Data for code 6 (protection against the ingress of dust) is given in EN 60529.

Not possible in combination with HOG 9 DN 1024 I rotary pulse encoder (order code **G05**) and/or brake BFK458 (order code **F01**) and/or paint finish, cast-iron parts primed (order code **S00**).

EN 60529 contains a comprehensive description of this degree of protection as well as test conditions.

With motors that have a vertical shaft extension, the end user must prevent an ingress of fluid along the shaft.

For motors with shaft extension pointing downwards, the version "Protective cover for types of construction" order code **H00** is urgently recommended, see also the explanations on "Types of construction" on page 1/45.













With flange-mounted motors, for IM V3 type of construction, collection of fluid in the flange basin can be prevented by drainage holes (on request).

The condensation drainage holes at the drive end (DE) and non-drive end (NDE) are sealed (IP55) on delivery. If the condensation drainage holes are ordered for motors of the IM B6, IM B7 or IM B8 type of construction (feet on side or top), the position of the drainage holes will be in the correct position for the type of construction.

Order code **H03**

Overview

Standard types of construction and special types of construction

| Type of construction acc. to EN 60034-7 | | Frame size | Letter of the 14th position of the Article No. | Additional identification code -Z with order code |
|---|---|------------|--|--|
| Without flange | | | | |
| IM B3/IM 1001 |  | 63 to 450 | A | - |
| IM B6/IM 1051 |  | 63 to 355 | T | - |
| IM B7/IM 1061 |  | 63 to 355 | U | - |
| IM B8/IM 1071 |  | 63 to 355 | V | - |
| IM V5/IM1011 without protective cover |  | 63 to 450 | C ¹⁾ | - |
| IM V6/IM 1031 |  | 63 to 450 | D | - |
| IM V5/IM 1011 with protective cover |  | 71 to 450 | C | + H00 ²⁾ |
| With flange | | | | |
| IM B5/IM 3001 |  | 63 to 450 | F | - |
| IM V1/IM 3011 without protective cover |  | 63 to 450 | G ¹⁾ | - |
| IM V1/IM 3011 with protective cover |  | 71 to 450 | G | + H00 ²⁾ |
| IM V3/IM 3031 |  | 63 to 355 | H | - |
| IM B35/IM 2001 |  | 63 to 450 | J | - |
| IM V15/IM 2011 |  | 71 to 315 | W | - |

In the EN 50347 standard, flanges FF with through holes and flanges FT with tapped holes are specified.

For footnotes, see next page.











Introduction

Mechanical version

Types of construction

1

Overview

| Type of construction acc. to EN 60034-7 | | Frame size | Letter of the 14th position of the Article No. | Additional identification code -Z with order code |
|---|---|------------|--|--|
| With flange | | | | |
| IM B14/IM 3601 |  | 63 to 160 | K | – |
| IM V19/IM 3631 |  | 80 to 315 | L | – |
| IM V18/IM 3611 without protective cover |  | 80 to 315 | M ¹⁾ | – |
| IM V 18/IM 3611 with protective cover |  | 80 to 315 | M | + H00 ²⁾ |
| IM B34/IM 2101 |  | 80 to 315 | N | – |
| With flange – next largest | | | | |
| IM B14/IM 3601 |  | 80 to 315 | K | + P01 |
| IM B34/IM 2101 |  | 80 to 315 | N | + P01 |
| IM V18/IM 3611 without protective cover |  | 80 to 315 | M ¹⁾ | + P01 |
| IM V 18/IM 3611 with protective cover |  | 80 to 315 | M | + P01 + H00 ²⁾ |
| IM V19/IM 3631 |  | 80 to 315 | L | + P01 |

In EN 50347, flanges are assigned to the frame sizes as FT with tapped holes. See the table on the next page for flange dimensions.

The dimensions of the following types of construction are identical: IM B3, IM B6, IM B7, IM B8, IM V5 and IM V6
IM B5, IM V1 and IM V3
IM B14, IM V18 and IM V19

Motors in the standard power range can be ordered in basic types of construction IM B3, IM B5 or IM B14 and operated in mounting positions IM B6, IM B7, IM B8, IM V5, IM V6, IM V1, IM V3 (up to frame size 160 L) or IM V18 and IM V19. Lifting eyes are available for transport and installation in a horizontal position. In conjunction with the lifting eyes, for the purpose of stabilizing the position when the motor is arranged vertically, additional slings (EN 1492-1) and/or lashings (EN 12195-2) must be used.

When a motor for mounting position IM V1 is ordered directly, the motor is supplied with lifting eyes for vertical mounting (up to frame size 90 and frame sizes 180 and 200 for aluminum motors without eyebolts).

¹⁾  The following applies for explosion-protected motors: In the case of the types of construction with shaft extension pointing downwards, the version "with protective cover" is required. For types of construction with shaft extension pointing upwards, a suitable cover must be implemented to prevent small parts from falling into the fan cover (see the standard IEC/EN 60079-0). The cover must not block the cooling air flow.

The motors are designated in accordance with the types of construction on the rating plate.

With motors that have a vertical shaft extension, the end user must prevent an ingress of fluid along the shaft. In the case of all types of construction with shaft extension pointing downwards, the version "with protective cover" is urgently recommended, see section "Degrees of protection" on page 1/44 – housing version.

Motors with feet, in some cases, have two fixing holes at the non-drive end (NDE), see dimension tables on pages 2/142 to 2/181.

A screwed-on cover (made of sheet metal or plastic) is included as standard for horizontal types of construction and types of construction with shaft pointing upwards (14th position of the Article No. letter **A, T, U, V, D, F, H, J, K, L, N**) on motors up to FS 160 in combination with condensation drainage holes, order code **H03**.

²⁾ Standard cylindrical shaft extension (second shaft extension), order code **L05**, is not possible.

Overview

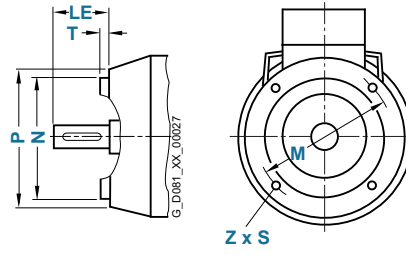
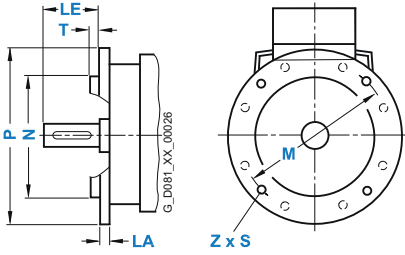

In EN 50347, the frame sizes are allocated flange FF with through holes and flange FT with tapped holes. The designation of DIN 42948 (invalid since September 2003) are also listed for information purposes. See the table below.
(Z = the number of retaining holes)

| Frame size | No. of poles | Type of construction | Flange type – possibly with order code | Flange with | | Dimension designation acc. to IEC | | | | | | | |
|-------------------|--------------------------------|---|--|--|--|-----------------------------------|------|------|------|------|------|-----|---|
| | | | | Through holes (FF/A) Acc. to EN 50347 | Tapped holes (FT/C) Acc. to DIN 42948 | LA | LE | M | N | P | S | T | Z |
| 63 M | 2 ... 8 | IM B5, IM B35, IM V1, IM V3 | Flange | FF115 | A 140 | – | 23 | 115 | 95 | 140 | 10 | 3 | 4 |
| | | | Next smallest flange – P02 | FF100 | A 120 | – | 23 | 100 | 80 | 120 | 7 | 3 | 4 |
| | IM B14, IM B34, IM V18, IM V19 | Flange | FF75 | C 90 | – | 23 | 75 | 60 | 90 | M6 | 2.5 | 4 | |
| | | Next largest flange ¹⁾ – P01 | FT100 | C 120 | – | 23 | 100 | 80 | 120 | M6 | 3 | 4 | |
| 71 M | 2 ... 8 | IM B5, IM B35, IM V1, IM V3 | Flange | FF130 | A 160 | 5 | 30 | 130 | 110 | 160 | 10 | 3.5 | 4 |
| | | | Next smallest flange – P02 | FF115 | A 140 | – | 30 | 115 | 95 | 140 | 10 | 3 | 4 |
| | IM B14, IM B34, IM V18, IM V19 | Flange | FT85 | C 105 | – | 30 | 85 | 70 | 105 | M6 | 2.5 | 4 | |
| | | Next largest flange ¹⁾ – P01 | FT115 | C 140 | – | 30 | 115 | 95 | 140 | M8 | 3 | 4 | |
| 80 M | 2 ... 8 | IM B5, IM B35, IM V1, IM V3 | Flange | FF165 | A 200 | 10 | 40 | 165 | 130 | 200 | 12 | 3.5 | 4 |
| | | | Next smallest flange – P02 | FF130 | A 160 | – | 40 | 130 | 110 | 160 | 10 | 3.5 | 4 |
| | IM B14, IM B34, IM V18, IM V19 | Flange | FT100 | C 120 | – | 40 | 100 | 80 | 120 | M6 | 3 | 4 | |
| | | Next largest flange ¹⁾ – P01 | FT130 | C 160 | – | 40 | 130 | 110 | 160 | M8 | 3.5 | 4 | |
| 90 S/L | 2 ... 8 | IM B5, IM B35, IM V1, IM V3 | Flange | FF165 | A 200 | 10 | 50 | 165 | 130 | 200 | 12 | 3.5 | 4 |
| | | | Next largest flange – P01 | FF215 | A 250 | – | 50 | 215 | 180 | 250 | 14.5 | 4 | 4 |
| | IM B14, IM B34, IM V18, IM V19 | Flange | FT115 | C 140 | – | 50 | 115 | 95 | 140 | M8 | 3 | 4 | |
| | | Next largest flange – P01 | FT130 | C 160 | – | 50 | 130 | 110 | 160 | M8 | 3.5 | 4 | |
| 100 L | 2 ... 8 | IM B5, IM B35, IM V1, IM V3 | Flange | FF215 | A 250 | 11 | 60 | 215 | 180 | 250 | 14.5 | 4 | 4 |
| | | | Next largest flange – P01 | FF265 | A 300 | 12 | 60 | 265 | 230 | 300 | 14.5 | 4 | 4 |
| | IM B14, IM B34, IM V18, IM V19 | Next smallest flange – P02 | FF165 | A 200 | 11 | 60 | 165 | 130 | 200 | 12 | 3.5 | 4 | |
| | | Flange | FT130 | C 160 | – | 60 | 130 | 110 | 160 | M8 | 3.5 | 4 | |
| 112 M | 2 ... 8 | IM B5, IM B35, IM V1, IM V3 | Next largest flange – P01 | FT165 | C 200 | – | 60 | 165 | 130 | 200 | M10 | 3.5 | 4 |
| | | | Next smallest flange – P02 | FT115 | C 140 | – | 60 | 115 | 95 | 140 | M8 | 3 | 4 |
| | IM B14, IM B34, IM V18, IM V19 | Flange | FF215 | A 250 | 11 | 60 | 215 | 180 | 250 | 14.5 | 4 | 4 | |
| | | Next largest flange – P01 | FF265 | A 300 | 12 | 60 | 265 | 230 | 300 | 14.5 | 4 | 4 | |
| 132 S/M | 2 ... 8 | IM B5, IM B35, IM V1, IM V3 | Next smallest flange – P02 | FF165 | A 200 | 11 | 60 | 165 | 130 | 200 | 12 | 3.5 | 4 |
| | | | Flange | FT130 | C 160 | – | 60 | 130 | 110 | 160 | M8 | 3.5 | 4 |
| | IM B14, IM B34, IM V18, IM V19 | Next largest flange – P01 | FF265 | A 300 | 12 | 80 | 265 | 230 | 300 | 14.5 | 4 | 4 | |
| | | Flange | FF300 | A 350 | 13 | 80 | 300 | 250 | 350 | 18.5 | 5 | 4 | |
| 160 M/L | 2 ... 8 | IM B5, IM B35, IM V1, IM V3 | Next smallest flange – P02 | FF215 | A 250 | 11 | 80 | 215 | 180 | 250 | 14.5 | 4 | 4 |
| | | | Flange | FT165 | C 200 | – | 80 | 165 | 130 | 200 | M10 | 3.5 | 4 |
| | IM B14, IM B34, IM V18, IM V19 | Next largest flange – P01 | FT215 | C 250 | – | 80 | 215 | 180 | 250 | M12 | 4 | 4 | |
| | | Flange | FF300 | A 350 | 13 | 110 | 300 | 250 | 350 | 18.5 | 5 | 4 | |
| 180 M/L | 2 ... 8 | IM B5, IM B35, IM V1, IM V3 | Next smallest flange – P02 | FF265 | A 300 | 12 | 110 | 265 | 230 | 300 | 14.5 | 4 | 4 |
| | | | Flange | FF350 | A 400 | 15 | 110 | 350 | 300 | 400 | 18.5 | 5 | 4 |
| | IM B14, IM B34, IM V18, IM V19 | Next smallest flange – P02 | FF300 | A 350 | 13 | 110 | 300 | 250 | 350 | 18.5 | 5 | 4 | |
| | | Flange | FF400 | A 450 | 16 | 110 | 400 | 350 | 450 | 18.5 | 5 | 8 | |
| 200 L | 2 ... 8 | IM B5, IM B35, IM V1, IM V3 | Next smallest flange – P02 | FF350 | A 400 | 15 | 110 | 350 | 300 | 400 | 18.5 | 5 | 4 |
| | | | Flange | FF300 | A 350 | 13 | 110 | 300 | 250 | 350 | 18.5 | 5 | 4 |
| | IM B14, IM B34, IM V18, IM V19 | Next smallest flange – P02 | FF400 | A 450 | 16 | 110 | 400 | 350 | 450 | 18.5 | 5 | 8 | |
| | | Flange | FF500 | A 550 | 18 | 140 | 500 | 450 | 550 | 18.5 | 5 | 8 | |
| 225 S/M | 2 ... 8 | IM B5, IM B35, IM V1, IM V3 | Next smallest flange – P02 | FF350 | A 400 | 15 | 110 | 350 | 300 | 400 | 18.5 | 5 | 4 |
| | | | Flange | FF300 | A 350 | 13 | 110 | 300 | 250 | 350 | 18.5 | 5 | 4 |
| | IM B14, IM B34, IM V18, IM V19 | Next smallest flange – P02 | FF400 | A 450 | 16 | 110 | 400 | 350 | 450 | 18.5 | 5 | 8 | |
| | | Flange | FF500 | A 550 | 18 | 140 | 500 | 450 | 550 | 18.5 | 5 | 8 | |
| 250 M | 2 ... 8 | IM B5, IM B35, IM V1, IM V3 | Next smallest flange – P02 | FF400 | A 450 | 16 | 110 | 400 | 350 | 450 | 18.5 | 5 | 8 |
| | | | Flange | FF500 | A 550 | 18 | 140 | 500 | 450 | 550 | 18.5 | 5 | 8 |
| | IM B14, IM B34, IM V18, IM V19 | Next smallest flange – P02 | FF400 | A 450 | 16 | 110 | 400 | 350 | 450 | 18.5 | 5 | 8 | |
| | | Flange | FF600 | A 660 | 22 | 140 | 600 | 550 | 660 | 24 | 6 | 8 | |
| 315 L for 1LE5 | 2 ... 8 | IM B5, IM B35, IM V1, IM V3 | Next smallest flange – P02 | FF740 | A 800 | 25 | 140 | 740 | 680 | 800 | 24 | 6 | 8 |
| | | | Flange | FF740 | A 800 | 25 | 140 | 740 | 680 | 800 | 24 | 6 | 8 |
| | IM B14, IM B34, IM V18, IM V19 | Next smallest flange – P02 | FF740 | A 800 | 25 | 140 | 740 | 680 | 800 | 24 | 6 | 8 | |
| | | Flange | FF840 | A 900 | 25 | 140 | 840 | 780 | 900 | 24 | 6 | 8 | |
| 315 M/L for 1LE5 | 2 ... 8 | IM B5, IM B35, IM V1, IM V3 | Next smallest flange – P02 | FF740 | A 800 | 25 | 140 | 740 | 680 | 800 | 24 | 6 | 8 |
| | | | Flange | FF840 | A 900 | 25 | 140 | 840 | 780 | 900 | 24 | 6 | 8 |
| | IM B14, IM B34, IM V18, IM V19 | Next smallest flange – P02 | FF740 | A 800 | 25 | 140 | 740 | 680 | 800 | 24 | 6 | 8 | |
| | | Flange | FF940 | A1000 | 28 | 170 | 940 | 880 | 1000 | 22 | 6 | 8 | |
| 400 for 1LE5/1MBS | 2 ... 8 | IM B5, IM B35, IM V1, IM V3 | Next smallest flange – P02 | FF940 | A1000 | 28 | 170 | 940 | 880 | 1000 | 22 | 6 | 8 |
| | | | Flange | FF1080 | A1150 | 30 | 170 | 1080 | 1000 | 1150 | 26 | 6 | 8 |
| | IM B14, IM B34, IM V18, IM V19 | Next smallest flange – P02 | FF940 | A1000 | 28 | 170 | 940 | 880 | 1000 | 22 | 6 | 8 | |
| | | Flange | FF1080 | A1150 | 30 | 170 | 1080 | 1000 | 1150 | 26 | 6 | 8 | |

¹⁾ With reference to standard EN 50347, flanges that are 2 levels larger are used with option P01 in the frame sizes 63 to 80.

Introduction

Mechanical version

Shaft and rotor

1

Overview

Shaft extension

60° center hole acc. to DIN 332, Part 2 with M3 to M24 tapped hole depending on the shaft diameter (see dimension tables in section 2 of the catalog).

| DE (shaft extension) | |
|----------------------|---------------|
| Diameter mm | Thread mm |
| 7 ... 10 | DR M3 |
| > 10 ... 13 | DR M4 |
| > 13 ... 16 | DR M5 |
| > 16 ... 21 | DR M6 |
| > 21 ... 24 | DR M8 |
| > 24 ... 30 | DR M10 |
| > 30 ... 38 | DR M12 |
| > 38 ... 50 | DR M16/DS M16 |
| > 50 ... 85 | DS M20 |
| > 85 ... 130 | DS M24 |

Shaft extension with standard dimensions, without feather keyway

For motor series 1LE1, 1LE5, 1MB1, 1MB5, and 1PC1, the standard shaft extension can be ordered with standard dimensions without a feather keyway. The key convention does not have to be stamped onto the rating plate for balancing.

Order code **L04**

Standard shaft made of stainless steel

A standard shaft made of stainless steel can be ordered for the 1LE1, 1LE5, 1MB1, 1MB5, and 1PC1 motor series (e.g. 1.4021). This is only possible for shaft extensions of standard dimensions.

Order code **L06**

Special non-rusting materials are only available on request.

Non-standard cylindrical shaft extension

The non-standard cylindrical shaft extension can be used on the drive end (DE) (with plain text according to table). The feather keys are supplied in every case.

Order code **Y58**

For order code **Y58** non-standard cylindrical shaft extension (DE):

- Dimension D: less than or equal to the inner diameter of the roller bearing, tolerance band less than tolerance band acc. to EN 50347.
- Dimension E: less than or equal to 2 × length E (standard) of the shaft extension.

See the table below "Admissible changes to the shaft extension DE" and the dimension tables in the relevant sections of the catalog.

Admissible changes to the shaft extension DE (Y58)

| Motor series | Frame size | No. of poles | Shaft extension length E in mm | | Shaft extension diameter D in mm | | |
|---------------------------|------------|--------------|--------------------------------|------------|----------------------------------|----------|--------------------------|
| | | | Standard | up to max. | minimum | Standard | up to max. ¹⁾ |
| 1LE1 | 63 | 2 ... 6 | 23 | 46 | 11 | 11 | 12 |
| | | | 60 | 14 | 14 | 15 | |
| 1LE1, 1MB1 | 71 | 2 ... 8 | 30 | 60 | 14 | 14 | 15 |
| | | | 80 | 19 | 19 | 20 | |
| 1LE1, 1MB1, 1PC1 | 80/90 | 2 ... 8 | 40 | 80 | 19 | 19 | 20 |
| | | | 50 | 100 | 24 | 24 | 25 |
| 1LE1, 1MB1, 1PC1 | 100 | 2 ... 8 | 60 | 120 | 24 | 24 | 25 |
| | | | 112 | 132 | 28 | 28 | 30 |
| 1LE1, 1MB1, 1PC1 | 132 | 2 ... 8 | 80 | 160 | 28 | 28 | 30 |
| | | | 160 | 38 | 38 | 40 | |
| 1LE15, 1LE16, 1MB1 | 180 | 2 ... 8 | 110 | 220 | 38 | 38 | 45 |
| | | | 120 | 48 | 48 | 48 | |
| 1LE15, 1LE16, 1MB1 | 200 | 2 ... 8 | 110 | 220 | 48 | 48 | 48 |
| | | | 120 | 55 | 55 | 55 | |
| 1LE15, 1LE16, 1MB1 | 225 | 2 ... 8 | 110 | 220 | 55 | 55 | 55 |
| | | | 140 | 60 | 60 | 60 | |
| 1LE15, 1LE16, 1MB1 | 250 | 2 ... 8 | 140 | 280 | 60 | 60 | 70 |
| | | | 140 | 280 | 60 | 70 | |
| 1LE15, 1LE16, 1MB1 | 280 | 2 ... 8 | 140 | 280 | 65 | 65 | 70 |
| | | | 140 | 280 | 65 | 70 | |
| 1LE15, 1LE16, 1MB1 | 315 | 2 ... 8 | 140 | 280 | 75 | 75 | 80 |
| | | | 170 | 280 | 75 | 80 | |
| 1LE5, 1MB5 | 315 | 2 ... 8 | 140 | 280 | 80 | 80 | 85 |
| | | | 170 | 280 | 85 | 95 | |
| 1LE5, 1MB5 | 355 | 2 ... 8 | 140 | 280 | 75 | 75 | 85 |
| | | | 170 | 340 | 95 | 100 | |

Standard, cylindrical shaft extension NDE acc. to EN 50347 (second shaft extension)

Order code **L05** (on request)

For a coupling output, the standard, cylindrical shaft extension can transmit the full rated power.

Please also inquire about the transmitted power and admissible cantilever force if belt pulleys, chains or gear pinions are used on the standard, cylindrical shaft extension.

A standard, cylindrical shaft extension (second shaft extension) NDE is not available if a rotary pulse encoder and/or a separately driven fan has been mounted onto the motor. Please inquire for mounted brakes.

Dimensions and tolerances for keyways and keys are designed to EN 50347. The motors are always supplied with a key inserted in the shaft.

If the second shaft extension has non-standard dimensions, this must be ordered with order code **Y59** non-standard shaft dimensions NDE.

For the order code **Y59** (with plain text specifications according to the table):

- Dimension D: less than or equal to fan hub inner diameter, for frame size 160 tolerance band is less than tolerance band to EN 50347
- Dimension E: less than or equal to 2 × length E (standard) of the shaft extension

See the table below "Admissible changes to the shaft extension NDE" and the dimension tables in the relevant sections of the catalog.

Admissible changes to the shaft extension NDE (Y59)

| Motor series | Frame size | No. of poles | Shaft extension length E in mm | | Shaft extension diameter D in mm | | |
|---------------------------|------------|--------------|--------------------------------|------------|----------------------------------|----------|--------------------------|
| | | | Standard | up to max. | minimum | Standard | up to max. ¹⁾ |
| 1LE1 | 63 | 2 ... 6 | 23 | 46 | 11 | 11 | 12 |
| 1LE1, 1MB1 | 71 | 2 ... 8 | 30 | 60 | 14 | 14 | 15 |
| 1LE1, 1MB1 | 80/90 | 2 ... 8 | 40 | 80 | 19 | 19 | 20 |
| 1LE1, 1MB1, 1PC1 | 100 | 2 ... 8 | 50 | 100 | 24 | 24 | 25 |
| | | | 112 | 132 | 28 | 28 | 35 |
| 1LE15, 1LE16, 1MB1 | 180 | 2 ... 8 | 110 | 220 | 48 | 48 | 48 |
| | | | 120 | 220 | 55 | 55 | 55 |
| 1LE15, 1LE16, 1MB1 | 200 | 2 ... 8 | 110 | 220 | 55 | 55 | 55 |
| | | | 120 | 220 | 55 | 55 | |
| 1LE15, 1LE16, 1MB1 | 225 | 2 ... 8 | 110 | 220 | 55 | 55 | 55 |
| | | | 140 | 280 | 60 | 60 | 70 |
| 1LE15, 1LE16, 1MB1 | 250 | 2 ... 8 | 110 | 220 | 55 | 55 | 70 |
| | | | 140 | 280 | 60 | 70 | |
| 1LE15, 1LE16, 1MB1 | 280 | 2 ... 8 | 140 | 280 | 60 | 70 | 70 |
| | | | 140 | 280 | 65 | 70 | |
| 1LE15, 1LE16, 1MB1 | 315 | 2 ... 8 | 140 | 280 | 60 | 75 | 75 |
| | | | 140 | 280 | 70 | 75 | |
| 1LE5, 1MB5 | 315 | 2 ... 8 | 140 | 280 | 60 | 75 | 75 |
| | | | 140 | 280 | 70 | 75 | |
| 1LE5, 1MB5 | 355 | 2 ... 8 | 140 | 280 | 60 | 75 | 75 |
| | | | 170 | 280 | 80 | 90 | |

Non-standard, cylindrical shaft extensions up to the specified lengths and diameters can be supplied for the motor series listed in the tables "Admissible changes to the shaft extension DE (Y58)" and "Admissible changes to the shaft extension NDE (Y59)". All other dimensions are available on request.

It is the responsibility of the customer to ensure that the admissible cantilever forces are reduced in accordance with the non-standard shaft extension.

¹⁾ At maximum admissible diameter, a step increase in shaft diameter is not possible.

Overview**Shaft extension run-out, concentricity and perpendicularity in accordance with IEC 60072-1 precision class for flange-mounted motors**

In IEC 60072-1, normal class (normal) and precision class (reduced) are defined:

1. Circular run-out tolerances for the shaft extension
2. Concentricity tolerances for the shaft extension and flange centering
3. Perpendicularity tolerances for the shaft extension and flange surface

The shaft extension run-out, concentricity and perpendicularity according to IEC 60072-1 precision class for flange-mounted motors can be ordered using order code **L08**.

This order code can be combined for motors with deep-groove bearings of series 60..., 62... and 63... This is not possible in combination with a mounted brake or encoder.

The shaft extension run-out can be ordered according to IEC 60072-1 precision class for types of construction without flange with order code **L07**.

Circular run-out tolerance for the shaft extension

| Diameter of the cylindrical shaft extension D | Circular run-out tolerance | |
|--|----------------------------|---------------------------|
| | Normal class | Precision class (reduced) |
| mm | mm | mm |
| ≤ 10 | 0.03 | 0.015 |
| > 10 ... 18 | 0.035 | 0.018 |
| > 18 ... 30 | 0.04 | 0.021 |
| > 30 ... 50 | 0.05 | 0.025 |
| > 50 ... 80 | 0.06 | 0.03 |
| > 80 ... 120 | 0.07 | 0.035 |

Concentricity tolerance of the centering spigot and linear movement tolerance of the flange surface to the shaft extension axis

| Flange FF/FT | Dimension designation acc. to IEC | | Concentricity and perpendicularity tolerance | |
|-----------------|--------------------------------------|---------|---|-----------------------|
| | N mm | P mm | Normal class mm | Precision class mm |
| 55 | 40 | 70 | 0.08 | 0.04 |
| 65 | 50 | 80 | 0.08 | 0.04 |
| 75 | 60 | 90 | 0.08 | 0.04 |
| 85 | 70 | 105 | 0.08 | 0.04 |
| 100 | 80 | 120 | 0.08 | 0.04 |
| 115 | 95 | 140 | 0.08 | 0.04 |
| 130 | 110 | 160 | 0.1 | 0.05 |
| 165 | 130 | 200 | 0.1 | 0.05 |
| 215 | 180 | 250 | 0.1 | 0.05 |
| 265 | 230 | 300 | 0.1 | 0.05 |
| 300 | 250 | 350 | 0.125 | 0.063 |
| 350 | 300 | 400 | 0.125 | 0.063 |
| 400 | 350 | 450 | 0.125 | 0.063 |
| 500 | 450 | 550 | 0.125 | 0.063 |
| 600 | 550 | 660 | 0.16 | 0.08 |
| 740 | 680 | 800 | 0.16 | 0.08 |
| 940 | 880 | 1000 | 0.2 | 0.1 |
| 1080 | 1000 | 1150 | 0.2 | 0.1 |

Measures for gear mounting**Overview**

The flange-mounted motors can be equipped with a radial sealing ring in order to mount gearing.
Order code **H23**

It must be ensured that the sealing ring is lubricated using grease, oil mist, or oil spray. (It is not admissible to use pressurized oil > 0.1 bar.) We recommend that the admissible bearing loads are carefully checked.

Introduction

Mechanical version

Balance and vibration severity

Overview

All rotors are dynamically balanced with an inserted half key. This corresponds to vibration severity grade A (normal or standard). DIN EN 60034-14 Aug. 2018 regulates the vibrational behavior of machinery. Based on ISO 21940-32, the key convention "half key (H)" must be used for balancing.

Note:

If there is a keyway, a full feather key is always inserted on delivery.

The type of key convention is stamped on the face of the shaft extension at the customer side DE/NDE:

- F = Balancing with full key
(full-key convention)
- H = Balancing with half key
(half-key convention) – standard
- N = Balancing without key –
Plain text required (convention without key)

For motors up to frame size 112 the code is stamped on the rating plate.

Full-key balancing or balancing with full feather key (F) is possible by specifying order code **L02** (additional charge).

Balancing without feather key (N) is possible by specifying order code **L01** (additional charge).

Vibration severity grade A is the standard version and is valid up to a rated frequency of 60 Hz. If 2-pole motors of frame sizes 280 and 315 are to be rigidly installed, cast feet are necessary in order to comply with the vibration requirements of IEC 60034-14. IE4 2-pole motors in frame size 315 and pole-changing motors (4-pole/2-pole) fulfill the vibration requirements specified in IEC 60034-14 only when the motor is elastically suspended.

The low-vibration version B can be supplied to fulfill stricter requirements on smooth running (additional charge).

Vibration severity grade B
Not possible with cylindrical roller bearings.
Order code **L00**

The order code **L00** vibration severity grade B is not possible in combination with order codes **G40, G41, G42**. 2-pole trans-standard aluminum motors in frame sizes 180 and 200 (14th position of the Article No. is A, C, D, J, T, U, V) and order code **L00** have cast-iron feet.

This vibration is assessed in accordance with vibration severity grade A or B according to EN 60034-14 (see table).

The limits stated in the table apply to uncoupled, freely suspended, idling motors.

For converter operation with frequencies higher than 60 Hz, special balancing is required for compliance with the specified limit values (plain text: maximum supply frequency/speed).

For further details, see the online help in the DT Configurator.

Limits (rms values) for max. vibration severity in terms of vibration displacement (s) and vibration velocity (v) for the shaft height H

| Vibration severity grade | Machine installation | Shaft height H in mm | | | |
|--------------------------|----------------------|----------------------|-------------------|-----------------|-------------------|
| | | 56 ≤ H ≤ 132 | | H > 132 | |
| | | s_{rms} μm | v_{rms} mm/s | s_{rms} μm | v_{rms} mm/s |
| A | Free suspension | 45 | 2.8 | 45 | 2.8 |
| | Rigid clamping | – | – | 37 | 2.3 |
| B | Free suspension | 18 | 1.1 | 29 | 1.8 |
| | Rigid clamping | – | – | 24 | 1.5 |

For details, see standard EN 60034-14 Aug. 2018, EN 60034-14:2004 + A1:2007

If the type tests for machines with shaft height $H > 132$ mm demonstrate a determining component with twice the line frequency, the limit for maximum vibration severity in the Table (for grade A) can be increased from 2.3 mm/s (rms value) to 2.8 mm/s (rms value) or (for grade B) from 1.5 mm/s (rms value) to 1.8 mm/s (rms value). Higher values must be agreed beforehand. A component with twice the line frequency is regarded as dominant if the type test shows that it is greater than 70 % of 2.3 mm/s (rms value) (for grade A) or 70 % of 1.5 mm/s (rms value) (for grade B).

Overview

The noise is measured in accordance with EN ISO 1680 in a dead room. It is specified as A-weighted enveloping surface sound pressure level L_{pFA} in dB (A).

This value is the spatial average value of the sound pressure levels measured at the measuring surface. The measuring surface is a cube 1 m away from the surface of the motor. The sound power level is also specified as L_{WA} in dB (A).

The specified values are valid at 50 Hz and rated power (see the selection and ordering data). The tolerance is +3 dB. Noise values for motors in converter operation on request.

To reduce noise levels, 2-pole motors from frame size 132 S to frame size 355 and higher can optionally be equipped with a unidirectional axial-flow fan.

For frame sizes 400 and 450, the axial-flow fan is standard.

The values are listed in the table "Low-noise version" below.

Clockwise rotation:

Order code **F77**

Counterclockwise rotation:

Order code **F78**

Second shaft extension and/or mountings (mounting of brake, separately driven fan or encoder) not possible except for 1MB.553 motors.

| Low-noise version | | | |
|--|------------|---------------------|--------------------|
| Motor series | Frame size | 2-pole motors | |
| | | L_{pFA} dB (A) | L_{WA} dB (A) |
| 1LE1 ¹⁾ | 132 | 60 | 72 |
| 1MB1 ¹⁾ | 160 | 60 | 72 |
| 1LE10, 1LE15/6, 1MB15/6 ²⁾ | 180 | 63 | 76 |
| | 200 | 64 | 77 |
| 1LE15/6, 1MB15/6 ²⁾ | 225 | 72 | 86 |
| | 250 | 73 | 87 |
| | 280 | 72 | 85 |
| | 315 | 76 | 90 |
| 1LE5, 1MB5 | 315 | 78.9 | 93.6 |
| | 355 | 79.2 | 94 |
| | 400 | 74 | 90 |
| | 450 | 75 | 91 |
| 1MB555 | 315 | 73.5 | 88.3 |
| | 355 | 79.6 | 94.9 |

¹⁾ With the exception of 1LE1 and 1MB1 motors with option **F90** – version "Forced-air cooled motors without external fan and fan cover".

²⁾ 1MB15/6 also applies to 1MB154, 1MB164, and 1MB155.

Introduction

Mechanical version

Bearings and lubrication

1

Overview

Bearing lifetime (nominal lifetime)

The nominal bearing lifetime is defined according to standardized calculation procedures (ISO 281) and is reached or even exceeded for 90 % of the bearings when the motors are operated in compliance with the data provided in the catalog.

Under average operating conditions, a lifetime (L_{10h}) of 100 000 hours can be achieved.

Generally, the bearing lifetime is defined by the bearing size, the bearing load, the operating conditions, the speed and the grease lifetime. A bearing lifetime calculation is possible on request.

Bearing system

The bearing lifetime of motors with horizontal mounting is 40 000 hours if there is no additional axial loading at the coupling output and 20 000 hours when utilized according to the maximum admissible load. This assumes that the motor is operated at 50 Hz. The nominal bearing lifetime is reduced for converter operation at higher frequencies.

In order to achieve the calculated lifetime in continuous operation, the admissible vibration values (measured at bearing plate) must be determined according to evaluation zones A and B stipulated in ISO 10816. If higher vibration velocities occur in operation (e.g. with option **H02**), special measures must be taken (please inquire).

Due to their physical characteristics, variable-speed motors have a different bearing lifetime under the same load conditions – this relationship is linear, i.e. if the frequency increases by 20 % from 50 Hz to 60 Hz, the lifetime decreases by 20 % from 20 000 to 16 000 hours under the load conditions specified in the catalog.

If the frequency falls by 20 % from 50 Hz to 40 Hz, under the load conditions specified in the catalog, the lifetime rises by 20 % from 20 000 to 24 000 hours.

It should be observed that, for types of construction IM B6, IM B7, IM B8, IM V5, and IM V6, the belt tension is only permitted to act parallel to the mounting plane or towards the mounting plane and the feet must be supported. Both feet must be secured for foot-mounting types of construction.

In the basic bearing system, the floating bearing is situated at the drive end (DE) and the located bearing is situated at the non-drive end (NDE). For motors of the 1MB.553 series, the located bearing DE is the standard version.

The bearing system is axially preloaded with a spring element at the drive end (DE) to ensure smooth running of the motor without play (see Fig. 1 in the diagrams of bearings on page 1/60).

From frame size 160 upwards, the located bearing is axially secured at the non-drive end (NDE).

For the 1LE5 and 1MB5 motors of frame sizes 400 and 450, the located bearing is situated at the drive end (DE) and the floating bearing is situated at the non-drive end (NDE).

The bearing system on these motors is axially preloaded with a spring element at the non-drive end (NDE) to ensure smooth running of the motor without any play (see Figs. 6 and 7 under the bearing diagrams on page 1/60).

Up to frame size 132, an additional axially-secured located bearing can be supplied on the non-drive end (NDE) complete with a retaining ring (see Fig. 2 under the diagrams of bearings on page 1/60) or, for frame sizes 400 and 450, the located bearing can be supplied at the non-drive end (NDE).

Order code **L21**

Depending on the specific installation conditions (axial forces, cantilever forces and type of construction), testing of additional measures for the bearing version is recommended. The located bearing can also be supplied at the drive end (DE) (see Fig. 3 under the diagrams of bearings on page 1/60). A located bearing at the drive end (DE) is recommended when gearing is installed, for a shaft extension pointing downwards, or pumps and fans are mounted directly on the motor shaft.

Order code **L20**

For increased cantilever forces (e.g. belt drives), reinforced bearings can be used at the drive end (DE). Versions with cylindrical roller bearings are not axially preloaded, and must always operate under adequate radial loads (it is not permissible that motors are operated on a test stand without additional radial loads). The located bearing is at the non-drive end (NDE). For 1MB.553, the located bearing is at the drive-end (DE).

Not possible for motors of the 1MB.553 series.

Order code **L22**

1LE1, 1LE5, 1MB1, 1MB5, and 1PC1 motors can be supplied with reinforced bearings (size range 03) at both ends. In this case, the bearing plates are made of cast iron (standard for series 1LE16 motors). Standard for motors of the 1MB.553 series from frame size 100 upwards.

Order code **L25**

A measuring nipple for SPM shock pulse measurement can be mounted to check bearing vibration. The motors have an M8 tapped hole for each bearing plate and a measuring nipple with a protective cap. If a second tapped hole is provided, it is fitted with a sealing plug. Not possible for frame sizes < 100.

Order code **Q01**

Bearing selection for increased cantilever forces (see the Table "Bearing selection for 1LE10, 1MB10, and 1PC10 motors – Bearings for increased cantilever forces" on page 1/55) – for the maximum axial load, see page 1/67 onwards.

Bearing insulation

To prevent damage caused by bearing currents, insulated bearings can be supplied for frame sizes 225 to 355 – they are recommended for motors from frame size 225 upwards. For frame sizes 400 and 450 (for converter operation), the bearing insulation is indispensable.

- **L50** (DE bearing insulation) means NDE located bearing as standard
- **L51** (NDE bearing insulation) means DE located bearing as standard
- **L50 + L51** (insulated DE and NDE bearings) means NDE located bearing as standard
- Combination of order codes **L50** or **L51** or **L50 + L51** with **L22** (bearing version for increased cantilever forces) means NDE located bearing as standard.

According to IEC 60034-1-11, it is up to the user in the case of DE bearing insulation (order code **L50**) + NDE bearing insulation (order code **L51**) to ensure grounding of the rotor.

The rotor grounding can be implemented either in the system via the coupled driven machine or in the motor via a grounding brush.

The grounding brush (order code **L52**) must always be provided when the driven machine is connected to the motor via an insulating coupling or an insulating belt output shaft.

Permanent lubrication

On motors equipped with permanent lubrication, the bearing grease lifetime is matched to the bearing lifetime. This can, however, only be achieved if the motor is operated in accordance with the catalog specifications.

In the basic version, the motors have permanent lubrication.

Overview**Regreasing**

For motors which can be regreased at defined regreasing intervals, the bearing lifetime can be extended and/or unfavorable factors such as temperature, mounting conditions, speed, bearing size, and mechanical load can be compensated.

This regreasing option is possible in the following frame sizes:

- Frame sizes 100 to 160: M8 × 1 acc. to DIN 71412-A (conical lubricating nipple)
- Frame sizes 180 to 315: M10 × 1 acc. to DIN 3404-A (flat lubricating nipple).
- Frame sizes 400 to 450: M10 × 1-5.8-A acc. to DIN 3404-A.- (flat lubricating nipple)

Order code L23

(frame sizes ≥ 280 basic version, for the Performance Line motors of frame sizes ≥ 160 basic version)

A regreasing device with M10 × 1 conical lubricating nipple to DIN 71412-A can be optionally provided for frame sizes 180 to 450.

Order code L19

In the case of motors equipped with regreasing device, information regarding regreasing intervals, quantity of grease, type of grease and any additional data is provided on the lubrication plate or rating plate. For regreasing intervals for the basic version, see the Table "Grease lifetime and regreasing intervals for horizontal installation". For motors with a mounted holding brake (order code **F01**) a regreasing device cannot be installed, including up to FS 160.

Mechanical stress and grease lifetime

High speeds that exceed the rated speed with converter operation and the resulting increased vibrations alter the mechanical running smoothness and the bearings are subjected to increased mechanical stress. This reduces the grease lifetime and the bearing lifetime (please inquire where applicable).

The use of rigid couplings should be avoided as far as possible. For converter operation in particular, compliance with the mechanical limit speeds n_{\max} at maximum supply frequency f_{\max} is essential, see the following table "Mechanical limit speeds n_{\max} at maximum supply frequency f_{\max} ".

Introduction

Mechanical version

Bearings and lubrication

1

Overview

Mechanical limit speeds n_{max} at maximum supply frequency f_{max} (standard values) for 1LE1, 1LE5, 1PC1 motors – basic version and 1LE15 and 1LE16 motors – basic version with order codes L22, L25, L28 – 1MB10/5/6 motors with order codes L22 and L25

| Frame size | Type | 2-pole | | 4-pole | | 6-pole | | 8-pole | |
|--|--------------|------------------|-------------------------|------------------|-----------------|------------------|-----------------|------------------|-----------------|
| | | n_{max} rpm | f_{max} Hz | n_{max} rpm | f_{max} Hz | n_{max} rpm | f_{max} Hz | n_{max} rpm | f_{max} Hz |
| 1LE10 motors, basic version | | | | | | | | | |
| 1LE10..- | | | | | | | | | |
| 63 | 0B... | 6000 | 100 | 4200 | 140 | 3600 | 180 | 3000 | 200 |
| 71 | 0C... | 6000 | 100 | 4200 | 140 | 3600 | 180 | 3000 | 200 |
| 80 M | 0D... | 6000 | 100 | 4200 | 140 | 3600 | 180 | 3000 | 200 |
| 90 S/L | 0E... | 6000 | 100 | 4200 | 140 | 3600 | 180 | 3000 | 200 |
| 1LE15 Basic Line motors – bearings for increased cantilever forces – order code L22 1LE15 Basic Line motors – bearings reinforced at both ends – order code L25 | | | | | | | | | |
| 1LE15..- | | | | | | | | | |
| 71 M | 0C... | 6000 | 100 | 4200 | 140 | 3600 | 180 | 3000 | 200 |
| 80 M | 0D... | 6000 | 100 | 4200 | 140 | 3600 | 180 | 3000 | 200 |
| 90 S/L | 0E... | 6000 | 100 | 4200 | 140 | 3600 | 180 | 3000 | 200 |
| 1LE10, 1PC1 motors, basic version 1LE15 Basic Line and 1LE16 Performance Line – bearings for increased cantilever forces – order code L22 1LE15 Basic Line and 1LE16 Performance Line – bearings reinforced at both ends – order code L25 | | | | | | | | | |
| 1LE1...- 1PC1...- | | | | | | | | | |
| 100 L | 1A... | 6000 | 100 | 4200 | 140 | 3600 | 180 | 3000 | 200 |
| 112 M | 1B... | 6000 | 100 | 4200 | 140 | 3600 | 180 | 3000 | 200 |
| 132 S/M | 1C... | 5600 | 90 | 4200 | 140 | 3600 | 180 | 3000 | 200 |
| 160 M/L | 1D... | 4800 | 80 | 4200 | 140 | 3600 | 180 | 3000 | 200 |
| 180 M/L | 1E... | 4600 | 76 | 4200 | 140 | 3600 | 180 | 3000 | 200 |
| 200 L | 2A... | 4500 | 75 | 4200 | 140 | 3600 | 180 | 3000 | 200 |
| 1LE15 Basic Line and 1LE16 Performance Line – basic version 1LE15 Basic Line and 1LE16 Performance Line – bearings for increased cantilever forces – order code L22 1LE15 Basic Line and 1LE16 Performance Line – bearings reinforced at both ends – order code L25 1LE15 Basic Line and 1LE16 Performance Line – DE cylindrical roller bearings and NDE reinforced bearings – order code L28 | | | | | | | | | |
| 1LE15...- 1LE16...- | | | | | | | | | |
| 180 M/L | 1E... | 4600 | 76 | 4200 | 140 | 3600 | 180 | 3000 | 200 |
| 200 L | 2A... | 4500 | 75 | 4200 | 140 | 3600 | 180 | 3000 | 200 |
| 225 S/M | 2B... | 4500 | 75 | 4500 | 150 | 4400 | 220 | 4400 | 293 |
| 250 M | 2C... | 3900 | 65 | 3700 | 123 | 3700 | 185 | 3700 | 247 |
| 280 S/M | 2D... | 3600 | 60 | 3000 | 100 | 3000 | 150 | 3000 | 200 |
| 315 S/M/L | 3A... | 3600 | 60 | 2600 | 87 | 2600 | 130 | 2600 | 173 |
| 1LE55 Basic Line and 1LE56 Performance Line – basic version 1LE55 Basic Line and 1LE56 Performance Line – bearings for increased cantilever forces – order code L22 | | | | | | | | | |
| 1LE55...- 1LE56...- | | | | | | | | | |
| 315 L | 3A... | 5200 | 87 | 3400 | 113 | 3400 | 170 | 3400 | 227 |
| 355 M/L | 3B... | 5200 | 87 | 3800 | 93 | 2800 | 140 | 2800 | 187 |
| 400 | 4A... | IMB3 | 3600 | 60 | 2200 | 74 | 2200 | 110 | 2200 |
| 450 | 4B... | IMB3 | 3000/3600 ¹⁾ | 50 | 2100 | 70 | 2100 | 105 | 2100 |
| 400 | 4A... | IMV1 | – | – | 2100 | 70 | 2100 | 105 | 2100 |
| 450 | 4B... | IMV1 | – | – | 1800 | 60 | 1800 | 90 | 1800 |

The specified limit speeds are applicable to motors without additional mountings, such as brakes or rotary encoders. In such applications, the characteristics of the respective mounting parts must be taken into account.

Note:

Mechanical limit speeds for SIMOTICS XP 1MB motors, see Chapter 5.

¹⁾ Order on request.

Overview

Grease lifetime and regreasing intervals for horizontal installation

| Motor series | Frame size | No. of poles | Grease lifetime up to CT 40 °C ²⁾ | | | |
|--|-------------|--------------|--|----------------------|--------------------------------------|----------------------|
| Permanent lubrication ¹⁾ | | | | | | |
| 1LE1/1MB1/1PC1 | 63 ... 250 | 2 ... 8 | 20000 h or 40000 h ³⁾ | | | |
| Regreasing ¹⁾ | | | | | | |
| | | | Lubrication interval ISO CI F 155 °C | | Lubrication interval ISO CI H 180 °C | |
| | | | CT ≤ 40 °C | 40 °C < CT ≤ 80 °C | 40 °C < CT ≤ 60 °C | 60 °C < CT ≤ 80 °C |
| 1LE1/1MB1/1PC1 | 100 ... 160 | 2 ... 8 | 8000 h | 4000 h ²⁾ | 4000 h | 2000 h ²⁾ |
| | 180 ... 280 | 2 | 4000 h | 2000 h ²⁾ | 1000 h | 1000 h ²⁾ |
| | | 4 ... 8 | 8000 h | 4000 h ²⁾ | 2000 h | 2000 h ²⁾ |
| | 315 | 2 | 3000 h | 1500 h ²⁾ | 1000 h | 1000 h ²⁾ |
| | | 4 ... 8 | 6000 h | 3000 h ²⁾ | 1500 h | 1500 h ²⁾ |
| 1LE5/1MB5 | | | CT ≤ 40 °C | 40 °C < CT ≤ 80 °C | CT ≤ 40 °C | 40 °C < CT ≤ 80 °C |
| | 315, 355 | 2 | 3000 h | 1500 h ²⁾ | 3000 h | 1500 h ²⁾ |
| | | 4, 6 | 6000 h | 3000 h ²⁾ | 6000 h | 3000 h ²⁾ |
| | 400 | 2 | 4000 h | 2000 h | 4000 h | 2000 h |
| | | 4 ... 8 | 6000 h | 3000 h | 6000 h | 3000 h |
| | | 2 | 3000 h | 1500 h | 3000 h | 1500 h |
| | 450 | 4 ... 8 | 6000 h | 3000 h | 6000 h | 3000 h |

Bearing selection table for 1LE10, 1MB10, and 1PC10 motors – basic version

The bearing selection tables are only intended for planning purposes. Authoritative information on the actual type of bearings fitted in motors already supplied can be obtained by the factory by quoting the serial number or can be read from the rating plate.

When deep-groove bearings with side plates are used, the side plate is on the inside. Located bearing at drive end (DE) for 1LE1, 1MB1 and 1PC1 motors, see special version Fig. 2 in the "Diagrams of bearings" on Page 1/60.

| Frame size | No. of poles | Drive end (DE) bearing | | Non-drive end (NDE) bearing | | Fig. No. on page 1/60 |
|--------------------------|--------------|---|--|---|--|-----------------------|
| | | Horizontal and vertical types of construction | | Horizontal and vertical types of construction | | |
| 1LE10/1MB10 | | | | | | |
| 63 | 2 ... 6 | 6201 2ZC3 | | 6201 2ZC3 | | – |
| 71 | 2 ... 8 | 6202 2ZC3 | | 6202 2ZC3 | | – |
| 80 | 2 ... 8 | 6004 2ZC3 | | 6004 2ZC3 | | Fig. 1 |
| 90 | 2 ... 8 | 6205 2ZC3 | | 6004 2ZC3 | | Fig. 1 |
| 1LE10/1MB10/1PC10 | | | | | | |
| 100 L | 2 ... 8 | 6206 2ZC3 | | 6206 2ZC3 | | Fig. 1 |
| 112 M | 2 ... 8 | 6206 2ZC3 | | 6206 2ZC3 | | Fig. 1 |
| 132 S/M | 2 ... 8 | 6208 2ZC3 ⁴⁾ | | 6208 2ZC3 ⁴⁾ | | Fig. 1 |
| 160 M/L | 2 ... 8 | 6209 2ZC3 ⁴⁾ | | 6209 2ZC3 ⁴⁾ | | Fig. 2 |
| 1LE10 | | | | | | |
| 180 M/L | 2 ... 8 | 6210 ZC3 ⁵⁾ | | 6210 ZC3 ⁵⁾ | | Fig. 4 |
| 200 L | 2 ... 8 | 6212 ZC3 ⁵⁾ | | 6212 ZC3 ⁵⁾ | | Fig. 4 |

Bearing selection table for 1LE10, 1MB10, and 1PC10 motors – bearings for increased cantilever forces – order code L22

Please inquire about noise and vibration data. The bearing selection tables are only intended for planning purposes. Authoritative information on the actual type of bearings fitted in motors already supplied can be obtained by the factory by quoting the serial number or can be read from the rating plate.

When deep-groove bearings with side plates are used, the side plate is on the inside.

| Frame size | No. of poles | Drive end (DE) bearing | | Non-drive end (NDE) bearing | | Fig. No. on page 1/60 |
|--------------------------|--------------|---|--|---|--|-----------------------|
| | | Horizontal and vertical types of construction | | Horizontal and vertical types of construction | | |
| 1LE10/1MB10 | | | | | | |
| 80 | 2 ... 8 | 6304 2ZC3 | | 6304 2ZC3 | | – |
| 90 | 2 ... 8 | 6305 2ZC3 | | 6305 2ZC3 | | – |
| 1LE10/1MB10/1PC10 | | | | | | |
| 100 L | 2 ... 8 | 6306 2ZC3 | | 6206 2ZC3 | | Fig. 1 |
| 112 M | 2 ... 8 | 6306 2ZC3 | | 6206 2ZC3 | | |
| 132 S/M | 2 ... 8 | 6308 2ZC3 ⁴⁾ | | 6208 2ZC3 ⁴⁾ | | |
| 160 M/L | 2 ... 8 | 6309 2ZC3 ⁴⁾ | | 6209 2ZC3 ⁴⁾ | | Fig. 2 |
| 1LE10 | | | | | | |
| 180 M/L | 2 ... 8 | 6310 ZC3 ⁵⁾ | | 6210 ZC3 ⁵⁾ | | Fig. 4 |
| 200 L | 2 ... 8 | 6312 ZC3 ⁵⁾ | | 6212 ZC3 ⁵⁾ | | Fig. 4 |

¹⁾ For special uses and special greases, please inquire about grease lifetime and regreasing intervals.

²⁾ For every 10 K the coolant temperature is increased above 80 °C, the grease lifetime and regreasing interval are halved.

³⁾ 40 000 hours apply to horizontally installed motors with coupling output without additional axial loads.

⁴⁾ Deep-groove bearings with a side plate are used for regreasable versions (**L23**).

⁵⁾ Deep-groove bearings without a side plate are used for regreasable versions (**L23**).

Introduction

Mechanical version

Bearings and lubrication

1

Overview

Bearing selection table for 1LE10, 1MB10, and 1PC10 motors – bearings reinforced at both ends – order code L25

Please inquire about noise and vibration data. The bearing selection tables are only intended for planning purposes. Authoritative information on the actual type of bearings fitted in motors already supplied can be obtained by the factory by quoting the serial number or can be read from the rating plate.

When deep-groove bearings with side plates are used, the side plate is on the inside.

| Frame size | No. of poles | Drive end (DE) bearing Horizontal and vertical types of construction | Non-drive end (NDE) bearing Horizontal and vertical types of construction | Fig. No. on page 1/60 |
|--------------------------|--------------|---|--|-----------------------|
| 1LE10/1MB10 | | | | |
| 80 | 2 ... 8 | 6304 2ZC3 | 6304 2ZC3 | – |
| 90 | 2 ... 8 | 6305 2ZC3 | 6304 2ZC3 | – |
| 1LE10/1MB10/1PC10 | | | | |
| 100 L | 2 ... 8 | 6306 2ZC3 | 6306 2ZC3 | Fig. 1 |
| 112 M | 2 ... 8 | 6306 2ZC3 | 6306 2ZC3 | |
| 132 S/M | 2 ... 8 | 6308 2ZC3 ¹⁾ | 6308 2ZC3 ¹⁾ | |
| 160 M/L | 2 ... 8 | 6309 2ZC3 ¹⁾ | 6309 2ZC3 ¹⁾ | Fig. 2 |
| 1LE10 | | | | |
| 180 M/L | 2 ... 8 | 6310 ZC3 ²⁾ | 6310 ZC3 ²⁾ | Fig. 4 |
| 200 L | 2 ... 8 | 6312 ZC3 ²⁾ | 6312 ZC3 ²⁾ | Fig. 4 |

Bearing assignment for 1LE15/1MB15, 1LE16/1MB16, and 1LE5 motors (basic version)

| Frame size | No. of poles | Drive end (DE) bearing Horizontal and vertical type of construction | Non-drive end (NDE) bearing Horizontal and vertical type of construction | Fig. No. on page 1/60 | |
|--|--------------|--|---|----------------------------------|-----------------------|
| 1LE15, 1MB15 – Basic Line | | | | | |
| 71 M | 2 ... 8 | 6202 2ZC3 | 6202 2ZC3 | Fig. 1 | |
| 80 M | 2 ... 8 | 6204 2ZC3 | 6204 2ZC3 | Fig. 1 | |
| 90 S/L | 2 ... 8 | 6205 2ZC3 | 6204 2ZC3 | Fig. 1 | |
| 100 L | 2 ... 8 | 6206 2ZC3 ¹⁾ | 6206 2ZC3 ¹⁾ | Fig. 1 | |
| 112 M | 2 ... 8 | 6206 2ZC3 ¹⁾ | 6206 2ZC3 ¹⁾ | | |
| 132 S/M | 2 ... 8 | 6208 2ZC3 ¹⁾ | 6208 2ZC3 ¹⁾ | | |
| 160 M/L | 2 ... 8 | 6209 2ZC3 ¹⁾ | 6209 2ZC3 ¹⁾ | Fig. 2 | |
| 180 M/L | 2 ... 8 | 6210 ZC3 ²⁾ | 6210 ZC3 ²⁾ | Fig. 4 | |
| 200 L | 2 ... 8 | 6212 ZC3 ²⁾ | 6212 ZC3 ²⁾ | | |
| 225 S/M | 2 ... 8 | 6213 ZC3 ²⁾ | 6213 ZC3 ²⁾ | Fig. 1 | |
| 250 M | 2 ... 8 | 6215 ZC3 ²⁾ | 6215 ZC3 ²⁾ | | |
| 280 S/M | 2 | 6315 C3 | 6315 C3 | Fig. 2 | |
| | 4 ... 8 | 6317 C3 | 6317 C3 | | |
| 315 S/M/L | 2 | 6316 C3 | 6316 C3 | | |
| | 4 ... 8 | 6319 C3 | 6319 C3 | | |
| 1LE16, 1MB16 – Performance Line | | | | | |
| 100 L | 2 ... 8 | 6306 2ZC3 | 6306 2ZC3 | Fig. 1 | |
| 112 M | 2 ... 8 | 6306 2ZC3 | 6306 2ZC3 | | |
| 132 S/M | 2 ... 8 | 6308 2ZC3 | 6308 2ZC3 | | |
| 160 M/L | 2 ... 8 | 6309 ZC3 | 6309 ZC3 | Fig. 2 | |
| 180 M/L | 2 ... 8 | 6310 C3 | 6310 C3 | Fig. 4 | |
| 200 L | 2 ... 8 | 6312 C3 | 6312 C3 | | |
| 225 S/M | 2 ... 8 | 6313 C3 | 6313 C3 | Fig. 4 | |
| 250 M | 2 ... 8 | 6315 C3 | 6315 C3 | | |
| 280 S/M | 2 | 6315 C3 | 6315 C3 | | |
| | 4 ... 8 | 6317 C3 | 6317 C3 | | |
| 315 S/M/L | 2 | 6316 C3 | 6316 C3 | | |
| | 4 ... 8 | 6319 C3 | 6319 C3 | | |
| | | Type of construction Horizontal | Type of construction Horizontal | Type of construction Vertical | |
| 1LE5, 1MB5 | | | | | |
| 315 L | 2 | 6316 C4 | 6316 C4 | 7316 B | – |
| | 4, 6 | 6319 C4 | 6319 C4 | 7319 B | – |
| 355 M/L | 2 | 6317 C4 | 6317 C4 | 7317 B | – |
| | 4, 6 | 6320 C4 | 6320 C4 | 7320 B | – |
| 400 | 2 | 6318 C3 | 7218 B + 6218 C3 | 6218 C3 | Fig. 6, Fig. 7 |
| | 4, 6, 8 | 6224 C3 | 7224 B + 6224 C3 | 6224 C3 | Fig. 6, Fig. 7 |
| 450 | 2 | 6220 C3 | – | 6220 C3 | Fig. 6 |
| | 4, 6, 8 | 6226 C3 | 7226 B + 6226 C3 | 6226 C3 | Fig. 6, Fig. 7 |

¹⁾ Deep-groove bearings with a side plate are used for regreasable versions (**L23**).

²⁾ Deep-groove bearings without a side plate are used for regreasable versions (**L23**).

Overview

Bearing assignment for 1MB1/1MB5 motors with types of protection Ex db, Ex db eb (basic version)

| Frame size | No. of poles | Drive end (DE) bearing | | Non-drive end (NDE) bearing | | Fig. No. on page 1/60 |
|---|--------------|------------------------|------------|-----------------------------|------------|-----------------------|
| | | Type of construction | | Type of construction | | |
| | | Horizontal | Vertical | Horizontal | Vertical | |
| 1MB1, 1MB5 with type of protection Ex db, Ex db eb | | | | | | |
| 71 | 2 ... 8 | 6202-2Z C3 | 6202-2Z C3 | 6202-2Z C3 | 6202-2Z C3 | – |
| 80 | 2 ... 8 | 6204-2Z C3 | 6204-2Z C3 | 6204-2Z C3 | 6204-2Z C3 | – |
| 90 | 2 ... 8 | 6205-2Z C3 | 6205-2Z C3 | 6205-2Z C3 | 6205-2Z C3 | – |
| 100 | 2 ... 8 | 6306-2Z C3 | 6306-2Z C3 | 6306-2Z C3 | 6306-2Z C3 | – |
| 112 | 2 ... 8 | 6306-2Z C3 | 6306-2Z C3 | 6306-2Z C3 | 6306-2Z C3 | – |
| 132 | 2 ... 8 | 6308-2Z C3 | 6308-2Z C3 | 6308-2Z C3 | 6308-2Z C3 | – |
| 160 | 2 ... 8 | 6309 C3 | 6309 C3 | 6309 C3 | 6309 C3 | – |
| 180 | 2 ... 8 | 6310 C3 | 6310 C3 | 6310 C3 | 6310 C3 | – |
| 200 | 2 ... 8 | 6312 C3 | 6312 C3 | 6312 C3 | 6312 C3 | – |
| 225 | 2 ... 8 | 6313 C3 | 6313 C3 | 6313 C3 | 6313 C3 | – |
| 250 | 2 ... 8 | 6315 C3 | 6315 C3 | 6315 C3 | 6315 C3 | – |
| 280 | 2 | 6315 C3 | 6315 C3 | 6315 C3 | 6315 C3 | – |
| 280 | 4 ... 8 | 6317 C3 | 6317 C3 | 6317 C3 | 6317 C3 | – |
| 315 | 2 | 6316 C3 | 6319 C3 | 6316 C3 | 6319 C3 | – |
| 315 | 4 ... 8 | 6319 C3 | 6319 C3 | 6319 C3 | 6319 C3 | – |
| 355 | 2 | 6317 C4 | 6320 C4 | 6317 C4 | 6320 C4 | – |
| 355 | 4 ... 8 | 6320 C4 | 6320 C4 | 6320 C4 | 6320 C4 | – |

Introduction

Mechanical version

Bearings and lubrication

Overview

Bearing selection table for 1LE15, 1MB15, 1LE16, and 1MB16 motors (bearings for increased cantilever forces – order code L22)

For NU bearings (cylindrical roller bearings), in contrast to ball bearings, a minimum cantilever force is required. Cylindrical roller bearings are not suitable for coupling output.

$$F_{\min} \sim F_{\max}/2$$

| Frame size | No. of poles | Drive end (DE) bearing | | Non-drive end (NDE) bearing | | Fig. No. on page 1/60 |
|---------------------------------------|--------------|--|------------------|--|----------|-----------------------|
| | | Horizontal and vertical type of construction | | Horizontal and vertical type of construction | | |
| 1LE15/1MB15 – Basic Line | | | | | | |
| 71 M | 2 ... 8 | 6302 2ZC3 | | 6202 2ZC3 ³⁾ | | |
| 80 M | 2 ... 8 | 6304 2ZC3 | | 6204 2ZC3 ³⁾ | | |
| 90 S/L | 2 ... 8 | 6305 2ZC3 | | 6204 2ZC3 | | |
| 100 L | 2 ... 8 | 6306 2ZC3 ¹⁾ | | 6206 2ZC3 ¹⁾³⁾ | | |
| 112 M | 2 ... 8 | 6306 2ZC3 ¹⁾ | | 6206 2ZC3 ¹⁾³⁾ | | |
| 132 M | 2 ... 8 | 6308 2ZC3 ¹⁾ | | 6208 2ZC3 ¹⁾³⁾ | | |
| 160 M/L | 2 ... 8 | 6309 2ZC3 ¹⁾ | | 6209 2ZC3 ¹⁾³⁾ | | |
| 180 M/L | 2 ... 8 | NU 210 | | 6210 C3 | | Fig. 5 |
| 200 L | 2 ... 8 | NU 212 | | 6212 C3 | | |
| 225 M | 2 ... 8 | NU 213 | | 6213 C3 | | |
| 250 M | 2 ... 8 | NU 215 | | 6215 C3 | | |
| 280 M | 2 | NU 315 | | 6315 C3 ³⁾ | | |
| | 4 ... 8 | NU 317 | | 6317 C3 ³⁾ | | |
| 315 M/L | 2 | NU 316 | | 6316 C3 ³⁾ | | |
| | 4 ... 8 | NU 319 | | 6319 C3 ³⁾ | | |
| 1LE16/1MB16 – Performance Line | | | | | | |
| 100 L | 2 ... 8 | 2) | | | | |
| 112 M | 2 ... 8 | 2) | | | | |
| 132 M | 2 ... 8 | 2) | | | | |
| 160 M/L | 2 ... 8 | 2) | | | | |
| 180 M/L | 2 ... 8 | NU 310 | | 6310 C3 ³⁾ | | |
| 200 L | 2 ... 8 | NU 312 | | 6312 C3 ³⁾ | | |
| 225 M | 2 ... 8 | NU 313 | | 6313 C3 ³⁾ | | Fig. 5 |
| 250 M | 2 ... 8 | NU 315 | | 6315 C3 ³⁾ | | |
| 280 M | 2 | NU 315 | | 6315 C3 ³⁾ | | |
| | 4 ... 8 | NU 317 | | 6317 C3 ³⁾ | | |
| 315 M/L | 2 | NU 316 | | 6316 C3 ³⁾ | | |
| | 4 ... 8 | NU 319 | | 6319 C3 ³⁾ | | |
| | | Type of construction | | Type of construction | | |
| | | Horizontal | Vertical | Horizontal | Vertical | |
| 1LE5, 1MB5 | | | | | | |
| 315 L | 2 | NU316 | NU316 | 6316 C4 | O. R. | – |
| | 4, 6 | NU319 | NU319 | 6319 C4 | O. R. | – |
| 355 M/L | 2 | NU317 | NU317 | 6317 C4 | O. R. | – |
| | 4, 6 | NU320 | NU320 | 6320 C4 | O. R. | – |
| 400 | 2 | 6218 C3 | 7218 B + 6218 C3 | 6218 C3 | 6218 C3 | Fig. 6, Fig. 7 |
| | 4 ... 8 | 6224 C3 | 7224 B + 6224 C3 | 6224 C3 | 6224 C3 | |
| 450 | 2 | 6220 C3 | – | 6220 C3 | – | Fig. 6 |
| | 4 ... 8 | 6226 C3 | 7226 B + 6226 C3 | 6226 C3 | 6226 C3 | Fig. 6, Fig. 7 |

¹⁾ Deep-groove bearings with a side plate are used for regreasable versions (**L23**).

³⁾ As for basic version.

²⁾ Not permitted.

Overview

Bearing assignment for 1MB1/1MB5 motors with types of protection Ex db, Ex db eb (bearings for increased cantilever forces – order code L22)

For NU bearings (cylindrical roller bearings), in contrast to ball bearings, a minimum cantilever force is required. Cylindrical roller bearings are not suitable for coupling output.

$$F_{\min} \sim F_{\max}/2$$

| Frame size | No. of poles | Drive end (DE) bearing | | Non-drive end (NDE) bearing | | Fig. No. on page 1/60 |
|---|--------------|------------------------|----------|-----------------------------|----------|-----------------------|
| | | Type of construction | | Type of construction | | |
| | | Horizontal | Vertical | Horizontal | Vertical | |
| 1MB1, 1MB5 with type of protection Ex db, Ex db eb | | | | | | |
| 160 | 2 ... 8 | NU309 | NU309 | 6309 C3 | 6309 C3 | – |
| 180 | 2 ... 8 | NU310 | NU310 | 6310 C3 | 6310 C3 | – |
| 200 | 2 ... 8 | NU312 | NU312 | 6312 C3 | 6312 C3 | – |
| 225 | 2 ... 8 | NU313 | NU313 | 6313 C3 | 6313 C3 | – |
| 250 | 2 ... 8 | NU315 | NU315 | 6315 C3 | 6315 C3 | – |
| 280 | 2 | NU315 | NU315 | 6315 C3 | 6315 C3 | – |
| 280 | 4 ... 8 | NU317 | NU317 | 6317 C3 | 6317 C3 | – |
| 315 | 2 | NU316 | NU316 | 6316 C3 | 6319 C3 | – |
| 315 | 4 ... 8 | NU319 | NU319 | 6319 C3 | 6319 C3 | – |
| 355 | 2 | NU317 | NU317 | 6317 C4 | 6320 C4 | – |
| 355 | 4 ... 8 | NU320 | NU320 | 6320 C4 | 6320 C4 | – |

Bearing assignment for 1LE15/1MB15 and 1LE16/1MB16 motors and 1LE5 motors (bearings reinforced at both ends – order code L25, for 1LE16 motors – standard)

| Frame size | No. of poles | Drive end (DE) bearing | | Non-drive end (NDE) bearing | | Fig. No. on page 1/60 |
|--|--------------|--|----------|--|----------|-----------------------|
| | | Horizontal and vertical type of construction | | Horizontal and vertical type of construction | | |
| 1LE15, 1MB15 – Basic Line | | | | | | |
| 71 M | 2 ... 8 | 6302 2ZC3 | | 6302 2ZC3 | | |
| 80 M | 2 ... 8 | 6304 2ZC3 | | 6304 2ZC3 | | |
| 90 S/L | 2 ... 8 | 6305 2ZC3 | | 6304 2ZC3 | | |
| 100 L | 2 ... 8 | 6306 2ZC3 ¹⁾ | | 6306 2ZC3 ¹⁾ | | |
| 112 M | 2 ... 8 | 6306 2ZC3 ¹⁾ | | 6306 2ZC3 ¹⁾ | | |
| 132 M | 2 ... 8 | 6308 2ZC3 ¹⁾ | | 6308 2ZC3 ¹⁾ | | |
| 160 M/L | 2 ... 8 | 6309 2ZC3 ¹⁾ | | 6309 2ZC3 ¹⁾ | | |
| 180 M/L | 2 ... 8 | 6310 ZC3 ³⁾ | | 6310 ZC3 ³⁾ | | |
| 200 L | 2 ... 8 | 6312 ZC3 ³⁾ | | 6312 ZC3 ³⁾ | | |
| 225 M | 2 ... 8 | 6313 ZC3 ³⁾ | | 6313 ZC3 ³⁾ | | Fig. 4 |
| 250 M | 2 ... 8 | 6315 ZC3 ³⁾ | | 6315 ZC3 ³⁾ | | |
| 280 M | 2 | 6315 C3 ²⁾ | | 6315 C3 ²⁾ | | |
| | 4 ... 8 | 6317 C3 ²⁾ | | 6317 C3 ²⁾ | | |
| 315 M/L | 2 | 6316 C3 ²⁾ | | 6316 C3 ²⁾ | | |
| | 4 ... 8 | 6319 C3 ²⁾ | | 6319 C3 ²⁾ | | |
| 1LE16, 1MB16 – Performance Line – bearing version as for Performance Line basic version | | | | | | |
| | | Type of construction | | Type of construction | | |
| | | Horizontal | Vertical | Horizontal | Vertical | |
| 1LE5 | | | | | | |
| 315 L | 2 | 6316 C4 | 6316 C4 | 6316 C4 | 7316 B | – |
| | 4, 6 | 6319 C4 | 6319 C4 | 6319 C4 | 7319 B | – |
| 355 M/L | 2 | 6317 C4 | 6317 C4 | 6317 C4 | 7317 B | – |
| | 4, 6 | 6320 C4 | 6320 C4 | 6320 C4 | 7320 B | – |
| 400 | 2 | O. R. | O. R. | O. R. | O. R. | Fig. 6, Fig. 7 |
| | 4,6,8 | 6326 C3 | O. R. | 6326 C3 | O. R. | |
| 450 | 2 | O. R. | – | O. R. | – | Fig. 6 |
| | 4,6,8 | 6326 C3 | O. R. | 6326 C3 | O. R. | Fig. 6, Fig. 7 |

¹⁾ Deep-groove bearings with a side plate are used for regreasable versions (**L23**).

²⁾ As for basic version.

³⁾ Deep-groove bearings without a side plate are used for regreasable versions (**L23**).

Introduction

Mechanical version

Bearings and Lubrication

1

Overview

Diagrams of bearings

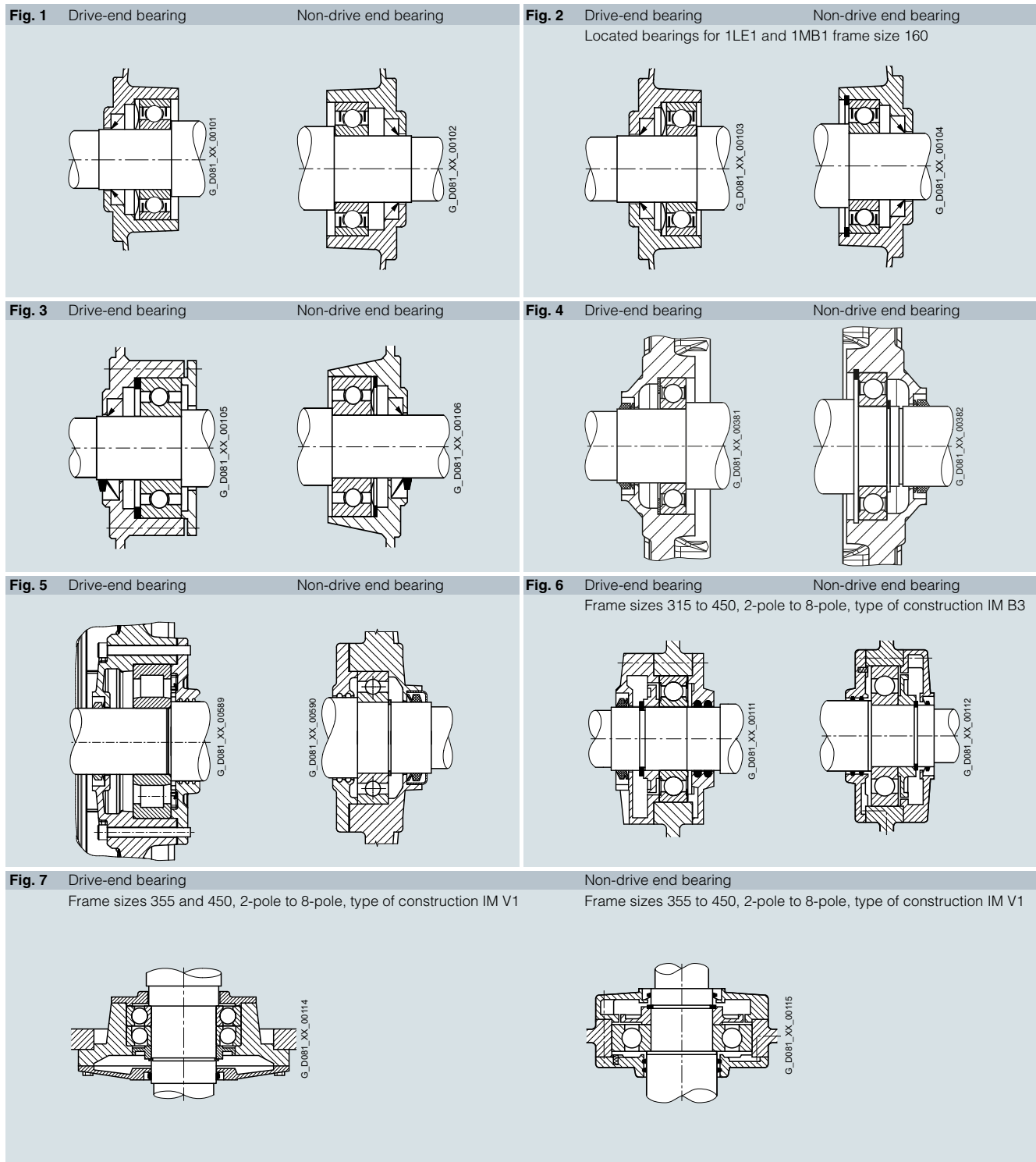

Overview

Admissible cantilever forces

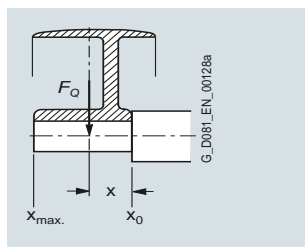

In order to calculate the admissible cantilever forces for a radial load, the line of force (i.e. the centerline of the pulley) of the cantilever force F_Q (N) must be within the free shaft extension (dimension x).

Dimension x (mm) is the distance between the point of application of the force F_Q and the shaft shoulder. The dimension

x_{max} corresponds to the length of the shaft extension.

Total cantilever force $F_Q = c \cdot F_U$

The pre-tension factor c is a value gained from experience from the belt manufacturer. The following approximate value can be assumed:

For normal flat leather belts with an idler pulley $c = 2$;
for V-belts $c = 2$ to 2.5;
for special synthetic belts (depending on the type of load and type of belt) $c = 2$ to 2.5.

The circumferential force F_U (N) is calculated using the following equation

$$F_U = 2 \cdot 10^7 \frac{P}{n \cdot D}$$

F_U circumferential force in N
 P rated motor power (transmitted power) in kW
 n rated motor speed in rpm
 D belt pulley diameter in mm

Admissible cantilever forces – basic version

| 1LE10, 1MB10 motors (frame sizes 80 ... 160) and 1PC10 (frame sizes 100 ... 160) at 50 Hz | | | | |
|---|-------------|--------------|--|--|
| Valid are: x_0 values for $x = 0$ and x_{max} values for $x = l$ (l = shaft extension) | | | | |
| Frame size | Type | No. of poles | Admissible cantilever force F_Q at x_0 | Admissible cantilever force F_Q at x_{max} |
| N | | | | |
| 1LE1 motors – values for motors with increased power ¹⁾ | | | | |
| 80 | 1LE10..-0DA | 2 | 485 | 400 |
| | 1LE10..-0DB | 4 | 625 | 515 |
| | 1LE10..-0DC | 6 | 735 | 605 |
| 90 | 1LE10..-0EA | 2 | 725 | 605 |
| | 1LE10..-0EB | 4 | 920 | 775 |
| | 1LE10..-0EC | 6 | 1090 | 910 |
| 100 | 1LE10..-1AA | 2 | 1010 | 825 |
| | 1LE10..-1AB | 4 | 1230 | 1010 |
| | 1LE10..-1AC | 6 | 1440 | 1180 |
| 112 | 1LE10..-1BA | 2 | 970 | 785 |
| | 1LE10..-1BB | 4 | 1235 | 1000 |
| | 1LE10..-1BC | 6 | 1440 | 1165 |
| 132 | 1LE10..-1CA | 2 | 1470 | 1180 |
| | 1LE10..-1CB | 4 | 1830 | 1470 |
| | 1LE10..-1CC | 6 | 2150 | 1730 |
| 160 | 1LE10..-1DA | 2 | 1550 | 1270 |
| | 1LE10..-1DB | 4 | 1910 | 1550 |
| | 1LE10..-1DC | 6 | 2230 | 1810 |
| 1LE1 motors – standard values ¹⁾ | | | | |
| 1MB1 motors – standard values ¹⁾ | | | | |
| 1PC1 motors – standard values ¹⁾ | | | | |
| 63 | 1LE10..-0BA | 2 | 270 | 240 |
| | 1LE10..-0BB | 4 | 350 | 305 |
| 71 | 1LE10..-0CA | 2 | 415 | 355 |
| | 1LE10..-0CB | 4 | 530 | 450 |
| 80 | 1LE10..-0DA | 2 | 485 | 400 |
| | 1MB10..-0DA | | | |
| | 1PC10..-0DA | | | |
| | 1LE10..-0DB | 4 | 625 | 515 |
| | 1MB10..-0DB | | | |
| | 1PC10..-0DB | | | |
| | 1LE10..-0DC | 6 | 735 | 605 |
| | 1MB10..-0DC | | | |
| | 1PC10..-0DC | | | |
| | 1LE10..-0DD | 8 | 815 | 675 |
| | 1MB10..-0DD | | | |
| | 1PC10..-0DD | | | |
| 90 | 1LE10..-0EA | 2 | 725 | 605 |
| | 1MB10..-0EA | | | |
| | 1PC10..-0EA | | | |
| | 1LE10..-0EB | 4 | 920 | 775 |
| | 1MB10..-0EB | | | |
| | 1PC10..-0EB | | | |
| | 1LE10..-0EC | 6 | 1090 | 910 |
| | 1MB10..-0EC | | | |
| | 1PC10..-0EC | | | |
| | 1LE10..-0ED | 8 | 1230 | 1030 |
| | 1MB10..-0ED | | | |
| | 1PC10..-0ED | | | |

Note:

¹⁾PC10 only for frame sizes 100 to 160.

In the case of cantilever forces that exceed this, see "Bearings for increased cantilever forces".

| 1LE10, 1MB10 motors (frame sizes 80 ... 160) and 1PC10 (frame sizes 100 ... 160) at 50 Hz | | | | |
|---|-------------|--------------|--|--|
| Valid are: x_0 values for $x = 0$ and x_{max} values for $x = l$ (l = shaft extension) | | | | |
| Frame size | Type | No. of poles | Admissible cantilever force F_Q at x_0 | Admissible cantilever force F_Q at x_{max} |
| N | | | | |
| 1LE1 motors – standard values ¹⁾ | | | | |
| 1MB1 motors – standard values ¹⁾ | | | | |
| 1PC1 motors – standard values ¹⁾ | | | | |
| 100 | 1LE10..-1AA | 2 | 1020 | 815 |
| | 1MB10..-1AA | | | |
| | 1PC10..-1AA | | | |
| | 1LE10..-1AB | 4 | 1250 | 1000 |
| | 1MB10..-1AB | | | |
| | 1PC10..-1AB | | | |
| | 1LE10..-1AC | 6 | 1450 | 1155 |
| | 1MB10..-1AC | | | |
| | 1PC10..-1AC | | | |
| | 1LE10..-1AD | 8 | 1615 | 1290 |
| | 1MB10..-1AD | | | |
| | 1PC10..-1AD | | | |
| 112 | 1LE10..-1BA | 2 | 1000 | 790 |
| | 1MB10..-1BA | | | |
| | 1PC10..-1BA | | | |
| | 1LE10..-1BB | 4 | 1250 | 990 |
| | 1MB10..-1BB | | | |
| | 1PC10..-1BB | | | |
| | 1LE10..-1BC | 6 | 1450 | 1150 |
| | 1MB10..-1BC | | | |
| | 1PC10..-1BC | | | |
| | 1LE10..-1BD | 8 | 1610 | 1275 |
| | 1MB10..-1BD | | | |
| | 1PC10..-1BD | | | |
| 132 | 1LE10..-1CA | 2 | 1505 | 1170 |
| | 1MB10..-1CA | | | |
| | 1PC10..-1CA | | | |
| | 1LE10..-1CB | 4 | 1880 | 1460 |
| | 1MB10..-1CB | | | |
| | 1PC10..-1CB | | | |
| | 1LE10..-1CC | 6 | 2170 | 1680 |
| | 1MB10..-1CC | | | |
| | 1PC10..-1CC | | | |
| | 1LE10..-1CD | 8 | 2420 | 1880 |
| | 1MB10..-1CD | | | |
| | 1PC10..-1CD | | | |
| 160 | 1LE10..-1DA | 2 | 1560 | 1240 |
| | 1MB10..-1DA | | | |
| | 1PC10..-1DA | | | |
| | 1LE10..-1DB | 4 | 2040 | 1590 |
| | 1MB10..-1DB | | | |
| | 1PC10..-1DB | | | |
| | 1LE10..-1DC | 6 | 2350 | 1820 |
| | 1MB10..-1DC | | | |
| | 1PC10..-1DC | | | |
| | 1LE10..-1DD | 8 | 2610 | 2030 |
| | 1MB10..-1DD | | | |
| | 1PC10..-1DD | | | |
| 180 | 1LE10.. | 2 | 1670 | 1380 |
| | | 4 | 2150 | 1740 |
| | | 6 | 2500 | 2000 |
| 200 | 1LE10.. | 2 | 2460 | 2070 |
| | | 4 | 3180 | 2630 |
| | | 6 | 3600 | 2980 |

¹⁾ For IE1 motors, the admissible cantilever force can be increased by up to 5%.

Introduction

Mechanical version

Bearings and lubrication

1

Overview

1LE15, 1MB15¹⁾, 1LE55, and 1MB55 motors¹⁾ at 50 Hz

Valid are: x_0 values for $x = 0$ and x_{max} values for $x = I$ ($I =$ shaft extension)

| For motors | No. of poles | Admissible cantilever force at x_0 | Admissible cantilever force at x_{max} |
|---|--------------|--------------------------------------|--|
| Frame size | N | N | N |
| 1LE1501/03/21/23, 1MB15 – Basic Line | | | |
| 71 | 2 | 400 | 340 |
| | 4 | 500 | 420 |
| | 6 | 570 | 490 |
| 80 | 2 | 680 | 570 |
| | 4 | 860 | 720 |
| | 6 | 980 | 820 |
| 90 | 2 | 760 | 620 |
| | 4 | 950 | 790 |
| | 6 | 1090 | 900 |
| 100 | 2 | 1010 | 815 |
| | 4 | 1230 | 1000 |
| | 6 | 1440 | 1155 |
| | 8 | 1615 | 1290 |
| 112 | 2 | 970 | 785 |
| | 4 | 1235 | 990 |
| | 6 | 1440 | 1150 |
| | 8 | 1610 | 1275 |
| 132 | 2 | 1470 | 1170 |
| | 4 | 1830 | 1460 |
| | 6 | 2150 | 1680 |
| | 8 | 2420 | 1880 |
| 160 | 2 | 1550 | 1240 |
| | 4 | 1910 | 1550 |
| | 6 | 2230 | 1810 |
| | 8 | 2610 | 2030 |
| 180 | 2 | 1670 | 1380 |
| | 4 | 2150 | 1740 |
| | 6 | 2500 | 2000 |
| | 8 | 2980 | 2430 |
| 200 | 2 | 2460 | 2070 |
| | 4 | 3180 | 2630 |
| | 6 | 3600 | 2980 |
| | 8 | 4200 | 3450 |
| 225 | 2 | 2850 | 2300 |
| | 4 | 3550 | 2800 |
| | 6 | 4050 | 3240 |
| | 8 | 4500 | 3500 |
| 250 | 2 | 3250 | 2600 |
| | 4 | 4100 | 3400 |
| | 6 | 4800 | 4000 |
| | 8 | 5250 | 4450 |
| 280 | 2 | 5200 | 4200 |
| | 4 | 8500 | 7 000 |
| | 6 | 9800 | 8150 |
| | 8 | 10800 | 9000 |
| 315 S/M | 2 | 5300 | 4500 |
| | 4 | 9150 | 7400 |
| | 6 | 10750 | 8750 |
| | 8 | 11600 | 9600 |
| 315 L | 2 | 4900 | 4300 |
| | 4 | 8900 | 7700 |
| | 6 | 10100 | 9150 |
| | 8 | 11100 | 10200 |
| 1LE5504/34/03/33, 1MB55 | | | |
| 315 L | 2 | 5800 | 5200 |
| | 4 | 9300 | 8 000 |
| | 6 | 10600 | 9200 |
| | 8 | 12000 | 9200 |
| 400 | 2 | 2910 | 2570 |
| | 4 | 6830 | 5870 |
| | 6 | 6520 | 5610 |
| | 8 | 7860 | 6760 |
| 450 | 2 | 3820 | 3410 |
| | 4 | 7130 | 6220 |
| | 6 | 6970 | 6080 |
| | 8 | 8110 | 7070 |

¹⁾ Not valid for 1MB.55 motors with type of protection Ex db eb.

1LE16, 1MB16, 1LE56, and 1MB56 motors at 50 Hz

Valid are: x_0 values for $x = 0$ and x_{max} values for $x = I$ ($I =$ shaft extension)

| For motors | No. of poles | Admissible cantilever force at x_0 | Admissible cantilever force at x_{max} |
|---|--------------|--------------------------------------|--|
| Frame size | N | N | N |
| 1LE1601/03/21/23, 1MB16 – Performance Line | | | |
| 100 | 2 | 1585 | 1270 |
| | 4 | 1960 | 1575 |
| | 6 | 2270 | 1815 |
| | 8 | 2520 | 2015 |
| 112 | 2 | 1545 | 1240 |
| | 4 | 1960 | 1555 |
| | 6 | 2270 | 1800 |
| | 8 | 2510 | 1990 |
| 132 | 2 | 2285 | 1795 |
| | 4 | 2860 | 2250 |
| | 6 | 3320 | 2580 |
| | 8 | 3700 | 2870 |
| 160 | 2 | 2800 | 2170 |
| | 4 | 3450 | 2750 |
| | 6 | 4000 | 3160 |
| | 8 | 4510 | 3500 |
| 180 | 2 | 3250 | 2610 |
| | 4 | 4110 | 3270 |
| | 6 | 4720 | 3740 |
| | 8 | 5320 | 4350 |
| 200 | 2 | 4320 | 3550 |
| | 4 | 5480 | 4500 |
| | 6 | 6220 | 5110 |
| | 8 | 7000 | 5800 |
| 225 | 2 | 5000 | 4150 |
| | 4 | 6250 | 4900 |
| | 6 | 7200 | 5750 |
| | 8 | 7800 | 6200 |
| 250 | 2 | 6000 | 4800 |
| | 4 | 7600 | 6200 |
| | 6 | 8750 | 7350 |
| | 8 | 9500 | 8 000 |
| 280 | 2 | 5200 | 4200 |
| | 4 | 8500 | 7 000 |
| | 6 | 9800 | 8150 |
| | 8 | 10800 | 9000 |
| 315 S/M | 2 | 5300 | 4500 |
| | 4 | 9150 | 7400 |
| | 6 | 10750 | 8750 |
| | 8 | 11600 | 9600 |
| 315 L | 2 | 4900 | 4300 |
| | 4 | 8900 | 7700 |
| | 6 | 10100 | 9150 |
| | 8 | 11100 | 10200 |
| 1LE5604/34/03/33, 1MB56 – Performance line | | | |
| 315 L | 2 | 5800 | 5200 |
| | 4 | 9300 | 8 000 |
| | 6 | 10600 | 9200 |
| | 8 | 12000 | 9200 |
| 355 M/L | 2 | 5800 | 5200 |
| | 4 | 9900 | 8700 |
| | 6 | 11200 | 9800 |
| | 8 | 11200 | 10000 |

In the case of cantilever forces that exceed this, see "Bearings for increased cantilever forces".

Overview

1MB1, 1MB5 motors for types of protection Ex db and Ex db eb at 50 HzValid are: x_0 values for $x = 0$, $x_{0.5}$ for $x = 0.5 \times l$ and x_{max} values for $x = l$ (l = shaft extension)

| Frame size | No. of poles N | Admissible cantilever force | | |
|---|----------------|-----------------------------|--------------|--------------|
| | | at x_0 | at $x_{0.5}$ | at x_{max} |
| 1MB1/1MB5 – for types of protection Ex db and Ex db eb | | | | |
| 71 | 2 | 360 | 340 | 300 |
| | 4 | 410 | 380 | 300 |
| | 6 | 490 | 390 | 300 |
| 80 | 2 | 570 | 530 | 420 |
| | 4 | 700 | 570 | 430 |
| | 6 | 800 | 580 | 430 |
| 90 | 2 | 520 | 480 | 440 |
| | 4 | 660 | 660 | 490 |
| | 6 | 850 | 690 | 510 |
| 100 | 2 | 1340 | 1110 | 830 |
| | 4 | 1620 | 1110 | 820 |
| | 6 | 1690 | 1120 | 830 |
| 112 | 2 | 1550 | 1030 | 760 |
| | 4 | 1300 | 1150 | 860 |
| | 6 | 1630 | 1300 | 970 |
| 132 | 2 | 1800 | 1190 | 880 |
| | 4 | 1820 | 1200 | 890 |
| | 6 | 1980 | 1790 | 1420 |
| 160 | 2 | 2460 | 1830 | 1290 |
| | 4 | 2810 | 1880 | 1330 |
| | 6 | 3050 | 2000 | 1420 |
| 180 | 2 | 2770 | 2510 | 1950 |
| | 4 | 3430 | 2850 | 1940 |
| | 6 | 3700 | 3290 | 2230 |
| 200 | 2 | 4300 | 2570 | 1750 |
| | 4 | 3070 | 2800 | 2570 |
| | 6 | 4380 | 3990 | 2940 |
| 225 | 2 | 4860 | 4430 | 3700 |
| | 4 | 3960 | 3640 | 3360 |
| | 6 | 5630 | 5170 | 4390 |
| 250 | 2 | 6190 | 5690 | 5250 |
| | 4 | 4500 | 4170 | 3890 |
| | 6 | 5590 | 5090 | 4660 |
| 280 | 2 | 6260 | 5690 | 5220 |
| | 4 | 7230 | 6580 | 4770 |
| | 6 | 5430 | 4930 | 4510 |
| 315 S/M | 2 | 6720 | 6100 | 5580 |
| | 4 | 7650 | 6950 | 6360 |
| | 6 | 8720 | 7920 | 6250 |
| 315 L | 2 | 4690 | 4330 | 4000 |
| | 4 | 7430 | 6580 | 6330 |
| | 6 | 8940 | 8240 | 7070 |
| 355 | 2 | 8860 | 8170 | 6790 |
| | 4 | 5480 | 5210 | 4970 |
| | 6 | 8300 | 7360 | 5530 |
| 355 | 2 | 9280 | 6910 | 4780 |
| | 4 | 9210 | 5700 | 4120 |
| | 6 | O. R. | O. R. | O. R. |
| 355 | 2 | O. R. | O. R. | O. R. |
| | 4 | 3900 | 3700 | 3520 |
| | 6 | 3930 | 3570 | 2610 |
| 355 | 2 | O. R. | O. R. | O. R. |
| | 4 | O. R. | O. R. | O. R. |
| | 6 | O. R. | O. R. | O. R. |

Admissible cantilever forces – bearings for increased cantilever forces – order code **L22****1LE10, 1MB10 motors (frame sizes 80 ... 160) and 1PC10 (frame sizes 100 ... 160) at 50 Hz with reinforced deep-groove bearings at DE**Valid are: x_0 values for $x = 0$ and x_{max} values for $x = l$ (l = shaft extension)

| Frame size | Type | No. of poles N | Admissible cantilever force F_Q | |
|---|--------------------|----------------|-----------------------------------|--------------|
| | | | at x_0 | at x_{max} |
| 1LE1 motors – values for motors with increased power ¹⁾ | | | | |
| 100 | 1LE10..-1AA | 2 | 1585 | 1300 |
| | 1LE10..-1AB | 4 | 1960 | 1610 |
| | 1LE10..-1AC | 6 | 2270 | 1865 |
| 112 | 1LE10..-1BA | 2 | 1545 | 1250 |
| | 1LE10..-1BB | 4 | 1960 | 1585 |
| | 1LE10..-1BC | 6 | 2270 | 1835 |
| 132 | 1LE10..-1CA | 2 | 2285 | 1840 |
| | 1LE10..-1CB | 4 | 2860 | 2300 |
| | 1LE10..-1CC | 6 | 3320 | 2670 |
| 160 | 1LE10..-1DA | 2 | 2800 | 2240 |
| | 1LE10..-1DB | 4 | 3450 | 2270 |
| | 1LE10..-1DC | 6 | 4000 | 3200 |
| 1LE1 motors – standard values ¹⁾ | | | | |
| 1MB1 motors – standard values ¹⁾ | | | | |
| 1PC1 motors – standard values ¹⁾ | | | | |
| 100 | 1LE10..-1AA | 2 | 1585 | 1270 |
| | 1MB10..-1AA | | | |
| | 1PC10..-1AA | | | |
| 112 | 1LE10..-1AB | 4 | 1960 | 1575 |
| | 1MB10..-1AB | | | |
| | 1PC10..-1AB | | | |
| 132 | 1LE10..-1AC | 6 | 2270 | 1815 |
| | 1MB10..-1AC | | | |
| | 1PC10..-1AC | | | |
| 160 | 1LE10..-1AD | 8 | 2520 | 2015 |
| | 1MB10..-1AD | | | |
| | 1PC10..-1AD | | | |
| 112 | 1LE10..-1BA | 2 | 1545 | 1240 |
| | 1MB10..-1BA | | | |
| | 1PC10..-1BA | | | |
| 132 | 1LE10..-1BB | 4 | 1960 | 1555 |
| | 1MB10..-1BB | | | |
| | 1PC10..-1BB | | | |
| 160 | 1LE10..-1BC | 6 | 2270 | 1800 |
| | 1MB10..-1BC | | | |
| | 1PC10..-1BC | | | |
| 112 | 1LE10..-1BD | 8 | 2510 | 1990 |
| | 1MB10..-1BD | | | |
| | 1PC10..-1BD | | | |
| 132 | 1LE10..-1CA | 2 | 2285 | 1795 |
| | 1MB10..-1CA | | | |
| | 1PC10..-1CA | | | |
| 160 | 1LE10..-1CB | 4 | 2860 | 2250 |
| | 1MB10..-1CB | | | |
| | 1PC10..-1CB | | | |
| 112 | 1LE10..-1CC | 6 | 3320 | 2580 |
| | 1MB10..-1CC | | | |
| | 1PC10..-1CC | | | |
| 132 | 1LE10..-1CD | 8 | 3700 | 2870 |
| | 1MB10..-1CD | | | |
| | 1PC10..-1CD | | | |
| 160 | 1LE10..-1DA | 2 | 2800 | 2170 |
| | 1MB10..-1DA | | | |
| | 1PC10..-1DA | | | |
| 112 | 1LE10..-1DB | 4 | 3450 | 2750 |
| | 1MB10..-1DB | | | |
| | 1PC10..-1DB | | | |
| 132 | 1LE10..-1DC | 6 | 4000 | 3160 |
| | 1MB10..-1DC | | | |
| | 1PC10..-1DC | | | |
| 160 | 1LE10..-1DD | 8 | 4510 | 3500 |
| | 1MB10..-1DD | | | |
| | 1PC10..-1DD | | | |
| 180 | 1LE10..-1EA | 2 | 3250 | 2610 |
| | | 4 | 4110 | 3270 |
| | | 6 | 4720 | 3740 |
| 200 | | 8 | 5130 | 4050 |
| | | 2 | 4320 | 3550 |
| | | 4 | 5480 | 4500 |
| 200 | | 6 | 6220 | 5110 |
| | | 8 | 6870 | 5640 |

¹⁾ For IE1 motors, the admissible cantilever force can be increased by up to 5 %.

Introduction

Mechanical version

Bearings and lubrication

1

Overview

1LE15 and 1MB15¹⁾ motors at 50 Hz with reinforced deep-groove bearings at DE up to frame size 160 with cylindrical roller bearings at DE in frame size 180 and above

Valid are: x_0 values for $x = 0$ and x_{max} values for $x = l$ (l = shaft extension)

For motors

| Frame size | Type | No. of poles | N | Admissible cantilever force at x_0 | Admissible cantilever force at x_{max} |
|---|----------------------------|--------------|------|--------------------------------------|--|
| 1LE1501/03/21/23, 1MB15 – Basic Line | | | | | |
| 71 | 1LE15..-0CA 1MB15..-0CA | 2 | 400 | 340 | |
| | 1LE15..-0CB 1MB15..-0CB | 4 | 490 | 420 | |
| | 1LE15..-0CC 1MB15..-0CC | 6 | 570 | 490 | |
| | 1LE15..-0CD 1MB15..-0CD | 8 | 640 | 540 | |
| | 1LE15..-0DA 1MB15..-0DA | 2 | 680 | 570 | |
| 80 | 1LE15..-0DB 1MB15..-0DB | 4 | 840 | 720 | |
| | 1LE15..-0DC 1MB15..-0DC | 6 | 970 | 820 | |
| | 1LE15..-0DD 1MB15..-0DD | 8 | 1090 | 910 | |
| | 1LE15..-0EA 1MB15..-0EA | 2 | 720 | 605 | |
| | 1LE15..-0EB 1MB15..-0EB | 4 | 920 | 775 | |
| 90 | 1LE15..-0EC 1MB15..-0EC | 6 | 1060 | 910 | |
| | 1LE15..-0ED 1MB15..-0ED | 8 | 1200 | 1030 | |
| | 1LE15..-1AA 1MB15..-1AA | 2 | 1585 | 1270 | |
| | 1LE15..-1AB 1MB15..-1AB | 4 | 1960 | 1575 | |
| | 1LE15..-1AC 1MB15..-1AC | 6 | 2270 | 1815 | |
| 112 | 1LE15..-1AD 1MB15..-1AD | 8 | 2520 | 2015 | |
| | 1LE15..-1BA 1MB15..-1BA | 2 | 1545 | 1240 | |
| | 1LE15..-1BB 1MB15..-1BB | 4 | 1960 | 1555 | |
| | 1LE15..-1BC 1MB15..-1BC | 6 | 2270 | 1800 | |
| | 1LE15..-1BD 1MB15..-1BD | 8 | 2510 | 1990 | |
| 132 | 1LE15..-1CA 1MB15..-1CA | 2 | 2285 | 1795 | |
| | 1LE15..-1CB 1MB15..-1CB | 4 | 2860 | 2250 | |
| | 1LE15..-1CC 1MB15..-1CC | 6 | 3320 | 2580 | |
| | 1LE15..-1CD 1MB15..-1CD | 8 | 3700 | 2870 | |
| | 1LE15..-1DA 1MB15..-1DA | 2 | 2800 | 2170 | |
| 160 | 1LE15..-1DB 1MB15..-1DB | 4 | 3450 | 2750 | |
| | 1LE15..-1DC 1MB15..-1DC | 6 | 4000 | 3160 | |
| | 1LE15..-1DD 1MB15..-1DD | 8 | 4510 | 3500 | |
| | 1LE15..-1EA 1MB15..-1EA | 2 | 4520 | 3630 | |
| | 1LE15..-1EB 1MB15..-1EB | 4 | 5560 | 4050 | |
| 200 | 1LE15..-1EC 1MB15..-1EC | 6 | 6280 | 4050 | |
| | 1LE15..-1ED 1MB15..-1ED | 8 | 6790 | 4050 | |
| | 1LE15..-2AA 1MB15..-2AA | 2 | 6840 | 5610 | |
| | 1LE15..-2AB 1MB15..-2AB | 4 | 8440 | 6000 | |
| | 1LE15..-2AC 1MB15..-2AC | 6 | 9480 | 6000 | |
| 1LE15..-2AD 1MB15..-2AD | 8 | 10100 | 6000 | | |

Note: 1PC10 and 1MB10 not for frame sizes 180 to 200.

¹⁾ Not valid for 1MB155 motors with type of protection Ex db eb.

1LE15 and 1MB15 motors at 50 Hz with reinforced deep-groove bearings at DE up to frame size 160 with cylindrical roller bearings at DE in frame size 180 and above

Valid are: x_0 values for $x = 0$ and x_{max} values for $x = l$ (l = shaft extension)

For motors

| Frame size | Type | No. of poles | N | Admissible cantilever force at x_0 | Admissible cantilever force at x_{max} |
|---|----------------------------|--------------|-------|--------------------------------------|--|
| 1LE1501/03/21/23, 1MB15 – Basic Line (continued) | | | | | |
| 225 | 1LE15..-2BA 1MB15..-2BA | 2 | 8 000 | 6800 | |
| | 1LE15..-2BB 1MB15..-2BB | 4 | 9800 | 7250 | |
| | 1LE15..-2BC 1MB15..-2BC | 6 | 11100 | 7300 | |
| | 1LE15..-2BD 1MB15..-2BD | 8 | 11300 | 7300 | |
| | 1LE15..-2CA 1MB15..-2CA | 2 | 9500 | 7400 | |
| 250 | 1LE15..-2CB 1MB15..-2CB | 4 | 12500 | 9400 | |
| | 1LE15..-2CC 1MB15..-2CC | 6 | 13500 | 9700 | |
| | 1LE15..-2CD 1MB15..-2CD | 8 | 14700 | 9700 | |
| | 1LE15..-2DA 1MB15..-2DA | 2 | 16500 | 9800 | |
| | 1LE15..-3AA 1MB15..-3AA | 2 | 18400 | 7600 | |

1LE16 and 1MB16 motors at 50 Hz with reinforced cylindrical roller bearings DE

Valid are: x_0 values for $x = 0$ and x_{max} values for $x = l$ (l = shaft extension)

For motors

| Frame size | No. of poles | N | Admissible cantilever force at x_0 | Admissible cantilever force at x_{max} |
|---|--------------|-------|--------------------------------------|--|
| 1LE1601/03/21/23, 1MB16 – Performance Line | | | | |
| 100, 112, 132, 160 | 2, 4, 6, 8 | – | – | – |
| 180 | 2 | 8150 | 4050 | |
| | 4 | 9800 | 4050 | |
| | 6 | 9800 | 4050 | |
| 200 | 2 | 11200 | 6000 | |
| | 4 | 13600 | 6000 | |
| | 6 | 13600 | 6000 | |
| 225 | 2 | 12700 | 7900 | |
| | 4 | 15700 | 7250 | |
| | 6 | 15700 | 7300 | |
| 250 | 2 | 17000 | 7750 | |
| | 4 | 21000 | 9400 | |
| | 6 | 21000 | 9700 | |
| 280 ²⁾ | 2 | 16500 | 9800 | |
| | 4 | 18400 | 7600 | |
| | 6 | 18400 | 7600 | |

Admissible cantilever forces – Bearing for increased cantilever forces – For all motors of frame sizes 400 and 450 at 50 Hz in the horizontal and vertical types of construction (order code **L22**) on request.

Please specify cantilever force and lever arm.

²⁾ For admissible cantilever forces 4, 6, and 8-pole versions, see diagrams on this page.

Overview

1LE15/6 and 1MB15/6 ¹⁾ motors for 50 Hz with cylindrical roller bearings DE for frame sizes 280 to 315 in 4 to 8-pole version

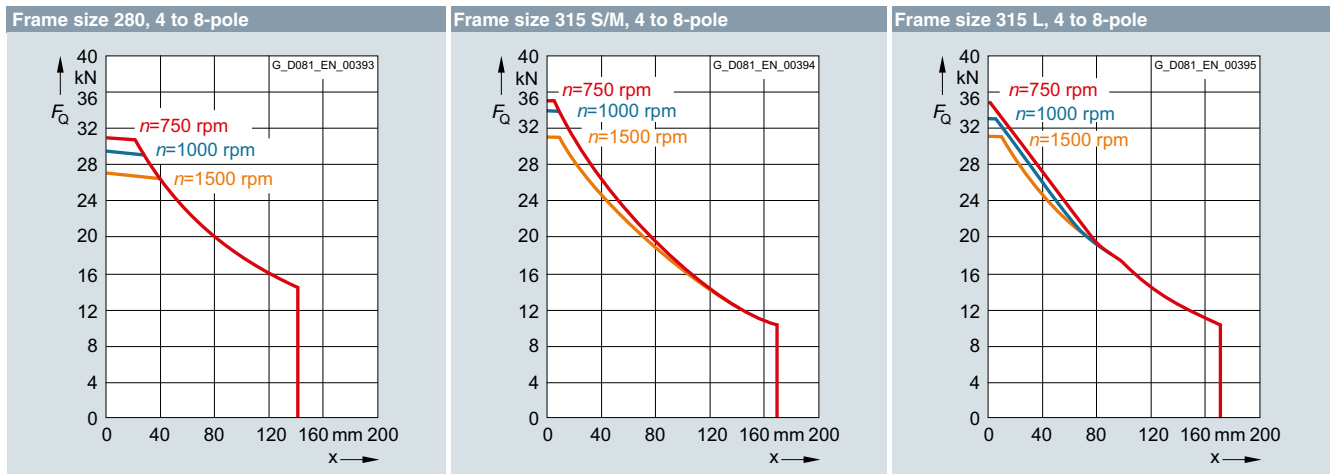

1LE55/6, 1MB55/6 motors for 50 Hz with cylindrical roller bearings DE for frame sizes 315 and 355 in 2 to 8-pole version

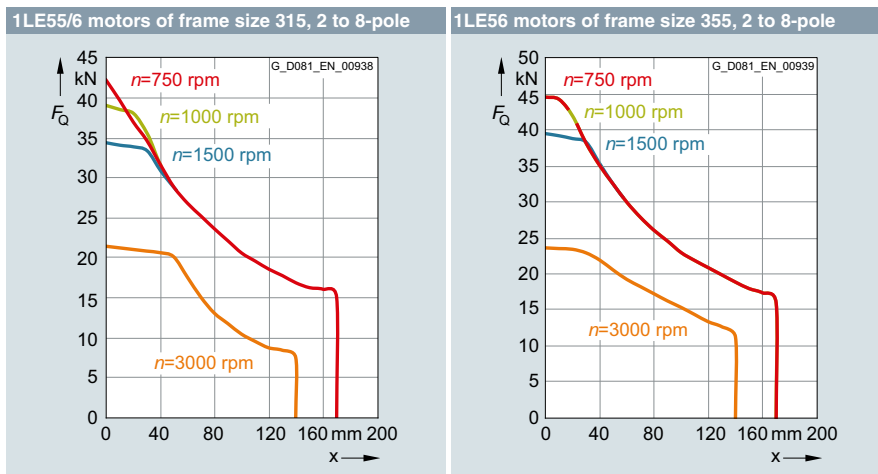

Admissible cantilever forces at 50 Hz – basic version

For motors in a horizontal type of construction, the maximum cantilever forces are specified as a function of the axial forces. See diagrams below.

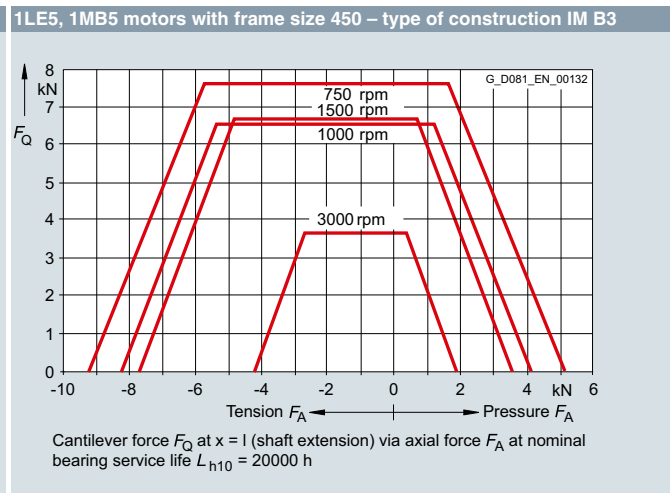
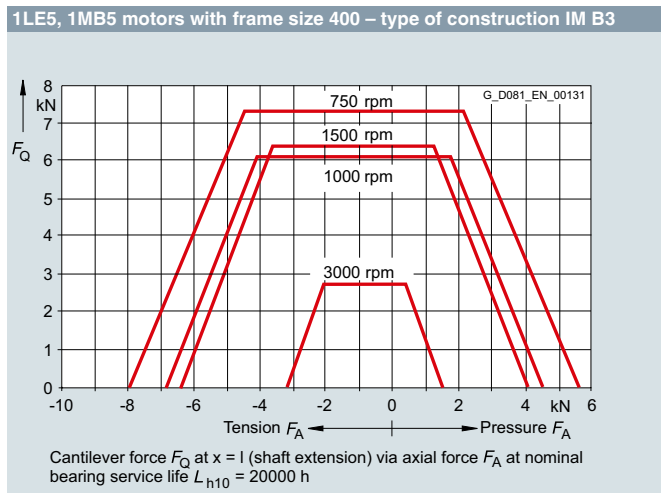

¹⁾ Not valid for 1MB155 motors with type of protection Ex db eb.

Introduction

Mechanical version

Bearings and lubrication

Overview

Admissible cantilever forces – bearings reinforced at both ends
– order code **L25**

1LE10, 1MB10 motors (frame sizes 80 ... 160) and 1PC10 (frame sizes 100 ... 160) for 50 Hz with deep-groove bearings reinforced at both ends

Valid are: x_0 values for $x = 0$ and x_{max} values for $x = l$ (l = shaft extension)

| Frame size | No. of poles | Admissible cantilever force | |
|---|--------------|-----------------------------|--------------|
| | | at x_0 | at x_{max} |
| 1LE1501/03/21/23, 1MB15 – Basic Line | | | |
| 1LE10, 1MB10, 1PC10 | | | |
| 71 | 2 | 610 | 510 |
| | 4 | 760 | 640 |
| | 6 | 880 | 740 |
| | 8 | 970 | 820 |
| 80 | 2 | 950 | 800 |
| | 4 | 1190 | 1000 |
| | 6 | 1370 | 1150 |
| | 8 | 1520 | 1270 |
| 90 | 2 | 1200 | 1000 |
| | 4 | 1530 | 1270 |
| | 6 | 1760 | 1450 |
| | 8 | 1950 | 1610 |
| 100 | 2 | 1585 | 1270 |
| | 4 | 1960 | 1575 |
| | 6 | 2270 | 1815 |
| | 8 | 2520 | 2015 |
| 112 | 2 | 1545 | 1240 |
| | 4 | 1960 | 1555 |
| | 6 | 2270 | 1800 |
| | 8 | 2510 | 1990 |
| 132 | 2 | 2285 | 1795 |
| | 4 | 2860 | 2250 |
| | 6 | 3320 | 2580 |
| | 8 | 3700 | 2870 |
| 160 | 2 | 2800 | 2170 |
| | 4 | 3450 | 2750 |
| | 6 | 4000 | 3160 |
| | 8 | 4510 | 3500 |
| 180 | 2 | 3250 | 2610 |
| | 4 | 4110 | 3270 |
| | 6 | 4720 | 3740 |
| | 8 | 5130 | 4050 |
| 200 | 2 | 4320 | 3550 |
| | 4 | 5480 | 4500 |
| | 6 | 6220 | 5110 |
| | 8 | 6870 | 5640 |
| 225 | 2 | 5000 | 4150 |
| | 4 | 6250 | 4900 |
| | 6 | 7200 | 5750 |
| | 8 | 7800 | 6200 |
| 250 | 2 | 6000 | 4800 |
| | 4 | 7600 | 6200 |
| | 6 | 8750 | 7350 |
| | 8 | 9500 | 8000 |
| 280 ¹⁾ | 2, 4, 6, 8 | – | – |
| 315 ¹⁾ | 2, 4, 6, 8 | – | – |

Note:

1PC10 only for frame sizes 100 to 160,
1MB10 only for frame sizes 80 to 160.

Admissible cantilever forces – bearings reinforced at both ends,
DE bearings for increased cantilever forces – order code **L28**

1LE15 and 1MB15 motors for 50 Hz with cylindrical roller bearings DE and with deep-groove bearings NDE
Valid are: x_0 values for $x = 0$ and x_{max} values for $x = l$ (l = shaft extension)

| Frame size | No. of poles | Admissible cantilever force | |
|---|--------------|-----------------------------|--------------|
| | | at x_0 | at x_{max} |
| 1LE1501/03/21/23, 1MB15 – Basic Line | | | |
| 100, 112, 132, 160 | 2, 4, 6, 8 | – | – |
| | 2 | 8150 | 4050 |
| | 4 | 9800 | 4050 |
| 180 | 6 | 9800 | 4050 |
| | 2 | 11200 | 6000 |
| | 4, 6 | 13600 | 6000 |
| 200 | 2 | 12700 | 7900 |
| | 4 | 15700 | 7250 |
| | 6, 8 | 15700 | 7300 |
| 225 | 2 | 17000 | 7750 |
| | 4 | 21000 | 9400 |
| | 6, 8 | 21000 | 9700 |
| 250 | 2, 4, 6, 8 | – | – |
| 280, 315 S, M, L ¹⁾ | 2, 4, 6, 8 | – | – |

Admissible cantilever forces – bearings for increased cantilever forces – order code **L22**

1MB1 and 1MB5 motors at 50 Hz with reinforced deep-groove bearings DE
Valid are: x_0 values for $x = 0$; $x_{0,5}$ values for $x = 0.5 \times l$ and x_{max} values for $x = l$ (l = shaft extension)

| Frame size | No. of poles | Admissible cantilever force | | |
|------------------|--------------|-----------------------------|--------------|--------------|
| | | at x_0 | at $x_{0,5}$ | at x_{max} |
| 1MB1/1MB5 | | | | |
| 160 | 2 | 5380 | 2870 | 1950 |
| | 4 | 5340 | 2850 | 1940 |
| | 6 | 6150 | 3290 | 2230 |
| | 8 | 4820 | 2570 | 1750 |
| 180 | 2 | 8150 | 4370 | 2980 |
| | 4 | 8100 | 4340 | 2960 |
| | 6 | 7930 | 4440 | 3030 |
| | 8 | 9950 | 5570 | 3810 |
| 200 | 2 | 11030 | 6140 | 4240 |
| | 4 | 11410 | 6350 | 4390 |
| | 6 | 11010 | 6130 | 4230 |
| | 8 | 13450 | 7490 | 5180 |
| 225 | 2 | 14990 | 8530 | 5940 |
| | 4 | 14640 | 8530 | 4980 |
| | 6 | 16110 | 8200 | 5480 |
| | 8 | 14010 | 7130 | 4770 |
| 250 | 2 | 18190 | 9950 | 6830 |
| | 4 | 19210 | 10510 | 7220 |
| | 6 | 18710 | 10240 | 7030 |
| | 8 | 17340 | 9490 | 6510 |
| 280 | 2 | 16480 | 9640 | 6710 |
| | 4 | 18070 | 10480 | 7270 |
| | 6 | 16800 | 9740 | 6750 |
| | 8 | 16140 | 9350 | 6490 |
| 315 S/M | 2 | 21250 | 12930 | 9270 |
| | 4 | 12970 | 6870 | 4980 |
| | 6 | 12100 | 6450 | 4810 |
| | 8 | 10590 | 5970 | 4170 |
| 315 L | 2 | 15960 | 9820 | 7130 |
| | 4 | 10300 | 5560 | 4030 |
| | 6 | 10740 | 5800 | 4210 |
| | 8 | 9920 | 5350 | 3880 |
| 355 | 2 | 18700 | 11400 | 8200 |
| | 4, 6, 8 | Values on request | | |

¹⁾ For values for frame sizes 280 to 315, see page 1/62. For frame sizes 280 to 315, bearings of size 63 are standard.

Overview

Admissible axial load

1LE10, 1MB10, ¹⁾ and 1PC10 ¹⁾ motors in vertical type of construction – basic version (with the exception of motors with increased power)

| Frame size | 3000 rpm | | | | 1500 rpm | | | | 1000 rpm | | | | 750 rpm | | | |
|------------|-------------------------------|---------|-----------------------------|---------|-----------|---------|-----------|---------|-----------|---------|-----------|---------|-----------|---------|-----------|---------|
| | Shaft extension pointing down | | Shaft extension pointing up | | down | | up | | down | | up | | down | | up | |
| | Load down N | up N | down N | up N | down N | up N | down N | up N | down N | up N | down N | up N | down N | up N | down N | up N |
| 63 | 80 | 245 | 230 | 95 | 80 | 330 | 310 | 95 | 80 | 410 | 390 | 95 | – | – | – | – |
| 71 | 105 | 365 | 335 | 130 | 90 | 380 | 440 | 130 | 90 | 590 | 550 | 130 | 90 | 700 | 660 | 130 |
| 80 | 110 | 425 | 360 | 160 | 100 | 540 | 480 | 165 | 100 | 650 | 590 | 165 | 100 | 760 | 700 | 165 |
| 90 | 110 | 440 | 360 | 180 | 100 | 680 | 580 | 190 | 100 | 920 | 820 | 190 | 100 | 1150 | 1050 | 190 |
| 100 | 140 | 700 | 550 | 280 | 130 | 990 | 820 | 285 | 130 | 1280 | 1110 | 285 | 130 | 1560 | 1390 | 285 |
| 112 | 140 | 710 | 550 | 300 | 130 | 1000 | 820 | 310 | 130 | 1290 | 1110 | 310 | 130 | 1570 | 1390 | 310 |
| 132 | 200 | 1200 | 950 | 470 | 180 | 1680 | 1200 | 470 | 180 | 1900 | 1600 | 470 | 190 | 2200 | 1900 | 440 |
| 160 | 1500 | 1400 | 950 | 1900 | 1900 | 1800 | 1300 | 2200 | 2200 | 2200 | 1600 | 2700 | 2700 | 2700 | 1950 | 2900 |
| 180 | 1260 | 1230 | 500 | 1990 | 1600 | 1770 | 840 | 2530 | 1920 | 2150 | 1160 | 2900 | 2050 | 2500 | 1290 | 3260 |
| 200 | 1810 | 1720 | 660 | 2870 | 2410 | 2480 | 1260 | 3630 | 2700 | 3050 | 1550 | 4200 | 3060 | 3510 | 1910 | 4660 |

The values shown do not assume a cantilever force on the shaft extension.

The admissible loads are valid for operation at 50 Hz; for 60 Hz, please inquire.

The calculation of the admissible axial load was based on the drive with generally available coupling.

For suppliers, see section "Accessories" on page 2/139 in the respective section of the catalog.

Please inquire if the load direction alternates.

1LE10, 1MB10, ¹⁾ and 1PC10 ¹⁾ motors in horizontal type of construction – basic version (with the exception of motors with increased power)

| Frame size | 3000 rpm | | | | 1500 rpm | | | | 1000 rpm | | | | 750 rpm | | | |
|------------|--------------|------------|---------------------|---------------------|--------------|------------|---------------------|---------------------|--------------|------------|---------------------|---------------------|--------------|------------|---------------------|---------------------|
| | Tensile load | | Thrust load (N) | | Tensile load | | Thrust load (N) | | Tensile load | | Thrust load (N) | | Tensile load | | Thrust load (N) | |
| | | | with radial load at | without radial load | | | with radial load at | without radial load | | | with radial load at | without radial load | | | with radial load at | without radial load |
| | N | x_0 N | $x_{max.}$ N | N | N | x_0 N | $x_{max.}$ N | N | N | x_0 N | $x_{max.}$ N | N | N | x_0 N | $x_{max.}$ N | N |
| 63 | 90 | 120 | 90 | 240 | 90 | 140 | 110 | 320 | 90 | 170 | 120 | 400 | – | – | – | – |
| 71 | 120 | 150 | 120 | 350 | 120 | 210 | 150 | 460 | 120 | 260 | 180 | 570 | 120 | 300 | 210 | 680 |
| 80 | 140 | 190 | 150 | 400 | 140 | 300 | 260 | 510 | 140 | 330 | 280 | 620 | 140 | 340 | 290 | 730 |
| 90 | 150 | 300 | 280 | 400 | 150 | 400 | 360 | 630 | 150 | 480 | 430 | 870 | 150 | 550 | 500 | 1100 |
| 100 | 220 | 450 | 350 | 630 | 220 | 600 | 500 | 910 | 220 | 650 | 550 | 1200 | 220 | 750 | 650 | 1480 |
| 112 | 220 | 450 | 350 | 630 | 220 | 600 | 500 | 910 | 220 | 650 | 550 | 1200 | 220 | 750 | 650 | 1480 |
| 132 | 350 | 650 | 520 | 1200 | 350 | 850 | 700 | 1600 | 350 | 1020 | 890 | 1900 | 350 | 1150 | 1020 | 2200 |
| 160 | 1500 | 850 | 720 | 1500 | 1500 | 1050 | 920 | 1800 | 1500 | 1250 | 1120 | 2200 | 1500 | 1350 | 1220 | 2600 |
| 180 | 1630 | – | – | 870 | 2070 | – | – | 1310 | 2420 | – | – | 1660 | 2660 | – | – | 1900 |
| 200 | 2340 | – | – | 1190 | 3020 | – | – | 1870 | 3450 | – | – | 2300 | 3860 | – | – | 2710 |

The values shown do not assume a cantilever force on the shaft extension.

The admissible loads are valid for operation at 50 Hz; for 60 Hz, please inquire.

The calculation of the admissible axial load was based on the drive with generally available coupling.

For suppliers, see the section "Accessories" on page 2/139.

Please inquire if the load direction alternates.

1MB5 motors for Ex db, Ex db eb with a vertical type of construction – basic version

| Frame size | 3000 rpm | | 1500 rpm | | 1000 rpm | | 750 rpm | |
|------------|-------------------------------|---------|-------------------------------|---------|-------------------------------|---------|-------------------------------|---------|
| | Shaft extension pointing down | | Shaft extension pointing down | | Shaft extension pointing down | | Shaft extension pointing down | |
| | Load down N | up N | down N | up N | down N | up N | down N | up N |
| 160 | 1790 | 2390 | 2460 | 3170 | 2730 | 3730 | 3420 | 4260 |
| 180 | 2020 | 2780 | 2760 | 3760 | 3350 | 4410 | 3770 | 5050 |
| 200 | 2910 | 4150 | 4070 | 5370 | 4840 | 6360 | 5460 | 7200 |
| 225 | 2570 | 4230 | 3590 | 5740 | 4250 | 6690 | 6110 | 8190 |
| 250 | 3470 | 5530 | 4770 | 7410 | 5880 | 8700 | 7260 | 9760 |
| 280 | 2440 | 5520 | 4300 | 8570 | 5860 | 9680 | 6920 | 10740 |
| 315 S/M | 1190 | 6350 | 4250 | 10130 | 5240 | 11980 | 6340 | 13080 |
| 315 L | 970 | 7250 | 3150 | 11170 | 3730 | 13070 | 4570 | 14130 |
| 355 | 270 | 10510 | Values on request | | Values on request | | Values on request | |

¹⁾ 1MB10 motors only available with frame sizes 80 to 160 and 1PC10 motors only available with frame sizes 100 to 160.

Introduction

Mechanical version

Bearings and lubrication

1

Overview

| Frame size | Type | 2-pole – 3000 rpm | | | | 4-pole – 1500 rpm | | | | 6-pole – 1000 rpm | | | | 8-pole – 750 rpm | | | | |
|---------------------------------|---------------------|-------------------------------|------|-----------------------------|------|-------------------|------|-------|------|-------------------|-------|-------|-------|------------------|-------|-------|-------|------|
| | | Shaft extension pointing down | | Shaft extension pointing up | | down | | up | | down | | up | | down | | up | | |
| | | Load down | up | down | up | down | up | down | up | down | up | down | up | down | up | down | up | |
| | | N | N | N | N | N | N | N | N | N | N | N | N | N | N | N | N | |
| 1LE56 – Performance Line | | | | | | | | | | | | | | | | | | |
| 315 | 1LE56...3A.6 | 10500 | 1800 | 10500 | 1800 | 17500 | 2500 | 17500 | 2500 | – | – | – | – | – | – | – | – | |
| | 1LE56...3A.7 | 10000 | 2300 | 10000 | 2300 | 17000 | 3000 | 17000 | 3000 | 20000 | 3000 | 20000 | 3000 | 22500 | 3400 | 22500 | 3400 | |
| | 1LE56...3A.8 | – | – | – | – | – | – | – | – | – | 19000 | 4000 | 19000 | 4000 | 21500 | 4400 | 21500 | 4400 |
| 355 | 1LE56...3B.3 | 9700 | 2900 | 9700 | 2900 | 20000 | 3600 | 20000 | 3600 | – | – | – | – | – | – | – | – | |
| | 1LE56...3B.4 | 9300 | 3500 | 9300 | 3500 | 19500 | 3800 | 19500 | 3800 | – | – | – | – | – | – | – | – | |
| | 1LE56...3B.5 | 9000 | 3700 | 9000 | 3700 | 18500 | 4600 | 18500 | 4600 | – | – | – | – | – | – | – | – | |
| | 1LE56...3BC2 | – | – | – | – | – | – | – | – | 21500 | 5000 | 21500 | 5000 | – | – | – | – | |
| | 1LE56...3BC3 | – | – | – | – | – | – | – | – | 21000 | 5500 | 21000 | 5500 | – | – | – | – | |
| | 1LE56...3BC4 | – | – | – | – | – | – | – | – | 21000 | 5500 | 21000 | 5500 | – | – | – | – | |
| | 1LE56...3BD1 | – | – | – | – | – | – | – | – | – | – | – | – | – | 23000 | 5500 | 23000 | 5500 |
| | 1LE56...3BD2 | – | – | – | – | – | – | – | – | – | – | – | – | – | 22000 | 5800 | 22000 | 5800 |

1MB15 and 1MB55 motors for Ex db, Ex db eb with a vertical type of construction – basic version

| Frame size | 2-pole – 3000 rpm | | | | 4-pole – 1500 rpm | | | | 6-pole – 1000 rpm | | | | 8-pole – 750 rpm | | | |
|------------|-----------------------------|-------|-------------------------------|-------|-------------------|-------|------|-------|-------------------|-------|-------|-------|------------------|-------|-------|-------|
| | Shaft extension pointing up | | Shaft extension pointing down | | up | | down | | up | | down | | up | | down | |
| | Load down | up | down | up | down | up | down | up | down | up | down | up | down | up | down | up |
| | N | N | N | N | N | N | N | N | N | N | N | N | N | N | N | N |
| 71 | 510 | 220 | 190 | 550 | 600 | 340 | 280 | 660 | 700 | 440 | 380 | 760 | 780 | 510 | 450 | 840 |
| 80 | 830 | 350 | 290 | 890 | 1000 | 540 | 460 | 1080 | 1130 | 690 | 590 | 1230 | 1220 | 780 | 680 | 1320 |
| 90 | 860 | 380 | 270 | 980 | 1050 | 590 | 450 | 1180 | 1210 | 760 | 610 | 1350 | 1310 | 860 | 720 | 1450 |
| 100 | 1660 | 1000 | 770 | 1890 | 2010 | 1380 | 1120 | 2270 | 2400 | 1740 | 1510 | 2630 | 2700 | 2020 | 1810 | 2910 |
| 112 | 1680 | 980 | 790 | 1860 | 2070 | 1430 | 1180 | 2320 | 2380 | 1760 | 1490 | 2640 | 2620 | 2030 | 1730 | 2920 |
| 132 | 2410 | 1480 | 1140 | 2750 | 2930 | 2100 | 1660 | 3370 | 3370 | 2580 | 2100 | 3850 | 3740 | 2970 | 2470 | 4240 |
| 160 | 2810 | 2310 | 1710 | 3420 | 3560 | 3170 | 2460 | 4270 | 3930 | 3820 | 2820 | 4920 | 4590 | 4320 | 3480 | 5430 |
| 180 | 2980 | 2620 | 1860 | 3740 | 3700 | 3580 | 2580 | 4700 | 4370 | 4310 | 3250 | 5430 | 4850 | 5010 | 3730 | 6130 |
| 200 | 3850 | 3380 | 2140 | 5080 | 4940 | 4540 | 3240 | 6250 | 5650 | 5460 | 3940 | 7160 | 6260 | 6300 | 4560 | 8010 |
| 225 | 4240 | 3950 | 2290 | 5900 | 5230 | 5430 | 3280 | 7380 | 5970 | 6460 | 4020 | 8400 | 7150 | 7280 | 5200 | 9230 |
| 250 | 5140 | 4820 | 2760 | 7200 | 6350 | 6610 | 3970 | 8990 | 7400 | 7840 | 5020 | 10220 | 8710 | 8830 | 6330 | 11210 |
| 280 | 4510 | 5210 | 2130 | 7590 | 6510 | 7980 | 3710 | 10780 | 8190 | 9210 | 5390 | 12010 | 8160 | 9180 | 5360 | 11980 |
| 315 S/M | 4700 | 7260 | 2100 | 9860 | 7650 | 10350 | 4470 | 13530 | 8290 | 11850 | 5110 | 15030 | 9500 | 13060 | 6320 | 16240 |
| 315 L | 4770 | 8450 | 2170 | 11050 | 6090 | 10930 | 2910 | 14110 | 6880 | 13040 | 3700 | 16220 | 7740 | 14120 | 4560 | 17300 |
| 355 | 5160 | 12600 | 2360 | 15400 | 6210 | 15170 | 2730 | 18650 | O. R. | O. R. | O. R. | O. R. | O. R. | O. R. | O. R. | O. R. |

Overview

1LE15 and 1MB15 motors in vertical type of construction – bearings reinforced at both ends – order code **L25**

| Frame size | Type | 2-pole – 3000 rpm | | | | 4-pole – 1500 rpm | | | | 6-pole – 1000 rpm | | | | 8-pole – 750 rpm | | | |
|----------------------------------|----------------------|-------------------------------|------|-----------------------------|------|-------------------|------|------|------|-------------------|------|------|------|------------------|------|------|------|
| | | Shaft extension pointing down | | Shaft extension pointing up | | down | | up | | down | | up | | down | | up | |
| | | Load down | up | down | up | down | up | down | up | down | up | down | up | down | up | down | up |
| | | N | N | N | N | N | N | N | N | N | N | N | N | N | N | N | N |
| 1LE15, 1MB15 – Basic Line | | | | | | | | | | | | | | | | | |
| 71/80/90 | | Available soon | | | | | | | | | | | | | | | |
| 100 | 1..15.1-1A.4 | 220 | 930 | 820 | 330 | 200 | 1330 | 1180 | 350 | 180 | 1640 | 1450 | 370 | 200 | 1900 | 1740 | 360 |
| | 1..15.1-1A.5 | – | – | – | – | 190 | 1320 | 1150 | 360 | – | – | – | – | 180 | 1900 | 1710 | 370 |
| | 1..15.1-1A.6 | 210 | 930 | 800 | 340 | 170 | 1320 | 1110 | 380 | 160 | 1640 | 1410 | 390 | – | – | – | – |
| | 1..15.3-1A.4 | 210 | 930 | 800 | 340 | 170 | 1320 | 1110 | 380 | – | – | – | – | – | – | – | – |
| | 1..15.3-1A.5 | – | – | – | – | 170 | 1320 | 1110 | 380 | – | – | – | – | – | – | – | – |
| 112 | 1..15.1-1B.2 | 200 | 940 | 790 | 350 | 180 | 1340 | 1150 | 370 | 170 | 1650 | 1440 | 380 | 170 | 1910 | 1700 | 380 |
| | 1..15.1-1B.6 | 180 | 940 | 750 | 370 | 170 | 1340 | 1120 | 390 | 160 | 1640 | 1410 | 390 | – | – | – | – |
| | 1..15.3-1B.2 | 180 | 940 | 750 | 370 | 170 | 1340 | 1120 | 390 | 160 | 1640 | 1410 | 390 | – | – | – | – |
| 132 | 1..15.1-1C.0 | 540 | 1120 | 890 | 770 | 520 | 1700 | 1430 | 790 | 520 | 2150 | 1880 | 790 | 510 | 2530 | 2240 | 800 |
| | 1..15.1-1C.1 | 520 | 1130 | 860 | 790 | – | – | – | – | – | – | – | – | – | – | – | – |
| | 1..15.1-1C.2 | – | – | – | – | 490 | 1710 | 1380 | 820 | 500 | 2150 | 1840 | 810 | 480 | 2540 | 2180 | 840 |
| | 1..15.1-1C.3 | – | – | – | – | – | – | – | – | 470 | 2150 | 1780 | 840 | – | – | – | – |
| | 1..15.1-1C.6 | 480 | 1130 | 780 | 830 | 440 | 1710 | 1280 | 870 | 420 | 2160 | 1690 | 890 | – | – | – | – |
| | 1..15.3-1C.0 | 520 | 1130 | 860 | 790 | 440 | 1710 | 1280 | 870 | 470 | 2150 | 1780 | 840 | – | – | – | – |
| | 1..15.3-1C.1 | 480 | 1130 | 780 | 830 | – | – | – | – | – | – | – | – | – | – | – | – |
| | 1..15.3-1C.2 | – | – | – | – | 440 | 1710 | 1280 | 870 | 470 | 2150 | 1780 | 840 | – | – | – | – |
| | 1..15.3-1C.3 | – | – | – | – | – | – | – | – | 420 | 2160 | 1690 | 890 | – | – | – | – |
| 160 | 1..15.1-1D.2 | 2200 | 1870 | 1480 | 2590 | 2860 | 2610 | 2140 | 3330 | 3320 | 3170 | 2600 | 3890 | 3830 | 3620 | 3110 | 4340 |
| | 1..15.1-1D.3 | 2150 | 1880 | 1430 | 2600 | – | – | – | – | – | – | – | – | 3730 | 3620 | 3010 | 4340 |
| | 1..15.1-1D.4 | 2120 | 1890 | 1400 | 2610 | 2760 | 2610 | 2040 | 3330 | 3200 | 3180 | 2480 | 3900 | 3650 | 3640 | 2930 | 4360 |
| | 1..15.1-1D.6 | 2020 | 1890 | 1300 | 2610 | 2680 | 2640 | 1960 | 3360 | 3050 | 3180 | 2330 | 3900 | – | – | – | – |
| | 1..15.1-1D.7 | – | – | – | – | 2570 | 2670 | 1850 | 3390 | – | – | – | – | – | – | – | – |
| | 1..15.3-1D.2 | 2150 | 1880 | 1430 | 2600 | 2760 | 2610 | 2040 | 3330 | 3200 | 3180 | 2480 | 3900 | – | – | – | – |
| | 1..15.3-1D.3 | 2120 | 1890 | 1400 | 2610 | – | – | – | – | – | – | – | – | – | – | – | – |
| | 1..15.3-1D.4 | 2020 | 1890 | 1300 | 2610 | 2680 | 2640 | 1960 | 3360 | 3050 | 3180 | 2330 | 3900 | – | – | – | – |
| 180 | 1..15...-1E.2 | 2510 | 2050 | 1360 | 3200 | 3240 | 2920 | 2090 | 4070 | – | – | – | – | – | – | – | – |
| | 1..15...-1E.4 | – | – | – | – | 3180 | 2930 | 2020 | 4090 | 3740 | 3560 | 2580 | 4710 | 4300 | 4090 | 3150 | 5240 |
| | 1..15...-1E.6 | 2490 | 2060 | 1330 | 3220 | 3160 | 2950 | 2010 | 4100 | 3740 | 3570 | 2580 | 4730 | 4090 | 4140 | 2940 | 5290 |
| 200 | 1..15...-2A.4 | 2920 | 3030 | 2110 | 3840 | – | – | – | – | 4570 | 5010 | 3760 | 5820 | – | – | – | – |
| | 1..15...-2A.5 | 2810 | 3060 | 2000 | 3870 | 3820 | 4210 | 3010 | 5020 | 4470 | 5060 | 3660 | 5870 | 5200 | 5750 | 4390 | 6560 |
| | 1..15...-2A.6 | 2810 | 3060 | 2000 | 3870 | 3820 | 4230 | 3010 | 5040 | 4400 | 5090 | 3590 | 5900 | 5010 | 5800 | 4200 | 6610 |
| 225 | 1..15...-2B.0 | – | – | – | – | 4200 | 4750 | 3150 | 5800 | – | – | – | – | 5900 | 6400 | 4850 | 7650 |
| | 1..15...-2B.2 | 3100 | 3400 | 2050 | 4450 | 4100 | 4850 | 3000 | 5850 | 4700 | 5800 | 3650 | 6850 | 5800 | 6450 | 4700 | 7500 |
| | 1..15...-2B.6 | 3100 | 3400 | 2050 | 4450 | 4100 | 4850 | 3000 | 5850 | 4650 | 5850 | 3600 | 6900 | 5500 | 6600 | 4400 | 7650 |
| 250 | 1..15...-2C.2 | 3850 | 4100 | 2250 | 5600 | 4850 | 5650 | 3250 | 7250 | 5750 | 6750 | 4200 | 8350 | 6900 | 7700 | 5300 | 9200 |
| | 1..15...-2C.6 | 3850 | 4100 | 2250 | 5600 | 4800 | 5750 | 3200 | 7400 | 5750 | 6750 | 4200 | 8450 | 6700 | 7800 | 5000 | 9300 |

For frame sizes > 250 standard version.

Overview

| Frame size | Type | 2-pole – 3000 rpm | | 4-pole – 1500 rpm | | 6-pole – 1000 rpm | | 8-pole – 750 rpm | | Type | 2-pole – 3000 rpm | | 4-pole – 1500 rpm | | 6-pole – 1000 rpm | | 8-pole – 750 rpm | | |
|-------------------------------------|---------------------|----------------------|--------|----------------------|--------|----------------------|--------|---------------------|--------|---|----------------------|---------|----------------------|---------|----------------------|---------|---------------------|---------|--------|
| | | Load | | Load | | Load | | Load | | | Load | | Load | | Load | | Load | | |
| | | Tension | Thrust | Tension | Thrust | Tension | Thrust | Tension | Thrust | | | Tension | Thrust | Tension | Thrust | Tension | Thrust | Tension | Thrust |
| | | N | N | N | N | N | N | N | N | | | N | N | N | N | N | N | N | N |
| 1LE55 and 1MB55 – Basic Line | | | | | | | | | | 1LE56 and 1MB56 – Performance Line | | | | | | | | | |
| 315 | 1LE55..-3A.6 | 5400 | 3000 | 7750 | 5400 | – | – | – | – | 1LE56..-3A.6 | 5400 | 3000 | 7750 | 5400 | – | – | – | – | – |
| | 1LE55..-3A.7 | 5200 | 2800 | 7750 | 5400 | 9100 | 6750 | – | – | 1LE56..-3A.7 | 5200 | 2800 | 7750 | 5400 | 9100 | 6750 | – | – | – |
| | 1LE55..-3A.8 | – | – | – | – | 9000 | 6650 | – | – | 1LE56..-3A.8 | – | – | – | – | 9000 | 6650 | – | – | – |
| 355 | – | – | – | – | – | – | – | – | – | 1LE56..-3B.2 | – | – | – | – | 9900 | 6000 | – | – | – |
| | – | – | – | – | – | – | – | – | – | 1LE56..-3B.3 | 5000 | 3200 | 8800 | 5000 | 9800 | 5900 | – | – | – |
| | – | – | – | – | – | – | – | – | – | 1LE56..-3B.4 | 5000 | 3200 | 8750 | 4950 | 9800 | 5900 | – | – | – |
| | – | – | – | – | – | – | – | – | – | 1LE56..-3B.5 | 5000 | 3200 | 8700 | 4900 | – | – | – | – | – |
| 400 | 1LE55..-4A.3 | 11600 | 8200 | 15900 | 5500 | 19200 | 3200 | 20400 | 4100 | – | – | – | – | – | – | – | – | – | – |
| | 1LE55..-4A.5 | 12000 | 7800 | 16300 | 5200 | 20000 | 2600 | 21200 | 3300 | – | – | – | – | – | – | – | – | – | – |
| | 1LE55..-4A.7 | 12400 | 7400 | 17100 | 4700 | 20900 | 2300 | 22100 | 2400 | – | – | – | – | – | – | – | – | – | – |
| 450 | 1LE55..-4B.3 | 13300 | 6500 | 20100 | 7400 | 23300 | 5200 | 24600 | 6200 | – | – | – | – | – | – | – | – | – | – |
| | 1LE55..-4B.5 | 13700 | 6200 | 20800 | 7 000 | 24300 | 4800 | 25500 | 5300 | – | – | – | – | – | – | – | – | – | – |
| | 1LE55..-4B.7 | 14200 | 5700 | 21600 | 6200 | 25400 | 4100 | 26600 | 4300 | – | – | – | – | – | – | – | – | – | – |

1LE15 and 1MB15 motors in horizontal type of construction – bearings reinforced at both ends – order code **L25**

| Frame size | Type | 2-pole – 3000 rpm | | 4-pole – 1500 rpm | | 6-pole – 1000 rpm | | 750 rpm | | Frame size | Type | 2-pole – 3000 rpm | | 4-pole – 1500 rpm | | 6-pole – 1000 rpm | | 8-pole – 750 rpm | | |
|----------------------------------|---------------------|----------------------|--------|----------------------|--------|----------------------|--------|---------------------|---------------------|----------------------------------|---------------------|----------------------|--------|----------------------|--------|----------------------|--------|---------------------|--------|------|
| | | Load | | Load | | Load | | Load | | | | Load | | Load | | Load | | Load | | |
| | | Tension | Thrust | Tension | Thrust | Tension | Thrust | Tension | Thrust | | | Tension | Thrust | Tension | Thrust | Tension | Thrust | Tension | Thrust | |
| | | N | N | N | N | N | N | N | N | | | N | N | N | N | N | N | N | N | |
| 1LE15, 1MB15 – Basic Line | | | | | | | | | | 1LE15, 1MB15 – Basic Line | | | | | | | | | | |
| 71/80/90 | | Available soon | | | | | | | | | | | | | | | | | | |
| 100 | 1..15.1-1A.4 | 1440 | 880 | 1820 | 1260 | 2110 | 1550 | 2380 | 1820 | 160 | 1..15.1-1D.2 | 2400 | 1680 | 3100 | 2380 | 3610 | 2890 | 4090 | 3370 | – |
| | 1..15.1-1A.5 | – | – | 1800 | 1240 | – | – | 2370 | 1810 | | 1..15.1-1D.3 | 2380 | 1660 | – | – | – | – | 4040 | 3320 | – |
| | 1..15.1-1A.6 | 1430 | 870 | 1780 | 1220 | 2090 | 1530 | – | – | | 1..15.1-1D.4 | 2370 | 1650 | 3050 | 2330 | 3550 | 2830 | 4010 | 3290 | – |
| | 1..15.3-1A.4 | 1430 | 870 | 1780 | 1220 | – | – | – | – | | 1..15.1-1D.6 | 2320 | 1600 | 3020 | 2300 | 3480 | 2760 | – | – | – |
| | 1..15.3-1A.5 | – | – | 1780 | 1220 | – | – | – | – | | 1..15.1-1D.7 | – | – | 2980 | 2260 | – | – | – | – | – |
| 112 | 1..15.1-1B.2 | 1430 | 870 | 1810 | 1250 | 2110 | 1550 | 2370 | 1810 | 180 | 1..15.3-1D.2 | 2380 | 1660 | 3050 | 2330 | 3550 | 2830 | – | – | – |
| | 1..15.1-1B.6 | 1410 | 850 | 1790 | 1230 | 2090 | 1530 | – | – | | 1..15.3-1D.3 | 2370 | 1650 | – | – | – | – | – | – | |
| | 1..15.3-1B.2 | 1410 | 850 | 1790 | 1230 | 2090 | 1530 | – | – | | 1..15.3-1D.4 | 2320 | 1600 | 3020 | 2300 | 3480 | 2760 | – | – | |
| | 1..15.1-1C.0 | 2330 | 1010 | 2890 | 1570 | 3340 | 2020 | 3710 | 2390 | | 200 | 1..15..-1E.2 | 2860 | 1710 | 3660 | 2510 | – | – | – | – |
| 1..15.1-1C.1 | 2320 | 1000 | – | – | – | – | – | 1..15..-1E.4 | – | – | | 3630 | 2480 | 4230 | 3080 | 4770 | 3620 | | | |
| 1..15.1-1C.2 | – | – | 2870 | 1550 | 3320 | 2000 | 3680 | 2360 | 1..15..-1E.6 | 2850 | | 1700 | 3630 | 2480 | 4230 | 3080 | 4690 | 3540 | | |
| 132 | 1..15.1-1C.3 | – | – | – | – | 3290 | 1970 | – | – | 225 | 1..15..-2A.4 | 3390 | 2580 | – | – | 5210 | 4400 | – | – | |
| | 1..15.1-1C.6 | 2280 | 960 | 2820 | 1500 | 3250 | 1930 | – | – | | 1..15..-2A.5 | 3340 | 2530 | 4430 | 3620 | 5170 | 4360 | 5880 | 5070 | |
| | 1..15.3-1C.0 | 2320 | 1000 | 2820 | 1500 | 3290 | 1970 | – | – | | 1..15..-2A.6 | 3340 | 2530 | 4430 | 3620 | 5150 | 4340 | 5810 | 5000 | |
| | 1..15.3-1C.1 | 2280 | 960 | – | – | – | – | – | – | | 250 | 1..15..-2B.0 | – | – | 4950 | 3900 | – | – | 6600 | 5550 |
| | 1..15.3-1C.2 | – | – | 2820 | 1500 | 3290 | 1970 | – | – | | | 1..15..-2B.2 | 3800 | 2750 | 4950 | 3900 | 5750 | 4700 | 6550 | 5500 |
| 1..15.3-1C.3 | – | – | – | – | 3250 | 1930 | – | – | 1..15..-2B.6 | 3800 | 2750 | 4900 | 3850 | 5700 | 4650 | 6500 | 5450 | | | |
| 1..15.3-1C.6 | – | – | – | – | 3250 | 1930 | – | – | 1..15..-2C.2 | 4750 | 3150 | 6050 | 4450 | 7100 | 5500 | 8100 | 6500 | | | |
| 1..15..-2C.6 | – | – | – | – | 3250 | 1930 | – | – | 1..15..-2C.6 | 4750 | 3150 | 6050 | 4450 | 7100 | 5500 | 8 000 | 6400 | | | |

For frame sizes > 250 standard version.

Introduction

Mechanical version

1

T-Drain – adjustable drainage of condensed water

Overview

The drainage of condensed water is an important aspect of proper motor maintenance.

Drainage of condensed water is made easy by rotating the outer cap.

If there are condensation drain holes present, these must be opened at regular intervals, depending on climatic conditions and in accordance with the motor operating instructions.

"Modifiable T-Drain" is closed on delivery of the motor and corresponds to IP55/IP56 degree of protection.

When opened, it corresponds to IP45/IP46 degree of protection. The opened T-Drain can be used for continuous drainage of condensed water in environments with low amounts of dust.

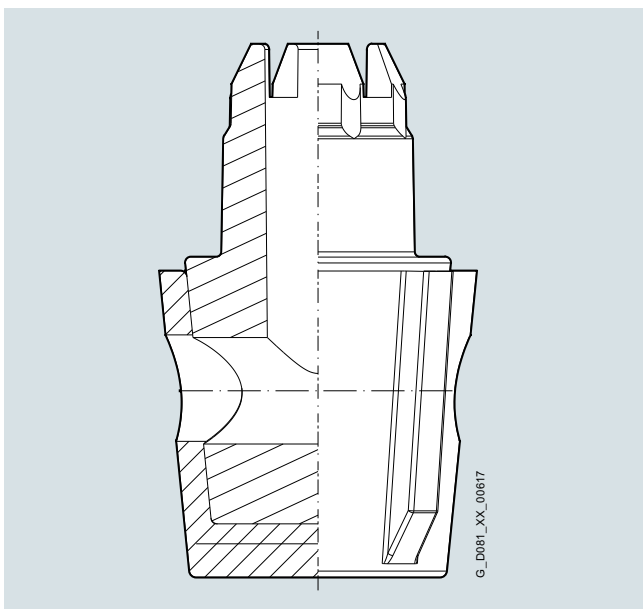

Note:

Condensation drain holes are not possible in motors with the types of protection Ex db and Ex db eb.

A screwed-on cover (made of sheet metal or plastic depending on the shaft height) is included as standard for horizontal types of construction and types of construction with shaft pointing upwards (14th position of the Article No. letter **A, T, U, V, D, F, H, J, K, L, N**) in combination with condensation drainage holes, order code (**H03**) to facilitate assembly/disassembly.

When the motors are used or stored outdoors, we recommend that they be kept under some sort of additional cover so that they are not subjected to direct intensive solar radiation, rain, snow, ice or dust over a long period of time. In such cases, technical consultation may be appropriate.

When the motors are used outdoors or in a corrosive environment, it is recommended that non-rusting screws are used externally.

Order code **H07**

Vibration-proof version

Continuous vibration resistance to class 3M4 according to IEC 721-3-3:1994 (order code **H02** in combination with order code **G04, G05, G06, G11**, and **G12** or **F70** on request only).
Order code **H02**

For availability of individual options for the relevant motor series, see section "Special versions" in the respective sections of the catalog.

Overview

1LE10, 1MB10 and 1PC10 motors without feet have four cast lifting eyes as standard, each offset by 90°; in the case of screwed-on feet, two lifting eyes are covered by the feet, so in this case only two lifting eyes are available for use. This data is only valid up to frame size 200.

Housing material

| Motor series | Frame size | Housing material | Housing feet |
|--|-------------|------------------|--------------------------|
| 1LE10, 1PC1 ²⁾ | 63 ... 160 | Aluminum alloy | cast ¹⁾ |
| | 180 ... 200 | Aluminum alloy | screwed on ¹⁾ |
| 1MB10 | 100 ... 160 | Aluminum alloy | cast ¹⁾ |
| 1LE15 1MB15 1PC1301 ³⁾ | 71 ... 315 | Cast iron | cast ¹⁾ |
| 1LE5 1MB5 | 315 ... 450 | Cast iron | cast |
| 1LE16 1MB16 | 100 ... 315 | Cast iron | cast ¹⁾ |

Arrangement of lifting eyes/eyebolts (standard)

| Frame size | Terminal box position | Cast-iron motors | Aluminum motors | Arrangement of eyebolts | Thread size |
|------------------------|---------------------------|---|-----------------|--|-------------|
| 63 | – | – | None | – | – |
| 71 | – | None | None | – | M8 |
| 80 | Short housing | None | None | – | M8 |
| | Top (long housing) | Two eyebolts | | Left/right center | |
| | Left/right (long housing) | One eyebolt | | Top center | |
| 90 | Top | Two eyebolts | None | Left/right center | M8 |
| | Left/right | One eyebolt | | Top center | |
| 100 | | Depending on type of construction ⁴⁾ | Lifting eyes | Top; Left DE side/ Right NDE side ¹⁰⁾ | M8 |
| 112 | | | | | |
| 132 | | | | | |
| 160 | | | | | M10 |
| 180 | | Two eyebolts ¹⁰⁾ | | | M12 |
| 200 | | | | | M16 |
| 225 | | Two eyebolts ¹¹⁾ | – | ^{5) 6) 7)} | M16 |
| 250 | | | | | M20 |
| 280 | | | | | |
| 315 S/M ¹²⁾ | | | | | M24 |
| 315 L | | Four eyebolts | | Top; | |
| 315 L (1LE5) | | Two eyebolts | | Left/right DE and NDE side ^{8) 9)} | M30 |
| 355 M/L (1LE5) | | | | | |
| 400 | | | | | |
| 450 | | | | | |

¹⁾ Basic version, cast feet: Special version "Screwed-on feet (instead of cast)" with digits **5**, **6**, and **7** in the 16th position of Article No. or digit **4** with order code **H01**. Screwed-on feet as standard for 1LE10 motors in frame sizes 180 and 200 and motors with increased power.

²⁾ Aluminum motors in frame sizes 80 and 90 and 1PC10 motors in frame sizes 100 to 160 without lifting eyes. Aluminum motors in frame sizes 100 to 200 with cast lifting eyes (does not apply to 1PC10 and 1MB10 motors in frame sizes 180 and 200).

³⁾ 1LE16 motors frame size 100 and above, 1PC1301 motors frame size 180 and above.

⁴⁾ Two eyebolts for
-IM B5, IM B14, IM V1 or
-IM B34, IM B35 with **H01** or left/right, side terminal box position.
Lifting eyes for
-IM B3 or
-IM B34, IM B35 without **H01** or non-side left/right terminal box position.

⁵⁾ For IM B3; IM B5: top; DE side left / NDE side right.
With rotation of the terminal box through 180° (R12): top; NDE side left / DE side right.

⁶⁾ For IM V1: top; NDE side right; down; NDE side left.

⁷⁾ For IM V3: top; DE side left; down; DE side right.

⁸⁾ For IM V1: NDE side, left/right; top/bottom.

⁹⁾ For IM V3: DE side, left/right; top/bottom.

¹⁰⁾ With rotation of the terminal box through 180° (R12): top; NDE side left / DE side right.

¹¹⁾ Motors with brakes have four top eyebolts.

For IM V1: NDE side, left/right; top/bottom.

For IM V3: DE side, left/right; top/bottom.

¹²⁾ The assignment 315 L is used for 1000 kg and over.

Introduction

Mounting technology

Preparation for mountings

1

Overview

Brakes as well as rotary encoders of the "modular and special technology" can be retrofitted. The motor must be prepared for this. This is possible for all 1LE. motors (with the exception of 1LE1 with option **F90** – version "Forced-air cooled motors without external fan and fan cover").

Preparation of the shaft extension at NDE can be ordered with the option "Prepared for mountings, only center hole", order code **G40** for the following frame sizes and mountings:

- Frame sizes 80 to 450: brakes with order code **F01**
- Frame sizes 71 and 90: only rotary encoders with order codes **G11** or **G12** from the "modular technology" range
- Frame sizes 100 to 450: all rotary encoders from the "modular and special technology" ranges

Dimensions of center holes

| Frame size | ∅ | L (drilling depth) |
|------------|------------------|--------------------|
| 100 | 16 ^{H7} | 34 |
| 112 | 16 ^{H7} | 34 |
| 132 | 22 ^{H8} | 39 |
| 160 | 28 ^{H8} | 42 |

The length of the motor does not change because the shaft extension is still under the fan cover.

For motors ordered with order code **G40**, the following conversion combinations are possible:

- Frame sizes 71 and 90: either brakes with order code **F01** or rotary encoders from the "modular technology" range. The combination of brake (**F01**) and rotary encoder is not possible.
- Frame sizes 100 to 450: Brakes with order code **F01** or rotary encoders from the "modular and special technology" range. The combination of brake (**F01**) and rotary encoder is possible.

Conversion is performed exclusively by the authorized contractual partners of Siemens.

For motors of series 1LE15, 1LE16, and 1LE5 frame sizes 100 to 450, grounding brushes are available for converter operation. Order code **L52**. Please contact your local Siemens office for advice.

For mountings, such as rotary encoders, supplied by the customer, the following applies:

For the Sendix 5020 rotary encoders, order code **G11** and **G12**

from the "modular technology" this preparation of the shaft extension on NDE can be ordered with the option "Prepared for mounting with shaft D12".

Order code **G41**

The length of the motor increases by Δl due to option **G41**. For an explanation of the additional dimensions and weights, see "Modular technology" "Dimensions and weights".

For the rotary encoders:

- LL 861 900 220, order code **G04**
- HOG 9 DN 1024 I, order code **G05**
- HOG 10 D 1024 I, order code **G06**

from the "special technology" this preparation of the shaft extension on NDE can be ordered with the option "Prepared for mounting with shaft D16" for motors of frame sizes 100 to 160 only.

Order code **G42**

The length of the motor increases by Δl due to option **G42**.

For an explanation of the additional dimensions and weights, see "Modular technology" "Dimensions and weights" from page 1/104.

Motors that are prepared for mountings supplied by the customer (order codes **G41**, **G42**) are supplied without a protective cover as standard. These mountings can be installed by the customer.

If a protective cover is requested as a cover or mechanical protection for mountings provided by the customer, this can be ordered with order code **G43**.

This protective cover is designed and mounted differently as described below according to frame size:

Frame sizes 71 to 90 and 180 to 200:

Motors ordered with order code **G43** are fitted as standard with a screwed-on cover (made of sheet metal or plastic depending on shaft height). The protective cover is mounted in the factory. To install the mountings supplied by the customer, the protective cover must be removed beforehand by unscrewing the external fixing screws and reattached afterwards. Protective covers for motors of these frame sizes are not suitable for mountings that correspond to the shape and size of the rotary encoders of the "special technology" (**G04**, **G05**, **G06**, see above).

Frame sizes 100 to 450:

The protective cover must be installed by the customer in accordance with the assembly instructions supplied. It has supports of varying length that can be used for installation according to the height of the planned mountings.

The standard protective cover (order code **H00**) is not suitable for protection of additional mountings, such as rotary encoders.

Order codes **G40**, **G41**, **G42** are not possible in conjunction with order code **L00** – vibration severity grade B.

Order code **G43** is only appropriate in combination with order codes **G41** and **G42**, and not in combination with **G40**.

Overview

The 1LE and 1FP motors (with the exception of 1LE1 with option **F90** – version "Forced-air cooled motors without external fan and fan cover" and 1PC1) can be used in a much wider range of applications (e.g. as motors with brakes) if the following modules are mounted:

- Separately driven fan
- Brake
- Rotary pulse encoder

Separately driven fan

The use of a separately driven fan is recommended to increase motor utilization at low speeds and to limit noise generation at speeds significantly higher than the synchronous speed. Both of these results can only be achieved with converter operation. Please inquire about traction and vibratory operation.

The separately driven fan can be supplied already fitted, order code **F70**. There is no automatic adjustment of the voltage for the separately driven fan when ordering a "special voltage" for the motor. This must be specified in addition using the **Y81** option. It can also be ordered separately and retrofitted. For selection information and article numbers, see the section "Accessories"

Technical specifications of separately driven fans
(according to tolerances of EN 60034-1)

| Frame size | Rated voltage range V | Frequency Hz | P_{max} kW | I_{max} A |
|------------|--------------------------|-----------------|-----------------|----------------|
| 63 | 1 AC 230 to 277 | 50 | 0.046 | 0.18 |
| | 3 AC 200 to 303 Δ | 50 | 0.028 | 0.15 |
| | 3 AC 346 to 525 Y | 50 | 0.028 | 0.09 |
| | 1 AC 230 to 277 | 60 | 0.054 | 0.21 |
| | 3 AC 220 to 332 Δ | 60 | 0.029 | 0.14 |
| | 3 AC 380 to 575 Y | 60 | 0.029 | 0.08 |
| 71 | 1 AC 230 to 277 | 50 | 0.048 | 0.18 |
| | 3 AC 200 to 303 Δ | 50 | 0.029 | 0.15 |
| | 3 AC 346 to 525 Y | 50 | 0.029 | 0.09 |
| | 1 AC 230 to 277 | 60 | 0.056 | 0.21 |
| | 3 AC 220 to 332 Δ | 60 | 0.028 | 0.13 |
| | 3 AC 380 to 575 Y | 60 | 0.028 | 0.07 |
| 80 | 1 AC 230 to 277 | 50 | 0.048 | 0.19 |
| | 3 AC 200 to 303 Δ | 50 | 0.033 | 0.16 |
| | 3 AC 346 to 525 Y | 50 | 0.033 | 0.09 |
| | 1 AC 230 to 277 | 60 | 0.059 | 0.22 |
| | 3 AC 220 to 332 Δ | 60 | 0.036 | 0.13 |
| | 3 AC 380 to 575 Y | 60 | 0.036 | 0.07 |
| 90 | 1 AC 220 to 277 | 50 | 0.059 | 0.29 |
| | 3 AC 200 to 303 Δ | 50 | 0.078 | 0.39 |
| | 3 AC 346 to 525 Y | 50 | 0.078 | 0.22 |
| | 1 AC 220 to 277 | 60 | 0.061 | 0.23 |
| | 3 AC 220 to 332 Δ | 60 | 0.071 | 0.32 |
| | 3 AC 380 to 575 Y | 60 | 0.071 | 0.18 |
| 100 | 1 AC 220 to 277 | 50 | 0.062 | 0.29 |
| | 3 AC 200 to 303 Δ | 50 | 0.08 | 0.37 |
| | 3 AC 346 to 525 Y | 50 | 0.08 | 0.21 |
| | 1 AC 220 to 277 | 60 | 0.073 | 0.28 |
| | 3 AC 220 to 332 Δ | 60 | 0.08 | 0.3 |
| | 3 AC 380 to 575 Y | 60 | 0.08 | 0.18 |
| 112 | 1 AC 220 to 277 | 50 | 0.064 | 0.27 |
| | 3 AC 200 to 303 Δ | 50 | 0.087 | 0.35 |
| | 3 AC 346 to 525 Y | 50 | 0.087 | 0.2 |
| | 1 AC 220 to 277 | 60 | 0.088 | 0.36 |
| | 3 AC 220 to 332 Δ | 60 | 0.093 | 0.29 |
| | 3 AC 380 to 575 Y | 60 | 0.093 | 0.17 |
| 132 | 1 AC 230 to 277 | 50 | 0.125 | 0.52 |
| | 3 AC 200 to 303 Δ | 50 | 0.16 | 0.64 |
| | 3 AC 346 to 525 Y | 50 | 0.16 | 0.37 |
| | 1 AC 230 to 277 | 60 | 0.163 | 0.61 |
| | 3 AC 220 to 332 Δ | 60 | 0.18 | 0.55 |
| | 3 AC 380 to 575 Y | 60 | 0.18 | 0.32 |

The brake must always be mounted in the factory for safety reasons. The rotary pulse encoder and/or the separately driven fan can also be retrofitted.

The degree of protection of the motors with modular technology is IP55. Higher degrees of protection on request.

Attaching rotary pulse encoder, brake, and separately driven fan increases the length of the motor by dimension Δl. For explanations of the additional dimension and weights, see "Mounting technology" and "Dimensions and weights" from page 1/104.

(available soon). A rating plate listing all the important data is fitted to the separately driven fan. Please note the direction of rotation of the separately driven fan (axial-flow fan) when connecting it. Admissible coolant temperatures $CT_{min} -25\text{ °C}$, $CT_{max} +65\text{ °C}$ ¹⁾, for frame sizes 400 and 450 coolant temperatures $CT_{min} -20\text{ °C}$, $CT_{max} +40\text{ °C}$, lower/higher coolant temperatures are available on request.

When the separately driven fan is mounted, the length of the motor increases by Δl. For explanations of the additional dimension and weights, see "Mounting technology" and "Dimensions and weights" from page 1/104.

Technical specifications of separately driven fans
(according to tolerances of EN 60034-1)

| Frame size | Rated voltage range V | Frequency Hz | P_{max} kW | I_{max} A |
|----------------|--------------------------|-----------------|-----------------|----------------|
| 160 to 200 | 1 AC 230 to 277 | 50 | 0.246 | 1.05 |
| | 3 AC 200 to 303 Δ | 50 | 0.314 | 1.28 |
| | 3 AC 346 to 525 Y | 50 | 0.314 | 0.74 |
| | 1 AC 230 to 277 | 60 | 0.39 | 1.52 |
| | 3 AC 220 to 332 Δ | 60 | 0.391 | 1.08 |
| | 3 AC 380 to 575 Y | 60 | 0.391 | 0.62 |
| 225 M to 280 M | 3 AC 230 Δ | 50 | 0.450 | 2.20 |
| | 3 AC 400 Y | 50 | 0.450 | 1.27 |
| | 3 AC 460 Y | 60 | 0.520 | 1.13 |
| 315 | 3 AC 230 Δ | 50 | 0.650 | 2.80 |
| | 3 AC 400 Y | 50 | 0.650 | 1.61 |
| | 3 AC 460 Y | 60 | 0.750 | 1.55 |
| 4-, 6-, 8-pole | 3 AC 230 Δ | 50 | 0.450 | 2.20 |
| | 3 AC 400 Y | 50 | 0.450 | 1.27 |
| | 3 AC 460 Y | 60 | 0.520 | 1.13 |
| 355 | 3 AC 200 to 240 Δ | 50 | 0.650 | 2.85 |
| | 3 AC 380 to 420 Y | 50 | 0.650 | 1.64 |
| | 3 AC 440 to 480 Y | 60 | 0.750 | 1.60 |
| 400 | 3 AC 230 Δ | 50 | 2.20 | 7.70 |
| | 3 AC 400 Y | 50 | 2.20 | 4.45 |
| | 3 AC 460 Y | 60 | 2.54 | 4.35 |
| 450 | 3 AC 230 Δ | 50 | 4.00 | 14.00 |
| | 3 AC 400 Y | 50 | 4.00 | 8.00 |
| | 3 AC 460 Y | 60 | 4.55 | 7.90 |

For article numbers and type details, see operating instructions.

Sound-pressure level of the motors under a load, 50 Hz

| Frame size | 2-pole | 4-pole | 6-pole | 8-pole |
|------------|--------------------|--------------------|--------------------|--------------------|
| | L_{WA} dB (A) | L_{WA} dB (A) | L_{WA} dB (A) | L_{WA} dB (A) |
| 63 | 70 | 70 | 70 | 70 |
| 71 | 72 | 72 | 72 | 72 |
| 80 | 79 | 79 | 79 | 79 |
| 90 | 79 | 79 | 79 | 79 |
| 100 | 84 | 84 | 84 | 84 |
| 112 | 84 | 84 | 84 | 84 |
| 132 | 84 | 84 | 84 | 84 |
| 160 | 87 | 87 | 87 | 87 |
| 180 | 87 | 87 | 87 | 87 |
| 200 | 87 | 87 | 87 | 87 |
| 225 | 90 | 87 | 87 | 87 |
| 250 | 90 | 87 | 87 | 87 |
| 280 | 90 | 87 | 87 | 87 |
| 315 | 92 | 92 | 95 | 95 |

¹⁾ For single-phase variants (1 AC) of frame size 160, the admissible coolant temperature CT_{max} is $+50\text{ °C}$.

Introduction

Mounting technology

Modular technology

1

Overview

Brakes

The brakes with order code **F01** (**F02** brake for increased frequency of operation for SIMOTICS GP motors on request) are designed to be spring-operated brakes. When the brake is ordered, the supply voltage must be specified. For an explanation of the supply voltage, see the descriptions of each brake model in "Modular technology".

For the design of the braking time, run-on revolutions, braking energy per braking procedure as well as the lifetime of the brake linings, see "Configuration of motors with brakes" on page 1/89.

When a brake is mounted, the length of the motor increases by Δl . For explanations of the additional dimension and weights, see "Mounting technology" and "Dimensions and weights" from page 1/104.

*The brake can be retrofitted by authorized partners. The motor must be prepared for this. When the motor is ordered, the option "Prepared for mountings, center hole only" order code **G40** must be specified (see "Mechanical version and degrees of protection" on page 1/76).*

Ambient temperature

- -40 °C to $+45\text{ °C}$ (with nominal excitation) for SFB-SH brake
- -40 °C to $+75\text{ °C}$ (with double excitation) for SFB-SH brake
- -20 °C to $+40\text{ °C}$ holding/operating brake (standard BFK458)
- up to $+60\text{ °C}$ only as holding brake
- -20 °C to $+60\text{ °C}$ holding/operating brake only for KFB and FDX brake

Definition of duty type

- **Operating brake:**
The motor shaft can be braked from full operating speed down to zero speed of the motor. All the kinetic energy produced by the drive train is converted to heat by friction during braking. Braking energy is produced at $n > 0$ rpm. The maximum permissible switching frequency must be taken into account. When this brake is used, installation of a separately driven fan is recommended in order to ensure adequate cooling when the motor is at a standstill. The operating brake is also capable of functioning as a holding brake.
- **Holding brake:**
The purpose of braking or "holding" the motor shaft is merely to suppress unintended rotation caused by externally applied torque forces, e.g. when a load is suspended from a crane rope drum. The holding brake is primarily deployed when the motor is at a standstill ($n = 0$ rpm) by holding the motor shaft or is close to $n = 0$ rpm and coasting down to a standstill. As a result, no additional braking energy or braking heat is transferred to the motor.

Note:

A holding brake must not be used as an operating brake as it could then cause danger to life and damage to property.

Bridge rectifier / half-wave rectifier

Brakes are connected through a standard bridge or half-wave rectifier or directly to the BFK458-/SFB-SH brake. See the circuit diagrams below.

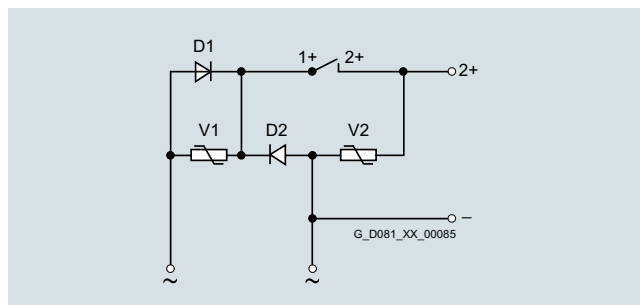

Half-wave rectifier 400 V AC

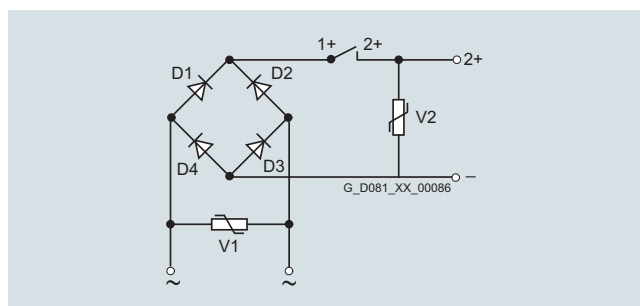

Rectifier bridge 230 V AC

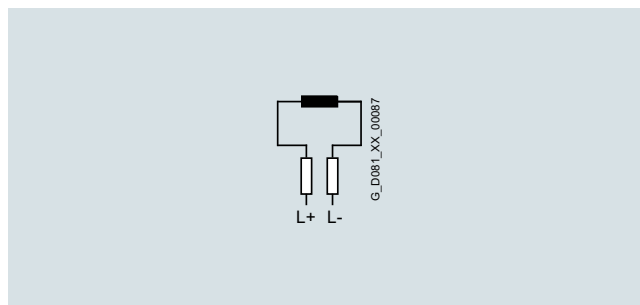

Brake connection for 24 V DC

Overview**BFK458 spring-operated disk brake****Motor series**

This brake is the standard brake for 1LE1/1FP1 motors in frame sizes 63 to 225 (except for 1LE1 with order code **F90** version "Forced-air cooled motors without external fan and fan cover").

Other characteristics of the BFK458 brake

The BFK458 brake has IP55 degree of protection.

Please inquire if motors with brakes are to be operated below the freezing point or in conjunction with very humid environments (e.g. close to the sea) with long standstill times. Please also inquire if motors with brakes are to be used for low-speed converter operation.

Design and mode of operation

The brake takes the form of a single-disk brake with two friction surfaces.

The braking torque is generated by friction when pressure is applied by one or more pressure springs in the de-energized state. The brake is released electromagnetically.

When the motor brakes, the rotor which can be axially shifted on the hub or the shaft is pressed via the armature disk against the friction surface by means of the springs. In the braked state, there is a gap S_{Gap} between the armature disk and the solenoid component. To release the brake, the solenoid is energized with DC voltage. The resulting magnetic force pulls the armature disk against the spring force on to the solenoid component. The spring force is then no longer applied to the rotor, which can rotate freely.

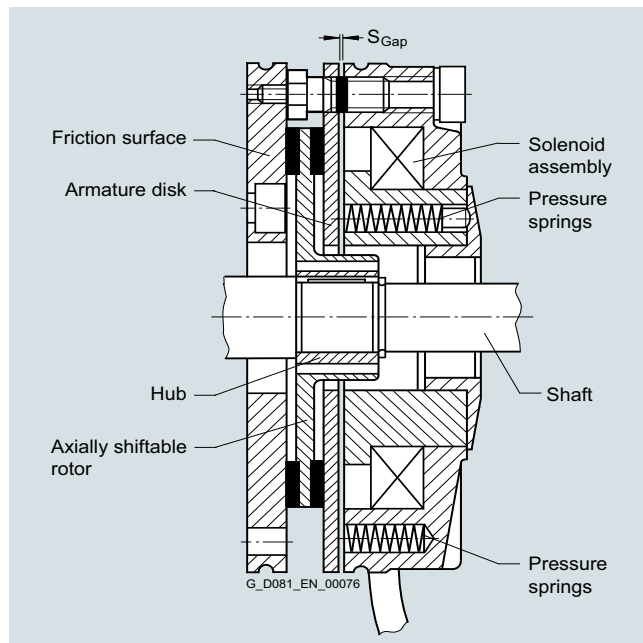

Design of the BFK458 spring-operated disk brake

Rating plate

The following brake data is specified on the motor rating plate:

- Brake type
- Supply voltage
- Frequency
- Current
- Temperature class
- Braking torque

Voltage and frequency

The solenoids and the brake rectifier are designed for connection to the following voltages or can be supplied for the following voltages:

- Brake supply voltage 24 V DC
Order code **F10**
- Brake supply voltage 230 V AC
Order code **F11**
- Brake supply voltage 400 V AC
(directly at the terminal strip)
Order code **F12**
- Brake supply voltage 180 V DC
Order code **F17**
- Brake supply voltage 205 V DC
Order code **F18**

When 60 Hz is used, the voltage for the brake must not be increased!

Order codes **F10**, **F11**, **F12**, **F17**, and **F18** must only be used in conjunction with order code **F01**

Lifetime of the brake lining

The braking energy L_N until readjustment of the brake depends on various factors. The main influencing factors include the masses to be braked, the operating speed, the switching frequency, and therefore the temperature at the frictional surfaces. This means it is not possible to specify a value for the friction energy until readjustment that is valid for all operating conditions.

When used as an operating brake, the specific frictional surface wear (wear volume for the frictional work) is approximately 0.05 to 2 cm³/kWh.

Introduction

Mounting technology

Modular technology

1

Overview

| For motor frame size | Brake type | Rated braking torque at 100 rpm | Rated braking torque at 100 rpm in % at the following speeds | | | Supply voltage | Current/ power input ¹⁾ | | Brake application time t_2 ²⁾ | Brake release time | Brake moment of inertia | Noise level L_p with rated air gap | Service capability of the brake | |
|----------------------|------------------|---------------------------------|--|----------|------------|----------------|------------------------------------|-----|--|--------------------|-------------------------|--------------------------------------|----------------------------------|--|
| | | | 1500 rpm | 3000 rpm | Max. speed | | A | W | | | | | Lifetime L of the brake lining | Air gap S_{Gap} adjustment required after braking energy L_N |
| 63 | BFK458-06 | 5 | 87 | 80 | 65 | AC 230 | 0.1 | 20 | 25 | 56 | 0.000013 | 77 | 105 | 16 |
| | | | | | | AC 400 | 0.11 | | | | | | | |
| | | | | | | DC 24 | 0.83 | | | | | | | |
| 71 | BFK458-06 | 5 | 87 | 80 | 65 | AC 230 | 0.1 | 20 | 25 | 56 | 0.000013 | 77 | 105 | 16 |
| | | | | | | AC 400 | 0.11 | | | | | | | |
| | | | | | | DC 24 | 0.83 | | | | | | | |
| 80 | BFK458-08 | 10 | 85 | 78 | 65 | AC 230 | 0.12 | 25 | 26 | 70 | 0.000045 | 75 | 270 | 29 |
| | | | | | | AC 400 | 0.14 | | | | | | | |
| | | | | | | DC 24 | 1.04 | | | | | | | |
| 90 | BFK458-10 | 20 | 83 | 76 | 66 | AC 230 | 0.15 | 32 | 37 | 90 | 0.00016 | 75 | 740 | 79 |
| | | | | | | AC 400 | 0.17 | | | | | | | |
| | | | | | | DC 24 | 1.25 | | | | | | | |
| 100 | BFK458-12 | 40 | 81 | 74 | 66 | AC 230 | 0.2 | 40 | 43 | 140 | 0.00036 | 80 | 1350 | 115 |
| | | | | | | AC 400 | 0.22 | | | | | | | |
| | | | | | | DC 24 | 1.67 | | | | | | | |
| 112 | BFK458-14 | 60 | 80 | 73 | 65 | AC 230 | 0.25 | 53 | 60 | 210 | 0.00063 | 77 | 1600 | 215 |
| | | | | | | AC 400 | 0.28 | | | | | | | |
| | | | | | | DC 24 | 2.1 | | | | | | | |
| 132 | BFK458-16 | 100 | 79 | 72 | 65 | AC 230 | 0.27 | 55 | 50 | 270 | 0.0015 | 77 | 2450 | 325 |
| | | | | | | AC 400 | 0.31 | | | | | | | |
| | | | | | | DC 24 | 2.3 | | | | | | | |
| 160 | BFK458-20 | 260 | 75 | 68 | 65 | AC 230 | 0.5 | 100 | 165 | 340 | 0.0073 | 79 | 7300 | 935 |
| | | | | | | AC 400 | 0.47 | | | | | | | |
| | | | | | | DC 24 | 4.2 | | | | | | | |
| 180 | BFK458-20 | 315 | 75 | 68 | 65 | AC 230 | 0.5 | 100 | 152 | 410 | 0.0073 | 79 | 5500 | 470 |
| | | | | | | AC 400 | 0.56 | | | | | | | |
| | | | | | | DC 24 | 4.2 | | | | | | | |
| 200, 225 | BFK458-25 | 400 | 73 | 68 | 65 | AC 230 | 0.55 | 110 | 230 | 390 | 0.0200 | 93 | 9450 | 1260 |
| | | | | | | AC 400 | 0.61 | | | | | | | |
| | | | | | | DC 24 | 4.6 | | | | | | | |

¹⁾ For 400 V AC and for 24 V DC, the power can deviate by up to +10 % as a function of the selected supply voltage.

²⁾ The specified switching times are valid for switching on the DC side with a rated release travel and with the coil already warm. They are average values, which may vary depending on factors such as the rectifier type and the release travel. The brake application time for switching on the AC side, for example, is approximately 6 times longer than for switching on the DC side.

Overview

Maximum admissible speeds

The maximum admissible speeds from which emergency stops can be made are listed in the next table. These speeds should be considered as guide values and must be checked for the specific operating conditions.

The maximum admissible friction energy depends on the switching frequency and is shown for the individual brakes in the following diagram. Increased wear can be expected when the brakes are used for emergency stops.

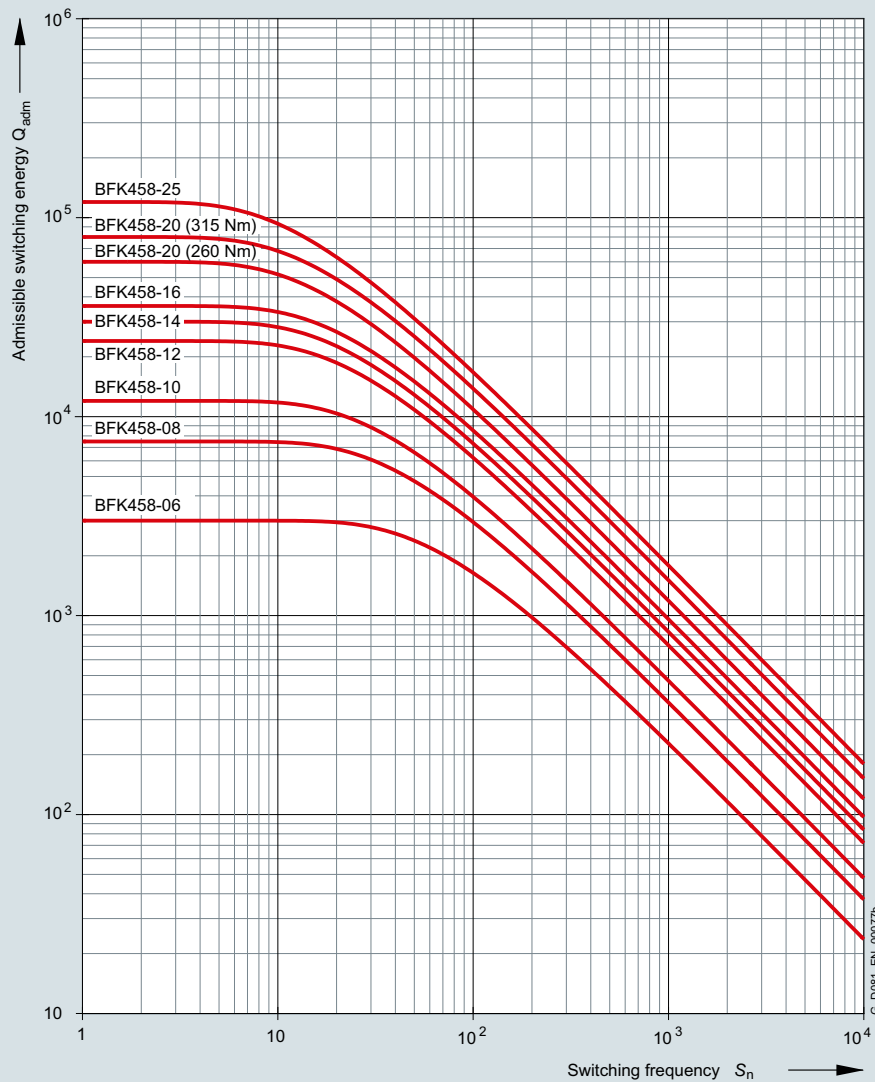

| For motor frame size | Brake type | Maximum admissible speeds | | | Changing the braking torque | | | Readjusting the air gap | | |
|----------------------|------------------|---|---|---|-----------------------------|-----------------------------|---------------------|--------------------------------------|---------------------------------------|---|
| | | Max. adm. operating rpm if max. operating energy utilized | Max. adm. no-load rpm with emergency stop function for horizontal mounting position | Max. adm. no-load rpm with emergency stop function for vertical mounting position | Reduction per notch | Dimension "O ₁ " | Min. braking torque | Rated air gap S _{Gap rated} | Maximum air gap S _{Gap max.} | Minimum rotor thickness h _{min.} |
| | | rpm | rpm | rpm | Nm | mm | Nm | mm | mm | mm |
| 63 | BFK458-06 | 3000 | 6000 | 6000 | 0.17 | 7 | 3.7 | 0.2 | 0.4 | 4.5 |
| 71 | BFK458-06 | 3000 | 6000 | 6000 | 0.17 | 7 | 3.7 | 0.2 | 0.4 | 4.5 |
| 80 | BFK458-08 | 3000 | 6000 | 6000 | 0.35 | 8.0 | 7.0 | 0.2 | 0.45 | 5.5 |
| 90 | BFK458-10 | 3000 | 6000 | 6000 | 0.76 | 7.5 | 18.2 | 0.2 | 0.55 | 7.5 |
| 100 | BFK458-12 | 3000 | 6000 | 6000 | 1.29 | 12.5 | 21.3 | 0.3 | 0.65 | 8.0 |
| 112 | BFK458-14 | 3000 | 6000 | 6000 | 1.66 | 11.0 | 32.8 | 0.3 | 0.75 | 7.5 |
| 132 | BFK458-16 | 3000 | 5300 | 5000 | 1.55 | 13.0 | 61.1 | 0.3 | 0.75 | 8.0 |
| 160 | BFK458-20 | 1500 | 4400 | 3200 | 5.6 | 17.0 | 157.5 | 0.4 | 1.2 | 12.0 |
| 180 | BFK458-20 | 1500 | 4400 | 3200 | 5.6 | 17.0 | 178.4 | 0.4 | 1.0 | 12.0 |
| 200, 225 | BFK458-25 | 1500 | 3000 | 3000 | 6.15 | 21.0 | 248.7 | 0.5 | 1.5 | 15.5 |

Introduction

Mounting technology

Modular technology

1

Overview

Changing the braking torque

The brake is supplied with the braking torque already set. For BFK458 brakes, the torque can be reduced to dimension O_1 by unscrewing the adjusting ring with a hook wrench. The braking torque changes by the values shown in the above table for each notch of the adjusting ring.

Readjusting the air gap

Under normal operating conditions, the brake is practically maintenance-free. The air gap S_{Gap} must only be checked at regular intervals if the application requires an extremely large amount of frictional energy and readjusted to the rated air gap $S_{\text{Gap rated}}$ at the latest when the maximum air gap $S_{\text{Gap max}}$ is reached.

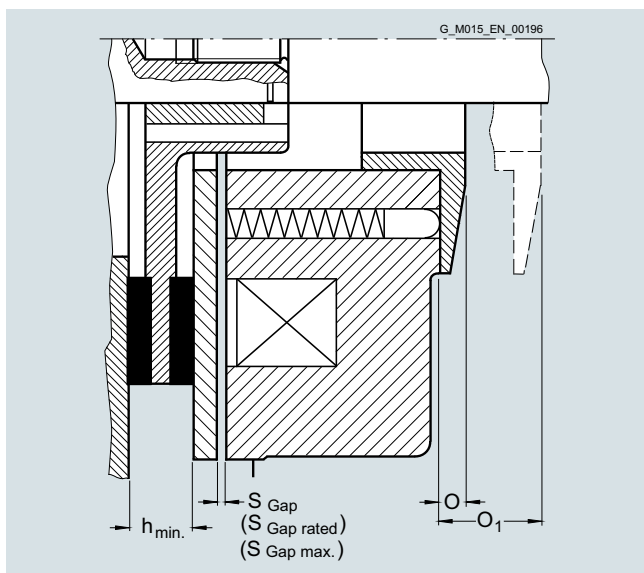

Connection

Labeled terminals are provided in the main terminal box of the motor to connect the brake.

The AC voltage for the brake excitation winding is connected to the two free terminals of the rectifier block (~).

The brake can be released when the motor is at a standstill by separately exciting the solenoid. In this case, an AC voltage must be connected at the rectifier block terminals. The brake remains released as long as this voltage is present.

The rectifiers are protected against overvoltages by varistors in the input and output circuits.

For 24 V DC brakes, the brake terminals are directly connected to the DC voltage source.

For this purpose, see the circuit diagrams on page 1/78.

Fast brake application

If the brake is disconnected from the line supply, the brake is applied.

The application time for the brake disk is delayed as a result of the inductance of the solenoid (shutdown on the AC side). This results in a considerable delay before the brake is mechanically applied. In order to achieve short brake application times, the circuit must be interrupted on the DC side. To realize this, the wire jumpers, located between contacts 1+ and 2+ at the rectifier, are removed and replaced by the contacts of an external switch.

For this purpose, see the circuit diagrams on page 1/78.

Mechanical manual brake release with lever

The brakes can be supplied with a mechanical manual release with lever.

Order code **F50**

The dimensions of the brake lever depend on the motor frame size and can be read from the dimensional drawing generator for motors in the DT Configurator tool for low-voltage motors.

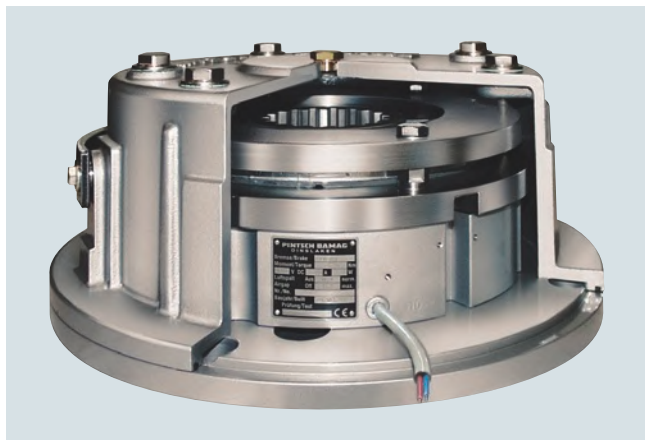
Overview**KFB spring-operated brake**

KFB spring-operated brake

The KFB solenoid double-disk spring-operated brake is a safety brake that brakes the motor if the supply is disconnected (power failure, emergency stop). The KFB brake with IP67 degree of protection is mainly used for electric motors for traversing, cross-traversing and lifting gear in cranes as well as for special industrial applications.

Motor series

This brake is the standard brake for 1LE1 motors in frame sizes 250 to 315. For frame sizes 180 to 225, apart from the standard brake BFK458, KFB brakes can also be supplied. Special brake selections are available on request.

Design and mode of operation

When the brake current is switched on, an electromagnetic field develops which overcomes the spring force of the brake. The corresponding modules, including the motor shaft, can rotate freely. The brake is released. If the brake current is switched off or if there is a power failure, the electromagnetic field of the brake disappears. The mechanical braking energy is transferred to the motor shaft. The motor is braked.

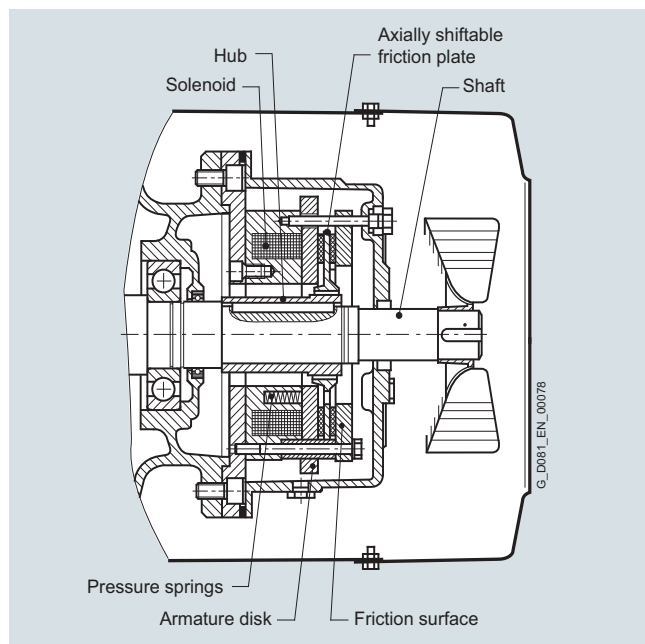

Design of KFB spring-operated brakes

Other characteristics of the KFB brake

- High degree of protection IP67.
- Corrosion-resistant in seawater and in the tropics.
- The brake is a dynamic brake, not simply a holding brake. For this reason there is less wear, especially in the case of emergency stops (commissioning).
- High wear reserves – repeated stepless air gap readjustment is possible. This results in extremely long operating times and low service and operating costs.
- The function and wear can be monitored with microswitches and proximity switches. Microswitch On/Off is standard for 1LE motors, frame size 250 to 315. Microswitch On/Off is not standard for 1LE motors, frame size up to 225. Anti-condensation heating is possible as an option.
- Fully functional brake for housing acceptance test. Visual inspection of brake is possible during operation.
- The brake (air gap) can be adjusted in the factory, for example, and mounted on the drive motor without further adjustments.
- The wearing parts can be replaced without great effort. After the housing has been opened (three screws), it is easy to replace the friction plate. It is not necessary to disassemble the entire brake.

Voltage and frequency

The solenoids and the brake rectifier can be connected to the following voltages:

1 AC 50 Hz 230 V \pm 10 %

When 60 Hz is used, the voltage for the brake must not be increased!

The brake can also be supplied for other voltages:

- Brake supply voltage: 24 V DC
Order code **F10**
- Brake supply voltage: 230 V AC
Order code **F11**
- Brake supply voltage: 400 V AC (directly at the terminal strip)
Order code **F12**

Order codes **F10** and **F12** may only be used in conjunction with order code **F01**.

Fast brake application

Not available for the KFB brake.

Mechanical manual brake release with lever

The brake can be released manually with screws as standard. Mechanical manual release with a lever can be ordered with order code **F50**.

The dimensions of the brake lever depend on the motor frame size and can be read from the dimension sheet generator for motors in the DT Configurator tool for low-voltage motors. Up-to-date data are available from the brake manufacturer.

Introduction

Mounting technology

Modular technology

1

Overview

Connection

Labeled terminals are provided in the main terminal box of the motor to connect the brake. KFB brakes are connected through a standard bridge or half-wave rectifier.

A special circuit is not required. Optimal switching times are achieved without the need to use special circuits.

For this purpose, see the circuit diagrams on page 1/78.

Maximum admissible speeds

The maximum admissible speeds from which emergency stops can be made are listed in the next table. These speeds should be considered as guide values and must be checked for the specific operating conditions.

The maximum admissible friction energy depends on the switching frequency and is shown for the individual brakes in the following diagram. Increased wear can be expected when the brakes are used for emergency stops.

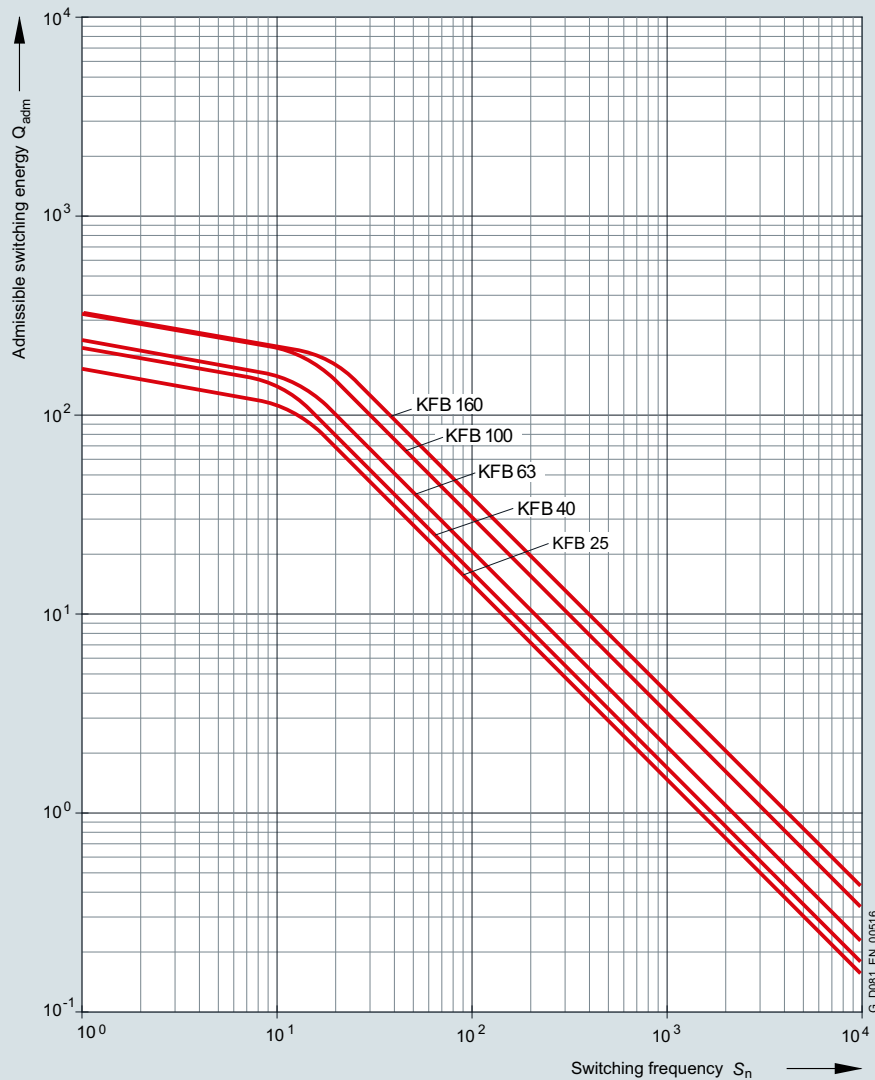

Overview

| Overview of brake selection for 1LE1 motors | | For motor frame sizes | | | | | |
|--|----------------------|-----------------------|-------------------|-------------------|-------------------|-------------------|-------------------|
| | | 180 ¹⁾ | 200 ¹⁾ | 225 ¹⁾ | 250 ²⁾ | 280 ²⁾ | 315 ²⁾ |
| No. of poles | | 2 to 8 | 2 to 8 | 2 to 8 | 2 to 8 | 4 to 8 | 4 to 8 |
| Flanged end shield NDE brake installation | | A300 | A350 | A350 | A400 | A450 | A550 |
| Max. diameter of 2nd shaft extension | mm | 48 _{k6} | 55 _{m6} | 55 _{m6} | 60 _{m6} | 65 _{m6} | 70 _{m6} |
| Brake type | | KFB 25 | KFB 40 | KFB 40 | KFB 63 | KFB 100 | KFB 160 |
| Braking torque | Nm | 225 | 360 | 360 | 567 | 900 | 1440 |
| Nominal dynamic braking torque according to VDE 0580 | Nm/rpm | 250/127 | 400/117 | 400/117 | 630/92 | 1000/78 | 1600/69 |
| Dynamic braking torque ³⁾ | at 750 rpm | Nm | 207 | 332 | 332 | 504 | 780 |
| | at 1000 rpm | Nm | 200 | 316 | 316 | 491 | 760 |
| | at 1500 rpm | Nm | 192 | 304 | 304 | 466 | 720 |
| | at 3000 rpm | Nm | 175 | 276 | 276 | 378 | 580 |
| | at n_{max} | Nm | 137 | 220 | 220 | 346 | 500 |
| Maximum speed n_{max} – IM B3/V1 | rpm | 6000 | 5500 | 5500 | 4700 | 4000 | 3600 |
| Power at 110 V DC | W | 158 | 196 | 196 | 220 | 307 | 344 |
| Power at 230 V AC | W | 160 | 188 | 188 | 206 | 316 | 340 |
| Current at 110 V DC | A | 1.44 | 1.78 | 1.78 | 2 | 2.79 | 3.13 |
| Current at 230 V AC (207 V DC coil voltage) | A | 0.77 | 0.91 | 0.91 | 1 | 1.53 | 1.64 |
| Current at 400 V AC (180 V DC coil voltage) | A | 0.8 | 1.18 | 1.18 | 1.25 | 1.8 | 2.1 |
| Current at 24 V DC | A | 5.21 | 6.92 | 6.92 | 8.17 | 12.2 | 12.8 |
| Weight, approx. | kg | 42 | 55 | 55 | 74 | 106 | 168 |
| Application time t_1 | ms | 70 | 80 | 80 | 112 | 126 | 183 |
| Release time t_2 | ms | 240 | 250 | 250 | 342 | 375 | 500 |
| Brake moment of inertia | kgm ² | 0.0048 | 0.0068 | 0.0068 | 0.0175 | 0.036 | 0.05 |
| Lifetime L of the brake lining | Nm · 10 ⁶ | 3600 | 3110 | 3110 | 4615 | 7375 | 10945 |
| Air gap adjustment L_N required after braking energy | Nm · 10 ⁶ | 810 | 935 | 935 | 1185 | 2330 | 3485 |

¹⁾ The standard brake for frame sizes 180 to 225 is the BFK458 brake. KFB brake on request.

²⁾ The standard brake for frame sizes 250 to 315 is the KFB brake.

³⁾ The dynamic braking torque also depends on the load data; temperatures in excess of the maximum admissible lining surface temperatures must be avoided.

Introduction

Mounting technology

Modular technology

1

Overview

SFB-SH solenoid double-disk spring-operated brake

Motor series

This brake is the standard brake for 1LE5 motors in frame sizes 315 to 355.

Special brake selections are available on request.

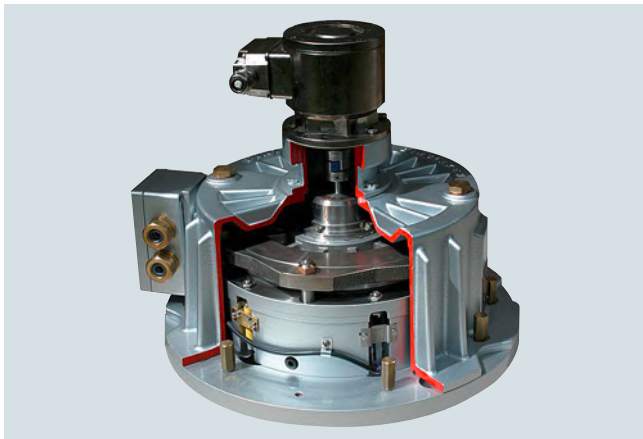

SFB-SH solenoid double-disk spring-operated brake

SFB-SH solenoid double-disk spring-operated brakes are safety brakes that are mechanically operated on a power failure. This ensures that the brake still works during a power failure. These brakes are designed for dry running, must only ever be operated in a safe state, and only installed, commissioned, operated, and maintained by specially trained installation personnel. The brakes of the SFB-SH type series have an increased braking torque due to use of a different friction material and are used for emergency stops as a dynamically loaded brake with a safety margin.

Other characteristics of the SFB-SH brake

- High degree of protection IP67.
- Corrosion-resistant in seawater and in the tropics.
- High wear margins - simple air-gap adjustment. This results in extremely long operating times and low service and operating costs.
- The function and wear can be monitored with microswitches and proximity switches. Microswitch On/Off is standard for 1LE5 motors. Anti-condensation heating is possible as an option.
- Fully functional brake for housing acceptance test. Visual inspection of brake is possible during operation.
- The brake (air gap) can be adjusted in the factory, for example, and mounted on the drive motor without further adjustments.
- The wearing parts can be replaced without great effort. After the housing has been opened (three acorn nuts), it is easy to replace the friction plate. It is not necessary to disassemble the entire brake.

Design and mode of operation

When the brake current is switched on, an electromagnetic field develops which overcomes the spring force of the brake. The corresponding modules, including the motor shaft, can rotate freely. The brake is released. If the brake current is switched off or if there is a power failure, the electromagnetic field of the brake disappears. The mechanical braking energy is transferred to the motor shaft. The motor is braked.

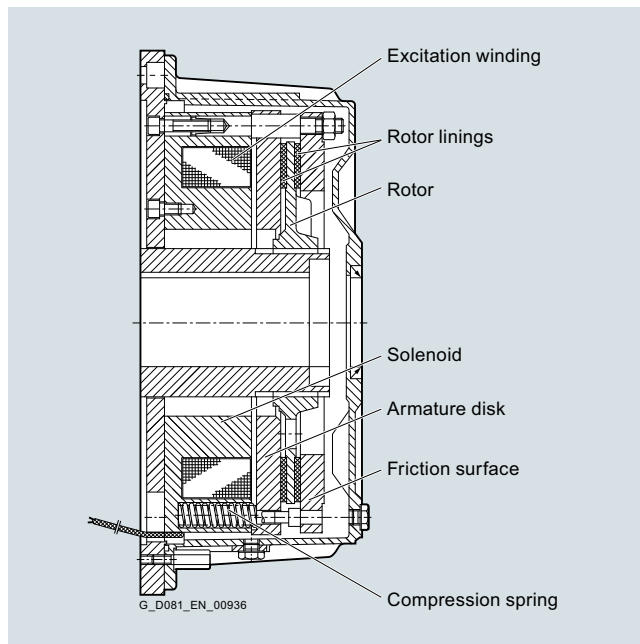

Design of the SFB-SH solenoid double-disk spring-operated brake

Voltage and frequency

The solenoids and the brake rectifier can be connected to the following voltages:

1 AC 50 Hz 230 V $\pm 10\%$

When 60 Hz is used, the voltage for the brake must not be increased!

The brake can also be supplied for other voltages:

- Brake supply voltage: 24 V DC
Order code **F10**
- Brake supply voltage: 230 V AC
Order code **F11**
- Brake supply voltage: 400 V AC (directly at the terminal strip)
Order code **F12**

Order codes **F10** and **F12** may only be used in conjunction with order code **F01**.

Overview**Connection**

Labeled terminals are provided in the main terminal box of the motor to connect the brake.

The AC voltage for the brake excitation winding is connected to the two free terminals of the rectifier block (~). The rectifier is located in the main terminal box and must be connected in the customer's switchboard.

The brake can be released when the motor is at a standstill by separately exciting the solenoid. In this case, an AC voltage must be connected at the rectifier block terminals. The brake remains released as long as this voltage is present.

For 24 V DC brakes, the brake terminals are directly connected to the DC voltage source.

For this purpose, see the circuit diagrams on page 1/78.

Maximum admissible speeds

The maximum admissible speeds from which emergency stops can be made are listed in the next table. These speeds should be considered as guide values and must be checked for the specific operating conditions.

The maximum admissible friction energy depends on the switching frequency and is shown for the individual brakes in the following diagram. Increased wear can be expected when the brakes are used for emergency stops.

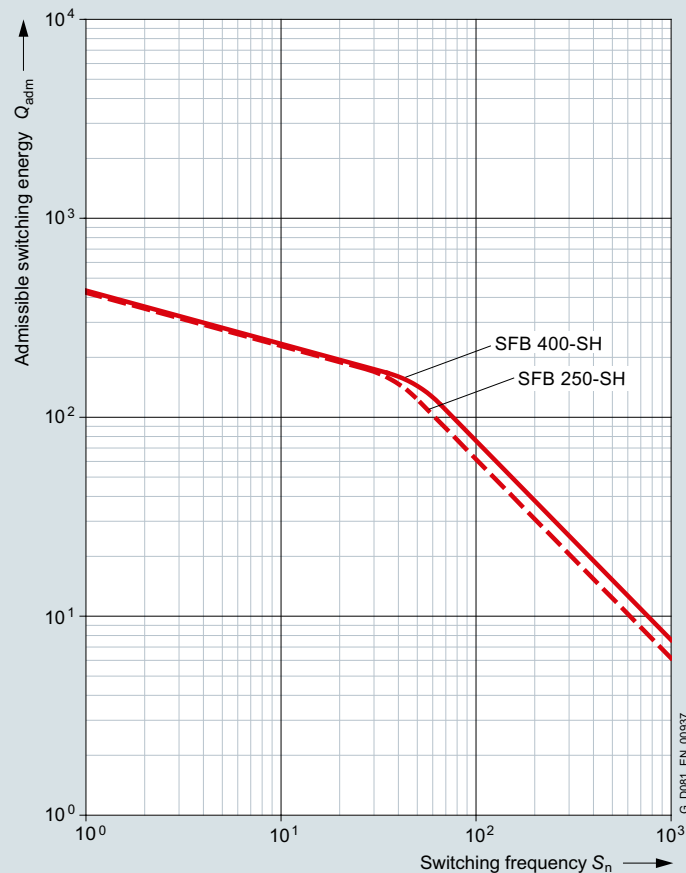

Introduction

Mounting technology

Modular technology

1

Overview

| Overview of brake selection for 1LE5 motors | | For motor frame sizes | |
|--|------------------|----------------------------|----------------------------|
| | | 315 | 355 |
| No. of poles | | 4 to 8 | 4 to 8 |
| Flanged end shield NDE brake installation | | FF500 (A550) ¹⁾ | FF600 (A660) ²⁾ |
| Max. diameter of 2nd shaft extension | mm | 75 _{m6} | 90 _{m6} |
| Brake type | | SFB 250-SH | SFB 400-SH |
| Braking torque | Nm | 2970 | 4680 |
| Nominal dynamic braking torque according to VDE 0580 | Nm/rpm | 3300/54 | 5200/47 |
| Dynamic braking torque ³⁾ | at 750 rpm | Nm | 2400 |
| | at 1000 rpm | Nm | 2200 |
| | at 1500 rpm | Nm | 1850 |
| | at n_{max} | Nm | 1580 |
| Maximum speed n_{max} – IM B3/V1 | rpm | 2800 | 2500 |
| Power at 110 V DC | W | 495 | 553 |
| Power at 230 V AC (207 V DC coil voltage) | W | 511 | – |
| Current at 110 V DC | A | 4.5 | 5.03 |
| Current at 230 V AC (207 V DC coil voltage) | A | 2.79 | 3.14 |
| Current at 400 V AC (180 V DC coil voltage) | A | 2.98 | 3.36 |
| Current at 24 V DC | A | 19.93 | – |
| Weight, approx. | kg | 306 | 357 |
| Application time t_1 | ms | 640 | 700 |
| Release time t_2 | ms | 690 | 1100 |
| Brake moment of inertia | kgm ² | 0.14 | 0.325 |
| Minimum air gap | mm | 0.4 | 0.4 |
| Maximum air gap | mm | 2.5 | 2.5 |

¹⁾ External dimension increases to 560 mm.

²⁾ External dimension decreases to 640 mm.

³⁾ The dynamic braking torque also depends on the load data, temperatures in excess of the maximum admissible lining surface temperatures must be avoided.

⁴⁾ Value is guaranteed by the brake manufacturer.
In practice, a higher braking torque can be expected.
Restrictions are determined at the test station of the brake manufacturer.
Information: www.pintschbubenzler.de

Overview**Configuration of motors with brakes****Braking time**

The time it takes the motor to come to a standstill comprises two components:

- The application time of the brake t_2
- The braking time t_{Br}

$$t_{Br} = \frac{J \cdot n_{rated}}{9.55 \cdot (T_B \pm T_L)}$$

t_{Br} Braking time in s

J Total moment of inertia in kgm^2

n_{rated} Rated speed of the motor with brake in rpm

T_B Rated braking torque in Nm

T_L Average load torque in Nm (If T_L supports the braking operation, T_L is positive)

Braking energy per braking operation Q_{adm}

The braking energy per braking operation in Nm comprises the energy of the moments of inertia to be braked Q_{Kin} and the energy Q , which must be applied in order to brake against a load torque:

$$Q_{adm} = Q_{Kin} + Q$$

- The energy of the moments of inertia in Nm

$$Q_{Kin} = \frac{J \cdot n_{rated}^2}{182.4}$$

n_{rated} Rated speed before braking in rpm

J Total moment of inertia in kgm^2 . The mass moment of inertia J specified in the formula corresponds to the total moment of inertia of all braked masses referred to the motor/brake speed.

- Braking energy on emergency trip

The braking energy for occasional emergency trips must be checked to ensure that it does not cause the brake to overheat. Please refer to table "Technical specifications of brakes" for admissible values. The braking energy produced for traversing gear can be calculated approximately with the following equation:

$$Q = \frac{J_{tot} \cdot n_{Br}^2}{182.4 \cdot 10^3} \cdot \frac{T_{Br}}{T_{Br} \pm T_L}$$

Q Energy capability/braking energy in kJ

T_{Br} Braking torque in Nm

T_L Total of all load torques in Nm referred to the brake (motor) shaft

n_{Br} Speed of brake (motor) shaft in rpm

J_{tot} Total moment of inertia to be braked in kgm^2 reduced to the brake (motor) shaft

T_L is positive if it supports braking (e.g. hoisting a load)

T_L is negative if it counteracts braking (e.g. lowering a load)

The total moment of inertia J_{tot} is the sum of the individual moments of inertia of the system components to be braked, reduced to the brake (motor) shaft, and the moments of inertia of the linear-motion masses. The equivalent mass inertia J_{Eqv} of a linear-motion mass m with velocity v , referred to the brake (motor) speed n_{Br} , is calculated as follows:

$$J_{Eqv} = 91.2 \cdot m \cdot \left(\frac{v}{n_{Br}}\right)^2$$

m Mass of the linear-motion load in kg

v Velocity of the linear-motion load in m/s

n_{Br} Speed of brake (motor) shaft in rpm

The velocity and/or speed to be entered here must equal the maximum values in normal operation. An increase in velocity resulting from wind forces may also need to be taken into account.

Definition of switching times (VDI 2241)

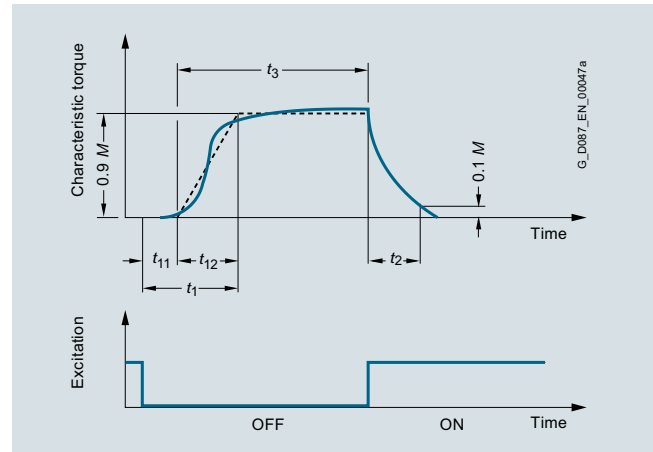

Brake switching times

Switching times:

t_1 Brake application time

t_2 Disconnection time

t_3 Slip time

t_{11} Response delay

t_{12} Rise time

Run-on revolutions U

The number of run-on revolutions U of the motor with brake can be calculated as follows:

$$U = \frac{n_{rated}}{60} \left(t_1 + \frac{t_{Br}}{2} \right)$$

t_1 Brake application time in ms

Lifetime of the brake lining L and readjustment of the air gap

The brake lining wears due to friction which increases the air gap and the release time for the brake at standard excitation.

In order to calculate the lifetime of the brake lining in terms of operations S_{max} , the lifetime of the brake lining L in Nm must be divided by the braking energy Q_{adm} :

$$S_{max} = \frac{L}{Q_{adm}}$$

The interval between adjustments N can be calculated in terms of operations by dividing the braking energy L_N that the brake can output until it is necessary to readjust the working air gap by Q_{adm} :

$$N = \frac{L_N}{Q_{adm}}$$

Introduction

Mounting technology

Modular technology

1

Overview

FDX spring-operated brake

Motor series

This brake is provided for 1LE1 motors in frame sizes 225 to 315.

Mode of operation of FDX spring-operated brake (holding brake/operating brake)

The FDX solenoid spring-operated brakes (order code **F04**), with IP67 degree of protection, are quiescent current brakes, meaning that the braking torque is produced by spring force and increased by magnetic force in normal operation.

During the braking operation, the built-in compression springs apply pressure to the rotor that interlocks radially with the machine shaft using the axially moving armature disk. In turn, this applies pressure to the opposing side against the friction surface (\rightarrow motor label). The braking torque is produced from the linings of the rotor and the armature disk/friction surface being in contact.

During the brake release process, a magnetic force is produced by applying a direct current via the excitation winding in the solenoid. The armature disk is thereby pulled from the solenoid and the rotor is released.

During the manual brake release process (only available for the brake version with manual brake release), the armature disk is pressed mechanically against the solenoid by operating the manual release lever. The brake can therefore still be released in the event of a power failure, for example.

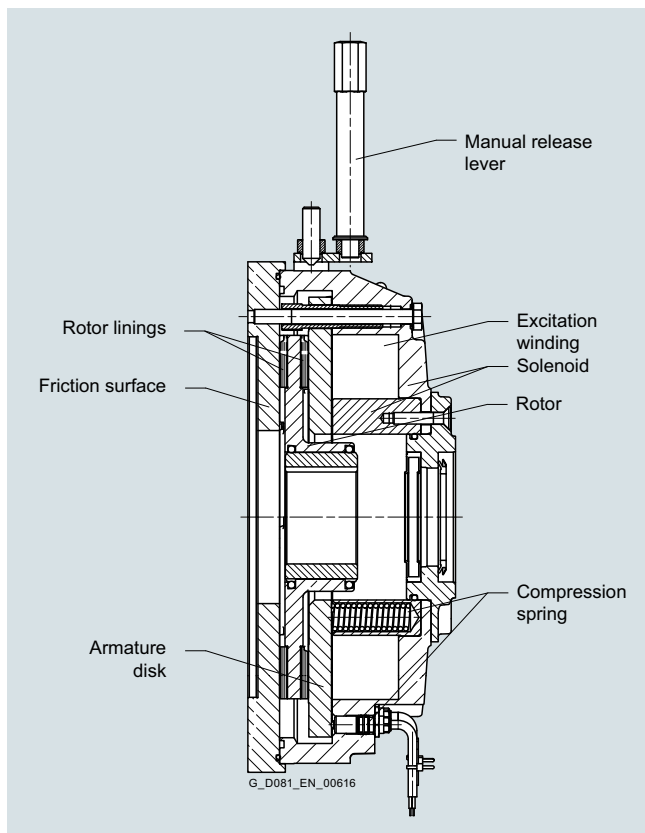

Voltage and frequency

The solenoids and the brake rectifier are designed for connection to the following voltages or can be supplied for the following voltages:

- Brake supply voltage 230 V AC
Order code **F11**
- Brake supply voltage 400 V AC
Order code **F12**

When 60 Hz is used, the voltage for the brake must not be increased!

Order codes **F11** and **F12** may only be used in conjunction with order code **F04**.

Connection

Labeled terminals are provided in the main terminal box of the motor to connect the brake.

The AC voltage for the brake excitation winding is connected to the two free terminals of the rectifier block (\sim).

The brake can be released when the motor is at a standstill by separately exciting the solenoid. In this case, an AC voltage must be connected at the rectifier block terminals. The brake remains released as long as this voltage is present.

The rectifiers are protected against overvoltages by varistors in the input and output circuits. The function and wear can be monitored with microswitches and proximity switches. Microswitch On/Off is standard for 1LE1 motors. Anti-condensation heating is possible as an option.

Mechanical manual brake release with lever

The brake can be supplied with a mechanical manual release with lever.

Order code **F50**

The dimensions of the brake lever depend on the motor frame size and can be read from the dimensional drawing generator for motors in the DT Configurator tool for low-voltage motors.

www.siemens.com/dt-configurator

Lifetime

The amount of frictional energy that can be transferred before the rotor must be replaced depends on various factors:

- Mass to be decelerated
- Switching frequency
- Speed
- Resulting temperature on the friction surfaces

As a result, only guide values can be specified for the frictional energy to be transferred until rotor replacement.

Overview**Abbreviations and definitions used (with their units):** T_{LR} = Motor starting torque (Nm) T_b = Braking torque (Nm) T_{breq} = Required braking torque (Nm) $T_{b, rated}$ = Rated torque of the spring-operated brake (Nm) T_L = Load torque (Nm) T_{tot} = Total torque (Nm) F = Force (N) r = Lever arm (m) n = Speed (rpm) K = Safety factor $K \geq 2$ P = Power (kW) t = Overall braking time (ms) t_{st} = Startup time (s) t_B = Braking time (s) t_2 = Disconnection time (ms) t_1 = Application time (ms) t_{11} = Response delay (ms) P_R = Frictional power (J/s) W_R = Friction energy (J) S = Switching cycles (brake operations) per second (Hz) J_E = Internal moment of inertia (kgm²) J_{add} = Additional moment of inertia (kgm²) $J_{2,3..}$ = Moment of inertia (kgm²) J_{tot} = Total moment of inertia (kgm²) n_1 = Motor speed (rpm) $n_{2,3..}$ = Speeds (rpm)

Multiple moments of inertia with different speeds are converted into a moment of inertia relative to the motor shaft:

$$J_{add} = \frac{J_2 \cdot n_2^2 + J_3 \cdot n_3^2 \dots}{n_1^2} \quad (\text{kgm}^2)$$

Torque

A spring-operated brake is designed mainly in accordance with the required braking torque T_{breq} . If the moment of inertia, speed, and admissible braking time of the machine are known, the braking torque of the spring-operated brake can be calculated. If the masses that are to be decelerated by the spring-operated brake are running at a different speed from the shaft decelerated by the spring-operated brake, the moment of inertia of these masses (J_{add}) must be calculated relative to this shaft (see above). In addition, the moment of inertia of the rotor-hub system (J_E) must be taken into account.

Load torque (static loading)

Torque which is present when the system is at a standstill and must be held by the brake. The loading force is converted into the load torque via the relevant lever arm:

$$T_L = F \cdot r \quad (\text{Nm})$$

Braking torque (dynamic loading)

A purely dynamic load is present when flywheels, rollers, etc., are to be delayed and the static load torque is negligibly small.

The required braking torque is calculated as follows:

$$T_b = 1.046 \cdot 10^2 \cdot J_{tot} \cdot \frac{n}{t - t_1} \quad (\text{Nm})$$

$$T_{breq} = T_b \cdot K \leq T_{b, rated} \quad (\text{Nm})$$

Dynamic and static loading

Most applications involve dynamic loading as well as static load torque:

$$T_{breq} = (T_b \pm T_L) \cdot K \quad (\text{Nm})$$

$$T_{breq} = (1.046 \cdot 10^2 \cdot J_{tot} \cdot \frac{n}{t - t_1} \pm T_L) \cdot K \quad (\text{Nm})$$

$$T_{breq} \leq T_{b, rated} \quad (\text{Nm})$$

Sign for T_L :

+ T_L = Load torque is applying force (in the direction of motion)

- T_L = Load torque is applying a decelerating force (opposite to the direction of motion)

If both cases occur, the specific configuration is always adapted to the larger torque.

Approximate determination of T_{breq}

If the moment of inertia is not known and if the input power has been defined, the required braking torque is determined as follows:

$$T_{breq} = 9.55 \cdot 10^3 \cdot \frac{P}{n} \cdot K \leq T_{b, rated} \quad (\text{Nm})$$

$K \geq 2$

Braking time**General information**

$$t = 1.046 \cdot 10^2 \cdot J_{tot} \cdot \frac{n}{T_{b, rated} \pm T_L} + t_1 \quad (\text{ms})$$

Sign for T_L :

- T_L = Load torque is applying force (in the direction of motion)

+ T_L = Load torque is applying a decelerating force (opposite to the direction of motion)

Calculation of the starting and braking time for motors**Startup time for motors with brakes**

$$t_{st} = J_{tot} \cdot \frac{n_1}{9.55 \cdot (T_{LR} \pm T_L)} + \frac{t_2}{1000} \quad (\text{s})$$

$$J_{tot} = J_E + J_{add} \quad (\text{kgm}^2)$$

Sign for T_L :

+ T_L = Load torque is applying force (in the direction of motion)

- T_L = Load torque is applying a decelerating force (opposite to the direction of motion)

Introduction

Mounting technology

Modular technology

1

Overview

Braking time for motors with brakes

$$t_B = J_{\text{tot}} \cdot \frac{n_1}{9.55 \cdot (T_{b, \text{rated}} \pm T_L)} + \frac{t_1}{1000} \quad (\text{s})$$

Sign for T_L :

- T_L = Load torque is applying force (in the direction of motion)
- + T_L = Load torque is applying a decelerating force (opposite to the direction of motion)

Thermal load

When braking, friction energy is applied during the slip phase, which releases thermal energy.

Friction energy per braking operation

$$W_R = J_{\text{tot}} \cdot n^2 \cdot \frac{T_{b, \text{rated}}}{182.5 \cdot (T_{b, \text{rated}} \pm T_L)} \quad (\text{J})$$

Sign for T_L :

- T_L = Load torque is applying force (in the direction of motion)
- + T_L = Load torque is applying a decelerating force (opposite to the direction of motion)

The friction energy per braking operation must be no greater than the admissible value $W_{R\text{max}}$

$$W_R \leq W_{R\text{max}} \quad (\text{J})$$

Frictional power

$$P_R = W_R \cdot S \quad (\text{J/s})$$

The friction energy must be no greater than the admissible value $P_{R\text{max}}$

$$P_R \leq P_{R\text{max}} \quad (\text{J/s})$$

Connection

Load rating of the rectifier diodes as a function of the ambient temperature:

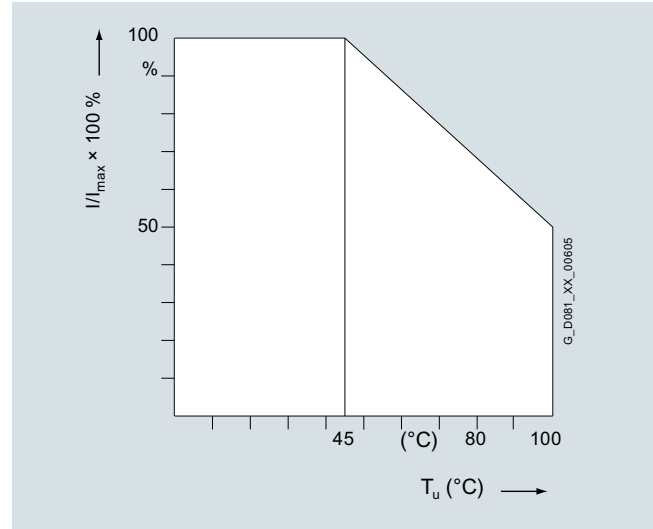

Block diagram:

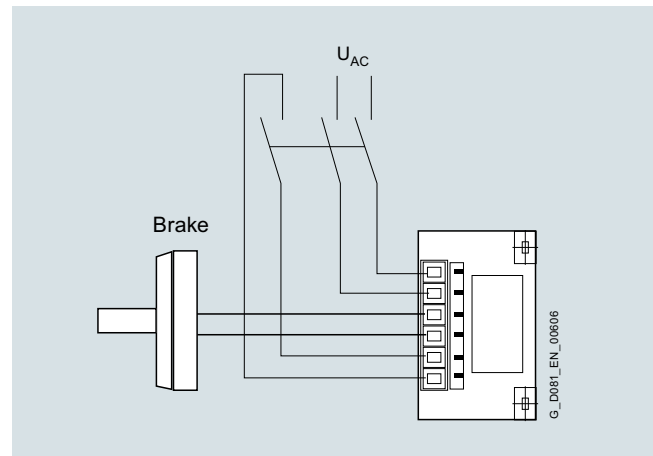

The high-speed rectifier performs the following functions:

- The coil is first supplied with a voltage $U_2 = 0.9 \times U_1$: Over-excitation of the brake
- After excitation time t_1 the voltage is reduced to $U_3 = 0.45 \times U_1$: Non-release voltage of the brake

| Designation | Supply voltage (V AC) | Output voltage (V DC) | | Ambient temperature |
|--------------|-----------------------|-----------------------|-------------------|---------------------|
| Article No.: | U_1 at 50/60 Hz | U_2 | U_3 | °C |
| PMG 480 | 215 ... 500 | $0.9 \times U_1$ | $0.45 \times U_1$ | -15 ... +80 |

Overview

Maximum admissible speeds

The maximum admissible speeds from which emergency stops can be made are listed in the next table. These speeds should be considered as guide values and must be checked for the specific operating conditions.

The maximum admissible friction energy depends on the switching frequency and is shown for the individual brakes in the following diagram. Increased wear can be expected when the brakes are used for emergency stops.

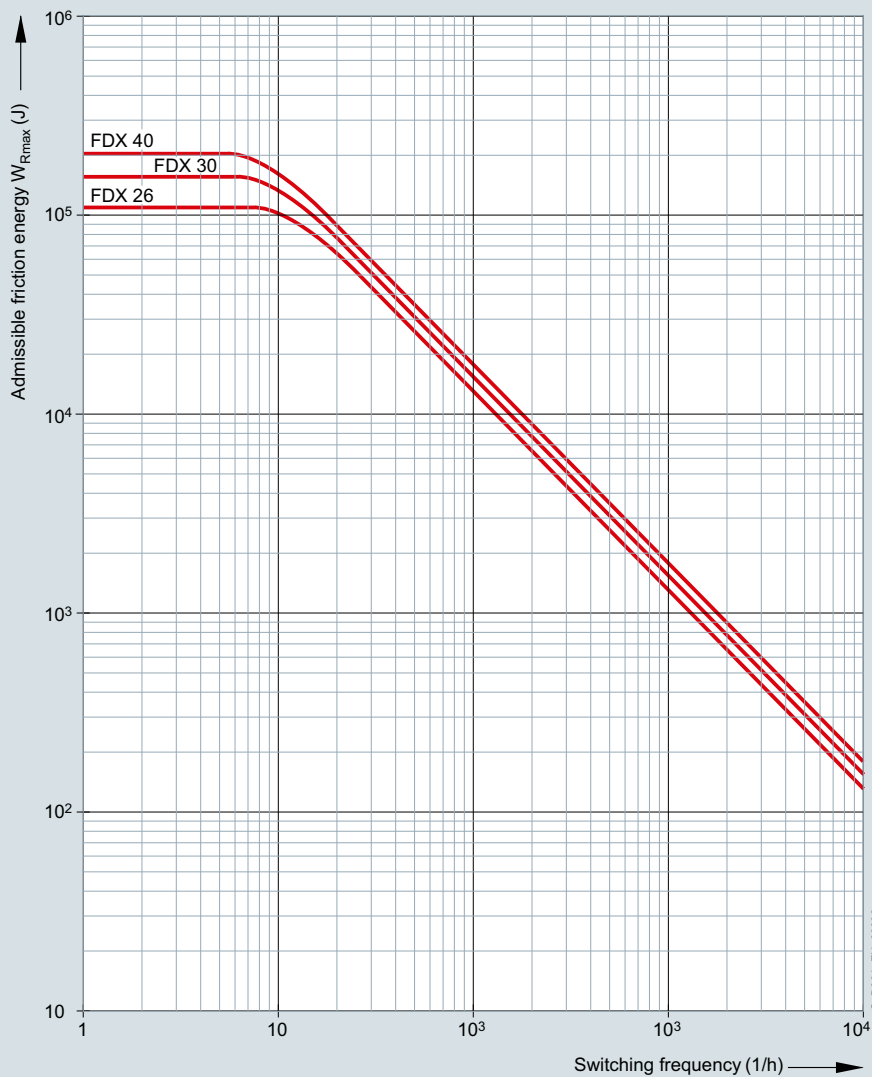

G_D081_EN_00002

Introduction

Mounting technology

Modular technology

1

Overview

| Overview of brake selection for 1LE1 motors (option F04) | | For motor frame sizes | | | |
|--|----------------------|--|--|--|--|
| | | 225 | 250 | 280 | 315 |
| No. of poles | | 2 to 8 | 2 to 8 | 2 to 8 | 2 to 8 |
| Flange bearing plate for brake mounting on the NDE side | | A350 | A400 | A450 | A535 |
| Max. diameter for the second shaft extensions | mm | 55m6 | 48m6 | 65m6 | 48m6 |
| Brake type | | FDX 30 | FDX 30 | FDX 40 | FDX 40 |
| Static braking torque | Nm | 450 | 567 | 900 | 1440 ¹⁾ |
| Dynamic rated braking torque acc. to DIN VDE 0580 | Nm/rpm | 500/88 | 630/88 | 1000/65 | 1600 ¹⁾ /65 |
| | at 750 rpm | Nm | 480 | 600 | 800 |
| | at 1000 rpm | Nm | 460 | 580 | 740 |
| | at 1500 rpm | Nm | 460 | 580 | 740 |
| | at 3000 rpm | Nm | 380 | 480 | 600 |
| Admissible speed n_{max} | rpm | 3000 ²⁾ /6000 ³⁾ | 3000 ²⁾ /6000 ³⁾ | 3000 ²⁾ /6000 ³⁾ | 3000 ²⁾ /6000 ³⁾ |
| Power at 180 V DC | W | 880/220 | 880/220 | 1080/270 | 1080/270 |
| Power at 103 V DC | W | 560/140 | 560/140 | 560/140 | 560/140 |
| Rated current at 230 V AC (103 V DC coil voltage) | A | 2.72/1.36 | 2.72/1.36 | 2.72/1.36 | 2.72/1.36 |
| Rated current at 400 V AC (180 V DC coil voltage) | A | 2.44/1.22 | 2.44/1.22 | 3/1.5 | 3/1.5 |
| Weight, approx. | kg | 45 | 45 | 80 | 80 |
| Closing time t_1 (switching on the DC side) | ms | 60 | 60 | 160 | 160 |
| Release time t_2 (switching on the DC side) | ms | 140 | 140 | 320 | 320 |
| Brake moment of inertia | kgm ² | 0.0195 | 0.0195 | 0.0445 | 0.0445 |
| Lifetime L of brake lining | Nm · 10 ⁶ | 3700 | 3700 | 4900 | 4900 |

1) Limit: ON time S3 -50 %

2) Operating brake

3) Holding brake

Overview

"Special technology" comprises rotary pulse encoders of 1LE1 motors (with the exception of 1LE1 with order code **F90** – version "Forced-air cooled motors without external fan and fan cover" and 1PC1).

1LE1 motors with order codes **F70** (mounting of separately driven fan), **F01** (mounting of holding brake (standard arrangement)) and **F01 + F70** (mounting of brake and separately driven fan) from the modular mounting concept can be combined with rotary pulse encoders LL 861 900 220, HOG 9 DN 1024 I and HOG 10 D 1024 I from the "Special technology" range. The length of the motor increases by Δl when the rotary pulse encoder is mounted. For an explanation of the additional dimensions and weights, please refer to "Mounting technology", "Dimensions and weights" from page 1/104.

The rotary pulse encoders of "Modular technology" and "Special technology" are fitted as standard with a protective cover made of non-corrosive sheet steel.

For mounting of rotary pulse encoders with order codes **G11** and **G12** for frame sizes 71 to 315 and with order codes **G04**, **G05**, and **G06** up to frame size 160, a protective cover (order code **G43**) is supplied as standard.

LL 861 900 220 rotary pulse encoder

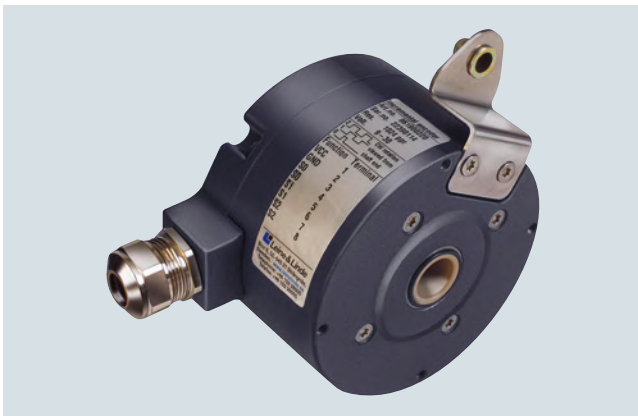

With its rugged construction, this rotary pulse encoder is also suitable for difficult operating environments. It is resistant to shock and vibration and has insulated bearings.

The LL 861 900 220 rotary pulse encoder can be supplied already mounted.
Order code **G04**

*The LL 861 900 220 rotary pulse encoder can be retrofitted. The motor must be prepared for this. When the motor is ordered, the option "Prepared for mountings, center hole only", order code **G40**, or the option "Prepared for mountings with shaft D16", order code **G42**, must be specified (see "Mechanical version and degrees of protection" on page 1/76). The rotary pulse encoder is not part of the scope of supply in this case.*

The version of the rotary pulse encoder with a diagnostics system (ADS) can be supplied by Leine and Linde.

Manufacturer:
Leine und Linde AG
Olivehällsvägen 8
SE-64542 Strängnäs
Phone +46 152 265 00
Fax +46 152 265 05

www.leinelinde.com
Email: info@leinelinde.de

For frame size 180 and above, a protective cover is **not** supplied as standard when rotary pulse encoders are mounted for order codes **G04**, **G05**, **G06**, **G07** and **G08**.

For mounting of rotary pulse encoders with order codes **G11**, **G12 + F70** (mounting of separately driven fan): The cable end is connected to a connector that is located outside the fan cover. The fan cover does not have to be removed to connect the rotary pulse encoder. The rotary pulse encoder can be connected to the main terminal box or an auxiliary terminal box where necessary.

For mounting of rotary pulse encoders with order codes **G04**, **G05**, **G06 + F70** (mounting of separately driven fan):

- Up to frame size 200, the fan cover has to be removed to connect the rotary pulse encoder. The rotary pulse encoder can also be connected to the main terminal box or an auxiliary terminal box where necessary.
- As of frame size 225, the fan cover does not have to be removed to connect the rotary pulse encoder. The rotary pulse encoder can be connected to the main terminal box and can be connected to the auxiliary terminal box where necessary.

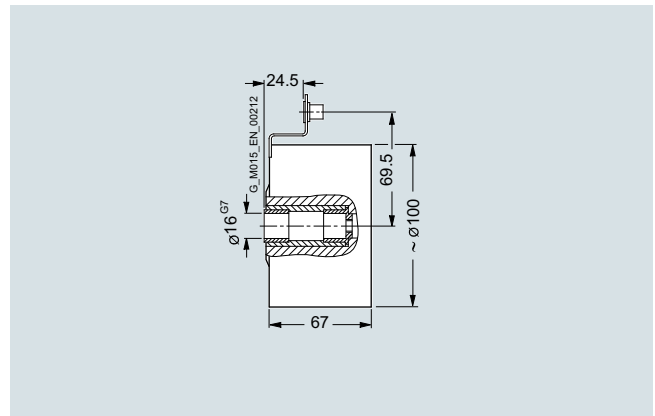

Mounting dimensions of LL 861 900 220 rotary pulse encoder

Technical specifications for LL 861 900 220 (HTL version)

Mounting of encoder for temperatures below -20 °C and higher than $+40\text{ °C}$ available on request.

| Supply voltage U_B | +9 V to +30 V |
|--------------------------------------|--|
| Current input without load | max. 80 mA |
| Admissible load current per output | 40 mA |
| Pulses per revolution | 1024 |
| Outputs | 6 short-circuit proof square-wave pulses A, A', B, B', 0, 0' |
| Pulse offset between the two outputs | $90^\circ \pm 25^\circ \text{ el.}$ |
| Output amplitude | $U_{\text{High}} > 20 \text{ V}$ $U_{\text{Low}} < 2.5 \text{ V}$ |
| Mark space ratio | 1:1 $\pm 10\%$ |
| Edge steepness | 50 V/ μs (without load) |
| Maximum frequency | 100 kHz for 350 m cable |
| Maximum speed | 4000 rpm |
| Temperature range | -20 to $+80\text{ °C}$ |
| Degree of protection | IP65 |
| Maximum adm. radial cantilever force | 300 N |
| Maximum adm. axial force | 100 N |
| Connection system | Terminal strips in encoder cable connection M20 x 1.5 radial |
| Weight | approx. 1.3 kg |

Introduction

Mounting technology

Special technology

1

Overview

HOG 9 DN 1024 I rotary pulse encoder



The encoder is fitted with insulated bearings.

The HOG 9 DN 1024 I rotary pulse encoder can be supplied already mounted.

Order code **G05**

*The HOG 9 DN 1024 I rotary pulse encoder can be retrofitted. The motor must be prepared for this. When the motor is ordered, the option "Prepared for mountings, center hole only", order code **G40**, or the option "Prepared for mountings with shaft D16", order code **G42**, must be specified (see "Mechanical version and degrees of protection" on page 1/76). The rotary pulse encoder is not part of the scope of supply in this case.*

Manufacturer:

Baumer Hübner GmbH

Max-Dohrn-Str. 2+4

10589 Berlin, Germany

Phone +49 (30) 69003-0

Fax +49 (30) 69003-104

www.baumer.com

Email: sales@baumerhuebner.com

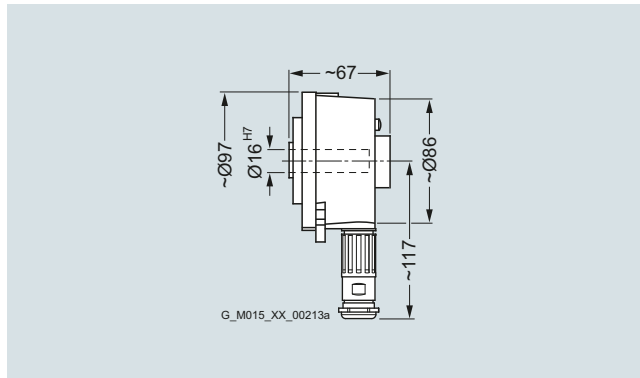

Mounting dimensions of HOG 9 DN 1024 I rotary pulse encoder

Technical specifications for HOG 9 DN 1024 I (HTL version)

Mounting of encoder for temperatures below -20 °C and higher than $+40\text{ °C}$ available on request.

| | |
|--|---|
| Supply voltage U_B | +9 V to +30 V |
| Current input without load | 50 to 100 mA |
| Admissible load current per output | 150 mA, 800 mA peak |
| Pulses per revolution | 1024 |
| Outputs | 6 short-circuit-proof square-wave pulses A+, A-, B+, B-, R+, R- |
| Pulse offset between the two outputs | $90^\circ \pm 20\%$ |
| Output amplitude | $U_{\text{High}} \geq U_B - 3.5\text{ V}$ $U_{\text{Low}} \leq 1.5\text{ V}$ |
| Mark space ratio | $1:1 \pm 20\%$ |
| Edge steepness | $10\text{ V}/\mu\text{s}$ |
| Maximum frequency | 120 kHz |
| Maximum speed | 7000 rpm |
| Temperature range | $-30\text{ to }+100\text{ °C}$ |
| Degree of protection | IP56 |
| Maximum adm. radial cantilever force | 500 N |
| Maximum adm. axial force | 400 N |
| Connection system | M23 flange socket, radial (mating connector is part of the scope of supply) |
| Mech. version acc. to Baumer Hübner Ident. No. | 73 522 B |
| Weight | approx. 0.9 kg |

Overview

POG 9 rotary pulse encoder



The POG 9 rotary pulse encoder can be supplied already mounted.

Order code **G08**

The POG 9 rotary pulse encoder can be retrofitted. The motor must be prepared for this. When the motor is ordered, the option "Prepared for mountings, center hole only", order code **G40**, or the option "Prepared for mountings with shaft D16", order code **G42**, must be specified (see "Mechanical version and degrees of protection" on page 1/76). The rotary pulse encoder is not part of the scope of supply in this case.

Manufacturer:
Baumer Hübner GmbH
Max-Dohrn-Str. 2+4
10589 Berlin, Germany
Phone +49 (30) 69003-0
Fax +49 (30) 69003-104

www.baumer.com
Email: sales@baumerhuebner.com

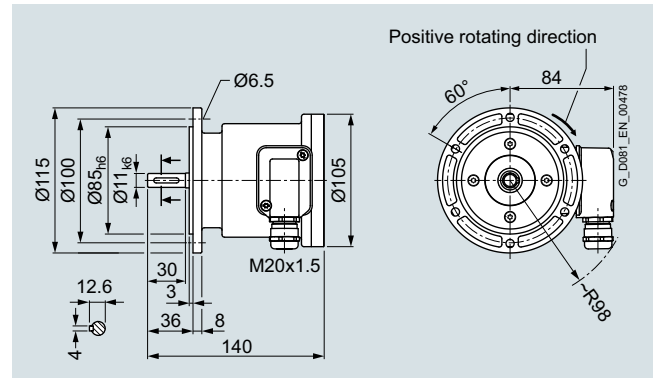

Mounting dimensions of POG 9 rotary pulse encoder

Technical specifications for POG 9

Mounting of encoder for temperatures below -20 °C and higher than $+40\text{ °C}$ available on request.

| Supply voltage U_B | +9 V to +30 V | +5 V $\pm 5\%$ |
|--------------------------------------|---|---|
| Current input without load | < 100 mA | |
| Admissible load current per output | 60 mA average 300 mA peak | 25 mA average 75 mA peak |
| Pulses per revolution | 300 ... 2500 | |
| Output amplitude | $U_{High} \geq U_B - 3.5\text{ V}$ $U_{Low} \leq 1.5\text{ V}$ | $U_{High} \geq 2.5\text{ V}$ $U_{Low} \leq 0.5\text{ V}$ |
| Mark space ratio | 1:1 $\pm 20\%$ | |
| Operating speed | $\leq 12000\text{ rpm}$ | |
| Switching rate | 120 kHz | |
| Temperature range | $-30\text{ to }+100\text{ °C}$ | |
| Degree of protection | IP56 | |
| Maximum adm. radial cantilever force | 150 N | |
| Maximum adm. axial force | 80 N | |
| Connection system | Terminal box | |
| Weight | approx. 1.4 kg | |

Introduction

Mounting technology

Special technology

1

Overview

POG 10 DN rotary pulse encoder



The POG 10 DN rotary pulse encoder can be supplied already mounted.

Order code **G07**

The POG 10 DN rotary pulse encoder can be retrofitted. The motor must be prepared for this. When the motor is ordered, the option "Prepared for mountings, center hole only", order code **G40**, or the option "Prepared for mountings with shaft D16", order code **G42**, must be specified (see "Mechanical version and degrees of protection" on page 1/76). The rotary pulse encoder is not part of the scope of supply in this case.

Manufacturer:

Baumer Hübner GmbH
Max-Dohrn-Str. 2+4
10589 Berlin, Germany
Phone +49 (30) 69003-0
Fax +49 (30) 69003-104

www.baumer.com

Email: sales@baumerhuebner.com

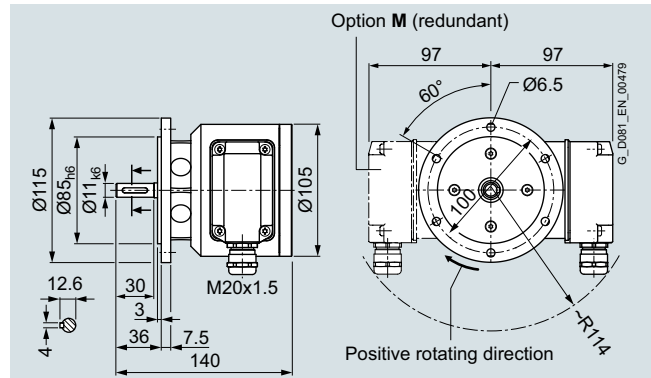

Mounting dimensions of POG 10 DN rotary pulse encoder

Technical specifications for POG 10 DN

Mounting of encoder for temperatures below -20 °C and higher than $+40\text{ °C}$ available on request.

| Supply voltage U_B | +9 V to +30 V | |
|--------------------------------------|------------------------------|-----------------------------|
| Current input without load | < 100 mA | |
| Admissible load current per output | 60 mA average 300 mA peak | 25 mA average 75 mA peak |
| Pulses per revolution | 300 ... 2500 | |
| Mark space ratio | 40:60 ... 60:40 | |
| Operating speed | ≤ 12000 rpm | |
| Switching rate | 120 kHz | |
| Temperature range | -40 to $+100\text{ °C}$ | |
| Degree of protection | IP66 | |
| Maximum adm. radial cantilever force | ≤ 450 N | |
| Maximum adm. axial force | ≤ 300 N | |
| Connection system | Terminal box | |
| Weight | approx. 1.9 kg | |

Overview

HOG 10 D 1024 I rotary pulse encoder

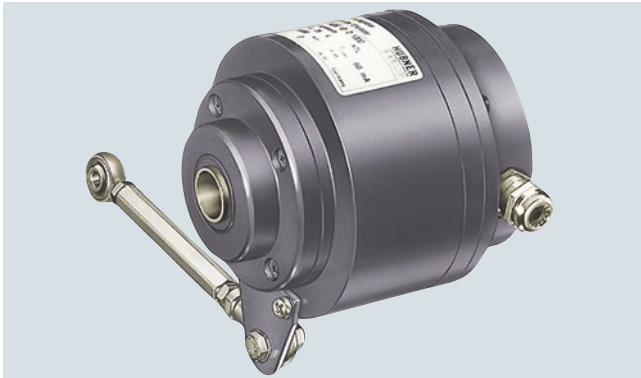

This encoder is extremely rugged and is therefore suitable for difficult operating conditions. It is fitted with insulated bearings.

The HOG 10 D 1024 I rotary pulse encoder can be supplied already mounted.

Order code **G06**

The HOG 10 D 1024 I rotary pulse encoder can be retrofitted. The motor must be prepared for this. When the motor is ordered, the option "Prepared for mountings, center hole only", order code **G40**, or the option "Prepared for mountings with shaft D16", order code **G42**, must be specified (see "Mechanical version and degrees of protection" on page 1/76). The rotary pulse encoder is not part of the scope of supply in this case. The letters FSL and ESL stand for the following terms:

FSL: (mechanical) centrifugal switch

ESL: electronic speed switch

Both switch types are suitable for tripping the motor when a critical limit speed is reached, or for accelerating the motor along a control ramp into the permissible speed range again, or for shutting down the motor completely (depending on the customer application).

The electronic speed switch is particularly suitable for converter operation.

The critical limit rotational speed to be monitored for the customer's application must be specified in the order.

Further settings might also be necessary. These settings will be made at the Baumer & Hübner factory according to customer specifications.

Manufacturer:
Baumer Hübner GmbH
Max-Dohrn-Str. 2+4
10589 Berlin, Germany
Phone +49 (30) 69003-0
Fax +49 (30) 69003-104

www.baumer.com
Email: sales@baumerhuebner.com

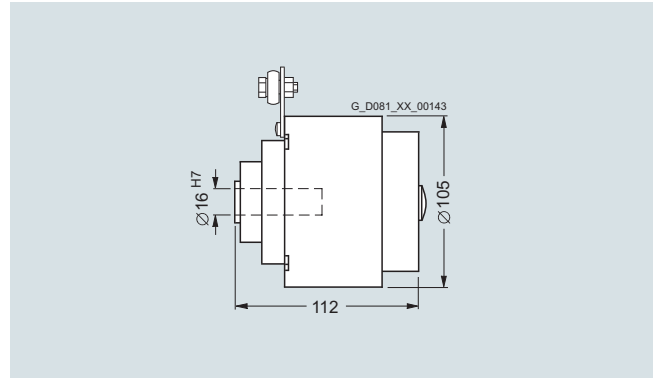

Mounting dimensions of HOG 10 D 1024 I rotary pulse encoder

Technical specifications for HOG 10 D 1024 I (HTL version)

Mounting of encoder for temperatures below -20 °C and higher than $+40\text{ °C}$ available on request.

| | |
|--|---|
| Supply voltage U_B | +9 V to +30 V |
| Current input without load | approx. 100 mA |
| Admissible load current per output | 600 mA, 300 mA peak |
| Pulses per revolution | 1024 |
| Outputs | 4 short-circuit proof square-wave pulses A, B and A', B' |
| Pulse offset between the two outputs | $90^\circ \pm 20\%$ |
| Output amplitude | $U_{\text{High}} \geq U_B - 3.5\text{ V}$ $U_{\text{Low}} \leq 1.5\text{ V}$ |
| Mark space ratio | 1:1 $\pm 20\%$ |
| Edge steepness | 10 V/ μs |
| Maximum frequency | 120 kHz |
| Maximum speed | 7000 rpm |
| Temperature range | -40 to $+100\text{ °C}$ |
| Degree of protection | IP66 |
| Maximum adm. radial cantilever force | 150 N |
| Maximum adm. axial force | 80 N |
| Connection system | Terminals, cable connection M20 \times 1.5 |
| Mech. version acc. to Baumer Hübner Ident. No. | 74 055 B |
| Weight | approx. 1.6 kg |

Introduction

Mounting technology

Special technology

1

Overview

Sendix 5020 rotary pulse encoder



The Sendix 5020 rotary pulse encoder can be ordered completely assembled as an HTL version with order code **G11** or as a TTL version with order code **G12**.

Features of the **G11** and **G12** encoders:

- Use of insulation to avoid surge currents
- Safety-lock technology for high resistance to vibrations, shaft loads, and installation errors
- Cable lengths available up to 300 m

In combination with a separately driven fan, the rotary pulse encoders are supplied with an external plug connection. The rotary pulse encoder can only be attached to a standard NDE shaft extension, meaning that a second shaft extension will not be available.

*The encoder can be retrofitted. When the motor is ordered, the option "Prepared for mountings, center hole only" order code **G40** or the option "Prepared for mountings with D12 shaft" order code **G41** must be specified.*

The dimensions of the motor are increased by Δl by mounting the rotary pulse encoder. The "Modular technology" and "Special technology" rotary pulse encoders are fitted with a protective cover made from corrosion-resistant sheet metal as standard. Mounted encoders for temperatures below -20 °C and above $+40\text{ °C}$ are available on request.

Technical specifications for Sendix 5020 (HTL/TTL version)

| | Sendix 5020 (HTL version) | Sendix 5020 (TTL version) |
|---|--|---------------------------|
| Supply voltage | 10 ... 30 V DC | 5 V DC $\pm 5\%$ |
| Energy consumption with inverted signal (no-load operation) | max. 100 mA | max. 90 mA |
| Admissible load/channel | max. ± 40 mA | max. ± 20 mA |
| Pulses per revolution | 1024 (2048 and 512 on request) | |
| Outputs | 2 square-wave pulses A, B – 2 inverted square-wave pulses A, B | |
| Pulse offset between the two outputs | 90° | |
| Signal level | $U_{\text{High}} = \text{min. } U_{\text{B}} - 1\text{ V}$ $U_{\text{High}} = \text{min. } 2.5\text{ V}$ $U_{\text{Low}} = \text{max. } 0.5\text{ V}$ | |
| Edge rise time t_r | max. 1 μs | max. 200 μs |
| Edge fall time t_f | max. 1 μs | max. 200 μs |
| Pulse frequency | max. 300 kHz | |
| Maximum speed | 12000 rpm/6000 rpm (continuous) | |
| Operating temperature range | -40 ¹⁾ ... $+100\text{ °C}$ | |
| Degree of protection acc. to EN 60529 | IP65 | |
| Maximum admissible radial cantilever force | 100 N | |
| Maximum admissible axial force | 50 N | |
| Connection system | 12-pin M23 connector (mating connectors are always supplied) | |
| Certificates | UL, CSA (ATEX on request) | |
| Weight | 0.4 kg | |
| Explosion protection certificate for explosive areas | Available on request for Zones 2 and 22 | |
| Shock resistance acc. to EN 60068-2-27 | 3000 m/s ² , 6 ms | |
| Vibration resistance acc. to EN 60068-2-6 | 300 m/s ² , 10 ... 2000 Hz | |

Manufacturer:
Fritz Kübler GmbH
Schubertstrasse 47
78054 Villingen-Schwenningen, Germany
Phone +49 (7720) 3903-0
Fax +49 (7720) 21564

www.kuebler.com/drehgeber
Email: info@kuebler.com

¹⁾ With connector: -40 °C , permanently installed cable: -30 °C , moving cable: -20 °C .

Overview**Rotary pulse encoders for SIL2, SIL3 safety applications**

The rotary pulse encoders with order codes **G21**, **G22**, **G25**, and **G27** are suitable for SIL2 and SIL3 safety applications and can be used subject to consideration of the mechanical installation conditions. The rotary pulse encoders from Baumer, Leine&Linde, and Kübler are designed for the implementation of safety-related functions, such as speed, direction of rotation, and position.

Functional safety

The safety integrity level SIL2 or SIL3 of the rotary pulse encoders is certified by the manufacturers Baumer, Leine&Linde, and Kübler. To ensure correct functioning of the rotary pulse encoder, various mounting measures are defined that are certified by TÜV and must correspond to safety applications up to levels PLd, category 3, SIL2 and PL e, category 4, SIL3.

The EC Declaration of Conformity complies with the Machinery Directive 42/2006/EC with consideration of EN 61800-5-2.

- Functional safety can only be ensured with the use of a suitable control and evaluation unit. It is mandatory to perform a function test in the safety circuit after initial installation, conversion, repair or modification.
- Installation, first commissioning and service requiring replacement of a rotary encoder on the customer's site must only be performed by qualified persons. If this requirement is not observed, the manufacturer's warranty will be voided.
- Upgrading with the functional safety rotary encoder for the defined SIMOTICS products that were originally manufactured without it is permissible on request provided that the upgrade is performed only in lead repair centers.
- Before you commission the motor with the functional safety encoder, read the information in the operating instructions.

General technical features

- The standard version of the motor is supplied with the order code **G43** (mechanical protection for encoder) and with a torque arm fitted between the encoder and motor.
- The functional safety encoders cannot be combined with the order codes **G40**, **G41**, and **G42** (prepared for externally mounted components) and can only be mounted at the non-drive end (NDE), i.e. a second shaft extension cannot be supplied.
- The safety rotary encoders with order code **G21** or **G22** are mounted with their cable and connector.
- The overall length of the motor and weight of the motor must be considered, see "Dimensions and weights".

Sendix 5834FS2/FS3 rotary pulse encoder

The Sendix 5834 rotary pulse encoder from Kübler in the version SinCos can be used in compliance with safety integrity level SIL2 when mounted complete on motors with the order code **G21** or SIL3 with the order code **G22** for frame sizes 71 to 315.

Technical specifications for Sendix 5834FS2/FS3

| | Sendix 5834FS2/FS3 |
|--|--|
| Supply voltage | 5 V DC ± 5 % |
| Current input without load | max. 70 mA |
| Pulses per revolution | 1024 |
| Outputs | Sine signal: B, B_inv Cosine signal: A, A_inv |
| Maximum frequency | 400 kHz |
| Signal level | 1 Vpp |
| Maximum speed | 9000 rpm/6000 rpm (continuous) |
| Operating temperature range | -40 ... +90 °C |
| Degree of protection acc. to EN 60529 | IP65 |
| Maximum admissible axial force | 40 N |
| Maximum admissible radial cantilever force | 80 N |
| Connection system | 12-pin connector M23 with 1 m cable |
| Certificates | PLD/SIL2 – SIL 3/PLe |
| Weight | 0.45 kg |
| Shock resistance acc. to EN 60068-2-27 | 500 m/s ² , 11 ms |
| Vibration resistance acc. to EN 60068-2-6 | 200 m/s ² , 10 ... 150 Hz |

Manufacturer:
Fritz Kübler GmbH
Schubertstrasse 47
78054 Villingen-Schwenningen, Germany
Phone +49 (7720) 3903-0
Fax +49 (7720) 21564

www.kuebler.com/drehgeber
Email: info@kuebler.com

Introduction

Mounting technology

Special technology

1

Overview

HOGS 100 S rotary pulse encoder



The HOGS 100 S rotary pulse encoder from Baumer in the version SinCos can be used in compliance with safety integrity level SIL2 when mounted complete on motors with order code **G25** for frame sizes 180 to 450.

Technical specifications for HOGS 100 S

| | |
|--------------------------------------|---|
| Supply voltage | HOGS 100 S 5 V DC \pm 10 % |
| Current input under load | \leq 150 mA |
| Sine cycles per revolution | 1024 |
| Operating speed | \leq 10000 rpm |
| Signal frequency | \leq 250 kHz |
| Temperature range | -20 ... +85 °C |
| Degree of protection | IP66 |
| Maximum adm. axial force | 250 N |
| Maximum adm. radial cantilever force | 400 N |
| Connection system | Terminal box |
| Anti-corrosion protection | Complies with corrosivity category C4 acc. to ISO 12944-2 |
| Explosion protection (gas) | II 3G Ex nA IIC T4 Gc |
| Explosion protection (dust) | II 3D Ex tc IIIC T135°C Dc |
| Functional safety | PL d / SIL2 |
| Weight | 1.8 kg |

Manufacturer:

Baumer Hübner GmbH
Max-Dohrn-Str. 2+4
10589 Berlin, Germany
Phone +49 (30) 69003-0
Fax +49 (30) 69003-104

www.baumer.com

Email: sales@baumerhuebner.com

FSI 862 rotary pulse encoder



This FSI 862 rotary pulse encoder is extremely rugged and is therefore suitable for difficult operating conditions. This rotary pulse encoder in a HC HTL (High Current HTL) version can be used in compliance with safety integrity level SIL2 when mounted complete on motors with order code **G27** for frame sizes 180 to 450.

Technical specifications for FSI 862

| | |
|--------------------------------------|--|
| Supply voltage | FSI 862 9 ... 30 V DC |
| Current input | 60 mA at 24 V DC (max. 80 mA) |
| Output current | \pm 40 mA |
| Pulses per revolution | 1024 or 2048 |
| Outputs | HCHTL |
| Pulse offset between the two outputs | 90° el \pm 25° el |
| Pitch error | \pm 50 el |
| Cable length | max. 350 m at 100 kHz |
| Maximum speed | 6000 rpm |
| Temperature range | -40 ... +85 °C |
| Degree of protection | IP66 (IP67) |
| Maximum adm. radial cantilever force | 100 N |
| Maximum adm. axial force | 300 N |
| Connection system | Cable gland M20 |
| Weight | approx. 1.3 kg |
| Shock resistance acc. to | \leq 400 g, 3.5 ms EN 60068-2-27 |
| Vibration resistance acc. to | \leq 20 g, 55 ... 2000 Hz EN 60068-2-6 |

Manufacturer:

Leine und Linde AG
Olivehällsvägen 8
SE-64542 Strängnäs
Phone +46 152 265 00
Fax +46 152 265 05

www.leinelinde.com

Email: info@leinelinde.de

Overview

Backstop, counterclockwise/clockwise motion blocked

The backstop (order code **F40/F41**) prevents the motor from moving while in de-energized state against its direction of rotation in the energized state.

The backstop is only available for SIMOTICS SD – 1LE15/1LE16, 1LE55/1LE56, VSD10, VSD4000 motors.

- Counterclockwise motion blocked: Option **F40**
- Clockwise motion blocked: Option **F41**

| Motor series | Frame size | No. of poles | Backstop Type | Rated torque, theoretical | Start speed | Maximum speed | Order code F40 | Order code F41 |
|----------------------|------------|---------------|---------------|---------------------------|-------------|---------------|-----------------------|-----------------------|
| | | | | Nm | rpm | rpm | Δl mm | Δl mm |
| 1LE15/1LE16 1FP15 | 132 | 2, 4, 6, 8 | FXM 66-25 NX | 950 | 700 | 5000 | 114 | 114 |
| | 160 | 2, 4, 6, 8 | FXM 76-25 NX | 1200 | 670 | 5000 | 130 | 130 |
| | 180 | 2, 4, 6, 8 | FXM 76-25 NX | 1200 | 670 | 5000 | 126 | 126 |
| | 200 | 2, 4, 6, 8 | FXM 86-25 NX | 1600 | 630 | 5000 | 137 | 137 |
| | 225 | 2, 4, 6, 8 | FXM 86-25 NX | 1600 | 630 | 5000 | 183 | 183 |
| | 250 | 2, 4, 6, 8 | FXM 86-25 NX | 1600 | 630 | 5000 | 106 | 106 |
| | 280 | 2, 4, 6, 8 | FXM 100-40 MX | 3700 | 400 | 4500 | 112 | 112 |
| | 315 | 2, 4, 6, 8 | FXM 120-50 MX | 7700 | 320 | 4000 | 115 | 115 |
| 1LE55/1LE56 | 315 | 2 | FXM 120-50 MX | 7700 | 320 | 4000 | 115 | 115 |
| | | 4, 6, 8 | FXM 140-50 MX | 10100 | 320 | 3000 | 115 | 115 |
| | 355 | 2 | FXM 120-50 MX | 7700 | 320 | 4000 | 155 | 155 |
| | 4 | FXM 140-50 MX | 10100 | 320 | 3000 | 155 | 155 | |
| | | FXM 170-63 MX | 20500 | 250 | 2700 | 155 | 155 | |

Protective cover diameter

| Frame size | Protective cover for separately driven fan | Protective cover | Protective cover for encoder | | Protective cover for encoder adapter | Protective cover |
|------------|--|------------------|------------------------------|--------------------|--------------------------------------|------------------|
| | | H00 | G11/G12 | G04 ... G06 | G41/G42 | F75 |
| | mm | mm | mm | mm | mm | mm |
| 71 | 140 | 125 | 125 | – | – | – |
| 80 | 157 | 155 | 155 | – | 155 | 160 |
| 90 | 177 | 155 | 155 | – | 155 | 180 |
| 100 | 210 | 195 | 195 | 195 | 195 | 195 |
| 112 | 249 | 195 | 195 | 195 | 195 | 195 |
| 132 | 300 | 260 | 260 | 260 | 260 | 260 |
| 160 | 338 | 260 | 260 | 260 | 260 | 260 |
| 180 | 340 | 340 | 165 | 340 | 340 | 340 |
| 200 | 338 | 340 | 165 | 340 | 340 | 340 |
| 225 | 470 | 425 | 165 | 250 | 165 | – |
| 250 | 470 | 470 | 165 | 250 | 165 | – |
| 280 | 525 | 525 | 165 | 250 | 165 | – |
| 315 | 590 | 525 | 165 | 250 | 165 | – |
| 355 | On request | On request | On request | On request | On request | On request |
| 400 | On request | On request | On request | On request | On request | On request |
| 450 | On request | On request | On request | On request | On request | On request |

Introduction

Mounting technology

Dimensions and weights of the mountings

1

Overview

Dimensions and weights

Fig. 1 Brake,
order codes **F01/F04**
[optionally with manual release, order code **F50**]

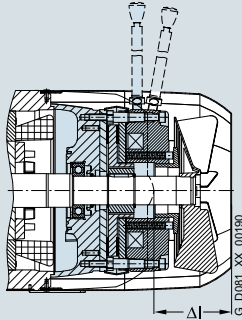
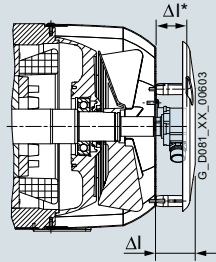

Fig. 2 Rotary pulse encoder (on cover)
Order codes **G04/G05/G06/G11/G12**
[**G11, G12** protective cover as standard]



| Frame size | Assignment | | | | | | | | | | | |
|-------------|-------------------------------|--------------------|--------------------------|--------------------|--------------------------|--------------------|--------------------------|--------------------|-------------------------------|--------------------|------------|------------|
| | Fig. 1 | | Fig. 2 | | | | HOG 10 D 1024 I | | Sendix 5020 | | | |
| | Order codes F01/F04 | Weight, approx. | Order code G04 | Weight, approx. | Order code G05 | Weight, approx. | Order code G06 | Weight, approx. | Order codes G11/G12 | Weight, approx. | | |
| | Δl | mm | kg | Δl | mm | kg | Δl | mm | kg | Δl | mm | kg |
| 1LE1 | | | | | | | | | | | | |
| 80 | 60 | 3.5 | – | – | – | – | – | – | 68.5 | 0.8 | | |
| 90 | 77.5 | 5.3 | – | – | – | – | – | – | 68.5 | 0.8 | | |
| 100 | 81 | 5.9 | 83 | 1.9 | 83 | 1.5 | 126 | 2.2 | 56 | 1.0 | | |
| 112 | 88 | 7.8 | 83 | 1.9 | 83 | 1.5 | 126 | 2.2 | 56 | 0.9 | | |
| 132 | 114 | 11.9 | 87 | 2.4 | 87 | 2 | 130 | 2.7 | 60 | 1.4 | | |
| 160 | 130 | 30.7 | 87 | 2.7 | 87 | 2.3 | 130 | 3 | 60 | 1.6 | | |
| 180 | 126 | 28 | 136.5 | 2.3 | 136.5 | 1.9 | 136.5 | 2.6 | 87 | 2.2 | | |
| 200 | 137 | 38 | 136.5 | 2.5 | 136.5 | 2.1 | 136.5 | 2.8 | 87 | 2.4 | | |
| 225 | 135/199 | 63/49 | 135 | 2 | 135 | 1.6 | 135 | 2.3 | 87 | 1 | | |
| 250 | 225/185 | 83/54 | 135 | 2 | 135 | 1.6 | 135 | 2.3 | 87 | 1 | | |
| 280 | 297/192 | 118/92 | 135 | 2 | 135 | 1.6 | 135 | 2.3 | 87 | 1 | | |
| 315 | 308/188 | 256/167 | 135 | 2 | 135 | 1.6 | 135 | 2.3 | 87 | 1 | | |
| 1LE5 | | | | | | | | | | | | |
| 315 | 309 | 355 | 135 | 2 | 135 | 1.6 | 135 | 2.3 | 87 | 1 | | |
| 355 | 324 | 425 | 135 | 2 | 135 | 1.6 | 135 | 2.3 | 87 | 1 | | |
| 400 | On request | On request | On request | On request | On request | On request | On request | On request | On request | On request | On request | On request |
| 450 | On request | On request | On request | On request | On request | On request | On request | On request | On request | On request | On request | On request |

| Frame size | Assignment | | | | | | | | |
|-------------|--------------------------|--------------------|--------------------------|--------------------|--------------------------|--------------------|-------------------------------|--------------------|------------|
| | Fig. 2 | | HOG 9 DN 1024 I | | HOG 10 D 1024 I | | Sendix 5020 | | |
| | Order code G04 | Weight, approx. | Order code G05 | Weight, approx. | Order code G06 | Weight, approx. | Order codes G11/G12 | Weight, approx. | |
| | Δl* | mm | kg | Δl* | mm | kg | Δl* | mm | kg |
| 1LE1 | | | | | | | | | |
| 225 | 75 | 1.3 | 72 | 0.9 | 116 | 1.6 | 65 | 0.4 | |
| 250 | 75 | 1.3 | 72 | 0.9 | 116 | 1.6 | 65 | 0.4 | |
| 280 | 75 | 1.3 | 72 | 0.9 | 116 | 1.6 | 65 | 0.4 | |
| 315 | 75 | 1.3 | 72 | 0.9 | 116 | 1.6 | 65 | 0.4 | |
| 1LE5 | | | | | | | | | |
| 355 | On request | On request | On request | On request | On request | On request | On request | On request | On request |
| 400 | On request | On request | On request | On request | On request | On request | On request | On request | On request |
| 450 | On request | On request | On request | On request | On request | On request | On request | On request | On request |

Overview

Fig. 3 Brake and rotary pulse encoder (on cover),
order codes **F01/F04**
+ G04/G05/G06/G11/G12
[optionally with manual release,
order code **F50**;
G11, G12 protective cover as standard]

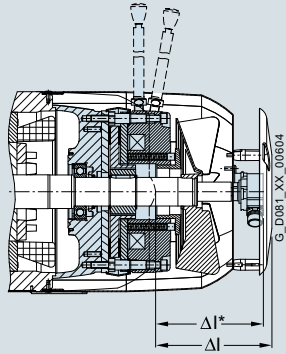
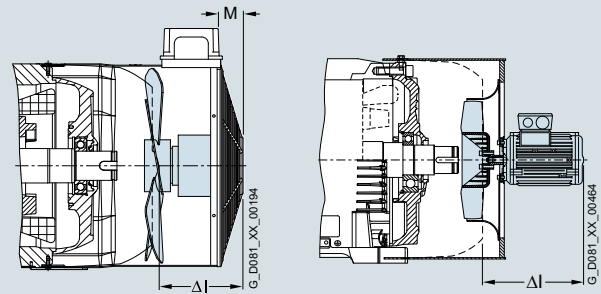

Fig. 4 Separately driven fan,
order code **F70**



Frame sizes 100 to 200

Frame sizes 225 to 315

Assignment

Fig. 3

Frame size Brake and rotary pulse encoder (on cover)
LL 861 900 220Order codes
F01
+ G04 Δl^*

mm

Weight,
approx.
kg**HOG 9 D 1024 I**Order codes
F01
+ G05 Δl^*

mm

Weight,
approx.
kg**HOG 10 D 1024 I**Order codes
F01
+ G06 Δl^*

mm

Weight,
approx.
kg**Sendix 5020**Order codes
F01
+ G11/G12 Δl

mm

Weight,
approx.
kg

Fig. 4

Separately driven fan

Order code
F70 Δl

mm

M

mm

Weight,
approx.
kg

1LE1

| Frame size | Δl^* | Weight, approx. kg | Δl^* | Weight, approx. kg | Δl^* | Weight, approx. kg | Δl | Weight, approx. kg | Δl | M | Weight, approx. kg |
|------------|--------------|--------------------|--------------|--------------------|--------------|--------------------|------------|--------------------|-------------------|----|--------------------|
| 71 | – | – | – | – | – | – | – | – | 75 | 20 | 1.9 |
| 80 | – | – | – | – | – | – | 128.5 | 4.3 | 88 | 20 | 1.9 |
| 90 | – | – | – | – | – | – | 146 | 6.1 | 104 | 30 | 2.5 |
| 100 | 164 | 7.8 | 164 | 7.4 | 207 | 8.1 | 137 | 6.9 | 86.5 | 30 | 2.6 |
| 112 | 171 | 9.7 | 171 | 9.3 | 214 | 10 | 144 | 8.7 | 81.5 | 30 | 2.9 |
| 132 | 201 | 14.3 | 201 | 13.9 | 244 | 14.6 | 174 | 13.3 | 116 | 40 | 3.9 |
| 160 | 217 | 33.4 | 217 | 33 | 260 | 33.7 | 190 | 32.3 | 135.5 | 40 | 5.6 |
| 180 | 216 | 30.3 | 216 | 29.9 | 252 | 30.6 | 216 | 30.2 | 257 | 40 | 8.3 |
| 200 | 228 | 40.5 | 228 | 40.1 | 264 | 40.8 | 228 | 40.4 | 262 | 40 | 9.3 |
| 225 | 210 | 64.3 | 207 | 64.2 | 251 | 63.9 | 186 | 63.4 | 221 | – | 22 |
| 250 | 300 | 84.3 | 297 | 84.2 | 341 | 83.9 | 276 | 83.4 | 226 | – | 25 |
| 280 | 372 | 119.3 | 369 | 119.2 | 413 | 118.9 | 348 | 118.4 | 222 | – | 28 |
| 315 | 383 | 256.3 | 380 | 256.2 | 424 | 255.9 | 359 | 256.4 | 236 ¹⁾ | – | 36 ¹⁾ |
| 315 | – | – | – | – | – | – | – | – | 276 ²⁾ | – | 38.8 ²⁾ |

1LE5

| Frame size | Δl | Weight, approx. kg | Δl | Weight, approx. kg | Δl | Weight, approx. kg | Δl | Weight, approx. kg | Δl | M | Weight, approx. kg |
|----------------------|------------|--------------------|------------|--------------------|------------|--------------------|------------|--------------------|------------|------------|--------------------|
| 315 2-pole 4-pole | 444 | 357 | 444 | 356.6 | 444 | 357.3 | 396 | 356 | 275 235 | – | 37.6 35.3 |
| 355 | 459 | 427 | 459 | 426.6 | 459 | 427.3 | 411 | 426 | 248 | – | 27.5 |
| 400 | On request | On request | On request | On request | On request | On request | On request | On request | On request | On request | On request |
| 450 | On request | On request | On request | On request | On request | On request | On request | On request | On request | On request | On request |

Assignment

Fig. 3

Frame size Brake and rotary pulse encoder (on cover)
LL 861 900 220Order codes
F04
+ G04 Δl

mm

Weight,
approx.
kg**HOG 9 D 1024 I**Order codes
F04
+ G05 Δl

mm

Weight,
approx.
kg**HOG 10 D 1024 I**Order codes
F04
+ G06 Δl

mm

Weight,
approx.
kg**Sendix 5020**Order codes
F04
+ G11/G12 Δl

mm

Weight,
approx.
kg

1LE1

| Frame size | Δl | Weight, approx. kg | Δl | Weight, approx. kg | Δl | Weight, approx. kg | Δl | Weight, approx. kg |
|------------|------------|--------------------|------------|--------------------|------------|--------------------|------------|--------------------|
| 225 | 274 | 50.3 | 271 | 49.9 | 315 | 50.6 | 285.5 | 49.4 |
| 250 | 260 | 55.3 | 257 | 54.9 | 301 | 55.6 | 271.5 | 54.4 |
| 280 | 267 | 93.3 | 264 | 92.9 | 308 | 93.6 | 278.5 | 92.4 |
| 315 | 263 | 168.3 | 260 | 167.9 | 304 | 168.6 | 274.5 | 167.4 |

1) Valid for 4-pole, 6-pole, and 8-pole motors

2) Valid for 2-pole motors

Introduction

Mounting technology

Dimensions and weights of the mountings

1

Overview

Fig. 5 Brake and separately driven fan, order codes **F01/F04 + F70** [optionally with manual release, order code **F50**]

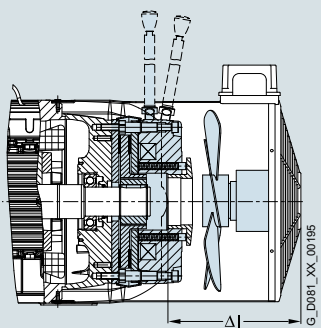

Frame sizes 100 to 200

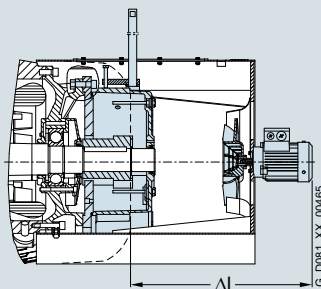

Frame sizes 225 to 355

Fig. 6 Rotary pulse encoder (under cover) and separately driven fan, order codes **F70 + G04/G05/G06/G11/G12**

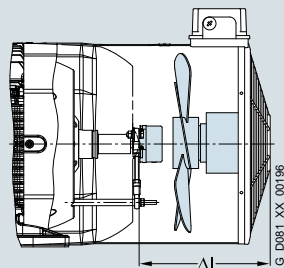

Frame sizes 100 to 200

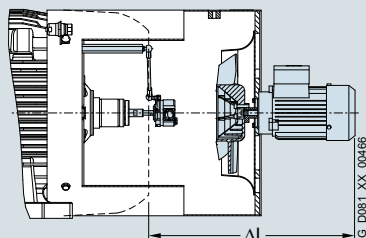

Frame sizes 225 to 355

| Frame size | Assignment Fig. 5 | | | | Fig. 6 | | | | | | | |
|--------------------------|---------------------------------|-----------------|-----------------------|-----------------|-----------------------|-----------------|-----------------------|-----------------|-----------------------|-----------------|---------------------------|-----------------|
| | Brake and separately driven fan | | Order codes F04 + F70 | | Order codes F70 + G04 | | Order codes F70 + G05 | | Order codes F70 + G06 | | Order codes F70 + G11/G12 | |
| | Δl | Weight, approx. | Δl | Weight, approx. | Δl | Weight, approx. | Δl | Weight, approx. | Δl | Weight, approx. | Δl | Weight, approx. |
| | mm | kg | mm | kg | mm | kg | mm | kg | mm | kg | mm | kg |
| 1LE1 | | | | | | | | | | | | |
| 71 | – | – | – | – | – | – | – | – | – | – | 165 | 2.7 |
| 80 | 161.5 | 5.4 | – | – | – | – | – | – | – | – | 161.5 | 3 |
| 90 | 174 | 7.7 | – | – | – | – | – | – | – | – | 174 | 3.6 |
| 100 | 161.5 | 8.3 | – | – | 161.5 | 4.8 | 161.5 | 4.4 | 246.5 | 5.3 | 161.5 | 3.9 |
| 112 | 156.5 | 10.4 | – | – | 156.5 | 5.1 | 156.5 | 4.7 | 241.5 | 5.6 | 156.5 | 4.1 |
| 132 | 186 | 15.7 | – | – | 186 | 6.8 | 186 | 6.4 | 291 | 7.4 | 186 | 5.8 |
| 160 | 205.5 | 37.2 | – | – | 205.5 | 9.8 | 205.5 | 9.4 | 320.5 | 10.5 | 205.5 | 8.7 |
| 180 | 257 | 40 | – | – | 257 | 10.6 | 257 | 10.2 | 400 | 10.9 | 257 | 10.5 |
| 200 | 262 | 53 | – | – | 262 | 11.8 | 262 | 11.4 | 397 | 12.1 | 262 | 11.7 |
| 225 | 563 | 87 | 440.5 | 60 | 410 | 26 | 410 | 26 | 410 | 26 | 410 | 25 |
| 250 | 609 | 110 | 409 | 79 | 425 | 28 | 425 | 28 | 425 | 28 | 425 | 27 |
| 280 | 571 | 149 | 402 | 120 | 429 | 31 | 429 | 31 | 429 | 31 | 429 | 30 |
| 315 (4-, 6-, and 8-pole) | 540 | 296 | 432 | 203 | 432 | 42 | 432 | 42 | 432 | 42 | 432 | 41 |
| 315 (2-pole) | 588 | 299 | – | – | 472 | 45 | 472 | 45 | 472 | 45 | 472 | 44 |
| 1LE5 | | | | | | | | | | | | |
| 315 2-pole | 633 | 415.7 | – | – | 633 | 39.6 | 633 | 39.2 | 633 | 39.9 | 633 | 38.6 |
| 315 4-pole | 593 | 413.7 | – | – | 593 | 37.3 | 593 | 36.9 | 593 | 37.6 | 593 | 36.3 |
| 355 | 628 | 471.7 | – | – | 381 | 29.5 | 381 | 29.1 | 381 | 29.8 | 381 | 28.5 |
| 400 | On request | On request | On request | On request | On request | On request | On request | On request | On request | On request | On request | On request |
| 450 | On request | On request | On request | On request | On request | On request | On request | On request | On request | On request | On request | On request |

Overview

Fig. 7 Brake, rotary pulse encoder (under cover) and separately driven fan, order codes **F01/F04 + F70 + G04/G05/G06/G11/G12** [optionally with manual release, order code **F50**]

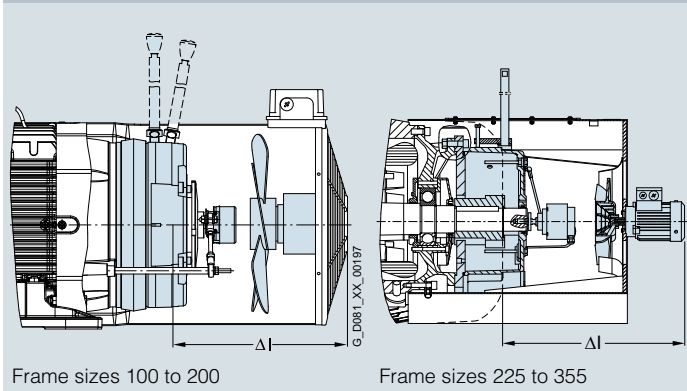
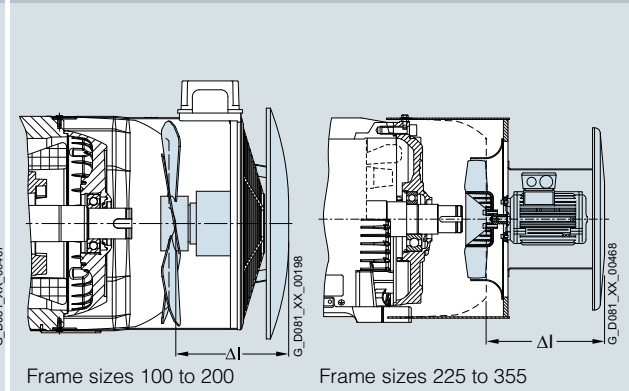

Fig. 8 Protective cover for separately driven fan, order code **H00**



| Frame size | Assignment Fig. 7 Brake, separately driven fan, and rotary pulse encoder (under cover) | | | | | | Sendix 5020 Order codes F01 + F70 + G11/G12 | | Fig. 8 Protective cover for separately driven fan Order code F70+H00 | | | |
|----------------------|--|--------------------|-----------------------------------|--------------------|-----------------------------------|--------------------|--|--------------------|---|--------------------|--|------------|
| | Order codes F01 + F70 + G04 | | Order codes F01 + F70 + G05 | | Order codes F01 + F70 + G06 | | Δl | Weight, approx. | Δl | Weight, approx. | Diameter of the separately- driven-fan cover mm | |
| | Δl | Weight, approx. | Δl | Weight, approx. | Δl | Weight, approx. | | | | | | |
| | mm | kg | mm | kg | mm | kg | mm | kg | mm | kg | mm | |
| 1LE1 | | | | | | | | | | | | |
| 80 | – | – | – | – | – | – | 186.5 | 6.7 | 124.5 | 0.2 | 157 | |
| 90 | – | – | – | – | – | – | 199 | 9 | 141.5 | 0.2 | 177 | |
| 100 | 196.5 | 10.9 | 196.5 | 10.5 | 246.5 | 11.5 | 196.5 | 10 | 124 | 1.4 | 210 | |
| 112 | 191.5 | 13.1 | 191.5 | 12.7 | 241.5 | 13.6 | 191.5 | 12.1 | 122 | 1.8 | 249 | |
| 132 | 241 | 19 | 241 | 18.6 | 291 | 19.6 | 241 | 18 | 149 | 2.4 | 300 | |
| 160 | 270.5 | 40.9 | 270.5 | 40.5 | 320.5 | 41.6 | 270.5 | 39.8 | 177 | 3 | 338 | |
| 180 | 257 | 38.6 | 257 | 38.2 | 400 | 40.6 | 257 | 38.5 | 288 | 1.7 | 338 | |
| 200 | 262 | 49.9 | 262 | 49.1 | 397 | 51.5 | 262 | 49.7 | 293 | 1.7 | 338 | |
| 225 | 563 | 88.3 | 563 | 88.2 | 563 | 88.9 | 563 | 87.4 | 305 | 2.5 | 210 | |
| 250 | 609 | 111.3 | 609 | 111.2 | 609 | 111.9 | 609 | 110.4 | 311 | 2.5 | 249 | |
| 280 | 571 | 150.3 | 571 | 150.2 | 571 | 150.9 | 571 | 149.4 | 307 | 2.5 | 300 | |
| 315 (4-, 6-, 8-pole) | 540 | 297.3 | 540 | 297.2 | 540 | 297.9 | 540 | 296.4 | 321 ¹⁾ | 2.5 ¹⁾ | 338 ¹⁾ | |
| 315 (2-pole) | 580 | 300.3 | 580 | 300.2 | 580 | 300.9 | 580 | 300.9 | – | – | – | |
| 1LE5 | | | | | | | | | | | | |
| 315 2-pole | – | – | – | – | – | – | – | – | 402 | 46.1 | 690 | |
| 315 4-pole | – | – | – | – | – | – | – | – | 317 | 43.5 | 690 | |
| 355 | – | – | – | – | – | – | – | – | 330 | 36 | 690 | |
| 400 | On request | On request | On request | On request | On request | On request | On request | On request | On request | On request | On request | On request |
| 450 | On request | On request | On request | On request | On request | On request | On request | On request | On request | On request | On request | On request |

| Frame size | Assignment Fig. 7 Brake, separately driven fan, and rotary pulse encoder (under cover) | | | | | | Sendix 5020 Order codes F04 + F70 + G11/G12 | | |
|-------------|--|--------------------|-----------------------------------|--------------------|-----------------------------------|--------------------|--|--------------------|--|
| | Order codes F04 + F70 + G04 | | Order codes F04 + F70 + G05 | | Order codes F04 + F70 + G06 | | Δl | Weight, approx. | |
| | Δl | Weight, approx. | Δl | Weight, approx. | Δl | Weight, approx. | | | |
| | mm | kg | mm | kg | mm | kg | mm | kg | |
| 1LE1 | | | | | | | | | |
| 225 | 593.5 | 67.3 | 593.5 | 66.9 | 593.5 | 67.6 | 593.5 | 66.4 | |
| 250 | 609 | 80.3 | 609 | 79.9 | 609 | 80.6 | 609 | 79.4 | |
| 280 | 572 | 121.3 | 572 | 120.9 | 572 | 121.6 | 572 | 120.4 | |
| 315 | 540 | 204.3 | 540 | 203.9 | 540 | 204.6 | 540 | 203.4 | |
| 1LE5 | | | | | | | | | |
| 315 2-pole | 633 | 417.7 | 633 | 417.3 | 633 | 418 | 633 | 416.7 | |
| 315 4-pole | 593 | 415.7 | 593 | 415.6 | 593 | 416 | 593 | 414.7 | |
| 355 | 628 | 473.7 | 628 | 473.3 | 628 | 474 | 628 | 472.7 | |

¹⁾ Valid for FS 315 (2, 4, 6, and 8-pole)

Introduction

Mounting technology

Dimensions and weights of the mountings

1

Overview

Fig. 9 Prepared for mountings, center hole only (for BFK458 brake, order code **F01** and/or encoder order code **G04/G05/G06/G11/G12**), order code **G40** (up to frame size 160, standard with frame size 180 and above)

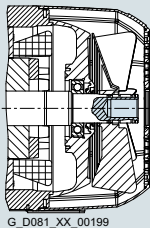
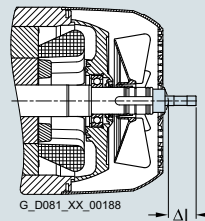

Fig. 10 Prepared for mountings with shaft D12/D16, order code **G41/G42**



Assignment

Fig. 9

Frame size Prepared for mountings, center hole only (for BFK458 brake, order code **F01** and/or encoder order codes **G04/G05/G06/G11/G12**)

order code **G40**

Order code **G40**

Δl Weight, approx. mm kg

Fig. 10

Prepared for mountings with shaft D12/D16, order code **G41/G42**

Order code **G41**

Δl Weight, approx. mm kg

Order code **G42**

Δl Weight, approx. mm kg

1LE1

| | | | | | | |
|-----|---|-----|------|------|------|------|
| 71 | – | – | – | – | – | – |
| 80 | – | – | 22 | 0.1 | 52 | 0.1 |
| 90 | – | – | 22 | 0.1 | 52 | 0.1 |
| 100 | – | – | 18.3 | 0.15 | 54.3 | 0.2 |
| 112 | – | – | 14.5 | 0.15 | 54.3 | 0.2 |
| 132 | – | 0.1 | 18.8 | 0.3 | 58.8 | 0.4 |
| 160 | – | 0.2 | 18.6 | 0.4 | 55.6 | 0.7 |
| 180 | – | – | 18 | 0.27 | 57 | 0.33 |
| 200 | – | – | 17 | 0.27 | 56 | 0.27 |
| 225 | – | – | 23 | 0.27 | 58 | 0.33 |
| 250 | – | – | 23 | 0.27 | 58 | 0.33 |
| 280 | – | – | 23 | 0.27 | 58 | 0.33 |
| 315 | – | – | 23 | 0.27 | 58 | 0.33 |

1LE5

| | | | | | | |
|-----|------------|------------|------------|------------|------------|------------|
| 315 | – | – | 23 | 0.27 | 58 | 0.33 |
| 355 | – | – | 23 | 0.27 | 58 | 0.33 |
| 400 | On request | On request | On request | On request | On request | On request |
| 450 | On request | On request | On request | On request | On request | On request |

Overview

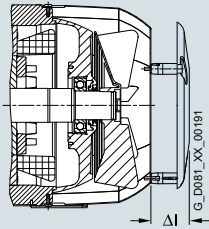
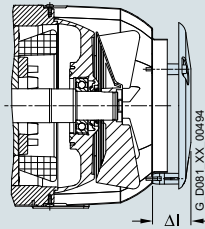
Fig. 11 Standard protective cover for types of construction, order code **H00****Fig. 12** Protective cover for textile industry, order code **F75**

| Frame size | Assignment Fig. 11 | | Assignment Fig. 12 | |
|-------------|--|-----------------------|--|-----------------------|
| | Protective cover Order code H00 | Weight, approx. kg | Protective cover Order code F75 | Weight, approx. kg |
| | Δl mm | | Δl mm | |
| 71 | 29 | 0.15 | – | – |
| 80 | 128 | 0.3 | 17 | 0.3 |
| 90 | 144 | 0.4 | 15 | 0.4 |
| 100 | 137 | 0.5 | 64 | 0.7 |
| 112 | 122 | 0.7 | 64 | 0.9 |
| 132 | 156 | 1.3 | 71 | 1.3 |
| 160 | 182.5 | 1.7 | 71 | 1.9 |
| 180 | 285 | 1.7 | 90 | 3.2 |
| 200 | 297 | 1.7 | 90 | 3.4 |
| 225 | 100 | 2.2 | On request | On request |
| 250 | 100 | 2.4 | On request | On request |
| 280 | 110 | 3.4 | On request | On request |
| 315 | 110 | 4 | On request | On request |
| 1LE5 | | | | |
| 315 | 110 | 8 | – | – |
| 355 | 140 | 8.5 | – | – |
| 400 | On request | On request | – | – |
| 450 | On request | On request | – | – |

Introduction

Notes

1

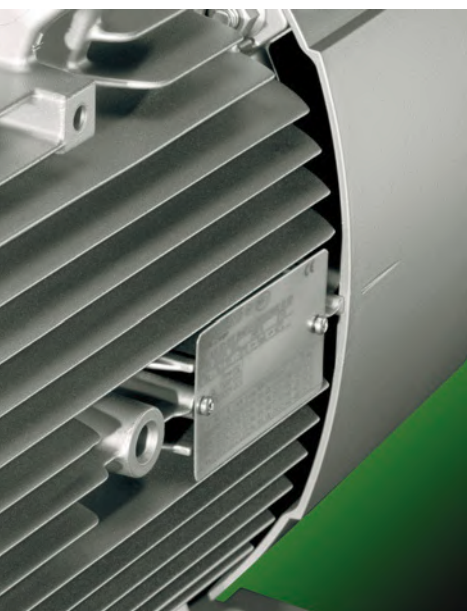

| | | | |
|--|---|--|--|
| 2/2 2/6 2/7 | Orientation Converter operation Article number code | 2/79 2/79 | Eagle Line · NEMA Premium Efficient MG1 Table 12-12 Aluminum series SIMOTICS GP 1LE1023 Cast-iron series SIMOTICS SD • 1LE1523 Basic Line • 1LE1623 Performance Line |
| 2/8 2/8 2/9 2/11 | IE4 Super Premium Efficiency Aluminum series SIMOTICS GP 1LE1004 Cast-iron series SIMOTICS SD • 1LE1504 Basic Line • 1LE1604 Performance Line | 2/88 2/89 | Eagle Line · NEMA Energy Efficient MG1 Table 12-11 Aluminum series SIMOTICS GP 1LE1021 Cast-iron series SIMOTICS SD 1LE1521 Basic Line |
| 2/13 2/13 2/16 2/17 2/18 2/21 2/25 2/26 2/27 | IE3 Premium Efficiency Aluminum series SIMOTICS GP • 1LE1003 • 1LE1003 with increased power • 1LE1083 Cast-iron series SIMOTICS SD • 1LE1503 Basic Line • 1LE1603 Performance Line • 1LE1503 Basic Line with increased power • 1LE1603 Performance Line with increased power • 1LE1583 | 2/90 2/90 2/91 | Pole-changing Aluminum series SIMOTICS GP • 1LE1011 for constant load torque • 1LE1011/1LE1012 for square-law load torque |
| 2/30 2/30 2/34 2/36 2/40 2/44 2/46 | IE2 High Efficiency Aluminum series SIMOTICS GP • 1LE1001 • 1LE1001 with increased power Cast-iron series SIMOTICS SD • 1LE1501 Basic Line • 1LE1601 Performance Line • 1LE1501 Basic Line with increased power • 1LE1601 Performance Line with increased power | 2/93 2/93 2/99 2/112 2/115 2/118 2/139 | Article No. supplements and special versions Voltages Types of construction Motor protection Terminal box position Options Accessories |
| 2/48 2/48 2/51 2/52 2/56 | IE1 Standard Efficiency Aluminum series SIMOTICS GP • 1LE1002 • 1LE1002 with increased power Cast-iron series SIMOTICS SD • 1LE1502 Basic Line • 1LE1502 Basic Line with increased power | 2/141 2/141 2/141 2/142 2/144 2/146 2/148 2/150 | Dimensions Notes on the dimensions Dimension sheet generator 2/142 Dimensions · Aluminum series SIMOTICS GP IE1, IE2, NEMA Energy Efficient, pole-changing • Frame sizes 63 M to 200 L IE1, IE2 with increased power • Frame sizes 80 M to 200 L IE1, IE2 • Frame sizes 80 M to 200 L IE3, NEMA Premium Efficient • Frame sizes 80 M to 90 L • Frame sizes 100 L to 200 L IE3 with increased power • Frame sizes 100 L to 200 L IE3 • Frame sizes 80 M to 90 L • Frame sizes 100 L to 200 L IE4 • Frame sizes 100 L to 200 L IR3 Rendimento Premium • Frame sizes 80 M to 160 L |
| 2/58 2/58 2/60 2/61 2/64 2/67 2/68 | APAC Line · IE3 Premium Efficiency Aluminum series SIMOTICS GP • 1LE1043 • 1LE1043 with increased power Cast-iron series SIMOTICS SD • 1LE1543 Basic Line • 1LE1643 Performance Line • 1LE1543 Basic Line with increased power • 1LE1643 Performance Line with increased power | 2/154 2/156 2/158 2/160 2/162 2/164 | 2/142 Dimensions · Cast-iron series SIMOTICS SD IE1, IE2, NEMA Energy Efficient • Frame sizes 71 M to 160 L • Frame sizes 180 M to 250 M • Frame sizes 280 S to 315 L IE3, NEMA Premium Efficient • Frame sizes 71 M to 160 L • Frame sizes 180 M to 315 L IE3 1LE1583 • Frame sizes 100 L to 200 L • Frame sizes 225 S to 315 L IE4 • Frame sizes 100 L to 160 L • Frame sizes 180 M to 315 L IR3 Rendimento Premium • Frame sizes 180 M to 280 M • Frame sizes 315 S to 315 L |
| 2/69 2/69 2/71 2/72 2/74 | APAC Line · IE2 High Efficiency Aluminum series SIMOTICS GP • 1LE1041 • 1LE1041 with increased power Cast-iron series SIMOTICS SD • 1LE1541 Basic Line • 1LE1541 Basic Line with increased power | 2/174 2/176 2/178 2/180 | |
| 2/75 2/75 2/77 | ABNT Line · IR3 Rendimento Premium Aluminum series SIMOTICS GP 1E1073 Cast-iron series SIMOTICS SD 1LE1573, 1LE5773 | 2/182 2/184 | |

SIMOTICS GP and SIMOTICS SD standard motors

Orientation

Overview

2

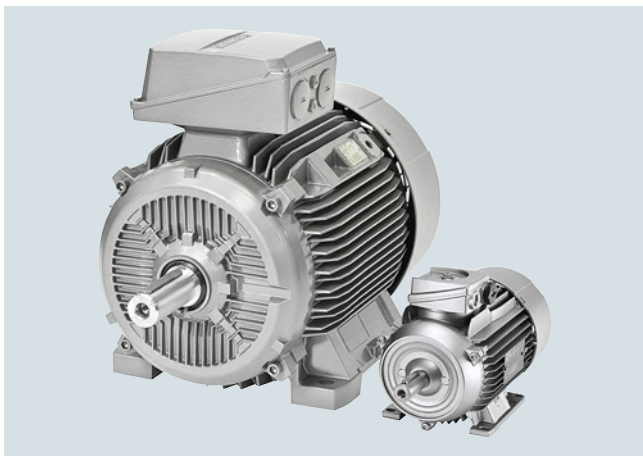

Increasing energy costs have resulted in greater emphasis on the power consumption of drive systems. It is extremely important to utilize the full potential for minimizing energy consumption here to secure competitiveness today and in the future. The environment will also profit from reduced energy consumption.

This is the reason why we have already developed a new generation of low-voltage motors. Innovative rotors create the best requisites for motors with a high degree of efficiency. IE1 and IE2 motors with the same power have the same dimensions. The new motors for IE2, IE3 and IE4 offer considerable energy savings and protect our environment. We also consider environmental compatibility and sustainable use of resources during production. Potting compounds and coatings are, for example, solvent-free.

The modular mounting concept provides total flexibility. Each motor is based on a uniform concept for all markets worldwide. Our motors are manufactured according to the most advanced ecological standards.

The new 1LE1 motor family is therefore one of the most compact in the world, because it is manufactured using innovative technology. For an optimized design, a compound of highly conductive materials is used in the rotor (up to frame size 200). This results in minimum rotor losses and an excellent starting and switching response.

The design of the 1LE1 motors ensures maximum flexibility and minimum installation costs. Users benefit from integral lifting eyes, screw-on feet, reinforced bearing plates with optimum mechanical properties and easily accessible terminal boxes. Encoders, brakes and separately driven fans can also be added without any problems. Smaller inventories make stockkeeping easier, so motor suppliers can respond to customer requirements more quickly.

The 1LE1/1LE5/1PC1 motor family comprises two main series:

- SIMOTICS GP for general purpose applications:
Motors with an aluminum housing

SIMOTICS GP 1LE1/1LE5/1PC1 motors with an aluminum housing are suitable for a wide range of standard drive tasks in the industrial environment. Thanks to their particular low weight, they are predestined for applications in pumps, fans and compressors. But they also reliably fulfill their tasks in conveyor systems and lifting gear.

| Brief overview | |
|--|---|
| Power and voltage range: | 0.09 ... 45 kW for all commonly used voltages |
| Frame sizes and types of construction: | 63 ... 200 in all common types of construction |
| Rated speed: | 750 ... 3600 rpm |
| Number of poles: | 2, 4, 6, 8 |
| Efficiency classes: | <ul style="list-style-type: none"> • IE1 (Standard Efficiency) • IE2 (High Efficiency) • IE3 (Premium Efficiency) • IE4 (Super Premium Efficiency) • IR3 (Rendimento Premium) • NEE (NEMA Energy Efficient, acc. to NEMA MG, Table 12-11) • NPE (NEMA Premium Efficient, acc. to NEMA MG, Table 12-12) |

- SIMOTICS SD for severe duty applications:
Motors with cast-iron housing

SIMOTICS SD 1LE1/1LE5 motors with a cast-iron housing are extremely rugged and are therefore the first choice for applications under harsh environmental conditions. They master dust or vibration in mills and mixers as well as the corrosive atmosphere in the petrochemical industry.

| Brief overview | |
|--|---|
| Power and voltage range: | 0.09 ... 300 kW for all commonly used voltages |
| Frame sizes and types of construction: | 71 ... 315 in all common types of construction |
| Rated speed: | 750 ... 3600 rpm |
| Number of poles: | 2, 4, 6, 8 |
| Efficiency classes: | <ul style="list-style-type: none"> • IE1 (Standard Efficiency) • IE2 (High Efficiency) • IE3 (Premium Efficiency) • IE4 (Super Premium Efficiency) • IR3 (Rendimento Premium) • NEE (NEMA Energy Efficient, acc. to NEMA MG, Table 12-11) • NPE (NEMA Premium Efficient, acc. to NEMA MG, Table 12-12) |

Overview

High efficiency energy-saving motors for a positive energy balance

Depending on requirements, energy-saving motors for a positive energy balance are available that are compliant with the legal requirements applicable in the European economic area in accordance with EU Directive 640/2009 as well as for the North American market in accordance with US federal law EISA (Energy Independence Security Act).

Motors with increased power and compact construction (1LE1)

Motors with increased power and compact construction can be used to advantage in confined spaces. For a slightly longer overall length, the power is at least as high as that of the next largest frame size. These compact motors are also optimized for efficiency. They are offered in IE2 and IE3 and therefore reduce operating costs.

Motors without fan cover and without external fan (1LE1 with order code F90)

Forced-air cooled motors with surface cooling without fan cover and without external fan are mainly used for driving fans.

Motors with reduced power without fan cover and without external fan (1PC1 motors on request)

Naturally cooled motors with surface cooling without fan cover and without external fan are suitable for the following operating conditions:

- Types of duty with adequate cooling times (e.g. temporary duty for positioning drives)
- Environmental conditions that demand compact installation space (e.g. in motors with a stopping function)

Requirements that make an external fan disadvantageous, e.g. simple cleaning in the food industry, textile industry.

Benefits

There is considerable potential in the new 1LE1/1PC1 series of low-voltage motors. As a consistent further development of existing motors, the 1LE1/1PC1 motors offer numerous advantages.

Greater efficiency

Innovative rotor technology and manufacturing technology has been implemented for the IE3 and IE4 high efficiency motor variants. The energy-efficient motors are therefore considerably more compact.

The SinaSave Webtool can be used to calculate the energy saving potential and life cycle costs of all motors. SinaSave can be downloaded free of charge from the following website:
www.sinasave.siemens.com

The 1LE1 motors also impress customers with their extremely long life and their weight-optimized design has a positive effect on the stability of the equipment unit.

A wider range of applications

The motors are certified for worldwide use and satisfy high standards of quality (confirmed, for example, by CSA ¹⁾, UL ²⁾, CQC ³⁾).

Improved design

The rugged housing in modern EMC design has an attractive appearance and enhances functionality. The rotatable, accessible terminal boxes, integral lifting eyes, screw-on feet and reinforced bearing plates ensure this.

Greater power

For the same frame size, the high-performance motors offer one complete rated power level more. We are also consistently implementing energy efficiency improvements here, too. The motors are offered (based on the categories of IEC 60034-30-1) in various efficiency classes.

More flexibility

The optimized design of the motors makes installation easier in general. Encoders, brakes and separately driven fans can be retrofitted easily. Terminal boxes and feet for flexible mounting can be selected. Smaller inventories make stockkeeping easier and motor suppliers can respond to customer requirements more quickly. Optimized manufacturing processes support fast availability. All motors up to 480 V can be operated either directly on the line or on a converter.

For general purpose applications: SIMOTICS GP motors with an aluminum housing

Particularly user friendly

The previously introduced, well-proven, obliquely partitioned terminal box is being implemented consistently throughout the entire motor series.

Special export line

For exporting to NAFTA, the Eagle Line is available. The motors are supplied with the electrical values stamped on the rating plate in accordance with EISA requirements.

¹⁾ Canadian Standard Association

²⁾ Underwriters Laboratories Inc.

³⁾ China Quality Certification

SIMOTICS GP and SIMOTICS SD standard motors

Orientation

Benefits

For severe duty applications: SIMOTICS SD motors with a cast-iron housing

The right motor for various challenges

The following lines are available for severe duty applications:

- **Basic Line (1LE15):** rugged, reliable motors for machine construction
- **Performance Line (1LE16):** Motors for the process industry with reinforced bearings and a more rugged coating – for requirements that extend beyond the Basic Line
- **"Eagle Line":** Motors for exporting to the NAFTA zone; they fulfill the requirements of UL and CSA and are supplied with the electrical values stamped on the rating plate in accordance with EISA requirements

Comparison: Basic Line versus Performance Line

| Function | Basic Line | Performance Line |
|------------------|--|--|
| Bearing size | 62 (63 from frame size 280 upwards) | 63 |
| Relubrication | Optional (standard from frame size 280 upwards) | Standard from frame size 160 upwards (optional for frame size 100 to 132) |
| Paint system | Standard paint finish, corrosivity category C2 ¹⁾ | Special paint finish, corrosivity category C3 ¹⁾ |
| Drainage | Drain plugs | T drains |
| Rating plate | Aluminum, plastic | Steel |
| Motor protection | Optional | PTC |
| Fan cover | Plastic | Steel |
| Warranty | Optionally 12 or 36 months for frame sizes 180 to 315 | Standard 36 months for frame sizes 180 to 315 |

Compact design

The size of a motor is often an important aspect in the case of machines. For this reason, the 1LE1 motors in IE2 and IE3 are not any longer than their predecessors in the 1LG series in IE2.

Another highlight: some of the IE3 motors fit in the same housing as the IE2 motors. The efficiency classes naturally do not differ with regard to shaft height, so that the mechanical interface to the equipment unit remains the same. This also supports a largely problem-free efficiency upgrade to IE3 – without the need to adapt the mechanical design of a machine.

Greater power

In severe duty applications, motors with increased power can also be the right solution if sufficient space is not available for a standard motor. Because these motors offer the same power range in the next smallest frame size.

Application

As soon as the range of motors and options is complete, it will be possible to use the 1LE1/1PC1 motors from Siemens in all areas and sectors of industry due to their numerous options. They are suitable both for special environmental conditions such as those that predominate in the chemical or petrochemical industry as well as for most climatic requirements such as those of offshore applications.

Their large range of line voltages enables them to be used all over the world.

The wide field of implementation includes the following applications:

- Pumps
- Fan
- Compressors
- Conveyor systems such as cranes, belts and lifting gear
- High-bay warehouses
- Packaging machines
- Automation and drives
- Manufacturing industry
- General machine construction

Motors with a cast-iron housing are particularly suitable for the following severe duty applications:

- Petrochemical industry
- Pharmaceuticals
- Chemical industry
- Printing industry
- Process industry

¹⁾ See also Chapter 1, pages 1/14 and 1/15.

SIMOTICS GP and SIMOTICS SD standard motors

Orientation

2

Technical specifications

Overview of technical specifications

This table lists the most important technical specifications. For more information and details, see Catalog Section 1 "Introduction".

| | |
|--|--|
| Type of motor | SIMOTICS GP/SD 1LE1/1LE5/1PC1 IEC Low-Voltage Motors |
| Connection types | Star/delta connection The connection type to be used can be established from the Article No. supplements for the required motor. |
| Number of poles | 2, 4, 6, 8 |
| Frame sizes | 63 M ... 315 L |
| Rated power | 0.09 ... 300 kW (1LE1/1LE5 motor series)/0.3 ... 9 kW (1PC1 motor series) |
| Frequencies | 50 Hz and 60 Hz |
| Versions | Self-ventilated 1LE1 energy-saving motors with: <ul style="list-style-type: none"> • IE1 (Standard Efficiency) • IE2 (High Efficiency) • IE3 (Premium Efficiency) • IE4 (Super Premium Efficiency) • IR3 (Rendimento Premium) • NEE (NEMA Energy Efficient, acc. to NEMA MG, Table 12-11) • NPE (NEMA Premium Efficient, acc. to NEMA MG, Table 12-12) Self-ventilated 1LE1 motors with increased power with: <ul style="list-style-type: none"> • IE1 (Standard Efficiency) • IE2 (High Efficiency) • IE3 (Premium Efficiency) Forced-air cooled 1LE1 motors without external fan and fan cover with: <ul style="list-style-type: none"> • IE1 (Standard Efficiency) • IE2 (High Efficiency) • IE3 (Premium Efficiency) • IE4 (Super Premium Efficiency) • IR3 (Rendimento Premium) Naturally cooled 1PC1 motors without external fan and fan cover with: <ul style="list-style-type: none"> • IE1 (Standard Efficiency) • IE2 (High Efficiency) • IE3 (Premium Efficiency) • IE4 (Super Premium Efficiency) |
| Marking | IEC 60034-30-1 IE1, IE2, IE3, IE4: 2, 4, 6 and 8-pole; NBR 17094-1: IR3 Rendimento Premium: 2, 4, 6, and 8-pole US Energy Independence Security Act EISA: 2, 4, 6 and 8-pole |
| Rated speed (synchronous speed) | 750 ... 3000 rpm |
| Rated torque | 0.6 ... 1978 Nm (1LE1/1LE5 motor series) |
| Insulation of the stator winding in accordance with EN 60034-1 (IEC 60034-1) | Temperature class 155 (F), utilized acc. to temperature class 130 (B) (also for motors with increased power) DURIGNIT IR 2000 insulation system |
| Degree of protection according to EN 60034-5 (IEC 60034-5) | IP55 as standard |
| Cooling according to EN 60034-6 (IEC 60034-6) | <ul style="list-style-type: none"> • Self-ventilated (IC411) (1LE1/1LE5 motor series) frame size 80 M to 315 L • Forced-air cooled (IC418) (1LE1/1LE5 motor series with order code F90), frame size 80 M to 200 L • Naturally cooled (IC410) (1PC1 motor series) frame size 100 L to 160 L |
| Permissible coolant temperature and installation altitude | -20 ... +40 °C as standard, installation altitude up to 1000 m above sea level. See "Coolant temperature and installation altitude" in Catalog Section 1 "Introduction". |
| Standard voltages according to EN 60038 (IEC 60038) | 50 Hz: 230 V, 400 V, 500 V, 690 V The voltage to be used can be found in the "Selection and ordering data" for the required motor. |
| Type of construction according to EN 60034-7 (IEC 60034-7) | <ul style="list-style-type: none"> • Without flange: IM B3, IM B6, IM B7, IM B8, IM V5 without protective cover, IM V6, IM V5 with protective cover • With flange: IM B5, IM V1, IM V3, IM B35 • With flange (next largest): IM B14, IM V19, IM V18, IM B34 |
| Paint finish Suitability of paint finish for climate group according to IEC 60721, Part 2-1 | Standard: Color RAL 7030 stone gray See "Paint finish" in Catalog Section 1 "Introduction". |
| Vibration severity grade according to EN 60034-14 (IEC 60034-14) | Grade A (normal – without special vibration requirements) Optionally: Grade B (with special vibration requirements) See "Balance and vibration severity" in Catalog Section 1 "Introduction". |
| Shaft extension according to DIN 748 (IEC 60072) | Balancing type: half-key balancing as standard See "Balance and vibration severity" in Catalog Section 1 "Introduction". |
| Sound pressure level according to EN ISO 1680 (tolerance +3 dB) | The corresponding sound pressure level is listed in the selection and ordering data for the required motor. |
| Weights | The corresponding weight is listed in the selection and ordering data for the required motor. |
| Modular mounting concept | Rotary pulse encoder, brake, separately driven fan or prepared for mountings |
| Consistent series concept | <ul style="list-style-type: none"> • Cast housing feet, screwed-on feet available as an option and retrofittable • Terminal box obliquely partitioned and rotatable through 4 × 90° • Bearings at DE and NDE are of identical design, reinforced bearings available as an option |
| Options | See "Article No. supplements and special versions" |

More information

For further information, please get in touch with your local Siemens contact and use the DT Configurator.

Contacts: www.siemens.com/automation/partner
DT Configurator: www.siemens.com/dt-configurator

Wherever possible, you will find a local contact for:

- Technical support
- Spare parts/repairs
- Service
- Training

- Sales
- Technical consultation/engineering

You start by selecting a:

- country,
- product or
- sector.

By further specifying the remaining criteria you will find exactly the right contact partner with his/her respective expertise.

SIMOTICS GP and SIMOTICS SD standard motors

Orientation

Converter operation

Overview

Converter operation up to 480 V +10 % line voltage

See Chapter 1, page 1/26.

During installation, the EMC guidelines must be complied with

Note:

When motors are operated on SINAMICS converters additional losses occur which, depending on the admissible winding temperature, can make it necessary to reduce the torque. The admissible torque values can be obtained from the SIZER (www.siemens.com/sizer) configuring tool. The lowest frequency specified there is 5 Hz. For stationary converter operation at lower frequencies, particularly in the case of frame sizes < 100, it is necessary to inquire at the Quotation Center.

Benefits

Motors operating with frequency converters offer the user numerous advantages.

The motors feature the future-oriented insulation system DURIGNIT IR 2000 (IR = Inverter Resistant). The DURIGNIT IR 2000 insulation system consists of high-quality enamel wires and insulating sheet materials in conjunction with temperature-resistant resin impregnation.

Application

The wide field of implementation includes the following applications:

- Conveyor systems such as cranes, belts and lifting gear
- High-bay warehouses
- Packaging machines
- Automation and drives

Their large range of line voltages enables them to be used all over the world.

Technical specifications

General note

All the data listed in the catalog is applicable for a 50 Hz line supply. With converter operation, the torque reduction factors for constant torque and drives for fans, pumps and compressors must be configured using the "SIZER for Siemens Drives" engineering tool. Higher noise levels must be expected at frequencies other than 50 Hz for motors operating with converters due to the harmonic content of the supply.

Mechanical limit speeds

When the motor is operated above its rated frequency, it is important to note that the maximum speeds are limited by the limits for the roller bearings, critical rotor speed and rigidity of the rotating parts (see page 1/54).

Motor protection

A motor protection function can be implemented using the I^2t sensing capability implemented in the converter software.

If required, more precise motor protection can be afforded by direct temperature measurement using KTY84 sensors, PTC thermistors, or Pt1000 resistance thermometers in the motor winding. Some converters from Siemens determine the motor temperature using the resistance of the temperature sensor. They can be set to a required temperature for alarm and tripping.

Insulation

The insulation of 1LE motors is designed such that converter operation is possible at voltages up to 480 V¹⁾.
 $\hat{U}_{\text{phase-to-phase}} \leq 1500 \text{ V}$, $\hat{U}_{\text{phase-to-ground}} \leq 1100 \text{ V}$, voltage rise times of $t_{\text{r}} > 0.1 \mu\text{s}$.

For converter operation with the power ratings specified in the catalog, the motors are used according to temperature class 155 (F), i.e. in this case neither a service factor > 1 nor an increased coolant temperature is possible (order codes N01, N02 and N03 cannot be ordered).

¹⁾ See also IEC 60034-1 Edition 13.0

Selection and ordering data

The article number consists of a combination of digits and letters and is divided into three hyphenated blocks to provide a better overview, e.g.:

1LE1001-1DB22-2CB5-Z
H00

The first block (positions 1 to 7) identifies the motor type. The second block (positions 8 to 12) defines the motor frame size and length, the number of poles and power and in some cases the frequency/voltage. In the third block (positions 13 to 16), the frequency/voltage, type of construction and further design features are encoded.

For deviations in the second and third block from the catalog codes either **Z** or **90** should be used as appropriate.

Ordering data:

- Complete Article No. and order code(s) or plain text
- If a quotation has been requested, please specify the quotation number in addition to the Article No.
- When ordering a complete motor as a spare part, please specify the works serial No. for the previously supplied motor as well as the Article No.

| Structure of the Article No.: | Position: | 1 | 2 | 3 | 4 | 5 | 6 | 7 | - | 8 | 9 | 10 | 11 | 12 | - | 13 | 14 | 15 | 16 | | |
|---|--|---|---|---|---|--|---|---|---|--------|--------|--------|--------|----|---|----|--------|--------|--------|--|-----|
| 1st to 4th position: Digit, letter, letter, digit | <ul style="list-style-type: none"> • Self-ventilated by fan mounted on and driven by the rotor • Forced-air cooled by air flow from the fan to be driven with option extension F90 • ABNT Line – self-ventilated or forced-air cooled as for 1LE1 • Naturally cooled without external fan and fan cover | 1 | L | E | 1 | | | | | | | | | | | | | | | | |
| 5th position: Digit | Aluminum housing Cast-iron housing Basic Line Cast-iron housing Performance Line Cast-iron housing ABNT Line IR3 (IE3) | | | | | 0 5 6 7 | | | | | | | | | | | | | | | |
| 6th to 7th position: 2 digits | Motors with IE2 High Efficiency APAC Line motors with IE2 High Efficiency Motors with IE1 Standard Efficiency Motors with IE3 Premium Efficiency Motors with IE3 Premium Efficiency (converter operation) APAC Line motors with IE3 Premium Efficiency Motors with IE4 Super Premium Efficiency Pole-changing motors with one winding connected in Dahlander circuit Pole-changing motors with two windings NEMA Energy Efficient MG1 motors, Table 12-11 – Eagle Line NEMA Premium Efficient MG1 motors, Table 12-12 – Eagle Line ABNT Line IR3 (IE3) motors | | | | | 0 1 4 1 0 2 0 3 8 3 4 3 0 4 1 1 1 2 2 1 2 3 7 3 | | | | | | | | | | | | | | | |
| 8th, 9th and 11th position: Digit, letter, digit | Motor frame size (frame size as a combination of shaft height and overall length, encoded) | | | | | | | | | 0 3 | A E | 0 6 | | | | | | | | | |
| 10th position: Letter | No. of poles A: 2-pole, B: 4-pole, C: 6-pole, D: 8-pole, J: 4/2-pole const. load torque, L: 8/4-pole const. load torque, P: 4/2-pole square-law load torque, Q: 6/4-pole square-law load torque, R: 8/4-pole square-law load torque | | | | | | | | | | A R | | | | | | | | | | |
| 12th and 13th position: 2 digits | Voltage, circuit and frequency (encoded with two digits, 9-0 requires order code M.. (e.g. M1Y)) | | | | | | | | | | | 0 9 | 0 8 | | | | | | | | |
| 14th position: Letter | Type of construction (encoded with A ... Z; Z requires order code Q.. (e.g. H00)) | | | | | | | | | | | | | | | | A V | | | | |
| 15th position: Letter | Motor protection (encoded with A ... Z; Z requires order code Q.. (e.g. Q2A)) | | | | | | | | | | | | | | | | | A Z | | | |
| 16th position: Digit | Terminal box position 4: Terminal box top, 5: Terminal box right, 6: Terminal box left, 7: Terminal box bottom | | | | | | | | | | | | | | | | | | 4 7 | | |
| | Special order versions: encoded – additional order code required not encoded – additional plain text required | | | | | | | | | | | | | | | | | | | | - Z |

Ordering example

| Selection criteria | Requirement | Structure of the Article No. |
|---|--|------------------------------|
| Motor type 1LE1 | Standard motor with IE3 High Efficiency, IP55 degree of protection, aluminum housing | 1LE1003-■■■■■■-■■■■■■ |
| Motor frame size/No. of poles/Speed | 160 M/4-pole/1500 rpm | 1LE1003-1DB2■■-■■■■■■ |
| Rated power | 11 kW | 1LE1003-1DB22-2■■■■■■ |
| Voltage and frequency | 230 VΔ/400 VY, 50 Hz | 1LE1003-1DB22-2C■■■■-Z |
| Type of construction with special version | IM V5 with protective cover ¹⁾ | 1LE1003-1DB22-2CB5-Z H00 |
| Motor protection | 1 or 3 PTC thermistors – for tripping (2 terminals) | 1LE1003-1DB22-2CB5-Z H00 |
| Terminal box position | Terminal box right (viewed from DE) | 1LE1003-1DB22-2CB5-Z H00 |

¹⁾ Standard without protective cover – the protective cover is defined with order code **H00** and must be ordered in addition to the Article No. with **-Z** and this order code.

SIMOTICS GP and SIMOTICS SD standard motors
IE4 Super Premium Efficiency



Aluminum series SIMOTICS GP 1LE1004 – self-ventilated or forced-air cooled

Selection and ordering data

| Operating values at rated power | | | | | | | | | | | | | | | Aluminum series | | | |
|--|-----------------------|---------------|----------------------------|----------------------|-------------------------|-------------------------|-------------------------|-----------------------------|----------------------|-----------------------------|-----------------------------|--------------------------------|--------------------|-------------------|-------------------------|------------------|-------------------------------|--|
| P_{rated} 50 Hz/ | P_{rated} 60 Hz/ | Frame size | n_{rated} 50 Hz | T_{rated} 50 Hz | η_{rated} 50 Hz | η_{rated} 50 Hz | η_{rated} 50 Hz | $\cos\phi_{rated}$ 50 Hz | I_{rated} 50 Hz | T_{LR}/I_{rated} 50 Hz | I_{LR}/I_{rated} 50 Hz | T_{β}/I_{rated} 50 Hz | L_{pfA} 50 Hz | L_{WA} 50 Hz | Article No. | $m_{IM\ B3}$ | J | |
| kW | kW | FS | rpm | Nm | % | % | % | | A | | | | | | kg | kgm ² | | |
| • Cooling: Self-ventilated (IC411) or with order code F90 forced-air cooled without external fan and fan cover (IC418) • Efficiency according to IEC 60034-30-1: IE4 Super Premium Efficiency, service factor (SF) 1.15 • Insulation: Thermal class 155 (temperature class F), IP55 degree of protection, utilization in accordance with thermal class 130 (temperature class B) | | | | | | | | | | | | | | | | | | |
| 2-pole: 3000 rpm at 50 Hz, 3600 rpm at 60 Hz ¹⁾ | | | | | | | | | | | | | | | | | | |
| 3 | 3.45 | 100 L | 2920 | 9.8 | 89.1 | 89.8 | 89.4 | 0.86 | 5.7 | 3.7 | 9 | 4.9 | 62 | 74 | 1LE1004-1AA4 | 27 | 0.0054 | |
| 4 | 4.55 | 112 M | 2950 | 13 | 90 | 90.4 | 89.7 | 0.89 | 7.2 | 2.6 | 8.8 | 4.1 | 68 | 80 | 1LE1004-1BA2 | 34 | 0.012 | |
| 5.5 | 6.3 | 132 S | 2960 | 18 | 90.9 | 90.9 | 89.8 | 0.84 | 10.4 | 2.1 | 8.6 | 4.6 | 67 | 84 | 1LE1004-1CA0 | 44 | 0.024 | |
| 7.5 | 8.6 | 132 S | 2955 | 24 | 91.7 | 92.4 | 92.3 | 0.91 | 13 | 2.2 | 8.6 | 4.3 | 67 | 80 | 1LE1004-1CA1 | 56 | 0.031 | |
| 11 | 12.6 | 160 M | 2955 | 36 | 92.6 | 92.8 | 92 | 0.9 | 19.1 | 2.8 | 8.6 | 4.2 | 74 | 87 | 1LE1004-1DA2 | 84 | 0.061 | |
| 15 | 17.3 | 160 M | 2955 | 48 | 93.3 | 93.5 | 92.9 | 0.9 | 26 | 3.1 | 9 | 4.5 | 74 | 87 | 1LE1004-1DA3 | 98 | 0.068 | |
| 18.5 | 21.3 | 160 L | 2955 | 60 | 93.7 | 94.1 | 93.8 | 0.91 | 31.5 | 3.1 | 8.9 | 4.3 | 74 | 87 | 1LE1004-1DA4 | 112 | 0.074 | |
| 22 | 24.5 | 180 M | 2950 | 71 | 94 | 94.4 | 94.1 | 0.89 | 38 | 2.8 | 8.9 | 4.3 | 71 | 84 | 1LE1004-1EA2 | 139 | 0.091 | |
| 30 | 33.5 | 200 L | 2955 | 97 | 94.5 | 94.8 | 94.4 | 0.85 | 54 | 2.8 | 7.9 | 4 | 69 | 83 | 1LE1004-2AA4 | 173 | 0.13 | |
| 37 | 41.5 | 200 L | 2955 | 120 | 94.8 | 95.1 | 94.9 | 0.88 | 64 | 2.9 | 7.8 | 4 | 69 | 83 | 1LE1004-2AA5 | 214 | 0.20 | |
| 4-pole: 1500 rpm at 50 Hz, 1800 rpm at 60 Hz ¹⁾ | | | | | | | | | | | | | | | | | | |
| 2.2 | 2.55 | 100 L | 1465 | 14 | 89.5 | 89.6 | 88.3 | 0.79 | 4.5 | 3.3 | 8.5 | 4.7 | 59 | 71 | 1LE1004-1AB4 | 30 | 0.014 | |
| 3 | 3.45 | 100 L | 1460 | 20 | 90.4 | 91 | 90.5 | 0.81 | 5.9 | 3.5 | 8.8 | 4.2 | 59 | 71 | 1LE1004-1AB5 | 38 | 0.016 | |
| 4 | 4.55 | 112 M | 1465 | 26 | 91.1 | 91.6 | 91 | 0.81 | 7.8 | 3.1 | 8.3 | 4.3 | 63 | 75 | 1LE1004-1BB2 | 46 | 0.020 | |
| 5.5 | 6.3 | 132 S | 1470 | 36 | 91.9 | 92.5 | 92.3 | 0.83 | 10.4 | 2.6 | 8.3 | 3.5 | 56 | 68 | 1LE1004-1CB0 | 59 | 0.039 | |
| 7.5 | 8.6 | 132 S | 1470 | 49 | 92.6 | 93.1 | 92.7 | 0.81 | 14.4 | 3 | 7.7 | 4 | 56 | 68 | 1LE1004-1CB2 | 62 | 0.046 | |
| 11 | 12.6 | 160 M | 1475 | 71 | 93.3 | 93.5 | 92.9 | 0.82 | 21 | 2.9 | 8.1 | 4.1 | 63 | 76 | 1LE1004-1DB2 | 98 | 0.099 | |
| 15 | 17.3 | 160 L | 1480 | 97 | 93.9 | 94 | 93.3 | 0.8 | 29 | 3.7 | 7.8 | 4.3 | 63 | 76 | 1LE1004-1DB4 | 109 | 0.11 | |
| 18.5 | 21.3 | 180 M | 1470 | 120 | 94.2 | 94.7 | 94.5 | 0.81 | 35 | 2.7 | 7.9 | 3.6 | 59 | 72 | 1LE1004-1EB2 | 153 | 0.17 | |
| 22 | 25.3 | 180 L | 1475 | 142 | 94.5 | 95 | 94.8 | 0.81 | 41.5 | 2.9 | 7.7 | 3.8 | 59 | 72 | 1LE1004-1EB4 | 158 | 0.18 | |
| 30 | 34.5 | 200 L | 1475 | 194 | 94.9 | 95.2 | 94.9 | 0.81 | 56 | 3.2 | 7.3 | 3.6 | 60 | 73 | 1LE1004-2AB5 | 205 | 0.27 | |
| Voltages | | | | | | | | | | | | | | | Version | | Order code | |
| Frame sizes 100 L to 200 L: Use of the 4 x 90° rotatable terminal box | | | | | | | | | | | | | | | | | | |
| 50 Hz 230 VΔ/400 VY | | | 60 Hz ¹⁾ 460 VY | | | Standard | | 2 2 | | | | | | | | - | | |
| 50 Hz 400 VΔ/690 VY | | | 60 Hz ¹⁾ 460 VΔ | | | Standard | | 3 4 | | | | | | | | - | | |
| For other voltages ¹⁾ and more information, see from page 2/93 | | | | | | | | | | | | | | | 9 0 | | ... | |
| Types of construction | | | | | | | | | | | | | | | Version | | Order code | |
| Without flange | | | IM B3 ²⁾ | | | Standard | | A | | | | | | | | - | | |
| With flange | | | IM B5 ²⁾ | | | With additional charge | | F | | | | | | | | - | | |
| With flange | | | IM B14 ²⁾ | | | With additional charge | | K | | | | | | | | - | | |
| For other types of construction and more information, see from page 2/99 | | | | | | | | | | | | | | | | | ... | |
| Motor protection | | | | | | | | | | | | | | | Version | | Order code | |
| Frame sizes 100 L to 200 L: Use of the 4 x 90° rotatable terminal box | | | | | | | | | | | | | | | | | | |
| Without | | | | | | Standard | | A | | | | | | | | - | | |
| PTC thermistor with 3 temperature sensors | | | | | | With additional charge | | B | | | | | | | | - | | |
| For other motor protection and more information, see from page 2/112 | | | | | | | | | | | | | | | | | ... | |
| Terminal box position | | | | | | | | | | | | | | | Version | | Order code(s) | |
| Terminal box at top | | | | | | Standard | | 4 | | | | | | | | | | |
| For other terminal box positions and more information, see from page 2/115 | | | | | | | | | | | | | | | | | | |
| Special versions | | | | | | | | | | | | | | | | | Order code(s) | |
| Forced-air cooled motors w/o ext. fan/fan cover (IC418) | | | | | | | | | | | | | | | 1LE1004- | | -Z F90 +. . . +. . . | |
| For options, see from page 2/118 | | | | | | | | | | | | | | | 1LE1004- | | -Z . . . +. . . +. . . | |

2

¹⁾ Operating values at rated power for 60 Hz are stored in the Drive Technology Configurator (DT Configurator; see Appendix, "Tools and engineering").

²⁾ Types derived from IM B3 (IM B6/7/8, IM V6, and IM V5), from IM B5 (IM V3 and IM V1) and from IM B14 (IM V19 and IM V18) are possible, provided that no requirements exist for condensation drainage holes (H03) or stamping of the type on the rating plate. The basic type IM B3, IM B5, or IM B14 is stamped as standard on the rating plate. For orders with condensation drainage holes (H03), the type must be specified.

Selection and ordering data

| P _{rated} 50 Hz/ P50 kW | P _{rated} 60 Hz/ P60 kW | Frame size FS | Operating values at rated power | | | | | | | | | | | | | | Cast-iron series 1LE1504 – Basic Line Article No. | m _{IM B3} kg | J kgm ² |
|--|---|---------------------|------------------------------------|-----------------------------------|----------------------------------|----------------------------------|----------------------------------|----------------------------------|--------------------------------------|----------------------------------|--|--|--|--------------------------------|--------------------------|------|--|--------------------------|-----------------------|
| | | | n _{rated} 50 Hz rpm | T _{rated} 50 Hz Nm | η _{rated} 50 Hz % | η _{rated} 50 Hz % | η _{rated} 50 Hz % | η _{rated} 50 Hz % | cos φ _{rated} 50 Hz % | I _{rated} 50 Hz A | T _{L,R} /T _{rated} 50 Hz % | I _{L,R} /I _{rated} 50 Hz % | T _B /T _{rated} 50 Hz % | L _{pA} dB(A) | L _{WA} dB(A) | | | | |
| 3 | 3.45 | 100 L | 2920 | 9.8 | 89.1 | 89.8 | 89.4 | 0.86 | 5.7 | 3.7 | 9 | 4.9 | 62 | 74 | 1LE1504-1AA4 | 38 | 0.0054 | | |
| 4 | 4.55 | 112 M | 2950 | 13 | 90 | 90.4 | 89.7 | 0.89 | 7.2 | 2.6 | 8.8 | 4.1 | 68 | 80 | 1LE1504-1BA2 | 45 | 0.012 | | |
| 5.5 | 6.3 | 132 S | 2960 | 18 | 90.9 | 90.9 | 89.8 | 0.84 | 10.4 | 2.1 | 8.6 | 4.6 | 67 | 84 | 1LE1504-1CA0 | 62 | 0.024 | | |
| 7.5 | 8.6 | 132 S | 2955 | 24 | 91.7 | 92.4 | 92.3 | 0.91 | 13 | 2.2 | 8.6 | 4.3 | 67 | 80 | 1LE1504-1CA1 | 74 | 0.031 | | |
| 11 | 12.6 | 160 M | 2955 | 36 | 92.6 | 92.8 | 92 | 0.9 | 19.1 | 2.8 | 8.6 | 4.2 | 74 | 87 | 1LE1504-1DA2 | 113 | 0.061 | | |
| 15 | 17.3 | 160 M | 2955 | 48 | 93.3 | 93.5 | 92.9 | 0.9 | 26 | 3.1 | 9 | 4.5 | 74 | 87 | 1LE1504-1DA3 | 130 | 0.068 | | |
| 18.5 | 21.3 | 160 L | 2955 | 60 | 93.7 | 94.1 | 93.8 | 0.91 | 31.5 | 3.1 | 8.9 | 4.3 | 74 | 87 | 1LE1504-1DA4 | 147 | 0.074 | | |
| 22 | 24.5 | 180 M | 2950 | 71 | 94 | 94.4 | 94.1 | 0.89 | 38 | 2.8 | 8.9 | 4.3 | 71 | 84 | 1LE1504-1EA2 | 175 | 0.091 | | |
| 30 | 33.5 | 200 L | 2955 | 97 | 94.5 | 94.8 | 94.4 | 0.85 | 54 | 2.8 | 7.9 | 4 | 69 | 83 | 1LE1504-2AA4 | 222 | 0.13 | | |
| 37 | 41.5 | 200 L | 2955 | 120 | 94.8 | 95.1 | 94.9 | 0.88 | 64 | 2.9 | 7.8 | 4 | 69 | 83 | 1LE1504-2AA5 | 263 | 0.20 | | |
| 45 | 51 | 225 M | 2970 | 145 | 95 | 95 | 94.4 | 0.85 | 80 | 3.1 | 8.8 | 4.1 | 73 | 86 | 1LE1504-2BA2 | 330 | 0.26 | | |
| 55 | 62 | 250 M | 2978 | 176 | 95.3 | 95.2 | 94.5 | 0.88 | 95 | 2.5 | 7.5 | 3.2 | 73 | 86 | 1LE1504-2CA2 | 430 | 0.48 | | |
| 75 | 84 | 280 S | 2980 | 240 | 95.6 | 95.6 | 95 | 0.89 | 127 | 2.7 | 8.4 | 3.5 | 73 | 87 | 1LE1504-2DA0 | 610 | 0.94 | | |
| 90 | 101 | 280 M | 2978 | 289 | 95.8 | 95.9 | 95.4 | 0.89 | 152 | 2.7 | 8.4 | 3.5 | 77 | 91 | 1LE1504-2DA2 | 610 | 1.0 | | |
| 110 | 123 | 315 S | 2985 | 352 | 96 | 96 | 95.3 | 0.89 | 186 | 2.6 | 8.8 | 3.4 | 77 | 91 | 1LE1504-3AA0 | 750 | 1.4 | | |
| 132 | 148 | 315 M | 2988 | 422 | 96.2 | 96.2 | 95.6 | 0.9 | 220 | 3.1 | 10.5 | 4 | 77 | 91 | 1LE1504-3AA2 | 980 | 1.9 | | |
| 160 | 180 | 315 L | 2988 | 511 | 96.3 | 96.3 | 95.8 | 0.92 | 260 | 3.2 | 10.3 | 3.9 | 78 | 91 | 1LE1504-3AA4 | 1060 | 2.1 | | |
| 200 | 224 | 315 L | 2986 | 640 | 96.5 | 96.5 | 96.1 | 0.92 | 325 | 3.5 | 10 | 3.9 | 78 | 93 | 1LE1504-3AA5 | 1180 | 2.4 | | |
| Voltages ²⁾ | | | Version | | | | | | | | | | | Order code | | | | | |
| 50 Hz 230 VΔ/400 VY | | | 60 Hz ¹⁾ 460 VY | | | | | | | | | | | Standard | | | | | |
| 50 Hz 400 VΔ/690 VY | | | 60 Hz ¹⁾ 460 VA | | | | | | | | | | | Standard | | | | | |
| For other voltages and more information, see from page 2/96 | | | | | | | | | | | | | | ... | | | | | |
| Types of construction | | | Version | | | | | | | | | | | Order code | | | | | |
| Without flange | | | IM B3 ³⁾ | | | | | | | | | | | Standard | | | | | |
| With flange | | | IM B5 ³⁾ | | | | | | | | | | | With additional charge | | | | | |
| With flange | | | IM B5 ³⁾ | | | | | | | | | | | With additional charge | | | | | |
| For other types of construction and more information, see from page 2/103 | | | | | | | | | | | | | | ... | | | | | |
| Motor protection | | | Version | | | | | | | | | | | Order code | | | | | |
| Without | | | Standard | | | | | | | | | | | A | | | | | |
| PTC thermistor with 3 temperature sensors | | | With additional charge | | | | | | | | | | | B | | | | | |
| For other motor protection and more information, see from page 2/113 | | | | | | | | | | | | | | ... | | | | | |
| Terminal box position | | | Version | | | | | | | | | | | Order code | | | | | |
| Terminal box at top | | | Standard | | | | | | | | | | | 4 | | | | | |
| For other terminal box positions and more information, see from page 2/116 | | | | | | | | | | | | | | ... | | | | | |
| Special versions | | | | | | | | | | | | | | Order code(s) | | | | | |
| Forced-air cooled motors w/o ext. fan/fan cover (IC418) | | | | | | | | | | | | | | 1LE1504-...-Z F90 +...+...+... | | | | | |
| For options, see from page 2/125 | | | | | | | | | | | | | | 1LE1504-...-Z ...+...+...+... | | | | | |

Note: IE4 motors (2-pole) in frame size 315 do not comply with the vibration values stipulated in IEC 60034-14 when rigidly installed (see also page 1/50).

¹⁾ Operating values at rated power for 60 Hz are stored in the Drive Technology Configurator (DT Configurator; see Appendix, "Tools and engineering").

²⁾ Parallel supply lines are required in the case of connection to ≤ 240 V. For frame size 315 with connection to ≤ 240 V, due to the high current, a drilled, removable entry plate (order code **R52**) or a larger terminal box (order code **R50**) can be used. Order codes **R52** and **R50** alter the motor dimensions.

³⁾ Types derived from IM B3 (IM B6/7/8, IM V6 and IM V5), from IM B5 (IM V3 and IM V1) and from IM B14 (IM V19 and IM V18) are possible, provided that no requirement exists for stamping of the type on the rating plate. The basic type IM B3, IM B5, or IM B14 is stamped as standard on the rating plate. If mounted in a different position, the position must be specified to ensure that the condensation drainage holes are positioned correctly.



SIMOTICS GP and SIMOTICS SD standard motors
IE4 Super Premium Efficiency

Cast-iron series SIMOTICS SD 1LE1504 Basic Line – self-ventilated or forced-air cooled

Selection and ordering data

| Operating values at rated power | | | | | | | | | | | | | | | Cast-iron series | | m _{IM B3} | J | | |
|--|---------------------------------|---------------------|----------------------------|----------------------------|--------------------|----------------------------|----------------------------|----------------------------|--------------------------------|----------------------------|--|--|--|--------------------------|-------------------------|----------------------|-----------------------|-------|-------------|----|
| P _{rated} , 50 Hz/ P50 | P _{rated} , 60 Hz/ P60 | Frame size | n _{rated} , 50 Hz | T _{rated} , 50 Hz | Different IE class | η _{rated} , 50 Hz | η _{rated} , 50 Hz | η _{rated} , 50 Hz | cos φ _{rated} , 50 Hz | I _{rated} , 50 Hz | T _r /I _r , 50 Hz | I _L /I _r , 50 Hz | T _B /I _r , 50 Hz | L _{pfA} , 50 Hz | L _{WA} , 50 Hz | 1LE1504 – Basic Line | | | Article No. | kg |
| kW | kW | FS | rpm | Nm | 60 Hz/P60 | % | % | % | % | A | | | | | | | | | | |
| • Cooling: Self-ventilated (IC411) or with order code F90 forced-air cooled without external fan and fan cover (IC418) • Efficiency according to IEC 60034-30-1: IE4 Super Premium Efficiency, service factor (SF) 1.15 • Insulation: Thermal class 155 (temperature class F), IP55 degree of protection, utilization in accordance with thermal class 130 (temperature class B) | | | | | | | | | | | | | | | | | | | | |
| 4-pole: 1500 rpm at 50 Hz, 1800 rpm at 60 Hz | | | | | | | | | | | | | | | | | | | | |
| 2.2 | 2.55 | 100 L | 1465 | 14 | | 89.5 | 89.6 | 88.3 | 0.79 | 4.5 | 3.3 | 8.5 | 4.7 | 59 | 71 | 1LE1504-1AB4 | 41 | 0.014 | | |
| 3 | 3.45 | 100 L | 1460 | 20 | | 90.4 | 91 | 90.5 | 0.81 | 5.9 | 3.5 | 8.8 | 4.2 | 59 | 71 | 1LE1504-1AB5 | 50 | 0.016 | | |
| 4 | 4.55 | 112 M | 1465 | 26 | | 91.1 | 91.6 | 91 | 0.81 | 7.8 | 3.1 | 8.3 | 4.3 | 63 | 75 | 1LE1504-1BB2 | 58 | 0.020 | | |
| 5.5 | 6.3 | 132 S | 1470 | 36 | | 91.9 | 92.5 | 92.3 | 0.83 | 10.4 | 2.6 | 8.3 | 3.5 | 56 | 68 | 1LE1504-1CB0 | 77 | 0.039 | | |
| 7.5 | 8.6 | 132 M | 1470 | 49 | | 92.6 | 93.1 | 92.7 | 0.81 | 14.4 | 3 | 7.7 | 4 | 56 | 68 | 1LE1504-1CB2 | 80 | 0.046 | | |
| 11 | 12.6 | 160 M | 1475 | 71 | | 93.3 | 93.5 | 92.9 | 0.82 | 21 | 2.9 | 8.1 | 4.1 | 63 | 76 | 1LE1504-1DB2 | 127 | 0.099 | | |
| 15 | 17.3 | 160 L | 1480 | 97 | | 93.9 | 94 | 93.3 | 0.8 | 29 | 3.7 | 7.8 | 4.3 | 63 | 76 | 1LE1504-1DB4 | 138 | 0.11 | | |
| 18.5 | 21.3 | 180 M | 1470 | 120 | | 94.2 | 94.7 | 94.5 | 0.81 | 35 | 2.7 | 7.9 | 3.6 | 59 | 72 | 1LE1504-1EB2 | 187 | 0.17 | | |
| 22 | 25.3 | 180 L | 1475 | 142 | | 94.5 | 95 | 94.8 | 0.81 | 41.5 | 2.9 | 7.7 | 3.8 | 59 | 72 | 1LE1504-1EB4 | 192 | 0.18 | | |
| 30 | 34.5 | 200 L | 1475 | 194 | | 94.9 | 95.2 | 94.9 | 0.81 | 56 | 3.2 | 7.3 | 3.6 | 60 | 73 | 1LE1504-2AB5 | 258 | 0.27 | | |
| 37 | 42.5 | 225 S | 1485 | 238 | | 95.2 | 95.5 | 95.2 | 0.84 | 67 | 3.2 | 8.4 | 3.2 | 69 | 83 | 1LE1504-2BB0 | 345 | 0.52 | | |
| 45 | 52 | 225 M | 1485 | 289 | IE3 | 95.4 | 95.7 | 95.4 | 0.84 | 81 | 3.4 | 8 | 3.3 | 69 | 83 | 1LE1504-2BB2 | 415 | 0.66 | | |
| 55 | 63 | 250 M | 1486 | 353 | | 95.7 | 95.8 | 95.4 | 0.86 | 96 | 3 | 8.2 | 3.3 | 68 | 82 | 1LE1504-2CB2 | 490 | 1.1 | | |
| 75 | 86 | 280 S | 1490 | 481 | | 96 | 96.1 | 95.6 | 0.85 | 133 | 3.4 | 9.2 | 3.8 | 69 | 83 | 1LE1504-2DB0 | 670 | 1.7 | | |
| 90 | 104 | 280 M | 1488 | 578 | | 96.1 | 96.3 | 96.1 | 0.86 | 157 | 3.2 | 9 | 3.4 | 70 | 84 | 1LE1504-2DB2 | 730 | 2.0 | | |
| 110 | 127 | 315 M ⁴⁾ | 1491 | 705 | | 96.3 | 96.4 | 95.9 | 0.86 | 192 | 3.2 | 8.6 | 3.3 | 73 | 87 | 1LE1504-3AB0 | 910 | 2.7 | | |
| 132 | 152 | 315 M | 1491 | 845 | | 96.4 | 96.6 | 96.2 | 0.87 | 225 | 3.3 | 8.7 | 3.3 | 73 | 87 | 1LE1504-3AB2 | 990 | 3.1 | | |
| 160 | 184 | 315 L | 1490 | 1025 | | 96.6 | 96.7 | 96.5 | 0.86 | 280 | 3.6 | 9 | 3.2 | 76 | 90 | 1LE1504-3AB4 | 1180 | 3.7 | | |
| 200 | 230 | 315 L | 1490 | 1282 | | 96.7 | 96.9 | 96.6 | 0.86 | 345 | 3.8 | 9.2 | 3.4 | 76 | 90 | 1LE1504-3AB5 | 1300 | 4.4 | | |
| Voltages²⁾ | | | | | | | | | | | | | | | Version | | Order code | | | |
| 50 Hz 230 VΔ/400 VY | | | 60 Hz ¹⁾ 460 VY | | | Standard | | 2 2 | | - | | | | | | | | | | |
| 50 Hz 400 VΔ/690 VY | | | 60 Hz ¹⁾ 460 VΔ | | | Standard | | 3 4 | | - | | | | | | | | | | |
| For other voltages and more information, see from page 2/96 | | | | | | | | | | | | | | | 9 0 | | ... | | | |
| Types of construction | | | | | | | | | | | | | | | Version | | Order code | | | |
| Without flange | | | IM B3 ³⁾ | | | Standard | | A | | - | | | | | | | | | | |
| With flange | | | IM B5 ³⁾ | | | With additional charge | | F | | - | | | | | | | | | | |
| With flange | | | IM B5 ³⁾ | | | With additional charge | | K | | - | | | | | | | | | | |
| For other types of construction and more information, see from page 2/103 | | | | | | | | | | | | | | | | | ... | | | |
| Motor protection | | | | | | | | | | | | | | | Version | | Order code | | | |
| Without | | | | | | Standard | | A | | - | | | | | | | | | | |
| PTC thermistor with 3 temperature sensors | | | | | | With additional charge | | B | | - | | | | | | | | | | |
| For other motor protection and more information, see from page 2/113 | | | | | | | | | | | | | | | | | ... | | | |
| Terminal box position | | | | | | | | | | | | | | | Version | | Order code | | | |
| Terminal box at top | | | | | | Standard | | 4 | | | | | | | | | | | | |
| For other terminal box positions and more information, see from page 2/116 | | | | | | | | | | | | | | | | | | | | |
| Special versions | | | | | | | | | | | | | | | | | Order code(s) | | | |
| Forced-air cooled motors w/o ext. fan/fan cover (IC418) | | | | | | | | | | | | | | | 1LE1504- -Z | | F90 + . . . + . . . | | | |
| For options, see from page 2/125 | | | | | | | | | | | | | | | 1LE1504- -Z | | . . . + . . . + . . . | | | |

2

1) Operating values at rated power for 60 Hz are stored in the Drive Technology Configurator (DT Configurator; see Appendix, "Tools and engineering").
 2) Parallel supply lines are required in the case of connection to ≤ 240 V. For frame size 315 with connection to ≤ 240 V, due to the high current, a drilled, removable entry plate (order code R52) or a larger terminal box (order code R50) can be used. Order codes R52 and R50 alter the motor dimensions.

3) Types derived from IM B3 (IM B6/7/8, IM V6 and IM V5), from IM B5 (IM V3 and IM V1) and from IM B14 (IM V19 and IM V18) are possible, provided that no requirement exists for stamping of the type on the rating plate. The basic type IM B3, IM B5, or IM B14 is stamped as standard on the rating plate. If mounted in a different position, the position must be specified to ensure that the condensation drainage holes are positioned correctly.
 4) As 315 M version (not the same as 315 S according to EN 50347).



Selection and ordering data

| P _{rated} 50 Hz/ P50 kW | P _{rated} 60 Hz/ P60 kW | Frame size FS | Operating values at rated power | | | | | | | | | | | | | Cast-iron series 1LE1604 – Performance Line Article No. | m _{IM B3} kg | J kgm ² | |
|--|---|---------------------|------------------------------------|-----------------------------------|----------------------------------|----------------------------------|----------------------------------|-------------------------------------|----------------------------------|---|---|---|------------------------------------|-----------------------------------|---------------------|--|--------------------------|-----------------------|--|
| | | | n _{rated} 50 Hz rpm | T _{rated} 50 Hz Nm | η _{rated} 50 Hz % | η _{rated} 50 Hz % | η _{rated} 50 Hz % | cosφ _{rated} 50 Hz % | I _{rated} 50 Hz A | T _{L,R} / T _{rated} 50 Hz | I _{L,R} / I _{rated} 50 Hz | T _B / T _{rated} 50 Hz | L _{pFA} 50 Hz dB(A) | L _{WA} 50 Hz dB(A) | | | | | |
| 3 | 3.45 | 100 L | 2920 | 9.8 | 89.1 | 89.8 | 89.4 | 0.86 | 5.7 | 3.7 | 9 | 4.9 | 62 | 74 | 1LE1604-1AA4 | 38 | 0.0054 | | |
| 4 | 4.55 | 112 M | 2950 | 13 | 90 | 90.4 | 89.7 | 0.89 | 7.2 | 2.6 | 8.8 | 4.1 | 68 | 80 | 1LE1604-1BA2 | 45 | 0.012 | | |
| 5.5 | 6.3 | 132 S | 2960 | 18 | 90.9 | 90.9 | 89.8 | 0.84 | 10.4 | 2.1 | 8.6 | 4.6 | 67 | 84 | 1LE1604-1CA0 | 62 | 0.024 | | |
| 7.5 | 8.6 | 132 S | 2955 | 24 | 91.7 | 92.4 | 92.3 | 0.91 | 13 | 2.2 | 8.6 | 4.3 | 67 | 80 | 1LE1604-1CA1 | 74 | 0.031 | | |
| 11 | 12.6 | 160 M | 2955 | 36 | 92.6 | 92.8 | 92 | 0.9 | 19.1 | 2.8 | 8.6 | 4.2 | 74 | 87 | 1LE1604-1DA2 | 113 | 0.061 | | |
| 15 | 17.3 | 160 M | 2955 | 48 | 93.3 | 93.5 | 92.9 | 0.9 | 26 | 3.1 | 9 | 4.5 | 74 | 87 | 1LE1604-1DA3 | 130 | 0.068 | | |
| 18.5 | 21.3 | 160 L | 2955 | 60 | 93.7 | 94.1 | 93.8 | 0.91 | 31.5 | 3.1 | 8.9 | 4.3 | 74 | 87 | 1LE1604-1DA4 | 147 | 0.074 | | |
| 22 | 24.5 | 180 M | 2950 | 71 | 94 | 94.4 | 94.1 | 0.89 | 38 | 2.8 | 8.9 | 4.3 | 71 | 84 | 1LE1604-1EA2 | 175 | 0.091 | | |
| 30 | 33.5 | 200 L | 2955 | 97 | 94.5 | 94.8 | 94.4 | 0.85 | 54 | 2.8 | 7.9 | 4 | 69 | 83 | 1LE1604-2AA4 | 222 | 0.13 | | |
| 37 | 41.5 | 200 L | 2955 | 120 | 94.8 | 95.1 | 94.9 | 0.88 | 64 | 2.9 | 7.8 | 4 | 69 | 83 | 1LE1604-2AA5 | 263 | 0.20 | | |
| 45 | 51 | 225 M | 2970 | 145 | 95 | 95 | 94.4 | 0.85 | 80 | 3.1 | 8.8 | 4.1 | 73 | 86 | 1LE1604-2BA2 | 330 | 0.26 | | |
| 55 | 62 | 250 M | 2978 | 176 | 95.3 | 95.2 | 94.5 | 0.88 | 95 | 2.5 | 7.5 | 3.2 | 73 | 86 | 1LE1604-2CA2 | 430 | 0.48 | | |
| 75 | 84 | 280 S | 2980 | 240 | 95.6 | 95.6 | 95 | 0.89 | 127 | 2.7 | 8.4 | 3.5 | 73 | 87 | 1LE1604-2DA0 | 610 | 0.94 | | |
| 90 | 101 | 280 M | 2978 | 289 | 95.8 | 95.9 | 95.4 | 0.89 | 152 | 2.7 | 8.4 | 3.5 | 77 | 91 | 1LE1604-2DA2 | 610 | 1.0 | | |
| 110 | 123 | 315 S | 2985 | 352 | 96 | 96 | 95.3 | 0.89 | 186 | 2.6 | 8.8 | 3.4 | 77 | 91 | 1LE1604-3AA0 | 750 | 1.4 | | |
| 132 | 148 | 315 M | 2988 | 422 | 96.2 | 96.2 | 95.6 | 0.9 | 220 | 3.1 | 10.5 | 4 | 77 | 91 | 1LE1604-3AA2 | 980 | 1.9 | | |
| 160 | 180 | 315 L | 2988 | 511 | 96.3 | 96.3 | 95.8 | 0.92 | 260 | 3.2 | 10.3 | 3.9 | 78 | 91 | 1LE1604-3AA4 | 1060 | 2.1 | | |
| 200 | 224 | 315 L | 2986 | 640 | 96.5 | 96.5 | 96.1 | 0.92 | 325 | 3.5 | 10 | 3.9 | 78 | 93 | 1LE1604-3AA5 | 1180 | 2.4 | | |
| Voltages ²⁾ | | | Version | | | | | | | | | | | Order code | | | | | |
| 50 Hz 230 VΔ/400 VY | | | Standard | | | | | | | | | | | 2 2 | | - | | | |
| 50 Hz 400 VΔ/690 VY | | | Standard | | | | | | | | | | | 3 4 | | - | | | |
| For other voltages and more information, see from page 2/96 | | | | | | | | | | | | | | 9 0 | | ... | | | |
| Types of construction | | | Version | | | | | | | | | | | Order code | | | | | |
| Without flange | | | IM B3 ³⁾ | | | | | | | | | | | Standard | | A | | - | |
| With flange | | | IM B5 ³⁾ | | | | | | | | | | | With additional charge | | F | | - | |
| With flange | | | IM B5 ³⁾ | | | | | | | | | | | With additional charge | | K | | - | |
| For other types of construction and more information, see from page 2/103 | | | | | | | | | | | | | | | | | | ... | |
| Motor protection | | | Version | | | | | | | | | | | Order code | | | | | |
| PTC thermistor with 3 temperature sensors | | | Standard | | | | | | | | | | | B | | - | | | |
| For other motor protection and more information, see from page 2/113 | | | | | | | | | | | | | | | | | | ... | |
| Terminal box position | | | Version | | | | | | | | | | | Order code | | | | | |
| Terminal box at top | | | Standard | | | | | | | | | | | 4 | | | | | |
| For other terminal box positions and more information, see from page 2/116 | | | | | | | | | | | | | | | | | | | |
| Special versions | | | | | | | | | | | | | | Order code(s) | | | | | |
| Forced-air cooled motors w/o ext. fan/fan cover (IC418) | | | | | | | | | | | | | | 1LE1604-...-Z F90 +...+...+... | | | | | |
| For options, see from page 2/125 | | | | | | | | | | | | | | 1LE1604-...-Z ...+...+...+... | | | | | |

Note: IE4 motors (2-pole) in frame size 315 do not comply with the vibration values stipulated in IEC 60034-14 when rigidly installed (see also page 1/50).

¹⁾ Operating values at rated power for 60 Hz are stored in the Drive Technology Configurator (DT Configurator; see Appendix, "Tools and engineering").

²⁾ Parallel supply lines are required in the case of connection to ≤ 240 V. For frame size 315 with connection to ≤ 240 V, due to the high current, a drilled, removable entry plate (order code **R52**) or a larger terminal box (order code **R50**) can be used. Order codes **R52** and **R50** alter the motor dimensions.

³⁾ Types derived from IM B3 (IM B6/7/8, IM V6 and IM V5), from IM B5 (IM V3 and IM V1) and from IM B14 (IM V19 and IM V18) are possible, provided that no requirement exists for stamping of the type on the rating plate. The basic type IM B3, IM B5, or IM B14 is stamped as standard on the rating plate. If mounted in a different position, the position must be specified to ensure that the condensation drainage holes are positioned correctly.



SIMOTICS GP and SIMOTICS SD standard motors

IE4 Super Premium Efficiency



Cast-iron series SIMOTICS SD 1LE1604 Performance Line – self-ventilated or forced-air cooled

Selection and ordering data

| P _{rated} 50 Hz/ P50 | P _{rated} 60 Hz/ P60 | Frame size | Operating values at rated power | | | | | | | | | | | | | Cast-iron series 1LE1604 – Performance Line Article No. | m _{IM B3} kg | J kgm ² | | | | | | | | | | | | | | |
|--|-------------------------------------|---------------------|---------------------------------|----------------------|------------------------------------|-------------------------|-------------------------|-------------------------|-----------------------------|----------------------|-----------------------------------|-----------------------------------|--------------------------------|------------------|-----------------|--|--------------------------|-----------------------|---------------|-----|---|---|---|---|---|---|---|---|---|---|---|---|
| | | | η_{rated} 50 Hz | T_{rated} 50 Hz | Different IE class 60 Hz/P60 | η_{rated} 50 Hz | η_{rated} 50 Hz | η_{rated} 50 Hz | $\cos\phi_{rated}$ 50 Hz | I_{rated} 50 Hz | $T_{LR}/$ T_{rated} 50 Hz | $I_{LR}/$ I_{rated} 50 Hz | $T_B/$ T_{rated} 50 Hz | L _{pfA} | L _{WA} | | | | | | | | | | | | | | | | | |
| kW | kW | FS | rpm | Nm | % | % | % | % | A | | | | | | | | | | | | | | | | | | | | | | | |
| 4-pole: 1500 rpm at 50 Hz, 1800 rpm at 60 Hz | | | | | | | | | | | | | | | | | | | | | | | | | | | | | | | | |
| 2.2 | 2.55 | 100 L | 1465 | 14 | | | 89.5 | 89.6 | 88.3 | 0.79 | 4.5 | 3.3 | 8.5 | 4.7 | 59 | 71 | 1LE1604-1AB4 | 41 | 0.014 | | | | | | | | | | | | | |
| 3 | 3.45 | 100 L | 1460 | 20 | | | 90.4 | 91 | 90.5 | 0.81 | 5.9 | 3.5 | 8.8 | 4.2 | 59 | 71 | 1LE1604-1AB5 | 50 | 0.016 | | | | | | | | | | | | | |
| 4 | 4.55 | 112 M | 1465 | 26 | | | 91.1 | 91.6 | 91 | 0.81 | 7.8 | 3.1 | 8.3 | 4.3 | 63 | 75 | 1LE1604-1BB2 | 58 | 0.020 | | | | | | | | | | | | | |
| 5.5 | 6.3 | 132 S | 1470 | 36 | | | 91.9 | 92.5 | 92.3 | 0.83 | 10.4 | 2.6 | 8.3 | 3.5 | 56 | 68 | 1LE1604-1CB0 | 77 | 0.039 | | | | | | | | | | | | | |
| 7.5 | 8.6 | 132 M | 1470 | 49 | | | 92.6 | 93.1 | 92.7 | 0.81 | 14.4 | 3 | 7.7 | 4 | 56 | 68 | 1LE1604-1CB2 | 80 | 0.046 | | | | | | | | | | | | | |
| 11 | 12.6 | 160 M | 1475 | 71 | | | 93.3 | 93.5 | 92.9 | 0.82 | 21 | 2.9 | 8.1 | 4.1 | 63 | 76 | 1LE1604-1DB2 | 127 | 0.099 | | | | | | | | | | | | | |
| 15 | 17.3 | 160 L | 1480 | 97 | | | 93.9 | 94 | 93.3 | 0.8 | 29 | 3.7 | 7.8 | 4.3 | 63 | 76 | 1LE1604-1DB4 | 138 | 0.11 | | | | | | | | | | | | | |
| 18.5 | 21.3 | 180 M | 1470 | 120 | | | 94.2 | 94.7 | 94.5 | 0.81 | 35 | 2.7 | 7.9 | 3.6 | 59 | 72 | 1LE1604-1EB2 | 187 | 0.17 | | | | | | | | | | | | | |
| 22 | 25.3 | 180 L | 1475 | 142 | | | 94.5 | 95 | 94.8 | 0.81 | 41.5 | 2.9 | 7.7 | 3.8 | 59 | 72 | 1LE1604-1EB4 | 192 | 0.18 | | | | | | | | | | | | | |
| 30 | 34.5 | 200 L | 1475 | 194 | | | 94.9 | 95.2 | 94.9 | 0.81 | 56 | 3.2 | 7.3 | 3.6 | 60 | 73 | 1LE1604-2AB5 | 258 | 0.27 | | | | | | | | | | | | | |
| 37 | 42.5 | 225 S | 1485 | 238 | | | 95.2 | 95.5 | 95.2 | 0.84 | 67 | 3.2 | 8.4 | 3.2 | 69 | 83 | 1LE1604-2BB0 | 345 | 0.52 | | | | | | | | | | | | | |
| 45 | 52 | 225 M | 1485 | 289 | IE3 | | 95.4 | 95.7 | 95.4 | 0.84 | 81 | 3.4 | 8 | 3.3 | 69 | 83 | 1LE1604-2BB2 | 415 | 0.66 | | | | | | | | | | | | | |
| 55 | 63 | 250 M | 1486 | 353 | | | 95.7 | 95.8 | 95.4 | 0.86 | 96 | 3 | 8.2 | 3.3 | 68 | 82 | 1LE1604-2CB2 | 490 | 1.1 | | | | | | | | | | | | | |
| 75 | 86 | 280 S | 1490 | 481 | | | 96 | 96.1 | 95.6 | 0.85 | 133 | 3.4 | 9.2 | 3.8 | 69 | 83 | 1LE1604-2DB0 | 670 | 1.7 | | | | | | | | | | | | | |
| 90 | 104 | 280 M | 1488 | 578 | | | 96.1 | 96.3 | 96.1 | 0.86 | 157 | 3.2 | 9 | 3.4 | 70 | 84 | 1LE1604-2DB2 | 730 | 2.0 | | | | | | | | | | | | | |
| 110 | 127 | 315 M ⁴⁾ | 1491 | 705 | | | 96.3 | 96.4 | 95.9 | 0.86 | 192 | 3.2 | 8.6 | 3.3 | 73 | 87 | 1LE1604-3AB0 | 910 | 2.7 | | | | | | | | | | | | | |
| 132 | 152 | 315 M | 1491 | 845 | | | 96.4 | 96.6 | 96.2 | 0.87 | 225 | 3.3 | 8.7 | 3.3 | 73 | 87 | 1LE1604-3AB2 | 990 | 3.1 | | | | | | | | | | | | | |
| 160 | 184 | 315 L | 1490 | 1025 | | | 96.6 | 96.7 | 96.5 | 0.86 | 280 | 3.6 | 9 | 3.2 | 76 | 90 | 1LE1604-3AB4 | 1180 | 3.7 | | | | | | | | | | | | | |
| 200 | 230 | 315 L | 1490 | 1282 | | | 96.7 | 96.9 | 96.6 | 0.86 | 345 | 3.8 | 9.2 | 3.4 | 76 | 90 | 1LE1604-3AB5 | 1300 | 4.4 | | | | | | | | | | | | | |
| Voltages²⁾ | | | | | | | | | | | | | | | Version | | | | Order code | | | | | | | | | | | | | |
| 50 Hz 230 VΔ/400 VY | | | 60 Hz ¹⁾ 460 VY | | | Standard | | | 2 | 2 | | | | | | | | | | – | | | | | | | | | | | | |
| 50 Hz 400 VΔ/690 VY | | | 60 Hz ¹⁾ 460 VΔ | | | Standard | | | 3 | 4 | | | | | | | | | | – | | | | | | | | | | | | |
| For other voltages and more information, see from page 2/96 | | | | | | | | | | | | | | | 9 | 0 | | | ... | | | | | | | | | | | | | |
| Types of construction | | | | | | | | | | | | | | | Version | | | | Order code | | | | | | | | | | | | | |
| Without flange | | | IM B3 ³⁾ | | | Standard | | | A | | | | | | | | | | | – | | | | | | | | | | | | |
| With flange | | | IM B5 ³⁾ | | | With additional charge | | | F | | | | | | | | | | | – | | | | | | | | | | | | |
| With flange | | | IM B5 ³⁾ | | | With additional charge | | | K | | | | | | | | | | | – | | | | | | | | | | | | |
| For other types of construction and more information, see from page 2/103 | | | | | | | | | | | | | | | | | | | ... | | | | | | | | | | | | | |
| Motor protection | | | | | | | | | | | | | | | Version | | | | Order code | | | | | | | | | | | | | |
| PTC thermistor with 3 temperature sensors | | | Standard | | | Standard | | | B | | | | | | | | | | | – | | | | | | | | | | | | |
| For other motor protection and more information, see from page 2/113 | | | | | | | | | | | | | | | | | | | ... | | | | | | | | | | | | | |
| Terminal box position | | | | | | | | | | | | | | | Version | | | | Order code | | | | | | | | | | | | | |
| Terminal box at top | | | Standard | | | Standard | | | 4 | | | | | | | | | | | – | | | | | | | | | | | | |
| For other terminal box positions and more information, see from page 2/116 | | | | | | | | | | | | | | | | | | | ... | | | | | | | | | | | | | |
| Special versions | | | | | | | | | | | | | | | | | | | Order code(s) | | | | | | | | | | | | | |
| Forced-air cooled motors w/o ext. fan/fan cover (IC418) | | | | | | | | | | | | | | | 1LE1604-.... | | | | -Z | F90 | + | + | + | + | + | + | + | + | + | + | + | + |
| For options, see from page 2/125 | | | | | | | | | | | | | | | 1LE1604-.... | | | | -Z | ... | + | + | + | + | + | + | + | + | + | + | + | + |

2

¹⁾ Operating values at rated power for 60 Hz are stored in the Drive Technology Configurator (DT Configurator; see Appendix, "Tools and engineering").

²⁾ Parallel supply lines are required in the case of connection to ≤ 240 V. For frame size 315 with connection to ≤ 240 V, due to the high current, a drilled, removable entry plate (order code **R52**) or a larger terminal box (order code **R50**) can be used. Order codes **R52** and **R50** alter the motor dimensions.

³⁾ Types derived from IM B3 (IM B6/7/8, IM V6 and IM V5), from IM B5 (IM V3 and IM V1) and from IM B14 (IM V19 and IM V18) are possible, provided that no requirement exists for stamping of the type on the rating plate. The basic type IM B3, IM B5, or IM B14 is stamped as standard on the rating plate. If mounted in a different position, the position must be specified to ensure that the condensation drainage holes are positioned correctly.

⁴⁾ As 315 M version (not the same as 315 S according to EN 50347).



Selection and ordering data

| Operating values at rated power | | | | | | | | | | | | | | | Aluminum series | | | |
|--|--|---------------|----------------------------|----------------------|-----------------------|---------------------------|-------------------------|-------------------------|-----------------------------|----------------------|-----------------------------|-----------------------------|--------------------------|--------------------|-------------------|------------------------------|---------------|------------------|
| P_{rated} 50 Hz/ P50 | P_{rated} 60 Hz/ P60 ¹⁾ | Frame size | n_{rated} 50 Hz | T_{rated} 50 Hz | Different IE class | η_{rated} 50 Hz | η_{rated} 50 Hz | η_{rated} 50 Hz | $\cos\phi_{rated}$ 50 Hz | I_{rated} 50 Hz | T_{LR}/I_{rated} 50 Hz | I_{LR}/I_{rated} 50 Hz | T_B/I_{rated} 50 Hz | L_{pFA} 50 Hz | L_{WA} 50 Hz | 1LE1003 | $m_{IM B3}$ | J |
| kW | kW | FS | rpm | Nm | 60 Hz/P60 | % | % | % | % | A | A | A | A | dB(A) | dB(A) | Article No. | kg | kgm ² |
| • Cooling: Self-ventilated (IC411) or with order code F90 forced-air cooled without external fan and fan cover (IC418) • Efficiency according to IEC 60034-30-1: IE3 Premium Efficiency, service factor (SF) 1.15 • Insulation: Thermal class 155 (temperature class F), IP55 degree of protection, utilization in accordance with thermal class 130 (temperature class B) | | | | | | | | | | | | | | | | | | |
| 2-pole: 3000 rpm at 50 Hz, 3600 rpm at 60 Hz ¹⁾ | | | | | | | | | | | | | | | | | | |
| 0.75 | 0.86 | 80 M | 2850 | 2.5 | | 80.7 | 82.2 | 81.9 | 0.86 | 1.56 | 2.6 | 6.2 | 3 | 60 | 71 | 1LE1003-0DA2 | 11 | 0.0011 |
| 1.1 | 1.27 | 80 M | 2885 | 3.6 | | 82.7 | 83.9 | 83.1 | 0.85 | 2.25 | 3 | 7.1 | 3.3 | 60 | 71 | 1LE1003-0DA3 | 12 | 0.0013 |
| 1.5 | 1.75 | 90 S | 2910 | 4.9 | | 84.2 | 84.6 | 83.2 | 0.86 | 3 | 2.7 | 8.1 | 4.2 | 65 | 77 | 1LE1003-0EA0 | 15 | 0.0021 |
| 2.2 | 2.55 | 90 L | 2910 | 7.2 | | 85.9 | 86.8 | 86.1 | 0.88 | 4.2 | 2.6 | 8.3 | 4 | 65 | 77 | 1LE1003-0EA4 | 19 | 0.0031 |
| 3 | 3.45 | 100 L | 2920 | 9.8 | | 87.1 | 87.9 | 87.5 | 0.88 | 5.6 | 3.2 | 8.1 | 4.6 | 71 | 79 | 1LE1003-1AA4 | 26 | 0.0054 |
| 4 | 4.55 | 112 M | 2950 | 13 | | 88.1 | 88.7 | 88.2 | 0.89 | 7.4 | 2.5 | 8.7 | 4 | 73 | 81 | 1LE1003-1BA2 | 34 | 0.012 |
| 5.5 | 6.3 | 132 S | 2950 | 18 | | 89.2 | 90.1 | 89.7 | 0.9 | 9.9 | 1.9 | 7.3 | 3.7 | 72 | 80 | 1LE1003-1CA0 | 43 | 0.024 |
| 7.5 | 8.6 | 132 S | 2950 | 24.5 | | 90.1 | 91 | 91 | 0.92 | 13.1 | 1.9 | 8.3 | 3.9 | 68 | 80 | 1LE1003-1CA1 | 57 | 0.031 |
| 11 | 12.6 | 160 M | 2955 | 35.5 | | 91.2 | 91 | 89.5 | 0.89 | 19.6 | 2.4 | 7.9 | 3.8 | 70 | 82 | 1LE1003-1DA2 | 75 | 0.053 |
| 15 | 17.3 | 160 M | 2960 | 48 | | 91.9 | 91.9 | 91 | 0.87 | 27 | 2.8 | 8.8 | 4.3 | 74 | 82 | 1LE1003-1DA3 | 84 | 0.061 |
| 18.5 | 21.3 | 160 L | 2955 | 60 | | 92.4 | 92.8 | 92.4 | 0.9 | 32 | 2.8 | 9 | 4.2 | 70 | 82 | 1LE1003-1DA4 | 94 | 0.068 |
| 22 | 24.5 | 180 M | 2950 | 71 | | 92.7 | 93.2 | 92.9 | 0.89 | 38.5 | 2.3 | 7.5 | 3.5 | 67 | 80 | 1LE1003-1EA2 | 122 | 0.08 |
| 30 | 33.5 | 200 L | 2955 | 97 | | 93.3 | 93.5 | 92.9 | 0.87 | 53 | 2.5 | 7 | 3.3 | 67 | 80 | 1LE1003-2AA4 | 173 | 0.134 |
| 37 | 41.5 | 200 L | 2955 | 120 | | 93.7 | 94.2 | 94 | 0.88 | 65 | 2.5 | 7.1 | 3.2 | 67 | 80 | 1LE1003-2AA5 | 194 | 0.158 |
| Voltages | | | | | | | | | | | | | | | Version | | Order code | |
| 50 Hz 230 VΔ/400 VY | | | 60 Hz ¹⁾ 460 VY | | | Standard | | 2 2 | | - | | | | | | | | |
| 50 Hz 400 VΔ/690 VY | | | 60 Hz ¹⁾ 460 VA | | | Standard | | 3 4 | | - | | | | | | | | |
| 50 Hz 500 VY | | | | | | Without additional charge | | 2 7 | | - | | | | | | | | |
| 50 Hz 500 VΔ | | | | | | Without additional charge | | 4 0 | | - | | | | | | | | |
| For other voltages ¹⁾ and more information, see from page 2/93 | | | | | | | | 9 0 | | ... | | | | | | | | |
| Types of construction | | | | | | | | | | | | | | | Version | | Order code | |
| Without flange | | | IM B3 ²⁾ | | | Standard | | A | | - | | | | | | | | |
| With flange | | | IM B5 ²⁾ | | | With additional charge | | F | | - | | | | | | | | |
| With flange | | | IM B14 ²⁾ | | | With additional charge | | K | | - | | | | | | | | |
| For other types of construction and more information, see from page 2/99 | | | | | | | | | | ... | | | | | | | | |
| Motor protection | | | | | | | | | | | | | | | Version | | Order code | |
| Without | | | | | | Standard | | A | | - | | | | | | | | |
| PTC thermistor with 1 or 3 temperature sensors (frame sizes 80, 90 or 100 to 200) | | | | | | With additional charge | | B | | - | | | | | | | | |
| For other motor protection and more information, see from page 2/112 | | | | | | | | | | ... | | | | | | | | |
| Terminal box position | | | | | | | | | | | | | | | Version | | Order code(s) | |
| Terminal box at top | | | | | | Standard | | 4 | | | | | | | | | | |
| For other terminal box positions and more information, see from page 2/115 | | | | | | | | | | | | | | | | | | |
| Special versions | | | | | | | | | | | | | | | Version | | Order code(s) | |
| For options, see from page 2/118 | | | | | | | | | | | | | | | | 1LE1003-...-Z...+...+...+... | | |



¹⁾ Operating values at rated power for 60 Hz are stored in the Drive Technology Configurator (DT Configurator; see Appendix, "Tools and engineering").

²⁾ Types derived from IM B3 (IM B6/7/8, IM V6, and IM V5), from IM B5 (IM V3 and IM V1) and from IM B14 (IM V19 and IM V18) are possible, provided that no requirements exist for condensation drainage holes (H03) or stamping of the type on the rating plate. The basic type IM B3, IM B5, or IM B14 is stamped as standard on the rating plate. For orders with condensation drainage holes (H03), the type must be specified.

SIMOTICS GP and SIMOTICS SD standard motors

IE3 Premium Efficiency



Aluminum series SIMOTICS GP 1LE1003 – self-ventilated

Selection and ordering data

| Operating values at rated power | | | | | | | | | | | | | | | Aluminum series | | | |
|--|--------------------|------------|----------------------------|--------------------|--------------------|---------------------------|-----------------------|-----------------------|---------------------------|--------------------|--------------------|--------------------|-----------------|------------------|-----------------|--------------|---------------|------------------|
| $P_{rated, 50 Hz}$ | $P_{rated, 60 Hz}$ | Frame size | $n_{rated, 50 Hz}$ | $T_{rated, 50 Hz}$ | Different IE class | $\eta_{rated, 50 Hz}$ | $\eta_{rated, 50 Hz}$ | $\eta_{rated, 50 Hz}$ | $\cos\phi_{rated, 50 Hz}$ | $I_{rated, 50 Hz}$ | T_{LR}/I_{rated} | I_{LR}/I_{rated} | T_B/I_{rated} | $L_{pfA, 50 Hz}$ | $L_{WA, 50 Hz}$ | 1LE1003 | $m_{IM B3}$ | J |
| P50 | P60 | FS | rpm | Nm | 60 Hz/P60 | % | % | % | % | A | | | | | | Article No. | kg | kgm ² |
| • Cooling: Self-ventilated (IC411) or with order code F90 forced-air cooled without external fan and fan cover (IC418) • Efficiency according to IEC 60034-30-1: IE3 Premium Efficiency, service factor (SF) 1.15 • Insulation: Thermal class 155 (temperature class F), IP55 degree of protection, utilization in accordance with thermal class 130 (temperature class B) | | | | | | | | | | | | | | | | | | |
| 4-pole: 1500 rpm at 50 Hz, 1800 rpm at 60 Hz ¹⁾ | | | | | | | | | | | | | | | | | | |
| 0.55 | 0.63 | 80 M | 1440 | 3.6 | | 80.8 | 81.1 | 79.3 | 0.78 | 1.26 | 2.1 | 5.9 | 3.1 | 53 | 64 | 1LE1003-0DB2 | 11 | 0.0021 |
| 0.75 | 0.86 | 80 M | 1450 | 4.9 | | 82.5 | 82.3 | 79.9 | 0.75 | 1.75 | 2.7 | 7.1 | 3.9 | 53 | 64 | 1LE1003-0DB3 | 14 | 0.0029 |
| 1.1 | 1.27 | 90 S | 1440 | 7.3 | | 84.1 | 84.7 | 83.4 | 0.78 | 2.4 | 2.9 | 6.9 | 3.6 | 56 | 68 | 1LE1003-0EB0 | 16 | 0.0036 |
| 1.5 | 1.75 | 90 L | 1445 | 9.9 | | 85.3 | 86.0 | 85.2 | 0.8 | 3.15 | 2.9 | 7.3 | 3.5 | 60 | 68 | 1LE1003-0EB4 | 19 | 0.0049 |
| 2.2 | 2.55 | 100 L | 1465 | 14.3 | IE2 | 86.7 | 87.3 | 86.4 | 0.83 | 4.4 | 2.1 | 7.6 | 3.6 | 60 | 72 | 1LE1003-1AB4 | 30 | 0.014 |
| 3 | 3.45 | 100 L | 1460 | 20 | | 87.7 | 88.4 | 88.2 | 0.83 | 5.9 | 2.3 | 7.3 | 3.7 | 60 | 72 | 1LE1003-1AB5 | 30 | 0.014 |
| 4 | 4.55 | 112 M | 1460 | 26 | | 88.6 | 89.2 | 88.6 | 0.82 | 7.9 | 2.4 | 7.1 | 3.7 | 58 | 70 | 1LE1003-1BB2 | 34 | 0.017 |
| 5.5 | 6.3 | 132 S | 1470 | 36 | IE2 | 89.6 | 90.1 | 89.5 | 0.84 | 10.5 | 2.1 | 7.2 | 3.4 | 64 | 76 | 1LE1003-1CB0 | 64 | 0.046 |
| 7.5 | 8.6 | 132 M | 1470 | 49 | IE2 | 90.4 | 91.1 | 90.8 | 0.84 | 14.3 | 2.4 | 7.4 | 3.5 | 64 | 76 | 1LE1003-1CB2 | 64 | 0.046 |
| 11 | 12.6 | 160 M | 1475 | 71 | | 91.4 | 91.9 | 91.4 | 0.84 | 20.5 | 2.2 | 6.8 | 3.2 | 65 | 77 | 1LE1003-1DB2 | 83 | 0.083 |
| 15 | 17.3 | 160 L | 1475 | 97 | | 92.1 | 92.3 | 91.5 | 0.82 | 28.5 | 2.5 | 8.5 | 3.8 | 65 | 77 | 1LE1003-1DB4 | 100 | 0.099 |
| 18.5 | 21.3 | 180 L | 1470 | 143 | | 93 | 93.6 | 93.6 | 0.83 | 41 | 2.3 | 6.8 | 3.3 | 68 | 75 | 1LE1003-1EB2 | 142 | 0.14 |
| 22 | 25.3 | 180 L | 1470 | 195 | | 93.6 | 94.0 | 93.8 | 0.79 | 59 | 3 | 8.2 | 3.8 | 67 | 74 | 1LE1003-1EB4 | 154 | 0.17 |
| 30 | 34.5 | 200 L | 1470 | 195 | IE2 | 93.6 | 94 | 93.7 | 0.84 | 55 | 2.6 | 7.3 | 3.1 | 65 | 72 | 1LE1003-2AB5 | 189 | 0.22 |
| Voltages | | | | | | | | | | | | | | | Version | | Order code | |
| 50 Hz 230 VΔ/400 VY | | | 60 Hz ¹⁾ 460 VY | | | Standard | | | 2 2 | | - | | | | | | | |
| 50 Hz 400 VΔ/690 VY | | | 60 Hz ¹⁾ 460 VA | | | Standard | | | 3 4 | | - | | | | | | | |
| 50 Hz 500 VY | | | | | | Without additional charge | | | 2 7 | | - | | | | | | | |
| 50 Hz 500 VΔ | | | | | | Without additional charge | | | 4 0 | | - | | | | | | | |
| For other voltages ¹⁾ and more information, see from page 2/93 | | | | | | | | | 9 0 | | ... | | | | | | | |
| Types of construction | | | | | | | | | | | | | | | Version | | Order code | |
| Without flange | | | IM B3 ²⁾ | | | Standard | | | A | | - | | | | | | | |
| With flange | | | IM B5 ²⁾ | | | With additional charge | | | F | | - | | | | | | | |
| With flange | | | IM B14 ²⁾ | | | With additional charge | | | K | | - | | | | | | | |
| For other types of construction and more information, see from page 2/99 | | | | | | | | | | | ... | | | | | | | |
| Motor protection | | | | | | | | | | | | | | | Version | | Order code | |
| Without | | | | | | Standard | | | A | | - | | | | | | | |
| PTC thermistor with 1 or 3 temperature sensors (frame sizes 80, 90 or 100 to 200) | | | | | | With additional charge | | | B | | - | | | | | | | |
| For other motor protection and more information, see from page 2/112 | | | | | | | | | | | ... | | | | | | | |
| Terminal box position | | | | | | | | | | | | | | | Version | | Order code(s) | |
| Terminal box at top | | | | | | Standard | | | 4 | | | | | | | | | |
| For other terminal box positions and more information, see from page 2/115 | | | | | | | | | | | | | | | | | | |
| Special versions | | | | | | | | | | | | | | | | | Order code(s) | |
| For options, see from page 2/118 | | | | | | | | | | | | | 1LE1003-...-Z | | ...+...+...+... | | | |

2

¹⁾ Operating values at rated power for 60 Hz are stored in the Drive Technology Configurator (DT Configurator; see Appendix, "Tools and engineering").

²⁾ Types derived from IM B3 (IM B6/7/8, IM V6, and IM V5), from IM B5 (IM V3 and IM V1) and from IM B14 (IM V19 and IM V18) are possible, provided that no requirements exist for condensation drainage holes (H03) or stamping of the type on the rating plate. The basic type IM B3, IM B5, or IM B14 is stamped as standard on the rating plate. For orders with condensation drainage holes (H03), the type must be specified.



Selection and ordering data

| Operating values at rated power | | | | | | | | | | | | | | | Aluminum series | | | | | |
|--|--------------------|------------|----------------------------|--------------------|--------------------|-----------------------|-----------------------|-----------------------|---------------------------|--------------------|--------------------|--------------------|-----------------|------------------|---------------------------|--------------|--------------------|------------------|---|--|
| $P_{rated, 50 Hz}$ | $P_{rated, 60 Hz}$ | Frame size | $n_{rated, 50 Hz}$ | $T_{rated, 50 Hz}$ | Different IE class | $\eta_{rated, 50 Hz}$ | $\eta_{rated, 50 Hz}$ | $\eta_{rated, 50 Hz}$ | $\cos\phi_{rated, 50 Hz}$ | $I_{rated, 50 Hz}$ | T_{LR}/I_{rated} | I_{LR}/I_{rated} | T_B/I_{rated} | $L_{pFA, 50 Hz}$ | $L_{WA, 50 Hz}$ | 1LE1003 | $m_{IM B3}$ | J | | |
| kW | kW | FS | rpm | Nm | 60 Hz/P60 | % | % | % | % | A | | | | | | Article No. | kg | kgm ² | | |
| • Cooling: Self-ventilated (IC411) or with order code F90 forced-air cooled without external fan and fan cover (IC418) • Efficiency according to IEC 60034-30-1: IE3 Premium Efficiency, service factor (SF) 1.15 • Insulation: Thermal class 155 (temperature class F), IP55 degree of protection, utilization in accordance with thermal class 130 (temperature class B) | | | | | | | | | | | | | | | | | | | | |
| 6-pole: 1000 rpm at 50 Hz, 1200 rpm at 60 Hz ¹⁾ | | | | | | | | | | | | | | | | | | | | |
| 0.37 | 0.43 | 80 M | 940 | 3.8 | | 73.5 | 73.1 | 69.4 | 0.66 | 1.1 | 2.3 | 4.2 | 2.7 | 42 | 53 | 1LE1003-0DC2 | 12 | 0.0025 | | |
| 0.55 | 0.63 | 80 M | 935 | 5.6 | | 77.2 | 77 | 73.9 | 0.67 | 1.53 | 2.5 | 4.5 | 2.8 | 42 | 53 | 1LE1003-0DC3 | 14 | 0.0031 | | |
| 0.75 | 0.86 | 90 S | 945 | 7.6 | | 78.9 | 80 | 78.8 | 0.7 | 1.96 | 2.2 | 4.6 | 2.6 | 43 | 55 | 1LE1003-0EC0 | 16 | 0.004 | | |
| 1.1 | 1.27 | 90 L | 950 | 11 | IE1 | 81.0 | 81.4 | 79.3 | 0.66 | 2.95 | 2.8 | 5.0 | 3 | 60 | 68 | 1LE1003-0EC4 | 19 | 0.0052 | | |
| 1.5 | 1.75 | 100 L | 970 | 14.8 | IE2 | 82.5 | 83.1 | 81.5 | 0.73 | 3.6 | 1.9 | 5.2 | 2.8 | 59 | 71 | 1LE1003-1AC4 | 25 | 0.011 | | |
| 2.2 | 2.55 | 112 M | 970 | 22 | IE2 | 84.3 | 85 | 83.9 | 0.75 | 5 | 2.2 | 5.6 | 2.8 | 65 | 74 | 1LE1003-1BC2 | 34 | 0.017 | | |
| 3 | 3.45 | 132 S | 975 | 29 | | 85.6 | 86.1 | 84.9 | 0.73 | 6.9 | 2.3 | 6.6 | 3.2 | 56 | 66 | 1LE1003-1CC0 | 42 | 0.034 | | |
| 4 | 4.55 | 132 M | 975 | 39 | | 86.8 | 87.1 | 86.2 | 0.73 | 9.1 | 2.2 | 6.2 | 3 | 67 | 75 | 1LE1003-1CC2 | 46 | 0.039 | | |
| 5.5 | 6.3 | 132 M | 975 | 54 | | 88.0 | 88.3 | 87.2 | 0.72 | 12.5 | 2.7 | 6.8 | 3.4 | 64 | 72 | 1LE1003-1CC3 | 58 | 0.050 | | |
| 7.5 | 8.6 | 160 M | 985 | 73 | | 89.1 | 89.5 | 88.6 | 0.81 | 15 | 2.3 | 7.9 | 3.2 | 71 | 79 | 1LE1003-1DC2 | 95 | 0.132 | | |
| 11 | 12.6 | 160 L | 980 | 107 | | 90.3 | 90.8 | 90.2 | 0.80 | 22 | 2.9 | 6.8 | 2.8 | 66 | 74 | 1LE1003-1DC4 | 106 | 0.164 | | |
| 15 | 18 | 180 L | 975 | 147 | IE2 | 91.2 | 92 | 91.9 | 0.8 | 29.5 | 2.3 | 5.9 | 2.8 | 61 | 68 | 1LE1003-1EC4 | 130 | 0.19 | | |
| 18.5 | 22 | 200 L | 978 | 181 | IE2 | 91.7 | 92.5 | 92.4 | 0.79 | 37 | 2.5 | 5.6 | 2.6 | 64 | 71 | 1LE1003-2AC4 | 166 | 0.28 | | |
| 22 | 26.5 | 200 L | 978 | 215 | IE2 | 92.2 | 93.1 | 93.2 | 0.79 | 43.5 | 2.5 | 5.6 | 2.6 | 61 | 68 | 1LE1003-2AC5 | 179 | 0.32 | | |
| 8-pole: 750 rpm at 50 Hz, 900 rpm at 60 Hz ¹⁾ | | | | | | | | | | | | | | | | | | | | |
| 2.2 | 2.55 | 132 S | 725 | 29 | | 81.9 | 82.9 | 81.8 | 0.63 | 6.2 | 1.4 | 3.6 | 1.8 | 64 | 77 | 1LE1003-1CD0 | 56 | 0.038 | | |
| 3 | 3.45 | 132 M | 725 | 40 | | 83.5 | 84.2 | 82.7 | 0.61 | 8.5 | 1.5 | 3.8 | 2 | 64 | 77 | 1LE1003-1CD2 | 65 | 0.048 | | |
| 4 | 4.55 | 160 M | 730 | 52 | | 84.8 | 85.6 | 84.5 | 0.66 | 10.3 | 1.6 | 3.6 | 1.8 | 65 | 78 | 1LE1003-1DD2 | 72 | 0.065 | | |
| 5.5 | 6.3 | 160 M | 730 | 72 | | 86.2 | 86.9 | 85.7 | 0.66 | 14 | 1.6 | 3.8 | 1.9 | 65 | 78 | 1LE1003-1DD3 | 86 | 0.083 | | |
| 7.5 | 8.6 | 160 L | 728 | 98 | | 87.3 | 88.2 | 87.7 | 0.65 | 19.1 | 1.6 | 3.8 | 1.9 | 65 | 78 | 1LE1003-1DD4 | 110 | 0.116 | | |
| 11 | 13.2 | 180 L | 725 | 145 | | 88.6 | 89.7 | 89.6 | 0.74 | 24 | 2.1 | 5.1 | 2.4 | 61 | 74 | 1LE1003-1ED4 | 161 | 0.267 | | |
| 15 | 18 | 200 L | 730 | 196 | | 89.6 | 90.1 | 89.4 | 0.73 | 33.5 | 3 | 6.8 | 3.7 | 57 | 70 | 1LE1003-2AD5 | 212 | 0.420 | | |
| Voltages | | | | | | | | | | | | | | | Version | | Order code | | | |
| 50 Hz 230 VΔ/400 VY | | | 60 Hz ¹⁾ 460 VY | | | | | | | | | | | | Standard | | 2 2 | | - | |
| 50 Hz 400 VΔ/690 VY | | | 60 Hz ¹⁾ 460 VΔ | | | | | | | | | | | | Standard | | 3 4 | | - | |
| 50 Hz 500 VY | | | | | | | | | | | | | | | Without additional charge | | 2 7 | | - | |
| 50 Hz 500 VΔ | | | | | | | | | | | | | | | Without additional charge | | 4 0 | | - | |
| | | | | | | | | | | | | | | | 9 0 | | ... | | | |
| Types of construction | | | | | | | | | | | | | | | Version | | Order code | | | |
| Without flange | | | IM B3 ²⁾ | | | | | | | | | | | | Standard | | A | | - | |
| With flange | | | IM B5 ²⁾ | | | | | | | | | | | | With additional charge | | F | | - | |
| With flange | | | IM B14 ²⁾ | | | | | | | | | | | | With additional charge | | K | | - | |
| | | | | | | | | | | | | | | | | | ... | | | |
| Motor protection | | | | | | | | | | | | | | | Version | | Order code | | | |
| Without | | | | | | | | | | | | | | | Standard | | A | | - | |
| PTC thermistor with 1 or 3 temperature sensors (frame sizes 80, 90 or 100 to 200) | | | | | | | | | | | | | | | With additional charge | | B | | - | |
| | | | | | | | | | | | | | | | | | ... | | | |
| Terminal box position | | | | | | | | | | | | | | | Version | | Order code(s) | | | |
| Terminal box at top | | | | | | | | | | | | | | | Standard | | 4 | | | |
| | | | | | | | | | | | | | | | | | ... | | | |
| Special versions | | | | | | | | | | | | | | | | | Order code(s) | | | |
| For options, see from page 2/118 | | | | | | | | | | | | | | | 1LE1003-.... | | -Z ...+...+...+... | | | |



¹⁾ Operating values at rated power for 60 Hz are stored in the Drive Technology Configurator (DT Configurator; see Appendix, "Tools and engineering").

²⁾ Types derived from IM B3 (IM B6/7/8, IM V6, and IM V5), from IM B5 (IM V3 and IM V1) and from IM B14 (IM V19 and IM V18) are possible, provided that no requirements exist for condensation drainage holes (H03) or stamping of the type on the rating plate. The basic type IM B3, IM B5, or IM B14 is stamped as standard on the rating plate. For orders with condensation drainage holes (H03), the type must be specified.

SIMOTICS GP and SIMOTICS SD standard motors

IE3 Premium Efficiency



Aluminum series SIMOTICS GP 1LE1003 with increased power – self-ventilated

Selection and ordering data

| Operating values at rated power | | | | | | | | | | | | | | Aluminum series | | | | |
|--|------------------------------|---------------|----------------------|----------------------|------------------------------------|-------------------------|-------------------------|-------------------------|-----------------------------|----------------------|--------------------------|--------------------------|--------------------|---------------------------|-------------------|--------------|------------------|-------|
| P_{rated} 50 Hz/ P50 | P_{rated} 60 Hz/ P60 | Frame size | n_{rated} 50 Hz | T_{rated} 50 Hz | Different IE class 60 Hz/P60 | η_{rated} 50 Hz | η_{rated} 50 Hz | η_{rated} 50 Hz | $\cos\phi_{rated}$ 50 Hz | I_{rated} 50 Hz | T_{LR}/I_{LR} 50 Hz | I_{LR}/I_{LR} 50 Hz | T_B/I_B 50 Hz | L_{pfA} 50 Hz | L_{WA} 50 Hz | 1LE1003 | $m_{IM B3}$ | J |
| kW | kW | FS | rpm | Nm | | % | % | % | % | A | | | | | Article No. | kg | kgm ² | |
| • Cooling: Self-ventilated (IC411) or with order code F90 forced-air cooled without external fan and fan cover (IC418) • Efficiency according to IEC 60034-30-1: IE3 Premium Efficiency, service factor (SF) 1.15 • Insulation: Thermal class 155 (temperature class F), IP55 degree of protection, utilization in accordance with thermal class 130 (temperature class B) | | | | | | | | | | | | | | | | | | |
| 2-pole: 3000 rpm at 50 Hz, 3600 rpm at 60 Hz ¹⁾ | | | | | | | | | | | | | | | | | | |
| 11 | 12.6 | 132 M | 2955 | 36 | | 91.2 | 91.7 | 91.8 | 0.86 | 20 | 2.5 | 9.4 | 4.1 | 71 | 80 | 1LE1003-1CA6 | 57 | 0.031 |
| 22 | 25.3 | 160 L | 2950 | 71 | | 92.7 | 93.4 | 93.3 | 0.91 | 37.5 | 2.8 | 8.7 | 4 | 70 | 82 | 1LE1003-1DA6 | 105 | 0.077 |
| 30 | 33.5 | 180 L | 2950 | 97 | | 93.3 | 93.9 | 93.9 | 0.88 | 53 | 2.6 | 8.6 | 3.9 | 67 | 80 | 1LE1003-1EA6 | 140 | 0.094 |
| 45 | 51 | 200 L | 2950 | 146 | | 94 | 94.3 | 94 | 0.87 | 79 | 2.5 | 7.1 | 3.2 | 77 | 84 | 1LE1003-2AA6 | 194 | 0.16 |
| 4-pole: 1500 rpm at 50 Hz, 1800 rpm at 60 Hz ¹⁾ | | | | | | | | | | | | | | | | | | |
| 11 | 12.6 | 132 M | 1470 | 71 | | 91.4 | 91.9 | 91.5 | 0.8 | 21.5 | 2.6 | 7.7 | 3.6 | 64 | 76 | 1LE1003-1CB6 | 81 | 0.049 |
| 18.5 | 21.3 | 160 L | 1470 | 195 | IE2 | 93.6 | 94.2 | 94.1 | 0.79 | 59 | 2.8 | 7.8 | 3.7 | 68 | 75 | 1LE1003-1DB6 | 110 | 0.101 |
| 30 | 34.5 | 180 L | 1470 | 195 | | 93.6 | 94 | 93.8 | 0.79 | 59 | 3 | 8.2 | 3.8 | 66 | 74 | 1LE1003-1EB6 | 154 | 0.173 |
| 37 | 42.5 | 200 L | 1475 | 240 | | 93.9 | 94.3 | 94.2 | 0.81 | 70 | 3.1 | 8.1 | 3.5 | 65 | 72 | 1LE1003-2AB6 | 154 | 0.173 |
| 6-pole: 1000 rpm at 50 Hz, 1200 rpm at 60 Hz ¹⁾ | | | | | | | | | | | | | | | | | | |
| 18.5 | 22 | 180 L | 975 | 181 | | 91.7 | 92.3 | 91.9 | 0.77 | 38 | 2.6 | 6.9 | 3.3 | 68 | 80 | 1LE1003-1EC6 | 150 | 0.247 |
| 30 | 36 | 200 L | 978 | 293 | IE2 | 92.9 | 93.7 | 93.7 | 0.79 | 59 | 2.8 | 6.5 | 2.8 | 61 | 68 | 1LE1003-2AC6 | 220 | 0.434 |
| Voltages | | | | | | | | | | | | | | | | | | |
| 50 Hz 230 VΔ/400 VY | | | | | | | | | | | | | | Version | | Order code | | |
| 60 Hz ¹⁾ 460 VY | | | | | | | | | | | | | | Standard | | 2 2 | | |
| 50 Hz 400 VΔ/690 VY | | | | | | | | | | | | | | Standard | | 3 4 | | |
| 60 Hz ¹⁾ 460 VΔ | | | | | | | | | | | | | | Without additional charge | | 2 7 | | |
| 50 Hz 500 VY | | | | | | | | | | | | | | Without additional charge | | 4 0 | | |
| 50 Hz 500 VΔ | | | | | | | | | | | | | | | | 9 0 | | |
| For other voltages ¹⁾ and more information, see from page 2/93 | | | | | | | | | | | | | | | | | | |
| Types of construction | | | | | | | | | | | | | | | | | | |
| Without flange | | | | | | | | | | | | | | Version | | Order code | | |
| IM B3 ²⁾ | | | | | | | | | | | | | | Standard | | A | | |
| With flange | | | | | | | | | | | | | | With additional charge | | F | | |
| IM B5 ²⁾ | | | | | | | | | | | | | | | | ... | | |
| For other types of construction and more information, see from page 2/99 | | | | | | | | | | | | | | | | | | |
| Motor protection | | | | | | | | | | | | | | | | | | |
| Without | | | | | | | | | | | | | | Version | | Order code | | |
| PTC thermistor with 3 temperature sensors | | | | | | | | | | | | | | Standard | | A | | |
| | | | | | | | | | | | | | | With additional charge | | B | | |
| | | | | | | | | | | | | | | | | ... | | |
| For other motor protection and more information, see from page 2/112 | | | | | | | | | | | | | | | | | | |
| Terminal box position | | | | | | | | | | | | | | | | | | |
| Terminal box at top | | | | | | | | | | | | | | Version | | Order code | | |
| | | | | | | | | | | | | | | Standard | | 4 | | |
| For other terminal box positions and more information, see from page 2/115 | | | | | | | | | | | | | | | | | | |
| Special versions | | | | | | | | | | | | | | | | | | |
| For options, see from page 2/118 | | | | | | | | | | | | | | 1LE1003-.... | | -Z | | |

¹⁾ Operating values at rated power for 60 Hz are stored in the Drive Technology Configurator (DT Configurator; see Appendix, "Tools and engineering").

²⁾ Types derived from IM B3 (IM B6/7/8, IM V6, and IM V5), from IM B5 (IM V3 and IM V1) and from IM B14 (IM V19 and IM V18) are possible, provided that no requirements exist for condensation drainage holes (H03) or stamping of the type on the rating plate. The basic type IM B3, IM B5, or IM B14 is stamped as standard on the rating plate. For orders with condensation drainage holes (H03), the type must be specified.

Selection and ordering data

| Operating values at rated power | | | | | | | | | | | | | | | Aluminum series 1LE1083 | | $m_{IM\ B3}$ | J |
|---|---------------------------------------|------------|---------------------|----------------------------|--------------------|------------------------|------------------------|---------------------------|----------------------------|---------------------|----------------------------|----------------------------|-------------------------|-------------------|----------------------------|-----------------------|----------------------------------|------------------|
| $P_{rated, 50\ Hz/}$ P_{50} | $P_{rated, 60\ Hz/}$ $P_{60}^{1)}$ | Frame size | $n_{rated, 50\ Hz}$ | $T_{rated, 50\ Hz}$ | Different IE class | $\eta_{rated, 50\ Hz}$ | $\eta_{rated, 50\ Hz}$ | $\eta_{rated, 50\ Hz}$ | $\cos\phi_{rated, 50\ Hz}$ | $I_{rated, 50\ Hz}$ | $T_{LR}/I_{rated, 50\ Hz}$ | $I_{LR}/I_{rated, 50\ Hz}$ | $T_B/I_{rated, 50\ Hz}$ | $L_{pfA, 50\ Hz}$ | $L_{WA, 50\ Hz}$ | Article No. | kg | kgm ² |
| kW | kW | FS | rpm | Nm | | % | % | % | | A | | | | | | | | |
| • Cooling: Self-ventilated (IC411) or with order code F90 forced-air cooled without external fan and fan cover (IC418) • Efficiency according to IEC 60034-30-1: IE3 Premium Efficiency, service factor (SF) 1.0 • Insulation: Thermal class 155 (temperature class F), IP55 degree of protection, utilization in accordance with thermal class 130 (temperature class B) | | | | | | | | | | | | | | | | | | |
| 2-pole: 3000 rpm at 50 Hz, 3600 rpm at 60 Hz ¹⁾ | | | | | | | | | | | | | | | | | | |
| 3 | 3.45 | 100 L | 2920 | 9.8 | | 87.1 | 87.8 | 87.4 | 0.88 | 5.6 | 3.2 | 8.1 | 4.6 | 67 | 79 | ▲ 1LE1083-1AA4 ■■■■■■ | 26 | 0.0054 |
| 4 | 4.55 | 112 M | 2920 | 10 | | 88.1 | 88.7 | 88.2 | 0.89 | 7.4 | 2.5 | 8.7 | 4.0 | 69 | 81 | ▲ 1LE1083-1BA2 ■■■■■■ | 34 | 0.012 |
| 5.5 | 6.3 | 132 S | 2950 | 13 | | 89.2 | 89.6 | 88.9 | 0.91 | 9.8 | 2.1 | 9.7 | 3.6 | 72 | 79 | ▲ 1LE1083-1CA0 ■■■■■■ | 57 | 0.024 |
| 7.5 | 8.6 | 132 S | 2960 | 18 | | 90.1 | 90.9 | 90.7 | 0.92 | 13.1 | 2.1 | 8.3 | 4.0 | 68 | 80 | ▲ 1LE1083-1CA1 ■■■■■■ | 57 | 0.031 |
| 11 | 12.6 | 160 M | 2950 | 24 | | 91.2 | 91.5 | 90.7 | 0.90 | 19.3 | 2.5 | 8.5 | 3.4 | 79 | 86 | ▲ 1LE1083-1DA2 ■■■■■■ | 84 | 0.053 |
| 15 | 17.3 | 160 M | 2955 | 36 | | 91.9 | 91.9 | 91.0 | 0.87 | 27 | 2.8 | 8.8 | 4.3 | 70 | 82 | ▲ 1LE1083-1DA3 ■■■■■■ | 84 | 0.061 |
| 18.5 | 21.3 | 160 L | 2960 | 48 | | 92.4 | 92.9 | 92.6 | 0.92 | 32 | 2.8 | 9.7 | 3.8 | 78 | 85 | ▲ 1LE1083-1DA4 ■■■■■■ | 109 | 0.068 |
| 22 | 24.5 | 180 M | 2960 | 60 | | 92.7 | 93 | 92.4 | 0.89 | 39 | 2.3 | 7.5 | 3.5 | 67 | 80 | ▲ 1LE1083-1EA2 ■■■■■■ | 129 | 0.08 |
| 30 | 33.5 | 200 L | 2950 | 71 | | 93.3 | 93.6 | 93.3 | 0.87 | 53 | 2.5 | 7.0 | 3.3 | 68 | 81 | ▲ 1LE1083-2AA4 ■■■■■■ | 173 | 0.134 |
| 37 | 41.5 | 200 L | 2955 | 97 | | 93.7 | 93.9 | 93.5 | 0.88 | 65 | 2.5 | 7.1 | 3.2 | 68 | 81 | ▲ 1LE1083-2AA5 ■■■■■■ | 194 | 0.158 |
| 4-pole: 1500 rpm at 50 Hz, 1800 rpm at 60 Hz ¹⁾ | | | | | | | | | | | | | | | | | | |
| 2.2 | 2.55 | 100 L | 1465 | 14 | | 86.7 | 87 | 85.9 | 0.83 | 4.4 | 3.2 | 8.4 | 4.4 | 60 | 72 | ▲ 1LE1083-1AB4 ■■■■■■ | 30 | 0.014 |
| 3 | 3.45 | 100 L | 1460 | 19.6 | | 87.7 | 88.4 | 87.8 | 0.84 | 5.9 | 2.4 | 8.5 | 3.4 | 68 | 75 | ▲ 1LE1083-1AB5 ■■■■■■ | 42 | 0.016 |
| 4 | 4.55 | 112 M | 1460 | 26 | | 88.6 | 89.6 | 89.4 | 0.85 | 7.7 | 2.1 | 7.5 | 3.0 | 67 | 74 | ▲ 1LE1083-1BB2 ■■■■■■ | 49 | 0.017 |
| 5.5 | 6.3 | 132 S | 1470 | 36 | | 89.6 | 90.1 | 89.7 | 0.82 | 10.8 | 2.9 | 8.5 | 3.7 | 64 | 76 | ▲ 1LE1083-1CB0 ■■■■■■ | 64 | 0.046 |
| 7.5 | 8.6 | 132 M | 1465 | 49 | | 90.4 | 91.1 | 90.8 | 0.84 | 14.3 | 2.6 | 8.2 | 3.7 | 64 | 76 | ▲ 1LE1083-1CB2 ■■■■■■ | 61 | 0.046 |
| 11 | 12.6 | 160 M | 1475 | 71 | | 91.4 | 91.8 | 91.2 | 0.84 | 21 | 2.6 | 7.6 | 3.4 | 65 | 77 | ▲ 1LE1083-1DB2 ■■■■■■ | 83 | 0.083 |
| 15 | 17.3 | 160 L | 1480 | 97 | | 92.1 | 92.4 | 92.0 | 0.85 | 28 | 2.9 | 8.1 | 3.3 | 67 | 74 | ▲ 1LE1083-1DB4 ■■■■■■ | 111 | 0.099 |
| 18.5 | 21.3 | 180 M | 1470 | 120 | | 92.6 | 93.1 | 93.0 | 0.82 | 35 | 2.5 | 7.2 | 3.3 | 66 | 73 | ▲ 1LE1083-1EB2 ■■■■■■ | 134 | 0.13 |
| 22 | 25.3 | 180 L | 1470 | 143 | | 93.0 | 93.4 | 93.1 | 0.83 | 41 | 2.3 | 6.8 | 3.3 | 62 | 75 | ▲ 1LE1083-1EB4 ■■■■■■ | 142 | 0.14 |
| 30 | 34.5 | 200 L | 1470 | 195 | | 93.6 | 94.3 | 94.5 | 0.84 | 55 | 2.6 | 7.3 | 3.1 | 59 | 72 | ▲ 1LE1083-2AB5 ■■■■■■ | 189 | 0.22 |
| 6-pole: 1000 rpm at 50 Hz, 1200 rpm at 60 Hz ¹⁾ | | | | | | | | | | | | | | | | | | |
| 1.5 | 1.8 | 180 L | 975 | 147 | | 91.2 | 91.6 | 91.2 | 0.80 | 30 | 2.3 | 5.9 | 2.8 | 55 | 68 | ▲ 1LE1083-1EC4 ■■■■■■ | 130 | 0.19 |
| 18.5 | 22 | 200 L | 978 | 181 | | 91.7 | 92.1 | 91.9 | 0.79 | 37 | 2.5 | 5.6 | 2.6 | 58 | 71 | ▲ 1LE1083-2AC4 ■■■■■■ | 166 | 0.28 |
| 22 | 26.5 | 200 L | 978 | 215 | | 92.2 | 93.3 | 93.5 | 0.79 | 44 | 2.5 | 5.6 | 2.6 | 55 | 68 | ▲ 1LE1083-2AC5 ■■■■■■ | 179 | 0.32 |
| 8-pole: 750 rpm at 50 Hz, 900 rpm at 60 Hz ¹⁾ | | | | | | | | | | | | | | | | | | |
| 1.1 | 1.3 | 180 L | 725 | 145 | | 88.6 | 89.5 | 89.2 | 0.74 | 24 | 2.1 | 5.1 | 2.4 | 62 | 75 | ▲ 1LE1083-1ED4 ■■■■■■ | 161 | 0.267 |
| 1.5 | 1.8 | 200 L | 730 | 196 | | 89.6 | 89.8 | 89.1 | 0.73 | 33 | 3.0 | 6.8 | 3.7 | 57 | 70 | ▲ 1LE1083-2AD5 ■■■■■■ | 212 | 0.420 |
| Voltagess | | | | | | | | | | | | | | | Version | | Order code | |
| 50 Hz 230 VΔ/400 VY | | | | 60 Hz ¹⁾ 460 VY | | | | Standard | | | | 2 2 | | - | | | | |
| 50 Hz 400 VΔ/690 VY | | | | 60 Hz ¹⁾ 460 VΔ | | | | Standard | | | | 3 4 | | - | | | | |
| 50 Hz 500 VY | | | | | | | | Without additional charge | | | | 2 7 | | - | | | | |
| 50 Hz 500 VΔ | | | | | | | | Without additional charge | | | | 4 0 | | - | | | | |
| For other voltages ¹⁾ and more information, see from page 2/93 | | | | | | | | | | | | | | | 9 0 | | ... | |
| Types of construction | | | | | | | | | | | | | | | Version | | Order code | |
| Without flange | | | | IM B3 ²⁾ | | | | Standard | | | | A | | - | | | | |
| With flange | | | | IM B5 ²⁾ | | | | With additional charge | | | | F | | - | | | | |
| With flange | | | | IM B14 ²⁾ | | | | With additional charge | | | | K | | - | | | | |
| For other types of construction and more information, see from page 2/99 | | | | | | | | | | | | | | | ... | | ... | |
| Motor protection | | | | | | | | | | | | | | | Version | | Order code | |
| Without | | | | | | | | Standard | | | | A | | - | | | | |
| PTC thermistor with 1 or 3 temperature sensors | | | | | | | | With additional charge | | | | B | | - | | | | |
| For other motor protection and more information, see from page 2/112 | | | | | | | | | | | | | | | ... | | ... | |
| Terminal box position | | | | | | | | | | | | | | | Version | | Order code | |
| Terminal box at top | | | | | | | | Standard | | | | 4 | | - | | | | |
| For other terminal box positions and more information, see from page 2/115 | | | | | | | | | | | | | | | ... | | ... | |
| Special versions | | | | | | | | | | | | | | | Order code(s) | | | |
| For options, see from page 2/118 | | | | | | | | | | | | | | | 1LE1083- ■■■■■■ | | -Z . . . + . . . + . . . + . . . | |



¹⁾ Operating values at rated power for 60 Hz are stored in the Drive Technology Configurator (DT Configurator; see Appendix, "Tools and engineering").

²⁾ Types derived from IM B3 (IM B6/7/8, IM V6, and IM V5), from IM B5 (IM V3 and IM V1) and from IM B14 (IM V19 and IM V18) are possible, provided that no requirements exist for condensation drainage holes (H03) or stamping of the type on the rating plate. The basic type IM B3, IM B5, or IM B14 is stamped as standard on the rating plate. For orders with condensation drainage holes (H03), the type must be specified.

SIMOTICS GP and SIMOTICS SD standard motors

IE3 Premium Efficiency

Cast-iron series SIMOTICS SD 1LE1503 Basic Line – self-ventilated or forced-air cooled

Selection and ordering data

| Operating values at rated power | | | | | | | | | | | | | | Cast-iron series | | $m_{IM\ B3}$ | J | | | | |
|--|--------------------------|------------|----------------------------|---------------------|--------------------|---------------------------|------------------------|------------------------|----------------------------|---------------------|----------------------------|----------------------------|-------------------------|-------------------|------------------|--------------|-----|----------------------|---------------|---------------|------------------|
| $P_{rated, 50\ Hz}$ | $P_{rated, 60\ Hz}^{1)}$ | Frame size | $n_{rated, 50\ Hz}$ | $T_{rated, 50\ Hz}$ | Different IE class | $\eta_{rated, 50\ Hz}$ | $\eta_{rated, 50\ Hz}$ | $\eta_{rated, 50\ Hz}$ | $\cos\phi_{rated, 50\ Hz}$ | $I_{rated, 50\ Hz}$ | $T_{LR}/I_{rated, 50\ Hz}$ | $I_{LR}/I_{rated, 50\ Hz}$ | $T_p/I_{rated, 50\ Hz}$ | $L_{pfA, 50\ Hz}$ | $L_{WA, 50\ Hz}$ | | | 1LE1503 – Basic Line | Article No. | kg | kgm ² |
| kW | kW | FS | rpm | Nm | 60 Hz/P60 | % | % | % | % | A | °C/A | °C/A | °C/A | dB(A) | dB(A) | | | | | | |
| • Cooling: Self-ventilated (IC411) or with order code F90 forced-air cooled without external fan and fan cover (IC418) • Efficiency according to IEC 60034-30-1: IE3 Premium Efficiency, service factor (SF) 1.15 • Insulation: Thermal class 155 (temperature class F), IP55 degree of protection, utilization in accordance with thermal class 130 (temperature class B) | | | | | | | | | | | | | | | | | | | | | |
| 2-pole: 3000 rpm at 50 Hz, 3600 rpm at 60 Hz ¹⁾ | | | | | | | | | | | | | | | | | | | | | |
| 0.37 | 0.43 | 71 M | 2850 | 1.2 | | 73.8 | 73.3 | 69.7 | 0.76 | 0.95 | 3.5 | 5.8 | 3.5 | 52 | 63 | 1LE1503-0CA2 | - | 13 | 0.00045 | | |
| 0.55 | 0.63 | 71 M | 2850 | 1.8 | | 77.8 | 77.5 | 74.5 | 0.76 | 1.34 | 3.7 | 6.1 | 3.7 | 57 | 68 | 1LE1503-0CA3 | - | 15 | 0.00056 | | |
| 0.75 | 0.86 | 80 M | 2850 | 2.5 | | 80.7 | 82.2 | 81.9 | 0.86 | 1.56 | 2.6 | 6.2 | 3 | 60 | 71 | 1LE1503-0DA2 | - | 18 | 0.0011 | | |
| 1.1 | 1.27 | 80 M | 2885 | 3.6 | | 82.7 | 83.9 | 83.1 | 0.85 | 2.25 | 3 | 7.1 | 3.3 | 60 | 71 | 1LE1503-0DA3 | - | 21 | 0.0013 | | |
| 1.5 | 1.75 | 90 S | 2910 | 4.9 | | 84.2 | 84.6 | 83.2 | 0.86 | 3 | 2.7 | 8.1 | 4.2 | 65 | 77 | 1LE1503-0EA0 | - | 26 | 0.0021 | | |
| 2.2 | 2.55 | 90 L | 2910 | 7.2 | | 85.9 | 86.8 | 86.1 | 0.88 | 4.2 | 2.6 | 8.3 | 4 | 65 | 77 | 1LE1503-0EA4 | - | 32 | 0.0031 | | |
| 3 | 3.45 | 100 L | 2920 | 9.8 | | 87.1 | 87.9 | 87.5 | 0.88 | 5.6 | 3.2 | 8.1 | 4.6 | 71 | 79 | 1LE1503-1AA4 | - | 36 | 0.0054 | | |
| 4 | 4.55 | 112 M | 2950 | 13 | | 88.1 | 88.7 | 88.2 | 0.89 | 7.4 | 2.5 | 8.7 | 4 | 73 | 81 | 1LE1503-1BA2 | - | 45 | 0.012 | | |
| 5.5 | 6.3 | 132 S | 2950 | 18 | | 89.2 | 90.1 | 89.7 | 0.9 | 9.9 | 1.9 | 7.3 | 3.7 | 72 | 80 | 1LE1503-1CA0 | - | 58 | 0.024 | | |
| 7.5 | 8.6 | 132 S | 2950 | 24.5 | | 90.1 | 91 | 91 | 0.92 | 13.1 | 1.9 | 8.3 | 3.9 | 68 | 80 | 1LE1503-1CA1 | - | 73 | 0.031 | | |
| 11 | 12.6 | 160 M | 2955 | 35.5 | | 91.2 | 91 | 89.5 | 0.89 | 19.6 | 2.4 | 7.9 | 3.8 | 70 | 82 | 1LE1503-1DA2 | - | 100 | 0.053 | | |
| 15 | 17.3 | 160 M | 2960 | 48 | | 91.9 | 91.9 | 91 | 0.87 | 27 | 2.8 | 8.8 | 4.3 | 74 | 82 | 1LE1503-1DA3 | - | 110 | 0.061 | | |
| 18.5 | 21.3 | 160 L | 2955 | 60 | | 92.4 | 92.8 | 92.4 | 0.9 | 32 | 2.8 | 9 | 4.2 | 70 | 82 | 1LE1503-1DA4 | - | 127 | 0.068 | | |
| 22 | 24.5 | 180 M | 2950 | 71 | | 92.7 | 93.2 | 92.9 | 0.89 | 38.5 | 2.3 | 7.5 | 3.5 | 67 | 80 | 1LE1503-1EA2 | - | 160 | 0.08 | | |
| 30 | 33.5 | 200 L | 2955 | 97 | | 93.3 | 93.5 | 92.9 | 0.87 | 53 | 2.5 | 7 | 3.3 | 67 | 80 | 1LE1503-2AA4 | - | 225 | 0.134 | | |
| 37 | 41.5 | 200 L | 2955 | 120 | | 93.7 | 94.2 | 94 | 0.88 | 65 | 2.5 | 7.1 | 3.2 | 67 | 80 | 1LE1503-2AA5 | - | 250 | 0.158 | | |
| 45 | 51 | 225 M | 2960 | 145 | | 94 | 94.5 | 94.4 | 0.89 | 78 | 2.4 | 6.9 | 3.3 | 73 | 87 | 1LE1503-2BA2 | - | 315 | 0.26 | | |
| 55 | 62 | 250 M | 2975 | 177 | | 94.3 | 94.5 | 93.9 | 0.89 | 95 | 2.3 | 6.7 | 3.1 | 73 | 87 | 1LE1503-2CA2 | - | 385 | 0.46 | | |
| 75 | 84 | 280 S | 2975 | 241 | IE2 | 94.7 | 94.8 | 94.1 | 0.89 | 128 | 2.4 | 6.8 | 3 | 74 | 88 | 1LE1503-2DA0 | - | 510 | 0.77 | | |
| 90 | 101 | 280 M | 2975 | 289 | IE2 | 95 | 95.1 | 94.6 | 0.9 | 152 | 2.4 | 7.2 | 3.1 | 74 | 88 | 1LE1503-2DA2 | - | 590 | 0.94 | | |
| 110 | 123 | 315 S | 2982 | 352 | | 95.2 | 95.4 | 94.9 | 0.91 | 183 | 2.4 | 7.1 | 3.1 | 75 | 89 | 1LE1503-3AA0 | - | 750 | 1.4 | | |
| 132 | 148 | 315 M | 2982 | 423 | | 95.4 | 95.5 | 95.2 | 0.91 | 220 | 2.5 | 7.2 | 3.1 | 75 | 89 | 1LE1503-3AA2 | - | 880 | 1.6 | | |
| 160 | 180 | 315 L | 2982 | 512 | IE2 | 95.6 | 95.7 | 95.2 | 0.92 | 265 | 2.8 | 7.8 | 3.3 | 77 | 91 | 1LE1503-3AA4 | - | 980 | 1.9 | | |
| 200 | 224 | 315 L | 2982 | 640 | | 95.8 | 95.9 | 95.5 | 0.92 | 330 | 2.5 | 7.2 | 3 | 77 | 91 | 1LE1503-3AA5 | - | 1150 | 2.3 | | |
| Voltages ²⁾ | | | | | | | | | | | | | | Version | | | | | Order code | | |
| 50 Hz 230 VΔ/400 VY | | | 60 Hz ¹⁾ 460 VY | | | Standard | | 2 | | 2 | | | | | | - | | | | | |
| 50 Hz 400 VΔ/690 VY | | | 60 Hz ¹⁾ 460 VΔ | | | Standard | | 3 | | 4 | | | | | | - | | | | | |
| 50 Hz 500 VY | | | | | | Without additional charge | | 2 | | 7 | | | | | | - | | | | | |
| 50 Hz 500 VΔ | | | | | | Without additional charge | | 4 | | 0 | | | | | | - | | | | | |
| For other voltages ¹⁾ and more information, see from page 2/96 | | | | | | | | | | | | | | | | 9 | | 0 | | ... | |
| Types of construction | | | | | | | | | | | | | | Version | | | | | Order code | | |
| Without flange | | | IM B3 ³⁾ | | | Standard | | A | | | | | | | | - | | | | | |
| With flange | | | IM B5 ³⁾ | | | With additional charge | | F | | | | | | | | - | | | | | |
| For other types of construction and more information, see from page 2/103 | | | | | | | | | | | | | | | | | | | | ... | |
| Motor protection | | | | | | | | | | | | | | Version | | | | | Order code | | |
| Without | | | | | | Standard | | A | | | | | | | | - | | | | | |
| PTC thermistor with 3 temperature sensors | | | | | | With additional charge | | B | | | | | | | | - | | | | | |
| For other motor protection and more information, see from page 2/113 | | | | | | | | | | | | | | | | | | | | ... | |
| Terminal box position | | | | | | | | | | | | | | Version | | | | | Order code(s) | | |
| Terminal box at top | | | | | | Standard | | 4 | | | | | | | | | | | | | |
| For other terminal box positions and more information, see from page 2/116 | | | | | | | | | | | | | | | | | | | | | |
| Special versions | | | | | | | | | | | | | | | | | | | | Order code(s) | |
| Forced-air cooled motors w/o ext. fan/fan cover (IC418) | | | | | | | | | | | | | | 1LE1503-.... | | -Z | | F90+....+.... | | | |
| For options, see from page 2/125 | | | | | | | | | | | | | | 1LE1503-.... | | -Z | |+....+.... | | | |

2

¹⁾ Operating values at rated power for 60 Hz are stored in the Drive Technology Configurator (DT Configurator; see Appendix, "Tools and engineering").

²⁾ Parallel supply lines are required in the case of connection to ≤ 240 V. For frame size 315 with connection to ≤ 240 V, due to the high current, a drilled, removable entry plate (order code **R52**) or a larger terminal box (order code **R50**) can be used. Order codes **R52** and **R50** alter the motor dimensions.

³⁾ Types derived from IM B3 (IM B6/7/8, IM V6 and IM V5), from IM B5 (IM V3 and IM V1) and from IM B14 (IM V19 and IM V18) are possible, provided that no requirement exists for stamping of the type on the rating plate. The basic type IM B3, IM B5, or IM B14 is stamped as standard on the rating plate. If mounted in a different position, the position must be specified to ensure that the condensation drainage holes are positioned correctly.



SIMOTICS GP and SIMOTICS SD standard motors
IE3 Premium Efficiency

Cast-iron series SIMOTICS SD 1LE1503 Basic Line – self-ventilated or forced-air cooled

Selection and ordering data

Table with columns: P_rated, P_60Hz, Frame size, n_rated, T_rated, Different IE class, η_rated, cosφ_rated, I_rated, T_LR, I_LR, T_B, L_pA, L_WA, Cast-iron series (1LE1503), Article No., m_IM B3, J. Includes operating values at rated power and a list of motor models from 0.25 to 200 kW.

Table for special versions and options. Columns include Voltages 2), Types of construction, Motor protection, Terminal box position, and Special versions. Includes options for forced-air cooled motors and fan covers.

1) Operating values at rated power for 60 Hz are stored in the Drive Technology Configurator (DT Configurator; see Appendix, "Tools and engineering").
2) Parallel supply lines are required in the case of connection to ≤ 240 V. For frame size 315 with connection to ≤ 240 V, due to the high current, a drilled, removable entry plate (order code R52) or a larger terminal box (order code R50) can be used. Order codes R52 and R50 alter the motor dimensions.

3) Types derived from IM B3 (IM B6/7/8, IM V6 and IM V5), from IM B5 (IM V3 and IM V1) and from IM B14 (IM V19 and IM V18) are possible, provided that no requirement exists for stamping of the type on the rating plate. The basic type IM B3, IM B5, or IM B14 is stamped as standard on the rating plate. If mounted in a different position, the position must be specified to ensure that the condensation drainage holes are positioned correctly.





SIMOTICS GP and SIMOTICS SD standard motors
IE3 Premium Efficiency

Cast-iron series SIMOTICS SD 1LE1503 Basic Line – self-ventilated or forced-air cooled

Selection and ordering data

| P _{rated} 50 Hz/ P50 kW | P _{rated} 60 Hz/ P60 ¹⁾ kW | Frame size | Operating values at rated power | | Different IE class 60 Hz/P60 | η _{rated} 50 Hz % | η _{rated} 50 Hz % | η _{rated} 50 Hz % | cos φ _{rated} 50 Hz % | I _{rated} 400 V A | T _{L/R} 50 Hz °C | I _{L/R} 50 Hz % | T _B 50 Hz °C | L _{pA} 50 Hz dB(A) | L _{WA} 50 Hz dB(A) | Cast-iron series | m _{IM B3} kg | J kgm ² |
|---|---|---------------|---------------------------------|--|------------------------------------|----------------------------------|----------------------------------|----------------------------------|--------------------------------------|----------------------------------|---------------------------------|--------------------------------|-------------------------------|-----------------------------------|-----------------------------------|------------------|--------------------------|-----------------------|
| | | | 1LE1503 – Basic Line | | | | | | | | | | | | | | | |
| FS | rpm | Nm | Article No. | | | | | | | | | | | | | | | |

- Cooling: Self-ventilated (IC411) or with order code F90 forced-air cooled without external fan and fan cover (IC418)
- Efficiency according to IEC 60034-30-1: IE3 Premium Efficiency, service factor (SF) 1.15
- Insulation: Thermal class 155 (temperature class F), IP55 degree of protection, utilization in accordance with thermal class 130 (temperature class B)

6-pole: 1000 rpm at 50 Hz, 1200 rpm at 60 Hz ¹⁾

| | | | | | | | | | | | | | | | | | | |
|------|------|-------|-----|------|-----|------|------|------|------|------|-----|-----|-----|----|----|--------------|------|--------|
| 0.18 | 0.21 | 71 M | 885 | 1.9 | | 63.9 | 64.8 | 60.8 | 0.69 | 0.59 | 2.3 | 2.8 | 2.3 | 39 | 50 | 1LE1503-0CC2 | 13 | 0.0010 |
| 0.25 | 0.29 | 71 M | 885 | 2.7 | | 68.6 | 69.5 | 66.2 | 0.69 | 0.76 | 2.6 | 3.2 | 2.6 | 46 | 57 | 1LE1503-0CC3 | 16 | 0.0015 |
| 0.37 | 0.43 | 80 M | 940 | 3.8 | | 73.5 | 73.1 | 69.4 | 0.66 | 1.1 | 2.3 | 4.2 | 2.7 | 42 | 53 | 1LE1503-0DC2 | 19 | 0.0025 |
| 0.55 | 0.63 | 80 M | 935 | 5.6 | | 77.2 | 77 | 73.9 | 0.67 | 1.53 | 2.5 | 4.5 | 2.8 | 42 | 53 | 1LE1503-0DC3 | 22 | 0.0031 |
| 0.75 | 0.86 | 90 S | 945 | 7.6 | | 78.9 | 80 | 78.8 | 0.7 | 1.96 | 2.2 | 4.6 | 2.6 | 43 | 55 | 1LE1503-0EC0 | 26 | 0.0040 |
| 1.1 | 1.27 | 90 L | 950 | 11 | IE1 | 81.0 | 81.4 | 79.3 | 0.66 | 2.95 | 2.8 | 5 | 3 | 60 | 68 | 1LE1503-0EC4 | 32 | 0.0052 |
| 1.5 | 1.75 | 100 L | 970 | 14.8 | IE2 | 82.5 | 83.1 | 81.5 | 0.73 | 3.6 | 1.9 | 5.2 | 2.8 | 59 | 71 | 1LE1503-1AC4 | 36 | 0.011 |
| 2.2 | 2.55 | 112 M | 970 | 22 | IE2 | 84.3 | 85 | 83.9 | 0.75 | 5 | 2.2 | 5.6 | 2.8 | 65 | 74 | 1LE1503-1BC2 | 53 | 0.017 |
| 3 | 3.45 | 132 S | 975 | 29 | | 85.6 | 86.1 | 84.9 | 0.73 | 6.9 | 2.3 | 6.6 | 3.2 | 56 | 66 | 1LE1503-1CC0 | 60 | 0.034 |
| 4 | 4.55 | 132 M | 975 | 39 | | 86.8 | 87.1 | 86.2 | 0.73 | 9.1 | 2.2 | 6.2 | 3 | 67 | 75 | 1LE1503-1CC2 | 64 | 0.039 |
| 5.5 | 6.3 | 132 M | 975 | 54 | | 88.0 | 88.3 | 87.2 | 0.72 | 12.5 | 2.7 | 6.8 | 3.4 | 64 | 72 | 1LE1503-1CC3 | 76 | 0.050 |
| 7.5 | 8.6 | 160 M | 985 | 73 | | 89.1 | 89.5 | 88.6 | 0.81 | 15 | 2.3 | 7.9 | 3.2 | 71 | 79 | 1LE1503-1DC2 | 124 | 0.132 |
| 11 | 12.6 | 160 L | 980 | 107 | | 90.3 | 90.8 | 90.2 | 0.80 | 22 | 2.9 | 6.8 | 2.8 | 66 | 74 | 1LE1503-1DC4 | 138 | 0.164 |
| 15 | 18 | 180 L | 975 | 147 | IE2 | 91.2 | 92 | 91.9 | 0.8 | 29.5 | 2.3 | 5.9 | 2.8 | 61 | 68 | 1LE1503-1EC4 | 180 | 0.19 |
| 18.5 | 22 | 200 L | 978 | 181 | IE2 | 91.7 | 92.5 | 92.4 | 0.79 | 37 | 2.5 | 5.6 | 2.6 | 64 | 71 | 1LE1503-2AC4 | 215 | 0.28 |
| 22 | 26.5 | 200 L | 978 | 215 | IE2 | 92.2 | 93.1 | 93.2 | 0.79 | 43.5 | 2.5 | 5.6 | 2.6 | 61 | 68 | 1LE1503-2EC5 | 230 | 0.32 |
| 30 | 36 | 225 M | 982 | 292 | IE2 | 92.9 | 93.6 | 93.5 | 0.83 | 56 | 2.6 | 6.6 | 3 | 64 | 77 | 1LE1503-2BC2 | 325 | 0.67 |
| 37 | 44.5 | 250 M | 985 | 359 | IE2 | 93.3 | 94 | 94 | 0.85 | 67 | 2.7 | 7 | 2.9 | 62 | 75 | 1LE1503-2CC2 | 405 | 1 |
| 45 | 54 | 280 S | 988 | 435 | IE2 | 93.7 | 94.3 | 94.2 | 0.85 | 82 | 3 | 6.8 | 2.8 | 60 | 74 | 1LE1503-2DC0 | 510 | 1.4 |
| 55 | 66 | 280 M | 988 | 532 | IE2 | 94.1 | 94.5 | 94.4 | 0.85 | 99 | 3.3 | 7.2 | 3 | 65 | 79 | 1LE1503-2DC2 | 560 | 1.64 |
| 75 | 90 | 315 S | 990 | 723 | | 94.6 | 94.9 | 94.4 | 0.84 | 136 | 2.6 | 7.5 | 3.1 | 63 | 78 | 1LE1503-3AC0 | 750 | 2.6 |
| 90 | 108 | 315 M | 991 | 867 | IE2 | 94.9 | 95.2 | 94.9 | 0.85 | 161 | 2.5 | 6.7 | 2.8 | 63 | 78 | 1LE1503-3AC2 | 890 | 3.1 |
| 110 | 132 | 315 L | 991 | 1060 | | 95.1 | 95.5 | 95.3 | 0.84 | 199 | 2.8 | 7.2 | 3 | 63 | 78 | 1LE1503-3AC4 | 990 | 3.9 |
| 132 | 158 | 315 L | 992 | 1271 | IE2 | 95.4 | 95.7 | 95.4 | 0.82 | 245 | 3.3 | 8 | 3.3 | 66 | 81 | 1LE1503-3AC5 | 1130 | 4.48 |
| 160 | 192 | 315 L | 992 | 1540 | IE2 | 95.6 | 95.8 | 95.5 | 0.82 | 295 | 3.5 | 8.5 | 3.6 | 66 | 81 | 1LE1503-3AC6 | 1260 | 5.41 |

| Voltages ²⁾ | Version | Order code |
|------------------------|---------------------------|------------|
| 50 Hz 230 VΔ/400 VY | Standard | 2 2 |
| 50 Hz 400 VΔ/690 VY | Standard | 3 4 |
| 50 Hz 500 VY | Without additional charge | 2 7 |
| 50 Hz 500 VΔ | Without additional charge | 4 0 |
| | | 9 0 |

For other voltages ¹⁾ and more information, see from page 2/96

| Types of construction | Version | Order code |
|------------------------------------|------------------------|------------|
| Without flange IM B3 ³⁾ | Standard | A |
| With flange IM B5 ³⁾ | With additional charge | F |

For other types of construction and more information, see from page 2/103

| Motor protection | Version | Order code |
|---|------------------------|------------|
| Without | Standard | A |
| PTC thermistor with 3 temperature sensors | With additional charge | B |

For other motor protection and more information, see from page 2/113

| Terminal box position | Version | Order code |
|-----------------------|----------|------------|
| Terminal box at top | Standard | 4 |

For other terminal box positions and more information, see from page 2/116

| Special versions | Order code(s) |
|---|-------------------------------|
| Forced-air cooled motors w/o ext. fan/fan cover (IC418) | 1LE1503-...-Z F90+...+...+... |
| | 1LE1503-...-Z ...+...+...+... |

For options, see from page 2/125

¹⁾ Operating values at rated power for 60 Hz are stored in the Drive Technology Configurator (DT Configurator; see Appendix, "Tools and engineering").
²⁾ Parallel supply lines are required in the case of connection to ≤ 240 V. For frame size 315 with connection to ≤ 240 V, due to the high current, a drilled, removable entry plate (order code R52) or a larger terminal box (order code R50) can be used. Order codes R52 and R50 alter the motor dimensions.
³⁾ Types derived from IM B3 (IM B6/7/8, IM V6 and IM V5), from IM B5 (IM V3 and IM V1) and from IM B14 (IM V19 and IM V18) are possible, provided that no requirement exists for stamping of the type on the rating plate. The basic type IM B3, IM B5, or IM B14 is stamped as standard on the rating plate. If mounted in a different position, the position must be specified to ensure that the condensation drainage holes are positioned correctly.



SIMOTICS GP and SIMOTICS SD standard motors
IE3 Premium Efficiency

Cast-iron series SIMOTICS SD 1LE1603 Performance Line – self-ventilated or forced-air cooled

Selection and ordering data

| P _{rated} 50 Hz/ P50 kW | P _{rated} 60 Hz/ P60 ¹⁾ kW | Frame size | Operating values at rated power | | | | | | | | | | | | | Cast-iron series 1LE1603 – Performance Line Article No. | m _{IM B3} kg | J kgm ² | | | |
|--|---|---------------|------------------------------------|-----------------------------------|------------------------------------|----------------------------------|----------------------------------|----------------------------------|-------------------------------------|----------------------------------|--|--|---|------------------------------------|-----------------------------------|--|--------------------------|------------------------|-----|---|---|
| | | | n _{rated} 50 Hz rpm | T _{rated} 50 Hz Nm | Different IE class 60 Hz/P60 | η _{rated} 50 Hz % | η _{rated} 50 Hz % | η _{rated} 50 Hz % | cosφ _{rated} 50 Hz % | I _{rated} 400 V A | T _{LR} / T _{rated} 50 Hz | I _{LR} / I _{rated} 50 Hz | T _B / T _{rated} 50 Hz | L _{pfA} 50 Hz dB(A) | L _{WA} 50 Hz dB(A) | | | | | | |
| 3 | 3.45 | 100 L | 2920 | 9.8 | | 87.1 | 87.9 | 87.5 | 0.88 | 5.6 | 3.2 | 8.1 | 4.6 | 67 | 79 | 1LE1603-1AA4 | 36 | 0.0054 | | | |
| 4 | 4.55 | 112 M | 2950 | 13 | | 88.1 | 88.7 | 88.2 | 0.89 | 7.4 | 2.5 | 8.7 | 4 | 69 | 81 | 1LE1603-1BA2 | 45 | 0.012 | | | |
| 5.5 | 6.3 | 132 S | 2950 | 18 | | 89.2 | 90.1 | 89.7 | 0.9 | 9.9 | 1.9 | 7.3 | 3.7 | 68 | 80 | 1LE1603-1CA0 | 58 | 0.024 | | | |
| 7.5 | 8.6 | 132 S | 2950 | 24.5 | | 90.1 | 91 | 91 | 0.92 | 13.1 | 1.9 | 8.3 | 3.9 | 68 | 80 | 1LE1603-1CA1 | 73 | 0.031 | | | |
| 11 | 12.6 | 160 M | 2955 | 35.5 | | 91.2 | 91 | 89.5 | 0.89 | 19.6 | 2.4 | 7.9 | 3.8 | 70 | 82 | 1LE1603-1DA2 | 100 | 0.053 | | | |
| 15 | 17.3 | 160 M | 2960 | 48 | | 91.9 | 91.9 | 91 | 0.87 | 27 | 2.8 | 8.8 | 4.3 | 74 | 82 | 1LE1603-1DA3 | 110 | 0.061 | | | |
| 18.5 | 21.3 | 160 L | 2955 | 60 | | 92.4 | 92.8 | 92.4 | 0.9 | 32 | 2.8 | 9 | 4.2 | 70 | 82 | 1LE1603-1DA4 | 127 | 0.068 | | | |
| 22 | 24.5 | 180 M | 2950 | 71 | | 92.7 | 93.2 | 92.9 | 0.89 | 38.5 | 2.3 | 7.5 | 3.5 | 67 | 80 | 1LE1603-1EA2 | 160 | 0.08 | | | |
| 30 | 33.5 | 200 L | 2955 | 97 | | 93.3 | 93.5 | 92.9 | 0.87 | 53 | 2.5 | 7 | 3.3 | 67 | 80 | 1LE1603-2AA4 | 225 | 0.134 | | | |
| 37 | 41.5 | 200 L | 2955 | 120 | | 93.7 | 94.2 | 94 | 0.88 | 65 | 2.5 | 7.1 | 3.2 | 67 | 80 | 1LE1603-2AA5 | 250 | 0.158 | | | |
| 45 | 51 | 225 M | 2960 | 145 | | 94 | 94.5 | 94.4 | 0.89 | 78 | 2.4 | 6.9 | 3.3 | 73 | 87 | 1LE1603-2BA2 | 315 | 0.26 | | | |
| 55 | 62 | 250 M | 2975 | 177 | | 94.3 | 94.5 | 93.9 | 0.89 | 95 | 2.3 | 6.7 | 3.1 | 73 | 87 | 1LE1603-2CA2 | 385 | 0.46 | | | |
| 75 | 84 | 280 S | 2975 | 241 | IE2 | 94.7 | 94.8 | 94.1 | 0.89 | 128 | 2.4 | 6.8 | 3 | 74 | 88 | 1LE1603-2DA0 | 510 | 0.77 | | | |
| 90 | 101 | 280 M | 2975 | 289 | IE2 | 95 | 95.1 | 94.6 | 0.9 | 152 | 2.4 | 7.2 | 3.1 | 74 | 88 | 1LE1603-2DA2 | 590 | 0.94 | | | |
| 110 | 123 | 315 S | 2982 | 352 | | 95.2 | 95.4 | 94.9 | 0.91 | 183 | 2.4 | 7.1 | 3.1 | 75 | 89 | 1LE1603-3AA0 | 750 | 1.4 | | | |
| 132 | 148 | 315 M | 2982 | 423 | | 95.4 | 95.5 | 95.2 | 0.91 | 220 | 2.5 | 7.2 | 3.1 | 75 | 89 | 1LE1603-3AA2 | 880 | 1.6 | | | |
| 160 | 180 | 315 L | 2982 | 512 | IE2 | 95.6 | 95.7 | 95.2 | 0.92 | 265 | 2.8 | 7.8 | 3.3 | 77 | 91 | 1LE1603-3AA4 | 980 | 1.9 | | | |
| 200 | 224 | 315 L | 2982 | 640 | | 95.8 | 95.9 | 95.5 | 0.92 | 330 | 2.5 | 7.2 | 3 | 77 | 91 | 1LE1603-3AA5 | 1150 | 2.3 | | | |
| Voltages ²⁾ | | | Version | | | | | | | | | | | | | Order code | | | | | |
| 50 Hz 230 VΔ/400 VY | | | 60 Hz ¹⁾ 460 VY | | | Standard | | | | | | | | | | | | | 2 | 2 | – |
| 50 Hz 400 VΔ/690 VY | | | 60 Hz ¹⁾ 460 VΔ | | | Standard | | | | | | | | | | | | | 3 | 4 | – |
| 50 Hz 500 VY | | | Without additional charge | | | | | | | | | | | | | 2 | 7 | – | | | |
| 50 Hz 500 VΔ | | | Without additional charge | | | | | | | | | | | | | 4 | 0 | – | | | |
| For other voltages ¹⁾ and more information, see from page 2/96 | | | | | | | | | | | | | | | | 9 | 0 | ... | | | |
| Types of construction | | | Version | | | | | | | | | | | | | Order code | | | | | |
| Without flange | | | IM B3 ³⁾ | | | Standard | | | | | | | | | | | | | A | – | |
| With flange | | | IM B5 ³⁾ | | | With additional charge | | | | | | | | | | | | | F | – | |
| For other types of construction and more information, see from page 2/103 | | | | | | | | | | | | | | | | | ... | | | | |
| Motor protection | | | Line | | | | | | | | | | | | | Version | | Order code | | | |
| PTC thermistor with 3 temperature sensors | | | | | | | | | | | | | | | | Standard | | B | – | | |
| For other motor protection and more information, see from page 2/113 | | | | | | | | | | | | | | | | | | | ... | | |
| Terminal box position | | | Version | | | | | | | | | | | | | Order code | | | | | |
| Terminal box at top | | | Standard | | | | | | | | | | | | | 4 | – | | | | |
| For other terminal box positions and more information, see from page 2/116 | | | | | | | | | | | | | | | | | | | ... | | |
| Special versions | | | | | | | | | | | | | | | | Order code(s) | | | | | |
| Forced-air cooled motors w/o ext. fan/fan cover (IC418) | | | | | | | | | | | | | | | | 1LE1603-...-Z | | F90+...+...+... | | | |
| For options, see from page 2/125 | | | | | | | | | | | | | | | | 1LE1603-...-Z | | ...+...+...+... | | | |



¹⁾ Operating values at rated power for 60 Hz are stored in the Drive Technology Configurator (DT Configurator; see Appendix, "Tools and engineering").

²⁾ Parallel supply lines are required in the case of connection to ≤ 240 V. For frame size 315 with connection to ≤ 240 V, due to the high current, a drilled, removable entry plate (order code **R52**) or a larger terminal box (order code **R50**) can be used. Order codes **R52** and **R50** alter the motor dimensions.

³⁾ Types derived from IM B3 (IM B6/7/8, IM V6 and IM V5), from IM B5 (IM V3 and IM V1) and from IM B14 (IM V19 and IM V18) are possible, provided that no requirement exists for stamping of the type on the rating plate. The basic type IM B3, IM B5, or IM B14 is stamped as standard on the rating plate. If mounted in a different position, the position must be specified to ensure that the condensation drainage holes are positioned correctly.

SIMOTICS GP and SIMOTICS SD standard motors

IE3 Premium Efficiency



Cast-iron series SIMOTICS SD 1LE1603 Performance Line – self-ventilated or forced-air cooled

Selection and ordering data

| Operating values at rated power | | | | | | | | | | | | | | | Cast-iron series | | $m_{IM\ B3}$ | J | | |
|--|-------------------------------|------------|----------------------------|---------------------|--------------------|---------------------------|------------------------|------------------------|----------------------------|---------------------|----------------------------|----------------------------|-------------------------------|-------------------|-------------------------------|--|--------------|-------|------------|------------------|
| $P_{rated, 50\ Hz/ P50}$ | $P_{rated, 60\ Hz/ P60}^{1)}$ | Frame size | $n_{rated, 50\ Hz}$ | $T_{rated, 50\ Hz}$ | Different IE class | $\eta_{rated, 50\ Hz}$ | $\eta_{rated, 50\ Hz}$ | $\eta_{rated, 50\ Hz}$ | $\cos\phi_{rated, 50\ Hz}$ | $I_{rated, 50\ Hz}$ | $T_{LR}/T_{rated, 50\ Hz}$ | $I_{LR}/I_{rated, 50\ Hz}$ | $T_{\beta}/T_{rated, 50\ Hz}$ | $L_{pFA, 50\ Hz}$ | $L_{WA, 50\ Hz}$ | 1LE1603 – Performance Line Article No. | | | kg | kgm ² |
| kW | kW | FS | rpm | Nm | | % | % | % | % | A | | | | | | | | | | |
| • Cooling: Self-ventilated (IC411) or with order code F90 forced-air cooled without external fan and fan cover (IC418) • Efficiency according to IEC 60034-30-1: IE3 Premium Efficiency, service factor (SF) 1.15 • Insulation: Thermal class 155 (temperature class F), IP55 degree of protection, utilization in accordance with thermal class 130 (temperature class B) | | | | | | | | | | | | | | | | | | | | |
| 4-pole: 1500 rpm at 50 Hz, 1800 rpm at 60 Hz ¹⁾ | | | | | | | | | | | | | | | | | | | | |
| 2.2 | 2.55 | 100 L | 1465 | 14.3 | IE2 | 86.7 | 87.3 | 86.4 | 0.83 | 4.4 | 2.1 | 7.6 | 3.6 | 60 | 72 | 1LE1603-1AB4 | 40 | 0.014 | | |
| 3 | 3.45 | 100 L | 1460 | 20 | | 87.7 | 88.4 | 88.2 | 0.83 | 5.9 | 2.3 | 7.3 | 3.7 | 60 | 72 | 1LE1603-1AB5 | 40 | 0.014 | | |
| 4 | 4.55 | 112 M | 1460 | 26 | | 88.6 | 89.2 | 88.6 | 0.82 | 7.9 | 2.4 | 7.1 | 3.7 | 58 | 70 | 1LE1603-1BB2 | 46 | 0.017 | | |
| 5.5 | 6.3 | 132 S | 1470 | 36 | IE2 | 89.6 | 90.1 | 89.5 | 0.84 | 10.5 | 2.1 | 7.2 | 3.4 | 64 | 76 | 1LE1603-1CB0 | 74 | 0.046 | | |
| 7.5 | 8.6 | 132 M | 1470 | 49 | IE2 | 90.4 | 91.1 | 90.8 | 0.84 | 14.3 | 2.4 | 7.4 | 3.5 | 64 | 76 | 1LE1603-1CB2 | 80 | 0.046 | | |
| 11 | 12.6 | 160 M | 1475 | 71 | | 91.4 | 91.9 | 91.4 | 0.84 | 20.5 | 2.2 | 6.8 | 3.2 | 65 | 77 | 1LE1603-1DB2 | 109 | 0.083 | | |
| 15 | 17.3 | 160 L | 1475 | 97 | | 92.1 | 92.3 | 91.5 | 0.82 | 28.5 | 2.5 | 8.5 | 3.8 | 65 | 77 | 1LE1603-1DB4 | 127 | 0.099 | | |
| 18.5 | 21.3 | 180 M | 1470 | 120 | | 92.6 | 93.1 | 92.9 | 0.82 | 35 | 2.5 | 7.2 | 3.3 | 66 | 73 | 1LE1603-1EB2 | 165 | 0.13 | | |
| 22 | 25.3 | 180 L | 1470 | 143 | | 93 | 93.6 | 93.6 | 0.83 | 41 | 2.3 | 6.8 | 3.3 | 67 | 75 | 1LE1603-1EB4 | 170 | 0.14 | | |
| 30 | 34.5 | 200 L | 1470 | 195 | IE2 | 93.6 | 94 | 93.7 | 0.84 | 55 | 2.6 | 7.3 | 3.1 | 65 | 72 | 1LE1603-2AB5 | 240 | 0.22 | | |
| 37 | 42.5 | 225 S | 1478 | 239 | IE2 | 93.9 | 94.5 | 94.4 | 0.86 | 66 | 2.5 | 6.4 | 2.7 | 65 | 78 | 1LE1603-2BB0 | 285 | 0.42 | | |
| 45 | 52 | 225 M | 1470 | 143 | | 93 | 93.6 | 93.6 | 0.83 | 41 | 2.3 | 6.8 | 3.3 | 67 | 75 | 1LE1603-2BB2 | 340 | 0.52 | | |
| 55 | 63 | 250 M | 1482 | 354 | IE2 | 94.6 | 95.1 | 95 | 0.87 | 96 | 2.5 | 6.8 | 2.9 | 66 | 79 | 1LE1603-2CB2 | 420 | 0.85 | | |
| 75 | 86 | 280 S | 1485 | 482 | IE2 | 95 | 95.3 | 95 | 0.86 | 133 | 2.5 | 6.9 | 3 | 69 | 83 | 1LE1603-2DB0 | 570 | 1.4 | | |
| 90 | 104 | 280 M | 1485 | 579 | IE2 | 95.2 | 95.5 | 95.3 | 0.87 | 157 | 2.6 | 7.2 | 3 | 70 | 84 | 1LE1603-2DB2 | 670 | 1.7 | | |
| 110 | 127 | 315 S | 1488 | 706 | | 95.4 | 95.8 | 95.5 | 0.87 | 191 | 2.6 | 6.8 | 2.9 | 70 | 84 | 1LE1603-3AB0 | 760 | 2.2 | | |
| 132 | 152 | 315 M | 1490 | 846 | | 95.6 | 95.9 | 95.9 | 0.87 | 230 | 2.8 | 7.3 | 3 | 73 | 87 | 1LE1603-3AB2 | 960 | 2.9 | | |
| 160 | 184 | 315 L | 1490 | 1025 | | 95.8 | 96.1 | 96.1 | 0.87 | 275 | 2.9 | 7.3 | 3.1 | 73 | 87 | 1LE1603-3AB4 | 990 | 3.1 | | |
| 200 | 230 | 315 L | 1488 | 1284 | IE2 | 96 | 96.3 | 96.1 | 0.88 | 340 | 3.2 | 7.4 | 3 | 73 | 87 | 1LE1603-3AB5 | 1190 | 3.7 | | |
| Voltages ²⁾ | | | | | | | | | | | | | | | Version | | Order code | | | |
| 50 Hz 230 VΔ/400 VY | | | 60 Hz ¹⁾ 460 VY | | | Standard | | 2 2 | | - | | | | | | | | | | |
| 50 Hz 400 VΔ/690 VY | | | 60 Hz ¹⁾ 460 VΔ | | | Standard | | 3 4 | | - | | | | | | | | | | |
| 50 Hz 500 VY | | | | | | Without additional charge | | 2 7 | | - | | | | | | | | | | |
| 50 Hz 500 VΔ | | | | | | Without additional charge | | 4 0 | | - | | | | | | | | | | |
| For other voltages ¹⁾ and more information, see from page 2/96 | | | | | | | | | | | | | | | | | | | | |
| Types of construction | | | | | | | | | | | | | | | Version | | Order code | | | |
| Without flange | | | IM B3 ³⁾ | | | Standard | | A | | - | | | | | | | | | | |
| With flange | | | IM B5 ³⁾ | | | With additional charge | | F | | - | | | | | | | | | | |
| For other types of construction and more information, see from page 2/103 | | | | | | | | | | | | | | | | | | | | |
| Motor protection | | | | | | | | | | | | | | | Line | | Version | | Order code | |
| PTC thermistor with 3 temperature sensors | | | | | | Standard | | A | | - | | | | | | | | | | |
| For other motor protection and more information, see from page 2/113 | | | | | | | | | | | | | | | | | | | | |
| Terminal box position | | | | | | | | | | | | | | | Version | | Order code | | | |
| Terminal box at top | | | | | | Standard | | 4 | | - | | | | | | | | | | |
| For other terminal box positions and more information, see from page 2/116 | | | | | | | | | | | | | | | | | | | | |
| Special versions | | | | | | | | | | | | | | | Order code(s) | | | | | |
| Forced-air cooled motors w/o ext. fan/fan cover (IC418) | | | | | | | | | | | | | | | 1LE1603-...-Z F90+...+...+... | | | | | |
| For options, see from page 2/125 | | | | | | | | | | | | | | | 1LE1603-...-Z ...+...+...+... | | | | | |

2

¹⁾ Operating values at rated power for 60 Hz are stored in the Drive Technology Configurator (DT Configurator; see Appendix, "Tools and engineering").

²⁾ Parallel supply lines are required in the case of connection to ≤ 240 V. For frame size 315 with connection to ≤ 240 V, due to the high current, a drilled, removable entry plate (order code **R52**) or a larger terminal box (order code **R50**) can be used. Order codes **R52** and **R50** alter the motor dimensions.

³⁾ Types derived from IM B3 (IM B6/7/8, IM V6 and IM V5), from IM B5 (IM V3 and IM V1) and from IM B14 (IM V19 and IM V18) are possible, provided that no requirement exists for stamping of the type on the rating plate. The basic type IM B3, IM B5, or IM B14 is stamped as standard on the rating plate. If mounted in a different position, the position must be specified to ensure that the condensation drainage holes are positioned correctly.



Selection and ordering data

| P _{rated} 50 Hz/ P50 kW | P _{rated} 60 Hz/ P60 kW | Frame size | Operating values at rated power | | | | | | | | | | | | | Cast-iron series 1LE1603 – Performance Line Article No. | m _{IM B3} kg | J kgm ² |
|---|---|---------------|------------------------------------|-----------------------------------|------------------------------------|----------------------------------|----------------------------------|----------------------------------|-------------------------------------|----------------------------------|-------------------------------------|-------------------------------------|------------------------------------|--------------------------------------|-------------------------------------|--|--------------------------|-----------------------|
| | | | n _{rated} 50 Hz rpm | T _{rated} 50 Hz Nm | Different IE class 60 Hz/P60 | η _{rated} 50 Hz % | η _{rated} 50 Hz % | η _{rated} 50 Hz % | cosφ _{rated} 50 Hz % | I _{rated} 400 V A | T _{LR} / 50 Hz dB(A) | I _{LR} / 50 Hz dB(A) | T _B / 50 Hz dB(A) | L _p fA, 50 Hz dB(A) | L _{WA} , 50 Hz dB(A) | | | |
| 1.5 | 1.75 | 100 L | 970 | 14.8 | IE2 | 82.5 | 83.1 | 81.5 | 0.73 | 3.6 | 1.9 | 5.2 | 2.8 | 59 | 71 | 1LE1603-1AC4 | 36 | 0.011 |
| 2.2 | 2.55 | 112 M | 970 | 22 | IE2 | 84.3 | 85 | 83.9 | 0.75 | 5 | 2.2 | 5.6 | 2.8 | 65 | 74 | 1LE1603-1BC2 | 53 | 0.017 |
| 3 | 3.45 | 132 S | 975 | 29 | | 85.6 | 86.1 | 84.9 | 0.73 | 6.9 | 2.3 | 6.6 | 3.2 | 53 | 66 | 1LE1603-1CC0 | 60 | 0.034 |
| 4 | 4.55 | 132 M | 975 | 39 | | 86.8 | 87.1 | 86.2 | 0.73 | 9.1 | 2.2 | 6.2 | 3 | 62 | 75 | 1LE1603-1CC2 | 64 | 0.039 |
| 5.5 | 6.3 | 132 M | 975 | 54 | | 88.0 | 88.3 | 87.2 | 0.72 | 12.5 | 2.7 | 6.8 | 3.4 | 59 | 72 | 1LE1603-1CC3 | 76 | 0.050 |
| 7.5 | 8.6 | 160 M | 985 | 73 | | 89.1 | 89.5 | 88.6 | 0.81 | 15 | 2.3 | 7.9 | 3.2 | 66 | 79 | 1LE1603-1DC2 | 124 | 0.132 |
| 11 | 12.6 | 160 L | 980 | 107 | | 90.3 | 90.8 | 90.2 | 0.80 | 22 | 2.9 | 6.8 | 2.8 | 61 | 74 | 1LE1603-1DC4 | 138 | 0.164 |
| 15 | 18 | 180 L | 975 | 147 | IE2 | 91.2 | 92 | 91.9 | 0.8 | 29.5 | 2.3 | 5.9 | 2.8 | 61 | 68 | 1LE1603-1EC4 | 180 | 0.19 |
| 18.5 | 22 | 200 L | 978 | 181 | IE2 | 91.7 | 92.5 | 92.4 | 0.79 | 37 | 2.5 | 5.6 | 2.6 | 64 | 71 | 1LE1603-2AC4 | 215 | 0.28 |
| 22 | 26.5 | 200 L | 978 | 215 | IE2 | 92.2 | 93.1 | 93.2 | 0.79 | 43.5 | 2.5 | 5.6 | 2.6 | 61 | 68 | 1LE1603-2AC5 | 230 | 0.32 |
| 30 | 36 | 225 M | 982 | 292 | IE2 | 92.9 | 93.6 | 93.5 | 0.83 | 56 | 2.6 | 6.6 | 3 | 64 | 77 | 1LE1603-2BC2 | 325 | 0.67 |
| 37 | 44.5 | 250 M | 985 | 359 | IE2 | 93.3 | 94 | 94 | 0.85 | 67 | 2.7 | 7 | 2.9 | 62 | 75 | 1LE1603-2CC2 | 405 | 1 |
| 45 | 54 | 280 S | 988 | 435 | IE2 | 93.7 | 94.3 | 94.2 | 0.85 | 82 | 3 | 6.8 | 2.8 | 60 | 74 | 1LE1603-2DC0 | 510 | 1.4 |
| 55 | 66 | 280 M | 988 | 532 | IE2 | 94.1 | 94.5 | 94.4 | 0.85 | 99 | 3.3 | 7.2 | 3 | 65 | 79 | 1LE1603-2DC2 | 560 | 1.64 |
| 75 | 90 | 315 S | 990 | 723 | | 94.6 | 94.9 | 94.4 | 0.84 | 136 | 2.6 | 7.5 | 3.1 | 63 | 78 | 1LE1603-3AC0 | 750 | 2.6 |
| 90 | 108 | 315 M | 991 | 867 | IE2 | 94.9 | 95.2 | 94.9 | 0.85 | 161 | 2.5 | 6.7 | 2.8 | 63 | 78 | 1LE1603-3AC2 | 890 | 3.1 |
| 110 | 132 | 315 L | 991 | 1060 | | 95.1 | 95.5 | 95.3 | 0.84 | 199 | 2.8 | 7.2 | 3 | 63 | 78 | 1LE1603-3AC4 | 990 | 3.9 |
| 132 | 158 | 315 L | 992 | 1271 | IE2 | 95.4 | 95.7 | 95.4 | 0.82 | 245 | 3.3 | 8 | 3.3 | 66 | 81 | 1LE1603-3AC5 | 1130 | 4.48 |
| 160 | 192 | 315 L | 992 | 1540 | IE2 | 95.6 | 95.8 | 95.5 | 0.82 | 295 | 3.5 | 8.5 | 3.6 | 66 | 81 | 1LE1603-3AC6 | 1260 | 5.41 |

| Voltages ²⁾ | Version | Order code |
|---|---------------------------|------------|
| 50 Hz 230 VΔ/400 VY | Standard | 2 2 |
| 50 Hz 400 VΔ/690 VY | Standard | 3 4 |
| 50 Hz 500 VY | Without additional charge | 2 7 |
| 50 Hz 500 VΔ | Without additional charge | 4 0 |
| For other voltages ¹⁾ and more information, see from page 2/96 | | 9 0 |

| Types of construction | Version | Order code |
|---|------------------------|------------|
| Without flange | Standard | A |
| With flange | With additional charge | F |
| For other types of construction and more information, see from page 2/103 | | ... |

| Motor protection | Version | Order code |
|--|----------|------------|
| PTC thermistor with 3 temperature sensors | Standard | B |
| For other motor protection and more information, see from page 2/113 | | ... |

| Terminal box position | Version | Order code |
|--|----------|------------|
| Terminal box at top | Standard | 4 |
| For other terminal box positions and more information, see from page 2/116 | | ... |

| Special versions | Order code(s) |
|---|--------------------------------|
| Forced-air cooled motors w/o ext. fan/fan cover (IC418) | 1LE1603-... -Z F90+...+...+... |
| For options, see from page 2/125 | 1LE1603-... -Z ...+...+...+... |



¹⁾ Operating values at rated power for 60 Hz are stored in the Drive Technology Configurator (DT Configurator; see Appendix, "Tools and engineering").

²⁾ Parallel supply lines are required in the case of connection to ≤ 240 V. For frame size 315 with connection to ≤ 240 V, due to the high current, a drilled, removable entry plate (order code **R52**) or a larger terminal box (order code **R50**) can be used. Order codes **R52** and **R50** alter the motor dimensions.

³⁾ Types derived from IM B3 (IM B6/7/8, IM V6 and IM V5), from IM B5 (IM V3 and IM V1) and from IM B14 (IM V19 and IM V18) are possible, provided that no requirement exists for stamping of the type on the rating plate. The basic type IM B3, IM B5, or IM B14 is stamped as standard on the rating plate. If mounted in a different position, the position must be specified to ensure that the condensation drainage holes are positioned correctly.

SIMOTICS GP and SIMOTICS SD standard motors

IE3 Premium Efficiency



Cast-iron series SIMOTICS SD 1LE1603 Performance Line – self-ventilated or forced-air cooled

Selection and ordering data

| Operating values at rated power | | | | | | | | | | | | | | | Cast-iron series | | $m_{IM\ B3}$ | J |
|--|---------------------|------------|----------------------------|---------------------|--------------------|---------------------------|------------------------|------------------------|----------------------------|---------------------|----------------------------|----------------------------|-------------------------------|-------------------|---------------------|--|---------------|------------------|
| $P_{rated, 50\ Hz}$ | $P_{rated, 60\ Hz}$ | Frame size | $n_{rated, 50\ Hz}$ | $T_{rated, 50\ Hz}$ | Different IE class | $\eta_{rated, 50\ Hz}$ | $\eta_{rated, 50\ Hz}$ | $\eta_{rated, 50\ Hz}$ | $\cos\phi_{rated, 50\ Hz}$ | $I_{rated, 50\ Hz}$ | $T_{LR}/I_{rated, 50\ Hz}$ | $I_{LR}/I_{rated, 50\ Hz}$ | $T_{\beta}/I_{rated, 50\ Hz}$ | $L_{pFA, 50\ Hz}$ | $L_{WA, 50\ Hz}$ | 1LE1603 – Performance Line Article No. | | |
| kW | kW | FS | rpm | Nm | 60 Hz/P60 | 4/4 | 3/4 | 2/4 | 4/4 | A | 50 Hz | 50 Hz | 50 Hz | dB(A) | dB(A) | | kg | kgm ² |
| • Cooling: Self-ventilated (IC411) or with order code F90 forced-air cooled without external fan and fan cover (IC418) • Efficiency according to IEC 60034-30-1: IE3 Premium Efficiency, service factor (SF) 1.15 • Insulation: Thermal class 155 (temperature class F), IP55 degree of protection, utilization in accordance with thermal class 130 (temperature class B) | | | | | | | | | | | | | | | | | | |
| 8-pole: 750 rpm at 50 Hz, 900 rpm at 60 Hz ¹⁾ | | | | | | | | | | | | | | | | | | |
| 2.2 | 2.55 | 132 S | 725 | 29 | | 81.9 | 82.9 | 81.8 | 0.63 | 6.2 | 1.4 | 3.6 | 1.8 | 64 | 77 | 1LE1603-1CD0 | 66 | 0.038 |
| 3 | 3.45 | 132 M | 725 | 40 | | 83.5 | 84.2 | 82.7 | 0.61 | 8.5 | 1.5 | 3.8 | 2 | 64 | 77 | 1LE1603-1CD2 | 78 | 0.048 |
| 4 | 4.55 | 160 M | 730 | 52 | | 84.8 | 85.6 | 84.5 | 0.66 | 10.3 | 1.6 | 3.6 | 1.8 | 65 | 78 | 1LE1603-1DD2 | 98 | 0.065 |
| 5.5 | 6.3 | 160 M | 730 | 72 | | 86.2 | 86.9 | 85.7 | 0.66 | 14 | 1.6 | 3.8 | 1.9 | 65 | 78 | 1LE1603-1DD3 | 110 | 0.083 |
| 7.5 | 8.6 | 160 L | 728 | 98 | | 87.3 | 88.2 | 87.7 | 0.65 | 19.1 | 1.6 | 3.8 | 1.9 | 65 | 78 | 1LE1603-1DD4 | 135 | 0.116 |
| 11 | 13.2 | 180 L | 725 | 145 | | 88.6 | 89.7 | 89.6 | 0.74 | 24 | 2.1 | 5.1 | 2.4 | 61 | 74 | 1LE1603-1ED4 | 190 | 0.267 |
| 15 | 18 | 200 L | 730 | 196 | | 89.6 | 90.1 | 89.4 | 0.73 | 33.5 | 3 | 6.8 | 3.7 | 57 | 70 | 1LE1603-2AD5 | 255 | 0.420 |
| 18.5 | 22 | 225 S | 732 | 241 | | 90.1 | 90.6 | 90 | 0.75 | 39.5 | 2.5 | 5.9 | 3 | 56 | 70 | 1LE1603-2BD0 | 270 | 0.50 |
| 22 | 26.5 | 225 M | 732 | 287 | | 90.6 | 91.4 | 91.2 | 0.77 | 45.5 | 2.6 | 5.9 | 2.9 | 56 | 70 | 1LE1603-2BD2 | 280 | 0.55 |
| 30 | 36 | 250 M | 735 | 390 | | 91.3 | 91.8 | 91.5 | 0.79 | 60 | 2.6 | 6.1 | 3 | 60 | 74 | 1LE1603-2CD2 | 370 | 0.86 |
| 37 | 44.5 | 280 S | 736 | 480 | | 91.8 | 92.5 | 92.4 | 0.78 | 75 | 2.3 | 5.4 | 2.4 | 63 | 77 | 1LE1603-2DD0 | 460 | 1.1 |
| 45 | 54 | 280 M | 738 | 582 | IE2 | 92.2 | 92.8 | 92.6 | 0.8 | 88 | 2.5 | 5.9 | 2.5 | 65 | 79 | 1LE1603-2DD2 | 550 | 1.6 |
| 55 | 66 | 315 S | 740 | 710 | | 92.5 | 92.9 | 92.6 | 0.81 | 106 | 2.3 | 6 | 2.7 | 66 | 81 | 1LE1603-3AD0 | 650 | 2.0 |
| 75 | 90 | 315 M | 738 | 970 | | 93.1 | 93.5 | 93.3 | 0.81 | 144 | 2.3 | 5.9 | 2.7 | 69 | 84 | 1LE1603-3AD2 | 720 | 2.5 |
| 90 | 108 | 315 L | 740 | 1161 | | 93.4 | 94.2 | 94.3 | 0.83 | 168 | 2.2 | 5.8 | 2.5 | 71 | 85 | 1LE1603-3AD4 | 860 | 3.1 |
| 110 | 132 | 315 L | 740 | 1419 | | 93.7 | 94.2 | 94.1 | 0.82 | 205 | 2.7 | 6.7 | 2.9 | 74 | 88 | 1LE1603-3AD5 | 980 | 3.9 |
| 132 | 158 | 315 L | 740 | 1703 | | 94 | 94.4 | 94.1 | 0.81 | 250 | 2.9 | 7.2 | 3.3 | 76 | 90 | 1LE1603-3AD6 | 1160 | 4.6 |
| Voltages ²⁾ | | | | | | | | | | | | | | | Version | | Order code | |
| 50 Hz 230 VΔ/400 VY | | | 60 Hz ¹⁾ 460 VY | | | Standard | | | | | | | | | 2 | 2 | – | |
| 50 Hz 400 VΔ/690 VY | | | 60 Hz ¹⁾ 460 VΔ | | | Standard | | | | | | | | | 3 | 4 | – | |
| 50 Hz 500 VY | | | | | | Without additional charge | | | | | | | | | 2 | 7 | – | |
| 50 Hz 500 VΔ | | | | | | Without additional charge | | | | | | | | | 4 | 0 | – | |
| For other voltages ¹⁾ and more information, see from page 2/96 | | | | | | | | | | | | | | | 9 | 0 | ... | |
| Types of construction | | | | | | | | | | | | | | | Version | | Order code | |
| Without flange | | | IM B3 ³⁾ | | | Standard | | | | | | | | | A | – | | |
| With flange | | | IM B5 ³⁾ | | | With additional charge | | | | | | | | | F | – | | |
| For other types of construction and more information, see from page 2/103 | | | | | | | | | | | | | | | | | ... | |
| Motor protection | | | | | | | | | | | | | | | Version | | Order code | |
| PTC thermistor with 3 temperature sensors | | | | | | Standard | | | | | | | | | B | – | | |
| For other motor protection and more information, see from page 2/113 | | | | | | | | | | | | | | | | | ... | |
| Terminal box position | | | | | | | | | | | | | | | Version | | Order code(s) | |
| Terminal box at top | | | | | | Standard | | | | | | | | | 4 | – | | |
| For other terminal box positions and more information, see from page 2/116 | | | | | | | | | | | | | | | | | | |
| Special versions | | | | | | | | | | | | | | | | | Order code(s) | |
| Forced-air cooled motors w/o ext. fan/fan cover (IC418) | | | | | | | | | | | | | | | 1LE1603- -Z | F90+ . . . + . . . + . . . | | |
| For options, see from page 2/125 | | | | | | | | | | | | | | | | | | |

2

¹⁾ Operating values at rated power for 60 Hz are stored in the Drive Technology Configurator (DT Configurator; see Appendix, "Tools and engineering").

²⁾ Parallel supply lines are required in the case of connection to ≤ 240 V. For frame size 315 with connection to ≤ 240 V, due to the high current, a drilled, removable entry plate (order code **R52**) or a larger terminal box (order code **R50**) can be used. Order codes **R52** and **R50** alter the motor dimensions.

³⁾ Types derived from IM B3 (IM B6/7/8, IM V6 and IM V5), from IM B5 (IM V3 and IM V1) and from IM B14 (IM V19 and IM V18) are possible, provided that no requirement exists for stamping of the type on the rating plate. The basic type IM B3, IM B5, or IM B14 is stamped as standard on the rating plate. If mounted in a different position, the position must be specified to ensure that the condensation drainage holes are positioned correctly.



Cast-iron series SIMOTICS SD 1LE1503 Basic Line with increased power – self-ventilated

Selection and ordering data

| $P_{rated, 50 Hz/}$ | | $P_{rated, 60 Hz/}$ | | Frame size | Operating values at rated power | | Different IE class | | $\eta_{rated, 50 Hz/}$ | $\eta_{rated, 50 Hz/}$ | $\eta_{rated, 50 Hz/}$ | $\cos\phi_{rated, 50 Hz/}$ | $I_{rated, 50 Hz/}$ | $T_{LR}/T_{rated, 50 Hz/}$ | $I_{LR}/I_{rated, 50 Hz/}$ | $T_{\beta}/T_{rated, 50 Hz/}$ | $L_{pfA, 50 Hz/}$ | $L_{WA, 50 Hz/}$ | Cast-iron series | | $m_{IM B3}$ | J |
|--|------|---------------------|------|------------|---------------------------------|-------|--------------------|------|------------------------|---------------------------|------------------------|----------------------------|---------------------|----------------------------|-------------------------------|-------------------------------|-------------------|------------------|------------------|----|------------------|-----|
| P50 P60 | | kW kW | | FS | rpm rpm | Nm Nm | 60 Hz/P60 | | 4/4 | 3/4 | 2/4 | 4/4 | 400 V | 50 Hz | 50 Hz | 50 Hz | dB(A) | dB(A) | Article No. | kg | kgm ² | |
| <ul style="list-style-type: none"> • Cooling: Self-ventilated (IC411) or with order code F90 forced-air cooled without external fan and fan cover (IC418) • Efficiency according to IEC 60034-30-1: IE3 Premium Efficiency, service factor (SF) 1.15 • Insulation: Thermal class 155 (temperature class F), IP55 degree of protection, utilization in accordance with thermal class 130 (temperature class B) | | | | | | | | | | | | | | | | | | | | | | |
| 2-pole: 3000 rpm at 50 Hz, 3600 rpm at 60 Hz ¹⁾ | | | | | | | | | | | | | | | | | | | | | | |
| 11 | 12.6 | 132 M | 2955 | 36 | 91.2 | 91.7 | 91.8 | 0.86 | 20 | 2.5 | 9.4 | 4.1 | 72 | 80 | 1LE1503-1CA6 | | 80 | 0.031 | | | | |
| 22 | 25.3 | 160 L | 2950 | 71 | 92.7 | 93.4 | 93.3 | 0.91 | 37.5 | 2.8 | 8.7 | 4 | 70 | 82 | 1LE1503-1DA6 | | 137 | 0.077 | | | | |
| 30 | 33.5 | 180 L | 2950 | 97 | 93.3 | 93.9 | 93.9 | 0.88 | 53 | 2.6 | 8.6 | 3.9 | 67 | 80 | 1LE1503-1EA6 | | 173 | 0.094 | | | | |
| 45 | 51 | 200 L | 2950 | 146 | 94 | 94.3 | 94 | 0.87 | 79 | 2.5 | 7.1 | 3.2 | 77 | 84 | 1LE1503-2AA6 | | 245 | 0.16 | | | | |
| 55 | 62 | 225 M | 2965 | 177 | 94.3 | 94.6 | 94.4 | 0.88 | 96 | 2.8 | 8 | 3.7 | 76 | 89 | 1LE1503-2BA6 | | 370 | 0.31 | | | | |
| 75 | 84 | 250 M | 2970 | 241 | 94.7 | 94.9 | 94.5 | 0.9 | 127 | 2.2 | 6.8 | 2.9 | 78 | 92 | 1LE1503-2CA6 | | 455 | 0.56 | | | | |
| 110 | 123 | 280 M | 2975 | 353 | 95.2 | 95.4 | 95.1 | 0.91 | 183 | 2.5 | 7.7 | 3.2 | 78 | 92 | 1LE1503-2DA6 | | 660 | 1.1 | | | | |
| 4-pole: 1500 rpm at 50 Hz, 1800 rpm at 60 Hz ¹⁾ | | | | | | | | | | | | | | | | | | | | | | |
| 11 | 12.6 | 132 M | 1470 | 71 | 91.4 | 91.9 | 91.5 | 0.8 | 21.5 | 2.6 | 7.7 | 3.6 | 64 | 76 | 1LE1503-1CB6 | | 97 | 0.049 | | | | |
| 18.5 | 21.3 | 160 L | 1475 | 120 | 92.6 | 92.4 | 91.1 | 0.76 | 38 | 2.8 | 8.3 | 4 | 65 | 74 | 1LE1503-1DB6 | | 126 | 0.101 | | | | |
| 30 | 34.5 | 180 L | 1470 | 195 | 93.6 | 94 | 93.8 | 0.79 | 59 | 3 | 8.2 | 3.8 | 66 | 74 | 1LE1503-1EB6 | | 193 | 0.173 | | | | |
| 37 | 42.5 | 200 L | 1475 | 240 | 93.9 | 94.3 | 94.2 | 0.81 | 70 | 3.1 | 8.1 | 3.5 | 65 | 72 | 1LE1503-2AB6 | | 260 | 0.275 | | | | |
| 55 | 63 | 225 M | 1478 | 355 | 94.6 | 95.3 | 95.5 | 0.86 | 98 | 2.8 | 6.5 | 2.7 | 70 | 83 | 1LE1503-2BB6 | | 405 | 0.65 | | | | |
| 75 | 86 | 250 M | 1486 | 482 | 95 | 95.2 | 94.8 | 0.85 | 134 | 3 | 7.9 | 3.4 | 70 | 83 | 1LE1503-2CB6 | | 510 | 1.1 | | | | |
| 110 | 127 | 280 M | 1486 | 707 | 95.4 | 95.5 | 95 | 0.85 | 196 | 3 | 8.3 | 3.4 | 73 | 87 | 1LE1503-2DB6 | | 710 | 1.8 | | | | |
| 6-pole: 1000 rpm at 50 Hz, 1200 rpm at 60 Hz ¹⁾ | | | | | | | | | | | | | | | | | | | | | | |
| 18.5 | 22 | 180 L | 975 | 181 | 91.7 | 92.3 | 91.9 | 0.77 | 38 | 2.6 | 6.9 | 3.3 | 68 | 80 | 1LE1503-1EC6 | | 185 | 0.247 | | | | |
| 30 | 36 | 200 L | 978 | 293 | 92.9 | 93.7 | 93.7 | 0.79 | 59 | 2.8 | 6.5 | 2.8 | 61 | 68 | 1LE1503-2AC6 | | 264 | 0.434 | | | | |
| 37 | 44.5 | 225 M | 982 | 360 | 93.3 | 93.9 | 93.7 | 0.81 | 71 | 3 | 7.1 | 3.2 | 65 | 79 | 1LE1503-2BC6 | | 395 | 0.84 | | | | |
| 45 | 54 | 250 M | 986 | 436 | 93.7 | 94.3 | 94.2 | 0.84 | 83 | 2.8 | 7 | 2.9 | 68 | 81 | 1LE1503-2CC6 | | 480 | 1.3 | | | | |
| 75 | 90 | 280 M | 988 | 725 | 94.6 | 95 | 94.8 | 0.83 | 138 | 3.7 | 8.6 | 3.3 | 68 | 81 | 1LE1503-2DC6 | | 630 | 1.9 | | | | |
| Voltages²⁾ | | | | | | | | | | Version | | | | | Order code | | | | | | | |
| 50 Hz 230 VΔ/400 VY | | | | | 60 Hz ¹⁾ 460 VY | | | | | Standard | | | 2 2 | | - | | | | | | | |
| 50 Hz 400 VΔ/690 VY | | | | | 60 Hz ¹⁾ 460 VΔ | | | | | Standard | | | 3 4 | | - | | | | | | | |
| 50 Hz 500 VY | | | | | | | | | | Without additional charge | | | 2 7 | | - | | | | | | | |
| 50 Hz 500 VΔ | | | | | | | | | | Without additional charge | | | 4 0 | | - | | | | | | | |
| For other voltages ¹⁾ and more information, see from page 2/96 | | | | | | | | | | | | | 9 0 | | ... | | | | | | | |
| Types of construction | | | | | | | | | | Version | | | | | Order code | | | | | | | |
| Without flange | | | | | IM B3 ³⁾ | | | | | Standard | | | A | | - | | | | | | | |
| With flange | | | | | IM B5 ³⁾ | | | | | With additional charge | | | F | | - | | | | | | | |
| With flange | | | | | IM B14 ³⁾ | | | | | With additional charge | | | K | | - | | | | | | | |
| For other types of construction and more information, see from page 2/103 | | | | | | | | | | | | | | | ... | | | | | | | |
| Motor protection | | | | | | | | | | Version | | | | | Order code | | | | | | | |
| Without | | | | | | | | | | Standard | | | A | | - | | | | | | | |
| PTC thermistor with 3 temperature sensors | | | | | | | | | | With additional charge | | | B | | - | | | | | | | |
| For other motor protection and more information, see from page 2/113 | | | | | | | | | | | | | | | ... | | | | | | | |
| Terminal box position | | | | | | | | | | Version | | | | | Order code(s) | | | | | | | |
| Terminal box at top | | | | | | | | | | Standard | | | 4 | | | | | | | | | |
| For other terminal box positions and more information, see from page 2/116 | | | | | | | | | | | | | | | | | | | | | | |
| Special versions | | | | | | | | | | | | | | | Order code(s) | | | | | | | |
| For options, see from page 2/125 | | | | | | | | | | | | | | | 1LE1503-...-Z ...+...+...+... | | | | | | | |

¹⁾ Operating values at rated power for 60 Hz are stored in the Drive Technology Configurator (DT Configurator; see Appendix, "Tools and engineering").

²⁾ Parallel supply lines are required in the case of connection to ≤ 240 V. For frame size 315 with connection to ≤ 240 V, due to the high current, a drilled, removable entry plate (order code **R52**) or a larger terminal box (order code **R50**) can be used. Order codes **R52** and **R50** alter the motor dimensions.

³⁾ Types derived from IM B3 (IM B6/7/8, IM V6 and IM V5), from IM B5 (IM V3 and IM V1) and from IM B14 (IM V19 and IM V18) are possible, provided that no requirement exists for stamping of the type on the rating plate. The basic type IM B3, IM B5, or IM B14 is stamped as standard on the rating plate. If mounted in a different position, the position must be specified to ensure that the condensation drainage holes are positioned correctly.

SIMOTICS GP and SIMOTICS SD standard motors

IE3 Premium Efficiency



Cast-iron series SIMOTICS SD 1LE1603 Performance Line with increased power – self-ventilated

Selection and ordering data

| Operating values at rated power | | | | | | | | | | | | | | Cast-iron series | | | | |
|--|--------------------------------|---------------|----------------------------|------------------------|---------------------------|---------------------------|---------------------------|---------------------------|-------------------------------|------------------------|---|-------------------------------------|--|----------------------|---------------------|--|------------------|-------|
| P_{rated} , 50 Hz/ P50 | P_{rated} , 60 Hz/ P60 | Frame size | n_{rated} , 50 Hz | T_{rated} , 50 Hz | Different IE class | η_{rated} , 50 Hz | η_{rated} , 50 Hz | η_{rated} , 50 Hz | $\cos\phi_{rated}$, 50 Hz | I_{rated} , 50 Hz | $T_{LR}/$ T_{rated} , 50 Hz | $I_{LR}/$ I_{rated} , 50 Hz | $T_{\beta}/$ T_{rated} , 50 Hz | L_{pfA} , 50 Hz | L_{WA} , 50 Hz | 1LE1603 – Performance Line Article No. | $m_{IM B3}$ | J |
| kW | kW | FS | rpm | Nm | | % | % | % | % | A | | | | | | kg | kgm ² | |
| • Cooling: Self-ventilated (IC411) or with order code F90 forced-air cooled without external fan and fan cover (IC418) | | | | | | | | | | | | | | | | | | |
| • Efficiency according to IEC 60034-30-1: IE3 Premium Efficiency, service factor (SF) 1.15 | | | | | | | | | | | | | | | | | | |
| • Insulation: Thermal class 155 (temperature class F), IP55 degree of protection, utilization in accordance with thermal class 130 (temperature class B) | | | | | | | | | | | | | | | | | | |
| 2-pole: 3000 rpm at 50 Hz, 3600 rpm at 60 Hz ¹⁾ | | | | | | | | | | | | | | | | | | |
| 11 | 12.6 | 132 M | 2955 | 36 | | 91.2 | 91.7 | 91.8 | 0.86 | 20 | 2.5 | 9.4 | 4.1 | 72 | 80 | 1LE1603-1CA6 - ■■■■■ | 80 | 0.031 |
| 22 | 25.3 | 160 L | 2950 | 71 | | 92.7 | 93.4 | 93.3 | 0.91 | 37.5 | 2.8 | 8.7 | 4 | 70 | 82 | 1LE1603-1DA6 - ■■■■■ | 137 | 0.077 |
| 30 | 33.5 | 180 L | 2950 | 97 | | 93.3 | 93.9 | 93.9 | 0.88 | 53 | 2.6 | 8.6 | 3.9 | 67 | 80 | 1LE1603-1EA6 - ■■■■■ | 173 | 0.094 |
| 45 | 51 | 200 L | 2950 | 146 | | 94 | 94.3 | 94 | 0.87 | 79 | 2.5 | 7.1 | 3.2 | 77 | 84 | 1LE1603-2AA6 - ■■■■■ | 245 | 0.16 |
| 55 | 62 | 225 M | 2965 | 177 | | 94.3 | 94.6 | 94.4 | 0.88 | 96 | 2.8 | 8 | 3.7 | 76 | 89 | 1LE1603-2BA6 - ■■■■■ | 370 | 0.31 |
| 75 | 84 | 250 M | 2970 | 241 | | 94.7 | 94.9 | 94.5 | 0.9 | 127 | 2.2 | 6.8 | 2.9 | 78 | 92 | 1LE1603-2CA6 - ■■■■■ | 455 | 0.56 |
| 110 | 123 | 280 M | 2975 | 353 | | 95.2 | 95.4 | 95.1 | 0.91 | 183 | 2.5 | 7.7 | 3.2 | 78 | 92 | 1LE1603-2DA6 - ■■■■■ | 660 | 1.1 |
| 4-pole: 1500 rpm at 50 Hz, 1800 rpm at 60 Hz ¹⁾ | | | | | | | | | | | | | | | | | | |
| 11 | 12.6 | 132 M | 1470 | 71 | | 91.4 | 91.9 | 91.5 | 0.8 | 21.5 | 2.6 | 7.7 | 3.6 | 64 | 76 | 1LE1603-1CB6 - ■■■■■ | 97 | 0.049 |
| 18.5 | 21.3 | 160 L | 1475 | 120 | | 92.6 | 92.4 | 91.1 | 0.76 | 38 | 2.8 | 8.3 | 4 | 65 | 74 | 1LE1603-1DB6 - ■■■■■ | 126 | 0.101 |
| 30 | 34.5 | 180 L | 1470 | 195 | | 93.6 | 94 | 93.8 | 0.79 | 59 | 3 | 8.2 | 3.8 | 66 | 74 | 1LE1603-1EB6 - ■■■■■ | 193 | 0.173 |
| 37 | 42.5 | 200 L | 1475 | 240 | | 93.9 | 94.3 | 94.2 | 0.81 | 70 | 3.1 | 8.1 | 3.5 | 65 | 72 | 1LE1603-2AB6 - ■■■■■ | 260 | 0.275 |
| 55 | 63 | 225 M | 1478 | 355 | IE2 | 94.6 | 95.3 | 95.5 | 0.86 | 98 | 2.8 | 6.5 | 2.7 | 70 | 83 | 1LE1603-2BB6 - ■■■■■ | 405 | 0.65 |
| 75 | 86 | 250 M | 1486 | 482 | | 95 | 95.2 | 94.8 | 0.85 | 134 | 3 | 7.9 | 3.4 | 70 | 83 | 1LE1603-2CB6 - ■■■■■ | 510 | 1.1 |
| 110 | 127 | 280 M | 1486 | 707 | IE2 | 95.4 | 95.5 | 95 | 0.85 | 196 | 3 | 8.3 | 3.4 | 73 | 87 | 1LE1603-2DB6 - ■■■■■ | 710 | 1.8 |
| 6-pole: 1000 rpm at 50 Hz, 1200 rpm at 60 Hz ¹⁾ | | | | | | | | | | | | | | | | | | |
| 18.5 | 22 | 180 L | 975 | 181 | | 91.7 | 92.3 | 91.9 | 0.77 | 38 | 2.6 | 6.9 | 3.3 | 68 | 80 | 1LE1603-1EC6 - ■■■■■ | 185 | 0.247 |
| 30 | 36 | 200 L | 978 | 293 | IE2 | 92.9 | 93.7 | 93.7 | 0.79 | 59 | 2.8 | 6.5 | 2.8 | 61 | 68 | 1LE1603-2AC6 - ■■■■■ | 264 | 0.434 |
| 37 | 44.5 | 225 M | 982 | 360 | IE2 | 93.3 | 93.9 | 93.7 | 0.81 | 71 | 3 | 7.1 | 3.2 | 65 | 79 | 1LE1603-2BC6 - ■■■■■ | 395 | 0.84 |
| 45 | 54 | 250 M | 986 | 436 | IE2 | 93.7 | 94.3 | 94.2 | 0.84 | 83 | 2.8 | 7 | 2.9 | 68 | 81 | 1LE1603-2CC6 - ■■■■■ | 480 | 1.3 |
| 75 | 90 | 280 M | 988 | 725 | | 94.6 | 95 | 94.8 | 0.83 | 138 | 3.7 | 8.6 | 3.3 | 68 | 81 | 1LE1603-2DC6 - ■■■■■ | 630 | 1.9 |
| Voltages ²⁾ | | | | | | | | | | | Version | | Order code | | | | | |
| 50 Hz 230 VΔ/400 VY | | | 60 Hz ¹⁾ 460 VY | | Standard | | | | | | 2 | 2 | - | | | | | |
| 50 Hz 400 VΔ/690 VY | | | 60 Hz ¹⁾ 460 VΔ | | Standard | | | | | | 3 | 4 | - | | | | | |
| 50 Hz 500 VY | | | | | Without additional charge | | | | | | 2 | 7 | - | | | | | |
| 50 Hz 500 VΔ | | | | | Without additional charge | | | | | | 4 | 0 | - | | | | | |
| For other voltages ¹⁾ and more information, see from page 2/96 | | | | | | | | | | | 9 | 0 | ... | | | | | |
| Types of construction | | | | | | | | | | | Version | | Order code | | | | | |
| Without flange | | | IM B3 ³⁾ | | Standard | | | | | | A | | - | | | | | |
| With flange | | | IM B5 ³⁾ | | With additional charge | | | | | | F | | - | | | | | |
| With flange | | | IM B14 ³⁾ | | With additional charge | | | | | | K | | - | | | | | |
| For other types of construction and more information, see from page 2/103 | | | | | | | | | | | | | ... | | | | | |
| Motor protection | | | | | | | | | | | Version | | Order code | | | | | |
| PTC thermistor with 3 temperature sensors | | | | | | | | | | | Standard | | B | | - | | | |
| For other motor protection and more information, see from page 2/113 | | | | | | | | | | | | | ... | | | | | |
| Terminal box position | | | | | | | | | | | Version | | Order code(s) | | | | | |
| Terminal box at top | | | | | | | | | | | Standard | | 4 | | | | | |
| For other terminal box positions and more information, see from page 2/116 | | | | | | | | | | | | | ... | | | | | |
| Special versions | | | | | | | | | | | Order code(s) | | | | | | | |
| For options, see from page 2/125 | | | | | | | | | | | 1LE1603-... ■■■■■ -Z ■■■■■ ■■■■■ ■■■■■ | | | | | | | |

¹⁾ Operating values at rated power for 60 Hz are stored in the Drive Technology Configurator (DT Configurator; see Appendix, "Tools and engineering").

²⁾ Parallel supply lines are required in the case of connection to ≤ 240 V. For frame size 315 with connection to ≤ 240 V, due to the high current, a drilled, removable entry plate (order code **R52**) or a larger terminal box (order code **R50**) can be used. Order codes **R52** and **R50** alter the motor dimensions.

³⁾ Types derived from IM B3 (IM B6/7/8, IM V6 and IM V5), from IM B5 (IM V3 and IM V1) and from IM B14 (IM V19 and IM V18) are possible, provided that no requirement exists for stamping of the type on the rating plate. The basic type IM B3, IM B5, or IM B14 is stamped as standard on the rating plate. If mounted in a different position, the position must be specified to ensure that the condensation drainage holes are positioned correctly.



Selection and ordering data

| P _{rated} 50 Hz/ P50 kW | P _{rated} 60 Hz/ P60 ¹⁾ kW | Frame size | Operating values at rated power | | | | | | | | | | | Cast-iron series 1LE1583 Article No. | m _{IM B3} kg | J kgm ² | | |
|--|---|---------------|------------------------------------|-----------------------------------|------------------------------------|----------------------------------|----------------------------------|----------------------------------|-------------------------------------|----------------------------------|--|--|---|--|--------------------------|-----------------------|------------------------------------|-----------------------------------|
| | | | n _{rated} 50 Hz rpm | T _{rated} 50 Hz Nm | Different IE class 60 Hz/P60 | η _{rated} 50 Hz % | η _{rated} 50 Hz % | η _{rated} 50 Hz % | cosφ _{rated} 50 Hz % | I _{rated} 50 Hz A | T _{LR} / T _{rated} 50 Hz | I _{LR} / I _{rated} 50 Hz | T _B / T _{rated} 50 Hz | | | | L _{pfA} 50 Hz dB(A) | L _{WA} 50 Hz dB(A) |
| 3 | 3.45 | 100 L | 2920 | 9.8 | | 87.1 | 87.8 | 87.4 | 0.88 | 5.6 | 3.2 | 8.1 | 4.6 | 67 | 79 | ▲ 1LE1583-1AA4 | 37 | 0.0054 |
| 4 | 4.55 | 112 M | 2920 | 10 | | 88.1 | 88.7 | 88.2 | 0.89 | 7.4 | 2.5 | 8.7 | 4.0 | 69 | 81 | ▲ 1LE1583-1BA2 | 43 | 0.012 |
| 5.5 | 6.3 | 132 S | 2950 | 13 | | 89.2 | 89.6 | 88.9 | 0.91 | 9.8 | 2.1 | 9.7 | 3.6 | 72 | 79 | ▲ 1LE1583-1CA0 | 75 | 0.024 |
| 7.5 | 8.6 | 132 S | 2960 | 18 | | 90.1 | 90.9 | 90.7 | 0.92 | 13.1 | 2.1 | 8.3 | 4.0 | 68 | 80 | ▲ 1LE1583-1CA1 | 75 | 0.031 |
| 11 | 12.6 | 160 M | 2950 | 24 | | 91.2 | 91.5 | 90.7 | 0.90 | 19.3 | 2.5 | 8.5 | 3.4 | 79 | 86 | ▲ 1LE1583-1DA2 | 111 | 0.053 |
| 15 | 17.3 | 160 M | 2955 | 36 | | 91.9 | 91.9 | 91.0 | 0.87 | 27 | 2.8 | 8.8 | 4.3 | 70 | 82 | ▲ 1LE1583-1DA3 | 111 | 0.061 |
| 18.5 | 21.3 | 160 L | 2960 | 48 | | 92.4 | 92.9 | 92.6 | 0.92 | 32 | 2.8 | 9.7 | 3.8 | 78 | 85 | ▲ 1LE1583-1DA4 | 131 | 0.068 |
| 22 | 24.5 | 180 M | 2960 | 60 | | 92.7 | 93 | 92.4 | 0.89 | 39 | 2.3 | 7.5 | 3.5 | 67 | 80 | ▲ 1LE1583-1EA2 | 160 | 0.08 |
| 30 | 33.5 | 200 L | 2950 | 71 | | 93.3 | 93.6 | 93.3 | 0.87 | 53 | 2.5 | 7.0 | 3.3 | 68 | 81 | ▲ 1LE1583-2AA4 | 225 | 0.134 |
| 37 | 41.5 | 200 L | 2955 | 97 | | 93.7 | 93.9 | 93.5 | 0.88 | 65 | 2.5 | 7.1 | 3.2 | 68 | 81 | ▲ 1LE1583-2AA5 | 250 | 0.158 |
| 45 | 51 | 225 M | 2960 | 145 | | 94.0 | 94.5 | 94.4 | 0.89 | 78 | 2.4 | 6.9 | 3.3 | 73 | 87 | ▲ 1LE1583-2BA2 | 315 | 0.26 |
| 55 | 62 | 250 M | 2975 | 177 | | 94.3 | 94.5 | 94 | 0.89 | 95 | 2.1 | 7.0 | 3.0 | 73 | 87 | ▲ 1LE1583-2CA2 | 385 | 0.46 |
| 75 | 84 | 280 S | 2980 | 241 | | 94.7 | 94.8 | 94.1 | 0.89 | 128 | 2.6 | 8.7 | 3.5 | 73 | 87 | ▲ 1LE1583-2DA0 | 610 | 0.94 |
| 90 | 101 | 280 M | 2980 | 289 | | 95.0 | 95.2 | 94.8 | 0.90 | 152 | 2.7 | 8.4 | 3.2 | 77 | 91 | ▲ 1LE1583-2DA2 | 620 | 1.0 |
| 110 | 123 | 315 S | 2982 | 352 | | 95.2 | 95.4 | 95 | 0.91 | 183 | 2.2 | 7.5 | 2.9 | 75 | 89 | ▲ 1LE1583-3AA0 | 750 | 1.4 |
| 132 | 148 | 315 M | 2984 | 423 | | 95.4 | 95.6 | 95.3 | 0.9 | 220 | 2.7 | 8.4 | 3.3 | 77 | 91 | ▲ 1LE1583-3AA2 | 980 | 1.9 |
| 160 | 180 | 315 L | 2982 | 512 | | 95.6 | 95.7 | 95.1 | 0.91 | 265 | 2.6 | 8.5 | 3.3 | 77 | 91 | ▲ 1LE1583-3AA4 | 980 | 1.9 |
| 200 | 225 | 315 L | 2986 | 640 | | 95.8 | 95.9 | 95.5 | 0.92 | 330 | 3.9 | 10.1 | 3.6 | 78 | 93 | ▲ 1LE1583-3AA5 | 1180 | 2.4 |
| Voltages ²⁾ | | | Version | | | | | | | | | | | Order code | | | | |
| 50 Hz 230 VΔ/400 VY | | | Standard | | | | | | | | | | | 2 2 | | | | |
| 50 Hz 400 VΔ/690 VY | | | Standard | | | | | | | | | | | 3 4 | | | | |
| 50 Hz 500 VY | | | Without additional charge | | | | | | | | | | | 2 7 | | | | |
| 50 Hz 500 VΔ | | | Without additional charge | | | | | | | | | | | 4 0 | | | | |
| For other voltages ¹⁾ and more information, see from page 2/96 | | | | | | | | | | | | | | 9 0 | | | | |
| Types of construction | | | Version | | | | | | | | | | | Order code | | | | |
| Without flange IM B3 ³⁾ | | | Standard | | | | | | | | | | | A | | | | |
| With flange IM B5 ³⁾ | | | With additional charge | | | | | | | | | | | F | | | | |
| For other types of construction and more information, see from page 2/103 | | | | | | | | | | | | | | | | | | |
| Motor protection | | | Version | | | | | | | | | | | Order code | | | | |
| Without | | | Standard | | | | | | | | | | | A | | | | |
| PTC thermistor with 3 temperature sensors | | | With additional charge | | | | | | | | | | | B | | | | |
| For other motor protection and more information, see from page 2/113 | | | | | | | | | | | | | | | | | | |
| Terminal box position | | | Version | | | | | | | | | | | Order code | | | | |
| Terminal box at top | | | Standard | | | | | | | | | | | 4 | | | | |
| For other terminal box positions and more information, see from page 2/116 | | | | | | | | | | | | | | | | | | |
| Special versions | | | | | | | | | | | | | | Order code(s) | | | | |
| Forced-air cooled motors w/o ext. fan/fan cover (IC418) | | | 1LE1583-...-Z | | | | | | | | | | | F90+...+...+... | | | | |
| For options, see from page 2/125 | | | 1LE1583-...-Z | | | | | | | | | | | ...+...+...+... | | | | |

¹⁾ Operating values at rated power for 60 Hz are stored in the Drive Technology Configurator (DT Configurator; see Appendix, "Tools and engineering").

²⁾ Parallel supply lines are required in the case of connection to ≤ 240 V. For frame size 315 with connection to ≤ 240 V, due to the high current, a drilled, removable entry plate (order code **R52**) or a larger terminal box (order code **R50**) can be used. Order codes **R52** and **R50** alter the motor dimensions.

³⁾ Types derived from IM B3 (IM B6/7/8, IM V6 and IM V5), from IM B5 (IM V3 and IM V1) and from IM B14 (IM V19 and IM V18) are possible, provided that no requirement exists for stamping of the type on the rating plate. The basic type IM B3, IM B5, or IM B14 is stamped as standard on the rating plate. If mounted in a different position, the position must be specified to ensure that the condensation drainage holes are positioned correctly.



SIMOTICS GP and SIMOTICS SD standard motors

IE3 Premium Efficiency



Cast-iron series SIMOTICS SD 1LE1583 – self-ventilated or forced-air cooled

Selection and ordering data

| P _{rated} 50 Hz/ P50 kW | P _{rated} 60 Hz/ P60 ¹⁾ kW | Frame size | Operating values at rated power | | | | | | | | | | | | | Cast-iron series 1LE1583 Article No. | m _{IM B3} kg | J kgm ² | | | |
|--|---|---------------------|------------------------------------|-----------------------------------|------------------------------------|----------------------------------|----------------------------------|----------------------------------|-------------------------------------|----------------------------------|--|--|------------------------------------|-----------------------------------|-------|--|--------------------------|-----------------------|-----|--|---|
| | | | n _{rated} 50 Hz rpm | T _{rated} 50 Hz Nm | Different IE class 60 Hz/P60 | η _{rated} 50 Hz % | η _{rated} 50 Hz % | η _{rated} 50 Hz % | cosφ _{rated} 50 Hz % | I _{rated} 50 Hz A | T _{LR} / I _{LR} 50 Hz % | T _B / I _B 50 Hz % | L _{pfA} 50 Hz dB(A) | L _{WA} 50 Hz dB(A) | ▲ New | | | | | | |
| 2.2 | 2.55 | 100 L | 1465 | 14 | | 86.7 | 87 | 85.9 | 0.83 | 4.4 | 3.2 | 8.4 | 4.4 | 60 | 72 | ▲ 1LE1583-1AB4 | 40 | 0.014 | | | |
| 3 | 3.45 | 100 L | 1460 | 19.6 | | 87.7 | 88.4 | 87.8 | 0.84 | 5.9 | 2.4 | 8.5 | 3.4 | 68 | 75 | ▲ 1LE1583-1AB5 | 52 | 0.016 | | | |
| 4 | 4.55 | 112 M | 1460 | 26 | | 88.6 | 89.6 | 89.4 | 0.85 | 7.7 | 2.1 | 7.5 | 3.0 | 67 | 74 | ▲ 1LE1583-1BB2 | 60 | 0.017 | | | |
| 5.5 | 6.3 | 132 S | 1470 | 36 | | 89.6 | 90.1 | 89.7 | 0.82 | 10.8 | 2.9 | 8.5 | 3.7 | 64 | 76 | ▲ 1LE1583-1CB0 | 67 | 0.046 | | | |
| 7.5 | 8.6 | 132 M | 1465 | 49 | | 90.4 | 91.1 | 90.8 | 0.84 | 14.3 | 2.6 | 8.2 | 3.7 | 64 | 76 | ▲ 1LE1583-1CB2 | 82 | 0.046 | | | |
| 11 | 12.6 | 160 M | 1475 | 71 | | 91.4 | 91.8 | 91.2 | 0.84 | 21 | 2.6 | 7.6 | 3.4 | 65 | 77 | ▲ 1LE1583-1DB2 | 110 | 0.083 | | | |
| 15 | 17.3 | 160 L | 1480 | 97 | | 92.1 | 92.4 | 92.0 | 0.85 | 28 | 2.9 | 8.1 | 3.3 | 67 | 74 | ▲ 1LE1583-1DB4 | 137 | 0.099 | | | |
| 18.5 | 21.3 | 180 M | 1470 | 120 | | 92.6 | 93.1 | 93.0 | 0.82 | 35 | 2.5 | 7.2 | 3.3 | 66 | 73 | ▲ 1LE1583-1EB2 | 165 | 0.13 | | | |
| 22 | 25.3 | 180 L | 1470 | 143 | | 93.0 | 93.4 | 93.1 | 0.83 | 41 | 2.3 | 6.8 | 3.3 | 62 | 75 | ▲ 1LE1583-1EB4 | 170 | 0.14 | | | |
| 30 | 34.5 | 200 L | 1470 | 195 | | 93.6 | 94.3 | 94.5 | 0.84 | 55 | 2.6 | 7.3 | 3.1 | 59 | 72 | ▲ 1LE1583-2AB5 | 240 | 0.22 | | | |
| 37 | 42.5 | 225 S | 1482 | 238 | | 93.9 | 94.3 | 94 | 0.84 | 68 | 3.2 | 8.3 | 3.1 | 69 | 83 | ▲ 1LE1583-2BB0 | 380 | 0.52 | | | |
| 45 | 52 | 225 M | 1484 | 290 | | 94.2 | 94.6 | 94.4 | 0.84 | 82 | 3.4 | 8.3 | 3.2 | 69 | 83 | ▲ 1LE1583-2BB2 | 450 | 0.65 | | | |
| 55 | 63 | 250 M | 1486 | 353 | | 94.6 | 94.9 | 94.4 | 0.86 | 98 | 3.0 | 8.3 | 3.3 | 68 | 82 | ▲ 1LE1583-2CB2 | 525 | 1.1 | | | |
| 75 | 86 | 280 S | 1488 | 481 | | 95.0 | 95.1 | 94.5 | 0.85 | 134 | 3.4 | 9.6 | 3.7 | 69 | 83 | ▲ 1LE1583-2DB0 | 670 | 1.7 | | | |
| 90 | 104 | 280 M | 1486 | 578 | | 95.2 | 95.5 | 95.3 | 0.86 | 159 | 2.5 | 7.5 | 3.0 | 70 | 84 | ▲ 1LE1583-2DB2 | 705 | 1.7 | | | |
| 110 | 127 | 315 M ⁴⁾ | 1491 | 705 | | 95.4 | 95.6 | 95.3 | 0.86 | 194 | 3.3 | 9.0 | 3.2 | 73 | 87 | ▲ 1LE1583-3AB0 | 950 | 2.7 | | | |
| 132 | 152 | 315 M | 1491 | 845 | | 95.6 | 95.9 | 95.8 | 0.86 | 230 | 3.3 | 8.6 | 3.3 | 73 | 87 | ▲ 1LE1583-3AB2 | 990 | 3.1 | | | |
| 160 | 184 | 315 L | 1490 | 1025 | | 95.8 | 96.2 | 96.1 | 0.86 | 280 | 3.3 | 8.3 | 3.0 | 73 | 87 | ▲ 1LE1583-3AB4 | 990 | 3.1 | | | |
| 200 | 230 | 315 L | 1490 | 1282 | | 96.0 | 96.2 | 96 | 0.87 | 345 | 3.8 | 9.0 | 3.5 | 76 | 90 | ▲ 1LE1583-3AB5 | 1300 | 4.4 | | | |
| Voltages²⁾ | | | Version | | | | | | | | | | | | | Order code | | | | | |
| 50 Hz 230 VΔ/400 VY | | | 60 Hz ¹⁾ 460 VY | | | Standard | | | | | | | | | | | | | 2 2 | | - |
| 50 Hz 400 VΔ/690 VY | | | 60 Hz ¹⁾ 460 VΔ | | | Standard | | | | | | | | | | | | | 3 4 | | - |
| 50 Hz 500 VY | | | Without additional charge | | | | | | | | | | | | | 2 7 | | - | | | |
| 50 Hz 500 VΔ | | | Without additional charge | | | | | | | | | | | | | 4 0 | | - | | | |
| For other voltages ¹⁾ and more information, see from page 2/96 | | | 9 0 | | | | | | | | | | | | | | | ... | | | |
| Types of construction | | | Version | | | | | | | | | | | | | Order code | | | | | |
| Without flange | | | IM B3 ³⁾ | | | Standard | | | | | | | | | | | | | A | | - |
| With flange | | | IM B5 ³⁾ | | | With additional charge | | | | | | | | | | | | | F | | - |
| For other types of construction and more information, see from page 2/103 | | | | | | | | | | | | | | | | | | ... | | | |
| Motor protection | | | Version | | | | | | | | | | | | | Order code | | | | | |
| Without | | | Standard | | | | | | | | | | | | | A | | - | | | |
| PTC thermistor with 3 temperature sensors | | | With additional charge | | | | | | | | | | | | | B | | - | | | |
| For other motor protection and more information, see from page 2/113 | | | | | | | | | | | | | | | | | | ... | | | |
| Terminal box position | | | Version | | | | | | | | | | | | | Order code(s) | | | | | |
| Terminal box at top | | | Standard | | | | | | | | | | | | | 4 | | | | | |
| For other terminal box positions and more information, see from page 2/116 | | | | | | | | | | | | | | | | | | | | | |
| Special versions | | | | | | | | | | | | | | | | Order code(s) | | | | | |
| Forced-air cooled motors w/o ext. fan/fan cover (IC418) | | | 1LE1583-...-Z | | | | | | | | | | | | | F90+...+...+... | | | | | |
| For options, see from page 2/125 | | | 1LE1583-...-Z | | | | | | | | | | | | | ...+...+...+... | | | | | |

2

¹⁾ Operating values at rated power for 60 Hz are stored in the Drive Technology Configurator (DT Configurator; see Appendix, "Tools and engineering").

²⁾ Parallel supply lines are required in the case of connection to ≤ 240 V. For frame size 315 with connection to ≤ 240 V, due to the high current, a drilled, removable entry plate (order code **R52**) or a larger terminal box (order code **R50**) can be used. Order codes **R52** and **R50** alter the motor dimensions.

³⁾ Types derived from IM B3 (IM B6/7/8, IM V6 and IM V5), from IM B5 (IM V3 and IM V1) and from IM B14 (IM V19 and IM V18) are possible, provided that no requirement exists for stamping of the type on the rating plate. The basic type IM B3, IM B5, or IM B14 is stamped as standard on the rating plate. If mounted in a different position, the position must be specified to ensure that the condensation drainage holes are positioned correctly.

⁴⁾ Version as 315 M (different from 315 S according to DIN EN 50347).



Selection and ordering data

| Operating values at rated power | | | | | | | | | | | | | | | Cast-iron series 1LE1583 | | | | | |
|---|--|---------------------|-----------------------------|----------------------------|------------------------------------|------------------------------|------------------------------|------------------------------|----------------------------------|---------------------------|----------------------------|----------------------------|-------------------------------|----------------------------|------------------------------------|----------------|-------------------|-------------------------|------------------|--|
| P_{rated} 50 Hz/ P50 kW | P_{rated} 60 Hz/ P60 ¹⁾ kW | Frame size FS | n_{rated} 50 Hz rpm | T_{rated} 50 Hz Nm | Different IE class 60 Hz/P60 | η_{rated} 50 Hz % | η_{rated} 50 Hz % | η_{rated} 50 Hz % | $\cos\phi_{rated}$ 50 Hz % | I_{rated} 50 Hz A | T_{LR} 50 Hz dB(A) | I_{LR} 50 Hz dB(A) | T_{β} 50 Hz dB(A) | L_{pA} 50 Hz dB(A) | L_{WA} 50 Hz dB(A) | Article No. | $m_{IM B3}$ kg | J kgm ² | | |
| <ul style="list-style-type: none"> • Cooling: Self-ventilated (IC411) or with order code F90 forced-air cooled without external fan and fan cover (IC418) • Efficiency according to IEC 60034-30-1: IE3 Premium Efficiency, service factor (SF) 1.0 • Insulation: Thermal class 155 (temperature class F), IP55 degree of protection, utilization in accordance with thermal class 130 (temperature class B) | | | | | | | | | | | | | | | | | | | | |
| 6-pole: 1000 rpm at 50 Hz, 1200 rpm at 60 Hz ¹⁾ | | | | | | | | | | | | | | | | | | | | |
| 15 | 18 | 180 L | 975 | 147 | | 91.2 | 91.6 | 91.2 | 0.80 | 30 | 2.3 | 5.9 | 2.8 | 55 | 68 | ▲ 1LE1583-1EC4 | 180 | 0.19 | | |
| 18.5 | 22 | 200 L | 978 | 181 | | 91.7 | 92.1 | 91.9 | 0.79 | 37 | 2.5 | 5.6 | 2.6 | 58 | 71 | ▲ 1LE1583-2AC4 | 215 | 0.28 | | |
| 22 | 26.5 | 200 L | 978 | 215 | | 92.2 | 93.3 | 93.5 | 0.79 | 44 | 2.5 | 5.6 | 2.6 | 55 | 68 | ▲ 1LE1583-2AC5 | 230 | 0.32 | | |
| 30 | 36 | 225 M | 982 | 292 | | 92.9 | 93.7 | 93.7 | 0.81 | 58 | 2.6 | 7.0 | 2.9 | 65 | 79 | ▲ 1LE1583-2BC2 | 435 | 0.82 | | |
| 37 | 44.5 | 250 M | 986 | 358 | | 93.3 | 94 | 94 | 0.84 | 68 | 2.8 | 7.5 | 2.9 | 68 | 81 | ▲ 1LE1583-2CC2 | 520 | 1.3 | | |
| 45 | 54 | 280 S | 990 | 434 | | 93.7 | 94.2 | 94.1 | 0.84 | 83 | 3.1 | 8.0 | 3.0 | 60 | 74 | ▲ 1LE1583-2DC0 | 600 | 1.6 | | |
| 55 | 66 | 280 M | 988 | 532 | | 94.1 | 94.8 | 94.9 | 0.84 | 100 | 3.2 | 8.6 | 3.0 | 68 | 81 | ▲ 1LE1583-2DC2 | 670 | 1.9 | | |
| 75 | 90 | 315 S | 992 | 722 | | 94.6 | 95.0 | 94.7 | 0.84 | 136 | 2.4 | 7.5 | 2.8 | 63 | 78 | ▲ 1LE1583-3AC0 | 930 | 3.1 | | |
| 90 | 108 | 315 M | 992 | 866 | | 94.9 | 95.3 | 95.1 | 0.84 | 163 | 2.8 | 7.9 | 3.0 | 63 | 78 | ▲ 1LE1583-3AC2 | 990 | 3.9 | | |
| 110 | 132 | 315 L | 993 | 1058 | | 95.1 | 95.4 | 95.2 | 0.84 | 199 | 2.8 | 8.3 | 3.2 | 67 | 82 | ▲ 1LE1583-3AC4 | 1160 | 4.3 | | |
| 132 | 158 | 315 L | 993 | 1269 | | 95.4 | 95.6 | 95.3 | 0.80 | 250 | 3.2 | 8.8 | 3.6 | 67 | 82 | ▲ 1LE1583-3AC5 | 1160 | 4.6 | | |
| 160 | 192 | 315 L | 992 | 1540 | | 95.6 | 95.9 | 95.7 | 0.82 | 295 | 3.5 | 9.0 | 3.6 | 67 | 82 | ▲ 1LE1583-3AC6 | 1270 | 5.4 | | |
| 8-pole: 750 rpm at 50 Hz, 900 rpm at 60 Hz ¹⁾ | | | | | | | | | | | | | | | | | | | | |
| 11 | 13.2 | 180 L | 725 | 145 | | 88.6 | 89.5 | 89.2 | 0.74 | 24 | 2.1 | 5.1 | 2.4 | 62 | 75 | ▲ 1LE1583-1ED4 | 190 | 0.19 | | |
| 15 | 18 | 200 L | 730 | 196 | | 89.6 | 89.8 | 89.1 | 0.73 | 33 | 3.0 | 6.8 | 3.7 | 57 | 70 | ▲ 1LE1583-2AD | 255 | 0.28 | | |
| 18.5 | 22 | 225 S | 732 | 241 | | 90.1 | 91.3 | 91.3 | 0.74 | 40 | 2.4 | 5.9 | 2.9 | 56 | 70 | ▲ 1LE1583-2BD0 | 270 | 0.50 | | |
| 22 | 26.5 | 225 M | 732 | 287 | | 90.6 | 91.8 | 92 | 0.77 | 45.5 | 2.4 | 6.0 | 2.8 | 56 | 70 | ▲ 1LE1583-2BD2 | 280 | 0.55 | | |
| 30 | 36 | 250 M | 734 | 390 | | 91.3 | 92 | 91.8 | 0.78 | 61 | 2.5 | 6.4 | 2.9 | 60 | 74 | ▲ 1LE1583-2CD2 | 370 | 0.86 | | |
| 37 | 44.5 | 280 S | 736 | 480 | | 91.8 | 93 | 93.3 | 0.78 | 75 | 2.2 | 5.6 | 2.3 | 63 | 77 | ▲ 1LE1583-2DD0 | 460 | 1.1 | | |
| 45 | 54 | 280 M | 738 | 582 | | 92.2 | 93.2 | 93.5 | 0.81 | 87 | 2.4 | 6.2 | 2.4 | 65 | 79 | ▲ 1LE1583-2DD2 | 550 | 1.6 | | |
| 55 | 66 | 315 S | 740 | 710 | | 92.5 | 93.5 | 93.7 | 0.80 | 107 | 2.2 | 6.2 | 2.6 | 66 | 81 | ▲ 1LE1583-3AD0 | 650 | 2.0 | | |
| 75 | 90 | 315 M | 738 | 971 | | 93.1 | 94.1 | 94.4 | 0.80 | 145 | 2.2 | 6.0 | 2.6 | 69 | 84 | ▲ 1LE1583-3AD2 | 720 | 2.5 | | |
| 90 | 108 | 315 L | 738 | 1161 | | 93.4 | 94.4 | 94.9 | 0.83 | 168 | 2.1 | 6.0 | 2.5 | 71 | 85 | ▲ 1LE1583-3AD4 | 860 | 3.1 | | |
| 110 | 132 | 315 L | 740 | 1419 | | 93.7 | 94.5 | 94.9 | 0.80 | 210 | 2.5 | 6.7 | 2.9 | 74 | 88 | ▲ 1LE1583-3AD5 | 960 | 3.9 | | |
| 132 | 158 | 315 L | 741 | 1701 | | 94.0 | 94.6 | 94.8 | 0.79 | 255 | 3.0 | 8.0 | 3.3 | 76 | 90 | ▲ 1LE1583-3AD6 | 1250 | 5.5 | | |
| Voltages²⁾ | | | | | | | | | | | | | | | Version | | | | Order code | |
| 50 Hz 230 VΔ/400 VY | | | 60 Hz ¹⁾ 460 VY | | | Standard | | | 2 2 | | - | | | | | | | | | |
| 50 Hz 400 VΔ/690 VY | | | 60 Hz ¹⁾ 460 VΔ | | | Standard | | | 3 4 | | - | | | | | | | | | |
| 50 Hz 500 VY | | | | | | Without additional charge | | | 2 7 | | - | | | | | | | | | |
| 50 Hz 500 VΔ | | | | | | Without additional charge | | | 4 0 | | - | | | | | | | | | |
| For other voltages ¹⁾ and more information, see from page 2/96 | | | | | | | | | | | | | | | | | | | | |
| Types of construction | | | | | | | | | | | | | | | Version | | | | Order code | |
| Without flange | | | IM B3 ³⁾ | | | Standard | | | A | | - | | | | | | | | | |
| With flange | | | IM B5 ³⁾ | | | With additional charge | | | F | | - | | | | | | | | | |
| For other types of construction and more information, see from page 2/103 | | | | | | | | | | | | | | | | | | | | |
| Motor protection | | | | | | | | | | | | | | | Version | | | | Order code | |
| Without | | | | | | Standard | | | A | | - | | | | | | | | | |
| PTC thermistor with 3 temperature sensors | | | | | | With additional charge | | | B | | - | | | | | | | | | |
| For other motor protection and more information, see from page 2/113 | | | | | | | | | | | | | | | | | | | | |
| Terminal box position | | | | | | | | | | | | | | | Version | | | | Order code | |
| Terminal box at top | | | | | | Standard | | | 4 | | - | | | | | | | | | |
| For other terminal box positions and more information, see from page 2/116 | | | | | | | | | | | | | | | | | | | | |
| Special versions | | | | | | | | | | | | | | | | | | | Order code(s) | |
| Forced-air cooled motors w/o ext. fan/fan cover (IC418) | | | | | | | | | | | | | | | 1LE1583-.... | | -Z | | F90+. .+. .+. .+ | |
| For options, see from page 2/125 | | | | | | | | | | | | | | | 1LE1583-.... | | -Z | | . .+. .+. .+. .+ | |



¹⁾ Operating values at rated power for 60 Hz are stored in the Drive Technology Configurator (DT Configurator; see Appendix, "Tools and engineering").

²⁾ Parallel supply lines are required in the case of connection to ≤ 240 V. For frame size 315 with connection to ≤ 240 V, due to the high current, a drilled, removable entry plate (order code R52) or a larger terminal box (order code R50) can be used. Order codes R52 and R50 alter the motor dimensions.

³⁾ Types derived from IM B3 (IM B6/7/8, IM V6 and IM V5), from IM B5 (IM V3 and IM V1) and from IM B14 (IM V19 and IM V18) are possible, provided that no requirement exists for stamping of the type on the rating plate. The basic type IM B3, IM B5, or IM B14 is stamped as standard on the rating plate. If mounted in a different position, the position must be specified to ensure that the condensation drainage holes are positioned correctly.

SIMOTICS GP and SIMOTICS SD standard motors

IE2 High Efficiency



Aluminum series SIMOTICS GP 1LE1001 – self-ventilated or forced-air cooled

Selection and ordering data

| Operating values at rated power | | | | | | | | | | | | | | Aluminum series | | | | |
|---|--|---------------|----------------------|----------------------|------------------------------------|---------------------------------|---------------------------------|---------------------------------|-------------------------------------|--------------------------------|-------------------|-------------------|----------------|--------------------|-------------------|--------------|-------------|------------------|
| P_{rated} 50 Hz/ P50 | P_{rated} 60 Hz/ P60 ¹⁾ | Frame size | n_{rated} 50 Hz | T_{rated} 50 Hz | Different IE class 60 Hz/P60 | η_{rated} 50 Hz, 4/4 | η_{rated} 50 Hz, 3/4 | η_{rated} 50 Hz, 2/4 | $\cos\phi_{rated}$ 50 Hz, 4/4 | I_{rated} 50 Hz, 400 V | T_{LR} 50 Hz | I_{LR} 50 Hz | T_p 50 Hz | L_{pTA} 50 Hz | L_{WA} 50 Hz | 1LE1001 | $m_{IM B3}$ | J |
| kW | kW | FS | rpm | Nm | | % | % | % | % | A | °C | A | °C | dB(A) | dB(A) | Article No. | kg | kgm ² |
| • Cooling: Self-ventilated (IC411) or with order code F90 forced-air cooled without external fan and fan cover (IC418) • Efficiency according to IEC 60034-30-1: IE2 High Efficiency, service factor (SF) 1.15 • Insulation: Thermal class 155 (temperature class F), IP55 degree of protection, utilization in accordance with thermal class 130 (temperature class B) | | | | | | | | | | | | | | | | | | |
| 2-pole: 3000 rpm at 50 Hz, 3600 rpm at 60 Hz ¹⁾ | | | | | | | | | | | | | | | | | | |
| 0.18 | 0.21 | 63 M | 2850 | 0.6 | | 60.4 | 59.4 | 53.7 | 0.78 | 0.55 | 2.2 | 4.5 | 2.7 | 57 | 64 | 1LE1001-0BA2 | 4 | 0.00022 |
| 0.25 | 0.29 | 63 M | 2835 | 0.84 | | 64.8 | 63.5 | 57.3 | 0.81 | 0.69 | 1.9 | 4.1 | 2.5 | 57 | 64 | 1LE1001-0BA3 | 5 | 0.00026 |
| 0.37 | 0.43 | 71 M | 2770 | 1.3 | | 69.5 | 70.5 | 67.9 | 0.81 | 0.95 | 2.5 | 4.1 | 2.5 | 58 | 69 | 1LE1001-0CA2 | 6 | 0.00035 |
| 0.55 | 0.63 | 71 M | 2780 | 1.9 | | 74.1 | 75.2 | 72.9 | 0.80 | 1.34 | 2.6 | 4.6 | 2.6 | 58 | 69 | 1LE1001-0CA3 | 7 | 0.00045 |
| 0.75 | 0.86 | 80 M | 2805 | 2.6 | | 77.4 | 80 | 80.1 | 0.84 | 1.67 | 1.9 | 4.9 | 2.3 | 60 | 71 | 1LE1001-0DA2 | 9 | 0.0008 |
| 1.1 | 1.27 | 80 M | 2835 | 3.7 | | 79.6 | 81.3 | 80.9 | 0.83 | 2.4 | 2.7 | 6 | 3.1 | 60 | 71 | 1LE1001-0DA3 | 11 | 0.0011 |
| 1.5 | 1.75 | 90 S | 2885 | 4.9 | | 81.3 | 81.7 | 79.8 | 0.84 | 3.15 | 2.7 | 6.9 | 3.6 | 65 | 77 | 1LE1001-0EA0 | 13 | 0.0017 |
| 2.2 | 2.55 | 90 L | 2890 | 7.3 | | 83.2 | 83.7 | 82 | 0.85 | 4.5 | 2.5 | 7.1 | 3.7 | 65 | 77 | 1LE1001-0EA4 | 15 | 0.0021 |
| 3 | 3.45 | 100 L | 2905 | 9.9 | | 84.6 | 85.5 | 84.6 | 0.84 | 6.1 | 2.3 | 7 | 3.3 | 67 | 79 | 1LE1001-1AA4 | 21 | 0.0044 |
| 4 | 4.55 | 112 M | 2945 | 13 | | 85.8 | 86.2 | 85.1 | 0.85 | 7.9 | 2.1 | 8 | 3.6 | 69 | 81 | 1LE1001-1BA2 | 27 | 0.0092 |
| 5.5 | 6.3 | 132 S | 2950 | 18 | | 87 | 88 | 87.6 | 0.87 | 10.5 | 1.8 | 6.6 | 2.9 | 68 | 80 | 1LE1001-1CA0 | 39 | 0.02 |
| 7.5 | 8.6 | 132 S | 2950 | 24 | | 88.1 | 88.5 | 87.6 | 0.87 | 14.1 | 2.2 | 7.5 | 3.1 | 68 | 80 | 1LE1001-1CA1 | 43 | 0.024 |
| 11 | 12.6 | 160 M | 2955 | 36 | | 89.4 | 89.3 | 88 | 0.87 | 20.5 | 2.1 | 7.4 | 3.2 | 70 | 82 | 1LE1001-1DA2 | 67 | 0.045 |
| 15 | 17.3 | 160 M | 2955 | 48 | | 90.3 | 90.7 | 90 | 0.88 | 27 | 2.4 | 7.6 | 3.4 | 70 | 82 | 1LE1001-1DA3 | 75 | 0.053 |
| 18.5 | 21.3 | 160 L | 2955 | 60 | | 90.9 | 91.3 | 90.6 | 0.88 | 33.5 | 2.9 | 7.9 | 3.6 | 70 | 82 | 1LE1001-1DA4 | 84 | 0.061 |
| 22 | 24.5 | 180 M | 2940 | 71 | | 91.3 | 91.8 | 91.3 | 0.87 | 40 | 2.7 | 7.4 | 3.6 | 77 | 84 | 1LE1001-1EA2 | 123 | 0.069 |
| 30 | 33.5 | 200 L | 2960 | 97 | | 92 | 92.3 | 91.8 | 0.87 | 54 | 2.5 | 6.9 | 3.3 | 78 | 85 | 1LE1001-2AA4 | 158 | 0.13 |
| 37 | 41.5 | 200 L | 2960 | 119 | | 92.5 | 93 | 92.7 | 0.88 | 66 | 2.7 | 7.4 | 3.5 | 78 | 85 | 1LE1001-2AA5 | 178 | 0.15 |

| Voltagess | Version | Order code |
|---|---------------------------|------------|
| 50 Hz 230 VΔ/400 VY | Standard | 2 2 |
| 50 Hz 400 VΔ/690 VY | Standard | 3 4 |
| 50 Hz 500 VY | Without additional charge | 2 7 |
| 50 Hz 500 VΔ | Without additional charge | 4 0 |
| For other voltages ¹⁾ and more information, see from page 2/93 | | 9 0 |

| Types of construction | Version | Order code |
|--|------------------------|------------|
| Without flange IM B3 ³⁾ | Standard | A |
| With flange IM B5 ³⁾ | With additional charge | F |
| With flange IM B14 ³⁾ | With additional charge | K |
| For other types of construction and more information, see from page 2/99 | | ... |

| Motor protection | Version | Order code |
|---|------------------------|------------|
| Without | Standard | A |
| PTC thermistor with 1 or 3 temperature sensors (frame sizes 63 to 90 or 100 to 200) | With additional charge | B |
| For other motor protection and more information, see from page 2/112 | | ... |

| Terminal box position | Version | Order code |
|--|----------|------------|
| Terminal box at top | Standard | 4 |
| For other terminal box positions and more information, see from page 2/115 | | ... |

| Special versions | Order code(s) |
|---|--------------------------------|
| Forced-air cooled motors w/o ext. fan/fan cover (IC418) | 1LE1001-...-Z F90 +...+...+... |
| For options, see from page 2/118 | 1LE1001-...-Z ...+...+...+... |

2

1) Operating values at rated power for 60 Hz are stored in the Drive Technology Configurator (DT Configurator; see Appendix, "Tools and engineering").

2) For converter operation of shaft heights 63 and 90, ordering with PTC thermistors and their connection to the converter is recommended.

3) Types derived from IM B3 (IM B6/7/8, IM V6, and IM V5), from IM B5 (IM V3 and IM V1) and from IM B14 (IM V19 and IM V18) are possible, provided that no requirements exist for condensation drainage holes (H03) or stamping of the type on the rating plate. The basic type IM B3, IM B5, or IM B14 is stamped as standard on the rating plate. For orders with condensation drainage holes (H03), the type must be specified.



IE2

SIMOTICS GP and SIMOTICS SD standard motors IE2 High Efficiency

Aluminum series SIMOTICS GP 1LE1001 – self-ventilated or forced-air cooled

Selection and ordering data

| Operating values at rated power | | | | | | | | | | | | | | | Aluminum series | | | |
|---|--|---------------|-----------------------------|----------------------------|------------------------------------|------------------------------|------------------------------|------------------------------|----------------------------------|---------------------------|-----------------------------|-----------------------------|----------------------------|-----------------------------|----------------------------|------------------------|-------------------|-------------------------|
| P_{rated} 50 Hz/ P50 kW | P_{rated} 60 Hz/ P60 ¹⁾ kW | Frame size | n_{rated} 50 Hz rpm | T_{rated} 50 Hz Nm | Different IE class 60 Hz/P60 | η_{rated} 50 Hz % | η_{rated} 50 Hz % | η_{rated} 50 Hz % | $\cos\phi_{rated}$ 50 Hz % | I_{rated} 50 Hz A | $T_{LR}/$ 50 Hz dB(A) | $I_{LR}/$ 50 Hz dB(A) | $T_{p/}$ 50 Hz dB(A) | L_{pFA} 50 Hz dB(A) | L_{WA} 50 Hz dB(A) | 1LE1001 Article No. | $m_{IM B3}$ kg | J kgm ² |
| • Cooling: Self-ventilated (IC411) or with order code F90 forced-air cooled without external fan and fan cover (IC418) • Efficiency according to IEC 60034-30-1: IE2 High Efficiency, service factor (SF) 1.15 • Insulation: Thermal class 155 (temperature class F), IP55 degree of protection, utilization in accordance with thermal class 130 (temperature class B) | | | | | | | | | | | | | | | | | | |
| 4-pole: 1500 rpm at 50 Hz, 1800 rpm at 60 Hz ¹⁾ | | | | | | | | | | | | | | | | | | |
| 0.12 | 0.14 | 63 M | 1390 | 0.82 | | 59.1 | 56.4 | 49.0 | 0.66 | 0.44 | 2.4 | 3.1 | 2.5 | 50 | 58 | 1LE1001-0BB2 | 5 | 0.00037 |
| 0.18 | 0.21 | 63 M | 1385 | 1.2 | | 64.7 | 62.4 | 55.7 | 0.65 | 0.62 | 2.6 | 3.3 | 2.6 | 57 | 64 | 1LE1001-0BB3 | 5 | 0.00045 |
| 0.25 | 0.29 | 71 M | 1395 | 1.7 | | 68.5 | 68.4 | 64.2 | 0.69 | 0.76 | 2.4 | 3.7 | 2.5 | 50 | 61 | 1LE1001-0CB2 | 6 | 0.00076 |
| 0.37 | 0.43 | 71 M | 1380 | 2.6 | | 72.7 | 73.2 | 69.9 | 0.72 | 1.02 | 2.3 | 3.8 | 2.4 | 50 | 61 | 1LE1001-0CB3 | 7 | 0.00095 |
| 0.55 | 0.63 | 80 M | 1440 | 3.6 | | 77.1 | 76.8 | 73.7 | 0.74 | 1.39 | 2.2 | 5.3 | 3.1 | 53 | 64 | 1LE1001-0DB2 | 10 | 0.0017 |
| 0.75 | 0.86 | 80 M | 1440 | 5 | | 79.6 | 79.9 | 77.5 | 0.76 | 1.79 | 2.2 | 5.6 | 3.1 | 53 | 64 | 1LE1001-0DB3 | 11 | 0.0021 |
| 1.1 | 1.27 | 90 S | 1425 | 7.4 | | 81.4 | 81.8 | 80 | 0.78 | 2.5 | 2.3 | 5.6 | 2.9 | 56 | 68 | 1LE1001-0EB0 | 13 | 0.0028 |
| 1.5 | 1.75 | 90 L | 1435 | 10 | | 82.8 | 83.5 | 82.2 | 0.79 | 3.3 | 2.6 | 6.4 | 3.4 | 56 | 68 | 1LE1001-0EB4 | 16 | 0.0036 |
| 2.2 | 2.55 | 100 L | 1455 | 14 | | 84.3 | 85.1 | 84.2 | 0.81 | 4.65 | 2.1 | 6.9 | 3.3 | 60 | 72 | 1LE1001-1AB4 | 21 | 0.0086 |
| 3 | 3.45 | 100 L | 1455 | 20 | | 85.5 | 86.4 | 85.6 | 0.82 | 6.2 | 2 | 6.9 | 3.1 | 60 | 72 | 1LE1001-1AB5 | 25 | 0.011 |
| 4 | 4.55 | 112 M | 1460 | 26 | | 86.6 | 87.3 | 86.4 | 0.81 | 8.2 | 2.5 | 7.1 | 3.2 | 58 | 70 | 1LE1001-1BB2 | 29 | 0.014 |
| 5.5 | 6.3 | 132 S | 1465 | 36 | | 87.7 | 88.4 | 87.6 | 0.8 | 11.3 | 2.3 | 6.9 | 2.9 | 64 | 76 | 1LE1001-1CB0 | 42 | 0.027 |
| 7.5 | 8.6 | 132 M | 1465 | 49 | | 88.7 | 89.8 | 89.8 | 0.83 | 14.7 | 2.3 | 6.9 | 2.9 | 64 | 76 | 1LE1001-1CB2 | 49 | 0.034 |
| 11 | 12.6 | 160 M | 1470 | 71 | | 89.8 | 91 | 90.9 | 0.85 | 21 | 2.1 | 6.7 | 2.8 | 65 | 77 | 1LE1001-1DB2 | 71 | 0.065 |
| 15 | 17.3 | 160 L | 1475 | 97 | | 90.6 | 91.2 | 90.8 | 0.85 | 28 | 2.3 | 7.3 | 3 | 65 | 77 | 1LE1001-1DB4 | 83 | 0.083 |
| 18.5 | 21.3 | 180 M | 1465 | 121 | | 91.2 | 92 | 91.9 | 0.84 | 35 | 2.5 | 7.2 | 3.4 | 61 | 74 | 1LE1001-1EB2 | 128 | 0.12 |
| 22 | 25.3 | 180 L | 1465 | 143 | | 91.6 | 92.2 | 91.9 | 0.84 | 41.5 | 2.6 | 7.3 | 3.5 | 69 | 76 | 1LE1001-1EB4 | 132 | 0.13 |
| 30 | 34.5 | 200 L | 1470 | 195 | | 92.3 | 92.9 | 92.6 | 0.84 | 56 | 2.5 | 6.7 | 3.3 | 70 | 77 | 1LE1001-2AB5 | 173 | 0.2 |

| Voltagess | Version | Order code |
|---|---------------------------|------------|
| 50 Hz 230 VΔ/400 VY | Standard | 2 2 |
| 50 Hz 400 VΔ/690 VY | Standard | 3 4 |
| 50 Hz 500 VY | Without additional charge | 2 7 |
| 50 Hz 500 VA | Without additional charge | 4 0 |
| For other voltages ¹⁾ and more information, see from page 2/93 | | 9 0 |

| Types of construction | Version | Order code |
|--|------------------------|------------|
| Without flange IM B3 ³⁾ | Standard | A |
| With flange IM B5 ³⁾ | With additional charge | F |
| With flange IM B14 ³⁾ | With additional charge | K |
| For other types of construction and more information, see from page 2/99 | | ... |

| Motor protection | Version | Order code |
|---|------------------------|------------|
| Without | Standard | A |
| PTC thermistor with 1 or 3 temperature sensors (frame sizes 63 to 90 or 100 to 200) | With additional charge | B |
| For other motor protection and more information, see from page 2/112 | | ... |

| Terminal box position | Version | Order code |
|--|----------|------------|
| Terminal box at top | Standard | 4 |
| For other terminal box positions and more information, see from page 2/115 | | ... |

| Special versions | Order code(s) |
|---|--------------------------------|
| Forced-air cooled motors w/o ext. fan/fan cover (IC418) | 1LE1001-...-Z F90 +...+...+... |
| For options, see from page 2/118 | 1LE1001-...-Z ...+...+...+... |



1) Operating values at rated power for 60 Hz are stored in the Drive Technology Configurator (DT Configurator; see Appendix, "Tools and engineering").
 2) For converter operation of shaft heights 63 and 90, ordering with PTC thermistors and their connection to the converter is recommended.

3) Types derived from IM B3 (IM B6/7/8, IM V6, and IM V5), from IM B5 (IM V3 and IM V1) and from IM B14 (IM V19 and IM V18) are possible, provided that no requirements exist for condensation drainage holes (H03) or stamping of the type on the rating plate. The basic type IM B3, IM B5, or IM B14 is stamped as standard on the rating plate. For orders with condensation drainage holes (H03), the type must be specified.

SIMOTICS GP and SIMOTICS SD standard motors

IE2 High Efficiency

IE2



Aluminum series SIMOTICS GP 1LE1001 – self-ventilated or forced-air cooled

Selection and ordering data

| Operating values at rated power | | | | | | | | | | | | | | | Aluminum series | | | | |
|--|--|------------|-----------------------------|----------------------------|--------------------|------------------------------|------------------------------|------------------------------|----------------------------------|---------------------------|-----------------------------|-----------------------------|--------------------------|-----------------------------|----------------------------|--------------|-------------|-------------------|-------------------------|
| P_{rated} 50 Hz/ P50 kW | P_{rated} 60 Hz/ P60 ¹⁾ kW | Frame size | n_{rated} 50 Hz rpm | T_{rated} 50 Hz Nm | Different IE class | η_{rated} 50 Hz % | η_{rated} 50 Hz % | η_{rated} 50 Hz % | $\cos\phi_{rated}$ 50 Hz % | I_{rated} 50 Hz A | T_{LR}/I_{rated} 50 Hz | I_{LR}/I_{rated} 50 Hz | T_p/I_{rated} 50 Hz | L_{ptA} 50 Hz dB(A) | L_{WA} 50 Hz dB(A) | 1LE1001 | Article No. | $m_{IM B3}$ kg | J kgm ² |
| 6-pole: 1000 rpm at 50 Hz, 1200 rpm at 60 Hz ¹⁾ | | | | | | | | | | | | | | | | | | | |
| 0.37 | 0.43 | 80 M | 925 | 3.8 | | 67.6 | 67.9 | 64.4 | 0.69 | 1.14 | 2.1 | 4 | 2.4 | 42 | 53 | 1LE1001-0DC2 | - | 9 | 0.0017 |
| 0.55 | 0.63 | 80 M | 935 | 5.6 | | 73.1 | 73.8 | 70.8 | 0.66 | 1.65 | 2.5 | 4.4 | 2.9 | 42 | 53 | 1LE1001-0DC3 | - | 12 | 0.0025 |
| 0.75 | 0.86 | 90 S | 935 | 7.7 | | 75.9 | 76.8 | 74.5 | 0.7 | 2.05 | 2 | 4.1 | 2.5 | 43 | 55 | 1LE1001-0EC0 | - | 13 | 0.003 |
| 1.1 | 1.27 | 90 L | 935 | 11 | IE1 | 78.1 | 79.3 | 77.7 | 0.7 | 2.9 | 2.2 | 4.4 | 2.6 | 43 | 55 | 1LE1001-0EC4 | - | 16 | 0.004 |
| 1.5 | 1.75 | 100 L | 970 | 15 | | 79.8 | 80.5 | 79 | 0.73 | 3.7 | 2 | 5.4 | 2.8 | 59 | 71 | 1LE1001-1AC4 | - | 25 | 0.011 |
| 2.2 | 2.55 | 112 M | 965 | 22 | | 81.8 | 82.7 | 81.7 | 0.75 | 5.2 | 2 | 5 | 2.8 | 62 | 74 | 1LE1001-1BC2 | - | 29 | 0.014 |
| 3 | 3.45 | 132 S | 970 | 30 | | 83.3 | 83.4 | 81 | 0.72 | 7.2 | 1.6 | 5 | 2.5 | 63 | 75 | 1LE1001-1CC0 | - | 38 | 0.024 |
| 4 | 4.55 | 132 M | 970 | 39 | | 84.6 | 85.5 | 84.3 | 0.75 | 9.1 | 1.6 | 5 | 2.3 | 63 | 75 | 1LE1001-1CC2 | - | 43 | 0.029 |
| 5.5 | 6.3 | 132 M | 970 | 54 | | 86 | 87.1 | 86.4 | 0.76 | 12.1 | 1.9 | 5.6 | 2.6 | 63 | 75 | 1LE1001-1CC3 | - | 52 | 0.037 |
| 7.5 | 8.6 | 160 M | 975 | 73 | | 87.2 | 87.9 | 87.2 | 0.74 | 16.8 | 1.9 | 4.7 | 2.2 | 67 | 79 | 1LE1001-1DC2 | - | 77 | 0.075 |
| 11 | 12.6 | 160 L | 975 | 108 | | 88.7 | 89.7 | 89.3 | 0.76 | 23.5 | 1.9 | 4.8 | 2.2 | 67 | 79 | 1LE1001-1DC4 | - | 93 | 0.098 |
| 15 | 18 | 180 L | 975 | 147 | | 89.7 | 90.1 | 89.5 | 0.78 | 31 | 2.5 | 6 | 3.1 | 57 | 70 | 1LE1001-1EC4 | - | 121 | 0.17 |
| 18.5 | 22 | 200 L | 978 | 181 | IE1 | 90.4 | 91.4 | 91.3 | 0.82 | 36 | 2.4 | 5.8 | 2.6 | 63 | 76 | 1LE1001-2AC4 | - | 151 | 0.25 |
| 22 | 26.5 | 200 L | 978 | 215 | IE1 | 90.9 | 91.7 | 91.4 | 0.82 | 42.5 | 2.5 | 6.2 | 2.6 | 63 | 76 | 1LE1001-2AC5 | - | 173 | 0.3 |

| Voltages | | Version | Order code |
|---|----------------------------|---------------------------|------------|
| 50 Hz 230 VΔ/400 VY | 60 Hz ¹⁾ 460 VY | Standard | 2 2 - |
| 50 Hz 400 VΔ/690 VY | 60 Hz ¹⁾ 460 VΔ | Standard | 3 4 - |
| 50 Hz 500 VY | | Without additional charge | 2 7 - |
| 50 Hz 500 VΔ | | Without additional charge | 4 0 - |
| For other voltages ¹⁾ and more information, see from page 2/93 | | | 9 0 ... |

| Types of construction | | Version | Order code |
|--|----------------------|------------------------|------------|
| Without flange | IM B3 ³⁾ | Standard | A - |
| With flange | IM B5 ³⁾ | With additional charge | F - |
| With flange | IM B14 ³⁾ | With additional charge | K - |
| For other types of construction and more information, see from page 2/99 | | | |

| Motor protection | | Version | Order code |
|---|--|------------------------|------------|
| Without | | Standard | A - |
| PTC thermistor with 1 or 3 temperature sensors (frame sizes 80, 90 or 100 to 200) | | With additional charge | B - |
| For other motor protection and more information, see from page 2/112 | | | |

| Terminal box position | | Version | Order code |
|--|--|----------|------------|
| Terminal box at top | | Standard | 4 - |
| For other terminal box positions and more information, see from page 2/115 | | | |

| Special versions | | Order code(s) |
|---|--|---------------------------------|
| Forced-air cooled motors w/o ext. fan/fan cover (IC418) | | 1LE1001-... -Z F90 +...+...+... |
| For options, see from page 2/118 | | 1LE1001-... -Z ...+...+...+... |

2

1) Operating values at rated power for 60 Hz are stored in the Drive Technology Configurator (DT Configurator; see Appendix, "Tools and engineering").
 2) For converter operation of shaft heights 63 and 90, ordering with PTC thermistors and their connection to the converter is recommended.

3) Types derived from IM B3 (IM B6/7/8, IM V6, and IM V5), from IM B5 (IM V3 and IM V1) and from IM B14 (IM V19 and IM V18) are possible, provided that no requirements exist for condensation drainage holes (H03) or stamping of the type on the rating plate. The basic type IM B3, IM B5, or IM B14 is stamped as standard on the rating plate. For orders with condensation drainage holes (H03), the type must be specified.



IE2

SIMOTICS GP and SIMOTICS SD standard motors IE2 High Efficiency

Aluminum series SIMOTICS GP 1LE1001 – self-ventilated or forced-air cooled

Selection and ordering data

| Operating values at rated power | | | | | | | | | | | | | | Aluminum series | | | | |
|---|--|---------------|----------------------|----------------------------|-----------------------|-------------------------|-------------------------|---------------------------|-----------------------------|----------------------|-----------------------------------|-----------------------------------|--------------------------------|-------------------|-------------------|------------------|------------------|--------|
| P_{rated} 50 Hz/ P50 | P_{rated} 60 Hz/ P60 ¹⁾ | Frame size | n_{rated} 50 Hz | T_{rated} 50 Hz | Different IE class | η_{rated} 50 Hz | η_{rated} 50 Hz | η_{rated} 50 Hz | $\cos\phi_{rated}$ 50 Hz | I_{rated} 400 V | $T_{LR}/$ T_{rated} 50 Hz | $I_{LR}/$ T_{rated} 50 Hz | $T_p/$ T_{rated} 50 Hz | L_{pA} 50 Hz | L_{WA} 50 Hz | 1LE1001 | $m_{IM B3}$ | J |
| kW | kW | FS | rpm | Nm | 60 Hz/P60 | % | % | % | % | A | | | | | Article No. | kg | kgm ² | |
| • Cooling: Self-ventilated (IC411) or with order code F90 forced-air cooled without external fan and fan cover (IC418) • Efficiency according to IEC 60034-30-1: IE2 High Efficiency, service factor (SF) 1.15 • Insulation: Thermal class 155 (temperature class F), IP55 degree of protection, utilization in accordance with thermal class 130 (temperature class B) | | | | | | | | | | | | | | | | | | |
| 8-pole: 750 rpm at 50 Hz, 900 rpm at 60 Hz ¹⁾ | | | | | | | | | | | | | | | | | | |
| 0.75 | 0.86 | 100 L | 705 | 10 | | 66.2 | 65.7 | 61.6 | 0.61 | 2.7 | 1.5 | 3.2 | 2.1 | 60 | 72 | 1LE1001-1AD4 | 21 | 0.0086 |
| 1.1 | 1.27 | 100 L | 695 | 15 | | 70.8 | 72.3 | 69.6 | 0.65 | 3.45 | 1.4 | 3.2 | 1.9 | 60 | 72 | 1LE1001-1AD5 | 25 | 0.011 |
| 1.5 | 1.75 | 112 M | 725 | 20 | | 74.1 | 73.9 | 71.2 | 0.63 | 4.65 | 1.6 | 4 | 2.4 | 63 | 75 | 1LE1001-1BD2 | 34 | 0.017 |
| 2.2 | 2.55 | 132 S | 725 | 29 | | 77.6 | 78.2 | 76.6 | 0.62 | 6.6 | 1.4 | 3.5 | 2 | 63 | 75 | 1LE1001-1CD0 | 46 | 0.034 |
| 3 | 3.45 | 132 M | 720 | 40 | IE1 | 80 | 80.7 | 79.2 | 0.62 | 8.7 | 1.4 | 3.7 | 2 | 63 | 75 | 1LE1001-1CD2 | 52 | 0.037 |
| 4 | 4.55 | 160 M | 730 | 52 | | 81.9 | 82.6 | 81.4 | 0.67 | 10.5 | 1.6 | 3.7 | 1.9 | 63 | 75 | 1LE1001-1DD2 | 69 | 0.065 |
| 5.5 | 6.3 | 160 M | 730 | 72 | | 83.8 | 84.2 | 83 | 0.67 | 14.1 | 1.7 | 3.9 | 2 | 63 | 75 | 1LE1001-1DD3 | 82 | 0.083 |
| 7.5 | 8.6 | 160 L | 725 | 99 | | 85.3 | 86.4 | 86 | 0.7 | 18.1 | 1.6 | 3.8 | 1.9 | 63 | 75 | 1LE1001-1DD4 | 94 | 0.098 |
| 11 | 13.2 | 180 L | 720 | 146 | IE1 | 86.9 | 88 | 87.6 | 0.7 | 26 | 2.3 | 4.9 | 2.6 | 72 | 80 | 1LE1001-1ED4 | 122 | 0.195 |
| 15 | 18 | 200 L | 718 | 199 | | 88 | 89.5 | 89.9 | 0.76 | 32.5 | 2.4 | 5.4 | 2.8 | 58 | 65 | 1LE1001-2AD5 | 172 | 0.344 |
| Voltages | | | | | | | | | | | | | | Version | | Order code | | |
| 50 Hz 230 VΔ/400 VY | | | | 60 Hz ¹⁾ 460 VY | | | | Standard | | 2 2 | | - | | - | | - | | |
| 50 Hz 400 VΔ/690 VY | | | | 60 Hz ¹⁾ 460 VΔ | | | | Standard | | 3 4 | | - | | - | | - | | |
| 50 Hz 500 VY | | | | | | | | Without additional charge | | 2 7 | | - | | - | | - | | |
| 50 Hz 500 VΔ | | | | | | | | Without additional charge | | 4 0 | | - | | - | | - | | |
| For other voltages ¹⁾ and more information, see from page 2/93 | | | | | | | | | | | | | | 9 0 | | ... | | |
| Types of construction | | | | | | | | | | | | | | Version | | Order code | | |
| Without flange | | | | IM B3 ²⁾ | | | | Standard | | A | | - | | - | | - | | |
| With flange | | | | IM B5 ²⁾ | | | | With additional charge | | F | | - | | - | | - | | |
| With flange | | | | IM B14 ²⁾ | | | | With additional charge | | K | | - | | - | | - | | |
| For other types of construction and more information, see from page 2/99 | | | | | | | | | | | | | | - | | ... | | |
| Motor protection | | | | | | | | | | | | | | Version | | Order code | | |
| Without | | | | | | | | Standard | | A | | - | | - | | - | | |
| PTC thermistor with 3 temperature sensors | | | | | | | | With additional charge | | B | | - | | - | | - | | |
| For other motor protection and more information, see from page 2/112 | | | | | | | | | | | | | | - | | ... | | |
| Terminal box position | | | | | | | | | | | | | | Version | | Order code | | |
| Terminal box at top | | | | | | | | Standard | | 4 | | - | | - | | - | | |
| For other terminal box positions and more information, see from page 2/115 | | | | | | | | | | | | | | - | | - | | |
| Special versions | | | | | | | | | | | | | | | | Order code(s) | | |
| Forced-air cooled motors w/o ext. fan/fan cover (IC418) | | | | | | | | | | | | | | 1LE1001-....-Z | | F90 +...+...+... | | |
| For options, see from page 2/118 | | | | | | | | | | | | | | 1LE1001-....-Z | | ...+...+...+... | | |

2

¹⁾ Operating values at rated power for 60 Hz are stored in the Drive Technology Configurator (DT Configurator; see Appendix, "Tools and engineering").

²⁾ Types derived from IM B3 (IM B6/7/8, IM V6, and IM V5), from IM B5 (IM V3 and IM V1) and from IM B14 (IM V19 and IM V18) are possible, provided that no requirements exist for condensation drainage holes (H03) or stamping of the type on the rating plate. The basic type IM B3, IM B5, or IM B14 is stamped as standard on the rating plate. For orders with condensation drainage holes (H03), the type must be specified.



SIMOTICS GP and SIMOTICS SD standard motors
IE2 High Efficiency



Aluminum series SIMOTICS GP 1LE1001 with increased power – self-ventilated

Selection and ordering data

Table with columns: P_rated, Frame size, Operating values at rated power (n_rated, T_rated, IE class, eta_rated, cos phi_rated, I_rated, T_LR, I_LR, T_p, L_ptA, L_WA, Aluminum series 1LE1001, m_IM B3, J), and various sub-sections like Voltages, Types of construction, Motor protection, Terminal box position, and Special versions.

2

1) Operating values at rated power for 60 Hz are stored in the Drive Technology Configurator (DT Configurator; see Appendix, "Tools and engineering").

2) Types derived from IM B3 (IM B6/7/8, IM V6, and IM V5), from IM B5 (IM V3 and IM V1) and from IM B14 (IM V19 and IM V18) are possible, provided that no requirements exist for condensation drainage holes (H03) or stamping of the type on the rating plate. The basic type IM B3, IM B5, or IM B14 is stamped as standard on the rating plate. For orders with condensation drainage holes (H03), the type must be specified.



IE2

SIMOTICS GP and SIMOTICS SD standard motors IE2 High Efficiency

Aluminum series SIMOTICS GP 1LE1001 with increased power – self-ventilated

Selection and ordering data

| Operating values at rated power | | | | | | | | | | | | | | | | | Aluminum series | | | |
|---|--|---------------|-----------------------------|----------------------------|------------------------------------|------------------------------|------------------------------|------------------------------|----------------------------------|---------------------------|-----------------------------------|-----------------------------------|--------------------------------------|-----------------------------|----------------------------|------------------------|-------------------|-------------------------|---------------|-----------------|
| P_{rated} 50 Hz/ P50 kW | P_{rated} 60 Hz/ P60 ¹⁾ kW | Frame size | n_{rated} 50 Hz rpm | T_{rated} 50 Hz Nm | Different IE class 60 Hz/P60 | η_{rated} 50 Hz % | η_{rated} 50 Hz % | η_{rated} 50 Hz % | $\cos\phi_{rated}$ 50 Hz % | I_{rated} 50 Hz A | $T_{LR}/$ T_{rated} 50 Hz | $I_{LR}/$ I_{rated} 50 Hz | $T_{\beta}/$ T_{rated} 50 Hz | L_{ptA} 50 Hz dB(A) | L_{WA} 50 Hz dB(A) | 1LE1001 Article No. | $m_{IM B3}$ kg | J kgm ² | | |
| <ul style="list-style-type: none"> • Cooling: Self-ventilated (IC411) or with order code F90 forced-air cooled without external fan and fan cover (IC418) • Efficiency according to IEC 60034-30-1: IE2 High Efficiency, service factor (SF) 1.15 • Insulation: Thermal class 155 (temperature class F), IP55 degree of protection, utilization in accordance with thermal class 130 (temperature class B) | | | | | | | | | | | | | | | | | | | | |
| 6-pole: 1000 rpm at 50 Hz, 1200 rpm at 60 Hz ¹⁾ | | | | | | | | | | | | | | | | | | | | |
| 2.2 | 2.55 | 100 L | 965 | 22 | IE1 | 81.8 | 83.3 | 82.7 | 0.76 | 5.1 | 1.7 | 4.9 | 2.5 | 59 | 71 | 1LE1001-1AC6 | 30 | 0.014 | | |
| 3 | 3.45 | 112 M | 965 | 30 | | 83.3 | 84 | 82.7 | 0.74 | 7 | 2.1 | 5.4 | 2.7 | 62 | 74 | 1LE1001-1BC6 | 34 | 0.017 | | |
| 7.5 | 8.6 | 132 M | 970 | 74 | | 87.2 | 88.1 | 87.1 | 0.75 | 16.6 | 2 | 5.6 | 2.6 | 63 | 75 | 1LE1001-1CC6 | 64 | 0.046 | | |
| 15 | 17.3 | 160 L | 975 | 147 | IE1 | 89.7 | 90.4 | 89.7 | 0.75 | 32 | 2 | 5.2 | 2.4 | 67 | 79 | 1LE1001-1DC6 | 115 | 0.12 | | |
| 18.5 | 22 | 180 L | 975 | 181 | | 90.4 | 90.9 | 90.5 | 0.77 | 38.5 | 2.3 | 6 | 2.9 | 67 | 80 | 1LE1001-1EC6 | 130 | 0.206 | | |
| 30 | 34.5 | 200 L | 975 | 294 | | 91.7 | 92.5 | 92.4 | 0.77 | 61 | 2.6 | 6.3 | 2.7 | 68 | 75 | 1LE1001-2AC6 | 192 | 0.381 | | |
| 8-pole: 750 rpm at 50 Hz, 900 rpm at 60 Hz ¹⁾ | | | | | | | | | | | | | | | | | | | | |
| 15 | 18 | 180 L | 720 | 199 | IE1 | 88 | 89.2 | 89 | 0.73 | 33.5 | 2.2 | 4.9 | 2.5 | 67 | 75 | 1LE1001-1ED6 | 151 | 0.263 | | |
| 18.5 | 22 | 200 L | 720 | 245 | IE1 | 88.6 | 89.9 | 90.2 | 0.78 | 38.5 | 2.6 | 5.8 | 3 | 65 | 72 | 1LE1001-2AD6 | 198 | 0.416 | | |
| Voltages | | | | | | | | | | | | | | | | | Version | | Order code | |
| 50 Hz 230 VΔ/400 VY | | | 60 Hz ¹⁾ 460 VY | | | Standard | | | | | | | | | | | 2 | 2 | - | |
| 50 Hz 400 VΔ/690 VY | | | 60 Hz ¹⁾ 460 VΔ | | | Standard | | | | | | | | | | | 3 | 4 | - | |
| 50 Hz 500 VY | | | | | | Without additional charge | | | | | | | | | | | 2 | 7 | - | |
| 50 Hz 500 VΔ | | | | | | Without additional charge | | | | | | | | | | | 4 | 0 | - | |
| For other voltages ¹⁾ and more information, see from page 2/93 | | | | | | | | | | | | | | | | | 9 | 0 | ... | |
| Types of construction | | | | | | | | | | | | | | | | | Version | | Order code | |
| Without flange | | | IM B3 ²⁾ | | | Standard | | | | | | | | | | | A | | - | |
| With flange | | | IM B5 ²⁾ | | | With additional charge | | | | | | | | | | | F | | - | |
| With flange | | | IM B14 ²⁾ | | | With additional charge | | | | | | | | | | | K | | - | |
| For other types of construction and more information, see from page 2/99 | | | | | | | | | | | | | | | | | | | ... | |
| Motor protection | | | | | | | | | | | | | | | | | Version | | Order code | |
| Without | | | | | | Standard | | | | | | | | | | | A | | - | |
| PTC thermistor with 3 temperature sensors | | | | | | With additional charge | | | | | | | | | | | B | | - | |
| For other motor protection and more information, see from page 2/112 | | | | | | | | | | | | | | | | | | | ... | |
| Terminal box position | | | | | | | | | | | | | | | | | Version | | Order code | |
| Terminal box at top | | | | | | Standard | | | | | | | | | | | 4 | | - | |
| For other terminal box positions and more information, see from page 2/115 | | | | | | | | | | | | | | | | | | | ... | |
| Special versions | | | | | | | | | | | | | | | | | Version | | Order code(s) | |
| For options, see from page 2/118 | | | | | | | | | | | | | | | | | 1LE1001- | ... | -Z | ...+...+...+... |

2

¹⁾ Operating values at rated power for 60 Hz are stored in the Drive Technology Configurator (DT Configurator; see Appendix, "Tools and engineering").

²⁾ Types derived from IM B3 (IM B6/7/8, IM V6, and IM V5), from IM B5 (IM V3 and IM V1) and from IM B14 (IM V19 and IM V18) are possible, provided that no requirements exist for condensation drainage holes (H03) or stamping of the type on the rating plate. The basic type IM B3, IM B5, or IM B14 is stamped as standard on the rating plate. For orders with condensation drainage holes (H03), the type must be specified.

SIMOTICS GP and SIMOTICS SD standard motors
IE2 High Efficiency



Cast-iron series SIMOTICS SD 1LE1501 Basic Line – self-ventilated or forced-air cooled

Selection and ordering data

| P _{rated} 50 Hz/ P50 | P _{rated} 60 Hz/ P60 ¹⁾ | Frame size | Operating values at rated power | | | | | | | | | | | | | | Cast-iron series 1LE1501 – Basic Line Article No. | m _{IM B3} | J | | | |
|---|---|---------------|---------------------------------|-----------------------------|-----------------------------|-----------------------------|-----------------------------|--------------------------------|-----------------------------|---|---|---|---------------------------|--------------------------|--------------|---------------|---|--------------------|---------------|---|----|------------------|
| | | | n _{rated} 50 Hz | T _{rated} 50 Hz | η _{rated} 50 Hz | η _{rated} 50 Hz | η _{rated} 50 Hz | cosφ _{rated} 50 Hz | I _{rated} 50 Hz | T _{LR} / I _{LR} 50 Hz | T _{LR} / I _{LR} 50 Hz | T _B / I _B 50 Hz | L _{pfA} 50 Hz | L _{WA} 50 Hz | Version | Order code | | | | | | |
| kW | kW | FS | rpm | Nm | % | % | % | A | A | A | A | A | A | A | A | A | A | A | A | A | kg | kgm ² |
| • Cooling: Self-ventilated (IC411) or with order code F90 forced-air cooled without external fan and fan cover (IC418) • Efficiency according to IEC 60034-30-1: IE2 High Efficiency, service factor (SF) 1.15 • Insulation: Thermal class 155 (temperature class F), IP55 degree of protection, utilization in accordance with thermal class 130 (temperature class B) | | | | | | | | | | | | | | | | | | | | | | |
| 2-pole: 3000 rpm at 50 Hz, 3600 rpm at 60 Hz ¹⁾ | | | | | | | | | | | | | | | | | | | | | | |
| 0.37 | 0.43 | 71 M | 2770 | 1.3 | 69.5 | 70.5 | 67.9 | 0.81 | 0.95 | 2.5 | 4.1 | 2.5 | 58 | 69 | 1LE1501-0CA2 | - | 11 | 0.00035 | | | | |
| 0.55 | 0.63 | 71 M | 2780 | 1.9 | 74.1 | 75.2 | 72.9 | 0.8 | 1.34 | 2.6 | 4.6 | 2.6 | 58 | 69 | 1LE1501-0CA3 | - | 13 | 0.00045 | | | | |
| 0.75 | 0.86 | 80 M | 2805 | 2.6 | 77.4 | 80 | 80.1 | 0.84 | 1.67 | 1.9 | 4.9 | 2.3 | 60 | 71 | 1LE1501-0DA2 | - | 16 | 0.0008 | | | | |
| 1.1 | 1.27 | 80 M | 2835 | 3.7 | 79.6 | 81.3 | 80.9 | 0.83 | 2.4 | 2.7 | 6 | 3.1 | 60 | 71 | 1LE1501-0DA3 | - | 18 | 0.0011 | | | | |
| 1.5 | 1.75 | 90 S | 2885 | 4.9 | 81.3 | 81.7 | 79.8 | 0.84 | 3.15 | 2.7 | 6.9 | 3.6 | 65 | 77 | 1LE1501-0EA0 | - | 23 | 0.0017 | | | | |
| 2.2 | 2.55 | 90 L | 2890 | 7.3 | 83.2 | 83.7 | 82 | 0.85 | 4.5 | 2.5 | 7.1 | 3.7 | 65 | 77 | 1LE1501-0EA4 | - | 25 | 0.0021 | | | | |
| 3 | 3.45 | 100 L | 2905 | 9.9 | 84.6 | 85.5 | 84.6 | 0.84 | 6.1 | 2.3 | 7 | 3.3 | 67 | 79 | 1LE1501-1AA4 | - | 32 | 0.0044 | | | | |
| 4 | 4.55 | 112 M | 2945 | 13 | 85.8 | 86.2 | 85.1 | 0.85 | 7.9 | 2.1 | 8 | 3.6 | 69 | 81 | 1LE1501-1BA2 | - | 39 | 0.0092 | | | | |
| 5.5 | 6.3 | 132 S | 2950 | 18 | 87 | 88 | 87.6 | 0.87 | 10.5 | 1.8 | 6.6 | 2.9 | 68 | 80 | 1LE1501-1CA0 | - | 57 | 0.02 | | | | |
| 7.5 | 8.6 | 132 S | 2950 | 24 | 88.1 | 88.5 | 87.6 | 0.87 | 14.1 | 2.2 | 7.5 | 3.1 | 68 | 80 | 1LE1501-1CA1 | - | 61 | 0.024 | | | | |
| 11 | 12.6 | 160 M | 2955 | 36 | 89.4 | 89.3 | 88 | 0.87 | 20.5 | 2.1 | 7.4 | 3.2 | 70 | 82 | 1LE1501-1DA2 | - | 96 | 0.045 | | | | |
| 15 | 17.3 | 160 M | 2955 | 48 | 90.3 | 90.7 | 90 | 0.88 | 27 | 2.4 | 7.6 | 3.4 | 70 | 82 | 1LE1501-1DA3 | - | 104 | 0.053 | | | | |
| 18.5 | 21.3 | 160 L | 2955 | 60 | 90.9 | 91.3 | 90.6 | 0.88 | 33.5 | 2.9 | 7.9 | 3.6 | 70 | 82 | 1LE1501-1DA4 | - | 113 | 0.061 | | | | |
| 22 | 24.5 | 180 M | 2940 | 71 | 91.3 | 91.8 | 91.3 | 0.87 | 40 | 2.7 | 7.4 | 3.6 | 77 | 84 | 1LE1501-1EA2 | - | 145 | 0.069 | | | | |
| 30 | 33.5 | 200 L | 2960 | 97 | 92 | 92.3 | 91.8 | 0.87 | 54 | 2.5 | 6.9 | 3.3 | 78 | 85 | 1LE1501-2AA4 | - | 200 | 0.13 | | | | |
| 37 | 41.5 | 200 L | 2960 | 119 | 92.5 | 93 | 92.7 | 0.88 | 66 | 2.7 | 7.4 | 3.5 | 78 | 85 | 1LE1501-2AA5 | - | 225 | 0.15 | | | | |
| 45 | 51 | 225 M | 2965 | 145 | 92.9 | 93.1 | 92.5 | 0.88 | 79 | 2.7 | 7.8 | 3.7 | 76 | 89 | 1LE1501-2BA2 | - | 295 | 0.23 | | | | |
| 55 | 62 | 250 M | 2970 | 177 | 93.2 | 93.3 | 92.4 | 0.88 | 97 | 2.3 | 6.8 | 3.1 | 76 | 89 | 1LE1501-2CA2 | - | 360 | 0.4 | | | | |
| 75 | 84 | 280 S | 2978 | 240 | 93.8 | 93.6 | 92.4 | 0.86 | 134 | 2.5 | 7.2 | 3.2 | 76 | 89 | 1LE1501-2DA0 | - | 490 | 0.71 | | | | |
| 90 | 101 | 280 M | 2975 | 289 | 94.1 | 94.2 | 93.5 | 0.88 | 157 | 2.5 | 7.1 | 3.1 | 76 | 89 | 1LE1501-2DA2 | - | 530 | 0.83 | | | | |
| 110 | 123 | 315 S | 2982 | 352 | 94.3 | 94.2 | 93.3 | 0.9 | 187 | 2.4 | 7.3 | 3 | 77 | 91 | 1LE1501-3AA0 | - | 720 | 1.3 | | | | |
| 132 | 148 | 315 M | 2982 | 423 | 94.6 | 94.7 | 94.1 | 0.91 | 220 | 2.4 | 7.2 | 3.1 | 77 | 91 | 1LE1501-3AA2 | - | 880 | 1.6 | | | | |
| 160 | 180 | 315 L | 2982 | 512 | 94.8 | 94.9 | 94.3 | 0.92 | 265 | 2.3 | 7 | 3.1 | 80 | 95 | 1LE1501-3AA4 | - | 930 | 1.8 | | | | |
| 200 | 224 | 315 L | 2982 | 640 | 95 | 95.2 | 94.8 | 0.92 | 330 | 2.5 | 7.3 | 3 | 80 | 95 | 1LE1501-3AA5 | - | 1130 | 2.2 | | | | |
| Voltages ²⁾ | | | | | | | | | | | | | | | | | Version | | Order code | | | |
| 50 Hz 230 VΔ/400 VY | | | 60 Hz ¹⁾ 460 VY | | | Standard | | | | | | | | | | 2 | 2 | - | | | | |
| 50 Hz 400 VΔ/690 VY | | | 60 Hz ¹⁾ 460 VΔ | | | Standard | | | | | | | | | | 3 | 4 | - | | | | |
| 50 Hz 500 VY | | | | | | Without additional charge | | | | | | | | | | 2 | 7 | - | | | | |
| 50 Hz 500 VΔ | | | | | | Without additional charge | | | | | | | | | | 4 | 0 | - | | | | |
| For other voltages ¹⁾ and more information, see from page 2/96 | | | | | | | | | | | | | | | | 9 | 0 | ... | | | | |
| Types of construction | | | | | | | | | | | | | | | | | Version | | Order code | | | |
| Without flange | | | IM B3 ³⁾ | | | Standard | | | | | | | | | | A | - | | | | | |
| With flange | | | IM B5 ³⁾ | | | With additional charge | | | | | | | | | | F | - | | | | | |
| With flange | | | IM B14 ³⁾ | | | With additional charge | | | | | | | | | | K | - | | | | | |
| For other types of construction and more information, see from page 2/103 | | | | | | | | | | | | | | | | | ... | | | | | |
| Motor protection | | | | | | | | | | | | | | | | | Version | | Order code | | | |
| Without | | | | | | Standard | | | | | | | | | | A | - | | | | | |
| PTC thermistor with 3 temperature sensors | | | | | | With additional charge | | | | | | | | | | B | - | | | | | |
| For other motor protection and more information, see from page 2/113 | | | | | | | | | | | | | | | | | ... | | | | | |
| Terminal box position | | | | | | | | | | | | | | | | | Version | | Order code(s) | | | |
| Terminal box at top | | | | | | Standard | | | | | | | | | | 4 | | | | | | |
| For other terminal box positions and more information, see from page 2/116 | | | | | | | | | | | | | | | | | | | | | | |
| Special versions | | | | | | | | | | | | | | | | | | | Order code(s) | | | |
| Forced-air cooled motors w/o ext. fan/fan cover (IC418) | | | | | | | | | | | | | | | | 1LE1501-...-Z | | F90+...+...+... | | | | |
| For options, see from page 2/125 | | | | | | | | | | | | | | | | 1LE1501-...-Z | | ...+...+...+... | | | | |

¹⁾ Operating values at rated power for 60 Hz are stored in the Drive Technology Configurator (DT Configurator; see Appendix, "Tools and engineering").

²⁾ Parallel supply lines are required in the case of connection to ≤ 240 V. For frame size 315 with connection to ≤ 240 V, due to the high current, a drilled, removable entry plate (order code R52) or a larger terminal box (order code R50) can be used. Order codes R52 and R50 alter the motor dimensions.

³⁾ Types derived from IM B3 (IM B6/7/8, IM V6 and IM V5), from IM B5 (IM V3 and IM V1) and from IM B14 (IM V19 and IM V18) are possible, provided that no requirement exists for stamping of the type on the rating plate. The basic type IM B3, IM B5, or IM B14 is stamped as standard on the rating plate. If mounted in a different position, the position must be specified to ensure that the condensation drainage holes are positioned correctly.



IE2

SIMOTICS GP and SIMOTICS SD standard motors IE2 High Efficiency

Cast-iron series SIMOTICS SD 1LE1501 Basic Line – self-ventilated or forced-air cooled

Selection and ordering data

| P _{rated} 50 Hz/ P50 kW | P _{rated} 60 Hz/ P60 ¹⁾ kW | Frame size FS | Operating values at rated power | | | | | | | | | | | | | Cast-iron series 1LE1501 – Basic Line Article No. | m _{IM B3} kg | J kgm ² |
|--|---|---------------------|------------------------------------|-----------------------------------|----------------------------------|----------------------------------|----------------------------------|-------------------------------------|----------------------------------|--|--|---|------------------------------------|-----------------------------------|---------------|--|--------------------------|-----------------------|
| | | | n _{rated} 50 Hz rpm | T _{rated} 50 Hz Nm | η _{rated} 50 Hz % | η _{rated} 50 Hz % | η _{rated} 50 Hz % | cosφ _{rated} 50 Hz % | I _{rated} 50 Hz A | T _{LR} /I _{rated} 50 Hz | I _{LR} /I _{rated} 50 Hz | T _B /I _{rated} 50 Hz | L _{pfA} 50 Hz dB(A) | L _{WA} 50 Hz dB(A) | | | | |
| 0.25 | 0.29 | 71 M | 1395 | 1.7 | 68.5 | 68.4 | 64.2 | 0.69 | 0.76 | 2.4 | 3.7 | 2.5 | 50 | 61 | 1LE1501-0CB2 | 12 | 0.00076 | |
| 0.37 | 0.43 | 71 M | 1380 | 2.6 | 72.7 | 73.2 | 69.9 | 0.72 | 1.02 | 2.3 | 3.8 | 2.4 | 50 | 61 | 1LE1501-0CB3 | 13 | 0.00095 | |
| 0.55 | 0.63 | 80 M | 1440 | 3.6 | 77.1 | 76.8 | 73.7 | 0.74 | 1.39 | 2.2 | 5.3 | 3.1 | 53 | 64 | 1LE1501-0DB2 | 17 | 0.0017 | |
| 0.75 | 0.86 | 80 M | 1440 | 5 | 79.6 | 79.9 | 77.5 | 0.76 | 1.79 | 2.2 | 5.6 | 3.1 | 53 | 64 | 1LE1501-0DB3 | 18 | 0.0021 | |
| 1.1 | 1.27 | 90 S | 1425 | 7.4 | 81.4 | 81.8 | 80 | 0.78 | 2.5 | 2.3 | 5.6 | 2.9 | 56 | 68 | 1LE1501-0EB0 | 23 | 0.0028 | |
| 1.5 | 1.75 | 90 L | 1435 | 10 | 82.8 | 83.5 | 82.2 | 0.79 | 3.3 | 2.6 | 6.4 | 3.4 | 56 | 68 | 1LE1501-0EB4 | 25 | 0.0036 | |
| 2.2 | 2.55 | 100 L | 1455 | 14 | 84.3 | 85.1 | 84.2 | 0.81 | 4.65 | 2.1 | 6.9 | 3.3 | 60 | 72 | 1LE1501-1AB4 | 32 | 0.0086 | |
| 3 | 3.45 | 100 L | 1455 | 20 | 85.5 | 86.4 | 85.6 | 0.82 | 6.2 | 2 | 6.9 | 3.1 | 60 | 72 | 1LE1501-1AB5 | 37 | 0.011 | |
| 4 | 4.55 | 112 M | 1460 | 26 | 86.6 | 87.3 | 86.4 | 0.81 | 8.2 | 2.5 | 7.1 | 3.2 | 58 | 70 | 1LE1501-1BB2 | 46 | 0.014 | |
| 5.5 | 6.3 | 132 S | 1465 | 36 | 87.7 | 88.4 | 87.6 | 0.8 | 11.3 | 2.3 | 6.9 | 2.9 | 64 | 76 | 1LE1501-1CB0 | 61 | 0.027 | |
| 7.5 | 8.6 | 132 M | 1465 | 49 | 88.7 | 89.8 | 89.8 | 0.83 | 14.7 | 2.3 | 6.9 | 2.9 | 64 | 76 | 1LE1501-1CB2 | 75 | 0.034 | |
| 11 | 12.6 | 160 M | 1470 | 71 | 89.8 | 91 | 90.9 | 0.85 | 21 | 2.1 | 6.7 | 2.8 | 65 | 77 | 1LE1501-1DB2 | 96 | 0.065 | |
| 15 | 17.3 | 160 L | 1475 | 97 | 90.6 | 91.2 | 90.8 | 0.85 | 28 | 2.3 | 7.3 | 3 | 65 | 77 | 1LE1501-1DB4 | 104 | 0.083 | |
| 18.5 | 21.3 | 180 M | 1465 | 121 | 91.2 | 92 | 91.9 | 0.84 | 35 | 2.5 | 7.2 | 3.4 | 61 | 74 | 1LE1501-1EB2 | 160 | 0.12 | |
| 22 | 25.3 | 180 L | 1465 | 143 | 91.6 | 92.2 | 91.9 | 0.84 | 41.5 | 2.6 | 7.3 | 3.5 | 69 | 76 | 1LE1501-1EB4 | 170 | 0.13 | |
| 30 | 34.5 | 200 L | 1470 | 195 | 92.3 | 92.9 | 92.6 | 0.84 | 56 | 2.5 | 6.7 | 3.3 | 70 | 77 | 1LE1501-2AB5 | 230 | 0.2 | |
| 37 | 42.5 | 225 S | 1470 | 240 | 92.7 | 93.5 | 93.5 | 0.88 | 65 | 2.3 | 6.6 | 2.9 | 66 | 79 | 1LE1501-2BB0 | 280 | 0.42 | |
| 45 | 52 | 225 M | 1475 | 291 | 93.1 | 93.8 | 93.7 | 0.87 | 80 | 2.5 | 6.9 | 3.1 | 66 | 79 | 1LE1501-2BB2 | 305 | 0.46 | |
| 55 | 63 | 250 M | 1480 | 355 | 93.5 | 93.9 | 93.5 | 0.85 | 100 | 2.7 | 6.8 | 3 | 66 | 79 | 1LE1501-2CB2 | 385 | 0.75 | |
| 75 | 86 | 280 S | 1485 | 482 | 94 | 94.2 | 93.8 | 0.87 | 132 | 2.5 | 6.8 | 3 | 71 | 85 | 1LE1501-2DB0 | 550 | 1.3 | |
| 90 | 104 | 280 M | 1486 | 578 | 94.2 | 94.3 | 93.6 | 0.87 | 159 | 2.6 | 7.3 | 3.1 | 71 | 85 | 1LE1501-2DB2 | 570 | 1.4 | |
| 110 | 127 | 315 S | 1490 | 705 | 94.5 | 94.6 | 94 | 0.86 | 195 | 2.7 | 7.4 | 3 | 72 | 86 | 1LE1501-3AB0 | 740 | 2 | |
| 132 | 152 | 315 M | 1490 | 846 | 94.7 | 94.9 | 94.6 | 0.87 | 230 | 2.7 | 7.1 | 2.9 | 75 | 89 | 1LE1501-3AB2 | 870 | 2.3 | |
| 160 | 184 | 315 L | 1490 | 1025 | 94.9 | 95 | 94.5 | 0.87 | 280 | 2.8 | 7.2 | 3.1 | 76 | 91 | 1LE1501-3AB4 | 940 | 2.8 | |
| 200 | 230 | 315 L | 1490 | 1282 | 95.1 | 95.3 | 94.7 | 0.87 | 350 | 3.1 | 7.5 | 3.2 | 77 | 92 | 1LE1501-3AB5 | 1140 | 3.5 | |
| Voltages²⁾ | | | | | | | | | | | | | | | Version | | Order code | |
| 50 Hz 230 VΔ/400 VY | | | 60 Hz ¹⁾ 460 VY | | | Standard | | | 2 2 | | - | | | | | | | |
| 50 Hz 400 VΔ/690 VY | | | 60 Hz ¹⁾ 460 VΔ | | | Standard | | | 3 4 | | - | | | | | | | |
| 50 Hz 500 VY | | | | | | Without additional charge | | | 2 7 | | - | | | | | | | |
| 50 Hz 500 VΔ | | | | | | Without additional charge | | | 4 0 | | - | | | | | | | |
| For other voltages ¹⁾ and more information, see from page 2/96 | | | | | | | | | | | | | | | 9 0 | | ... | |
| Types of construction | | | | | | | | | | | | | | | Version | | Order code | |
| Without flange | | | IM B3 ³⁾ | | | Standard | | | A | | - | | | | | | | |
| With flange | | | IM B5 ³⁾ | | | With additional charge | | | F | | - | | | | | | | |
| With flange | | | IM B14 ³⁾ | | | With additional charge | | | K | | - | | | | | | | |
| For other types of construction and more information, see from page 2/103 | | | | | | | | | | | | | | | ... | | | |
| Motor protection | | | | | | | | | | | | | | | Version | | Order code | |
| Without | | | | | | Standard | | | A | | - | | | | | | | |
| PTC thermistor with 3 temperature sensors | | | | | | With additional charge | | | B | | - | | | | | | | |
| For other motor protection and more information, see from page 2/113 | | | | | | | | | | | | | | | ... | | | |
| Terminal box position | | | | | | | | | | | | | | | Version | | Order code(s) | |
| Terminal box at top | | | | | | Standard | | | 4 | | | | | | | | | |
| For other terminal box positions and more information, see from page 2/116 | | | | | | | | | | | | | | | | | | |
| Special versions | | | | | | | | | | | | | | | | | | |
| Forced-air cooled motors w/o ext. fan/fan cover (IC418) | | | | | | | | | | | | | | | 1LE1501-...-Z | | F90+...+...+... | |
| For options, see from page 2/125 | | | | | | | | | | | | | | | 1LE1501-...-Z | | ...+...+...+... | |

2

¹⁾ Operating values at rated power for 60 Hz are stored in the Drive Technology Configurator (DT Configurator; see Appendix, "Tools and engineering").

²⁾ Parallel supply lines are required in the case of connection to ≤ 240 V. For frame size 315 with connection to ≤ 240 V, due to the high current, a drilled, removable entry plate (order code **R52**) or a larger terminal box (order code **R50**) can be used. Order codes **R52** and **R50** alter the motor dimensions.

³⁾ Types derived from IM B3 (IM B6/7/8, IM V6 and IM V5), from IM B5 (IM V3 and IM V1) and from IM B14 (IM V19 and IM V18) are possible, provided that no requirement exists for stamping of the type on the rating plate. The basic type IM B3, IM B5, or IM B14 is stamped as standard on the rating plate. If mounted in a different position, the position must be specified to ensure that the condensation drainage holes are positioned correctly.

SIMOTICS GP and SIMOTICS SD standard motors
IE2 High Efficiency

IE2



Cast-iron series SIMOTICS SD 1LE1501 Basic Line – self-ventilated or forced-air cooled

Selection and ordering data

| Operating values at rated power | | | | | | | | | | | | | | | Cast-iron series | | | |
|--|------------------------------|------------|--------------------|--------------------|----------------------------|-----------------------|-----------------------|-----------------------|---------------------------|---------------------------|---------------------------|---------------------------|------------------------|------------------|--------------------------------|----------------------|-------------|------------------|
| $P_{rated, 50 Hz/ P50}$ | $P_{rated, 60 Hz/ P60}^{1)}$ | Frame size | $n_{rated, 50 Hz}$ | $T_{rated, 50 Hz}$ | Different IE class | $\eta_{rated, 50 Hz}$ | $\eta_{rated, 60 Hz}$ | $\eta_{rated, 50 Hz}$ | $\cos\phi_{rated, 50 Hz}$ | $I_{rated, 50 Hz}$ | $T_{LR}/T_{rated, 50 Hz}$ | $I_{LR}/I_{rated, 50 Hz}$ | $T_B/T_{rated, 50 Hz}$ | $L_{pfA, 50 Hz}$ | $L_{WA, 50 Hz}$ | 1LE1501 – Basic Line | $m_{IM B3}$ | J |
| kW | kW | FS | rpm | Nm | 60 Hz/P60 | 4/4 | 3/4 | 2/4 | 4/4 | A | | | | | | Article No. | kg | kgm ² |
| <p>• Cooling: Self-ventilated (IC411) or with order code F90 forced-air cooled without external fan and fan cover (IC418)</p> <p>• Efficiency according to IEC 60034-30-1: IE2 High Efficiency, service factor (SF) 1.15</p> <p>• Insulation: Thermal class 155 (temperature class F), IP55 degree of protection, utilization in accordance with thermal class 130 (temperature class B)</p> <p>6-pole: 1000 rpm at 50 Hz, 1200 rpm at 60 Hz ¹⁾</p> | | | | | | | | | | | | | | | | | | |
| 0.18 | 0.21 | 71 M | 875 | 2 | | 56.6 | 56.9 | 52.7 | 0.68 | 0.68 | 2.2 | 2.5 | 2.3 | 46 | 57 | 1LE1501-0CC2 | 12 | 0.0008 |
| 0.25 | 0.29 | 71 M | 870 | 2.7 | | 61.6 | 62.7 | 59.2 | 0.7 | 0.84 | 2.3 | 2.6 | 2.3 | 46 | 57 | 1LE1501-0CC3 | 13 | 0.001 |
| 0.37 | 0.43 | 80 M | 925 | 3.8 | | 67.6 | 67.9 | 64.4 | 0.69 | 1.14 | 2.1 | 4 | 2.4 | 42 | 53 | 1LE1501-0DC2 | 17 | 0.0017 |
| 0.55 | 0.63 | 80 M | 935 | 5.6 | | 73.1 | 73.8 | 70.8 | 0.66 | 1.65 | 2.5 | 4.4 | 2.9 | 42 | 53 | 1LE1501-0DC3 | 19 | 0.0025 |
| 0.75 | 0.86 | 90 S | 935 | 7.7 | | 75.9 | 76.8 | 74.5 | 0.7 | 2.05 | 2 | 4.1 | 2.5 | 43 | 55 | 1LE1501-0EC0 | 23 | 0.003 |
| 1.1 | 1.27 | 90 L | 935 | 11 | IE1 | 78.1 | 79.3 | 77.7 | 0.7 | 2.9 | 2.2 | 4.4 | 2.6 | 43 | 55 | 1LE1501-0EC4 | 26 | 0.004 |
| 1.5 | 1.75 | 100 L | 970 | 15 | | 79.8 | 80.5 | 79 | 0.73 | 3.7 | 2 | 5.4 | 2.8 | 59 | 71 | 1LE1501-1AC4 | 36 | 0.011 |
| 2.2 | 2.55 | 112 M | 965 | 22 | | 81.8 | 82.7 | 81.7 | 0.75 | 5.2 | 2 | 5 | 2.8 | 62 | 74 | 1LE1501-1BC2 | 41 | 0.014 |
| 3 | 3.45 | 132 S | 970 | 30 | | 83.3 | 83.4 | 81 | 0.72 | 7.2 | 1.6 | 5 | 2.5 | 63 | 75 | 1LE1501-1CC0 | 56 | 0.024 |
| 4 | 4.55 | 132 M | 970 | 39 | | 84.6 | 85.5 | 84.3 | 0.75 | 9.1 | 1.6 | 5 | 2.3 | 63 | 75 | 1LE1501-1CC2 | 61 | 0.029 |
| 5.5 | 6.3 | 132 M | 970 | 54 | | 86 | 87.1 | 86.4 | 0.76 | 12.1 | 1.9 | 5.6 | 2.6 | 63 | 75 | 1LE1501-1CC3 | 70 | 0.037 |
| 7.5 | 8.6 | 160 M | 975 | 73 | | 87.2 | 87.9 | 87.2 | 0.74 | 16.8 | 1.9 | 4.7 | 2.2 | 67 | 79 | 1LE1501-1DC2 | 106 | 0.075 |
| 11 | 12.6 | 160 L | 975 | 108 | | 88.7 | 89.7 | 89.3 | 0.76 | 23.5 | 1.9 | 4.8 | 2.2 | 67 | 79 | 1LE1501-1DC4 | 122 | 0.098 |
| 15 | 18 | 180 L | 975 | 147 | | 89.7 | 90.1 | 89.5 | 0.78 | 31 | 2.5 | 6 | 3.1 | 57 | 70 | 1LE1501-1EC4 | 155 | 0.17 |
| 18.5 | 22 | 200 L | 978 | 181 | IE1 | 90.4 | 91.4 | 91.3 | 0.82 | 36 | 2.4 | 5.8 | 2.6 | 63 | 76 | 1LE1501-2AC4 | 200 | 0.25 |
| 22 | 26.5 | 200 L | 978 | 215 | IE1 | 90.9 | 91.7 | 91.4 | 0.82 | 42.5 | 2.5 | 6.2 | 2.6 | 63 | 76 | 1LE1501-2AC5 | 220 | 0.3 |
| 30 | 36 | 225 M | 980 | 292 | IE1 | 91.7 | 92.5 | 92.3 | 0.83 | 57 | 2.5 | 5.6 | 2.7 | 65 | 78 | 1LE1501-2BC2 | 300 | 0.58 |
| 37 | 44.5 | 250 M | 982 | 360 | IE1 | 92.2 | 93.1 | 93.1 | 0.83 | 70 | 2.8 | 6 | 2.5 | 62 | 77 | 1LE1501-2CC2 | 370 | 0.86 |
| 45 | 54 | 280 S | 985 | 436 | IE1 | 92.7 | 93.4 | 93.2 | 0.84 | 83 | 2.7 | 6.3 | 2.6 | 65 | 79 | 1LE1501-2DC0 | 460 | 1.1 |
| 55 | 66 | 280 M | 985 | 533 | IE1 | 93.1 | 93.9 | 94 | 0.86 | 99 | 2.5 | 6.4 | 2.6 | 65 | 79 | 1LE1501-2DC2 | 510 | 1.4 |
| 75 | 90 | 315 S | 988 | 725 | IE1 | 93.7 | 94 | 93.6 | 0.84 | 138 | 2.5 | 6.7 | 2.8 | 65 | 79 | 1LE1501-3AC0 | 660 | 2.1 |
| 90 | 108 | 315 M | 988 | 870 | IE1 | 94 | 94.3 | 93.6 | 0.84 | 165 | 2.6 | 6.9 | 2.8 | 65 | 79 | 1LE1501-3AC2 | 730 | 2.5 |
| 110 | 132 | 315 L | 988 | 1063 | IE1 | 94.3 | 94.6 | 94.5 | 0.86 | 196 | 2.7 | 7 | 2.8 | 68 | 82 | 1LE1501-3AC4 | 940 | 3.6 |
| 132 | 158 | 315 L | 988 | 1276 | | 94.6 | 94.9 | 94.7 | 0.86 | 235 | 3 | 7.5 | 2.9 | 69 | 84 | 1LE1501-3AC5 | 990 | 4 |
| 160 | 192 | 315 L | 988 | 1546 | | 94.8 | 94.7 | 94.4 | 0.86 | 285 | 3.1 | 7.7 | 3.3 | 69 | 84 | 1LE1501-3AC6 | 1160 | 4.7 |
| Voltages ²⁾ | | | | | | | | | | | | | | | Version | | Order code | |
| 50 Hz 230 VΔ/400 VY | | | | | 60 Hz ¹⁾ 460 VY | | | | | Standard | | 2 | 2 | - | | | | |
| 50 Hz 400 VΔ/690 VY | | | | | 60 Hz ¹⁾ 460 VΔ | | | | | Standard | | 3 | 4 | - | | | | |
| 50 Hz 500 VY | | | | | | | | | | Without additional charge | | 2 | 7 | - | | | | |
| 50 Hz 500 VΔ | | | | | | | | | | Without additional charge | | 4 | 0 | - | | | | |
| For other voltages ¹⁾ and more information, see from page 2/96 | | | | | | | | | | | | 9 | 0 | ... | | | | |
| Types of construction | | | | | | | | | | | | | | | Version | | Order code | |
| Without flange | | | | | IM B3 ³⁾ | | | | | Standard | | A | | - | | | | |
| With flange | | | | | IM B5 ³⁾ | | | | | With additional charge | | F | | - | | | | |
| With flange | | | | | IM B14 ³⁾ | | | | | With additional charge | | K | | - | | | | |
| For other types of construction and more information, see from page 2/103 | | | | | | | | | | | | | | ... | | | | |
| Motor protection | | | | | | | | | | | | | | | Version | | Order code | |
| Without | | | | | | | | | | Standard | | A | | - | | | | |
| PTC thermistor with 3 temperature sensors | | | | | | | | | | With additional charge | | B | | - | | | | |
| For other motor protection and more information, see from page 2/113 | | | | | | | | | | | | | | ... | | | | |
| Terminal box position | | | | | | | | | | | | | | | Version | | Order code | |
| Terminal box at top | | | | | | | | | | Standard | | 4 | | - | | | | |
| For other terminal box positions and more information, see from page 2/116 | | | | | | | | | | | | | | ... | | | | |
| Special versions | | | | | | | | | | | | | | | Order code(s) | | | |
| Forced-air cooled motors w/o ext. fan/fan cover (IC418) | | | | | | | | | | | | | | | 1LE1501-... -Z F90+...+...+... | | | |
| For options, see from page 2/125 | | | | | | | | | | | | | | | 1LE1501-... -Z ...+...+...+... | | | |

2

¹⁾ Operating values at rated power for 60 Hz are stored in the Drive Technology Configurator (DT Configurator; see Appendix, "Tools and engineering").

²⁾ Parallel supply lines are required in the case of connection to ≤ 240 V. For frame size 315 with connection to ≤ 240 V, due to the high current, a drilled, removable entry plate (order code **R52**) or a larger terminal box (order code **R50**) can be used. Order codes **R52** and **R50** alter the motor dimensions.

³⁾ Types derived from IM B3 (IM B6/7/8, IM V6 and IM V5), from IM B5 (IM V3 and IM V1) and from IM B14 (IM V19 and IM V18) are possible, provided that no requirement exists for stamping of the type on the rating plate. The basic type IM B3, IM B5, or IM B14 is stamped as standard on the rating plate. If mounted in a different position, the position must be specified to ensure that the condensation drainage holes are positioned correctly.



IE2

SIMOTICS GP and SIMOTICS SD standard motors IE2 High Efficiency

Cast-iron series SIMOTICS SD 1LE1501 Basic Line – self-ventilated or forced-air cooled

Selection and ordering data

| Operating values at rated power | | | | | | | | | | | | | | | | Cast-iron series | | |
|---|--|---------------|-------------------------------|------------------------------|------------------------------------|--------------------------------|--------------------------------|--------------------------------|------------------------------------|-----------------------------|--------------------|--------------------|-----------------------|-------------------------------|------------------------------|-------------------------------------|-------------------|-------------------------|
| P_{rated} , 50 Hz/ P50 kW | P_{rated} , 60 Hz/ P60 ¹⁾ kW | Frame size | n_{rated} , 50 Hz rpm | T_{rated} , 50 Hz Nm | Different IE class 60 Hz/P60 | η_{rated} , 50 Hz % | η_{rated} , 50 Hz % | η_{rated} , 50 Hz % | $\cos\phi_{rated}$, 50 Hz % | I_{rated} , 400 V A | $T_{LR}/$ 50 Hz | $I_{LR}/$ 50 Hz | $T_{\beta}/$ 50 Hz | L_{pfA} , 50 Hz dB(A) | L_{WA} , 50 Hz dB(A) | 1LE1501 – Basic Line Article No. | $m_{IM B3}$ kg | J kgm ² |
| <ul style="list-style-type: none"> • Cooling: Self-ventilated (IC411) or with order code F90 forced-air cooled without external fan and fan cover (IC418) • Efficiency according to IEC 60034-30-1: IE2 High Efficiency, service factor (SF) 1.15 • Insulation: Thermal class 155 (temperature class F), IP55 degree of protection, utilization in accordance with thermal class 130 (temperature class B) | | | | | | | | | | | | | | | | | | |
| 8-pole: 750 rpm at 50 Hz, 900 rpm at 60 Hz ¹⁾ | | | | | | | | | | | | | | | | | | |
| 0.09 | 0.11 | 71 M | 630 | 1.4 | 4) | 40.1 | 40.6 | 35.8 | 0.67 | 0.5 | 1.7 | 1.6 | 1.7 | 59 | 63 | 1LE1501-0CD2 | 12 | 0.00077 |
| 0.12 | 0.14 | 71 M | 640 | 1.8 | | 40.1 | 39.6 | 34.7 | 0.66 | 0.65 | 1.8 | 1.8 | 1.8 | 48 | 59 | 1LE1501-0CD3 | 13 | 0.00100 |
| 0.18 | 0.21 | 80 M | 690 | 2.5 | | 45.9 | 43.6 | 37.8 | 0.6 | 0.93 | 1.7 | 2.2 | 2.1 | 51 | 62 | 1LE1501-0DD2 | 17 | 0.00175 |
| 0.25 | 0.29 | 80 M | 705 | 3.4 | | 50.6 | 48.1 | 41.9 | 0.55 | 1.3 | 2 | 2.5 | 2.5 | 51 | 62 | 1LE1501-0DD3 | 19 | 0.00246 |
| 0.37 | 0.43 | 90 S | 675 | 5.2 | | 56.1 | 55.6 | 49.6 | 0.71 | 1.34 | 1.4 | 2.6 | 1.7 | 53 | 65 | 1LE1501-0ED0 | 23 | 0.00225 |
| 0.55 | 0.63 | 90 L | 665 | 7.9 | | 61.7 | 63.4 | 59.8 | 0.74 | 1.74 | 1.5 | 2.7 | 1.7 | 53 | 65 | 1LE1501-0ED4 | 26 | 0.00305 |
| 0.75 | 0.86 | 100 L | 705 | 10 | | 66.2 | 65.7 | 61.6 | 0.61 | 2.7 | 1.5 | 3.2 | 2.1 | 60 | 72 | 1LE1501-1AD4 | 32 | 0.0086 |
| 1.1 | 1.27 | 100 L | 695 | 15 | | 70.8 | 72.3 | 69.6 | 0.65 | 3.45 | 1.4 | 3.2 | 1.9 | 60 | 72 | 1LE1501-1AD5 | 36 | 0.011 |
| 1.5 | 1.75 | 112 M | 725 | 20 | | 74.1 | 73.9 | 71.2 | 0.63 | 4.65 | 1.6 | 4 | 2.4 | 63 | 75 | 1LE1501-1BD2 | 53 | 0.017 |
| 2.2 | 2.55 | 132 S | 725 | 29 | | 77.6 | 78.2 | 76.6 | 0.62 | 6.6 | 1.4 | 3.5 | 2 | 63 | 75 | 1LE1501-1CD0 | 64 | 0.034 |
| 3 | 3.45 | 132 M | 720 | 40 | IE1 | 80 | 80.7 | 79.2 | 0.62 | 8.7 | 1.4 | 3.7 | 2 | 63 | 75 | 1LE1501-1CD2 | 67 | 0.037 |
| 4 | 4.55 | 160 M | 730 | 52 | | 81.9 | 82.6 | 81.4 | 0.67 | 10.5 | 1.6 | 3.7 | 1.9 | 63 | 75 | 1LE1501-1DD2 | 98 | 0.065 |
| 5.5 | 6.3 | 160 M | 730 | 72 | | 83.8 | 84.2 | 83 | 0.67 | 14.1 | 1.7 | 3.9 | 2 | 63 | 75 | 1LE1501-1DD3 | 111 | 0.083 |
| 7.5 | 8.6 | 160 L | 725 | 99 | | 85.3 | 86.4 | 86 | 0.7 | 18.1 | 1.6 | 3.8 | 1.9 | 63 | 75 | 1LE1501-1DD4 | 123 | 0.098 |
| 11 | 13.2 | 180 L | 720 | 146 | IE1 | 86.9 | 88 | 87.6 | 0.7 | 26 | 2.3 | 4.9 | 2.6 | 72 | 80 | 1LE1501-1ED4 | 155 | 0.195 |
| 15 | 18 | 200 L | 718 | 199 | | 88 | 89.5 | 89.9 | 0.76 | 32.5 | 2.4 | 5.4 | 2.8 | 58 | 65 | 1LE1501-2AD5 | 220 | 0.344 |
| 18.5 | 22 | 225 S | 730 | 242 | IE1 | 89 | 89.9 | 89.5 | 0.78 | 38.5 | 2.2 | 5.4 | 2.7 | 59 | 72 | 1LE1501-2BD0 | 250 | 0.43 |
| 22 | 26.5 | 225 M | 730 | 288 | | 90.3 | 91.3 | 91.1 | 0.8 | 44 | 2.3 | 5.5 | 2.7 | 58 | 71 | 1LE1501-2BD2 | 270 | 0.5 |
| 30 | 36 | 250 M | 732 | 391 | | 91.3 | 92.2 | 92 | 0.8 | 59 | 2.4 | 5.6 | 2.7 | 60 | 73 | 1LE1501-2CD2 | 370 | 0.86 |
| 37 | 44.5 | 280 S | 736 | 480 | | 91.9 | 92.5 | 92.1 | 0.78 | 75 | 2.3 | 5.4 | 2.4 | 63 | 77 | 1LE1501-2DD0 | 460 | 1.1 |
| 45 | 54 | 280 M | 738 | 582 | | 92.4 | 92.8 | 92.4 | 0.79 | 89 | 2.5 | 5.7 | 2.5 | 66 | 80 | 1LE1501-2DD2 | 510 | 1.4 |
| 55 | 66 | 315 S | 740 | 710 | | 92.9 | 93.3 | 92.9 | 0.8 | 107 | 2.2 | 5.8 | 2.6 | 69 | 83 | 1LE1501-3AD0 | 640 | 2 |
| 75 | 90 | 315 M | 738 | 970 | | 93.5 | 94.4 | 94.5 | 0.81 | 143 | 2.3 | 5.9 | 2.7 | 69 | 84 | 1LE1501-3AD2 | 720 | 2.5 |
| 90 | 108 | 315 L | 740 | 1161 | | 93.5 | 94.3 | 94.4 | 0.83 | 167 | 2.2 | 5.8 | 2.5 | 69 | 84 | 1LE1501-3AD4 | 860 | 3.1 |
| 110 | 132 | 315 L | 740 | 1419 | | 92.3 | 95 | 95.1 | 0.82 | 205 | 2.7 | 6.7 | 2.9 | 74 | 88 | 1LE1501-3AD5 | 980 | 3.9 |

| Voltages ²⁾ | | Version | Order code |
|---|----------------------------|---------------------------|------------|
| 50 Hz 230 VΔ/400 VY | 60 Hz ¹⁾ 460 VY | Standard | 2 2 |
| 50 Hz 400 VΔ/690 VY | 60 Hz ¹⁾ 460 VΔ | Standard | 3 4 |
| 50 Hz 500 VY | | Without additional charge | 2 7 |
| 50 Hz 500 VΔ | | Without additional charge | 4 0 |
| For other voltages ¹⁾ and more information, see from page 2/96 | | | 9 0 |

| Types of construction | | Version | Order code |
|---|----------------------|------------------------|------------|
| Without flange | IM B3 ³⁾ | Standard | A |
| With flange | IM B5 ³⁾ | With additional charge | F |
| With flange | IM B14 ³⁾ | With additional charge | K |
| For other types of construction and more information, see from page 2/103 | | | ... |

| Motor protection | | Version | Order code |
|--|--|------------------------|------------|
| Without | | Standard | A |
| PTC thermistor with 3 temperature sensors | | With additional charge | B |
| For other motor protection and more information, see from page 2/113 | | | ... |

| Terminal box position | | Version | Order code |
|--|--|----------|------------|
| Terminal box at top | | Standard | 4 |
| For other terminal box positions and more information, see from page 2/116 | | | ... |

| Special versions | | Order code(s) |
|---|--|--------------------------------|
| Forced-air cooled motors w/o ext. fan/fan cover (IC418) | | 1LE1501-... -Z F90+...+...+... |
| For options, see from page 2/125 | | 1LE1501-... -Z ...+...+...+... |

2

1) Operating values at rated power for 60 Hz are stored in the Drive Technology Configurator (DT Configurator; see Appendix, "Tools and engineering").

2) Parallel supply lines are required in the case of connection to ≤ 240 V. For frame size 315 with connection to ≤ 240 V, due to the high current, a drilled, removable entry plate (order code **R52**) or a larger terminal box (order code **R50**) can be used. Order codes **R52** and **R50** alter the motor dimensions.

3) Types derived from IM B3 (IM B6/7/8, IM V6 and IM V5), from IM B5 (IM V3 and IM V1) and from IM B14 (IM V19 and IM V18) are possible, provided that no requirement exists for stamping of the type on the rating plate. The basic type IM B3, IM B5, or IM B14 is stamped as standard on the rating plate. If mounted in a different position, the position must be specified to ensure that the condensation drainage holes are positioned correctly.

4) No IE class for 50 and 60 Hz because the motor is outside the validity for the efficiency classes according to IEC 60034-30-1:2014.

SIMOTICS GP and SIMOTICS SD standard motors

IE2 High Efficiency



Cast-iron series SIMOTICS SD 1LE1601 Performance Line – self-ventilated or forced-air cooled

Selection and ordering data

| P _{rated} 50 Hz/ P50 kW | P _{rated} 60 Hz/ P60 ¹⁾ kW | Frame size FS | Operating values at rated power | | | | | | | | | | | | Cast-iron series 1LE1601 – Performance Line Article No. | m _{IM B3} kg | J kgm ² |
|--|---|---------------------|------------------------------------|-----------------------------------|----------------------------------|----------------------------------|----------------------------------|-------------------------------------|----------------------------------|---|---|--|------------------------------------|-----------------------------------|--|--------------------------|-----------------------|
| | | | n _{rated} 50 Hz rpm | T _{rated} 50 Hz Nm | η _{rated} 50 Hz % | η _{rated} 50 Hz % | η _{rated} 50 Hz % | cosφ _{rated} 50 Hz % | I _{rated} 50 Hz A | T _{LR} /I _{rated} 50 Hz % | I _{LR} /I _{rated} 50 Hz % | T _B /I _{rated} 50 Hz % | L _{pfA} 50 Hz dB(A) | L _{WA} 50 Hz dB(A) | | | |
| 3 | 3.45 | 100 L | 2905 | 9.9 | 84.6 | 85.5 | 84.6 | 0.84 | 6.1 | 2.3 | 7 | 3.3 | 67 | 79 | 1LE1601-1AA4 | 32 | 0.0044 |
| 4 | 4.55 | 112 M | 2945 | 13 | 85.8 | 86.2 | 85.1 | 0.85 | 7.9 | 2.1 | 8 | 3.6 | 69 | 81 | 1LE1601-1BA2 | 39 | 0.0092 |
| 5.5 | 6.3 | 132 S | 2950 | 18 | 87 | 88 | 87.6 | 0.87 | 10.5 | 1.8 | 6.6 | 2.9 | 68 | 80 | 1LE1601-1CA0 | 57 | 0.02 |
| 7.5 | 8.6 | 132 S | 2950 | 24 | 88.1 | 88.5 | 87.6 | 0.87 | 14.1 | 2.2 | 7.5 | 3.1 | 68 | 80 | 1LE1601-1CA1 | 61 | 0.024 |
| 11 | 12.6 | 160 M | 2955 | 36 | 89.4 | 89.3 | 88 | 0.87 | 20.5 | 2.1 | 7.4 | 3.2 | 70 | 82 | 1LE1601-1DA2 | 96 | 0.045 |
| 15 | 17.3 | 160 M | 2955 | 48 | 90.3 | 90.7 | 90 | 0.88 | 27 | 2.4 | 7.6 | 3.4 | 70 | 82 | 1LE1601-1DA3 | 104 | 0.053 |
| 18.5 | 21.3 | 160 L | 2955 | 60 | 90.9 | 91.3 | 90.6 | 0.88 | 33.5 | 2.9 | 7.9 | 3.6 | 70 | 82 | 1LE1601-1DA4 | 113 | 0.061 |
| 22 | 24.5 | 180 M | 2940 | 71 | 91.3 | 91.8 | 91.3 | 0.87 | 40 | 2.7 | 7.4 | 3.6 | 77 | 84 | 1LE1601-1EA2 | 145 | 0.069 |
| 30 | 33.5 | 200 L | 2960 | 97 | 92 | 92.3 | 91.8 | 0.87 | 54 | 2.5 | 6.9 | 3.3 | 78 | 85 | 1LE1601-2AA4 | 200 | 0.13 |
| 37 | 41.5 | 200 L | 2960 | 119 | 92.5 | 93 | 92.7 | 0.88 | 66 | 2.7 | 7.4 | 3.5 | 78 | 85 | 1LE1601-2AA5 | 225 | 0.15 |
| 45 | 51 | 225 M | 2965 | 145 | 92.9 | 93.1 | 92.5 | 0.88 | 79 | 2.7 | 7.8 | 3.7 | 76 | 89 | 1LE1601-2BA2 | 295 | 0.23 |
| 55 | 62 | 250 M | 2970 | 177 | 93.2 | 93.3 | 92.4 | 0.88 | 97 | 2.3 | 6.8 | 3.1 | 76 | 89 | 1LE1601-2CA2 | 360 | 0.4 |
| 75 | 84 | 280 S | 2978 | 240 | 93.8 | 93.6 | 92.4 | 0.86 | 134 | 2.5 | 7.2 | 3.2 | 76 | 89 | 1LE1601-2DA0 | 490 | 0.71 |
| 90 | 101 | 280 M | 2975 | 289 | 94.1 | 94.2 | 93.5 | 0.88 | 157 | 2.5 | 7.1 | 3.1 | 76 | 89 | 1LE1601-2DA2 | 530 | 0.83 |
| 110 | 123 | 315 S | 2982 | 352 | 94.3 | 94.2 | 93.3 | 0.9 | 187 | 2.4 | 7.3 | 3 | 77 | 91 | 1LE1601-3AA0 | 720 | 1.3 |
| 132 | 148 | 315 M | 2982 | 423 | 94.6 | 94.7 | 94.1 | 0.91 | 220 | 2.4 | 7.2 | 3.1 | 77 | 91 | 1LE1601-3AA2 | 880 | 1.6 |
| 160 | 180 | 315 L | 2982 | 512 | 94.8 | 94.9 | 94.3 | 0.92 | 265 | 2.3 | 7 | 3.1 | 80 | 95 | 1LE1601-3AA4 | 930 | 1.8 |
| 200 | 224 | 315 L | 2982 | 640 | 95 | 95.2 | 94.8 | 0.92 | 330 | 2.5 | 7.3 | 3 | 80 | 95 | 1LE1601-3AA5 | 1130 | 2.2 |
| Voltages ²⁾ | | | Version | | | | | | | | | | | | Order code | | |
| 50 Hz 230 VΔ/400 VY | | | Standard | | | | | | | | | | | | 2 2 – | | |
| 50 Hz 400 VΔ/690 VY | | | Standard | | | | | | | | | | | | 3 4 – | | |
| 50 Hz 500 VY | | | Without additional charge | | | | | | | | | | | | 2 7 – | | |
| 50 Hz 500 VΔ | | | Without additional charge | | | | | | | | | | | | 4 0 – | | |
| For other voltages ¹⁾ and more information, see from page 2/96 | | | 9 0 | | | | | | | | | | | | ... | | |
| Types of construction | | | Version | | | | | | | | | | | | Order code | | |
| Without flange IM B3 ³⁾ | | | Standard | | | | | | | | | | | | A – | | |
| With flange IM B5 ³⁾ | | | With additional charge | | | | | | | | | | | | F – | | |
| With flange IM B14 ³⁾ | | | With additional charge | | | | | | | | | | | | K – | | |
| For other types of construction and more information, see from page 2/103 | | | ... | | | | | | | | | | | | ... | | |
| Motor protection | | | Version | | | | | | | | | | | | Order code | | |
| PTC thermistor with 3 temperature sensors | | | Standard | | | | | | | | | | | | B – | | |
| For other motor protection and more information, see from page 2/113 | | | ... | | | | | | | | | | | | ... | | |
| Terminal box position | | | Version | | | | | | | | | | | | Order code | | |
| Terminal box at top | | | Standard | | | | | | | | | | | | 4 | | |
| For other terminal box positions and more information, see from page 2/116 | | | ... | | | | | | | | | | | | ... | | |
| Special versions | | | | | | | | | | | | | | | Order code(s) | | |
| Forced-air cooled motors w/o ext. fan/fan cover (IC418) | | | | | | | | | | | | | | | 1LE1601-... -Z F90+...+...+... | | |
| For options, see from page 2/125 | | | | | | | | | | | | | | | 1LE1601-... -Z ...+...+...+... | | |

¹⁾ Operating values at rated power for 60 Hz are stored in the Drive Technology Configurator (DT Configurator; see Appendix, "Tools and engineering").

²⁾ Parallel supply lines are required in the case of connection to ≤ 240 V. For frame size 315 with connection to ≤ 240 V, due to the high current, a drilled, removable entry plate (order code **R52**) or a larger terminal box (order code **R50**) can be used. Order codes **R52** and **R50** alter the motor dimensions.

³⁾ Types derived from IM B3 (IM B6/7/8, IM V6 and IM V5), from IM B5 (IM V3 and IM V1) and from IM B14 (IM V19 and IM V18) are possible, provided that no requirement exists for stamping of the type on the rating plate. The basic type IM B3, IM B5, or IM B14 is stamped as standard on the rating plate. If mounted in a different position, the position must be specified to ensure that the condensation drainage holes are positioned correctly.



IE2

SIMOTICS GP and SIMOTICS SD standard motors IE2 High Efficiency

Cast-iron series SIMOTICS SD 1LE1601 Performance Line – self-ventilated or forced-air cooled

Selection and ordering data

| P _{rated} 50 Hz/ P50 kW | P _{rated} 60 Hz/ P60 ¹⁾ kW | Frame size FS | Operating values at rated power | | | | | | | | | | | | | Cast-iron series 1LE1601 – Performance Line Article No. | m _{IM B3} kg | J kgm ² | |
|--|---|---------------------|------------------------------------|-----------------------------------|----------------------------------|----------------------------------|----------------------------------|-------------------------------------|----------------------------------|---------------------------------|--------------------------------|-------------------------------|------------------------------------|-----------------------------------|---------------------|--|--------------------------|-----------------------|--|
| | | | n _{rated} 50 Hz rpm | T _{rated} 50 Hz Nm | η _{rated} 50 Hz % | η _{rated} 50 Hz % | η _{rated} 50 Hz % | cosφ _{rated} 50 Hz % | I _{rated} 50 Hz A | T _{L/R} 50 Hz °C | I _{L/R} 50 Hz % | T _B 50 Hz °C | L _{pfA} 50 Hz dB(A) | L _{WA} 50 Hz dB(A) | | | | | |
| 2.2 | 2.55 | 100 L | 1455 | 14 | 84.3 | 85.1 | 84.2 | 0.81 | 4.65 | 2.1 | 6.9 | 3.3 | 60 | 72 | 1LE1601-1AB4 | 32 | 0.0086 | | |
| 3 | 3.45 | 100 L | 1455 | 20 | 85.5 | 86.4 | 85.6 | 0.82 | 6.2 | 2 | 6.9 | 3.1 | 60 | 72 | 1LE1601-1AB5 | 37 | 0.011 | | |
| 4 | 4.55 | 112 M | 1460 | 26 | 86.6 | 87.3 | 86.4 | 0.81 | 8.2 | 2.5 | 7.1 | 3.2 | 58 | 70 | 1LE1601-1BB2 | 46 | 0.014 | | |
| 5.5 | 6.3 | 132 S | 1465 | 36 | 87.7 | 88.4 | 87.6 | 0.8 | 11.3 | 2.3 | 6.9 | 2.9 | 64 | 76 | 1LE1601-1CB0 | 61 | 0.027 | | |
| 7.5 | 8.6 | 132 M | 1465 | 49 | 88.7 | 89.8 | 89.8 | 0.83 | 14.7 | 2.3 | 6.9 | 2.9 | 64 | 76 | 1LE1601-1CB2 | 75 | 0.034 | | |
| 11 | 12.6 | 160 M | 1470 | 71 | 89.8 | 91 | 90.9 | 0.85 | 21 | 2.1 | 6.7 | 2.8 | 65 | 77 | 1LE1601-1DB2 | 96 | 0.065 | | |
| 15 | 17.3 | 160 L | 1475 | 97 | 90.6 | 91.2 | 90.8 | 0.85 | 28 | 2.3 | 7.3 | 3 | 65 | 77 | 1LE1601-1DB4 | 104 | 0.083 | | |
| 18.5 | 21.3 | 180 M | 1465 | 121 | 91.2 | 92 | 91.9 | 0.84 | 35 | 2.5 | 7.2 | 3.4 | 61 | 74 | 1LE1601-1EB2 | 160 | 0.12 | | |
| 22 | 25.3 | 180 L | 1465 | 143 | 91.6 | 92.2 | 91.9 | 0.84 | 41.5 | 2.6 | 7.3 | 3.5 | 69 | 76 | 1LE1601-1EB4 | 170 | 0.13 | | |
| 30 | 34.5 | 200 L | 1470 | 195 | 92.3 | 92.9 | 92.6 | 0.84 | 56 | 2.5 | 6.7 | 3.3 | 70 | 77 | 1LE1601-2AB5 | 230 | 0.2 | | |
| 37 | 42.5 | 225 S | 1470 | 240 | 92.7 | 93.5 | 93.5 | 0.88 | 65 | 2.3 | 6.6 | 2.9 | 66 | 79 | 1LE1601-2BB0 | 280 | 0.42 | | |
| 45 | 52 | 225 M | 1475 | 291 | 93.1 | 93.8 | 93.7 | 0.87 | 80 | 2.5 | 6.9 | 3.1 | 66 | 79 | 1LE1601-2BB2 | 305 | 0.46 | | |
| 55 | 63 | 250 M | 1480 | 355 | 93.5 | 93.9 | 93.5 | 0.85 | 100 | 2.7 | 6.8 | 3 | 66 | 79 | 1LE1601-2CB2 | 385 | 0.75 | | |
| 75 | 86 | 280 S | 1485 | 482 | 94 | 94.2 | 93.8 | 0.87 | 132 | 2.5 | 6.8 | 3 | 71 | 85 | 1LE1601-2DB0 | 550 | 1.3 | | |
| 90 | 104 | 280 M | 1486 | 578 | 94.2 | 94.3 | 93.6 | 0.87 | 159 | 2.6 | 7.3 | 3.1 | 71 | 85 | 1LE1601-2DB2 | 570 | 1.4 | | |
| 110 | 127 | 315 S | 1490 | 705 | 94.5 | 94.6 | 94 | 0.86 | 195 | 2.7 | 7.4 | 3 | 72 | 86 | 1LE1601-3AB0 | 740 | 2 | | |
| 132 | 152 | 315 M | 1490 | 846 | 94.7 | 94.9 | 94.6 | 0.87 | 230 | 2.7 | 7.1 | 2.9 | 75 | 89 | 1LE1601-3AB2 | 870 | 2.3 | | |
| 160 | 184 | 315 L | 1490 | 1025 | 94.9 | 95 | 94.5 | 0.87 | 280 | 2.8 | 7.2 | 3.1 | 76 | 91 | 1LE1601-3AB4 | 940 | 2.8 | | |
| 200 | 230 | 315 L | 1490 | 1282 | 95.1 | 95.3 | 94.7 | 0.87 | 350 | 3.1 | 7.5 | 3.2 | 77 | 92 | 1LE1601-3AB5 | 1140 | 3.5 | | |
| Voltages ²⁾ | | | Version | | | | | | | | | | | | | Order code | | | |
| 50 Hz 230 VΔ/400 VY | | | Standard | | | | | | | | | | | | | 2 2 | | - | |
| 50 Hz 400 VΔ/690 VY | | | Standard | | | | | | | | | | | | | 3 4 | | - | |
| 50 Hz 500 VY | | | Without additional charge | | | | | | | | | | | | | 2 7 | | - | |
| 50 Hz 500 VΔ | | | Without additional charge | | | | | | | | | | | | | 4 0 | | - | |
| For other voltages ¹⁾ and more information, see from page 2/96 | | | 9 0 | | | | | | | | | | | | | ... | | | |
| Types of construction | | | Version | | | | | | | | | | | | | Order code | | | |
| Without flange IM B3 ³⁾ | | | Standard | | | | | | | | | | | | | A | | - | |
| With flange IM B5 ³⁾ | | | With additional charge | | | | | | | | | | | | | F | | - | |
| With flange IM B14 ³⁾ | | | With additional charge | | | | | | | | | | | | | K | | - | |
| For other types of construction and more information, see from page 2/103 | | | ... | | | | | | | | | | | | | | | | |
| Motor protection | | | Version | | | | | | | | | | | | | Order code | | | |
| PTC thermistor with 3 temperature sensors | | | Standard | | | | | | | | | | | | | B | | - | |
| For other motor protection and more information, see from page 2/113 | | | ... | | | | | | | | | | | | | | | | |
| Terminal box position | | | Version | | | | | | | | | | | | | Order code | | | |
| Terminal box at top | | | Standard | | | | | | | | | | | | | 4 | | - | |
| For other terminal box positions and more information, see from page 2/116 | | | ... | | | | | | | | | | | | | | | | |
| Special versions | | | Order code(s) | | | | | | | | | | | | | | | | |
| Forced-air cooled motors w/o ext. fan/fan cover (IC418) | | | 1LE1601-...-Z F90+...+...+... | | | | | | | | | | | | | | | | |
| For options, see from page 2/125 | | | 1LE1601-...-Z ...+...+...+... | | | | | | | | | | | | | | | | |



¹⁾ Operating values at rated power for 60 Hz are stored in the Drive Technology Configurator (DT Configurator; see Appendix, "Tools and engineering").

²⁾ Parallel supply lines are required in the case of connection to ≤ 240 V. For frame size 315 with connection to ≤ 240 V, due to the high current, a drilled, removable entry plate (order code **R52**) or a larger terminal box (order code **R50**) can be used. Order codes **R52** and **R50** alter the motor dimensions.

³⁾ Types derived from IM B3 (IM B6/7/8, IM V6 and IM V5), from IM B5 (IM V3 and IM V1) and from IM B14 (IM V19 and IM V18) are possible, provided that no requirement exists for stamping of the type on the rating plate. The basic type IM B3, IM B5, or IM B14 is stamped as standard on the rating plate. If mounted in a different position, the position must be specified to ensure that the condensation drainage holes are positioned correctly.



SIMOTICS GP and SIMOTICS SD standard motors

IE2 High Efficiency

IE2

Cast-iron series SIMOTICS SD 1LE1601 Performance Line – self-ventilated or forced-air cooled

Selection and ordering data

| Operating values at rated power | | | | | | | | | | | | | | | | | Cast-iron series | | | |
|---|--|---------------|----------------------|----------------------------|-----------------------|-------------------------|-------------------------|---------------------------|-----------------------------|----------------------|--------------------------|--------------------------|-----------------------|--------------------|-------------------|--|------------------|------------------|-----------------|--|
| P_{rated} 50 Hz/ P50 | P_{rated} 60 Hz/ P60 ¹⁾ | Frame size | n_{rated} 50 Hz | T_{rated} 50 Hz | Different IE class | η_{rated} 50 Hz | η_{rated} 50 Hz | η_{rated} 50 Hz | $\cos\phi_{rated}$ 50 Hz | I_{rated} 50 Hz | $T_{LR}/$ T_{rated} | $I_{LR}/$ I_{rated} | $T_B/$ T_{rated} | L_{pFA} 50 Hz | L_{WA} 50 Hz | 1LE1601 – Performance Line Article No. | $m_{IM B3}$ | J | | |
| kW | kW | FS | rpm | Nm | | % | % | % | % | A | | | | dB(A) | dB(A) | | kg | kgm ² | | |
| • Cooling: Self-ventilated (IC411) or with order code F90 forced-air cooled without external fan and fan cover (IC418) • Efficiency according to IEC 60034-30-1: IE2 High Efficiency, service factor (SF) 1.15 • Insulation: Thermal class 155 (temperature class F), IP55 degree of protection, utilization in accordance with thermal class 130 (temperature class B) | | | | | | | | | | | | | | | | | | | | |
| 6-pole: 1000 rpm at 50 Hz, 1200 rpm at 60 Hz ¹⁾ | | | | | | | | | | | | | | | | | | | | |
| 1.5 | 1.75 | 100 L | 970 | 15 | | 79.8 | 80.5 | 79 | 0.73 | 3.7 | 2 | 5.4 | 2.8 | 59 | 71 | 1LE1601-1AC4 | 36 | 0.011 | | |
| 2.2 | 2.55 | 112 M | 965 | 22 | | 81.8 | 82.7 | 81.7 | 0.75 | 5.2 | 2 | 5 | 2.8 | 62 | 74 | 1LE1601-1BC2 | 41 | 0.014 | | |
| 3 | 3.45 | 132 S | 970 | 30 | | 83.3 | 83.4 | 81 | 0.72 | 7.2 | 1.6 | 5 | 2.5 | 63 | 75 | 1LE1601-1CC0 | 56 | 0.024 | | |
| 4 | 4.55 | 132 M | 970 | 39 | | 84.6 | 85.5 | 84.3 | 0.75 | 9.1 | 1.6 | 5 | 2.3 | 63 | 75 | 1LE1601-1CC2 | 61 | 0.029 | | |
| 5.5 | 6.3 | 132 M | 970 | 54 | | 86 | 87.1 | 86.4 | 0.76 | 12.1 | 1.9 | 5.6 | 2.6 | 63 | 75 | 1LE1601-1CC3 | 70 | 0.037 | | |
| 7.5 | 8.6 | 160 M | 975 | 73 | | 87.2 | 87.9 | 87.2 | 0.74 | 16.8 | 1.9 | 4.7 | 2.2 | 67 | 79 | 1LE1601-1DC2 | 106 | 0.075 | | |
| 11 | 12.6 | 160 L | 975 | 108 | | 88.7 | 89.7 | 89.3 | 0.76 | 23.5 | 1.9 | 4.8 | 2.2 | 67 | 79 | 1LE1601-1DC4 | 122 | 0.098 | | |
| 15 | 18 | 180 L | 975 | 147 | | 89.7 | 90.1 | 89.5 | 0.78 | 31 | 2.5 | 6 | 3.1 | 57 | 70 | 1LE1601-1EC4 | 155 | 0.17 | | |
| 18.5 | 22 | 200 L | 978 | 181 | IE1 | 90.4 | 91.4 | 91.3 | 0.82 | 36 | 2.4 | 5.8 | 2.6 | 63 | 76 | 1LE1601-2AC4 | 200 | 0.25 | | |
| 22 | 26.5 | 200 L | 978 | 215 | IE1 | 90.9 | 91.7 | 91.4 | 0.82 | 42.5 | 2.5 | 6.2 | 2.6 | 63 | 76 | 1LE1601-2AC5 | 220 | 0.3 | | |
| 30 | 36 | 225 M | 980 | 292 | IE1 | 91.7 | 92.5 | 92.3 | 0.83 | 57 | 2.5 | 5.6 | 2.7 | 65 | 78 | 1LE1601-2BC2 | 300 | 0.58 | | |
| 37 | 44.5 | 250 M | 982 | 360 | IE1 | 92.2 | 93.1 | 93.1 | 0.83 | 70 | 2.8 | 6 | 2.5 | 62 | 77 | 1LE1601-2CC2 | 370 | 0.86 | | |
| 45 | 54 | 280 S | 985 | 436 | IE1 | 92.7 | 93.4 | 93.2 | 0.84 | 83 | 2.7 | 6.3 | 2.6 | 65 | 79 | 1LE1601-2DC0 | 460 | 1.1 | | |
| 55 | 66 | 280 M | 985 | 533 | IE1 | 93.1 | 93.9 | 94 | 0.86 | 99 | 2.5 | 6.4 | 2.6 | 65 | 79 | 1LE1601-2DC2 | 510 | 1.4 | | |
| 75 | 90 | 315 S | 988 | 725 | IE1 | 93.7 | 94 | 93.6 | 0.84 | 138 | 2.5 | 6.7 | 2.8 | 65 | 79 | 1LE1601-3AC0 | 660 | 2.1 | | |
| 90 | 108 | 315 M | 988 | 870 | IE1 | 94 | 94.3 | 93.6 | 0.84 | 165 | 2.6 | 6.9 | 2.8 | 65 | 79 | 1LE1601-3AC2 | 730 | 2.5 | | |
| 110 | 132 | 315 L | 988 | 1063 | IE1 | 94.3 | 94.6 | 94.5 | 0.86 | 196 | 2.7 | 7 | 2.8 | 68 | 82 | 1LE1601-3AC4 | 940 | 3.6 | | |
| 132 | 158 | 315 L | 988 | 1276 | | 94.6 | 94.9 | 94.7 | 0.86 | 235 | 3 | 7.5 | 2.9 | 69 | 84 | 1LE1601-3AC5 | 990 | 4 | | |
| 160 | 192 | 315 L | 988 | 1546 | | 94.8 | 94.7 | 94.4 | 0.86 | 285 | 3.1 | 7.7 | 3.3 | 69 | 84 | 1LE1601-3AC6 | 1160 | 4.7 | | |
| Voltages²⁾ | | | | | | | | | | | | | | | | | Version | | Order code | |
| 50 Hz 230 VΔ/400 VY | | | | 60 Hz ¹⁾ 460 VY | | | | Standard | | | | 2 2 | | - | | | | | | |
| 50 Hz 400 VΔ/690 VY | | | | 60 Hz ¹⁾ 460 VΔ | | | | Standard | | | | 3 4 | | - | | | | | | |
| 50 Hz 500 VY | | | | | | | | Without additional charge | | | | 2 7 | | - | | | | | | |
| 50 Hz 500 VΔ | | | | | | | | Without additional charge | | | | 4 0 | | - | | | | | | |
| For other voltages ¹⁾ and more information, see from page 2/96 | | | | | | | | | | | | | | | | | | | | |
| Types of construction | | | | | | | | | | | | | | | | | Version | | Order code | |
| Without flange | | | | IM B3 ³⁾ | | | | Standard | | | | A | | - | | | | | | |
| With flange | | | | IM B5 ³⁾ | | | | With additional charge | | | | F | | - | | | | | | |
| With flange | | | | IM B14 ³⁾ | | | | With additional charge | | | | K | | - | | | | | | |
| For other types of construction and more information, see from page 2/103 | | | | | | | | | | | | | | | | | | | | |
| Motor protection | | | | | | | | | | | | | | | | | Version | | Order code | |
| PTC thermistor with 3 temperature sensors | | | | | | | | Standard | | | | B | | - | | | | | | |
| For other motor protection and more information, see from page 2/113 | | | | | | | | | | | | | | | | | | | | |
| Terminal box position | | | | | | | | | | | | | | | | | Version | | Order code | |
| Terminal box at top | | | | | | | | Standard | | | | 4 | | - | | | | | | |
| For other terminal box positions and more information, see from page 2/116 | | | | | | | | | | | | | | | | | | | | |
| Special versions | | | | | | | | | | | | | | | | | | | Order code(s) | |
| Forced-air cooled motors w/o ext. fan/fan cover (IC418) | | | | | | | | | | | | | | | | | 1LE1601-...-Z | | F90+...+...+... | |
| For options, see from page 2/125 | | | | | | | | | | | | | | | | | 1LE1601-...-Z | | ...+...+...+... | |

2

¹⁾ Operating values at rated power for 60 Hz are stored in the Drive Technology Configurator (DT Configurator; see Appendix, "Tools and engineering").

²⁾ Parallel supply lines are required in the case of connection to ≤ 240 V. For frame size 315 with connection to ≤ 240 V, due to the high current, a drilled, removable entry plate (order code **R52**) or a larger terminal box (order code **R50**) can be used. Order codes **R52** and **R50** alter the motor dimensions.

³⁾ Types derived from IM B3 (IM B6/7/8, IM V6 and IM V5), from IM B5 (IM V3 and IM V1) and from IM B14 (IM V19 and IM V18) are possible, provided that no requirement exists for stamping of the type on the rating plate. The basic type IM B3, IM B5, or IM B14 is stamped as standard on the rating plate. If mounted in a different position, the position must be specified to ensure that the condensation drainage holes are positioned correctly.



IE2

SIMOTICS GP and SIMOTICS SD standard motors IE2 High Efficiency

Cast-iron series SIMOTICS SD 1LE1601 Performance Line – self-ventilated or forced-air cooled

Selection and ordering data

| Operating values at rated power | | | | | | | | | | | | | | | Cast-iron series | | | |
|---|--|---------------|-----------------------------|----------------------------|------------------------------------|------------------------------|------------------------------|------------------------------|----------------------------------|---------------------------|------------------------|------------------------|---------------------------|-----------------------------|----------------------------|--|-------------------|-------------------------|
| P_{rated} 50 Hz/ P50 kW | P_{rated} 60 Hz/ P60 ¹⁾ kW | Frame size | n_{rated} 50 Hz rpm | T_{rated} 50 Hz Nm | Different IE class 60 Hz/P60 | η_{rated} 50 Hz % | η_{rated} 50 Hz % | η_{rated} 50 Hz % | $\cos\phi_{rated}$ 50 Hz % | I_{rated} 400 V A | T_{LR} 50 Hz % | I_{LR} 50 Hz % | T_{β} 50 Hz % | L_{pfA} 50 Hz dB(A) | L_{WA} 50 Hz dB(A) | 1LE1601 – Performance Line Article No. | $m_{IM B3}$ kg | J kgm ² |
| <ul style="list-style-type: none"> • Cooling: Self-ventilated (IC411) or with order code F90 forced-air cooled without external fan and fan cover (IC418) • Efficiency according to IEC 60034-30-1: IE2 High Efficiency, service factor (SF) 1.15 • Insulation: Thermal class 155 (temperature class F), IP55 degree of protection, utilization in accordance with thermal class 130 (temperature class B) | | | | | | | | | | | | | | | | | | |
| 8-pole: 750 rpm at 50 Hz, 900 rpm at 60 Hz ¹⁾ | | | | | | | | | | | | | | | | | | |
| 0.75 | 0.86 | 100 L | 705 | 10 | | 66.2 | 65.7 | 61.6 | 0.61 | 2.7 | 1.5 | 3.2 | 2.1 | 60 | 72 | 1LE1601-1AD4 | 32 | 0.0086 |
| 1.1 | 1.27 | 100 L | 695 | 15 | | 70.8 | 72.3 | 69.6 | 0.65 | 3.45 | 1.4 | 3.2 | 1.9 | 60 | 72 | 1LE1601-1AD5 | 36 | 0.011 |
| 1.5 | 1.75 | 112 M | 725 | 20 | | 74.1 | 73.9 | 71.2 | 0.63 | 4.65 | 1.6 | 4 | 2.4 | 63 | 75 | 1LE1601-1BD2 | 53 | 0.017 |
| 2.2 | 2.55 | 132 S | 725 | 29 | | 77.6 | 78.2 | 76.6 | 0.62 | 6.6 | 1.4 | 3.5 | 2 | 63 | 75 | 1LE1601-1CD0 | 64 | 0.034 |
| 3 | 3.45 | 132 M | 720 | 40 | IE1 | 80 | 80.7 | 79.2 | 0.62 | 8.7 | 1.4 | 3.7 | 2 | 63 | 75 | 1LE1601-1CD2 | 67 | 0.037 |
| 4 | 4.55 | 160 M | 730 | 52 | | 81.9 | 82.6 | 81.4 | 0.67 | 10.5 | 1.6 | 3.7 | 1.9 | 63 | 75 | 1LE1601-1DD2 | 98 | 0.065 |
| 5.5 | 6.3 | 160 M | 730 | 72 | | 83.8 | 84.2 | 83 | 0.67 | 14.1 | 1.7 | 3.9 | 2 | 63 | 75 | 1LE1601-1DD3 | 111 | 0.083 |
| 7.5 | 8.6 | 160 L | 725 | 99 | | 85.3 | 86.4 | 86 | 0.7 | 18.1 | 1.6 | 3.8 | 1.9 | 63 | 75 | 1LE1601-1DD4 | 123 | 0.098 |
| 11 | 13.2 | 180 L | 720 | 146 | IE1 | 86.9 | 88 | 87.6 | 0.7 | 26 | 2.3 | 4.9 | 2.6 | 72 | 80 | 1LE1601-1ED4 | 155 | 0.195 |
| 15 | 18 | 200 L | 718 | 199 | | 88 | 89.5 | 89.9 | 0.76 | 32.5 | 2.4 | 5.4 | 2.8 | 58 | 65 | 1LE1601-2AD5 | 220 | 0.344 |
| 18.5 | 22 | 225 S | 730 | 242 | IE1 | 89 | 89.9 | 89.5 | 0.78 | 38.5 | 2.2 | 5.4 | 2.7 | 59 | 72 | 1LE1601-2BD0 | 250 | 0.43 |
| 22 | 26.5 | 225 M | 730 | 288 | | 90.3 | 91.3 | 91.1 | 0.8 | 44 | 2.3 | 5.5 | 2.7 | 58 | 71 | 1LE1601-2BD2 | 270 | 0.5 |
| 30 | 36 | 250 M | 732 | 391 | | 91.3 | 92.2 | 92 | 0.8 | 59 | 2.4 | 5.6 | 2.7 | 60 | 73 | 1LE1601-2CD2 | 370 | 0.86 |
| 37 | 44.5 | 280 S | 736 | 480 | | 91.9 | 92.5 | 92.1 | 0.78 | 75 | 2.3 | 5.4 | 2.4 | 63 | 77 | 1LE1601-2DD0 | 460 | 1.1 |
| 45 | 54 | 280 M | 738 | 582 | | 92.4 | 92.8 | 92.4 | 0.79 | 89 | 2.5 | 5.7 | 2.5 | 66 | 80 | 1LE1601-2DD2 | 510 | 1.4 |
| 55 | 66 | 315 S | 740 | 710 | | 92.9 | 93.3 | 92.9 | 0.8 | 107 | 2.2 | 5.8 | 2.6 | 69 | 83 | 1LE1601-3AD0 | 640 | 2 |
| 75 | 90 | 315 M | 738 | 970 | | 93.5 | 94.4 | 94.5 | 0.81 | 143 | 2.3 | 5.9 | 2.7 | 69 | 84 | 1LE1601-3AD2 | 720 | 2.5 |
| 90 | 108 | 315 L | 740 | 1161 | | 93.5 | 94.3 | 94.4 | 0.83 | 167 | 2.2 | 5.8 | 2.5 | 69 | 84 | 1LE1601-3AD4 | 860 | 3.1 |
| 110 | 132 | 315 L | 740 | 1419 | | 94.2 | 95 | 95.1 | 0.82 | 205 | 2.7 | 6.7 | 2.9 | 74 | 88 | 1LE1601-3AD5 | 980 | 3.9 |
| Voltages²⁾ | | | | | | | | | | | | | | | Version | | Order code | |
| 50 Hz 230 VΔ/400 VY | | | 60 Hz ¹⁾ 460 VY | | | Standard | | | | | | | | | 2 | 2 | - | |
| 50 Hz 400 VΔ/690 VY | | | 60 Hz ¹⁾ 460 VΔ | | | Standard | | | | | | | | | 3 | 4 | - | |
| 50 Hz 500 VY | | | | | | Without additional charge | | | | | | | | | 2 | 7 | - | |
| 50 Hz 500 VΔ | | | | | | Without additional charge | | | | | | | | | 4 | 0 | - | |
| For other voltages ¹⁾ and more information, see from page 2/96 | | | | | | | | | | | | | | | 9 | 0 | ... | |
| Types of construction | | | | | | | | | | | | | | | Version | | Order code | |
| Without flange | | | IM B3 ³⁾ | | | Standard | | | | | | | | | A | - | | |
| With flange | | | IM B5 ³⁾ | | | With additional charge | | | | | | | | | F | - | | |
| With flange | | | IM B14 ³⁾ | | | With additional charge | | | | | | | | | K | - | | |
| For other types of construction and more information, see from page 2/103 | | | | | | | | | | | | | | | | | ... | |
| Motor protection | | | | | | | | | | | | | | | Version | | Order code | |
| PTC thermistor with 3 temperature sensors | | | | | | Standard | | | | | | | | | B | - | | |
| For other motor protection and more information, see from page 2/113 | | | | | | | | | | | | | | | | | ... | |
| Terminal box position | | | | | | | | | | | | | | | Version | | Order code | |
| Terminal box at top | | | | | | Standard | | | | | | | | | 4 | - | | |
| For other terminal box positions and more information, see from page 2/116 | | | | | | | | | | | | | | | | | | |
| Special versions | | | | | | | | | | | | | | | | | Order code(s) | |
| Forced-air cooled motors w/o ext. fan/fan cover (IC418) | | | | | | 1LE1601-...-Z | | | | | | | | | F90+ | ...+...+... | | |
| For options, see from page 2/125 | | | | | | 1LE1601-...-Z | | | | | | | | | ... | ...+...+...+... | | |



1) Operating values at rated power for 60 Hz are stored in the Drive Technology Configurator (DT Configurator; see Appendix, "Tools and engineering").

2) Parallel supply lines are required in the case of connection to ≤ 240 V. For frame size 315 with connection to ≤ 240 V, due to the high current, a drilled, removable entry plate (order code R52) or a larger terminal box (order code R50) can be used. Order codes R52 and R50 alter the motor dimensions.

3) Types derived from IM B3 (IM B6/7/8, IM V6 and IM V5), from IM B5 (IM V3 and IM V1) and from IM B14 (IM V19 and IM V18) are possible, provided that no requirement exists for stamping of the type on the rating plate. The basic type IM B3, IM B5, or IM B14 is stamped as standard on the rating plate. If mounted in a different position, the position must be specified to ensure that the condensation drainage holes are positioned correctly.

4) No IE class for 50 and 60 Hz because the motor is outside the validity for the efficiency classes according to IEC 60034-30-1:2014.

SIMOTICS GP and SIMOTICS SD standard motors

IE2 High Efficiency

IE2



Cast-iron series SIMOTICS SD 1LE1501 Basic Line with increased power – self-ventilated

Selection and ordering data

| Operating values at rated power | | | | | | | | | | | | | | Cast-iron series | | | | |
|---|--|---------------|----------------------|----------------------------|-----------------------|-------------------------|-------------------------|---------------------------|-----------------------------|----------------------|-----------------------------|-----------------------------|--------------------------|--------------------|-------------------|----------------------|------------------|--------|
| P_{rated} 50 Hz/ P50 | P_{rated} 60 Hz/ P60 ¹⁾ | Frame size | n_{rated} 50 Hz | T_{rated} 50 Hz | Different IE class | η_{rated} 50 Hz | η_{rated} 50 Hz | η_{rated} 50 Hz | $\cos\phi_{rated}$ 50 Hz | I_{rated} 50 Hz | T_{LR}/T_{rated} 50 Hz | I_{LR}/I_{rated} 50 Hz | T_B/T_{rated} 50 Hz | L_{pFA} 50 Hz | L_{WA} 50 Hz | 1LE1501 – Basic Line | $m_{IM B3}$ | J |
| kW | kW | FS | rpm | Nm | 60 Hz/P60 | 4/4 | 3/4 | 2/4 | 4/4 | A | | | | | Article No. | kg | kgm ² | |
| • Cooling: Self-ventilated (IC411) or with order code F90 forced-air cooled without external fan and fan cover (IC418) • Efficiency according to IEC 60034-30-1: IE2 High Efficiency, service factor (SF) 1.15 • Insulation: Thermal class 155 (temperature class F), IP55 degree of protection, utilization in accordance with thermal class 130 (temperature class B) | | | | | | | | | | | | | | | | | | |
| 2-pole: 3000 rpm at 50 Hz, 3600 rpm at 60 Hz ¹⁾ | | | | | | | | | | | | | | | | | | |
| 4 | 4.55 | 100 L | 2905 | 13 | | 85.8 | 86.9 | 86.5 | 0.86 | 7.8 | 2.5 | 7.6 | 3.5 | 67 | 79 | 1LE1501-1AA6 | 45 | 0.0054 |
| 5.5 | 6.3 | 112 M | 2945 | 18 | | 87 | 87.8 | 87.4 | 0.88 | 10.4 | 2.3 | 8.5 | 3.8 | 69 | 81 | 1LE1501-1BA6 | 53 | 0.012 |
| 11 | 12.6 | 132 M | 2950 | 36 | | 89.4 | 90.1 | 89.9 | 0.89 | 20 | 2.3 | 7.9 | 3.2 | 68 | 80 | 1LE1501-1CA6 | 80 | 0.031 |
| 22 | 25.3 | 160 L | 2955 | 71 | | 91.3 | 91.8 | 91.4 | 0.89 | 39 | 3.1 | 8.4 | 3.7 | 70 | 82 | 1LE1501-1DA6 | 126 | 0.068 |
| 30 | 33.5 | 180 L | 2940 | 97 | | 92 | 92.6 | 92.3 | 0.89 | 53 | 2.3 | 7.8 | 3.4 | 76 | 83 | 1LE1501-1EA6 | 180 | 0.094 |
| 45 | 51 | 200 L | 2950 | 146 | | 92.9 | 93.2 | 92.9 | 0.87 | 81 | 2.5 | 7.1 | 3.2 | 77 | 84 | 1LE1501-2AA6 | 245 | 0.176 |
| 55 | 62 | 225 M | 2960 | 177 | | 93.2 | 93.6 | 93.2 | 0.88 | 97 | 2.5 | 7 | 3.3 | 76 | 89 | 1LE1501-2BA6 | 320 | 0.26 |
| 75 | 84 | 250 M | 2970 | 241 | | 93.8 | 93.6 | 92.6 | 0.84 | 137 | 2.2 | 7 | 3.3 | 75 | 89 | 1LE1501-2CA6 | 390 | 0.46 |
| 110 | 123 | 280 M | 2978 | 353 | | 94.3 | 94.5 | 94.1 | 0.9 | 187 | 2.9 | 8.5 | 3.6 | 80 | 91 | 1LE1501-2DA6 | 650 | 1.2 |
| 4-pole: 1500 rpm at 50 Hz, 1800 rpm at 60 Hz ¹⁾ | | | | | | | | | | | | | | | | | | |
| 4 | 4.55 | 100 L | 1460 | 26 | | 86.6 | 88 | 87.5 | 0.8 | 8.3 | 2.2 | 7.5 | 3.5 | 60 | 72 | 1LE1501-1AB6 | 46 | 0.014 |
| 5.5 | 6.3 | 112 M | 1460 | 36 | | 87.7 | 88.2 | 87.2 | 0.81 | 11.2 | 2.5 | 7.1 | 3.2 | 58 | 70 | 1LE1501-1BB6 | 58 | 0.017 |
| 11 | 12.6 | 132 M | 1465 | 72 | | 89.8 | 90.9 | 90.9 | 0.84 | 21 | 2.6 | 7.7 | 3.1 | 64 | 76 | 1LE1501-1CB6 | 80 | 0.046 |
| 18.5 | 21.3 | 160 L | 1475 | 120 | | 91.2 | 91.8 | 91.3 | 0.85 | 34.5 | 2.5 | 7.7 | 3.3 | 65 | 77 | 1LE1501-1DB6 | 116 | 0.099 |
| 30 | 34.5 | 180 L | 1465 | 196 | | 92.3 | 93 | 92.9 | 0.81 | 58 | 2.5 | 7.3 | 3.3 | 70 | 77 | 1LE1501-1EB6 | 185 | 0.159 |
| 37 | 42.5 | 200 L | 1470 | 240 | | 92.7 | 93.5 | 93.6 | 0.84 | 69 | 2.4 | 7 | 3 | 68 | 75 | 1LE1501-2AB6 | 240 | 0.246 |
| 55 | 63 | 225 M | 1475 | 356 | | 93.5 | 94.2 | 94.1 | 0.84 | 101 | 2.5 | 5.8 | 2.7 | 69 | 82 | 1LE1501-2BB6 | 320 | 0.47 |
| 75 | 86 | 250 M | 1480 | 484 | | 94 | 94.5 | 94.3 | 0.86 | 134 | 2.3 | 6.2 | 2.8 | 74 | 87 | 1LE1501-2CB6 | 440 | 0.85 |
| 110 | 127 | 280 M | 1485 | 707 | | 94.5 | 94.9 | 94.8 | 0.87 | 193 | 2.5 | 6.9 | 3 | 73 | 87 | 1LE1501-2DB6 | 680 | 1.7 |
| Voltages²⁾ | | | | | | | | | | | | | | Version | | Order code | | |
| 50 Hz 230 VΔ/400 VY | | | | 60 Hz ¹⁾ 460 VY | | | | Standard | | 2 2 | | - | | | | | | |
| 50 Hz 400 VΔ/690 VY | | | | 60 Hz ¹⁾ 460 VΔ | | | | Standard | | 3 4 | | - | | | | | | |
| 50 Hz 500 VY | | | | | | | | Without additional charge | | 2 7 | | - | | | | | | |
| 50 Hz 500 VΔ | | | | | | | | Without additional charge | | 4 0 | | - | | | | | | |
| For other voltages ¹⁾ and more information, see from page 2/96 | | | | | | | | | | | | | | 9 0 | | ... | | |
| Types of construction | | | | | | | | | | | | | | Version | | Order code | | |
| Without flange | | | | IM B3 ³⁾ | | | | Standard | | A | | - | | | | | | |
| With flange | | | | IM B5 ³⁾ | | | | With additional charge | | F | | - | | | | | | |
| With flange | | | | IM B14 ³⁾ | | | | With additional charge | | K | | - | | | | | | |
| For other types of construction and more information, see from page 2/103 | | | | | | | | | | | | | | | | ... | | |
| Motor protection | | | | | | | | | | | | | | Version | | Order code | | |
| Without | | | | | | | | Standard | | A | | - | | | | | | |
| PTC thermistor with 3 temperature sensors | | | | | | | | With additional charge | | B | | - | | | | | | |
| For other motor protection and more information, see from page 2/113 | | | | | | | | | | | | | | | | ... | | |
| Terminal box position | | | | | | | | | | | | | | Version | | Order code | | |
| Terminal box at top | | | | | | | | Standard | | 4 | | | | | | | | |
| For other terminal box positions and more information, see from page 2/116 | | | | | | | | | | | | | | | | | | |
| Special versions | | | | | | | | | | | | | | | | Order code(s) | | |
| For options, see from page 2/125 | | | | | | | | | | | | | | 1LE1501-...-Z | | ...+...+...+... | | |

2

¹⁾ Operating values at rated power for 60 Hz are stored in the Drive Technology Configurator (DT Configurator; see Appendix, "Tools and engineering").

²⁾ Parallel supply lines are required in the case of connection to ≤ 240 V. For frame size 315 with connection to ≤ 240 V, due to the high current, a drilled, removable entry plate (order code **R52**) or a larger terminal box (order code **R50**) can be used. Order codes **R52** and **R50** alter the motor dimensions.

³⁾ Types derived from IM B3 (IM B6/7/8, IM V6 and IM V5), from IM B5 (IM V3 and IM V1) and from IM B14 (IM V19 and IM V18) are possible, provided that no requirement exists for stamping of the type on the rating plate. The basic type IM B3, IM B5, or IM B14 is stamped as standard on the rating plate. If mounted in a different position, the position must be specified to ensure that the condensation drainage holes are positioned correctly.



IE2

SIMOTICS GP and SIMOTICS SD standard motors IE2 High Efficiency

Cast-iron series SIMOTICS SD 1LE1501 Basic Line with increased power – self-ventilated

Selection and ordering data

| Operating values at rated power | | | | | | | | | | | | | | | | | Cast-iron series | | |
|---|--|---------------|-----------------------------|----------------------------|------------------------------------|------------------------------|------------------------------|------------------------------|----------------------------------|---------------------------|-----------------------------------|-----------------------------------|--------------------------------|-----------------------------|----------------------------|-------------------------------------|-------------------|-------------------------|-----------------|
| P_{rated} 50 Hz/ P50 kW | P_{rated} 60 Hz/ P60 ¹⁾ kW | Frame size | n_{rated} 50 Hz rpm | T_{rated} 50 Hz Nm | Different IE class 60 Hz/P60 | η_{rated} 50 Hz % | η_{rated} 50 Hz % | η_{rated} 50 Hz % | $\cos\phi_{rated}$ 50 Hz % | I_{rated} 50 Hz A | $T_{LR}/$ T_{rated} 50 Hz | $I_{LR}/$ I_{rated} 50 Hz | $T_B/$ T_{rated} 50 Hz | L_{pfA} 50 Hz dB(A) | L_{WA} 50 Hz dB(A) | 1LE1501 – Basic Line Article No. | $m_{IM B3}$ kg | J kgm ² | |
| <ul style="list-style-type: none"> • Cooling: Self-ventilated (IC411) or with order code F90 forced-air cooled without external fan and fan cover (IC418) • Efficiency according to IEC 60034-30-1: IE2 High Efficiency, service factor (SF) 1.15 • Insulation: Thermal class 155 (temperature class F), IP55 degree of protection, utilization in accordance with thermal class 130 (temperature class B) | | | | | | | | | | | | | | | | | | | |
| 6-pole: 1000 rpm at 50 Hz, 1200 rpm at 60 Hz ¹⁾ | | | | | | | | | | | | | | | | | | | |
| 2.2 | 2.55 | 100 L | 965 | 22 | IE1 | 81.8 | 83.3 | 82.7 | 0.76 | 5.1 | 1.7 | 4.9 | 2.5 | 59 | 71 | 1LE1501-1AC6 | 49 | 0.014 | |
| 3 | 3.45 | 112 M | 965 | 30 | | 83.3 | 84 | 82.7 | 0.74 | 7 | 2.1 | 5.4 | 2.7 | 62 | 74 | 1LE1501-1BC6 | 53 | 0.017 | |
| 7.5 | 8.6 | 132 M | 970 | 74 | | 87.2 | 88.1 | 87.1 | 0.75 | 16.6 | 2 | 5.6 | 2.6 | 63 | 75 | 1LE1501-1CC6 | 83 | 0.046 | |
| 15 | 17.3 | 160 L | 975 | 147 | IE1 | 89.7 | 90.4 | 89.7 | 0.75 | 32 | 2 | 5.2 | 2.4 | 67 | 79 | 1LE1501-1DC6 | 147 | 0.12 | |
| 18.5 | 22 | 180 L | 975 | 181 | | 90.4 | 90.9 | 90.5 | 0.77 | 38.5 | 2.3 | 6 | 2.9 | 67 | 80 | 1LE1501-1EC6 | 165 | 0.206 | |
| 30 | 34.5 | 200 L | 975 | 294 | | 91.7 | 92.5 | 92.4 | 0.77 | 61 | 2.6 | 6.3 | 2.7 | 68 | 75 | 1LE1501-2AC6 | 240 | 0.381 | |
| 37 | 44.5 | 225 M | 978 | 361 | IE1 | 92.2 | 93 | 92.9 | 0.83 | 70 | 2.5 | 6.3 | 2.9 | 64 | 77 | 1LE1501-2BC6 | 325 | 0.67 | |
| 45 | 54 | 250 M | 985 | 436 | IE1 | 92.7 | 93.4 | 93.4 | 0.84 | 83 | 2.4 | 6.6 | 2.7 | 67 | 81 | 1LE1501-2CC6 | 410 | 1 | |
| 75 | 90 | 280 M | 986 | 726 | | 93.7 | 94.3 | 94.4 | 0.85 | 136 | 3.2 | 7 | 2.9 | 66 | 80 | 1LE1501-2DC6 | 570 | 1.8 | |
| 8-pole: 750 rpm at 50 Hz, 900 rpm at 60 Hz ¹⁾ | | | | | | | | | | | | | | | | | | | |
| 15 | 18 | 180 L | 720 | 199 | IE1 | 88 | 89.2 | 89 | 0.73 | 33.5 | 2.2 | 4.9 | 2.5 | 67 | 75 | 1LE1501-1ED6 | 190 | 0.263 | |
| 18.5 | 22 | 200 L | 720 | 245 | IE1 | 88.6 | 89.9 | 90.2 | 0.78 | 38.5 | 2.6 | 5.8 | 3 | 65 | 72 | 1LE1501-2AD6 | 250 | 0.416 | |
| 30 | 36 | 225 M | 732 | 391 | | 90.8 | 92 | 92.1 | 0.76 | 63 | 2.8 | 6.1 | 3.2 | 62 | 76 | 1LE1501-2BD6 | 325 | 0.67 | |
| 37 | 44.5 | 250 M | 730 | 484 | | 91.6 | 92.6 | 92.7 | 0.83 | 70 | 2.3 | 5.5 | 2.6 | 63 | 77 | 1LE1501-2CD6 | 405 | 1 | |
| 55 | 66 | 280 M | 736 | 714 | | 92.9 | 93.4 | 93 | 0.8 | 107 | 2.5 | 5.9 | 2.5 | 70 | 81 | 1LE1501-2DD6 | 550 | 1.6 | |
| Voltages²⁾ | | | | | | | | | | | | | | | | | Order code | | |
| 50 Hz 230 VΔ/400 VY | | | 60 Hz ¹⁾ 460 VY | | | Standard | | | | | | | | | | | 2 | 2 | – |
| 50 Hz 400 VΔ/690 VY | | | 60 Hz ¹⁾ 460 VΔ | | | Standard | | | | | | | | | | | 3 | 4 | – |
| 50 Hz 500 VY | | | | | | Without additional charge | | | | | | | | | | | 2 | 7 | – |
| 50 Hz 500 VΔ | | | | | | Without additional charge | | | | | | | | | | | 4 | 0 | – |
| For other voltages ¹⁾ and more information, see from page 2/96 | | | | | | | | | | | | | | | | | 9 | 0 | ... |
| Types of construction | | | | | | | | | | | | | | | | | Order code | | |
| Without flange | | | IM B3 ³⁾ | | | Standard | | | | | | | | | | | A | – | |
| With flange | | | IM B5 ³⁾ | | | With additional charge | | | | | | | | | | | F | – | |
| With flange | | | IM B14 ³⁾ | | | With additional charge | | | | | | | | | | | K | – | |
| For other types of construction and more information, see from page 2/103 | | | | | | | | | | | | | | | | | – | – | ... |
| Motor protection | | | | | | | | | | | | | | | | | Order code | | |
| Without | | | | | | Standard | | | | | | | | | | | A | – | |
| PTC thermistor with 1 or 3 temperature sensors | | | | | | With additional charge | | | | | | | | | | | B | – | |
| For other motor protection and more information, see from page 2/113 | | | | | | | | | | | | | | | | | – | – | ... |
| Terminal box position | | | | | | | | | | | | | | | | | Order code | | |
| Terminal box at top | | | | | | Standard | | | | | | | | | | | 4 | – | |
| For other terminal box positions and more information, see from page 2/116 | | | | | | | | | | | | | | | | | – | – | ... |
| Special versions | | | | | | | | | | | | | | | | | Order code(s) | | |
| For options, see from page 2/125 | | | | | | | | | | | | | | | | | 1LE1501-...-Z | | ...+...+...+... |

2

¹⁾ Operating values at rated power for 60 Hz are stored in the Drive Technology Configurator (DT Configurator; see Appendix, "Tools and engineering").

²⁾ Parallel supply lines are required in the case of connection to ≤ 240 V. For frame size 315 with connection to ≤ 240 V, due to the high current, a drilled, removable entry plate (order code **R52**) or a larger terminal box (order code **R50**) can be used. Order codes **R52** and **R50** alter the motor dimensions.

³⁾ Types derived from IM B3 (IM B6/7/8, IM V6 and IM V5), from IM B5 (IM V3 and IM V1) and from IM B14 (IM V19 and IM V18) are possible, provided that no requirement exists for stamping of the type on the rating plate. The basic type IM B3, IM B5, or IM B14 is stamped as standard on the rating plate. If mounted in a different position, the position must be specified to ensure that the condensation drainage holes are positioned correctly.

SIMOTICS GP and SIMOTICS SD standard motors

IE2 High Efficiency



Cast-iron series SIMOTICS SD 1LE1601 Performance Line with increased power – self-ventilated

Selection and ordering data

| Operating values at rated power | | | | | | | | | | | | | | Cast-iron series | | $m_{IM\ B3}$ | J | |
|---|----------------------|------------|---------------------|----------------------------|--------------------|------------------------|------------------------|---------------------------|----------------------------|---------------------|----------------------------|----------------------------|-------------------------|-------------------|------------------|-----------------|-----|--|
| $P_{rated, 50\ Hz/}$ | $P_{rated, 60\ Hz/}$ | Frame size | $n_{rated, 50\ Hz}$ | $T_{rated, 50\ Hz}$ | Different IE class | $\eta_{rated, 50\ Hz}$ | $\eta_{rated, 50\ Hz}$ | $\eta_{rated, 50\ Hz}$ | $\cos\phi_{rated, 50\ Hz}$ | $I_{rated, 50\ Hz}$ | $T_{LR}/I_{rated, 50\ Hz}$ | $I_{LR}/I_{rated, 50\ Hz}$ | $T_B/I_{rated, 50\ Hz}$ | $L_{pFA, 50\ Hz}$ | $L_{WA, 50\ Hz}$ | | | 1LE1601 – Performance Line Article No. |
| kW | kW | FS | rpm | Nm | 60 Hz/P60 | % | % | % | % | A | | | | dB(A) | dB(A) | | kg | kgm ² |
| • Cooling: Self-ventilated (IC411) or with order code F90 forced-air cooled without external fan and fan cover (IC418) • Efficiency according to IEC 60034-30-1: IE2 High Efficiency, service factor (SF) 1.15 • Insulation: Thermal class 155 (temperature class F), IP55 degree of protection, utilization in accordance with thermal class 130 (temperature class B) | | | | | | | | | | | | | | | | | | |
| 2-pole: 3000 rpm at 50 Hz, 3600 rpm at 60 Hz ¹⁾ | | | | | | | | | | | | | | | | | | |
| 4 | 4.55 | 100 L | 2905 | 13 | | 85.8 | 86.9 | 86.5 | 0.86 | 7.8 | 2.5 | 7.6 | 3.5 | 67 | 79 | 1LE1601-1AA6 | 45 | 0.0054 |
| 5.5 | 6.3 | 112 M | 2945 | 18 | | 87 | 87.8 | 87.4 | 0.88 | 10.4 | 2.3 | 8.5 | 3.8 | 69 | 81 | 1LE1601-1BA6 | 53 | 0.012 |
| 11 | 12.6 | 132 M | 2950 | 36 | | 89.4 | 90.1 | 89.9 | 0.89 | 20 | 2.3 | 7.9 | 3.2 | 68 | 80 | 1LE1601-1CA6 | 80 | 0.031 |
| 22 | 25.3 | 160 L | 2955 | 71 | | 91.3 | 91.8 | 91.4 | 0.89 | 39 | 3.1 | 8.4 | 3.7 | 70 | 82 | 1LE1601-1DA6 | 126 | 0.068 |
| 30 | 33.5 | 180 L | 2940 | 97 | | 92 | 92.6 | 92.3 | 0.89 | 53 | 2.3 | 7.8 | 3.4 | 76 | 83 | 1LE1601-1EA6 | 180 | 0.094 |
| 45 | 51 | 200 L | 2950 | 146 | | 92.9 | 93.2 | 92.9 | 0.87 | 81 | 2.5 | 7.1 | 3.2 | 77 | 84 | 1LE1601-2AA6 | 245 | 0.176 |
| 55 | 62 | 225 M | 2960 | 177 | | 93.2 | 93.6 | 93.2 | 0.88 | 97 | 2.5 | 7 | 3.3 | 76 | 89 | 1LE1601-2BA6 | 320 | 0.26 |
| 75 | 84 | 250 M | 2970 | 241 | | 93.8 | 93.6 | 92.6 | 0.84 | 137 | 2.2 | 7 | 3.3 | 75 | 89 | 1LE1601-2CA6 | 390 | 0.46 |
| 110 | 123 | 280 M | 2978 | 353 | | 94.3 | 94.5 | 94.1 | 0.9 | 187 | 2.9 | 8.5 | 3.6 | 80 | 91 | 1LE1601-2DA6 | 650 | 1.2 |
| 4-pole: 1500 rpm at 50 Hz, 1800 rpm at 60 Hz ¹⁾ | | | | | | | | | | | | | | | | | | |
| 4 | 4.55 | 100 L | 1460 | 26 | | 86.6 | 88 | 87.5 | 0.8 | 8.3 | 2.2 | 7.5 | 3.5 | 60 | 72 | 1LE1601-1AB6 | 46 | 0.014 |
| 5.5 | 6.3 | 112 M | 1460 | 36 | | 87.7 | 88.2 | 87.2 | 0.81 | 11.2 | 2.5 | 7.1 | 3.2 | 58 | 70 | 1LE1601-1BB6 | 58 | 0.017 |
| 11 | 12.6 | 132 M | 1465 | 72 | | 89.8 | 90.9 | 90.9 | 0.84 | 21 | 2.6 | 7.7 | 3.1 | 64 | 76 | 1LE1601-1CB6 | 80 | 0.046 |
| 18.5 | 21.3 | 160 L | 1475 | 120 | | 91.2 | 91.8 | 91.3 | 0.85 | 34.5 | 2.5 | 7.7 | 3.3 | 65 | 77 | 1LE1601-1DB6 | 116 | 0.099 |
| 30 | 34.5 | 180 L | 1465 | 196 | | 92.3 | 93 | 92.9 | 0.81 | 58 | 2.5 | 7.3 | 3.3 | 70 | 77 | 1LE1601-1EB6 | 185 | 0.159 |
| 37 | 42.5 | 200 L | 1470 | 240 | | 92.7 | 93.5 | 93.6 | 0.84 | 69 | 2.4 | 7 | 3 | 68 | 75 | 1LE1601-2AB6 | 240 | 0.246 |
| 55 | 63 | 225 M | 1475 | 356 | | 93.5 | 94.2 | 94.1 | 0.84 | 101 | 2.5 | 5.8 | 2.7 | 69 | 82 | 1LE1601-2BB6 | 320 | 0.47 |
| 75 | 86 | 250 M | 1480 | 484 | | 94 | 94.5 | 94.3 | 0.86 | 134 | 2.3 | 6.2 | 2.8 | 74 | 87 | 1LE1601-2CB6 | 440 | 0.85 |
| 110 | 127 | 280 M | 1485 | 707 | | 94.5 | 94.9 | 94.8 | 0.87 | 193 | 2.5 | 6.9 | 3 | 73 | 87 | 1LE1601-2DB6 | 680 | 1.7 |
| Voltages ²⁾ | | | | | | | | | | | | | | Version | | Order code | | |
| 50 Hz 230 VΔ/400 VY | | | | 60 Hz ¹⁾ 460 VY | | | | Standard | | 2 2 | | - | | | | | | |
| 50 Hz 400 VΔ/690 VY | | | | 60 Hz ¹⁾ 460 VΔ | | | | Standard | | 3 4 | | - | | | | | | |
| 50 Hz 500 VY | | | | | | | | Without additional charge | | 2 7 | | - | | | | | | |
| 50 Hz 500 VΔ | | | | | | | | Without additional charge | | 4 0 | | - | | | | | | |
| For other voltages ¹⁾ and more information, see from page 2/96 | | | | | | | | | | | | | | 9 0 | | ... | | |
| Types of construction | | | | | | | | | | | | | | Version | | Order code | | |
| Without flange | | | | IM B3 ³⁾ | | | | Standard | | A | | - | | | | | | |
| With flange | | | | IM B5 ³⁾ | | | | With additional charge | | F | | - | | | | | | |
| With flange | | | | IM B14 ³⁾ | | | | With additional charge | | K | | - | | | | | | |
| For other types of construction and more information, see from page 2/103 | | | | | | | | | | | | | | B | | ... | | |
| Motor protection | | | | | | | | | | | | | | Version | | Order code | | |
| PTC thermistor with 3 temperature sensors | | | | | | | | Standard | | B | | - | | | | | | |
| For other motor protection and more information, see from page 2/113 | | | | | | | | | | | | | | | | ... | | |
| Terminal box position | | | | | | | | | | | | | | Version | | Order code | | |
| Terminal box at top | | | | | | | | Standard | | 4 | | | | | | | | |
| For other terminal box positions and more information, see from page 2/116 | | | | | | | | | | | | | | | | | | |
| Special versions | | | | | | | | | | | | | | | | Order code(s) | | |
| For options, see from page 2/125 | | | | | | | | | | | | | | 1LE1601-...-Z | | ...+...+...+... | | |

¹⁾ Operating values at rated power for 60 Hz are stored in the Drive Technology Configurator (DT Configurator; see Appendix, "Tools and engineering").

²⁾ Parallel supply lines are required in the case of connection to ≤ 240 V. For frame size 315 with connection to ≤ 240 V, due to the high current, a drilled, removable entry plate (order code **R52**) or a larger terminal box (order code **R50**) can be used. Order codes **R52** and **R50** alter the motor dimensions.

³⁾ Types derived from IM B3 (IM B6/7/8, IM V6 and IM V5), from IM B5 (IM V3 and IM V1) and from IM B14 (IM V19 and IM V18) are possible, provided that no requirement exists for stamping of the type on the rating plate. The basic type IM B3, IM B5, or IM B14 is stamped as standard on the rating plate. If mounted in a different position, the position must be specified to ensure that the condensation drainage holes are positioned correctly.



IE2

SIMOTICS GP and SIMOTICS SD standard motors IE2 High Efficiency

Cast-iron series SIMOTICS SD 1LE1601 Performance Line with increased power – self-ventilated

Selection and ordering data

| Operating values at rated power | | | | | | | | | | | | | | | | | Cast-iron series | | |
|---|--|---------------|-----------------------------|----------------------------|------------------------------------|------------------------------|------------------------------|------------------------------|----------------------------------|---------------------------|----------------------------|----------------------------|-------------------------|-----------------------------|----------------------------|--|-------------------|-------------------------|-----------------|
| P_{rated} 50 Hz/ P50 kW | P_{rated} 60 Hz/ P60 ¹⁾ kW | Frame size | n_{rated} 50 Hz rpm | T_{rated} 50 Hz Nm | Different IE class 60 Hz/P60 | η_{rated} 50 Hz % | η_{rated} 50 Hz % | η_{rated} 50 Hz % | $\cos\phi_{rated}$ 50 Hz % | I_{rated} 400 V A | T_{LR} 50 Hz dB(A) | I_{LR} 50 Hz dB(A) | T_B 50 Hz dB(A) | L_{pFA} 50 Hz dB(A) | L_{WA} 50 Hz dB(A) | 1LE1601 – Performance Line Article No. | $m_{IM B3}$ kg | J kgm ² | |
| <ul style="list-style-type: none"> • Cooling: Self-ventilated (IC411) or with order code F90 forced-air cooled without external fan and fan cover (IC418) • Efficiency according to IEC 60034-30-1: IE2 High Efficiency, service factor (SF) 1.15 • Insulation: Thermal class 155 (temperature class F), IP55 degree of protection, utilization in accordance with thermal class 130 (temperature class B) | | | | | | | | | | | | | | | | | | | |
| 6-pole: 1000 rpm at 50 Hz, 1200 rpm at 60 Hz ¹⁾ | | | | | | | | | | | | | | | | | | | |
| 2.2 | 2.55 | 100 L | 965 | 22 | IE1 | 81.8 | 83.3 | 82.7 | 0.76 | 5.1 | 1.7 | 4.9 | 2.5 | 59 | 71 | 1LE1601-1AC6 | 49 | 0.014 | |
| 3 | 3.45 | 112 M | 965 | 30 | | 83.3 | 84 | 82.7 | 0.74 | 7 | 2.1 | 5.4 | 2.7 | 62 | 74 | 1LE1601-1BC6 | 53 | 0.017 | |
| 7.5 | 8.6 | 132 M | 970 | 74 | | 87.2 | 88.1 | 87.1 | 0.75 | 16.6 | 2 | 5.6 | 2.6 | 63 | 75 | 1LE1601-1CC6 | 83 | 0.046 | |
| 15 | 17.3 | 160 L | 975 | 147 | IE1 | 89.7 | 90.4 | 89.7 | 0.75 | 32 | 2 | 5.2 | 2.4 | 67 | 79 | 1LE1601-1DC6 | 147 | 0.12 | |
| 18.5 | 22 | 180 L | 975 | 181 | | 90.4 | 90.9 | 90.5 | 0.77 | 38.5 | 2.3 | 6 | 2.9 | 67 | 80 | 1LE1601-1EC6 | 165 | 0.206 | |
| 30 | 34.5 | 200 L | 975 | 294 | | 91.7 | 92.5 | 92.4 | 0.77 | 61 | 2.6 | 6.3 | 2.7 | 68 | 75 | 1LE1601-2AC6 | 240 | 0.381 | |
| 37 | 44.5 | 225 M | 978 | 361 | IE1 | 92.2 | 93 | 92.9 | 0.83 | 70 | 2.5 | 6.3 | 2.9 | 64 | 77 | 1LE1601-2BC6 | 325 | 0.67 | |
| 45 | 54 | 250 M | 985 | 436 | IE1 | 92.7 | 93.4 | 93.4 | 0.84 | 83 | 2.4 | 6.6 | 2.7 | 67 | 81 | 1LE1601-2CC6 | 410 | 1 | |
| 75 | 90 | 280 M | 986 | 726 | | 93.7 | 94.3 | 94.4 | 0.85 | 136 | 3.2 | 7 | 2.9 | 66 | 80 | 1LE1601-2DC6 | 570 | 1.8 | |
| 8-pole: 750 rpm at 50 Hz, 900 rpm at 60 Hz ¹⁾ | | | | | | | | | | | | | | | | | | | |
| 15 | 18 | 180 L | 720 | 199 | IE1 | 88 | 89.2 | 89 | 0.73 | 33.5 | 2.2 | 4.9 | 2.5 | 67 | 75 | 1LE1601-1ED6 | 190 | 0.263 | |
| 18.5 | 22 | 200 L | 720 | 245 | IE1 | 88.6 | 89.9 | 90.2 | 0.78 | 38.5 | 2.6 | 5.8 | 3 | 65 | 72 | 1LE1601-2AD6 | 250 | 0.416 | |
| 30 | 36 | 225 M | 732 | 391 | | 90.8 | 92 | 92.1 | 0.76 | 63 | 2.8 | 6.1 | 3.2 | 62 | 76 | 1LE1601-2BD6 | 325 | 0.67 | |
| 37 | 44.5 | 250 M | 730 | 484 | | 91.6 | 92.6 | 92.7 | 0.83 | 70 | 2.3 | 5.5 | 2.6 | 63 | 77 | 1LE1601-2CD6 | 405 | 1 | |
| 55 | 66 | 280 M | 736 | 714 | | 92.9 | 93.4 | 93 | 0.8 | 107 | 2.5 | 5.9 | 2.5 | 70 | 81 | 1LE1601-2DD6 | 550 | 1.6 | |
| Voltages²⁾ | | | | | | | | | | | | | | | | | Order code | | |
| 50 Hz 230 VΔ/400 VY | | | 60 Hz ¹⁾ 460 VY | | | Standard | | | | | | | | | | | 2 | 2 | – |
| 50 Hz 400 VΔ/690 VY | | | 60 Hz ¹⁾ 460 VΔ | | | Standard | | | | | | | | | | | 3 | 4 | – |
| 50 Hz 500 VY | | | | | | Without additional charge | | | | | | | | | | | 2 | 7 | – |
| 50 Hz 500 VΔ | | | | | | Without additional charge | | | | | | | | | | | 4 | 0 | – |
| For other voltages ¹⁾ and more information, see from page 2/96 | | | | | | | | | | | | | | | | | 9 | 0 | ... |
| Types of construction | | | | | | | | | | | | | | | | | Order code | | |
| Without flange | | | IM B3 ³⁾ | | | Standard | | | | | | | | | | | A | – | |
| With flange | | | IM B5 ³⁾ | | | With additional charge | | | | | | | | | | | F | – | |
| With flange | | | IM B14 ³⁾ | | | With additional charge | | | | | | | | | | | K | – | |
| For other types of construction and more information, see from page 2/103 | | | | | | | | | | | | | | | | | – | – | ... |
| Motor protection | | | | | | | | | | | | | | | | | Order code | | |
| PTC thermistor with 1 or 3 temperature sensors | | | | | | Standard | | | | | | | | | | | B | – | |
| For other motor protection and more information, see from page 2/113 | | | | | | | | | | | | | | | | | – | – | ... |
| Terminal box position | | | | | | | | | | | | | | | | | Order code | | |
| Terminal box at top | | | | | | Standard | | | | | | | | | | | 4 | – | |
| For other terminal box positions and more information, see from page 2/116 | | | | | | | | | | | | | | | | | – | – | ... |
| Special versions | | | | | | | | | | | | | | | | | Order code(s) | | |
| For options, see from page 2/125 | | | | | | | | | | | | | | | | | 1LE1601-...-Z | | ...+...+...+... |

2

¹⁾ Operating values at rated power for 60 Hz are stored in the Drive Technology Configurator (DT Configurator; see Appendix, "Tools and engineering").

²⁾ Parallel supply lines are required in the case of connection to ≤ 240 V. For frame size 315 with connection to ≤ 240 V, due to the high current, a drilled, removable entry plate (order code **R52**) or a larger terminal box (order code **R50**) can be used. Order codes **R52** and **R50** alter the motor dimensions.

³⁾ Types derived from IM B3 (IM B6/7/8, IM V6 and IM V5), from IM B5 (IM V3 and IM V1) and from IM B14 (IM V19 and IM V18) are possible, provided that no requirement exists for stamping of the type on the rating plate. The basic type IM B3, IM B5, or IM B14 is stamped as standard on the rating plate. If mounted in a different position, the position must be specified to ensure that the condensation drainage holes are positioned correctly.



SIMOTICS GP and SIMOTICS SD standard motors

IE1 Standard Efficiency

Aluminum series SIMOTICS GP 1LE1002 – self-ventilated or forced-air cooled

Selection and ordering data

| Operating values at rated power | | | | | | | | | | | | | | | | Aluminum series | | | |
|--|--|---------------|------------------------|------------------------|-----------------------------------|-----------------------------------|-----------------------------------|---------------------------------------|----------------------------------|-------------------------------------|-------------------------------------|----------------------------------|---------------------|---------------------|--------------|------------------|---------|--|--|
| P_{rated} , 50 Hz/ P50 | P_{rated} , 60 Hz/ P60 ¹⁾ | Frame size | n_{rated} , 50 Hz | T_{rated} , 50 Hz | η_{rated} , 50 Hz, 4/4 | η_{rated} , 50 Hz, 3/4 | η_{rated} , 50 Hz, 2/4 | $\cos\phi_{rated}$, 50 Hz, 4/4 | I_{rated} , 50 Hz, 400 V | $T_{LR}/$ T_{rated} , 50 Hz | $I_{LR}/$ I_{rated} , 50 Hz | $T_B/$ T_{rated} , 50 Hz | L_{pA} , 50 Hz | L_{WA} , 50 Hz | Article No. | $m_{IM B3}$ | J | | |
| kW | kW | FS | rpm | Nm | % | % | % | A | | | | | | | kg | kgm ² | | | |
| 2-pole: 3000 rpm at 50 Hz, 3600 rpm at 60 Hz ¹⁾ | | | | | | | | | | | | | | | | | | | |
| 0.18 | 0.21 | 63 M | 2805 | 0.61 | 52.8 | 50.1 | 44.2 | 0.79 | 1.08 | 1.7 | 3.4 | 2.2 | 55 | 62 | 1LE1002-0BA2 | 4 | 0.00018 | | |
| 0.25 | 0.29 | 63 M | 2835 | 0.84 | 58.2 | 55.5 | 48.6 | 0.75 | 1.44 | 1.9 | 3.6 | 2.6 | 56 | 63 | 1LE1002-0BA3 | 4 | 0.00022 | | |
| 0.37 | 0.43 | 71 M | 2755 | 1.3 | 63.9 | 64.5 | 61.1 | 0.79 | 1.06 | 2.2 | 3.4 | 2.2 | 62 | 73 | 1LE1002-0CA2 | 5 | 0.00029 | | |
| 0.55 | 0.63 | 71 M | 2750 | 1.9 | 69.0 | 69.9 | 66.5 | 0.79 | 1.46 | 2.2 | 3.7 | 2.2 | 62 | 73 | 1LE1002-0CA3 | 6 | 0.00041 | | |
| 0.75 | 0.86 | 80 M | 2835 | 2.5 | 72.1 | 72.6 | 69.9 | 0.86 | 1.75 | 2.1 | 5.2 | 2.3 | 64 | 71 | 1LE1002-0DA2 | 9 | 0.00079 | | |
| 1.1 | 1.27 | 80 M | 2840 | 3.7 | 75.0 | 75.7 | 73.4 | 0.86 | 2.45 | 2.5 | 5.7 | 2.5 | 64 | 71 | 1LE1002-0DA3 | 12 | 0.0010 | | |
| 1.5 | 1.75 | 90 S | 2835 | 5.1 | 77.2 | 78.2 | 76.8 | 0.85 | 3.3 | 2.6 | 5.5 | 2.9 | 71 | 78 | 1LE1002-0EA0 | 13 | 0.0014 | | |
| 2.2 | 2.55 | 90 L | 2855 | 7.4 | 79.7 | 80.9 | 81.3 | 0.85 | 4.7 | 2.8 | 6.5 | 3.2 | 71 | 78 | 1LE1002-0EA4 | 14 | 0.0018 | | |
| 3 | 3.45 | 100 L | 2835 | 10 | 81.5 | 83.2 | 82.8 | 0.87 | 6.1 | 3.2 | 6.4 | 3.5 | 67 | 79 | 1LE1002-1AA4 | 20 | 0.0034 | | |
| 4 | 4.55 | 112 M | 2935 | 13 | 83.1 | 83.0 | 80.8 | 0.85 | 8.2 | 3.3 | 8.3 | 4.2 | 69 | 81 | 1LE1002-1BA2 | 25 | 0.0067 | | |
| 5.5 | 6.3 | 132 S | 2910 | 18 | 84.7 | 85.9 | 85.7 | 0.88 | 10.7 | 1.8 | 5.7 | 2.6 | 68 | 80 | 1LE1002-1CA0 | 35 | 0.013 | | |
| 7.5 | 8.6 | 132 S | 2925 | 24 | 86.0 | 86.7 | 86.1 | 0.88 | 14.3 | 2.2 | 6.8 | 3.1 | 68 | 80 | 1LE1002-1CA1 | 40 | 0.016 | | |
| 11 | 12.6 | 160 M | 2925 | 36 | 87.6 | 88.0 | 87.1 | 0.86 | 21.0 | 2.0 | 5.7 | 2.7 | 70 | 82 | 1LE1002-1DA2 | 60 | 0.030 | | |
| 15 | 17.3 | 160 M | 2935 | 49 | 88.7 | 88.9 | 87.7 | 0.85 | 28.5 | 2.4 | 6.8 | 3.2 | 70 | 82 | 1LE1002-1DA3 | 68 | 0.036 | | |
| 18.5 | 21.3 | 160 L | 2935 | 60 | 89.3 | 89.7 | 89.3 | 0.87 | 34.5 | 2.7 | 7.6 | 3.4 | 70 | 82 | 1LE1002-1DA4 | 78 | 0.044 | | |
| 22 | 24.5 | 180 M | 2945 | 71 | 89.9 | 90.6 | 90.4 | 0.87 | 40.5 | 2.5 | 7.7 | 3.5 | 72 | 85 | 1LE1002-1EA2 | 112 | 0.069 | | |
| 30 | 33.5 | 200 L | 2960 | 97 | 90.7 | 90.9 | 90.2 | 0.79 | 60 | 2.5 | 7.3 | 3.6 | 72 | 85 | 1LE1002-2AA4 | 149 | 0.124 | | |
| 37 | 41.5 | 200 L | 2955 | 120 | 91.2 | 91.6 | 91.2 | 0.88 | 67 | 2.7 | 8.2 | 3.5 | 72 | 85 | 1LE1002-2AA5 | 169 | 0.15 | | |

| Voltages | | Version | Order code |
|---|----------------------------|---------------------------|------------|
| 50 Hz 230 VΔ/400 VY | 60 Hz ¹⁾ 460 VY | Standard | 2 2 |
| 50 Hz 400 VΔ/690 VY | 60 Hz ¹⁾ 460 VΔ | Standard | 3 4 |
| 50 Hz 500 VY | | Without additional charge | 2 7 |
| 50 Hz 500 VΔ | | Without additional charge | 4 0 |
| For other voltages ¹⁾ and more information, see from page 2/93 | | | 9 0 |

| Types of construction | | Version | Order code |
|--|----------------------|------------------------|------------|
| Without flange | IM B3 ²⁾ | Standard | A |
| With flange | IM B5 ²⁾ | With additional charge | F |
| With flange | IM B14 ²⁾ | With additional charge | K |
| For other types of construction and more information, see from page 2/99 | | | ... |

| Motor protection | | Version | Order code |
|---|--|------------------------|------------|
| Without | | Standard | A |
| PTC thermistor with 1 or 3 temperature sensors (frame sizes 63 to 90 or 100 to 200) | | With additional charge | B |
| For other motor protection and more information, see from page 2/112 | | | ... |

| Terminal box position | | Version | Order code |
|--|--|----------|------------|
| Terminal box at top | | Standard | 4 |
| For other terminal box positions and more information, see from page 2/115 | | | ... |

| Special versions | | Order code(s) |
|---|--|-------------------------------|
| Forced-air cooled motors w/o ext. fan/fan cover (IC418) | | 1LE1002-...-Z F90+...+...+... |
| For options, see from page 2/118 | | 1LE1002-...-Z ...+...+...+... |

2

¹⁾ Operating values at rated power for 60 Hz are stored in the Drive Technology Configurator (DT Configurator; see Appendix, "Tools and engineering").

²⁾ Types derived from IM B3 (IM B6/7/8, IM V6, and IM V5), from IM B5 (IM V3 and IM V1) and from IM B14 (IM V19 and IM V18) are possible, provided that no requirements exist for condensation drainage holes (H03) or stamping of the type on the rating plate. The basic type IM B3, IM B5, or IM B14 is stamped as standard on the rating plate. For orders with condensation drainage holes (H03), the type must be specified.



IE1

SIMOTICS GP and SIMOTICS SD standard motors
IE1 Standard Efficiency

Aluminum series SIMOTICS GP 1LE1002 – self-ventilated or forced-air cooled

Selection and ordering data

| P _{rated} 50 Hz/ P50 kW | P _{rated} 60 Hz/ P60 ¹⁾ kW | Frame size FS | Operating values at rated power | | | | | | | | | | | | | Aluminum series 1LE1002 | | m _{IM B3} kg | J kgm ² |
|--|---|---------------------|------------------------------------|-----------------------------------|----------------------------------|----------------------------------|----------------------------------|----------------------------------|-------------------------------------|----------------------------------|---|---|--|------------------------------------|-----------------------------------|----------------------------|--------------------|--------------------------|-----------------------|
| | | | n _{rated} 50 Hz rpm | T _{rated} 50 Hz Nm | η _{rated} 50 Hz % | η _{rated} 50 Hz % | η _{rated} 50 Hz % | η _{rated} 50 Hz % | cosφ _{rated} 50 Hz % | I _{rated} 50 Hz A | T _{LR} /I _{rated} 50 Hz % | I _{LR} /I _{rated} 50 Hz % | T _B /I _{rated} 50 Hz % | L _{pfA} 50 Hz dB(A) | L _{WA} 50 Hz dB(A) | Article No. | | | |
| • Cooling: Self-ventilated (IC411) or with order code F90 forced-air cooled without external fan and fan cover (IC418) • Efficiency according to IEC 60034-30-1: IE1 Standard Efficiency, service factor (SF) 1.1 • Insulation: Thermal class 155 (temperature class F), IP55 degree of protection, utilization in accordance with thermal class 130 (temperature class B) | | | | | | | | | | | | | | | | | | | |
| 4-pole: 1500 rpm at 50 Hz, 1800 rpm at 60 Hz ¹⁾ | | | | | | | | | | | | | | | | | | | |
| 0.12 | 0.14 | 63 M | 1360 | 0.84 | 50.0 | 47.3 | 39.1 | 0.71 | 0.85 | 1.6 | 2.5 | 1.8 | 48 | 55 | 1LE1002-0BB2 | 4 | 0.00029 | | |
| 0.18 | 0.21 | 63 M | 1360 | 1.3 | 57.0 | 55.1 | 47.8 | 0.71 | 1.12 | 1.9 | 2.8 | 2.1 | 55 | 62 | 1LE1002-0BB3 | 4 | 0.00037 | | |
| 0.25 | 0.29 | 71 M | 1365 | 1.8 | 61.5 | 61.4 | 56.1 | 0.73 | 0.80 | 1.8 | 3.0 | 2.0 | 54 | 65 | 1LE1002-0CB2 | 5 | 0.00052 | | |
| 0.37 | 0.43 | 71 M | 1350 | 2.7 | 66.0 | 67.7 | 65.0 | 0.75 | 1.08 | 2.0 | 3.2 | 2.0 | 54 | 65 | 1LE1002-0CB3 | 6 | 0.00077 | | |
| 0.55 | 0.63 | 80 M | 1385 | 3.8 | 70.0 | 70.7 | 67.7 | 0.79 | 1.44 | 2.1 | 3.7 | 2.2 | 59 | 66 | 1LE1002-0DB2 | 9 | 0.0014 | | |
| 0.75 | 0.86 | 80 M | 1385 | 5.2 | 72.1 | 72.0 | 67.0 | 0.76 | 1.85 | 2.1 | 3.6 | 2.3 | 59 | 66 | 1LE1002-0DB3 | 11 | 0.0017 | | |
| 1.1 | 1.27 | 90 S | 1405 | 7.5 | 75.0 | 75.9 | 73.6 | 0.81 | 2.5 | 2.1 | 4.5 | 2.3 | 61 | 68 | 1LE1002-0EB0 | 12 | 0.0024 | | |
| 1.5 | 1.75 | 90 L | 1410 | 10 | 77.2 | 77.8 | 75.1 | 0.80 | 3.35 | 2.4 | 4.7 | 2.6 | 61 | 68 | 1LE1002-0EB4 | 15 | 0.0033 | | |
| 2.2 | 2.55 | 100 L | 1425 | 15 | 79.7 | 80.5 | 78.5 | 0.81 | 4.9 | 2.2 | 5.1 | 2.3 | 60 | 72 | 1LE1002-1AB4 | 18 | 0.0059 | | |
| 3 | 3.45 | 100 L | 1425 | 20 | 81.5 | 83.0 | 82.3 | 0.85 | 6.3 | 2.4 | 5.4 | 2.6 | 60 | 72 | 1LE1002-1AB5 | 22 | 0.0078 | | |
| 4 | 4.55 | 112 M | 1435 | 27 | 83.1 | 84.3 | 83.7 | 0.83 | 8.4 | 2.5 | 6.1 | 2.9 | 58 | 70 | 1LE1002-1BB2 | 27 | 0.010 | | |
| 5.5 | 6.3 | 132 S | 1450 | 36 | 84.7 | 85.7 | 84.9 | 0.82 | 11.2 | 2.3 | 5.7 | 2.7 | 64 | 76 | 1LE1002-1CB0 | 38 | 0.019 | | |
| 7.5 | 8.6 | 132 M | 1450 | 49 | 86.0 | 86.9 | 86.3 | 0.82 | 15.2 | 2.6 | 6.6 | 3.1 | 64 | 76 | 1LE1002-1CB2 | 44 | 0.024 | | |
| 11 | 12.6 | 160 M | 1460 | 72 | 87.6 | 87.9 | 86.7 | 0.81 | 22.5 | 2.7 | 6.9 | 3.3 | 65 | 77 | 1LE1002-1DB2 | 62 | 0.044 | | |
| 15 | 17.3 | 160 L | 1460 | 98 | 88.7 | 89.1 | 88.0 | 0.82 | 30.0 | 3.0 | 7.5 | 3.6 | 65 | 77 | 1LE1002-1DB4 | 73 | 0.056 | | |
| 18.5 | 21.3 | 180 M | 1468 | 120 | 89.3 | 90.2 | 90.2 | 0.85 | 35 | 2.2 | 7.3 | 3.1 | 63 | 76 | 1LE1002-1EB2 | 131 | 0.13 | | |
| 22 | 25.3 | 180 L | 1465 | 143 | 89.9 | 90.8 | 90.7 | 0.83 | 42.5 | 2.7 | 8 | 3.6 | 63 | 76 | 1LE1002-1EB4 | 132 | 0.13 | | |
| 30 | 34.5 | 200 L | 1472 | 195 | 90.7 | 91.5 | 91.4 | 0.83 | 58 | 2.3 | 6.9 | 3.1 | 64 | 78 | 1LE1002-2AB5 | 169 | 0.2 | | |
| Voltages | | | | | | | | | | | | | | | Version | | Order code | | |
| 50 Hz 230 VΔ/400 VY | | | 60 Hz ¹⁾ 460 VY | | | Standard | | 2 2 | | - | | | | | | | | | |
| 50 Hz 400 VΔ/690 VY | | | 60 Hz ¹⁾ 460 VA | | | Standard | | 3 4 | | - | | | | | | | | | |
| 50 Hz 500 VY | | | | | | Without additional charge | | 2 7 | | - | | | | | | | | | |
| 50 Hz 500 VA | | | | | | Without additional charge | | 4 0 | | - | | | | | | | | | |
| For other voltages ¹⁾ and more information, see from page 2/93 | | | | | | | | | | | | | | | | | | | |
| Types of construction | | | | | | | | | | | | | | | Version | | Order code | | |
| Without flange | | | IM B3 ²⁾ | | | Standard | | A | | - | | | | | | | | | |
| With flange | | | IM B5 ²⁾ | | | With additional charge | | F | | - | | | | | | | | | |
| With flange | | | IM B14 ²⁾ | | | With additional charge | | K | | - | | | | | | | | | |
| For other types of construction and more information, see from page 2/99 | | | | | | | | | | | | | | | | | | | |
| Motor protection | | | | | | | | | | | | | | | Version | | Order code | | |
| Without | | | | | | Standard | | A | | - | | | | | | | | | |
| PTC thermistor with 1 or 3 temperature sensors (frame sizes 63 to 90 or 100 to 200) | | | | | | With additional charge | | B | | - | | | | | | | | | |
| For other motor protection and more information, see from page 2/112 | | | | | | | | | | | | | | | | | | | |
| Terminal box position | | | | | | | | | | | | | | | Version | | Order code | | |
| Terminal box at top | | | | | | Standard | | 4 | | | | | | | | | | | |
| For other terminal box positions and more information, see from page 2/115 | | | | | | | | | | | | | | | | | | | |
| Special versions | | | | | | | | | | | | | | | | | Order code(s) | | |
| Forced-air cooled motors w/o ext. fan/fan cover (IC418) | | | | | | | | | | | | | | | 1LE1002-.... | | -Z F90+...+...+... | | |
| For options, see from page 2/118 | | | | | | | | | | | | | | | 1LE1002-.... | | -Z ...+...+...+... | | |

2

¹⁾ Operating values at rated power for 60 Hz are stored in the Drive Technology Configurator (DT Configurator; see Appendix, "Tools and engineering").

²⁾ Types derived from IM B3 (IM B6/7/8, IM V6, and IM V5), from IM B5 (IM V3 and IM V1) and from IM B14 (IM V19 and IM V18) are possible, provided that no requirements exist for condensation drainage holes (H03) or stamping of the type on the rating plate. The basic type IM B3, IM B5, or IM B14 is stamped as standard on the rating plate. For orders with condensation drainage holes (H03), the type must be specified.



SIMOTICS GP and SIMOTICS SD standard motors

IE1 Standard Efficiency

Aluminum series SIMOTICS GP 1LE1002 – self-ventilated or forced-air cooled

Selection and ordering data

| Operating values at rated power | | | | | | | | | | | | | | Aluminum series | | m _{IM B3} | J | | |
|--|---|---------------|-----------------------------|-----------------------------|-----------------------------|-----------------------------|-----------------------------|-----------------------------|--------------------------------|-----------------------------|---|---|---|---------------------------|--------------------------|---------------------|---|---------|-------------|
| P _{rated} 50 Hz/ P50 | P _{rated} 60 Hz/ P60 ¹⁾ | Frame size | n _{rated} 50 Hz | T _{rated} 50 Hz | η _{rated} 50 Hz | η _{rated} 50 Hz | η _{rated} 50 Hz | η _{rated} 50 Hz | cosφ _{rated} 50 Hz | I _{rated} 50 Hz | T _{L,R} / T _{rated} 50 Hz | I _{L,R} / I _{rated} 50 Hz | T _B / T _{rated} 50 Hz | L _{ptA} 50 Hz | L _{WA} 50 Hz | | | 1LE1002 | Article No. |
| kW | kW | FS | rpm | Nm | % | % | % | % | A | A | | | | | | | | | |
| • Cooling: Self-ventilated (IC411) or with order code F90 forced-air cooled without external fan and fan cover (IC418) • Efficiency according to IEC 60034-30-1: IE1 Standard Efficiency, service factor (SF) 1.1 • Insulation: Thermal class 155 (temperature class F), IP55 degree of protection, utilization in accordance with thermal class 130 (temperature class B) | | | | | | | | | | | | | | | | | | | |
| 6-pole: 1000 rpm at 50 Hz, 1200 rpm at 60 Hz ¹⁾ | | | | | | | | | | | | | | | | | | | |
| 0.09 | 0.11 | 63 M | 895 | 1.3 | 42.7 | 38.5 | 30.4 | 0.63 | 0.84 | 1.8 | 2.0 | 1.9 | 56 | 62 | | 1LE1002-0BC2 | - | 4 | 0.00037 |
| 0.18 | 0.21 | 71 M | 800 | 2.2 | 45.5 | 44.4 | 38.3 | 0.67 | 0.84 | 1.9 | 2.0 | 2.0 | 51 | 62 | | 1LE1002-0CC2 | - | 5 | 0.00055 |
| 0.25 | 0.29 | 71 M | 860 | 2.8 | 52.1 | 52.8 | 48.4 | 0.71 | 0.98 | 2.0 | 2.2 | 2.0 | 51 | 62 | | 1LE1002-0CC3 | - | 6 | 0.00080 |
| 0.37 | 0.43 | 80 M | 915 | 3.9 | 57.9 | 56.9 | 51.1 | 0.70 | 1.23 | 1.6 | 2.7 | 1.8 | 56 | 64 | | 1LE1002-0DC2 | - | 9 | 0.0014 |
| 0.55 | 0.63 | 80 M | 900 | 5.8 | 65.8 | 66.6 | 62.6 | 0.72 | 1.68 | 1.7 | 2.7 | 1.9 | 56 | 64 | | 1LE1002-0DC3 | - | 12 | 0.0017 |
| 0.75 | 0.86 | 90 S | 940 | 7.6 | 70.0 | 70.0 | 66.0 | 0.67 | 2.30 | 2.0 | 3.8 | 2.2 | 59 | 70 | | 1LE1002-0EC0 | - | 13 | 0.0033 |
| 1.1 | 1.27 | 90 L | 925 | 11 | 72.9 | 73.8 | 71.2 | 0.69 | 3.15 | 2.2 | 3.8 | 2.4 | 59 | 70 | | 1LE1002-0EC4 | - | 15 | 0.004 |
| 1.5 | 1.75 | 100 L | 940 | 15 | 75.2 | 76.0 | 72.4 | 0.74 | 3.9 | 2.0 | 4.0 | 2.2 | 59 | 71 | | 1LE1002-1AC4 | - | 19 | 0.0065 |
| 2.2 | 2.55 | 112 M | 940 | 22 | 77.7 | 78.5 | 76.3 | 0.72 | 5.7 | 2.6 | 4.6 | 2.7 | 57 | 69 | | 1LE1002-1BC2 | - | 25 | 0.0092 |
| 3 | 3.45 | 132 S | 955 | 30 | 79.7 | 80.2 | 77.7 | 0.74 | 7.3 | 2.0 | 4.6 | 2.6 | 63 | 75 | | 1LE1002-1CC0 | - | 34 | 0.017 |
| 4 | 4.55 | 132 M | 955 | 40 | 81.4 | 82.6 | 81.9 | 0.76 | 9.3 | 2.3 | 5.2 | 2.6 | 63 | 75 | | 1LE1002-1CC2 | - | 39 | 0.021 |
| 5.5 | 6.3 | 132 M | 955 | 55 | 83.1 | 84.0 | 83.0 | 0.75 | 12.7 | 2.7 | 5.7 | 3.0 | 63 | 75 | | 1LE1002-1CC3 | - | 48 | 0.027 |
| 7.5 | 8.6 | 160 M | 970 | 74 | 84.7 | 85.4 | 85.0 | 0.73 | 17.5 | 2.1 | 5.5 | 2.9 | 67 | 79 | | 1LE1002-1DC2 | - | 72 | 0.056 |
| 11 | 12.6 | 160 L | 965 | 109 | 86.4 | 86.4 | 85.4 | 0.77 | 24 | 1.9 | 5.9 | 2.7 | 67 | 79 | | 1LE1002-1DC4 | - | 92 | 0.078 |
| 15 | 18 | 180 L | 975 | 147 | 87.7 | 88.5 | 87.9 | 0.77 | 32 | 2.3 | 6.1 | 3 | 56 | 69 | | 1LE1002-1EC4 | - | 119 | 0.17 |
| 18.5 | 22 | 200 L | 980 | 214 | 89.2 | 90 | 89.6 | 0.79 | 45 | 2.8 | 6.8 | 2.9 | 59 | 72 | | 1LE1002-2AC4 | - | 149 | 0.25 |
| 22 | 26.5 | 200 L | 980 | 214 | 89.2 | 90 | 89.6 | 0.79 | 45 | 2.8 | 6.8 | 2.9 | 59 | 72 | | 1LE1002-2AC5 | - | 166 | 0.3 |
| 8-pole: 750 rpm at 50 Hz, 900 rpm at 60 Hz ¹⁾ | | | | | | | | | | | | | | | | | | | |
| 0.09 | 0.11 | 71 M | 635 | 1.4 | 39 | 35.7 | 28.6 | 0.63 | 0.53 | 1.8 | 1.8 | 2 | 49 | 56 | | 1LE1002-0CD2 | - | 6 | 0.00080 |
| 0.12 | 0.14 | 71 M | 625 | 1.8 | 31 | 30.5 | 27.1 | 0.68 | 0.82 | 1.7 | 2 | 1.7 | 49 | 56 | | 1LE1002-0CD3 | - | 6 | 0.00080 |
| 0.75 | 0.86 | 100 L | 705 | 10 | 61.2 | 58.1 | 50.5 | 0.62 | 2.85 | 1.9 | 3 | 2.2 | 60 | 72 | | 1LE1002-1AD4 | - | 17 | 0.0056 |
| 1.1 | 1.27 | 100 L | 690 | 15 | 66.5 | 66.0 | 61.8 | 0.61 | 3.90 | 2.0 | 3.2 | 2.3 | 60 | 72 | | 1LE1002-1AD5 | - | 22 | 0.0078 |
| 1.5 | 1.75 | 112 M | 700 | 20 | 70.2 | 71.1 | 68.7 | 0.66 | 4.65 | 1.9 | 3.5 | 2.1 | 63 | 75 | | 1LE1002-1BD2 | - | 29 | 0.0094 |
| 2.2 | 2.55 | 132 S | 715 | 29 | 74.2 | 74.1 | 71.4 | 0.66 | 6.5 | 1.7 | 3.9 | 2.4 | 63 | 75 | | 1LE1002-1CD0 | - | 37 | 0.019 |
| 3 | 3.45 | 132 M | 715 | 40 | 77.0 | 77.4 | 75.2 | 0.68 | 8.3 | 1.8 | 3.9 | 2.2 | 63 | 75 | | 1LE1002-1CD2 | - | 44 | 0.024 |
| 4 | 4.55 | 160 M | 720 | 53 | 79.2 | 79.3 | 76.3 | 0.67 | 10.9 | 1.6 | 4.1 | 2.3 | 63 | 75 | | 1LE1002-1DD2 | - | 60 | 0.044 |
| 5.5 | 6.3 | 160 M | 720 | 73 | 81.4 | 81.9 | 80.3 | 0.68 | 14.3 | 1.6 | 4 | 2.2 | 63 | 75 | | 1LE1002-1DD3 | - | 72 | 0.056 |
| 7.5 | 8.6 | 160 L | 715 | 100 | 83.1 | 83.7 | 82.4 | 0.69 | 18.9 | 1.7 | 3.8 | 2.2 | 63 | 75 | | 1LE1002-1DD4 | - | 91 | 0.077 |
| 11 | 13.2 | 180 L | 720 | 146 | 85 | 86.2 | 86 | 0.7 | 26.5 | 1.9 | 5 | 2.5 | 65 | 78 | | 1LE1002-1ED4 | - | 122 | 0.2 |
| 15 | 18 | 200 L | 718 | 199 | 86.2 | 87.9 | 88.4 | 0.75 | 33.5 | 2.5 | 5.5 | 2.9 | 55 | 69 | | 1LE1002-2AD5 | - | 170 | 0.3 |
| Voltagess | | | | | | | | | | | | | | Version | | Order code | | | |
| 50 Hz 230 VΔ/400 VY | | | 60 Hz ¹⁾ 460 VY | | | Standard | | 2 | | 2 | | - | | | | | | | |
| 50 Hz 400 VΔ/690 VY | | | 60 Hz ¹⁾ 460 VΔ | | | Standard | | 3 | | 4 | | - | | | | | | | |
| 50 Hz 500 VY | | | | | Without additional charge | | 2 | | 7 | | - | | | | | | | | |
| 50 Hz 500 VΔ | | | | | Without additional charge | | 4 | | 0 | | - | | | | | | | | |
| For other voltages ¹⁾ and more information, see from page 2/93 | | | | | | | | | | | | | | 9 | | 0 | | ... | |
| Types of construction | | | | | | | | | | | | | | Version | | Order code | | | |
| Without flange | | | IM B3 ²⁾ | | | Standard | | A | | - | | | | | | | | | |
| With flange | | | IM B5 ²⁾ | | | With additional charge | | F | | - | | | | | | | | | |
| With flange | | | IM B14 ²⁾ | | | With additional charge | | K | | - | | | | | | | | | |
| For other types of construction and more information, see from page 2/99 | | | | | | | | | | | | | | 4 | | ... | | | |
| Motor protection | | | | | | | | | | | | | | Version | | Order code | | | |
| Without | | | | | | Standard | | A | | - | | | | | | | | | |
| PTC thermistor with 1 or 3 temperature sensors (frame sizes 63 to 90 or 100 to 200) | | | | | | With additional charge | | B | | - | | | | | | | | | |
| For other motor protection and more information, see from page 2/112 | | | | | | | | | | | | | | 4 | | ... | | | |
| Terminal box position | | | | | | | | | | | | | | Version | | Order code(s) | | | |
| Terminal box at top | | | | | | Standard | | 4 | | - | | | | | | | | | |
| For other terminal box positions and more information, see from page 2/115 | | | | | | | | | | | | | | | | | | | |
| Special versions | | | | | | | | | | | | | | | | | | | |
| Forced-air cooled motors w/o ext. fan/fan cover (IC418) | | | | | | | | | | | | | | 1LE1002-.... | | -Z F90 +...+...+... | | | |
| For options, see from page 2/118 | | | | | | | | | | | | | | 1LE1002-.... | | -Z ...+...+...+... | | | |

2

¹⁾ Operating values at rated power for 60 Hz are stored in the Drive Technology Configurator (DT Configurator; see Appendix, "Tools and engineering").

²⁾ Types derived from IM B3 (IM B6/7/8, IM V6, and IM V5), from IM B5 (IM V3 and IM V1) and from IM B14 (IM V19 and IM V18) are possible, provided that no requirements exist for condensation drainage holes (H03) or stamping of the type on the rating plate. The basic type IM B3, IM B5, or IM B14 is stamped as standard on the rating plate. For orders with condensation drainage holes (H03), the type must be specified.



IE1

SIMOTICS GP and SIMOTICS SD standard motors
IE1 Standard Efficiency

Aluminum series SIMOTICS GP 1LE1002 with increased power – self-ventilated

Selection and ordering data

| P _{rated} 50 Hz/ P50 kW | P _{rated} 60 Hz/ P60 ¹⁾ kW | Frame size FS | Operating values at rated power | | | | | | | | | | | | | Aluminum series 1LE1002 | | m _{IM B3} kg | J kgm ² |
|---|---|---------------------|------------------------------------|-----------------------------------|----------------------------------|----------------------------------|----------------------------------|-------------------------------------|----------------------------------|---|---|--|------------------------------------|-----------------------------------|---------------------|----------------------------|-------------------------------|--------------------------|-----------------------|
| | | | n _{rated} 50 Hz rpm | T _{rated} 50 Hz Nm | η _{rated} 50 Hz % | η _{rated} 50 Hz % | η _{rated} 50 Hz % | cosφ _{rated} 50 Hz % | I _{rated} 50 Hz A | T _{LR} /I _{rated} 50 Hz % | I _{LR} /I _{rated} 50 Hz % | T _B /I _{rated} 50 Hz % | L _{ptA} 50 Hz dB(A) | L _{WA} 50 Hz dB(A) | Article No. | | | | |
| • Cooling: Self-ventilated (IC411) or with order code F90 forced-air cooled without external fan and fan cover (IC418) • Efficiency according to IEC 60034-30-1: IE1 Standard Efficiency, (SF) 1.1 • Insulation: Thermal class 155 (temperature class F), IP55 degree of protection, utilization in accordance with thermal class 130 (temperature class B) | | | | | | | | | | | | | | | | | | | |
| 2-pole: 3000 rpm at 50 Hz, 3600 rpm at 60 Hz ¹⁾ | | | | | | | | | | | | | | | | | | | |
| 0.37 | 0.43 | 63 M | 2795 | 1.3 | 63.9 | 60.3 | 51.9 | 0.71 | 1.18 | 2.4 | 3.5 | 2.6 | 58 | 65 | 1LE1002-0BA6 | 5 | 0.0018 | | |
| 0.75 | 0.86 | 71 M | 2780 | 2.6 | 72.1 | 72.5 | 70.2 | 0.83 | 1.81 | 2.2 | 4.5 | 2.2 | 65 | 72 | 1LE1002-0CA6 | 5 | 0.0029 | | |
| 4 | 4.55 | 100 L | 2850 | 13 | 83.1 | 83.9 | 83 | 0.85 | 8.2 | 4.5 | 7 | 4.1 | 67 | 79 | 1LE1002-1AA6 | 25 | 0.0044 | | |
| 5.5 | 6.3 | 112 L | 2935 | 18 | 84.7 | 84.7 | 82.7 | 0.86 | 10.9 | 2.9 | 7.5 | 3.8 | 69 | 81 | 1LE1002-1BA6 | 31 | 0.0085 | | |
| 11 | 12.6 | 132 M | 2920 | 36 | 87.6 | 88.3 | 87.8 | 0.9 | 20 | 2.8 | 7.5 | 3.7 | 68 | 80 | 1LE1002-1CA6 | 53 | 0.022 | | |
| 22 | 24.5 | 160 L | 2935 | 72 | 89.9 | 90.2 | 89.5 | 0.9 | 39 | 2.6 | 7.5 | 3.4 | 70 | 82 | 1LE1002-1DA6 | 85 | 0.049 | | |
| 4-pole: 1500 rpm at 50 Hz, 1800 rpm at 60 Hz ¹⁾ | | | | | | | | | | | | | | | | | | | |
| 0.25 | 0.29 | 63 M | 1365 | 1.7 | 61.5 | 59.6 | 53.5 | 0.68 | 0.86 | 2.3 | 2.9 | 2.3 | 52 | 59 | 1LE1002-0BB6 | 5 | 0.0029 | | |
| 0.55 | 0.63 | 71 M | 1365 | 3.8 | 70 | 70.5 | 67.4 | 0.7 | 1.62 | 2.5 | 3.6 | 2.5 | 59 | 66 | 1LE1002-0CB6 | 7 | 0.0077 | | |
| 4 | 4.55 | 100 L | 1435 | 27 | 83.1 | 83.8 | 82.3 | 0.81 | 8.6 | 2.9 | 5.8 | 3.1 | 60 | 72 | 1LE1002-1AB6 | 27 | 0.010 | | |
| 5.5 | 6.3 | 112 M | 1420 | 37 | 84.7 | 85.9 | 85.3 | 0.81 | 11.6 | 3 | 5.8 | 3.1 | 58 | 70 | 1LE1002-1BB6 | 33 | 0.012 | | |
| 11 | 12.6 | 132 M | 1450 | 72 | 87.6 | 88.2 | 87.6 | 0.84 | 21.5 | 2.5 | 7.2 | 3 | 64 | 76 | 1LE1002-1CB6 | 58 | 0.033 | | |
| 18.5 | 21.3 | 160M | 1460 | 121 | 89.3 | 89.8 | 89.2 | 0.85 | 35 | 2.7 | 7.2 | 3.2 | 65 | 77 | 1LE1002-1DB6 | 85 | 0.068 | | |
| 6-pole: 1000 rpm at 50 Hz, 1200 rpm at 60 Hz ¹⁾ | | | | | | | | | | | | | | | | | | | |
| 2.2 | 2.55 | 100 L | 930 | 23 | 77.7 | 79.5 | 78.1 | 0.78 | 5.2 | 2 | 4 | 2.2 | 59 | 71 | 1LE1002-1AC6 | 24 | 0.0084 | | |
| 3 | 3.45 | 112 M | 945 | 30 | 79.7 | 79.5 | 76.3 | 0.72 | 7.5 | 2.9 | 4.6 | 3 | 57 | 69 | 1LE1002-1BC6 | 32 | 0.013 | | |
| 7.5 | 8.6 | 132 M | 950 | 75 | 84.7 | 85.3 | 84.1 | 0.74 | 17.3 | 2.4 | 5.3 | 3 | 63 | 75 | 1LE1002-1CC6 | 54 | 0.032 | | |
| 15 | 17.3 | 160 M | 965 | 148 | 87.7 | 87.9 | 86.5 | 0.75 | 33 | 2.9 | 6 | 3.4 | 67 | 79 | 1LE1002-1DC6 | 109 | 0.094 | | |
| Voltages | | | | | | | | | | | | | | | | | | | |
| 50 Hz 230 VΔ/400 VY | | | 60 Hz ¹⁾ 460 VY | | | Standard | | | 2 | | | 2 | | | Order code | | | | |
| 50 Hz 400 VΔ/690 VY | | | 60 Hz ¹⁾ 460 VΔ | | | Standard | | | 3 | | | 4 | | | - | | | | |
| 50 Hz 500 VY | | | | | | Without additional charge | | | 2 | | | 7 | | | - | | | | |
| 50 Hz 500 VΔ | | | | | | Without additional charge | | | 4 | | | 0 | | | - | | | | |
| For other voltages ¹⁾ and more information, see from page 2/93 | | | | | | | | | | | | | | | | | | | |
| Types of construction | | | | | | | | | | | | | | | | | | | |
| Without flange | | | IM B3 ²⁾ | | | Standard | | | A | | | | | | Order code | | | | |
| With flange | | | IM B5 ²⁾ | | | With additional charge | | | F | | | | | | - | | | | |
| With flange | | | IM B14 ²⁾ | | | With additional charge | | | K | | | | | | - | | | | |
| For other types of construction and more information, see from page 2/99 | | | | | | | | | | | | | | | | | | | |
| Motor protection | | | | | | | | | | | | | | | | | | | |
| Without | | | | | | Standard | | | A | | | | | | Order code | | | | |
| PTC thermistor with 1 or 3 temperature sensors (frame sizes 63 to 90 or 100 to 200) | | | | | | With additional charge | | | B | | | | | | - | | | | |
| For other motor protection and more information, see from page 2/112 | | | | | | | | | | | | | | | | | | | |
| Terminal box position | | | | | | | | | | | | | | | | | | | |
| Terminal box at top | | | | | | Standard | | | 4 | | | | | | Order code(s) | | | | |
| For other terminal box positions and more information, see from page 2/115 | | | | | | | | | | | | | | | | | | | |
| Special versions | | | | | | | | | | | | | | | | | | | |
| For options, see from page 2/118 | | | | | | | | | | | | | | | | | | | |
| | | | | | | | | | | | | | | | 1LE1002- -Z | | . . . + . . . + . . . + . . . | | |

2

¹⁾ Operating values at rated power for 60 Hz are stored in the Drive Technology Configurator (DT Configurator; see Appendix, "Tools and engineering").

²⁾ Types derived from IM B3 (IM B6/7/8, IM V6, and IM V5), from IM B5 (IM V3 and IM V1) and from IM B14 (IM V19 and IM V18) are possible, provided that no requirements exist for condensation drainage holes (H03) or stamping of the type on the rating plate. The basic type IM B3, IM B5, or IM B14 is stamped as standard on the rating plate. For orders with condensation drainage holes (H03), the type must be specified.



SIMOTICS GP and SIMOTICS SD standard motors

IE1 Standard Efficiency

Cast-iron series SIMOTICS SD 1LE1502 Basic Line – self-ventilated or forced-air cooled

Selection and ordering data

| Operating values at rated power | | | | | | | | | | | | | | | Cast-iron series | | | |
|--|--------------------|------------|--------------------|----------------------------|----------------------------|----------------------------|----------------------------|--------------------------------|---------------------------|---------------------------|---------------------------|------------------------|------------------|-----------------|----------------------|-------------|--------------------------|--|
| $P_{rated, 50 Hz}$ | $P_{rated, 60 Hz}$ | Frame size | $n_{rated, 50 Hz}$ | $T_{rated, 50 Hz}$ | $\eta_{rated, 50 Hz, 4/4}$ | $\eta_{rated, 50 Hz, 3/4}$ | $\eta_{rated, 50 Hz, 2/4}$ | $\cos\phi_{rated, 50 Hz, 4/4}$ | $I_{rated, 50 Hz, 400 V}$ | $T_{LR}/T_{rated, 50 Hz}$ | $I_{LR}/I_{rated, 50 Hz}$ | $T_B/T_{rated, 50 Hz}$ | $L_{pFA, 50 Hz}$ | $L_{WA, 50 Hz}$ | 1LE1502 – Basic Line | $m_{IM B3}$ | J | |
| kW | kW | FS | rpm | Nm | % | % | % | | A | | | | dB(A) | dB(A) | Article No. | kg | kgm ² | |
| • Cooling: Self-ventilated (IC411) or with order code F90 forced-air cooled without external fan and fan cover (IC418) • Efficiency according to IEC 60034-30-1: IE1 Standard Efficiency, service factor (SF) 1.1 • Insulation: Thermal class 155 (temperature class F), IP55 degree of protection, utilization in accordance with thermal class 130 (temperature class B) | | | | | | | | | | | | | | | | | | |
| 2-pole: 3000 rpm at 50 Hz, 3600 rpm at 60 Hz ¹⁾ | | | | | | | | | | | | | | | | | | |
| 3 | 3.45 | 100 L | 2835 | 10 | 81.5 | 83.2 | 82.8 | 0.87 | 6.1 | 3.2 | 6.4 | 3.5 | 66 | 80 | 1LE1502-1AA4 | 31 | 0.0034 | |
| 4 | 4.55 | 112 M | 2935 | 13 | 83.1 | 83.0 | 80.8 | 0.85 | 8.2 | 3.3 | 8.3 | 4.2 | 70 | 83 | 1LE1502-1BA2 | 36 | 0.0067 | |
| 5.5 | 6.3 | 132 S | 2910 | 18 | 84.7 | 85.9 | 85.7 | 0.88 | 10.7 | 1.8 | 5.7 | 2.6 | 68 | 82 | 1LE1502-1CA0 | 53 | 0.013 | |
| 7.5 | 8.6 | 132 S | 2925 | 24 | 86.0 | 86.7 | 86.1 | 0.88 | 14.3 | 2.2 | 6.8 | 3.1 | 68 | 82 | 1LE1502-1CA1 | 58 | 0.016 | |
| 11 | 12.6 | 160 M | 2925 | 36 | 87.6 | 88.0 | 87.1 | 0.86 | 21.0 | 2.0 | 5.7 | 2.7 | 73 | 86 | 1LE1502-1DA2 | 87 | 0.030 | |
| 15 | 18 | 160 M | 2935 | 49 | 88.7 | 88.9 | 87.7 | 0.85 | 28.5 | 2.4 | 6.8 | 3.2 | 73 | 86 | 1LE1502-1DA3 | 95 | 0.036 | |
| 18.5 | 22 | 160 L | 2935 | 60 | 89.3 | 89.7 | 89.3 | 0.87 | 34.5 | 2.7 | 7.6 | 3.4 | 73 | 86 | 1LE1502-1DA4 | 105 | 0.044 | |
| 22 | 24.5 | 180 M | 2945 | 71 | 89.9 | 90.6 | 90.4 | 0.87 | 40.5 | 2.5 | 7.7 | 3.5 | 72 | 85 | 1LE1502-1EA2 | 150 | 0.069 | |
| 30 | 33.5 | 200 L | 2960 | 97 | 90.7 | 90.9 | 90.2 | 0.79 | 60 | 2.5 | 7.3 | 3.6 | 72 | 85 | 1LE1502-2AA4 | 195 | 0.124 | |
| 37 | 41.5 | 200 L | 2955 | 120 | 91.2 | 91.6 | 91.2 | 0.88 | 67 | 2.7 | 8.2 | 3.5 | 72 | 85 | 1LE1502-2AA5 | 230 | 0.15 | |
| 45 | 51 | 225 M | 2960 | 145 | 91.7 | 92 | 91.6 | 0.88 | 80 | 2.3 | 6.7 | 3 | 73 | 86 | 1LE1502-2BA2 | 280 | 0.22 | |
| 55 | 62 | 250 M | 2970 | 177 | 92.1 | 92.3 | 91.4 | 0.88 | 98 | 2 | 6.7 | 2.9 | 77 | 91 | 1LE1502-2CA2 | 360 | 0.4 | |
| 75 | 84 | 280 S | 2975 | 241 | 92.7 | 92.5 | 91.3 | 0.86 | 136 | 2.2 | 6.8 | 3 | 78 | 92 | 1LE1502-2DA0 | 470 | 0.72 | |
| 90 | 101 | 280 M | 2975 | 289 | 93 | 93.1 | 92.4 | 0.88 | 159 | 2.5 | 7.1 | 3.1 | 76 | 89 | 1LE1502-2DA2 | 530 | 0.83 | |
| 110 | 123 | 315 S | 2982 | 352 | 93.3 | 92.9 | 91.5 | 0.86 | 198 | 2.3 | 7.5 | 3.3 | 80 | 94 | 1LE1502-3AA0 | 680 | 1.2 | |
| 132 | 148 | 315 M | 2982 | 423 | 93.5 | 93.2 | 92.5 | 0.89 | 230 | 2.3 | 7.6 | 3 | 80 | 94 | 1LE1502-3AA2 | 740 | 1.4 | |
| 160 | 180 | 315 L | 2982 | 512 | 93.8 | 93.6 | 93.1 | 0.91 | 270 | 2.3 | 7.4 | 2.9 | 80 | 94 | 1LE1502-3AA4 | 880 | 1.6 | |
| 200 | 224 | 315 L | 2982 | 640 | 94 | 93.9 | 93.5 | 0.92 | 335 | 2.2 | 7.1 | 2.8 | 80 | 94 | 1LE1502-3AA5 | 1000 | 2.1 | |
| Voltages ²⁾ | | | | | | | | | | | | | | | Version | | Order code | |
| 50 Hz 230 VΔ/400 VY | | | | 60 Hz ¹⁾ 460 VY | | | | Standard | | | | 2 | 2 | – | | | | |
| 50 Hz 400 VΔ/690 VY | | | | 60 Hz ¹⁾ 460 VA | | | | Standard | | | | 3 | 4 | – | | | | |
| 50 Hz 500 VY | | | | | | | | Without additional charge | | | | 2 | 7 | – | | | | |
| 50 Hz 500 VA | | | | | | | | Without additional charge | | | | 4 | 0 | – | | | | |
| For other voltages ¹⁾ and more information, see from page 2/96 | | | | | | | | | | | | | | | | | | |
| Types of construction | | | | | | | | | | | | | | | Version | | Order code | |
| Without flange | | | | IM B3 ³⁾ | | | | Standard | | | | A | | – | | | | |
| With flange | | | | IM B5 ³⁾ | | | | With additional charge | | | | F | | – | | | | |
| With flange | | | | IM B14 ³⁾ | | | | With additional charge | | | | K | | – | | | | |
| For other types of construction and more information, see from page 2/103 | | | | | | | | | | | | | | | | | | |
| Motor protection | | | | | | | | | | | | | | | Version | | Order code | |
| Without | | | | | | | | Standard | | | | A | | – | | | | |
| PTC thermistor with 3 temperature sensors | | | | | | | | With additional charge | | | | B | | – | | | | |
| For other motor protection and more information, see from page 2/113 | | | | | | | | | | | | | | | | | | |
| Terminal box position | | | | | | | | | | | | | | | Version | | Order code | |
| Terminal box at top | | | | | | | | Standard | | | | 4 | | – | | | | |
| For other terminal box positions and more information, see from page 2/116 | | | | | | | | | | | | | | | | | | |
| Special versions | | | | | | | | | | | | | | | | | Order code(s) | |
| Forced-air cooled motors w/o ext. fan/fan cover (IC418) | | | | | | | | | | | | | | | 1LE1502- | | -Z F90 + . . . + . . . | |
| For options, see from page 2/125 | | | | | | | | | | | | | | | 1LE1502- | | -Z . . . + . . . + . . . | |

2

¹⁾ Operating values at rated power for 60 Hz are stored in the Drive Technology Configurator (DT Configurator; see Appendix, "Tools and engineering").
²⁾ Parallel supply lines are required in the case of connection to ≤ 240 V. For frame size 315 with connection to ≤ 240 V, due to the high current, a drilled, removable entry plate (order code **R52**) or a larger terminal box (order code **R50**) can be used. Order codes **R52** and **R50** alter the motor dimensions.

³⁾ Types derived from IM B3 (IM B6/7/8, IM V6 and IM V5), from IM B5 (IM V3 and IM V1) and from IM B14 (IM V19 and IM V18) are possible, provided that no requirement exists for stamping of the type on the rating plate. The basic type IM B3, IM B5, or IM B14 is stamped as standard on the rating plate. If mounted in a different position, the position must be specified to ensure that the condensation drainage holes are positioned correctly.



IE1

SIMOTICS GP and SIMOTICS SD standard motors
IE1 Standard Efficiency

Cast-iron series SIMOTICS SD 1LE1502 Basic Line – self-ventilated or forced-air cooled

Selection and ordering data

| P _{rated} 50 Hz/ P50 kW | P _{rated} 60 Hz/ P60 ¹⁾ kW | Frame size FS | Operating values at rated power | | | | | | | | | | | | | Cast-iron series | | m _{IM B3} kg | J kgm ² |
|--|---|---------------------|---------------------------------|-----------------------------|-----------------------------|-----------------------------|-----------------------------|--------------------------------|-----------------------------|---------------------------|---------------------------|-------------------------|---------------------------|--------------------------|---------------------|----------------------|-------------------------------|--------------------------|-----------------------|
| | | | η _{rated} 50 Hz | T _{rated} 50 Hz | η _{rated} 50 Hz | η _{rated} 50 Hz | η _{rated} 50 Hz | cosφ _{rated} 50 Hz | I _{rated} 50 Hz | T _{L/R} 50 Hz | I _{L/R} 50 Hz | T _B 50 Hz | L _{pfA} 50 Hz | L _{WA} 50 Hz | Article No. | 1LE1502 – Basic Line | | | |
| rpm | Nm | % | % | % | A | A | A | A | A | A | A | A | A | dB(A) | dB(A) | kg | kgm ² | | |
| • Cooling: Self-ventilated (IC411) or with order code F90 forced-air cooled without external fan and fan cover (IC418) • Efficiency according to IEC 60034-30-1: IE1 Standard Efficiency, service factor (SF) 1.1 • Insulation: Thermal class 155 (temperature class F), IP55 degree of protection, utilization in accordance with thermal class 130 (temperature class B) | | | | | | | | | | | | | | | | | | | |
| 4-pole: 1500 rpm at 50 Hz, 1800 rpm at 60 Hz ¹⁾ | | | | | | | | | | | | | | | | | | | |
| 2.2 | 2.55 | 100 L | 1425 | 15 | 79.7 | 80.3 | 78.1 | 0.81 | 4.9 | 2.3 | 5.1 | 2.7 | 60 | 72 | 1LE1502-1AB4 | 29 | 0.0059 | | |
| 3 | 3.45 | 100 L | 1425 | 20 | 81.5 | 82.6 | 81.5 | 0.85 | 6.3 | 2.4 | 5.4 | 2.6 | 60 | 72 | 1LE1502-1AB5 | 33 | 0.0078 | | |
| 4 | 4.55 | 112 M | 1435 | 27 | 83.1 | 84.3 | 83.7 | 0.83 | 8.4 | 2.5 | 6.1 | 2.9 | 57 | 70 | 1LE1502-1BB2 | 38 | 0.010 | | |
| 5.5 | 56.3 | 132 S | 1450 | 36 | 84.7 | 85.3 | 84.2 | 0.82 | 11.4 | 2.3 | 5.7 | 2.7 | 64 | 76 | 1LE1502-1CB0 | 56 | 0.019 | | |
| 7.5 | 8.6 | 132 M | 1450 | 49 | 86.0 | 86.5 | 85.4 | 0.82 | 15.4 | 2.6 | 6.6 | 3.1 | 64 | 76 | 1LE1502-1CB2 | 59 | 0.024 | | |
| 11 | 12.6 | 160 M | 1460 | 72 | 87.6 | 87.9 | 86.7 | 0.81 | 22.5 | 2.7 | 6.9 | 3.3 | 70 | 82 | 1LE1502-1DB2 | 89 | 0.044 | | |
| 15 | 17.3 | 160 L | 1460 | 98 | 88.7 | 89.1 | 88.0 | 0.82 | 30.0 | 3.0 | 7.5 | 3.6 | 70 | 82 | 1LE1502-1DB4 | 105 | 0.056 | | |
| 18.5 | 21.3 | 180 M | 1468 | 120 | 89.3 | 90.2 | 90.2 | 0.85 | 35 | 2.2 | 7.3 | 3.1 | 63 | 76 | 1LE1502-1EB2 | 170 | 0.13 | | |
| 22 | 25.3 | 180 L | 1465 | 143 | 89.9 | 90.8 | 90.7 | 0.83 | 42.5 | 2.7 | 8 | 3.6 | 63 | 76 | 1LE1502-1EB4 | 170 | 0.13 | | |
| 30 | 34.5 | 200 L | 1472 | 195 | 90.7 | 91.5 | 91.4 | 0.83 | 58 | 2.3 | 6.9 | 3.1 | 64 | 78 | 1LE1502-2AB5 | 220 | 0.2 | | |
| 37 | 42.5 | 225 S | 1475 | 240 | 91.2 | 91.6 | 91.1 | 0.85 | 69 | 2.3 | 7 | 3.2 | 69 | 83 | 1LE1502-2BB0 | 260 | 0.37 | | |
| 45 | 52 | 225 M | 1475 | 291 | 91.7 | 92.1 | 91.7 | 0.86 | 82 | 2.6 | 7.2 | 3.2 | 69 | 82 | 1LE1502-2BB2 | 290 | 0.45 | | |
| 55 | 63 | 250 M | 1475 | 356 | 92.1 | 92.5 | 92.1 | 0.85 | 101 | 2.4 | 6.1 | 2.6 | 69 | 83 | 1LE1502-2CB2 | 370 | 0.69 | | |
| 75 | 86 | 280 S | 1485 | 482 | 92.7 | 92.9 | 92.2 | 0.85 | 137 | 2.3 | 7 | 2.8 | 75 | 89 | 1LE1502-2DB0 | 500 | 1.2 | | |
| 90 | 104 | 280 M | 1482 | 580 | 93 | 93.4 | 93.1 | 0.87 | 161 | 2.2 | 6.5 | 2.8 | 73 | 87 | 1LE1502-2DB2 | 560 | 1.4 | | |
| 110 | 127 | 315 S | 1488 | 706 | 93.3 | 93.4 | 92.8 | 0.84 | 205 | 2.3 | 6.5 | 2.7 | 76 | 90 | 1LE1502-3AB0 | 690 | 1.9 | | |
| 132 | 152 | 315 M | 1488 | 847 | 93.5 | 93.7 | 93.3 | 0.85 | 240 | 2.5 | 6.8 | 2.7 | 76 | 91 | 1LE1502-3AB2 | 760 | 2.2 | | |
| 160 | 184 | 315 L | 1486 | 1028 | 93.8 | 93.9 | 93.5 | 0.86 | 285 | 2.7 | 7.2 | 2.7 | 76 | 90 | 1LE1502-3AB4 | 940 | 2.9 | | |
| 200 | 230 | 315 L | 1486 | 1285 | 94 | 94.2 | 94 | 0.87 | 355 | 2.5 | 6.9 | 2.7 | 76 | 91 | 1LE1502-3AB5 | 1140 | 3.5 | | |
| Voltages²⁾ | | | | | | | | | | | | | | | Version | | Order code | | |
| 50 Hz 230 VΔ/400 VY | | | 60 Hz ¹⁾ 460 VY | | | Standard | | | 2 2 | | - | | | | | | | | |
| 50 Hz 400 VΔ/690 VY | | | 60 Hz ¹⁾ 460 VΔ | | | Standard | | | 3 4 | | - | | | | | | | | |
| 50 Hz 500 VY | | | | | | Without additional charge | | | 2 7 | | - | | | | | | | | |
| 50 Hz 500 VΔ | | | | | | Without additional charge | | | 4 0 | | - | | | | | | | | |
| For other voltages ¹⁾ and more information, see from page 2/96 | | | | | | | | | | | | | | | 9 0 | | ... | | |
| Types of construction | | | | | | | | | | | | | | | Version | | Order code | | |
| Without flange | | | IM B3 ³⁾ | | | Standard | | | A | | - | | | | | | | | |
| With flange | | | IM B5 ³⁾ | | | With additional charge | | | F | | - | | | | | | | | |
| With flange | | | IM B14 ³⁾ | | | With additional charge | | | K | | - | | | | | | | | |
| For other types of construction and more information, see from page 2/103 | | | | | | | | | | | | | | | | | | | |
| Motor protection | | | | | | | | | | | | | | | Version | | Order code | | |
| Without | | | | | | Standard | | | A | | - | | | | | | | | |
| PTC thermistor with 3 temperature sensors | | | | | | With additional charge | | | B | | - | | | | | | | | |
| For other motor protection and more information, see from page 2/113 | | | | | | | | | | | | | | | | | | | |
| Terminal box position | | | | | | | | | | | | | | | Version | | Order code | | |
| Terminal box at top | | | | | | Standard | | | 4 | | | | | | | | | | |
| For other terminal box positions and more information, see from page 2/116 | | | | | | | | | | | | | | | | | | | |
| Special versions | | | | | | | | | | | | | | | | | Order code(s) | | |
| Forced-air cooled motors w/o ext. fan/fan cover (IC418) | | | | | | | | | | | | | | | 1LE1502- -Z | | F90 + . . . + . . . + . . . | | |
| For options, see from page 2/125 | | | | | | | | | | | | | | | 1LE1502- -Z | | . . . + . . . + . . . + . . . | | |

2

1) Operating values at rated power for 60 Hz are stored in the Drive Technology Configurator (DT Configurator; see Appendix, "Tools and engineering").
 2) Parallel supply lines are required in the case of connection to ≤ 240 V. For frame size 315 with connection to ≤ 240 V, due to the high current, a drilled, removable entry plate (order code R52) or a larger terminal box (order code R50) can be used. Order codes R52 and R50 alter the motor dimensions.

3) Types derived from IM B3 (IM B6/7/8, IM V6 and IM V5), from IM B5 (IM V3 and IM V1) and from IM B14 (IM V19 and IM V18) are possible, provided that no requirement exists for stamping of the type on the rating plate. The basic type IM B3, IM B5, or IM B14 is stamped as standard on the rating plate. If mounted in a different position, the position must be specified to ensure that the condensation drainage holes are positioned correctly.



SIMOTICS GP and SIMOTICS SD standard motors

IE1 Standard Efficiency

Cast-iron series SIMOTICS SD 1LE1502 Basic Line – self-ventilated or forced-air cooled

Selection and ordering data

| Operating values at rated power | | | | | | | | | | | | | | Cast-iron series | | | |
|--|--|---------------|----------------------|----------------------------|-------------------------|-------------------------|-------------------------|-----------------------------|----------------------|-----------------------------------|-----------------------------------|--------------------------------|--------------------|--------------------------------|----------------------|-------------|------------------|
| P_{rated} 50 Hz/ P50 | P_{rated} 60 Hz/ P60 ¹⁾ | Frame size | n_{rated} 50 Hz | T_{rated} 50 Hz | η_{rated} 50 Hz | η_{rated} 50 Hz | η_{rated} 50 Hz | $\cos\phi_{rated}$ 50 Hz | I_{rated} 400 V | $T_{LR}/$ T_{rated} 50 Hz | $I_{LR}/$ I_{rated} 50 Hz | $T_B/$ T_{rated} 50 Hz | L_{pFA} 50 Hz | L_{WA} 50 Hz | 1LE1502 – Basic Line | $m_{IM B3}$ | J |
| kW | kW | FS | rpm | Nm | % | % | % | A | A | | | | | | Article No. | kg | kgm ² |
| • Cooling: Self-ventilated (IC411) or with order code F90 forced-air cooled without external fan and fan cover (IC418) • Efficiency according to IEC 60034-30-1: IE1 Standard Efficiency, service factor (SF) 1.1 • Insulation: Thermal class 155 (temperature class F), IP55 degree of protection, utilization in accordance with thermal class 130 (temperature class B) | | | | | | | | | | | | | | | | | |
| 6-pole: 1000 rpm at 50 Hz, 1200 rpm at 60 Hz ¹⁾ | | | | | | | | | | | | | | | | | |
| 1.5 | 1.75 | 100 L | 940 | 15 | 75.2 | 75.6 | 72.3 | 0.74 | 3.9 | 2 | 4 | 2.2 | 59 | 71 | 1LE1502-1AC4 | 30 | 0.0065 |
| 2.2 | 2.55 | 112 M | 940 | 22 | 77.7 | 78.5 | 76.3 | 0.72 | 5.7 | 2.6 | 4.6 | 2.7 | 59 | 71 | 1LE1502-1BC2 | 37 | 0.0092 |
| 3 | 3.45 | 132 S | 955 | 30 | 79.7 | 79.9 | 77.1 | 0.74 | 7.3 | 2 | 4.6 | 2.6 | 65 | 78 | 1LE1502-1CC0 | 52 | 0.017 |
| 4 | 4.55 | 132 M | 955 | 40 | 81.4 | 82.6 | 81.9 | 0.76 | 9.3 | 2.3 | 5.2 | 2.6 | 65 | 78 | 1LE1502-1CC2 | 57 | 0.021 |
| 5.5 | 6.3 | 132 M | 955 | 55 | 83.1 | 84.0 | 83.0 | 0.75 | 12.7 | 2.7 | 5.7 | 3.0 | 65 | 78 | 1LE1502-1CC3 | 66 | 0.027 |
| 7.5 | 8.6 | 160 M | 970 | 74 | 84.7 | 85.4 | 85.0 | 0.73 | 17.5 | 2.1 | 5.5 | 2.9 | 67 | 79 | 1LE1502-1DC2 | 100 | 0.056 |
| 11 | 12.6 | 160 L | 965 | 109 | 86.4 | 86.8 | 85.9 | 0.77 | 24 | 1.9 | 5.9 | 2.7 | 67 | 79 | 1LE1502-1DC4 | 120 | 0.078 |
| 15 | 18 | 180 L | 975 | 147 | 87.7 | 88.5 | 87.9 | 0.77 | 32 | 2.3 | 6.1 | 3 | 56 | 69 | 1LE1502-1EC4 | 155 | 0.17 |
| 18.5 | 22 | 200 L | 978 | 181 | 88.6 | 89.8 | 89.8 | 0.79 | 38 | 2.5 | 6.3 | 2.6 | 59 | 72 | 1LE1502-2AC4 | 200 | 0.25 |
| 22 | 26.5 | 200 L | 980 | 214 | 89.2 | 90 | 89.6 | 0.79 | 45 | 2.8 | 6.8 | 2.9 | 59 | 72 | 1LE1502-2AC5 | 220 | 0.3 |
| 30 | 36 | 225 M | 978 | 293 | 90.2 | 91 | 90.7 | 0.82 | 59 | 2.7 | 6 | 2.5 | 65 | 77 | 1LE1502-2BC2 | 270 | 0.49 |
| 37 | 44.5 | 250 M | 980 | 361 | 90.8 | 91.5 | 91.3 | 0.82 | 72 | 2.7 | 6 | 2.4 | 63 | 77 | 1LE1502-2CC2 | 330 | 0.76 |
| 45 | 54 | 280 S | 986 | 436 | 91.4 | 92 | 91.6 | 0.84 | 85 | 2.6 | 7 | 2.6 | 63 | 77 | 1LE1502-2DC0 | 440 | 1.1 |
| 55 | 66 | 280 M | 986 | 533 | 91.9 | 92.5 | 92.6 | 0.85 | 102 | 2.6 | 6.7 | 2.6 | 63 | 77 | 1LE1502-2DC2 | 500 | 1.3 |
| 75 | 90 | 315 S | 988 | 725 | 92.6 | 92.8 | 92.1 | 0.83 | 141 | 2.5 | 7.1 | 2.7 | 62 | 77 | 1LE1502-3AC0 | 660 | 2.1 |
| 90 | 108 | 315 M | 988 | 870 | 92.9 | 93.2 | 92.8 | 0.83 | 168 | 2.6 | 7.3 | 2.6 | 61 | 77 | 1LE1502-3AC2 | 740 | 2.5 |
| 110 | 132 | 315 L | 988 | 1063 | 93.3 | 93.6 | 93.4 | 0.86 | 198 | 2.6 | 6.8 | 2.8 | 61 | 78 | 1LE1502-3AC4 | 880 | 3.2 |
| 132 | 158 | 315 L | 988 | 1276 | 93.5 | 93.7 | 93.4 | 0.86 | 235 | 3 | 7.5 | 2.9 | 61 | 78 | 1LE1502-3AC5 | 1030 | 4 |
| 160 | 192 | 315 L | 988 | 1546 | 93.8 | 93.9 | 93.6 | 0.86 | 285 | 3.1 | 7.7 | 3 | 64 | 79 | 1LE1502-3AC6 | 1160 | 4.7 |
| Voltages²⁾ | | | | | | | | | | | | | | Version | | Order code | |
| 50 Hz 230 VΔ/400 VY | | | | 60 Hz ¹⁾ 460 VY | | | | Standard | | | | 2 | 2 | – | | | |
| 50 Hz 400 VΔ/690 VY | | | | 60 Hz ¹⁾ 460 VΔ | | | | Standard | | | | 3 | 4 | – | | | |
| 50 Hz 500 VY | | | | | | | | Without additional charge | | | | 2 | 7 | – | | | |
| 50 Hz 500 VΔ | | | | | | | | Without additional charge | | | | 4 | 0 | – | | | |
| For other voltages ¹⁾ and more information, see from page 2/96 | | | | | | | | | | | | | | | | | |
| Types of construction | | | | | | | | | | | | | | Version | | Order code | |
| Without flange | | | | IM B3 ³⁾ | | | | Standard | | | | A | – | | | | |
| With flange | | | | IM B5 ³⁾ | | | | With additional charge | | | | F | – | | | | |
| With flange | | | | IM B14 ³⁾ | | | | With additional charge | | | | K | – | | | | |
| For other types of construction and more information, see from page 2/103 | | | | | | | | | | | | | | | | | |
| Motor protection | | | | | | | | | | | | | | Version | | Order code | |
| Without | | | | | | | | Standard | | | | A | – | | | | |
| PTC thermistor with 3 temperature sensors | | | | | | | | With additional charge | | | | B | – | | | | |
| For other motor protection and more information, see from page 2/113 | | | | | | | | | | | | | | | | | |
| Terminal box position | | | | | | | | | | | | | | Version | | Order code | |
| Terminal box at top | | | | | | | | Standard | | | | 4 | – | | | | |
| For other terminal box positions and more information, see from page 2/116 | | | | | | | | | | | | | | | | | |
| Special versions | | | | | | | | | | | | | | Order code(s) | | | |
| Forced-air cooled motors w/o ext. fan/fan cover (IC418) | | | | | | | | | | | | | | 1LE1502-...-Z F90 +...+...+... | | | |
| For options, see from page 2/125 | | | | | | | | | | | | | | | | | |

2

¹⁾ Operating values at rated power for 60 Hz are stored in the Drive Technology Configurator (DT Configurator; see Appendix, "Tools and engineering").

²⁾ Parallel supply lines are required in the case of connection to ≤ 240 V. For frame size 315 with connection to ≤ 240 V, due to the high current, a drilled, removable entry plate (order code **R52**) or a larger terminal box (order code **R50**) can be used. Order codes **R52** and **R50** alter the motor dimensions.

³⁾ Types derived from IM B3 (IM B6/7/8, IM V6 and IM V5), from IM B5 (IM V3 and IM V1) and from IM B14 (IM V19 and IM V18) are possible, provided that no requirement exists for stamping of the type on the rating plate. The basic type IM B3, IM B5, or IM B14 is stamped as standard on the rating plate. If mounted in a different position, the position must be specified to ensure that the condensation drainage holes are positioned correctly.



IE1

SIMOTICS GP and SIMOTICS SD standard motors
IE1 Standard Efficiency

Cast-iron series SIMOTICS SD 1LE1502 Basic Line – self-ventilated or forced-air cooled

Selection and ordering data

| P _{rated} 50 Hz/ P50 kW | P _{rated} 60 Hz/ P60 kW | Frame size FS | Operating values at rated power | | | | | | | | | | | Cast-iron series | | m _{IM B3} kg | J kgm ² |
|--|---|---------------------|------------------------------------|-----------------------------------|----------------------------------|----------------------------------|----------------------------------|-------------------------------------|----------------------------------|--|--|---|------------------------------------|-----------------------------------|----------------------|--------------------------|-----------------------|
| | | | n _{rated} 50 Hz rpm | T _{rated} 50 Hz Nm | η _{rated} 50 Hz % | η _{rated} 50 Hz % | η _{rated} 50 Hz % | cosφ _{rated} 50 Hz % | I _{rated} 50 Hz A | T _{LR} / T _{rated} 50 Hz | I _{LR} / I _{rated} 50 Hz | T _B / T _{rated} 50 Hz | L _{pfA} 50 Hz dB(A) | L _{WA} 50 Hz dB(A) | 1LE1502 – Basic Line | | |
| 0.75 | 0.86 | 100 L | 705 | 10 | 61.2 | 58.1 | 50.5 | 0.62 | 2.85 | 1.9 | 3 | 2.2 | 64 | 72 ⁴⁾ | 1LE1502-1AD4 | 28 | 0.0056 |
| 1.1 | 1.27 | 100 L | 690 | 15 | 66.5 | 66.0 | 61.8 | 0.61 | 3.90 | 2.0 | 3.2 | 2.3 | 64 | 72 ⁴⁾ | 1LE1502-1AD5 | 33 | 0.0078 |
| 1.5 | 1.75 | 112 M | 700 | 20 | 70.2 | 71.1 | 68.7 | 0.66 | 4.65 | 1.9 | 3.5 | 2.1 | 67 | 78 ⁴⁾ | 1LE1502-1BD2 | 42 | 0.0094 |
| 2.2 | 2.55 | 132 S | 715 | 29 | 74.2 | 74.1 | 71.4 | 0.66 | 6.5 | 1.7 | 3.9 | 2.4 | 63 | 75 | 1LE1502-1CD0 | 60 | 0.019 |
| 3 | 3.45 | 132 M | 715 | 40 | 77 | 77.4 | 75.2 | 0.68 | 8.3 | 1.8 | 3.9 | 2.2 | 63 | 75 | 1LE1502-1CD2 | 62 | 0.024 |
| 4 | 4.55 | 160 M | 720 | 53 | 79.2 | 79.3 | 76.3 | 0.67 | 10.9 | 1.6 | 4.1 | 2.3 | 63 | 75 | 1LE1502-1DD2 | 89 | 0.044 |
| 5.5 | 6.3 | 160 M | 720 | 73 | 81.4 | 81.9 | 80.3 | 0.68 | 14.3 | 1.6 | 4 | 2.2 | 63 | 75 | 1LE1502-1DD3 | 96 | 0.056 |
| 7.5 | 8.6 | 160 L | 715 | 100 | 83.1 | 83.7 | 82.4 | 0.69 | 18.9 | 1.7 | 3.8 | 2.2 | 63 | 75 | 1LE1502-1DD4 | 120 | 0.077 |
| 11 | 13.2 | 180 L | 720 | 146 | 85 | 86.2 | 86 | 0.7 | 26.5 | 1.9 | 5 | 2.5 | 65 | 78 | 1LE1502-1ED4 | 160 | 0.20 |
| 15 | 18 | 200 L | 718 | 199 | 86.2 | 87.9 | 88.4 | 0.75 | 33.5 | 2.5 | 5.5 | 2.9 | 55 | 69 | 1LE1502-2AD5 | 220 | 0.3 |
| 18.5 | 22 | 225 S | 730 | 242 | 86.9 | 87.8 | 87.4 | 0.78 | 39.5 | 2.2 | 5.5 | 2.7 | 59 | 72 | 1LE1502-2BD0 | 250 | 0.43 |
| 22 | 26.5 | 225 M | 730 | 288 | 87.4 | 88.3 | 88.1 | 0.79 | 46 | 2.3 | 5.5 | 2.7 | 60 | 73 | 1LE1502-2BD2 | 270 | 0.5 |
| 30 | 36 | 250 M | 732 | 391 | 88.3 | 89.2 | 89.2 | 0.81 | 61 | 2.3 | 5.5 | 2.6 | 54 | 68 | 1LE1502-2CD2 | 370 | 0.84 |
| 37 | 44.5 | 280 S | 735 | 481 | 88.8 | 89.7 | 89.7 | 0.81 | 74 | 2.1 | 5 | 2.1 | 54 | 68 | 1LE1502-2DD0 | 460 | 1.22 |
| 45 | 54 | 280 M | 735 | 585 | 89.2 | 90.3 | 90.4 | 0.81 | 90 | 2.1 | 5.3 | 2.1 | 58 | 71 | 1LE1502-2DD2 | 500 | 1.42 |
| 55 | 66 | 315 S | 740 | 710 | 89.7 | 90.1 | 89.7 | 0.8 | 111 | 2.1 | 5.7 | 2.6 | 69 | 83 | 1LE1502-3AD0 | 640 | 2 |
| 75 | 90 | 315 M | 738 | 970 | 90.3 | 90.7 | 90.5 | 0.81 | 148 | 2.3 | 5.9 | 2.7 | 69 | 84 | 1LE1502-3AD2 | 720 | 2.5 |
| 90 | 108 | 315 L | 738 | 1165 | 90.7 | 91.2 | 91.2 | 0.84 | 171 | 2.2 | 5.9 | 2.6 | 68 | 83 | 1LE1502-3AD4 | 840 | 3.1 |
| 110 | 132 | 315 L | 740 | 1419 | 91.1 | 91.6 | 91.5 | 0.82 | 215 | 2.7 | 6.7 | 2.9 | 73 | 87 | 1LE1502-3AD5 | 1000 | 3.9 |
| 132 | 158 | 315 L | 740 | 1703 | 91.5 | 91.9 | 91.6 | 0.81 | 255 | 2.9 | 7.2 | 3.3 | 75 | 89 | 1LE1502-3AD6 | 1080 | 4.5 |
| Voltages²⁾ | | | Version | | | | | | | | | | | | | Order code | |
| 50 Hz 230 VΔ/400 VY | | | Standard | | | | | | | | | | | 2 2 | | - | |
| 50 Hz 400 VΔ/690 VY | | | Standard | | | | | | | | | | | 3 4 | | - | |
| 50 Hz 500 VY | | | Without additional charge | | | | | | | | | | | 2 7 | | - | |
| 50 Hz 500 VΔ | | | Without additional charge | | | | | | | | | | | 4 0 | | - | |
| For other voltages ¹⁾ and more information, see from page 2/96 | | | | | | | | | | | | | | 9 0 | | ... | |
| Types of construction | | | Version | | | | | | | | | | | | | Order code | |
| Without flange | | | Standard | | | | | | | | | | | A | | - | |
| With flange | | | With additional charge | | | | | | | | | | | F | | - | |
| With flange | | | With additional charge | | | | | | | | | | | K | | - | |
| For other types of construction and more information, see from page 2/103 | | | | | | | | | | | | | | | | ... | |
| Motor protection | | | Version | | | | | | | | | | | | | Order code | |
| Without | | | Standard | | | | | | | | | | | A | | - | |
| PTC thermistor with 3 temperature sensors | | | With additional charge | | | | | | | | | | | B | | - | |
| For other motor protection and more information, see from page 2/113 | | | | | | | | | | | | | | | | ... | |
| Terminal box position | | | Version | | | | | | | | | | | | | Order code(s) | |
| Terminal box at top | | | Standard | | | | | | | | | | | 4 | | | |
| For other terminal box positions and more information, see from page 2/116 | | | | | | | | | | | | | | | | | |
| Special versions | | | | | | | | | | | | | | | | Order code(s) | |
| Forced-air cooled motors w/o ext. fan/fan cover (IC418) | | | | | | | | | | | | | | 1LE1502-...-Z | | F90+...+...+... | |
| For options, see from page 2/125 | | | | | | | | | | | | | | 1LE1502-...-Z | | ...+...+...+... | |

1) Operating values at rated power for 60 Hz are stored in the Drive Technology Configurator (DT Configurator; see Appendix, "Tools and engineering").

2) Parallel supply lines are required in the case of connection to ≤ 240 V. For frame size 315 with connection to ≤ 240 V, due to the high current, a drilled, removable entry plate (order code **R52**) or a larger terminal box (order code **R50**) can be used. Order codes **R52** and **R50** alter the motor dimensions.

3) Types derived from IM B3 (IM B6/7/8, IM V6 and IM V5), from IM B5 (IM V3 and IM V1) and from IM B14 (IM V19 and IM V18) are possible, provided that no requirement exists for stamping of the type on the rating plate. The basic type IM B3, IM B5, or IM B14 is stamped as standard on the rating plate. If mounted in a different position, the position must be specified to ensure that the condensation drainage holes are positioned correctly.

4) The noise limit values specified as permissible in IEC 60034-9 under load can be exceeded.





SIMOTICS GP and SIMOTICS SD standard motors

IE1 Standard Efficiency

Cast-iron series SIMOTICS SD 1LE1502 Basic Line with increased power – self-ventilated or forced-air cooled

Selection and ordering data

| P _{rated} 50 Hz/ P50 kW | P _{rated} 60 Hz/ P60 ¹⁾ kW | Frame size FS | Operating values at rated power | | | | | | | | | | | | | Cast-iron series | |
|--|---|---------------------|------------------------------------|-----------------------------------|----------------------------------|----------------------------------|----------------------------------|-------------------------------------|----------------------------------|------------------------------------|------------------------------------|----------------------------------|------------------------------------|-----------------------------------|----------------------|--------------------|--------|
| | | | n _{rated} 50 Hz rpm | T _{rated} 50 Hz Nm | η _{rated} 50 Hz % | η _{rated} 50 Hz % | η _{rated} 50 Hz % | cosφ _{rated} 50 Hz % | I _{rated} 50 Hz A | T _{L/R} 50 Hz dB(A) | I _{L/R} 50 Hz dB(A) | T _B 50 Hz dB(A) | L _{pfA} 50 Hz dB(A) | L _{WA} 50 Hz dB(A) | 1LE1502 – Basic Line | m _{IM} B3 | J |
| Article No. | | | | | | | | | | | | | | | | | |
| • Cooling: Self-ventilated (IC411) or with order code F90 forced-air cooled without external fan and fan cover (IC418) • Efficiency according to IEC 60034-30-1: IE1 Standard Efficiency, service factor (SF) 1.1 • Insulation: Thermal class 155 (temperature class F), IP55 degree of protection, utilization in accordance with thermal class 155 (temperature class F) | | | | | | | | | | | | | | | | | |
| 2-pole: 3000 rpm at 50 Hz, 3600 rpm at 60 Hz ¹⁾ | | | | | | | | | | | | | | | | | |
| 4 | 4.6 | 100 L | 2850 | 13 | 83.1 | 83.9 | 83 | 0.85 | 8.2 | 4.5 | 7 | 4.1 | 67 | 79 | 1LE1502-1AA6 | 33 | 0.0044 |
| 5.5 | 6.3 | 112 M | 2935 | 18 | 84.7 | 84.7 | 82.7 | 0.86 | 10.9 | 2.9 | 7.5 | 3.8 | 69 | 81 | 1LE1502-1BA6 | 40 | 0.0085 |
| 11 | 12.6 | 132 M | 2920 | 36 | 87.6 | 88.3 | 87.8 | 0.9 | 20 | 2.8 | 7.5 | 3.7 | 68 | 80 | 1LE1502-1CA6 | 76 | 0.022 |
| 22 | 24.5 | 160 L | 2935 | 72 | 89.9 | 90.2 | 89.5 | 0.9 | 39 | 2.6 | 7.5 | 3.4 | 70 | 82 | 1LE1502-1DA6 | 125 | 0.049 |
| 30 | 33.5 | 180 L | 2940 | 97 | 90.7 | 91.5 | 91.5 | 0.89 | 54 | 2.4 | 8.1 | 3.5 | 72 | 85 | 1LE1502-1EA6 | 180 | 0.094 |
| 45 | 51 | 200 L | 2955 | 145 | 91.7 | 92.3 | 92.4 | 0.85 | 83 | 2.5 | 8.1 | 3.6 | 71 | 85 | 1LE1502-2AA6 | 245 | 0.176 |
| 55 | 62 | 225 M | 2960 | 177 | 92.1 | 92.4 | 92 | 0.88 | 98 | 2.5 | 7.3 | 3.2 | 76 | 89 | 1LE1502-2BA6 | 330 | 0.27 |
| 75 | 84 | 250 M | 2970 | 241 | 92.7 | 92.8 | 92.1 | 0.87 | 134 | 2.4 | 7.3 | 3.1 | 76 | 89 | 1LE1502-2CA6 | 420 | 0.48 |
| 110 | 123 | 280 M | 2975 | 353 | 93.3 | 93.5 | 93.1 | 0.9 | 189 | 2.4 | 7.3 | 3.1 | 77 | 90 | 1LE1502-2DA6 | 620 | 1 |
| 4-pole: 1500 rpm at 50 Hz, 1800 rpm at 60 Hz ¹⁾ | | | | | | | | | | | | | | | | | |
| 4 | 4.6 | 100 L | 1435 | 27 | 83.1 | 83.8 | 82.3 | 0.81 | 8.6 | 2.9 | 5.8 | 3.1 | 60 | 72 | 1LE1502-1AB6 | 36 | 0.01 |
| 5.5 | 6.3 | 112 M | 1420 | 37 | 84.7 | 85.9 | 85.3 | 0.81 | 11.6 | 3 | 5.8 | 3.1 | 58 | 70 | 1LE1502-1BB6 | 43 | 0.012 |
| 11 | 12.6 | 132 M | 1450 | 72 | 87.6 | 88.2 | 87.6 | 0.84 | 21.5 | 2.5 | 7.2 | 3 | 64 | 76 | 1LE1502-1CB6 | 76 | 0.033 |
| 18.5 | 21.3 | 160 L | 1460 | 121 | 89.3 | 89.8 | 89.2 | 0.85 | 35 | 2.7 | 7.2 | 3.2 | 65 | 77 | 1LE1502-1DB6 | 125 | 0.068 |
| 30 | 34.5 | 180 L | 1465 | 196 | 90.7 | 91.7 | 91.9 | 0.79 | 60 | 2.6 | 7.2 | 3.4 | 64 | 77 | 1LE1502-1EB6 | 185 | 0.159 |
| 37 | 42.5 | 200 L | 1470 | 240 | 91.2 | 92 | 92.1 | 0.82 | 71 | 2.4 | 6.8 | 2.9 | 64 | 78 | 1LE1502-2AB6 | 240 | 0.246 |
| 55 | 63 | 225 M | 1475 | 356 | 92.1 | 92.8 | 92.6 | 0.86 | 100 | 2.5 | 6.7 | 2.6 | 70 | 83 | 1LE1502-2BB6 | 320 | 0.49 |
| 75 | 86 | 250 M | 1482 | 483 | 92.7 | 93.1 | 92.6 | 0.84 | 139 | 2.5 | 7.4 | 3 | 73 | 87 | 1LE1502-2CB6 | 440 | 0.86 |
| 110 | 127 | 280 M | 1486 | 707 | 93.3 | 93.5 | 93 | 0.85 | 200 | 2.6 | 8 | 3.3 | 75 | 89 | 1LE1502-2DB6 | 670 | 1.7 |
| Voltages²⁾ | | | Version | | | | | | | | | | | Order code | | | |
| 50 Hz 230 VΔ/400 VY | | | Standard | | | | | | | | | | | 2 2 | | | |
| 50 Hz 400 VΔ/690 VY | | | Standard | | | | | | | | | | | 3 4 | | | |
| 50 Hz 500 VY | | | Without additional charge | | | | | | | | | | | 2 7 | | | |
| 50 Hz 500 VΔ | | | Without additional charge | | | | | | | | | | | 4 0 | | | |
| For other voltages ¹⁾ and more information, see from page 2/96 | | | | | | | | | | | | | | 9 0 | | | |
| Types of construction | | | Version | | | | | | | | | | | Order code | | | |
| Without flange IM B3 ³⁾ | | | Standard | | | | | | | | | | | A | | | |
| With flange IM B5 ³⁾ | | | With additional charge | | | | | | | | | | | F | | | |
| With flange IM B14 ³⁾ | | | With additional charge | | | | | | | | | | | K | | | |
| For other types of construction and more information, see from page 2/103 | | | | | | | | | | | | | | | | | |
| Motor protection | | | Version | | | | | | | | | | | Order code | | | |
| Without | | | Standard | | | | | | | | | | | A | | | |
| PTC thermistor with 3 temperature sensors | | | With additional charge | | | | | | | | | | | B | | | |
| For other motor protection and more information, see from page 2/113 | | | | | | | | | | | | | | | | | |
| Terminal box position | | | Version | | | | | | | | | | | Order code | | | |
| Terminal box at top | | | Standard | | | | | | | | | | | 4 | | | |
| For other terminal box positions and more information, see from page 2/116 | | | | | | | | | | | | | | | | | |
| Special versions | | | | | | | | | | | | | | Order code(s) | | | |
| Forced-air cooled motors w/o ext. fan/fan cover (IC418) | | | 1LE1502-...-Z | | | | | | | | | | | F90 +...+...+... | | | |
| For options, see from page 2/125 | | | 1LE1502-...-Z | | | | | | | | | | | ...+...+...+... | | | |

2

¹⁾ Operating values at rated power for 60 Hz are stored in the Drive Technology Configurator (DT Configurator; see Appendix, "Tools and engineering").

²⁾ Parallel supply lines are required in the case of connection to ≤ 240 V. For frame size 315 with connection to ≤ 240 V, due to the high current, a drilled, removable entry plate (order code **R52**) or a larger terminal box (order code **R50**) can be used. Order codes **R52** and **R50** alter the motor dimensions.

³⁾ Types derived from IM B3 (IM B6/7/8, IM V6 and IM V5), from IM B5 (IM V3 and IM V1) and from IM B14 (IM V19 and IM V18) are possible, provided that no requirement exists for stamping of the type on the rating plate. The basic type IM B3, IM B5, or IM B14 is stamped as standard on the rating plate. If mounted in a different position, the position must be specified to ensure that the condensation drainage holes are positioned correctly.



IE1

SIMOTICS GP and SIMOTICS SD standard motors
IE1 Standard Efficiency

Cast-iron series SIMOTICS SD 1LE1502 Basic Line with increased power – self-ventilated or forced-air cooled

Selection and ordering data

| Operating values at rated power | | | | | | | | | | | | | | | Cast-iron series | | |
|--|--|---------------------|-----------------------------|----------------------------|------------------------------|------------------------------|------------------------------|----------------------------------|---------------------------|----------------------------------|----------------------------------|-------------------------------|-----------------------------|----------------------------|----------------------|-------------------|-------------------------|
| P_{rated} 50 Hz/ P50 kW | P_{rated} 60 Hz/ P60 ¹⁾ kW | Frame size FS | n_{rated} 50 Hz rpm | T_{rated} 50 Hz Nm | η_{rated} 50 Hz % | η_{rated} 50 Hz % | η_{rated} 50 Hz % | $\cos\phi_{rated}$ 50 Hz % | I_{rated} 50 Hz A | T_{LR}/I_{rated} 50 Hz A | I_{LR}/I_{rated} 50 Hz % | T_B/I_{rated} 50 Hz A | L_{pFA} 50 Hz dB(A) | L_{WA} 50 Hz dB(A) | 1LE1502 – Basic Line | $m_{IM B3}$ kg | J kgm ² |
| Article No. | | | | | | | | | | | | | | | | | |
| <ul style="list-style-type: none"> • Cooling: Self-ventilated (IC411) or with order code F90 forced-air cooled without external fan and fan cover (IC418) • Efficiency according to IEC 60034-30-1: IE1 Standard Efficiency, service factor (SF) 1.1 • Insulation: Thermal class 155 (temperature class F), IP55 degree of protection, utilization in accordance with thermal class 155 (temperature class F) | | | | | | | | | | | | | | | | | |
| 6-pole: 1000 rpm at 50 Hz, 1200 rpm at 60 Hz ¹⁾ | | | | | | | | | | | | | | | | | |
| 2.2 | 2.55 | 100 L | 930 | 23 | 77.7 | 79.5 | 78.1 | 0.78 | 5.2 | 2 | 4 | 2.2 | 59 | 71 | 1LE1502-1AC6 | 35 | 0.0084 |
| 3 | 3.45 | 112 M | 945 | 30 | 79.7 | 79.5 | 76.3 | 0.72 | 7.5 | 2.9 | 4.6 | 3 | 57 | 69 | 1LE1502-1BC6 | 45 | 0.013 |
| 7.5 | 8.6 | 132 M | 950 | 75 | 84.7 | 85.3 | 84.1 | 0.74 | 17.3 | 2.4 | 5.3 | 3 | 63 | 75 | 1LE1502-1CC6 | 78 | 0.032 |
| 15 | 17.3 | 160 L | 965 | 148 | 87.7 | 87.9 | 86.5 | 0.75 | 33 | 2.9 | 6 | 3.4 | 67 | 79 | 1LE1502-1DC6 | 140 | 0.094 |
| 18.5 | 22 | 180 L | 970 | 182 | 88.6 | 89.4 | 89.1 | 0.77 | 39 | 2.2 | 5.9 | 2.9 | 56 | 69 | 1LE1502-1EC6 | 165 | 0.206 |
| 30 | 34.5 | 200 L | 975 | 294 | 90.2 | 91.4 | 91.7 | 0.78 | 62 | 2.6 | 6 | 2.7 | 61 | 75 | 1LE1502-2AC6 | 245 | 0.381 |
| 37 | 44.5 | 225 M | 978 | 361 | 90.8 | 91.5 | 91.5 | 0.82 | 72 | 2.5 | 6.1 | 2.8 | 76 | 93 | 1LE1502-2BC6 | 310 | 0.62 |
| 45 | 54 | 250 M | 982 | 438 | 91.4 | 92.2 | 92.1 | 0.83 | 86 | 2.7 | 6.6 | 2.3 | 76 | 95 | 1LE1502-2CC6 | 390 | 0.93 |
| 75 | 90 | 280 M | 985 | 727 | 92.6 | 93.3 | 93.2 | 0.84 | 139 | 2.9 | 7 | 2.7 | 61 | 75 | 1LE1502-2DC6 | 560 | 1.7 |
| 8-pole: 750 rpm at 50 Hz, 900 rpm at 60 Hz ¹⁾ | | | | | | | | | | | | | | | | | |
| 15 | 18 | 180 L | 718 | 199 | 86.2 | 87.5 | 87.2 | 0.74 | 34 | 2.1 | 4.7 | 2.3 | 64 | 78 | 1LE1502-1ED6 | 190 | 0.263 |
| 18.5 | 22 | 200 L | 720 | 245 | 86.9 | 88.2 | 88.4 | 0.76 | 40 | 2.7 | 6.1 | 3.2 | 59 | 72 | 1LE1502-2AD6 | 250 | 0.416 |
| 30 | 36 | 225 M | 730 | 392 | 88.3 | 89.1 | 89.1 | 0.79 | 62 | 2.6 | 5.6 | 2.8 | 57 | 70 | 1LE1502-2BD6 | 320 | 0.73 |
| 37 | 44.5 | 250 M | 730 | 484 | 88.8 | 89.8 | 89.9 | 0.83 | 72 | 2.3 | 5.7 | 2.6 | 63 | 77 | 1LE1502-2CD6 | 405 | 1 |
| 55 | 66 | 280 M | 736 | 714 | 89.7 | 90.4 | 90.5 | 0.8 | 111 | 2.5 | 5.7 | 2.5 | 70 | 81 | 1LE1502-2DD6 | 550 | 1.6 |
| Voltages²⁾ | | | | | | | | | | | | | | | Version | | Order code |
| 50 Hz 230 VΔ/400 VY | | | 60 Hz ¹⁾ 460 VY | | | Standard | | | | | | | | | 2 | – | |
| 50 Hz 400 VΔ/690 VY | | | 60 Hz ¹⁾ 460 VΔ | | | Standard | | | | | | | | | 3 | – | |
| 50 Hz 500 VY | | | | | | Without additional charge | | | | | | | | | 4 | – | |
| 50 Hz 500 VΔ | | | | | | Without additional charge | | | | | | | | | 7 | – | |
| For other voltages ¹⁾ and more information, see from page 2/96 | | | | | | | | | | | | | | | 0 | ... | |
| Types of construction | | | | | | | | | | | | | | | Version | | Order code |
| Without flange | | | IM B3 ³⁾ | | | Standard | | | | | | | | | A | – | |
| With flange | | | IM B5 ³⁾ | | | With additional charge | | | | | | | | | F | – | |
| With flange | | | IM B14 ³⁾ | | | With additional charge | | | | | | | | | K | – | |
| For other types of construction and more information, see from page 2/103 | | | | | | | | | | | | | | | ... | | |
| Motor protection | | | | | | | | | | | | | | | Version | | Order code |
| Without | | | | | | Standard | | | | | | | | | A | – | |
| PTC thermistor with 3 temperature sensors | | | | | | With additional charge | | | | | | | | | B | – | |
| For other motor protection and more information, see from page 2/113 | | | | | | | | | | | | | | | ... | | |
| Terminal box position | | | | | | | | | | | | | | | Version | | Order code(s) |
| Terminal box at top | | | | | | Standard | | | | | | | | | 4 | – | |
| For other terminal box positions and more information, see from page 2/116 | | | | | | | | | | | | | | | ... | | |
| Special versions | | | | | | | | | | | | | | | Version | | Order code(s) |
| Forced-air cooled motors w/o ext. fan/fan cover (IC418) | | | | | | | | | | | | | | | 1LE1502-...-Z | | F90+...+...+... |
| For options, see from page 2/125 | | | | | | | | | | | | | | | 1LE1502-...-Z | | ...+...+...+... |

2

¹⁾ Operating values at rated power for 60 Hz are stored in the Drive Technology Configurator (DT Configurator; see Appendix, "Tools and engineering").
²⁾ Parallel supply lines are required in the case of connection to ≤ 240 V. For frame size 315 with connection to ≤ 240 V, due to the high current, a drilled, removable entry plate (order code R52) or a larger terminal box (order code R50) can be used. Order codes R52 and R50 alter the motor dimensions.

³⁾ Types derived from IM B3 (IM B6/7/8, IM V6 and IM V5), from IM B5 (IM V3 and IM V1) and from IM B14 (IM V19 and IM V18) are possible, provided that no requirement exists for stamping of the type on the rating plate. The basic type IM B3, IM B5, or IM B14 is stamped as standard on the rating plate. If mounted in a different position, the position must be specified to ensure that the condensation drainage holes are positioned correctly.

SIMOTICS GP and SIMOTICS SD standard motors

APAC Line · IE3 Premium Efficiency



Aluminum series SIMOTICS GP 1LE1043 – self-ventilated or forced-air cooled

Selection and ordering data

Technical specifications at 60 Hz/P50 power rating

| Operating values at rated power | | | | | | | | | | | | | | Aluminum series | | m _{IM B3} | J | | |
|---|---------------------------------------|---------------|-------------------------------|-------------------------------|------------------------------------|---------------------------------------|---------------------------------------|---------------------------------------|--|---|--|--|---|------------------------------|----------------------------|--------------------|-----|---------|-------------|
| P _{rated} , 60 Hz/ P50 | P _{rated} , 60 Hz/ P60 | Frame size | n _{rated} , 60 Hz | T _{rated} , 60 Hz | Different IE class 60 Hz/P60 | η _{rated} , 60 Hz, 4/4 | η _{rated} , 60 Hz, 3/4 | η _{rated} , 60 Hz, 2/4 | cosφ _{rated} , 60 Hz, 4/4 | I _{rated} , 60 Hz, 460 V | T _{LR} / I _{rated} , 60 Hz | I _{LR} / I _{rated} , 60 Hz | T _B / I _{rated} , 60 Hz | L _{pfiA} , 60 Hz | L _{WA} , 60 Hz | | | 1LE1043 | Article No. |
| 2-pole: 3000 rpm at 50 Hz, 3600 rpm at 60 Hz | | | | | | | | | | | | | | | | | | | |
| 0.75 | 0.86 | 80 M | 3480 | 2.1 | | 77 | 77.2 | 75.7 | 0.84 | 1.45 | 3 | 7.1 | 3.6 | 64 | 75 | 1LE1043-0DA2 | 11 | 0.0011 | |
| 1.1 | 1.27 | 80 M | 3500 | 3 | | 84 | 84 | 82 | 0.83 | 1.98 | 3.3 | 8.4 | 4 | 64 | 75 | 1LE1043-0DA3 | 12 | 0.0013 | |
| 1.5 | 1.75 | 90 S | 3525 | 4.1 | | 85.5 | 84.8 | 82.3 | 0.84 | 2.6 | 3.1 | 9.8 | 4.9 | 69 | 81 | 1LE1043-0EA0 | 15 | 0.0021 | |
| 2.2 | 2.55 | 90 L | 3530 | 6 | | 86.5 | 86.4 | 84.5 | 0.87 | 3.65 | 3 | 9.6 | 4.9 | 69 | 81 | 1LE1043-0EA4 | 19 | 0.0031 | |
| 3 | 3.45 | 100 L | 3525 | 8.1 | | 88.5 | 88.7 | 87.2 | 0.87 | 4.9 | 3.8 | 9.7 | 5.5 | 71 | 83 | 1LE1043-1AA4 | 26 | 0.0054 | |
| 4 | 4.55 | 112 M | 3560 | 10 | | 88.5 | 88 | 86.2 | 0.88 | 6 | 3.2 | 10.8 | 5.1 | 73 | 85 | 1LE1043-1BA2 | 34 | 0.012 | |
| 5.5 | 6.3 | 132 S | 3555 | 15 | | 89.5 | 89.4 | 88.2 | 0.9 | 8.6 | 2.1 | 8.6 | 4.4 | 72 | 84 | 1LE1043-1CA0 | 43 | 0.024 | |
| 7.5 | 8.6 | 132 S | 3555 | 20 | | 90.2 | 90.5 | 90 | 0.91 | 11.5 | 2.4 | 9.5 | 4.7 | 72 | 84 | 1LE1043-1CA1 | 57 | 0.031 | |
| 11 | 12.6 | 160 M | 3560 | 30 | | 91 | 90.4 | 88.4 | 0.88 | 17.2 | 2.8 | 8.5 | 4.3 | 77 | 89 | 1LE1043-1DA2 | 75 | 0.053 | |
| 15 | 17.3 | 160 M | 3565 | 40 | | 91 | 90.5 | 88.9 | 0.86 | 24 | 3.1 | 9.7 | 4.8 | 77 | 89 | 1LE1043-1DA3 | 84 | 0.061 | |
| 18.5 | 21.3 | 160 L | 3560 | 50 | | 91.7 | 91.5 | 90.3 | 0.9 | 28 | 3.1 | 9.4 | 4.4 | 77 | 89 | 1LE1043-1DA4 | 94 | 0.068 | |
| 22 | 24.5 | 180 M | 3560 | 59 | | 91.7 | 91.4 | 90 | 0.89 | 34 | 2.8 | 8.2 | 3.9 | 77 | 89 | 1LE1043-1EA2 | 129 | 0.08 | |
| 30 | 33.5 | 200 L | 3560 | 80 | | 92.4 | 92.2 | 91.4 | 0.87 | 47 | 2.9 | 7.6 | 3.6 | 77 | 84 | 1LE1043-2AA4 | 173 | 0.134 | |
| 37 | 41.5 | 200 L | 3560 | 99 | | 93 | 92.8 | 91.6 | 0.88 | 57 | 2.8 | 7.5 | 3.6 | 77 | 84 | 1LE1043-2AA5 | 194 | 0.158 | |
| 4-pole: 1500 rpm at 50 Hz, 1800 rpm at 60 Hz | | | | | | | | | | | | | | | | | | | |
| 0.75 | 0.86 | 80 M | 1760 | 4.1 | | 83.5 | 82.6 | 79.3 | 0.71 | 1.59 | 3.1 | 8.3 | 4.7 | 55 | 66 | 1LE1043-0DB3 | 14 | 0.0021 | |
| 1.1 | 1.27 | 90 S | 1750 | 6 | | 86.5 | 86.4 | 84.2 | 0.75 | 2.15 | 3.4 | 8.2 | 4.4 | 58 | 70 | 1LE1043-0EB0 | 16 | 0.0029 | |
| 1.5 | 1.75 | 90 L | 1755 | 8.2 | | 86.5 | 86.2 | 84.5 | 0.77 | 2.85 | 3.4 | 8.6 | 4.3 | 62 | 70 | 1LE1043-0EB4 | 19 | 0.0049 | |
| 2.2 | 2.55 | 100 L | 1770 | 11.9 | | 89.5 | 89.2 | 87.2 | 0.81 | 3.8 | 3.5 | 9.6 | 5.1 | 62 | 74 | 1LE1043-1AB4 | 30 | 0.014 | |
| 3 | 3.45 | 100 L | 1760 | 16.3 | | 89.5 | 89.5 | 88.3 | 0.82 | 5.1 | 3.1 | 9.5 | 4.6 | 62 | 74 | 1LE1043-1AB5 | 30 | 0.014 | |
| 4 | 4.55 | 112 M | 1770 | 19 | | 89.5 | 89.4 | 87.7 | 0.8 | 6.5 | 2.9 | 8.2 | 4.3 | 62 | 74 | 1LE1043-1BB2 | 34 | 0.017 | |
| 5.5 | 6.3 | 132 S | 1775 | 30 | | 91.7 | 91.6 | 90.5 | 0.81 | 9.3 | 3.9 | 9.7 | 4.5 | 68 | 80 | 1LE1043-1CB0 | 64 | 0.046 | |
| 7.5 | 8.6 | 132 M | 1770 | 40 | | 91.7 | 91.8 | 91 | 0.83 | 12.4 | 2.7 | 9.6 | 4.2 | 68 | 80 | 1LE1043-1CB2 | 64 | 0.046 | |
| 11 | 12.6 | 160 M | 1775 | 59 | | 92.4 | 92.3 | 91.1 | 0.83 | 18 | 3 | 8.9 | 3.8 | 69 | 81 | 1LE1043-1DB2 | 83 | 0.083 | |
| 15 | 17.3 | 160 L | 1780 | 80 | | 93 | 92.8 | 91.4 | 0.81 | 25 | 2.9 | 9.5 | 4.3 | 69 | 81 | 1LE1043-1DB4 | 100 | 0.099 | |
| 18.5 | 21.3 | 180 M | 1775 | 100 | | 93.6 | 93.7 | 93.1 | 0.81 | 30.5 | 2.7 | 7.8 | 3.6 | 68 | 75 | 1LE1043-1EB2 | 134 | 0.13 | |
| 22 | 25.3 | 180 L | 1775 | 118 | | 93.6 | 93.8 | 93.3 | 0.81 | 36.5 | 2.8 | 7.7 | 3.7 | 70 | 77 | 1LE1043-1EB4 | 142 | 0.14 | |
| 30 | 34.5 | 200 L | 1778 | 161 | IE2 | 94.1 | 94.3 | 93.8 | 0.83 | 48 | 3 | 8.1 | 3.5 | 70 | 77 | 1LE1043-2AB5 | 189 | 0.22 | |
| Voltages | | | | | | | | | | | | | | Version | | Order code | | | |
| 50 Hz 230 VΔ/400 VY | | | 60 Hz 460 VY | | | Standard | | 2 2 | | - | | | | | | | | | |
| 50 Hz 400 VΔ/690 VY | | | 60 Hz 460 VΔ | | | Standard | | 3 4 | | - | | | | | | | | | |
| 50 Hz 500 VY | | | | | | Without additional charge | | 2 7 | | - | | | | | | | | | |
| 50 Hz 500 VΔ | | | | | | Without additional charge | | 4 0 | | - | | | | | | | | | |
| For other voltages and more information, see from page 2/93 | | | | | | | | | | | | | | 9 0 | | ... | | | |
| Types of construction | | | | | | | | | | | | | | Version | | Order code | | | |
| Without flange | | | IM B3 ¹⁾ | | | Standard | | A | | - | | | | | | | | | |
| With flange | | | IM B5 ¹⁾ | | | With additional charge | | F | | - | | | | | | | | | |
| With flange | | | IM B14 ¹⁾ | | | With additional charge | | K | | - | | | | | | | | | |
| For other types of construction and more information, see from page 2/99 | | | | | | | | | | | | | | | | ... | | | |
| Motor protection | | | | | | | | | | | | | | Version | | Order code | | | |
| Without | | | | | | Standard | | A | | - | | | | | | | | | |
| PTC thermistor with 1 or 3 temperature sensors (frame sizes 80, 90 or 100 to 200) | | | | | | With additional charge | | B | | - | | | | | | | | | |
| For other motor protection and more information, see from page 2/112 | | | | | | | | | | | | | | | | ... | | | |
| Terminal box position | | | | | | | | | | | | | | Version | | Order code | | | |
| Terminal box at top | | | | | | Standard | | 4 | | - | | | | | | | | | |
| For other terminal box positions and more information, see from page 2/115 | | | | | | | | | | | | | | | | | | | |
| Special versions | | | | | | | | | | | | | | | | Order code(s) | | | |
| Forced-air cooled motors w/o ext. fan/fan cover (IC416) | | | | | | | | | | | | | | 1LE1043-.... | | -Z F90+...+...+... | | | |
| For options and information, see from page 2/118 | | | | | | | | | | | | | | 1LE1043-.... | | -Z ...+...+...+... | | | |

¹⁾ Types derived from IM B3 (IM B6/7/8, IM V6, and IM V5), from IM B5 (IM V3 and IM V1) and from IM B14 (IM V19 and IM V18) are possible, provided that no requirements exist for condensation drainage holes (H03) or stamping of the type on the rating plate. The basic type IM B3, IM B5, or IM B14 is stamped as standard on the rating plate. For orders with condensation drainage holes (H03), the type must be specified.



SIMOTICS GP and SIMOTICS SD standard motors
APAC Line · IE3 Premium Efficiency

Aluminum series SIMOTICS GP 1LE1043 – self-ventilated or forced-air cooled

Selection and ordering data

Technical specifications at 60 Hz/P50 power rating

| Operating values at rated power | | | | | | | | | | | | | | | Aluminum series | | m _{IM B3} | J | | | | | | |
|---|-------------------------------------|---------------|-----------------------------|-----------------------------|------------------------------------|-------------------------------------|-------------------------------------|-------------------------------------|--|---------------------------------------|--|--|---|----------------------------|--------------------------|---------------------|--------------------|-----|--------------------|----|------------------|--|--|--|
| P _{rated} 60 Hz/ P50 | P _{rated} 60 Hz/ P60 | Frame size | n _{rated} 60 Hz | T _{rated} 60 Hz | Different IE class 60 Hz/P60 | η _{rated} 60 Hz, 4/4 | η _{rated} 60 Hz, 3/4 | η _{rated} 60 Hz, 2/4 | cosφ _{rated} 60 Hz, 4/4 | I _{rated} 60 Hz, 460 V | T _{LR} / T _{rated} 60 Hz | I _{LR} / I _{rated} 60 Hz | T _B / T _{rated} 60 Hz | L _{pifA} 60 Hz | L _{WA} 60 Hz | 1LE1043 | | | Article No. | kg | kgm ² | | | |
| 0.75 | 0.86 | 90 S | 1155 | 6.2 | | 82.5 | 82.4 | 79.9 | 0.65 | 1.76 | 2.4 | 5.3 | 3.1 | 46 | 58 | 1LE1043-0EC0 | - - - - - | 16 | 0.004 | | | | | |
| 1.1 | 1.27 | 100 L | 1180 | 8.9 | | 87.5 | 87.2 | 84.8 | 0.69 | 2.3 | 2.4 | 6.7 | 3.3 | 62 | 74 | 1LE1043-1AC3 | - - - - - | 30 | 0.014 | | | | | |
| 1.5 | 1.75 | 112 S | 1170 | 14 | | 88.5 | 88.7 | 87.3 | 0.76 | 3.25 | 2 | 6.2 | 2.8 | 65 | 77 | 1LE1043-1BC1 | - - - - - | 34 | 0.017 | | | | | |
| 2.2 | 2.55 | 132 S | 1180 | 21 | | 89.5 | 89.2 | 87.7 | 0.72 | 4.3 | 2.4 | 7.3 | 3.5 | 63 | 71 | 1LE1043-1CC1 | - - - - - | 42 | 0.033 | | | | | |
| 3 | 3.45 | 132 S | 1180 | 24 | | 89.5 | 89.5 | 87.9 | 0.70 | 6 | 2.6 | 7.6 | 3.8 | 61 | 69 | 1LE1043-1CC0 | - - - - - | 42 | 0.034 | | | | | |
| 4 | 4.55 | 132 M | 1180 | 30 | | 89.5 | 89.9 | 88.2 | 0.69 | 7.1 | 2.8 | 7.5 | 3.8 | 62 | 70 | 1LE1043-1CC2 | - - - - - | 46 | 0.039 | | | | | |
| 5.5 | 6.3 | 132 M | 1180 | 45 | | 91.0 | 90.8 | 89.2 | 0.69 | 11 | 3 | 7.8 | 4 | 67 | 75 | 1LE1043-1CC3 | - - - - - | 58 | 0.050 | | | | | |
| 7.5 | 8.6 | 160 M | 1185 | 60 | | 91.0 | 90.8 | 89.3 | 0.80 | 12 | 2.7 | 9.3 | 3.7 | 73 | 81 | 1LE1043-1DC2 | - - - - - | 95 | 0.132 | | | | | |
| 11 | 12.6 | 160 L | 1185 | 89 | | 91.7 | 91.7 | 90.5 | 0.78 | 19 | 3.4 | 8 | 3.2 | 72 | 80 | 1LE1043-1DC4 | - - - - - | 106 | 0.164 | | | | | |
| 15 | 18 | 180 L | 1178 | 122 | IE2 | 91.7 | 92 | 91.4 | 0.79 | 26 | 2.5 | 6.8 | 3 | 61 | 68 | 1LE1043-1EC4 | - - - - - | 130 | 0.19 | | | | | |
| 18.5 | 22 | 200 L | 1180 | 150 | IE2 | 93 | 93.8 | 93.8 | 0.78 | 32 | 2.8 | 6.5 | 3 | 64 | 71 | 1LE1043-2AC4 | - - - - - | 166 | 0.28 | | | | | |
| 22 | 26.5 | 200 L | 1180 | 178 | IE2 | 93 | 93.5 | 93.4 | 0.79 | 37.5 | 2.6 | 6.3 | 2.8 | 63 | 70 | 1LE1043-2AC5 | - - - - - | 179 | 0.32 | | | | | |
| Voltagess | | | | | | | | | | | | | | | Version | | Order code | | | | | | | |
| 50 Hz 230 VΔ/400 VY | | | 60 Hz 460 VY | | | Standard | | 2 2 | | - | | | | | | | | | | | | | | |
| 50 Hz 400 VΔ/690 VY | | | 60 Hz 460 VΔ | | | Standard | | 3 4 | | - | | | | | | | | | | | | | | |
| 50 Hz 500 VY | | | | | | Without additional charge | | 2 7 | | - | | | | | | | | | | | | | | |
| 50 Hz 500 VΔ | | | | | | Without additional charge | | 4 0 | | - | | | | | | | | | | | | | | |
| For other voltages and more information, see from page 2/93 | | | | | | | | | | | | | | | 9 0 | | ... | | | | | | | |
| Types of construction | | | | | | | | | | | | | | | Version | | Order code | | | | | | | |
| Without flange | | | IM B3 ¹⁾ | | | Standard | | A | | - | | | | | | | | | | | | | | |
| With flange | | | IM B5 ¹⁾ | | | With additional charge | | F | | - | | | | | | | | | | | | | | |
| With flange | | | IM B14 ¹⁾ | | | With additional charge | | K | | - | | | | | | | | | | | | | | |
| For other types of construction and more information, see from page 2/99 | | | | | | | | | | | | | | | - | | ... | | | | | | | |
| Motor protection | | | | | | | | | | | | | | | Version | | Order code | | | | | | | |
| Without | | | | | | Standard | | A | | - | | | | | | | | | | | | | | |
| PTC thermistor with 1 or 3 temperature sensors (frame sizes 90 or 100 to 200) | | | | | | With additional charge | | B | | - | | | | | | | | | | | | | | |
| For other motor protection and more information, see from page 2/112 | | | | | | | | | | | | | | | - | | ... | | | | | | | |
| Terminal box position | | | | | | | | | | | | | | | Version | | Order code | | | | | | | |
| Terminal box at top | | | | | | Standard | | 4 | | | | | | | | | | | | | | | | |
| For other terminal box positions and more information, see from page 2/115 | | | | | | | | | | | | | | | | | | | | | | | | |
| Special versions | | | | | | | | | | | | | | | | | Order code(s) | | | | | | | |
| Forced-air cooled motors w/o ext. fan/fan cover (IC416) | | | | | | | | 1LE1043-.... | | -Z F90 +...+...+... | | | | | | | | | | | | | | |
| For options and information, see from page 2/118 | | | | | | | | | | | | | | | | | 1LE1043-.... | | -Z ...+...+...+... | | | | | |



¹⁾ Types derived from IM B3 (IM B6/7/8, IM V6, and IM V5), from IM B5 (IM V3 and IM V1) and from IM B14 (IM V19 and IM V18) are possible, provided that no requirements exist for condensation drainage holes (H03) or stamping of the type on the rating plate. The basic type IM B3, IM B5, or IM B14 is stamped as standard on the rating plate. For orders with condensation drainage holes (H03), the type must be specified.

SIMOTICS GP and SIMOTICS SD standard motors

APAC Line · IE3 Premium Efficiency



Aluminum series SIMOTICS GP 1LE1043 with increased power – self-ventilated or forced-air cooled

Selection and ordering data

Technical specifications at 60 Hz/P50 power rating

| Operating values at rated power | | | | | | | | | | | | | | Aluminum series | | $m_{IM\ B3}$ | J | | |
|--|-----------------------------|---------------|----------------------|----------------------|------------------------------------|---------------------------------|---------------------------------|---------------------------------|-------------------------------------|--------------------------------|-----------------------------------|-----------------------------------|--------------------------------|--|-------------------|---------------------|-----|---------|-------------|
| P_{rated} 60 Hz P50 | P_{rated} 60 Hz P60 | Frame size | n_{rated} 60 Hz | T_{rated} 60 Hz | Different IE class 60 Hz/P60 | η_{rated} 60 Hz, 4/4 | η_{rated} 60 Hz, 3/4 | η_{rated} 60 Hz, 2/4 | $\cos\phi_{rated}$ 60 Hz, 4/4 | I_{rated} 60 Hz, 460 V | $T_{LR}/$ T_{rated} 60 Hz | $I_{LR}/$ I_{rated} 60 Hz | $T_B/$ T_{rated} 60 Hz | L_{pIA} 60 Hz | L_{WA} 60 Hz | | | 1LE1043 | Article No. |
| 4 | 4.55 | 100 L | 3500 | 12 | | 88.5 | 89.6 | 89.5 | 0.89 | 7.3 | 3 | 8.4 | 4 | 75 | 83 | 1LE1043-1AA6 | 26 | 0.0054 | |
| 11 | 12.6 | 132 M | 3565 | 29 | | 91 | 91.1 | 90.3 | 0.86 | 17.6 | 2.5 | 9.6 | 5.2 | 72 | 84 | 1LE1043-1CA6 | 57 | 0.031 | |
| 15 | 17.3 | 132 L | 3555 | 46 | | 91.7 | 92.1 | 91.7 | 0.89 | 26.5 | 2.4 | 8.7 | 4.8 | 72 | 84 | 1LE1043-1CA7 | 65 | 0.035 | |
| 22 | 25.3 | 160 L | 3560 | 59 | | 91.7 | 91.8 | 90.9 | 0.9 | 33.5 | 3.1 | 9.7 | 4.5 | 77 | 89 | 1LE1043-1DA6 | 105 | 0.073 | |
| 30 | 33.5 | 180 L | 3560 | 80 | | 92.4 | 92.6 | 92.1 | 0.87 | 47 | 2.9 | 8.8 | 4.5 | 77 | 89 | 1LE1043-1EA6 | 140 | 0.094 | |
| 45 | 51 | 200 L | 3560 | 121 | | 93.6 | 93.7 | 93 | 0.86 | 70 | 3 | 8.4 | 3.7 | 77 | 84 | 1LE1043-2AA6 | 194 | 0.170 | |
| 4-pole: 1500 rpm at 50 Hz, 1800 rpm at 60 Hz | | | | | | | | | | | | | | | | | | | |
| 11 | 12.6 | 132 M | 1775 | 59 | | 92.4 | 92.6 | 91.8 | 0.79 | 19 | 3.1 | 8.7 | 4.1 | 68 | 80 | 1LE1043-1CB6 | 62 | 0.046 | |
| 18.5 | 21.3 | 160 L | 1780 | 99 | | 93.6 | 93.3 | 91.9 | 0.75 | 33 | 3.9 | 9.6 | 4.5 | 69 | 81 | 1LE1043-1DB6 | 110 | 0.099 | |
| 30 | 34.5 | 180 L | 1775 | 160 | | 94.1 | 94.2 | 93.5 | 0.78 | 51 | 3.3 | 9.5 | 4.3 | 79 | 86 | 1LE1043-1EB6 | 154 | 0.173 | |
| 37 | 42.5 | 200 L | 1780 | 198 | | 94.5 | 94.7 | 94.2 | 0.8 | 61 | 3.3 | 9 | 4 | 70 | 77 | 1LE1043-2AB6 | 205 | 0.275 | |
| Voltagess | | | | | | | | | | | | | | Version | | Order code | | | |
| 50 Hz 230 VΔ/400 VY | | | 60 Hz 460 VY | | | Standard | | 2 | | - | | - | | - | | - | | | |
| 50 Hz 400 VΔ/690 VY | | | 60 Hz 460 VΔ | | | Standard | | 3 | | 4 | | - | | - | | - | | | |
| 50 Hz 500 VY | | | | | | Without additional charge | | 2 | | 7 | | - | | - | | - | | | |
| 50 Hz 500 VΔ | | | | | | Without additional charge | | 4 | | 0 | | - | | - | | - | | | |
| For other voltages and more information, see from page 2/93 | | | | | | | | | | | | | | 9 | | 0 | | ... | |
| Types of construction | | | | | | | | | | | | | | Version | | Order code | | | |
| Without flange | | | IM B3 ¹⁾ | | | Standard | | A | | - | | - | | - | | - | | | |
| With flange | | | IM B5 ¹⁾ | | | With additional charge | | F | | - | | - | | - | | - | | | |
| With flange | | | IM B14 ¹⁾ | | | With additional charge | | K | | - | | - | | - | | - | | | |
| For other types of construction and more information, see from page 2/99 | | | | | | | | | | | | | | - | | - | | - | |
| Motor protection | | | | | | | | | | | | | | Version | | Order code | | | |
| Without | | | | | | Standard | | A | | - | | - | | - | | - | | | |
| PTC thermistor with 3 temperature sensors | | | | | | With additional charge | | B | | - | | - | | - | | - | | | |
| For other motor protection and more information, see from page 2/112 | | | | | | | | | | | | | | - | | - | | - | |
| Terminal box position | | | | | | | | | | | | | | Version | | Order code | | | |
| Terminal box at top | | | | | | Standard | | 4 | | - | | - | | - | | - | | | |
| For other terminal box positions and more information, see from page 2/115 | | | | | | | | | | | | | | - | | - | | - | |
| Special versions | | | | | | | | | | | | | | Order code(s) | | | | | |
| Forced-air cooled motors w/o ext. fan/fan cover (IC416) | | | | | | | | | | | | | | 1LE1043- -Z F90 + . . . + | | | | | |
| For options and information, see from page 2/118 | | | | | | | | | | | | | | 1LE1043- -Z . . . + . . . + | | | | | |

¹⁾ Types derived from IM B3 (IM B6/7/8, IM V6, and IM V5), from IM B5 (IM V3 and IM V1) and from IM B14 (IM V19 and IM V18) are possible, provided that no requirements exist for condensation drainage holes (H03) or stamping of the type on the rating plate. The basic type IM B3, IM B5, or IM B14 is stamped as standard on the rating plate. For orders with condensation drainage holes (H03), the type must be specified.



Selection and ordering data

Technical specifications at 60 Hz/P50 power rating

| Operating values at rated power | | | | | | | | | | | | | | Cast-iron series | | | | |
|--|--------------------------------|---------------|------------------------|------------------------|------------------------------------|-----------------------------------|-----------------------------------|-----------------------------------|---------------------------------------|----------------------------------|-------------------------------------|-------------------------------------|----------------------------------|----------------------|---------------------|----------------------|-------------|------------------|
| P_{rated} , 60 Hz/ P50 | P_{rated} , 60 Hz/ P60 | Frame size | n_{rated} , 60 Hz | T_{rated} , 60 Hz | Different IE class 60 Hz/P60 | η_{rated} , 60 Hz, 4/4 | η_{rated} , 60 Hz, 3/4 | η_{rated} , 60 Hz, 2/4 | $\cos\phi_{rated}$, 60 Hz, 4/4 | I_{rated} , 60 Hz, 460 V | $T_{LR}/$ T_{rated} , 60 Hz | $I_{LR}/$ I_{rated} , 60 Hz | $T_B/$ T_{rated} , 60 Hz | L_{pFA} , 60 Hz | L_{WA} , 60 Hz | 1LE1543 – Basic Line | $m_{IM B3}$ | J |
| kW | kW | FS | rpm | Nm | | % | % | % | | A | | | | dB(A) | dB(A) | Article No. | kg | kgm ² |
| <ul style="list-style-type: none"> • Cooling: Self-ventilated (IC411) or with order code F90 forced-air cooled without external fan and fan cover (IC418) • Efficiency according to IEC 60034-30-1: IE3 Premium Efficiency • Insulation: Thermal class 155 (temperature class F), IP55 degree of protection, utilization in accordance with thermal class 130 (temperature class B) | | | | | | | | | | | | | | | | | | |
| 2-pole: 3000 rpm at 50 Hz, 3600 rpm at 60 Hz | | | | | | | | | | | | | | | | | | |
| 0.75 | 0.86 | 80 M | 3480 | 2.1 | | 77 | 77.2 | 75.7 | 0.84 | 1.45 | 3 | 7.1 | 3.6 | 64 | 75 | 1LE1543-0DA2 | 18 | 0.0011 |
| 1.1 | 1.27 | 80 M | 3500 | 3 | | 84 | 84 | 82 | 0.83 | 1.98 | 3.3 | 8.4 | 4 | 64 | 75 | 1LE1543-0DA3 | 21 | 0.0013 |
| 1.5 | 1.75 | 90 S | 3525 | 4.1 | | 85.5 | 84.8 | 82.3 | 0.84 | 2.6 | 3.1 | 9.8 | 4.9 | 69 | 81 | 1LE1543-0EA0 | 26 | 0.0021 |
| 2.2 | 2.55 | 90 L | 3530 | 6 | | 86.5 | 86.4 | 84.5 | 0.87 | 3.65 | 3 | 9.6 | 4.9 | 69 | 81 | 1LE1543-0EA4 | 32 | 0.0031 |
| 3 | 3.45 | 100 L | 3525 | 8.1 | | 88.5 | 88.7 | 87.2 | 0.87 | 4.9 | 3.8 | 9.7 | 5.5 | 71 | 83 | 1LE1543-1AA4 | 36 | 0.0054 |
| 3.7 | 4.55 | 112 M | 3560 | 10 | | 88.5 | 88 | 86.2 | 0.88 | 6 | 3.2 | 10.8 | 5.1 | 73 | 85 | 1LE1543-1BA2 | 45 | 0.012 |
| 5.5 | 6.3 | 132 S | 3555 | 15 | | 89.5 | 89.4 | 88.2 | 0.9 | 8.6 | 2.1 | 8.6 | 4.4 | 72 | 84 | 1LE1543-1CA0 | 58 | 0.024 |
| 7.5 | 8.6 | 132 S | 3555 | 20 | | 90.2 | 90.5 | 90 | 0.91 | 11.5 | 2.4 | 9.5 | 4.7 | 72 | 84 | 1LE1543-1CA1 | 73 | 0.031 |
| 11 | 12.6 | 160 M | 3560 | 30 | | 91 | 90.4 | 88.4 | 0.88 | 17.2 | 2.8 | 8.5 | 4.3 | 77 | 89 | 1LE1543-1DA2 | 100 | 0.053 |
| 15 | 17.3 | 160 M | 3565 | 40 | | 91 | 90.5 | 88.9 | 0.86 | 24 | 3.1 | 9.7 | 4.8 | 77 | 89 | 1LE1543-1DA3 | 110 | 0.061 |
| 18.5 | 21.3 | 160 L | 3560 | 50 | | 91.7 | 91.5 | 90.3 | 0.9 | 28 | 3.1 | 9.4 | 4.4 | 77 | 89 | 1LE1543-1DA4 | 127 | 0.068 |
| 22 | 24.5 | 180 M | 3560 | 59 | | 91.7 | 91.4 | 90 | 0.89 | 34 | 2.8 | 8.2 | 3.9 | 77 | 89 | 1LE1543-1EA2 | 160 | 0.08 |
| 30 | 33.5 | 200 L | 3560 | 80 | | 92.4 | 92.2 | 91.4 | 0.87 | 47 | 2.9 | 7.6 | 3.6 | 77 | 84 | 1LE1543-2AA4 | 225 | 0.134 |
| 37 | 41.5 | 200 L | 3560 | 99 | | 93 | 92.8 | 91.6 | 0.88 | 57 | 2.8 | 7.5 | 3.6 | 77 | 84 | 1LE1543-2AA5 | 250 | 0.158 |
| 45 | 51 | 225 M | 3570 | 120 | | 93.6 | 93.7 | 93.1 | 0.88 | 69 | 2.7 | 7.6 | 3.5 | 75 | 89 | 1LE1543-2BA2 | 315 | 0.26 |
| 55 | 62 | 250 M | 3578 | 147 | | 93.6 | 93.4 | 92.3 | 0.89 | 83 | 2.5 | 7.3 | 3.3 | 76 | 90 | 1LE1543-2CA2 | 385 | 0.46 |
| 75 | 84 | 280 S | 3578 | 200 | IE2 | 94.1 | 93.9 | 92.7 | 0.89 | 112 | 2.7 | 7.6 | 3.2 | 78 | 92 | 1LE1543-2DA0 | 510 | 0.77 |
| 90 | 101 | 280 M | 3578 | 240 | IE2 | 95 | 94.8 | 93.8 | 0.9 | 132 | 2.7 | 8.1 | 3.3 | 78 | 92 | 1LE1543-2DA2 | 590 | 0.94 |
| 110 | 123 | 315 S | 3585 | 293 | | 95 | 94.8 | 93.8 | 0.91 | 160 | 2.6 | 8 | 3.3 | 79 | 93 | 1LE1543-3AA0 | 750 | 1.4 |
| 132 | 148 | 315 M | 3585 | 352 | | 95.4 | 95.1 | 94 | 0.91 | 191 | 2.8 | 8 | 3.4 | 79 | 93 | 1LE1543-3AA2 | 880 | 1.6 |
| 160 | 180 | 315 L | 3588 | 426 | IE2 | 95.4 | 95.1 | 93.9 | 0.91 | 230 | 3.2 | 8.8 | 3.5 | 82 | 96 | 1LE1543-3AA4 | 980 | 1.9 |
| 200 | 224 | 315 L | 3586 | 533 | | 95.8 | 95.7 | 94.8 | 0.92 | 285 | 3.2 | 8.3 | 3.3 | 82 | 96 | 1LE1543-3AA5 | 1150 | 2.3 |

| Order code | Version | 2 | 3 | 4 | 7 | 0 | 9 |
|---------------------------|---------------------------|---|---|---|---|---|---|
| Standard | Standard | 2 | 3 | 4 | 7 | 0 | 9 |
| Without additional charge | Without additional charge | 2 | 7 | | | | |
| Without additional charge | Without additional charge | 4 | 0 | | | | |
| ... | ... | 9 | 0 | | | | |

| Order code | Version | A | F |
|------------------------|------------------------|---|---|
| Standard | Standard | A | F |
| With additional charge | With additional charge | | |
| ... | ... | | |

| Order code | Version | A | B |
|------------------------|------------------------|---|---|
| Standard | Standard | A | B |
| With additional charge | With additional charge | | |
| ... | ... | | |

| Order code | Version | 4 |
|------------|----------|---|
| Standard | Standard | 4 |

| Order code(s) | Version |
|-------------------------------|-------------------------------|
| 1LE1543-...-Z F90+...+...+... | 1LE1543-...-Z F90+...+...+... |
| 1LE1543-...-Z ...+...+...+... | 1LE1543-...-Z ...+...+...+... |

¹⁾ Types derived from IM B3 (IM B6/7/8, IM V6 and IM V5), from IM B5 (IM V3 and IM V1) and from IM B14 (IM V19 and IM V18) are possible, provided that no requirement exists for stamping of the type on the rating plate. The basic type IM B3, IM B5, or IM B14 is stamped as standard on the rating plate. If mounted in a different position, the position must be specified to ensure that the condensation drainage holes are positioned correctly.



SIMOTICS GP and SIMOTICS SD standard motors

APAC Line · IE3 Premium Efficiency



Cast-iron series SIMOTICS SD 1LE1543 Basic Line – self-ventilated or forced-air cooled

Selection and ordering data

Technical specifications at 60 Hz/P50 power rating

| Operating values at rated power | | | | | | | | | | | | | Cast-iron series | | m _{IM B3} | J | | |
|---------------------------------------|---------------------------------------|---------------|-------------------------------|-------------------------------|------------------------------------|---------------------------------------|---------------------------------------|---------------------------------------|--|---|--|--|---|-----------------------------|--------------------|---|----------------------------|-------------|
| P _{rated} , 60 Hz/ P50 | P _{rated} , 60 Hz/ P60 | Frame size | n _{rated} , 60 Hz | T _{rated} , 60 Hz | Different IE class 60 Hz/P60 | η _{rated} , 60 Hz, 4/4 | η _{rated} , 60 Hz, 3/4 | η _{rated} , 60 Hz, 2/4 | cosφ _{rated} , 60 Hz, 4/4 | I _{rated} , 60 Hz, 460 V | T _{LR} /I _{rated} , 60 Hz | I _{LR} /I _{rated} , 60 Hz | T _B /I _{rated} , 60 Hz | L _p μA, 60 Hz | | | L _{WA} , 60 Hz | Article No. |
| kW | kW | FS | rpm | Nm | | % | % | % | | A | | | | | | | | |

- Cooling: Self-ventilated (IC411) or with order code F90 forced-air cooled without external fan and fan cover (IC418)
- Efficiency according to IEC 60034-30-1: IE3 Premium Efficiency
- Insulation: Thermal class 155 (temperature class F), IP55 degree of protection, utilization in accordance with thermal class 130 (temperature class B)

| 4-pole: 1500 rpm at 50 Hz, 1800 rpm at 60 Hz | | | | | | | | | | | | | | | | | | |
|--|------|-------|------|------|-----|------|------|------|------|------|-----|-----|-----|----|----|--------------|------|--------|
| 0.75 | 0.86 | 80 M | 1760 | 4.1 | | 83.5 | 82.6 | 79.3 | 0.71 | 1.59 | 3.1 | 8.3 | 4.7 | 55 | 66 | 1LE1543-0DB3 | 22 | 0.0029 |
| 1.1 | 1.27 | 90 S | 1750 | 6 | | 86.5 | 86.4 | 84.2 | 0.75 | 2.15 | 3.4 | 8.2 | 4.4 | 58 | 70 | 1LE1543-0EB0 | 25 | 0.0036 |
| 1.5 | 1.75 | 90 L | 1755 | 8.2 | | 86.5 | 86.2 | 84.5 | 0.77 | 2.85 | 3.4 | 8.6 | 4.3 | 62 | 70 | 1LE1543-0EB4 | 31 | 0.0049 |
| 2.2 | 2.55 | 100 L | 1770 | 11.9 | | 89.5 | 89.2 | 87.2 | 0.81 | 3.8 | 3.5 | 9.6 | 5.1 | 62 | 74 | 1LE1543-1AB4 | 40 | 0.014 |
| 3 | 3.45 | 100 L | 1760 | 16.3 | | 89.5 | 89.5 | 88.3 | 0.82 | 5.1 | 3.1 | 9.5 | 4.6 | 62 | 74 | 1LE1543-1AB5 | 40 | 0.014 |
| 4 | 4.55 | 112 M | 1770 | 19 | | 89.5 | 89.4 | 87.7 | 0.8 | 6.5 | 2.9 | 8.2 | 4.3 | 62 | 74 | 1LE1543-1BB2 | 46 | 0.017 |
| 5.5 | 6.3 | 132 S | 1775 | 30 | | 91.7 | 91.6 | 90.5 | 0.81 | 9.3 | 3.9 | 9.7 | 4.5 | 68 | 80 | 1LE1543-1CB0 | 74 | 0.046 |
| 7.5 | 8.6 | 132 M | 1770 | 40 | | 91.7 | 91.8 | 91 | 0.83 | 12.4 | 2.7 | 9.6 | 4.2 | 68 | 80 | 1LE1543-1CB2 | 80 | 0.046 |
| 11 | 12.6 | 160 M | 1775 | 59 | | 92.4 | 92.3 | 91.1 | 0.83 | 18 | 3 | 8.9 | 3.8 | 69 | 81 | 1LE1543-1DB2 | 109 | 0.083 |
| 15 | 17.3 | 160 L | 1780 | 80 | | 93 | 92.8 | 91.4 | 0.81 | 25 | 2.9 | 9.5 | 4.3 | 69 | 81 | 1LE1543-1DB4 | 127 | 0.099 |
| 18.5 | 21.3 | 180 M | 1775 | 100 | | 93.6 | 93.7 | 93.1 | 0.81 | 30.5 | 2.7 | 7.8 | 3.6 | 68 | 75 | 1LE1543-1EB2 | 165 | 0.13 |
| 22 | 25.3 | 180 L | 1775 | 118 | | 93.6 | 93.8 | 93.3 | 0.81 | 36.5 | 2.8 | 7.7 | 3.7 | 70 | 77 | 1LE1543-1EB4 | 170 | 0.14 |
| 30 | 34.5 | 200 L | 1778 | 161 | IE2 | 94.1 | 94.3 | 93.8 | 0.83 | 48 | 3 | 8.1 | 3.5 | 70 | 77 | 1LE1543-2AB5 | 240 | 0.22 |
| 37 | 42.5 | 225 S | 1782 | 198 | IE2 | 94.5 | 94.7 | 94.2 | 0.85 | 58 | 2.8 | 7.5 | 3 | 66 | 80 | 1LE1543-2BB0 | 285 | 0.42 |
| 45 | 52 | 225 M | 1782 | 241 | IE2 | 95.0 | 95.3 | 95.1 | 0.85 | 70 | 3 | 7.7 | 3.3 | 66 | 80 | 1LE1543-2BB2 | 340 | 0.52 |
| 55 | 63 | 250 M | 1786 | 294 | IE2 | 95.4 | 95.6 | 95.1 | 0.86 | 84 | 2.8 | 7.6 | 3.2 | 67 | 81 | 1LE1543-2CB2 | 420 | 0.85 |
| 75 | 86 | 280 S | 1785 | 460 | IE2 | 94.5 | 94.7 | 94.2 | 0.87 | 131 | 2.5 | 6.8 | 2.9 | 77 | 91 | 1LE1543-2DB0 | 570 | 1.39 |
| 90 | 104 | 280 M | 1788 | 481 | IE2 | 95.4 | 95.5 | 94.9 | 0.87 | 136 | 2.9 | 8 | 3.3 | 79 | 93 | 1LE1543-2DB2 | 670 | 1.7 |
| 110 | 127 | 315 S | 1790 | 587 | | 95.8 | 95.9 | 95.4 | 0.86 | 168 | 3 | 7.5 | 3.1 | 73 | 87 | 1LE1543-3AB0 | 760 | 2.2 |
| 132 | 152 | 315 M | 1790 | 704 | | 96.2 | 96.3 | 95.8 | 0.87 | 198 | 3.1 | 8.2 | 3.2 | 76 | 90 | 1LE1543-3AB2 | 960 | 2.9 |
| 160 | 184 | 315 L | 1791 | 853 | | 96.2 | 96.2 | 95.7 | 0.87 | 240 | 3.3 | 8.4 | 3.3 | 76 | 90 | 1LE1543-3AB4 | 990 | 3.1 |
| 200 | 230 | 315 L | 1791 | 1066 | IE2 | 96.2 | 96.2 | 95.5 | 0.87 | 300 | 3.5 | 8.7 | 3.2 | 78 | 93 | 1LE1543-3AB5 | 1190 | 3.7 |

| Voltages | | Version | Order code |
|--|---------------------|---------------------------|--------------------|
| 50 Hz 230 VΔ/400 VY | 60 Hz 460 VY | Standard | 2 2 |
| 50 Hz 400 VΔ/690 VY | 60 Hz 460 VΔ | Standard | 3 4 |
| 50 Hz 500 VY | | Without additional charge | 2 7 |
| 50 Hz 500 VΔ | | Without additional charge | 4 0 |
| For other voltages and more information, see from page 2/96 | | | 9 0 |
| Types of construction | | Version | Order code |
| Without flange | IM B3 ¹⁾ | Standard | A |
| With flange | IM B5 ¹⁾ | With additional charge | F |
| For other types of construction and more information, see from page 2/103 | | | |
| Motor protection | | Version | Order code |
| Without | | Standard | A |
| PTC thermistor with 3 temperature sensors | | With additional charge | B |
| For other motor protection and more information, see from page 2/113 | | | |
| Terminal box position | | Version | Order code(s) |
| Terminal box at top | | Standard | 4 |
| For other terminal box positions and more information, see from page 2/116 | | | |
| Special versions | | Order code(s) | |
| Forced-air cooled motors w/o ext. fan/fan cover (IC418) | | 1LE1543-.... | -Z F90+...+...+... |
| For options, see from page 2/125 | | 1LE1543-.... | -Z ...+...+...+... |

¹⁾ Types derived from IM B3 (IM B6/7/8, IM V6 and IM V5), from IM B5 (IM V3 and IM V1) and from IM B14 (IM V19 and IM V18) are possible, provided that no requirement exists for stamping of the type on the rating plate. The basic type IM B3, IM B5, or IM B14 is stamped as standard on the rating plate. If mounted in a different position, the position must be specified to ensure that the condensation drainage holes are positioned correctly.



SIMOTICS GP and SIMOTICS SD standard motors
APAC Line · IE3 Premium Efficiency

Cast-iron series SIMOTICS SD 1LE1543 Basic Line – self-ventilated or forced-air cooled

Selection and ordering data

Technical specifications at 60 Hz/P50 power rating

| Operating values at rated power | | | | | | | | | | | | | | Cast-iron series | | m _{IM B3} | J | | |
|--|--------------------------------------|---------------|-------------------------------|-------------------------------|-----------------------|---------------------------------------|---------------------------------------|---------------------------------------|--|---|--|--|---|-----------------------------|----------------------------|--------------------|------|----------------------|-------------|
| P _{rated} , 60 Hz P50 | P _{rated} , 60 Hz P60 | Frame size | n _{rated} , 60 Hz | T _{rated} , 60 Hz | Different IE class | η _{rated} , 60 Hz, 4/4 | η _{rated} , 60 Hz, 3/4 | η _{rated} , 60 Hz, 2/4 | cosφ _{rated} , 60 Hz, 4/4 | I _{rated} , 60 Hz, 460 V | T _{LR} / I _{rated} , 60 Hz | I _{LR} / I _{rated} , 60 Hz | T _β / I _{rated} , 60 Hz | L _p μA, 60 Hz | L _{WA} , 60 Hz | | | 1LE1543 – Basic Line | Article No. |
| kW | kW | FS | rpm | Nm | | % | % | % | | A | | | | | | | | | |
| <ul style="list-style-type: none"> Cooling: Self-ventilated (IC411) or with order code F90 forced-air cooled without external fan and fan cover (IC418) Efficiency according to IEC 60034-30-1: IE3 Premium Efficiency Insulation: Thermal class 155 (temperature class F), IP55 degree of protection, utilization in accordance with thermal class 130 (temperature class B) | | | | | | | | | | | | | | | | | | | |
| 6-pole: 1000 rpm at 50 Hz, 1200 rpm at 60 Hz | | | | | | | | | | | | | | | | | | | |
| 0.75 | 0.86 | 90 S | 1155 | 6.2 | | 82.5 | 82.4 | 79.9 | 0.65 | 3.05 | 2.4 | 5.3 | 3.1 | 46 | 58 | 1LE1543-0EC0 | 27 | 0.004 | |
| 1.1 | 1.27 | 100 L | 1180 | 8.9 | | 87.5 | 87.2 | 84.8 | 0.69 | 2.3 | 2.4 | 6.7 | 3.3 | 62 | 74 | 1LE1543-1AC3 | 25 | 0.011 | |
| 1.5 | 1.75 | 112 M | 1175 | 12 | | 88.5 | 88.3 | 86.2 | 0.73 | 2.9 | 2.2 | 6.9 | 3.2 | 65 | 77 | 1LE1543-1BC1 | 53 | 0.017 | |
| 2.2 | 2.55 | 132 S | 1180 | 21 | | 89.5 | 89.2 | 87.7 | 0.72 | 4.3 | 2.4 | 7.3 | 3.5 | 63 | 71 | 1LE1543-1CC1 | 60 | 0.033 | |
| 3 | 3.45 | 132 S | 1180 | 24 | | 89.5 | 89.5 | 87.9 | 0.70 | 6 | 2.6 | 7.6 | 3.8 | 61 | 69 | 1LE1543-1CC0 | 60 | 0.034 | |
| 4 | 4.55 | 132 M | 1180 | 30 | | 89.5 | 89.9 | 88.2 | 0.69 | 7.1 | 2.8 | 7.5 | 3.8 | 62 | 70 | 1LE1543-1CC2 | 64 | 0.039 | |
| 5.5 | 6.3 | 132 M | 1180 | 45 | | 91.0 | 90.8 | 89.2 | 0.69 | 11 | 3 | 7.8 | 4 | 67 | 75 | 1LE1543-1CC3 | 76 | 0.050 | |
| 7.5 | 8.6 | 160 M | 1185 | 60 | | 91.0 | 90.8 | 89.3 | 0.80 | 12.9 | 2.7 | 9.3 | 3.7 | 73 | 81 | 1LE1543-1DC2 | 124 | 0.132 | |
| 11 | 12.6 | 160 L | 1185 | 89 | | 91.7 | 91.7 | 90.5 | 0.78 | 19.3 | 3.4 | 8 | 3.2 | 72 | 80 | 1LE1543-1DC4 | 138 | 0.164 | |
| 15 | 18 | 180 L | 1178 | 122 | IE2 | 91.7 | 92 | 91.4 | 0.79 | 26 | 2.5 | 6.8 | 3 | 61 | 68 | 1LE1543-1EC4 | 180 | 0.19 | |
| 18.5 | 22 | 200 L | 1180 | 150 | IE2 | 93 | 93.8 | 93.8 | 0.78 | 32 | 2.8 | 6.5 | 3 | 64 | 71 | 1LE1543-2AC4 | 215 | 0.28 | |
| 22 | 26.5 | 200 L | 1180 | 178 | IE2 | 93 | 93.5 | 93.4 | 0.79 | 37.5 | 2.6 | 6.3 | 2.8 | 63 | 70 | 1LE1543-2AC5 | 230 | 0.32 | |
| 37 | 44.5 | 250 M | 1188 | 297 | IE2 | 94.1 | 94.4 | 93.9 | 0.83 | 59 | 3.1 | 8 | 3.1 | 63 | 76 | 1LE1543-2CC2 | 405 | 1 | |
| 45 | 54 | 280 S | 1190 | 361 | IE2 | 94.5 | 94.6 | 94.1 | 0.83 | 72 | 3.3 | 7.7 | 3.1 | 66 | 80 | 1LE1543-2DC0 | 510 | 1.4 | |
| 55 | 66 | 280 M | 1190 | 441 | IE2 | 94.5 | 94.6 | 93.9 | 0.84 | 87 | 3.6 | 9.2 | 3.3 | 66 | 80 | 1LE1543-2DC2 | 560 | 1.64 | |
| 75 | 90 | 315 S | 1192 | 601 | | 95 | 94.9 | 94.1 | 0.82 | 121 | 3.1 | 8.4 | 3.3 | 64 | 79 | 1LE1543-3AC0 | 750 | 2.6 | |
| 90 | 108 | 315 M | 1192 | 721 | IE2 | 95 | 95 | 94.4 | 0.84 | 142 | 2.7 | 7.7 | 3 | 64 | 79 | 1LE1543-3AC2 | 890 | 3.1 | |
| 110 | 132 | 315 L | 1192 | 881 | IE2 | 95.8 | 95.9 | 95.5 | 0.83 | 174 | 3.2 | 8.2 | 3.4 | 64 | 79 | 1LE1543-3AC4 | 990 | 3.9 | |
| 132 | 158 | 315 L | 1193 | 1057 | IE2 | 95.8 | 95.9 | 95.4 | 0.81 | 215 | 3.7 | 9.6 | 3.7 | 65 | 80 | 1LE1543-3AC5 | 1130 | 4.48 | |
| Voltages | | | | | | | | | | | | | | Version | | | | Order code | |
| 50 Hz 230 VΔ/400 VY | | | | 60 Hz 460 VY | | | | Standard | | | | 2 2 | | - | | | | | |
| 50 Hz 400 VΔ/690 VY | | | | 60 Hz 460 VΔ | | | | Standard | | | | 3 4 | | - | | | | | |
| 50 Hz 500 VY | | | | | | | | Without additional charge | | | | 2 7 | | - | | | | | |
| 50 Hz 500 VΔ | | | | | | | | Without additional charge | | | | 4 0 | | - | | | | | |
| For other voltages and more information, see from page 2/96 | | | | | | | | | | | | | | 9 0 | | ... | | | |
| Types of construction | | | | | | | | | | | | | | Version | | | | Order code | |
| Without flange | | | | IM B3 ¹⁾ | | | | Standard | | | | A | | - | | | | | |
| With flange | | | | IM B5 ¹⁾ | | | | With additional charge | | | | F | | - | | | | | |
| For other types of construction and more information, see from page 2/103 | | | | | | | | | | | | | | | | ... | | | |
| Motor protection | | | | | | | | | | | | | | Version | | | | Order code | |
| Without | | | | | | | | Standard | | | | A | | - | | | | | |
| PTC thermistor with 3 temperature sensors | | | | | | | | With additional charge | | | | B | | - | | | | | |
| For other motor protection and more information, see from page 2/113 | | | | | | | | | | | | | | | | ... | | | |
| Terminal box position | | | | | | | | | | | | | | Version | | | | Order code | |
| Terminal box at top | | | | | | | | Standard | | | | 4 | | | | | | | |
| For other terminal box positions and more information, see from page 2/116 | | | | | | | | | | | | | | | | | | | |
| Special versions | | | | | | | | | | | | | | | | Order code(s) | | | |
| Forced-air cooled motors w/o ext. fan/fan cover (IC418) | | | | | | | | | | | | | | 1LE1543-.... | | -Z F90+...+...+... | | | |
| For options, see from page 2/125 | | | | | | | | | | | | | | 1LE1543-.... | | -Z ...+...+...+... | | | |



¹⁾ Types derived from IM B3 (IM B6/7/8, IM V6 and IM V5), from IM B5 (IM V3 and IM V1) and from IM B14 (IM V19 and IM V18) are possible, provided that no requirement exists for stamping of the type on the rating plate. The basic type IM B3, IM B5, or IM B14 is stamped as standard on the rating plate. If mounted in a different position, the position must be specified to ensure that the condensation drainage holes are positioned correctly.

Cast-iron series SIMOTICS SD 1LE1643 Performance Line – self-ventilated or forced-air cooled

Selection and ordering data

Technical specifications at 60 Hz/P50 power rating

| Operating values at rated power | | | | | | | | | | | | | Cast-iron series 1LE1643 – Performance Line Article No. | $m_{IM\ B3}$ | J | | |
|---------------------------------|--------------------------|------------|---------------------|---------------------|---------------------------------|-----------------------------|-----------------------------|-----------------------------|---------------------------------|-----------------------------|----------------------------|----------------------------|--|--------------|-----|-------------------------|-------------------|
| $P_{rated, 60\ Hz/ P50}$ | $P_{rated, 60\ Hz/ P60}$ | Frame size | $n_{rated, 60\ Hz}$ | $T_{rated, 60\ Hz}$ | Different IE class 60 Hz/P60 | $\eta_{rated, 60\ Hz, 4/4}$ | $\eta_{rated, 60\ Hz, 3/4}$ | $\eta_{rated, 60\ Hz, 2/4}$ | $\cos\phi_{rated, 60\ Hz, 4/4}$ | $I_{rated, 60\ Hz, 460\ V}$ | $T_{LR}/T_{rated, 60\ Hz}$ | $I_{LR}/I_{rated, 60\ Hz}$ | | | | $T_B/T_{rated, 60\ Hz}$ | $L_{pFA, 60\ Hz}$ |
| kW | kW | FS | rpm | Nm | | % | % | % | | A | | | | | | kg | kgm ² |

- Cooling: Self-ventilated (IC411) or with order code F90 forced-air cooled without external fan and fan cover (IC418)
- Efficiency according to IEC 60034-30-1: IE3 Premium Efficiency
- Insulation: Thermal class 155 (temperature class F), IP55 degree of protection, utilization in accordance with thermal class 130 (temperature class B)

| 2-pole: 3000 rpm at 50 Hz, 3600 rpm at 60 Hz | | | | | | | | | | | | | | | | | | |
|--|------|-------|------|-----|-----|------|------|------|------|------|-----|------|-----|----|----|--------------|------|--------|
| 0.75 | 0.86 | 80 M | 3480 | 2.1 | | 77 | 77.2 | 75.7 | 0.84 | 1.45 | 3 | 7.1 | 3.6 | 64 | 75 | 1LE1643-0DA2 | 18 | 0.0011 |
| 1.1 | 1.27 | 80 M | 3500 | 3 | | 84 | 84 | 82 | 0.83 | 1.98 | 3.3 | 8.4 | 4 | 64 | 75 | 1LE1643-0DA3 | 21 | 0.0013 |
| 1.5 | 1.75 | 90 S | 3525 | 4.1 | | 85.5 | 84.8 | 82.3 | 0.84 | 2.6 | 3.1 | 9.8 | 4.9 | 69 | 81 | 1LE1643-0EA0 | 26 | 0.0021 |
| 2.2 | 2.55 | 90 L | 3530 | 6 | | 86.5 | 86.4 | 84.5 | 0.87 | 3.65 | 3 | 9.6 | 4.9 | 69 | 81 | 1LE1643-0EA4 | 32 | 0.0031 |
| 3 | 3.45 | 100 L | 3525 | 8.1 | | 88.5 | 88.7 | 87.2 | 0.87 | 4.9 | 3.8 | 9.7 | 5.5 | 71 | 83 | 1LE1643-1AA4 | 36 | 0.0054 |
| 3.7 | 4.55 | 112 M | 3560 | 10 | | 88.5 | 88 | 86.2 | 0.88 | 6 | 3.2 | 10.8 | 5.1 | 73 | 85 | 1LE1643-1BA2 | 45 | 0.012 |
| 5.5 | 6.3 | 132 S | 3555 | 15 | | 89.5 | 89.4 | 88.2 | 0.9 | 8.6 | 2.1 | 8.6 | 4.4 | 72 | 84 | 1LE1643-1CA0 | 58 | 0.024 |
| 7.5 | 8.6 | 132 S | 3555 | 20 | | 90.2 | 90.5 | 90 | 0.91 | 11.5 | 2.4 | 9.5 | 4.7 | 72 | 84 | 1LE1643-1CA1 | 73 | 0.031 |
| 11 | 12.6 | 160 M | 3560 | 30 | | 91 | 90.4 | 88.4 | 0.88 | 17.2 | 2.8 | 8.5 | 4.3 | 77 | 89 | 1LE1643-1DA2 | 100 | 0.053 |
| 15 | 17.3 | 160 M | 3565 | 40 | | 91 | 90.5 | 88.9 | 0.86 | 24 | 3.1 | 9.7 | 4.8 | 77 | 89 | 1LE1643-1DA3 | 110 | 0.061 |
| 18.5 | 21.3 | 160 L | 3560 | 50 | | 91.7 | 91.5 | 90.3 | 0.9 | 28 | 3.1 | 9.4 | 4.4 | 77 | 89 | 1LE1643-1DA4 | 127 | 0.068 |
| 22 | 24.5 | 180 M | 3560 | 59 | | 91.7 | 91.4 | 90 | 0.89 | 34 | 2.8 | 8.2 | 3.9 | 77 | 89 | 1LE1643-1EA2 | 160 | 0.08 |
| 30 | 33.5 | 200 L | 3560 | 80 | | 92.4 | 92.2 | 91.4 | 0.87 | 47 | 2.9 | 7.6 | 3.6 | 77 | 84 | 1LE1643-2AA4 | 225 | 0.134 |
| 37 | 41.5 | 200 L | 3560 | 99 | | 93 | 92.8 | 91.6 | 0.88 | 57 | 2.8 | 7.5 | 3.6 | 77 | 84 | 1LE1643-2AA5 | 250 | 0.158 |
| 45 | 51 | 225 M | 3570 | 120 | | 93.6 | 93.7 | 93.1 | 0.88 | 69 | 2.7 | 7.6 | 3.5 | 75 | 89 | 1LE1643-2BA2 | 315 | 0.26 |
| 55 | 62 | 250 M | 3578 | 147 | | 93.6 | 93.4 | 92.3 | 0.89 | 83 | 2.5 | 7.3 | 3.3 | 76 | 90 | 1LE1643-2CA2 | 385 | 0.46 |
| 75 | 84 | 280 S | 3578 | 200 | IE2 | 94.1 | 93.9 | 92.7 | 0.89 | 112 | 2.7 | 7.6 | 3.2 | 78 | 92 | 1LE1643-2DA0 | 510 | 0.77 |
| 90 | 101 | 280 M | 3578 | 240 | IE2 | 95 | 94.8 | 93.8 | 0.9 | 132 | 2.7 | 8.1 | 3.3 | 78 | 92 | 1LE1643-2DA2 | 590 | 0.94 |
| 110 | 123 | 315 S | 3585 | 293 | | 95 | 94.8 | 93.8 | 0.91 | 160 | 2.6 | 8 | 3.3 | 79 | 93 | 1LE1643-3AA0 | 750 | 1.4 |
| 132 | 148 | 315 M | 3585 | 352 | | 95.4 | 95.1 | 94 | 0.91 | 191 | 2.8 | 8 | 3.4 | 79 | 93 | 1LE1643-3AA2 | 880 | 1.6 |
| 160 | 180 | 315 L | 3588 | 426 | IE2 | 95.4 | 95.1 | 93.9 | 0.91 | 230 | 3.2 | 8.8 | 3.5 | 82 | 96 | 1LE1643-3AA4 | 980 | 1.9 |
| 200 | 224 | 315 L | 3586 | 533 | | 95.8 | 95.7 | 94.8 | 0.92 | 285 | 3.2 | 8.3 | 3.3 | 82 | 96 | 1LE1643-3AA5 | 1150 | 2.3 |

| Voltages | | Version | Order code |
|--|---------------------|---------------------------|-------------------------------|
| 50 Hz 230 VΔ/400 VY | 60 Hz 460 VY | Standard | 2 2 |
| 50 Hz 400 VΔ/690 VY | 60 Hz 460 VΔ | Standard | 3 4 |
| 50 Hz 500 VY | | Without additional charge | 2 7 |
| 50 Hz 500 VΔ | | Without additional charge | 4 0 |
| For other voltages and more information, see from page 2/96 | | | 9 0 |
| Types of construction | | Version | Order code |
| Without flange | IM B3 ¹⁾ | Standard | A |
| With flange | IM B5 ¹⁾ | With additional charge | F |
| For other types of construction and more information, see from page 2/103 | | | |
| Motor protection | | Version | Order code |
| PTC thermistor with 3 temperature sensors | | Standard | B |
| For other motor protection and more information, see from page 2/113 | | | |
| Terminal box position | | Version | Order code |
| Terminal box at top | | Standard | 4 |
| For other terminal box positions and more information, see from page 2/116 | | | |
| Special versions | | | Order code(s) |
| Forced-air cooled motors w/o ext. fan/fan cover (IC418) | | | 1LE1643-...-Z F90+...+...+... |
| For options, see from page 2/125 | | | 1LE1643-...-Z ...+...+...+... |

¹⁾ Types derived from IM B3 (IM B6/7/8, IM V6 and IM V5), from IM B5 (IM V3 and IM V1) and from IM B14 (IM V19 and IM V18) are possible, provided that no requirement exists for stamping of the type on the rating plate. The basic type IM B3, IM B5, or IM B14 is stamped as standard on the rating plate. If mounted in a different position, the position must be specified to ensure that the condensation drainage holes are positioned correctly.



SIMOTICS GP and SIMOTICS SD standard motors
APAC Line · IE3 Premium Efficiency

Cast-iron series SIMOTICS SD 1LE1643 Performance Line – self-ventilated or forced-air cooled

Selection and ordering data

Technical specifications at 60 Hz/P50 power rating

| Operating values at rated power | | | | | | | | | | | | | | Cast-iron series 1LE1643 – Performance Line Article No. | $m_{IM\ B3}$ | J | | | |
|--|----------------------------|--------------|---------------------|---------------------|---------------------------------|-----------------------------|-----------------------------|-----------------------------|---------------------------------|-----------------------------|-----------------|----------------------------|-----------------------|---|--------------|--------------|------------------|------------------|--|
| $P_{rated, 60\ Hz}$ P50 | $P_{rated, 60\ Hz}$ P60 | Frame size | $n_{rated, 60\ Hz}$ | $T_{rated, 60\ Hz}$ | Different IE class 60 Hz/P60 | $\eta_{rated, 60\ Hz, 4/4}$ | $\eta_{rated, 60\ Hz, 3/4}$ | $\eta_{rated, 60\ Hz, 2/4}$ | $\cos\phi_{rated, 60\ Hz, 4/4}$ | $I_{rated, 60\ Hz, 460\ V}$ | T_{LR}/I_{LR} | $I_{LR}/I_{rated, 60\ Hz}$ | T_{β}/I_{β} | | | | $L_{pA, 60\ Hz}$ | $L_{WA, 60\ Hz}$ | |
| kW | kW | FS | rpm | Nm | | % | % | % | | A | | | | | | kg | kgm ² | | |
| <ul style="list-style-type: none"> • Cooling: Self-ventilated (IC411) or with order code F90 forced-air cooled without external fan and fan cover (IC418) • Efficiency according to IEC 60034-30-1: IE3 Premium Efficiency • Insulation: Thermal class 155 (temperature class F), IP55 degree of protection, utilization in accordance with thermal class 130 (temperature class B) | | | | | | | | | | | | | | | | | | | |
| 4-pole: 1500 rpm at 50 Hz, 1800 rpm at 60 Hz | | | | | | | | | | | | | | | | | | | |
| 3 | 3.45 | 100 L | 1760 | 16.3 | | 89.5 | 89.5 | 88.3 | 0.82 | 5.1 | 3.1 | 9.5 | 4.6 | 62 | 74 | 1LE1643-1AB5 | 40 | 0.014 | |
| 4 | 4.55 | 112 M | 1770 | 19 | | 89.5 | 89.4 | 87.7 | 0.8 | 6.5 | 2.9 | 8.2 | 4.3 | 62 | 74 | 1LE1643-1BB2 | 46 | 0.017 | |
| 5.5 | 6.3 | 132 S | 1775 | 30 | | 91.7 | 91.6 | 90.5 | 0.81 | 9.3 | 3.9 | 9.7 | 4.5 | 68 | 80 | 1LE1643-1CB0 | 74 | 0.046 | |
| 7.5 | 8.6 | 132 M | 1770 | 40 | | 91.7 | 91.8 | 91 | 0.83 | 12.4 | 2.7 | 9.6 | 4.2 | 68 | 80 | 1LE1643-1CB2 | 80 | 0.046 | |
| 11 | 12.6 | 160 M | 1775 | 59 | | 92.4 | 92.3 | 91.1 | 0.83 | 18 | 3 | 8.9 | 3.8 | 69 | 81 | 1LE1643-1DB2 | 109 | 0.083 | |
| 15 | 17.3 | 160 L | 1780 | 80 | | 93 | 92.8 | 91.4 | 0.81 | 25 | 2.9 | 9.5 | 4.3 | 69 | 81 | 1LE1643-1DB4 | 127 | 0.099 | |
| 18.5 | 21.3 | 180 M | 1775 | 100 | | 93.6 | 93.7 | 93.1 | 0.81 | 30.5 | 2.7 | 7.8 | 3.6 | 68 | 75 | 1LE1643-1EB2 | 165 | 0.13 | |
| 22 | 25.3 | 180 L | 1775 | 118 | | 93.6 | 93.8 | 93.3 | 0.81 | 36.5 | 2.8 | 7.7 | 3.7 | 70 | 77 | 1LE1643-1EB4 | 170 | 0.14 | |
| 30 | 34.5 | 200 L | 1778 | 161 | IE2 | 94.1 | 94.3 | 93.8 | 0.83 | 48 | 3 | 8.1 | 3.5 | 70 | 77 | 1LE1643-2AB5 | 240 | 0.22 | |
| 37 | 42.5 | 225 S | 1782 | 198 | IE2 | 94.5 | 94.7 | 94.2 | 0.85 | 58 | 2.8 | 7.5 | 3 | 66 | 80 | 1LE1643-2BB0 | 285 | 0.42 | |
| 45 | 52 | 225 M | 1782 | 241 | IE2 | 95.0 | 95.3 | 95.1 | 0.85 | 70 | 3 | 7.7 | 3.3 | 66 | 80 | 1LE1643-2BB2 | 340 | 0.52 | |
| 55 | 63 | 250 M | 1786 | 294 | IE2 | 95.4 | 95.6 | 95.1 | 0.86 | 84 | 2.8 | 7.6 | 3.2 | 67 | 81 | 1LE1643-2CB2 | 420 | 0.85 | |
| 75 | 86 | 280 S | 1785 | 460 | IE2 | 94.5 | 94.7 | 94.2 | 0.87 | 131 | 2.5 | 6.8 | 2.9 | 77 | 91 | 1LE1643-2DB0 | 570 | 1.39 | |
| 90 | 104 | 280 M | 1788 | 481 | IE2 | 95.4 | 95.5 | 94.9 | 0.87 | 136 | 2.9 | 8 | 3.3 | 79 | 93 | 1LE1643-2DB2 | 670 | 1.7 | |
| 110 | 127 | 315 S | 1790 | 587 | | 95.8 | 95.9 | 95.4 | 0.86 | 168 | 3 | 7.5 | 3.1 | 73 | 87 | 1LE1643-3AB0 | 760 | 2.2 | |
| 132 | 152 | 315 M | 1790 | 704 | | 96.2 | 96.3 | 95.8 | 0.87 | 198 | 3.1 | 8.2 | 3.2 | 76 | 90 | 1LE1643-3AB2 | 960 | 2.9 | |
| 160 | 184 | 315 L | 1791 | 853 | | 96.2 | 96.2 | 95.7 | 0.87 | 240 | 3.3 | 8.4 | 3.3 | 76 | 90 | 1LE1643-3AB4 | 990 | 3.1 | |
| 200 | 230 | 315 L | 1791 | 1066 | IE2 | 96.2 | 96.2 | 95.5 | 0.87 | 300 | 3.5 | 8.7 | 3.2 | 78 | 93 | 1LE1643-3AB5 | 1190 | 3.7 | |
| Voltagess | | | | | | | | | | | | | | | | | | | |
| 50 Hz 230 VΔ/400 VY | | 60 Hz 460 VY | | Version | | Standard | | | | | | | | | | | | Order code | |
| 50 Hz 400 VΔ/690 VY | | 60 Hz 460 VΔ | | Version | | Standard | | | | | | | | | | | | Order code | |
| 50 Hz 500 VY | | | | Version | | Without additional charge | | | | | | | | | | | | Order code | |
| 50 Hz 500 VΔ | | | | Version | | Without additional charge | | | | | | | | | | | | Order code | |
| For other voltages and more information, see from page 2/96 | | | | | | | | | | | | | | | | | | | |
| Types of construction | | | | | | | | | | | | | | | | | | | |
| Without flange | | | | IM B3 ¹⁾ | | Standard | | | | | | | | | | | | Order code | |
| With flange | | | | IM B5 ¹⁾ | | With additional charge | | | | | | | | | | | | Order code | |
| For other types of construction and more information, see from page 2/103 | | | | | | | | | | | | | | | | | | | |
| Motor protection | | | | | | | | | | | | | | | | | | | |
| PTC thermistor with 3 temperature sensors | | | | Version | | Standard | | | | | | | | | | | | Order code | |
| For other motor protection and more information, see from page 2/113 | | | | | | | | | | | | | | | | | | | |
| Terminal box position | | | | | | | | | | | | | | | | | | | |
| Terminal box at top | | | | Version | | Standard | | | | | | | | | | | | Order code(s) | |
| For other terminal box positions and more information, see from page 2/116 | | | | | | | | | | | | | | | | | | | |
| Special versions | | | | | | | | | | | | | | | | | | | |
| Forced-air cooled motors w/o ext. fan/fan cover (IC418) | | | | | | | | | | | | | | 1LE1643-...-Z F90+...+...+... | | | | | |
| For options, see from page 2/125 | | | | | | | | | | | | | | | | | | | |



¹⁾ Types derived from IM B3 (IM B6/7/8, IM V6 and IM V5), from IM B5 (IM V3 and IM V1) and from IM B14 (IM V19 and IM V18) are possible, provided that no requirement exists for stamping of the type on the rating plate. The basic type IM B3, IM B5, or IM B14 is stamped as standard on the rating plate. If mounted in a different position, the position must be specified to ensure that the condensation drainage holes are positioned correctly.

SIMOTICS GP and SIMOTICS SD standard motors

APAC Line · IE3 Premium Efficiency



Cast-iron series SIMOTICS SD 1LE1643 Performance Line – self-ventilated or forced-air cooled

Selection and ordering data

Technical specifications at 60 Hz/P50 power rating

| Operating values at rated power | | | | | | | | | | | | | Cast-iron series 1LE1643 – Performance Line Article No. | $m_{IM\ B3}$ kg | J kgm ² | | | |
|--|------------------------------|---------------|----------------------|----------------------|------------------------------------|---------------------------------|---------------------------------|---------------------------------|-------------------------------------|--------------------------------|-----------------------------|-----------------------------|---|--------------------|--|--------------------------------|---------------------------|-------------------|
| P_{rated} 60 Hz/ P50 | P_{rated} 60 Hz/ P60 | Frame size | n_{rated} 60 Hz | T_{rated} 60 Hz | Different IE class 60 Hz/P60 | η_{rated} 60 Hz, 4/4 | η_{rated} 60 Hz, 3/4 | η_{rated} 60 Hz, 2/4 | $\cos\phi_{rated}$ 60 Hz, 4/4 | I_{rated} 60 Hz, 460 V | I_{LR}/I_{rated} 60 Hz | I_{LR}/I_{rated} 60 Hz | | | | T_{β}/I_{rated} 60 Hz | $L_{p\text{fA}}$ 60 Hz | L_{WA} 60 Hz |
| kW | kW | FS | rpm | Nm | | % | % | % | | A | | | | dB(A) | dB(A) | | | |
| <ul style="list-style-type: none"> Cooling: Self-ventilated (IC411) or with order code F90 forced-air cooled without external fan and fan cover (IC418) Efficiency according to IEC 60034-30-1: IE3 Premium Efficiency Insulation: Thermal class 155 (temperature class F), IP55 degree of protection, utilization in accordance with thermal class 130 (temperature class B) | | | | | | | | | | | | | | | | | | |
| 6-pole: 1000 rpm at 50 Hz, 1200 rpm at 60 Hz | | | | | | | | | | | | | | | | | | |
| 1.1 | 1.27 | 100 L | 1180 | 8.9 | | 87.5 | 87.2 | 84.8 | 0.69 | 2.3 | 2.4 | 6.7 | 3.3 | 62 | 74 | 1LE1643-1AC3 ■■■■■■ | 25 | 0.011 |
| 1.5 | 1.75 | 112 M | 1175 | 12 | | 88.5 | 88.3 | 86.2 | 0.73 | 2.9 | 2.2 | 6.9 | 3.2 | 65 | 77 | 1LE1643-1BC1 ■■■■■■ | 53 | 0.017 |
| 2.2 | 2.55 | 132 S | 1180 | 21 | | 89.5 | 89.2 | 87.7 | 0.72 | 4.3 | 2.4 | 7.3 | 3.5 | 58 | 71 | 1LE1643-1CC1 ■■■■■■ | 60 | 0.033 |
| 3 | 3.45 | 132 S | 1180 | 24 | | 89.5 | 89.5 | 87.9 | 0.70 | 6. | 2.6 | 7.6 | 3.8 | 55 | 69 | 1LE1643-1CC0 ■■■■■■ | 60 | 0.034 |
| 4 | 4.55 | 132 M | 1180 | 30 | | 89.5 | 89.9 | 88.2 | 0.69 | 7.1 | 2.8 | 7.5 | 3.8 | 57 | 70 | 1LE1643-1CC2 ■■■■■■ | 64 | 0.039 |
| 5.5 | 6.3 | 132 M | 1180 | 45 | | 91.0 | 90.8 | 89.2 | 0.69 | 11 | 3 | 7.8 | 4 | 61 | 75 | 1LE1643-1CC3 ■■■■■■ | 76 | 0.050 |
| 7.5 | 8.6 | 160 M | 1185 | 60 | | 91.0 | 90.8 | 89.3 | 0.80 | 12.9 | 2.7 | 9.3 | 3.7 | 68 | 81 | 1LE1643-1DC2 ■■■■■■ | 124 | 0.132 |
| 11 | 12.6 | 160 L | 1185 | 89 | | 91.7 | 91.7 | 90.5 | 0.78 | 19.3 | 3.4 | 8 | 3.2 | 67 | 80 | 1LE1643-1DC4 ■■■■■■ | 138 | 0.164 |
| 15 | 18 | 180 L | 1178 | 122 | IE2 | 91.7 | 92 | 91.4 | 0.79 | 26 | 2.5 | 6.8 | 3 | 61 | 68 | 1LE1643-1EC4 ■■■■■■ | 180 | 0.19 |
| 18.5 | 22 | 200 L | 1180 | 150 | IE2 | 93 | 93.8 | 93.8 | 0.78 | 32 | 2.8 | 6.5 | 3 | 64 | 71 | 1LE1643-2AC4 ■■■■■■ | 215 | 0.28 |
| 22 | 26.5 | 200 L | 1180 | 178 | IE2 | 93 | 93.5 | 93.4 | 0.79 | 37.5 | 2.6 | 6.3 | 2.8 | 63 | 70 | 1LE1643-2AC5 ■■■■■■ | 230 | 0.32 |
| 37 | 44.5 | 250 M | 1188 | 297 | IE2 | 94.1 | 94.4 | 93.9 | 0.83 | 59 | 3.1 | 8 | 3.1 | 63 | 76 | 1LE1643-2CC2 ■■■■■■ | 405 | 1 |
| 45 | 54 | 280 S | 1190 | 361 | IE2 | 94.5 | 94.6 | 94.1 | 0.83 | 72 | 3.3 | 7.7 | 3.1 | 66 | 80 | 1LE1643-2DC0 ■■■■■■ | 510 | 1.4 |
| 55 | 66 | 280 M | 1190 | 441 | IE2 | 94.5 | 94.6 | 94 | 0.83 | 88 | 3.6 | 7.9 | 3.3 | 66 | 80 | 1LE1643-2DC2 ■■■■■■ | 560 | 1.64 |
| 75 | 90 | 315 S | 1192 | 601 | | 95 | 94.9 | 94.1 | 0.82 | 121 | 3.1 | 8.4 | 3.3 | 64 | 79 | 1LE1643-3AC0 ■■■■■■ | 750 | 2.6 |
| 90 | 108 | 315 M | 1192 | 721 | IE2 | 95 | 95 | 94.4 | 0.84 | 142 | 2.7 | 7.7 | 3 | 64 | 79 | 1LE1643-3AC2 ■■■■■■ | 890 | 3.1 |
| 110 | 132 | 315 L | 1192 | 881 | IE2 | 95.8 | 95.9 | 95.5 | 0.83 | 174 | 3.2 | 8.2 | 3.4 | 64 | 79 | 1LE1643-3AC4 ■■■■■■ | 990 | 3.9 |
| 132 | 158 | 315 L | 1193 | 1057 | IE2 | 95.8 | 95.9 | 95.4 | 0.81 | 215 | 3.7 | 9.6 | 3.7 | 65 | 80 | 1LE1643-3AC5 ■■■■■■ | 1130 | 4.48 |
| Voltagess | | | | | | | | | | | | | | | | | | |
| 50 Hz 230 VΔ/400 VY | | | | | | | | | | | | | Version | | Order code | | | |
| 60 Hz 460 VY | | | | | | | | | | | | | Standard | | 2 2 | | | |
| 50 Hz 400 VΔ/690 VY | | | | | | | | | | | | | Standard | | 3 4 | | | |
| 50 Hz 500 VY | | | | | | | | | | | | | Without additional charge | | 2 7 | | | |
| 50 Hz 500 VΔ | | | | | | | | | | | | | Without additional charge | | 4 0 | | | |
| | | | | | | | | | | | | | | | 9 0 | | | |
| For other voltages and more information, see from page 2/96 | | | | | | | | | | | | | | | | | | |
| Types of construction | | | | | | | | | | | | | | | | | | |
| Without flange | | | | | | | | | | | | | Version | | Order code | | | |
| IM B3 ¹⁾ | | | | | | | | | | | | | Standard | | A | | | |
| With flange | | | | | | | | | | | | | With additional charge | | F | | | |
| | | | | | | | | | | | | | | | ■■■■■ | | | |
| For other types of construction and more information, see from page 2/103 | | | | | | | | | | | | | | | | | | |
| Motor protection | | | | | | | | | | | | | | | | | | |
| PTC thermistor with 3 temperature sensors | | | | | | | | | | | | | Version | | Order code | | | |
| | | | | | | | | | | | | | Standard | | B | | | |
| | | | | | | | | | | | | | | | ■■■■■ | | | |
| For other motor protection and more information, see from page 2/113 | | | | | | | | | | | | | | | | | | |
| Terminal box position | | | | | | | | | | | | | | | | | | |
| Terminal box at top | | | | | | | | | | | | | Version | | Order code(s) | | | |
| | | | | | | | | | | | | | Standard | | 4 | | | |
| For other terminal box positions and more information, see from page 2/116 | | | | | | | | | | | | | | | | | | |
| Special versions | | | | | | | | | | | | | | | | | | |
| Forced-air cooled motors w/o ext. fan/fan cover (IC418) | | | | | | | | | | | | | | | 1LE1643- ■■■■■■ -Z F90+ . . . + . . . | | | |
| For options, see from page 2/125 | | | | | | | | | | | | | | | 1LE1643- ■■■■■■ -Z . . . + . . . + . . . | | | |

2

¹⁾ Types derived from IM B3 (IM B6/7/8, IM V6 and IM V5), from IM B5 (IM V3 and IM V1) and from IM B14 (IM V19 and IM V18) are possible, provided that no requirement exists for stamping of the type on the rating plate. The basic type IM B3, IM B5, or IM B14 is stamped as standard on the rating plate. If mounted in a different position, the position must be specified to ensure that the condensation drainage holes are positioned correctly.



Cast-iron series SIMOTICS SD 1LE1543 Basic Line with increased power – self-ventilated

Selection and ordering data

Technical specifications at 60 Hz/P50 power rating

| Operating values at rated power | | | | | | | | | | | | | | Cast-iron series | | | | |
|--|------------------------------|---------------|----------------------|----------------------|------------------------------------|---------------------------------|---------------------------------|---------------------------------|-------------------------------------|--------------------------------|--------------------------|-----------------------------|--------------------------------|---------------------------|-------------------|----------------------|-------------|------------------|
| P_{rated} 60 Hz/ P50 | P_{rated} 60 Hz/ P60 | Frame size | n_{rated} 60 Hz | T_{rated} 60 Hz | Different IE class 60 Hz/P60 | η_{rated} 60 Hz, 4/4 | η_{rated} 60 Hz, 3/4 | η_{rated} 60 Hz, 2/4 | $\cos\phi_{rated}$ 60 Hz, 4/4 | I_{rated} 60 Hz, 460 V | T_{LR}/I_{LR} 60 Hz | I_{LR}/I_{rated} 60 Hz | T_{β}/I_{rated} 60 Hz | $L_{p(A)}$ 60 Hz | L_{WA} 60 Hz | 1LE1543 – Basic Line | $m_{IM B3}$ | J |
| kW | kW | FS | rpm | Nm | | % | % | % | | A | | | | | | Article No. | kg | kgm ² |
| <ul style="list-style-type: none"> • Cooling: Self-ventilated (IC411) or with order code F90 forced-air cooled without external fan and fan cover (IC418) • Efficiency according to IEC 60034-30-1: IE3 Premium Efficiency • Insulation: Thermal class 155 (temperature class F), IP55 degree of protection, utilization in accordance with thermal class 130 (temperature class B) | | | | | | | | | | | | | | | | | | |
| 2-pole: 3000 rpm at 50 Hz, 3600 rpm at 60 Hz | | | | | | | | | | | | | | | | | | |
| 4 | 4.55 | 100 L | 3530 | 10 | | 88.5 | 88.0 | 86.4 | 0.80 | 6.6 | 4.5 | 12.4 | 5.8 | 75 | 83 | 1LE1543-1AA6 | 37 | 0.0054 |
| 11 | 12.6 | 132 M | 3565 | 29 | | 91.0 | 91.3 | 90.4 | 0.86 | 17.6 | 2.9 | 10.9 | 4.7 | 75 | 83 | 1LE1543-1CA6 | 75 | 0.031 |
| 15 | 17.3 | 132 M | 3570 | 40 | | 91.0 | 90.9 | 90.1 | 0.83 | 24 | 3.4 | 11.1 | 5.4 | 78 | 86 | 1LE1543-1CA7 | 85 | 0.035 |
| 22 | 25.3 | 160 L | 3560 | 59 | | 91.7 | 91.8 | 90.9 | 0.9 | 33.5 | 3.1 | 9.7 | 4.5 | 77 | 89 | 1LE1543-1DA6 | 148 | 0.073 |
| 30 | 33.5 | 180 L | 3560 | 80 | | 92.4 | 92.6 | 92.1 | 0.87 | 47 | 2.9 | 8.8 | 4.5 | 77 | 89 | 1LE1543-1EA6 | 180 | 0.094 |
| 45 | 51 | 200 L | 3560 | 121 | | 93.6 | 93.7 | 93 | 0.86 | 70 | 3 | 8.4 | 3.7 | 77 | 84 | 1LE1543-2AA6 | 245 | 0.17 |
| 55 | 62 | 225 M | 3570 | 147 | | 93.6 | 93.6 | 92.8 | 0.88 | 84 | 3.2 | 8.9 | 4 | 76 | 89 | 1LE1543-2BA6 | 370 | 0.31 |
| 75 | 84 | 250 M | 3575 | 200 | | 94.1 | 93.9 | 92.9 | 0.9 | 111 | 2.5 | 7.5 | 3.2 | 82 | 96 | 1LE1543-2CA6 | 455 | 0.56 |
| 110 | 123 | 280 M | 3578 | 294 | | 95 | 94.8 | 94 | 0.91 | 160 | 2.9 | 8.5 | 3.5 | 82 | 96 | 1LE1543-2DA6 | 660 | 1.1 |
| 4-pole: 1500 rpm at 50 Hz, 1800 rpm at 60 Hz | | | | | | | | | | | | | | | | | | |
| 11 | 12.6 | 132 M | 1775 | 59 | | 92.4 | 92.6 | 91.8 | 0.79 | 19 | 3.1 | 8.7 | 4.1 | 68 | 80 | 1LE1543-1CB6 | 82 | 0.046 |
| 18.5 | 21.3 | 160 L | 1780 | 99 | | 93.6 | 93.3 | 91.9 | 0.75 | 33 | 3.9 | 9.6 | 4.5 | 69 | 81 | 1LE1543-1DB6 | 140 | 0.099 |
| 30 | 34.5 | 180 L | 1775 | 160 | | 94.1 | 94.2 | 93.5 | 0.78 | 51 | 3.3 | 9.5 | 4.3 | 79 | 86 | 1LE1543-1EB6 | 193 | 0.173 |
| 37 | 42.5 | 200 L | 1780 | 198 | | 94.5 | 94.7 | 94.2 | 0.8 | 61 | 3.3 | 9 | 4 | 70 | 77 | 1LE1543-2AB6 | 258 | 0.275 |
| 55 | 63 | 225 M | 1782 | 295 | IE2 | 95.4 | 95.7 | 95.4 | 0.85 | 85 | 3.1 | 7.4 | 3 | 75 | 89 | 1LE1543-2BB6 | 405 | 0.65 |
| 75 | 86 | 250 M | 1788 | 401 | | 95.4 | 95.4 | 94.8 | 0.84 | 117 | 3.4 | 8.8 | 3.8 | 75 | 89 | 1LE1543-2CB6 | 510 | 1.1 |
| 110 | 127 | 280 M | 1788 | 587 | IE2 | 95.8 | 95.7 | 94.9 | 0.85 | 170 | 3.4 | 9.2 | 3.7 | 82 | 96 | 1LE1543-2DB6 | 710 | 1.8 |
| 6-pole: 1000 rpm at 50 Hz, 1200 rpm at 60 Hz | | | | | | | | | | | | | | | | | | |
| 18.5 | 22 | 180 L | 1180 | 150 | | 93 | 93.2 | 92.6 | 0.75 | 33.5 | 2.9 | 7.9 | 3.7 | 69 | 81 | 1LE1543-1EC6 | 185 | 0.247 |
| 30 | 36 | 200 L | 1182 | 242 | IE2 | 94.1 | 94.5 | 94.2 | 0.77 | 52 | 3.2 | 7.6 | 3.2 | 63 | 70 | 1LE1543-2AC6 | 270 | 0.434 |
| 37 | 44.5 | 225 M | 1186 | 298 | IE2 | 94.1 | 94.3 | 93.7 | 0.8 | 62 | 3.3 | 8.2 | 3.5 | 71 | 85 | 1LE1543-2BC6 | 395 | 0.84 |
| 45 | 54 | 250 M | 1188 | 362 | IE2 | 94.5 | 94.7 | 94.2 | 0.83 | 72 | 2.8 | 8.1 | 3.2 | 69 | 83 | 1LE1543-2CC6 | 480 | 1.3 |
| 75 | 90 | 280 M | 1190 | 602 | | 95 | 95.1 | 94.6 | 0.82 | 121 | 4.2 | 9.5 | 3.6 | 70 | 84 | 1LE1543-2DC6 | 630 | 1.9 |
| 160 | 192 | 315 L | 1193 | 1281 | IE2 | 95.8 | 95.8 | 95.2 | 0.81 | 260 | 4 | 9.8 | 4 | 68 | 82 | 1LE1543-3AC6 | 1260 | 5.4 |
| Voltagess | | | | | | | | | | | | | | | | | | |
| 50 Hz 230 VΔ/400 VY | | | | | | | | | | | | | | Version | | Order code | | |
| 60 Hz 460 VY | | | | | | | | | | | | | | Standard | | 2 2 | | |
| 50 Hz 400 VΔ/690 VY | | | | | | | | | | | | | | Standard | | 3 4 | | |
| 60 Hz 460 VΔ | | | | | | | | | | | | | | Without additional charge | | 2 7 | | |
| 50 Hz 500 VY | | | | | | | | | | | | | | Without additional charge | | 4 0 | | |
| 50 Hz 500 VΔ | | | | | | | | | | | | | | | | 9 0 | | |
| For other voltages and more information, see from page 2/96 | | | | | | | | | | | | | | | | | | |
| Types of construction | | | | | | | | | | | | | | | | | | |
| Without flange | | | | | | | | | | | | | | Version | | Order code | | |
| IM B3 ¹⁾ | | | | | | | | | | | | | | Standard | | A | | |
| With flange | | | | | | | | | | | | | | With additional charge | | F | | |
| For other types of construction and more information, see from page 2/103 | | | | | | | | | | | | | | | | | | |
| Motor protection | | | | | | | | | | | | | | | | | | |
| Without | | | | | | | | | | | | | | Version | | Order code | | |
| PTC thermistor with 3 temperature sensors | | | | | | | | | | | | | | Standard | | A | | |
| | | | | | | | | | | | | | | With additional charge | | B | | |
| For other motor protection and more information, see from page 2/113 | | | | | | | | | | | | | | | | | | |
| Terminal box position | | | | | | | | | | | | | | | | | | |
| Terminal box at top | | | | | | | | | | | | | | Version | | Order code | | |
| | | | | | | | | | | | | | | Standard | | 4 | | |
| For other terminal box positions and more information, see from page 2/116 | | | | | | | | | | | | | | | | | | |
| Special versions | | | | | | | | | | | | | | | | | | |
| For options, see from page 2/125 | | | | | | | | | | | | | | | | | | |
| 1LE1543- | | | | | | | | | | | | | | | | -Z | | |

¹⁾ Types derived from IM B3 (IM B6/7/8, IM V6 and IM V5), from IM B5 (IM V3 and IM V1) and from IM B14 (IM V19 and IM V18) are possible, provided that no requirement exists for stamping of the type on the rating plate. The basic type IM B3, IM B5, or IM B14 is stamped as standard on the rating plate. If mounted in a different position, the position must be specified to ensure that the condensation drainage holes are positioned correctly.



Cast-iron series SIMOTICS SD 1LE1643 Performance Line with increased power – self-ventilated

Selection and ordering data

Technical specifications at 60 Hz/P50 power rating

| Operating values at rated power | | | | | | | | | | | | | | Cast-iron series 1LE1643 – Performance Line Article No. | m _{IM B3} | J | |
|---------------------------------------|---------------------------------------|---------------|-------------------------------|-------------------------------|------------------------------------|---------------------------------------|---------------------------------------|---------------------------------------|--|---|--|--|---|--|--------------------|----|-----------------------------|
| P _{rated} , 60 Hz/ P50 | P _{rated} , 60 Hz/ P60 | Frame size | n _{rated} , 60 Hz | T _{rated} , 60 Hz | Different IE class 60 Hz/P60 | η _{rated} , 60 Hz, 4/4 | η _{rated} , 60 Hz, 3/4 | η _{rated} , 60 Hz, 2/4 | cosφ _{rated} , 60 Hz, 4/4 | I _{rated} , 60 Hz, 460 V | T _{LR} /I _{rated} , 60 Hz | I _{LR} /I _{rated} , 60 Hz | T _β /I _{rated} , 60 Hz | | | | L _{pfA} , 60 Hz |
| kW | kW | FS | rpm | Nm | | % | % | % | | A | | | | dB(A) | dB(A) | kg | kgm ² |

- Cooling: Self-ventilated (IC411) or with order code F90 forced-air cooled without external fan and fan cover (IC418)
- Efficiency according to IEC 60034-30-1: IE3 Premium Efficiency
- Insulation: Thermal class 155 (temperature class F), IP55 degree of protection, utilization in accordance with thermal class 130 (temperature class B)

2-pole: 3000 rpm at 50 Hz, 3600 rpm at 60 Hz

| | | | | | | | | | | | | | | | | | | |
|-----|------|-------|------|-----|--|------|------|------|------|------|-----|------|-----|----|----|--------------|-----|--------|
| 4 | 4.55 | 100 L | 3530 | 10 | | 88.5 | 88.0 | 86.4 | 0.80 | 6.6 | 4.5 | 12.4 | 5.8 | 75 | 83 | 1LE1643-1AA6 | 37 | 0.0054 |
| 11 | 12.6 | 132 M | 3565 | 29 | | 91.0 | 91.3 | 90.4 | 0.86 | 17.6 | 2.9 | 10.9 | 4.7 | 75 | 83 | 1LE1643-1CA6 | 75 | 0.031 |
| 15 | 17.3 | 132 M | 3570 | 40 | | 91.0 | 90.9 | 90.1 | 0.83 | 24 | 3.4 | 11.1 | 5.4 | 78 | 86 | 1LE1643-1CA7 | 85 | 0.035 |
| 22 | 25.3 | 160 L | 3560 | 59 | | 91.7 | 91.8 | 90.9 | 0.9 | 33.5 | 3.1 | 9.7 | 4.5 | 77 | 89 | 1LE1643-1DA6 | 148 | 0.073 |
| 30 | 33.5 | 180 L | 3560 | 80 | | 92.4 | 92.6 | 92.1 | 0.87 | 47 | 2.9 | 8.8 | 4.5 | 77 | 89 | 1LE1643-1EA6 | 180 | 0.094 |
| 45 | 51 | 200 L | 3560 | 121 | | 93.6 | 93.7 | 93 | 0.86 | 70 | 3 | 8.4 | 3.7 | 77 | 84 | 1LE1643-2AA6 | 245 | 0.17 |
| 55 | 62 | 225 M | 3570 | 147 | | 93.6 | 93.6 | 92.8 | 0.88 | 84 | 3.2 | 8.9 | 4 | 76 | 89 | 1LE1643-2BA6 | 370 | 0.31 |
| 75 | 84 | 250 M | 3575 | 200 | | 94.1 | 93.9 | 92.9 | 0.9 | 111 | 2.5 | 7.5 | 3.2 | 82 | 96 | 1LE1643-2CA6 | 455 | 0.56 |
| 110 | 123 | 280 M | 3578 | 294 | | 95 | 94.8 | 94 | 0.91 | 160 | 2.9 | 8.5 | 3.5 | 82 | 96 | 1LE1643-2DA6 | 660 | 1.1 |

4-pole: 1500 rpm at 50 Hz, 1800 rpm at 60 Hz

| | | | | | | | | | | | | | | | | | | |
|------|------|-------|------|-----|-----|------|------|------|------|-----|-----|-----|-----|----|----|--------------|-----|-------|
| 11 | 12.6 | 132 M | 1775 | 59 | | 92.4 | 92.6 | 91.8 | 0.79 | 19 | 3.1 | 8.7 | 4.1 | 68 | 80 | 1LE1643-1CB6 | 82 | 0.046 |
| 18.5 | 21.3 | 160 L | 1780 | 99 | | 93.6 | 93.3 | 91.9 | 0.75 | 33 | 3.9 | 9.6 | 4.5 | 69 | 81 | 1LE1643-1DB6 | 140 | 0.099 |
| 30 | 34.5 | 180 L | 1775 | 160 | | 94.1 | 94.2 | 93.5 | 0.78 | 51 | 3.3 | 9.5 | 4.3 | 79 | 86 | 1LE1643-1EB6 | 193 | 0.173 |
| 37 | 42.5 | 200 L | 1780 | 198 | | 94.5 | 94.7 | 94.2 | 0.8 | 61 | 3.3 | 9 | 4 | 70 | 77 | 1LE1643-2AB6 | 258 | 0.275 |
| 55 | 63 | 225 M | 1782 | 295 | IE2 | 95.4 | 95.7 | 95.4 | 0.85 | 85 | 3.1 | 7.4 | 3 | 75 | 89 | 1LE1643-2BB6 | 405 | 0.65 |
| 75 | 86 | 250 M | 1788 | 401 | | 95.4 | 95.4 | 94.8 | 0.84 | 117 | 3.4 | 8.8 | 3.8 | 75 | 89 | 1LE1643-2CB6 | 510 | 1.1 |
| 110 | 127 | 280 M | 1788 | 587 | IE2 | 95.8 | 95.7 | 94.9 | 0.85 | 170 | 3.4 | 9.2 | 3.7 | 82 | 96 | 1LE1643-2DB6 | 710 | 1.8 |

6-pole: 1000 rpm at 50 Hz, 1200 rpm at 60 Hz

| | | | | | | | | | | | | | | | | | | |
|------|------|-------|------|------|-----|------|------|------|------|------|-----|-----|-----|----|----|--------------|------|-------|
| 18.5 | 22 | 180 L | 1180 | 150 | | 93 | 93.2 | 92.6 | 0.75 | 33.5 | 2.9 | 7.9 | 3.7 | 69 | 81 | 1LE1643-1EC6 | 185 | 0.247 |
| 30 | 36 | 200 L | 1182 | 242 | IE2 | 94.1 | 94.5 | 94.2 | 0.77 | 52 | 3.2 | 7.6 | 3.2 | 63 | 70 | 1LE1643-2AC6 | 270 | 0.434 |
| 37 | 44.5 | 225 M | 1186 | 298 | IE2 | 94.1 | 94.3 | 93.7 | 0.8 | 62 | 3.3 | 8.2 | 3.5 | 71 | 85 | 1LE1643-2BC6 | 395 | 0.84 |
| 45 | 54 | 250 M | 1188 | 362 | IE2 | 94.5 | 94.7 | 94.2 | 0.83 | 72 | 2.8 | 8.1 | 3.2 | 69 | 83 | 1LE1643-2CC6 | 480 | 1.3 |
| 75 | 90 | 280 M | 1190 | 602 | | 95 | 95.1 | 94.6 | 0.82 | 121 | 4.2 | 9.5 | 3.6 | 70 | 84 | 1LE1643-2DC6 | 630 | 1.9 |
| 160 | 192 | 315 L | 1193 | 1281 | IE2 | 95.8 | 95.8 | 95.2 | 0.81 | 260 | 4 | 9.8 | 4 | 68 | 82 | 1LE1643-3AC6 | 1260 | 5.4 |

| Voltagess | Version | Order code |
|--|---------------------------|--------------------|
| 50 Hz 230 VΔ/400 VY | Standard | 2 2 |
| 50 Hz 400 VΔ/690 VY | Standard | 3 4 |
| 50 Hz 500 VY | Without additional charge | 2 7 |
| 50 Hz 500 VΔ | Without additional charge | 4 0 |
| For other voltages and more information, see from page 2/96 | | |
| 9 0 | | ... |
| Types of construction | Version | Order code |
| Without flange | Standard | A |
| With flange | With additional charge | F |
| For other types of construction and more information, see from page 2/103 | | |
| ... | | ... |
| Motor protection | Version | Order code |
| PTC thermistor with 3 temperature sensors | Standard | B |
| For other motor protection and more information, see from page 2/113 | | |
| ... | | ... |
| Terminal box position | Version | Order code(s) |
| Terminal box at top | Standard | 4 |
| For other terminal box positions and more information, see from page 2/116 | | |
| Special versions | Version | Order code(s) |
| For options, see from page 2/125 | | |
| 1LE1643-.... | | -Z ...+...+...+... |

¹⁾ Types derived from IM B3 (IM B6/7/8, IM V6 and IM V5), from IM B5 (IM V3 and IM V1) and from IM B14 (IM V19 and IM V18) are possible, provided that no requirement exists for stamping of the type on the rating plate. The basic type IM B3, IM B5, or IM B14 is stamped as standard on the rating plate. If mounted in a different position, the position must be specified to ensure that the condensation drainage holes are positioned correctly.



Aluminum series SIMOTICS GP 1LE1041 – self-ventilated or forced-air cooled

Selection and ordering data

| Operating values at rated power | | | | | | | | | | | | | | Aluminum series | | | |
|---|------------------------------------|---------------------|-----------------------------|----------------------------|------------------------------|------------------------------|------------------------------|----------------------------------|---------------------------|-----------------------------------|-----------------------------------|--------------------------------|-----------------------------|----------------------------|--------------|--------------------|--------|
| P_{rated} 60 Hz/ P50 kW | P_{rated} 60 Hz/ P60 kW | Frame size FS | n_{rated} 60 Hz rpm | T_{rated} 60 Hz Nm | η_{rated} 60 Hz % | η_{rated} 60 Hz % | η_{rated} 60 Hz % | $\cos\phi_{rated}$ 60 Hz % | I_{rated} 460 V A | $T_{LR}/$ T_{rated} 60 Hz | $I_{LR}/$ I_{rated} 60 Hz | $T_B/$ T_{rated} 60 Hz | L_{pfA} 60 Hz dB(A) | L_{WA} 60 Hz dB(A) | 1LE1041 | $m_{IM B3}$ | J |
| Article No. | | | | | | | | | | | | | | | | | |
| <ul style="list-style-type: none"> • Cooling: Self-ventilated (IC411) or with order code F90 forced-air cooled without external fan and fan cover (IC418) • Efficiency according to IEC 60034-30-1: IE2 High Efficiency • Insulation: Thermal class 155 (temperature class F), IP55 degree of protection, utilization in accordance with thermal class 130 (temperature class B) | | | | | | | | | | | | | | | | | |
| 2-pole: 3000 rpm at 50 Hz, 3600 rpm at 60 Hz | | | | | | | | | | | | | | | | | |
| 0.75 | 0.86 | 80 M | 3445 | 2.1 | 75.5 | 76.2 | 74.8 | 0.83 | 1.5 | 2.1 | 6 | 3 | 64 | 75 | 1LE1041-0DA2 | 9 | 0.0008 |
| 1.5 | 1.75 | 90 S | 3505 | 4.1 | 84 | 83.5 | 80.7 | 0.82 | 2.75 | 3.1 | 8.5 | 4.5 | 69 | 81 | 1LE1041-0EA0 | 13 | 0.0017 |
| 2.2 | 2.55 | 90 L | 3510 | 6 | 85.5 | 85.2 | 82.6 | 0.83 | 3.9 | 3 | 8.7 | 4.6 | 69 | 81 | 1LE1041-0EA4 | 15 | 0.0021 |
| 4 | 4.55 | 112 M | 3555 | 10 | 87.5 | 86.9 | 84.6 | 0.83 | 6.4 | 2.7 | 9.9 | 4.5 | 73 | 85 | 1LE1041-1BA2 | 27 | 0.0092 |
| 5.5 | 6.3 | 132 S | 3555 | 15 | 88.5 | 88.4 | 87 | 0.86 | 9.1 | 2 | 7.6 | 3.3 | 72 | 84 | 1LE1041-1CA0 | 39 | 0.02 |
| 7.5 | 8.6 | 132 S | 3560 | 20 | 89.5 | 89.7 | 88.7 | 0.87 | 12.1 | 2.3 | 8.2 | 3.6 | 72 | 84 | 1LE1041-1CA1 | 43 | 0.024 |
| 11 | 12.6 | 160 M | 3560 | 30 | 90.2 | 89.6 | 87.4 | 0.86 | 17.8 | 2.4 | 8.2 | 3.6 | 77 | 89 | 1LE1041-1DA2 | 67 | 0.045 |
| 15 | 17.3 | 160 M | 3565 | 40 | 90.2 | 90 | 88.6 | 0.87 | 24 | 2.8 | 8.4 | 3.9 | 77 | 89 | 1LE1041-1DA3 | 75 | 0.053 |
| 18.5 | 21.3 | 160 L | 3565 | 50 | 91 | 90.8 | 89.5 | 0.87 | 29.5 | 3.3 | 8.9 | 4.1 | 77 | 89 | 1LE1041-1DA4 | 84 | 0.061 |
| 4-pole: 1500 rpm at 50 Hz, 1800 rpm at 60 Hz | | | | | | | | | | | | | | | | | |
| 0.75 | 0.86 | 80 M | 1750 | 4.1 | 78 | 77.4 | 74.6 | 0.72 | 1.68 | 2.5 | 6.8 | 3.8 | 55 | 66 | 1LE1041-0DB3 | 11 | 0.0021 |
| 1.5 | 1.75 | 90 L | 1745 | 8.2 | 84 | 84 | 81.9 | 0.75 | 3 | 2.9 | 7.5 | 4 | 58 | 70 | 1LE1041-0EB4 | 16 | 0.0036 |
| 2.2 | 2.55 | 100 L | 1760 | 12 | 87.5 | 88.3 | 87.4 | 0.78 | 4.05 | 2.5 | 8.1 | 3.9 | 62 | 74 | 1LE1041-1AB4 | 21 | 0.0086 |
| 4 | 4.55 | 112 M | 1770 | 20 | 87.5 | 87.2 | 85.1 | 0.77 | 6.9 | 3 | 8.7 | 4 | 62 | 74 | 1LE1041-1BB2 | 29 | 0.014 |
| 5.5 | 6.3 | 132 S | 1770 | 30 | 89.5 | 89.6 | 88.1 | 0.78 | 9.9 | 2.6 | 8 | 3.3 | 68 | 80 | 1LE1041-1CB0 | 42 | 0.027 |
| 7.5 | 8.6 | 132 M | 1770 | 40 | 89.5 | 90 | 89.3 | 0.82 | 12.8 | 2.7 | 8 | 3.4 | 68 | 80 | 1LE1041-1CB2 | 49 | 0.034 |
| 11 | 12.6 | 160 M | 1775 | 59 | 91 | 91.2 | 90.1 | 0.84 | 18.1 | 2.5 | 7.7 | 3.2 | 69 | 81 | 1LE1041-1DB2 | 71 | 0.065 |
| 15 | 17.3 | 160 L | 1780 | 80 | 91 | 91.1 | 90.1 | 0.84 | 24.5 | 2.6 | 8.5 | 3.4 | 69 | 81 | 1LE1041-1DB4 | 83 | 0.083 |
| Voltages (≤ 600 V) | | | | | | | | | | | | | | Version | | Order code | |
| 50 Hz 230 VΔ/400 VY | | | | 60 Hz 460 VY | | | | Standard | | | | 2 | 2 | - | | | |
| 50 Hz 400 VΔ | | | | 60 Hz 460 VΔ | | | | Standard | | | | 3 | 4 | - | | | |
| 50 Hz 500 VY | | | | | | | | Without additional charge | | | | 2 | 7 | - | | | |
| 50 Hz 500 VΔ | | | | | | | | Without additional charge | | | | 4 | 0 | - | | | |
| For other voltages and more information, see from page 2/93 | | | | | | | | | | | | | | 9 | 0 | ... | |
| Types of construction | | | | | | | | | | | | | | Version | | Order code | |
| With flange | | | | IM B5 ¹⁾ | | | | With additional charge | | | | F | - | | | | |
| With flange | | | | IM B14 ¹⁾ | | | | With additional charge | | | | K | - | | | | |
| For other types of construction and more information, see from page 2/99 | | | | | | | | | | | | | | | | ... | |
| Motor protection | | | | | | | | | | | | | | Version | | Order code | |
| Without | | | | | | | | Standard | | | | A | - | | | | |
| PTC thermistor with 1 or 3 temperature sensors (frame sizes 80, 90 or 100 to 200) | | | | | | | | With additional charge | | | | B | - | | | | |
| For other motor protection and more information, see from page 2/112 | | | | | | | | | | | | | | | | ... | |
| Terminal box position | | | | | | | | | | | | | | Version | | Order code(s) | |
| Terminal box at top | | | | | | | | Standard | | | | 4 | | | | | |
| For other terminal box positions and more information, see from page 2/115 | | | | | | | | | | | | | | | | | |
| Special versions | | | | | | | | | | | | | | | | Order code(s) | |
| Forced-air cooled motors w/o ext. fan/fan cover (IC418) | | | | | | | | | | | | | | 1LE1041-.... | | -Z F90+...+...+... | |
| For options, see from page 2/118 | | | | | | | | | | | | | | 1LE1041-.... | | -Z ...+...+...+... | |



¹⁾ Types derived from IM B5 (IM V3 and IM V1) and from IM B14 (IM V19 and IM V18) are possible, provided that no requirements exist for condensation drainage holes (H03) and stamping of the type on the rating plate. The basic type IM B5 or IM B14 is stamped as standard on the rating plate. For orders with condensation drainage holes (H03), the type must be specified.

SIMOTICS GP and SIMOTICS SD standard motors

APAC Line · IE2 High Efficiency



Aluminum series SIMOTICS GP 1LE1041 – self-ventilated or forced-air cooled

Selection and ordering data

| Operating values at rated power | | | | | | | | | | | | | | Aluminum series | | | |
|---|------------------------------------|---------------|-----------------------------|----------------------------|------------------------------|------------------------------|------------------------------|----------------------------------|---------------------------|-----------------------------------|-----------------------------------|--------------------------------|-----------------------------|----------------------------|--------------|-----------------|-------|
| P_{rated} 60 Hz/ P50 kW | P_{rated} 60 Hz/ P60 kW | Frame size | n_{rated} 60 Hz rpm | T_{rated} 60 Hz Nm | η_{rated} 60 Hz % | η_{rated} 60 Hz % | η_{rated} 60 Hz % | $\cos\phi_{rated}$ 60 Hz % | I_{rated} 60 Hz A | $T_{LR}/$ T_{rated} 60 Hz | $I_{LR}/$ I_{rated} 60 Hz | $T_B/$ T_{rated} 60 Hz | L_{pFA} 60 Hz dB(A) | L_{WA} 60 Hz dB(A) | 1LE1041 | $m_{IM B3}$ | J |
| Article No. | | | | | | | | | | | | | | | | | |
| <ul style="list-style-type: none"> Cooling: Self-ventilated (IC411) or with order code F90 forced-air cooled without external fan and fan cover (IC418) Efficiency according to IEC 60034-30-1: IE2 High Efficiency Insulation: Thermal class 155 (temperature class F), IP55 degree of protection, utilization in accordance with thermal class 130 (temperature class B) | | | | | | | | | | | | | | | | | |
| 6-pole: 1000 rpm at 50 Hz, 1200 rpm at 60 Hz | | | | | | | | | | | | | | | | | |
| 0.75 | 0.86 | 90 S | 1145 | 6.3 | 73 | 72.7 | 69.7 | 0.65 | 1.98 | 2.2 | 4.5 | 3 | 46 | 58 | 1LE1041-0EC0 | 13 | 0.003 |
| 1.5 | 1.75 | 100 L | 1175 | 12 | 86.5 | 86.3 | 84.2 | 0.69 | 3.15 | 2.2 | 6.4 | 3.2 | 62 | 74 | 1LE1041-1AC4 | 25 | 0.011 |
| 2.2 | 2.55 | 112 M | 1170 | 18 | 87.5 | 87.6 | 86 | 0.73 | 4.3 | 2.1 | 6.3 | 3.2 | 65 | 77 | 1LE1041-1BC2 | 29 | 0.014 |
| 4 | 4.55 | 132 M | 1180 | 30 | 87.5 | 87.5 | 85.7 | 0.71 | 7.5 | 1.9 | 6.2 | 3 | 67 | 79 | 1LE1041-1CC2 | 43 | 0.029 |
| 5.5 | 6.3 | 132 M | 1175 | 45 | 89.5 | 89.9 | 88.9 | 0.73 | 10.6 | 2.1 | 6.5 | 2.9 | 67 | 79 | 1LE1041-1CC3 | 52 | 0.037 |
| 7.5 | 8.6 | 160 M | 1180 | 61 | 89.5 | 89.6 | 88.4 | 0.73 | 14.4 | 2.1 | 5.4 | 2.5 | 70 | 82 | 1LE1041-1DC2 | 77 | 0.075 |
| 11 | 12.6 | 160 L | 1180 | 89 | 90.2 | 90.5 | 89.5 | 0.74 | 20.5 | 2.2 | 5.5 | 2.5 | 70 | 82 | 1LE1041-1DC4 | 93 | 0.098 |
| Voltages (≤ 600 V) | | | | | | | | | | | | | | Version | | Order code | |
| 50 Hz 230 VΔ/400 VY | | | | 60 Hz 460 VY | | | | Standard | | 2 2 | | - | | - | | - | |
| 50 Hz 400 VΔ | | | | 60 Hz 460 VΔ | | | | Standard | | 3 4 | | - | | - | | - | |
| 50 Hz 500 VY | | | | | | | | Without additional charge | | 2 7 | | - | | - | | - | |
| 50 Hz 500 VΔ | | | | | | | | Without additional charge | | 4 0 | | - | | - | | - | |
| For other voltages and more information, see from page 2/93 | | | | | | | | | | | | | | 9 0 | | ... | |
| Types of construction | | | | | | | | | | | | | | Version | | Order code | |
| With flange | | | | IM B5 ¹⁾ | | | | With additional charge | | F | | - | | - | | - | |
| With flange | | | | IM B14 ¹⁾ | | | | With additional charge | | K | | - | | - | | - | |
| For other types of construction and more information, see from page 2/99 | | | | | | | | | | | | | | | | ... | |
| Motor protection | | | | | | | | | | | | | | Version | | Order code | |
| Without | | | | | | | | Standard | | A | | - | | - | | - | |
| PTC thermistor with 1 or 3 temperature sensors (frame sizes 90 or 100 to 200) | | | | | | | | With additional charge | | B | | - | | - | | - | |
| For other motor protection and more information, see from page 2/112 | | | | | | | | | | | | | | | | ... | |
| Terminal box position | | | | | | | | | | | | | | Version | | Order code | |
| Terminal box at top | | | | | | | | Standard | | 4 | | - | | - | | - | |
| For other terminal box positions and more information, see from page 2/115 | | | | | | | | | | | | | | | | ... | |
| Special versions | | | | | | | | | | | | | | | | Order code(s) | |
| Forced-air cooled motors w/o ext. fan/fan cover (IC418) | | | | | | | | | | | | | | 1LE1041-...-Z | | F90+...+...+... | |
| For options, see from page 2/118 | | | | | | | | | | | | | | 1LE1041-...-Z | | ...+...+...+... | |

¹⁾ Types derived from IM B5 (IM V3 and IM V1) and from IM B14 (IM V19 and IM V18) are possible, provided that no requirements exist for condensation drainage holes (H03) and stamping of the type on the rating plate. The basic type IM B5 or IM B14 is stamped as standard on the rating plate. For orders with condensation drainage holes (H03), the type must be specified.

Selection and ordering data

| Operating values at rated power | | | | | | | | | | | | | | Aluminum series | | | | | |
|---|--------------------|------------|--------------------|--------------------|--------------------|-----------------------|-----------------------|-----------------------|---------------------------|--------------------|---------------------------|---------------------------|------------------------|---------------------------|-----------------|--------------|-------------|------------------|--|
| $P_{rated, 60 Hz}$ | $P_{rated, 60 Hz}$ | Frame size | $n_{rated, 60 Hz}$ | $T_{rated, 60 Hz}$ | Different IE class | $\eta_{rated, 60 Hz}$ | $\eta_{rated, 60 Hz}$ | $\eta_{rated, 60 Hz}$ | $\cos\phi_{rated, 60 Hz}$ | $I_{rated, 60 Hz}$ | $T_{LR}/T_{rated, 60 Hz}$ | $I_{LR}/I_{rated, 60 Hz}$ | $T_B/T_{rated, 60 Hz}$ | $L_{pFA, 60 Hz}$ | $L_{WA, 60 Hz}$ | 1LE1041 | $m_{IM B3}$ | J | |
| P50 | P60 | FS | rpm | Nm | | 4/4 | 3/4 | 2/4 | 4/4 | 460 V | 60 Hz | 60 Hz | 60 Hz | | | Article No. | kg | kgm ² | |
| kW | kW | FS | rpm | Nm | | % | % | % | | A | | | | | | | kg | kgm ² | |
| • Cooling: Self-ventilated (IC411) or with order code F90 forced-air cooled without external fan and fan cover (IC418) • Efficiency according to IEC 60034-30-1: IE2 High Efficiency • Insulation: Thermal class 155 (temperature class F), IP55 degree of protection, utilization in accordance with thermal class 130 (temperature class B) | | | | | | | | | | | | | | | | | | | |
| 2-pole: 3000 rpm at 50 Hz, 3600 rpm at 60 Hz | | | | | | | | | | | | | | | | | | | |
| 4 | 4.55 | 100 L | 3530 | 10 | | 87.5 | 87.5 | 85.9 | 0.84 | 6.3 | 3.3 | 9.6 | 4.6 | 71 | 83 | 1LE1041-1AA6 | 26 | 0.0054 | |
| 5.5 | 6.3 | 112 M | 3550 | 15 | | 88.5 | 88.6 | 87.4 | 0.87 | 9 | 2.8 | 9.9 | 4.5 | 73 | 85 | 1LE1041-1BA6 | 34 | 0.012 | |
| 11 | 12.6 | 132 M | 3555 | 30 | | 90.2 | 90.5 | 89.8 | 0.9 | 17 | 2.7 | 9.3 | 3.6 | 72 | 84 | 1LE1041-1CA6 | 57 | 0.031 | |
| 15 | 17.3 | 132 L | 3555 | 40 | | 90.2 | 90.6 | 90.3 | 0.91 | 23 | 2.5 | 10 | 4.7 | 72 | 84 | 1LE1041-1CA7 | 65 | 0.035 | |
| 22 | 25.3 | 160 L | 3565 | 59 | | 91 | 91 | 89.9 | 0.89 | 34 | 3.6 | 9.6 | 4.3 | 77 | 89 | 1LE1041-1DA6 | 94 | 0.068 | |
| 4-pole: 1500 rpm at 50 Hz, 1800 rpm at 60 Hz | | | | | | | | | | | | | | | | | | | |
| 4 | 4.55 | 100 L | 1770 | 20 | | 87.5 | 87.7 | 86.3 | 0.76 | 7 | 2.8 | 9.2 | 4.3 | 62 | 74 | 1LE1041-1AB6 | 30 | 0.014 | |
| 5.5 | 6.3 | 112 M | 1765 | 30 | | 89.5 | 89.3 | 87.4 | 0.8 | 9.6 | 2.8 | 8.3 | 3.6 | 62 | 74 | 1LE1041-1BB6 | 34 | 0.017 | |
| 11 | 12.6 | 132 M | 1770 | 59 | | 91 | 91.5 | 90.8 | 0.82 | 18.5 | 2.9 | 8.5 | 3.6 | 68 | 80 | 1LE1041-1CB6 | 64 | 0.046 | |
| 18.5 | 21.3 | 160 L | 1780 | 99 | | 92.4 | 92.4 | 91.3 | 0.84 | 30 | 2.9 | 8.8 | 3.6 | 69 | 81 | 1LE1041-1DB6 | 100 | 0.099 | |
| 6-pole: 1000 rpm at 50 Hz, 1200 rpm at 60 Hz | | | | | | | | | | | | | | | | | | | |
| 7.5 | 8.6 | 132 M | 1175 | 61 | | 89.5 | 89.8 | 88.7 | 0.72 | 14.6 | 2.2 | 6.4 | 3 | 67 | 79 | 1LE1041-1CC6 | 64 | 0.046 | |
| 15 | 17.3 | 160 L | 1180 | 121 | IE1 | 90.2 | 90.4 | 89.3 | 0.73 | 28.5 | 2.3 | 5.8 | 2.6 | 70 | 82 | 1LE1041-1DC6 | 115 | 0.12 | |
| Voltages (≤ 600 V) ¹⁾ | | | | | | | | | | | | | | | | | | | |
| 50 Hz 230 VΔ/400 VY | | | | | | | | | | | | | | Version | | Order code | | | |
| 60 Hz 460 VY | | | | | | | | | | | | | | Standard | | 2 2 | | - | |
| 50 Hz 400 VΔ | | | | | | | | | | | | | | Standard | | 3 4 | | - | |
| 50 Hz 500 VY | | | | | | | | | | | | | | Without additional charge | | 2 7 | | - | |
| 50 Hz 500 VΔ | | | | | | | | | | | | | | Without additional charge | | 4 0 | | - | |
| For other voltages and more information, see from page 2/93 | | | | | | | | | | | | | | | | 9 0 | | ... | |
| Types of construction ²⁾ | | | | | | | | | | | | | | | | | | | |
| With flange IM B5 ³⁾ | | | | | | | | | | | | | | Version | | | | Order code | |
| With flange IM B14 ³⁾ | | | | | | | | | | | | | | With additional charge | | F | | - | |
| With flange IM B14 ³⁾ | | | | | | | | | | | | | | With additional charge | | K | | - | |
| For other types of construction and more information, see from page 2/99 | | | | | | | | | | | | | | | | | | ... | |
| Motor protection | | | | | | | | | | | | | | | | | | | |
| Without | | | | | | | | | | | | | | Version | | | | Order code | |
| PTC thermistor with 3 temperature sensors | | | | | | | | | | | | | | Standard | | A | | - | |
| For other motor protection and more information, see from page 2/112 | | | | | | | | | | | | | | With additional charge | | B | | - | |
| | | | | | | | | | | | | | | | | | | ... | |
| Terminal box position | | | | | | | | | | | | | | | | | | | |
| Terminal box at top | | | | | | | | | | | | | | Version | | | | Order code(s) | |
| For other terminal box positions and more information, see from page 2/115 | | | | | | | | | | | | | | Standard | | 4 | | | |
| Special versions | | | | | | | | | | | | | | | | | | | |
| Forced-air cooled motors w/o ext. fan/fan cover (IC418) | | | | | | | | | | | | | | 1LE1041-.... | | -Z | | F90+...+...+... | |
| For options, see from page 2/118 | | | | | | | | | | | | | | 1LE1041-.... | | -Z | | ...+...+...+... | |



¹⁾ Operating voltages only ≤ 600 V admissible in accordance with MG1 Table 12-11.

²⁾ Types of construction with feet are not possible for 2-pole, 4-pole and 6-pole motors ≤ 200 hp in accordance with MG1 Table 12-11.

³⁾ Types derived from IM B5 (IM V3 and IM V1) and from IM B14 (IM V19 and IM V18) are possible, provided that no requirements exist for condensation drainage holes (H03) and stamping of the type on the rating plate. The basic type IM B5 or IM B14 is stamped as standard on the rating plate. For orders with condensation drainage holes (H03), the type must be specified.

SIMOTICS GP and SIMOTICS SD standard motors

APAC Line · IE2 High Efficiency



Cast-iron series SIMOTICS SD 1LE1541 Basic Line – self-ventilated or forced-air cooled

Selection and ordering data

| Operating values at rated power | | | | | | | | | | | | | | | Cast-iron series | | | |
|---|--------------------|------------|---------------------|--------------------|--------------------|---------------------------|-----------------------|-----------------------|---------------------------|--------------------|---------------------------|---------------------------|------------------------|------------------|------------------|----------------------|---------------------|-------|
| $P_{rated, 60 Hz}$ | $P_{rated, 50 Hz}$ | Frame size | $n_{rated, 60 Hz}$ | $T_{rated, 60 Hz}$ | Different IE class | $\eta_{rated, 60 Hz}$ | $\eta_{rated, 60 Hz}$ | $\eta_{rated, 60 Hz}$ | $\cos\phi_{rated, 60 Hz}$ | $I_{rated, 60 Hz}$ | $T_{LR}/I_{rated, 60 Hz}$ | $I_{LR}/I_{rated, 60 Hz}$ | $T_B/I_{rated, 60 Hz}$ | $L_{pfA, 60 Hz}$ | $L_{WA, 60 Hz}$ | 1LE1541 – Basic Line | $m_{IM B3}$ | J |
| kW | kW | FS | rpm | Nm | | % | % | % | % | A | | | | | Article No. | kg | kgm ² | |
| • Cooling: Self-ventilated (IC411) or with order code F90 forced-air cooled without external fan and fan cover (IC418) • Efficiency according to IEC 60034-30-1: IE2 High Efficiency • Insulation: Thermal class 155 (temperature class F), IP55 degree of protection, utilization in accordance with thermal class 130 (temperature class B) | | | | | | | | | | | | | | | | | | |
| 2-pole: 3000 rpm at 50 Hz, 3600 rpm at 60 Hz | | | | | | | | | | | | | | | | | | |
| 22 | 24.5 | 180 M | 3550 | 59 | | 91 | 90.8 | 89.5 | 0.86 | 35.5 | 3 | 8.4 | 4.1 | 81 | 84 | 1LE1541-1EA2 | 145 | 0.069 |
| 30 | 33.5 | 200 L | 3565 | 80 | | 91.7 | 91.2 | 89.6 | 0.86 | 47.5 | 2.9 | 7.7 | 3.8 | 82 | 89 | 1LE1541-2AA4 | 200 | 0.13 |
| 37 | 41.5 | 200 L | 3565 | 99 | | 92.4 | 92.2 | 91 | 0.87 | 58 | 3.3 | 8.1 | 3.8 | 82 | 89 | 1LE1541-2AA5 | 225 | 0.15 |
| 45 | 51 | 225 M | 3570 | 120 | | 93 | 92.7 | 91.3 | 0.88 | 69 | 3.1 | 8.7 | 3.8 | 77 | 90 | 1LE1541-2BA2 | 295 | 0.23 |
| 55 | 62 | 250 M | 3575 | 147 | | 93 | 92.5 | 91 | 0.89 | 83 | 2.4 | 7.4 | 3.5 | 80 | 94 | 1LE1541-2CA2 | 360 | 0.4 |
| 75 | 84 | 280 S | 3580 | 200 | | 93.6 | 92.9 | 91.1 | 0.87 | 116 | 2.8 | 7.7 | 3.5 | 81 | 95 | 1LE1541-2DA0 | 490 | 0.71 |
| 90 | 101 | 280 M | 3578 | 240 | | 94.5 | 94.2 | 93.1 | 0.88 | 136 | 2.7 | 7.9 | 3.4 | 81 | 95 | 1LE1541-2DA2 | 530 | 0.83 |
| 110 | 123 | 315 S | 3585 | 293 | | 94.5 | 94 | 92.5 | 0.9 | 162 | 2.6 | 7.9 | 3.3 | 82 | 96 | 1LE1541-3AA0 | 720 | 1.3 |
| 132 | 148 | 315 M | 3585 | 352 | | 95 | 94.7 | 93.6 | 0.91 | 192 | 2.7 | 8.1 | 3.4 | 82 | 96 | 1LE1541-3AA2 | 880 | 1.6 |
| 160 | 180 | 315 L | 3585 | 426 | | 95 | 94.6 | 93.3 | 0.92 | 230 | 2.7 | 8 | 3.2 | 84 | 99 | 1LE1541-3AA4 | 930 | 1.8 |
| 200 | 224 | 315 L | 3585 | 533 | | 95.4 | 95.2 | 94.2 | 0.92 | 285 | 3.1 | 8.3 | 3.2 | 84 | 99 | 1LE1541-3AA5 | 1130 | 2.2 |
| 4-pole: 1500 rpm at 50 Hz, 1800 rpm at 60 Hz | | | | | | | | | | | | | | | | | | |
| 18.5 | 21.3 | 180 M | 1770 | 100 | | 92.4 | 92.6 | 91.9 | 0.83 | 30.5 | 2.8 | 7.7 | 3.9 | 64 | 77 | 1LE1541-1EB2 | 160 | 0.12 |
| 22 | 25.3 | 180 L | 1770 | 119 | | 92.4 | 92.5 | 91.8 | 0.83 | 36 | 3 | 8.4 | 3.9 | 72 | 79 | 1LE1541-1EB4 | 170 | 0.13 |
| 30 | 34.5 | 200 L | 1778 | 161 | | 93 | 93.1 | 92.2 | 0.84 | 48 | 3.2 | 8.2 | 3.7 | 72 | 79 | 1LE1541-2AB5 | 230 | 0.2 |
| 37 | 42.5 | 225 S | 1778 | 199 | | 93 | 93.2 | 92.5 | 0.87 | 57 | 2.7 | 7.2 | 3.3 | 69 | 82 | 1LE1541-2BB0 | 280 | 0.42 |
| 45 | 52 | 225 M | 1778 | 242 | | 93.6 | 93.8 | 93.1 | 0.86 | 70 | 3 | 7.6 | 3.5 | 69 | 83 | 1LE1541-2BB2 | 305 | 0.46 |
| 55 | 63 | 250 M | 1785 | 294 | | 94.1 | 94.1 | 93.3 | 0.84 | 87 | 3.1 | 7.3 | 3.3 | 69 | 83 | 1LE1541-2CB2 | 385 | 0.75 |
| 75 | 86 | 280 S | 1788 | 401 | | 94.5 | 94.3 | 93.2 | 0.87 | 114 | 2.7 | 7.6 | 3.2 | 79 | 92 | 1LE1541-2DB0 | 550 | 1.3 |
| 90 | 104 | 280 M | 1788 | 481 | | 94.5 | 94.3 | 93.3 | 0.87 | 137 | 2.9 | 8.1 | 3.4 | 78 | 92 | 1LE1541-2DB2 | 570 | 1.4 |
| 110 | 127 | 315 S | 1790 | 587 | | 95 | 94.8 | 93.8 | 0.86 | 169 | 3.1 | 8 | 3.3 | 79 | 93 | 1LE1541-3AB0 | 740 | 2 |
| 132 | 152 | 315 M | 1790 | 704 | | 95 | 94.8 | 94 | 0.86 | 205 | 3.1 | 7.8 | 3.2 | 79 | 93 | 1LE1541-3AB2 | 870 | 2.3 |
| 160 | 184 | 315 L | 1790 | 854 | | 95 | 94.7 | 93.5 | 0.87 | 245 | 3.1 | 8.3 | 3.2 | 80 | 95 | 1LE1541-3AB4 | 940 | 2.8 |
| 200 | 230 | 315 L | 1792 | 1066 | | 95.4 | 94.7 | 93.6 | 0.86 | 305 | 3.8 | 9 | 3.2 | 84 | 98 | 1LE1541-3AB5 | 1140 | 3.5 |
| Voltages | | | | | | | | | | | | | | | Version | | Order code | |
| 50 Hz 230 VΔ/400 VY | | | 60 Hz 460 VY | | | Standard | | | 2 2 | | - | | | | | | | |
| 50 Hz 400 VΔ/690 VY | | | 60 Hz 460 VΔ | | | Standard | | | 3 4 | | - | | | | | | | |
| 50 Hz 500 VY | | | | | | Without additional charge | | | 2 7 | | - | | | | | | | |
| 50 Hz 500 VΔ | | | | | | Without additional charge | | | 4 0 | | - | | | | | | | |
| For other voltages and more information, see from page 2/96 | | | | | | | | | | | | | | | 9 0 | | ... | |
| Types of construction | | | | | | | | | | | | | | | Version | | Order code | |
| With flange | | | IM B5 ¹⁾ | | | With additional charge | | | F | | - | | | | | | | |
| For other types of construction and more information, see from page 2/103 | | | | | | | | | | | | | | | | | ... | |
| Motor protection | | | | | | | | | | | | | | | Version | | Order code | |
| Without | | | | | | Standard | | | A | | - | | | | | | | |
| PTC thermistor with 3 temperature sensors | | | | | | With additional charge | | | B | | - | | | | | | | |
| For other motor protection and more information, see from page 2/113 | | | | | | | | | | | | | | | | | ... | |
| Terminal box position | | | | | | | | | | | | | | | Version | | Order code(s) | |
| Terminal box at top | | | | | | Standard | | | 4 | | | | | | | | | |
| For other terminal box positions and more information, see from page 2/116 | | | | | | | | | | | | | | | | | | |
| Special versions | | | | | | | | | | | | | | | | | Order code(s) | |
| Forced-air cooled motors w/o ext. fan/fan cover (IC418) | | | | | | | | | | | | | | | 1LE1541-.... | | -Z F90 +...+...+... | |
| For options, see from page 2/125 | | | | | | | | | | | | | | | 1LE1541-.... | | -Z ...+...+...+... | |

2

¹⁾ Types derived from IM B5 (IM V3 and IM V1) and from IM B14 (IM V19 and IM V18) are possible, provided that no requirement exists for stamping of the type on the rating plate. The basic type IM B5 or IM B14 is stamped as standard on the rating plate. If mounted in a different position, the position must be specified to ensure that the condensation drainage holes are positioned correctly.

Selection and ordering data

| Operating values at rated power | | | | | | | | | | | | | | | Cast-iron series | | m _{IM B3} | J | | |
|---|---------------------------------------|---------------|-------------------------------|-------------------------------|----------------------------|-------------------------------|-------------------------------|-------------------------------|----------------------------------|-------------------------------|---|---|---|-----------------------------|---|----------------------|--------------------|------------|-------------|----|
| P _{rated} , 60 Hz/ P50 | P _{rated} , 60 Hz/ P60 | Frame size | n _{rated} , 60 Hz | T _{rated} , 60 Hz | Differ- ent IE class | η _{rated} , 60 Hz | η _{rated} , 60 Hz | η _{rated} , 60 Hz | cosφ _{rated} , 60 Hz | I _{rated} , 60 Hz | T _{LR} / I _{LR} , 60 Hz | I _{LR} / I _{LR} , 60 Hz | T _B / T _B , 60 Hz | L _{pFA} , 60 Hz | L _{WA} , 60 Hz | 1LE1541 – Basic Line | | | Article No. | kg |
| kW | kW | FS | rpm | Nm | | % | % | % | % | A | | | | | | | | | | |
| • Cooling: Self-ventilated (IC411) or with order code F90 forced-air cooled without external fan and fan cover (IC418) • Efficiency according to IEC 60034-30-1: IE2 High Efficiency • Insulation: Thermal class 155 (temperature class F), IP55 degree of protection, utilization in accordance with thermal class 130 (temperature class B) | | | | | | | | | | | | | | | | | | | | |
| 6-pole: 1000 rpm at 50 Hz, 1200 rpm at 60 Hz | | | | | | | | | | | | | | | | | | | | |
| 15 | 18 | 180 L | 1178 | 122 | | 90.2 | 90.2 | 89 | 0.77 | 27 | 2.8 | 6.9 | 3.4 | 60 | 73 | 1LE1541-1EC4 | 155 | 0.17 | | |
| 18.5 | 22 | 200 L | 1182 | 149 | IE1 | 91.7 | 92 | 91.5 | 0.81 | 31.5 | 2.6 | 6.7 | 3 | 66 | 79 | 1LE1541-2AC4 | 200 | 0.25 | | |
| 22 | 26.5 | 200 L | 1182 | 178 | IE1 | 91.7 | 92.1 | 91.6 | 0.81 | 37 | 3 | 7.4 | 3 | 66 | 79 | 1LE1541-2AC5 | 220 | 0.3 | | |
| 30 | 36 | 225 M | 1182 | 242 | IE1 | 93 | 93.3 | 92.6 | 0.83 | 49 | 2.9 | 7 | 3.1 | 66 | 79 | 1LE1541-2BC2 | 300 | 0.58 | | |
| 37 | 44.5 | 250 M | 1185 | 298 | IE1 | 93 | 93.3 | 92.6 | 0.83 | 60 | 3.3 | 7.3 | 2.8 | 66 | 79 | 1LE1541-2CC2 | 370 | 0.86 | | |
| 45 | 54 | 280 S | 1188 | 362 | IE1 | 93.6 | 93.8 | 93.1 | 0.84 | 72 | 3.1 | 7.4 | 3 | 67 | 81 | 1LE1541-2DC0 | 460 | 1.1 | | |
| 55 | 66 | 280 M | 1188 | 442 | IE1 | 93.6 | 93.9 | 93.4 | 0.85 | 87 | 3.1 | 7.2 | 2.9 | 67 | 81 | 1LE1541-2DC2 | 510 | 1.4 | | |
| 75 | 90 | 315 S | 1190 | 602 | IE1 | 94.1 | 94.1 | 93.2 | 0.83 | 121 | 2.7 | 7.5 | 3 | 67 | 82 | 1LE1541-3AC0 | 660 | 2.1 | | |
| 90 | 108 | 315 M | 1190 | 722 | IE1 | 94.1 | 94.4 | 93.5 | 0.84 | 143 | 2.9 | 7.6 | 3.1 | 68 | 83 | 1LE1541-3AC2 | 730 | 2.5 | | |
| 110 | 132 | 315 L | 1190 | 883 | IE1 | 95 | 95 | 94.6 | 0.85 | 171 | 3.3 | 8.1 | 3.2 | 69 | 84 | 1LE1541-3AC4 | 940 | 3.6 | | |
| 132 | 158 | 315 L | 1190 | 1059 | | 95 | 95 | 94.4 | 0.85 | 205 | 3.7 | 9.2 | 3.6 | 69 | 84 | 1LE1541-3AC5 | 990 | 4 | | |
| 160 | 192 | 315 L | 1192 | 1282 | | 95 | 94.9 | 94.2 | 0.85 | 250 | 3.8 | 9.3 | 3.4 | 72 | 87 | 1LE1541-3AC6 | 1160 | 4.7 | | |
| Voltages | | | | | | | | | | | | | | | Version | | | Order code | | |
| 50 Hz 230 VΔ/400 VY | | | 60 Hz 460 VY | | | Standard | | | 2 | 2 | - | | | | | | | | | |
| 50 Hz 400 VΔ/690 VY | | | 60 Hz 460 VΔ | | | Standard | | | 3 | 4 | - | | | | | | | | | |
| 50 Hz 500 VY | | | | | | Without additional charge | | | 2 | 7 | - | | | | | | | | | |
| 50 Hz 500 VΔ | | | | | | Without additional charge | | | 4 | 0 | - | | | | | | | | | |
| For other voltages and more information, see from page 2/96 | | | | | | | | | | | | | | | 9 | 0 | ... | | | |
| Types of construction ¹⁾ | | | | | | | | | | | | | | | Version | | | Order code | | |
| With flange | | | IM B5 ²⁾ | | | With additional charge | | | F | - | | | | | | | | | | |
| For other types of construction and more information, see from page 2/103 | | | | | | | | | | | | | | | | ... | | | | |
| Motor protection | | | | | | | | | | | | | | | Version | | | Order code | | |
| Without | | | | | | Standard | | | A | - | | | | | | | | | | |
| PTC thermistor with 3 temperature sensors | | | | | | With additional charge | | | B | - | | | | | | | | | | |
| For other motor protection and more information, see from page 2/113 | | | | | | | | | | | | | | | | ... | | | | |
| Terminal box position | | | | | | | | | | | | | | | Version | | | Order code | | |
| Terminal box at top | | | | | | Standard | | | 4 | - | | | | | | | | | | |
| For other terminal box positions and more information, see from page 2/116 | | | | | | | | | | | | | | | | ... | | | | |
| Special versions | | | | | | | | | | | | | | | Order code(s) | | | | | |
| Forced-air cooled motors w/o ext. fan/fan cover (IC418) | | | | | | | | | | | | | | | 1LE1541-....-Z F90 +. . . +. . . +. . . | | | | | |
| For options, see from page 2/125 | | | | | | | | | | | | | | | 1LE1541-....-Z . . . +. . . +. . . +. . . | | | | | |



¹⁾ Types of construction with feet are not possible for 2-pole, 4-pole and 6-pole motors ≤ 200 hp in accordance with MG1 Table 12-11.

²⁾ Types derived from IM B5 (IM V3 and IM V1) and from IM B14 (IM V19 and IM V18) are possible, provided that no requirement exists for stamping of the type on the rating plate. The basic type IM B5 or IM B14 is stamped as standard on the rating plate. If mounted in a different position, the position must be specified to ensure that the condensation drainage holes are positioned correctly.

SIMOTICS GP and SIMOTICS SD standard motors

ABNT Line · IR3 Rendimento Premium

Aluminum series SIMOTICS GP 1LE1073 – self-ventilated or forced-air cooled

Selection and ordering data

Technical specifications at 60 Hz/P50 power rating

| Operating values at rated power | | | | | | | | | | | | | | Aluminum series 1LE1073 | | m _{IM B3} | J | |
|---|---------------------------------------|---------------|-------------------------------|-------------------------------|---------------------------------------|---------------------------------------|---------------------------------------|--|---|--|--|---|------------------------------|----------------------------|----------------|--------------------------------|--------|-------|
| P _{rated} , 60 Hz/ P50 | P _{rated} , 60 Hz/ P50 | Frame size | n _{rated} , 60 Hz | T _{rated} , 60 Hz | η _{rated} , 60 Hz, 4/4 | η _{rated} , 60 Hz, 3/4 | η _{rated} , 60 Hz, 2/4 | cosφ _{rated} , 60 Hz, 4/4 | I _{rated} , 60 Hz, 440 V | T _{LR} / T _{rated} , 60 Hz | I _{LR} / I _{rated} , 60 Hz | T _B / T _{rated} , 60 Hz | L _{pfiA} , 60 Hz | L _{WA} , 60 Hz | Article No. | | | ▲ New |
| <ul style="list-style-type: none"> • Cooling: Self-ventilated (IC411) or with order code F90 forced-air cooled without external fan and fan cover (IC418) • Efficiency according to NBR 17094-1: IR3 Rendimento Premium • Insulation: Thermal class 155 (temperature class F), IP55 degree of protection, utilization in accordance with thermal class 130 (temperature class B) | | | | | | | | | | | | | | | | | | |
| 2-pole: 3000 rpm at 50 Hz, 3600 rpm at 60 Hz | | | | | | | | | | | | | | | | | | |
| 1.1 | 1.5 | 80 M | 3485 | 3 | 84.0 | 84.3 | 82.5 | 0.84 | 2.05 | 3.5 | 8.5 | 3.6 | 69 | 77 | ▲ 1LE1073-0DA3 | 12 | 0.0013 | |
| 1.5 | 2 | 80 M | 3470 | 4.15 | 85.5 | 85.7 | 85.0 | 0.85 | 2.7 | 4.2 | 9.2 | 4.2 | 74 | 82 | ▲ 1LE1073-0DA6 | 18 | 0.0014 | |
| 2.2 | 3 | 90 S | 3515 | 6 | 86.5 | 86.5 | 84.2 | 0.88 | 3.8 | 2.7 | 9.1 | 4.6 | 74 | 82 | ▲ 1LE1073-0EA4 | 20 | 0.0031 | |
| 3 | 4 | 100 L | 3520 | 8.1 | 88.5 | 88.9 | 88.0 | 0.90 | 4.95 | 3.2 | 9.4 | 4.6 | 75 | 83 | ▲ 1LE1073-1AA4 | 26 | 0.0054 | |
| 3.7 | 5 | 100 L | 3515 | 10.1 | 88.5 | 89.1 | 88.4 | 0.87 | 6.3 | 3.7 | 9.6 | 4.1 | 75 | 83 | ▲ 1LE1073-1AA6 | 26 | 0.0054 | |
| 4.5 | 6 | 112 M | 3550 | 12.1 | 88.5 | 89.2 | 87.9 | 0.90 | 7.4 | 2.4 | 9.6 | 3.9 | 79 | 87 | ▲ 1LE1073-1BA5 | 36 | 0.012 | |
| 5.5 | 7.5 | 112 M | 3545 | 14.8 | 89.5 | 90.6 | 90.6 | 0.88 | 9.2 | 2.4 | 9.7 | 3.7 | 79 | 87 | ▲ 1LE1073-1BA6 | 36 | 0.012 | |
| 7.5 | 10 | 132 S | 3560 | 20 | 90.2 | 90.3 | 89.7 | 0.92 | 11.9 | 2.3 | 10 | 3.8 | 75 | 83 | ▲ 1LE1073-1CA1 | 57 | 0.0031 | |
| 9.2 | 12.5 | 132 M | 3550 | 24.5 | 91.0 | 91.5 | 91.5 | 0.82 | 14.4 | 2.0 | 8.8 | 3.3 | 76 | 84 | ▲ 1LE1073-1CA5 | 62 | 0.0031 | |
| 11 | 15 | 132 M | 3555 | 29.5 | 91.0 | 91.8 | 91.8 | 0.90 | 17.6 | 2.1 | 9.6 | 4.5 | 76 | 84 | ▲ 1LE1073-1CA6 | 62 | 0.0031 | |
| 15 | 20 | 160 M | 3560 | 40 | 91.0 | 90.9 | 89.6 | 0.90 | 24 | 2.3 | 9.2 | 3.9 | 81 | 89 | ▲ 1LE1073-1DA3 | 84 | 0.0061 | |
| 18.5 | 25 | 160 M | 3555 | 49.5 | 91.7 | 91.8 | 90.8 | 0.91 | 29 | 2.6 | 9.0 | 3.8 | 81 | 89 | ▲ 1LE1073-1DA4 | 94 | 0.0068 | |
| 22 | 30 | 160 L | 3550 | 59 | 91.7 | 92.1 | 91.5 | 0.92 | 34 | 2.7 | 9.1 | 3.8 | 81 | 89 | ▲ 1LE1073-1DA6 | 120 | 0.077 | |
| 4-pole: 1500 rpm at 50 Hz, 1800 rpm at 60 Hz | | | | | | | | | | | | | | | | | | |
| 0.75 | 1 | 80 M | 1760 | 4.05 | 83.0 | 81.6 | 77.8 | 0.70 | 1.69 | 3.2 | 7.8 | 4.2 | 58 | 66 | ▲ 1LE1073-0DB3 | 13 | 0.0029 | |
| 1.1 | 1.5 | 80 M | 1750 | 6 | 84.0 | 84.4 | 83.1 | 0.78 | 2.2 | 3.1 | 8.0 | 3.9 | 58 | 66 | ▲ 1LE1073-0DB6 | 14 | 0.0032 | |
| 1.5 | 2 | 90 S | 1750 | 8.2 | 86.5 | 86.7 | 85.1 | 0.79 | 2.9 | 2.8 | 8.0 | 4.1 | 62 | 70 | ▲ 1LE1073-0EB4 | 20 | 0.0049 | |
| 2.2 | 3 | 90 L | 1745 | 12 | 87.5 | 87.3 | 85.7 | 0.79 | 4.2 | 3.1 | 8.5 | 4.2 | 65 | 73 | ▲ 1LE1073-0EB6 | 25 | 0.0057 | |
| 3 | 4 | 100 L | 1760 | 16.3 | 89.5 | 90.8 | 89.7 | 0.84 | 5.2 | 2.8 | 8.9 | 4.2 | 66 | 74 | ▲ 1LE1073-1AB5 | 30 | 0.014 | |
| 3.7 | 5 | 100 L | 1760 | 20 | 89.5 | 90.4 | 90.2 | 0.82 | 6.6 | 2.7 | 8.6 | 3.7 | 66 | 74 | ▲ 1LE1073-1AB6 | 42 | 0.016 | |
| 4.5 | 6 | 112 M | 1765 | 24.5 | 89.5 | 89.8 | 88.9 | 0.83 | 7.9 | 2.3 | 8.5 | 3.6 | 68 | 76 | ▲ 1LE1073-1BB5 | 34 | 0.017 | |
| 5.5 | 7.5 | 112 M | 1765 | 30 | 91.0 | 91.2 | 90.5 | 0.80 | 9.9 | 3.0 | 9.8 | 4.2 | 71 | 79 | ▲ 1LE1073-1BB6 | 39 | 0.020 | |
| 7.5 | 10 | 132 S | 1770 | 40.5 | 91.7 | 92.2 | 91.6 | 0.85 | 12.6 | 2.4 | 8.9 | 3.8 | 72 | 80 | ▲ 1LE1073-1CB2 | 61 | 0.046 | |
| 9.2 | 12.5 | 132 M | 1770 | 49.5 | 92.4 | 92.8 | 93.1 | 0.84 | 15.6 | 2.5 | 8.2 | 3.2 | 70 | 78 | ▲ 1LE1073-1CB5 | 80 | 0.049 | |
| 11 | 15 | 132 M | 1765 | 60 | 92.4 | 92.9 | 92.3 | 0.84 | 18.6 | 2.5 | 8.2 | 3.4 | 68 | 76 | ▲ 1LE1073-1CB6 | 80 | 0.049 | |
| 15 | 20 | 160 M | 1780 | 80 | 93.0 | 93.3 | 92.5 | 0.84 | 25 | 2.5 | 7.6 | 3.7 | 69 | 77 | ▲ 1LE1073-1DB4 | 100 | 0.099 | |
| 18.5 | 25 | 160 L | 1780 | 99 | 93.6 | 93.7 | 93.1 | 0.81 | 32 | 2.5 | 8.5 | 3.6 | 69 | 77 | ▲ 1LE1073-1DB6 | 110 | 0.101 | |
| Voltages | | | | | | | | | | | | | | Version | | Order code | | |
| 50 Hz 220 VΔΔ/380 VYY/440 VΔ | | | | | | | | | | | | | | Standard | | - | | |
| For other voltages and more information, see from page 2/98 | | | | | | | | | | | | | | 6 4 | | ... | | |
| 9 0 | | | | | | | | | | | | | | A | | ... | | |
| Types of construction | | | | | | | | | | | | | | Version | | Order code | | |
| Without flange IM B3 ¹⁾ | | | | | | | | | | | | | | Standard | | - | | |
| With flange IM B5 ¹⁾ | | | | | | | | | | | | | | With additional charge | | - | | |
| For other types of construction and more information, see from page 2/108 | | | | | | | | | | | | | | F | | ... | | |
| Motor protection | | | | | | | | | | | | | | Version | | Order code | | |
| Without | | | | | | | | | | | | | | Standard | | - | | |
| PTC thermistor with 3 temperature sensors | | | | | | | | | | | | | | With additional charge | | - | | |
| For other motor protection and more information, see from page 2/114 | | | | | | | | | | | | | | A | | ... | | |
| B | | | | | | | | | | | | | | 4 | | | | |
| Terminal box position | | | | | | | | | | | | | | Version | | Order code(s) | | |
| Terminal box at top | | | | | | | | | | | | | | Standard | | 1LE1073-...-Z F90 +...+...+... | | |
| For other terminal box positions and more information, see from page 2/117 | | | | | | | | | | | | | | 4 | | 1LE1073-...-Z ...+...+...+... | | |
| Special versions | | | | | | | | | | | | | | | | | | |

¹⁾ Types derived from IM B3 (IM B6/7/8, IM V6 and IM V5), from IM B5 (IM V3 and IM V1) and from IM B14 (IM V19 and IM V18) are possible, provided that no requirement exists for stamping of the type on the rating plate. The basic type IM B3, IM B5, or IM B14 is stamped as standard on the rating plate. If mounted in a different position, the position must be specified to ensure that the condensation drainage holes are positioned correctly.



SIMOTICS GP and SIMOTICS SD standard motors

ABNT Line · IR3 Rendimento Premium

Aluminum series SIMOTICS GP 1LE1073 – self-ventilated or forced-air cooled

Selection and ordering data

Technical specifications at 60 Hz/P50 power rating

| Operating values at rated power | | | | | | | | | | | | | | Aluminum series 1LE1073 | | m _{IM B3} | J | | |
|---|-------------------------------------|------------|-----------------------------|-----------------------------|----------------------------------|----------------------------------|----------------------------------|----------------------------------|-----------------------|------------------------------------|--|--|---|---------------------------|--------------------------|--------------------|--------|-------------|-------|
| P _{rated} 60 Hz/ P50 | P _{rated} 60 Hz/ P50 | Frame size | n _{rated} 60 Hz | T _{rated} 60 Hz | η _{rated} 60 Hz, 4/4 | η _{rated} 60 Hz, 3/4 | η _{rated} 60 Hz, 2/4 | η _{rated} 60 Hz, 4/4 | cosφ _{rated} | I _{rated} 60 Hz, 440 V | T _{LR} /T _{rated} 60 Hz | I _{LR} /I _{rated} 60 Hz | T _B /T _{rated} 60 Hz | L _{pfA} 60 Hz | L _{WA} 60 Hz | | | Article No. | ▲ New |
| kW | CV (hp) | FS | rpm | Nm | % | % | % | % | | A | | | | dB(A) | dB(A) | | | | |
| <ul style="list-style-type: none"> • Cooling: Self-ventilated (IC411) or with order code F90 forced-air cooled without external fan and fan cover (IC418) • Efficiency according to NBR 17094-1: IR3 Rendimento Premium • Insulation: Thermal class 155 (temperature class F), IP55 degree of protection, utilization in accordance with thermal class 130 (temperature class B) | | | | | | | | | | | | | | | | | | | |
| 6-pole: 1000 rpm at 50 Hz, 1200 rpm at 60 Hz | | | | | | | | | | | | | | | | | | | |
| 0.37 | 0.5 | 80 M | 1150 | 3.05 | 75.3 | 73.8 | 68.7 | 0.59 | 1.09 | 3.2 | 4.8 | 3.5 | 55 | 63 | ▲ 1LE1073-0DC2 | 12 | 0.0025 | | |
| 0.55 | 0.75 | 80 M | 1135 | 4.65 | 79.5 | 79.3 | 76.3 | 0.66 | 1.38 | 2.8 | 4.9 | 3.1 | 58 | 66 | ▲ 1LE1073-0DC3 | 13 | 0.0031 | | |
| 0.75 | 1 | 90 S | 1150 | 6.2 | 82.5 | 83.3 | 81.8 | 0.70 | 1.78 | 2.2 | 5.2 | 2.8 | 61 | 69 | ▲ 1LE1073-0EC0 | 16 | 0.004 | | |
| 1.1 | 1.5 | 100 L | 1170 | 9 | 87.5 | 87.2 | 87.2 | 0.66 | 2.5 | 3.0 | 7.0 | 3.9 | 62 | 70 | ▲ 1LE1073-1AC3 | 28 | 0.014 | | |
| 1.5 | 2 | 112 M | 1175 | 12.2 | 88.5 | 88.2 | 86.2 | 0.70 | 3.2 | 3.5 | 9.0 | 4.3 | 62 | 70 | ▲ 1LE1073-1BC1 | 32 | 0.017 | | |
| 2.2 | 3 | 132 S | 1175 | 17.9 | 89.5 | 89.5 | 88.2 | 0.74 | 4.35 | 2.1 | 6.8 | 3.2 | 63 | 71 | ▲ 1LE1073-1CC1 | 43 | 0.037 | | |
| 3 | 4 | 132 S | 1178 | 24.5 | 89.5 | 89.5 | 88.0 | 0.70 | 6.3 | 2.5 | 7.2 | 3.6 | 63 | 71 | ▲ 1LE1073-1CC0 | 43 | 0.037 | | |
| 3.7 | 5 | 132 S | 1180 | 30 | 89.5 | 89.3 | 88.0 | 0.71 | 7.6 | 2.7 | 7.6 | 3.7 | 65 | 73 | ▲ 1LE1073-1CC2 | 47 | 0.037 | | |
| 4.5 | 6 | 132 S | 1175 | 36.5 | 89.5 | 89.7 | 88.2 | 0.70 | 9 | 2.7 | 7.1 | 3.6 | 67 | 75 | ▲ 1LE1073-1CC4 | 47 | 0.037 | | |
| 5.5 | 7.5 | 132 M | 1175 | 44.5 | 91.0 | 91.0 | 89.8 | 0.73 | 10.9 | 2.7 | 7.3 | 3.6 | 67 | 75 | ▲ 1LE1073-1CC3 | 58 | 0.046 | | |
| 7.5 | 10 | 132 M | 1180 | 61 | 91.0 | 91.5 | 91.2 | 0.69 | 15.7 | 3.2 | 7.7 | 4.0 | 67 | 75 | ▲ 1LE1073-1CC6 | 58 | 0.046 | | |
| 9.2 | 12.5 | 160 M | 1185 | 74 | 91.7 | 91.9 | 90.5 | 0.78 | 16.9 | 3.1 | 7.8 | 3.1 | 71 | 79 | ▲ 1LE1073-1DC3 | 105 | 0.12 | | |
| 11 | 15 | 160 M | 1180 | 89 | 91.7 | 91.9 | 91.1 | 0.80 | 19.7 | 3.1 | 7.3 | 2.9 | 72 | 80 | ▲ 1LE1073-1DC4 | 105 | 0.12 | | |
| 15 | 20 | 160 L | 1185 | 121 | 91.7 | 91.7 | 90.5 | 0.74 | 29 | 3.8 | 8.1 | 3.5 | 73 | 81 | ▲ 1LE1073-1DC6 | 105 | 0.12 | | |
| 8-pole: 750 rpm at 50 Hz, 900 rpm at 60 Hz | | | | | | | | | | | | | | | | | | | |
| 0.25 | 0.33 | 80 M | 855 | 2.8 | 68.0 | 66.6 | 61.0 | 0.54 | 0.89 | 1.9 | 3.3 | 2.5 | 56 | 64 | ▲ 1LE1073-0DD3 | 13 | 0.003 | | |
| 0.37 | 0.5 | 90 S | 840 | 4.2 | 72.0 | 72.1 | 68.8 | 0.67 | 1.01 | 1.6 | 3.2 | 2.1 | 64 | 72 | ▲ 1LE1073-0ED0 | 16 | 0.004 | | |
| 0.55 | 0.75 | 90 L | 850 | 6.2 | 74.0 | 73.9 | 70.9 | 0.66 | 1.48 | 2.1 | 3.9 | 2.6 | 63 | 71 | ▲ 1LE1073-0ED4 | 19 | 0.0048 | | |
| 0.75 | 1 | 100 L | 855 | 8.4 | 75.5 | 76.6 | 74.4 | 0.70 | 1.86 | 1.6 | 4.0 | 2.2 | 65 | 73 | ▲ 1LE1073-1AD4 | 21 | 0.0089 | | |
| 2.2 | 3 | 132 S | 880 | 24 | 85.5 | 84.9 | 82.3 | 0.68 | 4.95 | 2.2 | 6.1 | 3.1 | 62 | 70 | ▲ 1LE1073-1CD0 | 42 | 0.048 | | |
| 3.7 | 5 | 132 M | 875 | 40.5 | 86.5 | 86.2 | 83.8 | 0.66 | 7.9 | 2.5 | 6.1 | 3.2 | 67 | 75 | ▲ 1LE1073-1CD6 | 58 | 0.069 | | |
| 4.5 | 6 | 160 M | 875 | 49 | 86.5 | 86.5 | 85.3 | 0.72 | 9.5 | 1.9 | 6.1 | 2.8 | 74 | 82 | ▲ 1LE1073-1DD1 | 60 | 0.078 | | |
| 5.5 | 7.5 | 160 M | 880 | 60 | 86.5 | 88.5 | 89.9 | 0.73 | 11.4 | 1.8 | 5.1 | 2.1 | 73 | 81 | ▲ 1LE1073-1DD3 | 60 | 0.078 | | |
| 7.5 | 10 | 160 L | 885 | 81 | 89.5 | 90.0 | 88.8 | 0.72 | 15.3 | 2.4 | 6.3 | 2.8 | 70 | 78 | ▲ 1LE1073-1DD4 | 78 | 0.131 | | |
| Voltages | | | | | | | | | | | | | | Version | | Order code | | | |
| 50 Hz 220 VΔΔ/380 VYY/440 VA | | | | | | | | | | | | | | Standard | | - | | | |
| For other voltages and more information, see from page 2/98 | | | | | | | | | | | | | | 6 4 | | ... | | | |
| 9 0 | | | | | | | | | | | | | | A | | ... | | | |
| Types of construction | | | | | | | | | | | | | | Version | | Order code | | | |
| Without flange IM B3 ¹⁾ | | | | | | | | | | | | | | Standard | | - | | | |
| With flange IM B5 ¹⁾ | | | | | | | | | | | | | | With additional charge | | - | | | |
| For other types of construction and more information, see from page 2/108 | | | | | | | | | | | | | | F | | ... | | | |
| Motor protection | | | | | | | | | | | | | | Version | | Order code | | | |
| Without | | | | | | | | | | | | | | Standard | | - | | | |
| PTC thermistor with 3 temperature sensors | | | | | | | | | | | | | | With additional charge | | - | | | |
| For other motor protection and more information, see from page 2/114 | | | | | | | | | | | | | | A B | | ... | | | |
| Terminal box position | | | | | | | | | | | | | | Version | | Order code | | | |
| Terminal box at top | | | | | | | | | | | | | | Standard | | 4 | | | |
| For other terminal box positions and more information, see from page 2/117 | | | | | | | | | | | | | | | | | | | |
| Special versions | | | | | | | | | | | | | | | | Order code(s) | | | |
| Forced-air cooled motors w/o ext. fan/fan cover (IC418) | | | | | | | | | | | | | | 1LE1073-...-Z | | F90 +...+...+... | | | |
| For options, see from page 2/133 | | | | | | | | | | | | | | 1LE1073-...-Z | | ...+...+...+... | | | |

¹⁾ Types derived from IM B3 (IM B6/7/8, IM V6 and IM V5), from IM B5 (IM V3 and IM V1) and from IM B14 (IM V19 and IM V18) are possible, provided that no requirement exists for stamping of the type on the rating plate. The basic type IM B3, IM B5, or IM B14 is stamped as standard on the rating plate. If mounted in a different position, the position must be specified to ensure that the condensation drainage holes are positioned correctly.

SIMOTICS GP and SIMOTICS SD standard motors

ABNT Line · IR3 Rendimento Premium

Cast-iron series SIMOTICS SD 1LE1573, 1LE5773 – self-ventilated or forced-air cooled

Selection and ordering data

Technical specifications at 60 Hz/P50 power rating

| Operating values at rated power | | | | | | | | | | | | | | Cast-iron series 1LE1573/1LE5773 | | $m_{IM\ B3}$ | J | |
|---|------------------------------|---------------|----------------------|----------------------|---------------------------------|---------------------------------|---------------------------------|-------------------------------------|--------------------------------|-----------------------------------|-----------------------------------|--------------------------------|--------------------|-------------------------------------|----------------|--------------|-------|------------------|
| P_{rated} 60 Hz/ P50 | P_{rated} 60 Hz/ P50 | Frame size | n_{rated} 60 Hz | T_{rated} 60 Hz | η_{rated} 60 Hz, 4/4 | η_{rated} 60 Hz, 3/4 | η_{rated} 60 Hz, 2/4 | $\cos\phi_{rated}$ 60 Hz, 4/4 | I_{rated} 60 Hz, 440 V | $T_{LR}/$ T_{rated} 60 Hz | $I_{LR}/$ I_{rated} 60 Hz | $T_B/$ T_{rated} 60 Hz | L_{pfa} 60 Hz | L_{WA} 60 Hz | Article No. | ▲ New | kg | kgm ² |
| <ul style="list-style-type: none"> • Cooling: Self-ventilated (IC411) or with order code F90 forced-air cooled without external fan and fan cover (IC418) • Efficiency according to NBR 17094-1: IR3 Rendimento Premium • Insulation: Thermal class 155 (temperature class F), IP55 degree of protection, utilization in accordance with thermal class 130 (temperature class B) | | | | | | | | | | | | | | | | | | |
| 2-pole: 3000 rpm at 50 Hz, 3600 rpm at 60 Hz | | | | | | | | | | | | | | | | | | |
| 30 | 40 | 200 L | 3565 | 80 | 92.4 | 92.6 | 92.1 | 0.86 | 49.5 | 2.9 | 8.2 | 3.7 | 78 | 86 | ▲ 1LE1573-2AA4 | 220 | 0.134 | |
| 37 | 50 | 200 L | 3560 | 99 | 93.0 | 93.4 | 92.3 | 0.87 | 60 | 3.1 | 8.5 | 3.7 | 78 | 86 | ▲ 1LE1573-2AA5 | 245 | 0.158 | |
| 45 | 60 | 225 S | 3565 | 121 | 93.6 | 93.7 | 92.9 | 0.89 | 71 | 2.7 | 7.2 | 3.1 | 75 | 89 | ▲ 1LE1573-2BA2 | 325 | 0.265 | |
| 55 | 75 | 225 M | 3555 | 148 | 93.6 | 94.0 | 93.8 | 0.88 | 88 | 2.2 | 6.6 | 2.8 | 76 | 89 | ▲ 1LE1573-2BA6 | 385 | 0.315 | |
| 75 | 100 | 250 M | 3570 | 201 | 94.1 | 94.1 | 93.3 | 0.90 | 116 | 2.1 | 6.6 | 2.7 | 82 | 96 | ▲ 1LE1573-2CA6 | 475 | 0.564 | |
| 90 | 125 | 280 S | 3575 | 240 | 95.0 | 95.0 | 94.2 | 0.90 | 138 | 2.2 | 7.0 | 2.7 | 78 | 92 | ▲ 1LE1573-2DA2 | 610 | 0.934 | |
| 110 | 150 | 280 M | 3570 | 294 | 95.0 | 95.0 | 94.3 | 0.91 | 167 | 2.3 | 7.0 | 2.8 | 82 | 96 | ▲ 1LE1573-2DA6 | 680 | 1.08 | |
| 132 | 175 | 315 S | 3575 | 353 | 95.4 | 95.3 | 94.3 | 0.88 | 205 | 1.7 | 6.1 | 2.3 | 84 | 99 | ▲ 1LE5773-3AA2 | 1030 | 2.0 | |
| 150 | 200 | 315 M | 3582 | 400 | 95.4 | 95.1 | 94.0 | 0.90 | 230 | 2.4 | 8.0 | 3.1 | 84 | 99 | ▲ 1LE5773-3AA4 | 1190 | 2.0 | |
| 185 | 250 | 315 M | 3578 | 394 | 95.8 | 95.9 | 95.4 | 0.90 | 280 | 1.5 | 6.1 | 2.2 | 82 | 96 | ▲ 1LE5773-3AA5 | 1280 | 2.38 | |
| 220 | 300 | 315 L | 3582 | 587 | 95.8 | 95.8 | 95.2 | 0.91 | 330 | 2.2 | 8.0 | 2.9 | 84 | 99 | ▲ 1LE5773-3AA6 | 1340 | 2.73 | |
| 4-pole: 1500 rpm at 50 Hz, 1800 rpm at 60 Hz | | | | | | | | | | | | | | | | | | |
| 22 | 30 | 180 M | 1775 | 118 | 93.6 | 93.9 | 93.4 | 0.81 | 38 | 2.7 | 8.3 | 3.7 | 69 | 77 | ▲ 1LE1573-1EB4 | 178 | 0.14 | |
| 30 | 40 | 200 L | 1775 | 161 | 94.1 | 94.6 | 94.5 | 0.84 | 50 | 2.7 | 7.9 | 3.1 | 66 | 74 | ▲ 1LE1573-2AB5 | 240 | 0.22 | |
| 37 | 50 | 200 L | 1775 | 199 | 94.5 | 94.7 | 94.6 | 0.83 | 62 | 2.9 | 8.4 | 3.3 | 66 | 74 | ▲ 1LE1573-2AB6 | 258 | 0.275 | |
| 45 | 60 | 225 S | 1782 | 241 | 95.0 | 95.3 | 94.9 | 0.84 | 74 | 2.9 | 7.6 | 2.9 | 69 | 82 | ▲ 1LE1573-2BB2 | 315 | 0.47 | |
| 55 | 75 | 225 M | 1782 | 295 | 95.4 | 95.8 | 95.6 | 0.85 | 89 | 3.0 | 7.8 | 2.9 | 75 | 89 | ▲ 1LE1573-2BB6 | 420 | 0.655 | |
| 75 | 100 | 250 M | 1780 | 403 | 95.4 | 95.6 | 95.4 | 0.85 | 121 | 2.1 | 6.2 | 2.5 | 75 | 89 | ▲ 1LE1573-2CB6 | 530 | 1.07 | |
| 90 | 125 | 280 S | 1782 | 482 | 95.4 | 95.7 | 95.4 | 0.88 | 141 | 2.2 | 6.6 | 2.5 | 79 | 93 | ▲ 1LE1573-2DB2 | 690 | 1.56 | |
| 110 | 150 | 280 M | 1785 | 589 | 95.8 | 96.0 | 95.7 | 0.90 | 167 | 2.5 | 7.2 | 2.7 | 82 | 96 | ▲ 1LE1573-2DB6 | 740 | 1.67 | |
| 132 | 175 | 315 S | 1790 | 704 | 96.2 | 96.3 | 95.7 | 0.86 | 210 | 2.1 | 7.5 | 2.6 | 79 | 93 | ▲ 1LE5773-3AB2 | 1350 | 2.8 | |
| 150 | 200 | 315 M | 1790 | 800 | 96.2 | 96.3 | 95.7 | 0.85 | 240 | 1.9 | 6.9 | 2.6 | 81 | 96 | ▲ 1LE5773-3AB4 | 1110 | 3.13 | |
| 185 | 250 | 315 M | 1790 | 987 | 96.2 | 96.3 | 95.8 | 0.90 | 280 | 2.3 | 8 | 2.8 | 82 | 96 | ▲ 1LE5773-3AB5 | 1210 | 3.64 | |
| 220 | 300 | 315 L | 1790 | 1174 | 96.2 | 96.3 | 95.8 | 0.87 | 345 | 2.3 | 7.2 | 2.7 | 81 | 96 | ▲ 1LE5773-3AB6 | 1400 | 4.53 | |
| 300 | 400 | 315 L | 1788 | 1602 | 96.2 | 96.5 | 96.4 | 0.86 | 475 | 2.3 | 6.8 | 2.7 | 81 | 95 | ▲ 1LE5773-3AB7 | 1560 | 5.28 | |
| Voltages | | | | | | | | | | | | | | Version | | Order code | | |
| 50 Hz 220 VΔΔ/380 VYY/440 VΔ | | | | | | | | | | | | | | Standard | | 6 4 9 0 | | |
| For other voltages and more information, see from page 2/98 | | | | | | | | | | | | | | | | | | |
| Types of construction | | | | | | | | | | | | | | Version | | Order code | | |
| Without flange IM B3 ¹⁾ | | | | | | | | | | | | | | Standard | | A | | |
| With flange IM B5 ¹⁾ | | | | | | | | | | | | | | With additional charge | | F | | |
| For other types of construction and more information, see from page 2/108 | | | | | | | | | | | | | | | | | | |
| Motor protection | | | | | | | | | | | | | | Version | | Order code | | |
| Without | | | | | | | | | | | | | | Standard | | A | | |
| PTC thermistor with 3 temperature sensors | | | | | | | | | | | | | | With additional charge | | B | | |
| For other motor protection and more information, see from page 2/114 | | | | | | | | | | | | | | | | | | |
| Terminal box position | | | | | | | | | | | | | | Version | | Order code | | |
| Terminal box at top | | | | | | | | | | | | | | Standard | | 4 | | |
| For other terminal box positions and more information, see from page 2/117 | | | | | | | | | | | | | | | | | | |
| Special versions | | | | | | | | | | | | | | Order code(s) | | | | |
| Forced-air cooled motors w/o ext. fan/fan cover (IC418) | | | | | | | | | | | | | | 1LE .. 73- ... -Z F90 +...+...+... | | | | |
| For options, see from page 2/133 | | | | | | | | | | | | | | | | | | |
| | | | | | | | | | | | | | | 1LE .. 73- ... -Z ...+...+...+... | | | | |

¹⁾ Types derived from IM B3 (IM B6/7/8, IM V6 and IM V5), from IM B5 (IM V3 and IM V1) and from IM B14 (IM V19 and IM V18) are possible, provided that no requirement exists for stamping of the type on the rating plate. The basic type IM B3, IM B5, or IM B14 is stamped as standard on the rating plate. If mounted in a different position, the position must be specified to ensure that the condensation drainage holes are positioned correctly.



SIMOTICS GP and SIMOTICS SD standard motors

ABNT Line · IR3 Rendimento Premium

Cast-iron series SIMOTICS SD 1LE1573, 1LE5773 – self-ventilated or forced-air cooled

Selection and ordering data

Technical specifications at 60 Hz/P50 power rating

| Operating values at rated power | | | | | | | | | | | | | | Cast-iron series 1LE1573/1LE5773 | | $m_{IM\ B3}$ | J | | |
|---|------------------------------|---------------|----------------------|----------------------|---------------------------------|---------------------------------|---------------------------------|---------------------------------|---------------------------------------|--------------------------------|-----------------------------|-----------------------------|--------------------------|-------------------------------------|-------------------|--------------|--------|-----------------------|------------------|
| P_{rated} 60 Hz/ P50 | P_{rated} 60 Hz/ P50 | Frame size | n_{rated} 60 Hz | T_{rated} 60 Hz | η_{rated} 60 Hz, 4/4 | η_{rated} 60 Hz, 3/4 | η_{rated} 60 Hz, 2/4 | η_{rated} 60 Hz, 4/4 | $\cos\phi_{rated}$ 60 Hz, 440 V | I_{rated} 60 Hz, 440 V | T_{LR}/I_{rated} 60 Hz | I_{LR}/I_{rated} 60 Hz | T_B/I_{rated} 60 Hz | L_{pifA} 60 Hz | L_{WA} 60 Hz | Article No. | ▲ New | kg | kgm ² |
| kW | CV (hp) | FS | rpm | Nm | % | % | % | % | A | A | | | | | | | | | |
| <ul style="list-style-type: none"> • Cooling: Self-ventilated (IC411) or with order code F90 forced-air cooled without external fan and fan cover (IC418) • Efficiency according to NBR 17094-1: IR3 Rendimento Premium • Insulation: Thermal class 155 (temperature class F), IP55 degree of protection, utilization in accordance with thermal class 130 (temperature class B) | | | | | | | | | | | | | | | | | | | |
| 6-pole: 1000 rpm at 50 Hz, 1200 rpm at 60 Hz | | | | | | | | | | | | | | | | | | | |
| 18.5 | 25 | 180 L | 1180 | 150 | 93.0 | 93.3 | 92.8 | 0.75 | 35 | 2.9 | 7.9 | 3.7 | 73 | 81 | ▲ 1LE1573-1EC6 | 185 | 0.247 | | |
| 22 | 30 | 200 L | 1180 | 178 | 93.0 | 93.4 | 93.3 | 0.78 | 40 | 2.6 | 6.5 | 2.8 | 62 | 70 | ▲ 1LE1573-2AC5 | 230 | 0.32 | | |
| 30 | 40 | 200 L | 1182 | 240 | 94.1 | 94.3 | 93.7 | 0.75 | 56 | 3.2 | 7.8 | 3.3 | 66 | 74 | ▲ 1LE1573-2AC6 | 264 | 0.434 | | |
| 37 | 50 | 225 M | 1186 | 298 | 94.1 | 94.5 | 94.2 | 0.81 | 64 | 3.0 | 7.7 | 3.1 | 71 | 85 | ▲ 1LE1573-2BC6 | 320 | 0.815 | | |
| 45 | 60 | 250 S | 1186 | 363 | 94.5 | 95.0 | 94.7 | 0.84 | 74 | 2.8 | 7.7 | 2.9 | 69 | 83 | ▲ 1LE1573-2CC6 | 500 | 1.27 | | |
| 55 | 75 | 280 S | 1186 | 443 | 94.5 | 95.0 | 94.8 | 0.85 | 90 | 2.5 | 6.8 | 2.3 | 66 | 80 | ▲ 1LE1573-2DC2 | 580 | 1.64 | | |
| 75 | 100 | 280 S | 1186 | 604 | 95.0 | 95.7 | 95.9 | 0.84 | 123 | 3.2 | 7.4 | 2.7 | 70 | 84 | ▲ 1LE1573-2DC6 | 650 | 1.93 | | |
| 90 | 125 | 280 M | 1186 | 725 | 95.0 | 95.7 | 95.8 | 0.85 | 146 | 3.2 | 7.9 | 2.7 | 71 | 85 | ▲ 1LE1573-2DC7 | 760 | 2.41 | | |
| 110 | 150 | 315 M | 1190 | 883 | 95.8 | 96.3 | 96.3 | 0.86 | 175 | 2.2 | 7.3 | 2.8 | 67 | 82 | ▲ 1LE5773-3AC4 | 1080 | 4.36 | | |
| 132 | 175 | 315 M | 1188 | 1061 | 95.8 | 96.5 | 96.6 | 0.85 | 215 | 2.0 | 6.5 | 2.6 | 68 | 82 | ▲ 1LE5773-3AC5 | 1160 | 4.99 | | |
| 150 | 200 | 315 M | 1191 | 1203 | 95.8 | 96.1 | 96.0 | 0.83 | 250 | 2.3 | 7.3 | 2.8 | 69 | 83 | ▲ 1LE5773-3AC6 | 1250 | 5.56 | | |
| 185 | 250 | 315 L | 1191 | 1483 | 95.8 | 96.2 | 96.2 | 0.83 | 305 | 2.3 | 7.0 | 2.6 | 71 | 86 | ▲ 1LE5773-3AC7 | 1410 | 6.06 | | |
| 8-pole: 750 rpm at 50 Hz, 900 rpm at 60 Hz | | | | | | | | | | | | | | | | | | | |
| 9.2 | 12.5 | 180 M | 875 | 100 | 89.5 | 90.2 | 89.9 | 0.72 | 18.7 | 2.1 | 5.2 | 2.5 | 75 | 83 | ▲ 1LE1573-1ED3 | 153 | 0.195 | | |
| 11 | 15 | 180 L | 875 | 120 | 89.5 | 90.1 | 89.7 | 0.74 | 22.0 | 2.3 | 5.8 | 2.7 | 68 | 76 | ▲ 1LE1573-1ED4 | 190 | 0.267 | | |
| 15 | 20 | 180 L | 875 | 164 | 90.2 | 91.4 | 91.6 | 0.75 | 29.0 | 2.1 | 5.4 | 2.5 | 69 | 77 | ▲ 1LE1573-1ED6 | 187 | 0.267 | | |
| 18.5 | 25 | 200 L | 880 | 200 | 90.2 | 90.3 | 89.2 | 0.68 | 39.5 | 3.3 | 7.2 | 4.1 | 62 | 76 | ▲ 1LE1573-2AD6 | 255 | 0.420 | | |
| 22 | 30 | 225 S | 882 | 238.2 | 91.7 | 92.2 | 91.8 | 0.78 | 40.5 | 2.6 | 6.4 | 3.0 | 60 | 74 | ▲ 1LE1573-2BD2 | 315 | 0.549 | | |
| 30 | 40 | 225 M | 886 | 323.3 | 91.7 | 92.4 | 92.1 | 0.76 | 56.0 | 2.8 | 6.4 | 3.2 | 66 | 79 | ▲ 1LE1573-2BD6 | 335 | 0.672 | | |
| 37 | 50 | 250 M | 886 | 398.8 | 92.4 | 92.5 | 91.6 | 0.78 | 67.0 | 2.8 | 7.0 | 3.0 | 65 | 79 | ▲ 1LE1573-2CD6 | 425 | 1.02 | | |
| 45 | 60 | 250 M | 882 | 487.2 | 92.4 | 93.2 | 93.2 | 0.82 | 78.0 | 2.4 | 6.3 | 2.7 | 66 | 80 | ▲ 1LE1573-2CD7 | 435 | 1.02 | | |
| 55 | 75 | 280 S | 888 | 591.5 | 93.6 | 94.1 | 93.8 | 0.79 | 98.0 | 2.5 | 6.1 | 2.5 | 70 | 81 | ▲ 1LE1573-2DD6 | 580 | 1.62 | | |
| 75 | 100 | 280 M | 888 | 806.5 | 93.6 | 94.1 | 93.8 | 0.79 | 133 | 2.8 | 6.8 | 2.7 | 69 | 80 | ▲ 1LE1573-2DD7 | 680 | 1.89 | | |
| 90 | 125 | 315 M | 893 | 962.4 | 94.1 | 94.4 | 94.0 | 0.82 | 153 | 2.5 | 7.0 | 2.6 | 74 | 88 | ▲ 1LE5773-3AD4 | 1000 | 3.74 | | |
| 110 | 150 | 315 M | 891 | 1179 | 94.1 | 94.5 | 94.4 | 0.83 | 185 | 2.2 | 6.5 | 2.4 | 79 | 93 | ▲ 1LE5773-3AD5 | 1100 | 4.48 | | |
| 132 | 175 | 315 L | 890 | 1416 | 94.5 | 95.0 | 94.9 | 0.84 | 220 | 2.1 | 6.0 | 2.3 | 82 | 97 | ▲ 1LE5773-3AD6 | 1150 | 5.36 | | |
| 150 | 200 | 315 L | 890 | 1609 | 94.5 | 95.3 | 95.5 | 0.80 | 260 | 2.1 | 5.9 | 2.1 | 76 | 90 | ▲ 1LE5773-3AD7 | 1420 | 6.76 | | |
| 185 | 250 | 315 L | 893 | 1978 | 95.0 | 95.3 | 95.0 | 0.78 | 330 | 2.7 | 7.3 | 2.9 | 76 | 90 | ▲ 1LE5773-3AD8 | 1660 | 8.4 | | |
| Voltagess 50 Hz 220 VΔΔ/380 VYY/440 VΔ | | | | | | | | | | | | | | Version Standard | | 6 9 | 4 0 | Order code - | |
| For other voltages and more information, see from page 2/98 | | | | | | | | | | | | | | | | | | ... | |
| Types of construction | | | | | | | | | | | | | | Version Standard | | | | Order code - | |
| Without flange IM B3 ¹⁾ | | | | | | | | | | | | | | | | | | ... | |
| With flange IM B5 ¹⁾ | | | | | | | | | | | | | | With additional charge | | | A F | Order code - | |
| For other types of construction and more information, see from page 2/108 | | | | | | | | | | | | | | | | | | ... | |
| Motor protection | | | | | | | | | | | | | | Version Standard | | | | Order code - | |
| Without | | | | | | | | | | | | | | | | | | ... | |
| PTC thermistor with 3 temperature sensors | | | | | | | | | | | | | | With additional charge | | | A B | Order code - | |
| For other motor protection and more information, see from page 2/114 | | | | | | | | | | | | | | | | | | ... | |
| Terminal box position | | | | | | | | | | | | | | Version Standard | | | | Order code(s) - | |
| Terminal box at top | | | | | | | | | | | | | | | | | 4 | ... | |
| For other terminal box positions and more information, see from page 2/117 | | | | | | | | | | | | | | | | | | | |
| Special versions | | | | | | | | | | | | | | | | | | Order code(s) | |
| Forced-air cooled motors w/o ext. fan/fan cover (IC418) | | | | | | | | | | | | | | 1LE .. 73- .. . | | | | -Z F90 + .. + .. + .. | |
| For options, see from page 2/133 | | | | | | | | | | | | | | 1LE .. 73- .. . | | | | -Z .. + .. + .. + .. | |

2

¹⁾ Types derived from IM B3 (IM B6/7/8, IM V6 and IM V5), from IM B5 (IM V3 and IM V1) and from IM B14 (IM V19 and IM V18) are possible, provided that no requirement exists for stamping of the type on the rating plate. The basic type IM B3, IM B5, or IM B14 is stamped as standard on the rating plate. If mounted in a different position, the position must be specified to ensure that the condensation drainage holes are positioned correctly.



SIMOTICS GP and SIMOTICS SD standard motors
Eagle Line · NEMA Premium Efficient MG1 Table 12-12

Aluminum series SIMOTICS GP 1LE1023 – self-ventilated or forced-air cooled

Selection and ordering data

| Operating values at rated power | | | | | | | | | | | | | | Aluminum series | | m _{IM B3} | J | | | | |
|--|-------------------------------------|---------------|-----------------------------|-----------------------------|--------------------------|-----------------------------|-----------------------------|-----------------------------|--------------------------------|-----------------------------|--------------------------|--------------------------|-------------------------|---------------------------|--------------------------|--------------------|-----|-------------|----|------------------|--|
| P _{rated} 60 Hz/ P50 | P _{rated} 60 Hz/ P60 | Frame size | n _{rated} 60 Hz | T _{rated} 60 Hz | EISA CC No. CC032A | η _{rated} 60 Hz | η _{rated} 60 Hz | η _{rated} 60 Hz | cosφ _{rated} 60 Hz | I _{rated} 460 V | T _{LR} 60 Hz | I _{LR} 60 Hz | T _B 60 Hz | L _{pfA} 60 Hz | L _{WA} 60 Hz | | | Article No. | kg | kgm ² | |
| • Cooling: Self-ventilated (IC411) or with order code F90 forced-air cooled without external fan and fan cover (IC418) • Efficiency: NEMA Premium Efficient, UL, CSA, and service factor (SF) 1.15 – for operation in the USA, Canada, and Mexico • Insulation: Thermal class 155 (temperature class F), IP55 degree of protection, utilization in accordance with thermal class 130 (temperature class B) | | | | | | | | | | | | | | | | | | | | | |
| 2-pole: 3000 rpm at 50 Hz, 3600 rpm at 60 Hz | | | | | | | | | | | | | | | | | | | | | |
| 0.75 | 1 | 80 M | 3480 | 2.1 | ✓ | 77 | 77.2 | 75.7 | 0.84 | 1.45 | 3 | 7.1 | 3.6 | 64 | 75 | 1LE1023-0DA2 | 11 | 0.0011 | | | |
| 1.1 | 1.5 | 80 M | 3500 | 3 | ✓ | 84 | 84 | 82 | 0.83 | 1.98 | 3.3 | 8.4 | 4 | 64 | 75 | 1LE1023-0DA3 | 12 | 0.0013 | | | |
| 1.5 | 2 | 90 S | 3525 | 4.1 | ✓ | 85.5 | 84.8 | 82.3 | 0.84 | 2.6 | 3.1 | 9.8 | 4.9 | 69 | 81 | 1LE1023-0EA0 | 15 | 0.0021 | | | |
| 2.2 | 3 | 90 L | 3530 | 6 | ✓ | 86.5 | 86.4 | 84.5 | 0.87 | 3.65 | 3 | 9.6 | 4.9 | 69 | 81 | 1LE1023-0EA4 | 19 | 0.0031 | | | |
| 3 | 4 | 100 L | 3525 | 8.1 | ✓ | 88.5 | 88.7 | 87.2 | 0.87 | 4.9 | 3.8 | 9.7 | 5.5 | 71 | 83 | 1LE1023-1AA4 | 26 | 0.0054 | | | |
| 3.7 | 5 | 112 M | 3560 | 10 | ✓ | 88.5 | 88 | 86.2 | 0.88 | 6 | 3.2 | 10.8 | 5.1 | 73 | 85 | 1LE1023-1BA2 | 34 | 0.012 | | | |
| 5.5 | 7.5 | 132 S | 3555 | 15 | ✓ | 89.5 | 89.4 | 88.2 | 0.9 | 8.6 | 2.1 | 8.6 | 4.4 | 72 | 84 | 1LE1023-1CA0 | 43 | 0.024 | | | |
| 7.5 | 10 | 132 S | 3555 | 20 | ✓ | 90.2 | 90.5 | 90 | 0.91 | 11.5 | 2.4 | 9.5 | 4.7 | 72 | 84 | 1LE1023-1CA1 | 57 | 0.031 | | | |
| 11 | 15 | 160 M | 3560 | 30 | ✓ | 91 | 90.4 | 88.4 | 0.88 | 17.2 | 2.8 | 8.5 | 4.3 | 77 | 89 | 1LE1023-1DA2 | 75 | 0.053 | | | |
| 15 | 20 | 160 M | 3565 | 40 | ✓ | 91 | 90.5 | 88.9 | 0.86 | 24 | 3.1 | 9.7 | 4.8 | 77 | 89 | 1LE1023-1DA3 | 84 | 0.061 | | | |
| 18.5 | 25 | 160 L | 3560 | 50 | ✓ | 91.7 | 91.5 | 90.3 | 0.9 | 28 | 3.1 | 9.4 | 4.4 | 77 | 89 | 1LE1023-1DA4 | 94 | 0.068 | | | |
| 22 | 30 | 180 M | 3560 | 59 | ✓ | 91.7 | 91.4 | 90 | 0.89 | 34 | 2.8 | 8.2 | 3.9 | 77 | 89 | 1LE1023-1EA2 | 129 | 0.08 | | | |
| 30 | 40 | 200 L | 3560 | 80 | ✓ | 92.4 | 92.2 | 91.4 | 0.87 | 47 | 2.9 | 7.6 | 3.6 | 77 | 84 | 1LE1023-2AA4 | 173 | 0.134 | | | |
| 37 | 50 | 200 L | 3560 | 99 | ✓ | 93 | 92.8 | 91.6 | 0.88 | 57 | 2.8 | 7.5 | 3.6 | 77 | 84 | 1LE1023-2AA5 | 194 | 0.158 | | | |
| 4-pole: 1500 rpm at 50 Hz, 1800 rpm at 60 Hz | | | | | | | | | | | | | | | | | | | | | |
| 0.55 | 0.75 | 80 M | 1750 | 3 | – | 81.1 | 80.8 | 78.2 | 0.74 | 1.15 | 2.7 | 6.9 | 3.8 | 55 | 66 | 1LE1023-0DB2 | 11 | 0.0021 | | | |
| 0.75 | 1 | 80 M | 1760 | 4.1 | ✓ | 83.5 | 82.6 | 79.3 | 0.71 | 1.59 | 3.1 | 8.3 | 4.7 | 55 | 66 | 1LE1023-0DB3 | 14 | 0.0029 | | | |
| 1.1 | 1.5 | 90 S | 1750 | 6 | ✓ | 86.5 | 86.4 | 84.2 | 0.75 | 2.15 | 3.4 | 8.2 | 4.4 | 58 | 70 | 1LE1023-0EB0 | 16 | 0.0036 | | | |
| 1.5 | 2 | 90 L | 1755 | 8.2 | ✓ | 86.5 | 86.2 | 84.5 | 0.77 | 2.85 | 3.4 | 8.6 | 4.3 | 62 | 70 | 1LE1023-0EB4 | 19 | 0.0049 | | | |
| 2.2 | 3 | 100 L | 1770 | 11.9 | ✓ | 89.5 | 89.2 | 87.2 | 0.81 | 3.8 | 3.5 | 9.6 | 5.1 | 62 | 74 | 1LE1023-1AB4 | 30 | 0.014 | | | |
| 3 | 4 | 100 L | 1760 | 16.3 | ✓ | 89.5 | 89.5 | 88.3 | 0.82 | 5.1 | 3.1 | 9.5 | 4.6 | 62 | 74 | 1LE1023-1AB5 | 30 | 0.014 | | | |
| 3.7 | 5 | 112 M | 1770 | 19 | ✓ | 89.5 | 89.4 | 87.7 | 0.8 | 6.5 | 2.9 | 8.2 | 4.3 | 62 | 74 | 1LE1023-1BB2 | 34 | 0.017 | | | |
| 5.5 | 7.5 | 132 S | 1775 | 30 | ✓ | 91.7 | 91.6 | 90.5 | 0.81 | 9.3 | 3.9 | 9.7 | 4.5 | 68 | 80 | 1LE1023-1CB0 | 64 | 0.046 | | | |
| 7.5 | 10 | 132 M | 1770 | 40 | ✓ | 91.7 | 91.8 | 91 | 0.83 | 12.4 | 2.7 | 9.6 | 4.2 | 68 | 80 | 1LE1023-1CB2 | 64 | 0.046 | | | |
| 11 | 15 | 160 M | 1775 | 59 | ✓ | 92.4 | 92.3 | 91.1 | 0.83 | 18 | 3 | 8.9 | 3.8 | 69 | 81 | 1LE1023-1DB2 | 83 | 0.083 | | | |
| 15 | 20 | 160 L | 1780 | 80 | ✓ | 93 | 92.8 | 91.4 | 0.81 | 25 | 2.9 | 9.5 | 4.3 | 69 | 81 | 1LE1023-1DB4 | 100 | 0.099 | | | |
| 18.5 | 25 | 180 M | 1775 | 100 | ✓ | 93.6 | 93.7 | 93.1 | 0.81 | 30.5 | 2.7 | 7.8 | 3.6 | 68 | 75 | 1LE1023-1EB2 | 134 | 0.13 | | | |
| 22 | 30 | 180 L | 1775 | 118 | ✓ | 93.6 | 93.8 | 93.3 | 0.81 | 36.5 | 2.8 | 7.7 | 3.7 | 70 | 77 | 1LE1023-1EB4 | 142 | 0.14 | | | |
| 30 | 40 | 200 L | 1778 | 161 | ✓ | 94.1 | 94.3 | 93.8 | 0.83 | 48 | 3 | 8.1 | 3.5 | 70 | 77 | 1LE1023-2AB5 | 189 | 0.22 | | | |
| Voltages (≤ 600 V)¹⁾ | | | | | | | | | | | | | | Version | | Order code | | | | | |
| 50 Hz 230 VΔ/400 VY | | | 60 Hz 460 VY | | | Standard | | 2 | | 2 | | – | | | | | | | | | |
| 50 Hz 400 VΔ | | | 60 Hz 460 VΔ | | | Standard | | 3 | | 4 | | – | | | | | | | | | |
| 50 Hz 500 VY | | | | | | Without additional charge | | 2 | | 7 | | – | | | | | | | | | |
| 50 Hz 500 VΔ | | | | | | Without additional charge | | 4 | | 0 | | – | | | | | | | | | |
| For other voltages and more information, see from page 2/93 | | | | | | | | | | | | | | 9 | | 0 | | ... | | | |
| Types of construction | | | | | | | | | | | | | | Version | | Order code | | | | | |
| Without flange | | | IM B3 ²⁾ | | | Standard | | A | | – | | | | | | | | | | | |
| With flange | | | IM B5 ²⁾ | | | With additional charge | | F | | – | | | | | | | | | | | |
| With flange | | | IM B14 ²⁾ | | | With additional charge | | K | | – | | | | | | | | | | | |
| For other types of construction and more information, see from page 2/99 | | | | | | | | | | | | | | 4 | | 0 | | ... | | | |
| Motor protection | | | | | | | | | | | | | | Version | | Order code | | | | | |
| Without | | | | | | Standard | | A | | – | | | | | | | | | | | |
| PTC thermistor with 1 or 3 temperature sensors (frame sizes 80, 90 or 100 to 200) | | | | | | With additional charge | | B | | – | | | | | | | | | | | |
| For other motor protection and more information, see from page 2/112 | | | | | | | | | | | | | | 4 | | 0 | | ... | | | |
| Terminal box position | | | | | | | | | | | | | | Version | | Order code | | | | | |
| Terminal box at top | | | | | | Standard | | 4 | | – | | | | | | | | | | | |
| For other terminal box positions and more information, see from page 2/115 | | | | | | | | | | | | | | 4 | | 0 | | ... | | | |
| Special versions | | | | | | | | | | | | | | | | Order code(s) | | | | | |
| Forced-air cooled motors w/o ext. fan/fan cover (IC418) | | | | | | | | | | | | | | 1LE1023-...-Z | | F90+...+...+... | | | | | |
| For options, see from page 2/118 | | | | | | | | | | | | | | 1LE1023-...-Z | | ...+...+...+... | | | | | |

- Not required
- ✓ Available

¹⁾ Operating voltages only ≤ 600 V admissible in accordance with MG1 Table 12-12.

²⁾ Types derived from IM B3 (IM B6/7/8, IM V6, and IM V5), from IM B5 (IM V3 and IM V1) and from IM B14 (IM V19 and IM V18) are possible, provided that no requirements exist for condensation drainage holes (H03) or stamping of the type on the rating plate. The basic type IM B3, IM B5, or IM B14 is stamped as standard on the rating plate. For orders with condensation drainage holes (H03), the type must be specified.

SIMOTICS GP and SIMOTICS SD standard motors
Eagle Line · NEMA Premium Efficient MG1 Table 12-12



Aluminum series SIMOTICS GP 1LE1023 – self-ventilated or forced-air cooled

Selection and ordering data

| Operating values at rated power | | | | | | | | | | | | | | | Aluminum series | | m _{IM B3} | J |
|---|---------------------------------------|---------------|-------------------------------|-------------------------------|--------------------------|-------------------------------|-------------------------------|-------------------------------|----------------------------------|-------------------------------|----------------------------|----------------------------|---------------------------|-----------------------------|--------------------------------|----------------------------|------------------------------|------------------------|
| P _{rated} , 60 Hz/ P50 | P _{rated} , 60 Hz/ P60 | Frame size | n _{rated} , 60 Hz | T _{rated} , 60 Hz | EISA CC No. CC032A | η _{rated} , 60 Hz | η _{rated} , 60 Hz | η _{rated} , 60 Hz | cosφ _{rated} , 60 Hz | I _{rated} , 460 V | T _{LR} / 60 Hz | I _{LR} / 60 Hz | T _B / 60 Hz | L _{pfA} , 60 Hz | L _{WA} , 60 Hz | Article No. | | |
| 0.37 | 0.5 | 80 M | 1150 | 3.1 | – | 75.3 | 74.3 | 70 | 0.61 | 1.01 | 2.7 | 5 | 3.3 | 45 | 56 | 1LE1023-0DC2 ■■■■■■ | 12 | 0.0025 |
| 0.55 | 0.75 | 80 M | 1145 | 4.6 | – | 81.7 | 80.5 | 76.4 | 0.63 | 1.34 | 2.8 | 5.3 | 3.4 | 45 | 56 | 1LE1023-0DC3 ■■■■■■ | 14 | 0.0031 |
| 0.75 | 1 | 90 S | 1155 | 6.2 | ✓ | 82.5 | 82.4 | 79.9 | 0.65 | 1.76 | 2.4 | 5.3 | 3.1 | 46 | 58 | 1LE1023-0EC0 ■■■■■■ | 16 | 0.004 |
| 1.1 | 1.5 | 100 L | 1180 | 8.9 | ✓ | 87.5 | 87.2 | 84.8 | 0.69 | 2.3 | 2.4 | 6.7 | 3.3 | 62 | 74 | 1LE1023-1AC3 ■■■■■■ | 30 | 0.014 |
| 3 | 4 | 132 S | 1180 | 24 | ✓ | 89.5 | 89.5 | 87.9 | 0.70 | 6 | 2.6 | 7.6 | 3.8 | 61 | 69 | 1LE1023-1CC0 ■■■■■■ | 42 | 0.034 |
| 3.7 | 5 | 132 M | 1180 | 30 | ✓ | 89.5 | 89.9 | 88.2 | 0.69 | 7.1 | 2.8 | 7.5 | 3.8 | 62 | 70 | 1LE1023-1CC2 ■■■■■■ | 46 | 0.039 |
| 5.5 | 7.5 | 132 M | 1180 | 45 | ✓ | 91.0 | 90.8 | 89.2 | 0.69 | 11 | 3 | 7.8 | 4 | 67 | 75 | 1LE1023-1CC3 ■■■■■■ | 58 | 0.05 |
| 7.5 | 10 | 160 M | 1185 | 60 | ✓ | 91.0 | 90.8 | 89.3 | 0.80 | 12.9 | 2.7 | 9.3 | 3.7 | 73 | 81 | 1LE1023-1DC2 ■■■■■■ | 95 | 0.132 |
| 11 | 15 | 160 L | 1185 | 89 | ✓ | 91.7 | 91.7 | 90.5 | 0.78 | 19.3 | 3.4 | 8 | 3.2 | 72 | 80 | 1LE1023-1DC4 ■■■■■■ | 106 | 0.164 |
| 15 | 20 | 180 L | 1178 | 122 | ✓ | 91.7 | 92 | 91.4 | 0.79 | 26 | 2.5 | 6.8 | 3 | 61 | 68 | 1LE1023-1EC4 ■■■■■■ | 130 | 0.19 |
| 18.5 | 25 | 200 L | 1180 | 150 | ✓ | 93 | 93.8 | 93.8 | 0.78 | 32 | 2.8 | 6.5 | 3 | 64 | 71 | 1LE1023-2AC4 ■■■■■■ | 166 | 0.28 |
| 22 | 30 | 200 L | 1180 | 178 | ✓ | 93 | 93.5 | 93.4 | 0.79 | 37.5 | 2.6 | 6.3 | 2.8 | 63 | 70 | 1LE1023-2AC5 ■■■■■■ | 179 | 0.32 |
| 8-pole: 750 rpm at 50 Hz, 900 rpm at 60 Hz | | | | | | | | | | | | | | | | | | |
| 2.2 | 3 | 132 S | 880 | 24 | ✓ | 85.5 | 85.6 | 83.6 | 0.6 | 5.4 | 1.5 | 4 | 2.1 | 67 | 80 | 1LE1023-1CD0 ■■■■■■ | 56 | 0.038 |
| 3 | 4 | 132 M | 880 | 33 | ✓ | 86.5 | 86.7 | 84.9 | 0.6 | 7.3 | 1.7 | 4.3 | 2.3 | 67 | 80 | 1LE1023-1CD2 ■■■■■■ | 65 | 0.048 |
| 3.7 | 5 | 160 M | 885 | 40 | ✓ | 86.5 | 86.2 | 84 | 0.62 | 8.7 | 2 | 4.4 | 2.2 | 66 | 79 | 1LE1023-1DD2 ■■■■■■ | 72 | 0.065 |
| 5.5 | 7.5 | 160 M | 884 | 59 | ✓ | 86.5 | 86.5 | 85 | 0.64 | 12.5 | 1.9 | 4.4 | 2.2 | 66 | 79 | 1LE1023-1DD3 ■■■■■■ | 86 | 0.083 |
| 7.5 | 10 | 160 L | 882 | 81 | ✓ | 89.5 | 89.8 | 88.9 | 0.64 | 16.4 | 2 | 4.3 | 2.2 | 66 | 79 | 1LE1023-1DD4 ■■■■■■ | 110 | 0.116 |
| 11 | 15 | 180 L | 880 | 119 | ✓ | 89.5 | 89.9 | 89.3 | 0.72 | 21.5 | 2.3 | 5.8 | 2.7 | 65 | 78 | 1LE1023-1ED4 ■■■■■■ | 161 | 0.267 |
| 15 | 20 | 200 L | 882 | 162 | ✓ | 90.2 | 90.2 | 89.2 | 0.7 | 30 | 3.4 | 7.7 | 4.2 | 60 | 73 | 1LE1023-2AD5 ■■■■■■ | 212 | 0.420 |
| Voltages (≤ 600 V)¹⁾ | | | | | | | | | | | | | | | | | | |
| 50 Hz 230 VΔ/400 VY | | | | | | | | | | | | | | | Standard | 2 | 2 | – |
| 50 Hz 400 VΔ | | | | | | | | | | | | | | | Standard | 3 | 4 | – |
| 50 Hz 500 VY | | | | | | | | | | | | | | | Without additional charge | 2 | 7 | – |
| 50 Hz 500 VΔ | | | | | | | | | | | | | | | Without additional charge | 4 | 0 | – |
| For other voltages and more information, see from page 2/93 | | | | | | | | | | | | | | | | 9 | 0 | ... |
| Types of construction | | | | | | | | | | | | | | | | | | |
| Without flange | | | | | | | | | | | | | | | IM B3 ²⁾ | Standard | A | – |
| With flange | | | | | | | | | | | | | | | IM B5 ²⁾ | With additional charge | F | – |
| With flange | | | | | | | | | | | | | | | IM B14 ²⁾ | With additional charge | K | – |
| For other types of construction and more information, see from page 2/99 | | | | | | | | | | | | | | | | | | ... |
| Motor protection | | | | | | | | | | | | | | | | | | |
| Without | | | | | | | | | | | | | | | Standard | A | – | |
| PTC thermistor with 1 or 3 temperature sensors (frame sizes 80, 90 or 100 to 200) | | | | | | | | | | | | | | | With additional charge | B | – | |
| For other motor protection and more information, see from page 2/112 | | | | | | | | | | | | | | | | | | ... |
| Terminal box position | | | | | | | | | | | | | | | | | | |
| Terminal box at top | | | | | | | | | | | | | | | Standard | 4 | – | |
| For other terminal box positions and more information, see from page 2/115 | | | | | | | | | | | | | | | | | | |
| Special versions | | | | | | | | | | | | | | | | | | Order code(s) |
| Forced-air cooled motors w/o ext. fan/fan cover (IC418) | | | | | | | | | | | | | | | 1LE1023- ■■■■■■ | -Z | F90 | + . . . + . . . |
| For options, see from page 2/118 | | | | | | | | | | | | | | | 1LE1023- ■■■■■■ | -Z | . . . + . . . + . . . | |

- Not required
- ✓ Available

¹⁾ Operating voltages only ≤ 600 V admissible in accordance with MG1 Table 12-12.

²⁾ Types derived from IM B3 (IM B6/7/8, IM V6, and IM V5), from IM B5 (IM V3 and IM V1) and from IM B14 (IM V19 and IM V18) are possible, provided that no requirements exist for condensation drainage holes (**H03**) or stamping of the type on the rating plate. The basic type IM B3, IM B5, or IM B14 is stamped as standard on the rating plate. For orders with condensation drainage holes (**H03**), the type must be specified.



SIMOTICS GP and SIMOTICS SD standard motors
Eagle Line · NEMA Premium Efficient MG1 Table 12-12

Cast-iron series SIMOTICS SD 1LE1523 Basic Line – self-ventilated or forced-air cooled

Selection and ordering data

| Operating values at rated power | | | | | | | | | | | | | | | Cast-iron series | | | |
|--|------------------------------|---------------|----------------------|----------------------|--------------------------|---------------------------------|---------------------------------|---------------------------------|-------------------------------------|--------------------------------|-----------------------------|-----------------------------|--------------------------|--------------------|-------------------|----------------------|------------------|---------|
| P_{rated} 60 Hz/ P50 | P_{rated} 60 Hz/ P60 | Frame size | n_{rated} 60 Hz | T_{rated} 60 Hz | EISA CC No. CC032A | η_{rated} 60 Hz, 4/4 | η_{rated} 60 Hz, 3/4 | η_{rated} 60 Hz, 2/4 | $\cos\phi_{rated}$ 60 Hz, 4/4 | I_{rated} 60 Hz, 460 V | T_{LR}/I_{rated} 60 Hz | I_{LR}/I_{rated} 60 Hz | T_p/I_{rated} 60 Hz | L_{pFA} 60 Hz | L_{WA} 60 Hz | 1LE1523 – Basic Line | $m_{IM B3}$ | J |
| kW | hp | FS | rpm | Nm | | % | % | % | | A | | | | | Article No. | kg | kgm ² | |
| • Cooling: Self-ventilated (IC411) or with order code F90 forced-air cooled without external fan and fan cover (IC418) • Efficiency: NEMA Premium Efficient, UL, CSA, and service factor (SF) 1.15 – for operation in the USA, Canada, and Mexico • Insulation: Thermal class 155 (temperature class F), IP55 degree of protection, utilization in accordance with thermal class 130 (temperature class B) | | | | | | | | | | | | | | | | | | |
| 2-pole: 3000 rpm at 50 Hz, 3600 rpm at 60 Hz | | | | | | | | | | | | | | | | | | |
| 0.37 | 0.5 | 71 M | 3470 | 1 | – | 73.4 | 71.7 | 67 | 0.73 | 0.87 | 4.2 | 6.8 | 4.2 | 57 | 68 | 1LE1523-0CA2 | 13 | 0.00045 |
| 0.55 | 0.75 | 71 M | 3470 | 1.5 | – | 76.8 | 75.3 | 71 | 0.73 | 1.23 | 4.5 | 7.2 | 4.5 | 62 | 73 | 1LE1523-0CA3 | 15 | 0.00056 |
| 0.75 | 1 | 80 M | 3480 | 2.1 | ✓ | 77 | 77.2 | 75.7 | 0.84 | 1.45 | 3 | 7.1 | 3.6 | 64 | 75 | 1LE1523-0DA2 | 18 | 0.0011 |
| 1.1 | 1.5 | 80 M | 3500 | 3 | ✓ | 84 | 84 | 82 | 0.83 | 1.98 | 3.3 | 8.4 | 4 | 64 | 75 | 1LE1523-0DA3 | 21 | 0.0013 |
| 1.5 | 2 | 90 S | 3525 | 4.1 | ✓ | 85.5 | 84.8 | 82.3 | 0.84 | 2.6 | 3.1 | 9.8 | 4.9 | 69 | 81 | 1LE1523-0EA0 | 26 | 0.0021 |
| 2.2 | 3 | 90 L | 3530 | 6 | ✓ | 86.5 | 86.4 | 84.5 | 0.87 | 3.65 | 3 | 9.6 | 4.9 | 69 | 81 | 1LE1523-0EA4 | 32 | 0.0031 |
| 3 | 4 | 100 L | 3525 | 8.1 | ✓ | 88.5 | 88.7 | 87.2 | 0.87 | 4.9 | 3.8 | 9.7 | 5.5 | 71 | 83 | 1LE1523-1AA4 | 36 | 0.0054 |
| 3.7 | 5 | 112 M | 3560 | 10 | ✓ | 88.5 | 88 | 86.2 | 0.88 | 6 | 3.2 | 10.8 | 5.1 | 73 | 85 | 1LE1523-1BA2 | 45 | 0.012 |
| 5.5 | 7.5 | 132 S | 3555 | 15 | ✓ | 89.5 | 89.4 | 88.2 | 0.9 | 8.6 | 2.1 | 8.6 | 4.4 | 72 | 84 | 1LE1523-1CA0 | 58 | 0.024 |
| 7.5 | 10 | 132 S | 3555 | 20 | ✓ | 90.2 | 90.5 | 90 | 0.91 | 11.5 | 2.4 | 9.5 | 4.7 | 72 | 84 | 1LE1523-1CA1 | 73 | 0.031 |
| 11 | 15 | 160 M | 3560 | 30 | ✓ | 91 | 90.4 | 88.4 | 0.88 | 17.2 | 2.8 | 8.5 | 4.3 | 77 | 89 | 1LE1523-1DA2 | 100 | 0.053 |
| 15 | 20 | 160 M | 3565 | 40 | ✓ | 91 | 90.5 | 88.9 | 0.86 | 24 | 3.1 | 9.7 | 4.8 | 77 | 89 | 1LE1523-1DA3 | 110 | 0.061 |
| 18.5 | 25 | 160 L | 3560 | 50 | ✓ | 91.7 | 91.5 | 90.3 | 0.9 | 28 | 3.1 | 9.4 | 4.4 | 77 | 89 | 1LE1523-1DA4 | 127 | 0.068 |
| 22 | 30 | 180 M | 3560 | 59 | ✓ | 91.7 | 91.4 | 90 | 0.89 | 34 | 2.8 | 8.2 | 3.9 | 77 | 89 | 1LE1523-1EA2 | 160 | 0.08 |
| 30 | 40 | 200 L | 3560 | 80 | ✓ | 92.4 | 92.2 | 91.4 | 0.87 | 47 | 2.9 | 7.6 | 3.6 | 77 | 84 | 1LE1523-2AA4 | 225 | 0.134 |
| 37 | 50 | 200 L | 3560 | 99 | ✓ | 93 | 92.8 | 91.6 | 0.88 | 57 | 2.8 | 7.5 | 3.6 | 77 | 84 | 1LE1523-2AA5 | 250 | 0.158 |
| 45 | 60 | 225 M | 3570 | 120 | ✓ | 93.6 | 93.7 | 93.1 | 0.88 | 69 | 2.7 | 7.6 | 3.5 | 75 | 89 | 1LE1523-2BA2 | 315 | 0.26 |
| 55 | 75 | 250 M | 3578 | 147 | ✓ | 93.6 | 93.4 | 92.3 | 0.89 | 83 | 2.5 | 7.3 | 3.3 | 76 | 90 | 1LE1523-2CA2 | 385 | 0.46 |
| 75 | 100 | 280 S | 3578 | 200 | ✓ | 94.1 | 93.9 | 92.7 | 0.89 | 112 | 2.7 | 7.6 | 3.2 | 78 | 92 | 1LE1523-2DA0 | 510 | 0.77 |
| 90 | 125 | 280 M | 3578 | 240 | ✓ | 95 | 94.8 | 93.8 | 0.9 | 132 | 2.7 | 8.1 | 3.3 | 78 | 92 | 1LE1523-2DA2 | 590 | 0.94 |
| 110 | 150 | 315 S | 3585 | 293 | ✓ | 95 | 94.8 | 93.8 | 0.91 | 160 | 2.6 | 8 | 3.3 | 79 | 93 | 1LE1523-3AA0 | 750 | 1.4 |
| 132 | 175 | 315 M | 3585 | 352 | ✓ | 95.4 | 95.1 | 94 | 0.91 | 191 | 2.8 | 8 | 3.4 | 79 | 93 | 1LE1523-3AA2 | 880 | 1.6 |
| 150 | 200 | 315 L | 3588 | 399 | ✓ | 95.4 | 95.1 | 93.9 | 0.91 | 215 | 3.3 | 9.1 | 3.7 | 82 | 96 | 1LE1523-3AA4 | 980 | 1.9 |
| 185 | 250 | 315 L | 3586 | 493 | ✓ | 95.8 | 95.7 | 94.8 | 0.92 | 265 | 3.5 | 8.5 | 3.5 | 82 | 96 | 1LE1523-3AA5 | 1150 | 2.3 |
| Voltages (≤ 600 V)¹⁾ | | | | | | | | | | | | | | | Version | | Order code | |
| 50 Hz 230 VΔ/400 VY | | | 60 Hz 460 VY | | | Standard | | | | | | | | | 2 | 2 | – | |
| 50 Hz 400 VΔ | | | 60 Hz 460 VΔ | | | Standard | | | | | | | | | 3 | 4 | – | |
| 50 Hz 500 VY | | | | | | Without additional charge | | | | | | | | | 2 | 7 | – | |
| 50 Hz 500 VΔ | | | | | | Without additional charge | | | | | | | | | 4 | 0 | – | |
| For other voltages and more information, see from page 2/96 | | | | | | | | | | | | | | | 9 | 0 | ... | |
| Types of construction | | | | | | | | | | | | | | | Version | | Order code | |
| Without flange | | | IM B3 ²⁾ | | | Standard | | | | | | | | | A | – | | |
| With flange | | | IM B5 ²⁾ | | | With additional charge | | | | | | | | | F | – | | |
| With flange | | | IM B14 ²⁾ | | | With additional charge | | | | | | | | | K | – | | |
| For other types of construction and more information, see from page 2/103 | | | | | | | | | | | | | | | | | | |
| Motor protection | | | | | | | | | | | | | | | Version | | Order code | |
| Without | | | | | | Standard | | | | | | | | | A | – | | |
| PTC thermistor with 3 temperature sensors | | | | | | With additional charge | | | | | | | | | B | – | | |
| For other motor protection and more information, see from page 2/113 | | | | | | | | | | | | | | | | | | |
| Terminal box position | | | | | | | | | | | | | | | Version | | Order code | |
| Terminal box at top | | | | | | Standard | | | | | | | | | 4 | – | | |
| For other terminal box positions and more information, see from page 2/116 | | | | | | | | | | | | | | | | | | |
| Special versions | | | | | | | | | | | | | | | | | Order code(s) | |
| Forced-air cooled motors w/o ext. fan/fan cover (IC418) | | | | | | | | | | | | | | | 1LE1523-...-Z | | F90+...+...+... | |
| For options, see from page 2/125 | | | | | | | | | | | | | | | 1LE1523-...-Z | | ...+...+...+... | |

- Not required
- ✓ Available

¹⁾ Operating voltages only ≤ 600 V admissible in accordance with MG1 Table 12-12. Parallel supply lines are required in the case of connection to ≤ 240 V. For frame size 315 with connection to ≤ 240 V, due to the high current, a drilled, removable entry plate (order code R52) or a larger terminal box (order code R50) can be used. Order codes R52 and R50 alter the motor dimensions.

²⁾ Types derived from IM B3 (IM B6/7/8, IM V6, and IM V5), from IM B5 (IM V3 and IM V1) and from IM B14 (IM V19 and IM V18) are possible, provided that no requirement exists for stamping of the type on the rating plate. The basic type IM B3, IM B5, or IM B14 is stamped as standard on the rating plate. If mounted in a different position, the position must be specified to ensure that the condensation drainage holes are positioned correctly.



SIMOTICS GP and SIMOTICS SD standard motors
Eagle Line · NEMA Premium Efficient MG1 Table 12-12



Cast-iron series SIMOTICS SD 1LE1523 Basic Line – self-ventilated or forced-air cooled

Selection and ordering data

| Operating values at rated power | | | | | | | | | | | | | | | Cast-iron series | | | |
|--|------------------------------|---------------|----------------------|----------------------|--------------------------|---------------------------------|---------------------------------|---------------------------------|-------------------------------------|----------------------|--------------------|--------------------|-------------------|--------------------|-------------------|----------------------|--------------------|--------|
| P_{rated} 60 Hz/ P50 | P_{rated} 60 Hz/ P60 | Frame size | n_{rated} 60 Hz | T_{rated} 60 Hz | EISA CC No. CC032A | η_{rated} 60 Hz, 4/4 | η_{rated} 60 Hz, 3/4 | η_{rated} 60 Hz, 2/4 | $\cos\phi_{rated}$ 60 Hz, 4/4 | I_{rated} 460 V | $T_{LR}/$ 60 Hz | $I_{LR}/$ 60 Hz | $T_{p}/$ 60 Hz | L_{pFA} 60 Hz | L_{WA} 60 Hz | 1LE1523 – Basic Line | $m_{IM B3}$ | J |
| kW | hp | FS | rpm | Nm | % | % | % | % | A | | | | | | Article No. | kg | kgm ² | |
| • Cooling: Self-ventilated (IC411) or with order code F90 forced-air cooled without external fan and fan cover (IC418) • Efficiency: NEMA Premium Efficient, UL, CSA, and service factor (SF) 1.15 – for operation in the USA, Canada, and Mexico • Insulation: Thermal class 155 (temperature class F), IP55 degree of protection, utilization in accordance with thermal class 130 (temperature class B) | | | | | | | | | | | | | | | | | | |
| 4-pole: 1500 rpm at 50 Hz, 1800 rpm at 60 Hz | | | | | | | | | | | | | | | | | | |
| 0.25 | 0.33 | 71 M | 1715 | 1.4 | - | 73.4 | 72.3 | 68 | 0.68 | 0.63 | 2.9 | 4.9 | 3.1 | 47 | 58 | 1LE1523-0CB2 | 13 | 0.0095 |
| 0.37 | 0.5 | 71 M | 1720 | 2.1 | - | 78.2 | 76.9 | 72.5 | 0.66 | 0.9 | 3.6 | 5.7 | 3.8 | 62 | 73 | 1LE1523-0CB3 | 16 | 0.0014 |
| 0.55 | 0.75 | 80 M | 1750 | 3 | - | 81.1 | 80.8 | 78.2 | 0.74 | 1.15 | 2.7 | 6.9 | 3.8 | 55 | 66 | 1LE1523-0DB2 | 19 | 0.0021 |
| 0.75 | 1 | 80 M | 1760 | 4.1 | ✓ | 83.5 | 82.6 | 79.3 | 0.71 | 1.59 | 3.1 | 8.3 | 4.7 | 55 | 66 | 1LE1523-0DB3 | 23 | 0.0029 |
| 1.1 | 1.5 | 90 S | 1750 | 6 | ✓ | 86.5 | 86.4 | 84.2 | 0.75 | 2.15 | 3.4 | 8.2 | 4.4 | 58 | 70 | 1LE1523-0EB0 | 25 | 0.0036 |
| 1.5 | 2 | 90 L | 1755 | 8.2 | ✓ | 86.5 | 86.2 | 84.5 | 0.77 | 2.85 | 3.4 | 8.6 | 4.3 | 62 | 70 | 1LE1523-0EB4 | 31 | 0.0049 |
| 2.2 | 3 | 100 L | 1770 | 11.9 | ✓ | 89.5 | 89.2 | 87.2 | 0.81 | 3.8 | 3.5 | 9.6 | 5.1 | 62 | 74 | 1LE1523-1AB4 | 40 | 0.014 |
| 3 | 4 | 100 L | 1760 | 16.3 | ✓ | 89.5 | 89.5 | 88.3 | 0.82 | 5.1 | 3.1 | 9.5 | 4.6 | 62 | 74 | 1LE1523-1AB5 | 40 | 0.014 |
| 3.7 | 5 | 112 M | 1770 | 19 | ✓ | 89.5 | 89.4 | 87.7 | 0.8 | 6.5 | 2.9 | 8.2 | 4.3 | 62 | 74 | 1LE1523-1BB2 | 46 | 0.017 |
| 5.5 | 7.5 | 132 S | 1775 | 30 | ✓ | 91.7 | 91.6 | 90.5 | 0.81 | 9.3 | 3.9 | 9.7 | 4.5 | 68 | 80 | 1LE1523-1CB0 | 74 | 0.046 |
| 7.5 | 10 | 132 M | 1770 | 40 | ✓ | 91.7 | 91.8 | 91 | 0.83 | 12.4 | 2.7 | 9.6 | 4.2 | 68 | 80 | 1LE1523-1CB2 | 80 | 0.046 |
| 11 | 15 | 160 M | 1775 | 59 | ✓ | 92.4 | 92.3 | 91.1 | 0.83 | 18 | 3 | 8.9 | 3.8 | 69 | 81 | 1LE1523-1DB2 | 109 | 0.083 |
| 15 | 20 | 160 L | 1780 | 80 | ✓ | 93 | 92.8 | 91.4 | 0.81 | 25 | 2.9 | 9.5 | 4.3 | 69 | 81 | 1LE1523-1DB4 | 127 | 0.099 |
| 18.5 | 25 | 180 M | 1775 | 100 | ✓ | 93.6 | 93.7 | 93.1 | 0.81 | 30.5 | 2.7 | 7.8 | 3.6 | 68 | 75 | 1LE1523-1EB2 | 165 | 0.13 |
| 22 | 30 | 180 L | 1775 | 118 | ✓ | 93.6 | 93.8 | 93.3 | 0.81 | 36.5 | 2.8 | 7.7 | 3.7 | 70 | 77 | 1LE1523-1EB4 | 170 | 0.14 |
| 30 | 40 | 200 L | 1778 | 161 | ✓ | 94.1 | 94.3 | 93.8 | 0.83 | 48 | 3 | 8.1 | 3.5 | 70 | 77 | 1LE1523-2AB5 | 240 | 0.22 |
| 37 | 50 | 225 S | 1782 | 198 | ✓ | 94.5 | 94.7 | 94.2 | 0.85 | 58 | 2.8 | 7.5 | 3 | 66 | 80 | 1LE1523-2BB0 | 285 | 0.42 |
| 45 | 60 | 225 M | 1782 | 241 | ✓ | 95 | 95.3 | 95.1 | 0.85 | 70 | 3 | 7.7 | 3 | 66 | 80 | 1LE1523-2BB2 | 340 | 0.52 |
| 55 | 75 | 250 M | 1786 | 294 | ✓ | 95.4 | 95.6 | 95.1 | 0.86 | 84 | 2.8 | 7.6 | 3.2 | 67 | 81 | 1LE1523-2CB2 | 420 | 0.85 |
| 75 | 100 | 280 S | 1788 | 401 | ✓ | 95.4 | 95.3 | 94.5 | 0.85 | 116 | 2.8 | 7.7 | 3.3 | 77 | 91 | 1LE1523-2DB0 | 570 | 1.4 |
| 90 | 125 | 280 M | 1788 | 481 | ✓ | 95.4 | 95.5 | 94.9 | 0.87 | 136 | 2.9 | 8 | 3.3 | 79 | 93 | 1LE1523-2DB2 | 670 | 1.7 |
| 110 | 150 | 315 S | 1790 | 587 | ✓ | 95.8 | 95.9 | 95.4 | 0.86 | 168 | 3 | 7.5 | 3.1 | 73 | 87 | 1LE1523-3AB0 | 760 | 2.2 |
| 132 | 175 | 315 M | 1790 | 704 | ✓ | 96.2 | 96.3 | 95.8 | 0.87 | 198 | 3.1 | 8.2 | 3.2 | 76 | 90 | 1LE1523-3AB2 | 960 | 2.9 |
| 150 | 200 | 315 L | 1791 | 800 | ✓ | 96.2 | 96.2 | 95.7 | 0.87 | 225 | 3.5 | 8.8 | 3.6 | 76 | 90 | 1LE1523-3AB4 | 990 | 3.1 |
| 185 | 250 | 315 L | 1791 | 986 | ✓ | 96.2 | 96.2 | 95.5 | 0.87 | 275 | 3.9 | 9 | 3.6 | 78 | 93 | 1LE1523-3AB5 | 1190 | 3.7 |
| Voltages (≤ 600 V)¹⁾ | | | | | | | | | | | | | | | Version | | Order code | |
| 50 Hz 230 VΔ/400 VY | | | 60 Hz 460 VY | | | Standard | | | 2 2 | | - | | | | | | | |
| 50 Hz 400 VΔ | | | 60 Hz 460 VΔ | | | Standard | | | 3 4 | | - | | | | | | | |
| 50 Hz 500 VY | | | | | | Without additional charge | | | 2 7 | | - | | | | | | | |
| 50 Hz 500 VΔ | | | | | | Without additional charge | | | 4 0 | | - | | | | | | | |
| For other voltages and more information, see from page 2/96 | | | | | | | | | | | | | | | 9 0 | | ... | |
| Types of construction | | | | | | | | | | | | | | | Version | | Order code | |
| Without flange | | | IM B3 ²⁾ | | | Standard | | | A | | - | | | | | | | |
| With flange | | | IM B5 ²⁾ | | | With additional charge | | | F | | - | | | | | | | |
| With flange | | | IM B14 ²⁾ | | | With additional charge | | | K | | - | | | | | | | |
| For other types of construction and more information, see from page 2/103 | | | | | | | | | | | | | | | | | ... | |
| Motor protection | | | | | | | | | | | | | | | Version | | Order code | |
| Without | | | | | | Standard | | | A | | - | | | | | | | |
| PTC thermistor with 3 temperature sensors | | | | | | With additional charge | | | B | | - | | | | | | | |
| For other motor protection and more information, see from page 2/113 | | | | | | | | | | | | | | | | | ... | |
| Terminal box position | | | | | | | | | | | | | | | Version | | Order code(s) | |
| Terminal box at top | | | | | | Standard | | | 4 | | | | | | | | | |
| For other terminal box positions and more information, see from page 2/116 | | | | | | | | | | | | | | | | | | |
| Special versions | | | | | | | | | | | | | | | | | Order code(s) | |
| Forced-air cooled motors w/o ext. fan/fan cover (IC418) | | | | | | | | | | | | | | | 1LE1523-.... | | -Z F90+...+...+... | |
| For options, see from page 2/125 | | | | | | | | | | | | | | | 1LE1523-.... | | -Z ...+...+...+... | |

- Not required
- ✓ Available

¹⁾ Operating voltages only ≤ 600 V admissible in accordance with MG1 Table 12-12. Parallel supply lines are required in the case of connection to ≤ 240 V. For frame size 315 with connection to ≤ 240 V, due to the high current, a drilled, removable entry plate (order code R52) or a larger terminal box (order code R50) can be used. Order codes R52 and R50 alter the motor dimensions.

²⁾ Types derived from IM B3 (IM B6/7/8, IM V6 and IM V5), from IM B5 (IM V3 and IM V1) and from IM B14 (IM V19 and IM V18) are possible, provided that no requirement exists for stamping of the type on the rating plate. The basic type IM B3, IM B5, or IM B14 is stamped as standard on the rating plate. If mounted in a different position, the position must be specified to ensure that the condensation drainage holes are positioned correctly.



SIMOTICS GP and SIMOTICS SD standard motors
Eagle Line · NEMA Premium Efficient MG1 Table 12-12

Cast-iron series SIMOTICS SD 1LE1523 Basic Line – self-ventilated or forced-air cooled

Selection and ordering data

| Operating values at rated power | | | | | | | | | | | | | | | Cast-iron series | | m _{IM B3} | J |
|--|---|---------------------|------------------------------------|-----------------------------------|--------------------------|----------------------------------|----------------------------------|----------------------------------|---------------------------------------|----------------------------------|--------------------------------|-------------------------------|-------------------------------|------------------------------------|-----------------------------------|--------------|--------------------|--------|
| P _{rated} 60 Hz/ P50 kW | P _{rated} 60 Hz/ P60 hp | Frame size FS | n _{rated} 60 Hz rpm | T _{rated} 60 Hz Nm | EISA CC No. CC032A | η _{rated} 60 Hz % | η _{rated} 60 Hz % | η _{rated} 60 Hz % | cosφ _{rated} 60 Hz 4/4 | I _{rated} 60 Hz A | T _{LR} 60 Hz °C | I _{LR} 60 Hz A | T _B 60 Hz °C | L _{pFA} 60 Hz dB(A) | L _{WA} 60 Hz dB(A) | Article No. | | |
| 6-pole: 1000 rpm at 50 Hz, 1200 rpm at 60 Hz | | | | | | | | | | | | | | | | | | |
| 0.18 | 0.25 | 71 M | 1110 | 1.5 | - | 67.5 | 66.3 | 61 | 0.63 | 0.53 | 2.8 | 3.5 | 2.9 | 42 | 53 | 1LE1523-0CC2 | 13 | 0.001 |
| 0.25 | 0.33 | 71 M | 1110 | 2.2 | - | 71.4 | 70.6 | 66.4 | 0.64 | 0.69 | 3.2 | 3.9 | 3.2 | 48 | 59 | 1LE1523-0CC3 | 16 | 0.015 |
| 0.37 | 0.5 | 80 M | 1150 | 3.1 | - | 75.3 | 74.3 | 70 | 0.61 | 1.01 | 2.7 | 5 | 3.3 | 45 | 56 | 1LE1523-0DC2 | 19 | 0.0025 |
| 0.55 | 0.75 | 80 M | 1145 | 4.6 | - | 81.7 | 80.5 | 76.4 | 0.63 | 1.34 | 2.8 | 5.3 | 3.4 | 45 | 56 | 1LE1523-0DC3 | 23 | 0.0031 |
| 0.75 | 1 | 90 S | 1155 | 6.2 | ✓ | 82.5 | 82.4 | 79.9 | 0.65 | 1.76 | 2.4 | 5.3 | 3.1 | 46 | 58 | 1LE1523-0EC0 | 27 | 0.0040 |
| 3 | 4 | 132 S | 1180 | 24 | ✓ | 89.5 | 89.5 | 87.9 | 0.70 | 6 | 2.6 | 7.6 | 3.8 | 61 | 69 | 1LE1523-1CC0 | 60 | 0.034 |
| 3.7 | 5 | 132 M | 1180 | 30 | ✓ | 89.5 | 89.9 | 88.2 | 0.69 | 7.1 | 2.8 | 7.5 | 3.8 | 62 | 70 | 1LE1523-1CC2 | 64 | 0.039 |
| 5.5 | 7.5 | 132 M | 1180 | 45 | ✓ | 91.0 | 90.8 | 89.2 | 0.69 | 11 | 3 | 7.8 | 4 | 67 | 75 | 1LE1523-1CC3 | 76 | 0.05 |
| 7.5 | 10 | 160 M | 1185 | 60 | ✓ | 91.0 | 90.8 | 89.3 | 0.80 | 12.9 | 2.7 | 9.3 | 3.7 | 73 | 81 | 1LE1523-1DC2 | 124 | 0.132 |
| 11 | 15 | 160 L | 1185 | 89 | ✓ | 91.7 | 91.7 | 90.5 | 0.78 | 19.3 | 3.4 | 8 | 3.2 | 72 | 80 | 1LE1523-1DC4 | 138 | 0.164 |
| 15 | 20 | 180 L | 1178 | 122 | ✓ | 91.7 | 92 | 91.4 | 0.79 | 26 | 2.5 | 6.8 | 3 | 61 | 68 | 1LE1523-1EC4 | 180 | 0.19 |
| 18.5 | 25 | 200 L | 1180 | 150 | ✓ | 93 | 93.8 | 93.8 | 0.78 | 32 | 2.8 | 6.5 | 3 | 64 | 71 | 1LE1523-2AC4 | 215 | 0.28 |
| 22 | 30 | 200 L | 1180 | 178 | ✓ | 93 | 93.5 | 93.4 | 0.79 | 37.5 | 2.6 | 6.3 | 2.8 | 63 | 70 | 1LE1523-2AC5 | 230 | 0.32 |
| 30 | 40 | 225 M | 1185 | 242 | ✓ | 94.1 | 94.4 | 94.1 | 0.82 | 49 | 2.9 | 7.6 | 3.3 | 66 | 79 | 1LE1523-2BC2 | 325 | 0.67 |
| 37 | 50 | 250 M | 1188 | 297 | ✓ | 94.1 | 94.4 | 93.9 | 0.83 | 59 | 3.1 | 8 | 3.1 | 63 | 76 | 1LE1523-2CC2 | 405 | 1 |
| 45 | 60 | 280 S | 1190 | 361 | ✓ | 94.5 | 94.6 | 94.1 | 0.83 | 72 | 3.3 | 7.7 | 3.1 | 66 | 80 | 1LE1523-2DC0 | 510 | 1.4 |
| 55 | 75 | 280 M | 1190 | 441 | ✓ | 94.5 | 94.6 | 93.9 | 0.84 | 87 | 3.6 | 9.2 | 3.3 | 66 | 80 | 1LE1523-2DC2 | 560 | 1.64 |
| 75 | 100 | 315 S | 1192 | 601 | ✓ | 95 | 94.9 | 94.1 | 0.82 | 121 | 3.1 | 8.4 | 3.3 | 64 | 79 | 1LE1523-3AC0 | 750 | 2.6 |
| 90 | 125 | 315 M | 1192 | 721 | ✓ | 95 | 95 | 94.4 | 0.84 | 142 | 2.7 | 7.7 | 3 | 64 | 79 | 1LE1523-3AC2 | 890 | 3.1 |
| 110 | 150 | 315 L | 1192 | 881 | ✓ | 95.8 | 95.9 | 95.5 | 0.83 | 174 | 3.2 | 8.2 | 3.4 | 64 | 79 | 1LE1523-3AC4 | 990 | 3.9 |
| 132 | 175 | 315 L | 1193 | 1057 | ✓ | 95.8 | 95.9 | 95.4 | 0.81 | 215 | 3.7 | 9.6 | 3.7 | 65 | 80 | 1LE1523-3AC5 | 1130 | 4.48 |
| 150 | 200 | 315 L | 1194 | 1200 | ✓ | 95.8 | 95.7 | 95.0 | 0.80 | 245 | 4.3 | 11 | 4.3 | 69 | 83 | 1LE1523-3AC6 | 1260 | 5.41 |
| Voltages (≤ 600 V)¹⁾ | | | | | | | | | | | | | | | Version | | Order code | |
| 50 Hz 230 VΔ/400 VY | | | 60 Hz 460 VY | | | Standard | | 2 2 | | - | | | | | | | | |
| 50 Hz 400 VΔ | | | 60 Hz 460 VΔ | | | Standard | | 3 4 | | - | | | | | | | | |
| 50 Hz 500 VY | | | | | | Without additional charge | | 2 7 | | - | | | | | | | | |
| 50 Hz 500 VΔ | | | | | | Without additional charge | | 4 0 | | - | | | | | | | | |
| For other voltages and more information, see from page 2/96 | | | | | | | | | | | | | | | 9 0 | | ... | |
| Types of construction | | | | | | | | | | | | | | | Version | | Order code | |
| Without flange | | | IM B3 ²⁾ | | | Standard | | A | | - | | | | | | | | |
| With flange | | | IM B5 ²⁾ | | | With additional charge | | F | | - | | | | | | | | |
| With flange | | | IM B14 ²⁾ | | | With additional charge | | K | | - | | | | | | | | |
| For other types of construction and more information, see from page 2/103 | | | | | | | | | | | | | | | ... | | | |
| Motor protection | | | | | | | | | | | | | | | Version | | Order code | |
| Without | | | | | | Standard | | A | | - | | | | | | | | |
| PTC thermistor with 3 temperature sensors | | | | | | With additional charge | | B | | - | | | | | | | | |
| For other motor protection and more information, see from page 2/113 | | | | | | | | | | | | | | | ... | | | |
| Terminal box position | | | | | | | | | | | | | | | Version | | Order code | |
| Terminal box at top | | | | | | Standard | | 4 | | | | | | | | | | |
| For other terminal box positions and more information, see from page 2/116 | | | | | | | | | | | | | | | ... | | | |
| Special versions | | | | | | | | | | | | | | | Order code(s) | | | |
| Forced-air cooled motors w/o ext. fan/fan cover (IC418) | | | | | | | | | | | | | | | 1LE1523-.... | | -Z F90+...+...+... | |
| For options, see from page 2/125 | | | | | | | | | | | | | | | 1LE1523-.... | | -Z ...+...+...+... | |

- Not required
- ✓ Available

¹⁾ Operating voltages only ≤ 600 V admissible in accordance with MG1 Table 12-12. Parallel supply lines are required in the case of connection to ≤ 240 V. For frame size 315 with connection to ≤ 240 V, due to the high current, a drilled, removable entry plate (order code **R52**) or a larger terminal box (order code **R50**) can be used. Order codes **R52** and **R50** alter the motor dimensions.

²⁾ Types derived from IM B3 (IM B6/7/8, IM V6 and IM V5), from IM B5 (IM V3 and IM V1) and from IM B14 (IM V19 and IM V18) are possible, provided that no requirement exists for stamping of the type on the rating plate. The basic type IM B3, IM B5, or IM B14 is stamped as standard on the rating plate. If mounted in a different position, the position must be specified to ensure that the condensation drainage holes are positioned correctly.



SIMOTICS GP and SIMOTICS SD standard motors
Eagle Line · NEMA Premium Efficient MG1 Table 12-12



Cast-iron series SIMOTICS SD 1LE1623 Performance Line – self-ventilated or forced-air cooled

Selection and ordering data

| Operating values at rated power | | | | | | | | | | | | | | | Cast-iron series | | | |
|--|------------------------------|---------------|----------------------|----------------------|--------------------------|---------------------------|-------------------------|-------------------------|-----------------------------|----------------------|-----------------------------|-----------------------------|--------------------------------|--------------------|-------------------|--|--------------------------------|------------------|
| P_{rated} 60 Hz/ P50 | P_{rated} 60 Hz/ P60 | Frame size | n_{rated} 60 Hz | T_{rated} 60 Hz | EISA CC No. CC032A | η_{rated} 60 Hz | η_{rated} 60 Hz | η_{rated} 60 Hz | $\cos\phi_{rated}$ 60 Hz | I_{rated} 460 V | T_{LR}/I_{rated} 60 Hz | I_{LR}/I_{rated} 60 Hz | T_{β}/I_{rated} 60 Hz | L_{pFA} 60 Hz | L_{WA} 60 Hz | 1LE1623 – Performance Line Article No. | $m_{IM B3}$ | J |
| kW | hp | FS | rpm | Nm | | % | % | % | | A | | | | | | | kg | kgm ² |
| 2-pole: 3000 rpm at 50 Hz, 3600 rpm at 60 Hz | | | | | | | | | | | | | | | | | | |
| 3 | 4 | 100 L | 3525 | 8.1 | ✓ | 88.5 | 88.7 | 87.2 | 0.87 | 4.9 | 3.8 | 9.7 | 5.5 | 71 | 83 | 1LE1623-1AA4 | 36 | 0.0054 |
| 3.7 | 5 | 112 M | 3560 | 10 | ✓ | 88.5 | 88 | 86.2 | 0.88 | 6 | 3.2 | 10.8 | 5.1 | 73 | 85 | 1LE1623-1BA2 | 45 | 0.012 |
| 5.5 | 7.5 | 132 S | 3555 | 15 | ✓ | 89.5 | 89.4 | 88.2 | 0.9 | 8.6 | 2.1 | 8.6 | 4.4 | 72 | 84 | 1LE1623-1CA0 | 58 | 0.024 |
| 7.5 | 10 | 132 S | 3555 | 20 | ✓ | 90.2 | 90.5 | 90 | 0.91 | 11.5 | 2.4 | 9.5 | 4.7 | 72 | 84 | 1LE1623-1CA1 | 73 | 0.031 |
| 11 | 15 | 160 M | 3560 | 30 | ✓ | 91 | 90.4 | 88.4 | 0.88 | 17.2 | 2.8 | 8.5 | 4.3 | 77 | 89 | 1LE1623-1DA2 | 100 | 0.053 |
| 15 | 20 | 160 M | 3565 | 40 | ✓ | 91 | 90.5 | 88.9 | 0.86 | 24 | 3.1 | 9.7 | 4.8 | 77 | 89 | 1LE1623-1DA3 | 110 | 0.061 |
| 18.5 | 25 | 160 L | 3560 | 50 | ✓ | 91.7 | 91.5 | 90.3 | 0.9 | 28 | 3.1 | 9.4 | 4.4 | 77 | 89 | 1LE1623-1DA4 | 127 | 0.068 |
| 22 | 30 | 180 M | 3560 | 59 | ✓ | 91.7 | 91.4 | 90 | 0.89 | 34 | 2.8 | 8.2 | 3.9 | 77 | 89 | 1LE1623-1EA2 | 160 | 0.08 |
| 30 | 40 | 200 L | 3560 | 80 | ✓ | 92.4 | 92.2 | 91.4 | 0.87 | 47 | 2.9 | 7.6 | 3.6 | 77 | 84 | 1LE1623-2AA4 | 225 | 0.134 |
| 37 | 50 | 200 L | 3560 | 99 | ✓ | 93 | 92.8 | 91.6 | 0.88 | 57 | 2.8 | 7.5 | 3.6 | 77 | 84 | 1LE1623-2AA5 | 250 | 0.158 |
| 45 | 60 | 225 M | 3570 | 120 | ✓ | 93.6 | 93.7 | 93.1 | 0.88 | 69 | 2.7 | 7.6 | 3.5 | 75 | 89 | 1LE1623-2BA2 | 315 | 0.26 |
| 55 | 75 | 250 M | 3578 | 147 | ✓ | 93.6 | 93.4 | 92.3 | 0.89 | 83 | 2.5 | 7.3 | 3.3 | 76 | 90 | 1LE1623-2CA2 | 385 | 0.46 |
| 75 | 100 | 280 S | 3578 | 200 | ✓ | 94.1 | 93.9 | 92.7 | 0.89 | 112 | 2.7 | 7.6 | 3.2 | 78 | 92 | 1LE1623-2DA0 | 510 | 0.77 |
| 90 | 125 | 280 M | 3578 | 240 | ✓ | 95 | 94.8 | 93.8 | 0.9 | 132 | 2.7 | 8.1 | 3.3 | 78 | 92 | 1LE1623-2DA2 | 590 | 0.94 |
| 110 | 150 | 315 S | 3585 | 293 | ✓ | 95 | 94.8 | 93.8 | 0.91 | 160 | 2.6 | 8 | 3.3 | 79 | 93 | 1LE1623-3AA0 | 750 | 1.4 |
| 132 | 175 | 315 M | 3585 | 352 | ✓ | 95.4 | 95.1 | 94 | 0.91 | 191 | 2.8 | 8 | 3.4 | 79 | 93 | 1LE1623-3AA2 | 880 | 1.6 |
| 150 | 200 | 315 L | 3588 | 399 | ✓ | 95.4 | 95.1 | 93.9 | 0.91 | 215 | 3.3 | 9.1 | 3.7 | 82 | 96 | 1LE1623-3AA4 | 980 | 1.9 |
| 185 | 250 | 315 L | 3586 | 493 | ✓ | 95.8 | 95.7 | 94.8 | 0.92 | 265 | 3.5 | 8.5 | 3.5 | 82 | 96 | 1LE1623-3AA5 | 1150 | 2.3 |
| Voltages (≤ 600 V)¹⁾ | | | | | | | | | | | | | | | Version | | Order code | |
| 50 Hz 230 VΔ/400 VY | | | 60 Hz 460 VY | | | Standard | | | 2 2 | | - | | | | | | | |
| 50 Hz 400 VΔ | | | 60 Hz 460 VΔ | | | Standard | | | 3 4 | | - | | | | | | | |
| 50 Hz 500 VY | | | | | | Without additional charge | | | 2 7 | | - | | | | | | | |
| 50 Hz 500 VΔ | | | | | | Without additional charge | | | 4 0 | | - | | | | | | | |
| For other voltages and more information, see from page 2/96 | | | | | | | | | | | | | | | | | ... | |
| Types of construction | | | | | | | | | | | | | | | Version | | Order code | |
| Without flange | | | IM B3 ²⁾ | | | Standard | | | A | | - | | | | | | | |
| With flange | | | IM B5 ²⁾ | | | With additional charge | | | F | | - | | | | | | | |
| With flange | | | IM B14 ²⁾ | | | With additional charge | | | K | | - | | | | | | | |
| For other types of construction and more information, see from page 2/103 | | | | | | | | | | | | | | | | | ... | |
| Motor protection | | | | | | | | | | | | | | | Version | | Order code | |
| PTC thermistor with 3 temperature sensors | | | | | | Standard | | | B | | - | | | | | | | |
| For other motor protection and more information, see from page 2/113 | | | | | | | | | | | | | | | | | ... | |
| Terminal box position | | | | | | | | | | | | | | | Version | | Order code(s) | |
| Terminal box at top | | | | | | Standard | | | 4 | | | | | | | | | |
| For other terminal box positions and more information, see from page 2/116 | | | | | | | | | | | | | | | | | | |
| Special versions | | | | | | | | | | | | | | | | | Order code(s) | |
| Forced-air cooled motors w/o ext. fan/fan cover (IC418) | | | | | | | | | 1LE1623-....-Z | | F90+...+...+... | | | | | | | |
| For options, see from page 2/125 | | | | | | | | | | | | | | | | | 1LE1623-....-Z ...+...+...+... | |

- Not required
- ✓ Available

¹⁾ Operating voltages only ≤ 600 V admissible in accordance with MG1 Table 12-12. Parallel supply lines are required in the case of connection to ≤ 240 V. For frame size 315 with connection to ≤ 240 V, due to the high current, a drilled, removable entry plate (order code **R52**) or a larger terminal box (order code **R50**) can be used. Order codes **R52** and **R50** alter the motor dimensions.

²⁾ Types derived from IM B3 (IM B6/7/8, IM V6, and IM V5), from IM B5 (IM V3 and IM V1) and from IM B14 (IM V19 and IM V18) are possible, provided that no requirement exists for stamping of the type on the rating plate. The basic type IM B3, IM B5, or IM B14 is stamped as standard on the rating plate. If mounted in a different position, the position must be specified to ensure that the condensation drainage holes are positioned correctly.



SIMOTICS GP and SIMOTICS SD standard motors
Eagle Line · NEMA Premium Efficient MG1 Table 12-12

Cast-iron series SIMOTICS SD 1LE1623 Performance Line – self-ventilated or forced-air cooled

Selection and ordering data

| Operating values at rated power | | | | | | | | | | | | | | | Cast-iron series | | m _{IM B3} | J | |
|--|-------------------------------------|---------------|-----------------------------|-----------------------------|--------------------------|-------------------------------------|-------------------------------------|-------------------------------------|--|---------------------------------------|--|--|---|---------------------------|--------------------------|--|--------------------------------|-------|----|
| P _{rated} 60 Hz/ P50 | P _{rated} 60 Hz/ P60 | Frame size | n _{rated} 60 Hz | T _{rated} 60 Hz | EISA CC No. CC032A | η _{rated} 60 Hz, 4/4 | η _{rated} 60 Hz, 3/4 | η _{rated} 60 Hz, 2/4 | cosφ _{rated} 60 Hz, 4/4 | I _{rated} 60 Hz, 460 V | T _{LR} / T _{rated} 60 Hz | I _{LR} / I _{rated} 60 Hz | T _B / T _{rated} 60 Hz | L _{pFA} 60 Hz | L _{WA} 60 Hz | 1LE1623 – Performance Line Article No. | | | kg |
| kW | hp | FS | rpm | Nm | | % | % | % | | A | | | | | | | | | |
| • Cooling: Self-ventilated (IC411) or with order code F90 forced-air cooled without external fan and fan cover (IC418) • Efficiency: NEMA Premium Efficient, UL, CSA, and service factor (SF) 1.15 – for operation in the USA, Canada, and Mexico • Insulation: Thermal class 155 (temperature class F), IP55 degree of protection, utilization in accordance with thermal class 130 (temperature class B) | | | | | | | | | | | | | | | | | | | |
| 4-pole: 1500 rpm at 50 Hz, 1800 rpm at 60 Hz | | | | | | | | | | | | | | | | | | | |
| 2.2 | 3 | 100 L | 1770 | 11.9 | ✓ | 89.5 | 89.2 | 87.2 | 0.81 | 3.8 | 3.5 | 9.6 | 5.1 | 62 | 74 | 1LE1623-1AB4 | 40 | 0.014 | |
| 3 | 4 | 100 L | 1760 | 16.3 | ✓ | 89.5 | 89.5 | 88.3 | 0.82 | 5.1 | 3.1 | 9.5 | 4.6 | 62 | 74 | 1LE1623-1AB5 | 40 | 0.014 | |
| 3.7 | 5 | 112 M | 1770 | 19 | ✓ | 89.5 | 89.4 | 87.7 | 0.8 | 6.5 | 2.9 | 8.2 | 4.3 | 62 | 74 | 1LE1623-1BB2 | 46 | 0.017 | |
| 5.5 | 7.5 | 132 S | 1775 | 30 | ✓ | 91.7 | 91.6 | 90.5 | 0.81 | 9.3 | 3.9 | 9.7 | 4.5 | 68 | 80 | 1LE1623-1CB0 | 74 | 0.046 | |
| 7.5 | 10 | 132 M | 1770 | 40 | ✓ | 91.7 | 91.8 | 91 | 0.83 | 12.4 | 2.7 | 9.6 | 4.2 | 68 | 80 | 1LE1623-1CB2 | 80 | 0.046 | |
| 11 | 15 | 160 M | 1775 | 59 | ✓ | 92.4 | 92.3 | 91.1 | 0.83 | 18 | 3 | 8.9 | 3.8 | 69 | 81 | 1LE1623-1DB2 | 109 | 0.083 | |
| 15 | 20 | 160 L | 1780 | 80 | ✓ | 93 | 92.8 | 91.4 | 0.81 | 25 | 2.9 | 9.5 | 4.3 | 69 | 81 | 1LE1623-1DB4 | 127 | 0.099 | |
| 18.5 | 25 | 180 M | 1775 | 100 | ✓ | 93.6 | 93.7 | 93.1 | 0.81 | 30.5 | 2.7 | 7.8 | 3.6 | 68 | 75 | 1LE1623-1EB2 | 165 | 0.13 | |
| 22 | 30 | 180 L | 1775 | 118 | ✓ | 93.6 | 93.8 | 93.3 | 0.81 | 36.5 | 2.8 | 7.7 | 3.7 | 70 | 77 | 1LE1623-1EB4 | 170 | 0.14 | |
| 30 | 40 | 200 L | 1778 | 161 | ✓ | 94.1 | 94.3 | 93.8 | 0.83 | 48 | 3 | 8.1 | 3.5 | 70 | 77 | 1LE1623-2AB5 | 240 | 0.22 | |
| 37 | 50 | 225 S | 1782 | 198 | ✓ | 94.5 | 94.7 | 94.2 | 0.85 | 58 | 2.8 | 7.5 | 3 | 66 | 80 | 1LE1623-2BB0 | 285 | 0.42 | |
| 45 | 60 | 225 M | 1782 | 241 | ✓ | 95 | 95.3 | 95.1 | 0.85 | 70 | 3 | 7.7 | 3 | 66 | 80 | 1LE1623-2BB2 | 340 | 0.52 | |
| 55 | 75 | 250 M | 1786 | 294 | ✓ | 95.4 | 95.6 | 95.1 | 0.86 | 84 | 2.8 | 7.6 | 3.2 | 67 | 81 | 1LE1623-2CB2 | 420 | 0.85 | |
| 75 | 100 | 280 S | 1788 | 401 | ✓ | 95.4 | 95.3 | 94.5 | 0.85 | 116 | 2.8 | 7.7 | 3.3 | 77 | 91 | 1LE1623-2DB0 | 570 | 1.4 | |
| 90 | 125 | 280 M | 1788 | 481 | ✓ | 95.4 | 95.5 | 94.9 | 0.87 | 136 | 2.9 | 8 | 3.3 | 79 | 93 | 1LE1623-2DB2 | 670 | 1.7 | |
| 110 | 150 | 315 S | 1790 | 587 | ✓ | 95.8 | 95.9 | 95.4 | 0.86 | 168 | 3 | 7.5 | 3.1 | 73 | 87 | 1LE1623-3AB0 | 760 | 2.2 | |
| 132 | 175 | 315 M | 1790 | 704 | ✓ | 96.2 | 96.3 | 95.8 | 0.87 | 198 | 3.1 | 8.2 | 3.2 | 76 | 90 | 1LE1623-3AB2 | 960 | 2.9 | |
| 150 | 200 | 315 L | 1791 | 800 | ✓ | 96.2 | 96.2 | 95.7 | 0.87 | 225 | 3.5 | 8.8 | 3.6 | 76 | 90 | 1LE1623-3AB4 | 990 | 3.1 | |
| 185 | 250 | 315 L | 1791 | 986 | ✓ | 96.2 | 96.2 | 95.5 | 0.87 | 275 | 3.9 | 9 | 3.6 | 78 | 93 | 1LE1623-3AB5 | 1190 | 3.7 | |
| Voltages (≤ 600 V)¹⁾ | | | | | | | | | | | | | | | Version | | Order code | | |
| 50 Hz 230 VΔ/400 VY | | | 60 Hz 460 VY | | | Standard | | 2 2 | | - | | | | | | | | | |
| 50 Hz 400 VΔ | | | 60 Hz 460 VΔ | | | Standard | | 3 4 | | - | | | | | | | | | |
| 50 Hz 500 VY | | | | | | Without additional charge | | 2 7 | | - | | | | | | | | | |
| 50 Hz 500 VΔ | | | | | | Without additional charge | | 4 0 | | - | | | | | | | | | |
| For other voltages and more information, see from page 2/96 | | | | | | | | | | | | | | | 9 0 | | ... | | |
| Types of construction | | | | | | | | | | | | | | | Version | | Order code | | |
| Without flange | | | IM B3 ²⁾ | | | Standard | | A | | - | | | | | | | | | |
| With flange | | | IM B5 ²⁾ | | | With additional charge | | F | | - | | | | | | | | | |
| With flange | | | IM B14 ²⁾ | | | With additional charge | | K | | - | | | | | | | | | |
| For other types of construction and more information, see from page 2/103 | | | | | | | | | | | | | | | | | | | |
| Motor protection | | | | | | | | | | | | | | | Version | | Order code | | |
| PTC thermistor with 3 temperature sensors | | | | | | Standard | | B | | - | | | | | | | | | |
| For other motor protection and more information, see from page 2/113 | | | | | | | | | | | | | | | | | | | |
| Terminal box position | | | | | | | | | | | | | | | Version | | Order code | | |
| Terminal box at top | | | | | | Standard | | 4 | | - | | | | | | | | | |
| For other terminal box positions and more information, see from page 2/116 | | | | | | | | | | | | | | | | | | | |
| Special versions | | | | | | | | | | | | | | | | | Order code(s) | | |
| Forced-air cooled motors w/o ext. fan/fan cover (IC418) | | | | | | | | | | | | | | | 1LE1623- | | -Z F90+ + | | |
| For options, see from page 2/125 | | | | | | | | | | | | | | | 1LE1623- | | -Z + + | | |

- Not required
- ✓ Available

¹⁾ Operating voltages only ≤ 600 V admissible in accordance with MG1 Table 12-12. Parallel supply lines are required in the case of connection to ≤ 240 V. For frame size 315 with connection to ≤ 240 V, due to the high current, a drilled, removable entry plate (order code R52) or a larger terminal box (order code R50) can be used. Order codes R52 and R50 alter the motor dimensions.

²⁾ Types derived from IM B3 (IM B6/7/8, IM V6 and IM V5), from IM B5 (IM V3 and IM V1) and from IM B14 (IM V19 and IM V18) are possible, provided that no requirement exists for stamping of the type on the rating plate. The basic type IM B3, IM B5, or IM B14 is stamped as standard on the rating plate. If mounted in a different position, the position must be specified to ensure that the condensation drainage holes are positioned correctly.



SIMOTICS GP and SIMOTICS SD standard motors
Eagle Line · NEMA Premium Efficient MG1 Table 12-12



Cast-iron series SIMOTICS SD 1LE1623 Performance Line – self-ventilated or forced-air cooled

Selection and ordering data

| Operating values at rated power | | | | | | | | | | | | | | | Cast-iron series | | | | | | | | | | | |
|--|------------------------------|---------------|----------------------|----------------------|--------------------------|---------------------------------|---------------------------------|---------------------------------|-------------------------------------|--------------------------------|-----------------------------------|-----------------------------------|--------------------------------|--------------------|-------------------|--|------------------|------------------|-----|--|-----------------------|--|--|--|--|--|
| P_{rated} 60 Hz/ P50 | P_{rated} 60 Hz/ P60 | Frame size | n_{rated} 60 Hz | T_{rated} 60 Hz | EISA CC No. CC032A | η_{rated} 60 Hz, 4/4 | η_{rated} 60 Hz, 3/4 | η_{rated} 60 Hz, 2/4 | $\cos\phi_{rated}$ 60 Hz, 4/4 | I_{rated} 60 Hz, 460 V | $T_{LR}/$ T_{rated} 60 Hz | $I_{LR}/$ I_{rated} 60 Hz | $T_B/$ T_{rated} 60 Hz | L_{pFA} 60 Hz | L_{WA} 60 Hz | 1LE1623 – Performance Line Article No. | $m_{IM B3}$ | J | | | | | | | | |
| kW | hp | FS | rpm | Nm | | % | % | % | | A | | | | | | | kg | kgm ² | | | | | | | | |
| 6-pole: 1000 rpm at 50 Hz, 1200 rpm at 60 Hz | | | | | | | | | | | | | | | | | | | | | | | | | | |
| 3 | 4 | 132 S | 1180 | 24 | ✓ | 89.5 | 89.5 | 87.9 | 0.70 | 6 | 2.6 | 7.6 | 3.8 | 61 | 69 | 1LE1623-1CC0 | 60 | 0.034 | | | | | | | | |
| 3.7 | 5 | 132 M | 1180 | 30 | ✓ | 89.5 | 89.9 | 88.2 | 0.69 | 7.1 | 2.8 | 7.5 | 3.8 | 62 | 70 | 1LE1623-1CC2 | 64 | 0.039 | | | | | | | | |
| 5.5 | 7.5 | 132 M | 1180 | 45 | ✓ | 91.0 | 90.8 | 89.2 | 0.69 | 11 | 3 | 7.8 | 4 | 67 | 75 | 1LE1623-1CC3 | 76 | 0.05 | | | | | | | | |
| 7.5 | 10 | 160 M | 1185 | 60 | ✓ | 91.0 | 90.8 | 89.3 | 0.80 | 12.9 | 2.7 | 9.3 | 3.7 | 73 | 81 | 1LE1623-1DC2 | 124 | 0.132 | | | | | | | | |
| 11 | 15 | 160 L | 1185 | 89 | ✓ | 91.7 | 91.7 | 90.5 | 0.78 | 19.3 | 3.4 | 8 | 3.2 | 72 | 80 | 1LE1623-1DC4 | 138 | 0.164 | | | | | | | | |
| 15 | 20 | 180 L | 1178 | 122 | ✓ | 91.7 | 92 | 91.4 | 0.79 | 26 | 2.5 | 6.8 | 3 | 61 | 68 | 1LE1623-1EC4 | 180 | 0.19 | | | | | | | | |
| 18.5 | 25 | 200 L | 1180 | 150 | ✓ | 93 | 93.8 | 93.8 | 0.78 | 32 | 2.8 | 6.5 | 3 | 64 | 71 | 1LE1623-2AC4 | 215 | 0.28 | | | | | | | | |
| 22 | 30 | 200 L | 1180 | 178 | ✓ | 93 | 93.5 | 93.4 | 0.79 | 37.5 | 2.6 | 6.3 | 2.8 | 63 | 70 | 1LE1623-2AC5 | 230 | 0.32 | | | | | | | | |
| 30 | 40 | 225 M | 1185 | 242 | ✓ | 94.1 | 94.4 | 94.1 | 0.82 | 49 | 2.9 | 7.6 | 3.3 | 66 | 79 | 1LE1623-2BC2 | 325 | 0.67 | | | | | | | | |
| 37 | 50 | 250 M | 1188 | 297 | ✓ | 94.1 | 94.4 | 93.9 | 0.83 | 59 | 3.1 | 8 | 3.1 | 63 | 76 | 1LE1623-2CC2 | 405 | 1 | | | | | | | | |
| 45 | 60 | 280 S | 1190 | 361 | ✓ | 94.5 | 94.6 | 94.1 | 0.83 | 72 | 3.3 | 7.7 | 3.1 | 66 | 80 | 1LE1623-2DC0 | 510 | 1.4 | | | | | | | | |
| 55 | 75 | 280 M | 1190 | 441 | ✓ | 94.5 | 94.6 | 93.9 | 0.84 | 87 | 3.6 | 9.2 | 3.3 | 66 | 80 | 1LE1623-2DC2 | 560 | 1.64 | | | | | | | | |
| 75 | 100 | 315 S | 1192 | 601 | ✓ | 95 | 94.9 | 94.1 | 0.82 | 121 | 3.1 | 8.4 | 3.3 | 64 | 79 | 1LE1623-3AC0 | 750 | 2.6 | | | | | | | | |
| 90 | 125 | 315 M | 1192 | 721 | ✓ | 95 | 95 | 94.4 | 0.84 | 142 | 2.7 | 7.7 | 3 | 64 | 79 | 1LE1623-3AC2 | 890 | 3.1 | | | | | | | | |
| 110 | 150 | 315 L | 1192 | 881 | ✓ | 95.8 | 95.9 | 95.5 | 0.83 | 174 | 3.2 | 8.2 | 3.4 | 64 | 79 | 1LE1623-3AC4 | 990 | 3.9 | | | | | | | | |
| 132 | 175 | 315 L | 1193 | 1057 | ✓ | 95.8 | 95.9 | 95.4 | 0.81 | 215 | 3.7 | 9.6 | 3.7 | 65 | 80 | 1LE1623-3AC5 | 1130 | 4.48 | | | | | | | | |
| 150 | 200 | 315 L | 1194 | 1200 | ✓ | 95.8 | 95.7 | 95.0 | 0.80 | 245 | 4.3 | 11 | 4.3 | 69 | 83 | 1LE1623-3AC6 | 1260 | 5.41 | | | | | | | | |
| Voltages (≤ 600 V) ¹⁾ | | | | | | | | | | | | | | | Version | | Order code | | | | | | | | | |
| 50 Hz 230 VΔ/400 VY | | | 60 Hz 460 VY | | | Standard | | | 2 | | 2 | | - | | | | | | | | | | | | | |
| 50 Hz 400 VΔ | | | 60 Hz 460 VΔ | | | Standard | | | 3 | | 4 | | - | | | | | | | | | | | | | |
| 50 Hz 500 VY | | | | | | Without additional charge | | | 2 | | 7 | | - | | | | | | | | | | | | | |
| 50 Hz 500 VΔ | | | | | | Without additional charge | | | 4 | | 0 | | - | | | | | | | | | | | | | |
| For other voltages and more information, see from page 2/96 | | | | | | | | | | | | | | | 9 | | 0 | | ... | | | | | | | |
| Types of construction | | | | | | | | | | | | | | | Version | | Order code | | | | | | | | | |
| Without flange | | | IM B3 ²⁾ | | | Standard | | | A | | | | - | | | | | | | | | | | | | |
| With flange | | | IM B5 ²⁾ | | | With additional charge | | | F | | | | - | | | | | | | | | | | | | |
| With flange | | | IM B14 ²⁾ | | | With additional charge | | | K | | | | - | | | | | | | | | | | | | |
| For other types of construction and more information, see from page 2/103 | | | | | | | | | | | | | | | | | ... | | | | | | | | | |
| Motor protection | | | | | | | | | | | | | | | Version | | Order code | | | | | | | | | |
| PTC thermistor with 3 temperature sensors | | | | | | Standard | | | B | | | | - | | | | | | | | | | | | | |
| For other motor protection and more information, see from page 2/113 | | | | | | | | | | | | | | | | | ... | | | | | | | | | |
| Terminal box position | | | | | | | | | | | | | | | Version | | Order code | | | | | | | | | |
| Terminal box at top | | | | | | Standard | | | 4 | | | | | | | | | | | | | | | | | |
| For other terminal box positions and more information, see from page 2/116 | | | | | | | | | | | | | | | | | | | | | | | | | | |
| Special versions | | | | | | | | | | | | | | | | | Order code(s) | | | | | | | | | |
| Forced-air cooled motors w/o ext. fan/fan cover (IC418) | | | | | | | | | 1LE1623- | | -Z | | F90+ . . . + . . . | | | | | | | | | | | | | |
| For options, see from page 2/125 | | | | | | | | | | | | | | | | | 1LE1623- | | -Z | | . . . + . . . + . . . | | | | | |

- Not required
- ✓ Available

¹⁾ Operating voltages only ≤ 600 V admissible in accordance with MG1 Table 12-12. Parallel supply lines are required in the case of connection to ≤ 240 V. For frame size 315 with connection to ≤ 240 V, due to the high current, a drilled, removable entry plate (order code **R52**) or a larger terminal box (order code **R50**) can be used. Order codes **R52** and **R50** alter the motor dimensions.

²⁾ Types derived from IM B3 (IM B6/7/8, IM V6 and IM V5), from IM B5 (IM V3 and IM V1) and from IM B14 (IM V19 and IM V18) are possible, provided that no requirement exists for stamping of the type on the rating plate. The basic type IM B3, IM B5, or IM B14 is stamped as standard on the rating plate. If mounted in a different position, the position must be specified to ensure that the condensation drainage holes are positioned correctly.



SIMOTICS GP and SIMOTICS SD standard motors
Eagle Line · NEMA Premium Efficient MG1 Table 12-12

Cast-iron series SIMOTICS SD 1LE1623 Performance Line – self-ventilated or forced-air cooled

Selection and ordering data

| Operating values at rated power | | | | | | | | | | | | | | Cast-iron series | | m _{IM B3} | J | | | | |
|--|-------------------------------------|---------------|-----------------------------|-----------------------------|--------------------------|------------------------------------|------------------------------------|------------------------------------|---------------------------------------|--------------------------------------|--|--|---|---------------------------|--------------------------|--------------------------------|------|--|----|------------------|--|
| P _{rated} 60 Hz/ P50 | P _{rated} 60 Hz/ P60 | Frame size | n _{rated} 60 Hz | T _{rated} 60 Hz | EISA CC No. CC032A | η _{rated} 60 Hz 4/4 | η _{rated} 60 Hz 3/4 | η _{rated} 60 Hz 2/4 | cosφ _{rated} 60 Hz 4/4 | I _{rated} 60 Hz 460 V | T _{LR} / T _{rated} 60 Hz | I _{LR} / I _{rated} 60 Hz | T _B / T _{rated} 60 Hz | L _{pFA} 60 Hz | L _{WA} 60 Hz | | | 1LE1623 – Performance Line Article No. | kg | kgm ² | |
| • Cooling: Self-ventilated (IC411) or with order code F90 forced-air cooled without external fan and fan cover (IC418) • Efficiency: NEMA Premium Efficient, UL, CSA, and service factor (SF) 1.15 – for operation in the USA, Canada, and Mexico • Insulation: Thermal class 155 (temperature class F), IP55 degree of protection, utilization in accordance with thermal class 130 (temperature class B) | | | | | | | | | | | | | | | | | | | | | |
| 8-pole: 750 rpm at 50 Hz, 900 rpm at 60 Hz | | | | | | | | | | | | | | | | | | | | | |
| 2.2 | 3 | 132 S | 880 | 24 | ✓ | 85.5 | 85.6 | 83.6 | 0.6 | 5.4 | 1.5 | 4 | 2.1 | 67 | 80 | 1LE1623-1CD0 | 66 | 0.038 | | | |
| 3 | 4 | 132 M | 880 | 33 | ✓ | 86.5 | 86.7 | 84.9 | 0.6 | 7.3 | 1.7 | 4.3 | 2.3 | 67 | 80 | 1LE1623-1CD2 | 78 | 0.048 | | | |
| 3.7 | 5 | 160 M | 885 | 40 | ✓ | 86.5 | 86.2 | 84 | 0.62 | 8.7 | 2 | 4.4 | 2.2 | 66 | 79 | 1LE1623-1DD2 | 98 | 0.065 | | | |
| 5.5 | 7.5 | 160 M | 884 | 59 | ✓ | 86.5 | 86.5 | 85 | 0.64 | 12.5 | 1.9 | 4.4 | 2.2 | 66 | 79 | 1LE1623-1DD3 | 110 | 0.083 | | | |
| 7.5 | 10 | 160 L | 882 | 81 | ✓ | 89.5 | 89.8 | 88.9 | 0.64 | 16.4 | 2 | 4.3 | 2.2 | 66 | 79 | 1LE1623-1DD4 | 135 | 0.116 | | | |
| 11 | 15 | 180 L | 880 | 119 | ✓ | 89.5 | 89.9 | 89.3 | 0.72 | 21.5 | 2.3 | 5.8 | 2.7 | 65 | 78 | 1LE1623-1ED4 | 190 | 0.267 | | | |
| 15 | 20 | 200 L | 882 | 162 | ✓ | 90.2 | 90.2 | 89.2 | 0.7 | 30 | 3.4 | 7.7 | 4.2 | 60 | 73 | 1LE1623-2AD5 | 255 | 0.420 | | | |
| 18.5 | 25 | 225 S | 886 | 199 | ✓ | 90.2 | 90.2 | 89 | 0.73 | 35.5 | 2.9 | 6.6 | 3.4 | 58 | 72 | 1LE1623-2BD0 | 270 | 0.50 | | | |
| 22 | 30 | 225 M | 886 | 237 | ✓ | 91.7 | 91.8 | 90.8 | 0.76 | 39.5 | 2.9 | 6.8 | 3.3 | 60 | 74 | 1LE1623-2BD2 | 280 | 0.55 | | | |
| 30 | 40 | 250 M | 888 | 323 | ✓ | 91.7 | 91.9 | 91.1 | 0.77 | 53 | 2.9 | 7 | 3.3 | 63 | 77 | 1LE1623-2CD2 | 370 | 0.86 | | | |
| 37 | 50 | 280 S | 890 | 397 | ✓ | 92.4 | 92.6 | 91.9 | 0.77 | 65 | 2.5 | 6.1 | 2.6 | 64 | 78 | 1LE1623-2DD0 | 460 | 1.1 | | | |
| 45 | 60 | 280 M | 890 | 483 | ✓ | 92.4 | 92.5 | 91.9 | 0.79 | 77 | 2.7 | 6.8 | 2.7 | 65 | 79 | 1LE1623-2DD2 | 550 | 1.6 | | | |
| 55 | 75 | 315 S | 891 | 589 | ✓ | 93.6 | 93.6 | 92.9 | 0.79 | 93 | 2.6 | 6.8 | 3 | 68 | 82 | 1LE1623-3AD0 | 650 | 2.0 | | | |
| 75 | 100 | 315 M | 890 | 805 | ✓ | 93.6 | 93.7 | 93 | 0.8 | 126 | 2.5 | 6.7 | 3 | 73 | 87 | 1LE1623-3AD2 | 720 | 2.5 | | | |
| 90 | 125 | 315 L | 890 | 966 | ✓ | 94.1 | 94.4 | 94.1 | 0.81 | 148 | 2.4 | 6.5 | 2.8 | 74 | 88 | 1LE1623-3AD4 | 860 | 3.1 | | | |
| 110 | 150 | 315 L | 891 | 1179 | ✓ | 94.1 | 94.2 | 93.7 | 0.81 | 181 | 2.8 | 7.2 | 3.2 | 74 | 88 | 1LE1623-3AD5 | 980 | 3.9 | | | |
| 132 | 175 | 315 L | 892 | 1413 | ✓ | 94.5 | 94.5 | 93.9 | 0.8 | 220 | 3.2 | 7.9 | 3.7 | 78 | 92 | 1LE1623-3AD6 | 1070 | 4.5 | | | |
| Voltages (≤ 600 V)¹⁾ | | | | | | | | | | | | | | Version | | Order code | | | | | |
| 50 Hz 230 VΔ/400 VY | | | 60 Hz 460 VY | | | Standard | | 2 | | 2 | | - | | | | | | | | | |
| 50 Hz 400 VΔ | | | 60 Hz 460 VΔ | | | Standard | | 3 | | 4 | | - | | | | | | | | | |
| 50 Hz 500 VY | | | | | | Without additional charge | | 2 | | 7 | | - | | | | | | | | | |
| 50 Hz 500 VΔ | | | | | | Without additional charge | | 4 | | 0 | | - | | | | | | | | | |
| For other voltages and more information, see from page 2/96 | | | | | | | | | | | | | | 9 | | 0 | | ... | | | |
| Types of construction | | | | | | | | | | | | | | Version | | Order code | | | | | |
| Without flange | | | IM B3 ²⁾ | | | Standard | | A | | | | - | | | | | | | | | |
| With flange | | | IM B5 ²⁾ | | | With additional charge | | F | | | | - | | | | | | | | | |
| With flange | | | IM B14 ²⁾ | | | With additional charge | | K | | | | - | | | | | | | | | |
| For other types of construction and more information, see from page 2/103 | | | | | | | | | | | | | | | | ... | | | | | |
| Motor protection | | | | | | | | | | | | | | Version | | Order code | | | | | |
| PTC thermistor with 3 temperature sensors | | | | | | Standard | | B | | | | - | | | | | | | | | |
| For other motor protection and more information, see from page 2/113 | | | | | | | | | | | | | | | | ... | | | | | |
| Terminal box position | | | | | | | | | | | | | | Version | | Order code | | | | | |
| Terminal box at top | | | | | | Standard | | 4 | | | | | | | | | | | | | |
| For other terminal box positions and more information, see from page 2/116 | | | | | | | | | | | | | | | | | | | | | |
| Special versions | | | | | | | | | | | | | | | | Order code(s) | | | | | |
| Forced-air cooled motors w/o ext. fan/fan cover (IC418) | | | | | | | | | | | | | | 1LE1623- | | -Z F90+ + | | | | | |
| For options, see from page 2/125 | | | | | | | | | | | | | | 1LE1623- | | -Z + + | | | | | |

- Not required
- ✓ Available

¹⁾ Operating voltages only ≤ 600 V admissible in accordance with MG1 Table 12-12. Parallel supply lines are required in the case of connection to ≤ 240 V. For frame size 315 with connection to ≤ 240 V, due to the high current, a drilled, removable entry plate (order code R52) or a larger terminal box (order code R50) can be used. Order codes R52 and R50 alter the motor dimensions.

²⁾ Types derived from IM B3 (IM B6/7/8, IM V6 and IM V5), from IM B5 (IM V3 and IM V1) and from IM B14 (IM V19 and IM V18) are possible, provided that no requirement exists for stamping of the type on the rating plate. The basic type IM B3, IM B5, or IM B14 is stamped as standard on the rating plate. If mounted in a different position, the position must be specified to ensure that the condensation drainage holes are positioned correctly.



SIMOTICS GP and SIMOTICS SD standard motors
Eagle Line · NEMA Energy Efficient MG1 Table 12-11



Aluminum series SIMOTICS GP 1LE1021 – self-ventilated or forced-air cooled

Selection and ordering data

| Operating values at rated power | | | | | | | | | | | | | | | | Aluminum series | | |
|--|--------------------------------|---------------|------------------------|------------------------|--------------------------|----------------------------------|----------------------------------|----------------------------------|--------------------------------------|---------------------------------|-------------------------------------|-------------------------------------|----------------------------------|----------------------|---------------------|---------------------|-------------|-----------------------|
| P_{rated} , 60 Hz/ P50 | P_{rated} , 60 Hz/ P60 | Frame size | n_{rated} , 60 Hz | T_{rated} , 60 Hz | EISA CC No. CC032A | η_{rated} , 60 Hz 4/4 | η_{rated} , 60 Hz 3/4 | η_{rated} , 60 Hz 2/4 | $\cos\phi_{rated}$, 60 Hz 4/4 | I_{rated} , 60 Hz 460 V | $T_{LR}/$ T_{rated} , 60 Hz | $I_{LR}/$ I_{rated} , 60 Hz | $T_B/$ T_{rated} , 60 Hz | L_{pFA} , 60 Hz | L_{WA} , 60 Hz | 1LE1021 | $m_{IM B3}$ | J |
| kW | hp | FS | rpm | Nm | % | % | % | % | A | | | | | | | Article No. | | |
| • Cooling: Self-ventilated (IC411) or with order code F90 forced-air cooled without external fan and fan cover (IC418) • Efficiency: NEMA Energy Efficient, UL, CSA, and service factor (SF) 1.15 – for operation in the USA and Canada, not admissible for exporting to Mexico • Insulation: Thermal class 155 (temperature class F), IP55 degree of protection, utilization in accordance with thermal class 130 (temperature class B) | | | | | | | | | | | | | | | | | | |
| 4-pole: 1500 rpm at 50 Hz, 1800 rpm at 60 Hz | | | | | | | | | | | | | | | | | | |
| 0.55 | 0.75 | 80 M | 1750 | 3 | - | 75.5 | 74.6 | 71.1 | 0.71 | 1.29 | 2.7 | 6.4 | 3.8 | 55 | 66 | 1LE1021-0DB2 | 10 | 0.0017 |
| 6-pole: 1000 rpm at 50 Hz, 1200 rpm at 60 Hz | | | | | | | | | | | | | | | | | | |
| 0.37 | 0.5 | 80 M | 1140 | 3.1 | - | 64 | 63 | 59.1 | 0.63 | 1.15 | 2.3 | 4.6 | 2.9 | 45 | 56 | 1LE1021-0DC2 | 9 | 0.0017 |
| 0.55 | 0.75 | 80 M | 1135 | 4.6 | - | 68 | 67.4 | 63.7 | 0.61 | 1.66 | 2.9 | 5.2 | 3.6 | 45 | 56 | 1LE1021-0DC3 | 12 | 0.0025 |
| Voltages (≤ 600 V) ¹⁾ | | | | | | | | | | | | | | | | Version | | Order code |
| 50 Hz 230 VΔ/400 VY | | | | 60 Hz 460 VY | | | | Standard | | 2 2 | | | | | | - | | |
| 50 Hz 400 VΔ | | | | 60 Hz 460 VΔ | | | | Standard | | 3 4 | | | | | | - | | |
| 50 Hz 500 VY | | | | | | | | Without additional charge | | 2 7 | | | | | | - | | |
| 50 Hz 500 VΔ | | | | | | | | Without additional charge | | 4 0 | | | | | | - | | |
| For other voltages and more information, see from page 2/93 | | | | | | | | | | | | | | | | 9 0 | | ... |
| Types of construction ²⁾ | | | | | | | | | | | | | | | | Version | | Order code |
| With flange | | | | IM B5 ³⁾ | | | | With additional charge | | F | | | | | | - | | |
| With flange | | | | IM B14 ³⁾ | | | | With additional charge | | K | | | | | | - | | |
| For other types of construction and more information, see from page 2/99 | | | | | | | | | | | | | | | | | | ... |
| Motor protection | | | | | | | | | | | | | | | | Version | | Order code |
| Without | | | | | | | | Standard | | A | | | | | | - | | |
| PTC thermistor with 1 temperature sensor | | | | | | | | With additional charge | | B | | | | | | - | | |
| For other motor protection and more information, see from page 2/112 | | | | | | | | | | | | | | | | | | ... |
| Terminal box position | | | | | | | | | | | | | | | | Version | | Order code |
| Terminal box at top | | | | | | | | Standard | | 4 | | | | | | | | |
| For other terminal box positions and more information, see from page 2/115 | | | | | | | | | | | | | | | | | | |
| Special versions | | | | | | | | | | | | | | | | | | Order code(s) |
| Forced-air cooled motors w/o ext. fan/fan cover (IC418) | | | | | | | | | | | | | | | | 1LE1021- -Z | | F90 + . . . + . . . |
| For options, see from page 2/118 | | | | | | | | | | | | | | | | 1LE1021- -Z | | . . . + . . . + . . . |

- Not required
- ✓ Available

¹⁾ Operating voltages only ≤ 600 V admissible in accordance with MG1 Table 12-11.

²⁾ Types of construction with feet are not possible for 2-pole, 4-pole and 6-pole motors ≤ 200 hp in accordance with MG1 Table 12-11.

³⁾ Types derived from IM B5 (IM V3 and IM V1) and from IM B14 (IM V19 and IM V18) are possible, provided that no requirements exist for condensation drainage holes (H03) and stamping of the type on the rating plate. The basic type IM B5 or IM B14 is stamped as standard on the rating plate. For orders with condensation drainage holes (H03), the type must be specified.



SIMOTICS GP and SIMOTICS SD standard motors
Eagle Line · NEMA Energy Efficient MG1 Table 12-11

Cast-iron series SIMOTICS SD 1LE1521 Basic Line – self-ventilated or forced-air cooled

Selection and ordering data

| Operating values at rated power | | | | | | | | | | | | | | Cast-iron series | | | | |
|--|------------------------------|---------------|----------------------|----------------------|--------------------------|-------------------------|-------------------------|---------------------------|-----------------------------|----------------------|-----------------------------|-----------------------------|--------------------------|-------------------------------|-------------------|--------------|------------------|---------|
| P_{rated} 60 Hz/ P50 | P_{rated} 60 Hz/ P60 | Frame size | n_{rated} 60 Hz | T_{rated} 60 Hz | EISA CC No. CC032A | η_{rated} 60 Hz | η_{rated} 60 Hz | η_{rated} 60 Hz | $\cos\phi_{rated}$ 60 Hz | I_{rated} 60 Hz | T_{LR}/I_{rated} 60 Hz | I_{LR}/I_{rated} 60 Hz | T_B/I_{rated} 60 Hz | L_{pfA} 60 Hz | L_{WA} 60 Hz | Article No. | $m_{IM B3}$ | J |
| kW | hp | FS | rpm | Nm | % | % | % | % | A | A | | | | | | kg | kgm ² | |
| 2-pole: 3000 rpm at 50 Hz, 3600 rpm at 60 Hz | | | | | | | | | | | | | | | | | | |
| 0.37 | 0.5 | 71 M | 3410 | 1.0 | - | 72 | 71.4 | 67.8 | 0.77 | 0.84 | 2.9 | 5.1 | 3 | 63 | 74 | 1LE1521-0CA2 | 12 | 0.00035 |
| 0.55 | 0.75 | 71 M | 3420 | 1.5 | - | 74 | 73.4 | 69.6 | 0.76 | 1.23 | 3.4 | 5.4 | 3.4 | 63 | 74 | 1LE1521-0CA3 | 13 | 0.00045 |
| 4-pole: 1500 rpm at 50 Hz, 1800 rpm at 60 Hz | | | | | | | | | | | | | | | | | | |
| 0.25 | 0.33 | 71 M | 1715 | 1.4 | - | 70 | 68.5 | 63.6 | 0.64 | 0.7 | 2.8 | 4.4 | 3.1 | 53 | 64 | 1LE1521-0CB2 | 12 | 0.00076 |
| 0.37 | 0.5 | 71 M | 1705 | 2.1 | - | 72 | 71.2 | 66.9 | 0.67 | 0.96 | 2.8 | 4.4 | 2.8 | 53 | 64 | 1LE1521-0CB3 | 13 | 0.00095 |
| 0.55 | 0.75 | 80 M | 1750 | 3.0 | - | 75.5 | 74.6 | 71.1 | 0.71 | 1.29 | 2.7 | 6.4 | 3.8 | 55 | 66 | 1LE1521-0DB2 | 17 | 0.0017 |
| 6-pole: 1000 rpm at 50 Hz, 1200 rpm at 60 Hz | | | | | | | | | | | | | | | | | | |
| 0.18 | 0.25 | 71 M | 1105 | 1.6 | - | 55 | 53.6 | 48.8 | 0.61 | 0.67 | 2.9 | 2.7 | 2.9 | 49 | 60 | 1LE1521-0CC2 | 12 | 0.00080 |
| 0.25 | 0.33 | 71 M | 1100 | 2.4 | - | 59.5 | 58.9 | 54.7 | 0.64 | 0.82 | 2.7 | 3 | 2.7 | 49 | 60 | 1LE1521-0CC3 | 13 | 0.00100 |
| 0.37 | 0.5 | 80 M | 1140 | 3.1 | - | 64 | 63 | 59.1 | 0.63 | 1.15 | 2.3 | 4.6 | 2.9 | 45 | 56 | 1LE1521-0DC2 | 17 | 0.0017 |
| 0.55 | 0.75 | 80 M | 1135 | 4.6 | - | 68 | 67.4 | 63.7 | 0.61 | 1.66 | 2.9 | 5.2 | 3.6 | 45 | 56 | 1LE1521-0DC3 | 19 | 0.0025 |
| 8-pole: 750 rpm at 50 Hz, 900 rpm at 60 Hz | | | | | | | | | | | | | | | | | | |
| 0.09 | 0.12 | 71 M | 815 | 1.1 | - | 40 | 38 | 33 | 0.59 | 0.5 | 2.1 | 1.8 | 2.1 | 59 | 63 | 1LE1521-0CD2 | 12 | 0.00077 |
| 0.12 | 0.16 | 71 M | 815 | 1.4 | - | 40 | 38 | 33 | 0.57 | 0.7 | 2.3 | 2.1 | 2.4 | 52 | 63 | 1LE1521-0CD3 | 13 | 0.00100 |
| 0.18 | 0.25 | 80 M | 855 | 2.1 | - | 46 | 43.5 | 37 | 0.53 | 0.93 | 2 | 2.5 | 2.6 | 55 | 66 | 1LE1521-0DD2 | 17 | 0.00175 |
| 0.25 | 0.33 | 80 M | 860 | 2.8 | - | 52 | 49 | 43 | 0.51 | 1.21 | 2.2 | 2.9 | 3 | 55 | 66 | 1LE1521-0DD3 | 19 | 0.00246 |
| 0.37 | 0.5 | 90 S | 845 | 4.2 | - | 58 | 55.8 | 49.5 | 0.64 | 1.25 | 1.6 | 3 | 2.1 | 57 | 69 | 1LE1521-0ED0 | 23 | 0.00225 |
| 0.55 | 0.75 | 90 L | 840 | 6.3 | - | 62 | 61.2 | 56.5 | 0.66 | 1.69 | 1.8 | 3.1 | 2.1 | 57 | 69 | 1LE1521-0ED4 | 26 | 0.00305 |
| Voltages ($\leq 600 V$)¹⁾ | | | | | | | | | | | | | | Version | | Order code | | |
| 50 Hz 230 VΔ/400 VY | | | | 60 Hz 460 VY | | | | Standard | | | | 2 | 2 | - | | | | |
| 50 Hz 400 VΔ | | | | 60 Hz 460 VΔ | | | | Standard | | | | 3 | 4 | - | | | | |
| 50 Hz 500 VY | | | | | | | | Without additional charge | | | | 2 | 7 | - | | | | |
| 50 Hz 500 VΔ | | | | | | | | Without additional charge | | | | 4 | 0 | - | | | | |
| For other voltages and more information, see from page 2/96 | | | | | | | | | | | | | | 9 | 0 | ... | | |
| Types of construction ²⁾ | | | | | | | | | | | | | | Version | | Order code | | |
| Without flange | | | | IM B3 ³⁾ | | | | Standard | | | | A | - | | | | | |
| With flange | | | | IM B5 ³⁾ | | | | With additional charge | | | | F | - | | | | | |
| For other types of construction and more information, see from page 2/103 | | | | | | | | | | | | | | | | ... | | |
| Motor protection | | | | | | | | | | | | | | Version | | Order code | | |
| Without | | | | | | | | Standard | | | | A | - | | | | | |
| PTC thermistor with 1 temperature sensor | | | | | | | | With additional charge | | | | B | - | | | | | |
| For other motor protection and more information, see from page 2/113 | | | | | | | | | | | | | | | | ... | | |
| Terminal box position | | | | | | | | | | | | | | Version | | Order code | | |
| Terminal box at top | | | | | | | | Standard | | | | 4 | - | | | | | |
| For other terminal box positions and more information, see from page 2/116 | | | | | | | | | | | | | | | | | | |
| Special versions | | | | | | | | | | | | | | Order code(s) | | | | |
| Forced-air cooled motors w/o ext. fan/fan cover (IC418) | | | | | | | | | | | | | | 1LE1521-...-Z F90+...+...+... | | | | |
| For options, see from page 2/125 | | | | | | | | | | | | | | 1LE1521-...-Z ...+...+...+... | | | | |

- Not required
- ✓ Available

1) Operating voltages only $\leq 600 V$ admissible in accordance with MG1 Table 12-11. Parallel supply lines are required in the case of connection to $\leq 240 V$. For frame size 315 with connection to $\leq 240 V$, due to the high current, a drilled, removable entry plate (order code **R52**) or a larger terminal box (order code **R50**) can be used. Order codes **R52** and **R50** alter the motor dimensions.

2) Types of construction with feet are not possible for 2-pole, 4-pole and 6-pole motors $\leq 200 hp$ in accordance with MG1 Table 12-11.

3) Types derived from IM B5 (IM V3 and IM V1) and from IM B14 (IM V19 and IM V18) are possible, provided that no requirement exists for stamping of the type on the rating plate. The basic type IM B5 or IM B14 is stamped as standard on the rating plate. If mounted in a different position, the position must be specified to ensure that the condensation drainage holes are positioned correctly.



SIMOTICS GP and SIMOTICS SD standard motors

Pole-changing

Aluminum series SIMOTICS GP 1LE1011 for constant load torque – self-ventilated

Selection and ordering data

| P _{rated1} , P _{rated2} 50 Hz 50 Hz | | Frame size | Operating values at rated power for N1 | | | | | | | | | | Operating values at rated power for N2 | | | | | | Aluminum series | | m _{IM B3} | J | | | |
|---|-------------|--------------|--|--------------------------------|--------------------------------|------------------------------------|--------------------------------|----------------------------|----------------------------|---------------------------|--------------------------------|--------------------------------|--|------------------------------------|--------------------------------|----------------------------|----------------------------|---------------------------|--------------------------|----|--------------------|---------------------------|---|---|-----------------|
| | | | n _{rated1} , 50 Hz | T _{rated1} , 50 Hz | η _{rated1} , 50 Hz | cos φ _{rated1} , 50 Hz | I _{rated1} , 400 V | T _{LR} / 50 Hz | I _{LR} / 50 Hz | T _B / 50 Hz | n _{rated2} , 50 Hz | T _{rated2} , 50 Hz | η _{rated2} , 50 Hz | cos φ _{rated2} , 50 Hz | I _{rated2} , 400 V | T _{LR} / 50 Hz | I _{LR} / 50 Hz | T _B / 50 Hz | 1LE1011 – one winding | | | | | | |
| Article No. | | | | | | | | | | | | | | | | | | | | | kg | kgm ² | | | |
| KW | KW | FS | rpm | Nm | % | A | | | | | rpm | Nm | % | A | | | | | | | | | | | |
| <ul style="list-style-type: none"> • Cooling: Self-ventilated (IC411) • Line operation: Double pole-changing for constant load torque • Insulation: Thermal class 155 (temperature class F), IP55 degree of protection, utilization in accordance with thermal class 130 (temperature class B) | | | | | | | | | | | | | | | | | | | | | | | | | |
| 4/2-pole: 1500/3000 rpm at 50 Hz with one winding connected in Dahlander circuit | | | | | | | | | | | | | | | | | | | | | | | | | |
| 1500 rpm | 3000 rpm | 1500 rpm | | | | | | | | | | | | | | | | | | | 3000 rpm | | | | |
| 1.9 | 2.4 | 100 L | 1390 | 13.1 | 72 | 0.87 | 4.40 | 1.7 | 4.1 | 1.8 | 2800 | 8.2 | 70 | 0.88 | 5.6 | 1.8 | 4.2 | 1.8 | 1LE1011-1AJ4 | 18 | 0.0059 | | | | |
| 2.5 | 3.1 | 100 L | 1440 | 16.6 | 76.3 | 0.87 | 5.4 | 1.9 | 5.2 | 2.8 | 2840 | 10.4 | 77.3 | 0.9 | 6.4 | 2.1 | 5.2 | 2.9 | 1LE1011-1AJ5 | 22 | 0.0078 | | | | |
| 3.7 | 4.4 | 112 M | 1420 | 24.9 | 79.9 | 0.86 | 7.8 | 1.8 | 4.9 | 2.3 | 2885 | 14.6 | 80.8 | 0.92 | 8.5 | 2.1 | 6.4 | 2.6 | 1LE1011-1BJ2 | 27 | 0.01 | | | | |
| 4.7 | 5.9 | 132 S | 1440 | 31.2 | 82 | 0.84 | 9.8 | 1.6 | 5.6 | 2.7 | 2875 | 19.6 | 80 | 0.89 | 12.0 | 1.8 | 5.6 | 2.8 | 1LE1011-1CJ0 | 38 | 0.019 | | | | |
| 6.5 | 8.0 | 132 M | 1435 | 43.3 | 82 | 0.86 | 13.3 | 1.7 | 5.4 | 2.6 | 2880 | 26.5 | 82 | 0.92 | 15.3 | 1.8 | 6.3 | 2.8 | 1LE1011-1CJ2 | 44 | 0.024 | | | | |
| 9.3 | 11.5 | 160 M | 1440 | 61.7 | 84.5 | 0.87 | 18.3 | 1.7 | 5.7 | 2.8 | 2870 | 38.3 | 82 | 0.92 | 22.0 | 1.8 | 6 | 2.9 | 1LE1011-1DJ2 | 62 | 0.044 | | | | |
| 13.0 | 16 | 160 L | 1450 | 85.6 | 87 | 0.85 | 25.5 | 1.6 | 6 | 2.3 | 2920 | 52.3 | 86 | 0.94 | 35.5 | 1.9 | 7.1 | 2.8 | 1LE1011-1DJ6 | 85 | 0.068 | | | | |
| 8/4-pole: 750/1500 rpm at 50 Hz with one winding connected in Dahlander circuit | | | | | | | | | | | | | | | | | | | | | | | | | |
| 750 rpm | 1500 rpm | 750 rpm | | | | | | | | | | | | | | | | | | | 1500 rpm | | | | |
| 0.55 | 1.1 | 100 L | 715 | 7.3 | 57 | 0.53 | 2.65 | 2 | 3 | 2.7 | 1425 | 7.4 | 77.7 | 0.87 | 2.35 | 1.7 | 4.6 | 2.1 | 1LE1011-1AL4 | 18 | 0.0059 | | | | |
| 0.9 | 1.5 | 100 L | 700 | 12.3 | 64.2 | 0.64 | 3.15 | 1.5 | 2.9 | 2 | 1415 | 10.1 | 77.7 | 0.89 | 3.15 | 1.5 | 4.5 | 1.9 | 1LE1011-1AL5 | 22 | 0.0078 | | | | |
| 1.1 | 1.9 | 112 M | 715 | 14.7 | 66.5 | 0.6 | 4.00 | 1.6 | 3.2 | 2.3 | 1440 | 12.6 | 80.9 | 0.87 | 3.90 | 1.6 | 5.4 | 2.3 | 1LE1011-1BL2 | 27 | 0.01 | | | | |
| 1.6 | 3.2 | 132 S | 730 | 20.9 | 61.5 | 0.53 | 7.1 | 1.6 | 3.3 | 2.6 | 1450 | 21.1 | 82.3 | 0.87 | 6.5 | 1.4 | 5 | 2.1 | 1LE1011-1CL0 | 38 | 0.019 | | | | |
| 2.2 | 4.4 | 132 M | 730 | 28.8 | 68 | 0.52 | 9.0 | 2 | 3.8 | 3 | 1450 | 29 | 84.5 | 0.88 | 8.5 | 1.5 | 5.5 | 2.3 | 1LE1011-1CL2 | 44 | 0.024 | | | | |
| 3.5 | 7 | 160 M | 730 | 45.8 | 77.5 | 0.57 | 11.4 | 2 | 4.2 | 2.8 | 1450 | 46.1 | 84 | 0.9 | 13.4 | 1.6 | 5.2 | 2.2 | 1LE1011-1DL2 | 62 | 0.044 | | | | |
| 5.6 | 11 | 160 L | 725 | 73.8 | 80.2 | 0.6 | 16.8 | 1.9 | 4 | 2.7 | 1445 | 72.7 | 84.4 | 0.9 | 21.0 | 1.5 | 5.1 | 2.2 | 1LE1011-1DL4 | 73 | 0.056 | | | | |
| Voltages | | | | | | | | | | | | | | | | | | | | | | Version | | | Order code |
| 50 Hz 230 V | | | | | | | | | | | | | | | | | | | | | | Standard | 2 | 2 | – |
| 50 Hz 400 V | | | | | | | | | | | | | | | | | | | | | | Standard | 3 | 4 | – |
| 50 Hz 500 V | | | | | | | | | | | | | | | | | | | | | | Without additional charge | 4 | 0 | – |
| 50 Hz 690 V | | | | | | | | | | | | | | | | | | | | | | Without additional charge | 4 | 7 | – |
| For other voltages ¹⁾ and more information, see from page 2/95 | | | | | | | | | | | | | | | | | | | | | | | 9 | 0 | ... |
| Types of construction | | | | | | | | | | | | | | | | | | | | | | Version | | | Order code |
| Without flange IM B3 ²⁾ | | | | | | | | | | | | | | | | | | | | | | Standard | | A | – |
| With flange IM B5 ²⁾ | | | | | | | | | | | | | | | | | | | | | | With additional charge | | F | – |
| With flange IM B14 ²⁾ | | | | | | | | | | | | | | | | | | | | | | With additional charge | | K | – |
| For other types of construction and more information, see from page 2/99 | | | | | | | | | | | | | | | | | | | | | | | | | ... |
| Motor protection | | | | | | | | | | | | | | | | | | | | | | Version | | | Order code |
| Without | | | | | | | | | | | | | | | | | | | | | | Standard | | A | – |
| PTC thermistor with 3 temperature sensors | | | | | | | | | | | | | | | | | | | | | | With additional charge | | B | – |
| For other motor protection and more information, see from page 2/112 | | | | | | | | | | | | | | | | | | | | | | | | | ... |
| Terminal box position | | | | | | | | | | | | | | | | | | | | | | Version | | | Order code |
| Terminal box at top | | | | | | | | | | | | | | | | | | | | | | Standard | | 4 | – |
| For other terminal box positions and more information, see from page 2/115 | | | | | | | | | | | | | | | | | | | | | | | | | |
| Special versions | | | | | | | | | | | | | | | | | | | | | | | | | Order code(s) |
| For options, see from page 2/118 | | | | | | | | | | | | | | | | | | | | | | 1LE1011-....-Z | | | ...+...+...+... |

Note: Pole-changing motors (4/2-pole) do not comply with the vibration values stipulated in IEC 60034-14 when rigidly installed (see also page 1/50).

¹⁾ Operating values for 60 Hz are available on request.

²⁾ Types derived from IM B3 (IM B6/7/8, IM V6, and IM V5), from IM B5 (IM V3 and IM V1) and from IM B14 (IM V19 and IM V18) are possible, provided that no requirements exist for condensation drainage holes (**H03**) or stamping of the type on the rating plate. The basic type IM B3, IM B5, or IM B14 is stamped as standard on the rating plate. For orders with condensation drainage holes (**H03**), the type must be specified.

SIMOTICS GP and SIMOTICS SD standard motors

Pole-changing

Aluminum series SIMOTICS GP 1LE1011/1LE1012 for square-law load torque – self-ventilated

Selection and ordering data

| P _{rated1} , P _{rated2} 50 Hz 50 Hz | | Frame size | Operating values at rated power for N1 | | | | | | | | | | Operating values at rated power for N2 | | | | | | | | | | Aluminum series | m _{IM B3} | J | | | | | | | | | | | | | | | | | | | | | | | | | | | | | | | | | | | | | | | | | | | | | | | | | | | | | | | | | | | | | | | | | | | | | | | | | | | | | | | | | | |
|--|---------------------------|------------------------|--|--------------------------------|--------------------------------|------------------------------------|--------------------------------|---|---|--|--------------------------------|--------------------------------|--|------------------------------------|--------------------------------|---|---|--|--------------------------|--------------|---------------------------|--------------|-----------------|--------------------|--------------|--------------|--|----------|--|---------|------------|-------------|----------|-----|---|-------------|----------|-----|---|-------------|---------------------------|-----|---|-------------|---------------------------|-----|---|---|--|-----|-----|-----------------------|--|---------|------------|----------------|---------------------|----------|---|-------------|---------------------|------------------------|---|-------------|----------------------|------------------------|---|--|--|--|-----|------------------|--|---------|------------|---------|--|----------|---|---|--|------------------------|---|--|--|--|-----|-----------------------|--|---------|------------|---------------------|--|----------|---|--|--|--|--|------------------|--|---------------|--|----------------------------------|--|---------------|-------------|
| | | | n _{rated1} , 50 Hz | T _{rated1} , 50 Hz | η _{rated1} , 50 Hz | cos φ _{rated1} , 50 Hz | I _{rated1} , 50 Hz | T _{LR1} / T _{rated1} | I _{LR1} / I _{rated1} | T _{B1} / T _{rated1} | n _{rated2} , 50 Hz | T _{rated2} , 50 Hz | η _{rated2} , 50 Hz | cos φ _{rated2} , 50 Hz | I _{rated2} , 50 Hz | T _{LR2} / T _{rated2} | I _{LR2} / I _{rated2} | T _{B2} / T _{rated2} | 1LE1011 – one winding | | 1LE1012 – two windings | | Article No. | | | | | | | | | | | | | | | | | | | | | | | | | | | | | | | | | | | | | | | | | | | | | | | | | | | | | | | | | | | | | | | | | | | | | | | | | | | | | | | | | | | | |
| | | | 4/4 | 4/4 | 4/4 | 4/4 | 4/4 | 4/4 | 4/4 | 4/4 | 4/4 | 4/4 | 4/4 | 4/4 | 4/4 | 4/4 | 4/4 | 4/4 | 4/4 | 1LE1011-1AP4 | 1LE1011-1AP5 | 1LE1011-1BP2 | 1LE1011-1CP0 | 1LE1011-1CP2 | 1LE1011-1DP2 | 1LE1011-1DP6 | | | | | | | | | | | | | | | | | | | | | | | | | | | | | | | | | | | | | | | | | | | | | | | | | | | | | | | | | | | | | | | | | | | | | | | | | | | | | | | | | |
| 4/2-pole: 1500/3000 rpm at 50 Hz with one winding connected in Dahlander circuit | | | | | | | | | | | | | | | | | | | | | | | | | | | | | | | | | | | | | | | | | | | | | | | | | | | | | | | | | | | | | | | | | | | | | | | | | | | | | | | | | | | | | | | | | | | | | | | | | | | | | | | | | | | |
| 1500 rpm | 3000 rpm | 1500 rpm | | | | | | | | | 3000 rpm | | | | | | | | | | | | | | | | | | | | | | | | | | | | | | | | | | | | | | | | | | | | | | | | | | | | | | | | | | | | | | | | | | | | | | | | | | | | | | | | | | | | | | | | | | | | | | | | |
| 0.65 | 2.4 | 100 L | 1415 | 4.4 | 75 | 0.86 | 1.45 | 1.6 | 4.1 | 1.8 | 2800 | 8.2 | 70 | 0.88 | 5.6 | 1.8 | 4.2 | 1.8 | 1LE1011-1AP4 | 18 | 0.0059 | | | | | | | | | | | | | | | | | | | | | | | | | | | | | | | | | | | | | | | | | | | | | | | | | | | | | | | | | | | | | | | | | | | | | | | | | | | | | | | | | | | | | | |
| 0.8 | 3.1 | 100 L | 1435 | 5.3 | 79 | 0.85 | 1.72 | 1.9 | 5.2 | 2.8 | 2840 | 10.4 | 77.3 | 0.9 | 6.4 | 2.1 | 5.2 | 2.8 | 1LE1011-1AP5 | 22 | 0.0078 | | | | | | | | | | | | | | | | | | | | | | | | | | | | | | | | | | | | | | | | | | | | | | | | | | | | | | | | | | | | | | | | | | | | | | | | | | | | | | | | | | | | | | |
| 1.1 | 4.4 | 112 M | 1455 | 7.2 | 83.4 | 0.85 | 2.25 | 2.2 | 6.1 | 2.5 | 2885 | 14.6 | 80.8 | 0.92 | 8.5 | 2.1 | 6.4 | 2.5 | 1LE1011-1BP2 | 27 | 0.01 | | | | | | | | | | | | | | | | | | | | | | | | | | | | | | | | | | | | | | | | | | | | | | | | | | | | | | | | | | | | | | | | | | | | | | | | | | | | | | | | | | | | | | |
| 1.45 | 5.9 | 132 S | 1460 | 9.5 | 84 | 0.84 | 2.95 | 1.6 | 5.8 | 2.8 | 2875 | 19.6 | 80 | 0.89 | 12.0 | 1.8 | 5.6 | 2.8 | 1LE1011-1CP0 | 38 | 0.019 | | | | | | | | | | | | | | | | | | | | | | | | | | | | | | | | | | | | | | | | | | | | | | | | | | | | | | | | | | | | | | | | | | | | | | | | | | | | | | | | | | | | | | |
| 2.0 | 8.0 | 132 M | 1455 | 13.1 | 85 | 0.85 | 4.00 | 1.8 | 5.6 | 2.8 | 2880 | 26.5 | 82 | 0.92 | 15.3 | 1.8 | 6.3 | 2.8 | 1LE1011-1CP2 | 44 | 0.024 | | | | | | | | | | | | | | | | | | | | | | | | | | | | | | | | | | | | | | | | | | | | | | | | | | | | | | | | | | | | | | | | | | | | | | | | | | | | | | | | | | | | | | |
| 2.9 | 11.5 | 160 M | 1465 | 18.9 | 86.5 | 0.86 | 5.6 | 1.8 | 5.9 | 2.9 | 2870 | 38.3 | 82 | 0.92 | 22.0 | 1.8 | 6 | 2.9 | 1LE1011-1DP2 | 62 | 0.044 | | | | | | | | | | | | | | | | | | | | | | | | | | | | | | | | | | | | | | | | | | | | | | | | | | | | | | | | | | | | | | | | | | | | | | | | | | | | | | | | | | | | | | |
| 4.3 | 16 | 160 L | 1455 | 28.2 | 87 | 0.85 | 8.4 | 1.6 | 6 | 2.3 | 2920 | 52.3 | 86 | 0.94 | 28.5 | 1.9 | 7.1 | 2.3 | 1LE1011-1DP6 | 85 | 0.068 | | | | | | | | | | | | | | | | | | | | | | | | | | | | | | | | | | | | | | | | | | | | | | | | | | | | | | | | | | | | | | | | | | | | | | | | | | | | | | | | | | | | | | |
| 6/4-pole: 1000/1500 rpm at 50 Hz with two windings | | | | | | | | | | | | | | | | | | | | | | | | | | | | | | | | | | | | | | | | | | | | | | | | | | | | | | | | | | | | | | | | | | | | | | | | | | | | | | | | | | | | | | | | | | | | | | | | | | | | | | | | | | | |
| 1000 rpm | 1500 rpm | 1000 rpm | | | | | | | | | 1500 rpm | | | | | | | | | | | | | | | | | | | | | | | | | | | | | | | | | | | | | | | | | | | | | | | | | | | | | | | | | | | | | | | | | | | | | | | | | | | | | | | | | | | | | | | | | | | | | | | | |
| 0.6 | 1.7 | 100 L | 970 | 5.9 | 55.5 | 0.62 | 2.50 | 1.7 | 3.4 | 2.7 | 1435 | 11.3 | 76.2 | 0.83 | 3.90 | 1.8 | 4.6 | 2.7 | 1LE1012-1AQ4 | 18 | 0.0059 | | | | | | | | | | | | | | | | | | | | | | | | | | | | | | | | | | | | | | | | | | | | | | | | | | | | | | | | | | | | | | | | | | | | | | | | | | | | | | | | | | | | | | |
| 0.75 | 2.1 | 100 L | 955 | 8 | 64.2 | 0.77 | 2.20 | 1.2 | 3.4 | 2 | 1435 | 14 | 78.4 | 0.84 | 4.60 | 2 | 5.4 | 2 | 1LE1012-1AQ5 | 22 | 0.0078 | | | | | | | | | | | | | | | | | | | | | | | | | | | | | | | | | | | | | | | | | | | | | | | | | | | | | | | | | | | | | | | | | | | | | | | | | | | | | | | | | | | | | | |
| 0.9 | 3.0 | 112 M | 975 | 8.8 | 64.7 | 0.66 | 3.05 | 1.6 | 3.9 | 2.5 | 1455 | 19.7 | 81.4 | 0.78 | 6.8 | 2.1 | 6.4 | 2.5 | 1LE1012-1BQ2 | 27 | 0.01 | | | | | | | | | | | | | | | | | | | | | | | | | | | | | | | | | | | | | | | | | | | | | | | | | | | | | | | | | | | | | | | | | | | | | | | | | | | | | | | | | | | | | | |
| 1.2 | 3.9 | 132 S | 980 | 11.7 | 72.3 | 0.7 | 3.40 | 1.4 | 4.6 | 2.5 | 1455 | 25.6 | 83.1 | 0.83 | 8.2 | 1.5 | 5.7 | 2.5 | 1LE1012-1CQ0 | 38 | 0.019 | | | | | | | | | | | | | | | | | | | | | | | | | | | | | | | | | | | | | | | | | | | | | | | | | | | | | | | | | | | | | | | | | | | | | | | | | | | | | | | | | | | | | | |
| 1.7 | 5.4 | 132 M | 980 | 16.6 | 74.1 | 0.71 | 4.65 | 1.7 | 5 | 2.5 | 1465 | 35.2 | 85.9 | 0.82 | 11.1 | 2 | 6.9 | 2.5 | 1LE1012-1CQ2 | 44 | 0.024 | | | | | | | | | | | | | | | | | | | | | | | | | | | | | | | | | | | | | | | | | | | | | | | | | | | | | | | | | | | | | | | | | | | | | | | | | | | | | | | | | | | | | | |
| 2.5 | 7.2 | 160 M | 985 | 24.2 | 77.7 | 0.71 | 6.5 | 1.5 | 4.7 | 2.6 | 1470 | 46.8 | 86.9 | 0.85 | 14.1 | 1.8 | 6.3 | 2.6 | 1LE1012-1DQ2 | 62 | 0.044 | | | | | | | | | | | | | | | | | | | | | | | | | | | | | | | | | | | | | | | | | | | | | | | | | | | | | | | | | | | | | | | | | | | | | | | | | | | | | | | | | | | | | | |
| 3.7 | 12.0 | 160 L | 985 | 35.9 | 82.4 | 0.69 | 9.4 | 2.3 | 6.2 | 3.5 | 1475 | 77.7 | 87.9 | 0.8 | 24.5 | 2.1 | 7.5 | 3.5 | 1LE1012-1DQ4 | 73 | 0.059 | | | | | | | | | | | | | | | | | | | | | | | | | | | | | | | | | | | | | | | | | | | | | | | | | | | | | | | | | | | | | | | | | | | | | | | | | | | | | | | | | | | | | | |
| 6.5 | 19 | 180 L | 985 | 63 | 81.0 | 0.7 | 16.5 | 1.8 | 5.5 | 2.7 | 1475 | 123 | 0.9 | 38.0 | 2.5 | 8.1 | 3.7 | | 1LE1012-1EQ4 | 132 | 0.13 | | | | | | | | | | | | | | | | | | | | | | | | | | | | | | | | | | | | | | | | | | | | | | | | | | | | | | | | | | | | | | | | | | | | | | | | | | | | | | | | | | | | | | |
| 9.5 | 26 | 200 L | 985 | 92 | 84.5 | 0.7 | 23.0 | 2.3 | 6.5 | 2.8 | 1475 | 168 | 0.91 | 0.8 | 52 | 2.3 | 7.5 | 3.4 | 1LE1012-2AQ5 | 173 | 0.20 | | | | | | | | | | | | | | | | | | | | | | | | | | | | | | | | | | | | | | | | | | | | | | | | | | | | | | | | | | | | | | | | | | | | | | | | | | | | | | | | | | | | | | |
| <table border="1"> <thead> <tr> <th colspan="2">Voltages</th> <th>Version</th> <th>Order code</th> </tr> </thead> <tbody> <tr> <td>50 Hz 230 V</td> <td>Standard</td> <td>2 2</td> <td>–</td> </tr> <tr> <td>50 Hz 400 V</td> <td>Standard</td> <td>3 4</td> <td>–</td> </tr> <tr> <td>50 Hz 500 V</td> <td>Without additional charge</td> <td>4 0</td> <td>–</td> </tr> <tr> <td>50 Hz 690 V</td> <td>Without additional charge</td> <td>4 7</td> <td>–</td> </tr> <tr> <td colspan="2">For other voltages ¹⁾ and more information, see from page 2/95</td> <td>9 0</td> <td>...</td> </tr> <tr> <th colspan="2">Types of construction</th> <th>Version</th> <th>Order code</th> </tr> <tr> <td>Without flange</td> <td>IM B3 ²⁾</td> <td>Standard</td> <td>A</td> </tr> <tr> <td>With flange</td> <td>IM B5 ²⁾</td> <td>With additional charge</td> <td>F</td> </tr> <tr> <td>With flange</td> <td>IM B14 ²⁾</td> <td>With additional charge</td> <td>K</td> </tr> <tr> <td colspan="2">For other types of construction and more information, see from page 2/99</td> <td></td> <td>...</td> </tr> <tr> <th colspan="2">Motor protection</th> <th>Version</th> <th>Order code</th> </tr> <tr> <td>Without</td> <td></td> <td>Standard</td> <td>A</td> </tr> <tr> <td>PTC thermistor with 3 temperature sensors</td> <td></td> <td>With additional charge</td> <td>B</td> </tr> <tr> <td colspan="2">For other motor protection and more information, see from page 2/112</td> <td></td> <td>...</td> </tr> <tr> <th colspan="2">Terminal box position</th> <th>Version</th> <th>Order code</th> </tr> <tr> <td>Terminal box at top</td> <td></td> <td>Standard</td> <td>4</td> </tr> <tr> <td colspan="2">For other terminal box positions and more information, see from page 2/115</td> <td></td> <td></td> </tr> <tr> <th colspan="2">Special versions</th> <th colspan="2">Order code(s)</th> </tr> <tr> <td colspan="2">For options, see from page 2/118</td> <td>1LE1011-...-Z</td> <td>...+...+...</td> </tr> </tbody> </table> | | | | | | | | | | | | | | | | | | | | | | | | | | | | Voltages | | Version | Order code | 50 Hz 230 V | Standard | 2 2 | – | 50 Hz 400 V | Standard | 3 4 | – | 50 Hz 500 V | Without additional charge | 4 0 | – | 50 Hz 690 V | Without additional charge | 4 7 | – | For other voltages ¹⁾ and more information, see from page 2/95 | | 9 0 | ... | Types of construction | | Version | Order code | Without flange | IM B3 ²⁾ | Standard | A | With flange | IM B5 ²⁾ | With additional charge | F | With flange | IM B14 ²⁾ | With additional charge | K | For other types of construction and more information, see from page 2/99 | | | ... | Motor protection | | Version | Order code | Without | | Standard | A | PTC thermistor with 3 temperature sensors | | With additional charge | B | For other motor protection and more information, see from page 2/112 | | | ... | Terminal box position | | Version | Order code | Terminal box at top | | Standard | 4 | For other terminal box positions and more information, see from page 2/115 | | | | Special versions | | Order code(s) | | For options, see from page 2/118 | | 1LE1011-...-Z | ...+...+... |
| Voltages | | Version | Order code | | | | | | | | | | | | | | | | | | | | | | | | | | | | | | | | | | | | | | | | | | | | | | | | | | | | | | | | | | | | | | | | | | | | | | | | | | | | | | | | | | | | | | | | | | | | | | | | | | | | | | | | |
| 50 Hz 230 V | Standard | 2 2 | – | | | | | | | | | | | | | | | | | | | | | | | | | | | | | | | | | | | | | | | | | | | | | | | | | | | | | | | | | | | | | | | | | | | | | | | | | | | | | | | | | | | | | | | | | | | | | | | | | | | | | | | | |
| 50 Hz 400 V | Standard | 3 4 | – | | | | | | | | | | | | | | | | | | | | | | | | | | | | | | | | | | | | | | | | | | | | | | | | | | | | | | | | | | | | | | | | | | | | | | | | | | | | | | | | | | | | | | | | | | | | | | | | | | | | | | | | |
| 50 Hz 500 V | Without additional charge | 4 0 | – | | | | | | | | | | | | | | | | | | | | | | | | | | | | | | | | | | | | | | | | | | | | | | | | | | | | | | | | | | | | | | | | | | | | | | | | | | | | | | | | | | | | | | | | | | | | | | | | | | | | | | | | |
| 50 Hz 690 V | Without additional charge | 4 7 | – | | | | | | | | | | | | | | | | | | | | | | | | | | | | | | | | | | | | | | | | | | | | | | | | | | | | | | | | | | | | | | | | | | | | | | | | | | | | | | | | | | | | | | | | | | | | | | | | | | | | | | | | |
| For other voltages ¹⁾ and more information, see from page 2/95 | | 9 0 | ... | | | | | | | | | | | | | | | | | | | | | | | | | | | | | | | | | | | | | | | | | | | | | | | | | | | | | | | | | | | | | | | | | | | | | | | | | | | | | | | | | | | | | | | | | | | | | | | | | | | | | | | | |
| Types of construction | | Version | Order code | | | | | | | | | | | | | | | | | | | | | | | | | | | | | | | | | | | | | | | | | | | | | | | | | | | | | | | | | | | | | | | | | | | | | | | | | | | | | | | | | | | | | | | | | | | | | | | | | | | | | | | | |
| Without flange | IM B3 ²⁾ | Standard | A | | | | | | | | | | | | | | | | | | | | | | | | | | | | | | | | | | | | | | | | | | | | | | | | | | | | | | | | | | | | | | | | | | | | | | | | | | | | | | | | | | | | | | | | | | | | | | | | | | | | | | | | |
| With flange | IM B5 ²⁾ | With additional charge | F | | | | | | | | | | | | | | | | | | | | | | | | | | | | | | | | | | | | | | | | | | | | | | | | | | | | | | | | | | | | | | | | | | | | | | | | | | | | | | | | | | | | | | | | | | | | | | | | | | | | | | | | |
| With flange | IM B14 ²⁾ | With additional charge | K | | | | | | | | | | | | | | | | | | | | | | | | | | | | | | | | | | | | | | | | | | | | | | | | | | | | | | | | | | | | | | | | | | | | | | | | | | | | | | | | | | | | | | | | | | | | | | | | | | | | | | | | |
| For other types of construction and more information, see from page 2/99 | | | ... | | | | | | | | | | | | | | | | | | | | | | | | | | | | | | | | | | | | | | | | | | | | | | | | | | | | | | | | | | | | | | | | | | | | | | | | | | | | | | | | | | | | | | | | | | | | | | | | | | | | | | | | |
| Motor protection | | Version | Order code | | | | | | | | | | | | | | | | | | | | | | | | | | | | | | | | | | | | | | | | | | | | | | | | | | | | | | | | | | | | | | | | | | | | | | | | | | | | | | | | | | | | | | | | | | | | | | | | | | | | | | | | |
| Without | | Standard | A | | | | | | | | | | | | | | | | | | | | | | | | | | | | | | | | | | | | | | | | | | | | | | | | | | | | | | | | | | | | | | | | | | | | | | | | | | | | | | | | | | | | | | | | | | | | | | | | | | | | | | | | |
| PTC thermistor with 3 temperature sensors | | With additional charge | B | | | | | | | | | | | | | | | | | | | | | | | | | | | | | | | | | | | | | | | | | | | | | | | | | | | | | | | | | | | | | | | | | | | | | | | | | | | | | | | | | | | | | | | | | | | | | | | | | | | | | | | | |
| For other motor protection and more information, see from page 2/112 | | | ... | | | | | | | | | | | | | | | | | | | | | | | | | | | | | | | | | | | | | | | | | | | | | | | | | | | | | | | | | | | | | | | | | | | | | | | | | | | | | | | | | | | | | | | | | | | | | | | | | | | | | | | | |
| Terminal box position | | Version | Order code | | | | | | | | | | | | | | | | | | | | | | | | | | | | | | | | | | | | | | | | | | | | | | | | | | | | | | | | | | | | | | | | | | | | | | | | | | | | | | | | | | | | | | | | | | | | | | | | | | | | | | | | |
| Terminal box at top | | Standard | 4 | | | | | | | | | | | | | | | | | | | | | | | | | | | | | | | | | | | | | | | | | | | | | | | | | | | | | | | | | | | | | | | | | | | | | | | | | | | | | | | | | | | | | | | | | | | | | | | | | | | | | | | | |
| For other terminal box positions and more information, see from page 2/115 | | | | | | | | | | | | | | | | | | | | | | | | | | | | | | | | | | | | | | | | | | | | | | | | | | | | | | | | | | | | | | | | | | | | | | | | | | | | | | | | | | | | | | | | | | | | | | | | | | | | | | | | | | | |
| Special versions | | Order code(s) | | | | | | | | | | | | | | | | | | | | | | | | | | | | | | | | | | | | | | | | | | | | | | | | | | | | | | | | | | | | | | | | | | | | | | | | | | | | | | | | | | | | | | | | | | | | | | | | | | | | | | | | | |
| For options, see from page 2/118 | | 1LE1011-...-Z | ...+...+... | | | | | | | | | | | | | | | | | | | | | | | | | | | | | | | | | | | | | | | | | | | | | | | | | | | | | | | | | | | | | | | | | | | | | | | | | | | | | | | | | | | | | | | | | | | | | | | | | | | | | | | | |

Note: Pole-changing motors (4/2-pole) do not comply with the vibration values stipulated in IEC 60034-14 when rigidly installed (see also page 1/50).

¹⁾ Operating values for 60 Hz are available on request.

²⁾ Types derived from IM B3 (IM B6/7/8, IM V6, and IM V5), from IM B5 (IM V3 and IM V1) and from IM B14 (IM V19 and IM V18) are possible, provided that no requirements exist for condensation drainage holes (**H03**) or stamping of the type on the rating plate. The basic type IM B3, IM B5, or IM B14 is stamped as standard on the rating plate. For orders with condensation drainage holes (**H03**), the type must be specified.

SIMOTICS GP and SIMOTICS SD standard motors

Article No. supplements and special versions · Voltages

Aluminum series SIMOTICS GP 1LE10

| Voltages | Article No. supplement | | Frame size | | | | | | | | | | Motor version | | | | |
|---|--|---|-----------------------------------|----|----|----|---------|---------|-----|-----|-----|-----|---------------|------------|-----------|------------------------------------|-------------------|
| | Voltage code 12th and 13th position of the Article No. | Additional identification code with order code and plain text if required | 63 | 71 | 80 | 90 | 100 | 112 | 132 | 160 | 180 | 200 | | | | | |
| | | | | | | | 1LE1004 | | | | | | IEC | IE4 | ① | | |
| | | | | | | | 1LE1003 | | | | | | | IE3 | ② | | |
| | | | | | | | | 1LE1083 | | | | | | | ③ | | |
| | | | | | | | 1LE1001 | | | | | | | IE2 | ④ | | |
| | | | | | | | 1LE1002 | | | | | | | IE1 | ⑤ | | |
| | | | | | | | | 1LE1043 | | | | | APAC Line | IE3 | ⑥ | | |
| | | | | | | | | 1LE1041 | | | | | | IE2 | ⑦ | | |
| | | | | | | | | 1LE1023 | | | | | Eagle Line | NPE (NEMA) | ⑧ | | |
| | | | | | | | | 1LE1021 | | | | | | NEE (NEMA) | ⑨ | | |
| 1LE10...-...-...-...-... Order code | | | | | | | | | | | | | | | | | |
| Voltage at 60 Hz and required power at 60 Hz (continued) | | | | | | | | | | | | | | | | | |
| 380 VΔ/660 VY; 60 Hz power ^{1) 5)} | 9 | 0 | M1B | ✓ | ✓ | ✓ | ✓ | ✓ | ✓ | ✓ | ✓ | ✓ | ✓ | ✓ | Not for: | APAC Line Eagle Line IEC IE3 | ⑥, ⑦ ⑧, ⑨ ③ |
| 440 VY; 50 Hz power | 9 | 0 | M2C | ✓ | ✓ | ✓ | ✓ | ✓ | ✓ | ✓ | ✓ | ✓ | ✓ | ✓ | Not for: | IEC IE3 | ③ |
| 440 VY; 60 Hz power | 9 | 0 | M1C | ✓ | ✓ | ✓ | ✓ | ✓ | ✓ | ✓ | ✓ | ✓ | ✓ | ✓ | Not for: | APAC Line Eagle Line IEC IE3 | ⑥, ⑦ ⑧, ⑨ ③ |
| 440 VΔ; 50 Hz power | 9 | 0 | M2D | ✓ | ✓ | ✓ | ✓ | ✓ | ✓ | ✓ | ✓ | ✓ | ✓ | ✓ | Not for: | IEC IE3 | ③ |
| 440 VΔ; 60 Hz power | 9 | 0 | M1D | ✓ | ✓ | ✓ | ✓ | ✓ | ✓ | ✓ | ✓ | ✓ | ✓ | ✓ | Not for: | APAC Line Eagle Line IEC IE3 | ⑥, ⑦ ⑧, ⑨ ③ |
| 460 VY; 50 Hz power | 9 | 0 | M2E | ✓ | ✓ | ✓ | ✓ | ✓ | ✓ | ✓ | ✓ | ✓ | ✓ | ✓ | Not for: | IEC IE3 | ③ |
| 460 VY; 60 Hz power | 9 | 0 | M1E | ○ | ○ | ○ | ○ | ○ | ○ | ○ | ○ | ○ | ○ | ○ | Not for: | APAC Line Eagle Line IEC IE3 | ⑥, ⑦ ⑧, ⑨ ③ |
| 460 VΔ; 50 Hz power | 9 | 0 | M2F | ✓ | ✓ | ✓ | ✓ | ✓ | ✓ | ✓ | ✓ | ✓ | ✓ | ✓ | Not for: | IEC IE3 | ③ |
| 460 VΔ; 60 Hz power | 9 | 0 | M1F | ○ | ○ | ○ | ○ | ○ | ○ | ○ | ○ | ○ | ○ | ○ | Not for: | APAC Line Eagle Line IEC IE3 | ⑥, ⑦ ⑧, ⑨ ③ |
| 575 VY; 50 Hz power ⁷⁾ | 9 | 0 | M2G | ✓ | ✓ | ✓ | ✓ | ✓ | ✓ | ✓ | ✓ | ✓ | ✓ | ✓ | Not for: | IEC IE4 IEC IE3 | ① ③ |
| 575 VY; 60 Hz power ⁷⁾ | 9 | 0 | M1G | ✓ | ✓ | ✓ | ✓ | ✓ | ✓ | ✓ | ✓ | ✓ | ✓ | ✓ | Not for: | APAC Line Eagle Line IEC IE3 | ⑥, ⑦ ⑧, ⑨ ③ |
| 575 VΔ; 50 Hz power ⁷⁾ | 9 | 0 | M2H | ✓ | ✓ | ✓ | ✓ | ✓ | ✓ | ✓ | ✓ | ✓ | ✓ | ✓ | Not for: | IEC IE4 IEC IE3 | ① ③ |
| 575 VΔ; 60 Hz power ⁷⁾ | 9 | 0 | M1H | ✓ | ✓ | ✓ | ✓ | ✓ | ✓ | ✓ | ✓ | ✓ | ✓ | ✓ | Not for: | APAC Line Eagle Line IEC IE3 | ⑥, ⑦ ⑧, ⑨ ③ |
| 400 VΔ/690 VY; 50 Hz power ¹⁾ | 9 | 0 | M2J | ✓ | ✓ | ✓ | ✓ | ✓ | ✓ | ✓ | ✓ | ✓ | ✓ | ✓ | Not for: | Eagle Line IEC IE3 | ⑧, ⑨ ③ |
| 400 VΔ; 50 Hz power | | | | - | - | ✓ | ✓ | ✓ | ✓ | ✓ | ✓ | ✓ | ✓ | ✓ | Only for: | Eagle Line IEC IE3 | ⑧, ⑨ ③ |
| 400 VΔ/690 VY; 60 Hz power | 9 | 0 | M1J | ✓ | ✓ | ✓ | ✓ | ✓ | ✓ | ✓ | ✓ | ✓ | ✓ | ✓ | Not for: | Eagle Line IEC IE3 | ⑧, ⑨ ③ |
| 480 VY; 50 Hz power | 9 | 0 | M2K | ✓ | ✓ | ✓ | ✓ | ✓ | ✓ | ✓ | ✓ | ✓ | ✓ | ✓ | Not for: | IEC IE3 | ③ |
| 480 VY; 60 Hz power | 9 | 0 | M1K | ✓ | ✓ | ✓ | ✓ | ✓ | ✓ | ✓ | ✓ | ✓ | ✓ | ✓ | Not for: | Eagle Line IEC IE3 | ⑧, ⑨ ③ |
| 480 VΔ; 50 Hz power | 9 | 0 | M2L | ✓ | ✓ | ✓ | ✓ | ✓ | ✓ | ✓ | ✓ | ✓ | ✓ | ✓ | Not for: | IEC IE3 | ③ |
| 480 VΔ; 60 Hz power | 9 | 0 | M1L | ✓ | ✓ | ✓ | ✓ | ✓ | ✓ | ✓ | ✓ | ✓ | ✓ | ✓ | Not for: | Eagle Line IEC IE3 | ⑧, ⑨ ③ |
| 230 VΔ/400 VY; 50 Hz power | 9 | 0 | M2M | ✓ | ✓ | ✓ | ✓ | ✓ | ✓ | ✓ | ✓ | ✓ | ✓ | ✓ | Not for: | IEC IE3 | ③ |
| 230 VΔ/400 VY; 60 Hz power | 9 | 0 | M1M | ✓ | ✓ | ✓ | ✓ | ✓ | ✓ | ✓ | ✓ | ✓ | ✓ | ✓ | Not for: | Eagle Line IEC IE3 | ⑧, ⑨ ③ |
| Voltage at 87 Hz and 87 Hz power | | | | | | | | | | | | | | | | | |
| 400 VΔ ⁵⁾ | 9 | 0 | M3A | - | - | ✓ | ✓ | ✓ | ✓ | ✓ | ✓ | ✓ | ✓ | ✓ | Not for: | IEC IE3 | ③ |
| Non-standard voltage and/or frequencies | | | | | | | | | | | | | | | | | |
| Non-standard winding ⁶⁾ | 9 | 0 | M1Y • and customer specifications | ✓ | ✓ | ✓ | ✓ | ✓ | ✓ | ✓ | ✓ | ✓ | ✓ | ✓ | | | |

- Standard version
- Without additional charge
- This order code only determines the price of the version – Additional plain text is required.
- ✓ With additional charge
- Not possible

1) For North America export versions Eagle Line 1LE1021 NEMA Energy Efficient, 1LE1023 NEMA Premium Efficient and 1LE1083, voltages above 600 V will not be stamped.
 2) Frame sizes 80 and 90 with voltage code 02 can only be supplied without motor protection (motor protection code letter A).
 3) Delta connection is not possible.
 4) Star connection is not possible.

5) Only possible for 4-pole, 6-pole and 8-pole motors. The operating data for converter operation is also provided in a table on the rating plate.
 6) Plain text must be specified in the order: Voltage between 200 and 690 V (voltages outside this range are available on request), frequency, circuit, for 60 Hz additionally required rated power in kW.
 7) Not possible for 2-pole and 4-pole motors with increased power (11th position of the Article No.: 6) in frame sizes 80 and 90.

SIMOTICS GP and SIMOTICS SD standard motors

Article No. supplements and special versions · Voltages

Cast-iron series SIMOTICS SD 1LE15 Basic Line, 1LE16 Performance Line

| Voltages | Article No. supplement | | Frame size | | | | | | | | | | | Motor version | | | | | |
|--|------------------------|---|-----------------------------------|----|----|--------------------------|-----|-----|-----|-----|-----|-----|-----|---------------|-----|---|------------|--|---|
| | Voltage code | Additional identification code with order code and plain text if required | 71 | 80 | 90 | 100 | 112 | 132 | 160 | 180 | 200 | 225 | 250 | 280 | 315 | | | | |
| | | | | | | 1LE1504 Basic Line | | | | | | | | | | | IEC | IE4 | ① |
| | | | | | | 1LE1604 Performance Line | | | | | | | | | | | | | ② |
| | | | | | | 1LE1503 Basic Line | | | | | | | | | | | | IE3 | ③ |
| | | | | | | 1LE1603 Performance Line | | | | | | | | | | | | | ④ |
| | | | | | | 1LE1583 | | | | | | | | | | | | | ⑤ |
| | | | | | | 1LE1501 Basic Line | | | | | | | | | | | | IE2 | ⑥ |
| | | | | | | 1LE1601 Performance Line | | | | | | | | | | | | | ⑦ |
| | | | | | | 1LE1502 Basic Line | | | | | | | | | | | | IE1 | ⑧ |
| | | | | | | 1LE1543 Basic Line | | | | | | | | | | | APAC Line | IE3 | ⑨ |
| | | | | | | 1LE1643 Performance Line | | | | | | | | | | | | | ⑩ |
| | | | | | | 1LE1541 Basic Line | | | | | | | | | | | | IE2 | ⑪ |
| | | | | | | 1LE1523 Basic Line | | | | | | | | | | | Eagle Line | NPE (NEMA) | ⑫ |
| | | | | | | 1LE1623 Performance Line | | | | | | | | | | | | | ⑬ |
| | | | | | | 1LE1521 Basic Line | | | | | | | | | | | | NEE (NEMA) | ⑭ |
| Order code | | | | | | | | | | | | | | | | | | | |
| 1LE1.....-...-...-... | | | | | | | | | | | | | | | | | | | |
| Voltage at 60 Hz and required power (continued) | | | | | | | | | | | | | | | | | | | |
| 440 VΔ; 50 Hz power | 9 | 0 | M2D | - | - | ✓ | ✓ | ✓ | ✓ | ✓ | ✓ | ✓ | ✓ | ✓ | ✓ | ✓ | Not for: | IEC IE3 | ⑤ |
| 440 VΔ; 60 Hz power ²⁾ | 9 | 0 | M1D | - | - | ✓ | ✓ | ✓ | ✓ | ✓ | ✓ | ✓ | ✓ | ✓ | ✓ | ✓ | Not for: | APAC Line ⑨, ⑩, ⑪ Eagle Line ⑫, ⑬, ⑭ IEC IE3 ⑤ | |
| 460 VY; 50 Hz power | 9 | 0 | M2E | - | - | ✓ | ✓ | ✓ | ✓ | ✓ | ✓ | ✓ | ✓ | ✓ | ✓ | ✓ | Not for: | IEC IE3 | ⑤ |
| 460 VY; 60 Hz power ²⁾ | 9 | 0 | M1E | - | - | ○ | ○ | ○ | ○ | ○ | ○ | ○ | ○ | ○ | ○ | ○ | Not for: | APAC Line ⑨, ⑩, ⑪ Eagle Line ⑫, ⑬, ⑭ IEC IE3 ⑤ | |
| 460 VΔ; 50 Hz power | 9 | 0 | M2F | - | - | ✓ | ✓ | ✓ | ✓ | ✓ | ✓ | ✓ | ✓ | ✓ | ✓ | ✓ | Not for: | IEC IE3 | ⑤ |
| 460 VΔ; 60 Hz power ²⁾ | 9 | 0 | M1F | - | - | ○ | ○ | ○ | ○ | ○ | ○ | ○ | ○ | ○ | ○ | ○ | Not for: | APAC Line ⑨, ⑩, ⑪ Eagle Line ⑫, ⑬, ⑭ IEC IE3 ⑤ | |
| 575 VY; 50 Hz power | 9 | 0 | M2G | - | - | ✓ | ✓ | ✓ | ✓ | ✓ | ✓ | ✓ | ✓ | ✓ | ✓ | ✓ | Not for: | IEC IE4 ①, ② frame sizes 100 ... 160 IEC IE3 ⑤ | |
| 575 VY; 60 Hz power ²⁾ | 9 | 0 | M1G | - | - | ✓ | ✓ | ✓ | ✓ | ✓ | ✓ | ✓ | ✓ | ✓ | ✓ | ✓ | Not for: | ①, ②, ③, ④ and ①, ② frame sizes 100 ... 160 | |
| 575 VΔ; 50 Hz power | 9 | 0 | M2H | - | - | ✓ | ✓ | ✓ | ✓ | ✓ | ✓ | ✓ | ✓ | ✓ | ✓ | ✓ | Not for: | IEC IE4 ①, ② frame sizes 100 ... 160 IEC IE3 ⑤ | |
| 575 VΔ; 60 Hz power ²⁾ | 9 | 0 | M1H | - | - | ✓ | ✓ | ✓ | ✓ | ✓ | ✓ | ✓ | ✓ | ✓ | ✓ | ✓ | Not for: | ①, ②, ③, ④ and ①, ② frame sizes 100 ... 160 | |
| 400 VΔ/690 VY; 50 Hz power ¹⁾ | 9 | 0 | M2J | ✓ | ✓ | ✓ | ✓ | ✓ | ✓ | ✓ | ✓ | ✓ | ✓ | ✓ | ✓ | ✓ | Not for: | IEC IE1 ⑧ Eagle Line ⑫, ⑬ | |
| 400 VΔ; 50 Hz power ¹⁾ | | | | ✓ | ✓ | ✓ | ✓ | ✓ | ✓ | ✓ | ✓ | ✓ | ✓ | ✓ | ✓ | ✓ | Only for: | IEC IE1 ⑧ Eagle Line ⑫, ⑬ | |
| 400 VΔ/690 VY; 60 Hz power | 9 | 0 | M1J | ✓ | ✓ | ✓ | ✓ | ✓ | ✓ | ✓ | ✓ | ✓ | ✓ | ✓ | ✓ | ✓ | Not for: | IEC IE1 ⑧ Eagle Line ⑫, ⑬ | |
| 480 VY; 50 Hz power | 9 | 0 | M2K | ✓ | ✓ | ✓ | ✓ | ✓ | ✓ | ✓ | ✓ | ✓ | ✓ | ✓ | ✓ | ✓ | Not for: | IEC IE3 | ⑤ |
| 480 VY; 60 Hz power | 9 | 0 | M1K | ✓ | ✓ | ✓ | ✓ | ✓ | ✓ | ✓ | ✓ | ✓ | ✓ | ✓ | ✓ | ✓ | Not for: | IEC IE1 ⑧ Eagle Line ⑫, ⑬ | |
| 480 VΔ; 50 Hz power | 9 | 0 | M2L | ✓ | ✓ | ✓ | ✓ | ✓ | ✓ | ✓ | ✓ | ✓ | ✓ | ✓ | ✓ | ✓ | Not for: | IEC IE3 | ⑤ |
| 480 VΔ; 60 Hz power | 9 | 0 | M1L | ✓ | ✓ | ✓ | ✓ | ✓ | ✓ | ✓ | ✓ | ✓ | ✓ | ✓ | ✓ | ✓ | Not for: | IEC IE1 ⑧ Eagle Line ⑫, ⑬ | |
| 230 VΔ/400 VY; 50 Hz power | 9 | 0 | M2M | ✓ | ✓ | ✓ | ✓ | ✓ | ✓ | ✓ | ✓ | ✓ | ✓ | ✓ | ✓ | ✓ | Not for: | IEC IE3 | ⑤ |
| 230 VΔ/400 VY; 60 Hz power | 9 | 0 | M1M | ✓ | ✓ | ✓ | ✓ | ✓ | ✓ | ✓ | ✓ | ✓ | ✓ | ✓ | ✓ | ✓ | Not for: | IEC IE1 ⑧ Eagle Line ⑫, ⑬ | |
| Voltage at 87 Hz and 87 Hz power | | | | | | | | | | | | | | | | | | | |
| 400 VΔ ⁵⁾ | 9 | 0 | M3A | ✓ | ✓ | ✓ | ✓ | ✓ | ✓ | ✓ | ✓ | ✓ | ✓ | ✓ | ✓ | ✓ | Not for: | IEC IE3 | ⑤ |
| Non-standard voltage and/or frequencies | | | | | | | | | | | | | | | | | | | |
| Non-standard winding ⁶⁾ | 9 | 0 | M1Y • and customer specifications | ✓ | ✓ | ✓ | ✓ | ✓ | ✓ | ✓ | ✓ | ✓ | ✓ | ✓ | ✓ | ✓ | | | |

- Standard version
- Without additional charge
- ✓ With additional charge
- O. R. Possible on request

- Not possible
- This order code only determines the price of the version – Additional plain text is required.

¹⁾ For North America export versions Eagle Line 1LE1521 NEMA Energy Efficient, 1LE1523/1LE1623 NEMA Premium Efficient and 1LE1583, voltages above 600 V will not be stamped.

²⁾ Not admissible for North America export versions Eagle Line 1LE1521 NEMA Energy Efficient and 1LE1523/1LE1623 NEMA Premium Efficient.

³⁾ Delta connection is not possible.

⁴⁾ Star connection is not possible.

⁵⁾ Only possible for 4-pole, 6-pole and 8-pole motors. The operating data for converter operation is also provided in a table on the rating plate.

⁶⁾ Plain text must be specified in the order: Voltage between 200 and 690 V (voltages outside this range are available on request), frequency, circuit, for 60 Hz additionally required rated power in kW.

SIMOTICS GP and SIMOTICS SD standard motors

Article No. supplements and special versions · Voltages

Aluminum series SIMOTICS GP 1LE1073 and cast-iron series SIMOTICS SD 1LE1573, 1LE5773

Selection and ordering data

| Voltages | Article No. | supplement | Frame size | | | | | | | | | | | Motor version | | |
|---|-------------|------------|--|--------------------------|--------------------------|--------------------------|--------------------------|--------------------------|--------------------------|--------------------------|--------------------------|--------------------------|--------------------------|--------------------------|--------------------------|--------------------------|
| | | | 80 | 90 | 100 | 112 | 132 | 160 | 180 | 200 | 225 | 250 | 280 | 315 | IEC | IE3 |
| | | | 1LE1073 | | | | | 1LE1573 | | | | | 1LE5773 | | | |
| Order code | | | 1LE.....-.....-..... | | | | | | | | | | | | | |
| Voltage at 60 Hz and 50 Hz power | | | | | | | | | | | | | | | | |
| 220 VΔ/380 VYY, 440 VΔ 50 Hz power | 6 | 4 | – | <input type="checkbox"/> | <input type="checkbox"/> | <input type="checkbox"/> | <input type="checkbox"/> | <input type="checkbox"/> | <input type="checkbox"/> | <input type="checkbox"/> | <input type="checkbox"/> | <input type="checkbox"/> | <input type="checkbox"/> | <input type="checkbox"/> | <input type="checkbox"/> | <input type="checkbox"/> |
| 220 VΔ/380 VY; 50 Hz power | 9 | 0 | M2A | ✓ | ✓ | ✓ | ✓ | ✓ | ✓ | ✓ | ✓ | ✓ | ✓ | ✓ | ✓ | – |
| 380 VΔ/660 VY; 50 Hz power | 9 | 0 | M2B | ✓ | ✓ | ✓ | ✓ | ✓ | ✓ | ✓ | ✓ | ✓ | ✓ | ✓ | ✓ | ✓ |
| 440 VY; 50 Hz power | 9 | 0 | M2C | ✓ | ✓ | ✓ | ✓ | ✓ | ✓ | ✓ | ✓ | ✓ | ✓ | ✓ | ✓ | – |
| 440 VΔ; 50 Hz power | 9 | 0 | M2D | ✓ | ✓ | ✓ | ✓ | ✓ | ✓ | ✓ | ✓ | ✓ | ✓ | ✓ | ✓ | ✓ |
| 460 VY; 50 Hz power | 9 | 0 | M2E | ✓ | ✓ | ✓ | ✓ | ✓ | ✓ | ✓ | ✓ | ✓ | ✓ | ✓ | ✓ | – |
| 460 VΔ; 50 Hz power | 9 | 0 | M2F | ✓ | ✓ | ✓ | ✓ | ✓ | ✓ | ✓ | ✓ | ✓ | ✓ | ✓ | ✓ | ✓ |
| 575 VY; 50 Hz power | 9 | 0 | M2G | ✓ | ✓ | ✓ | ✓ | ✓ | ✓ | ✓ | ✓ | ✓ | ✓ | ✓ | ✓ | – |
| 575 VΔ; 50 Hz power | 9 | 0 | M2H | ✓ | ✓ | ✓ | ✓ | ✓ | ✓ | ✓ | ✓ | ✓ | ✓ | ✓ | ✓ | ✓ |
| 400 VΔ/690 VY; 50 Hz power | 9 | 0 | M2J | ✓ | ✓ | ✓ | ✓ | ✓ | ✓ | ✓ | ✓ | ✓ | ✓ | ✓ | ✓ | ✓ |
| 480 VY; 50 Hz power | 9 | 0 | M2K | ✓ | ✓ | ✓ | ✓ | ✓ | ✓ | ✓ | ✓ | ✓ | ✓ | ✓ | ✓ | – |
| 480 VΔ; 50 Hz power | 9 | 0 | M2L | ✓ | ✓ | ✓ | ✓ | ✓ | ✓ | ✓ | ✓ | ✓ | ✓ | ✓ | ✓ | ✓ |
| 230 VΔ/400 VY; 50 Hz power | 9 | 0 | M2M | ✓ | ✓ | ✓ | ✓ | ✓ | ✓ | ✓ | ✓ | ✓ | ✓ | ✓ | ✓ | – |
| Non-standard voltage and/or frequencies | | | | | | | | | | | | | | | | |
| Non-standard winding ¹⁾ | 9 | 0 | M1Y • and customer specifica- tions | ✓ | ✓ | ✓ | ✓ | ✓ | ✓ | ✓ | ✓ | ✓ | ✓ | ✓ | ✓ | ✓ |

- Standard version
- With additional charge
- This order code only determines the price of the version – Additional plain text is required.
- Not possible













¹⁾ Plain text must be specified in the order: Voltage between 200 and 690 V (voltages outside this range are available on request), frequency, circuit, for 60 Hz additionally required rated power in kW.

SIMOTICS GP and SIMOTICS SD standard motors

Article No. supplements and special versions · Types of construction

Aluminum series SIMOTICS GP 1LE10

Selection and ordering data

| Types of construction | Article No. | supplement | Frame size | | | | | | | | | | Motor version | | | | | |
|---|---|--|------------|-----------------------|----------------|----------------|----------------|----------------|----------------|----------------|----------------|----------------|----------------|----------------|---|------------|---------------------------------|---|
| | | | 63 | 71 | 80 | 90 | 100 | 112 | 132 | 160 | 180 | 200 | | | | | | |
| | | For types of construction with order code(s) Article No. with additional identification code -Z | | | | | 1LE1004 | | | | | | | | | IEC | IE4 | ① |
| | | | | 1LE1003 | | | | | | | | | | | | | IE3 | ② |
| | | | | | | | | 1LE1083 | | | | | | | | | | ③ |
| | | | 1LE1001 | | | | | | | | | | | | | | IE2 | ④ |
| | | | 1LE1002 | | | | | | | | | | | | | | IE1 | ⑤ |
| | | | | | 1LE1043 | | | | | | | | | | | APAC Line | IE3 | ⑥ |
| | | | | | 1LE1041 | | | | | | | | | | | | IE2 | ⑦ |
| | | | | | 1LE1023 | | | | | | | | | | | Eagle Line | NPE (NEMA) | ⑧ |
| | | | | | 1LE1021 | | | | | | | | | | | | NEE (NEMA) | ⑨ |
| | | | | | | | | 1LE1011 | | | | | | | | | Pole-changing | ⑩ |
| | 1LE10..... | Order code | | | | | | 1LE1012 | | | | | | | | | | ⑪ |
| Without flange | | | | | | | | | | | | | | | | | | |
| IM B3 ^{1) 2) 3)} |  | A | - | | | | | | | | | | | | | Not for: | APAC Line IE2 ⑦ | Eagle Line NEE ⑨ |
| IM B6 ^{2) 3)} |  | T | - | | | | | | | | | | | | | Not for: | APAC Line IE2 ⑦ | Eagle Line NEE ⑨ |
| IM B7 ^{2) 3) 9)} |  | U | - | | | | | | | | | | | | | Not for: | APAC Line IE2 ⑦ | Eagle Line NEE ⑨ |
| IM B8 ^{2) 3)} |  | V | - | | | | | | | | | | | | | Not for: | APAC Line IE2 ⑦ | Eagle Line NEE ⑨ |
| IM V6 ^{2) 3)} |  | D | - | | | | | | | | | | | | | Not for: | APAC Line IE2 ⑦ | Eagle Line NEE ⑨ |
| IM V5 without protective cover ^{2) 3)} |  | C | - | | | | | | | | | | | | | Not for: | APAC Line IE2 ⑦ | Eagle Line NEE ⑨ |
| IM V5 with protective cover ^{2) 3) 4) 5) 6)} |  | C | H00 | ✓ | ✓ | ✓ | ✓ | ✓ | ✓ | ✓ | ✓ | ✓ | ✓ | ✓ | ✓ | Not for: | APAC Line IE2 ⑦ | Eagle Line NEE ⑨ Combination with order code F90 |
| With flange | | | | EN 50347 DIN 42948 | FF115 A 140 | FF130 A 160 | FF165 A 200 | FF165 A 200 | FF215 A 250 | FF215 A 250 | FF265 A 300 | FF300 A 350 | FF300 A 350 | FF350 A 400 | | | | |
| IM B5 ^{2) 7)} |  | F | - | | ✓ | ✓ | ✓ | ✓ | ✓ | ✓ | ✓ | ✓ | ✓ | ✓ | ✓ | | | |
| IM V1 without protective cover ²⁾ |  | G | - | | ✓ | ✓ | ✓ | ✓ | ✓ | ✓ | ✓ | ✓ | ✓ | ✓ | ✓ | | | |
| IM V1 with protective cover ^{2) 4) 5) 6)} |  | G | H00 | | ✓ | ✓ | ✓ | ✓ | ✓ | ✓ | ✓ | ✓ | ✓ | ✓ | ✓ | Not for: | Combination with order code F90 | |
| IM V3 ⁴⁾ |  | H | - | | ✓ | ✓ | ✓ | ✓ | ✓ | ✓ | ✓ | ✓ | ✓ | ✓ | ✓ | | | |
| IM B35 ³⁾ |  | J | - | | ✓ | ✓ | ✓ | ✓ | ✓ | ✓ | ✓ | ✓ | ✓ | ✓ | ✓ | Not for: | APAC Line IE2 ⑦ | Eagle Line NEE ⑨ |









For legends and footnotes, see page 2/102.

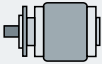

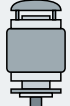
SIMOTICS GP and SIMOTICS SD standard motors

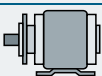
Article No. supplements and special versions · Types of construction

Aluminum series SIMOTICS GP 1LE10

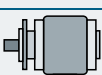









| Types of construction | Article No. | supplement | Frame size | | | | | | | | | | Motor version | | | | |
|--|---|------------|----------------|----------------|----------------|----------------|----------------|----------------|----------------|----------------|----------------|----------------|---------------|----------|---------------------------------|-----------------------------|---|
| | | | 63 | 71 | 80 | 90 | 100 | 112 | 132 | 160 | 180 | 200 | | | | | |
| | | | | | | | | 1LE1004 | | | | | | | IEC | IE4 | ① |
| | | | | | | | | 1LE1003 | | | | | | | | IE3 | ② |
| | | | | | | | | | | | | | | | | | ③ |
| | | | | | | | | 1LE1001 | | | | | | | | IE2 | ④ |
| | | | | | | | | 1LE1002 | | | | | | | | IE1 | ⑤ |
| | | | | | | | | 1LE1043 | | | | | | | APAC Line | IE3 | ⑥ |
| | | | | | | | | 1LE1041 | | | | | | | | IE2 | ⑦ |
| | | | | | | | | 1LE1023 | | | | | | | Eagle Line | NPE (NEMA) | ⑧ |
| | | | | | | | | 1LE1021 | | | | | | | | NEE (NEMA) | ⑨ |
| | | | | | | | | | | | | | | | | | ⑩ |
| | | | | | | | | | | | | | | | | | ⑪ |
| 1LE10 (-Z) | | Order code | | | | | | | | | | | | | | | |
| With flange next largest | EN 50347 DIN 42948 | | - | - | - | FF215 A 250 | FF265 A 300 | FF265 A 300 | FF300 A 350 | - | - | - | - | | | | |
| IM B5 ^{2) 7)} |  | F | P01 | - | - | - | ✓ | ✓ | ✓ | ✓ | - | - | - | | | | |
| IM V1 without protective cover ²⁾ |  | G | P01 | - | - | - | ✓ | ✓ | ✓ | ✓ | - | - | - | | | | |
| IM V1 with protective cover ^{2) 4) 5) 6)} |  | G | P01+H00 | - | - | - | ✓ | ✓ | ✓ | ✓ | - | - | - | Not for: | Combination with order code F90 | | |
| IM V3 ⁴⁾ |  | H | P01 | - | - | - | ✓ | ✓ | ✓ | ✓ | - | - | - | | | | |
| IM B35 ³⁾ |  | J | P01 | - | - | - | ✓ | ✓ | ✓ | ✓ | - | - | - | Not for: | APAC Line IE2 ^⑦ | Eagle Line NEE ^⑨ | |
| With flange next smallest | EN 50347 DIN 42948 | | | FF100 A 120 | FF115 A 140 | FF130 A 160 | FF165 A 200 | FF165 A 200 | FF215 A 250 | FF265 A 300 | FF265 A 300 | FF300 A 350 | | | | | |
| IM B5 ^{2) 7)} |  | F | P02 | ✓ | ✓ | ✓ | - | ✓ | ✓ | ✓ | ✓ | ✓ | ✓ | | | | |
| IM V1 without protective cover ²⁾ |  | G | P02 | ✓ | ✓ | ✓ | - | ✓ | ✓ | ✓ | ✓ | ✓ | ✓ | | | | |
| IM V1 with protective cover ^{2) 4) 5) 6)} |  | G | P02+H00 | ✓ | ✓ | ✓ | - | ✓ | ✓ | ✓ | ✓ | ✓ | ✓ | Not for: | Combination with order code F90 | | |
| IM V3 ⁴⁾ |  | H | P02 | ✓ | ✓ | ✓ | - | ✓ | ✓ | ✓ | ✓ | ✓ | ✓ | | | | |
| IM B35 ³⁾ |  | J | P02 | ✓ | ✓ | ✓ | - | ✓ | ✓ | ✓ | ✓ | ✓ | ✓ | Not for: | APAC Line IE2 ^⑦ | Eagle Line NEE ^⑨ | |

For legends and footnotes, see page 2/102.

SIMOTICS GP and SIMOTICS SD standard motors

Article No. supplements and special versions · Types of construction





Aluminum series SIMOTICS GP 1LE10

| Types of construction | Article No. | supplement | Frame size | | | | | | | | | | Motor version | | | | |
|---|---|-------------------|------------------------|------------------------|------------------------|------------------------|------------------------|------------------------|------------------------|------------------------|-----|-----|---------------|---|------------|---------------|--|
| | | | 63 | 71 | 80 | 90 | 100 | 112 | 132 | 160 | 180 | 200 | | | | | |
| | | | | | | | 1LE1004 | | | | | | | | IEC | IE4 | ① |
| | | | | | | 1LE1003 | | | | | | | | | | IE3 | ② |
| | | | | | | | | 1LE1083 | | | | | | | | | ③ |
| | | | | | | 1LE1001 | | | | | | | | | | IE2 | ④ |
| | | | | | | 1LE1002 | | | | | | | | | | IE1 | ⑤ |
| | | | | | | | 1LE1043 | | | | | | | | APAC Line | IE3 | ⑥ |
| | | | | | | | 1LE1041 | | | | | | | | | IE2 | ⑦ |
| | | | | | | | 1LE1023 | | | | | | | | Eagle Line | NPE (NEMA) | ⑧ |
| | | | | | | | 1LE1021 | | | | | | | | | NEE (NEMA) | ⑨ |
| | | | | | | | | | | 1LE1011 | | | | | | Pole-changing | ⑩ |
| | | | | | | | | | | 1LE1012 | | | | | | | ⑪ |
| 1LE10 (-Z) | | Order code | | | | | | | | | | | | | | | |
| With flange | EN 50347 DIN 42948 | | FT75 C 90 | FT85 C 105 | FT100 C 120 | FT115 C 140 | FT130 C 160 | FT130 C 160 | FT165 C 200 | FT215 C 250 | | | | | | | |
| IM B14 ^{2) 8)} |  | K | – | – | – | – | – | – | – | – | – | – | – | – | – | – | – |
| IM V19 ²⁾ |  | L | – | – | – | – | – | – | – | – | – | – | – | – | – | – | – |
| IM V18 without protective cover ²⁾ |  | M | – | – | – | – | – | – | – | – | – | – | – | – | – | – | – |
| IM V18 with protective cover ^{2) 4) 5) 6)} |  | M | H00 | – | – | – | – | – | – | – | – | – | – | – | – | – | Not for: Combination with order code F90 |
| IM B34 ³⁾ |  | N | – | – | – | – | – | – | – | – | – | – | – | – | – | – | Not for: Eagle Line NEE ⑨ |
| With flange next largest ¹⁰⁾ | EN 50347 DIN 42948 | | FT100 C 120 | FT115 C 140 | FT130 C 160 | FT130 C 160 | FT165 C 200 | FT165 C 200 | FT215 C 250 | | | | | | | | |
| IM B14 ^{2) 8)} |  | K | P01 | – | – | – | – | – | – | – | – | – | – | – | – | – | – |
| IM V19 ²⁾ |  | L | P01 | – | – | – | – | – | – | – | – | – | – | – | – | – | – |
| IM V18 without protective cover ²⁾ |  | M | P01 | – | – | – | – | – | – | – | – | – | – | – | – | – | – |
| IM V18 with protective cover ^{2) 4) 5) 6)} |  | M | P01+H00 | – | – | – | – | – | – | – | – | – | – | – | – | – | Not for: Combination with order code F90 |
| IM B34 ³⁾ |  | N | P01 | – | – | – | – | – | – | – | – | – | – | – | – | – | Not for: APAC Line IE2 ⑦ Eagle Line NEE ⑨ |

SIMOTICS GP and SIMOTICS SD standard motors

Article No. supplements and special versions · Types of construction

Aluminum series SIMOTICS GP 1LE10

| Types of construction | Article No. | supplement | Frame size | | | | | | | | | Motor version | | | | | |
|---|---|------------|----------------|--------------|----|----|----------------|---------|-----|-----|-----|---------------|-------|------------|-----|---|---|
| | | | 63 | 71 | 80 | 90 | 100 | 112 | 132 | 160 | 180 | 200 | | | | | |
| | | | | | | | | 1LE1004 | | | | | | IEC | IE4 | ① | |
| | | | | | | | | 1LE1003 | | | | | | | IE3 | ② | |
| | | | | | | | | | | | | | | | | ③ | |
| | | | | | | | | 1LE1083 | | | | | | | IE2 | ④ | |
| | | | | | | | | 1LE1001 | | | | | | | IE1 | ⑤ | |
| | | | | | | | | 1LE1002 | | | | | | | | | |
| | | | | | | | | 1LE1043 | | | | | | APAC | IE3 | ⑥ | |
| | | | | | | | | 1LE1041 | | | | | Line | IE2 | ⑦ | | |
| | | | | | | | | 1LE1023 | | | | | Eagle | NPE (NEMA) | ⑧ | | |
| | | | | | | | | 1LE1021 | | | | | Line | NEE (NEMA) | ⑨ | | |
| | | | | | | | | | | | | | | | | ⑩ | |
| | | | | | | | | 1LE1011 | | | | | | | | | ⑪ |
| | | | | | | | | 1LE1012 | | | | | | | | | |
| 1LE10 (-Z) | | Order code | | | | | | | | | | | | | | | |
| With flange next smallest | EN 50347 DIN 42948 | | FT65 C 80 | FT75 C 90 | - | - | FT115 C 140 | - | - | - | - | - | - | - | - | - | - |
| IM B14 ^{2) 8)} |  | K | P02 | ✓ | ✓ | - | - | ✓ | - | - | - | - | - | - | - | - | Not for: EC IE4 ① IEC IE3 ③ |
| IM V19 ²⁾ |  | L | P02 | ✓ | ✓ | - | - | ✓ | - | - | - | - | - | - | - | - | Not for: IEC IE4 ① IEC IE3 ③ |
| IM V18 without protective cover ²⁾ |  | M | P02 | ✓ | ✓ | - | - | ✓ | - | - | - | - | - | - | - | - | Not for: IEC IE4 ① IEC IE3 ③ |
| IM V18 with protective cover ^{2) 4) 5) 6)} |  | M | P02+H00 | ✓ | ✓ | - | - | ✓ | - | - | - | - | - | - | - | - | Not for: IEC IE4 ① Combination with order code F90 IEC IE3 ③ |
| IM B34 ³⁾ |  | N | P02 | ✓ | ✓ | - | - | ✓ | - | - | - | - | - | - | - | - | Not for: IEC IE4 ① IEC IE3 ③ APAC Line IE2 ⑦ Eagle Line NEE ⑨ |

- Standard version
- ✓ With additional charge
- Not possible

- 1) The types of construction IM B6/7/8, IM V6 and IM V5 with/without protective cover are also possible as long as there are no condensation drainage holes (order code **H03**) and these types of construction do not have to be stamped on the rating plate. As standard the type of construction IM B3 is then stamped on the rating plate. With type of construction IM V5 with protective cover, the protective cover has to be additionally ordered with order code **H00**. The protective cover is not stamped on the rating plate.
- 2) The type of construction is stamped on the rating plate. For orders with condensation drainage holes (order code **H03**), if mounted in a different position, the position must be specified to ensure that the condensation drainage holes are positioned correctly.
- 3) For North America export version Eagle Line 1LE1021 NEMA Energy Efficient, types of construction with feet are not possible for 2-pole, 4-pole and 6-pole motors ≤ 200 hp in accordance with NEMA MG1 Table 12-11.
- 4) The "Standard cylindrical shaft extension (second shaft extension)" option (order code **L05**) is not possible.
- 5) In combination with an encoder, it is not necessary to order the protective cover (order code **H00**), as this is delivered as a protection for the encoder as standard. In this case the protective cover is standard version (without additional charge).
- 6) Not possible for forced-air cooled 1LE1 motors with order code **F90** without external fan and fan cover.
- 7) The types of construction IM V3 and IM V1 with/without protective cover are also possible as long as there are no condensation drainage holes (order code **H03**) and these types of construction do not have to be stamped on the rating plate. As standard the type of construction IM B5 is then stamped on the rating plate. With type of construction IM V1 with protective cover, the protective cover has to be additionally ordered with order code **H00**. The protective cover is not stamped on the rating plate.
- 8) The types of construction IM V19 and IM V18 with/without protective cover are also possible as long as there are no condensation drainage holes (order code **H03**) and these types of construction do not have to be stamped on the rating plate. As standard the type of construction IM B14 is then stamped on the rating plate. With type of construction IM V18 with protective cover, the protective cover has to be additionally ordered with order code **H00**. The protective cover is not stamped on the rating plate.
- 9) When ordering frame size B7 and the required cable outlet below, option **R12** must also be ordered.
- 10) For the standard EN 50347, flanges which are 2 levels larger are used in frame size 80 with option **P01**.

SIMOTICS GP and SIMOTICS SD standard motors

Article No. supplements and special versions · Types of construction

Cast-iron series SIMOTICS SD 1LE15 Basic Line, 1LE16 Performance Line

| Types of construction | Article No. supplement | Frame size | | | | | | | | | | | | | | Motor version | | | | | | | |
|---|------------------------|---------------------|----------------|--------------------|--------------------------|--------------------|--------------------------|----------------|----------------|----------------|----------------|----------------|----------------|----------------|----------------|--------------------|---|------------|---|-----------|-----|-----|---|
| | | 71 | 80 | 90 | 100 | 112 | 132 | 160 | 180 | 200 | 225 | 250 | 280 | 315 S/M | 315 L 2-pole | 315 L 4- to 8-pole | | | | | | | |
| | | | | | 1LE1504 Basic Line | | | | | | | | | | | | | | IEC | IE4 | ① | | |
| | | | | | 1LE1604 Performance Line | | | | | | | | | | | | | | | | ② | | |
| | | | | 1LE1503 Basic Line | | | | | | | | | | | | | | | IE3 | ③ | | | |
| | | | | | | | 1LE1603 Performance Line | | | | | | | | | | | | | | | | ④ |
| | | | | | | | 1LE1583 | | | | | | | | | | | | | | | | ⑤ |
| | | | | 1LE1501 Basic Line | | | | | | | | | | | | | | | IE2 | ⑥ | | | |
| | | | | | | | 1LE1601 Performance Line | | | | | | | | | | | | | | | | ⑦ |
| | | | | | | | 1LE1502 Basic Line | | | | | | | | | | | | | | | IE1 | ⑧ |
| | | | | | | 1LE1543 Basic Line | | | | | | | | | | | | | | APAC Line | IE3 | ⑨ | |
| | | | | | | | 1LE1643 Performance Line | | | | | | | | | | | | | | | | ⑩ |
| | | | | | | | 1LE1541 Basic Line | | | | | | | | | | | | | | | IE2 | ⑪ |
| | | | | 1LE1523 Basic Line | | | | | | | | | | | | | | Eagle Line | NPE (NEMA) | ⑫ | | | |
| | | | | | | | 1LE1623 Performance Line | | | | | | | | | | | | | | | | ⑬ |
| | | | | 1LE1521 Basic Line | | | | | | | | | | | | | | Eagle Line | NEE (NEMA) | ⑭ | | | |
| | | | | | | | | | | | | | | | | | | | | | | | |
| With flange | EN 50347 DIN 42948 | FF130 A 160 | FF165 A 200 | FF165 A 200 | FF215 A 250 | FF215 A 250 | FF265 A 300 | FF300 A 350 | FF300 A 350 | FF350 A 400 | FF400 A 450 | FF500 A 550 | FF500 A 550 | FF600 A 660 | FF600 A 660 | FF600 A 660 | | | | | | | |
| IM B5 2) 6) | F | – | ✓ | ✓ | ✓ | ✓ | ✓ | ✓ | ✓ | ✓ | ✓ | ✓ | ✓ | ✓ | ✓ | ✓ | – | – | | | | | |
| IM V1 without protective cover 2) | G | – | ✓ | ✓ | ✓ | ✓ | ✓ | ✓ | ✓ | ✓ | ✓ | ✓ | ✓ | ✓ | ✓ | ✓ | ✓ | ✓ | | | | | |
| IM V1 with protective cover 2) 4) 5) | G | H00 | ✓ | ✓ | ✓ | ✓ | ✓ | ✓ | ✓ | ✓ | ✓ | ✓ | ✓ | ✓ | ✓ | ✓ | ✓ | ✓ | | | | | |
| IM V3 5) | H | – | ✓ | ✓ | ✓ | ✓ | ✓ | ✓ | ✓ | ✓ | ✓ | ✓ | ✓ | ✓ | ✓ | ✓ | – | – | | | | | |
| IM B35 3) | J | – | ✓ | ✓ | ✓ | ✓ | ✓ | ✓ | ✓ | ✓ | ✓ | ✓ | ✓ | ✓ | ✓ | ✓ | ✓ | ✓ | Not for: ⑩, ⑭ 2, 4, 6-pole ≤ 200 hp; ⑫, ⑬ 8-pole ≤ 200 hp | | | | |
| With flange next largest | EN 50347 DIN 42948 | – | – | FF215 A 250 | FF265 A 300 | FF265 A 300 | FF300 A 350 | – | – | – | – | – | – | – | – | – | – | – | | | | | |
| IM B5 2) 6) | F | P01 | – | – | ✓ | ✓ | ✓ | – | – | – | – | – | – | – | – | – | – | – | | | | | |
| IM V1 without protective cover 2) | G | P01 | – | – | ✓ | ✓ | ✓ | – | – | – | – | – | – | – | – | – | – | – | | | | | |
| IM V1 with protective cover 2) 4) 5) | G | P01+ H00 | – | – | ✓ | ✓ | ✓ | – | – | – | – | – | – | – | – | – | – | – | | | | | |
| IM V3 5) | H | P01 | – | – | ✓ | ✓ | ✓ | – | – | – | – | – | – | – | – | – | – | – | | | | | |
| IM B35 3) | J | P01 | – | – | ✓ | ✓ | ✓ | – | – | – | – | – | – | – | – | – | – | – | Not for: ⑩, ⑭ 2, 4, 6-pole ≤ 200 hp; ⑫, ⑬ 8-pole ≤ 200 hp | | | | |

For legends and footnotes, see page 2/107.

SIMOTICS GP and SIMOTICS SD standard motors

Article No. supplements and special versions · Types of construction

Cast-iron series SIMOTICS SD 1LE15 Basic Line, 1LE16 Performance Line

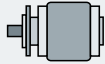
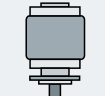
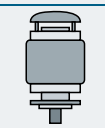
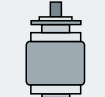
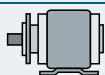
| Types of construction | Article No. supplement | Frame size | Motor version | | | | | | | | | | | | | | | |
|---|------------------------|----------------|--------------------------|----------------|----------------|----------------|----------------|----------------|----------------|-----|-----|-----|-----|-----|---------|--------------|---|-----|
| | | | 71 | 80 | 90 | 100 | 112 | 132 | 160 | 180 | 200 | 225 | 250 | 280 | 315 S/M | 315 L 2-pole | 315 L 4- to 8-pole | IEC |
| | | | 1LE1504 Basic Line | | | | | | | | | | | | | IEC | IE4 | ① |
| | | | 1LE1604 Performance Line | | | | | | | | | | | | | | | ② |
| | | | 1LE1503 Basic Line | | | | | | | | | | | | | | IE3 | ③ |
| | | | 1LE1603 Performance Line | | | | | | | | | | | | | | | ④ |
| | | | 1LE1583 | | | | | | | | | | | | | | | ⑤ |
| | | | 1LE1501 Basic Line | | | | | | | | | | | | | | IE2 | ⑥ |
| | | | 1LE1601 Performance Line | | | | | | | | | | | | | | | ⑦ |
| | | | 1LE1502 Basic Line | | | | | | | | | | | | | | IE1 | ⑧ |
| | | | 1LE1543 Basic Line | | | | | | | | | | | | | APAC Line | IE3 | ⑨ |
| | | | 1LE1643 Performance Line | | | | | | | | | | | | | | | ⑩ |
| | | | 1LE1541 Basic Line | | | | | | | | | | | | | | IE2 | ⑪ |
| | | | 1LE1523 Basic Line | | | | | | | | | | | | | Eagle Line | NPE (NEMA) | ⑫ |
| | | | 1LE1623 Performance Line | | | | | | | | | | | | | | | ⑬ |
| | | | 1LE1521 Basic Line | | | | | | | | | | | | | | NEE (NEMA) | ⑭ |
| 1LE1 | ... (-Z) | Order code | | | | | | | | | | | | | | | | |
| With flange next smallest | EN 50347 DIN 42948 | - | FF130 - A 160 - | FF165 A 200 | FF165 A 200 | FF215 A 250 | FF265 A 300 | FF265 A 300 | FF300 A 350 | - | - | - | - | - | - | - | - | - |
| IM B5 ^{2) 6)}  | F | P02 | - | ✓ | - | ✓ | ✓ | ✓ | ✓ | ✓ | - | - | - | - | - | - | - | - |
| IM V1 without protective cover ²⁾  | G | P02 | - | ✓ | - | ✓ | ✓ | ✓ | ✓ | ✓ | - | - | - | - | - | - | - | - |
| IM V1 with protective cover ^{2) 4) 5)}  | G | P02+H00 | - | ✓ | - | ✓ | ✓ | ✓ | ✓ | ✓ | - | - | - | - | - | - | - | - |
| IM V3 ⁵⁾  | H | P02 | - | ✓ | - | ✓ | ✓ | ✓ | ✓ | ✓ | - | - | - | - | - | - | - | - |
| IM B35 ³⁾  | J | P02 | - | ✓ | - | ✓ | ✓ | ✓ | ✓ | ✓ | - | - | - | - | - | - | - | - |
| | | | | | | | | | | | | | | | | Not for: | ⑫, ⑬ 2, 4, 6-pole ≤ 200 hp; ⑭, ⑮ 8-pole ≤ 200 hp | |



For legends and footnotes, see page 2/107.

SIMOTICS GP and SIMOTICS SD standard motors

Article No. supplements and special versions · Types of construction

Cast-iron series SIMOTICS SD 1LE15 Basic Line, 1LE16 Performance Line



| Types of construction | Article No. supplement | Frame size | | | | | | | | | | | | | Motor version | | | | |
|---|-------------------------------|------------------------|------------------------|------------------------|--------------------------|------------------------|--------------------------|-----|-----|-----|-----|-----------|-----|---------|---------------|--------------------|------------|------------|---|
| | | 71 | 80 | 90 | 100 | 112 | 132 | 160 | 180 | 200 | 225 | 250 | 280 | 315 S/M | 315 L 2-pole | 315 L 4- to 8-pole | | | |
| | | | | | 1LE1504 Basic Line | | | | | | | | | IEC | IE4 | ① | | | |
| | | | | | 1LE1604 Performance Line | | | | | | | | | | | ② | | | |
| | | | | 1LE1503 Basic Line | | | | | | | | | | | | | IE3 | ③ | |
| | | | | | | | 1LE1603 Performance Line | | | | | | | | ④ | | | | |
| | | | | | | | 1LE1583 | | | | | | | | ⑤ | | | | |
| | | | | 1LE1501 Basic Line | | | | | | | | | | | | | IE2 | ⑥ | |
| | | | | | | | 1LE1601 Performance Line | | | | | | | | ⑦ | | | | |
| | | | | | | | 1LE1502 Basic Line | | | | | | IE1 | ⑧ | | | | | |
| | | | | | | 1LE1543 Basic Line | | | | | | APAC Line | IE3 | ⑨ | | | | | |
| | | | | | | | 1LE1643 Performance Line | | | | | | | | ⑩ | | | | |
| | | | | | | | 1LE1541 Basic Line | | | | | | IE2 | ⑪ | | | | | |
| | | | | 1LE1523 Basic Line | | | | | | | | | | | | | Eagle Line | NPE (NEMA) | ⑫ |
| | | | | | | | 1LE1623 Performance Line | | | | | | | | ⑬ | | | | |
| | | | | 1LE1521 Basic Line | | | | | | | | | | | | | Eagle Line | NEE (NEMA) | ⑭ |
| 1LE1 | ... (-Z) | | | | | | | | | | | | | | | | | | |
| With flange | EN 50347 DIN 42948 | FT85 C 105 | FT100 C 120 | FT115 C 140 | FT130 C 160 | FT165 C 200 | FT215 C 250 | - | - | - | - | - | - | - | - | - | - | - | - |
| IM B14 2) 7) | K | - | ✓ | ✓ | ✓ | ✓ | ✓ | ✓ | ✓ | ✓ | ✓ | ✓ | ✓ | ✓ | ✓ | ✓ | ✓ | ✓ | ✓ |
| IM V19 2) | L | - | ✓ | ✓ | ✓ | ✓ | ✓ | ✓ | ✓ | ✓ | ✓ | ✓ | ✓ | ✓ | ✓ | ✓ | ✓ | ✓ | ✓ |
| IM V18 without protective cover 2) | M | - | ✓ | ✓ | ✓ | ✓ | ✓ | ✓ | ✓ | ✓ | ✓ | ✓ | ✓ | ✓ | ✓ | ✓ | ✓ | ✓ | ✓ |
| IM V18 with protective cover 2) 4) 5) | M | H00 | ✓ | ✓ | ✓ | ✓ | ✓ | ✓ | ✓ | ✓ | ✓ | ✓ | ✓ | ✓ | ✓ | ✓ | ✓ | ✓ | ✓ |
| IM B34 3) | N | - | ✓ | ✓ | ✓ | ✓ | ✓ | ✓ | ✓ | ✓ | ✓ | ✓ | ✓ | ✓ | ✓ | ✓ | ✓ | ✓ | ✓ |
| With flange next largest | EN 50347 DIN 42948 | FT115 C 140 | FT130 C 160 | FT130 C 160 | FT165 C 200 | FT165 C 200 | FT215 C 250 | - | - | - | - | - | - | - | - | - | - | - | - |
| IM B14 2) 7) 8) | K | P01 | ✓ | ✓ | ✓ | ✓ | ✓ | ✓ | ✓ | ✓ | ✓ | ✓ | ✓ | ✓ | ✓ | ✓ | ✓ | ✓ | ✓ |
| IM V19 2) 8) | L | P01 | ✓ | ✓ | ✓ | ✓ | ✓ | ✓ | ✓ | ✓ | ✓ | ✓ | ✓ | ✓ | ✓ | ✓ | ✓ | ✓ | ✓ |
| IM V18 without protective cover 2) 8) | M | P01 | ✓ | ✓ | ✓ | ✓ | ✓ | ✓ | ✓ | ✓ | ✓ | ✓ | ✓ | ✓ | ✓ | ✓ | ✓ | ✓ | ✓ |
| IM V18 with protective cover 2) 4) 5) 8) | M | P01+ H00 | ✓ | ✓ | ✓ | ✓ | ✓ | ✓ | ✓ | ✓ | ✓ | ✓ | ✓ | ✓ | ✓ | ✓ | ✓ | ✓ | ✓ |
| IM B34 3) 8) | N | P01 | ✓ | ✓ | ✓ | ✓ | ✓ | ✓ | ✓ | ✓ | ✓ | ✓ | ✓ | ✓ | ✓ | ✓ | ✓ | ✓ | ✓ |
| | | | | | | | | | | | | | | | | | | | Not for: ⑪, ⑬, ⑭ 2, 4, 6-pole ≤ 200 hp; ⑫, ⑯ 8-pole ≤ 200 hp |

For legends and footnotes, see page 2/107.

SIMOTICS GP and SIMOTICS SD standard motors

Article No. supplements and special versions · Types of construction

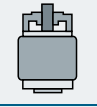
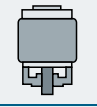
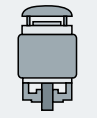
Cast-iron series SIMOTICS SD 1LE15 Basic Line, 1LE16 Performance Line

| Types of construction | Article No. supplement | Frame size | | | | | | | | | | | | | Motor version | | | | | | | |
|---------------------------------------|---|------------|---------------------|--------------------|--------------------------|--------------------|--------------------------|-----|-----|-----|-----|-----|-----|---------|---------------|--------------------|------------|------------|-----------|-----------|-----|---|
| | | 71 | 80 | 90 | 100 | 112 | 132 | 160 | 180 | 200 | 225 | 250 | 280 | 315 S/M | 315 L 2-pole | 315 L 4- to 8-pole | | | | | | |
| | | | | | 1LE1504 Basic Line | | | | | | | | | | | | | IEC | IE4 | ① | | |
| | | | | | 1LE1604 Performance Line | | | | | | | | | | | | | | | ② | | |
| | | | | 1LE1503 Basic Line | | | | | | | | | | | | | | IE3 | ③ | | | |
| | | | | | | | 1LE1603 Performance Line | | | | | | | | | | | | | | | ④ |
| | | | | | | | 1LE1583 | | | | | | | | | | | | | | | ⑤ |
| | | | | 1LE1501 Basic Line | | | | | | | | | | | | | | IE2 | ⑥ | | | |
| | | | | | | | 1LE1601 Performance Line | | | | | | | | | | | | | | | ⑦ |
| | | | | | | | 1LE1502 Basic Line | | | | | | | | | | | | | | IE1 | ⑧ |
| | | | | | | 1LE1543 Basic Line | | | | | | | | | | | | | | IE3 | ⑨ | |
| | | | | | | | 1LE1643 Performance Line | | | | | | | | | | | | | APAC Line | | ⑩ |
| | | | | | | | 1LE1541 Basic Line | | | | | | | | | | | | | | IE2 | ⑪ |
| | | | | 1LE1523 Basic Line | | | | | | | | | | | | | Eagle Line | NPE (NEMA) | ⑫ | | | |
| | | | | | | | 1LE1623 Performance Line | | | | | | | | | | | | | | | ⑬ |
| | | | | 1LE1521 Basic Line | | | | | | | | | | | | | | NEE (NEMA) | ⑭ | | | |
| 1LE1 | ... (-Z) | Order code | | | | | | | | | | | | | | | | | | | | |
| With flange next smallest | EN 50347 DIN 42948 | | - | - | - | FT115 | - | - | - | - | - | - | - | - | - | - | - | - | | | | |
| | | | - | - | - | C 140 | - | - | - | - | - | - | - | - | - | - | - | - | | | | |
| IM B14 2) 7) |  | K | P02 | - | - | - | ✓ | - | - | - | - | - | - | - | - | - | - | Not for: | IEC IE3 ⑤ | | | |
| IM V19 2) |  | L | P02 | - | - | - | ✓ | - | - | - | - | - | - | - | - | - | - | Not for: | IEC IE3 ⑤ | | | |
| IM V18 without protective cover 2) |  | M | P02 | - | - | - | ✓ | - | - | - | - | - | - | - | - | - | - | Not for: | IEC IE3 ⑤ | | | |
| IM V18 with protective cover 2) 4) 5) |  | M | P02+ H00 | - | - | - | ✓ | - | - | - | - | - | - | - | - | - | - | Not for: | IEC IE3 ⑤ | | | |
| IM B34 3) |  | N | P02 | - | - | - | ✓ | - | - | - | - | - | - | - | - | - | - | Not for: | IEC IE3 ⑤ | | | |

- Standard version
- ✓ With additional charge
- O. R. Possible on request
- Not possible

- 1) The types of construction IM B6/7/8, IM V6 and IM V5 with/without protective cover are also possible as long as no stamping of these types of construction on the rating plate is required. As standard the type of construction IM B3 is then stamped on the rating plate. With type of construction IM V5 with protective cover, the protective cover has to be additionally ordered with order code **H00**. The protective cover is not stamped on the rating plate.
- 2) The type of construction is stamped on the rating plate. If mounted in a different position, the position must be specified to ensure that the condensation drainage holes are positioned correctly.
- 3) For North America export version Eagle Line 1LE1521 NEMA Energy Efficient, types of construction with feet are not possible for 2-pole, 4-pole and 6-pole motors ≤ 200 hp in accordance with NEMA MG1 Table 12-11.
- 4) In combination with an encoder, it is not necessary to order the protective cover (order code **H00**), as this is delivered as a protection for the encoder as standard. In this case the protective cover is standard design (without additional charge).
- 5) The "Standard cylindrical shaft extension (second shaft extension)" option (order code **L05**) is not possible.
- 6) The types of construction IM V3 and IM V1 with/without protective cover are also possible as long as no stamping of these types of construction on the rating plate is required. As standard the type of construction IM B5 is then stamped on the rating plate. With type of construction IM V1 with protective cover, the protective cover has to be additionally ordered with order code **H00**. The protective cover is not stamped on the rating plate.
- 7) The types of construction IM V19 and IM V18 with/without protective cover are also possible as long as no stamping of these types of construction on the rating plate is required. As standard the type of construction IM B14 is then stamped on the rating plate. With type of construction IM V18 with protective cover, the protective cover has to be additionally ordered with order code **H00**. The protective cover is not stamped on the rating plate.
- 8) With reference to standard EN 50347, flanges that are 2 levels larger are used with option **P01** in the frame sizes 71 and 80.
- 9) When ordering frame size B7 and the required cable outlet below, option **R12** must also be ordered.















SIMOTICS GP and SIMOTICS SD standard motors

Article No. supplements and special versions · Types of construction

Aluminum series SIMOTICS GP 1LE1073 and cast-iron series SIMOTICS SD 1LE1573, 1LE5773

Selection and ordering data







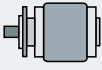

| Types of construction | Article No. supplement | For types of construction with order code(s) | Frame size | | | | | | | | | | | Motor version | | |
|--|--|--|------------|-------|-------|-------|---------|-------|-------|-------|---------|-------|-------|---------------|-----|-----|
| | | | 80 | 90 | 100 | 112 | 132 | 160 | 180 | 200 | 225 | 250 | 280 | 315 | IEC | IE3 |
| | | | 1LE1073 | | | | 1LE1573 | | | | 1LE5773 | | | | | |
| | 1LE.....-Z | Order code | | | | | | | | | | | | | | |
| Without flange | | | | | | | | | | | | | | | | |
| IM B3 ^{1) 2)} |  A | - | □ | □ | □ | □ | □ | □ | □ | □ | □ | □ | □ | □ | □ | |
| IM B6 ²⁾ |  T | - | □ | □ | □ | □ | □ | □ | □ | □ | □ | □ | □ | □ | □ | |
| IM B7 ^{2) 8)} |  U | - | □ | □ | □ | □ | □ | □ | □ | □ | □ | □ | □ | □ | □ | |
| IM B8 ²⁾ |  V | - | □ | □ | □ | □ | □ | □ | □ | □ | □ | □ | □ | □ | □ | |
| IM V6 ²⁾ |  D | - | □ | □ | □ | □ | □ | □ | □ | □ | □ | □ | □ | □ | □ | |
| IM V5 without protective cover ²⁾ |  C | - | □ | □ | □ | □ | □ | □ | □ | □ | □ | □ | □ | □ | □ | |
| IM V5 with protective cover ^{2) 3) 4) 5)} |  C | H00 | ✓ | ✓ | ✓ | ✓ | ✓ | ✓ | ✓ | ✓ | ✓ | ✓ | ✓ | ✓ | ✓ | |
| With flange | | | | | | | | | | | | | | | | |
| | EN 50347 | | FF165 | FF165 | FF215 | FF215 | FF265 | FF300 | FF300 | FF350 | FF400 | FF500 | FF500 | FF600 | | |
| | DIN 42948 | | A 200 | A 200 | A 250 | A 250 | A 300 | A 350 | A 350 | A 400 | A 450 | A 550 | A 550 | A 660 | | |
| IM B5 ^{2) 6)} |  F | - | ✓ | ✓ | ✓ | ✓ | ✓ | ✓ | ✓ | ✓ | ✓ | ✓ | ✓ | ✓ | ✓ | |
| IM V1 without protective cover ²⁾ |  G | - | ✓ | ✓ | ✓ | ✓ | ✓ | ✓ | ✓ | ✓ | ✓ | ✓ | ✓ | ✓ | ✓ | |
| IM V1 with protective cover ^{2) 3) 4) 5)} |  G | H00 | - | - | ✓ | ✓ | ✓ | ✓ | ✓ | ✓ | ✓ | ✓ | ✓ | ✓ | ✓ | |
| IM V3 ³⁾ |  H | - | ✓ | ✓ | ✓ | ✓ | ✓ | ✓ | ✓ | ✓ | ✓ | ✓ | ✓ | ✓ | ✓ | |
| IM B35 |  J | - | ✓ | ✓ | ✓ | ✓ | ✓ | ✓ | ✓ | ✓ | ✓ | ✓ | ✓ | ✓ | ✓ | |

For legends and footnotes, see page 2/111.

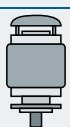
SIMOTICS GP and SIMOTICS SD standard motors

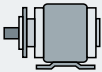
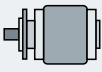
Article No. supplements and special versions · Types of construction

Aluminum series SIMOTICS GP 1LE1073 and cast-iron series SIMOTICS SD 1LE1573, 1LE5773

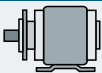









| Types of construction | Article No. | supplement | Frame size | | | | | | | | | | | Motor version | |
|--|---|--|----------------|-------|-------|-------|---------|-------|-------|-------|---------|-----|-----|---------------|-----|
| | | | 80 | 90 | 100 | 112 | 132 | 160 | 180 | 200 | 225 | 250 | 280 | 315 | IEC |
| | | For types of construction with order code(s) Article No. with additional identification code -Z Order code | 1LE1073 | | | | 1LE1573 | | | | 1LE5773 | | | IEC | IE3 |
| 1LE.....-.....-...(-Z) | | | | | | | | | | | | | | | |
| With flange next largest | EN 50347 DIN 42948 | | - | FF215 | FF265 | FF265 | FF300 | - | - | - | - | - | - | - | - |
| | | | - | A 250 | A 300 | A 300 | A 350 | - | - | - | - | - | - | - | - |
| IM B5 ^{2) 6)} |  | F | P01 | - | ✓ | ✓ | ✓ | ✓ | - | - | - | - | - | - | - |
| IM V1 without protective cover ²⁾ |  | G | P01 | - | ✓ | ✓ | ✓ | ✓ | - | - | - | - | - | - | - |
| IM V1 with protective cover ^{2) 3) 4) 5)} |  | G | P01+H00 | - | ✓ | ✓ | ✓ | ✓ | - | - | - | - | - | - | - |
| IM V3 ³⁾ |  | H | P01 | - | ✓ | ✓ | ✓ | ✓ | - | - | - | - | - | - | - |
| IM B35 |  | J | P01 | - | ✓ | ✓ | ✓ | ✓ | - | - | - | - | - | - | - |
| With flange next smallest | EN 50347 DIN 42948 | | | FF130 | - | FF165 | FF165 | FF215 | FF265 | FF265 | FF300 | - | - | - | - |
| | | | | A 160 | - | A 200 | A 200 | A 250 | A 300 | A 300 | A 350 | - | - | - | - |
| IM B5 ^{2) 6)} |  | F | P02 | ✓ | - | ✓ | ✓ | ✓ | ✓ | ✓ | ✓ | - | - | - | - |
| IM V1 without protective cover ²⁾ |  | G | P02 | ✓ | - | ✓ | ✓ | ✓ | ✓ | ✓ | ✓ | - | - | - | - |
| IM V1 with protective cover ^{2) 3) 4) 5)} |  | G | P02+H00 | ✓ | - | ✓ | ✓ | ✓ | ✓ | ✓ | ✓ | - | - | - | - |
| IM V3 ³⁾ |  | H | P02 | ✓ | - | ✓ | ✓ | ✓ | ✓ | ✓ | ✓ | - | - | - | - |
| IM B35 |  | J | P02 | ✓ | - | ✓ | ✓ | ✓ | ✓ | ✓ | ✓ | - | - | - | - |

For legends and footnotes, see page 2/111.

SIMOTICS GP and SIMOTICS SD standard motors

Article No. supplements and special versions · Types of construction

Aluminum series SIMOTICS GP 1LE1073 and cast-iron series SIMOTICS SD 1LE1573, 1LE5773

| Types of construction | Article No. supplement | Type of construction code letter 14th position of the Article No. | For types of construction with order code(s) Article No. with additional identification code -Z Order code | Frame size | | | | | | | | | | | Motor version | |
|---|---|--|--|--------------|--------------|--------------|--------------|--------------|--------------|-----|-----|---------|-----|-----|---------------|-----|
| | | | | 80 | 90 | 100 | 112 | 132 | 160 | 180 | 200 | 225 | 250 | 280 | 315 | IEC |
| | | | | 1LE1073 | | | | 1LE1573 | | | | 1LE5773 | | | | |
| 1LE.....-.....-...(-Z) | | | | | | | | | | | | | | | | |
| With flange | EN 50347 | | | FT100 | FT115 | FT130 | FT130 | FT165 | FT215 | - | - | - | - | - | - | |
| | DIN 42948 | | | C 120 | C 140 | C 160 | C 160 | C 200 | C 250 | - | - | - | - | - | - | |
| IM B14 ^{2) 7)} |  | K | - | ✓ | ✓ | ✓ | ✓ | ✓ | ✓ | - | - | - | - | - | - | |
| IM V19 ²⁾ |  | L | - | ✓ | ✓ | ✓ | ✓ | ✓ | ✓ | - | - | - | - | - | - | |
| IM V18 without protective cover ²⁾ |  | M | - | ✓ | ✓ | ✓ | ✓ | ✓ | ✓ | - | - | - | - | - | - | |
| IM V18 with protective cover ^{2) 3) 4) 5)} |  | M | H00 | ✓ | ✓ | ✓ | ✓ | ✓ | ✓ | - | - | - | - | - | - | |
| IM B34 |  | N | - | ✓ | ✓ | ✓ | ✓ | ✓ | ✓ | - | - | - | - | - | - | |
| With flange next largest ⁹⁾ | EN 50347 | | | FT130 | FT130 | FT165 | FT165 | FT215 | - | - | - | - | - | - | - | |
| | DIN 42948 | | | C 160 | C 160 | C 200 | C 200 | C 250 | - | - | - | - | - | - | - | |
| IM B14 ^{2) 7)} |  | K | P01 | ✓ | ✓ | ✓ | ✓ | ✓ | - | - | - | - | - | - | - | |
| IM V19 ²⁾ |  | L | P01 | ✓ | ✓ | ✓ | ✓ | ✓ | - | - | - | - | - | - | - | |
| IM V18 without protective cover ²⁾ |  | M | P01 | ✓ | ✓ | ✓ | ✓ | ✓ | - | - | - | - | - | - | - | |
| IM V18 with protective cover ^{2) 3) 4) 5)} |  | M | P01+H00 | ✓ | ✓ | ✓ | ✓ | ✓ | - | - | - | - | - | - | - | |
| IM B34 |  | N | P01 | ✓ | ✓ | ✓ | ✓ | ✓ | - | - | - | - | - | - | - | |

For legends and footnotes, see page 2/111.

SIMOTICS GP and SIMOTICS SD standard motors

Article No. supplements and special versions · Motor protection

Aluminum series SIMOTICS GP 1LE10

Selection and ordering data

| Motor protection | Article No. | supplement | Frame size | | | | | | | | | | Motor version | | | | |
|------------------|-----------------|------------|------------|----|----|----|-----|---------|-----|-----|-----|-----|---------------|------------|---------------|-----|---|
| | | | 63 | 71 | 80 | 90 | 100 | 112 | 132 | 160 | 180 | 200 | | | | | |
| | | | | | | | | 1LE1004 | | | | | | | IEC | IE4 | ① |
| | | | | | | | | 1LE1003 | | | | | | | | IE3 | ② |
| | | | | | | | | 1LE1083 | | | | | | | | | ③ |
| | | | | | | | | 1LE1001 | | | | | | | | IE2 | ④ |
| | | | | | | | | 1LE1002 | | | | | | | | IE1 | ⑤ |
| | | | | | | | | 1LE1043 | | | | | | | APAC Line | IE3 | ⑥ |
| | | | | | | | | 1LE1041 | | | | | | | | IE2 | ⑦ |
| | | | | | | | | 1LE1023 | | | | | | Eagle Line | NPE (NEMA) | | ⑧ |
| | | | | | | | | 1LE1021 | | | | | | | NEE (NEMA) | | ⑨ |
| | | | | | | | | 1LE1011 | | | | | | | Pole-changing | | ⑩ |
| | | | | | | | | 1LE1012 | | | | | | | | | ⑪ |
| | 1LE10 | | | | | | | | | | | | | | | | |
| | | Order code | | | | | | | | | | | | | | | |

| Motor protection | | | | | | | | | | | | | | | | | |
|---|---|-----|---|---|---|---|---|---|---|---|---|---|---|-----------|---------|---|--|
| None (standard) | A | - | ☐ | ☐ | ☐ | ☐ | ☐ | ☐ | ☐ | ☐ | ☐ | ☐ | ☐ | | | | |
| 1 or 3 PTC thermistors – for tripping (2 terminals) ¹⁾ | B | - | ✓ | ✓ | ✓ | ✓ | ✓ | ✓ | ✓ | ✓ | ✓ | ✓ | ✓ | | | | |
| 2 or 6 PTC thermistors – for alarm and tripping (4 terminals) ¹⁾ | C | - | ✓ | ✓ | ✓ | ✓ | ✓ | ✓ | ✓ | ✓ | ✓ | ✓ | ✓ | | | | |
| 1 KTY84-130 temperature sensor (2 terminals) ¹⁾ | F | - | ✓ | ✓ | ✓ | ✓ | ✓ | ✓ | ✓ | ✓ | ✓ | ✓ | ✓ | | | | |
| 2 KTY84-130 temperature sensors (4 terminals) ¹⁾ | G | - | ✓ | ✓ | ✓ | ✓ | ✓ | ✓ | ✓ | ✓ | ✓ | ✓ | ✓ | | | | |
| 3 Pt100 resistance thermometers – 2-wire input (6 terminals) ¹⁾ | H | - | - | - | - | - | ✓ | ✓ | ✓ | ✓ | ✓ | ✓ | ✓ | | | | |
| 6 Pt100 resistance thermometers – 2-wire input (12 terminals) | J | - | - | - | - | - | ✓ | ✓ | ✓ | ✓ | ✓ | ✓ | ✓ | Only for: | IEC IE3 | ③ | |
| 1 Pt1000 resistance thermometer (2 terminals) ²⁾ | K | - | ✓ | ✓ | ✓ | ✓ | ✓ | ✓ | ✓ | ✓ | ✓ | ✓ | ✓ | | | | |
| 2 Pt1000 resistance thermometers (4 terminals) ²⁾ | L | - | ✓ | ✓ | ✓ | ✓ | ✓ | ✓ | ✓ | ✓ | ✓ | ✓ | ✓ | | | | |
| 1 Pt100 resistance thermometer – 2-wire input (2 terminals) | P | - | - | - | - | - | ✓ | ✓ | ✓ | ✓ | ✓ | ✓ | ✓ | | | | |
| 3 Pt100 resistance thermometers – 3-wire input (9 terminals) | Q | - | - | - | - | - | ✓ | ✓ | ✓ | ✓ | ✓ | ✓ | ✓ | | | | |
| 6 Pt100 resistance thermometers – 3-wire input (18 terminals) | R | - | - | - | - | - | ✓ | ✓ | ✓ | ✓ | ✓ | ✓ | ✓ | | | | |
| 3 NTC thermistors – for tripping (6 terminals) ¹⁾ | Z | Q2A | - | - | - | - | ✓ | ✓ | ✓ | ✓ | ✓ | ✓ | ✓ | | | | |
| 3 bimetal sensors (NC contacts) – for tripping (2 terminals) ¹⁾ | Z | Q3A | ✓ | ✓ | ✓ | ✓ | ✓ | ✓ | ✓ | ✓ | ✓ | ✓ | ✓ | | | | |

- ☐ Standard version
 ✓ With additional charge
 – Not possible

¹⁾ Evaluation with appropriate tripping unit (see Catalog IC 10) is recommended. For pole-changing motors with two separate windings, double the number of temperature sensors or temperature detectors is required. This also results in a double additional charge.

²⁾ Not UL-certified. Not in combination with option D31.

SIMOTICS GP and SIMOTICS SD standard motors

Article No. supplements and special versions · Motor protection

Cast-iron series SIMOTICS SD 1LE15 Basic Line, 1LE16 Performance Line

Selection and ordering data

| Motor protection | Article No. | supplement | Frame size | | | | | | | | | | | | | Motor version | | |
|-----------------------|-------------|------------|--------------------------|----|----|--------------------------|-----|-----|-----|-----|-----|-----|-----|-----|-----|---------------|------------|--------------|
| | | | 71 | 80 | 90 | 100 | 112 | 132 | 160 | 180 | 200 | 225 | 250 | 280 | 315 | | | |
| | | | | | | 1LE1504 Basic Line | | | | | | | | | | IEC | IE4 | ① |
| | | | | | | 1LE1604 Performance Line | | | | | | | | | | | | ② |
| | | | 1LE1503 Basic Line | | | | | | | | | | | | | IE3 | ③ | |
| | | | 1LE1603 Performance Line | | | | | | | | | | | | | | ④ | |
| | | | 1LE1583 | | | | | | | | | | | | | ⑤ | | |
| | | | 1LE1501 Basic Line | | | | | | | | | | | | | IE2 | ⑥ | |
| | | | 1LE1601 Performance Line | | | | | | | | | | | | | | ⑦ | |
| | | | 1LE1502 Basic Line | | | | | | | | | | | | | IE1 | ⑧ | |
| | | | 1LE1543 Basic Line | | | | | | | | | | | | | | APAC Line | ⑨ |
| | | | 1LE1643 Performance Line | | | | | | | | | | | | | ⑩ | | |
| | | | 1LE1541 Basic Line | | | | | | | | | | | | | IE2 | ⑪ | |
| | | | 1LE1523 Basic Line | | | | | | | | | | | | | | Eagle Line | NPE (NEMA) ⑫ |
| | | | 1LE1623 Performance Line | | | | | | | | | | | | | ⑬ | | |
| | | | 1LE1521 Basic Line | | | | | | | | | | | | | NEE (NEMA) ⑭ | | |
| 1LE1 | | | | | | | | | | | | | | | | | | |
| | | Order code | | | | | | | | | | | | | | | | |

| Motor protection | | | | | | | | | | | | | | | | | |
|--|----------|------------|---|---|---|---|---|---|---|---|---|---|---|---|---|---|---|
| Without (standard) ¹⁾ | A | – | □ | □ | □ | □ | □ | □ | □ | □ | □ | □ | □ | □ | □ | □ | Only for: Basic Line ①, ③, ⑥, ⑧, ⑨, ⑪, ⑫, ⑭ |
| 1 or 3 PTC thermistors – for tripping (2 terminals) ^{1) 2)} | B | – | ✓ | ✓ | ✓ | ✓ | ✓ | ✓ | ✓ | ✓ | ✓ | ✓ | ✓ | ✓ | ✓ | ✓ | Only for: Basic Line ①, ③, ⑥, ⑧, ⑨, ⑪, ⑫, ⑭ |
| | | | □ | □ | □ | □ | □ | □ | □ | □ | □ | □ | □ | □ | □ | □ | Only for: Performance Line ②, ④, ⑦, ⑩, ⑬ |
| 2 or 6 PTC thermistors – for alarm and tripping (4 terminals) ²⁾ | C | – | ✓ | ✓ | ✓ | ✓ | ✓ | ✓ | ✓ | ✓ | ✓ | ✓ | ✓ | ✓ | ✓ | ✓ | |
| 1 KTY84-130 temperature sensor (2 terminals) ²⁾ | F | – | ✓ | ✓ | ✓ | ✓ | ✓ | ✓ | ✓ | ✓ | ✓ | ✓ | ✓ | ✓ | ✓ | ✓ | |
| 2 KTY84-130 temperature sensors (4 terminals) ²⁾ | G | – | ✓ | ✓ | ✓ | ✓ | ✓ | ✓ | ✓ | ✓ | ✓ | ✓ | ✓ | ✓ | ✓ | ✓ | |
| 3 Pt100 resistance thermometers – 2-wire input (6 terminals) | H | – | ✓ | ✓ | ✓ | ✓ | ✓ | ✓ | ✓ | ✓ | ✓ | ✓ | ✓ | ✓ | ✓ | ✓ | |
| 6 Pt100 resistance thermometers – 2-wire input (12 terminals) | J | – | – | – | – | – | – | – | – | ✓ | ✓ | ✓ | ✓ | ✓ | ✓ | ✓ | |
| 1 Pt1000 resistance thermometers (2 terminals) ³⁾ | K | – | ✓ | ✓ | ✓ | ✓ | ✓ | ✓ | ✓ | ✓ | ✓ | ✓ | ✓ | ✓ | ✓ | ✓ | |
| 2 Pt1000 resistance thermometers (4 terminals) ³⁾ | L | – | ✓ | ✓ | ✓ | ✓ | ✓ | ✓ | ✓ | ✓ | ✓ | ✓ | ✓ | ✓ | ✓ | ✓ | |
| 1 Pt100 resistance thermometer – 2-wire input (2 terminals) | P | – | – | – | – | ✓ | ✓ | ✓ | ✓ | ✓ | ✓ | ✓ | ✓ | ✓ | ✓ | ✓ | |
| 3 Pt100 resistance thermometers – 3-wire input (9 terminals) | Q | – | – | – | – | ✓ | ✓ | ✓ | ✓ | ✓ | ✓ | ✓ | ✓ | ✓ | ✓ | ✓ | |
| 6 Pt100 resistance thermometers – 3-wire input (18 terminals) | R | – | – | – | – | ✓ | ✓ | ✓ | ✓ | ✓ | ✓ | ✓ | ✓ | ✓ | ✓ | ✓ | |
| 3 NTC thermistors – for tripping (6 terminals) | Z | Q2A | ✓ | ✓ | ✓ | ✓ | ✓ | ✓ | ✓ | – | – | – | – | – | – | – | |
| 3 bimetal sensors (NC contacts) – for tripping (2 terminals) ²⁾ | Z | Q3A | ✓ | ✓ | ✓ | ✓ | ✓ | ✓ | ✓ | ✓ | ✓ | ✓ | ✓ | ✓ | ✓ | ✓ | |
| 6 bimetal sensors (NC contacts) for alarm and tripping (4 terminals) ²⁾ | Z | Q9A | – | – | – | ✓ | ✓ | ✓ | ✓ | ✓ | ✓ | ✓ | ✓ | ✓ | ✓ | ✓ | |

- Standard version
- ✓ With additional charge
- Not possible

Note:

Options are available specifically for bearing protection – for order codes and descriptions, see from page 2/125.

¹⁾ For the Performance Line, motor protection by means of PTC thermistors with 3 built-in temperature sensors for tripping (motor protection code letter B) is already included in the basic price. For the Performance Line, the option "Without motor protection" (motor protection code letter A) is not possible.

²⁾ Evaluation with appropriate tripping unit (see Catalog IC 10) is recommended.

³⁾ Not UL-certified. Not in combination with option **D31**.

SIMOTICS GP and SIMOTICS SD standard motors

Article No. supplements and special versions · Motor protection

Aluminum series SIMOTICS GP 1LE1073 and cast-iron series SIMOTICS SD 1LE1573, 1LE5773

Selection and ordering data

| Motor protection | Article No. | supplement | Frame size | | | | | | | | | | | | | Motor version | |
|------------------|-------------|------------|-----------------------|----|-----|-----|-----|-----|---------|-----|-----|-----|---------|-----|-----|---------------|--|
| | | | 80 | 90 | 100 | 112 | 132 | 160 | 180 | 200 | 225 | 250 | 280 | 315 | IEC | IE3 | |
| | | | 1LE1073 | | | | | | 1LE1573 | | | | 1LE5773 | | | | |
| | | | 1LE.....-.....-...-.. | | | | | | | | | | | | | | |

| Motor protection | Article No. | supplement | 80 | 90 | 100 | 112 | 132 | 160 | 180 | 200 | 225 | 250 | 280 | 315 |
|--|-------------|------------|----|----|-----|-----|-----|-----|-----|-----|-----|-----|-----|-----|
| None (standard) | A | – | □ | □ | □ | □ | □ | □ | □ | □ | □ | □ | □ | □ |
| 1 or 3 PTC thermistors – for tripping (2 terminals) ¹⁾ | B | – | ✓ | ✓ | ✓ | ✓ | ✓ | ✓ | ✓ | ✓ | ✓ | ✓ | ✓ | ✓ |
| 2 or 6 PTC thermistors – for alarm and tripping (4 terminals) ¹⁾ | C | – | ✓ | ✓ | ✓ | ✓ | ✓ | ✓ | ✓ | ✓ | ✓ | ✓ | ✓ | ✓ |
| 1 KTY84-130 temperature sensor (2 terminals) ¹⁾ | F | – | ✓ | ✓ | ✓ | ✓ | ✓ | ✓ | ✓ | ✓ | ✓ | ✓ | ✓ | ✓ |
| 2 KTY84-130 temperature sensors (4 terminals) ¹⁾ | G | – | ✓ | ✓ | ✓ | ✓ | ✓ | ✓ | ✓ | ✓ | ✓ | ✓ | ✓ | ✓ |
| 3 Pt100 resistance thermometers – 2-wire input (6 terminals) | H | – | – | – | ✓ | ✓ | ✓ | ✓ | ✓ | ✓ | ✓ | ✓ | ✓ | ✓ |
| 6 Pt100 resistance thermometers – 2-wire input (12 terminals) | J | – | – | – | – | – | – | – | ✓ | ✓ | ✓ | ✓ | ✓ | ✓ |
| 1 Pt1000 resistance thermometer (2 terminals) ²⁾ | K | – | ✓ | ✓ | ✓ | ✓ | ✓ | ✓ | ✓ | ✓ | ✓ | ✓ | ✓ | ✓ |
| 2 Pt1000 resistance thermometers (4 terminals) ²⁾ | L | – | ✓ | ✓ | ✓ | ✓ | ✓ | ✓ | ✓ | ✓ | ✓ | ✓ | ✓ | ✓ |
| 1 Pt100 resistance thermometer – 2-wire input (2 terminals) | P | – | – | – | ✓ | ✓ | ✓ | ✓ | ✓ | ✓ | ✓ | ✓ | ✓ | ✓ |
| 3 Pt100 resistance thermometers – 3-wire input (9 terminals) | Q | – | – | – | ✓ | ✓ | ✓ | ✓ | ✓ | ✓ | ✓ | ✓ | ✓ | ✓ |
| 6 Pt100 resistance thermometers – 3-wire input (18 terminals) | R | – | – | – | ✓ | ✓ | ✓ | ✓ | ✓ | ✓ | ✓ | ✓ | ✓ | ✓ |
| 3 NTC thermistors – for tripping (6 terminals) | Z | Q2A | – | – | ✓ | ✓ | ✓ | ✓ | – | – | – | – | – | – |
| 3 bimetal sensors (NC contacts) – for tripping (2 terminals) ¹⁾ | Z | Q3A | ✓ | ✓ | ✓ | ✓ | ✓ | ✓ | ✓ | ✓ | ✓ | ✓ | ✓ | ✓ |
| 6 bimetal sensors (NC contacts) for alarm and tripping (4 terminals) ¹⁾ | Z | Q9A | – | – | ✓ | ✓ | ✓ | ✓ | ✓ | ✓ | ✓ | ✓ | ✓ | ✓ |

- Standard version
- ✓ With additional charge
- Not possible

Note:

Options are available specifically for bearing protection – for order codes and descriptions, see from page 2/125.

¹⁾ Evaluation with appropriate tripping unit (see Catalog IC 10) is recommended.

²⁾ Not UL-certified. Not in combination with option D31.

SIMOTICS GP and SIMOTICS SD standard motors

Article No. supplements and special versions · Terminal box position

Aluminum series SIMOTICS GP 1LE10

Selection and ordering data

| Terminal box position | Article No. supplement | Frame size | | | | | | | | | | | Motor version | | | |
|--|---|---|----|----|----|-----|-----|-----|-----|-----|-----|---|---------------|---------------|------------|---|
| | | 63 | 71 | 80 | 90 | 100 | 112 | 132 | 160 | 180 | 200 | | | | | |
| | Terminal box position code 16th position of the Article No. | Additional identification code with order code and plain text if required | | | | | | | | | | | IEC | IE4 | ① | |
| | | 1LE1004 | | | | | | | | | | | | IE3 | ② | |
| | | 1LE1003 | | | | | | | | | | | | IE2 | ③ | |
| | | 1LE1083 | | | | | | | | | | | | IE1 | ④ | |
| | | 1LE1001 | | | | | | | | | | | | IE1 | ⑤ | |
| | | 1LE1002 | | | | | | | | | | | | APAC Line | IE3 | ⑥ |
| | | 1LE1043 | | | | | | | | | | | | IE2 | ⑦ | |
| | | 1LE1041 | | | | | | | | | | | | Eagle Line | NPE (NEMA) | ⑧ |
| | | 1LE1023 | | | | | | | | | | | | NEE (NEMA) | ⑨ | |
| | | 1LE1021 | | | | | | | | | | | | Pole-changing | ⑩ | |
| 1LE1011 | | | | | | | | | | | | ⑪ | | | | |
| 1LE1012 | | | | | | | | | | | | | | | | |
| Order code | | | | | | | | | | | | | | | | |
| 1LE10 | | | | | | | | | | | | | | | | |
| Terminal box position | | | | | | | | | | | | | | | | |
| Terminal box top ¹⁾ | 4 | - | □ | □ | □ | □ | □ | □ | □ | □ | □ | □ | □ | | | |
| Terminal box right-hand side ²⁾ | 5 | - | - | - | ✓ | ✓ | ✓ | ✓ | ✓ | ✓ | ✓ | ✓ | ✓ | | | |
| Terminal box left-hand side ²⁾ | 6 | - | - | - | ✓ | ✓ | ✓ | ✓ | ✓ | ✓ | ✓ | ✓ | ✓ | | | |
| Terminal box at bottom ^{2) 3)} | 7 | - | - | - | - | - | ✓ | ✓ | ✓ | ✓ | - | - | - | | | |

- Standard version
- ✓ With additional charge
- Not possible



¹⁾ For types of construction with feet up to and including frame size 160, cast feet are standard. Screwed-on feet are available with order code **H01**. Frame sizes 180 and 200 are fitted as standard with screwed-on feet.

²⁾ For types of construction with feet, screwed-on feet are standard.

³⁾ Not generally possible for motors with feet.

SIMOTICS GP and SIMOTICS SD standard motors

Article No. supplements and special versions · Terminal box position

Cast-iron series SIMOTICS SD 1LE15 Basic Line, 1LE16 Performance Line

2

Selection and ordering data

| Terminal box position | | Article No. supplement | | Frame size | | | | | | | | | | | | | Motor version | | | |
|---|-----------------------|---|---|--------------------------|----|----|-----|-----|-----|-----|-----|-----|-----|-----|-----|-----|---------------|--------------|---------------|--------------|
| | | Terminal box position code 16th position of the Article No. | Additional identification code with order code and plain text if required | 71 | 80 | 90 | 100 | 112 | 132 | 160 | 180 | 200 | 225 | 250 | 280 | 315 | | | | |
| <p>Terminal box position diagrams showing positions 4, 5, 6, and 7.</p> | <p>1LE1</p> | | | 1LE1504 Basic Line | | | | | | | | | | | | | | IEC | IE4 | ① |
| | | | | 1LE1604 Performance Line | | | | | | | | | | | | | | | | ② |
| | | | | 1LE1503 Basic Line | | | | | | | | | | | | | | IE3 | ③ | |
| | | | | 1LE1603 Performance Line | | | | | | | | | | | | | | | ④ | |
| | | | | 1LE1583 | | | | | | | | | | | | | | | ⑤ | |
| | | | | 1LE1501 Basic Line | | | | | | | | | | | | | | IE2 | ⑥ | |
| | | | | 1LE1601 Performance Line | | | | | | | | | | | | | | | ⑦ | |
| | | | | 1LE1502 Basic Line | | | | | | | | | | | | | | IE1 | ⑧ | |
| | | | | 1LE1543 Basic Line | | | | | | | | | | | | | | | APAC Line | ⑨ |
| | | | | 1LE1643 Performance Line | | | | | | | | | | | | | | ⑩ | | |
| | | | | 1LE1541 Basic Line | | | | | | | | | | | | | | IE2 | ⑪ | |
| | | | | 1LE1523 Basic Line | | | | | | | | | | | | | | | Eagle Line | NPE (NEMA) ⑫ |
| | | | | 1LE1623 Performance Line | | | | | | | | | | | | | | ⑬ | | |
| | | | | 1LE1521 Basic Line | | | | | | | | | | | | | | NEE (NEMA) ⑭ | ⑭ | |
| | | | | | | | | | | | | | | | | | | | | |

Order code

- Standard version
- ✓ With additional charge
- Not possible

1) For types of construction with feet and flange-mounted with feet, cast feet are standard. Screwed-on feet are available with order code **H01**.
 2) For types of construction with feet and flange-mounted with feet, screwed-on feet are standard. Except for frame sizes 225, 250, 280 and 315: in which case for types of construction with feet and flange-mounted with feet, cast feet are standard. Screwed-on feet are available with order code **H01**.

3) Not generally possible for motors with feet.

SIMOTICS GP and SIMOTICS SD standard motors

Article No. supplements and special versions · Terminal box position

Aluminum series SIMOTICS GP 1LE1073 and cast-iron series SIMOTICS SD 1LE1573, 1LE5773

Selection and ordering data

| Terminal box position | Article No. supplement | | Frame size | | | | | | | | | | | | | Motor version | |
|---|---|---|------------|----|-----|-----|-----|---------|-----|-----|-----|-----|---------|-----|-----|---------------|--|
| | Terminal box position code 16th position of the Article No. | Additional identification code with order code and plain text if required | 80 | 90 | 100 | 112 | 132 | 160 | 180 | 200 | 225 | 250 | 280 | 315 | IEC | IE3 | |
| | | | 1LE1073 | | | | | 1LE1573 | | | | | 1LE5773 | | | | |
| 1LE - - | | Order code | | | | | | | | | | | | | | | |
| Terminal box position | | | | | | | | | | | | | | | | | |
| Terminal box base left with terminal box at the top | 0 | – | – | – | – | – | – | – | – | – | – | – | – | – | – | ✓ | |
| Terminal box base right with terminal box at the top | 1 | – | – | – | – | – | – | – | – | – | – | – | – | – | – | ✓ | |
| Terminal box base left with oblique terminal box 45° | 2 | – | – | – | – | – | – | – | – | – | – | – | – | – | ○ | | |
| Terminal box base right with oblique terminal box 45° | 3 | – | – | – | – | – | – | – | – | – | – | – | – | – | □ | | |
| Terminal box at top | 4 | – | □ | □ | □ | □ | □ | □ | □ | □ | □ | □ | □ | □ | – | | |
| Terminal box on right-hand side | 5 | – | ✓ | ✓ | ✓ | ✓ | ✓ | ✓ | ✓ | ✓ | ✓ | ✓ | ✓ | ✓ | ✓ | | |
| Terminal box on left-hand side | 6 | – | ✓ | ✓ | ✓ | ✓ | ✓ | ✓ | ✓ | ✓ | ✓ | ✓ | ✓ | ✓ | ✓ | | |
| Terminal box bottom ¹⁾ | 7 | – | – | – | ✓ | ✓ | ✓ | ✓ | – | – | – | – | – | – | – | | |
| Terminal box left-hand side (base below) ¹⁾ | 9 | R5L | – | – | – | – | – | – | – | – | – | – | – | – | ✓ | | |
| Terminal box right-hand side (base below) ¹⁾ | 9 | R6R | – | – | – | – | – | – | – | – | – | – | – | – | ✓ | | |
| Terminal box bottom left ¹⁾ | 9 | R7L | – | – | – | – | – | – | – | – | – | – | – | – | ✓ | | |
| Terminal box bottom right ¹⁾ | 9 | R7R | – | – | – | – | – | – | – | – | – | – | – | – | ✓ | | |

- Standard version
- Without additional charge
- ✓ With additional charge
- Not possible

¹⁾ Not generally possible for motors with feet.

SIMOTICS GP and SIMOTICS SD standard motors

Article No. supplements and special versions · Options

Aluminum series SIMOTICS GP 1LE10

Selection and ordering data

| Special versions | Additional identification code -Z with order code and plain text if required | Frame size | | | | | | | | | Motor version | | | |
|------------------|--|------------|----|---------|---------|---------|-----|-----|-----|---------|---------------|------------|---------------|---|
| | | 63 | 71 | 80 | 90 | 100 | 112 | 132 | 160 | 180 | 200 | | | |
| | | | | | | 1LE1004 | | | | | | IEC | IE4 | ① |
| | | | | 1LE1003 | | | | | | | | | IE3 | ② |
| | | | | | | 1LE1083 | | | | | | | | ③ |
| | | | | 1LE1001 | | | | | | | | | IE2 | ④ |
| | | | | 1LE1002 | | | | | | | | | IE1 | ⑤ |
| | | | | | 1LE1043 | | | | | | | APAC Line | IE3 | ⑥ |
| | | | | | 1LE1041 | | | | | | | | IE2 | ⑦ |
| | | | | | 1LE1023 | | | | | | | Eagle Line | NPE (NEMA) | ⑧ |
| | | | | | | 1LE1021 | | | | | | | NEE (NEMA) | ⑨ |
| | | | | | | | | | | 1LE1011 | | | Pole-changing | ⑩ |
| | | | | | | | | | | 1LE1012 | | | | ⑪ |
| | 1LE10 -Z | Order code | | | | | | | | | | | | |

| Motor protection | | | | | | | | | | | | |
|---|-----|---|---|---|---|-------|-------|-------|-------|-------|-------|---------------|
| 1 or 3 PTC thermistors – for tripping (2 terminals) | Q11 | ✓ | ✓ | ✓ | ✓ | ✓ | ✓ | ✓ | ✓ | ✓ | ✓ | |
| 2 or 6 PTC thermistors – for alarm and tripping (4 terminals) | Q12 | ✓ | ✓ | ✓ | ✓ | ✓ | ✓ | ✓ | ✓ | ✓ | ✓ | |
| 1 KTY84-130 temperature sensor (2 terminals) | Q23 | ✓ | ✓ | ✓ | ✓ | ✓ | ✓ | ✓ | ✓ | ✓ | ✓ | |
| 2 KTY84-130 temperature sensors (4 terminals) | Q25 | ✓ | ✓ | ✓ | ✓ | ✓ | ✓ | ✓ | ✓ | ✓ | ✓ | |
| 3 bimetal sensors (NC contacts) for tripping (2 terminals) | Q31 | - | - | ✓ | ✓ | ✓ | ✓ | ✓ | ✓ | ✓ | ✓ | |
| 6 bimetal sensors (NC contacts) for alarm and tripping (4 terminals) | Q32 | - | - | ✓ | ✓ | ✓ | ✓ | ✓ | ✓ | ✓ | ✓ | |
| 3 bimetal sensors (NC contacts) for tripping (6 terminals) | Q33 | - | - | - | - | - | - | - | - | ✓ | ✓ | |
| 6 bimetal sensors (NC contacts) for alarm and tripping (12 terminals) | Q34 | - | - | - | - | - | - | - | - | ✓ | ✓ | |
| 1 Pt1000 resistance thermometer (2 terminals) ⁴⁰⁾ | Q35 | ✓ | ✓ | ✓ | ✓ | ✓ | ✓ | ✓ | ✓ | ✓ | ✓ | |
| 2 Pt1000 resistance thermometers (4 terminals) ⁴⁰⁾ | Q36 | ✓ | ✓ | ✓ | ✓ | ✓ | ✓ | ✓ | ✓ | ✓ | ✓ | |
| 3 Pt100 resistance thermometers – 2-wire input (6 terminals) | Q60 | - | - | - | - | ✓ | ✓ | ✓ | ✓ | ✓ | ✓ | |
| 6 Pt100 resistance thermometers – 2-wire input (12 terminals) | Q61 | - | - | - | - | ✓ | ✓ | ✓ | ✓ | ✓ | ✓ | |
| 1 Pt100 resistance thermometer – 2-wire input (2 terminals) | Q62 | - | - | - | - | ✓ | ✓ | ✓ | ✓ | ✓ | ✓ | |
| 3 Pt100 resistance thermometers – 3-wire input (9 terminals) | Q63 | - | - | - | - | ✓ | ✓ | ✓ | ✓ | ✓ | ✓ | |
| 6 Pt100 resistance thermometers – 3-wire input (18 terminals) | Q64 | - | - | - | - | ✓ | ✓ | ✓ | ✓ | ✓ | ✓ | |
| 2 Pt100 resistance thermometers in basic configuration for bearings (2 terminals) | Q72 | - | - | - | - | O. R. | O. R. | O. R. | O. R. | ✓ | ✓ | |
| 2 Pt100 resistance thermometers in 3-wire input for bearing (6 terminals) | Q78 | - | - | - | - | O. R. | O. R. | O. R. | O. R. | ✓ | ✓ | |
| 2 Pt100 double resistance thermometers in 3-wire input for bearing (12 terminals) | Q79 | - | - | - | - | O. R. | O. R. | O. R. | O. R. | ✓ | ✓ | |
| Motor connection and terminal box | | | | | | | | | | | | |
| External grounding | H04 | ✓ | ✓ | ✓ | ✓ | ✓ | ✓ | ✓ | ✓ | ✓ | ✓ | |
| Terminal box on NDE ³⁾ | H08 | ✓ | ✓ | ✓ | ✓ | ✓ | ✓ | ✓ | ✓ | ✓ | ✓ | |
| Rotation of the terminal box through 90°, entry from DE ¹⁾ | R10 | ○ | ○ | ○ | ○ | ○ | ○ | ○ | ○ | ○ | ✓ | |
| Rotation of the terminal box through 90°, entry from NDE | R11 | ○ | ○ | ○ | ○ | ○ | ○ | ○ | ○ | ○ | ✓ | |
| Rotation of the terminal box through 180° | R12 | ○ | ○ | ○ | ○ | ○ | ○ | ○ | ○ | ○ | ✓ | |
| Terminal box in position 0°, connection from right ⁴¹⁾ | R13 | ○ | ○ | ○ | ○ | ○ | ○ | ○ | - | - | - | Not for: ③ |
| One metal cable gland | R15 | ✓ | ✓ | ✓ | ✓ | ✓ | ✓ | ✓ | ✓ | ✓ | ✓ | |
| Metal cable gland, maximum configuration | R18 | ✓ | ✓ | ✓ | ✓ | ✓ | ✓ | ✓ | ✓ | ✓ | ✓ | |
| 3 cables protruding, 0.5 m long ⁴⁵⁾ | R20 | ✓ | ✓ | ✓ | ✓ | ✓ | ✓ | ✓ | ✓ | - | - | Not for: ⑩, ⑪ |
| 3 cables protruding, 1.5 m long ⁴⁵⁾ | R21 | ✓ | ✓ | ✓ | ✓ | ✓ | ✓ | ✓ | ✓ | O. R. | O. R. | Not for: ⑩, ⑪ |
| 6 cables protruding, 0.5 m long ⁴⁾ | R22 | ✓ | ✓ | ✓ | ✓ | ✓ | ✓ | ✓ | ✓ | O. R. | O. R. | |
| 6 cables protruding, 1.5 m long ⁴⁾ | R23 | ✓ | ✓ | ✓ | ✓ | ✓ | ✓ | ✓ | ✓ | O. R. | O. R. | |

For legends and footnotes, see page 2/124.

SIMOTICS GP and SIMOTICS SD standard motors

Article No. supplements and special versions · Options

Aluminum series SIMOTICS GP 1LE10

| Special versions | Additional identification code -Z with order code and plain text if required | Frame size | | | | | | | | | Motor version | | | |
|--|--|------------|----|----|---------|---------|-------|-------|-------|-------|---------------|------------|---------------|-----------------------|
| | | 63 | 71 | 80 | 90 | 100 | 112 | 132 | 160 | 180 | 200 | | | |
| | | | | | | 1LE1004 | | | | | | IEC | IE4 | ① |
| | | | | | | 1LE1003 | | | | | | | IE3 | ② |
| | | | | | | | | | | | | | IE3 | ③ |
| | | | | | 1LE1001 | | | | | | | | IE2 | ④ |
| | | | | | 1LE1002 | | | | | | | | IE1 | ⑤ |
| | | | | | | | | | | | | APAC Line | IE3 | ⑥ |
| | | | | | 1LE1043 | | | | | | | | IE2 | ⑦ |
| | | | | | 1LE1041 | | | | | | | | NPE (NEMA) | ⑧ |
| | | | | | 1LE1023 | | | | | | | Eagle Line | NEE (NEMA) | ⑨ |
| | | | | | | | | | | | | | NEE (NEMA) | ⑩ |
| | | | | | | | | | | | | | Pole-changing | ⑪ |
| | 1LE10 -Z | Order code | | | | 1LE1011 | | | | | | | | |
| | | | | | | 1LE1012 | | | | | | | | |
| Motor connection and terminal box (continued) | | | | | | | | | | | | | | |
| 6 cables protruding, 3 m long ⁴⁾ | R24 | | ✓ | ✓ | ✓ | ✓ | ✓ | ✓ | ✓ | ✓ | ✓ | O. R. | O. R. | |
| Reduction piece for M cable gland in accordance with British Standard, mounted on both cable entries ²⁾ | R30 | | - | - | - | - | ✓ | ✓ | ✓ | ✓ | - | - | | |
| Larger terminal box | R50 | | ✓ | ✓ | ✓ | ✓ | ✓ | ✓ | ✓ | ✓ | ✓ | ✓ | Not for: | ⑧, ⑨ < frame size 100 |
| | - | | - | - | □ | □ | □ | □ | □ | □ | □ | □ | Only for: | ⑧, ⑨ < frame size 100 |
| Auxiliary terminal box, aluminum | R60 | | - | - | - | - | - | - | - | - | ✓ | ✓ | | |
| Motor connector Han-Drive 10e for 230 VΔ/400 VY ³⁰⁾ | R70 | | ✓ | ✓ | ✓ | ✓ | ✓ | ✓ | - | - | - | - | | |
| Motor connector Han-Drive 10e EMC for 230 VΔ/400 VY ³⁰⁾ | R71 | | ✓ | ✓ | ✓ | ✓ | ✓ | ✓ | - | - | - | - | | |
| Small motor connector CQ12 with EMC | R72 | | - | - | ✓ | ✓ | - | - | - | - | - | - | Not for: | ③ |
| Small motor connector CQ12 without EMC | R73 | | - | - | ✓ | ✓ | - | - | - | - | - | - | Not for: | ③ |
| Windings and insulation | | | | | | | | | | | | | | |
| Temperature class 155 (F), utilized acc. to 155 (F), with service factor | N01 | | - | - | - | - | ✓ | ✓ | ✓ | ✓ | ✓ | ✓ | Not for: | ③ |
| Temperature class 155 (F), utilized acc. to 155 (F), with increased power | N02 | | - | - | - | - | ✓ | ✓ | ✓ | ✓ | ✓ | ✓ | Not for: | ③ |
| Temperature class 155 (F), utilized acc. to 155 (F), with increased coolant temperature | N03 | | ✓ | ✓ | ✓ | ✓ | ✓ | ✓ | ✓ | ✓ | ✓ | ✓ | Not for: | ③ |
| Temperature class 155 (F), utilized acc. to 130 (B), coolant temperature 45 °C, derating approx. 4 % | N05 | | ✓ | ✓ | ✓ | ✓ | ✓ | ✓ | ✓ | ✓ | ✓ | ✓ | | |
| Temperature class 155 (F), utilized acc. to 130 (B), coolant temperature 50 °C, derating approx. 8 % | N06 | | ✓ | ✓ | ✓ | ✓ | ✓ | ✓ | ✓ | ✓ | ✓ | ✓ | | |
| Temperature class 155 (F), utilized acc. to 130 (B), coolant temperature 55 °C, derating approx. 13 % | N07 | | ✓ | ✓ | ✓ | ✓ | ✓ | ✓ | ✓ | ✓ | ✓ | ✓ | | |
| Temperature class 155 (F), utilized acc. to 130 (B), coolant temperature 60 °C, derating approx. 18 % | N08 | | ✓ | ✓ | ✓ | ✓ | ✓ | ✓ | ✓ | ✓ | ✓ | ✓ | | |
| Temperature class 180 (H) ³¹⁾ | N10 | | ✓ | ✓ | ✓ | ✓ | - | - | - | - | - | - | Not for: | ①, ③, ⑥, ⑦, ⑨, ⑪ |
| Temperature class 180 (H) at rated power and max. CT 60 °C ^{6) 31)} | N11 | | ✓ | ✓ | ✓ | ✓ | ✓ | ✓ | ✓ | ✓ | ✓ | ✓ | Not for: | ①, ③ |
| Increased air humidity/temperature with 30 to 60 g water per m ³ of air | N30 | | ✓ | ✓ | ✓ | ✓ | ✓ | ✓ | ✓ | ✓ | ✓ | ✓ | | |
| Increased air humidity/temperature with 60 to 100 g water per m ³ of air | N31 | | ✓ | ✓ | ✓ | ✓ | ✓ | ✓ | ✓ | ✓ | ✓ | ✓ | | |
| Temperature class 155 (F), utilized acc. to 130 (B), with higher coolant temperature and/or installation altitude | Y50 • | | ✓ | ✓ | ✓ | ✓ | ✓ | ✓ | ✓ | ✓ | ✓ | ✓ | | |
| | and spec. power, CT ... °C or IA ... m above sea level | | | | | | | | | | | | | |
| Temperature class 155 (F), utilized acc. to 155 (F), other requirements | Y52 • | | ✓ | ✓ | ✓ | ✓ | ✓ | ✓ | ✓ | ✓ | ✓ | ✓ | Not for: | ③ |
| | and spec. power, CT ... °C or IA ... m above sea level | | | | | | | | | | | | | |
| Temperature class 180 (H), utilized according to 155 (F) | Y75 • | | - | - | - | - | O. R. | O. R. | O. R. | O. R. | - | - | Not for: | ①, ③ |
| | and spec. power, CT ... °C or IA ... m above sea level | | | | | | | | | | | | | |



For legends and footnotes, see page 2/124.

SIMOTICS GP and SIMOTICS SD standard motors

Article No. supplements and special versions · Options

Aluminum series SIMOTICS GP 1LE10

| Special versions | Additional identification code -Z with order code and plain text if required | Frame size | | | | | | | | | | Motor version | | |
|------------------|--|------------|----|----|---------|---------|-----|-----|-----|-----|-----|---------------|---------------|---|
| | | 63 | 71 | 80 | 90 | 100 | 112 | 132 | 160 | 180 | 200 | | | |
| | | | | | | 1LE1004 | | | | | | IEC | IE4 | ① |
| | | | | | | 1LE1003 | | | | | | | IE3 | ② |
| | | | | | | | | | | | | | IE2 | ③ |
| | | | | | 1LE1001 | | | | | | | | IE2 | ④ |
| | | | | | 1LE1002 | | | | | | | | IE1 | ⑤ |
| | | | | | | | | | | | | APAC Line | IE3 | ⑥ |
| | | | | | | | | | | | | | IE2 | ⑦ |
| | | | | | | | | | | | | Eagle Line | NPE (NEMA) | ⑧ |
| | | | | | | | | | | | | | NEE (NEMA) | ⑨ |
| | | | | | | | | | | | | | Pole-changing | ⑩ |
| | | | | | | | | | | | | | | ⑪ |
| | 1LE10 -Z | Order code | | | | | | | | | | | | |

| Colors and paint finish | | | | | | | | | | | | | | |
|--|--------------------------------|-------|-------|-------|-------|-------|-------|-------|-------|-------|-------|-------|-------|---|
| Standard paint finish C2 in RAL 7030 stone gray | | | ☐ | ☐ | ☐ | ☐ | ☐ | ☐ | ☐ | ☐ | ☐ | ☐ | ☐ | |
| Unpainted (only cast-iron parts primed) | S00 | ○ | ○ | ○ | ○ | ○ | ○ | ○ | ○ | ○ | ○ | ○ | ○ | |
| Unpainted, only primed | S01 | ✓ | ✓ | ✓ | ✓ | ✓ | ✓ | ✓ | ✓ | ✓ | ✓ | ✓ | ✓ | |
| Special paint finish C3 | S02 | ✓ | ✓ | ✓ | ✓ | ✓ | ✓ | ✓ | ✓ | ✓ | ✓ | ✓ | ✓ | |
| Special paint finish sea air resistant C4 | S03 | ✓ | ✓ | ✓ | ✓ | ✓ | ✓ | ✓ | ✓ | ✓ | ✓ | ✓ | ✓ | |
| Internal coating | S05 | ✓ | ✓ | ✓ | ✓ | ✓ | ✓ | ✓ | ✓ | ✓ | ✓ | ✓ | ✓ | |
| Top coat polyurethane ³⁴⁾ | S06 | ✓ | ✓ | ✓ | ✓ | ✓ | ✓ | ✓ | ✓ | ✓ | ✓ | ✓ | ✓ | |
| Paint finish in other standard RAL colors: RAL 1002, 1013, 1015, 1019, 2003, 2004, 3000, 3007, 5002, 5007, 5009, 5010, 5012, 5015, 5017, 5018, 5019, 6011, 6019, 6021, 7000, 7001, 7004, 7011, 7016, 7022, 7031, 7032, 7033, 7035, 9001, 9002, 9005 (see Catalog Section 1 "Introduction") | Y53 • and paint finish RAL.... | ✓ | ✓ | ✓ | ✓ | ✓ | ✓ | ✓ | ✓ | ✓ | ✓ | ✓ | ✓ | |
| Paint finish in special RAL colors: For RAL colors, see "Special paint finish in special RAL colors" (see Catalog Section 1 "Introduction") | Y56 • and paint finish RAL.... | ✓ | ✓ | ✓ | ✓ | ✓ | ✓ | ✓ | ✓ | ✓ | ✓ | ✓ | ✓ | |
| Modular technology – Basic versions ⁷⁾ | | | | | | | | | | | | | | |
| Mounting of holding brake (standard assignment) ^{8) 28)} | F01 | ✓ | ✓ | ✓ | ✓ | ✓ | ✓ | ✓ | ✓ | ✓ | ✓ | ✓ | ✓ | |
| Mounting of brake for higher switching frequency (operating brake) | F02 | O. R. | O. R. | O. R. | O. R. | O. R. | O. R. | O. R. | O. R. | O. R. | O. R. | O. R. | O. R. | |
| Mounting of separately driven fan ²⁹⁾ | F70 | ✓ | ✓ | ✓ | ✓ | ✓ | ✓ | ✓ | ✓ | ✓ | ✓ | ✓ | ✓ | |
| Mounting of Kübler Sendix 5020 HTL, 1024 I rotary pulse encoder | G11 | ✓ | ✓ | ✓ | ✓ | ✓ | ✓ | ✓ | ✓ | ✓ | ✓ | ✓ | ✓ | |
| Mounting of Kübler Sendix 5020 TTL, 1024 I rotary pulse encoder | G12 | ✓ | ✓ | ✓ | ✓ | ✓ | ✓ | ✓ | ✓ | ✓ | ✓ | ✓ | ✓ | |
| Modular technology – Additional versions | | | | | | | | | | | | | | |
| Brake supply voltage 24 V DC | F10 | ✓ | ✓ | ✓ | ✓ | ✓ | ✓ | ✓ | ✓ | ✓ | ✓ | ✓ | ✓ | |
| Brake supply voltage 230 V AC, 50/60 Hz | F11 | ✓ | ✓ | ✓ | ✓ | ○ | ○ | ○ | ○ | ○ | ○ | ○ | ○ | |
| Brake supply voltage 400 V AC, 50/60 Hz | F12 | ✓ | ✓ | ✓ | ✓ | ✓ | ✓ | ✓ | ✓ | ✓ | ✓ | ✓ | ✓ | |
| Brake supply voltage 180 V DC | F17 | ✓ | ✓ | ✓ | ✓ | ✓ | ✓ | ✓ | ✓ | ✓ | ✓ | ✓ | ✓ | Only for: Motors in combination with order code F01 |
| Brake supply voltage 205 V DC | F18 | ✓ | ✓ | ✓ | ✓ | ✓ | ✓ | ✓ | ✓ | ✓ | ✓ | ✓ | ✓ | Only for: Motors in combination with order code F01 |
| Mechanical manual brake release with lever (no locking) | F50 | ✓ | ✓ | ✓ | ✓ | ✓ | ✓ | ✓ | ✓ | ✓ | ✓ | ✓ | ✓ | |
| Special technology ⁷⁾ | | | | | | | | | | | | | | |
| Mounting of LL 861 900 220 rotary pulse encoder ⁹⁾ | G04 | - | - | - | - | ✓ | ✓ | ✓ | ✓ | ✓ | ✓ | ✓ | ✓ | |
| Mounting of HOG 9 DN 1024 I rotary pulse encoder ⁹⁾ | G05 | - | - | - | - | ✓ | ✓ | ✓ | ✓ | ✓ | ✓ | ✓ | ✓ | |
| Mounting of HOG 10 D 1024 I rotary pulse encoder ⁹⁾ | G06 | - | - | - | - | ✓ | ✓ | ✓ | ✓ | ✓ | ✓ | ✓ | ✓ | |
| Mounting of Kübler Sendix 5834FS2 1024, SIL-2 rotary pulse encoder | G21 | - | - | - | - | ✓ | ✓ | ✓ | ✓ | ✓ | ✓ | ✓ | ✓ | |
| Mounting of Kübler Sendix 5834FS3 1024, SIL-3 rotary pulse encoder | G22 | - | - | - | - | ✓ | ✓ | ✓ | ✓ | ✓ | ✓ | ✓ | ✓ | |
| Mounting of HOGS100S-B76.626.01024.1 rotary pulse encoder | G25 | - | - | - | - | - | - | - | - | - | ✓ | ✓ | ✓ | Only for: ③ |
| Mounting of LL FSI 862-184560-1024, SIL-2 rotary pulse encoder | G27 | - | - | - | - | - | - | - | - | - | ✓ | ✓ | ✓ | Only for: ③ |

For legends and footnotes, see page 2/124.

SIMOTICS GP and SIMOTICS SD standard motors

Article No. supplements and special versions · Options

Aluminum series SIMOTICS GP 1LE10

| Special versions | Additional identification code -Z with order code and plain text if required | Frame size | | | | | | | | | Motor version | | | | |
|---|--|------------|-------|-------|---------|---------|-------|-------|-------|-------|---------------|------------|------------|---|---|
| | | 63 | 71 | 80 | 90 | 100 | 112 | 132 | 160 | 180 | 200 | | | | |
| | | | | | | 1LE1004 | | | | | | IEC | IE4 | ① | |
| | | | | | | 1LE1003 | | | | | | | IE3 | ② | |
| | | | | | | | | | | | | | IE2 | ③ | |
| | | | | | 1LE1001 | | | | | | | | IE2 | ④ | |
| | | | | | 1LE1002 | | | | | | | | IE1 | ⑤ | |
| | | | | | | | | | | | | APAC Line | IE3 | ⑥ | |
| | | | | | | | | | | | | | IE2 | ⑦ | |
| | | | | | | | | | | | | Eagle Line | NPE (NEMA) | ⑧ | |
| | | | | | | | | | | | | | NEE (NEMA) | ⑨ | |
| | | | | | | | | | | | | | | ⑩ | |
| | | | | | | | | | | | | | | ⑪ | |
| | 1LE10 -Z | Order code | | | | | | | | | | | | | |
| Mechanical version and degrees of protection | | | | | | | | | | | | | | | |
| Low-noise version for 2-pole motors with clockwise direction of rotation | F77 | - | - | - | - | - | - | ✓ | ✓ | ✓ | ✓ | | | | |
| Low-noise version for 2-pole motors with counterclockwise direction of rotation | F78 | - | - | - | - | - | - | ✓ | ✓ | ✓ | ✓ | | | | |
| Prepared for mountings, centering hole only ¹⁰⁾ | G40 | - | - | ✓ | ✓ | ✓ | ✓ | ✓ | ✓ | □ | □ | | | | |
| Prepared for mountings with shaft D12 ¹⁵⁾ | G41 | ✓ | ✓ | ✓ | ✓ | ✓ | ✓ | ✓ | ✓ | ✓ | ✓ | | | | |
| Prepared for mountings with shaft D16 ¹⁵⁾ | G42 | - | - | O. R. | O. R. | ✓ | ✓ | ✓ | ✓ | ✓ | ✓ | | | | |
| Mechanical protection for encoder | G43 | O. R. | O. R. | ✓ | ✓ | ✓ | ✓ | ✓ | ✓ | ✓ | ✓ | | | | |
| Protective cover ^{9) 11)} | H00 | ✓ | ✓ | ✓ | ✓ | ✓ | ✓ | ✓ | ✓ | ✓ | ✓ | | | | |
| Screwed-on (instead of cast) feet | H01 | - | - | ✓ | ✓ | ✓ | ✓ | ✓ | ✓ | □ | □ | | | | |
| Vibration-proof version; vibration resistance to Class 3M4 according to IEC 60721-3-3:1994 ³⁹⁾ | H02 | ✓ | ✓ | ✓ | ✓ | ✓ | ✓ | ✓ | ✓ | ✓ | ✓ | | | | |
| Condensation drainage holes ¹⁴⁾ | H03 | ✓ | ✓ | ✓ | ✓ | ✓ | ✓ | ✓ | ✓ | ✓ | ✓ | | | | |
| Rust-resistant screws (externally) | H07 | ✓ | ✓ | ✓ | ✓ | ✓ | ✓ | ✓ | ✓ | ✓ | ✓ | | | | |
| Housing with screw mounting ³²⁾ | H10 | - | - | ✓ | ✓ | - | - | - | - | ✓ | ✓ | | | | Only for: ②, ④, ⑥, ⑦ (frame sizes 80, 90), ⑧, ⑨ |
| Degree of protection IP65 ¹³⁾ | H20 | ✓ | ✓ | ✓ | ✓ | ✓ | ✓ | ✓ | ✓ | ✓ | ✓ | | | | |
| Degree of protection IP56 ¹²⁾ | H22 | ✓ | ✓ | ✓ | ✓ | ✓ | ✓ | ✓ | ✓ | ✓ | ✓ | | | | |
| Drive-end seal for flange-mounting motors, oil-tight to 0.1 bar ¹⁶⁾ | H23 | ✓ | ✓ | ✓ | ✓ | ✓ | ✓ | ✓ | ✓ | ✓ | ✓ | | | | |
| Coolant temperature and installation altitude | | | | | | | | | | | | | | | |
| Coolant temperature -40 to +40 °C ^{16) 28)} | D03 | ✓ | ✓ | ✓ | ✓ | ✓ | ✓ | ✓ | ✓ | ✓ | ✓ | | | | |
| Coolant temperature -30 to +40 °C ^{16) 28)} | D04 | ✓ | ✓ | ✓ | ✓ | ✓ | ✓ | ✓ | ✓ | ✓ | ✓ | | | | |
| Versions in accordance with standards and specifications | | | | | | | | | | | | | | | |
| VIK version | C02 | - | - | ✓ | ✓ | ✓ | ✓ | ✓ | ✓ | - | - | | | | Only for: ② |
| CCC China Compulsory Certification ¹⁷⁾ | D01 | ✓ | ✓ | ✓ | ✓ | - | - | - | - | - | - | | | | Only for: Voltage code 21st or 22nd |
| Motor without CE marking for export outside EEA (see EU Directive 640/2009) | D22 | - | ○ | ○ | ○ | ○ | ○ | ○ | ○ | ○ | ○ | | | | Only for: ④ |
| Electrical according to NEMA MG1-12 ¹⁸⁾ | D30 | ✓ | ✓ | ✓ | ✓ | ✓ | ✓ | ✓ | ✓ | ✓ | ✓ | | | | Not for: ⑧, ⑨ |
| | - | - | - | □ | □ | □ | □ | □ | □ | □ | □ | | | | Only for: ⑧, ⑨ |
| Design according to UL with "Recognition Mark" ¹⁹⁾ | D31 | ✓ | ✓ | ✓ | ✓ | ✓ | ✓ | ✓ | ✓ | ✓ | ✓ | | | | Not for: ⑧, ⑨ |
| | - | - | - | □ | □ | □ | □ | □ | □ | □ | □ | | | | Only for: ⑧, ⑨ |
| KEMCO Korea Energy Efficiency Label | D33 | - | - | ✓ | ✓ | ✓ | ✓ | ✓ | ✓ | ✓ | ✓ | | | | Only for: ⑥, ⑦ |
| | - | - | - | - | O. R. | O. R. | O. R. | O. R. | O. R. | O. R. | O. R. | | | | Only for: ③ (2-pole to 6-pole) |
| China Energy Efficiency Label ³⁸⁾ | D34 | - | - | ○ | ○ | ○ | ○ | ○ | ○ | ○ | ○ | | | | Not for: ①, ⑤, ⑩, ⑪ |
| | - | - | - | - | O. R. | O. R. | O. R. | O. R. | O. R. | O. R. | O. R. | | | | Only for: ③ |
| Canadian regulations (CSA) ^{33) 37)} | D40 | ✓ | ✓ | ✓ | ✓ | ✓ | ✓ | ✓ | ✓ | ✓ | ✓ | | | | Not for: ⑤, ⑧, ⑨, ⑩, ⑪ |
| | - | - | - | □ | □ | □ | □ | □ | □ | □ | □ | | | | Only for: ⑧, ⑨ |
| NEMA Premium Efficient, North America version acc. to NEMA MG1, Table 12-11, incl. UL and CSA | D41 | - | - | - | - | O. R. | O. R. | O. R. | O. R. | O. R. | O. R. | | | | Only for: ③ |
| TR CU product safety certificate EAC for Eurasian Customs Union ³⁵⁾ | D47 | ✓ | ✓ | ✓ | ✓ | ✓ | ✓ | ✓ | ✓ | ✓ | ✓ | | | | |
| MEPS Australia | D70 | - | - | - | - | O. R. | O. R. | O. R. | O. R. | O. R. | O. R. | | | | Only for: ③ |
| Version suitable for railways IC411, EN IEC 60349, without EN 45545, with external fan and fan cover in plastic | L90 | - | - | ✓ | ✓ | ✓ | ✓ | ✓ | ✓ | ✓ | ✓ | | | | Not for: ①, ③ |
| Version suitable for railways IC411, EN IEC 60349, with EN 45545, with external fan and fan cover in metal | L91 | ✓ | ✓ | ✓ | ✓ | ✓ | ✓ | ✓ | ✓ | ✓ | ✓ | | | | Not for: ①, ③ |
| Version suitable for railways IC418, EN IEC 60349, without EN 45545, without external fan and fan cover | L92 | ✓ | ✓ | ✓ | ✓ | ✓ | ✓ | ✓ | ✓ | ✓ | ✓ | | | | Not for: ①, ③ |

For legends and footnotes, see page 2/124.



SIMOTICS GP and SIMOTICS SD standard motors

Article No. supplements and special versions · Options

Aluminum series SIMOTICS GP 1LE10

| Special versions | Additional identification code -Z with order code and plain text if required | Frame size | | | | | | | | | Motor version | | | |
|--|--|------------|----|----|---------|---------|-----|-----|-----|---------|---------------|------------|---------------|---|
| | | 63 | 71 | 80 | 90 | 100 | 112 | 132 | 160 | 180 | 200 | | | |
| | | | | | | 1LE1004 | | | | | | IEC | IE4 | ① |
| | | | | | | 1LE1003 | | | | | | | IE3 | ② |
| | | | | | | | | | | | | | IE2 | ③ |
| | | | | | 1LE1001 | | | | | | | | IE2 | ④ |
| | | | | | 1LE1002 | | | | | | | | IE1 | ⑤ |
| | | | | | | | | | | | | APAC Line | IE3 | ⑥ |
| | | | | | 1LE1043 | | | | | | | | IE2 | ⑦ |
| | | | | | 1LE1041 | | | | | | | | NPE (NEMA) | ⑧ |
| | | | | | 1LE1023 | | | | | | | Eagle Line | NEE (NEMA) | ⑨ |
| | | | | | | | | | | 1LE1021 | | | | |
| | | | | | | | | | | | | | Pole-changing | ⑩ |
| | 1LE10 -Z | Order code | | | | | | | | 1LE1011 | | | | |
| | | | | | | | | | | 1LE1012 | | | | ⑪ |
| Bearings and lubrication | | | | | | | | | | | | | | |
| Regreasing device with M10 x 1 grease nipple according to DIN 71412-A ²⁰⁾ | L19 | | - | - | - | - | - | - | - | - | - | ✓ | ✓ | |
| Located bearing DE | L20 | | ✓ | ✓ | ✓ | ✓ | ✓ | ✓ | ✓ | ✓ | ✓ | ✓ | ✓ | |
| Located bearing NDE | L21 | | ✓ | ✓ | ✓ | ✓ | ✓ | ✓ | ✓ | □ | □ | □ | | |
| Bearing design for increased cantilever forces ³⁶⁾ | L22 | | - | - | ✓ | ✓ | ✓ | ✓ | ✓ | ✓ | ✓ | ✓ | ✓ | Not for: Motors of frame sizes 80 and 90 in combination with order code F01 |
| Regreasing device ²⁰⁾ | L23 | | - | - | - | - | ✓ | ✓ | ✓ | ✓ | ✓ | ✓ | ✓ | |
| Bearings reinforced at both ends for DE and NDE, bearing size 63 | L25 | | - | - | ✓ | ✓ | ✓ | ✓ | ✓ | ✓ | ✓ | ✓ | ✓ | Not for: Motors of frame sizes 80 and 90 in combination with order code F01 |
| Bearing insulation NDE | L51 | | - | - | - | - | ✓ | ✓ | ✓ | ✓ | ✓ | ✓ | ✓ | |
| Measuring nipple for SPM shock pulse measurement for bearing inspection ²⁰⁾ | Q01 | | - | - | - | - | ✓ | ✓ | ✓ | ✓ | ✓ | ✓ | ✓ | |
| Balance and vibration severity | | | | | | | | | | | | | | |
| Vibration severity grade A | | | □ | □ | □ | □ | □ | □ | □ | □ | □ | □ | □ | |
| Vibration severity grade B | L00 | | ✓ | ✓ | ✓ | ✓ | ✓ | ✓ | ✓ | ✓ | ✓ | ✓ | ✓ | |
| Half-key balancing (standard) | | | □ | □ | □ | □ | □ | □ | □ | □ | □ | □ | □ | |
| Balancing without feather key | L01 | | ✓ | ✓ | ✓ | ✓ | ✓ | ✓ | ✓ | ✓ | ✓ | ✓ | ✓ | |
| Full-key balancing | L02 | | - | - | ✓ | ✓ | ✓ | ✓ | ✓ | ✓ | ✓ | ✓ | ✓ | |
| Shaft and rotor | | | | | | | | | | | | | | |
| Shaft extension with standard dimensions, without feather keyway | L04 | | ✓ | ✓ | ✓ | ✓ | ✓ | ✓ | ✓ | ✓ | ✓ | ✓ | ✓ | |
| Standard, cylindrical shaft extension (second shaft extension) NDE acc. to EN 50347 | L05 | | ✓ | ✓ | ✓ | ✓ | ✓ | ✓ | ✓ | ✓ | ✓ | ✓ | ✓ | |
| Standard shaft made of stainless steel (e.g. 1.4021) | L06 | | ✓ | ✓ | ✓ | ✓ | ✓ | ✓ | ✓ | ✓ | ✓ | ✓ | ✓ | |
| Shaft extension run-out in accordance with IEC 60072-1 precision class | L07 | | ✓ | ✓ | ✓ | ✓ | ✓ | ✓ | ✓ | ✓ | ✓ | ✓ | ✓ | |
| Shaft extension run-out, concentricity and perpendicularity in accordance with IEC 60072-1 precision class for flange-mounted motors | L08 | | ✓ | ✓ | ✓ | ✓ | ✓ | ✓ | ✓ | ✓ | ✓ | ✓ | ✓ | |
| Non-standard cylindrical shaft extension, DE ²¹⁾ | Y58 • and customer specifications | | ✓ | ✓ | ✓ | ✓ | ✓ | ✓ | ✓ | ✓ | ✓ | ✓ | ✓ | |
| Non-standard cylindrical shaft extension, NDE ²¹⁾ | Y59 • and customer specifications | | ✓ | ✓ | ✓ | ✓ | ✓ | ✓ | ✓ | ✓ | ✓ | ✓ | ✓ | |
| Heating and ventilation | | | | | | | | | | | | | | |
| Sheet metal fan cover | F74 | | - | - | ✓ | ✓ | ✓ | ✓ | ✓ | ✓ | ✓ | ✓ | ✓ | |
| Fan cover for textile industry ²²⁾ | F75 | | ✓ | ✓ | ✓ | ✓ | ✓ | ✓ | ✓ | ✓ | ✓ | ✓ | ✓ | |
| Metal external fan ^{23) 29)} | F76 | | ✓ | ✓ | ✓ | ✓ | ✓ | ✓ | ✓ | ✓ | ✓ | ✓ | ✓ | |
| Without external fan and without fan cover | F90 | | ✓ | ✓ | ✓ | ✓ | ✓ | ✓ | ✓ | ✓ | ✓ | ✓ | ✓ | Not for: ⑩, ⑪ |
| Anti-condensation heating for 230 V (2 terminals) | Q02 | | ✓ | ✓ | ✓ | ✓ | ✓ | ✓ | ✓ | ✓ | ✓ | ✓ | ✓ | |
| Anti-condensation heating for 115 V (2 terminals) | Q03 | | ✓ | ✓ | ✓ | ✓ | ✓ | ✓ | ✓ | ✓ | ✓ | ✓ | ✓ | |

For legends and footnotes, see page 2/124.

SIMOTICS GP and SIMOTICS SD standard motors

Article No. supplements and special versions · Options

Aluminum series SIMOTICS GP 1LE10

| Special versions | Additional identification code -Z with order code and plain text if required | Frame size | | | | | | | | | | Motor version | | | | |
|---------------------------|--|------------|----|----|---------|---------|-----|-----|-----|---------|-----|---------------|------------|---------------|---|--|
| | | 63 | 71 | 80 | 90 | 100 | 112 | 132 | 160 | 180 | 200 | | | | | |
| | | | | | | 1LE1004 | | | | | | | IEC | IE4 | ① | |
| | | | | | | 1LE1003 | | | | | | | | IE3 | ② | |
| | | | | | | | | | | 1LE1083 | | | | | ③ | |
| | | | | | 1LE1001 | | | | | | | | | IE2 | ④ | |
| | | | | | 1LE1002 | | | | | | | | | IE1 | ⑤ | |
| | | | | | | 1LE1043 | | | | | | | APAC Line | IE3 | ⑥ | |
| | | | | | | 1LE1041 | | | | | | | | IE2 | ⑦ | |
| | | | | | | 1LE1023 | | | | | | | Eagle Line | NPE (NEMA) | ⑧ | |
| | | | | | | | | | | 1LE1021 | | | | NEE (NEMA) | ⑨ | |
| | | | | | | | | | | 1LE1011 | | | | Pole-changing | ⑩ | |
| | | | | | | | | | | 1LE1012 | | | | | ⑪ | |
| 1LE10 -Z | | Order code | | | | | | | | | | | | | | |

| Rating plate and additional rating plates | | | | | | | | | | | | | |
|---|--|---|---|---|---|---|---|---|---|---|---|---|------------------------------|
| Additional rating plate for voltage tolerance ²⁴⁾ | B07 | ✓ | ✓ | ✓ | ✓ | ✓ | ✓ | ✓ | ✓ | ✓ | ✓ | ✓ | Not for: ⑩, ⑪, 8-pole motors |
| Second rating plate, loose ²⁵⁾ | M10 | ✓ | ✓ | ✓ | ✓ | ✓ | ✓ | ✓ | ✓ | ✓ | ✓ | ✓ | |
| Rating plate, stainless steel | M11 | ✓ | ✓ | ✓ | ✓ | ✓ | ✓ | ✓ | ✓ | ✓ | ✓ | ✓ | |
| Additional rating plate with deviating rating plate data | Y80 • and customer specifications | ✓ | ✓ | ✓ | ✓ | ✓ | ✓ | ✓ | ✓ | ✓ | ✓ | ✓ | |
| Additional rating plate with customer specifications | Y82 • and customer specifications | ✓ | ✓ | ✓ | ✓ | ✓ | ✓ | ✓ | ✓ | ✓ | ✓ | ✓ | |
| Additional information on rating plate and on package label (max. 20 characters) | Y84 • and customer specifications | ✓ | ✓ | ✓ | ✓ | ✓ | ✓ | ✓ | ✓ | ✓ | ✓ | ✓ | |
| Adhesive label, supplied loose (printed with: Article No., Serial No.; 2 lines of text) | Y85 • and customer specifications | - | - | - | - | ✓ | ✓ | ✓ | ✓ | ✓ | ✓ | ✓ | |
| Packaging, safety notes, documentation and test certificates | | | | | | | | | | | | | |
| A printed version of the safety notes in German/English and safety notes in the language of the country of use is supplied in each wire-lattice pallet ²⁷⁾ | B01 | ○ | ○ | ○ | ○ | ○ | ○ | ○ | ○ | ○ | ○ | ○ | |
| Inspection certificate 3.1 according to EN 10204 ²⁶⁾ | B02 | ✓ | ✓ | ✓ | ✓ | ✓ | ✓ | ✓ | ✓ | ✓ | ✓ | ✓ | |
| Document - Electrical datasheet | B60 | ✓ | ✓ | ✓ | ✓ | ✓ | ✓ | ✓ | ✓ | ✓ | ✓ | ✓ | |
| Document - Order dimensional drawing | B61 | ✓ | ✓ | ✓ | ✓ | ✓ | ✓ | ✓ | ✓ | ✓ | ✓ | ✓ | |
| Type test with heat run for horizontal motors, with acceptance | B83 | ✓ | ✓ | ✓ | ✓ | ✓ | ✓ | ✓ | ✓ | ✓ | ✓ | ✓ | |
| "Basic" documentation package | B90 | ✓ | ✓ | ✓ | ✓ | ✓ | ✓ | ✓ | ✓ | ✓ | ✓ | ✓ | |
| "Advanced" documentation package | B91 | ✓ | ✓ | ✓ | ✓ | ✓ | ✓ | ✓ | ✓ | ✓ | ✓ | ✓ | |
| "Projects" documentation package | B92 | ✓ | ✓ | ✓ | ✓ | ✓ | ✓ | ✓ | ✓ | ✓ | ✓ | ✓ | |
| Wire-lattice pallet packaging | B99 | ✓ | ✓ | ○ | ○ | ○ | ○ | ○ | ○ | ○ | ○ | ○ | |
| Connected in star for dispatch | M01 | ✓ | ✓ | ✓ | ✓ | ✓ | ✓ | ✓ | ✓ | ✓ | ✓ | ✓ | |
| Connected in delta for dispatch | M02 | ✓ | ✓ | ✓ | ✓ | ✓ | ✓ | ✓ | ✓ | ✓ | ✓ | ✓ | |

SIMOTICS GP and SIMOTICS SD standard motors

Article No. supplements and special versions · Options

Aluminum series SIMOTICS GP 1LE10

- Standard version
- Without additional charge
- This order code only determines the price of the version – Additional plain text is required.
- ✓ With additional charge
- O.R. Possible on request
- Not possible

2

- 1) With IM B5 flange, only possible in combination with **H08**.
- 2) Not possible in combination with order code **R15** "One metal cable gland".
- 3) With **H08**, feet dimensions C and CA differ from EN 50347! Further information is available in the DT Configurator (see Appendix, "Tools and engineering").
- 4) In conjunction with motor protection (15th position of the Article No.) or anti-condensation heating option, please inquire before ordering.
- 5) Not possible in combination with voltage code **22** or **34**.
- 6) Cannot be used for motors in UL version (order code **D31**). The grease lifetime specified in Catalog Section 1 "Introduction" refers to CT 40 °C. If the coolant temperature is increased by 10 K, the grease lifetime and regreasing interval are halved.
- 7) A second shaft extension is not possible. Please inquire for mounted brakes.
- 8) For order codes **F10**, **F11**, **F12**, **F17**, and **F18**, the brake supply voltage must be specified or ordered.
- 9) All encoders are supplied with a protective cover as standard. The protective cover is omitted at the factory when a rotary pulse encoder is combined with a separately driven fan, because in this case the rotary pulse encoder is installed under the fan cover. In combination with a separately driven fan (order code **F70**) the 1XP8032-10 rotary pulse encoder is used instead of 1XP8012-10 or 1XP8032-20 is used instead of 1XP8012-20.
- 10) As standard, motors that are prepared for additional mountings (order codes **G40**, **G41**, **G42**) are shipped without protective cover. If a protective cover is requested as a cover or mechanical protection for mountings provided by the customer, this can be ordered with order code **G43**. Not possible in combination with order code **L00** vibration severity grade B. In combination with a separately driven fan (order code **F70**) the 1XP8032-10 rotary pulse encoder is used instead of 1XP8012-10 or 1XP8032-20 is used instead of 1XP8012-20.
- 11) Order code **H00** provides mechanical protection for encoders.
- 12) Not possible in combination with brake BFK458 – order code **F01**.
- 13) Not possible in combination with HOG 9 DN 1024 I rotary pulse encoder (order code **G05**) and/or brake BFK458 (order code **F01**).
- 14) Supplied with the condensation drainage holes sealed at the drive end DE and non-drive end NDE (IP55, IP56, IP65). If the condensation drainage holes are required for motors of the IM B6, IM B7 or IM B8 type of construction (feet on side or top), the motors must be ordered in the respective type of construction and with order code **H03**, so that the condensation drainage holes will be placed in the correct position.
- 15) As standard, motors that are prepared for additional mountings (order codes **G40**, **G41**, **G42**) are shipped without protective cover. If a protective cover is requested as a cover or mechanical protection for mountings provided by the customer, this can be ordered with order code **G43**. Not possible in combination with order code **L00** vibration severity grade B.
- 16) In connection with mountings, the respective technical specifications must be observed, please inquire before ordering.
- 17) CCC mandatory certification, see Chapter 1 Page 1/21.
- 18) Possible up to 600 V max. The rated voltage is indicated on the rating plate without voltage range. Order codes **D30** and **D31** do not authorize importing into USA and Mexico. The North America export versions Eagle Line 1LE1021 NEMA Energy Efficient and 1LE1023 NEMA Premium Efficient are available for this purpose.
- 19) In connection with mountings, the respective technical specifications must be observed, please inquire before ordering.
- 20) Not possible when brake is mounted.
- 21) When motors are ordered that have a longer or shorter shaft extension than normal, the required position and length of the feather keyway must be specified in a sketch. It must be ensured that only feather keys in accordance with EN 50347, Form A are used. The feather keyway is positioned centrally on the shaft extension. The length is defined by the manufacturer in accordance with the appropriate standard. Not valid for: Conical shafts, non-standard threaded journals, non-standard shaft tolerances, friction welded journals, extremely "thin" shafts, special geometry dimensions (e.g. square journals), hollow shafts. Valid for non-standard shaft extensions DE or NDE. The feather keys are supplied in every case. For order codes **Y58**, **Y59** and **L05** the following applies:
 - Dimensions D and DA ≤ ball bearing inner diameter (see dimension tables for "Dimensions")
 - Dimensions E and EA ≤ 2 × length E (standard) of the shaft extension.
- 22) The special requirements of the textile industry regarding the sheet metal cover open up the possibility that a finger may be inserted between the cover and housing. The customer must implement appropriate measures to ensure that the installed system is "finger-safe".
- 23) Converter operation is permitted for 1LE1 motors with metal external fans. The metal external fan is not possible in combination with the low-noise version – order code **F77** or **F78**.
- 24) Can be ordered for 230 VΔ/400 VY or 400 VΔ/690 VY (voltage code **"22"** or **"34"**). Not possible in combination with order code **D34**.
- 25) As adhesive label for frame sizes 80 and 90.
- 26) The delivery time for the manufacturer's test certificate may differ from the delivery time for the motor and will be dispatched by e-mail.
- 27) The manual "Low-Voltage motors SIMOTICS GP, SD, DP Safety instructions SH 63 ... 355" is available in the Internet as PDF in all official languages of the EU: <https://support.industry.siemens.com/cs/ww/en/view/109756537>
- 28) Not possible in combination with order codes **N05**, **N06**, **N07**, **N08**, and **N11**.
- 29) Order codes **F70** and **F76** cannot be combined.
- 30) When ordering with order code **R70** and **R71**, order code **R50** is included.
- 31) Not possible for 2-pole and 4-pole motors with increased power (11th position of the Article No.: 6) in frame sizes 80 and 90.
- 32) Possible with frame sizes 180 and 200 with screw-mounted fan cover.
- 33) For frame sizes 180 and 200, constructed with metric entry thread.
- 34) Order code **S06** cannot be combined with order code **S00** and **S01**. It can be combined with **Y53** and **Y56** on request.
- 35) Please note the additional use of order code **D22** "Motor without CE marking for export outside EEA (see EU Directive 640/2009)".
- 36) A minimum cantilever force F_{\min} of $0.5 \cdot F_{\max}$ is required for NU bearings (cylindrical roller bearings) in contrast to ball bearings. Cylindrical roller bearings are not suitable for coupling output or for brief periods of no-load operation without cantilever force.
- 37) The rated voltage is indicated on the rating plate without voltage range. Order code **D40** does not authorize importing into Canada. The North America export versions Eagle Line 1LE1021 NEMA Energy Efficient and 1LE1023 NEMA Premium Efficient are available for this purpose.
- 38) Not possible in combination with voltage code (12th or 13th position of the Article No.) 17, 18, 30, 31, 60, 61, 62, 63 and 90 with the additional order codes **M1A**; **M2A**; **M2B**; **M1B**; **M1C**; **M2C**; **M1D**; **M2D**; **M1E**; **M2E**; **M1F**; **M2F**; **M1G**; **M2G**; **M1H**; **M2H**; **1K**; **M2K**; **M1J**; **M2J**; **M1L**; **M2L**; **M1M**; **M2M** and **M3A**.
- 39) Not possible in combination with order code **R50**.
- 40) Not UL-certified. Not in combination with option **D31**.
- 41) Only possible in combination with order codes **R70**, **R71**, **R72**, and **R73**.

SIMOTICS GP and SIMOTICS SD standard motors

Article No. supplements and special versions · Options

Cast-iron series SIMOTICS SD 1LE15 Basic Line, 1LE16 Performance Line

Selection and ordering data

| Special versions | Additional identification code -Z with order code and plain text if required | Frame size | | | | | | | | | | | Motor version | | | | |
|------------------|--|------------|---------------|--------------------|--------------------------|-----|-----|-----|-----|--------------------|-----|-----|---------------|-----|------------|------------|---|
| | | 71 | 80 | 90 | 100 | 112 | 132 | 160 | 180 | 200 | 225 | 250 | 280 | 315 | | | |
| | | | | | 1LE1504 Basic Line | | | | | | | | | | IEC | IE4 | ① |
| | | | | | 1LE1604 Performance Line | | | | | | | | | | | | ② |
| | | | | 1LE1503 Basic Line | | | | | | | | | | | | IE3 | ③ |
| | | | | | 1LE1603 Performance Line | | | | | | | | | | | | ④ |
| | | | | | 1LE1583 | | | | | | | | | | | | ⑤ |
| | | | | 1LE1501 Basic Line | | | | | | | | | | | | IE2 | ⑥ |
| | | | | | 1LE1601 Performance Line | | | | | | | | | | | | ⑦ |
| | | | | | 1LE1502 Basic Line | | | | | | | | | | | IE1 | ⑧ |
| | | | | | 1LE1543 Basic Line | | | | | | | | | | APAC Line | IE3 | ⑨ |
| | | | | | 1LE1643 Performance Line | | | | | | | | | | | | ⑩ |
| | | | | | | | | | | 1LE1541 Basic Line | | | | | | IE2 | ⑪ |
| | | | | 1LE1523 Basic Line | | | | | | | | | | | Eagle Line | NPE (NEMA) | ⑫ |
| | | | | | 1LE1623 Performance Line | | | | | | | | | | | | ⑬ |
| | | | 1LE1 -Z | Order code | | | | | | 1LE1521 Basic Line | | | | | | NEE (NEMA) | ⑭ |

Motor protection

| Motor protection | | | | | | | | | | | | | | | | | | | |
|--|-----|--|---|---|---|---|---|---|---|---|---|---|---|---|---|---|---|---|---|
| 1 or 3 PTC thermistors – for tripping (2 terminals) | Q11 | | - | - | - | ✓ | ✓ | ✓ | ✓ | ✓ | ✓ | ✓ | ✓ | ✓ | ✓ | ✓ | ✓ | ✓ | ✓ |
| 2 or 6 PTC thermistors – for alarm and tripping (4 terminals) | Q12 | | - | - | - | ✓ | ✓ | ✓ | ✓ | ✓ | ✓ | ✓ | ✓ | ✓ | ✓ | ✓ | ✓ | ✓ | ✓ |
| 1 KTY84-130 temperature sensor (2 terminals) | Q23 | | - | - | - | ✓ | ✓ | ✓ | ✓ | ✓ | ✓ | ✓ | ✓ | ✓ | ✓ | ✓ | ✓ | ✓ | ✓ |
| 2 KTY84-130 temperature sensors (4 terminals) | Q25 | | - | - | - | ✓ | ✓ | ✓ | ✓ | ✓ | ✓ | ✓ | ✓ | ✓ | ✓ | ✓ | ✓ | ✓ | ✓ |
| 3 bimetal sensors (NC contacts) for tripping (2 terminals) | Q31 | | - | - | - | ✓ | ✓ | ✓ | ✓ | ✓ | ✓ | ✓ | ✓ | ✓ | ✓ | ✓ | ✓ | ✓ | ✓ |
| 6 bimetal sensors (NC contacts) for alarm and tripping (4 terminals) | Q32 | | - | - | - | ✓ | ✓ | ✓ | ✓ | ✓ | ✓ | ✓ | ✓ | ✓ | ✓ | ✓ | ✓ | ✓ | ✓ |
| 3 bimetal sensors (NC contacts) for tripping (6 terminals) | Q33 | | - | - | - | ✓ | ✓ | ✓ | ✓ | ✓ | ✓ | ✓ | ✓ | ✓ | ✓ | ✓ | ✓ | ✓ | ✓ |
| 6 bimetal sensors (NC contacts) for alarm and tripping (12 terminals) | Q34 | | - | - | - | ✓ | ✓ | ✓ | ✓ | ✓ | ✓ | ✓ | ✓ | ✓ | ✓ | ✓ | ✓ | ✓ | ✓ |
| 1 Pt1000 resistance thermometer (2 terminals) ⁴⁰⁾ | Q35 | | - | - | - | ✓ | ✓ | ✓ | ✓ | ✓ | ✓ | ✓ | ✓ | ✓ | ✓ | ✓ | ✓ | ✓ | ✓ |
| 2 Pt1000 resistance thermometers (4 terminals) ⁴⁰⁾ | Q36 | | - | - | - | ✓ | ✓ | ✓ | ✓ | ✓ | ✓ | ✓ | ✓ | ✓ | ✓ | ✓ | ✓ | ✓ | ✓ |
| 3 Pt100 resistance thermometers – 2-wire input (6 terminals) | Q60 | | - | - | - | ✓ | ✓ | ✓ | ✓ | ✓ | ✓ | ✓ | ✓ | ✓ | ✓ | ✓ | ✓ | ✓ | ✓ |
| 6 Pt100 resistance thermometers – 2-wire input (12 terminals) ²⁷⁾ | Q61 | | - | - | - | ✓ | ✓ | ✓ | ✓ | ✓ | ✓ | ✓ | ✓ | ✓ | ✓ | ✓ | ✓ | ✓ | ✓ |
| 1 Pt100 resistance thermometer – 2-wire input (2 terminals) | Q62 | | - | - | - | ✓ | ✓ | ✓ | ✓ | ✓ | ✓ | ✓ | ✓ | ✓ | ✓ | ✓ | ✓ | ✓ | ✓ |
| 3 Pt100 resistance thermometers – 3-wire input (9 terminals) ³⁰⁾ | Q63 | | - | - | - | ✓ | ✓ | ✓ | ✓ | ✓ | ✓ | ✓ | ✓ | ✓ | ✓ | ✓ | ✓ | ✓ | ✓ |
| 6 Pt100 resistance thermometers – 3-wire input (18 terminals) ³⁰⁾ | Q64 | | - | - | - | ✓ | ✓ | ✓ | ✓ | ✓ | ✓ | ✓ | ✓ | ✓ | ✓ | ✓ | ✓ | ✓ | ✓ |
| 2 Pt100 resistance thermometers in basic configuration for bearing (2 terminals) ²⁾ | Q72 | | - | - | - | - | - | - | - | ✓ | ✓ | ✓ | ✓ | ✓ | ✓ | ✓ | ✓ | ✓ | ✓ |
| 2 Pt100 resistance thermometers in 3-wire input for bearing (6 terminals) | Q78 | | - | - | - | - | - | - | - | ✓ | ✓ | ✓ | ✓ | ✓ | ✓ | ✓ | ✓ | ✓ | ✓ |
| 2 Pt100 double resistance thermometers in 3-wire input for bearing (12 terminals) | Q79 | | - | - | - | - | - | - | - | ✓ | ✓ | ✓ | ✓ | ✓ | ✓ | ✓ | ✓ | ✓ | ✓ |

Motor connection and terminal box

| | | | | | | | | | | | | | | | | | | | |
|--|-----|--|---|---|---|---|---|---|---|---|---|---|---|---|---|---|---|---|---|
| External grounding | H04 | | ✓ | ✓ | ✓ | ✓ | ✓ | ✓ | ✓ | ✓ | ✓ | ✓ | ✓ | ✓ | ✓ | ✓ | ✓ | ✓ | ✓ |
| Terminal box on NDE ²⁷⁾ | H08 | | ✓ | ✓ | ✓ | ✓ | ✓ | ✓ | ✓ | ✓ | ✓ | ✓ | ✓ | ✓ | ✓ | ✓ | ✓ | ✓ | ✓ |
| Second external grounding | H70 | | - | - | - | ✓ | ✓ | ✓ | ✓ | ✓ | ✓ | ✓ | ✓ | ✓ | ✓ | ✓ | ✓ | ✓ | ✓ |
| Rotation of the terminal box through 90°, entry from DE ⁴¹⁾ | R10 | | ○ | ○ | ○ | ○ | ○ | ○ | ○ | ✓ | ✓ | ✓ | ✓ | ✓ | ✓ | ✓ | ✓ | ✓ | ✓ |
| Rotation of the terminal box through 90°, entry from NDE | R11 | | ○ | ○ | ○ | ○ | ○ | ○ | ○ | ✓ | ✓ | ✓ | ✓ | ✓ | ✓ | ✓ | ✓ | ✓ | ✓ |
| Rotation of the terminal box through 180° | R12 | | ○ | ○ | ○ | ○ | ○ | ○ | ○ | ✓ | ✓ | ✓ | ✓ | ✓ | ✓ | ✓ | ✓ | ✓ | ✓ |
| One EMC cable gland | R14 | | ✓ | ✓ | ✓ | ✓ | ✓ | ✓ | ✓ | ✓ | ✓ | ✓ | ✓ | ✓ | ✓ | ✓ | ✓ | ✓ | ✓ |
| One metal cable gland | R15 | | ✓ | ✓ | ✓ | ✓ | ✓ | ✓ | ✓ | ✓ | ✓ | ✓ | ✓ | ✓ | ✓ | ✓ | ✓ | ✓ | ✓ |
| EMC cable gland, maximum configuration | R16 | | ✓ | ✓ | ✓ | ✓ | ✓ | ✓ | ✓ | ✓ | ✓ | ✓ | ✓ | ✓ | ✓ | ✓ | ✓ | ✓ | ✓ |
| Stud terminal for cable connection, accessories pack (3 items) | R17 | | - | - | - | - | - | - | - | - | - | - | - | - | - | ✓ | ✓ | ✓ | ✓ |
| Metal cable gland, maximum configuration | R18 | | ✓ | ✓ | ✓ | ✓ | ✓ | ✓ | ✓ | ✓ | ✓ | ✓ | ✓ | ✓ | ✓ | ✓ | ✓ | ✓ | ✓ |

SIMOTICS GP and SIMOTICS SD standard motors
 Article No. supplements and special versions · Options

Cast-iron series SIMOTICS SD 1LE15 Basic Line, 1LE16 Performance Line

2

| Special versions | Additional identification code -Z with order code and plain text if required | Frame size | Motor version | | | | | | | | | | | | | | | |
|--|--|------------|--------------------------|----|----|-----|-----|-----|-----|-----|-----|-----|-----|-----|-----|------------|------------|---|
| | | | 71 | 80 | 90 | 100 | 112 | 132 | 160 | 180 | 200 | 225 | 250 | 280 | 315 | | | |
| | | | 1LE1504 Basic Line | | | | | | | | | | | | | IEC | IE4 | ① |
| | | | 1LE1604 Performance Line | | | | | | | | | | | | | | | ② |
| | | | 1LE1503 Basic Line | | | | | | | | | | | | | | IE3 | ③ |
| | | | 1LE1603 Performance Line | | | | | | | | | | | | | | | ④ |
| | | | 1LE1583 | | | | | | | | | | | | | | | ⑤ |
| | | | 1LE1501 Basic Line | | | | | | | | | | | | | | IE2 | ⑥ |
| | | | 1LE1601 Performance Line | | | | | | | | | | | | | | | ⑦ |
| | | | 1LE1502 Basic Line | | | | | | | | | | | | | | IE1 | ⑧ |
| | | | 1LE1543 Basic Line | | | | | | | | | | | | | APAC Line | IE3 | ⑨ |
| | | | 1LE1643 Performance Line | | | | | | | | | | | | | | | ⑩ |
| | | | 1LE1541 Basic Line | | | | | | | | | | | | | | IE2 | ⑪ |
| | | | 1LE1523 Basic Line | | | | | | | | | | | | | Eagle Line | NPE (NEMA) | ⑫ |
| | | | 1LE1623 Performance Line | | | | | | | | | | | | | | | ⑬ |
| | | | 1LE1521 Basic Line | | | | | | | | | | | | | | NEE (NEMA) | ⑭ |
| 1LE1 - Z Order code | | | | | | | | | | | | | | | | | | |

Motor connection and terminal box (continued)

| | | 71 | 80 | 90 | 100 | 112 | 132 | 160 | 180 | 200 | 225 | 250 | 280 | 315 | |
|--|--|----|----|----|-----|-----|-----|-----|-----|-------|-------|-------|-------|-------|---|
| Saddle terminal for connection without cable lug, accessories pack | R19 | - | - | - | - | - | - | - | - | - | - | ✓ | ✓ | ✓ | |
| 3 cables protruding, 0.5 m long | R20 | ✓ | ✓ | ✓ | ✓ | ✓ | ✓ | ✓ | ✓ | ✓ | ✓ | ✓ | ✓ | ✓ | |
| 3 cables protruding, 1.5 m long | R21 | ✓ | ✓ | ✓ | ✓ | ✓ | ✓ | ✓ | ✓ | O. R. | O. R. | O. R. | O. R. | O. R. | |
| 6 cables protruding, 0.5 m long | R22 | ✓ | ✓ | ✓ | ✓ | ✓ | ✓ | ✓ | ✓ | ✓ | - | - | - | - | |
| 6 cables protruding, 1.5 m long | R23 | ✓ | ✓ | ✓ | ✓ | ✓ | ✓ | ✓ | ✓ | ✓ | O. R. | O. R. | O. R. | O. R. | |
| 6 cables protruding, 3 m long | R24 | ✓ | ✓ | ✓ | ✓ | ✓ | ✓ | ✓ | ✓ | ✓ | O. R. | O. R. | O. R. | O. R. | |
| Reduction piece for M cable gland in accordance with British Standard, mounted on both cable entries | R30 | - | - | - | ✓ | ✓ | ✓ | ✓ | ✓ | - | - | - | - | - | |
| Larger terminal box | R50 | ✓ | ✓ | ✓ | ✓ | ✓ | ✓ | ✓ | ✓ | ✓ | ✓ | ✓ | ✓ | ✓ | |
| Terminal box without cable entry opening | R51 | - | - | - | ○ | ○ | ○ | ○ | ○ | ○ | ○ | ○ | ○ | ○ | |
| Drilled removable entry plate | R52 | - | - | - | - | - | - | - | - | ✓ | ✓ | ✓ | ✓ | ✓ | |
| Undrilled removable entry plate | R53 | - | - | - | - | - | - | - | - | ✓ | ✓ | ✓ | ✓ | ✓ | |
| Cast-iron auxiliary terminal box (small) 30) | R62 | - | - | - | - | - | - | - | - | ✓ | ✓ | ✓ | ✓ | ✓ | Only for: Motors with order code R50 possible |
| | | - | - | - | ✓ | ✓ | ✓ | - | - | - | - | - | - | - | |
| Silicone-free version | R74 | - | - | - | □ | □ | □ | □ | □ | □ | □ | ✓ | ✓ | ✓ | |
| Non-standard threaded through hole (NPT or G thread) | Y61 and customer specifications | - | - | - | ✓ | ✓ | ✓ | ✓ | ✓ | ✓ | ✓ | ✓ | ✓ | ✓ | |

Windings and insulation

| | | 71 | 80 | 90 | 100 | 112 | 132 | 160 | 180 | 200 | 225 | 250 | 280 | 315 | |
|---|------------|----|----|----|-----|-----|-----|-----|-----|-----|-----|-----|-----|-----|------------------------------------|
| Temperature class 155 (F), utilized according to 155 (F), with service factor | N01 | ✓ | ✓ | ✓ | ✓ | ✓ | ✓ | ✓ | ✓ | ✓ | ✓ | ✓ | ✓ | ✓ | Not for: ⑤ |
| Temperature class 155 (F), utilized acc. to 155 (F), with increased power | N02 | ✓ | ✓ | ✓ | ✓ | ✓ | ✓ | ✓ | ✓ | ✓ | ✓ | ✓ | ✓ | ✓ | Not for: ⑤ |
| Temperature class 155 (F), utilized acc. to 155 (F), with increased coolant temperature | N03 | ✓ | ✓ | ✓ | ✓ | ✓ | ✓ | ✓ | ✓ | ✓ | ✓ | ✓ | ✓ | ✓ | Not for: ⑤ |
| Temperature class 155 (F), utilized acc. to 130 (B), coolant temperature 45 °C, derating approx. 4 % | N05 | ✓ | ✓ | ✓ | ✓ | ✓ | ✓ | ✓ | ✓ | ✓ | ✓ | ✓ | ✓ | ✓ | |
| Temperature class 155 (F), utilized acc. to 130 (B), coolant temperature 50 °C, derating approx. 8 % | N06 | ✓ | ✓ | ✓ | ✓ | ✓ | ✓ | ✓ | ✓ | ✓ | ✓ | ✓ | ✓ | ✓ | |
| Temperature class 155 (F), utilized acc. to 130 (B), coolant temperature 55 °C, derating approx. 13 % | N07 | ✓ | ✓ | ✓ | ✓ | ✓ | ✓ | ✓ | ✓ | ✓ | ✓ | ✓ | ✓ | ✓ | |
| Temperature class 155 (F), utilized acc. to 130 (B), coolant temperature 60 °C, derating approx. 18 % | N08 | ✓ | ✓ | ✓ | ✓ | ✓ | ✓ | ✓ | ✓ | ✓ | ✓ | ✓ | ✓ | ✓ | |
| Temperature class 180 (H) | N10 | ✓ | ✓ | ✓ | ✓ | ✓ | ✓ | ✓ | ✓ | ✓ | ✓ | ✓ | ✓ | ✓ | Not for: ①, ②, ⑤, ⑨, ⑩, ⑪, ⑫, ⑬, ⑭ |
| Temperature class 180 (H) at rated power and max. CT 60 °C 4) 5) | N11 | ✓ | ✓ | ✓ | ✓ | ✓ | ✓ | ✓ | ✓ | ✓ | ✓ | ✓ | ✓ | ✓ | Not for: ①, ②, ⑤ |
| Increased air humidity/temperature with 30 to 60 g water per m ³ of air | N30 | ✓ | ✓ | ✓ | ✓ | ✓ | ✓ | ✓ | ✓ | ✓ | ✓ | ✓ | ✓ | ✓ | |
| Increased air humidity/temperature with 60 to 100 g water per m ³ of air | N31 | ✓ | ✓ | ✓ | ✓ | ✓ | ✓ | ✓ | ✓ | ✓ | ✓ | ✓ | ✓ | ✓ | |

For legends and footnotes, see page 2/132.

SIMOTICS GP and SIMOTICS SD standard motors

Article No. supplements and special versions · Options

Cast-iron series SIMOTICS SD 1LE15 Basic Line, 1LE16 Performance Line

| Special versions | Additional identification code -Z with order code and plain text if required | Frame size | | | | | | | | | | | | Motor version | | | | | | |
|--|---|------------|----|--------------------|--------------------------|--------------------|--------------------------|-----|-----|-----|-----|-----|------------|---------------|-----------|---------------------------|---------------------------|-----------|-----|---|
| | | 71 | 80 | 90 | 100 | 112 | 132 | 160 | 180 | 200 | 225 | 250 | 280 | 315 | | | | | | |
| | | | | | 1LE1504 Basic Line | | | | | | | | IEC | IE4 | ① | | | | | |
| | | | | | 1LE1604 Performance Line | | | | | | | | | | ② | | | | | |
| | | | | 1LE1503 Basic Line | | | | | | | | | | | | IE3 | | ③ | | |
| | | | | | | | 1LE1603 Performance Line | | | | | | | ④ | | | | | | |
| | | | | | | | 1LE1583 | | | | | | | ⑤ | | | | | | |
| | | | | 1LE1501 Basic Line | | | | | | | | | | | | IE2 | | ⑥ | | |
| | | | | | | | 1LE1601 Performance Line | | | | | | | ⑦ | | | | | | |
| | | | | | | | 1LE1502 Basic Line | | | | | | IE1 | ⑧ | | | | | | |
| | | | | | | 1LE1543 Basic Line | | | | | | | | | | | | APAC Line | IE3 | ⑨ |
| | | | | | | | 1LE1643 Performance Line | | | | | | | ⑩ | | | | | | |
| | | | | | | | 1LE1541 Basic Line | | | | | | IE2 | ⑪ | | | | | | |
| | | | | 1LE1523 Basic Line | | | | | | | | | | | | Eagle Line | NPE (NEMA) | ⑫ | | |
| | | | | | | | 1LE1623 Performance Line | | | | | | | ⑬ | | | | | | |
| | 1LE1 - - - - - -Z | Order code | | | | | 1LE1521 Basic Line | | | | | | NEE (NEMA) | ⑭ | | | | | | |
| Windings and insulation (continued) | | | | | | | | | | | | | | | | | | | | |
| Temperature class 155 (F), utilized acc. to 130 (B), with higher coolant temperature and/or installation altitude | Y50 • and spec. power, CT ... °C or IA m above sea level | | ✓ | ✓ | ✓ | ✓ | ✓ | ✓ | ✓ | ✓ | ✓ | ✓ | ✓ | ✓ | ✓ | | | | | |
| Temperature class 155 (F), utilized acc. to 155 (F), other requirements ⁵⁾ | Y52 • and spec. power, CT ... °C or IA m above sea level | | ✓ | ✓ | ✓ | ✓ | ✓ | ✓ | ✓ | ✓ | ✓ | ✓ | ✓ | ✓ | ✓ | Not for: | ⑤ | | | |
| Temperature class 180 (H), utilized according to 155 (F) | Y75 • and spec. power, CT ... °C or IA m above sea level | | - | - | - | ✓ | ✓ | ✓ | ✓ | ✓ | ✓ | ✓ | ✓ | ✓ | Not for: | ①, ②, ⑤ | | | | |
| Colors and paint finish | | | | | | | | | | | | | | | | | | | | |
| Standard paint finish C2 in RAL 7030 stone gray | | | □ | □ | □ | □ | □ | □ | □ | □ | □ | □ | □ | □ | □ | Only for: | ①, ③, ⑤, ⑥, ⑧, ⑨, ⑪, ⑫, ⑭ | | | |
| Unpainted (only cast-iron parts primed) | S00 | | ○ | ○ | ○ | ○ | ○ | ○ | ○ | ○ | ○ | ○ | ○ | ○ | ○ | | | | | |
| Unpainted, only primed | S01 | | ✓ | ✓ | ✓ | ✓ | ✓ | ✓ | ✓ | ✓ | ✓ | ✓ | ✓ | ✓ | ✓ | | | | | |
| Special paint finish C3 | S02 | | ✓ | ✓ | ✓ | ✓ | ✓ | ✓ | ✓ | ✓ | ✓ | ✓ | ✓ | ✓ | Not for: | ②, ④, ⑦, ⑩, ⑬ | | | | |
| | - | | □ | □ | □ | □ | □ | □ | □ | □ | □ | □ | □ | □ | Only for: | ②, ④, ⑦, ⑩, ⑬ | | | | |
| Special paint finish sea air resistant C4 | S03 | | ✓ | ✓ | ✓ | ✓ | ✓ | ✓ | ✓ | ✓ | ✓ | ✓ | ✓ | ✓ | | | | | | |
| Special paint finish for use offshore C5 | S04 | | ✓ | ✓ | ✓ | ✓ | ✓ | ✓ | ✓ | ✓ | ✓ | ✓ | ✓ | ✓ | | | | | | |
| Internal coating | S05 | | - | - | - | ✓ | ✓ | ✓ | ✓ | ✓ | ✓ | ✓ | ✓ | ✓ | | | | | | |
| Top coat polyurethane ³³⁾ | S06 | | ✓ | ✓ | ✓ | ✓ | ✓ | ✓ | ✓ | ✓ | ✓ | ✓ | ✓ | ✓ | | | | | | |
| Paint finish in other standard RAL colors: RAL 1002, 1013, 1015, 1019, 2003, 2004, 3000, 3007, 5002, 5007, 5009, 5010, 5012, 5015, 5017, 5018, 5019, 6011, 6019, 6021, 7000, 7001, 7004, 7011, 7016, 7022, 7031, 7032, 7033, 7035, 9001, 9002, 9005 (see Catalog Section 1 "Introduction") | Y53 • and paint finish RAL.... | | ✓ | ✓ | ✓ | ✓ | ✓ | ✓ | ✓ | ✓ | ✓ | ✓ | ✓ | ✓ | Only for: | ①, ③, ⑤, ⑥, ⑧, ⑨, ⑪, ⑫, ⑭ | | | | |
| Paint finish in special RAL colors: For RAL colors, see "Special paint finish in special RAL colors" (see Catalog Section 1 "Introduction") | Y56 • and paint finish RAL.... | | ✓ | ✓ | ✓ | ✓ | ✓ | ✓ | ✓ | ✓ | ✓ | ✓ | ✓ | ✓ | | | | | | |
| Modular technology – Basic versions ⁶⁾ | | | | | | | | | | | | | | | | | | | | |
| Mounting of holding brake (standard assignment) ^{7) 31) 32)} | F01 | | - | - | - | ✓ | ✓ | ✓ | ✓ | ✓ | ✓ | ✓ | ✓ | ✓ | | | | | | |
| Mounting of PRECIMA brake | F04 | | - | - | - | - | - | - | - | - | ✓ | ✓ | ✓ | ✓ | | | | | | |
| Mounting of separately driven fan ^{28) 34)} | F70 | | ✓ | ✓ | ✓ | ✓ | ✓ | ✓ | ✓ | ✓ | ✓ | ✓ | ✓ | ✓ | | | | | | |
| Mounting of Kübler Sendix 5020 HTL, 1024 I rotary pulse encoder | G11 | | ✓ | ✓ | ✓ | ✓ | ✓ | ✓ | ✓ | ✓ | ✓ | ✓ | ✓ | ✓ | | | | | | |
| Mounting of Kübler Sendix 5020 TTL, 1024 I rotary pulse encoder | G12 | | ✓ | ✓ | ✓ | ✓ | ✓ | ✓ | ✓ | ✓ | ✓ | ✓ | ✓ | ✓ | | | | | | |

For legends and footnotes, see page 2/132.



SIMOTICS GP and SIMOTICS SD standard motors

Article No. supplements and special versions · Options

Cast-iron series SIMOTICS SD 1LE15 Basic Line, 1LE16 Performance Line

| Special versions | Additional identification code -Z with order code and plain text if required | Frame size | | | | | | | | | | | | | Motor version | | | | |
|------------------|---|------------|----|----|-----|-----|-----|-----|-----|-----|-----|-----|-----|-----|---------------|--|------------|------------|---|
| | | 71 | 80 | 90 | 100 | 112 | 132 | 160 | 180 | 200 | 225 | 250 | 280 | 315 | | | | | |
| | | | | | | | | | | | | | | | | | IEC | IE4 | ① |
| | | | | | | | | | | | | | | | | | | | ② |
| | | | | | | | | | | | | | | | | | | IE3 | ③ |
| | | | | | | | | | | | | | | | | | | | ④ |
| | | | | | | | | | | | | | | | | | | | ⑤ |
| | | | | | | | | | | | | | | | | | | IE2 | ⑥ |
| | | | | | | | | | | | | | | | | | | | ⑦ |
| | | | | | | | | | | | | | | | | | | IE1 | ⑧ |
| | | | | | | | | | | | | | | | | | APAC Line | IE3 | ⑨ |
| | | | | | | | | | | | | | | | | | | | ⑩ |
| | | | | | | | | | | | | | | | | | | IE2 | ⑪ |
| | | | | | | | | | | | | | | | | | Eagle Line | NPE (NEMA) | ⑫ |
| | | | | | | | | | | | | | | | | | | | ⑬ |
| | | | | | | | | | | | | | | | | | | NEE (NEMA) | ⑭ |
| | 1LE1 - - - Z | Order code | | | | | | | | | | | | | | | | | |

Modular technology – Additional versions

| Additional version | Order code | 71 | 80 | 90 | 100 | 112 | 132 | 160 | 180 | 200 | 225 | 250 | 280 | 315 | |
|--|------------|----|----|----|-----|-----|-----|-----|-----|-----|-----|-----|-----|-----|---|
| Brake supply voltage 24 V DC | F10 | - | - | - | ✓ | ✓ | ✓ | ✓ | ✓ | ✓ | ✓ | ✓ | ✓ | ✓ | |
| Brake supply voltage 230 V AC, 50/60 Hz | F11 | - | - | - | ○ | ○ | ○ | ○ | ○ | ○ | ○ | ○ | ○ | ○ | |
| Brake supply voltage 400 V AC, 50/60 Hz ³²⁾ | F12 | - | - | - | ✓ | ✓ | ✓ | ✓ | ✓ | ✓ | ✓ | ✓ | ✓ | ✓ | |
| Brake supply voltage 180 V DC | F17 | - | - | - | ✓ | ✓ | ✓ | ✓ | ✓ | ✓ | ✓ | - | - | - | Only for: Motors in combination with order code F01 |
| Brake supply voltage 205 V DC | F18 | - | - | - | ✓ | ✓ | ✓ | ✓ | ✓ | ✓ | ✓ | - | - | - | Only for: Motors in combination with order code F01 |
| Backstop, counterclockwise motion blocked, clockwise direction of rotation | F40 | - | - | - | - | - | ✓ | ✓ | ✓ | ✓ | ✓ | ✓ | ✓ | ✓ | Not for: Motors in combination with order code Q79 |
| Backstop, clockwise motion blocked, counterclockwise direction of rotation | F41 | - | - | - | - | - | ✓ | ✓ | ✓ | ✓ | ✓ | ✓ | ✓ | ✓ | Not for: Motors in combination with order code Q79 |
| Mechanical manual brake release with lever (no locking) | F50 | - | - | - | ✓ | ✓ | ✓ | ✓ | ✓ | ✓ | ✓ | ✓ | ✓ | ✓ | |

Special technology ⁶⁾

| Special technology | Order code | 71 | 80 | 90 | 100 | 112 | 132 | 160 | 180 | 200 | 225 | 250 | 280 | 315 | |
|--|---|----|----|----|------|------|------|------|------|------|------|------|------|------|-------------|
| Mounting of LL 861 900 220 rotary pulse encoder ¹⁰⁾ | G04 | - | - | - | ✓ | ✓ | ✓ | ✓ | ✓ | ✓ | ✓ | ✓ | ✓ | ✓ | |
| Mounting of HOG 9 DN 1024 I rotary pulse encoder ¹⁰⁾ | G05 | - | - | - | ✓ | ✓ | ✓ | ✓ | ✓ | ✓ | ✓ | ✓ | ✓ | ✓ | |
| Mounting of HOG 10 D 1024 I rotary pulse encoder ¹⁰⁾ | G06 | - | - | - | ✓ | ✓ | ✓ | ✓ | ✓ | ✓ | ✓ | ✓ | ✓ | ✓ | |
| Mounting of POG 10 DN rotary pulse encoder (only in combination with separately driven fan or brake) ¹¹⁾ | G07 | - | - | - | - | - | - | - | ✓ | ✓ | ✓ | ✓ | ✓ | ✓ | |
| Mounting of POG 9 rotary pulse encoder (only in combination with separately driven fan or brake) ¹¹⁾ | G08 | - | - | - | - | - | - | - | ✓ | ✓ | ✓ | ✓ | ✓ | ✓ | |
| Mounting of HOG 10 DN 1024 I rotary pulse encoder, terminal box moisture protection | G15 | - | - | - | ✓ | ✓ | ✓ | ✓ | ✓ | ✓ | ✓ | ✓ | ✓ | ✓ | |
| Mounting of HOG 10 DN 1024 I rotary pulse encoder, terminal box dust protection | G16 | - | - | - | ✓ | ✓ | ✓ | ✓ | ✓ | ✓ | ✓ | ✓ | ✓ | ✓ | |
| Mounting of Kübler Sendix 5834FS2 1024, SIL-2 rotary pulse encoder | G21 | - | - | - | ✓ | ✓ | ✓ | ✓ | ✓ | ✓ | ✓ | ✓ | ✓ | ✓ | Only for: ⑤ |
| Mounting of Kübler Sendix 5834FS3 1024, SIL-3 rotary pulse encoder | G22 | - | - | - | ✓ | ✓ | ✓ | ✓ | ✓ | ✓ | ✓ | ✓ | ✓ | ✓ | Only for: ⑤ |
| Mounting of HOGS100S-B76.626.01024.1 rotary pulse encoder | G25 | - | - | - | - | - | - | - | ✓ | ✓ | ✓ | ✓ | ✓ | ✓ | Only for: ⑤ |
| Mounting of LL FSI 862-184560-1024, SIL-2 rotary pulse encoder | G27 | - | - | - | - | - | - | - | ✓ | ✓ | ✓ | ✓ | ✓ | ✓ | Only for: ⑤ |
| Mounting of a special type of rotary pulse encoder | Y70 • and customer specifications | - | - | - | O.R. | O.R. | O.R. | O.R. | O.R. | O.R. | O.R. | O.R. | O.R. | O.R. | Only for: ⑤ |
| Mounting of rotary pulse encoder HOG 10 DN 1024 I + FSL, (integrated centrifugal switch, speed ... rpm), terminal box moisture protection | Y74 • and spec. speed rpm | - | - | - | - | - | - | - | ✓ | ✓ | ✓ | ✓ | ✓ | ✓ | |
| Mounting of rotary pulse encoder HOG 10 DN 1024 I + FSL, (integrated centrifugal switch, speed rpm), terminal box dust protection | Y76 • and spec. speed rpm | - | - | - | - | - | - | - | ✓ | ✓ | ✓ | ✓ | ✓ | ✓ | |
| Mounting of rotary pulse encoder HOG 10 DN 1024 I + ESL 93, (integrated electronic speed switch, speed rpm), terminal box dust protection | Y79 • and spec. speed (max 3) rpm | - | - | - | - | - | - | - | ✓ | ✓ | ✓ | ✓ | ✓ | ✓ | |

For legends and footnotes, see page 2/132.

SIMOTICS GP and SIMOTICS SD standard motors

Article No. supplements and special versions · Options

Cast-iron series SIMOTICS SD 1LE15 Basic Line, 1LE16 Performance Line

| Special versions | Additional identification code -Z with order code and plain text if required | Frame size | | | | | | | | | | | Motor version | | | | | |
|------------------|---|------------|-----------|-----------|------------|--------------------------|------------|------------|------------|------------|------------|------------|---------------|------------|------------|--|--|---|
| | | 71 | 80 | 90 | 100 | 112 | 132 | 160 | 180 | 200 | 225 | 250 | 280 | 315 | | | | |
| | | | | | | 1LE1504 Basic Line | | | | | | | | IEC | IE4 | | | ① |
| | | | | | | 1LE1604 Performance Line | | | | | | | | | | | | ② |
| | | | | | | 1LE1503 Basic Line | | | | | | | | | IE3 | | | ③ |
| | | | | | | 1LE1603 Performance Line | | | | | | | | | | | | ④ |
| | | | | | | 1LE1583 | | | | | | | | | | | | ⑤ |
| | | | | | | 1LE1501 Basic Line | | | | | | | | | IE2 | | | ⑥ |
| | | | | | | 1LE1601 Performance Line | | | | | | | | | | | | ⑦ |
| | | | | | | 1LE1502 Basic Line | | | | | | | | | IE1 | | | ⑧ |
| | | | | | | 1LE1543 Basic Line | | | | | | | | APAC Line | IE3 | | | ⑨ |
| | | | | | | 1LE1643 Performance Line | | | | | | | | | | | | ⑩ |
| | | | | | | 1LE1541 Basic Line | | | | | | | | | IE2 | | | ⑪ |
| | | | | | | 1LE1523 Basic Line | | | | | | | | Eagle Line | NPE (NEMA) | | | ⑫ |
| | | | | | | 1LE1623 Performance Line | | | | | | | | | | | | ⑬ |
| | 1LE1 ... - ... - ... -Z | Order code | | | | 1LE1521 Basic Line | | | | | | | | | NEE (NEMA) | | | ⑭ |

| Mechanical version and degrees of protection | | | | | | | | | | | | | | | | | | | |
|---|------------|--|---|---|---|-----|-----|-----|-----|-----|-----|-----|-----|-----|-----|-----|-----|-----------|---|
| Low-noise version for 2-pole motors with clockwise direction of rotation | F77 | | - | - | - | - | - | ✓ | ✓ | ✓ | ✓ | ✓ | ✓ | ✓ | ✓ | ✓ | ✓ | Not for: | Motors in combination with order code F90 |
| Low-noise version for 2-pole motors with counterclockwise direction of rotation | F78 | | - | - | - | - | - | ✓ | ✓ | ✓ | ✓ | ✓ | ✓ | ✓ | ✓ | ✓ | ✓ | Not for: | Motors in combination with order code F90 |
| Prepared for mounted components, centering hole only | G40 | | - | ✓ | ✓ | ✓ | ✓ | ✓ | ✓ | ✓ | ✓ | ✓ | ✓ | ✓ | ✓ | ✓ | ✓ | Not for: | Motors in combination with order code F90 |
| Prepared for mountings with D12 shaft | G41 | | ✓ | ✓ | ✓ | ✓ | ✓ | ✓ | ✓ | ✓ | ✓ | ✓ | ✓ | ✓ | ✓ | ✓ | ✓ | Not for: | Motors in combination with order code F90 |
| Prepared for mountings with D16 shaft | G42 | | - | ✓ | ✓ | ✓ | ✓ | ✓ | ✓ | ✓ | ✓ | ✓ | ✓ | ✓ | ✓ | ✓ | ✓ | Not for: | Motors in combination with order code F90 |
| Mechanical protection for encoder | G43 | | ✓ | ✓ | ✓ | ✓ | ✓ | ✓ | ✓ | ✓ | ✓ | ✓ | ✓ | ✓ | ✓ | ✓ | ✓ | Not for: | Motors in combination with order code F90 |
| Protective cover ^{8) 10) 12)} | H00 | | ✓ | ✓ | ✓ | ✓ | ✓ | ✓ | ✓ | ✓ | ✓ | ✓ | ✓ | ✓ | ✓ | ✓ | ✓ | Not for: | Motors in combination with order code F90 |
| Screwed-on (instead of cast) feet | H01 | | - | - | - | ✓ | ✓ | ✓ | ✓ | ✓ | ✓ | ✓ | ✓ | ✓ | ✓ | ✓ | ✓ | | |
| Vibration-proof version; vibration resistance to Class 3M4 according to IEC 60721-3-3:1994 ³⁹⁾ | H02 | | ✓ | ✓ | ✓ | ✓ | ✓ | ✓ | ✓ | ✓ | ✓ | ✓ | ✓ | ✓ | ✓ | ✓ | ✓ | | |
| Condensation drainage holes ³⁸⁾ | H03 | | ✓ | ✓ | ✓ | □ | □ | □ | □ | □ | □ | □ | □ | □ | □ | □ | □ | | |
| Rust-resistant screws (externally) | H07 | | ✓ | ✓ | ✓ | ✓ | ✓ | ✓ | ✓ | ✓ | ✓ | ✓ | ✓ | ✓ | ✓ | ✓ | ✓ | | |
| Degree of protection IP65 ¹⁴⁾ | H20 | | ✓ | ✓ | ✓ | ✓ | ✓ | ✓ | ✓ | ✓ | ✓ | ✓ | ✓ | ✓ | ✓ | ✓ | ✓ | | |
| Degree of protection IP54 | H21 | | - | - | - | - | - | - | ✓ | ✓ | ✓ | ✓ | ✓ | ✓ | ✓ | ✓ | ✓ | | |
| Degree of protection IP56 ¹⁵⁾ | H22 | | ✓ | ✓ | ✓ | ✓ | ✓ | ✓ | ✓ | ✓ | ✓ | ✓ | ✓ | ✓ | ✓ | ✓ | ✓ | | |
| Drive-end seal for flange-mounting motors, oil-tight to 0.1 bar ^{13) 29)} | H23 | | ✓ | ✓ | ✓ | ✓ | ✓ | ✓ | ✓ | ✓ | ✓ | ✓ | ✓ | ✓ | ✓ | ✓ | ✓ | | |
| Grounding brush for converter operation | L52 | | - | - | - | - | - | - | - | - | - | - | - | - | - | - | ✓ | ✓ | |
| Coolant temperature and installation altitude | | | | | | | | | | | | | | | | | | | |
| Coolant temperature -50 to +40 °C | D02 | | - | - | - | ✓ | ✓ | ✓ | ✓ | ✓ | ✓ | ✓ | ✓ | ✓ | ✓ | ✓ | ✓ | | |
| Coolant temperature -40 to +40 °C ¹⁶⁾ | D03 | | ✓ | ✓ | ✓ | ✓ | ✓ | ✓ | ✓ | ✓ | ✓ | ✓ | ✓ | ✓ | ✓ | ✓ | ✓ | | |
| Coolant temperature -30 to +40 °C ¹⁷⁾ | D04 | | ✓ | ✓ | ✓ | ✓ | ✓ | ✓ | ✓ | ✓ | ✓ | ✓ | ✓ | ✓ | ✓ | ✓ | ✓ | | |
| Versions in accordance with standards and specifications | | | | | | | | | | | | | | | | | | | |
| VIK version | C02 | | - | - | - | ✓ | ✓ | ✓ | ✓ | ✓ | ✓ | ✓ | ✓ | ✓ | ✓ | ✓ | ✓ | Only for: | ③, ④ |
| | | | | | | | | | | | | | | | | | | Not for: | ⑤ |
| CCC China Compulsory Certification | D01 | | ✓ | ✓ | ✓ | - | - | - | - | - | - | - | - | - | - | - | - | Only for: | Voltage code 21 or 22 |
| | | | | | | | | | | | | | | | | | | Not for: | ⑤ |
| Motor without CE marking for export outside EEA (see EU Directive 640/2009) | D22 | | ○ | ○ | ○ | ○ | ○ | ○ | ○ | ○ | ○ | ○ | ○ | ○ | ○ | ○ | ○ | Not for: | ①, ② |
| Electrical according to NEMA MG1-12 ¹⁵⁾ | D30 | | - | - | - | ✓ | ✓ | ✓ | ✓ | ✓ | ✓ | ✓ | ✓ | ✓ | ✓ | ✓ | ✓ | Not for: | ⑫, ⑬, ⑭ |
| | - | | □ | □ | □ | □ | □ | □ | □ | □ | □ | □ | □ | □ | □ | □ | □ | Only for: | ⑫, ⑬, ⑭ |
| Design according to UL with "Recognition Mark" ¹⁸⁾ | D31 | | - | ✓ | ✓ | ✓ | ✓ | ✓ | ✓ | ✓ | ✓ | ✓ | ✓ | ✓ | ✓ | ✓ | ✓ | Not for: | ⑫, ⑬, ⑭ |
| | - | | □ | □ | □ | □ | □ | □ | □ | □ | □ | □ | □ | □ | □ | □ | □ | Only for: | ⑫, ⑬, ⑭ |
| KEMCO Korea Energy Efficiency Label | D33 | | - | ✓ | ✓ | ✓ | ✓ | ✓ | ✓ | ✓ | ✓ | ✓ | ✓ | ✓ | ✓ | ✓ | ✓ | Only for: | ⑨, ⑩, ⑪ |
| | | | - | - | - | O.R | O.R | O.R | O.R | O.R | O.R | O.R | O.R | O.R | O.R | O.R | O.R | Only for: | ⑤ |
| China Energy Efficiency Label ⁴²⁾ | D34 | | ○ | ○ | ○ | ○ | ○ | ○ | ○ | ○ | ○ | ○ | ○ | ○ | ○ | ○ | ○ | Not for: | ①, ②, ⑧, motors with increased power |
| | | | - | - | - | O.R | O.R | O.R | O.R | O.R | O.R | O.R | O.R | O.R | O.R | O.R | O.R | Only for: | ⑤ |
| Canadian regulations (CSA) ¹⁷⁾ | D40 | | ✓ | ✓ | ✓ | ✓ | ✓ | ✓ | ✓ | ✓ | ✓ | ✓ | ✓ | ✓ | ✓ | ✓ | ✓ | Not for: | ⑫, ⑬, ⑭ |
| | - | | □ | □ | □ | □ | □ | □ | □ | □ | □ | □ | □ | □ | □ | □ | □ | Only for: | ⑫, ⑬, ⑭ |

SIMOTICS GP and SIMOTICS SD standard motors

Article No. supplements and special versions · Options

Cast-iron series SIMOTICS SD 1LE15 Basic Line, 1LE16 Performance Line

| Special versions | Additional identification code -Z with order code and plain text if required | Frame size | | | | | | | | | | | | Motor version | | | |
|--|--|--------------------|----|----|--------------------------|-----|-----|-----|-----|-----|-----|-----|-----------|---------------|------------|-----|--|
| | | 71 | 80 | 90 | 100 | 112 | 132 | 160 | 180 | 200 | 225 | 250 | 280 | 315 | IEC | IE4 | |
| | | | | | 1LE1504 Basic Line | | | | | | | | | IE4 | ① | | |
| | | | | | 1LE1604 Performance Line | | | | | | | | | | ② | | |
| | | 1LE1503 Basic Line | | | | | | | | | | | | | IE3 | ③ | |
| | | | | | 1LE1603 Performance Line | | | | | | | | | | ④ | | |
| | | | | | 1LE1583 | | | | | | | | | | ⑤ | | |
| | | 1LE1501 Basic Line | | | | | | | | | | | | | IE2 | ⑥ | |
| | | | | | 1LE1601 Performance Line | | | | | | | | | | ⑦ | | |
| | | | | | 1LE1502 Basic Line | | | | | | | | | IE1 | ⑧ | | |
| | | | | | 1LE1543 Basic Line | | | | | | | | APAC Line | IE3 | ⑨ | | |
| | | | | | 1LE1643 Performance Line | | | | | | | | | | ⑩ | | |
| | | | | | 1LE1541 Basic Line | | | | | | | | | IE2 | ⑪ | | |
| | | 1LE1523 Basic Line | | | | | | | | | | | | Eagle Line | NPE (NEMA) | ⑫ | |
| | | | | | 1LE1623 Performance Line | | | | | | | | | | ⑬ | | |
| | | 1LE1521 Basic Line | | | | | | | | | | | | | NEE (NEMA) | ⑭ | |
| 1LE1 - - - - - - - - - - - - - - - - - Z | | Order code | | | | | | | | | | | | | | | |

| Versions in accordance with standards and specifications (continued) | | | | | | | | | | | | | | | | | | |
|--|-----------------------------------|---|---|---|------|------|------|------|------|------|------|------|------|------|------|------|------|-------------------------------------|
| NEMA Premium Efficient, North America version acc. to NEMA MG1, Table 12-11, incl. UL and CSA | D41 | - | - | - | O.R. | O.R. | O.R. | O.R. | O.R. | O.R. | O.R. | O.R. | O.R. | O.R. | O.R. | O.R. | O.R. | Only for: ⑤ |
| TR CU product safety certificate EAC for Eurasian Customs Union ³⁵⁾ | D47 | ✓ | ✓ | ✓ | ✓ | ✓ | ✓ | ✓ | ✓ | ✓ | ✓ | ✓ | ✓ | ✓ | ✓ | ✓ | ✓ | |
| MEPS Australia | D70 | - | - | - | O.R. | O.R. | O.R. | O.R. | O.R. | O.R. | O.R. | O.R. | O.R. | O.R. | O.R. | O.R. | O.R. | Only for: ⑤ |
| Bearings and lubrication | | | | | | | | | | | | | | | | | | |
| Regreasing device with M10 x 1 grease nipple according to DIN 71412-A ¹⁾ | L19 | - | - | - | - | - | - | - | ✓ | ✓ | ✓ | ✓ | ○ | ○ | ○ | ○ | ○ | Only for: ①, ③, ⑤, ⑤, ⑥, ⑧, ⑨, ⑫, ⑭ |
| | | - | - | - | - | - | - | - | ○ | ○ | ○ | ○ | ○ | ○ | ○ | ○ | ○ | Only for: ②, ④, ⑦, ⑩, ⑬ |
| Located bearing DE | L20 | ✓ | ✓ | ✓ | ✓ | ✓ | ✓ | ✓ | ✓ | ✓ | ✓ | ✓ | ✓ | ✓ | ✓ | ✓ | ✓ | |
| Located bearing NDE | L21 | ✓ | ✓ | ✓ | ✓ | ✓ | ✓ | □ | □ | □ | □ | □ | □ | □ | □ | □ | □ | |
| Bearing design for increased cantilever forces ³⁶⁾ | L22 | ✓ | ✓ | ✓ | ✓ | ✓ | ✓ | ✓ | ✓ | ✓ | ✓ | ✓ | ✓ | ✓ | ✓ | ✓ | ✓ | Not for: ②, ④, ⑦, ⑩, ⑬ |
| | | ✓ | ✓ | ✓ | □ | □ | □ | □ | ✓ | ✓ | ✓ | ✓ | ✓ | ✓ | ✓ | ✓ | ✓ | Only for: ②, ④, ⑦, ⑩, ⑬ |
| Regreasing device ¹⁾ | L23 | - | - | - | ✓ | ✓ | ✓ | ✓ | ✓ | ✓ | ✓ | ✓ | □ | □ | □ | □ | □ | Not for: ②, ④, ⑦, ⑩, ⑬ |
| | | - | - | - | ✓ | ✓ | ✓ | □ | □ | □ | □ | □ | □ | □ | □ | □ | □ | Only for: ②, ④, ⑦, ⑩, ⑬ |
| Bearings reinforced at both ends for DE and NDE, bearing size 63 ¹⁹⁾ | L25 | ✓ | ✓ | ✓ | ✓ | ✓ | ✓ | ✓ | ✓ | ✓ | ✓ | ✓ | □ | □ | □ | □ | □ | Not for: ②, ④, ⑦, ⑩, ⑬ |
| | - | □ | □ | □ | □ | □ | □ | □ | □ | □ | □ | □ | □ | □ | □ | □ | □ | Only for: ②, ④, ⑦, ⑩, ⑬ |
| Reinforced bearings at both DE and NDE, DE bearing for increased cantilever forces | L28 | - | - | - | - | - | - | - | ✓ | ✓ | ✓ | ✓ | - | - | - | - | - | |
| Bearing insulation DE | L50 | - | - | - | - | - | - | - | - | ✓ | ✓ | ✓ | ✓ | ✓ | ✓ | ✓ | ✓ | |
| Bearing insulation NDE | L51 | - | - | - | ✓ | ✓ | ✓ | ✓ | ✓ | ✓ | ✓ | ✓ | ✓ | ✓ | ✓ | ✓ | ✓ | |
| Measuring nipple for SPM shock pulse measurement for bearing inspection ¹⁾ | Q01 | - | - | - | ✓ | ✓ | ✓ | ✓ | ✓ | ✓ | ✓ | ✓ | ✓ | ✓ | ✓ | ✓ | ✓ | |
| Balance and vibration severity | | | | | | | | | | | | | | | | | | |
| Vibration severity grade A | | □ | □ | □ | □ | □ | □ | □ | □ | □ | □ | □ | □ | □ | □ | □ | □ | |
| Vibration severity grade B ²⁰⁾ | L00 | ✓ | ✓ | ✓ | ✓ | ✓ | ✓ | ✓ | ✓ | ✓ | ✓ | ✓ | ✓ | ✓ | ✓ | ✓ | ✓ | |
| Half-key balancing (standard) | | □ | □ | □ | □ | □ | □ | □ | □ | □ | □ | □ | □ | □ | □ | □ | □ | |
| Balancing without feather key | L01 | ✓ | ✓ | ✓ | ✓ | ✓ | ✓ | ✓ | ✓ | ✓ | ✓ | ✓ | ✓ | ✓ | ✓ | ✓ | ✓ | |
| Full-key balancing | L02 | ✓ | ✓ | ✓ | ✓ | ✓ | ✓ | ✓ | ✓ | ✓ | ✓ | ✓ | ✓ | ✓ | ✓ | ✓ | ✓ | |
| Shaft and rotor | | | | | | | | | | | | | | | | | | |
| Shaft extension with standard dimensions, without feather keyway | L04 | ✓ | ✓ | ✓ | ✓ | ✓ | ✓ | ✓ | ✓ | ✓ | ✓ | ✓ | ✓ | ✓ | ✓ | ✓ | ✓ | |
| Standard, cylindrical shaft extension (second shaft extension) NDE acc. to EN 50347 | L05 | ✓ | ✓ | ✓ | ✓ | ✓ | ✓ | ✓ | ✓ | ✓ | ✓ | ✓ | ✓ | ✓ | ✓ | ✓ | ✓ | |
| Standard shaft made of stainless steel (e.g. 1.4021) | L06 | ✓ | ✓ | ✓ | ✓ | ✓ | ✓ | ✓ | ✓ | ✓ | ✓ | ✓ | ✓ | ✓ | ✓ | ✓ | ✓ | |
| Shaft extension run-out in accordance with IEC 60072-1 precision class | L07 | ✓ | ✓ | ✓ | ✓ | ✓ | ✓ | ✓ | ✓ | ✓ | ✓ | ✓ | ✓ | ✓ | ✓ | ✓ | ✓ | |
| Shaft extension run-out, concentricity and perpendicularity in accordance with IEC 60072-1 precision class for flange-mounted motors | L08 | ✓ | ✓ | ✓ | ✓ | ✓ | ✓ | ✓ | ✓ | ✓ | ✓ | ✓ | ✓ | ✓ | ✓ | ✓ | ✓ | |
| Non-standard cylindrical shaft extension, DE ²¹⁾ | Y58 • and customer specifications | ✓ | ✓ | ✓ | ✓ | ✓ | ✓ | ✓ | ✓ | ✓ | ✓ | ✓ | ✓ | ✓ | ✓ | ✓ | ✓ | |
| Non-standard cylindrical shaft extension, NDE ²¹⁾ | Y59 • and customer specifications | ✓ | ✓ | ✓ | ✓ | ✓ | ✓ | ✓ | ✓ | ✓ | ✓ | ✓ | ✓ | ✓ | ✓ | ✓ | ✓ | |
| Special shaft steel | Y60 • and customer specifications | - | - | - | O.R. | O.R. | O.R. | O.R. | O.R. | O.R. | O.R. | O.R. | O.R. | O.R. | O.R. | O.R. | O.R. | |

For legends and footnotes, see page 2/132.

SIMOTICS GP and SIMOTICS SD standard motors

Article No. supplements and special versions · Options

Cast-iron series SIMOTICS SD 1LE15 Basic Line, 1LE16 Performance Line

- Standard version
- Without additional charge
- This order code only determines the price of the version – Additional plain text is required.
- ✓ With additional charge
- O. R. Possible on request
- Not possible

2

- 1) Up to frame size 160 not possible when brake is mounted.
- 2) Evaluation with appropriate tripping unit (see Catalog IC 10) is recommended.
- 3) Parallel Whitworth threaded pipe DIN ISO 228 (DIN 259) BSPP (British Standard Pipe Parallel) threaded pipe for connections not sealed in the thread (cylindrical), external = G.
- 4) Cannot be used for motors in UL version (order code **D31**). The grease lifetime specified in Catalog Section 1 "Introduction" refers to CT 40 °C. If the coolant temperature is increased by 10 K, the grease lifetime and regreasing interval are halved.
- 5) Not possible for 1LE15 and 1LE16 motors with increased power.
- 6) A second shaft extension is not possible. Please inquire for mounted brakes.
- 7) For order codes **F10**, **F11**, **F12**, **F17**, and **F18**, the brake supply voltage must be specified or ordered.
- 8) The 1XP8 rotary pulse encoders are fitted with a protective cover as standard. The protective cover is omitted at the factory when a rotary pulse encoder is combined with a separately driven fan, because in this case the rotary pulse encoder is installed under the fan cover.
- 9) In combination with a separately driven fan (order code **F70**) the 1XP8032-10 rotary pulse encoder is used instead of 1XP8012-10 or 1XP8032-20 is used instead of 1XP8012-20.
- 10) LL and HOG rotary pulse encoders up to frame size 160 are fitted with a protective cover as standard. The protective cover is omitted at the factory when a rotary pulse encoder is combined with a separately driven fan, because in this case the rotary pulse encoder is installed under the fan cover.
- 11) Option (encoder mounting) is only possible for motors with a mounted separately driven fan or for naturally cooled motors (without an external fan). This option can be used in combination with brakes of type KFB! This option cannot be used in combination with brakes of type BFK458!
- 12) Order code **H00** provides mechanical protection for encoders.
- 13) Not possible for type of construction IM V3.
- 14) Not possible in combination with HOG 9 DN 1024 I rotary pulse encoder (order code **G05**) and/or brake BFK458 (order code **F01**).
- 15) Not possible in combination with brake BFK458 – order code **F01**.
- 16) In connection with mountings, the respective technical specifications must be observed, please inquire before ordering.
- 17) The rated voltage is indicated on the rating plate without voltage range. Order code **D40** does not authorize importing into Canada. The North America export versions Eagle Line 1LE1521 NEMA Energy Efficient and 1LE1523/1LE1623 NEMA Premium Efficient are available for this purpose.
- 18) Possible up to 600 V max. The rated voltage is indicated on the rating plate without voltage range. Order codes **D30** and **D31** do not authorize importing into USA and Mexico. The North America export versions Eagle Line 1LE1521 NEMA Energy Efficient and 1LE1523/1LE1623 NEMA Premium Efficient are available for this purpose.
- 19) For Performance Line motors (all frame sizes) and Basic Line motors (from frame size 280) in the standard version.
- 20) On request for 2-pole motors (concerns frame sizes 225 to 315).
- 21) When motors are ordered that have a longer or shorter shaft extension than normal, the required position and length of the feather keyway must be specified in a sketch. It must be ensured that only feather keys in accordance with EN 50347, Form A are used. The feather keyway is positioned centrally on the shaft extension. The length is defined by the manufacturer in accordance with the appropriate standard. Not valid for: Conical shafts, non-standard threaded journals, non-standard shaft tolerances, friction welded journals, extremely "thin" shafts, special geometry dimensions (e.g. square journals), hollow shafts. Valid for non-standard shaft extensions DE or NDE. The feather keys are supplied in every case. For order codes **Y58**, **Y59** and **L05** the following applies:
 - Dimensions D and DA ≤ ball bearing inner diameter (see dimension tables for "Dimensions")
 - Dimensions E and EA ≤ 2 × length E (standard) of the shaft extension.
- 22) Converter operation is permitted for 1LE1 motors with metal external fans.
- 23) Can be ordered for 230 VΔ/400 VY or 400 VΔ/690 VY (voltage code **"22"** or **"34"**). Not possible for 8-pole motors and in combination with order code **D34**.
- 24) Wearing parts (bearings) are excluded from the warranty extension.
- 25) The delivery time for the manufacturer's test certificate may differ from the delivery time for the motor.
- 26) The Operating Instructions (compact) are available in PDF format for all official EU languages at <http://support.automation.siemens.com/WWW/view/en/40761976>.
- 27) With **H08**, feet dimensions C and CA differ from EN 50347! Further information is available in the DT Configurator (see Appendix, "Tools and engineering").
- 28) Order codes **F70** and **F76** cannot be combined.
- 29) Not possible in combination with order codes **Q72** and **Q78**.
- 30) For frame sizes 100 to 132 only possible in combination with order code **R50**.
- 31) Not possible in combination with order codes **N05**, **N06**, **N07**, **N08**, and **N11**.
- 32) For frame size 315, when combining order codes **F01** and **F12**, the rectifier for the brake will be supplied separately as a single part.
- 33) Order code **S06** cannot be combined with order codes **S00**, **S01**, and **S02**. It can be combined with **Y53** and **Y56** on request.
- 34) Order codes **F70** (separately driven fan) and **H02** (vibration-proof version) cannot be combined for motors in frame sizes 71, 80, and 90.
- 35) Please note the additional use of order code **D22** "Motor without CE marking for export outside EEA (see EU Directive 640/2009)".
- 36) A minimum cantilever force F_{min} of $0.5 \cdot F_{max}$ is required for NU bearings (cylindrical roller bearings) in contrast to ball bearings. Cylindrical roller bearings are not suitable for coupling output or for brief periods of no-load operation without cantilever force.
- 37) Order code **R62** only possible in combination with **R50**.
- 38) Supplied with the condensation drainage holes sealed at the drive end DE and non-drive end NDE (IP55, IP56, IP65). If the condensation drainage holes are required for motors of the IM B6, IM B7 or IM B8 type of construction (feet on side or top), the motors must be ordered in the respective type of construction and with order code **H03**, so that the condensation drainage holes will be placed in the correct position.
- 39) Not possible in combination with order code **R50**.
- 40) Not UL-certified. Not in combination with option **D31**.
- 41) With IM B5 flange, only possible in combination with **H08**.
- 42) Not possible in combination with voltage code (12th or 13th position of the Article No.) 17, 18, 30, 31 and 90 with the additional order codes M1E; M2E; M1F; M2F; M1G; M2G; M1H; M2H; M1J; M2J; M1K; M2K; M1L; M2L; M1M; M2M and M3A.

SIMOTICS GP and SIMOTICS SD standard motors

Article No. supplements and special versions · Options

Aluminum series SIMOTICS GP 1LE1073 and cast-iron series SIMOTICS SD 1LE1573, 1LE5773

Selection and ordering data

| Special versions | Additional identification code -Z with order code and plain text if required | Frame size | | | | | | | | | | | Motor version | | | |
|--|--|------------|----|-----|-----|-----|---------|-----|-----|-----|-----|---------|---------------|-----|----------|---|
| | | 80 | 90 | 100 | 112 | 132 | 160 | 180 | 200 | 225 | 250 | 280 | 315 | IEC | IE3 | |
| | | 1LE1073 | | | | | 1LE1573 | | | | | 1LE5773 | | | | |
| 1LE1 -Z | | Order code | | | | | | | | | | | | | | |
| Motor protection | | | | | | | | | | | | | | | | |
| 1 or 3 PTC thermistors – for tripping (2 terminals) | Q11 | ✓ | ✓ | ✓ | ✓ | ✓ | ✓ | ✓ | ✓ | ✓ | ✓ | ✓ | ✓ | ✓ | | |
| 2 or 6 PTC thermistors – for alarm and tripping (4 terminals) | Q12 | ✓ | ✓ | ✓ | ✓ | ✓ | ✓ | ✓ | ✓ | ✓ | ✓ | ✓ | ✓ | ✓ | | |
| 1 KTY84-130 temperature sensor (2 terminals) | Q23 | ✓ | ✓ | ✓ | ✓ | ✓ | ✓ | ✓ | ✓ | ✓ | ✓ | ✓ | ✓ | ✓ | | |
| 2 KTY84-130 temperature sensors (4 terminals) | Q25 | ✓ | ✓ | ✓ | ✓ | ✓ | ✓ | ✓ | ✓ | ✓ | ✓ | ✓ | ✓ | ✓ | | |
| 3 bimetal sensors (NC contacts) for tripping (2 terminals) | Q31 | ✓ | ✓ | ✓ | ✓ | ✓ | ✓ | ✓ | ✓ | ✓ | ✓ | ✓ | ✓ | ✓ | | |
| 6 bimetal sensors (NC contacts) for alarm and tripping (4 terminals) | Q32 | ✓ | ✓ | ✓ | ✓ | ✓ | ✓ | ✓ | ✓ | ✓ | ✓ | ✓ | ✓ | ✓ | | |
| 3 bimetal sensors (NC contacts) for tripping (6 terminals) | Q33 | - | - | - | - | - | - | ✓ | ✓ | ✓ | ✓ | ✓ | ✓ | ✓ | | |
| 6 bimetal sensors (NC contacts) for alarm and tripping (12 terminals) | Q34 | - | - | - | - | - | - | ✓ | ✓ | ✓ | ✓ | ✓ | ✓ | ✓ | | |
| 1 Pt1000 resistance thermometer (2 terminals) | Q35 | ✓ | ✓ | ✓ | ✓ | ✓ | ✓ | ✓ | ✓ | ✓ | ✓ | ✓ | ✓ | ✓ | | |
| 2 Pt1000 resistance thermometer (4 terminals) | Q36 | ✓ | ✓ | ✓ | ✓ | ✓ | ✓ | ✓ | ✓ | ✓ | ✓ | ✓ | ✓ | ✓ | | |
| 3 Pt100 resistance thermometers – 2-wire input (6 terminals) | Q60 | - | - | - | - | - | - | ✓ | ✓ | ✓ | ✓ | ✓ | ✓ | ✓ | | |
| 6 Pt100 resistance thermometers – 2-wire input (12 terminals) ¹⁹⁾ | Q61 | - | - | - | - | - | - | ✓ | ✓ | ✓ | ✓ | ✓ | ✓ | ✓ | | |
| 1 Pt100 resistance thermometer – 2-wire input (2 terminals) | Q62 | - | - | - | - | - | - | ✓ | ✓ | ✓ | ✓ | ✓ | ✓ | ✓ | | |
| 3 Pt100 resistance thermometers – 3-wire input (9 terminals) ²²⁾ | Q63 | - | - | - | - | - | - | ✓ | ✓ | ✓ | ✓ | ✓ | ✓ | ✓ | | |
| 6 Pt100 resistance thermometers – 3-wire input (18 terminals) ²²⁾ | Q64 | - | - | - | - | - | - | ✓ | ✓ | ✓ | ✓ | ✓ | ✓ | ✓ | | |
| 2 Pt100 resistance thermometers in basic configuration for bearing (2 terminals) ²⁾ | Q72 | - | - | - | - | - | - | ✓ | ✓ | ✓ | ✓ | ✓ | ✓ | ✓ | | |
| 2 Pt100 resistance thermometers in 3-wire input for bearing (6 terminals) | Q78 | - | - | - | - | - | - | ✓ | ✓ | ✓ | ✓ | ✓ | ✓ | ✓ | | |
| 2 Pt100 double resistance thermometers in 3-wire input for bearing (12 terminals) | Q79 | - | - | - | - | - | - | ✓ | ✓ | ✓ | ✓ | ✓ | ✓ | ✓ | Not for: | Motors in combination with order codes F40 and F41 (frame sizes 225 to 315) |
| Motor connection and terminal box | | | | | | | | | | | | | | | | |
| External grounding | H04 | ✓ | ✓ | ✓ | ✓ | ✓ | ✓ | □ | □ | □ | □ | □ | □ | □ | | |
| Terminal box on NDE ¹⁹⁾ | H08 | O | R | O | R | O | R | O | R | O | R | ✓ | ✓ | ✓ | ✓ | |
| Second external grounding | H70 | - | - | - | - | - | - | ✓ | ✓ | ✓ | ✓ | ✓ | ✓ | ✓ | | |
| Rotation of the terminal box through 90°, entry from DE ³⁰⁾ | R10 | O | O | O | O | O | O | ✓ | ✓ | ✓ | ✓ | ✓ | ✓ | ✓ | | |
| Rotation of the terminal box through 90°, entry from NDE | R11 | O | O | O | O | O | O | ✓ | ✓ | ✓ | ✓ | ✓ | ✓ | ✓ | | |
| Rotation of the terminal box through 180° | R12 | O | O | O | O | O | O | ✓ | ✓ | ✓ | ✓ | ✓ | ✓ | ✓ | | |
| One EMC cable gland | R14 | ✓ | ✓ | ✓ | ✓ | ✓ | ✓ | ✓ | ✓ | ✓ | ✓ | ✓ | ✓ | ✓ | | |
| One metal cable gland | R15 | ✓ | ✓ | ✓ | ✓ | ✓ | ✓ | ✓ | ✓ | ✓ | ✓ | ✓ | ✓ | ✓ | | |
| EMC cable gland, maximum configuration | R16 | ✓ | ✓ | ✓ | ✓ | ✓ | ✓ | ✓ | ✓ | ✓ | ✓ | ✓ | ✓ | ✓ | | |
| Stud terminal for cable connection, accessories pack (3 items) | R17 | - | - | - | - | - | - | - | - | - | - | ✓ | ✓ | ✓ | | |
| Metal cable gland, maximum configuration | R18 | ✓ | ✓ | ✓ | ✓ | ✓ | ✓ | ✓ | ✓ | ✓ | ✓ | ✓ | ✓ | ✓ | | |
| Saddle terminal for connection without cable lug, accessories pack | R19 | - | - | - | - | - | - | - | - | - | - | ✓ | ✓ | ✓ | | |
| 3 cables protruding, 0.5 m long | R20 | ✓ | ✓ | ✓ | ✓ | ✓ | ✓ | ✓ | - | - | - | - | - | - | | |
| 3 cables protruding, 1.5 m long | R21 | ✓ | ✓ | ✓ | ✓ | ✓ | ✓ | O | R | O | R | O | R | O | R | |
| 6 cables protruding, 0.5 m long | R22 | ✓ | ✓ | ✓ | ✓ | ✓ | ✓ | ✓ | - | - | - | - | - | - | | |
| 6 cables protruding, 1.5 m long | R23 | ✓ | ✓ | ✓ | ✓ | ✓ | ✓ | O | R | O | R | O | R | O | R | |
| 6 cables protruding, 3 m long | R24 | ✓ | ✓ | ✓ | ✓ | ✓ | ✓ | O | R | O | R | O | R | O | R | |

For legends and footnotes, see page 2/138.



SIMOTICS GP and SIMOTICS SD standard motors

Article No. supplements and special versions · Options

Aluminum series SIMOTICS GP 1LE1073 and cast-iron series SIMOTICS SD 1LE1573, 1LE5773

| Special versions | Additional identification code -Z with order code and plain text if required | Frame size | | | | | | | | | | | Motor version | | | |
|---|--|------------|-------|-------|-------|-------|-------|---------|-------|-----|-----|---------|---------------|-----|-----|--|
| | | 80 | 90 | 100 | 112 | 132 | 160 | 180 | 200 | 225 | 250 | 280 | 315 | IEC | IE3 | |
| | | 1LE1073 | | | | | | 1LE1573 | | | | 1LE5773 | | | | |
| 1LE1 -Z | Order code | | | | | | | | | | | | | | | |
| Motor connection and terminal box (continued) | | | | | | | | | | | | | | | | |
| 12 cables protruding with cable lugs | R31 | ☐ | ☐ | ☐ | ☐ | ☐ | ☐ | ☐ | ☐ | ☐ | ☐ | ☐ | ☐ | | | |
| Larger terminal box | R50 | ✓ | ✓ | ✓ | ✓ | ✓ | ✓ | ✓ | ✓ | ✓ | ✓ | ✓ | ✓ | | | |
| Terminal box without cable entry opening | R51 | - | - | - | - | - | - | ○ | ○ | ○ | ○ | ○ | ○ | | | |
| Drilled removable entry plate | R52 | - | - | - | - | - | - | ✓ | ✓ | ✓ | ✓ | ✓ | ✓ | | | |
| Undrilled removable entry plate | R53 | - | - | - | - | - | - | ✓ | ✓ | ✓ | ✓ | ✓ | ✓ | | | |
| Cast-iron auxiliary terminal box (small 22) | R62 | - | - | - | - | - | ✓ | ✓ | ✓ | ✓ | ✓ | ✓ | ✓ | | | |
| Cast-iron auxiliary terminal box (large) | R63 | - | - | - | - | - | - | - | - | - | - | - | - | ✓ | | |
| Silicone-free version | R74 | - | - | ☐ | ☐ | ☐ | ☐ | ☐ | ☐ | ☐ | ☐ | ☐ | ☐ | ✓ | ✓ | |
| Non-standard threaded through hole (NPT or G thread) | Y61 • and customer specifications | - | - | - | - | - | - | ✓ | ✓ | ✓ | ✓ | ✓ | ✓ | ✓ | ✓ | |
| Windings and insulation | | | | | | | | | | | | | | | | |
| Temperature class 155 (F), utilized according to 155 (F), with service factor | N01 | ✓ | ✓ | ✓ | ✓ | ✓ | ✓ | ✓ | ✓ | ✓ | ✓ | ✓ | ✓ | ✓ | ✓ | |
| Temperature class 155 (F), utilized acc. to 155 (F), with increased power | N02 | ✓ | ✓ | ✓ | ✓ | ✓ | ✓ | ✓ | ✓ | ✓ | ✓ | ✓ | ✓ | ✓ | ✓ | |
| Temperature class 155 (F), utilized acc. to 155 (F), with increased coolant temperature | N03 | ✓ | ✓ | ✓ | ✓ | ✓ | ✓ | ✓ | ✓ | ✓ | ✓ | ✓ | ✓ | ✓ | ✓ | |
| Temperature class 155 (F), utilized acc. to 130 (B), coolant temperature 45 °C, derating approx. 4 % | N05 | ✓ | ✓ | ✓ | ✓ | ✓ | ✓ | ✓ | ✓ | ✓ | ✓ | ✓ | ✓ | ✓ | ✓ | |
| Temperature class 155 (F), utilized acc. to 130 (B), coolant temperature 50 °C, derating approx. 8 % | N06 | ✓ | ✓ | ✓ | ✓ | ✓ | ✓ | ✓ | ✓ | ✓ | ✓ | ✓ | ✓ | ✓ | ✓ | |
| Temperature class 155 (F), utilized acc. to 130 (B), coolant temperature 55 °C, derating approx. 13 % | N07 | ✓ | ✓ | ✓ | ✓ | ✓ | ✓ | ✓ | ✓ | ✓ | ✓ | ✓ | ✓ | ✓ | ✓ | |
| Temperature class 155 (F), utilized acc. to 130 (B), coolant temperature 60 °C, derating approx. 18 % | N08 | ✓ | ✓ | ✓ | ✓ | ✓ | ✓ | ✓ | ✓ | ✓ | ✓ | ✓ | ✓ | ✓ | ✓ | |
| Temperature class 180 (H) | N10 | O. R. | O. R. | O. R. | O. R. | O. R. | O. R. | O. R. | O. R. | ✓ | ✓ | ✓ | ✓ | ✓ | ✓ | |
| Temperature class 180 (H) at rated power and max. CT 60 °C ⁴⁾ | N11 | ✓ | ✓ | ✓ | ✓ | ✓ | ✓ | ✓ | ✓ | ✓ | ✓ | ✓ | ✓ | ✓ | ✓ | |
| Increased air humidity/temperature with 30 to 60 g water per m ³ of air | N30 | ✓ | ✓ | ✓ | ✓ | ✓ | ✓ | ✓ | ✓ | ✓ | ✓ | ✓ | ✓ | ✓ | ✓ | |
| Increased air humidity/temperature with 60 to 100 g water per m ³ of air | N31 | ✓ | ✓ | ✓ | ✓ | ✓ | ✓ | ✓ | ✓ | ✓ | ✓ | ✓ | ✓ | ✓ | ✓ | |
| Temperature class 155 (F), utilized acc. to 130 (B), with higher coolant temperature and/or installation altitude | Y50 • and spec. power, CT .. °C or IA m above sea level | - | - | ✓ | ✓ | ✓ | ✓ | ✓ | ✓ | ✓ | ✓ | ✓ | ✓ | ✓ | ✓ | |
| Temperature class 155 (F), utilized acc. to 155 (F), other requirements | Y52 • and spec. power, CT .. °C or IA m above sea level | ✓ | ✓ | ✓ | ✓ | ✓ | ✓ | ✓ | ✓ | ✓ | ✓ | ✓ | ✓ | ✓ | ✓ | |
| Temperature class 180 (H), utilized according to 155 (F) | Y75 • and spec. power, CT .. °C or IA m above sea level | - | - | O. R. | O. R. | O. R. | O. R. | O. R. | ✓ | ✓ | ✓ | ✓ | ✓ | ✓ | ✓ | |
| Colors and paint finish | | | | | | | | | | | | | | | | |
| Unpainted (only cast-iron parts primed) | S00 | ○ | ○ | ○ | ○ | ○ | ○ | ○ | ○ | ○ | ○ | ○ | ○ | ○ | ○ | |
| Unpainted, only primed | S01 | ✓ | ✓ | ✓ | ✓ | ✓ | ✓ | ✓ | ✓ | ✓ | ✓ | ✓ | ✓ | ✓ | ✓ | |
| Special paint finish C3 | S02 | ☐ | ☐ | ☐ | ☐ | ☐ | ☐ | ☐ | ☐ | ☐ | ☐ | ☐ | ☐ | ☐ | ☐ | |
| Special paint finish sea air resistant C4 | S03 | ✓ | ✓ | ✓ | ✓ | ✓ | ✓ | ✓ | ✓ | ✓ | ✓ | ✓ | ✓ | ✓ | ✓ | |
| Special paint finish for use offshore C5 | S04 | - | - | - | - | - | - | ✓ | ✓ | ✓ | ✓ | ✓ | ✓ | ✓ | ✓ | |

For legends and footnotes, see page 2/138.

SIMOTICS GP and SIMOTICS SD standard motors

Article No. supplements and special versions · Options

Aluminum series SIMOTICS GP 1LE1073 and cast-iron series SIMOTICS SD 1LE1573, 1LE5773

| Special versions | Additional identification code -Z with order code and plain text if required | Frame size | | | | | | | | | | | Motor version | | | | |
|--|--|------------|----|-----|-----|-----|-----|---------|-----|-----|-----|---------|---------------|-----|-----|--|--|
| | | 80 | 90 | 100 | 112 | 132 | 160 | 180 | 200 | 225 | 250 | 280 | 315 | IEC | IE3 | | |
| | | 1LE1073 | | | | | | 1LE1573 | | | | 1LE5773 | | | | | |
| 1LE1...-...-...-Z | Order code | | | | | | | | | | | | | | | | |
| Colors and paint finish (continued) | | | | | | | | | | | | | | | | | |
| Internal coating | S05 | ✓ | ✓ | ✓ | ✓ | ✓ | ✓ | ✓ | ✓ | ✓ | ✓ | ✓ | ✓ | ✓ | | | |
| Top coat polyurethane ²⁵⁾ | S06 | ✓ | ✓ | ✓ | ✓ | ✓ | ✓ | ✓ | ✓ | ✓ | ✓ | ✓ | ✓ | ✓ | | | |
| Paint finish in other standard RAL colors: RAL 1002, 1013, 1015, 1019, 2003, 2004, 3000, 3007, 5002, 5007, 5009, 5010, 5012, 5015, 5017, 5018, 5019, 6011, 6019, 6021, 7000, 7001, 7004, 7011, 7016, 7022, 7031, 7032, 7033, 7035, 9001, 9002, 9005 (see Catalog Section 1 "Introduction") | Y53 • and paint finish RAL.... | ✓ | ✓ | ✓ | ✓ | ✓ | ✓ | ✓ | ✓ | ✓ | ✓ | ✓ | ✓ | ✓ | | | |
| Paint finish in special RAL colors: For RAL colors, see "Special paint finish in special RAL colors" (see Catalog Section 1 "Introduction") | Y56 • and paint finish RAL.... | ✓ | ✓ | ✓ | ✓ | ✓ | ✓ | ✓ | ✓ | ✓ | ✓ | ✓ | ✓ | ✓ | | | |
| Modular technology – Basic versions ⁵⁾ | | | | | | | | | | | | | | | | | |
| Mounting of holding brake, (standard assignment) ^{6) 23) 24)} | F01 | ✓ | ✓ | ✓ | ✓ | ✓ | ✓ | ✓ | ✓ | ✓ | ✓ | ✓ | ✓ | ✓ | | | |
| Mounting of PRECIMA brake | F04 | - | - | - | - | - | - | - | ✓ | ✓ | ✓ | ✓ | - | | | | |
| Mounting of separately driven fan ^{20) 26)} | F70 | ✓ | ✓ | ✓ | ✓ | ✓ | ✓ | ✓ | ✓ | ✓ | ✓ | ✓ | ✓ | ✓ | | | |
| Mounting of Kübler Sendix 5020 HTL, 1024 I rotary pulse encoder | G11 | ✓ | ✓ | ✓ | ✓ | ✓ | ✓ | ✓ | ✓ | ✓ | ✓ | ✓ | ✓ | ✓ | | | |
| Mounting of Kübler Sendix 5020 TTL, 1024 I rotary pulse encoder | G12 | ✓ | ✓ | ✓ | ✓ | ✓ | ✓ | ✓ | ✓ | ✓ | ✓ | ✓ | ✓ | ✓ | | | |
| Modular technology – Additional versions | | | | | | | | | | | | | | | | | |
| Brake supply voltage 24 V DC | F10 | ✓ | ✓ | ✓ | ✓ | ✓ | ✓ | ✓ | ✓ | ✓ | ✓ | ✓ | ✓ | ✓ | | | |
| Brake supply voltage 230 V AC, 50/60 Hz | F11 | ✓ | ✓ | ○ | ○ | ○ | ○ | ○ | ○ | ○ | ○ | ○ | ○ | ○ | | | |
| Brake supply voltage 400 V AC, 50/60 Hz ²⁴⁾ | F12 | ✓ | ✓ | ✓ | ✓ | ✓ | ✓ | ✓ | ✓ | ✓ | ✓ | ✓ | ✓ | ✓ | | | |
| Brake supply voltage 180 V DC | F17 | ✓ | ✓ | ✓ | ✓ | ✓ | ✓ | ✓ | ✓ | - | - | - | - | | | | |
| Brake supply voltage 205 V DC | F18 | ✓ | ✓ | ✓ | ✓ | ✓ | ✓ | ✓ | ✓ | - | - | - | - | | | | |
| Backstop, counterclockwise motion blocked, clockwise direction of rotation | F40 | - | - | - | - | ✓ | ✓ | ✓ | ✓ | ✓ | ✓ | ✓ | ✓ | ✓ | | | |
| Backstop, clockwise motion blocked, counterclockwise direction of rotation | F41 | - | - | - | - | - | - | ✓ | ✓ | ✓ | ✓ | ✓ | ✓ | ✓ | | | |
| Mechanical manual brake release with lever (no locking) | F50 | ✓ | ✓ | ✓ | ✓ | ✓ | ✓ | ✓ | ✓ | ✓ | ✓ | ✓ | ✓ | ✓ | | | |
| Special technology ⁵⁾ | | | | | | | | | | | | | | | | | |
| Mounting of LL 861 900 220 rotary pulse encoder ⁷⁾ | G04 | - | - | ✓ | ✓ | ✓ | ✓ | ✓ | ✓ | ✓ | ✓ | ✓ | ✓ | ✓ | | | |
| Mounting of HOG 9 DN 1024 I rotary pulse encoder ⁷⁾ | G05 | - | - | ✓ | ✓ | ✓ | ✓ | ✓ | ✓ | ✓ | ✓ | ✓ | ✓ | ✓ | | | |
| Mounting of HOG 10 D 1024 I rotary pulse encoder ⁷⁾ | G06 | - | - | ✓ | ✓ | ✓ | ✓ | ✓ | ✓ | ✓ | ✓ | ✓ | ✓ | ✓ | | | |
| Mounting of POG 10 DN rotary pulse encoder (only in combination with separately driven fan or brake) ⁷⁾ | G07 | - | - | - | - | - | - | ✓ | ✓ | ✓ | ✓ | ✓ | ✓ | ✓ | | | |
| Mounting of POG 9 rotary pulse encoder (only in combination with separately driven fan or brake) ⁶⁾ | G08 | - | - | - | - | - | - | ✓ | ✓ | ✓ | ✓ | ✓ | ✓ | ✓ | | | |
| Mounting of HOG 10 DN 1024 I rotary pulse encoder, terminal box moisture protection | G15 | - | - | - | - | - | - | ✓ | ✓ | ✓ | ✓ | ✓ | ✓ | ✓ | | | |
| Mounting of HOG 10 DN 1024 I rotary pulse encoder, terminal box dust protection | G16 | - | - | - | - | - | - | ✓ | ✓ | ✓ | ✓ | ✓ | ✓ | ✓ | | | |
| Mounting of Kübler Sendix 5834FS2 1024, SIL-2 rotary pulse encoder | G21 | ✓ | ✓ | ✓ | ✓ | ✓ | ✓ | ✓ | ✓ | ✓ | ✓ | ✓ | ✓ | ✓ | | | |
| Mounting of Kübler Sendix 5834FS3 1024, SIL-3 rotary pulse encoder | G22 | ✓ | ✓ | ✓ | ✓ | ✓ | ✓ | ✓ | ✓ | ✓ | ✓ | ✓ | ✓ | ✓ | | | |
| Mounting of HOGS100S-B76.626.01024.1 rotary pulse encoder | G25 | - | - | - | - | - | - | ✓ | ✓ | ✓ | ✓ | ✓ | ✓ | ✓ | | | |
| Mounting of LL FSI 862-184560-1024, SIL-2 rotary pulse encoder | G27 | - | - | - | - | - | - | ✓ | ✓ | ✓ | ✓ | ✓ | ✓ | ✓ | | | |
| Mounting of rotary pulse encoder HOG 10 DN 1024 I + FSL, (integrated centrifugal switch, speed ... rpm), terminal box moisture protection | Y74 • and spec. speed rpm | - | - | - | - | - | - | ✓ | ✓ | ✓ | ✓ | ✓ | ✓ | ✓ | | | |

SIMOTICS GP and SIMOTICS SD standard motors

Article No. supplements and special versions · Options

Aluminum series SIMOTICS GP 1LE1073 and cast-iron series SIMOTICS SD 1LE1573, 1LE5773

| Special versions | Additional identification code -Z with order code and plain text if required | Frame size | | | | | | | | | | | Motor version | | |
|--|--|------------|----|-----|-----|-----|-----|---------|-----|-----|-----|---------|---------------|-----|-----|
| | | 80 | 90 | 100 | 112 | 132 | 160 | 180 | 200 | 225 | 250 | 280 | 315 | IEC | IE3 |
| | | 1LE1073 | | | | | | 1LE1573 | | | | 1LE5773 | | | |
| 1LE1 -Z | | Order code | | | | | | | | | | | | | |
| Special technology ⁵⁾ (continued) | | | | | | | | | | | | | | | |
| Mounting of rotary pulse encoder HOG 10 DN 1024 I + FSL, (integrated centrifugal switch, speed rpm), terminal box dust protection | Y76 • and spec. speed rpm | - | - | - | - | - | - | ✓ | ✓ | ✓ | ✓ | ✓ | ✓ | | |
| Mounting of rotary pulse encoder HOG 10 DN 1024 I + ESL 93, (integrated electronic speed switch, speed rpm), terminal box dust protection | Y79 • and spec. speed (max 3) rpm | - | - | - | - | - | - | ✓ | ✓ | ✓ | ✓ | ✓ | ✓ | | |
| Mechanical version and degrees of protection | | | | | | | | | | | | | | | |
| Low-noise version for 2-pole motors with clockwise direction of rotation | F77 | - | - | - | - | ✓ | ✓ | ✓ | ✓ | ✓ | ✓ | ✓ | ✓ | | |
| Low-noise version for 2-pole motors with counterclockwise direction of rotation | F78 | - | - | - | - | ✓ | ✓ | ✓ | ✓ | ✓ | ✓ | ✓ | ✓ | | |
| Prepared for mounted components, centering hole only | G40 | ✓ | ✓ | ✓ | ✓ | ✓ | ✓ | □ | □ | □ | □ | □ | □ | | |
| Prepared for mountings with D12 shaft | G41 | ✓ | ✓ | ✓ | ✓ | ✓ | ✓ | ✓ | ✓ | ✓ | ✓ | ✓ | ✓ | | |
| Prepared for mountings with D16 shaft | G42 | ✓ | ✓ | ✓ | ✓ | ✓ | ✓ | ✓ | ✓ | ✓ | ✓ | ✓ | ✓ | | |
| Mechanical protection for encoder | G43 | ✓ | ✓ | ✓ | ✓ | ✓ | ✓ | ✓ | ✓ | ✓ | ✓ | ✓ | ✓ | | |
| Protective cover ^{7) 9)} | H00 | ✓ | ✓ | ✓ | ✓ | ✓ | ✓ | ✓ | ✓ | ✓ | ✓ | ✓ | ✓ | | |
| Screwed-on (instead of cast) feet | H01 | □ | □ | □ | □ | □ | □ | □ | □ | □ | □ | □ | □ | - | |
| Vibration-proof version; vibration resistance to Class 3M4 according to IEC 60721-3-3:1994 ²⁹⁾ | H02 | ✓ | ✓ | ✓ | ✓ | ✓ | ✓ | ✓ | ✓ | ✓ | ✓ | ✓ | ✓ | | |
| Condensation drainage holes ²⁸⁾ | H03 | ✓ | ✓ | ✓ | ✓ | ✓ | ✓ | □ | □ | □ | □ | □ | □ | | |
| Rust-resistant screws (externally) | H07 | ✓ | ✓ | ✓ | ✓ | ✓ | ✓ | ✓ | ✓ | ✓ | ✓ | ✓ | ✓ | | |
| Degree of protection IP56 ¹²⁾ | H22 | ✓ | ✓ | ✓ | ✓ | ✓ | ✓ | ✓ | ✓ | ✓ | ✓ | ✓ | ✓ | | |
| Drive-end seal for flange-mounting motors, oil-tight to 0.1 bar ^{10) 21)} | H23 | ✓ | ✓ | ✓ | ✓ | ✓ | ✓ | ✓ | ✓ | ✓ | ✓ | ✓ | ✓ | | |
| Grounding brush for converter operation | L52 | - | - | - | - | - | - | - | - | - | - | ✓ | ✓ | | |
| Coolant temperature and installation altitude | | | | | | | | | | | | | | | |
| Coolant temperature -50 to +40 °C | D02 | - | - | - | - | - | - | ✓ | ✓ | ✓ | ✓ | ✓ | ✓ | | |
| Coolant temperature -40 to +40 °C ¹³⁾ | D03 | ✓ | ✓ | ✓ | ✓ | ✓ | ✓ | ✓ | ✓ | ✓ | ✓ | ✓ | ✓ | | |
| Coolant temperature -30 to +40 °C | D04 | ✓ | ✓ | ✓ | ✓ | ✓ | ✓ | ✓ | ✓ | ✓ | ✓ | ✓ | ✓ | | |
| Versions in accordance with standards and specifications | | | | | | | | | | | | | | | |
| Motor without CE marking for export outside EEA (see EU Directive 640/2009) | D22 | ✓ | ✓ | ✓ | ✓ | ✓ | ✓ | ✓ | ✓ | ✓ | ✓ | ✓ | ✓ | | |
| Bearings and lubrication | | | | | | | | | | | | | | | |
| Regreasing device with M10 × 1 grease nipple according to DIN 71412-A ¹⁾ | L19 | - | - | - | - | - | - | ✓ | ✓ | ✓ | ✓ | ○ | ○ | | |
| Located bearing DE | L20 | ✓ | ✓ | ✓ | ✓ | ✓ | ✓ | ✓ | ✓ | ✓ | ✓ | ✓ | ✓ | | |
| Located bearing NDE | L21 | ✓ | ✓ | ✓ | ✓ | ✓ | ✓ | □ | □ | □ | □ | □ | □ | | |
| Bearing design for increased cantilever forces ²⁷⁾ | L22 | ✓ | ✓ | ✓ | ✓ | ✓ | ✓ | ✓ | ✓ | ✓ | ✓ | ✓ | ✓ | | |
| Regreasing device ¹⁾ | L23 | - | - | ✓ | ✓ | ✓ | ✓ | ✓ | ✓ | ✓ | ✓ | □ | □ | | |
| Bearings reinforced at both ends for DE and NDE, bearing size 63 ⁴⁾ | L25 | ✓ | ✓ | ✓ | ✓ | ✓ | ✓ | ✓ | ✓ | ✓ | ✓ | □ | □ | | |
| Reinforced bearings at both DE and NDE, DE bearing for increased cantilever forces | L28 | - | - | - | - | - | - | ✓ | ✓ | ✓ | ✓ | - | - | | |
| Bearing insulation DE | L50 | - | - | - | - | - | - | - | - | ✓ | ✓ | ✓ | ✓ | | |
| Bearing insulation NDE | L51 | - | - | - | - | - | - | - | - | ✓ | ✓ | ✓ | ✓ | | |
| Measuring nipple for SPM shock pulse measurement for bearing inspection ¹⁾ | Q01 | - | - | ✓ | ✓ | ✓ | ✓ | ✓ | ✓ | ✓ | ✓ | ✓ | ✓ | | |
| Balance and vibration severity | | | | | | | | | | | | | | | |
| Vibration severity grade A | | □ | □ | □ | □ | □ | □ | □ | □ | □ | □ | □ | □ | | |
| Vibration severity grade B ¹⁵⁾ | L00 | ✓ | ✓ | ✓ | ✓ | ✓ | ✓ | ✓ | ✓ | ✓ | ✓ | ✓ | ✓ | | |
| Half-key balancing (standard) | | □ | □ | □ | □ | □ | □ | □ | □ | □ | □ | □ | □ | | |
| Balancing without feather key | L01 | ✓ | ✓ | ✓ | ✓ | ✓ | ✓ | ✓ | ✓ | ✓ | ✓ | ✓ | ✓ | | |
| Full-key balancing | L02 | ✓ | ✓ | ✓ | ✓ | ✓ | ✓ | ✓ | ✓ | ✓ | ✓ | ✓ | ✓ | | |

For legends and footnotes, see page 2/138.

SIMOTICS GP and SIMOTICS SD standard motors

Article No. supplements and special versions · Options

Aluminum series SIMOTICS GP 1LE1073 and cast-iron series SIMOTICS SD 1LE1573, 1LE5773

| Special versions | Additional identification code -Z with order code and plain text if required | Frame size | | | | | | | | | | | Motor version | | |
|--|--|------------|----|-----|-----|-----|-----|---------|-------|-------|-------|---------|---------------|-------|-----|
| | | 80 | 90 | 100 | 112 | 132 | 160 | 180 | 200 | 225 | 250 | 280 | 315 | IEC | IE3 |
| | | 1LE1073 | | | | | | 1LE1573 | | | | 1LE5773 | | | |
| 1LE1 -Z | | Order code | | | | | | | | | | | | | |
| Shaft and rotor | | | | | | | | | | | | | | | |
| Shaft extension with standard dimensions, without feather keyway | L04 | ✓ | ✓ | ✓ | ✓ | ✓ | ✓ | ✓ | ✓ | ✓ | ✓ | ✓ | ✓ | ✓ | |
| Standard, cylindrical shaft extension (second shaft extension) NDE acc. to EN 50347 | L05 | ✓ | ✓ | ✓ | ✓ | ✓ | ✓ | ✓ | ✓ | ✓ | ✓ | ✓ | ✓ | ✓ | |
| Standard shaft made of stainless steel (e.g. 1.4021) | L06 | ✓ | ✓ | ✓ | ✓ | ✓ | ✓ | ✓ | ✓ | ✓ | ✓ | ✓ | ✓ | ✓ | |
| Shaft extension run-out in accordance with IEC 60072-1 precision class | L07 | ✓ | ✓ | ✓ | ✓ | ✓ | ✓ | ✓ | ✓ | ✓ | ✓ | ✓ | ✓ | ✓ | |
| Shaft extension run-out, concentricity and perpendicularity in accordance with IEC 60072-1 precision class for flange-mounted motors | L08 | ✓ | ✓ | ✓ | ✓ | ✓ | ✓ | ✓ | ✓ | ✓ | ✓ | ✓ | ✓ | ✓ | |
| Non-standard cylindrical shaft extension, DE ¹⁶⁾ | Y58 • and customer specifications | ✓ | ✓ | ✓ | ✓ | ✓ | ✓ | ✓ | ✓ | ✓ | ✓ | ✓ | ✓ | ✓ | |
| Non-standard cylindrical shaft extension, NDE ¹⁶⁾ | Y59 • and customer specifications | ✓ | ✓ | ✓ | ✓ | ✓ | ✓ | ✓ | ✓ | ✓ | ✓ | ✓ | ✓ | ✓ | |
| Special shaft steel | Y60 • and customer specifications | - | - | - | - | - | - | O. R. | O. R. | O. R. | O. R. | O. R. | O. R. | O. R. | |
| Heating and ventilation | | | | | | | | | | | | | | | |
| Sheet metal fan cover | F74 | ✓ | ✓ | ✓ | ✓ | ✓ | ✓ | ✓ | ✓ | ✓ | ✓ | ✓ | ✓ | ✓ | |
| Metal external fan ^{17) 29)} | F76 | ✓ | ✓ | ✓ | ✓ | ✓ | ✓ | ✓ | ✓ | ✓ | ✓ | ✓ | ✓ | ✓ | |
| Without external fan and without fan cover | F90 | ✓ | ✓ | ✓ | ✓ | ✓ | ✓ | ✓ | ✓ | ✓ | ✓ | ✓ | ✓ | ✓ | |
| Anti-condensation heating for 230 V (2 terminals) | Q02 | ✓ | ✓ | ✓ | ✓ | ✓ | ✓ | ✓ | ✓ | ✓ | ✓ | ✓ | ✓ | ✓ | |
| Anti-condensation heating for 115 V (2 terminals) | Q03 | ✓ | ✓ | ✓ | ✓ | ✓ | ✓ | ✓ | ✓ | ✓ | ✓ | ✓ | ✓ | ✓ | |
| Separately driven fan with non-standard voltage and/or frequency | Y81 • and customer specifications | - | - | - | - | - | - | - | - | ✓ | ✓ | ✓ | ✓ | ✓ | |
| Rating plate and additional rating plates | | | | | | | | | | | | | | | |
| Second rating plate, loose | M10 | ✓ | ✓ | ✓ | ✓ | ✓ | ✓ | ✓ | ✓ | ✓ | ✓ | ✓ | ✓ | ✓ | |
| Rating plate, stainless steel | M11 | □ | □ | □ | □ | □ | □ | □ | □ | □ | □ | □ | □ | □ | |
| Additional rating plate with deviating rating plate data | Y80 • and customer specifications | ✓ | ✓ | ✓ | ✓ | ✓ | ✓ | ✓ | ✓ | ✓ | ✓ | ✓ | ✓ | ✓ | |
| Additional rating plate with customer specifications | Y82 • and customer specifications | ✓ | ✓ | ✓ | ✓ | ✓ | ✓ | ✓ | ✓ | ✓ | ✓ | ✓ | ✓ | ✓ | |
| Additional information on rating plate and on package label (max. 20 characters) | Y84 • and customer specifications | ✓ | ✓ | ✓ | ✓ | ✓ | ✓ | ✓ | ✓ | ✓ | ✓ | ✓ | ✓ | ✓ | |
| Adhesive label, supplied loose (printed with: Article No., Serial No.; 2 lines of text) | Y85 • and customer specifications | - | - | ✓ | ✓ | ✓ | ✓ | ✓ | ✓ | ✓ | ✓ | ✓ | ✓ | ✓ | |
| Packaging, safety notes, documentation and test certificates | | | | | | | | | | | | | | | |
| Inspection certificate 3.1 ¹⁸⁾ according to EN 10204 | B02 | ✓ | ✓ | ✓ | ✓ | ✓ | ✓ | ✓ | ✓ | ✓ | ✓ | ✓ | ✓ | ✓ | |
| Document - Electrical datasheet | B60 | ✓ | ✓ | ✓ | ✓ | ✓ | ✓ | ✓ | ✓ | ✓ | ✓ | ✓ | ✓ | ✓ | |
| Document - Order dimensional drawing | B61 | ✓ | ✓ | ✓ | ✓ | ✓ | ✓ | ✓ | ✓ | ✓ | ✓ | ✓ | ✓ | ✓ | |
| Standard test (routine test) with acceptance | B65 | - | - | ✓ | ✓ | ✓ | ✓ | ✓ | ✓ | ✓ | ✓ | ✓ | ✓ | ✓ | |
| Type test with heat run for horizontal motors, without acceptance | B82 | ✓ | ✓ | ✓ | ✓ | ✓ | ✓ | ✓ | ✓ | ✓ | ✓ | ✓ | ✓ | ✓ | |
| Type test with heat run for horizontal motors, with acceptance | B83 | ✓ | ✓ | ✓ | ✓ | ✓ | ✓ | ✓ | ✓ | ✓ | ✓ | ✓ | ✓ | ✓ | |
| Connected in star for dispatch | M01 | ✓ | ✓ | ✓ | ✓ | ✓ | ✓ | ✓ | ✓ | ✓ | ✓ | ✓ | ✓ | ✓ | |
| Connected in delta for dispatch | M02 | ✓ | ✓ | ✓ | ✓ | ✓ | ✓ | ✓ | ✓ | ✓ | ✓ | ✓ | ✓ | ✓ | |

For legends and footnotes, see page 2/138.

SIMOTICS GP and SIMOTICS SD standard motors

Article No. supplements and special versions · Options

Aluminum series SIMOTICS GP 1LE1073 and cast-iron series SIMOTICS SD 1LE1573, 1LE5773

- Standard version
- Without additional charge
- This order code only determines the price of the version – Additional plain text is required.
- ✓ With additional charge
- O. R. Possible on request
- Not possible

2

- 1) Up to frame size 160 not possible when brake is mounted.
- 2) Evaluation with appropriate tripping unit (see Catalog IC 10) is recommended.
- 3) Parallel Whitworth threaded pipe DIN ISO 228 (DIN 259) BSPP (British Standard Pipe Parallel) threaded pipe for connections not sealed in the thread (cylindrical), external = G.
- 4) Cannot be used for motors in UL version (order code **D31**). The grease lifetime specified in Catalog Section 1 "Introduction" refers to CT 40 °C. If the coolant temperature is increased by 10 K, the grease lifetime and regreasing interval are halved.
- 5) A second shaft extension is not possible. Please inquire for mounted brakes.
- 6) For order codes **F10**, **F11**, **F12**, **F17**, and **F18**, the brake supply voltage must be specified or ordered.
- 7) LL and HOG rotary pulse encoders up to frame size 160 are fitted with a protective cover as standard. The protective cover is omitted at the factory when a rotary pulse encoder is combined with a separately driven fan, because in this case the rotary pulse encoder is installed under the fan cover.
- 8) Option (encoder mounting) is only possible for motors with a mounted separately driven fan or for naturally cooled motors (without an external fan). This option can be used in combination with brakes of type KFB! This option cannot be used in combination with brakes of type 2LM8!
- 9) Order code **H00** provides mechanical protection for encoders.
- 10) Not possible for type of construction IM V3.
- 11) Not possible in combination with HOG 9 DN 1024 I rotary pulse encoder (order code **G05**) and/or brake 2LM8 (order code **F01**).
- 12) Not possible in combination with 2LM8 brake – order code **F01**.
- 13) In connection with mountings, the respective technical specifications must be observed, please inquire before ordering.
- 14) From frame size 280 standard version.
- 15) On request for 2-pole motors (concerns frame sizes 225 to 315).
- 16) When motors are ordered that have a longer or shorter shaft extension than normal, the required position and length of the feather keyway must be specified in a sketch. It must be ensured that only feather keys in accordance with EN 50347, Form A are used. The feather keyway is positioned centrally on the shaft extension. The length is defined by the manufacturer in accordance with the appropriate standard. Not valid for: Conical shafts, non-standard threaded journals, non-standard shaft tolerances, friction welded journals, extremely "thin" shafts, special geometry dimensions (e.g. square journals), hollow shafts. Valid for non-standard shaft extensions DE or NDE. The feather keys are supplied in every case. For order codes **Y58**, **Y59** and **L05** the following applies:
 - Dimensions D and DA ≤ ball bearing inner diameter (see dimension tables for "Dimensions")
 - Dimensions E and EA ≤ 2 × length E (standard) of the shaft extension.
- 17) Converter operation is permitted for 1LE1 motors with metal external fans.
- 18) The delivery time for the manufacturer's test certificate may differ from the delivery time for the motor.
- 19) With **H08**, feet dimensions C and CA differ from EN 50347! Further information is available in the DT Configurator (see Appendix, "Tools and engineering").
- 20) Order codes **F70** and **F76** cannot be combined.
- 21) Not possible in combination with order codes **Q72** and **Q78**.
- 22) For frame sizes 100 to 132 only possible in combination with order code **R50**.
- 23) Not possible in combination with order codes **N05**, **N06**, **N07**, **N08**, and **N11**.
- 24) For frame size 315, when combining order codes **F01** and **F12**, the rectifier for the brake will be supplied separately as a single part.
- 25) Order code **S06** cannot be combined with order codes **S00**, **S01**, and **S02**. It can be combined with **Y53** and **Y56** on request.
- 26) Order codes **F70** (separately driven fan) and **H02** (vibration-proof version) cannot be combined for motors in frame sizes 71, 80, and 90.
- 27) A minimum cantilever force F_{\min} of $0.5 \cdot F_{\max}$ is required for NU bearings (cylindrical roller bearings) in contrast to ball bearings. Cylindrical roller bearings are not suitable for coupling output or for brief periods of no-load operation without cantilever force.
- 28) Supplied with the condensation drainage holes sealed at the drive end DE and non-drive end NDE (IP55, IP56, IP65). If the condensation drainage holes are required for motors of the IM B6, IM B7 or IM B8 type of construction (feet on side or top), the motors must be ordered in the respective type of construction and with order code **H03**, so that the condensation drainage holes will be placed in the correct position.
- 29) Not possible in combination with order code **R50**.
- 30) With IM B5 flange, only possible in combination with **H08**.

Overview

Couplings

The motor from Siemens is connected to the machine or gear unit through a coupling. Flender is an important coupling manufacturer with a wide range of products.

For standard applications, Siemens recommends that flexible couplings, types N-EUPEX and RUPEX or torsionally rigid couplings, types ARPEX and ZAPEX are used. For special applications, FLUDEX and ELPEX-S couplings are recommended.

Available from:

Siemens contact partner – ordering from catalog
Siemens MD 10.1 "FLENDER Standard Couplings"

or

Flender GmbH
Kupplungswerk Mussum
Industriepark Bocholt
Schlavenhorst 100
46395 Bocholt, Germany
Phone +49 (2871) 922185
Fax +49 (2871) 922579

www.flender.com

Email: flender-kupplungen-2.pd.de@siemens.com

Taper pins according to DIN 258 with threaded ends and constant taper lengths

Taper pins are used for components that are repeatedly removed. The drilled hole is conically ground using a conical reamer until the pin can be pushed in by hand until the cone shoulder lies approx. 3 to 4 mm above the rim of the hole.

It can then be driven in using a hammer until it is correctly seated. The pin is removed from the drilled hole by screwing on the nut and tightening it.

Standardized taper pins are commercially available.

For instance, available from:

Otto Roth GmbH & Co. KG
Rutesheimer Strasse 22
70499 Stuttgart, Germany
Phone +49 (711) 1388-0
Fax +49 (711) 1388-233

www.ottoroth.de

Email: info@ottoroth.de

Foundation block according to DIN 799

The foundation blocks are inserted into the stone foundation and embedded in concrete. They are used for fixing machines of medium size, slide rails, pedestal bearings, base frames, etc. After the fixing bolts have been unscrewed, the machines can be shifted without them having to be lifted.

When the machine is initially installed, the foundation block that is bolted to the machine (without washers) and fitted with taper pins is not embedded with concrete until the machine has been fully aligned. In this case, the machine is positioned 2 to 3 mm lower. The difference in shaft height is compensated by inserting shims on final installation. The taper pins safeguard the exact position of the machine when it is repeatedly removed and replaced without the need for realignment.

Available from:

Lütgert & Co. GmbH
Postfach 42 51
33276 Gütersloh, Germany
Phone +49 (5241) 7407-0
Fax +49 (5241) 7407-90

www.luetgert-antriebe.de

Email: info@luetgert-antriebe.de

Slide rails with fixing bolts and tensioning screws according to DIN 42923

Slide rails are used to tension the belt of a machine easily and conveniently when there is no belt-tensioning pulley. They are fixed to the base using stone bolts or foundation blocks.

The assignment of slide rails to motor size can be found in DIN 42923.

For motors of frame sizes 355 to 450, there are no standardized slide rails (please inquire).

Available from:

Lütgert & Co. GmbH
Postfach 42 51
33276 Gütersloh, Germany
Phone +49 (5241) 7407-0
Fax +49 (5241) 7407-90

www.luetgert-antriebe.de

Email: info@luetgert-antriebe.de

SIMOTICS GP and SIMOTICS SD standard motors

Article No. supplements and special versions · Accessories

More information

Replacement motors and repair parts

- Commitment to provide replacement motors and repair parts following delivery of the motor:
 - For up to 3 years after delivery of the original motor, in the event of total motor failure, Siemens will supply a comparable replacement motor with regard to the mounting dimensions and functions (the type series may vary).
 - If a replacement motor is supplied within the 3-year period, this does not mean that the warranty restarts.
 - Replacement motors delivered after the active production of the machine series are also identified as spare motors on the rating plate.
 - Spare parts are offered only for these spare motors on request; repair and replacement are not possible.
 - After a period of 3 years (after the delivery of the original motor), it is only possible to repair these motors (depending on the availability of the spare parts required).
 - For up to 5 years after the delivery of the original motor, spare parts will be available and for a further 5 years, Siemens will provide information about spare parts and will supply documents when required.
- When repair parts are ordered, the following details must be provided:
 - Designation and part number
 - Article No. and factory number of the motor.

Example for ordering a fan cover 1LE1003,
frame size 112 M, 4-pole:

**Fan cover No. 7.40,
1LE1003-1BB23-4AA4-Z, part No. E1001/5236197_01_001**

- For bearing types, see Catalog Section 1 "Introduction".
- Repair parts for 1MJ6, 1MJ7, 1MJ8, 1MJ1, 1ME8, 1ML8 motors are available on request.
- For standard components, a commitment to supply repaired parts does not apply.
- Support hotline
In Germany
Phone +49 (180) 5050448

You will find telephone numbers for other countries on our Internet site:

www.siemens.com/automation/service&support

Overview

- Dimensional designations according to EN 50347 and IEC 60072.

Fits

The shaft extensions specified in the dimension tables (DIN 748) and centering spigot diameters (EN 50347) are machined with the following fits:

| Dimension designation | ISO fit DIN ISO 286-2 | |
|-----------------------|-----------------------|-----|
| D, DA | to 30 | j6 |
| | over 30 to 50 | k6 |
| | over 50 | m6 |
| N | to 250 | j6 |
| | over 250 | h6 |
| F, FA | | h9 |
| K | | H17 |
| S | flange (FF) | H17 |

The drilled holes of couplings and belt pulleys should have an ISO fit of at least H7.

- Dimensional tolerances

For the following dimensions, the admissible deviations are given below:

| Dimension designation | Dimension | Admissible deviation |
|-----------------------|-----------|----------------------|
| H | to 250 | - 0.5 |
| | over 250 | - 1.0 |
| E, EA | | - 0.5 |

Keyways and feather keyways (dimensions GA, GC, F, and FA) are made in compliance with DIN 6885 Part 1.

- All dimensions are specified in mm.

Dimension sheet generator (within the DT Configurator)

Overview

A dimensional drawing can be created in the "Drive Technology Configurator" (DT Configurator) for every configurable motor. A dimensional drawing can be requested for every other motor.

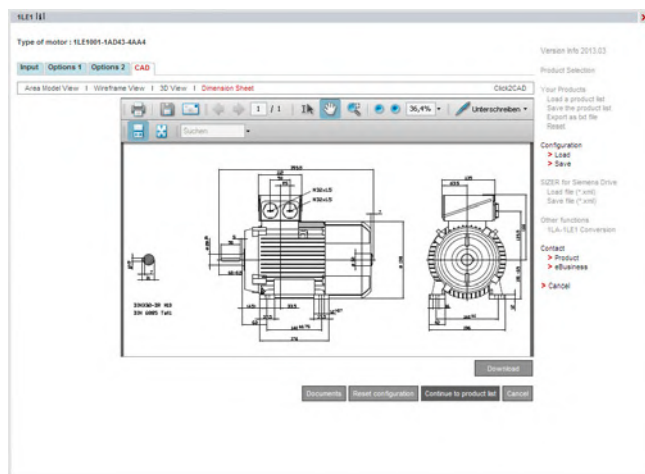

When a complete Article No. is entered with or without order codes, a dimensional drawing can be called up under the "Documentation" tab.

These dimensional drawings can be presented in different views and sections and printed.

The corresponding dimension sheets can be exported, saved and processed further in DXF format (interchange/import format for CAD systems) or as bitmap graphics.

Online access in the Siemens Industry Mall

The DT Configurator is integrated into the Siemens Industry Mall and can be used on the Internet without installation.

German: www.siemens.de/dt-konfigurator
English: www.siemens.com/dt-configurator

SIMOTICS GP and SIMOTICS SD standard motors

Dimensions · Aluminum series SIMOTICS GP

IE1, IE2, NEMA Energy Efficient and pole-changing – self-ventilated · Frame sizes 63 M to 200

Dimensional drawings

Type of construction IM B3

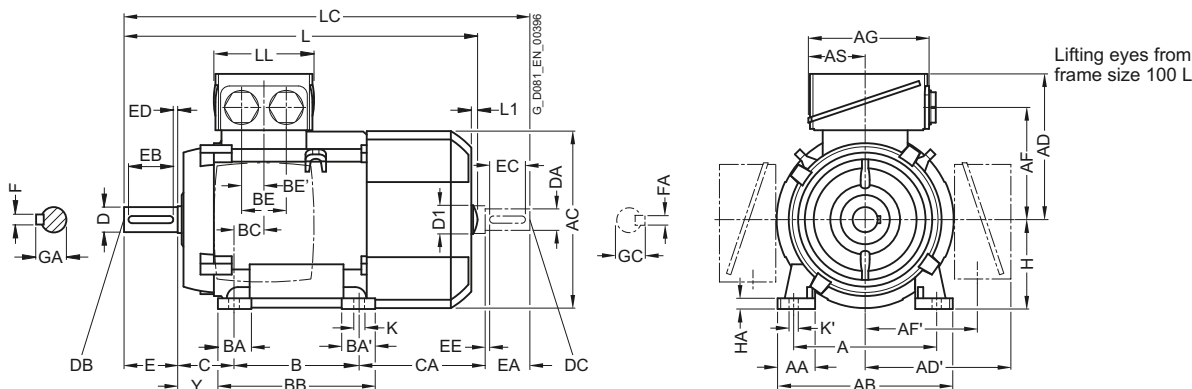

Types of construction IM B5 and IM V1

For flange dimensions, see page 1/47 (Z = the number of retaining holes)

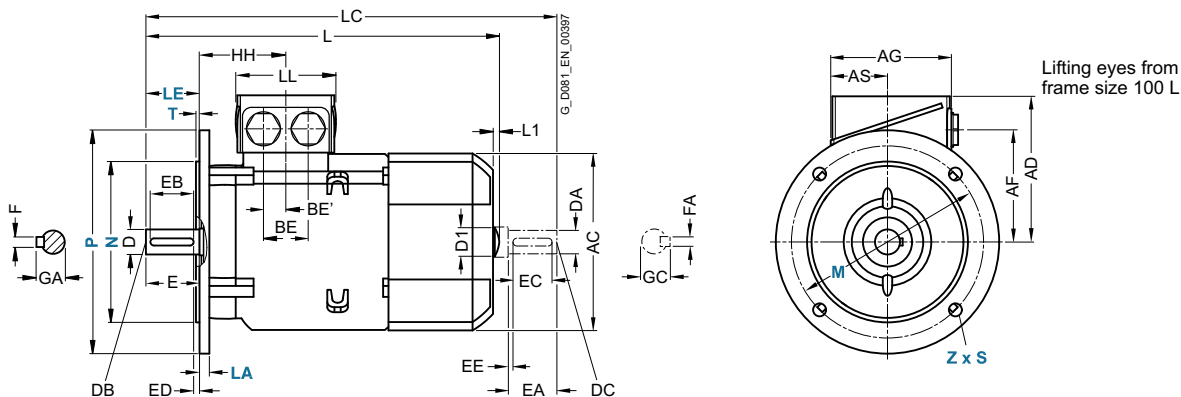

| For motor | | Dimension designation acc. to IEC | | | | | | | | | | | | | | | | | | | | | | |
|------------|--|-----------------------------------|-----|------|------------|-----|--------------|-------|-------|-------|-----|-------|-----|------|------------------|-------------------|------|----|------------------|-----|-------------------|------------|----|------|
| Frame size | Motor type | No. of poles | A | AA | AB | AC | AD | AD' | AF | AF' | AG | AS | B | BA | BA' | BB | BC | BE | BE' | C | CA | H | HA | Y |
| 63 M | 1LE100. 1LE101. 1LE1021 | 2, 4, 6 | 100 | 27 | 120 | 124 | 101 | – | 78 | – | 75 | 37.5 | 80 | 27 | – | 96 | 30 | 32 | 18 | 40 | 66 | 63 | 7 | 26.5 |
| | 1LE1001-0B.2 1LE1002-0B.3 1LE1001-0B.3 1LE1002-0B.6 | 2, 4 | | | | | | | | | | | | | | | | | | 92 | | | | |
| 71 M | 1LE1001, 1LE1002 | 2, 4, 6, 8 | 112 | 30.5 | 132 | 145 | 111 | – | 88 | – | 75 | 37.5 | 90 | 27 | – | 106 | 18 | 32 | 18 | 45 | 83 | 71 | 7 | 31.5 |
| 80 M | 1LE1001 | 2, 4, 6 | 125 | 30.5 | 150 | 159 | 121.5 | 121.5 | 96.5 | 96.5 | 93 | 43 | 100 | 32 | 32 | 118 | 23 | – | 18 ¹⁾ | 50 | 113 | 80 | 8 | 41 |
| 90 S | 1LE1041 | 2, 4, 6 | 140 | 30.5 | 165 | 178 | 126 | 126 | 101.5 | 101.5 | 93 | 43 | 100 | 33 | 54 | 143 | 22.5 | – | 18 ¹⁾ | 56 | 174 | 90 | 10 | 47 |
| 90 L | | 2, 4, 6 | 140 | 30.5 | 165 | 178 | 126 | 126 | 101.5 | 101.5 | 93 | 43 | 125 | 33 | 54 | 143 | 22.5 | – | 18 ¹⁾ | 56 | 174 | 90 | 10 | 47 |
| 100 L | All | 2, 4, 6, 8 | 160 | 42 | 196 | 198 | 166 | 166 | 125.5 | 125.5 | 135 | 63.5 | 140 | 37.5 | 37.5 | 176 | 33.5 | 50 | 25 | 63 | 141 | 100 | 12 | 45 |
| 112 M | All | 2, 4, 6, 8 | 190 | 46 | 226 | 222 | 177 | 177 | 136.5 | 136.5 | 135 | 63.5 | 140 | 37.5 | 37.5 | 176 | 26 | 50 | 25 | 70 | 130 | 112 | 12 | 52 |
| 132 S | All | 2, 4, 6, 8 | 216 | 53 | 256 | 262 | 202 | 202 | 159.5 | 159.5 | 155 | 70.5 | 140 | 38 | 76 ³⁾ | 218 ⁴⁾ | 26.5 | 48 | 24 | 89 | 167 | 132 | 15 | 69 |
| 132 M | All | 2, 4, 6, 8 | 216 | 53 | 256 | 262 | 202 | 202 | 159.5 | 159.5 | 155 | 70.5 | 178 | 38 | 76 | 218 | 26.5 | 48 | 24 | 89 | 179 | 132 | 15 | 69 |
| 160 M | All | 2, 4, 6, 8 | 254 | 60 | 300 | 314 | 236.5 | 236.5 | 190 | 190 | 175 | 77.5 | 210 | 44 | 89 ⁵⁾ | 300 ⁶⁾ | 47 | 57 | 28.5 | 108 | 192 | 160 | 18 | 85 |
| 160 L | All | 2, 4, 6, 8 | 254 | 60 | 300 | 314 | 236.5 | 236.5 | 190 | 190 | 175 | 77.5 | 254 | 44 | 89 | 300 | 47 | 57 | 28.5 | 108 | 148 ²⁾ | 160 | 18 | 85 |
| 180 M | All | 2, 4, 6, 8 | 279 | 65 | 339 | 356 | 259 | 259 | 212.5 | 212.5 | 175 | 77.5 | 241 | 80 | 100 | 328 | 30 | 57 | 28.5 | 121 | 232 | 180 | 20 | 95 |
| 180 L | All | 2, 4, 6, 8 | 279 | 65 | 339 | 356 | 259 | 259 | 212.5 | 212.5 | 175 | 77.5 | 279 | 80 | 100 | 328 | 30 | 57 | 28.5 | 121 | 194 | 180 | 20 | 95 |
| 200 L | All | 2, 4, 6, 8 | 318 | 70 | 378 | 396 | 296 | 296 | 238 | 238 | 225 | 102.5 | 305 | 90 | 100 | 355 | 45 | 75 | 37.5 | 133 | 202 | 200 | 25 | 108 |

1) Only one termination hole available.

2) Only for pole-changing types 1LE1011-1DP6 and 1LE1012-1DQ6 the dimension CA* is 208 mm.

3) With screwed-on feet, dimension BA' is 38 mm.

4) With screwed-on feet, dimension BB is 180 mm.

5) With screwed-on feet, dimension BA' is 44 mm.

6) With screwed-on feet, dimension BB is 256 mm.

SIMOTICS GP and SIMOTICS SD standard motors

Dimensions · Aluminum series SIMOTICS GP

IE1, IE2, NEMA Energy Efficient and pole-changing – self-ventilated · Frame sizes 63 M to 200

Dimensional drawings

Type of construction IM B35

For flange dimensions, see page 1/47 (**Z** = the number of retaining holes)

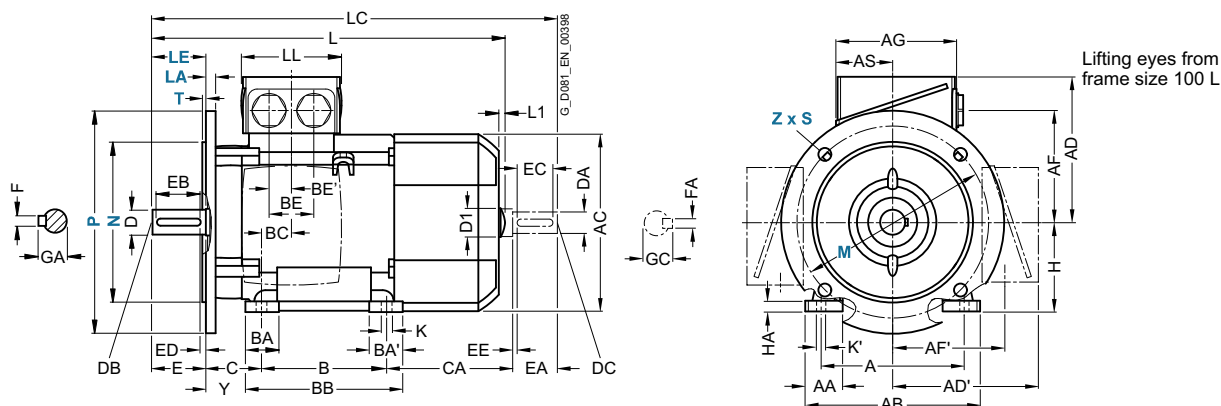

Type of construction IM B14

For flange dimensions, see page 1/47 (**Z** = the number of retaining holes)

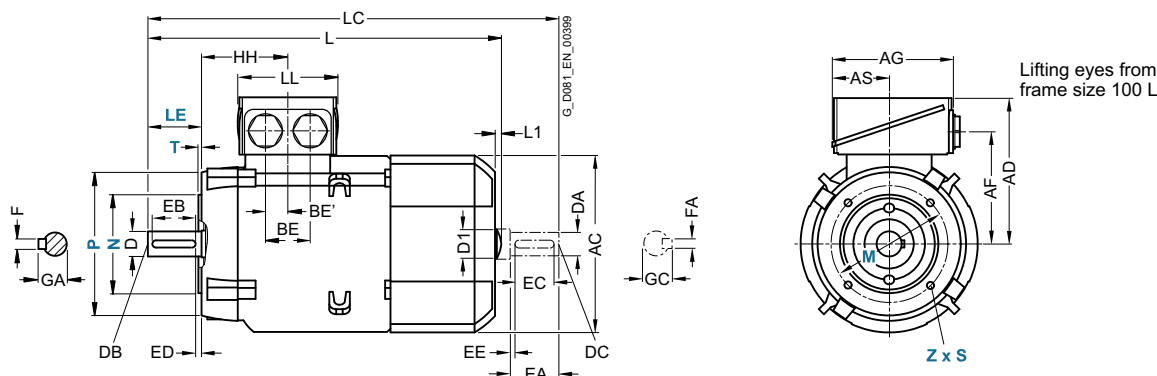

| For motor | | | Dimension designation acc. to IEC | | | | | DE shaft extension | | | | | NDE shaft extension | | | | | | | | | | | |
|------------|------------------------------------|--------------|-----------------------------------|------|------|---------------------------|-----|--------------------|-------------------|-----|----|-----|---------------------|-----|-----|----|------|----|-----|-----|-----|-----|----|------|
| Frame size | Motor type | No. of poles | HH | K | K' | L ¹⁾ | L1 | D1 | LC | LL | D | DB | E | EB | ED | F | GA | DA | DC | EA | EC | EE | FA | GC |
| 63 M | 1LE100-0B.2 1LE1001. 1LE1021 | 2, 4, 6 | 69.5 | 7 | 10 | 202.5⁴⁾ | - | - | 232 ⁴⁾ | 75 | 11 | M4 | 23 | 16 | 3.5 | 4 | 12.5 | 11 | M4 | 23 | 16 | 3.5 | 4 | 12.5 |
| | 1LE1001-0B.3 1LE1002-0B.6 | 2, 4 | | | | 228.5 | | | 258 | | | | | | | | | | | | | | | |
| 71 M | 1LE1001, 1LE1002 | 2, 4, 6, 8 | 63.5 | 7 | 10 | 240 | - | - | 278 | 75 | 14 | M5 | 30 | 22 | 4 | 5 | 16 | 14 | M5 | 30 | 22 | 4 | 5 | 16 |
| 80 M | 1LE1001 | 2, 4, 6 | 73 | 9.5 | 13.5 | 292 | - | - | 342.5 | 79 | 19 | M6 | 40 | 32 | 4 | 6 | 21.5 | 19 | M6 | 40 | 32 | 4 | 6 | 21.5 |
| 90 S | 1LE1041 | 2, 4, 6 | 78.5 | 10 | 14 | 347 | - | - | 405 | 79 | 24 | M8 | 50 | 40 | 5 | 8 | 27 | 19 | M6 | 40 | 32 | 4 | 6 | 21.5 |
| 90 L | | 2, 4, 6 | 78.5 | 10 | 14 | 347 | - | - | 405 | 79 | 24 | M8 | 50 | 40 | 5 | 8 | 27 | 19 | M6 | 40 | 32 | 4 | 6 | 21.5 |
| 100 L | All | 2, 4, 6, 8 | 96.5 | 12 | 16 | 395.5 | 7 | 32 | 454 | 112 | 28 | M10 | 60 | 50 | 5 | 8 | 31 | 24 | M8 | 50 | 40 | 5 | 8 | 27 |
| 112 M | All | 2, 4, 6, 8 | 96 | 12 | 16 | 389 | 7 | 32 | 450 | 112 | 28 | M10 | 60 | 50 | 5 | 8 | 31 | 24 | M8 | 50 | 40 | 5 | 8 | 27 |
| | | | | | | 414 | | | | | | | | | | | | | | | | | | |
| 132 S | All | 2, 4, 6, 8 | 115.5 | 12 | 16 | 465 | 8.5 | 39 | 535.5 | 130 | 38 | M12 | 80 | 70 | 5 | 10 | 41 | 28 | M10 | 60 | 50 | 5 | 8 | 31 |
| 132 M | All | 2, 4, 6, 8 | 115.5 | 12 | 16 | 465 | 8.5 | 39 | 535.5 | 130 | 38 | M12 | 80 | 70 | 5 | 10 | 41 | 28 | M10 | 60 | 50 | 5 | 8 | 31 |
| 160 M | All | 2, 4, 6, 8 | 155 | 15 | 19 | 604 | 10 | 45 | 730 | 145 | 42 | M16 | 110 | 90 | 10 | 12 | 45 | 42 | M16 | 110 | 90 | 10 | 12 | 45 |
| 160 L | All | 2, 4, 6, 8 | 155 | 15 | 19 | 604²⁾ | 10 | 45 | 730 ³⁾ | 145 | 42 | M16 | 110 | 90 | 10 | 12 | 45 | 42 | M16 | 110 | 90 | 10 | 12 | 45 |
| 180 M | All | 2, 4, 6, 8 | 151 | 14.5 | 19 | 698 | - | - | 814 | 145 | 48 | M16 | 110 | 100 | 5 | 14 | 52 | 48 | M16 | 110 | 100 | 5 | 14 | 52 |
| 180 L | All | 2, 4, 6, 8 | 151 | 14.5 | 19 | 698 | - | - | 814 | 145 | 48 | M16 | 110 | 100 | 5 | 14 | 52 | 48 | M16 | 110 | 100 | 5 | 14 | 52 |
| 200 L | All | 2, 4, 6, 8 | 178 | 18.5 | 25 | 746 | - | - | 860 | 185 | 55 | M20 | 110 | 100 | 5 | 16 | 59 | 55 | M20 | 110 | 100 | 5 | 16 | 59 |

¹⁾ The length is specified as far as the tip of the fan cover.

²⁾ Only for pole-changing types 1LE1011-1DP6 and 1LE1012-1DQ6 the dimension L is 664 mm.

³⁾ Only for pole-changing types 1LE1011-1DP6 and 1LE1012-1DQ6 the dimension LC is 790 mm.

⁴⁾ For 1LE1002-0B.3 with the type of construction code letters (14th position of the article number) **F, G, H** (IM B5, IM V1 without protective cover, IM V3) is dimension L 228.5 mm. Dimension LC is 258 mm.



SIMOTICS GP and SIMOTICS SD standard motors

Dimensions · Aluminum series SIMOTICS GP

IE1, IE2 – self-ventilated with increased power · Frame sizes 80 M to 200 L

Dimensional drawings

Type of construction IM B3

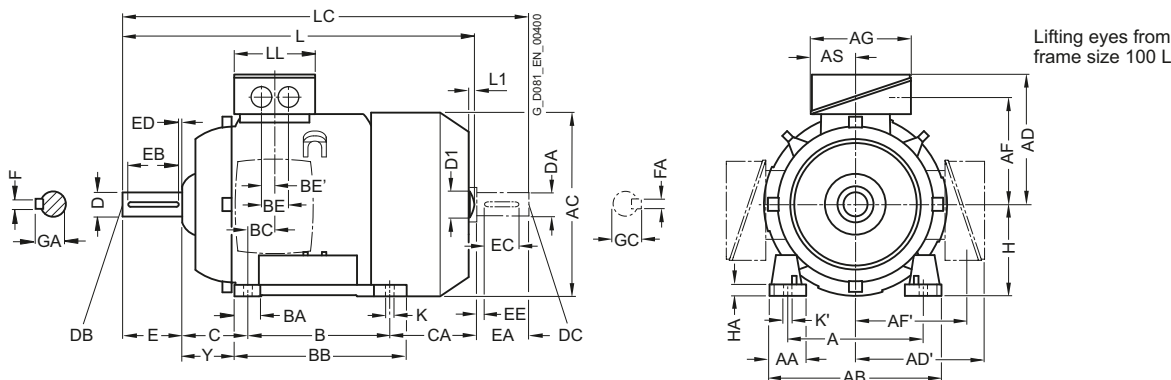

Types of construction IM B5 and IM V1

For flange dimensions, see page 1/47 (Z = the number of retaining holes)

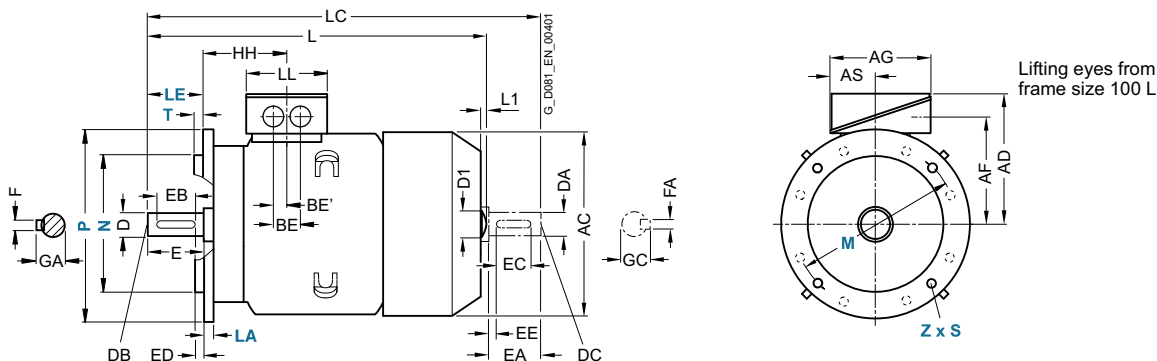

| For motor | | Dimension designation acc. to IEC | | | | | | | | | | | | | | | | | | | | | | |
|------------|--------------------|-----------------------------------|-----|------|------------|-----|--------------|-------|-------|-------|-----|-------|-----|------|------|-----|------|----|------------------|-----|-----|------------|----|-----|
| Frame size | Motor type | No. of poles | A | AA | AB | AC | AD | AD' | AF | AF' | AG | AS | B | BA | BA' | BB | BC | BE | BE' | C | CA | H | HA | Y |
| 80 M | All | 2, 4 | 125 | 30.5 | 150 | 159 | 121.5 | 121.5 | 96.5 | 96.5 | 93 | 43 | 100 | 32 | 32 | 118 | 23 | – | 18 ¹⁾ | 50 | 148 | 80 | 8 | 41 |
| 90 L | All | 2, 4 | 140 | 30.5 | 165 | 178 | 126 | 126 | 101.5 | 101.5 | 93 | 43 | 125 | 33 | 54 | 143 | 22.5 | – | 18 ¹⁾ | 56 | 174 | 90 | 10 | 47 |
| 100 L | All | 2, 4, 6, 8 | 160 | 42 | 196 | 198 | 166 | 166 | 125.5 | 125.5 | 135 | 63.5 | 140 | 37.5 | 37.5 | 176 | 33.5 | 50 | 25 | 63 | 176 | 100 | 12 | 45 |
| 112 M | All | 2, 4, 6, 8 | 190 | 46 | 226 | 222 | 177 | 177 | 136.5 | 136.5 | 135 | 63.5 | 140 | 37.5 | 37.5 | 176 | 26 | 50 | 25 | 70 | 155 | 112 | 12 | 52 |
| 132 M | All | 2, 4, 6, 8 | 216 | 53 | 256 | 262 | 202 | 202 | 159.5 | 159.5 | 155 | 70.5 | 178 | 38 | 76 | 218 | 26.5 | 48 | 24 | 89 | 179 | 132 | 15 | 69 |
| 160 L | All | 2, 4, 6, 8 | 254 | 60 | 300 | 314 | 236.5 | 236.5 | 190 | 190 | 175 | 77.5 | 254 | 44 | 89 | 300 | 47 | 57 | 28.5 | 108 | 208 | 160 | 18 | 85 |
| 180 L | 1LE1001 1LE1002 | 2, 4, 6, 8 | 279 | 65 | 339 | 356 | 259 | 259 | 212.5 | 212.5 | 175 | 77.5 | 279 | 80 | 100 | 328 | 30 | 57 | 28.5 | 121 | 194 | 180 | 20 | 95 |
| 200 L | 1LE1001 1LE1002 | 2, 4, 6, 8 | 318 | 70 | 378 | 396 | 296 | 296 | 238 | 238 | 225 | 102.5 | 305 | 90 | 100 | 355 | 45 | 75 | 37.5 | 133 | 202 | 200 | 25 | 108 |

¹⁾ Only one termination hole available.

SIMOTICS GP and SIMOTICS SD standard motors

Dimensions · Aluminum series SIMOTICS GP

IE1, IE2 – self-ventilated with increased power · Frame sizes 80 M to 200 L

Dimensional drawings

Type of construction IM B35

For flange dimensions, see page 1/47 (**Z** = the number of retaining holes)

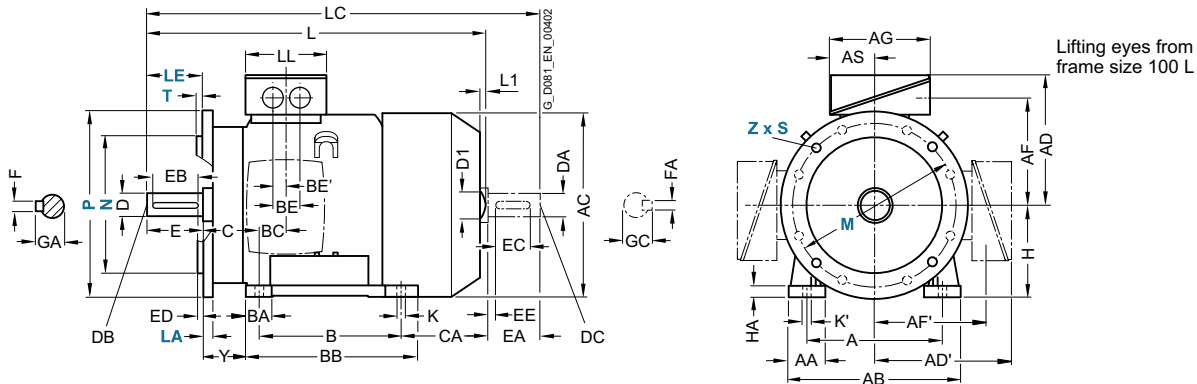

Type of construction IM B14

For flange dimensions, see page 1/47 (**Z** = the number of retaining holes)

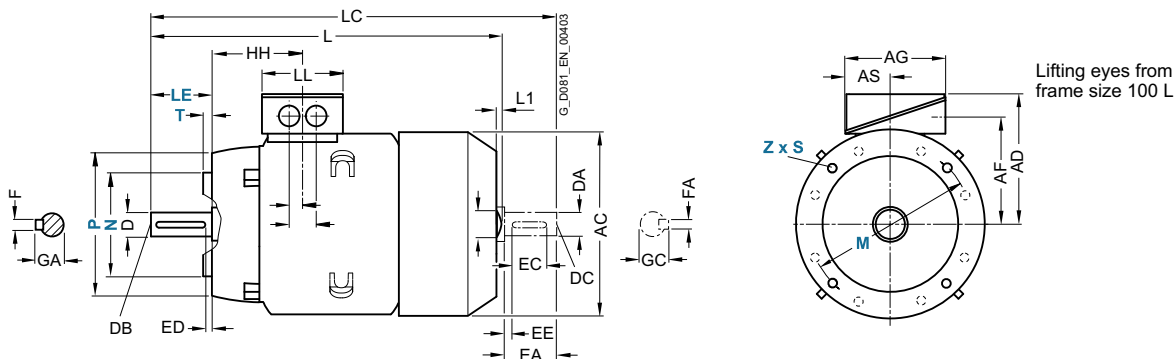

| For motor | | | Dimension designation acc. to IEC | | | | | | | DE shaft extension | | | | | NDE shaft extension | | | | | | | | | |
|------------|--------------------|--------------|-----------------------------------|------|------|-----------------|-----|----|-------|--------------------|----|-----|-----|-----|---------------------|----|------|----|-----|-----|-----|----|----|------|
| Frame size | Motor type | No. of poles | HH | K | K' | L ¹⁾ | L1 | D1 | LC | LL | D | DB | E | EB | ED | F | GA | DA | DC | EA | EC | EE | FA | GC |
| 80 M | All | 2, 4 | 73 | 9.5 | 13.5 | 327 | 327 | – | 378 | 79 | 19 | M6 | 40 | 32 | 4 | 6 | 21.5 | 19 | M6 | 40 | 32 | 4 | 6 | 21.5 |
| 90 L | All | 2, 4 | 78.5 | 10 | 14 | 387 | – | – | 445 | 79 | 24 | M8 | 50 | 40 | 5 | 8 | 27 | 19 | M6 | 40 | 32 | 4 | 6 | 21.5 |
| 100 L | All | 2, 4, 6, 8 | 96.5 | 12 | 16 | 430.5 | 7 | 32 | 489 | 112 | 28 | M10 | 60 | 50 | 5 | 8 | 31 | 24 | M8 | 50 | 40 | 5 | 8 | 27 |
| 112 M | All | 2, 4, 6, 8 | 96 | 12 | 16 | 414 | 7 | 32 | 475 | 112 | 28 | M10 | 60 | 50 | 5 | 8 | 31 | 24 | M8 | 50 | 40 | 5 | 8 | 27 |
| 132 M | All | 2, 4, 6, 8 | 115.5 | 12 | 16 | 515 | 8.5 | 39 | 585.5 | 130 | 38 | M12 | 80 | 70 | 5 | 10 | 41 | 28 | M10 | 60 | 50 | 5 | 8 | 31 |
| 160 L | All | 2, 4, 6, 8 | 155 | 15 | 19 | 664 | 10 | 45 | 790 | 145 | 42 | M16 | 110 | 90 | 10 | 12 | 45 | 42 | M16 | 110 | 90 | 10 | 12 | 45 |
| 180 L | 1LE1001 1LE1002 | 2, 4, 6 | 151 | 14.5 | 19 | 698 | – | – | 814 | 145 | 48 | M16 | 110 | 100 | 5 | 14 | 52 | 48 | M16 | 110 | 100 | 5 | 14 | 52 |
| 200 L | 1LE1001 1LE1002 | 2, 4, 6 | 178 | 18.5 | 25 | 746 | – | – | 860 | 185 | 55 | M20 | 110 | 100 | 5 | 16 | 59 | 55 | M20 | 110 | 100 | 5 | 16 | 59 |

¹⁾ The length is specified as far as the tip of the fan cover.



SIMOTICS GP and SIMOTICS SD standard motors

Dimensions · Aluminum series SIMOTICS GP

IE1, IE2 – forced-air/naturally cooled · Frame sizes 80 M to 200 L

Dimensional drawings

Type of construction IM B3

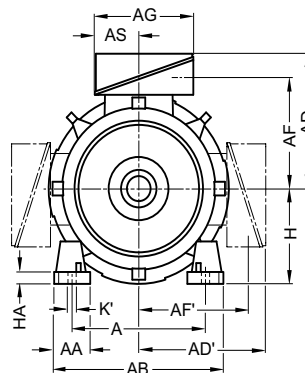
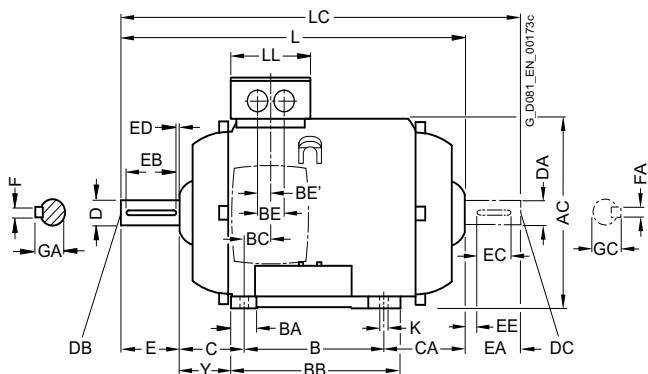

Lifting eyes from frame size 100 L

Only cast housing feet for frame sizes 132 S/M and 160 L/M each have 2 holes at NDE.

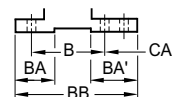

Types of construction IM B5 and IM V1

For flange dimensions, see page 1/47 (Z = the number of retaining holes)

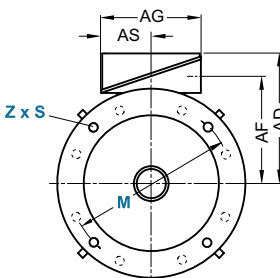
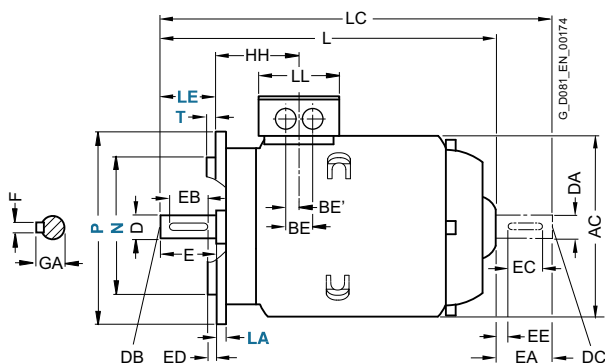

Lifting eyes from frame size 100 L

| For motor | | | Dimension designation acc. to IEC | | | | | | | | | | | | | | | | | | | | | |
|------------|--------------------|--------------|-----------------------------------|------|------------|-----|--------------|-------|-------|-------|-------|-------|-----|------|------------------|-------------------|------|-----------------|------------------|-----|------|------------|----|-----|
| Frame size | Motor type | No. of poles | A | AA | AB | AC | AD | AD' | AF | AF' | AG | AS | B | BA | BA' | BB | BC | BE | BE' | C | CA | H | HA | Y |
| 80 M | 1LE1001 | 2, 4, 6 | 125 | 30.5 | 150 | 159 | 121.5 | 121.5 | 96.5 | 96.5 | 93 | 43 | 100 | 32 | 32 | 118 | 23 | - | 18 ⁵⁾ | 50 | 70.5 | 80 | 8 | 41 |
| | 1LE1021 | 2, 4, 6 | | | | | 149.5 | 149.5 | 112.5 | 112.5 | 119.5 | 61.5 | | | | | | | | | | | | |
| 90 S | 1LE1001 | 2, 4, 6 | 140 | 30.5 | 165 | 178 | 126 | 126 | 101.5 | 101.5 | 93 | 43 | 100 | 33 | 54 | 143 | 22.5 | - ⁵⁾ | 18 ⁵⁾ | 56 | 103 | 90 | 10 | 47 |
| | 1LE1021 | 2, 4, 6 | | | | | 154.5 | 154.5 | 117.5 | 117.5 | 119.5 | 61.5 | | | | | | | | | | | | |
| 90 L | 1LE1001 | 2, 4, 6 | 140 | 30.5 | 165 | 178 | 126 | 126 | 101.5 | 101.5 | 93 | 43 | 125 | 33 | 54 | 143 | 22.5 | - ⁵⁾ | 18 ⁵⁾ | 56 | 78 | 90 | 10 | 47 |
| | 1LE1021 | 2, 4, 6 | | | | | 154.5 | 154.5 | 117.5 | 117.5 | 119.5 | 61.5 | | | | | | | | | | | | |
| 100 L | All | 2, 4, 6, 8 | 160 | 42 | 196 | 198 | 166 | 166 | 125.5 | 125.5 | 135 | 63.5 | 140 | 37.5 | 37.5 | 176 | 33.5 | 50 | 25 | 63 | 63 | 100 | 12 | 45 |
| 112 M | All | 2, 4, 6, 8 | 190 | 46 | 226 | 222 | 177 | 177 | 136.5 | 136.5 | 135 | 63.5 | 140 | 37.5 | 37.5 | 176 | 26 | 50 | 25 | 70 | 45 | 112 | 12 | 52 |
| | | | | | | | | | | | | | | | | | | | | | 70 | | | |
| 132 S | All | 2, 4, 6, 8 | 216 | 53 | 256 | 261 | 202 | 202 | 159.5 | 159.5 | 155 | 70.5 | 140 | 38 | 76 ¹⁾ | 218 ²⁾ | 26.5 | 48 | 24 | 89 | 77 | 132 | 15 | 69 |
| 132 M | All | 2, 4, 6, 8 | 216 | 53 | 256 | 261 | 202 | 202 | 159.5 | 159.5 | 155 | 70.5 | 178 | 38 | 76 | 218 | 26.5 | 48 | 24 | 89 | 39 | 132 | 15 | 69 |
| 160 M | All | 2, 4, 6, 8 | 254 | 60 | 300 | 314 | 236.5 | 236.5 | 190 | 190 | 175 | 77.5 | 210 | 44 | 89 ³⁾ | 300 ⁴⁾ | 47 | 57 | 28.5 | 108 | 92 | 160 | 18 | 85 |
| 160 L | All | 2, 4, 6, 8 | 254 | 60 | 300 | 314 | 236.5 | 236.5 | 190 | 190 | 175 | 77.5 | 254 | 44 | 89 | 300 | 47 | 57 | 28.5 | 108 | 48 | 160 | 18 | 85 |
| 180 M | 1LE1001 1LE1021 | 2, 4, 6, 8 | 279 | 65 | 339 | 356 | 259 | 259 | 212.5 | 212.5 | 175 | 77.5 | 241 | 80 | 100 | 328 | 30 | 57 | 28.5 | 121 | 124 | 180 | 20 | 95 |
| 200 L | 1LE1001 1LE1021 | 2, 4, 6, 8 | 318 | 70 | 378 | 396 | 296 | 296 | 238 | 238 | 225 | 102.5 | 305 | 90 | 100 | 355 | 45 | 75 | 37.5 | 133 | 101 | 200 | 25 | 108 |

1) With screwed-on feet, dimension BA' is 38 mm.
 2) With screwed-on feet, dimension BB is 180 mm.
 3) With screwed-on feet, dimension BA' is 44 mm.
 4) With screwed-on feet, dimension BB is 256 mm.

5) Only one termination hole available, except for 1LE1021. In this case, dimension BE is 32 mm.

SIMOTICS GP and SIMOTICS SD standard motors

Dimensions · Aluminum series SIMOTICS GP

IE1, IE2 – forced-air/naturally cooled · Frame sizes 80 M to 200 L

Dimensional drawings

Type of construction IM B35

For flange dimensions, see page 1/47 (**Z** = the number of retaining holes)

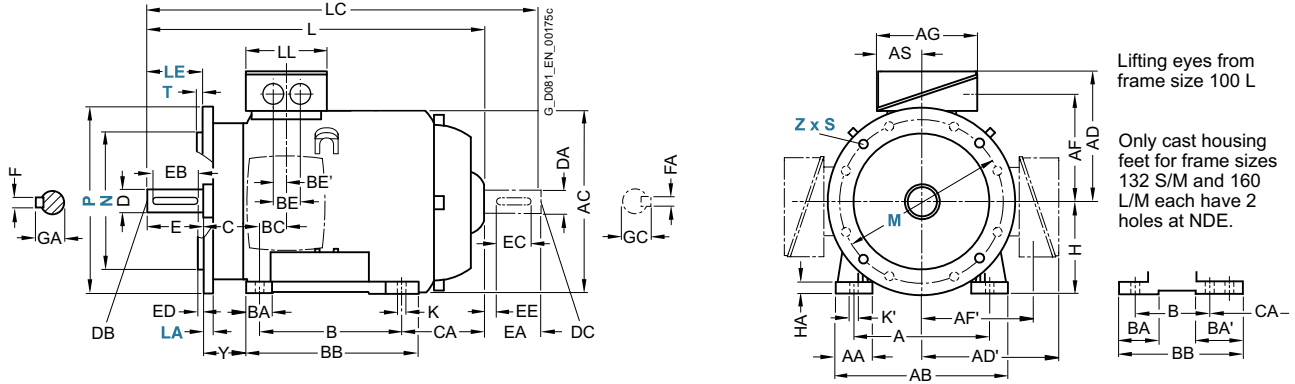

Type of construction IM B14

For flange dimensions, see page 1/47 (**Z** = the number of retaining holes)

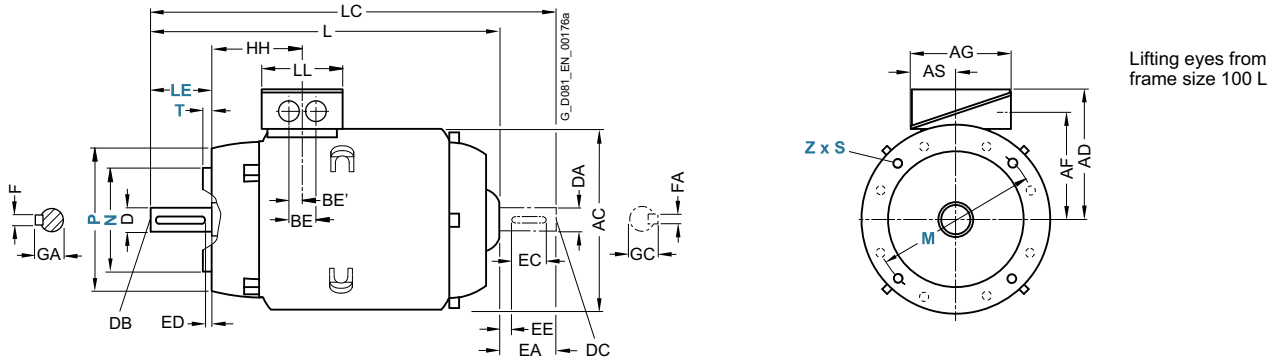

| For motor | | | Dimension designation acc. to IEC | | | | | | DE shaft extension | | | | | | NDE shaft extension | | | | | | | |
|------------|------------|--------------|-----------------------------------|------|------|--------------|-------|-----|--------------------|-----|-----|-----|----|----|---------------------|----|-----|-----|-----|-----|----|------|
| Frame size | Motor type | No. of poles | HH | K | K' | L | LC | LL | D | DB | E | EB | ED | F | GA | DA | DC | EA | EC | EE | FA | GC |
| 80 M | 1LE1001 | 2, 4, 6 | 73 | 9.5 | 13.5 | 253 | 300.5 | 79 | 19 | M6 | 40 | 32 | 4 | 6 | 21.5 | 19 | M6 | 40 | 32 | 4 | 6 | 21.5 |
| | 1LE1021 | 2, 4, 6 | | | | | | 123 | | | | | | | | | | | | | | |
| 90 S | 1LE1021 | 2, 4, 6 | 78.5 | 10 | 14 | 294.5 | 349 | 79 | 24 | M8 | 50 | 40 | 5 | 8 | 27 | 19 | M6 | 40 | 32 | 4 | 6 | 21.5 |
| | 1LE1021 | 2, 4, 6 | | | | | | 123 | | | | | | | | | | | | | | |
| 90 L | 1LE1021 | 2, 4, 6 | 78.5 | 10 | 14 | 294.5 | 349 | 123 | 24 | M8 | 50 | 40 | 5 | 8 | 27 | 19 | M6 | 40 | 32 | 4 | 6 | 21.5 |
| | 1LE1021 | 2, 4, 6 | | | | | | 123 | | | | | | | | | | | | | | |
| 100 L | All | 2, 4, 6, 8 | 96.5 | 12 | 16 | 324 | 376 | 112 | 28 | M10 | 60 | 50 | 5 | 8 | 31 | 24 | M8 | 50 | 40 | 5 | 8 | 27 |
| 112 M | All | 2, 4, 6, 8 | 96 | 12 | 16 | 311 | 365 | 112 | 28 | M10 | 60 | 50 | 5 | 8 | 31 | 24 | M8 | 50 | 40 | 5 | 8 | 27 |
| | | | | | | 336 | 390 | | | | | | | | | | | | | | | |
| 132 S | All | 2, 4, 6, 8 | 115.5 | 12 | 16 | 380.5 | 446 | 130 | 38 | M12 | 80 | 70 | 5 | 10 | 41 | 28 | M10 | 60 | 50 | 5 | 8 | 31 |
| 132 M | All | 2, 4, 6, 8 | 115.5 | 12 | 16 | 380.5 | 446 | 130 | 38 | M12 | 80 | 70 | 5 | 10 | 41 | 28 | M10 | 60 | 50 | 5 | 8 | 31 |
| 160 M | All | 2, 4, 6, 8 | 155 | 15 | 19 | 510 | 630 | 145 | 42 | M16 | 110 | 90 | 10 | 12 | 45 | 42 | M16 | 110 | 90 | 10 | 12 | 45 |
| 160 L | All | 2, 4, 6, 8 | 155 | 15 | 19 | 510 | 630 | 145 | 42 | M16 | 110 | 90 | 10 | 12 | 45 | 42 | M16 | 110 | 90 | 10 | 12 | 45 |
| 180 M | 1LE1001 | 2, 4, 6, 8 | 151 | 14.5 | 19 | 698 | 706 | 145 | 48 | M16 | 110 | 100 | 5 | 14 | 52 | 48 | M16 | 110 | 100 | 5 | 14 | 51.5 |
| | 1LE1021 | | | | | | | | | | | | | | | | | | | | | |
| 200 L | 1LE1001 | 2, 4, 6, 8 | 178 | 18.5 | 25 | 746 | 759 | 185 | 55 | M20 | 110 | 100 | 5 | 16 | 59 | 55 | M20 | 110 | 100 | 100 | 16 | 59 |
| | 1LE1021 | | | | | | | | | | | | | | | | | | | | | |



SIMOTICS GP and SIMOTICS SD standard motors

Dimensions · Aluminum series SIMOTICS GP

IE3, NEMA Premium Efficient – self-ventilated · Frame sizes 80 M to 90 L

Dimensional drawings

Type of construction IM B3

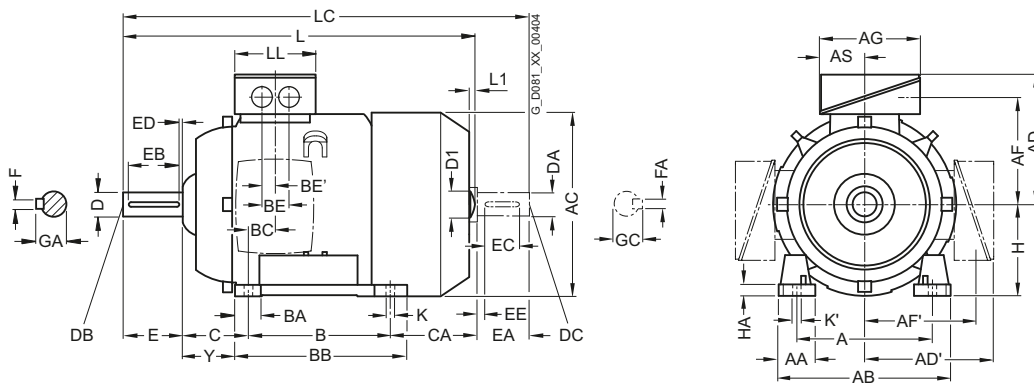

Types of construction IM B5 and IM V1

For flange dimensions, see page 1/47 (Z = the number of retaining holes)

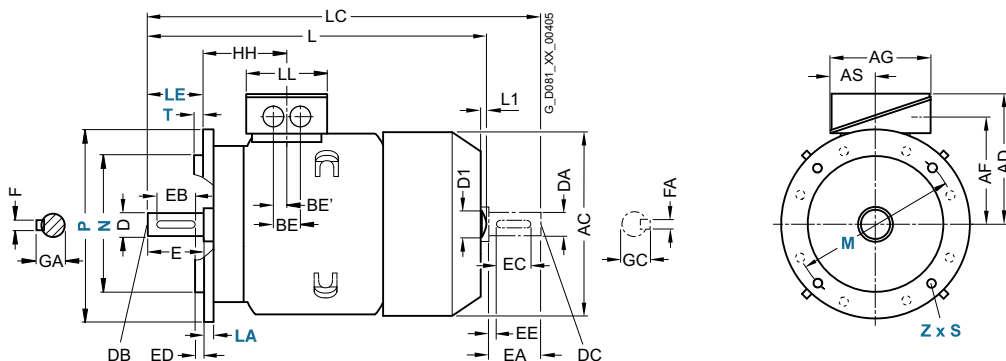

| For motor | | Dimension designation acc. to IEC | | | | | | | | | | | | | | | | | | | | | |
|------------|----------------------------|-----------------------------------|-----|------|-----|-----|-------|-------|-------|-------|-------|------|-----|----|-----|------|-----------------|------------------|----|-----|----|----|----|
| Frame size | Motor type | No. of poles | A | AA | AB | AC | AD | AD' | AF | AF' | AG | AS | B | BA | BB | BC | BE | BE' | C | CA | H | HA | Y |
| 80 M | 1LE1003-0DA2, -0DB2, -0DC2 | 2, 4, 6 | 125 | 30.5 | 150 | 159 | 121.5 | 121.5 | 96.5 | 96.5 | 93 | 43 | 100 | 32 | 118 | 23 | - ¹⁾ | 18 ¹⁾ | 50 | 113 | 80 | 8 | 41 |
| | 1LE1043-0DA2, -0DB3, -0DC3 | 2 | | | | | | | | | | | | | | | | | | 148 | | | |
| | 1LE1023-0DA2, -0DB2, -0DC2 | 2, 4, 6 | | | | | 149.5 | 149.5 | 112 | 112 | 119.5 | 61.5 | | | | | | | | 113 | | | |
| | 1LE1043-0DA2, -0DB3, -0DC3 | 2 | | | | | | | | | | | | | | | | | | 148 | | | |
| 90 S | 1LE1003-0EA0, -0EB0, -0EC0 | 2, 4, 6 | 140 | 30.5 | 165 | 178 | 126 | 126 | 101.5 | 101.5 | 93 | 43 | 100 | 33 | 143 | 22.5 | - ¹⁾ | 18 ¹⁾ | 56 | 159 | 90 | 10 | 47 |
| | 1LE1043-0EA0, -0EB4, -0EC4 | 2, 4 | | | | | | | | | | | | | | | | | | 154 | 90 | 10 | 47 |
| | 1LE1023-0EA0, -0EB0, -0EC0 | 2, 4, 6 | | | | | 154.5 | | 117.5 | 117 | 119.5 | 61.5 | | | | | | | | | | | |
| 90 L | 1LE1003-0EA4, -0EB4, -0EC4 | 2, 4, 6 | 140 | 30.5 | 165 | 178 | 126 | 126 | 101.5 | 101.5 | 93 | 43 | 125 | 33 | 143 | 22.5 | - ¹⁾ | 18 ¹⁾ | 56 | 154 | 90 | 10 | 47 |
| | 1LE1043-0EA4, -0EB4, -0EC4 | 2, 4 | | | | | | | | | | | | | | | | | | | | | |
| | 1LE1023-0EA4, -0EB4, -0EC4 | 2, 4, 6 | | | | | 154.5 | | 117.5 | 117.5 | 119.5 | 61.5 | | | | | | | | | | | |

¹⁾ Only one termination hole available, except for 1LE1023. In this case, dimension BE is 32 mm.

SIMOTICS GP and SIMOTICS SD standard motors

Dimensions · Aluminum series SIMOTICS GP

IE3, NEMA Premium Efficient – self-ventilated · Frame sizes 80 M to 90 L

Dimensional drawings

Type of construction IM B35

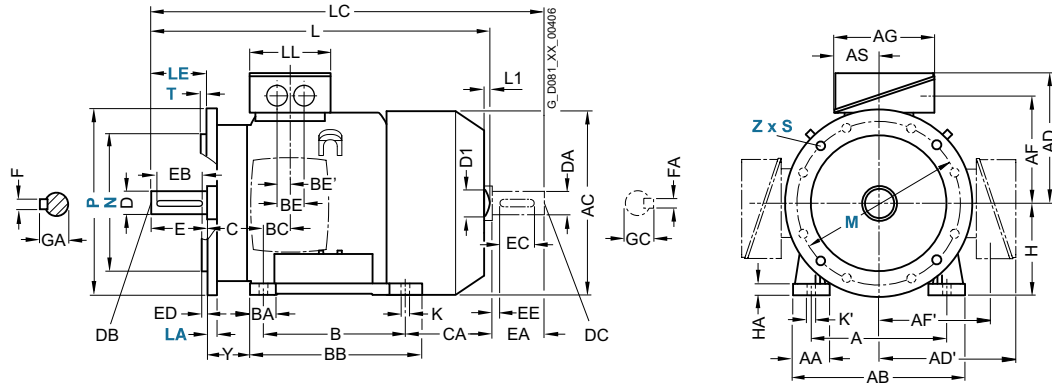
For flange dimensions, see page 1/47 (Z = the number of retaining holes)

Type of construction IM B14

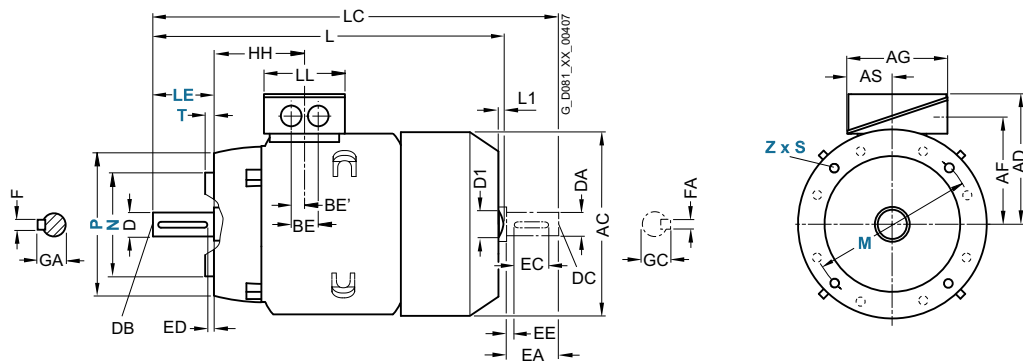
For flange dimensions, see page 1/47 (Z = the number of retaining holes)

| For motor | | No. of poles | Dimension designation acc. to IEC | | | | | | | DE shaft extension | | | | | | NDE shaft extension | | | | | | | | |
|------------|--|--------------|-----------------------------------|-----|------|-----------------|----|----|-----|--------------------|----|----|----|----|----|---------------------|------|----|----|----|----|----|----|------|
| Frame size | Motor type | | HH | K | K' | L ¹⁾ | L1 | D1 | LC | LL | D | DB | E | EB | ED | F | GA | DA | DC | EA | EC | EE | FA | GC |
| 80 M | 1LE1003-ODA2, -ODB2, -ODC2, -ODA3, -ODB3, -ODC3 | 2, 4, 6 | 73 | 9.5 | 13.5 | 292 | - | - | 343 | 79 | 19 | M6 | 40 | 32 | 4 | 6 | 21.5 | 19 | M6 | 40 | 32 | 4 | 6 | 21.5 |
| | 1LE1043-ODA2, | 2 | | | | 292 | | | | | | | | | | | | | | | | | | |
| | 1LE1023-ODA2, -ODB2, -ODC2, -ODA3, -ODB3, -ODC3 | 2, 4, 6 | | | | 292 | | | 343 | 123 | | | | | | | | | | | | | | |
| | | | | | | 327 | | | 378 | | | | | | | | | | | | | | | |
| 90 S | 1LE1003-OEA0, -OEB0, -OEC0 | 2, 4, 6 | 78.5 | 10 | 14 | 347 | - | - | 405 | 79 | 24 | M8 | 50 | 40 | 5 | 8 | 27 | 19 | M6 | 40 | 32 | 4 | 6 | 21.5 |
| | 1LE1043-OEA0, | 2 | | | | | | | | | | | | | | | | | | | | | | |
| | 1LE1023-OEA0, -OEB0, -OEC0 | 2, 4, 6 | | | | | | | 123 | | | | | | | | | | | | | | | |
| 90 L | 1LE1003-OEA4, -OEB4, -OEC4 | 2, 4, 6 | 78.5 | 10 | 14 | 387 | - | - | 445 | 79 | 24 | M8 | 50 | 40 | 5 | 8 | 27 | 19 | M6 | 40 | 32 | 4 | 6 | 21.5 |
| | 1LE1043-OEA4, -OEB4 | 2, 4 | | | | | | | | | | | | | | | | | | | | | | |
| | 1LE1023-OEA4, -OEB4, -OEC4 | 2, 4, 6 | | | | | | | 123 | | | | | | | | | | | | | | | |

¹⁾ The length is specified as far as the tip of the fan cover.

SIMOTICS GP and SIMOTICS SD standard motors

Dimensions · Aluminum series SIMOTICS GP

IE3, NEMA Premium Efficient – self-ventilated · Frame sizes 100 L to 200 L

Dimensional drawings

Type of construction IM B3

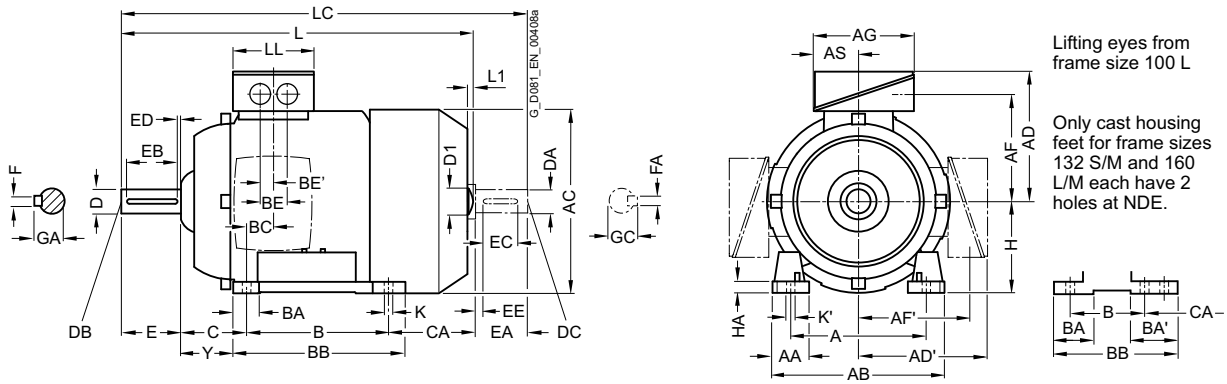

Types of construction IM B5 and IM V1

For flange dimensions, see page 1/47 (Z = the number of retaining holes)

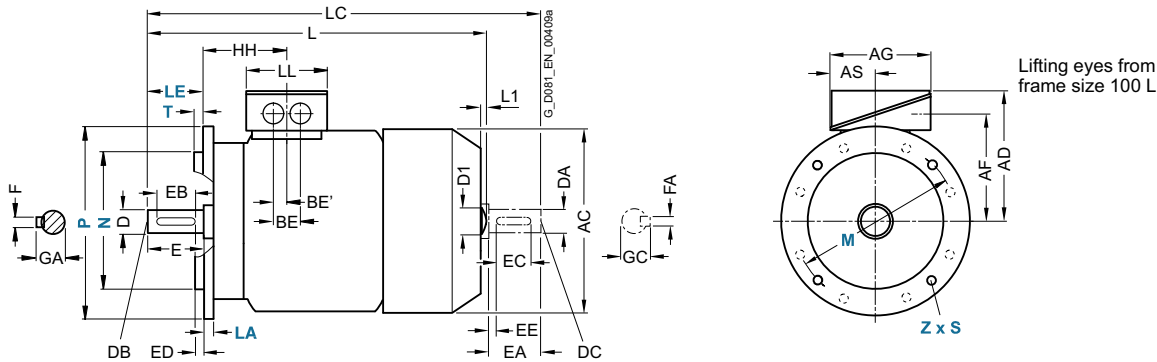

| For motor | | Dimension designation acc. to IEC | | | | | | | | | | | | | | | | | | | | | | |
|------------|------------------------------------|-----------------------------------|-----|----|------------|-----|--------------|-------|-------|-------|-----|-------|-----|------|------------------|-------------------|------|----|------|-----|-----|------------|----|-----|
| Frame size | Motor type | No. of poles | A | AA | AB | AC | AD | AD' | AF | AF' | AG | AS | B | BA | BA' | BB | BC | BE | BE' | C | CA | H | HA | Y |
| 100 L | 1AA4, 1AB4, 1AB5, 1AC4 | 2, 4, 6 | 160 | 42 | 196 | 198 | 166 | 166 | 125.5 | 125.5 | 135 | 63.5 | 140 | 37.5 | 37.5 | 176 | 33.5 | 50 | 25 | 63 | 176 | 100 | 12 | 45 |
| 112 M | 1BA2, 1BB2, 1BC2 | 2, 4, 6 | 190 | 46 | 226 | 222 | 177 | 177 | 136.5 | 136.5 | 135 | 63.5 | 140 | 37.5 | 37.5 | 176 | 26 | 50 | 25 | 70 | 155 | 112 | 12 | 52 |
| 132 S | 1CA0, 1CC0, 1CD0 | 2, 6, 8 | 216 | 53 | 256 | 262 | 202 | 202 | 159.5 | 159.5 | 155 | 70.5 | 140 | 38 | 76 ¹⁾ | 218 ²⁾ | 26.5 | 48 | 24 | 89 | 167 | 132 | 15 | 69 |
| | 1CA1, 1CB0 | 2, 4 | | | | | | | | | | | | | 38 | 180 | | | | | | 217 | | |
| 132 M | 1CC2 | 6 | 216 | 53 | 256 | 262 | 202 | 202 | 159.5 | 159.5 | 155 | 70.5 | 178 | 38 | 76 | 218 | 26.5 | 48 | 24 | 89 | 129 | 132 | 15 | 69 |
| | 1CB2, 1CC3, 1CD2 | 4, 6, 8 | | | | | | | | | | | | | 38 | | | | | | | 179 | | |
| 160 M | 1DA2, 1DA3, 1DB2, 1DC2, 1DD2, 1DD3 | 2, 4, 6, 8 | 254 | 60 | 300 | 314 | 236.5 | 236.5 | 190 | 190 | 175 | 77.5 | 210 | 44 | 89 ³⁾ | 300 ⁴⁾ | 47 | 57 | 28.5 | 108 | 192 | 160 | 18 | 85 |
| 160 L | 1DA4, 1DB4, 1DC4, 1DD4 | 2, 4, 6, 8 | 254 | 60 | 300 | 314 | 236.5 | 236.5 | 190 | 190 | 175 | 77.5 | 254 | 44 | 89 | 300 | 47 | 57 | 28.5 | 108 | 208 | 160 | 18 | 85 |
| 180 M | 1EA2 1EB2 | 2, 4 | 279 | 65 | 339 | 356 | 259 | 259 | 212.5 | 212.5 | 175 | 77.5 | 241 | 80 | 100 | 328 | 30 | 57 | 28.5 | 121 | 232 | 180 | 20 | 95 |
| 180 L | 1EB4, 1EC4, 1ED4 | 4, 6, 8 | 279 | 65 | 339 | 356 | 259 | 259 | 212.5 | 212.5 | 175 | 77.5 | 279 | 80 | 100 | 328 | 30 | 57 | 28.5 | 121 | 194 | 180 | 20 | 95 |
| 200 L | 2AA4, 2AA5, 2AB5, 2AC4, 2AC5, 2AD5 | 2, 4, 6, 8 | 318 | 70 | 378 | 396 | 296 | 296 | 238 | 238 | 225 | 102.5 | 305 | 90 | 100 | 355 | 45 | 75 | 37.5 | 133 | 202 | 200 | 25 | 108 |

1) With screwed-on feet, dimension BA' is 38 mm.
 2) With screwed-on feet, dimension BB is 180 mm.

3) With screwed-on feet, dimension BA' is 44 mm.
 4) With screwed-on feet, dimension BB is 256 mm.

SIMOTICS GP and SIMOTICS SD standard motors

Dimensions · Aluminum series SIMOTICS GP

IE3, NEMA Premium Efficient – self-ventilated · Frame sizes 100 L to 200 L

Dimensional drawings

Type of construction IM B35

For flange dimensions, see page 1/47 (**Z** = the number of retaining holes)

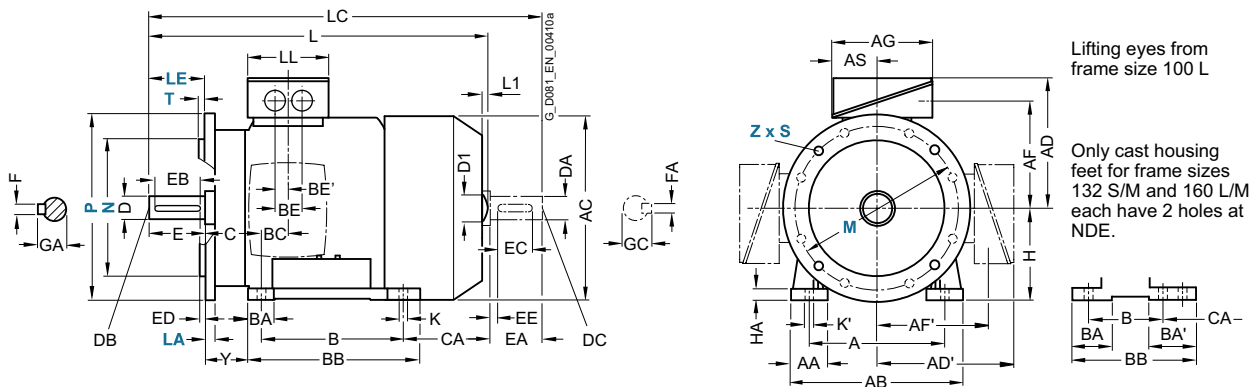

Type of construction IM B14

For flange dimensions, see page 1/47 (**Z** = the number of retaining holes)

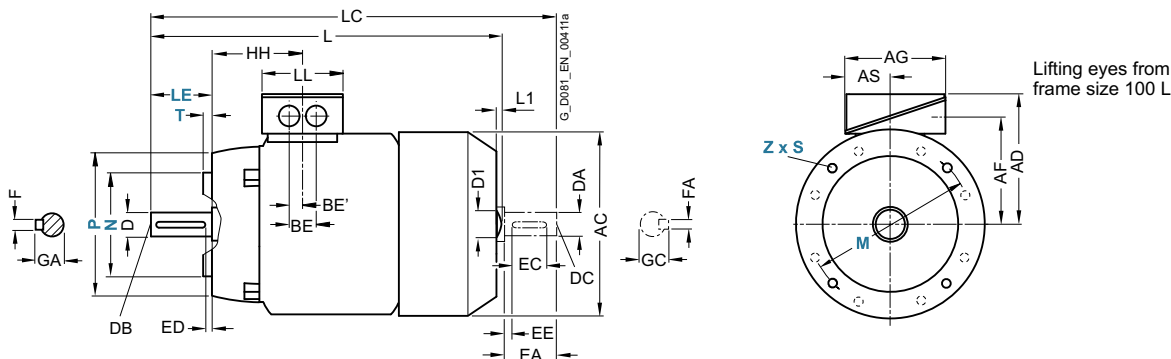

| For motor | | Dimension designation acc. to IEC | | | | | | | DE shaft extension | | | | | | NDE shaft extension | | | | | | | | | |
|------------|------------------------------------|-----------------------------------|-------|------|----|-----------------|-----|----|--------------------|-----|----|-----|-----|-----|---------------------|----|----|----|-----|-----|-----|----|----|----|
| Frame size | Motor type | No. of poles | HH | K | K' | L ¹⁾ | L1 | D1 | LC | LL | D | DB | E | EB | ED | F | GA | DA | DC | EA | EC | EE | FA | GC |
| 100 L | 1AA4, 1AB4, 1AB5, 1AC4 | 2, 4, 6 | 96.5 | 12 | 16 | 430.5 | 7 | 32 | 489 | 112 | 28 | M10 | 60 | 50 | 5 | 8 | 31 | 24 | M8 | 50 | 40 | 5 | 8 | 27 |
| 112 M | 1BA2, 1BB2, 1BC2 | 2, 4, 6 | 96 | 12 | 16 | 414 | 7 | 32 | 475 | 112 | 28 | M10 | 60 | 50 | 5 | 8 | 31 | 24 | M8 | 50 | 40 | 5 | 8 | 27 |
| 132 S | 1CA0, 1CC0, 1CD0 | 2, 6, 8 | 115.5 | 12 | 16 | 465 | 8.5 | 39 | 535.5 | 130 | 38 | M12 | 80 | 70 | 5 | 10 | 41 | 28 | M10 | 60 | 50 | 5 | 8 | 31 |
| | 1CA1, 1CB0 | 2, 4 | | | | 515 | | | 585.5 | | | | | | | | | | | | | | | |
| 132 M | 1CC2 | 6 | 115.5 | 12 | 16 | 465 | 8.5 | 39 | 535.5 | 130 | 38 | M12 | 80 | 70 | 5 | 10 | 41 | 28 | M10 | 60 | 50 | 5 | 8 | 31 |
| | 1CB2, 1CC3, 1CD2 | 4, 6, 8 | | | | 515 | | | 585.5 | | | | | | | | | | | | | | | |
| 160 M | 1DA2, 1DA3, 1DB2, 1DC2, 1DD2, 1DD3 | 2, 4, 6, 8 | 155 | 15 | 19 | 604 | 10 | 45 | 730 | 145 | 42 | M16 | 110 | 90 | 10 | 12 | 45 | 42 | M16 | 110 | 90 | 10 | 12 | 45 |
| 160 L | 1DA4, 1DB4, 1DC4, 1DD4 | 2, 4, 6, 8 | 155 | 15 | 19 | 664 | 10 | 45 | 790 | 145 | 42 | M16 | 110 | 90 | 10 | 12 | 45 | 42 | M16 | 110 | 90 | 10 | 12 | 45 |
| 180 M | 1EA2 1EB2 | 2, 4 | 151 | 14.5 | 19 | 698 | - | - | 814 | 145 | 48 | M16 | 110 | 100 | 5 | 14 | 52 | 48 | M16 | 110 | 100 | 5 | 14 | 52 |
| 180 L | 1EB4, 1EC4, 1ED4 | 4, 6, 8 | 151 | 14.5 | 19 | 698 | - | - | 814 | 145 | 48 | M16 | 110 | 100 | 5 | 14 | 52 | 48 | M16 | 110 | 100 | 5 | 14 | 52 |
| 200 L | 2AA4, 2AA5, 2AB5, 2AC4, 2AC5, 2AD5 | 2, 4, 6, 8 | 178 | 18.5 | 25 | 746 | - | - | 860 | 185 | 55 | M20 | 110 | 100 | 5 | 16 | 59 | 55 | M20 | 110 | 100 | 5 | 16 | 59 |

¹⁾ The length is specified as far as the tip of the fan cover.



SIMOTICS GP and SIMOTICS SD standard motors

Dimensions · Aluminum series SIMOTICS GP

IE3, NEMA Premium Efficient – self-ventilated · Frame sizes 100 L to 200 L

Dimensional drawings

Type of construction IM B3

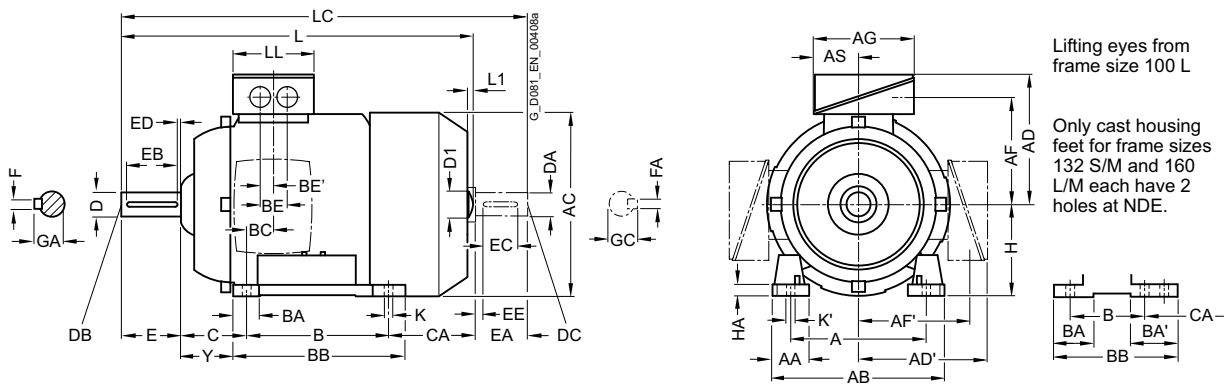

Types of construction IM B5 and IM V1

For flange dimensions, see page 1/47 (Z = the number of retaining holes)

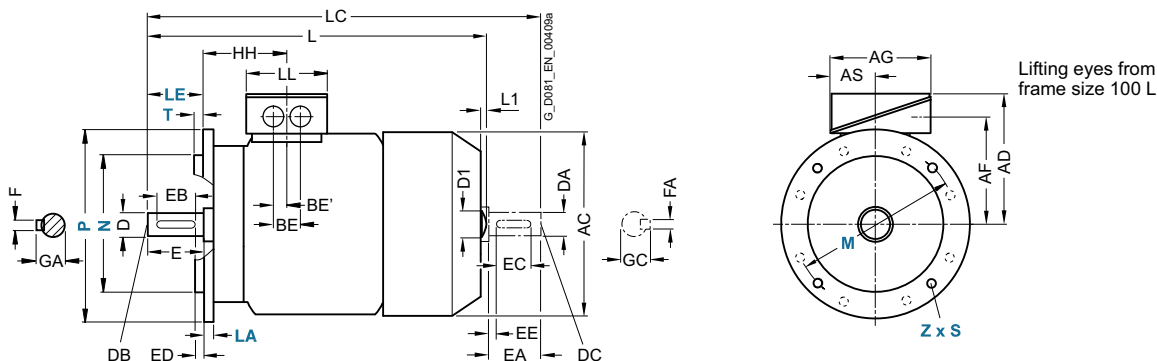

| For motor | | | Dimension designation acc. to IEC | | | | | | | | | | | | | | | | | | | | | |
|------------|---------------------------------------|--------------|-----------------------------------|----|------------|-----|--------------|-------|-------|-------|-----|-------|-----|------|------------------|-------------------|------|----|------|-----|-----|------------|----|-----|
| Frame size | Motor type | No. of poles | A | AA | AB | AC | AD | AD' | AF | AF' | AG | AS | B | BA | BA' | BB | BC | BE | BE' | C | CA | H | HA | Y |
| 100 L | 1AA4, 1AB4 1AB5 | 2, 4 4 | 160 | 42 | 196 | 198 | 166 | 166 | 125.5 | 125.5 | 135 | 63.5 | 140 | 37.5 | 37.5 | 176 | 33.5 | 50 | 25 | 63 | 176 | 100 | 12 | 45 |
| 112 M | 1BA2 1BB2 | 2 4 | 190 | 46 | 226 | 222 | 177 | 177 | 136.5 | 136.5 | 135 | 63.5 | 140 | 37.5 | 37.5 | 176 | 26 | 50 | 25 | 70 | 155 | 112 | 12 | 52 |
| 132 S | 1CA0, 1CA1, 1CB0 | 2, 4 | 216 | 53 | 256 | 262 | 202 | 202 | 159.5 | 159.5 | 155 | 70.5 | 140 | 38 | 76 ¹⁾ | 218 ²⁾ | 26.5 | 48 | 24 | 89 | 167 | 132 | 15 | 69 |
| 132 M | 1CB2 | 4 | 216 | 53 | 256 | 262 | 202 | 202 | 159.5 | 159.5 | 155 | 70.5 | 178 | 38 | 76 | 218 | 26.5 | 48 | 24 | 89 | 179 | 132 | 15 | 69 |
| 160 M | 1DA2, 1DA3, 1DB2 | 2, 4 | 254 | 60 | 300 | 314 | 236.5 | 236.5 | 190 | 190 | 175 | 77.5 | 210 | 44 | 89 ³⁾ | 300 ⁴⁾ | 47 | 57 | 28.5 | 108 | 192 | 160 | 18 | 85 |
| 160 L | 1DA4, 1DB4 | 2, 4 | 254 | 60 | 300 | 314 | 236.5 | 236.5 | 190 | 190 | 175 | 77.5 | 254 | 44 | 89 | 300 | 47 | 57 | 28.5 | 108 | 208 | 160 | 18 | 85 |
| 180 M | 1EA2 1EB2 | 2, 4 | 279 | 65 | 339 | 356 | 259 | 259 | 212.5 | 212.5 | 175 | 77.5 | 241 | 80 | 100 | 328 | 30 | 57 | 28.5 | 121 | 232 | 180 | 20 | 95 |
| 180 L | 1EB4, 1EC4, 1ED4 | 4, 6, 8 | 279 | 65 | 339 | 356 | 259 | 259 | 212.5 | 212.5 | 175 | 77.5 | 279 | 80 | 100 | 328 | 30 | 57 | 28.5 | 121 | 194 | 180 | 20 | 95 |
| 200 L | 2AA4, 2AA5, 2AB5, 2AC4, 2AC5, 2AD5 | 2, 4, 6, 8 | 318 | 70 | 378 | 396 | 296 | 296 | 238 | 238 | 225 | 102.5 | 305 | 90 | 100 | 355 | 45 | 75 | 37.5 | 133 | 202 | 200 | 25 | 108 |

1) With screwed-on feet, dimension BA' is 38 mm.
2) With screwed-on feet, dimension BB is 180 mm.

3) With screwed-on feet, dimension BA' is 44 mm.
4) With screwed-on feet, dimension BB is 256 mm.

SIMOTICS GP and SIMOTICS SD standard motors

Dimensions · Aluminum series SIMOTICS GP

IE3, NEMA Premium Efficient – self-ventilated · Frame sizes 100 L to 200 L

Dimensional drawings

Type of construction IM B35

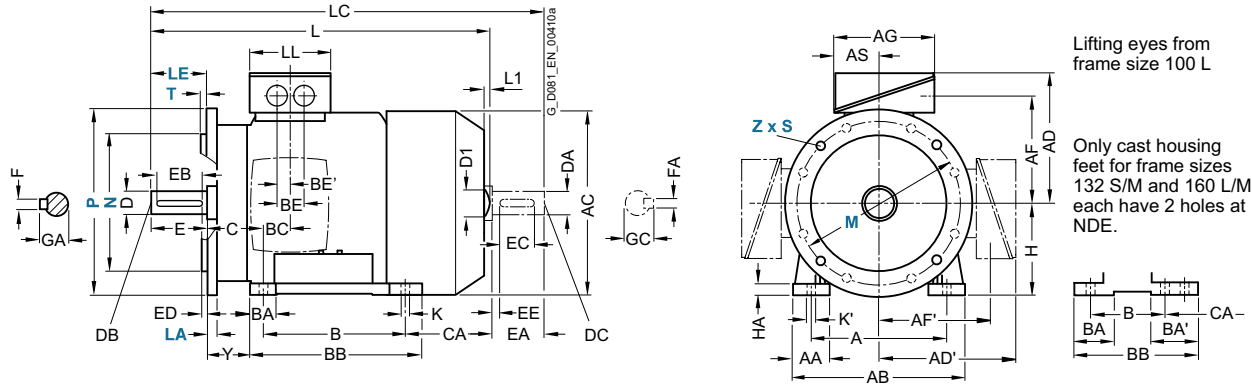
For flange dimensions, see page 1/47 (Z = the number of retaining holes)

Type of construction IM B14

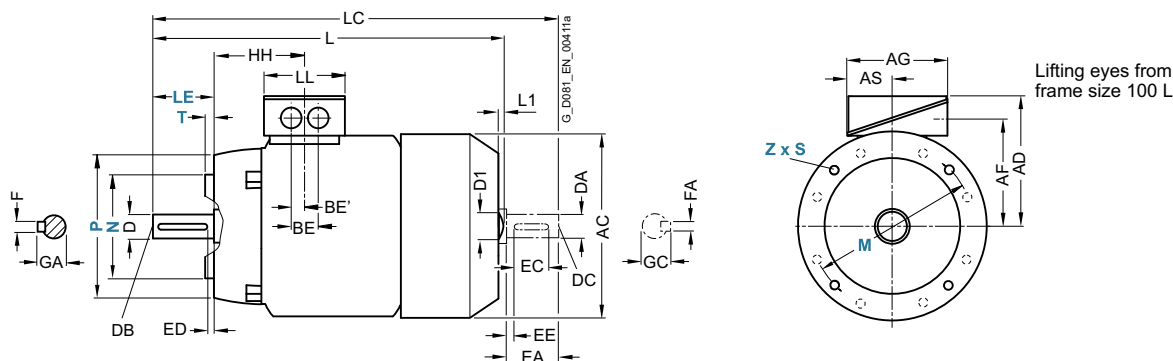
For flange dimensions, see page 1/47 (Z = the number of retaining holes)

| For motor | | No. of poles | Dimension designation acc. to IEC | | | | | | DE shaft extension | | | | | NDE shaft extension | | | | | | | | | | |
|------------|------------------------------------|--------------|-----------------------------------|------|----|--------------|-----|----|--------------------|-----|----|-----|-----|---------------------|----|----|----|----|-----|-----|-----|----|----|----|
| Frame size | Motor type | | HH | K | K' | $L^{1)}$ | L1 | D1 | LC | LL | D | DB | E | EB | ED | F | GA | DA | DC | EA | EC | EE | FA | GC |
| 100 L | 1AA4, 1AB4 | 2, 4 | 96.5 | 12 | 16 | 430.5 | 7 | 32 | 489 | 112 | 28 | M10 | 60 | 50 | 5 | 8 | 31 | 24 | M8 | 50 | 40 | 5 | 8 | 27 |
| | 1AB5 | 4 | | | | 470.5 | | | 529 | | | | | | | | | | | | | | | |
| | 1BA2 | 2 | 96 | 12 | 16 | 414 | 7 | 32 | 475 | 112 | 28 | M10 | 60 | 50 | 5 | 8 | 31 | 24 | M8 | 50 | 40 | 5 | 8 | 27 |
| | 1BB2 | 4 | | | | 459 | | | 520 | | | | | | | | | | | | | | | |
| 132 S | 1CA0, 1CA1, 1CB0 | 2, 4 | 115.5 | 12 | 16 | 515 | 8.5 | 39 | 585.5 | 130 | 38 | M12 | 80 | 70 | 5 | 10 | 41 | 28 | M10 | 60 | 50 | 5 | 8 | 31 |
| 132 M | 1CB2 | 4 | 115.5 | 12 | 16 | 515 | 8.5 | 39 | 585.5 | 130 | 38 | M12 | 80 | 70 | 5 | 10 | 41 | 28 | M10 | 60 | 50 | 5 | 8 | 31 |
| 160 M | 1DA2, 1DA3, 1DB2 | 2, 4 | 155 | 15 | 19 | 604 | 10 | 45 | 730 | 145 | 42 | M16 | 110 | 90 | 10 | 12 | 45 | 42 | M16 | 110 | 90 | 10 | 12 | 45 |
| 160 L | 1DA4, 1DB4 | 2, 4 | 155 | 15 | 19 | 664 | 10 | 45 | 790 | 145 | 42 | M16 | 110 | 90 | 10 | 12 | 45 | 42 | M16 | 110 | 90 | 10 | 12 | 45 |
| 180 M | 1EA2 1EB2 | 2, 4 | 151 | 14.5 | 19 | 698 | – | – | 814 | 145 | 48 | M16 | 110 | 100 | 5 | 14 | 52 | 48 | M16 | 110 | 100 | 5 | 14 | 52 |
| 180 L | 1EB4, 1EC4, 1ED4 | 4, 6, 8 | 151 | 14.5 | 19 | 698 | – | – | 814 | 145 | 48 | M16 | 110 | 100 | 5 | 14 | 52 | 48 | M16 | 110 | 100 | 5 | 14 | 52 |
| 200 L | 2AA4, 2AA5, 2AB5, 2AC4, 2AC5, 2AD5 | 2, 4, 6, 8 | 178 | 18.5 | 25 | 746 | – | – | 860 | 185 | 55 | M20 | 110 | 100 | 5 | 16 | 59 | 55 | M20 | 110 | 100 | 5 | 16 | 59 |

1) The length is specified as far as the tip of the fan cover.

SIMOTICS GP and SIMOTICS SD standard motors

Dimensions · Aluminum series SIMOTICS GP

IE3 – self-ventilated with increased power · Frame sizes 100 L to 200 L

Dimensional drawings

Type of construction IM B3

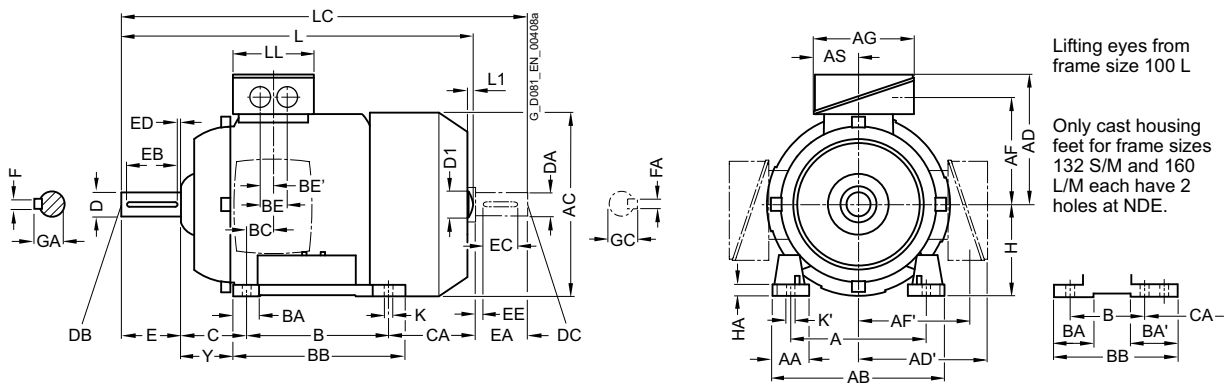

Types of construction IM B5 and IM V1

For flange dimensions, see page 1/47 (Z = the number of retaining holes)

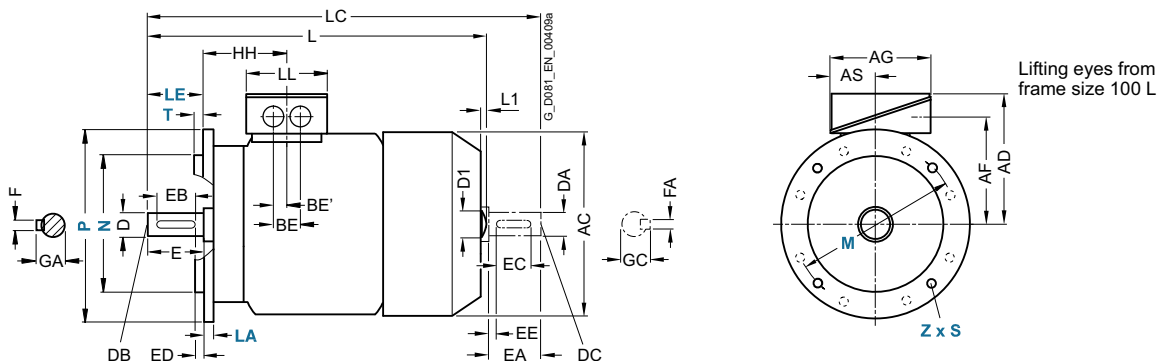

| For motor | | Dimension designation acc. to IEC | | | | | | | | | | | | | | | | | | | | | | |
|------------|---------------------------------------|-----------------------------------|-----|----|------------|-----|--------------|-------|-------|-------|-----|-------|-----|----|-----|-----|------|----|------|-----|-----|------------|----|-----|
| Frame size | Motor type | No. of poles | A | AA | AB | AC | AD | AD' | AF | AF' | AG | AS | B | BA | BA' | BB | BC | BE | BE' | C | CA | H | HA | Y |
| 132 M | 1LE1003-1CA6 1LE1043-1CA6 | 2 | 216 | 53 | 256 | 262 | 202 | 202 | 159.5 | 159.5 | 155 | 70.5 | 178 | 38 | 38 | 218 | 26.5 | 48 | 24 | 89 | 179 | 132 | 15 | 69 |
| 160 L | 1LE1003-1DA6 -1DB6 1LE1043-1DA6 | 2, 4 | 254 | 60 | 300 | 314 | 236.5 | 236.5 | 190 | 190 | 175 | 77.5 | 254 | 44 | 44 | 300 | 47 | 57 | 28.5 | 108 | 268 | 160 | 18 | 85 |
| 180 L | 1LE1003-1EA6 -1EB6 -1EC6 | 2, 4, 6 | 279 | 65 | 339 | 356 | 259 | 259 | 212.5 | 212.5 | 175 | 77.5 | 279 | 80 | 100 | 328 | 30 | 57 | 28.5 | 121 | 194 | 180 | 20 | 95 |
| 200 L | 1LE1003-2AA6 -2AB6 -2AC6 | 2, 4, 6 | 318 | 70 | 378 | 396 | 296 | 296 | 238 | 238 | 225 | 102.5 | 305 | 90 | 100 | 355 | 45 | 75 | 37.5 | 133 | 202 | 200 | 25 | 108 |

SIMOTICS GP and SIMOTICS SD standard motors

Dimensions · Aluminum series SIMOTICS GP

IE3 – self-ventilated with increased power · Frame sizes 100 L to 200 L

Dimensional drawings

Type of construction IM B35

For flange dimensions, see page 1/47 (**Z** = the number of retaining holes)

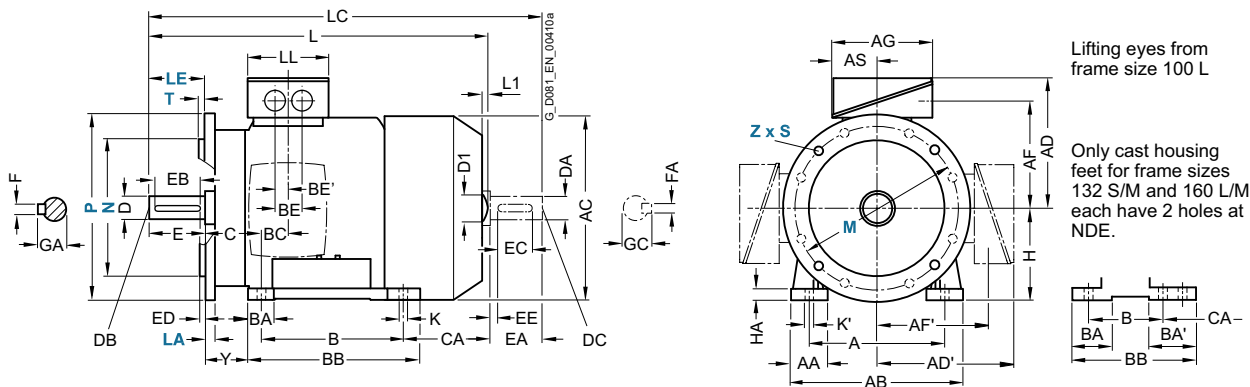

Type of construction IM B14

For flange dimensions, see page 1/47 (**Z** = the number of retaining holes)

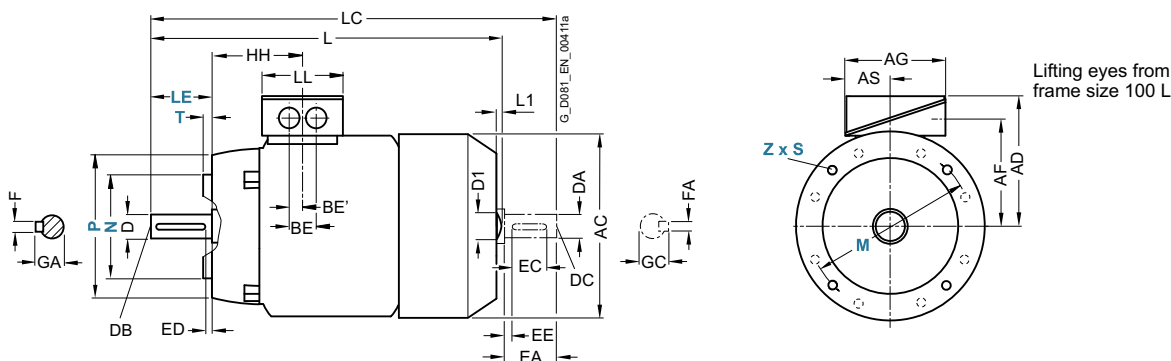

| For motor | | No. of poles | Dimension designation acc. to IEC | | | | | | | DE shaft extension | | | | | | NDE shaft extension | | | | | | | | |
|------------|---------------------------------------|--------------|-----------------------------------|------|----|-----------------|-----|----|-------|--------------------|----|-----|-----|-----|----|---------------------|----|----|-----|-----|-----|----|----|----|
| Frame size | Motor type | | HH | K | K' | L ¹⁾ | L1 | D1 | LC | LL | D | DB | E | EB | ED | F | GA | DA | DC | EA | EC | EE | FA | GC |
| 132 M | 1LE1003-1CA6 1LE1043-1CA6 | 2 | 115.5 | 12 | 16 | 515 | 8.5 | 39 | 585.5 | 130 | 38 | M12 | 80 | 70 | 5 | 10 | 41 | 28 | M10 | 60 | 50 | 5 | 8 | 31 |
| 160 L | 1LE1003-1DA6 -1DB6 1LE1043-1DA6 | 2, 4 | 155 | 15 | 19 | 664 | 10 | 45 | 790 | 145 | 42 | M16 | 110 | 90 | 10 | 12 | 45 | 42 | M16 | 110 | 90 | 10 | 12 | 45 |
| 180 L | 1LE1003-1EA6 -1EB6 -1EC6 | 2, 4, 6 | 151 | 14.5 | 19 | 698 | - | - | 814 | 145 | 48 | M16 | 110 | 100 | 5 | 14 | 52 | 48 | M16 | 110 | 100 | 5 | 14 | 52 |
| 200 L | 1LE1003-2AA6 -2AB6 -2AC6 | 2, 4, 6 | 178 | 18.5 | 25 | 746 | - | - | 860 | 185 | 55 | M20 | 110 | 100 | 5 | 16 | 59 | 55 | M20 | 110 | 100 | 5 | 16 | 59 |

¹⁾ The length is specified as far as the tip of the fan cover.

SIMOTICS GP and SIMOTICS SD standard motors

Dimensions · Aluminum series SIMOTICS GP

IE3 – forced-air cooled · Frame sizes 80 M to 90 L

Dimensional drawings

Type of construction IM B3

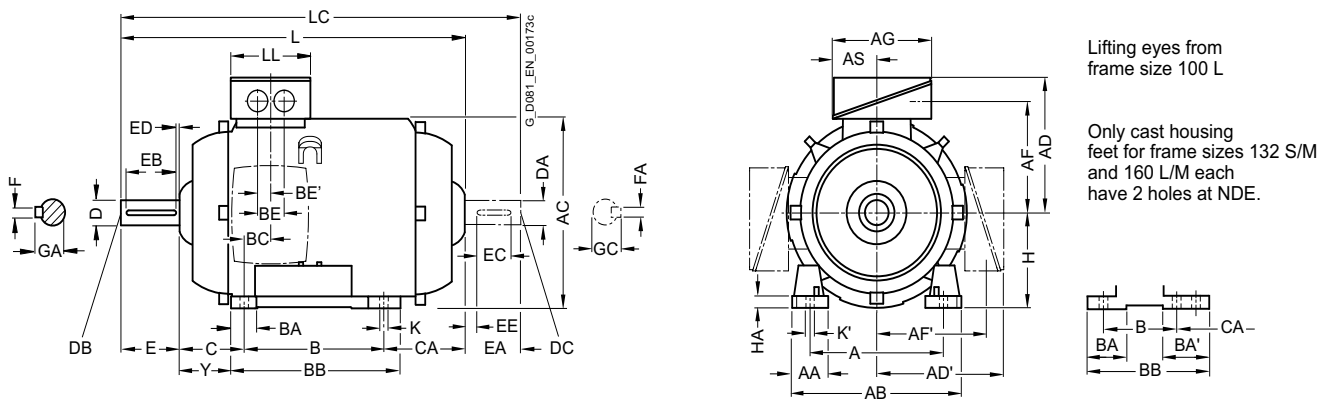

Types of construction IM B5 and IM V1

For flange dimensions, see page 1/47 (Z = the number of retaining holes)

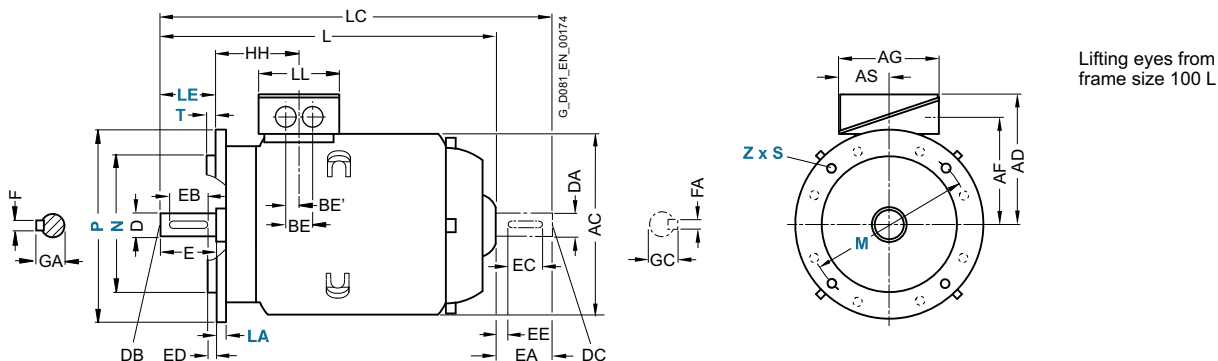

| Frame size | Motor type | No. of poles | Dimension designation acc. to IEC | | | | | | | | | | | | | | | | | | | | | |
|------------|------------------|--------------|-----------------------------------|------|------------|-----|--------------|-------|-------|-------|----|----|-----|----|-----|-----|------|----|------------------|----|-----|-----------|-------|----|
| | | | A | AA | AB | AC | AD | AD' | AF | AF' | AG | AS | B | BA | BA' | BB | BC | BE | BE' | C | CA | H | HA | Y |
| 80 M | 0DA2, 0DB2, 0DC2 | 2, 4, 6 | 125 | 30.5 | 150 | 159 | 121.5 | 121.5 | 96.5 | 96.5 | 93 | 43 | 100 | 32 | 32 | 118 | 23 | - | 18 ¹⁾ | 50 | 70 | 80 | 8 | 41 |
| | 0DA3, 0DB3, 0DC3 | 2, 4, 6 | | | | | | | | | | | | | | | | | | | | | 105.5 | |
| 90 S | 0EA0, 0EB0, 0EC0 | 2, 4, 6 | 140 | 30.5 | 165 | 178 | 126 | 126 | 101.5 | 101.5 | 93 | 43 | 100 | 33 | 54 | 143 | 22.5 | - | 18 ¹⁾ | 56 | 113 | 90 | 10 | 47 |
| 90 L | 0EA4, 0EB4, 0EC4 | 2, 4, 6 | 140 | 30.5 | 165 | 178 | 126 | 126 | 101.5 | 101.5 | 93 | 43 | 100 | 33 | 54 | 143 | 22.5 | - | 18 ¹⁾ | 56 | 153 | 90 | 10 | 47 |

¹⁾ Only one termination hole available.

SIMOTICS GP and SIMOTICS SD standard motors

Dimensions · Aluminum series SIMOTICS GP

IE3 – forced-air cooled · Frame sizes 80 M to 90 L

Dimensional drawings

Type of construction IM B35

For flange dimensions, see page 1/47 (**Z** = the number of retaining holes)

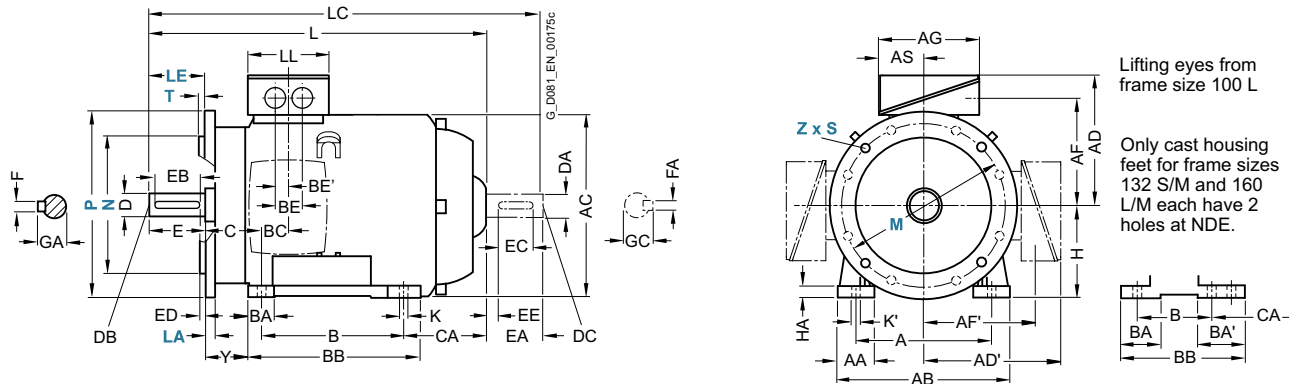

Type of construction IM B14

For flange dimensions, see page 1/47 (**Z** = the number of retaining holes)

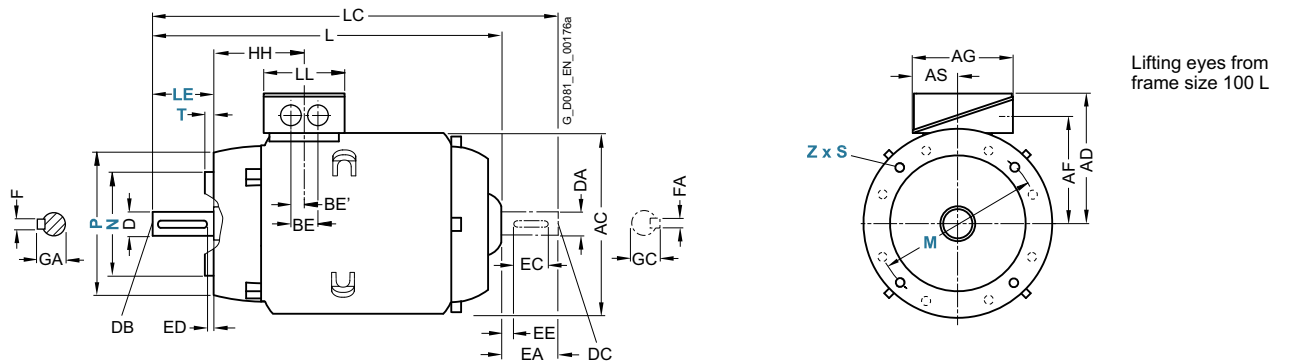

| For motor | | | Dimension designation acc. to IEC | | | | | | | DE shaft extension | | | | | | NDE shaft extension | | | | | | |
|------------|------------------------|--------------|-----------------------------------|-----|------|--------------|-------|----|----|--------------------|----|----|----|---|------|---------------------|----|----|----|----|----|------|
| Frame size | Motor type | No. of poles | HH | K | K' | L | LC | LL | D | DB | E | EB | ED | F | GA | DA | DC | EA | EC | EE | FA | GC |
| 80 M | 0DA2, 0DB2, 0DC2 | 2, 4, 6 | 73 | 9.5 | 13.5 | 253.5 | 300.5 | 79 | 19 | M6 | 40 | 32 | 4 | 6 | 21.5 | 19 | M6 | 40 | 32 | 4 | 6 | 21.5 |
| | 0DA3, 0DB3, 0DC3 | 2, 4, 6 | | | | 288 | 335.5 | | | | | | | | | | | | | | | |
| 90 S | 0EA0, 0EB0, 0EC0 | 2, 4, 6 | 78.5 | 10 | 14 | 294.5 | 349 | 79 | 19 | M6 | 40 | 32 | 5 | 8 | 27 | 19 | M6 | 40 | 32 | 4 | 6 | 21.5 |
| 90 L | 0EA4, 0EB4, 0EC4 | 2, 4, 6 | 78.5 | 10 | 14 | 334.5 | 389 | 79 | 19 | M6 | 40 | 32 | 5 | 8 | 27 | 19 | M6 | 40 | 32 | 4 | 6 | 21.5 |

2

SIMOTICS GP and SIMOTICS SD standard motors

Dimensions · Aluminum series SIMOTICS GP

IE3 – forced-air cooled · Frame sizes 100 L to 200 L

Dimensional drawings

Type of construction IM B3

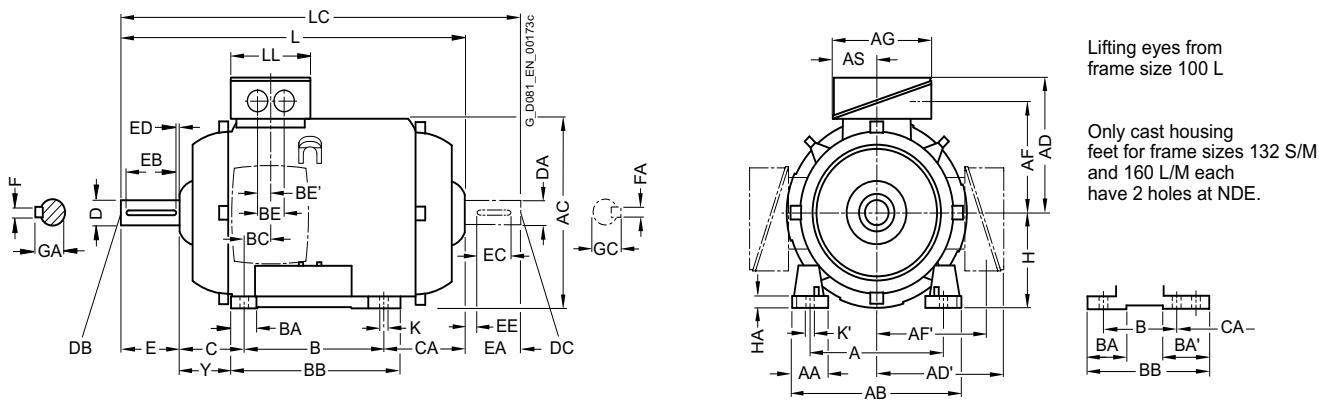

Types of construction IM B5 and IM V1

For flange dimensions, see page 1/47 (Z = the number of retaining holes)

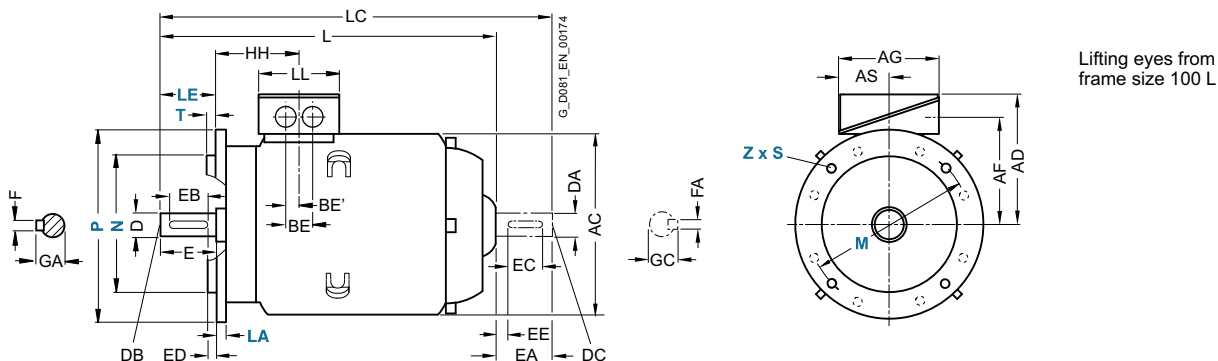

| For motor | | | Dimension designation acc. to IEC | | | | | | | | | | | | | | | | | | | | | |
|------------|------------------------------|--------------|-----------------------------------|----|------------|-----|--------------|-------|-------|-------|-----|-------|-----|------|------------------|-------------------|------|----|------|-----|----|------------|----|-----|
| Frame size | Motor type | No. of poles | A | AA | AB | AC | AD | AD' | AF | AF' | AG | AS | B | BA | BA' | BB | BC | BE | BE' | C | CA | H | HA | Y |
| 100 L | 1AA4, 1AB4, 1AB5, 1AC3 | 2, 4 6 | 160 | 42 | 196 | 198 | 166 | 166 | 125.5 | 125.5 | 135 | 63.5 | 140 | 37.5 | 37.5 | 176 | 33.5 | 50 | 25 | 63 | - | 100 | 12 | 45 |
| 112 M | 1BA2, 1BB2 | 2, 4 | 190 | 46 | 226 | 222 | 177 | 177 | 136.5 | 136.5 | 135 | 63.5 | 140 | 37.5 | 37.5 | 176 | 26 | 50 | 25 | 70 | - | 112 | 12 | 52 |
| 132 S | 1CA0, 1CC0 | 2, 6 | 216 | 53 | 256 | 262 | 202 | 202 | 159.5 | 159.5 | 155 | 70.5 | 140 | 38 | 76 ¹⁾ | 218 ²⁾ | 26.5 | 48 | 24 | 89 | - | 132 | 15 | 69 |
| 132 M | 1CC2 | 6 | 216 | 53 | 256 | 262 | 202 | 202 | 159.5 | 159.5 | 155 | 70.5 | 178 | 38 | 76 | 218 | 26.5 | 48 | 24 | 89 | - | 132 | 15 | 69 |
| 160 M | 1DA2, 1DA3, 1DB2, 1DC2 | 2, 4, 6 | 254 | 60 | 300 | 314 | 236.5 | 236.5 | 190 | 190 | 175 | 77.5 | 210 | 44 | 89 ³⁾ | 300 ⁴⁾ | 47 | 57 | 28.5 | 108 | - | 160 | 18 | 85 |
| 160 L | 1DA4, 1DB4, 1DC4 | 2, 4, 6 | 254 | 60 | 300 | 314 | 236.5 | 236.5 | 190 | 190 | 175 | 77.5 | 254 | 44 | 44 | 300 | 47 | 57 | 28.5 | 108 | - | 160 | 18 | 85 |
| 180 M | 1EA2, 1EB2 | 2, 4 | 279 | 65 | 339 | 356 | 259 | 259 | 212.5 | 212.5 | 175 | 77.5 | 241 | 80 | 100 | 328 | 30 | 57 | 28.5 | 121 | - | 180 | 20 | 95 |
| 180 L | 1EB4, 1EC4 | 4, 6 | 279 | 65 | 339 | 356 | 259 | 259 | 212.5 | 212.5 | 175 | 77.5 | 279 | 80 | 100 | 328 | 30 | 57 | 28.5 | 121 | - | 180 | 20 | 95 |
| 200 L | 2AA4, 2AA5, 2AB5, 2AC4, 2AC5 | 2, 4, 6 | 318 | 70 | 378 | 396 | 296 | 296 | 238 | 238 | 225 | 102.5 | 305 | 90 | 100 | 355 | 45 | 75 | 37.5 | 133 | - | 200 | 25 | 108 |

1) With screwed-on feet, dimension BA' is 38 mm.
 2) With screwed-on feet, dimension BB is 180 mm.
 3) With screwed-on feet, dimension BA' is 44 mm.

4) With screwed-on feet, dimension BB is 256 mm.

SIMOTICS GP and SIMOTICS SD standard motors

Dimensions · Aluminum series SIMOTICS GP

IE3 – forced-air cooled · Frame sizes 100 L to 200 L

Dimensional drawings

Type of construction IM B35

For flange dimensions, see page 1/47 (**Z** = the number of retaining holes)

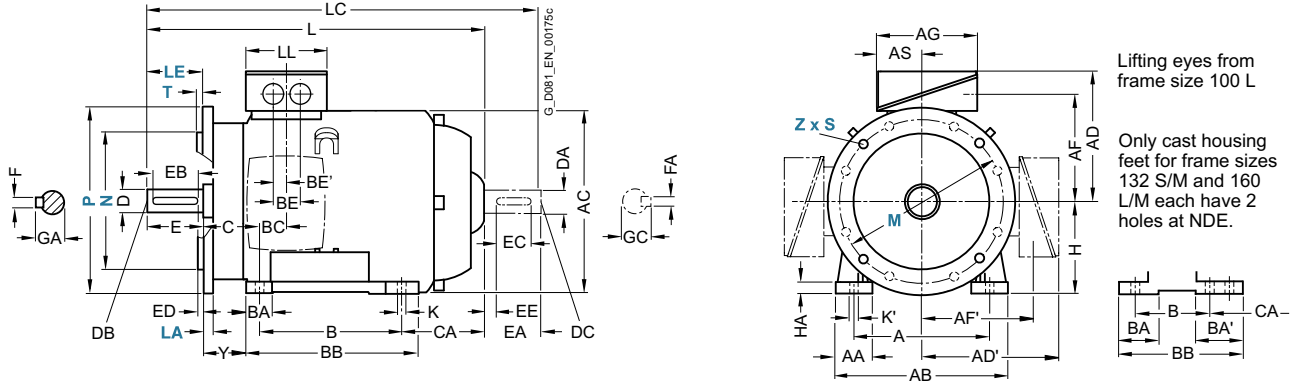

Type of construction IM B14

For flange dimensions, see page 1/47 (**Z** = the number of retaining holes)

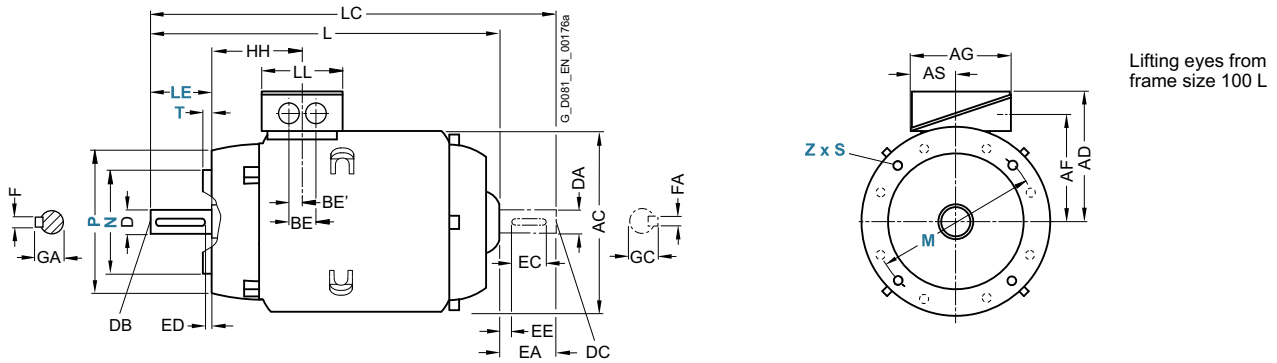

| For motor | | | Dimension designation acc. to IEC | | | | | | DE shaft extension | | | | | | NDE shaft extension | | | | | | | |
|------------|------------------------------|--------------|-----------------------------------|------|----|--------------|-----|-----|--------------------|-----|-----|-----|----|----|---------------------|----|-----|-----|-----|----|----|----|
| Frame size | Motor type | No. of poles | HH | K | K' | L | LC | LL | D | DB | E | EB | ED | F | GA | DA | DC | EA | EC | EE | FA | GC |
| 100 L | 1AA4, 1AB4, 1AB5, 1AC3 | 2, 4 6 | 96.5 | 12 | 16 | 356.5 | 411 | 112 | 28 | M10 | 60 | 50 | 5 | 8 | 31 | 24 | M8 | 50 | 40 | 5 | 8 | 27 |
| 112 M | 1BA2, 1BB2 | 2, 4 | 96 | 12 | 16 | 336 | 390 | 112 | 28 | M10 | 60 | 50 | 5 | 8 | 31 | 24 | M8 | 50 | 40 | 5 | 8 | 27 |
| 132 S | 1CA0, 1CC0 | 2, 6 | 115.5 | 12 | 16 | 380.5 | 446 | 130 | 38 | M12 | 80 | 70 | 5 | 10 | 41 | 28 | M10 | 60 | 50 | 5 | 8 | 31 |
| | 1CA1, 1CB0 | 2, 4 | | | | 430.5 | 496 | | | | | | | | | | | | | | | |
| 132 M | 1CC2 | 6 | 115.5 | 12 | 16 | 380.5 | 446 | 130 | 38 | M12 | 80 | 70 | 5 | 10 | 41 | 28 | M10 | 60 | 50 | 5 | 8 | 31 |
| | 1CB2, 1CC3 | 4, 6 | | | | 430.5 | 496 | | | | | | | | | | | | | | | |
| 160 M | 1DA2, 1DA3, 1DB2, 1DC2 | 2, 4, 6 | 155 | 15 | 19 | 510 | 630 | 145 | 42 | M16 | 110 | 90 | 10 | 12 | 45 | 42 | M16 | 110 | 90 | 10 | 12 | 45 |
| 160 L | 1DA4, 1DB4, 1DC4 | 2, 4, 6 | 155 | 15 | 19 | 570 | 690 | 145 | 42 | M16 | 110 | 90 | 10 | 12 | 45 | 42 | M16 | 110 | 90 | 10 | 12 | 45 |
| 180 M | 1EA2, 1EB2 | 2, 4 | 151 | 14.5 | 19 | 698 | 706 | 145 | 48 | M16 | 110 | 100 | 5 | 14 | 52 | 48 | M16 | 110 | 100 | 5 | 14 | 52 |
| 180 L | 1EB4, 1EC4 | 4, 6 | 151 | 14.5 | 19 | 698 | 706 | 145 | 48 | M16 | 110 | 100 | 5 | 14 | 52 | 48 | M16 | 110 | 100 | 5 | 14 | 52 |
| 200 L | 2AA4, 2AA5, 2AB5, 2AC4, 2AC5 | 2, 4, 6 | 178 | 18.5 | 25 | 746 | 759 | 185 | 55 | M20 | 110 | 100 | 5 | 16 | 59 | 55 | M20 | 110 | 100 | 5 | 16 | 59 |

SIMOTICS GP and SIMOTICS SD standard motors

Dimensions · Aluminum series SIMOTICS GP

IE4 – self-ventilated · Frame sizes 100 L to 200 L

Dimensional drawings

Type of construction IM B3

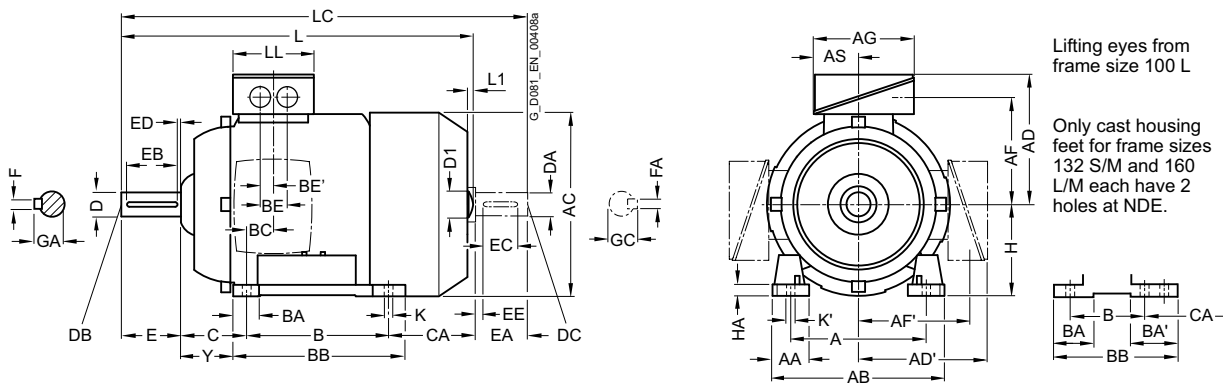

Lifting eyes from frame size 100 L

Only cast housing feet for frame sizes 132 S/M and 160 L/M each have 2 holes at NDE.

Types of construction IM B5 and IM V1

For flange dimensions, see page 1/47 (Z = the number of retaining holes)

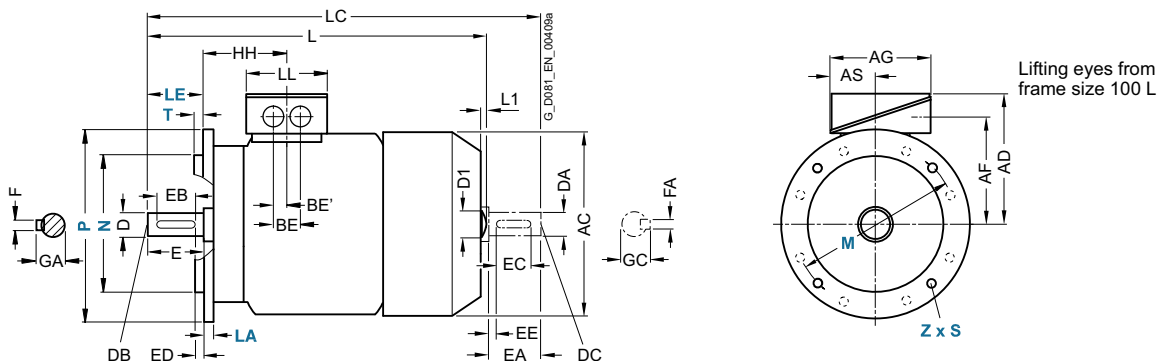

Lifting eyes from frame size 100 L

| For motor | | | Dimension designation acc. to IEC | | | | | | | | | | | | | | | | | | | | | |
|------------|------------|--------------|-----------------------------------|----|------------|-----|--------------|-------|-------|-------|-----|-------|-----|------|------------------|-------------------|------|----|------|-------|-------------------|------------|----|-----|
| Frame size | Motor type | No. of poles | A | AA | AB | AC | AD | AD' | AF | AF' | AG | AS | B | BA | BA' | BB | BC | BE | BE' | C | CA | H | HA | Y |
| 100 L | 1AA4 | 2 | 160 | 42 | 196 | 198 | 166 | 166 | 125.5 | 125.5 | 135 | 63.5 | 140 | 37.5 | 37.5 | 176 | 33.5 | 50 | 25 | 63 | 176 | 100 | 12 | 45 |
| | 1AB4 | 4 | | | | | | | | | | | | | | | | | | | | | | |
| | 1AB5 | 4 | | | | | | | | | | | | | | | | | | | | | | |
| 112 M | 1BA2 | 2 | 190 | 46 | 226 | 222 | 177 | 177 | 136.5 | 136.5 | 135 | 63.5 | 140 | 37.5 | 37.5 | 176 | 26 | 50 | 25 | 70 | 155 | 112 | 12 | 52 |
| | 1BB2 | 4 | | | | | | | | | | | | | | | | | | | | | | |
| 132 S | 1CA0 | 2 | 216 | 53 | 256 | 262 | 202 | 202 | 159.5 | 159.5 | 155 | 70.5 | 140 | 38 | 76 ¹⁾ | 218 ²⁾ | 26.5 | 48 | 24 | 89 | 128.5 | 132 | 15 | 69 |
| | 1CA1 | 2 | | | | | | | | | | | | | 38 | 180 | | | | 178.5 | | | | |
| | 1CB0 | 4 | | | | | | | | | | | | | | | | | | | | | | |
| 132 M | 1CB2 | 4 | 216 | 53 | 256 | 262 | 202 | 202 | 159.5 | 159.5 | 155 | 70.5 | 178 | 38 | 76 | 218 | 26.5 | 48 | 24 | 89 | 178.5 | 132 | 15 | 69 |
| 160 M | 1DA2 | 2 | 254 | 60 | 300 | 314 | 236.5 | 236.5 | 190 | 190 | 175 | 77.5 | 210 | 44 | 89 ³⁾ | 300 ⁴⁾ | 47 | 57 | 28.5 | 108 | 148 ⁵⁾ | 160 | 18 | 85 |
| | 1DA3 | 2 | | | | | | | | | | | | | 44 | 256 | | | | | | | | |
| | 1DB2 | 4 | | | | | | | | | | | | | | | | | | | | | | |
| 160 L | 1DA4 | 2 | 254 | 60 | 300 | 314 | 236.5 | 236.5 | 190 | 190 | 175 | 77.5 | 254 | 44 | 44 | 300 | 47 | 57 | 28.5 | 108 | 208 | 160 | 18 | 85 |
| | 1DB4 | 4 | | | | | | | | | | | | | | | | | | | | | | |
| 180 M | 1EA2 | 2 | 279 | 65 | 339 | 356 | 259 | 259 | 212.5 | 212.5 | 175 | 77.5 | 241 | 80 | 100 | 328 | 30 | 57 | 28.5 | 121 | 232 | 180 | 20 | 95 |
| | 1EB2 | 4 | | | | | | | | | | | | | | | | | | | | | | |
| 180 L | 1EB4 | 4 | 279 | 65 | 339 | 356 | 259 | 259 | 212.5 | 212.5 | 175 | 77.5 | 279 | 80 | 100 | 328 | 30 | 57 | 28.5 | 121 | 194 | 180 | 20 | 95 |
| 200 L | 2AA4 | 2 | 318 | 70 | 378 | 396 | 296 | 296 | 238 | 238 | 225 | 102.5 | 305 | 90 | 100 | 355 | 45 | 75 | 37.5 | 133 | 202 | 200 | 25 | 108 |
| | 2AA5 | 2 | | | | | | | | | | | | | | | | | | | | | | |
| | 2AB5 | 4 | | | | | | | | | | | | | | | | | | | | | | |

1) With screwed-on feet, dimension BA' is 38 mm.
 2) With screwed-on feet, dimension BB is 180 mm.
 3) With screwed-on feet, dimension BA' is 44 mm.

4) With screwed-on feet, dimension BB is 256 mm.
 5) With screwed-on feet, dimension CA is 192 mm.

SIMOTICS GP and SIMOTICS SD standard motors

Dimensions · Aluminum series SIMOTICS GP

IE4 – self-ventilated · Frame sizes 100 L to 200 L

Dimensional drawings

Type of construction IM B35

For flange dimensions, see page 1/47 (Z = the number of retaining holes)

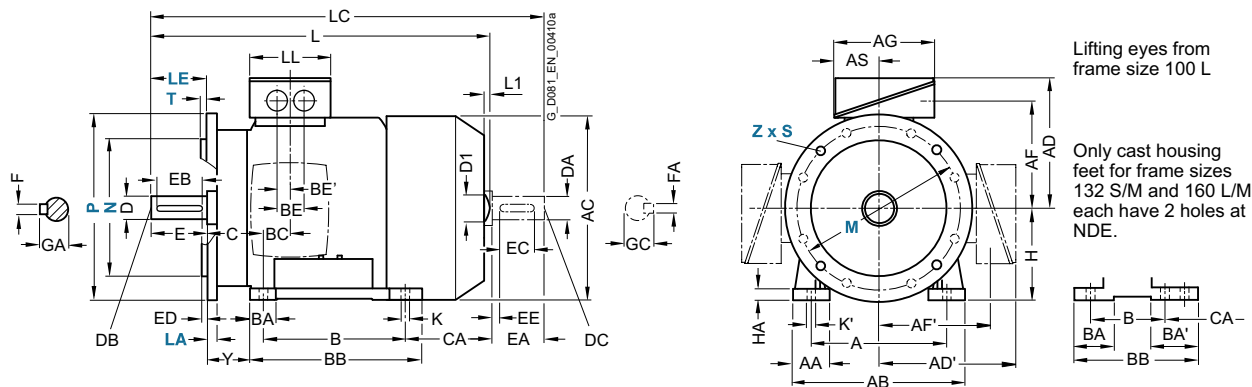

Type of construction IM B14

For flange dimensions, see page 1/47 (Z = the number of retaining holes)

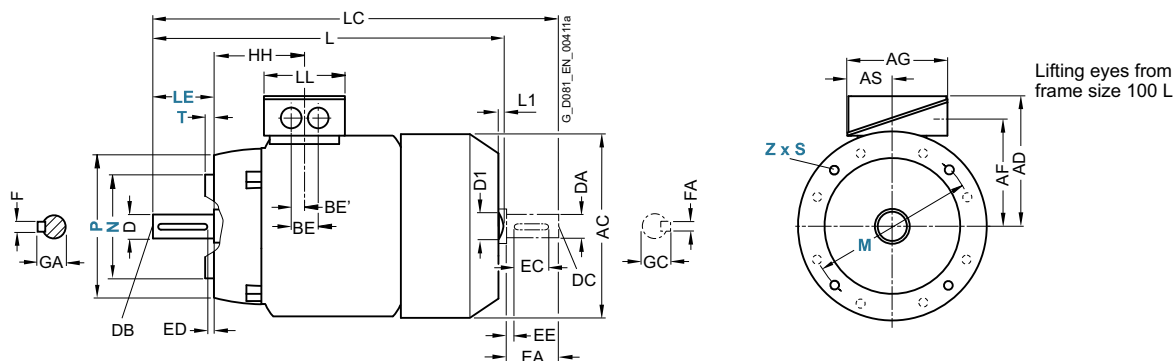

| Frame size | Motor type | No. of poles | Dimension designation acc. to IEC | | | | | | | | DE shaft extension | | | | | NDE shaft extension | | | | | | | | | |
|------------|------------|--------------|-----------------------------------|------|----|-----------------|-----|----|-------|-----|--------------------|-----|-----|-----|----|---------------------|----|----|-----|-----|-----|----|----|----|-------|
| | | | HH | K | K' | L ¹⁾ | L1 | D1 | LC | LL | D | DB | E | EB | ED | F | GA | DA | DC | EA | EC | EE | FA | GC | |
| 100 L | 1AA4 | 2 | 96.5 | 12 | 16 | 430.5 | 7 | 32 | 489 | 112 | 28 | M10 | 60 | 50 | 5 | 8 | 31 | 24 | M8 | 50 | 40 | 5 | 8 | 27 | |
| | 1AB4 | 4 | | | | 480.5 | | | | | | | | | | | | | | | | | | | 529 |
| | 1AB5 | 4 | | | | | | | | | | | | | | | | | | | | | | | |
| 112 M | 1BA2 | 2 | 96 | 12 | 16 | 414 | 7 | 32 | 475 | 112 | 28 | M10 | 60 | 50 | 5 | 8 | 31 | 24 | M8 | 50 | 40 | 5 | 8 | 27 | |
| | 1BB2 | 4 | | | | 464 | | | | | | | | | | | | | | | | | | | 520 |
| 132 S | 1CA0 | 2 | 115.5 | 12 | 16 | 465 | 8.5 | 39 | 535.5 | 130 | 38 | M12 | 80 | 70 | 5 | 10 | 41 | 28 | M10 | 60 | 50 | 5 | 8 | 31 | |
| | 1CA1 | 2 | | | | 515 | | | | | | | | | | | | | | | | | | | 585.5 |
| | 1CB0 | 4 | | | | | | | | | | | | | | | | | | | | | | | |
| 132 M | 1CB2 | 4 | 115.5 | 12 | 16 | 515 | 8.5 | 39 | 585.5 | 130 | 38 | M12 | 80 | 70 | 5 | 10 | 41 | 28 | M10 | 60 | 50 | 5 | 8 | 31 | |
| 160 M | 1DA2 | 2 | 155 | 15 | 19 | 604 | 10 | 45 | 730 | 145 | 42 | M16 | 110 | 90 | 10 | 12 | 45 | 42 | M16 | 110 | 90 | 10 | 12 | 45 | |
| | 1DA3 | 2 | | | | 664 | | | | | | | | | | | | | | | | | | | |
| | 1DB2 | 4 | | | | | | | | | | | | | | | | | | | | | | | |
| 160 L | 1DA4 | 2 | 155 | 15 | 19 | 664 | 10 | 45 | 790 | 145 | 42 | M16 | 110 | 90 | 10 | 12 | 45 | 42 | M16 | 110 | 90 | 10 | 12 | 45 | |
| | 1DB4 | 4 | | | | | | | | | | | | | | | | | | | | | | | |
| 180 M | 1EA2 | 2 | 151 | 14.5 | 19 | 698 | - | - | 814 | 145 | 48 | M16 | 110 | 100 | 5 | 14 | 52 | 48 | M16 | 110 | 100 | 5 | 14 | 52 | |
| | 1EB2 | 4 | | | | | | | | | | | | | | | | | | | | | | | |
| 180 L | 1EB4 | 4 | 151 | 14.5 | 19 | 698 | - | - | 814 | 145 | 48 | M16 | 110 | 100 | 5 | 14 | 52 | 48 | M16 | 110 | 100 | 5 | 14 | 52 | |
| 200 L | 2AA4 | 2 | 178 | 18.5 | 25 | 746 | - | - | 860 | 185 | 55 | M20 | 110 | 100 | 5 | 16 | 59 | 55 | M20 | 110 | 100 | 5 | 16 | 59 | |
| | 2AA5 | 2 | | | | | | | | | | | | | | | | | | | | | | | |
| | 2AB5 | 4 | | | | | | | | | | | | | | | | | | | | | | | |

¹⁾ The length is specified as far as the tip of the fan cover.



SIMOTICS GP and SIMOTICS SD standard motors

Dimensions · Aluminum series SIMOTICS GP

IR3 Rendimento Premium – self-ventilated · Frame sizes 80 M to 160 L

Dimensional drawings

Type of construction IM B3

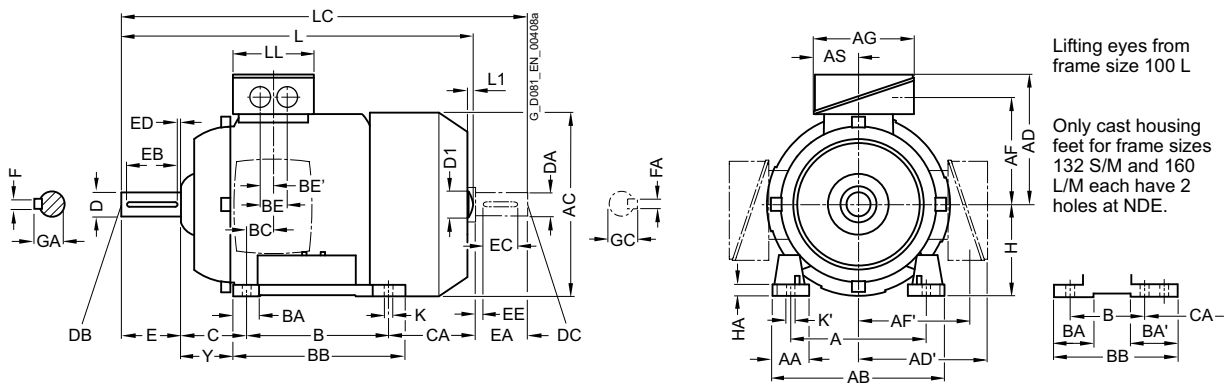

Types of construction IM B5 and IM V1

For flange dimensions, see page 1/47 (Z = the number of retaining holes)

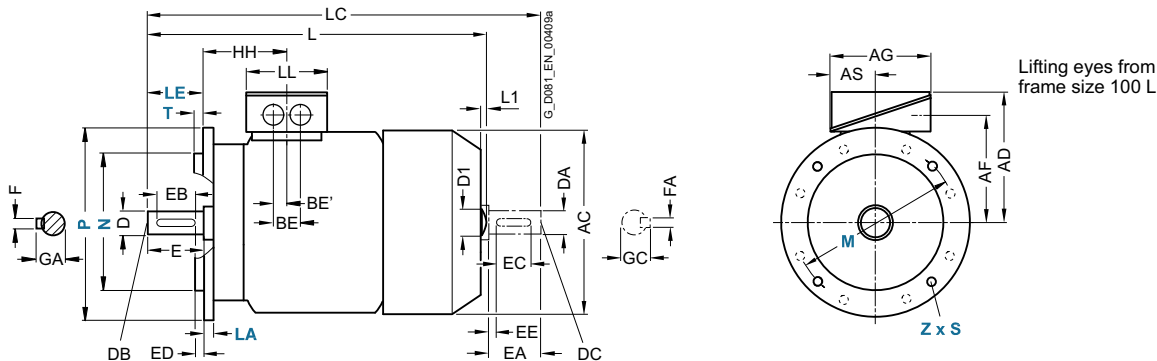

| Frame size | Motor type | No. of poles | Dimension designation acc. to IEC | | | | | | | | | | | | | | | | | | | | | |
|------------|--|----------------------|-----------------------------------|------|------------|-----|--------------|-------|-------|-------|-----|------|-----|------|------|-----|------|----|------|-----|-------|------------|----|----|
| | | | A | AA | AB | AC | AD | AD' | AF | AF' | AG | AS | B | BA | BA' | BB | BC | BE | BE' | C | CA | H | HA | Y |
| 80 M | 0DA3, 0DA6, 0DB3, 0DB6, 0DC3, 0DD3, 0DC2 | 2, 4, 6, 8 6, 8 | 125 | 30.5 | 150 | 159 | 121.5 | 121.5 | 96.5 | 96.5 | 93 | 43 | 100 | 32 | - | 118 | 23 | - | 18 | 50 | 113 | 80 | 8 | 41 |
| 90 S | 0EA4, 0EB4, 0EC0, 0EDO | 2, 4 6, 8 | 140 | 305 | 165 | 178 | 126 | 126 | 101.5 | 101.5 | 93 | 43 | 100 | 33 | - | 143 | 22.5 | - | 18 | 56 | 159 | 90 | 10 | 47 |
| 90 L | 0EB6, 0ED4 | 4 8 | 140 | 305 | 165 | 178 | 126 | 126 | 101.5 | 101.5 | 93 | 43 | 125 | 33 | - | 143 | 22.5 | - | 18 | 56 | 154 | 90 | 10 | 47 |
| 100 L | 1AA4, 1AA6, 1AB5, 1AC3, 1AB6, 1AD4 | 2, 4, 6, 8 4 8 | 160 | 42 | 196 | 198 | 166 | 166 | 125.5 | 125.5 | 135 | 63.5 | 140 | 37.5 | 37.5 | 176 | 33.5 | 50 | 25 | 63 | 176 | 100 | 12 | 45 |
| 112 M | 1BA5, 1BA6, 1BB5, 1BC1, 1BB6 | 2, 4, 6, 8 4 | 190 | 46 | 226 | 222 | 177 | 177 | 136.5 | 136.5 | 135 | 63.5 | 140 | 37.5 | 37 | 176 | 26 | 50 | 25 | 70 | 155 | 112 | 12 | 52 |
| 132 S | 1CA1, 1CB2, 1CC0, 1CC1, 1CC2, 1CC4, 1CD0 | 2, 4 6, 8 | 216 | 53 | 256 | 262 | 202 | 202 | 159.5 | 159.5 | 155 | 70.5 | 140 | 38 | 76 | 218 | 26.5 | 48 | 24 | 89 | 178.5 | 132 | 15 | 69 |
| 132 M | 1CA5, 1CA6, 1CC3, 1CC6, 1CB5, 1CB6 | 2, 6, 8 4 | 216 | 53 | 256 | 262 | 202 | 202 | 159.5 | 159.5 | 155 | 70.5 | 178 | 38 | 76 | 218 | 26.5 | 48 | 24 | 89 | 178.5 | 132 | 15 | 69 |
| 160 M | 1DA4, 1DB4, 1DC3, 1DC4, 1DA3, 1DD1, 1DD3 | 2, 4, 6 2, 8 | 254 | 60 | 300 | 314 | 236.5 | 236.5 | 190 | 190 | 175 | 77.5 | 210 | 44 | 44 | 256 | 47 | 57 | 28.5 | 108 | 192 | 160 | 18 | 85 |
| 160 L | 1DA6, 1DB6, 1DC6, 1DD4 | 2, 4, 6, 8 | 254 | 60 | 300 | 314 | 236.5 | 236.5 | 190 | 190 | 175 | 77.5 | 254 | 44 | 89 | 300 | 47 | 57 | 28.5 | 108 | 208 | 160 | 18 | 85 |

SIMOTICS GP and SIMOTICS SD standard motors

Dimensions · Aluminum series SIMOTICS GP

IR3 Rendimento Premium – self-ventilated · Frame sizes 80 M to 160 L

Dimensional drawings

Type of construction IM B35

For flange dimensions, see page 1/47 (Z = the number of retaining holes)

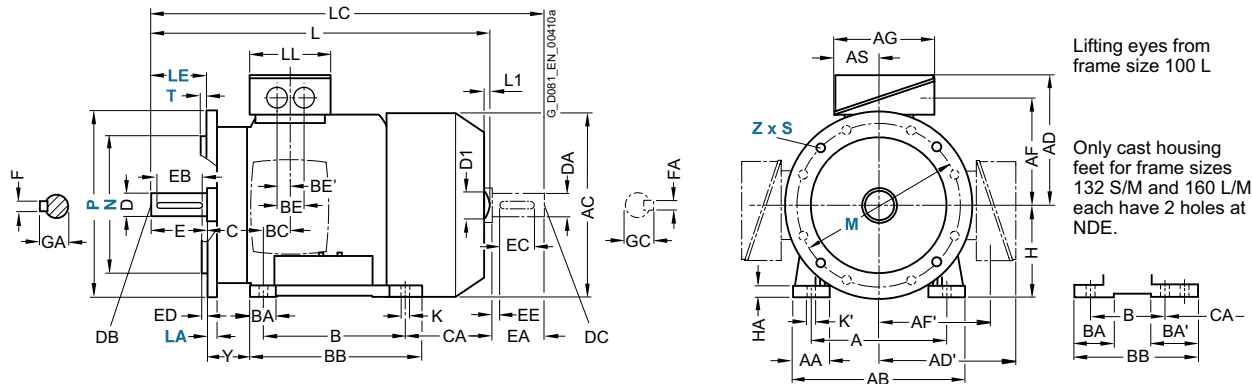

Type of construction IM B14

For flange dimensions, see page 1/47 (Z = the number of retaining holes)

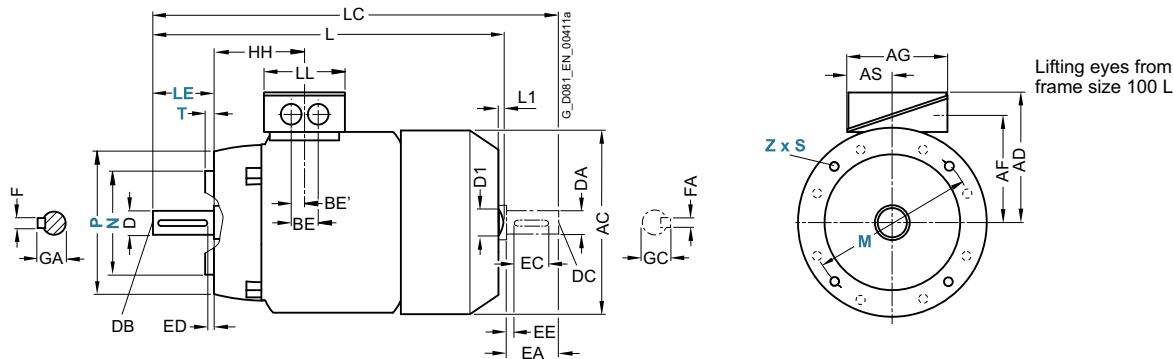

| Frame size | Motor type | No. of poles | Dimension designation acc. to IEC | | | | | | | DE shaft extension | | | | | NDE shaft extension | | | | | | | | | |
|------------|------------------------------------|--------------|-----------------------------------|-----|------|-----------------|-----|----|-------|--------------------|----|-----|-----|----|---------------------|----|------|----|-----|-----|----|----|----|------|
| | | | HH | K | K' | L ¹⁾ | L1 | D1 | LC | LL | D | DB | E | EB | ED | F | GA | DA | DC | EA | EC | EE | FA | GC |
| 80 M | 0DA3, 0DA6, 0DB3, 0DB6, 0DC3, 0DD3 | 2, 4, 6, 8 | 73 | 9.5 | 13.5 | 327 | - | - | 378 | 79 | 19 | M6 | 40 | 32 | 4 | 6 | 21.5 | 19 | M6 | 40 | 32 | 4 | 6 | 21.5 |
| | 0DC2 | 6, 8 | | | | 292 | | | 343 | | | | | | | | | | | | | | | |
| | 0EA4, 0EB4 | 2, 4 | 78.5 | 10 | 14 | 387 | - | - | 445 | 79 | 24 | M8 | 50 | 40 | 5 | 8 | 27 | 19 | M6 | 40 | 32 | 4 | 6 | 21.5 |
| 90 S | 0EC0, 0EDO | 6, 8 | | | | 347 | | | 405 | | | | | | | | | | | | | | | |
| | 0EB6 | 4 | 78.5 | 10 | 14 | 433 | - | - | 491 | 79 | 24 | M8 | 50 | 40 | 5 | 8 | 27 | 19 | M6 | 40 | 32 | 4 | 6 | 21.5 |
| 90 L | 0ED4 | 8 | | | | 347 | | | 405 | | | | | | | | | | | | | | | |
| | 1AA4, 1AA6, 1AB5, 1AC3 | 2, 4, 6, 8 | 96.5 | 12 | 16 | 430.5 | 7 | 32 | 489 | 112 | 28 | M10 | 60 | 50 | 5 | 8 | 31 | 24 | M8 | 50 | 40 | 5 | 8 | 27 |
| 100 L | 1AB6 | 4 | | | | 480.5 | | | 529 | | | | | | | | | | | | | | | |
| | 1AD4 | 8 | | | | 395.5 | | | 454 | | | | | | | | | | | | | | | |
| 112 M | 1BA5, 1BA6, 1BB5, 1BC1, 1BB6 | 2, 4, 6, 8 | 96 | 12 | 16 | 414 | 7 | 32 | 475 | 112 | 28 | M10 | 60 | 50 | 5 | 8 | 31 | 24 | M8 | 50 | 40 | 5 | 8 | 27 |
| | 1CB5, 1CB6 | 4 | | | | 464 | | | 520 | | | | | | | | | | | | | | | |
| 132 S | 1CA1, 1CB2 | 2, 4 | 115.5 | 12 | 16 | 515 | 8.5 | 39 | 585.5 | 130 | 38 | M12 | 80 | 70 | 5 | 10 | 41 | 28 | M10 | 60 | 50 | 5 | 8 | 31 |
| | 1CC0, 1CC1, 1CC2, 1CC4, 1CD0 | 6, 8 | | | | 465 | | | 535.5 | | | | | | | | | | | | | | | |
| | 1CA5, 1CA6, 1CC3, 1CC6, 1CB5, 1CB6 | 2, 6, 8 | 115.5 | 12 | 16 | 515 | 8.5 | 39 | 585.5 | 130 | 38 | M12 | 80 | 70 | 5 | 10 | 41 | 28 | M10 | 60 | 50 | 5 | 8 | 31 |
| 160 M | 1DA4, 1DB4, 1DC3, 1DC4 | 2, 4, 6 | 155 | 15 | 19 | 664 | 10 | 45 | 730 | 145 | 42 | M16 | 110 | 90 | 10 | 12 | 45 | 42 | M16 | 110 | 90 | 10 | 12 | 45 |
| | 1DA3, 1DD1, 1DD3 | 2, 8 | | | | 604 | | | | | | | | | | | | | | | | | | |
| | 1DA6, 1DB6, 1DC6, 1DD4 | 2, 4, 6, 8 | 155 | 15 | 19 | 664 | 10 | 54 | 790 | 145 | 42 | M16 | 110 | 90 | 10 | 12 | 45 | 42 | M16 | 110 | 90 | 10 | 12 | 45 |

¹⁾ In the low-noise version, a second shaft extension and/or mounted encoder is not possible.



SIMOTICS GP and SIMOTICS SD standard motors

Dimensions · Cast-iron series SIMOTICS SD

IE1, IE2, NEMA Energy Efficient – self-ventilated · Frame sizes 71 M to 160 L

Dimensional drawings

Type of construction IM B3

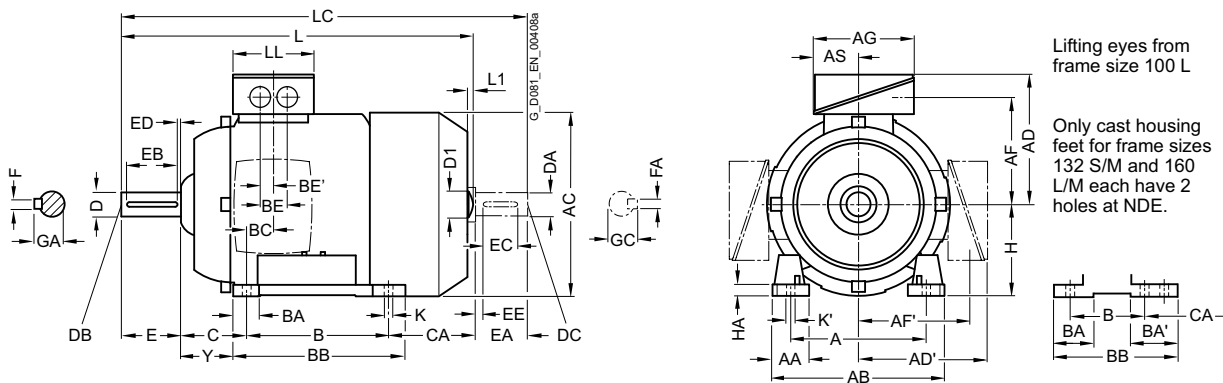

Types of construction IM B5 and IM V1

For flange dimensions, see page 1/47 (Z = the number of retaining holes)

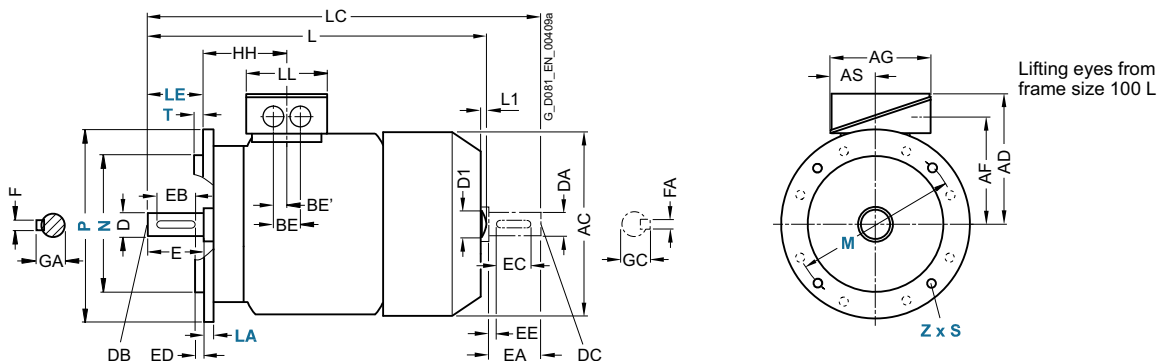

| For motor | | | Dimension designation acc. to IEC | | | | | | | | | | | | | | | | | | | | | |
|------------|---------------------------|--------------|-----------------------------------|------|------------|-------|--------------|-------|-----|-----|-----|------|-----|------------------|-------------------|-------------------|------|----|-----|-----|-------|------------|----|----|
| Frame size | Motor type | No. of poles | A | AA | AB | AC | AD | AD' | AF | AF' | AG | AS | B | BA | BA' | BB | BC | BE | BE' | C | CA | H | HA | Y |
| 71 M | 1LE15.1, 1LE16.1, 1LE1502 | 2, 4, 6 | 112 | 30.5 | 132 | 145 | 149 | 149 | 112 | 112 | 126 | 62 | 90 | 32 | 32 | 106 | 21 | 36 | 18 | 45 | 83 | 71 | 7 | 37 |
| 80 M | 1LE15.1 | 2, 4, 6 | 125 | 30.5 | 150 | 162 | 159 | 159 | 122 | 122 | 126 | 62 | 100 | 32 | 32 | 118 | 22.5 | 36 | 18 | 50 | 112.5 | 80 | 8 | 41 |
| 90 S | 1LE15.1 | 2, 4, 6 | 140 | 30.5 | 165 | 180 | 164 | 164 | 127 | 127 | 126 | 62 | 100 | 33 | 54 | 143 | 24.5 | 36 | 18 | 56 | 159 | 90 | 11 | 47 |
| 90 L | 1LE15.1 | 2, 4, 6 | 140 | 30.5 | 165 | 180 | 164 | 164 | 127 | 127 | 126 | 62 | 125 | 33 | 54 | 143 | 24.5 | 36 | 18 | 56 | 134 | 90 | 11 | 47 |
| 100 L | All | 2, 4, 6, 8 | 160 | 42 | 196 | 217 | 193 | 193 | 147 | 147 | 163 | 80.5 | 140 | 48 | 48 | 176 | 37.5 | 48 | 24 | 63 | 141 | 100 | 12 | 45 |
| 112 M | All | 2, 4, 6, 8 | 190 | 46 | 226 | 239 | 195 | 195 | 150 | 150 | 163 | 80.5 | 140 | 48 | 48 | 176 | 30 | 48 | 24 | 70 | 130 | 112 | 12 | 52 |
| 132 S | All | 2, 4, 6, 8 | 216 | 53 | 256 | 281 | 214.5 | 214.5 | 169 | 169 | 163 | 80.5 | 140 | 52 ⁵⁾ | 89 ¹⁾ | 218 ³⁾ | 26.5 | 48 | 24 | 89 | 166.5 | 132 | 15 | 69 |
| 132 M | All | 2, 4, 6, 8 | 216 | 53 | 256 | 281 | 214.5 | 214.5 | 169 | 169 | 163 | 80.5 | 178 | 52 ⁵⁾ | 89 ¹⁾ | 218 | 26.5 | 48 | 24 | 89 | 128.5 | 132 | 15 | 69 |
| 160 M | All | 2, 4, 6, 8 | 254 | 60 | 300 | 333.5 | 265 | 265 | 213 | 213 | 190 | 92 | 210 | 73 ⁶⁾ | 117 ²⁾ | 300 ⁴⁾ | 37 | 60 | 30 | 108 | 192 | 160 | 18 | 85 |
| 160 L | All | 2, 4, 6, 8 | 254 | 60 | 300 | 333.5 | 265 | 265 | 213 | 213 | 190 | 92 | 254 | 73 ⁶⁾ | 117 ²⁾ | 300 | 37 | 60 | 30 | 108 | 148 | 160 | 18 | 85 |

1) With screwed-on feet, dimension BA' is 41 mm.
 2) With screwed-on feet, dimension BA' is 51 mm.
 3) With screwed-on feet, dimension BB is 180 mm.

4) With screwed-on feet, dimension BB is 256 mm.
 5) With screwed-on feet, dimension BA is 41 mm.
 6) With screwed-on feet, dimension BA is 51 mm.

SIMOTICS GP and SIMOTICS SD standard motors

Dimensions · Cast-iron series SIMOTICS SD

IE1, IE2, NEMA Energy Efficient – self-ventilated · Frame sizes 71 M to 160 L

Dimensional drawings

Type of construction IM B35

For flange dimensions, see page 1/47 (**Z** = the number of retaining holes)

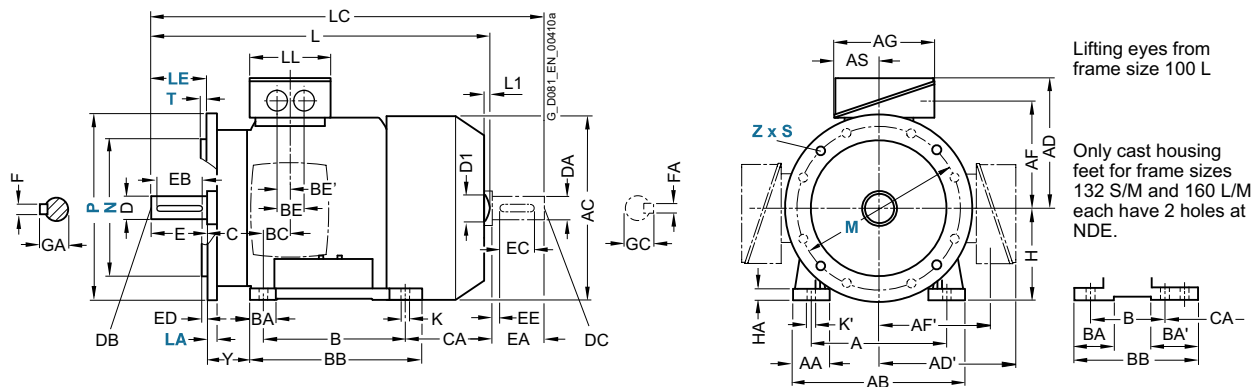

Type of construction IM B14

For flange dimensions, see page 1/47 (**Z** = the number of retaining holes)

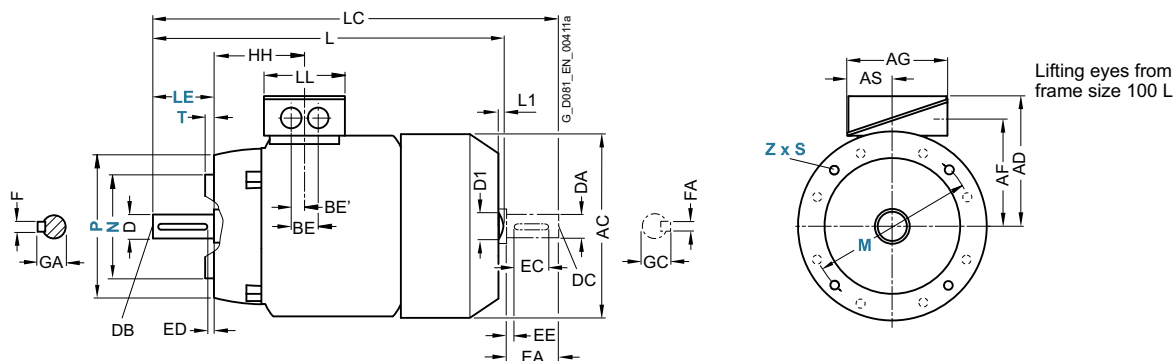

| For motor | | | Dimension designation acc. to IEC | | | | | | | DE shaft extension | | | | | NDE shaft extension | | | | | | | | | |
|------------|------------|--------------|-----------------------------------|------|-----|------------------------------|------------------|----|------------|--------------------|----|-----|-----|----|---------------------|----|------|----|-----|-----|----|----|----|------|
| Frame size | Motor type | No. of poles | HH | K | K' | L ¹⁾ | L1 ²⁾ | D1 | LC | LL | D | DB | E | EB | ED | F | GA | DA | DC | EA | EC | EE | FA | GC |
| 71 M | 1LE15.1 | 2, 4, 6 | 64.5 | 7.5 | 7.5 | 240 | - | - | 278 | 102 | 14 | M5 | 30 | 22 | 4 | 5 | 16 | 14 | M5 | 30 | 22 | 4 | 5 | 16 |
| 80 M | 1LE15.1 | 2, 4, 6 | 71.5 | 10 | 10 | 292 | - | - | 342.5 | 102 | 19 | M6 | 40 | 32 | 4 | 6 | 21.5 | 19 | M6 | 40 | 32 | 4 | 6 | 21.5 |
| 90 S | 1LE15.1 | 2, 4, 6 | 79.5 | 10 | 10 | 347 | - | - | 405 | 102 | 24 | M8 | 50 | 40 | 5 | 8 | 27 | 19 | M6 | 40 | 32 | 4 | 6 | 21.5 |
| 90 L | 1LE15.1 | 2, 4, 6 | 79.5 | 10 | 10 | 347 | - | - | 405 | 102 | 24 | M8 | 50 | 40 | 5 | 8 | 27 | 19 | M6 | 40 | 32 | 4 | 6 | 21.5 |
| 100 L | All | 2, 4, 6, 8 | 100.5 | 12 | 16 | 397.5 | 7 | 32 | 454 | 134 | 28 | M10 | 60 | 50 | 5 | 8 | 31 | 24 | M8 | 50 | 40 | 5 | 8 | 27 |
| 112 M | All | 2, 4, 6, 8 | 100.5 | 12 | 16 | 390.5 415.5 | 7 | 32 | 450 475 | 134 | 28 | M10 | 60 | 50 | 5 | 8 | 31 | 24 | M8 | 50 | 40 | 5 | 8 | 27 |
| 132 S | All | 2, 4, 6, 8 | 115.5 | 12 | 16 | 466.5 | 8.5 | 39 | 535.5 | 134 | 38 | M12 | 80 | 70 | 5 | 10 | 41 | 28 | M10 | 60 | 50 | 5 | 8 | 31 |
| 132 M | All | 2, 4, 6, 8 | 115.5 | 12 | 16 | 466.5 | 8.5 | 39 | 535.5 | 134 | 38 | M12 | 80 | 70 | 5 | 10 | 41 | 28 | M10 | 60 | 50 | 5 | 8 | 31 |
| 160 M | All | 2, 4, 6, 8 | 145 | 14.5 | 18 | 606 | 10 | 45 | 730 | 165 | 42 | M16 | 110 | 90 | 10 | 12 | 45 | 42 | M16 | 110 | 90 | 10 | 12 | 45 |
| 160 L | All | 2, 4, 6, 8 | 145 | 14.5 | 18 | 606 | 10 | 45 | 730 | 165 | 42 | M16 | 110 | 90 | 10 | 12 | 45 | 42 | M16 | 110 | 90 | 10 | 12 | 45 |

1) For 1LE16 motors less dimension L1.

2) Only for 1LE15 motors.



SIMOTICS GP and SIMOTICS SD standard motors

Dimensions · Cast-iron series SIMOTICS SD

IE1, IE2, NEMA Energy Efficient – self-ventilated · Frame sizes 180 M to 250 M

Dimensional drawings

Type of construction IM B3

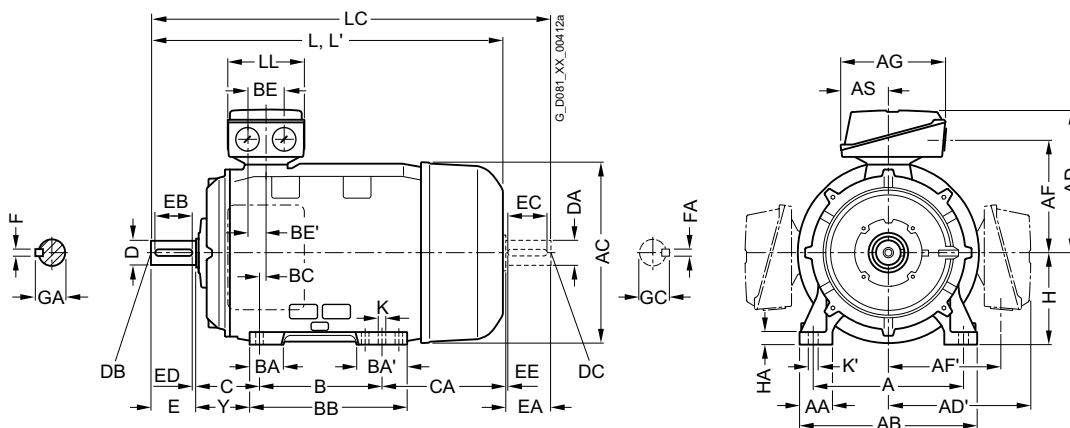

Types of construction IM B5 and IM V1

For flange dimensions, see page 1/47 (Z = the number of retaining holes)

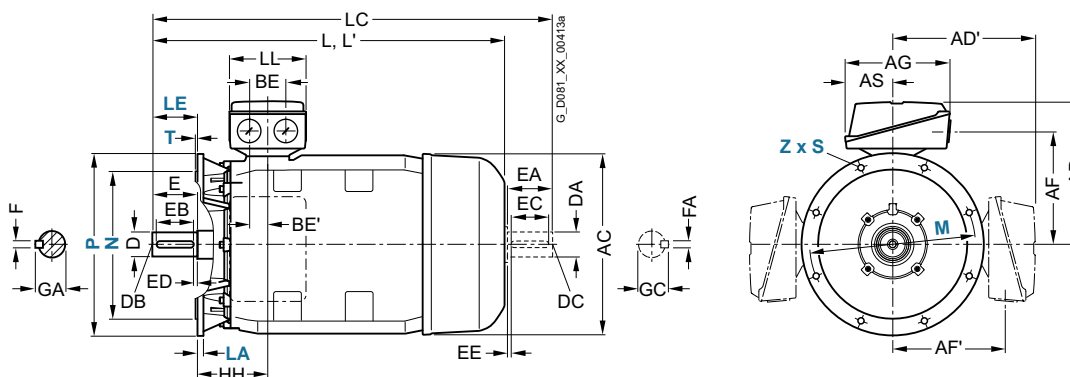

| For motor | | | Dimension designation acc. to IEC | | | | | | | | | | | | | | | | | | |
|-----------------|--|--------------|-----------------------------------|-----|------------|-----|------------|-----|-------|-------|-----|-----|-------------------|-----|-----|-----|----|-----|------|-----|-----|
| Frame size | Motor type | No. of poles | A | AA | AB | AC | AD | AD' | AF | AF' | AG | AS | B | BA | BA' | BB | BC | BE | BE' | C | CA |
| 180 M/ 180 L | 1LE1501-, 1LE1521-, 1LE1541- 1LE1601- 1LE1502- | 2, 4, 6 | 279 | 65 | 339 | 356 | 286 | 286 | 234 | 234 | 189 | 91 | 241 | 85 | 120 | 328 | 34 | 60 | 30 | 121 | 202 |
| | 1EB4, 1EA6, 1EB6, 1EC6 | 2, 4, 6 | | | | | | | | | | | 279 | | | | | | | | |
| 200 L | 2AA4, 2AA5, 2AB5, 2AC4, 2AC5, 2AD5 | 2, 4, 6, 8 | 318 | 70 | 378 | 396 | 315 | 315 | 258.5 | 258.5 | 265 | 112 | 305 | 104 | 104 | 355 | 31 | 85 | 42.5 | 133 | 177 |
| | 2AA6, 2AB6, 2AC6, 2AD6 | 2, 4, 6, 8 | | | | | | | | | | | | | | | | | | | |
| 225 S/ 225 M | 2BB0, 2BD0, | 4, 8 | 356 | 80 | 436 | 449 | 338 | 338 | 282 | 282 | 266 | 112 | 311 | 92 | 117 | 361 | 15 | 85 | 42.5 | 149 | 253 |
| | 2BB2, 2BC2, 2BD2, 2BB6, 2BC6, 2BD6 | 4, 6, 8 | | | | | | | | | | | 286 ¹⁾ | | | | | | | | |
| | 2BA2, 2BA6 | 2 | | | | | | | | | | | 286 ¹⁾ | | | | | | | | |
| 250 M | 2CA2, 2CA6 | 2 | 406 | 100 | 490 | 497 | 410 | 410 | 322 | 322 | 319 | 145 | 349 | 102 | 102 | 409 | 24 | 110 | 55 | 168 | 230 |
| | 2CB2, 2CC2, 2CD2, 2CC6, 2CD6, | 4, 6, 8 | | | | | | | | | | | | | | | | | | | |
| | 2CB6 | 4 | | | | | | | | | | | | | | | | | | | |

300

¹⁾ Only applicable for 1LE1502.

SIMOTICS GP and SIMOTICS SD standard motors

Dimensions · Cast-iron series SIMOTICS SD

IE1, IE2, NEMA Energy Efficient – self-ventilated · Frame sizes 180 M to 250 M

Dimensional drawings

Type of construction IM B35

For flange dimensions, see page 1/47 (**Z** = the number of retaining holes)

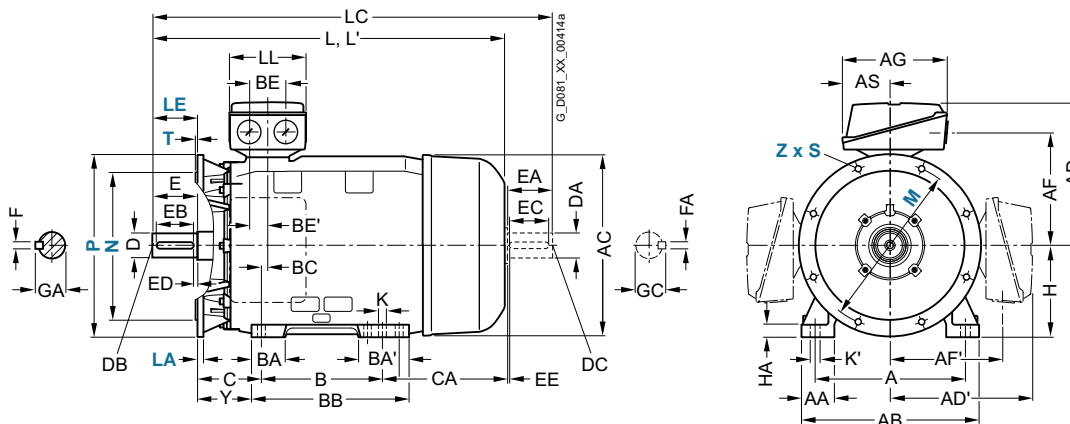

2

| For motor Motor type | Dimension designation acc. to IEC | | | | | | | DE shaft extension | | | | | | NDE shaft extension | | | | | | | | | |
|---|-----------------------------------|----|-----|-----|----|----|------|--------------------|-----|----|-----|-----|-----|---------------------|----|------|----|-----|-----|-----|----|----|------|
| | H | HA | Y | HH | K | K' | L | LC ¹⁾ | LL | D | DB | E | EB | ED | F | GA | DA | DC | EA | EC | EE | FA | GC |
| 1LE1501-, 1LE1521-, 1LE1541- 1LE1601- 1LE1502- | | | | | | | | | | | | | | | | | | | | | | | |
| 1EB2 ²⁾ , 1EA2, 1EB2, 1EC4 1EB4, 1EA6, 1EB6, 1EC6 | 180 | 20 | 95 | 155 | 15 | 19 | 668 | 784 | 164 | 48 | M16 | 110 | 100 | 5 | 14 | 51.5 | 48 | M16 | 110 | 100 | 5 | 14 | 51.5 |
| 2AA4, 2AA5, 2AB5, 2AC4, 2AC5, 2AD5 | 200 | 25 | 108 | 164 | 19 | 25 | 721 | 835 | 197 | 55 | M20 | 110 | 100 | 5 | 16 | 59 | 55 | M20 | 110 | 100 | 5 | 16 | 59 |
| 2AA6, 2AB6, 2AC6, 2AD6 | | | | | | | 746 | 860 | | | | | | | | | | | | | | | |
| 2BB0, 2BD0 | 225 | 34 | 124 | 164 | 19 | 25 | 788 | 903 | 197 | 60 | M20 | 140 | 125 | 10 | 18 | 64 | 55 | M20 | 110 | 100 | 5 | 16 | 59 |
| 2BB2, 2BC2, 2BD2, 2BB6, 2BC6, 2BD6 | | | | | | | 848 | 963 | | | | | | | | | | | | | | | |
| 2BA2, 2BA6 | | | | | | | 818 | 933 | 55 | | | 110 | 100 | 5 | 16 | 59 | 48 | M16 | | | | 14 | 51.5 |
| 2CA2, 2CA6 | 250 | 40 | 138 | 192 | 24 | 30 | 887 | 1002 | 233 | 60 | M20 | 140 | 125 | 10 | 18 | 64 | 55 | M20 | 110 | 100 | 5 | 16 | 59 |
| 2CB2, 2CC2, 2CD2, 2CC6, 2CD6 | | | | | | | 1032 | 1072 | 65 | | | | | | | 69 | 60 | | 140 | 125 | 10 | 18 | 64 |
| 2CB6 | | | | | | | 957 | 1072 | | | | | | | | | | | | | | | |

¹⁾ In the low-noise version, a second shaft extension and/or mounted encoder is not possible.

²⁾ Only applicable for 1LE1502.

SIMOTICS GP and SIMOTICS SD standard motors

Dimensions · Cast-iron series SIMOTICS SD

IE1, IE2, NEMA Energy Efficient – self-ventilated · Frame sizes 280 S to 315 L

Dimensional drawings

Type of construction IM B3

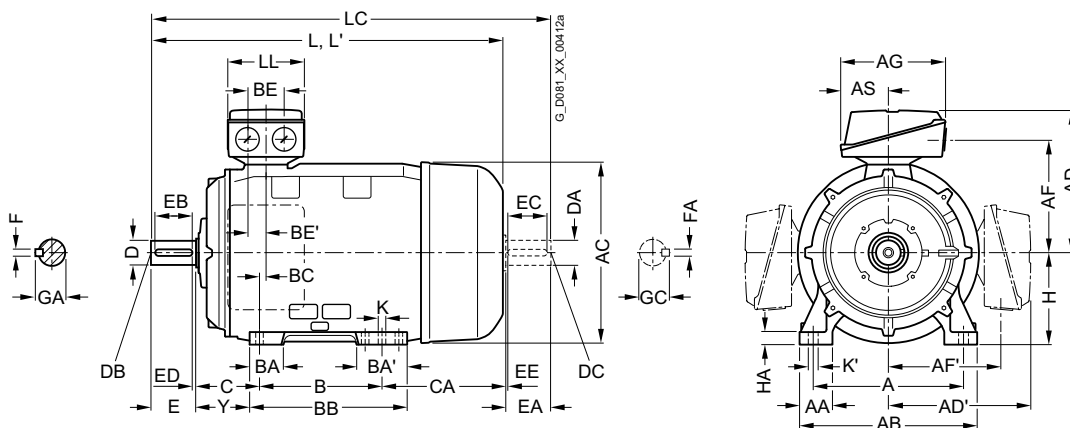

Types of construction IM B5 and IM V1

For flange dimensions, see page 1/47 (Z = the number of retaining holes)

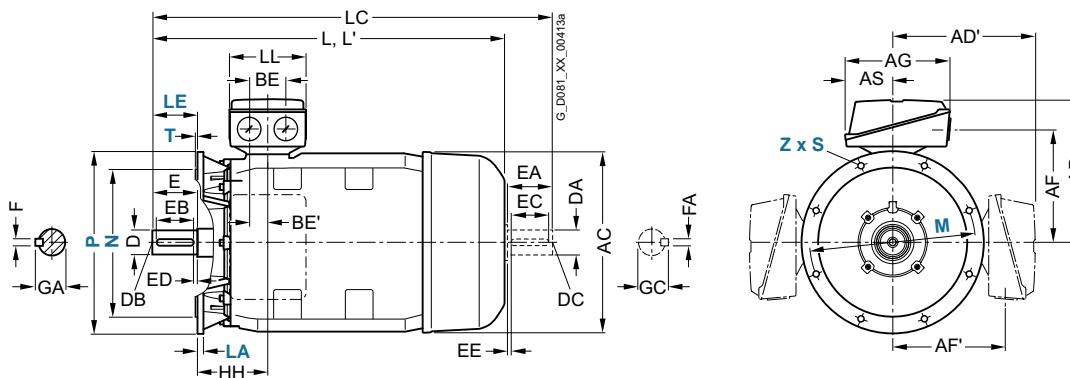

| For motor | | | Dimension designation acc. to IEC | | | | | | | | | | | | | | | | | | | |
|---------------------|---|--------------|-----------------------------------|-----|-----|-----|-----|-----|-----|-----|-----|-----|-----|-----|-----|-----|----|-----|-----|-----|-----|--|
| Frame size | Motor type | No. of poles | A | AA | AB | AC | AD | AD' | AF | AF' | AG | AS | B | BA | BA' | BB | BC | BE | BE' | C | CA | |
| 280 S | 2DA0 | 2 | 457 | 100 | 540 | 551 | 433 | 433 | 345 | 345 | 319 | 145 | 368 | 101 | 152 | 479 | 20 | 110 | 55 | 190 | 267 | |
| | 2DB0, 2DC0, 2DD0 | 4, 6, 8 | | | | | | | | | | | | | | | | | | | 267 | |
| 280 M | 2DA6 | 2 | | | | | | | | | | | 419 | | | | | | | | 326 | |
| | 2DA2 | | | | | | | | | | | | | | | | | | | | 216 | |
| | 2DB2, 2DC2, 2DD2, 2DC6, 2DD6 | 4, 6, 8 | | | | | | | | | | | | | | | | | | | | |
| | 2DB6 | 4 | | | | | | | | | | | | | | | | | | | 326 | |
| 315 S | 3AA0, 3AA2 ²⁾ | 2 | 508 | 120 | 610 | 616 | 515 | 515 | 404 | 404 | 374 | 164 | 406 | 113 | 170 | 527 | 22 | 110 | 55 | 216 | 295 | |
| | 3AB0, 3AC0, 3AD0 | 4, 6, 8 | | | | | | | | | | | | | | | | | | | | |
| 315 M | 3AA2 ¹⁾ , 3AA5 ²⁾ | 2 | | | | | | | | | | | 457 | | | 578 | | | | | 409 | |
| | 3AB2 ¹⁾ | 4 | | | | | | | | | | | | | | | | | | | | |
| | 3AC2, 3AD2 | 6, 8 | | | | | | | | | | | | | | | | | | | | |
| 315 L ¹⁾ | 3AA4 | 2 | | | | | | | | | | | 508 | | | 578 | | | | | 358 | |
| | 3AB4, 3AC4, 3AD4, 3AC5, 3AD5, 3AD6 | 4, 6, 8 | | | | | | | | | | | | | | | | | | | | |
| | 3AA5, 3AA6 | 2 | | | | | | | | | | | 508 | 176 | 227 | 648 | | | | | | |
| | 3AB5, 3AC6 | 4, 6 | | | | | | | | | | | | | | | | | | | | |
| | | | | | | | | | | | | | | | | | | | | | | |

¹⁾ For orders with screwed-on feet (order code **H01**), these screwed-on feet have 3 drilled holes on the NDE side with the dimension B 406 mm, 457 mm, and 508 mm respectively; the dimension BB is 666 mm.

²⁾ Only applicable for 1LE1502.

SIMOTICS GP and SIMOTICS SD standard motors

Dimensions · Cast-iron series SIMOTICS SD

IE1, IE2, NEMA Energy Efficient – self-ventilated · Frame sizes 280 S to 315 L

Dimensional drawings

Type of construction IM B35

For flange dimensions, see page 1/47 (**Z** = the number of retaining holes)

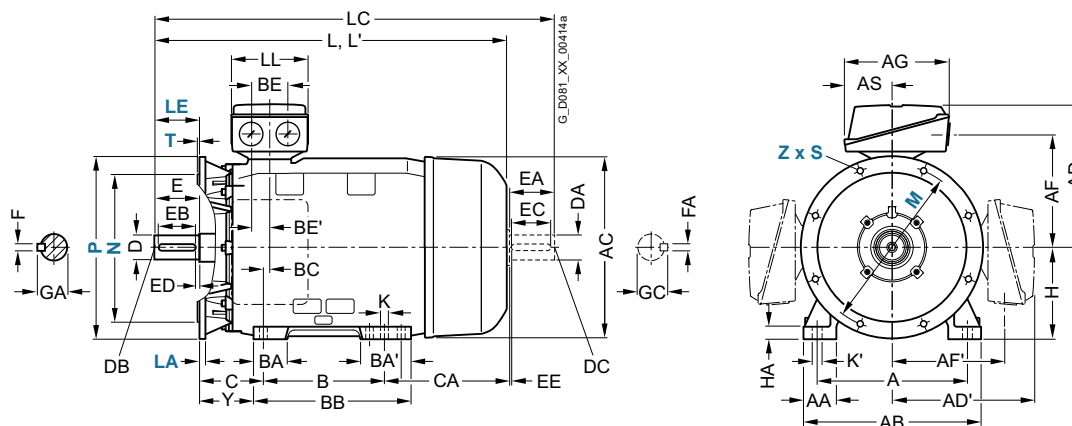

2

| For motor Motor type 1LE1501-, 1LE1521-, 1LE1541- 1LE1601- 1LE1502- | Dimension designation acc. to IEC | | | | | | | DE shaft extension | | | | | | | NDE shaft extension | | | | | | | | |
|---|-----------------------------------|----|-----|-----|----|----|-------------|--------------------|-----|----|-----|-----|-----|----|---------------------|------|----|-----|-----|-----|----|----|------|
| | H | HA | Y | HH | K | K' | L | LC ¹⁾ | LL | D | DB | E | EB | ED | F | GA | DA | DC | EA | EC | EE | FA | GC |
| 2DA0 | 280 | 40 | 160 | 210 | 24 | 30 | 960 | 1105 | 233 | 65 | M20 | 140 | 125 | 10 | 18 | 69 | 60 | M20 | 140 | 125 | 10 | 18 | 64 |
| 2DB0, 2DC0, 2DD0 | | | | | | | | | | 75 | | | | | 20 | 79.5 | 65 | | | | | | 69 |
| 2DA6 | | | | | | | 1070 | 1215 | | 65 | | | | | 18 | 69 | 60 | | | | | | 64 |
| 2DA2 | | | | | | | 960 | 1105 | | | | | | | | | | | | | | | |
| 2DB2, 2DC2, 2DD2, 2DC6, 2DD6 | | | | | | | | | | 75 | | | | | 20 | 79.5 | 65 | | | | | | 69 |
| 2DB6 | | | | | | | 1070 | 1215 | | | | | | | | | | | | | | | |
| 3AA0, 3AA2 ²⁾ | 315 | 50 | 181 | 238 | 28 | 35 | 1052 | 1197 | 299 | 65 | M20 | 140 | 125 | 10 | 18 | 69 | 60 | M20 | 140 | 125 | 10 | 18 | 64 |
| 3AB0, 3AC0, 3AD0 | | | | | | | 1082 | 1227 | | 80 | | 170 | 140 | 25 | 22 | 85 | 70 | | | | | 20 | 74.5 |
| 3AA2, 3AA5 ²⁾ | | | | | | | 1217 | 1362 | | 65 | | 140 | 125 | 10 | 18 | 69 | 60 | | | | | 18 | 64 |
| 3AB2 | | | | | | | 1247 | 1392 | | 80 | | 170 | 140 | 25 | 22 | 85 | 70 | | | | | 20 | 74.5 |
| 3AC2, 3AD2 | | | | | | | 1082 | 1227 | | | | | | | | | | | | | | | |
| 3AA4 | | | | | | | 1217 | 1362 | | 65 | | 140 | 125 | 10 | 18 | 69 | 60 | | | | | 18 | 64 |
| 3AB4, 3AC4, 3AD4, 3AC5, 3AD5, 3AD6 | | | | | | | 1247 | 1392 | | 80 | | 170 | 140 | 25 | 22 | 85 | 70 | | | | | 20 | 74.5 |
| 3AA5, 3AA6 | | | 146 | | | | 1372 | 1517 | | 65 | | 140 | 125 | 10 | 18 | 69 | 60 | | | | | 18 | 64 |
| 3AB5, 3AC6 | | | | | | | 1402 | 1547 | | 80 | | 170 | 140 | 25 | 22 | 85 | 70 | | | | | 20 | 74.5 |

¹⁾ In the low-noise version, a second shaft extension and/or mounted encoder is not possible.

²⁾ Only applicable for 1LE1502.

SIMOTICS GP and SIMOTICS SD standard motors

Dimensions · Cast-iron series SIMOTICS SD

IE3, NEMA Premium Efficient – self-ventilated · Frame sizes 71 M to 160 L

Dimensional drawings

Type of construction IM B3

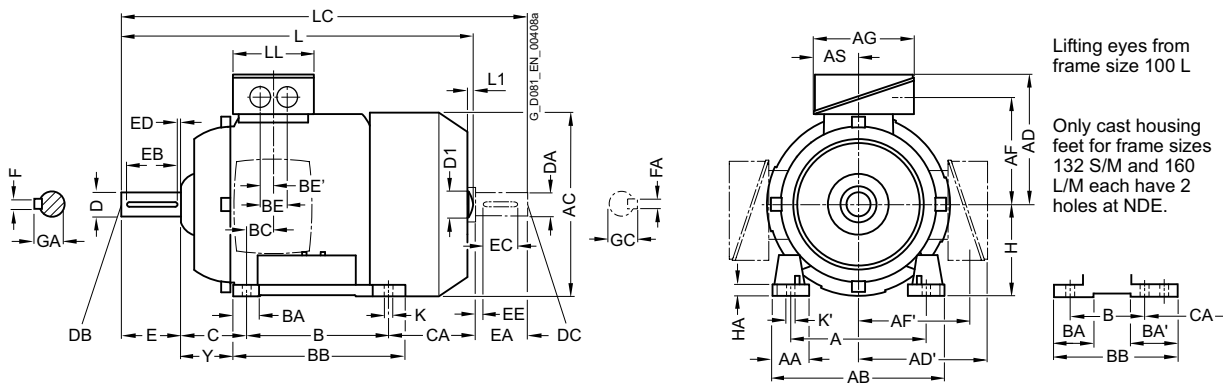

Types of construction IM B5 and IM V1

For flange dimensions, see page 1/47 (Z = the number of retaining holes)

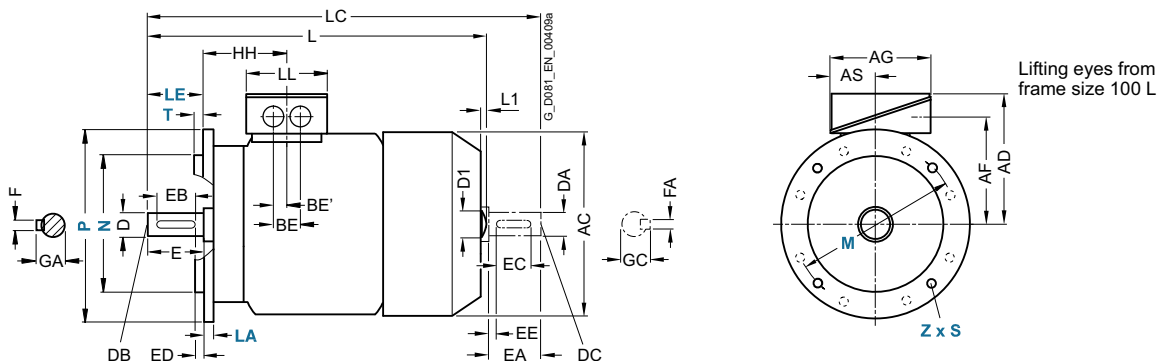

| For motor | | | Dimension designation acc. to IEC | | | | | | | | | | | | | | | | | | | | | |
|------------|-----------------------------|--------------|-----------------------------------|------|------------|-------|--------------|-------|-----|-----|-----|------|-----|------------------|-------------------|-------------------|------|----|-----|-----|-------|------------|----|----|
| Frame size | Motor type | No. of poles | A | AA | AB | AC | AD | AD' | AF | AF' | AG | AS | B | BA | BA' | BB | BC | BE | BE' | C | CA | H | HA | Y |
| 71 M | 1LE15.3-1LE16.3 | 2, 4, 6 | 112 | 30.5 | 132 | 145 | 149 | 149 | 112 | 112 | 126 | 62 | 90 | 32 | 32 | 106 | 21 | 36 | 18 | 45 | 83 | 71 | 7 | 37 |
| | 0..0, 0..2 0..3 | | 216 | 53 | 256 | 281 | 214.5 | 214.5 | 169 | 169 | 163 | 80.5 | 140 | 52 ²⁾ | 89 ¹⁾ | 218 ²⁾ | 26.5 | 48 | 24 | 89 | 166.5 | 132 | 15 | 69 |
| 80 M | 1LE15.3-0..0, 0..2 0..3 | 2, 4, 6 | 125 | 30.5 | 150 | 162 | 159 | 159 | 122 | 122 | 126 | 62 | 100 | 32 | 32 | 118 | 22.5 | 36 | 18 | 50 | 112.5 | 80 | 8 | 41 |
| 90 S | 1LE15.3-0..0, 0..2 0..3 | 2, 4, 6 | 140 | 30.5 | 165 | 180 | 164 | 164 | 127 | 127 | 126 | 62 | 100 | 33 | 54 | 143 | 24.5 | 36 | 18 | 56 | 159 | 90 | 11 | 47 |
| 90 L | 1LE15.3 | 2, 4, 6 | 140 | 30.5 | 165 | 180 | 164 | 164 | 127 | 127 | 126 | 62 | 125 | 33 | 54 | 143 | 24.5 | 36 | 18 | 56 | 134 | 90 | 11 | 47 |
| 100 L | 1AA4, 1AB4, 1AB5 1AC4 | 2, 4 6 | 160 | 42 | 196 | 217 | 193 | 193 | 147 | 147 | 163 | 80.5 | 140 | 48 | 48 | 176 | 37.5 | 48 | 24 | 63 | 141 | 100 | 12 | 45 |
| 112 M | All | 2, 4, 6 | 190 | 46 | 226 | 239 | 195 | 195 | 150 | 150 | 163 | 80.5 | 140 | 48 | 48 | 176 | 30 | 48 | 24 | 70 | 130 | 112 | 12 | 52 |
| 132 S | 1CA0, 1CC0, 1CD0 | 2, 6, 8 | 216 | 53 | 256 | 281 | 214.5 | 214.5 | 169 | 169 | 163 | 80.5 | 140 | 52 ²⁾ | 89 ¹⁾ | 218 ²⁾ | 26.5 | 48 | 24 | 89 | 166.5 | 132 | 15 | 69 |
| | 1CA1, 1CB0 | 2, 4 | | | | | | | | | | | | | | | | | | | 178.5 | | | |
| 132 M | 1CC2 | 6 | 216 | 53 | 256 | 281 | 214.5 | 214.5 | 169 | 169 | 163 | 80.5 | 178 | 52 ²⁾ | 89 ¹⁾ | 218 | 26.5 | 48 | 24 | 89 | 128.5 | 132 | 15 | 69 |
| | 1CB2, 1CC3, 1CD2 1CB6 | 4, 6, 8 4 | | | | | | | | | | | | | | | | | | | 178.5 | | | |
| 160 M | All | 2, 4, 6, 8 | 254 | 60 | 300 | 333.5 | 261 | 261 | 213 | 213 | 190 | 92 | 210 | 73 ⁶⁾ | 117 ³⁾ | 300 ⁴⁾ | 37 | 60 | 30 | 108 | 192 | 160 | 18 | 85 |
| 160 L | All | 2, 4, 6, 8 | 254 | 60 | 300 | 333.5 | 261 | 261 | 213 | 213 | 190 | 92 | 254 | 73 ⁶⁾ | 117 ³⁾ | 300 | 37 | 60 | 30 | 108 | 148 | 160 | 18 | 85 |

1) With screwed-on feet, dimension BA' is 41 mm.
 2) With screwed-on feet, dimension BB is 180 mm.
 3) With screwed-on feet, dimension BA' is 51 mm.

4) With screwed-on feet, dimension BB is 256 mm.
 5) With screwed-on feet, dimension BA is 41 mm.
 6) With screwed-on feet, dimension BA is 51 mm.

SIMOTICS GP and SIMOTICS SD standard motors

Dimensions · Cast-iron series SIMOTICS SD

IE3, NEMA Premium Efficient – self-ventilated · Frame sizes 71 M to 160 L

Dimensional drawings

Type of construction IM B35

For flange dimensions, see page 1/47 (**Z** = the number of retaining holes)

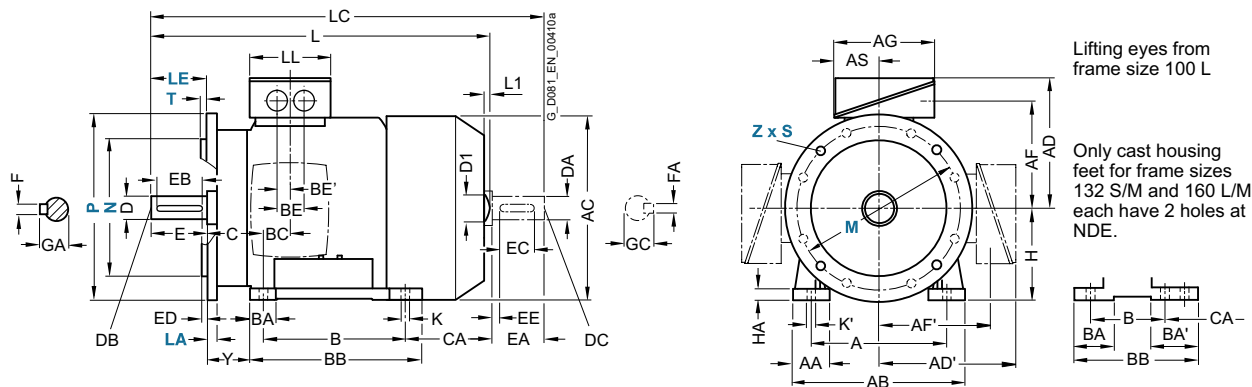

Type of construction IM B14

For flange dimensions, see page 1/47 (**Z** = the number of retaining holes)

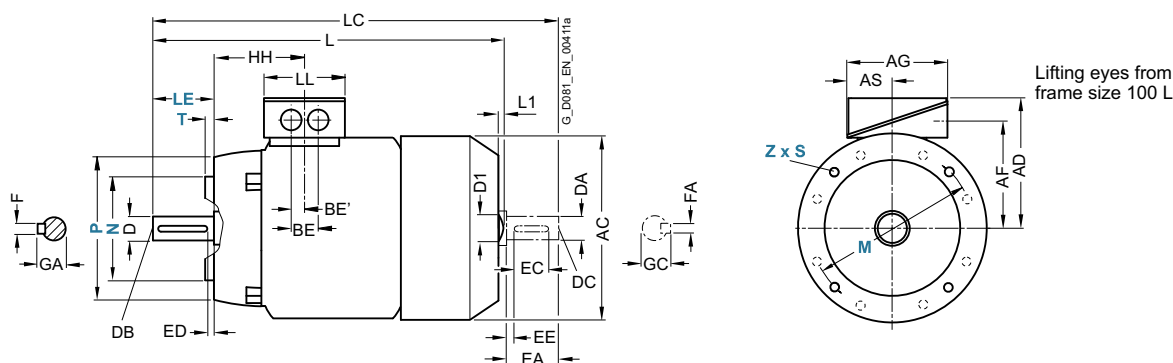

| For motor | | | Dimension designation acc. to IEC | | | | | | | DE shaft extension | | | | | | NDE shaft extension | | | | | | | | |
|------------|-------------------------|--------------|-----------------------------------|------|-----|-----------------|-------------------|----|-------|--------------------|----|-----|-----|----|----|---------------------|------|----|-----|-----|----|----|----|------|
| Frame size | Motor type | No. of poles | HH | K | K' | L ¹⁾ | L ¹⁾²⁾ | D1 | LC | LL | D | DB | E | EB | ED | F | GA | DA | DC | EA | EC | EE | FA | GC |
| 71 M | 1LE15.3-0..0, 0..2 0..3 | 2, 4, 6 | 64.5 | 7.5 | 7.5 | 240 | - | - | 278 | 102 | 14 | M5 | 30 | 22 | 4 | 5 | 16 | 14 | M5 | 30 | 22 | 4 | 5 | 16 |
| | | | | | | 280 | | | 318 | | | | | | | | | | | | | | | |
| 80 M | 1LE15.3-0..0, 0..2 0..3 | 2, 4, 6 | 71.5 | 10 | 10 | 292 | - | - | 343 | 102 | 19 | M6 | 40 | 32 | 4 | 6 | 21.5 | 19 | M6 | 40 | 32 | 4 | 6 | 21.5 |
| | | | | | | 327 | | | 378 | | | | | | | | | | | | | | | |
| 90 S | 1LE15.3-0..0, 0..2 0..3 | 2, 4, 6 | 79.5 | 10 | 10 | 347 | - | - | 405 | 102 | 24 | M8 | 50 | 40 | 5 | 8 | 27 | 19 | M6 | 40 | 27 | 4 | 6 | 21.5 |
| 90 L | 1LE15.3 | 2, 4, 6 | 79.5 | 10 | 10 | 387 | - | - | 445 | 102 | 24 | M8 | 50 | 40 | 5 | 8 | 27 | 19 | M6 | 40 | 27 | 4 | 6 | 21.5 |
| 100 L | 1AA4, 1AB4, 1AB5 1AC4 | 2, 4 | 100.5 | 12 | 16 | 432.5 | 7 | 32 | 489 | 134 | 28 | M10 | 60 | 50 | 5 | 8 | 31 | 24 | M8 | 50 | 40 | 5 | 8 | 27 |
| | | | | | | 397 | | | 342.5 | | | | | | | | | | | | | | | |
| 112 M | All | 2, 4, 6 | 100.5 | 12 | 16 | 415.5 | 7 | 32 | 475 | 134 | 28 | M10 | 60 | 50 | 5 | 8 | 31 | 24 | M8 | 50 | 40 | 5 | 8 | 27 |
| 132 S | 1CA0, 1CC0, 1CD0 | 2, 6, 8 | 115.5 | 12 | 16 | 466.5 | 8.5 | 39 | 535.5 | 134 | 38 | M12 | 80 | 70 | 5 | 10 | 41 | 28 | M10 | 60 | 50 | 5 | 8 | 31 |
| | | | | | | 516.5 | | | 585.5 | | | | | | | | | | | | | | | |
| 132 M | 1CC2 | 6 | 115.5 | 12 | 16 | 466.5 | 8.5 | 39 | 535.5 | 134 | 38 | M12 | 80 | 70 | 5 | 10 | 41 | 28 | M10 | 60 | 50 | 5 | 8 | 31 |
| | 1CB2, 1CC3, 1CD2 | 4, 6, 8 | | | | 516.5 | | | 585.5 | | | | | | | | | | | | | | | |
| | 1CB6 | 4 | | | | 567.5 | - | | 630.5 | | | | | | | | | | | | | | | |
| 160 M | All | 2, 4, 6, 8 | 145 | 14.5 | 18 | 606 | 10 | 45 | 730 | 165 | 42 | M16 | 110 | 90 | 10 | 12 | 45 | 42 | M16 | 110 | 90 | 10 | 12 | 45 |
| 160 L | All | 2, 4, 6, 8 | 145 | 14.5 | 18 | 666 | 10 | 45 | 790 | 165 | 42 | M16 | 110 | 90 | 10 | 12 | 45 | 42 | M16 | 110 | 90 | 10 | 12 | 45 |

1) For 1LE16 motors less dimension L1.

2) Only for 1LE15 motors.



SIMOTICS GP and SIMOTICS SD standard motors

Dimensions · Cast-iron series SIMOTICS SD

IE3, NEMA Premium Efficient – self-ventilated · Frame sizes 180 M to 315 L

Dimensional drawings

Type of construction IM B3

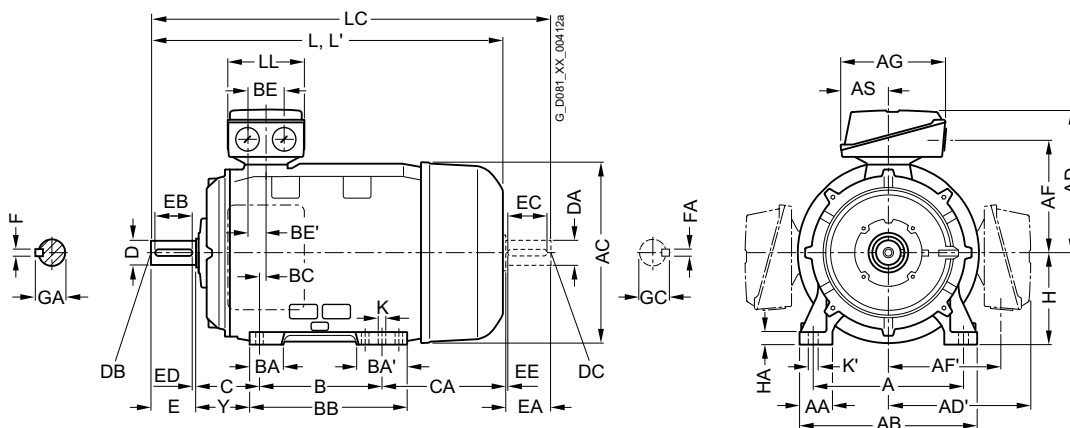

Types of construction IM B5 and IM V1

For flange dimensions, see page 1/47 (Z = the number of retaining holes)

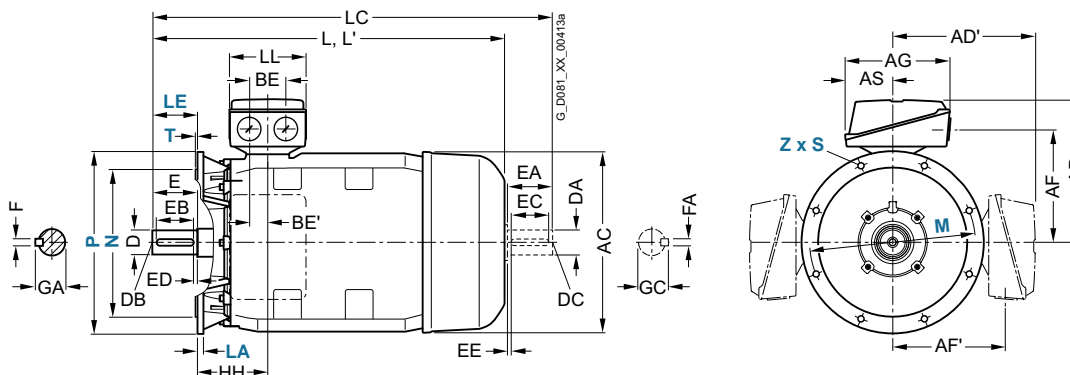

| For motor | | | Dimension designation acc. to IEC | | | | | | | | | | | | | | | | | | |
|---|--|--|-----------------------------------|-----|------------|-----|------------|-----|-----|-----|-----|-----|-----|-----|-----|-----|-----|-----|------|-----|-----|
| Frame size | Motor type | No. of poles | A | AA | AB | AC | AD | AD' | AF | AF' | AG | AS | B | BA | BA' | BB | BC | BE | BE' | C | CA |
| 180 M/ 180 L | 1EB2, 1EC4 1EA2, 1EB4, 1ED4 | 4, 6 2, 4, 8 | 279 | 65 | 339 | 356 | 286 | 286 | 234 | 234 | 190 | 92 | 241 | 85 | 120 | 328 | 34 | 60 | 30 | 121 | 202 |
| 200 L | 2AA4, 2AC4 2AA5, 2AB5, 2AC5, 2AD5 | 2, 6 2, 4, 6, 8 | 318 | 70 | 378 | 396 | 315 | 315 | 259 | 259 | 266 | 112 | 305 | 104 | 104 | 355 | 31 | 85 | 42.5 | 133 | 177 |
| 225 S 225 M | 2BB0, 2BD0 2BA2 2BB2, 2BC2, 2BD2 | 4, 8 2 4, 6, 8 | 356 | 80 | 436 | 449 | 338 | 338 | 282 | 282 | 266 | 112 | 286 | 92 | 117 | 361 | 15 | 85 | 42.5 | 149 | 218 |
| 250 M | 2CA2 2CB2, 2CC2, 2CD2 | 2 4, 6, 8 | 406 | 100 | 490 | 497 | 410 | 410 | 322 | 322 | 319 | 145 | 349 | 102 | 102 | 409 | 24 | 110 | 55 | 168 | 230 |
| 280 S 280 M | 2DA0 2DB0, 2DC0, 2DD0 2DC2, 2DD2 2DA2 2DB2 | 2 4, 6, 8 6, 8 2 4 | 457 | 100 | 540 | 551 | 433 | 433 | 345 | 345 | 319 | 145 | 368 | 101 | 152 | 479 | 20 | 110 | 55 | 190 | 267 |
| 315 S 315 M ¹⁾ 315 L ¹⁾ | 3AA0 3AB0, 3AC0, 3AD0 3AA2 3AB2, 3AC2, 3AD2 3AA4 3AB4, 3AC4, 3AD4 3AA5 3AB5, 3AC5, 3AC6, 3AD5, 3AD6 | 2 4, 6, 8 2 4, 6, 8 2 4, 6, 8 2 4, 6, 8 | 508 | 120 | 610 | 616 | 515 | 515 | 404 | 404 | 374 | 164 | 406 | 113 | 170 | 527 | 22 | 110 | 55 | 216 | 295 |
| | | | | | | | | | | | | | | | | 176 | 227 | 648 | | | 513 |

¹⁾ With terminal box position right, terminal box left, and with order code **H01** only screwed-on feet with 3 drilled holes with dimension "B" (406, 457, and 508 mm). The dimension "BB" will then be 666 mm.

SIMOTICS GP and SIMOTICS SD standard motors

Dimensions · Cast-iron series SIMOTICS SD

IE3, NEMA Premium Efficient – self-ventilated · Frame sizes 180 M to 315 L

Dimensional drawings

Type of construction IM B35

For flange dimensions, see page 1/47 (Z = the number of retaining holes)

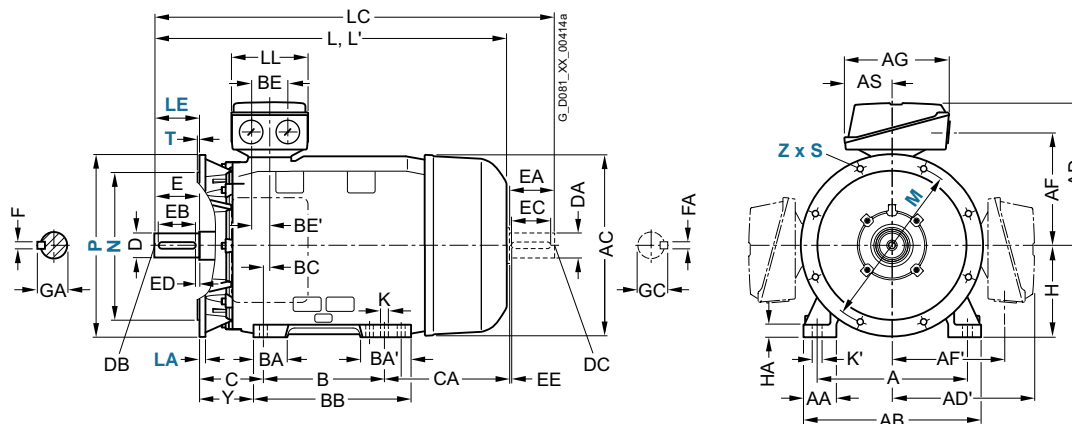

2

| For motor Motor type | Dimension designation acc. to IEC | | | | | | | | DE shaft extension | | | | | NDE shaft extension | | | | | | | | | |
|--|-----------------------------------|----|-----|-----|----|----|--|--|-------------------------------------|----------------------------------|-----|--|--|----------------------------------|----------------------------------|----------------------------------|----------------------------------|-----|------------|------------|---------|----------|--|
| | H | HA | Y | HH | K | K' | L | LC ¹⁾ | LL | D | DB | E | EB | ED | F | GA | DA | DC | EA | EC | EE | FA | GC |
| 1LE1503-, 1LE1523-, 1LE1543- 1LE1603-, 1LE1623-, 1LE1643- 1EB2, 1EC4 1EA2, 1EB4, 1ED4 | 180 | 20 | 95 | 155 | 15 | 19 | 668 698 | 784 814 | 164 | 48 | M16 | 110 | 100 | 5 | 14 | 51.5 | 48 | M16 | 110 | 100 | 5 | 14 | 51.5 |
| 2AA4, 2AC4 2AA5, 2AB5, 2AC5, 2AD5 | 200 | 25 | 108 | 164 | 19 | 25 | 721 746 | 835 860 | 197 | 55 | M20 | 110 | 100 | 5 | 16 | 59 | 55 | M20 | 110 | 100 | 5 | 16 | 59 |
| 2BB0, 2BD0 2BA2 2BB2, 2BC2, 2BD2 | 225 | 34 | 124 | 164 | 19 | 25 | 788 818 848 | 903 933 963 | 197 197 | 60 | M20 | 140 110 | 125 100 | 10 5 | 18 16 | 64 59 | 55 | M20 | 110 | 100 | 5 | 16 | 59 |
| 2CA2 2CB2, 2CC2, 2CD2 | 250 | 40 | 138 | 192 | 24 | 30 | 887 | 1002 1032 | 233 | 60 | M20 | 140 | 125 | 10 | 18 | 64 69 | 55 60 | M20 | 110 140 | 100 125 | 5 10 | 16 18 | 59 64 |
| 2DA0 2DB0, 2DC0, 2DD0 2DC2, 2DD2 2DA2 2DB2 | 280 | 40 | 160 | 210 | 24 | 30 | 960 960 1070 | 1105 1105 1215 | 233 | 65 75 75 | M20 | 140 | 125 | 10 | 18 20 20 | 69 79.5 79.5 | 60 65 65 | M20 | 140 | 125 | 10 | 18 18 | 64 69 64 69 |
| 3AA0 3AB0, 3AC0, 3AD0 3AA2 3AB2, 3AC2, 3AD2 3AA4 3AB4, 3AC4, 3AD4 3AA5 3AB5, 3AC5, 3AC6, 3AD5, 3AD6 | 315 | 50 | 181 | 238 | 28 | 35 | 1052 1082 1217 1247 1217 1247 1372 1402 | 1197 1227 1362 1392 1362 1392 1517 1547 | 299 80 299 80 299 80 | 65 80 65 80 65 80 | M20 | 140 170 140 170 140 170 | 125 140 125 140 125 140 | 10 25 10 25 10 25 | 18 22 18 22 18 22 | 69 85 69 85 69 85 | 60 70 60 70 60 70 | M20 | 140 | 125 | 10 | 18 | 64 74.5 64 74.5 64 74.5 64 74.5 |

¹⁾ In the low-noise version, a second shaft extension and/or mounted encoder is not possible.

SIMOTICS GP and SIMOTICS SD standard motors

Dimensions · Cast-iron series SIMOTICS SD

IE3 – 1LE1583 self-ventilated · Frame sizes 100 L to 200 L

Dimensional drawings

Type of construction IM B3

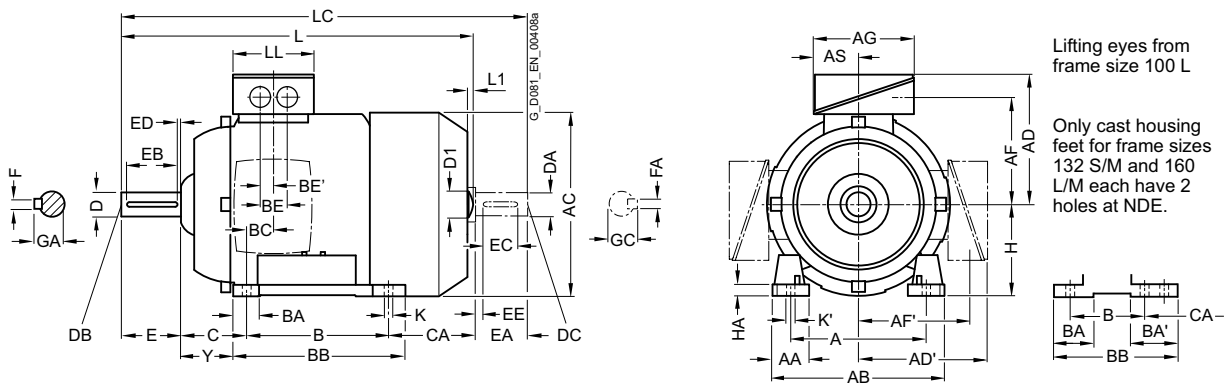

Types of construction IM B5 and IM V1

For flange dimensions, see page 1/47 (Z = the number of retaining holes)

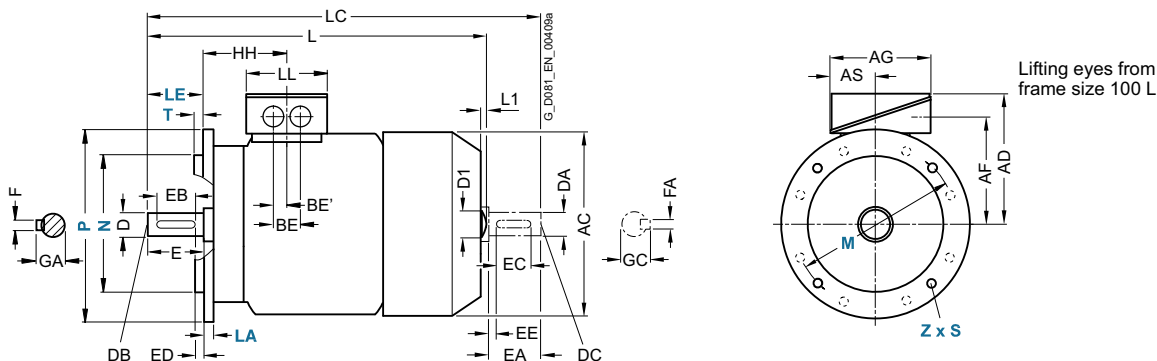

| For motor | | | Dimension designation acc. to IEC | | | | | | | | | | | | | | | | | | | | | |
|-------------|------------------------------|---------------|-----------------------------------|----|------------|-------|--------------|-------|-----|-----|-----|------|-----|------------------|-------------------|-------------------|------|----|------|-----|-------|------------|----|-----|
| Frame size | Motor type | No. of poles | A | AA | AB | AC | AD | AD' | AF | AF' | AG | AS | B | BA | BA' | BB | BC | BE | BE' | C | CA | H | HA | Y |
| 100 L | 1AA4, 1AB4, 1AB5 | 2, 4 | 160 | 42 | 196 | 217 | 193 | 193 | 147 | 147 | 163 | 80.5 | 140 | 48 | 48 | 176 | 37.5 | 48 | 24 | 63 | 141 | 100 | 12 | 45 |
| 112 M | 1BA2, 1BB2 | 2, 4 | 190 | 46 | 226 | 239 | 195 | 195 | 150 | 150 | 163 | 80.5 | 140 | 48 | 48 | 176 | 30 | 48 | 24 | 70 | 130 | 112 | 12 | 52 |
| 132 S | 1CA0, 1CA1, 1CB0 | 2, 4 | 216 | 53 | 256 | 281 | 214.5 | 214.5 | 169 | 169 | 163 | 80.5 | 140 | 52 ^{b)} | 89 ¹⁾ | 218 ²⁾ | 26.5 | 48 | 24 | 89 | 178.5 | 132 | 15 | 69 |
| 132 M | 1CB2 | | 216 | 53 | 256 | 281 | 214.5 | 214.5 | 169 | 169 | 163 | 80.5 | 178 | 52 ^{b)} | 89 ¹⁾ | 218 | 26.5 | 48 | 24 | 89 | 128.5 | 132 | 15 | 69 |
| 160 M | 1DA2, 1DA3, 1DB2 | 2, 4 | 254 | 60 | 300 | 333.5 | 261 | 261 | 213 | 213 | 190 | 92 | 210 | 73 ^{b)} | 117 ³⁾ | 300 ⁴⁾ | 37 | 60 | 30 | 108 | 192 | 160 | 18 | 85 |
| 160 L | 1DA4, 1DB4 | 2, 4 | 254 | 60 | 300 | 333.5 | 261 | 261 | 213 | 213 | 190 | 92 | 254 | 73 ^{b)} | 117 ³⁾ | 300 | 37 | 60 | 30 | 108 | 208 | 160 | 18 | 85 |
| 180 M/180 L | 1EB2, 1EC4, 1EA2, 1EB4 | 4, 6, 2, 4 | 279 | 65 | 339 | 356 | 286 | 286 | 234 | 234 | 190 | 92 | 241 | 85 | 120 | 328 | 34 | 60 | 30 | 121 | 164 | 180 | 20 | 95 |
| 200 L | 2AA4, 2AC4, 2AA5, 2AB5, 2AC5 | 2, 6, 2, 4, 6 | 318 | 70 | 378 | 396 | 315 | 315 | 259 | 259 | 266 | 112 | 305 | 104 | 104 | 355 | 31 | 85 | 42.5 | 133 | 177 | 200 | 25 | 108 |

1) With screwed-on feet, dimension BA' is 41 mm.
 2) With screwed-on feet, dimension BB is 180 mm.
 3) With screwed-on feet, dimension BA' is 51 mm.

4) With screwed-on feet, dimension BB is 256 mm.
 5) With screwed-on feet, dimension BA is 41 mm.
 6) With screwed-on feet, dimension BA is 51 mm.

SIMOTICS GP and SIMOTICS SD standard motors

Dimensions · Cast-iron series SIMOTICS SD

IE3 – 1LE1583 self-ventilated · Frame sizes 100 L to 200 L

Dimensional drawings

Type of construction IM B35

For flange dimensions, see page 1/47 (**Z** = the number of retaining holes)

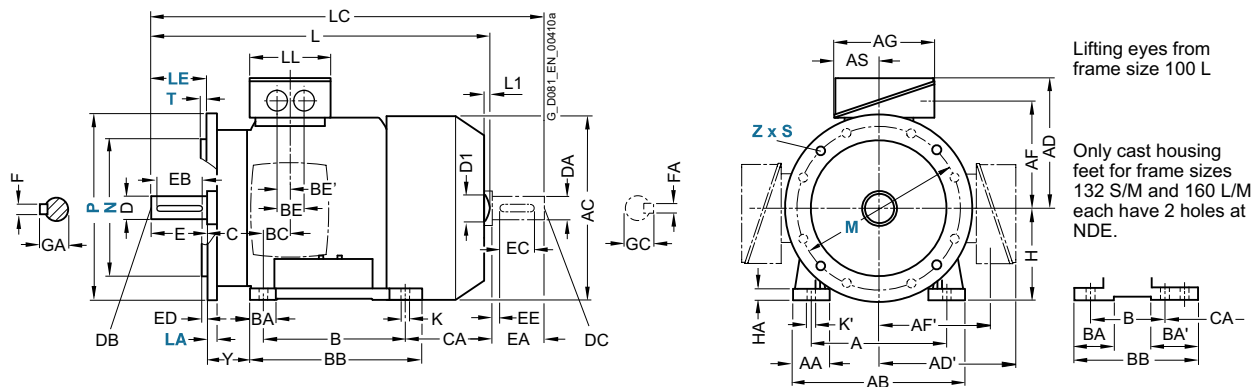

Type of construction IM B14

For flange dimensions, see page 1/47 (**Z** = the number of retaining holes)

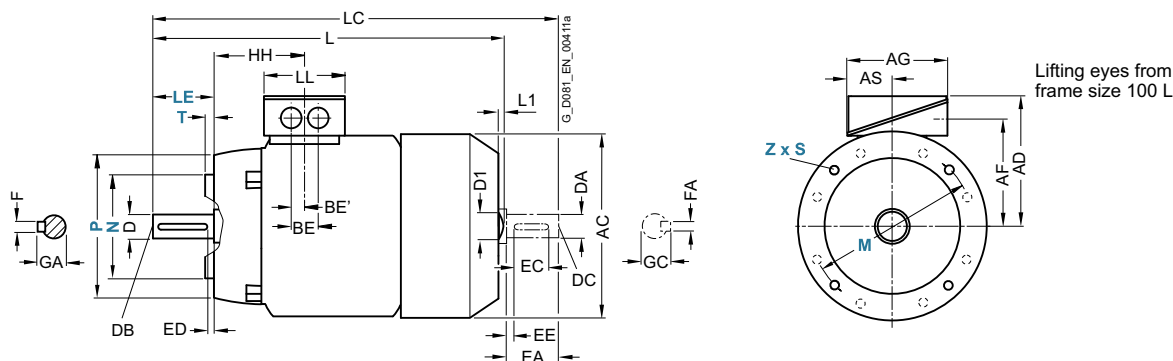

| For motor | | Dimension designation acc. to IEC | | | | | | | | | | DE shaft extension | | | | | NDE shaft extension | | | | | | | |
|-----------------|--------------------|-----------------------------------|-------|------|----|-------|------------------|----|-------|-----|----|--------------------|-----|-----|----|----|---------------------|----|-----|-----|-----|----|----|------|
| Frame size | Motor type 1LE1583 | No. of poles | HH | K | K' | L | L1 ¹⁾ | D1 | LC | LL | D | DB | E | EB | ED | F | GA | DA | DC | EA | EC | EE | FA | GC |
| 100 L | 1AA4, 1AB4, | 2 | 100.5 | 12 | 16 | 432.5 | 7 | 32 | 489 | 134 | 28 | M10 | 60 | 50 | 5 | 8 | 31 | 24 | M8 | 50 | 40 | 5 | 8 | 27 |
| | 1AB5 | 4 | | | | 472.5 | | | | | | | | | | | | | | | | | | |
| 112 M | 1BA2, | 2 | 100.5 | 12 | 16 | 415.5 | 7 | 32 | 475 | 134 | 28 | M10 | 60 | 50 | 5 | 8 | 31 | 24 | M8 | 50 | 40 | 5 | 8 | 27 |
| | 1BB2 | 4 | | | | 450.5 | | | | | | | | | | | | | | | | | | |
| 132 S | 1CA0, 1CA1, 1CB0 | 2, 4 | 115.5 | 12 | 16 | 516.5 | 8.5 | 39 | 585.5 | 134 | 38 | M12 | 80 | 70 | 5 | 10 | 41 | 28 | M10 | 60 | 50 | 5 | 8 | 31 |
| 132 M | 1CB2 | 4 | 115.5 | 12 | 16 | 516.5 | 8.5 | 39 | 585.5 | 134 | 38 | M12 | 80 | 70 | 5 | 10 | 41 | 28 | M10 | 60 | 50 | 5 | 8 | 31 |
| 160 M | 1DA2, 1DA3, 1DB2 | 2, 4 | 145 | 14.5 | 18 | 606 | 10 | 45 | 730 | 165 | 42 | M16 | 110 | 90 | 10 | 12 | 45 | 42 | M16 | 110 | 90 | 10 | 12 | 45 |
| 160 L | 1DA4, 1DB4 | 2, 4 | 145 | 14.5 | 18 | 666 | 10 | 45 | 790 | 165 | 42 | M16 | 110 | 90 | 10 | 12 | 45 | 42 | M16 | 110 | 90 | 10 | 12 | 45 |
| 180 M/ 180 L | 180 M/ | 4, 6 | 155 | 15 | 19 | 668 | - | - | 784 | 164 | 48 | M16 | 110 | 100 | 5 | 14 | 51.5 | 48 | M16 | 110 | 100 | 5 | 14 | 51.5 |
| | 180 L | 2, 4 | | | | 698 | | | | | | | | | | | | | | | | | | |
| 200 L | 2A4, 2AC4, | 2, 6 | 164 | 19 | 25 | 721 | - | - | 835 | 197 | 55 | M20 | 110 | 100 | 5 | 16 | 59 | 55 | M20 | 110 | 100 | 5 | 16 | 59 |
| | 2AA5, 2AB5, 2AC5 | 2, 4, 6 | | | | 746 | | | | | | | | | | | | | | | | | | |

¹⁾ In the low-noise version, a second shaft extension and/or mounted encoder is not possible.

SIMOTICS GP and SIMOTICS SD standard motors

Dimensions · Cast-iron series SIMOTICS SD

IE3 – 1LE1583 self-ventilated · Frame sizes 225 S to 315 L

Dimensional drawings

Type of construction IM B3

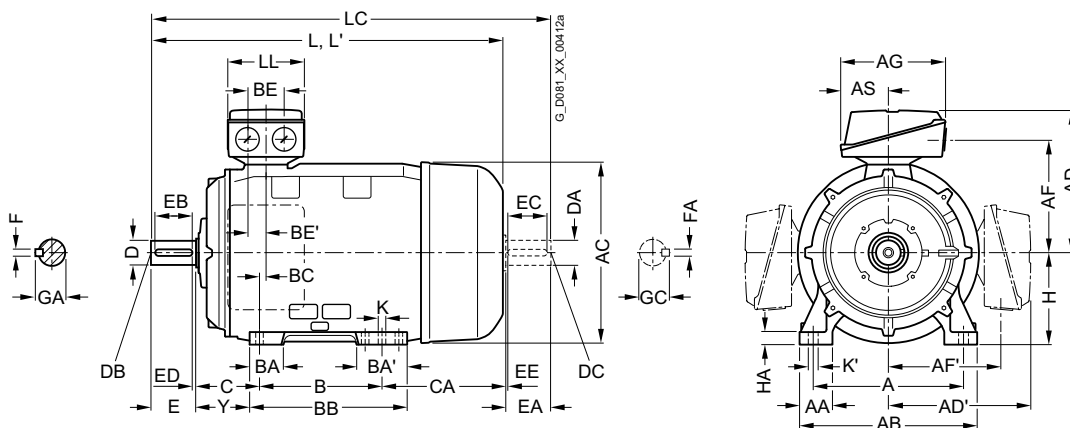

Types of construction IM B5 and IM V1

For flange dimensions, see page 1/47 (Z = the number of retaining holes)

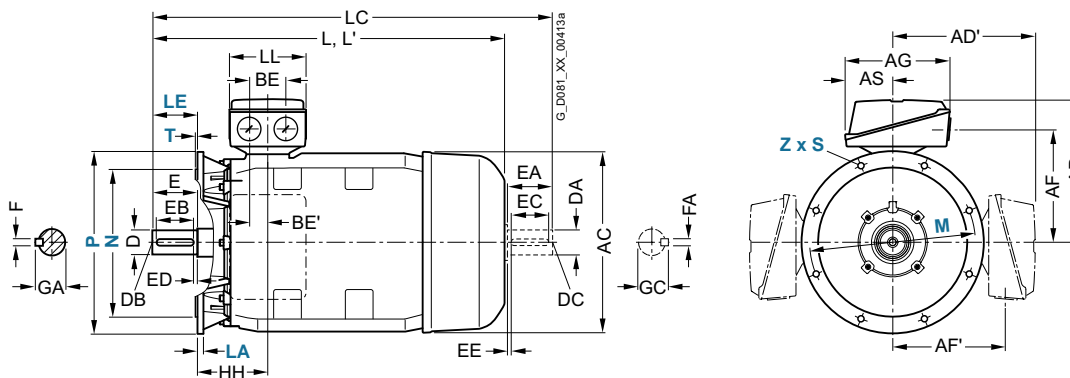

| For motor | | No. of poles | Dimension designation acc. to IEC | | | | | | | | | | | | | | | | | | |
|---------------------|---|--------------|-----------------------------------|-----|------------|-----|------------|-----|-----|-----|-----|-----|-----|-----|-----|-----|----|-----|------|-----|-----|
| Frame size | Motor type | | A | AA | AB | AC | AD | AD' | AF | AF' | AG | AS | B | BA | BA' | BB | BC | BE | BE' | C | CA |
| 225 S | 2BB0 | 4 | 356 | 80 | 436 | 449 | 338 | 338 | 282 | 282 | 266 | 112 | 286 | 92 | 117 | 361 | 15 | 85 | 42.5 | 149 | 278 |
| | 2BD0 | 8 | | | | | | | | | | | | | 118 | | | | | | 218 |
| 225 M | 2BB2, 2BC2 | 4, 6 | 356 | 80 | 436 | 449 | 338 | 338 | 282 | 282 | 266 | 112 | 311 | 92 | 117 | 361 | 15 | 85 | 42.5 | 149 | 333 |
| | 2BA2 | 2 | | | | | | | | | | | | | | | | | | | 253 |
| | 2BD2 | 8 | | | | | | | | | | | | | 118 | | | | | | 193 |
| 250 M | 2CA2, 2CD2 | 2, 8 | 406 | 100 | 490 | 497 | 410 | 410 | 322 | 322 | 319 | 145 | 349 | 102 | 102 | 409 | 24 | 110 | 55 | 168 | 235 |
| | 2CB2, 2CC2 | 4, 6 | | | | | | | | | | | | | | | | | | | 305 |
| | | | | | | | | | | | | | | | | | | | | | |
| 280 S | 2DA0, 2DB0 | 2, 4 | 457 | 100 | 540 | 551 | 433 | 433 | 345 | 345 | 319 | 145 | 368 | 101 | 152 | 479 | 20 | 110 | 55 | 190 | 377 |
| | 2DC0, 2DD0 | 6, 8 | | | | | | | | | | | | | | | | | | | 267 |
| 280 M | 2DA2, 2DB2, 2DC2 | 2, 4, 6 | 457 | 100 | 540 | 551 | 433 | 433 | 345 | 345 | 319 | 145 | 419 | 101 | 152 | 479 | 20 | 110 | 55 | 190 | 326 |
| | 2DD2 | 8 | | | | | | | | | | | | | | | | | | | 216 |
| | | | | | | | | | | | | | | | | | | | | | |
| 315 S | 3AA0, 3AD0 | 2, 8 | 508 | 120 | 610 | 616 | 515 | 515 | 404 | 404 | 374 | 164 | 406 | 113 | 170 | 527 | 22 | 110 | 55 | 216 | 295 |
| | 3AC0 | 6 | | | | | | | | | | | 457 | | 578 | | | | | | 409 |
| | | | | | | | | | | | | | | | | | | | | | |
| 315 M | 3AA2 ¹⁾ , 3AB0, 3AB2 ¹⁾ | 2, 4 | 508 | 120 | 610 | 616 | 515 | 515 | 404 | 404 | 374 | 164 | 457 | 113 | 170 | 578 | 22 | 110 | 55 | 216 | 409 |
| | 3AD2 ¹⁾ | 8 | | | | | | | | | | | | | 527 | | | | | | 244 |
| | | | | | | | | | | | | | | | | | | | | | |
| 315 L ¹⁾ | 3AA4, 3AB4, 3AC2, 3AD4, 3AD5, 3AD6 | 2, 4, 6, 8 | 508 | 120 | 610 | 616 | 515 | 515 | 404 | 404 | 374 | 164 | 508 | 113 | 170 | 578 | 22 | 110 | 55 | 216 | 358 |
| | 3AA5, 3AC4, 3AC5, 3AC6 | 2, 6 | | | | | | | | | | | 176 | 227 | 648 | | | | | | 513 |
| | 3AB5 | 4 | | | | | | | | | | | | | | | | | | | |
| | | | | | | | | | | | | | | | | | | | | | |

¹⁾ With terminal box position right, terminal box left, and with order code **H01** only screwed-on feet with 3 drilled holes with dimension "B" (406, 457, and 508 mm). The dimension "BB" will then be 666 mm.

SIMOTICS GP and SIMOTICS SD standard motors

Dimensions · Cast-iron series SIMOTICS SD

IE3 – 1LE1583 self-ventilated · Frame sizes 225 S to 315 L

Dimensional drawings

Type of construction IM B35

For flange dimensions, see page 1/47 (**Z** = the number of retaining holes)

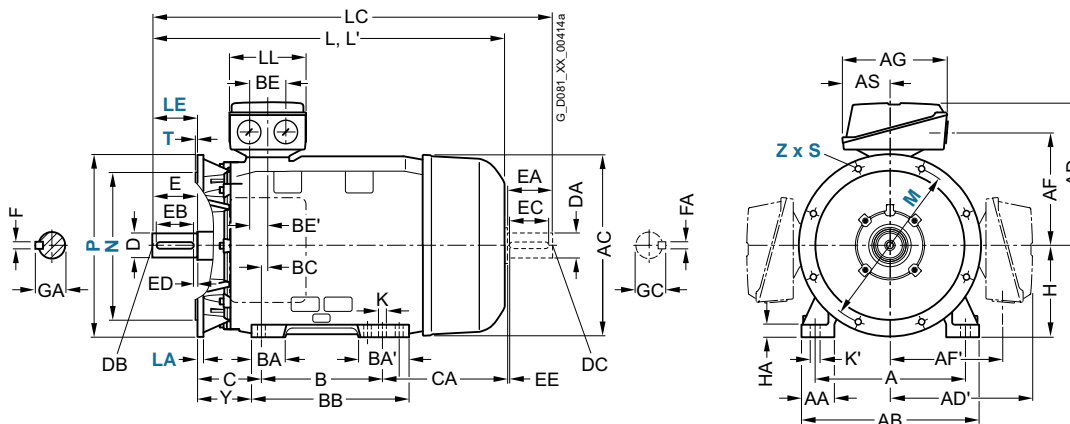

2

| For motor Motor type 1LE1583- | Dimension designation acc. to IEC | | | | | | | DE shaft extension | | | | | | | NDE shaft extension | | | | | | | | | |
|---------------------------------------|-----------------------------------|----|-----|-----|----|----|----------------------------|--------------------|-----|----------|------------|------------|------------|----------|---------------------|------------|----------|-----|------------|------------|---------|----------|------------|------------|
| | H | HA | Y | HH | K | K' | L | LC ¹⁾ | LL | D | DB | E | EB | ED | F | GA | DA | DC | EA | EC | EE | FA | GC | |
| 2BB0 | 225 | 34 | 124 | 164 | 19 | 25 | 848 | 903 | 197 | 60 | M20 | 140 | 125 | 10 | 18 | 64 | 55 | M20 | 110 | 100 | 5 | 16 | 59 | |
| 2BD0 | | | | | | | 788 | | | | | | | | | | | | | | | | | |
| 2BB2, 2BC2 | 225 | 34 | 124 | 164 | 19 | 25 | 928 | 963 | 197 | 60 | M20 | 140 | 125 | 10 | 18 | 64 | 55 | M20 | 110 | 100 | 5 | 16 | 59 | |
| 2BA2 | | | | | | | 818 | 933 | | 55 | 110 | 100 | 5 | 16 | 59 | 48 | M16 | | | | | 14 | 51.5 | |
| 2BD2 | | | | | | | 788 | 903 | | 60 | 140 | 125 | 10 | 18 | 64 | 55 | M20 | | | | | 16 | 59 | |
| 2CA2, 2CD2 | 250 | 40 | 138 | 192 | 24 | 30 | 887 | 1002 1032 | 233 | 60 65 | M20 | 140 | 125 | 10 | 18 | 64 69 | 55 60 | M20 | 110 140 | 100 125 | 5 10 | 16 18 | 59 64 | |
| 2CB2, 2CC2 | | | | | | | 957 | 1032 1072 | | | | | | | | 64 | | | | | | | | |
| 2DA0, 2DB0 | 280 | 40 | 160 | 210 | 24 | 30 | 1070 | 1215 | 233 | 65 75 | M20 | 140 | 125 | 10 | 18 | 69 79.5 | 60 65 | M20 | 140 | 125 | 10 | 18 | 64 69 | |
| 2DC0, 2DD0 | | | | | | | 960 | 1105 | | | | | | | | | | | | | | | | |
| 2DA2, 2DB2, 2DC2 | 280 | 40 | 160 | 210 | 24 | 30 | 1070 | 1215 | 233 | 65 75 | M20 | 140 | 125 | 10 | 18 | 69 79.5 | 60 65 | M20 | 140 | 125 | 10 | 18 | 64 69 | |
| 2DD2 | | | | | | | 960 | 1105 | | | | | | | | | | | | | | | | |
| 3AA0, 3AD0 | 315 | 50 | 181 | 238 | 28 | 35 | 1052 1082 | 1197 1227 | 299 | 65 80 | M20 | 140 170 | 125 140 | 10 25 | 18 22 | 69 85 | 60 70 | M20 | 140 | 125 | 10 | 18 | 64 74.5 | |
| 3AC0 | | | | | | | 1247 | 1392 | | | | | | | | | | | | | | | | |
| 3AA2, 3AB0, 3AB2 | 315 | 50 | 181 | 238 | 28 | 35 | 1217 1247 | 1362 1392 | 299 | 65 80 | M20 | 140 170 | 125 140 | 10 25 | 18 22 | 69 85 | 60 70 | M20 | 140 | 125 | 10 | 18 | 64 74.5 | |
| 3AD2 | | | | | | | 1082 | 1227 | | | | | | | | | | | | | | | | |
| 3AA4, 3AB4, 3AC2, 3AD4, 3AD5, 3AD6 | 315 | 50 | 181 | 238 | 28 | 35 | 1217 1247 | 1362 1392 | 299 | 65 80 | M20 | 140 170 | 125 140 | 10 25 | 18 22 | 69 85 | 60 70 | M20 | 140 | 125 | 10 | 18 | 64 74.5 | |
| 3AA5, 3AC4, 3AC5, 3AC6 | | | 146 | | | | 1372 1402 | 1517 1547 | | 65 80 | 140 170 | 125 140 | 10 25 | 18 22 | 69 85 | 60 70 | | | | | | | 18 20 | 64 74.5 |
| 3AB5 | | | | | | | | | | | | | | | | | | | | | | | | |

¹⁾ In the low-noise version, a second shaft extension and/or mounted encoder is not possible.

SIMOTICS GP and SIMOTICS SD standard motors

Dimensions · Cast-iron series SIMOTICS SD

IE4 – self-ventilated · Frame sizes 100 L to 160 L

Dimensional drawings

Type of construction IM B3

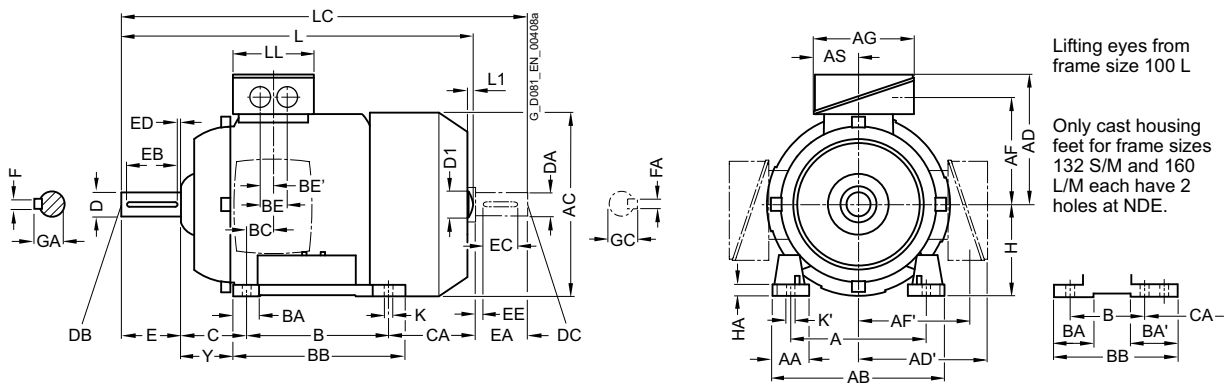

Types of construction IM B5 and IM V1

For flange dimensions, see page 1/47 (Z = the number of retaining holes)

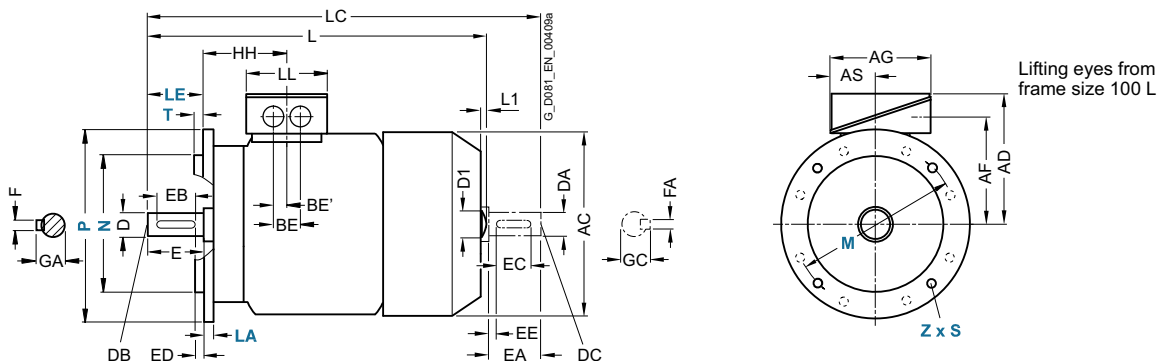

| For motor | | | Dimension designation acc. to IEC | | | | | | | | | | | | | | | | | | | | | |
|------------|------------|--------------|-----------------------------------|----|------------|-------|--------------|-------|-----|-----|-----|------|-----|------------------|-------------------|-------------------|------|----|-----|-----|-------|------------|----|----|
| Frame size | Motor type | No. of poles | A | AA | AB | AC | AD | AD' | AF | AF' | AG | AS | B | BA | BA' | BB | BC | BE | BE' | C | CA | H | HA | Y |
| 100 L | 1AA4 | 2 | 160 | 42 | 196 | 217 | 193 | 193 | 147 | 147 | 163 | 80.5 | 140 | 48 | 48 | 176 | 37.5 | 48 | 24 | 63 | 176 | 100 | 12 | 45 |
| | 1AB4 | 4 | | | | | | | | | | | | | | | | | | | | | | |
| | 1AB5 | 4 | | | | | | | | | | | | | | | | | | | | | | |
| 112 M | 1BA2 | 2 | 190 | 46 | 226 | 239 | 195 | 195 | 150 | 150 | 163 | 80.5 | 140 | 48 | 48 | 176 | 30 | 48 | 24 | 70 | 155 | 112 | 12 | 52 |
| | 1BB2 | 4 | | | | | | | | | | | | | | | | | | | | | | |
| 132 S | 1CA0 | 2 | 216 | 53 | 256 | 281 | 214.5 | 214.5 | 169 | 169 | 163 | 80.5 | 140 | 52 ¹⁾ | 89 ⁵⁾ | 218 ²⁾ | 26.5 | 48 | 24 | 89 | 130 | 132 | 15 | 69 |
| | 1CA1, 1CB0 | 2, 4 | | | | | | | | | | | | | | | | | | | 178.5 | | | |
| 132 M | 1CB2 | 4 | 216 | 53 | 256 | 281 | 214.5 | 214.5 | 169 | 169 | 163 | 80.5 | 178 | 52 ¹⁾ | 89 ⁶⁾ | 218 | 26.5 | 48 | 24 | 89 | 178.5 | 132 | 15 | 69 |
| 160 M | 1DA2 | 2 | 254 | 60 | 300 | 333.5 | 261 | 261 | 213 | 213 | 190 | 92 | 210 | 73 ³⁾ | 117 ⁷⁾ | 300 ⁴⁾ | 37 | 60 | 30 | 108 | 148 | 160 | 18 | 85 |
| | 1DA3, 1DB2 | 2, 4 | | | | | | | | | | | | | | | | | | | | | | |
| 160 L | 1DA4 | 2 | 254 | 60 | 300 | 333.5 | 261 | 261 | 213 | 213 | 190 | 92 | 254 | 73 ³⁾ | 117 ⁸⁾ | 300 | 37 | 60 | 30 | 108 | 208 | 160 | 18 | 85 |
| | 1DB4 | 4 | | | | | | | | | | | | | | | | | | | | | | |

1) With screwed-on feet, dimension BA is 41 mm.
 2) With screwed-on feet, dimension BB is 180 mm.
 3) With screwed-on feet, dimension BA is 51 mm.
 4) With screwed-on feet, dimension BB is 256 mm.

5) With screwed-on feet, dimension BA' is 41 mm.
 6) With screwed-on feet, dimension BA' is 79 mm.
 7) With screwed-on feet, dimension BA' is 51 mm.
 8) With screwed-on feet, dimension BA' is 95 mm.

SIMOTICS GP and SIMOTICS SD standard motors

Dimensions · Cast-iron series SIMOTICS SD

IE4 – self-ventilated · Frame sizes 100 L to 160 L

Dimensional drawings

Type of construction IM B35

For flange dimensions, see page 1/47 (**Z** = the number of retaining holes)

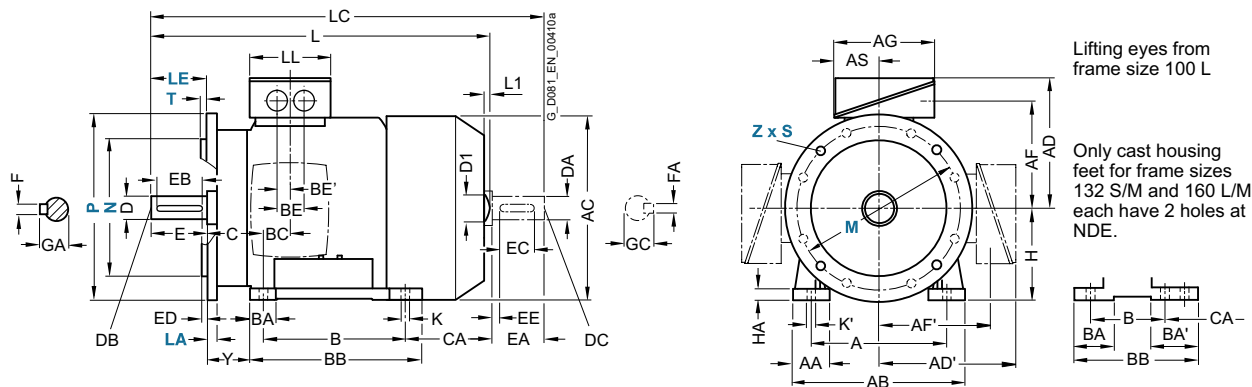

Type of construction IM B14

For flange dimensions, see page 1/47 (**Z** = the number of retaining holes)

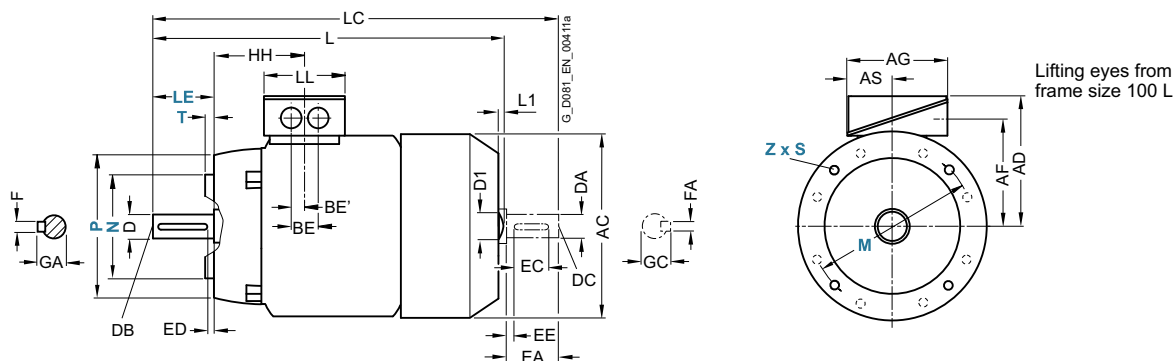

| For motor | | | Dimension designation acc. to IEC | | | | | | | DE shaft extension | | | | | NDE shaft extension | | | | | | | | | |
|------------|------------|--------------|-----------------------------------|----|----|-----------------|------------------|-----|-------|--------------------|----|-----|-----|----|---------------------|----|----|----|-----|-----|----|----|----|----|
| Frame size | Motor type | No. of poles | HH | K | K' | L ¹⁾ | L1 ²⁾ | D1 | LL | D | DB | E | EB | ED | F | GA | DA | DC | EA | EC | EE | FA | GC | |
| 100 L | 1AA4 | 2 | 100.5 | 12 | 16 | 432.5 | 7 | 32 | 489 | 134 | 28 | M10 | 60 | 50 | 5 | 8 | 31 | 24 | M8 | 50 | 40 | 5 | 8 | 27 |
| | 1AB4 | 4 | | | | 482.5 | 7 | 529 | | | | | | | | | | | | | | | | |
| | 1AB5 | 4 | | | | 482.5 | 7 | 529 | | | | | | | | | | | | | | | | |
| 112 M | 1BA2 | 2 | 100.5 | 12 | 16 | 415.5 | 7 | 32 | 475 | 134 | 28 | M10 | 60 | 50 | 5 | 8 | 31 | 24 | M8 | 50 | 40 | 5 | 8 | 27 |
| | 1BB2 | 4 | | | | 465.5 | 7 | 515 | | | | | | | | | | | | | | | | |
| 132 S | 1CA0 | 2 | 115.5 | 12 | 16 | 466.5 | 8.5 | 39 | 535.5 | 134 | 38 | M12 | 80 | 70 | 5 | 10 | 41 | 28 | M10 | 60 | 50 | 5 | 8 | 31 |
| | 1CA1, 1CB0 | 2, 4 | | | | 516.5 | 8.5 | 39 | 585.5 | | | | | | | | | | | | | | | |
| 132 M | 1CB2 | 4 | 115.5 | 12 | 16 | 516.5 | 8.5 | 39 | 585.5 | 134 | 38 | M12 | 80 | 70 | 5 | 10 | 41 | 28 | M10 | 60 | 50 | 5 | 8 | 31 |
| 160 M | 1DA2 | 2 | 145 | 15 | 19 | 606 | 10 | 45 | 730 | 165 | 42 | M16 | 110 | 90 | 10 | 12 | 45 | 42 | M16 | 110 | 90 | 10 | 12 | 45 |
| | 1DA3, 1DB2 | 2, 4 | | | | 666 | 10 | 45 | 730 | | | | | | | | | | | | | | | |
| 160 L | 1DA4 | 2 | 145 | 15 | 19 | 666 | 10 | 45 | 790 | 165 | 42 | M16 | 110 | 90 | 10 | 12 | 45 | 42 | M16 | 110 | 90 | 10 | 12 | 45 |
| | 1DB4 | 4 | | | | 666 | 10 | 45 | 790 | | | | | | | | | | | | | | | |

1) For 1LE16 motors less dimension L1.

2) Only for 1LE15 motors.



SIMOTICS GP and SIMOTICS SD standard motors

Dimensions · Cast-iron series SIMOTICS SD

IE4 – self-ventilated · Frame sizes 180 M to 315 L

Dimensional drawings

Type of construction IM B3

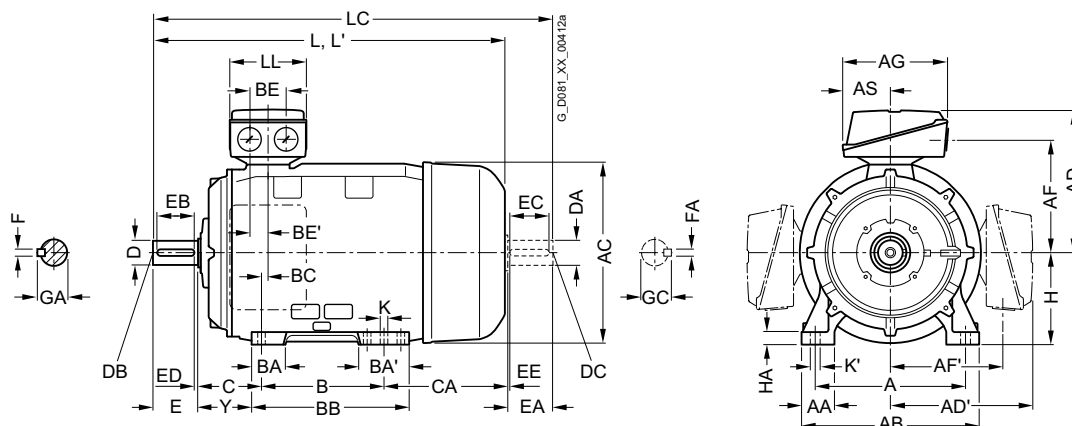

Types of construction IM B5 and IM V1

For flange dimensions, see page 1/47 (Z = the number of retaining holes)

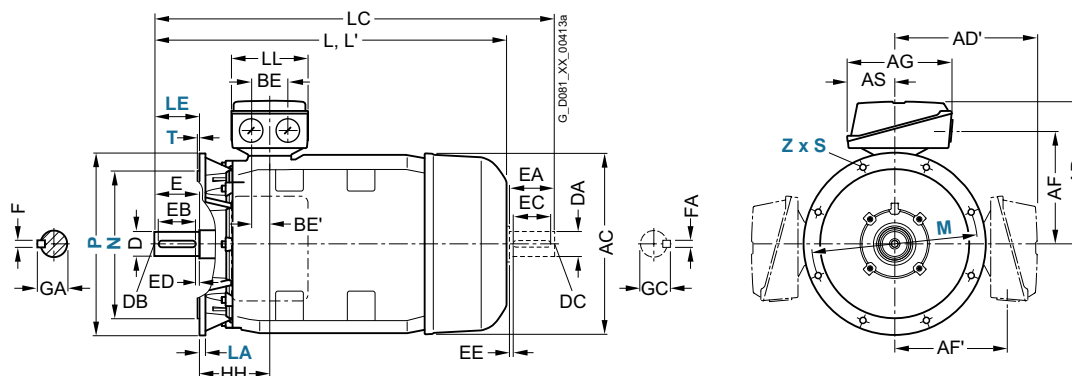

| For motor | | | Dimension designation acc. to IEC | | | | | | | | | | | | | | | | | | |
|---------------------|------------------------------------|------------------|-----------------------------------|-----|------------|-----|------------|-----|-------|-------|-----|-----|-------------|-----|-----|-----|----|-----|------|-----|------------|
| Frame size | Motor type 1LE1504- 1LE1604- | No. of poles | A | AA | AB | AC | AD | AD' | AF | AF' | AG | AS | B* | BA | BA' | BB | BC | BE | BE' | C | CA* |
| 180 M | 1EA2 | 2 | 279 | 65 | 339 | 356 | 286 | 286 | 234 | 234 | 189 | 92 | 241/ 279 | 85 | 120 | 328 | 34 | 60 | 30 | 121 | 202 |
| 180 M | 1EB2 | 4 | | | | | | | | | | | | | | | | | | | |
| 180 L | 1EB4 | 4 | | | | | | | | | | | | | | | | | | | |
| 200 L | 2AA4 2AA5, 2AB5 | 2 2, 4 | 318 | 70 | 378 | 396 | 315 | 315 | 258.5 | 258.5 | 265 | 112 | 305 | 104 | 104 | 355 | 31 | 85 | 42.5 | 133 | 177 |
| 225 S | 2BB0 | 4 | 356 | 80 | 436 | 449 | 338 | 338 | 282 | 282 | 266 | 112 | 286 | 92 | 117 | 361 | 15 | 85 | 42.5 | 149 | 218 |
| 225 M | 2BA2 2BB2 | 2 4 | 356 | 80 | 436 | 449 | 338 | 338 | 282 | 282 | 266 | 112 | 311 | 92 | 117 | 361 | 15 | 85 | 42.5 | 149 | 253 |
| 250 M | 2CA2 2CB2 | 2 4 | 406 | 100 | 490 | 497 | 410 | 410 | 322 | 322 | 319 | 145 | 349 | 102 | 102 | 409 | 24 | 110 | 55 | 168 | 230 |
| 280 S | 2DA0 2DB0 | 2 4 | 457 | 100 | 540 | 551 | 433 | 433 | 345 | 345 | 319 | 145 | 368 | 101 | 152 | 479 | 20 | 110 | 55 | 190 | 267 |
| 280 M | 2DA2 2DB2 | 2 4 | 457 | 100 | 540 | 551 | 433 | 433 | 345 | 345 | 319 | 145 | 419 | 101 | 152 | 479 | 20 | 110 | 55 | 190 | 216 326 |
| 315 S | 3AA0 | 2 | 508 | 120 | 610 | 616 | 515 | 515 | 404 | 404 | 374 | 164 | 406 | 113 | 170 | 527 | 22 | 110 | 55 | 216 | 295 |
| 315 M ²⁾ | 3AB0 | 4 | 508 | 120 | 610 | 616 | 515 | 515 | 404 | 404 | 374 | 164 | 457 | 113 | 170 | 578 | 22 | 110 | 55 | 216 | 295 |
| 315 M ¹⁾ | 3AA2 3AB2 | 2 4 | | | | | | | | | | | | | | | | | | | 409 |
| 315 L ¹⁾ | 3AA4 3AB4 3AA5 3AB5 | 2 4 2 4 | 508 | 120 | 610 | 616 | 515 | 515 | 404 | 404 | 374 | 164 | 508 | 113 | 170 | 578 | 22 | 110 | 55 | 216 | 358 513 |

* Please note that version 3AB0 does not comply with EN 50347 with respect to assignment of this dimension to the frame size.

¹⁾ With terminal box position right, terminal box left, and with order code **H01** only screwed-on feet with 3 drilled holes with dimension "B" (406, 457, and 508 mm). The dimension "BB" will then be 666 mm.

²⁾ 1LE1504-3AB0 and 1LE1604-3AB0 4-pole motors cannot be constructed in standard frame size 315 S because they require the longer housing of frame size 315 M in order to achieve the requisite efficiency levels. The foot clearance dimension "B" therefore changes from 406 to 457 mm. The motors comply with standard IEC 60034, but not with standard EN 50347 in this respect.

SIMOTICS GP and SIMOTICS SD standard motors

Dimensions · Cast-iron series SIMOTICS SD

IE4 – self-ventilated · Frame sizes 180 M to 315 L

Dimensional drawings

Type of construction IM B35

For flange dimensions, see page 1/47 (Z = the number of retaining holes)

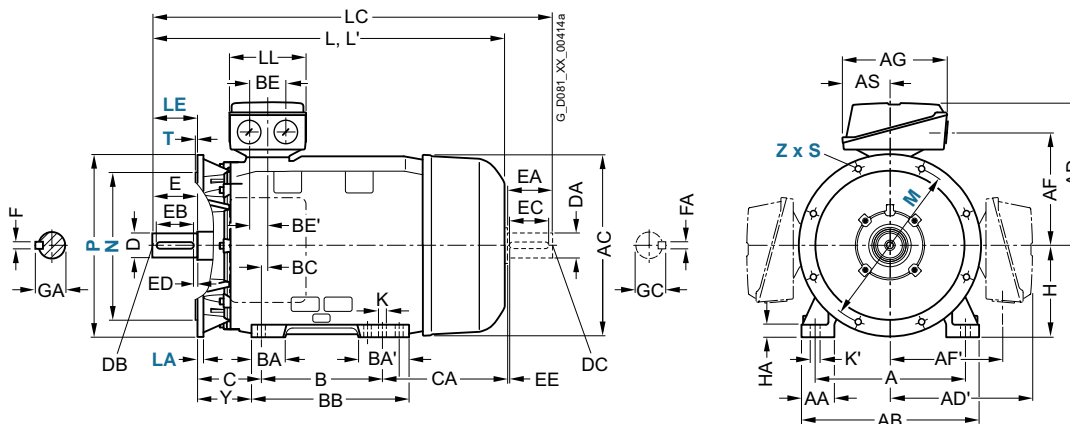

2

| For motor | Dimension designation acc. to IEC | DE shaft extension | | | | | NDE shaft extension | | | | | | | | | | | | | | | | | | |
|------------------------------------|-----------------------------------|--------------------|----|-----|-----|----|---------------------|-------------|------------------|-----|----|-----|-----|-----|----|------|------|----|-----|-----|-----|----|----|------|------|
| | | H | HA | Y | HH | K | K' | L | LC ¹⁾ | LL | D | DB | E | EB | ED | F | GA | DA | DC | EA | EC | EE | FA | GC | |
| Motor type 1LE1504- 1LE1604- | No. of poles | | | | | | | | | | | | | | | | | | | | | | | | |
| 1EA2 | 2 | 180 | 20 | 95 | 155 | 15 | 19 | 698 | 814 | 164 | 48 | M16 | 110 | 100 | 5 | 14 | 51.5 | 48 | M16 | 110 | 100 | 5 | 14 | 51.5 | |
| 1EB2 | 4 | | | | | | | 668 | 784 | | | | | | | | | | | | | | | | |
| 1EB4 | 4 | | | | | | | 698 | 814 | | | | | | | | | | | | | | | | |
| 2AA4 2AA5, 2AB5 | 2, 4 | 200 | 25 | 108 | 164 | 19 | 25 | 746 | 860 | 197 | 55 | M20 | 110 | 100 | 5 | 16 | 59 | 55 | M20 | 110 | 100 | 5 | 16 | 59 | |
| 2BB0 | 4 | 225 | 34 | 124 | 164 | 19 | 25 | 848 | 903 | 197 | 60 | M20 | 140 | 125 | 10 | 18 | 64 | 55 | M20 | 110 | 100 | 5 | 16 | 59 | |
| 2BA2 | 2 | 225 | 34 | 124 | 164 | 19 | 25 | 818 | 933 | 197 | 55 | M20 | 110 | 100 | 5 | 16 | 59 | 48 | M16 | 110 | 100 | 5 | 14 | 51.5 | |
| 2BB2 | 4 | | | | | | | 928 | 963 | | 60 | | 140 | 125 | 10 | 18 | 64 | 55 | M20 | | | | 16 | 59 | |
| 2CA2 | 2 | 250 | 40 | 138 | 192 | 24 | 30 | 887 | 1002 | 233 | 60 | M20 | 140 | 125 | 10 | 18 | 64 | 55 | M20 | 110 | 100 | 5 | 16 | 59 | |
| 2CB2 | 4 | | | | | | | 957 | 1032 | | 65 | | | | | 69 | 60 | | | 140 | 125 | 10 | 18 | 64 | |
| 2DA0 2DB0 | 2 4 | 280 | 40 | 160 | 210 | 24 | 30 | 1070 | 1105 | 233 | 65 | M20 | 140 | 125 | 10 | 18 | 69 | 60 | M20 | 140 | 125 | 10 | 18 | 64 | |
| 2DA2 | 2 | 280 | 40 | 160 | 210 | 24 | 30 | 1070 | 1215 | 233 | 65 | M20 | 140 | 125 | 10 | 18 | 69 | 60 | M20 | 140 | 125 | 10 | 18 | 64 | |
| 2DB2 | 4 | | | | | | | | | | 75 | | | | 20 | 79.5 | 65 | | | | | | | 69 | |
| 3AA0 | 2 | 315 | 50 | 181 | 238 | 28 | 35 | 1052 | 1197 | 299 | 65 | M20 | 140 | 125 | 10 | 18 | 69 | 60 | M20 | 140 | 125 | 10 | 18 | 64 | |
| 3AB0 | 4 | 315 | 50 | 181 | 238 | 28 | 35 | 1247 | 1392 | 299 | 80 | M20 | 170 | 140 | 25 | 22 | 85 | 70 | M20 | 140 | 125 | 10 | 20 | 74.5 | |
| 3AA2 | 2 | | | | | | | 1217 | 1362 | | 65 | | 140 | 125 | 10 | 18 | 69 | 60 | | | | | | 18 | 64 |
| 3AB2 | 4 | | | | | | | 1247 | 1392 | | 80 | | 170 | 140 | 25 | 22 | 85 | 70 | | | | | | 20 | 74.5 |
| 3AA4 | 2 | 315 | 50 | 181 | 238 | 28 | 35 | 1217 | 1362 | 299 | 65 | M20 | 140 | 125 | 10 | 18 | 69 | 60 | M20 | 140 | 125 | 10 | 18 | 64 | |
| 3AB4 | 4 | | | | | | | 1402 | 1392 | | 80 | | 170 | 140 | 25 | 22 | 85 | 70 | | | | | | 20 | 74.5 |
| 3AA5 | 2 | | | 146 | | | | 1372 | 1517 | | 65 | | 140 | 125 | 10 | 18 | 69 | 60 | | | | | | 18 | 64 |
| 3AB5 | 4 | | | | | | | 1402 | 1547 | | 80 | | 170 | 140 | 25 | 22 | 85 | 70 | | | | | | 20 | 74.5 |

¹⁾ In the low-noise version, a second shaft extension and/or mounted encoder is not possible.

SIMOTICS GP and SIMOTICS SD standard motors

Dimensions · Cast-iron series SIMOTICS SD

IR3 Rendimento Premium – self-ventilated · Frame sizes 180 M to 280 M

Dimensional drawings

Type of construction IM B3

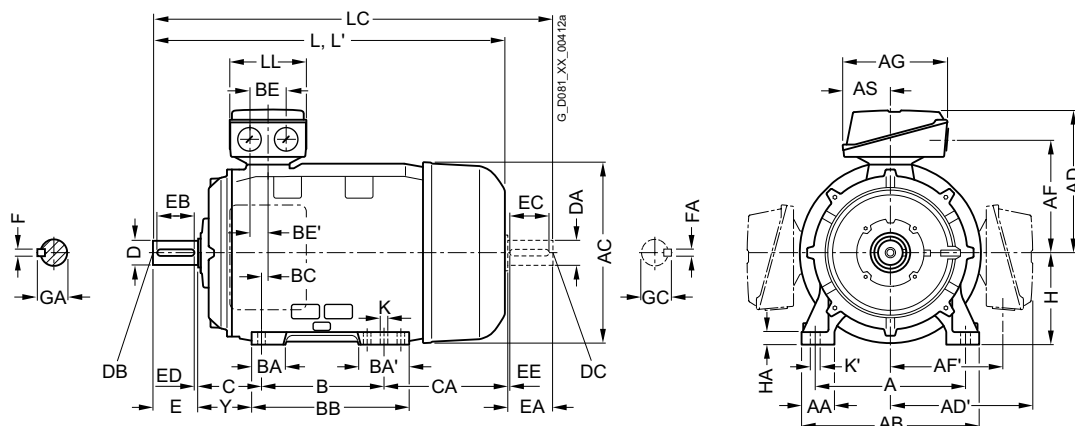

Types of construction IM B5 and IM V1

For flange dimensions, see page 1/47 (Z = the number of retaining holes)

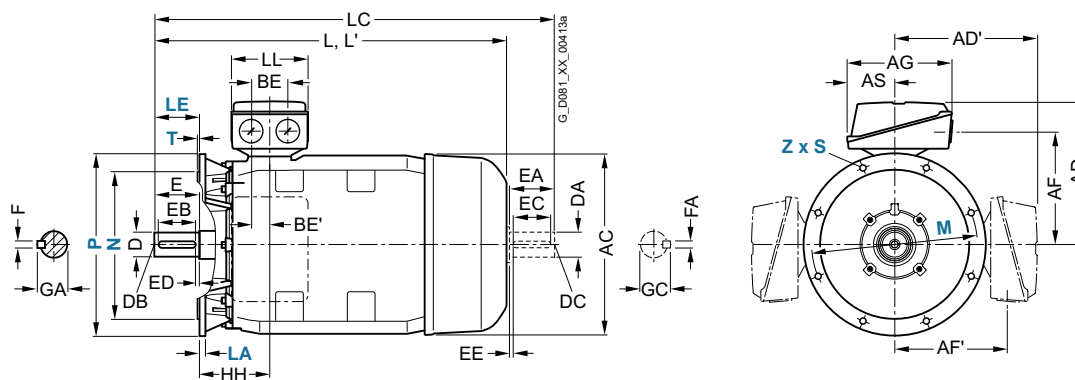

| For motor Frame size | Motor type 1LE1573- | No. of poles | Dimension designation acc. to IEC | | | | | | | | | | | | | | | | | | |
|-------------------------|------------------------------------|--------------|-----------------------------------|-----|------------|-----|------------|-----|-----|-----|-----|-----|-----|-----|-----|-----|----|-----|------|-----|-----|
| | | | A | AA | AB | AC | AD | AD' | AF | AF' | AG | AS | B | BA | BA' | BB | BC | BE | BE' | C | CA |
| 180 M | 1EB4 | 4 | 279 | 65 | 339 | 356 | 286 | 286 | 234 | 234 | 190 | 92 | 241 | 85 | 120 | 328 | 34 | 60 | 30 | 121 | 202 |
| | 1ED3 | 8 | | | | | | | | | | | | | | | | | | | |
| 180 L | 1EC6, 1ED4, 6, 8 | 2, 4, 6, 8 | 279 | 65 | 339 | 356 | 286 | 286 | 234 | 234 | 190 | 92 | 279 | 85 | 120 | 328 | 34 | 60 | 30 | 121 | 202 |
| | 1ED6 | 2 | | | | | | | | | | | | | | | | | | | |
| 200 L | 2AA5, 2AB5, 2AB6, 2AC5, 2AC6, 2AD6 | 2, 4, 6, 8 | 318 | 70 | 378 | 396 | 315 | 315 | 259 | 259 | 266 | 112 | 305 | 104 | 104 | 355 | 31 | 85 | 42.5 | 133 | 177 |
| | 2AA4 | 2 | | | | | | | | | | | | | | | | | | | |
| 225 S | 2BA2 | 2 | 356 | 80 | 436 | 449 | 338 | 338 | 282 | 282 | 266 | 112 | 286 | 92 | 115 | 361 | 15 | 85 | 42.5 | 149 | 278 |
| | 2BB2 | 4 | | | | | | | | | | | | | | | | | | | |
| 225 M | 2BD2 | 8 | 356 | 80 | 436 | 449 | 338 | 338 | 282 | 282 | 266 | 112 | 286 | 92 | 118 | 361 | 15 | 85 | 42.5 | 149 | 218 |
| | 2BA6 | 2 | | | | | | | | | | | 311 | | 117 | | | | | | 253 |
| | 2BB6, 2BC6 | 4, 6 | | | | | | | | | | | | | | | | | | | |
| | 2BD6 | 8 | | | | | | | | | | | | | 115 | | | | | | |
| 250 M | 2CA6 | 2 | 406 | 100 | 490 | 497 | 410 | 410 | 322 | 322 | 319 | 145 | 349 | 102 | 102 | 409 | 24 | 110 | 55 | 168 | 305 |
| | 2CB6, 2CC6 | 4, 6 | | | | | | | | | | | | | | | | | | | 235 |
| | 2CD6, 2CD7 | 8 | | | | | | | | | | | | | | | | | | | |
| 280 S | 2DA2 | 2 | 457 | 100 | 540 | 551 | 433 | 433 | 345 | 345 | 319 | 145 | 368 | 101 | 152 | 479 | 20 | 110 | 55 | 190 | 377 |
| | 2DB2 | 4 | | | | | | | | | | | | | | | | | | | |
| | 2DC2 | 6 | | | | | | | | | | | | | | | | | | | 267 |
| | 2DC6 | 6 | | | | | | | | | | | | | | | | | | | 377 |
| | 2DD6 | 8 | | | | | | | | | | | | | | | | | | | 267 |
| 280 M | 2DA6 | 2 | 457 | 100 | 540 | 551 | 433 | 433 | 345 | 345 | 319 | 145 | 419 | 101 | 152 | 479 | 20 | 110 | 55 | 190 | 326 |
| | 2DB6 | 4 | | | | | | | | | | | | | | | | | | | |
| | 2DC7, 2DD7 | 6, 8 | | | | | | | | | | | 368 | | | | | | | | 377 |

SIMOTICS GP and SIMOTICS SD standard motors

Dimensions · Cast-iron series SIMOTICS SD

IR3 Rendimento Premium – self-ventilated · Frame sizes 180 M to 280 M

Dimensional drawings

Type of construction IM B35

For flange dimensions, see page 1/47 (Z = the number of retaining holes)

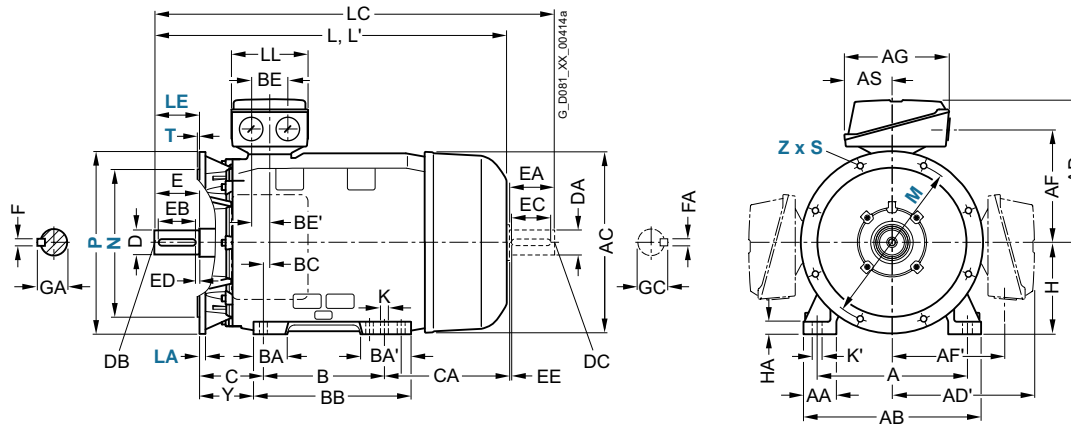

| For motor Frame size | Motor type 1LE1573- | No. of poles | Dimension designation acc. to IEC | | | | | | | | | | DE shaft extension | | | | | NDE shaft extension | | | | | | | | | | |
|-------------------------|------------------------------------|--------------|-----------------------------------|----|-----|-----|----|----|-------------|------------------|-----|----|--------------------|-----|-----|----|----|---------------------|------|-----|-----|-----|----|-----|------|----|----|----|
| | | | H | HA | Y | HH | K | K' | L | LC ¹⁾ | LL | D | DB | E | EB | ED | F | GA | DA | DC | EA | EC | EE | FA | GC | | | |
| 180 M | 1EB4 | 4 | 180 | 20 | 95 | 155 | 15 | 19 | 698 | 814 | 164 | 48 | M16 | 110 | 100 | 5 | 14 | 51.5 | 48 | M16 | 110 | 100 | 5 | 14 | 51.5 | | | |
| | 1ED3 | 8 | | | | | | | 668 | 784 | | | | | | | | | | | | | | | | | | |
| 180 L | 1EC6, 1ED4, 1ED6 | 6, 8 | 180 | 20 | 95 | 155 | 15 | 19 | 698 | 814 | 164 | 48 | M16 | 110 | 100 | 5 | 14 | 51.5 | 48 | M16 | 110 | 100 | 5 | 14 | 51.5 | | | |
| | 2AA5, 2AB5, 2AB6, 2AC5, 2AC6, 2AD6 | 2, 4, 6, 8 | 200 | 25 | 108 | 164 | 19 | 25 | 746 | 860 | 197 | 55 | M20 | 110 | 100 | 5 | 16 | 59 | 55 | M20 | 110 | 100 | 5 | 16 | 59 | | | |
| 225 S | 2AA4 | 2 | | | | | | | 721 | 835 | | | | | | | | | | | | | | | | | | |
| | 2BA2 | 2 | 225 | 34 | 124 | 164 | 19 | 25 | 818 | 933 | 197 | 55 | M20 | 110 | 100 | 5 | 16 | 59 | 48 | M16 | 110 | 100 | 5 | 14 | 51.5 | | | |
| 225 M | 2BB2 | 4 | | | | | | | 848 | 963 | 60 | | 140 | 125 | 10 | 18 | 64 | 55 | M20 | | | | | 16 | 59 | | | |
| | 2BD2 | 8 | 225 | 34 | 124 | 164 | 19 | 25 | 788 | 903 | 197 | 60 | M20 | 140 | 125 | 10 | 18 | 64 | 55 | M20 | 110 | 100 | 5 | 16 | 59 | | | |
| | 2BA6 | 2 | | | | | | | 898 | 933 | 55 | | 110 | 100 | 5 | 16 | 59 | 48 | | | | | | 14 | 51.5 | | | |
| | 2BB6, 2BC6, 2BD6 | 4, 6, 8 | | | | | | | 928 | 963 | 60 | | 140 | 125 | 10 | 18 | 64 | 55 | | | | | | | 16 | 59 | | |
| 250 M | 2CA6 | 2 | 250 | 40 | 138 | 192 | 24 | 30 | 957 | 1002 | 233 | 60 | M20 | 140 | 125 | 10 | 18 | 64 | 55 | M20 | 110 | 100 | 5 | 16 | 59 | | | |
| | 2CB6, 2CC6 | 4, 6 | | | | | | | | 1072 | 65 | | | | | | | 69 | 60 | | | | | 140 | 125 | 10 | 18 | 64 |
| | 2CD6, 2CD7 | 8 | | | | | | | 887 | 1032 | | | | | | | | | | | | | | | | | | |
| 280 S | 2DA2 | 2 | 280 | 40 | 160 | 210 | 24 | 30 | 1070 | 1215 | 233 | 65 | M20 | 140 | 125 | 10 | 18 | 69 | 60 | M20 | 140 | 125 | 10 | 18 | 64 | | | |
| | 2DB2 | 4 | | | | | | | | | | | | | | | | 20 | 79.5 | 65 | | | | | | | 69 | |
| | 2DC2 | 6 | | | | | | | 960 | 1105 | | | | | | | | | | | | | | | | | | |
| | 2DC6 | 6 | | | | | | | 1070 | | | | | | | | | | | | | | | | | | | |
| | 2DD6 | 8 | | | | | | | 960 | | | | | | | | | | | | | | | | | | | |
| 280 M | 2DA6 | 2 | 280 | 40 | 160 | 210 | 24 | 30 | 1070 | 1215 | 233 | 65 | M20 | 140 | 125 | 10 | 18 | 69 | 60 | M20 | 140 | 125 | 10 | 18 | 64 | | | |
| | 2DB6 | 4 | | | | | | | | | | | | | | | | 20 | 79.5 | 65 | | | | | | | 69 | |
| | 2DC7, 2DD7 | 6, 8 | | | | | | | | 1105 | | | | | | | | | | | | | | | | | | |

¹⁾ In the low-noise version, a second shaft extension and/or mounted encoder is not possible.

SIMOTICS GP and SIMOTICS SD standard motors

Dimensions · Cast-iron series SIMOTICS SD

IR3 Rendimento Premium – self-ventilated · Frame sizes 315 S to 315 L

Dimensional drawings

Type of construction IM B3

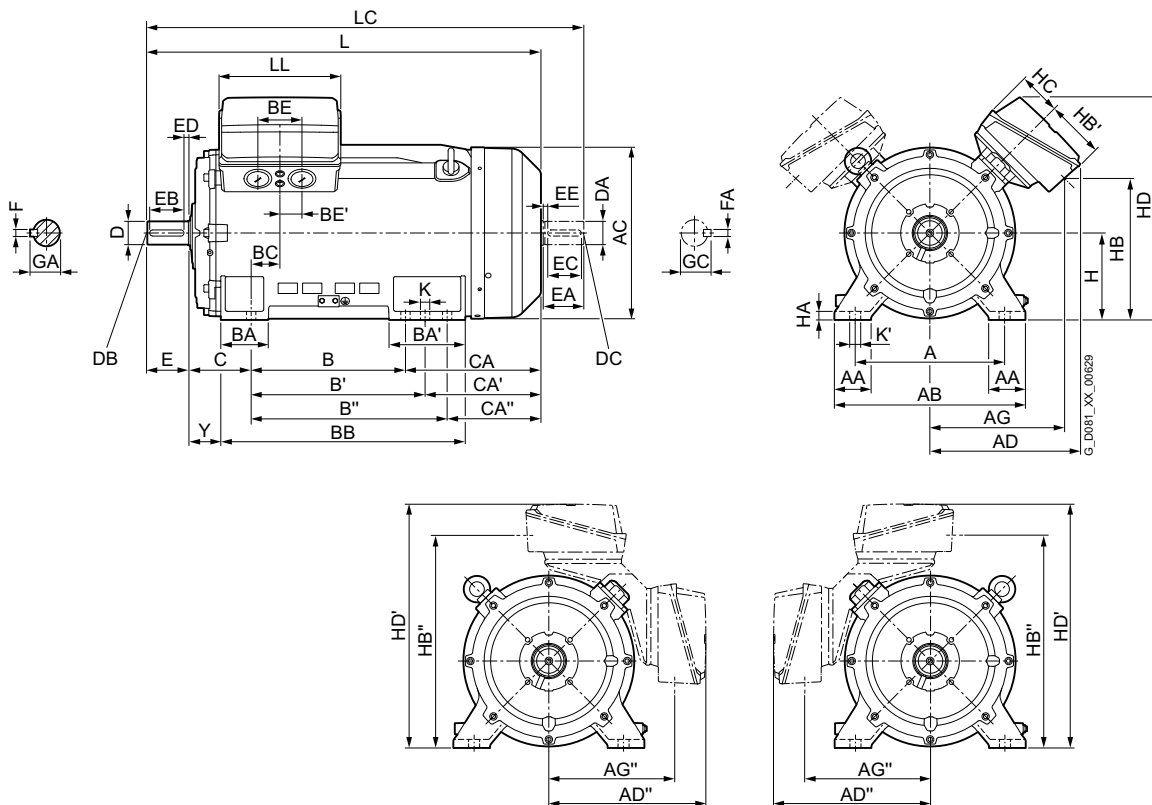

Types of construction IM B5 and IM V1

For flange dimensions, see page 1/47 (Z = the number of retaining holes)

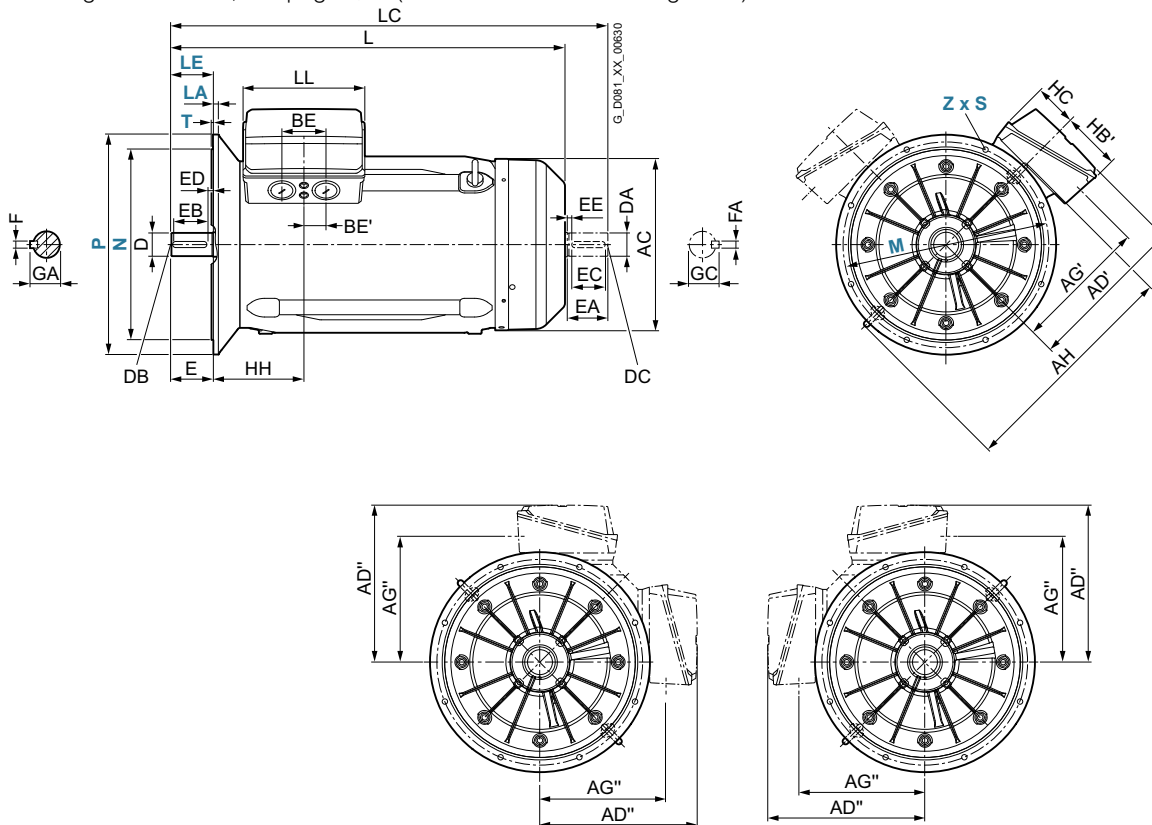

SIMOTICS GP and SIMOTICS SD standard motors

Dimensions · Cast-iron series SIMOTICS SD

IR3 Rendimento Premium – self-ventilated · Frame sizes 315 S to 315 L

Dimensional drawings

Type of construction IM B35

For flange dimensions, see page 1/47 (Z = the number of retaining holes)

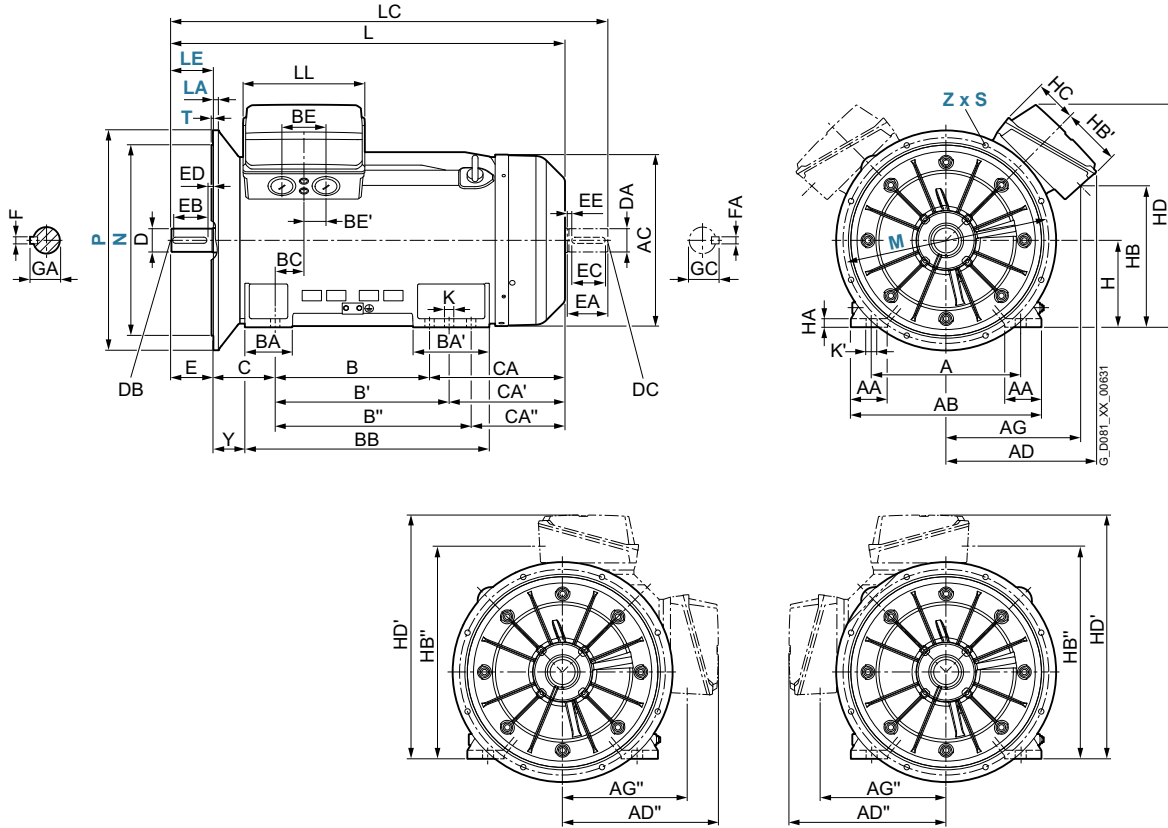

| For motor | | Dimension designation acc. to IEC | | | | | | | | | | | | | | | | | | | | | | | | | | | |
|------------|--|-----------------------------------|-----|-----|-----|-----|-----|-----|------|-----|-----|------|-----|-----|-----|-----|-----|-----|-----|-----|-----|------|------|-----|-----|------|-----|-----|-----|
| Frame size | Motor type | No. of poles | A | AA | AB | AC | AD | AD' | AD'' | AG | AG' | AG'' | AH | B | B' | B'' | BA | BA' | BB | BC | BE | BE' | C | CA | CA' | CA'' | H | HA | HB |
| 315 S | 3AA2 | 2 | 508 | 120 | 610 | 624 | 544 | 565 | 540 | 554 | 459 | 444 | 680 | 457 | 508 | - | 176 | 227 | 648 | 139 | 120 | 60 | 216 | 469 | 418 | - | 315 | 50 | 413 |
| | 3AB2 | 4 | | | | | | | | 491 | 480 | 434 | | | | | | | | | 135 | 67.5 | | | | | | 491 | |
| 315 M | 3AA4 | 2 | 508 | 120 | 610 | 624 | 544 | 565 | 540 | 554 | 459 | 444 | 680 | 457 | 508 | - | 176 | 227 | 648 | 139 | 120 | 60 | 216 | 469 | 418 | - | 315 | 50 | 413 |
| | 3AA5 | 2 | | | | | | | | | | | | | | | | | | | | | | | | | | | 491 |
| | 3AB4, 3AB5, 3AC4, 3AC5, 3AC6, 3AD4, 3AD5 | 4, 6, 8 | | | | | | | | | 491 | 480 | 434 | | | | | | | | | 135 | 67.5 | | | | | | 491 |
| | | | | | | | | | | | | | | | | | | | | | | | | | | | | | |
| 315 L | 3AB6 | 4 | 508 | 120 | 610 | 624 | 544 | 565 | 540 | 553 | 459 | 434 | 805 | 508 | 560 | 630 | 176 | 299 | 770 | 139 | 120 | 60 | 216 | 528 | 476 | 406 | 315 | 50 | 413 |
| | 3AB7 | 4 | | | | | | | | 554 | 446 | | | | | | | | | | | | 618 | 566 | 496 | | | 497 | |
| | 3AC7, 3AD7 | 6, 8 | | | | | | | | 491 | 470 | 421 | | | | | | | | | | 135 | 67.5 | 528 | 476 | 406 | | 491 | |
| | 3AD8 | 8 | | | | | | | | 554 | 459 | 446 | | | | | | | | | | | 618 | 566 | 496 | | 497 | | |
| | 3AA6 | 2 | | | | | | | | | | 434 | 805 | 457 | 508 | - | 176 | 227 | 648 | 139 | 120 | 60 | 469 | 418 | - | | 413 | | |
| 3AD6 | 8 | | | | | | | | | 491 | 480 | 680 | | | | | | | | | 135 | 67.5 | | | | | 491 | | |

| For motor | | Dimension designation acc. to IEC | | | | | | | | | | | | | | | | DE shaft extension | | | | NDE shaft extension | | | | | | |
|------------|--|-----------------------------------|-----|------|-----|-----|-----|-----|-----|----|------|------|------------------|-----|----|-----|-----|--------------------|----|----|----|---------------------|-----|-----|-----|----|------|------|
| Frame size | Motor type | No. of poles | HB' | HB'' | HC | HD | HD' | HH | Y | K | K' | L | LC ¹⁾ | LL | D | DB | E | EB | ED | F | GA | DA | DC | EA | EC | EE | FA | GC |
| 315 S | 3AA2 | 2 | 336 | 759 | 167 | 800 | 855 | 355 | 146 | 28 | 35 | 1132 | 1427 | 327 | 65 | M20 | 140 | 125 | 10 | 18 | 69 | 60 | M20 | 140 | 125 | 10 | 18 | 64 |
| | 3AB2 | 4 | 226 | 761 | | | | | | | | 1312 | 1457 | | 85 | | 170 | 140 | 25 | 22 | 90 | 70 | | | | | 20 | 74.5 |
| 315 M | 3AA4 | 2 | 336 | 759 | 167 | 800 | 855 | 355 | 146 | 28 | 35 | 1132 | 1427 | 327 | 65 | M20 | 140 | 125 | 10 | 18 | 69 | 60 | M20 | 140 | 125 | 10 | 18 | 64 |
| | 3AA5 | 2 | | 749 | | | | | | | | 1282 | | | | | | | | | | | | | | | | |
| | 3AB4, 3AB5, 3AC4, 3AC5, 3AC6, 3AD4, 3AD5 | 4, 6, 8 | 226 | 761 | 167 | 800 | 855 | 355 | 146 | 28 | 35 | 1312 | 1457 | 327 | 85 | M20 | 170 | 140 | 25 | 22 | 90 | 70 | M20 | 140 | 125 | 10 | 20 | 74.5 |
| | | | | | | | | | | | | | | | | | | | | | | | | | | | | |
| 315 L | 3AB6 | 4 | 336 | 749 | 167 | 800 | 855 | 355 | 146 | 28 | 35 | 1422 | 1567 | 327 | 85 | M20 | 170 | 140 | 25 | 22 | 90 | 70 | M20 | 140 | 125 | 10 | 20 | 74.5 |
| | 3AB7 | 4 | | 749 | | 885 | | | | | | 1512 | 1657 | | | | | | | | | | | | | | | |
| | 3AC7, 3AD7 | 6, 8 | | 763 | | 800 | | | | | | 1422 | 1567 | | | | | | | | | | | | | | | |
| | 3AD8 | 8 | | 749 | | | | | | | | 1512 | 1657 | | | | | | | | | | | | | | | |
| | 3AA6 | 2 | | | | | | | | | | 1282 | 1427 | | 65 | | 140 | 125 | 10 | 18 | 69 | 60 | | | | | 18 | 64 |
| 3AD6 | 8 | | 226 | 761 | | | | | | | 1312 | 1457 | | 85 | | 170 | 140 | 25 | 22 | 90 | 70 | | | | | 20 | 74.5 | |

¹⁾ In the low-noise version, a second shaft extension and/or mounted encoder is not possible.

SIMOTICS GP and SIMOTICS SD standard motors

Notes

2

SIMOTICS SD standard motors next generation

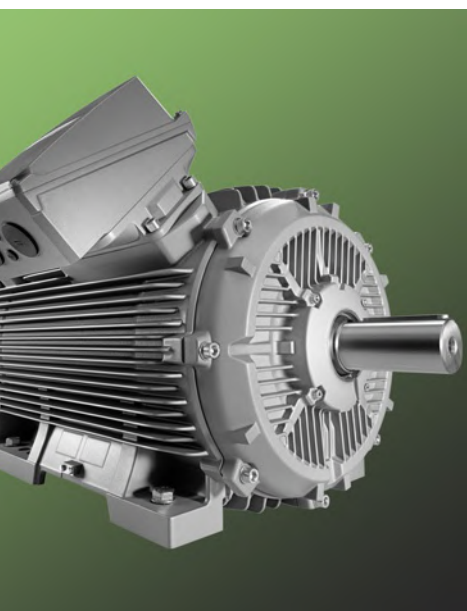

| | |
|-------------|---|
| 3/2 | Orientation |
| 3/7 | <u>Article number code</u> |
| 3/8 | IE4 Super Premium Efficiency |
| 3/8 | <u>Cast-iron series SIMOTICS SD</u> |
| 3/9 | • 1LE5504 Basic Line |
| 3/10 | • 1LE5604 Performance Line |
| 3/11 | <u>Cast-iron series SIMOTICS SD Add</u> |
| 3/12 | • 1LE5534 Basic Line |
| | • 1LE5634 Performance Line |
| | • 1LE5534 (frame sizes 400 and 450) |
| 3/13 | IE3 Premium Efficiency |
| 3/13 | <u>Cast-iron series SIMOTICS SD</u> |
| 3/14 | • 1LE5503 Basic Line |
| | • 1LE5603 Performance Line |
| | <u>Cast-iron series SIMOTICS SD Add</u> |
| 3/15 | • 1LE5533 Basic Line |
| 3/16 | • 1LE5633 Performance Line |
| 3/17 | • 1LE5533 (frame sizes 400 and 450) |
| | <u>Cast-iron series SIMOTICS SD Pro</u> |
| 3/18 | • 1LE5583 Basic Line |
| 3/19 | • 1LE5683 Performance Line |
| 3/20 | • 1LE5583 (frame sizes 400 and 450) |
| 3/21 | Article No. supplements and special versions |
| | <u>Voltages</u> |
| 3/21 | • Cast-iron series SIMOTICS SD 1LE55, 1LE56 |
| | <u>Types of construction</u> |
| 3/22 | • Cast-iron series SIMOTICS SD 1LE55, 1LE56 |
| | <u>Motor protection</u> |
| 3/24 | • Cast-iron series SIMOTICS SD 1LE55, 1LE56 |
| | <u>Terminal box position</u> |
| 3/25 | • Cast-iron series SIMOTICS SD 1LE55, 1LE56 |
| | <u>Options</u> |
| 3/26 | • Cast-iron series SIMOTICS SD 1LE55, 1LE56 |
| 3/34 | <u>Accessories</u> |
| 3/36 | Dimensions |
| 3/36 | Notes on the dimensions |
| 3/37 | Dimension sheet generator |
| | <u>Cast-iron series SIMOTICS SD</u> |
| 3/38 | • IE4, IE3 – Frame sizes 315 L to 355 L |
| | <u>Cast-iron series SIMOTICS SD Add</u> |
| 3/40 | • IE4, IE3 – Frame sizes 315 L to 355 L |
| | <u>Cast-iron series SIMOTICS SD Pro</u> |
| 3/42 | • IE3 – Frame sizes 315 L to 355 L |
| 3/44 | • IE3 – Frame sizes 400 and 450 |

SIMOTICS SD standard motors next generation

Orientation

Overview

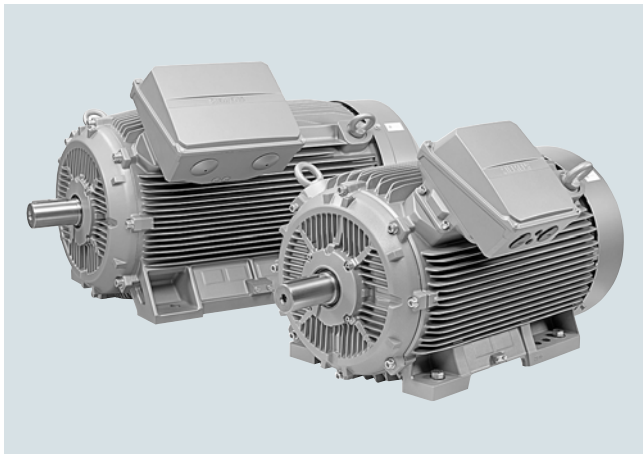

The SIMOTICS SD next generation is a new scalable generation of low-voltage motors. With their impressive performance and the additional versatility in their range of applications, this new motor series offers entry into a future-proof drive technology.

In addition to the future topics of digitalization and energy efficiency, this motor generation was developed with the focus on design optimization, which has resulted in a very compact motor design with a high power density. A standardized option range and the variable terminal box concept also enable flexible use of the motors in different system configurations and applications. The fact that the motors can either be operated on the line supply or with a converter is part of their versatility.

The following versions are available in the new 1LE5 motor series, differentiated by their performance features and functionality:

- **SIMOTICS SD**

These motors are characterized by reliable and powerful performance even in the toughest environmental conditions. The characteristics with higher torques ensure that higher starting and breakaway torques are available.

- **SIMOTICS SD Add**

The characteristic product feature of the SIMOTICS SD Add are the low starting currents. These not only meet industry-specific specifications, above all, in process industries, but also have a positive impact on the operating quality (higher power system stability, lower thermal load, increased motor lifetime). Through the availability of country-specific certificates, these motors can be used in all the important global regions and markets.

- **SIMOTICS SD Pro**

The SIMOTICS SD Pro range is characterized by its extremely flexible concept, which makes it universally deployable, in any plant, in any country in the world. Line and converter operation are generally possible up to 690 V and all important global, country and sector-specific certificates are available. Depending on the frame size - additional combinations of features are possible that further increase the flexibility. For SIMOTICS SD Pro frame sizes 315 and 355, which are above all used in the series business and are characterized by high starting and breakaway torques, this flexibility is manifested particularly through multi-voltage capability and efficiency stability irrespective of the line frequency 50 Hz/60 Hz. SIMOTICS SD Pro, frame sizes 400 to 450, have low starting currents. This version is aimed more at project business and is primarily used when converter operation up to 690 V is required in this power range.

One decisive advantage of these SIMOTICS SD next generation motors is the possibility of digital communication. This results in many advantages not just for engineering but throughout the product lifecycle.

SIMOTICS Digital Data App – Access to motor data at any time

The freely available SIMOTICS Digital Data App enables access to all motor-specific data and documents (electrical and mechanical data, dimensional drawings, operating instructions, spare part information, etc.) by reading in the data matrix codes present on every motor as standard. This increases transparency and makes commissioning and servicing easier.

SIMOTICS SD Next Generation – The first motors to have an interface with the digital world

The SIMOTICS SD next generation motors will be the first low-voltage motors to support cloud-based condition data analysis via MindSphere and MindApp with SIMOTICS CONNECT 400 in the near future. The motors are therefore ready for preventive maintenance and fast service, which further increases the availability and productivity of your system.

Benefits

- Rugged design in the cast-iron housing increases reliability and availability.
- Compact dimensions/high power density enable use even in confined space conditions.
- High energy efficiency in line (IE3, IE4) and converter operation (IES2) enable energy-saving operation.
- A standardized range of options and a variable terminal box concept increase the flexible adaptation to the requirements of the application.
- Support of line and converter operation reduces the variety.
- Provision of comprehensive CAD data simplifies the design and engineering phase.
- Digital features, such as the data matrix code and support by the cloud-based condition data analysis via MindSphere as part of SIMOTICS IQ permit efficient service and preventive maintenance.

Application

SIMOTICS SD 1LE5 motors are ideal for use in a large number of standard applications, such as

- Pumps, fans, compressors
- Conveyors
- Winders
- Mixers
- Extruders
- Cranes

They are preferably used in industries such as

- Mining, cement
- Chemical industry
- Oil and gas
- Steel industry
- Water, waste water
- Heating, ventilation and air conditioning (HVAC)
- Pulp and paper industry
- Marine engineering

Configuration





















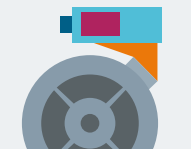

Terminal box positions

Standard

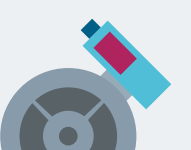
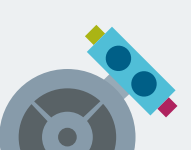
Rotated 180°

Rotated 90°, cable entry DE

Rotated 90°, cable entry NDE

| 1LE5..... | 1LE5.....-Z | 1LE5.....-Z | 1LE5.....-Z |
|--|--|---|--|
|  6 |  6 R12 |  6 R10 |  6 R11 |
|  2 |  2 R12 |  2 R10 |  2 R11 |
|  0 |  0 R12 |  0 R10 |  0 R11 |
|  1 |  1 R12 |  1 R10 |  1 R11 |
|  3 |  3 R12 |  3 R10 |  3 R11 |
|  5 |  5 R12 |  5 R10 |  5 R11 |

SIMOTICS SD standard motors next generation

Orientation

Configuration

Terminal box positions for flanged types of construction only

Standard

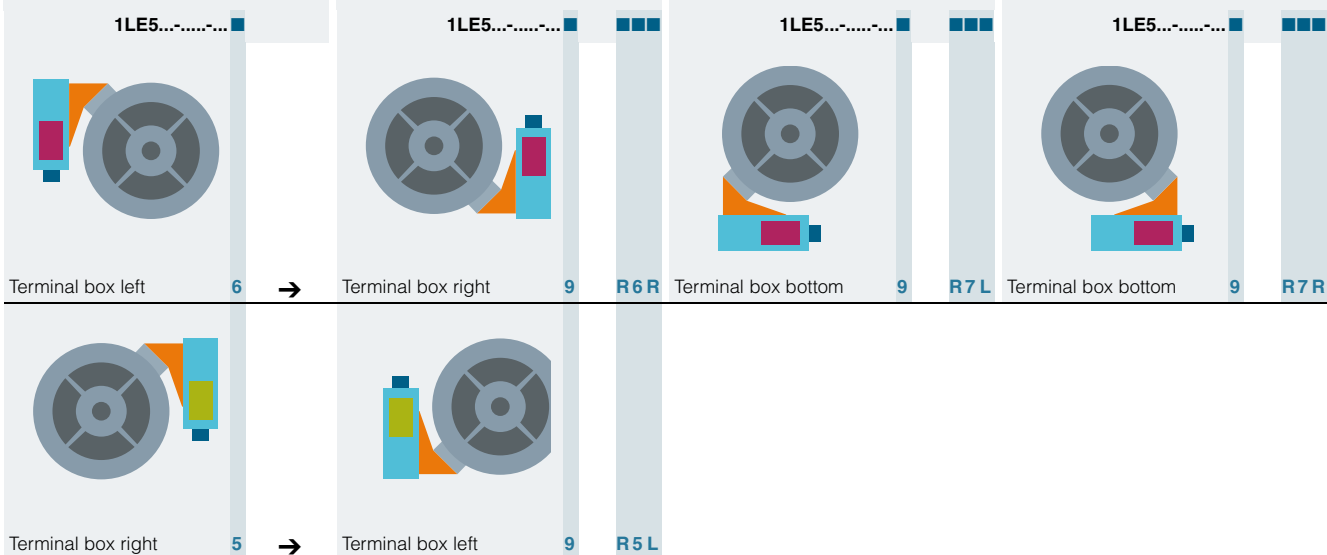

Types of construction

IM B3

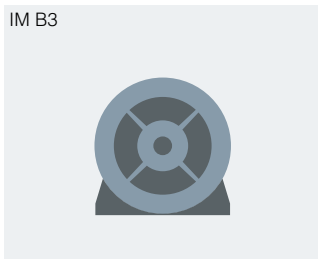

IM B5



Legend

- Auxiliary terminal box 1 (3)
- Auxiliary terminal box 2 (4)
- Terminal box
- Adapter
- Cable entry

3

Technical specifications

Overview of technical specifications

This table lists the most important technical specifications. For more information and details, see Catalog Section 1 "Introduction".

| | |
|--|---|
| Type of motor | SIMOTICS SD 1LE5 IEC Low-Voltage Motors |
| Connection types | Star/delta connection The connection type to be used can be taken from the Article No. supplements for the required motor. |
| Number of poles | 2, 4, 6, 8 |
| Frame sizes | 315 L ... 450 |
| Rated power | 200 ... 1000 kW |
| Frequencies | 50 Hz and 60 Hz |
| Versions | <ul style="list-style-type: none"> • IE3 (Premium Efficiency) • IE4 (Super Premium Efficiency) |
| Marking | IEC 60034-30-1 IE3, IE4: 2, 4, 6 and 8-pole |
| Rated speed (synchronous speed) | 1000 ... 3600 rpm |
| Rated torque | 670 ... 8100 Nm |
| Insulation of the stator winding in accordance with EN 60034-1 (IEC 60034-1) | <ul style="list-style-type: none"> • SD and SD Add: Temperature class 155 (F), utilized to temperature class 130 (B) DURIGNIT IR 2000 insulation system • SD Pro: Temperature class 155 (F), utilized to temperature class 155 (F) DURIGNIT IR 2000 insulation system |
| Degree of protection according to EN 60034-5 (IEC 60034-5) | IP55 as standard |
| Cooling in accordance with EN 60034-6 (IEC 60034-6) | <ul style="list-style-type: none"> • Self-ventilated (IC411) • Forced-air cooled motors w/o ext. fan/fan cover (IC418) • Forced-air cooled (IC416) |
| Permissible coolant temperature and installation altitude | -20 ... +40 °C as standard, installation altitude up to 1000 m above sea level. See "Coolant temperature and installation altitude" in Catalog Section 1 "Introduction". |
| Standard voltages according to EN 60038 (IEC 60038) | 50 Hz: 400 V, 500 V, 690 V The voltage used can be found in the "Selection and ordering data" for the required motor. |
| Type of construction according to EN 60034-7 (IEC 60034-7) | <ul style="list-style-type: none"> • Without flange: IM B3, IM B6, IM B7, IM B8, IM V5, IM V6 • With flange: IM B5, IM V1, IM V3, IM B35 |
| Paint finish | Standard: color RAL 7030 stone gray |
| Suitability of paint finish for climate group according to IEC 60721, Part 2-1 | See "Paint finish" in Catalog Section 1 "Introduction". |
| Vibration severity grade according to EN 60034-14 (IEC 60034-14) | Grade A (normal – without special vibration requirements) Optionally: Grade B (with special vibration requirements) See "Balance and vibration severity" in Catalog Section 1 "Introduction". |
| Shaft extension according to DIN 748 (IEC 60072) | Balancing type: Half-key balancing as standard See "Balance and vibration severity" in Catalog Section 1 "Introduction". |
| Sound pressure level according to EN ISO 1680 (tolerance +3 dB) | The sound pressure level is listed in the selection and ordering data for the required motor. |
| Weights | The weight is listed in the selection and ordering data for the required motor. |
| Modular mounting concept | Rotary pulse encoder, brake, separately driven fan or prepared for mountings |
| Consistent series concept | <ul style="list-style-type: none"> • Terminal box diagonally split - and can be optionally rotated through 4 x 90° • Bearings at DE and NDE are of identical design, reinforced bearings available as an option |
| Options | See "Article No. supplements and special versions" |

Converter operation

The motors are suitable for line operation and optionally for converter operation (bearing insulation NDE, order code **L51**). The values specified in the selection tables apply for pure sinusoidal supplies.

Rated voltage

The tolerance for the rated voltage is in accordance with EN 60034-1 in all cases, a rated voltage range is not specified.

Motor protection

A motor protection function can be implemented using the I2t sensing circuit implemented in the converter software.

If required, more precise motor protection can be provided by directly measuring the temperature using KTY84 sensors, Pt100 / Pt1000 resistance thermometers or PTC thermistors in the motor winding. Some converters from Siemens determine the motor temperature using the resistance of the temperature sensor. They can be set to a required temperature for alarm and tripping.

Bearings

To avoid damage caused by bearing currents, insulated bearings (L51) must be ordered.

When operating multiphase induction motors with a converter, the bearings are electrically stressed as a result of a capacitively induced voltage across the bearing lubricating film (as a result of the inherent principle of operation). The physical cause of this is the common-mode voltage at the converter output that is inherent in the control method for a converter: The sum of the three phase voltages is – in contrast to pure line operation – not equal to zero at every point in time. The high-frequency, pulsed common-mode voltage results in a residual current that flows back to the converter DC link via the internal capacitances of the motor, the motor housing and the grounding circuit. The machine's internal capacitances include the main insulation winding capacitance, the geometric capacitance between the rotor and stator, the lubricating film capacitance and the capacitance of any bearing insulation that may be present. The current flowing through the internal capacitances is proportional to the gradient, i.e. the voltage change of the common-mode voltage ($i(t) = C \cdot du/dt$).

SIMOTICS SD standard motors next generation

Orientation

Technical specifications

In order to apply currents to the motor which are sinusoidal as far as possible (smooth running, oscillation torques, stray losses), a high clock frequency is required for the converter's output voltage. The related (very steep) switching edges of the converter output voltage (and also, therefore, of the common-mode voltage) cause correspondingly high capacitive currents and voltages on the machine's internal capacitances.

In the worst-case scenario, the capacitive voltage induced via the bearing can lead to random arcing through the bearing lubricating film, thus causing premature bearing aging or damage. (The current pulses caused by the arcing across the lubricating film are referred to as EDM (Electrostatic Discharge Machining) currents in the literature.)

This physical effect, which occurs in isolated cases, has mostly been observed in connection with larger motors. EMC-compliant installation of the drive system is a basic prerequisite for preventing premature bearing damage via bearing currents. The most important measures for reducing damage to bearings.

- Insulated bearing at the non-drive end (NDE) (order code **L51**)
- Use cables with a symmetrical cable cross-section

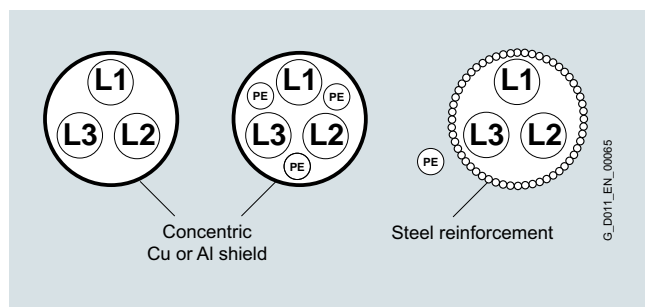

- Preference given to a supply with insulated neutral point (IT system)
- Using grounding cables with low impedance over a wide frequency range (DC up to approximately 70 MHz): for example, plaited copper ribbon cables, HF litz wires
- Separate HF equipotential-bonding cable between motor housing and driven machine
- Separate HF equipotential-bonding cable between motor housing and converter PE busbar
- 360° HF contacting of the cable shield on the motor housing and the converter PE busbar. This can be achieved using EMC screwed glands on the motor end and EMC shield clips at the converter, for example
- Using motor reactors at the converter
- Common-mode filters at the converter output.

More information

For further information, please get in touch with your local Siemens contact and use the DT Configurator.

Contacts: www.siemens.com/automation/partner

DT Configurator: www.siemens.com/dt-configurator

Here, you can find out about certain technologies through Siemens contact partners worldwide.

Wherever possible, you will find a local contact for:

- Technical support
- Spare parts/repairs
- Service
- Training
- Sales
- Technical consultation/engineering

Thermal torque limits

In the case of self-ventilated motors, the thermally admissible load torques are reduced for continuous operation for speeds below the rated speed. This must be taken into account for applications, especially those that do not have a square law load torque. Also in the case of forced-air cooled motors (order code F70), the maximum load torques are reduced slightly for high speed ranges.

When motors are operated at speeds above their rated speed (in the field-weakening range), the maximum load torque is also reduced.

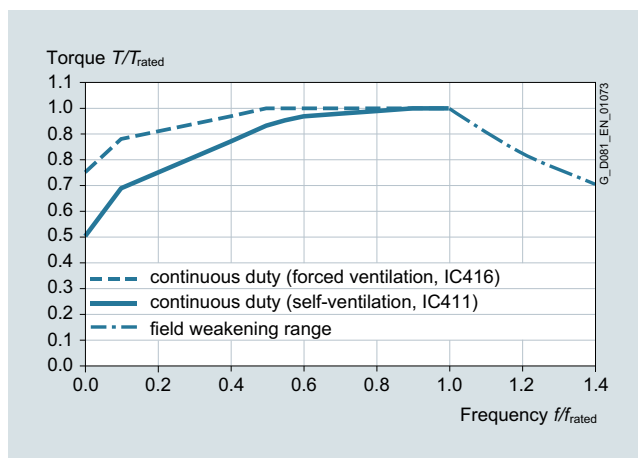

You start by selecting a:

- country
- product or
- sector.

Selection and ordering data

The article number consists of a combination of digits and letters and is divided into three hyphenated blocks to provide a better overview, e.g.:

**1LE5504-3AA63-4AA2-Z
H00**

The first block (positions 1 to 7) identifies the motor type. The second block (positions 8 to 12) defines the motor frame size and length, the number of poles and power and in some cases the frequency/voltage. In the third block (positions 13 to 16), the frequency/voltage, type of construction and further design features are encoded.

For deviations in the second and third block from the catalog codes either **Z** or **90** should be used as appropriate.

Ordering data:

- Complete Article No. and order code(s) or plain text
- If a quotation has been requested, please specify the quotation number in addition to the Article No.
- When ordering a complete motor as a spare part, please specify the works serial No. for the previously supplied motor as well as the Article No.

| Structure of the Article No.: | Position: | 1 | 2 | 3 | 4 | 5 | 6 | 7 | - | 8 | 9 | 10 | 11 | 12 | - | 13 | 14 | 15 | 16 | |
|---|---|---|---|---|---|--------|-----------------------|-----------------------|---|--------|------------------|----|--------|--------|--------|----|--------|--------|----------------------------|-----|
| 1st to 4th position: Digit, letter, letter, digit | • Self-ventilated by fan mounted on and driven by the rotor • Forced-air cooled by air flow from the fan to be driven with option extension F90 | 1 | L | E | 5 | | | | | | | | | | | | | | | |
| 5th position: Digit | Cast-iron housing Basic Line Cast-iron housing Performance Line | | | | | 5 6 | | | | | | | | | | | | | | |
| 6th to 7th position: 2 digits | SIMOTICS SD motors with IE3 Premium Efficiency SIMOTICS SD Add motors with IE3 Premium Efficiency SIMOTICS SD motors with IE4 Super Premium Efficiency SIMOTICS SD Add motors with IE4 Super Premium Efficiency SIMOTICS SD Pro motors with IE3 Premium Efficiency | | | | | | 0 3 0 3 8 | 3 3 4 4 3 | | | | | | | | | | | | |
| 8th, 9th and 11th position: Digit, letter, digit | Motor frame size (frame size as a combination of shaft height and overall length, encoded) | | | | | | | | | 3 4 | A B | | 3 8 | | | | | | | |
| 10th position: Letter | No. of poles A: 2-pole B: 4-pole C: 6-pole D: 8-pole | | | | | | | | | | A B C D | | | | | | | | | |
| 12th and 13th position: 2 digits | Voltage, circuit and frequency (encoded with two digits, 9-0 requires order code M.. (e.g. M1Y)) | | | | | | | | | | | | | 0 9 | 0 7 | | | | | |
| 14th position: Letter | Type of construction (encoded with A ... V) | | | | | | | | | | | | | | | | A V | | | |
| 15th position: Letter | Motor protection (encoded with A ... Z; Z requires order code Q.. (e.g. Q3A)) | | | | | | | | | | | | | | | | | A Z | | |
| 16th position: Digit | Terminal box position Terminal box base left with terminal box at the top Terminal box base right with terminal box at the top Terminal box base left with terminal box 45° Terminal box base right with terminal box 45° Terminal box on right-hand side Terminal box on left-hand side | | | | | | | | | | | | | | | | | | 0 1 2 3 5 6 | |
| | Special order versions: encoded – additional order code required not encoded – additional plain text required | | | | | | | | | | | | | | | | | | | - Z |

Ordering example

| Selection criteria | Requirement | Structure of the Article No. |
|---|---|-------------------------------|
| Motor type 1LE5 | Standard motor with IE4 Super Premium Efficiency, self-ventilated, IP55 degree of protection, cast-iron version, Performance Line | 1LE5604-■■■■■-■■■■■ |
| Motor frame size/No. of poles/Speed | 315 L/2-pole/3000 rpm | 1LE5604-3AA6■■-■■■■■ |
| Rated power | 250 kW | |
| Voltage and frequency | 400 VΔ/690 VY, 50 Hz | 1LE5604-3AA63-4■■■■■ |
| Type of construction with special version | IM V5 with protective cover ¹⁾ | 1LE5604-3AA63-4C■■■■-Z H00 |
| Motor protection | 1 or 3 PTC thermistors – for tripping (2 terminals) | 1LE5604-3AA63-4CB■■-Z H00 |
| Terminal box position | Terminal box base left with terminal box 45° | 1LE5604-3AA63-4CB2-Z H00 |

¹⁾ Standard without protective cover – the protective cover is defined with order code **H00** and must be ordered in addition to the Article No. with **-Z** and this order code.

SIMOTICS SD standard motors next generation

IE4 Super Premium Efficiency



Cast-iron series SIMOTICS SD 1LE5504 Basic Line – self-ventilated or forced-air cooled

Selection and ordering data

| Operating values at rated power | | | | | | | | | | | | | | | Cast-iron series | | |
|--|------------|-------------|-------------|---------------------|---------------------|---------------------|-------------------------|-------------|----------------------------|----------------------------|-------------------------|-----------|----------|--------------------------------|----------------------------|------------------|---------------|
| P_{rated} | Frame size | n_{rated} | T_{rated} | $\eta_{rated, 4/4}$ | $\eta_{rated, 3/4}$ | $\eta_{rated, 2/4}$ | $\cos\phi_{rated, 4/4}$ | I_{rated} | $\frac{T_{LR}}{T_{rated}}$ | $\frac{I_{LR}}{I_{rated}}$ | $\frac{T_B}{T_{rated}}$ | L_{pFA} | L_{WA} | 1LE5504 Basic Line Article No. | $m_{IM B3}$ | J | |
| kW | FS | rpm | Nm | % | % | % | | A | | | | dB(A) | dB(A) | | kg | kgm ² | |
| <ul style="list-style-type: none"> • Cooling: Self-ventilated (IC411) • Efficiency according to IEC 60034-30: IE4 Super Premium Efficiency • Insulation: Thermal class 155 (temperature class F), IP55 degree of protection, utilization in accordance with thermal class 130 (temperature class B) | | | | | | | | | | | | | | | | | |
| 2-pole: 3000 rpm at 50 Hz | | | | | | | | | | | | | | | | | |
| 250 | 315 L | 2986 | 800 | 96.5 | 96.4 | 95.7 | 0.88 | 425 | 3 | 9.3 | 4.2 | 80 | 94 | 1LE5504-3AA6 | 1340 | 2.82 | |
| 315 | 315 L | 2986 | 1007 | 96.5 | 96.3 | 95.5 | 0.87 | 540 | 3.5 | 9.9 | 4.2 | 81 | 96 | 1LE5504-3AA7 | 1520 | 3.27 | |
| 4-pole: 1500 rpm at 50 Hz | | | | | | | | | | | | | | | | | |
| 250 | 315 L | 1490 | 1602 | 96.7 | 96.8 | 96.5 | 0.86 | 435 | 2.8 | 7.9 | 3.2 | 75 | 90 | 1LE5504-3AB6 | 1500 | 4.98 | |
| 315 | 315 L | 1490 | 2019 | 96.7 | 96.7 | 96.3 | 0.83 | 570 | 3.2 | 8.5 | 3.5 | 75 | 90 | 1LE5504-3AB7 | 1560 | 5.39 | |
| 6-pole: 1000 rpm at 50 Hz | | | | | | | | | | | | | | | | | |
| 200 | 315 L | 992 | 1925 | 96.3 | 96.4 | 96.1 | 0.82 | 365 | 3 | 7.5 | 3.2 | 68 | 83 | 1LE5504-3AC7 | 1410 | 6.28 | |
| 250 | 315 L | 992 | 2407 | 96.5 | 96.6 | 96.3 | 0.81 | 460 | 3.2 | 8.2 | 3.3 | 69 | 84 | 1LE5504-3AC8 | 1700 | 8.00 | |
| 8-pole: 750 rpm at 50 Hz | | | | | | | | | | | | | | | | | |
| 160 | 315 L | 741 | 2062 | 95.1 | 95.5 | 95.5 | 0.79 | 305 | 2.5 | 6.3 | 2.5 | 67 | 82 | 1LE5504-3AD7 | 1420 | 6.78 | |
| 200 | 315 L | 742 | 2574 | 95.4 | 95.6 | 95.3 | 0.78 | 390 | 2.7 | 6.7 | 2.9 | 72 | 87 | 1LE5504-3AD8 | 1660 | 8.60 | |
| Voltages ¹⁾ | | | | | | | | | | | | | | | | | |
| 50 Hz 400 VΔ/690 VY | | | | | | | | | | | | | | | 60 Hz ¹⁾ 460 VΔ | | |
| Version | | | | | | | | | | | | | | | | | |
| Standard | | | | | | | | | | | | | | | 3 | 4 | Order code |
| Without additional charge | | | | | | | | | | | | | | | 4 | 0 | – |
| With additional charge | | | | | | | | | | | | | | | 4 | 7 | – |
| For other voltages ¹⁾ and more information, see from page 3/21 | | | | | | | | | | | | | | | | | |
| Types of construction | | | | | | | | | | | | | | | | | |
| Version | | | | | | | | | | | | | | | | | |
| Without flange IM B3 ²⁾ | | | | | | | | | | | | | | | A | – | Order code |
| With flange IM B5 ²⁾ | | | | | | | | | | | | | | | F | – | – |
| For other types of construction and more information, see from page 3/22 | | | | | | | | | | | | | | | | | |
| Motor protection | | | | | | | | | | | | | | | | | |
| Version | | | | | | | | | | | | | | | | | |
| Without | | | | | | | | | | | | | | | A | – | Order code |
| PTC thermistor with 3 temperature sensors | | | | | | | | | | | | | | | B | – | – |
| For other motor protection and more information, see from page 3/24 | | | | | | | | | | | | | | | | | |
| Terminal box position | | | | | | | | | | | | | | | | | |
| Version | | | | | | | | | | | | | | | | | |
| Terminal box base left with terminal box 45° | | | | | | | | | | | | | | | 2 | – | Order code |
| Terminal box base right with terminal box 45° | | | | | | | | | | | | | | | 3 | – | – |
| For other terminal box positions and more information, see from page 3/25 | | | | | | | | | | | | | | | | | |
| Special versions | | | | | | | | | | | | | | | | | |
| Forced-air cooled motors w/o ext. fan/fan cover (IC418) | | | | | | | | | | | | | | | –Z | F90+ | Order code(s) |
| For options, see from page 3/26 | | | | | | | | | | | | | | | –Z | ... | ... |

¹⁾ Parallel supply lines are required, except in the case of connection to 690 V.

²⁾ For a power rating of 315 kW, 2-pole, 60 Hz and 315 kW, 4-pole, 50 Hz, a larger terminal box can be used (order code **R50**) due to the magnitude of the current. Order code **R50** alters the motor dimensions.



SIMOTICS SD standard motors next generation
IE4 Super Premium Efficiency

Cast-iron series SIMOTICS SD 1LE5604 Performance Line – self-ventilated or forced-air cooled

Selection and ordering data

| P _{rated} | Frame size | Operating values at rated power | | | | | | | | | | | Cast-iron series 1LE5604 Performance Line Article No. | m _{IM B3} | J | |
|---|------------|---------------------------------|--------------------|-------------------------|-------------------------|-------------------------|----------------------------|--------------------|-------------------------------------|-------------------------------------|------------------------------------|---------------------------|--|--------------------|------------|------------------|
| | | n _{rated} | T _{rated} | η _{rated, 4/4} | η _{rated, 3/4} | η _{rated, 2/4} | cosφ _{rated, 4/4} | I _{rated} | T _{LR} /T _{rated} | I _{LR} /I _{rated} | T _B /T _{rated} | L _{pfA} | | | | L _{WA} |
| kW | FS | rpm | Nm | % | % | % | | A | | | | | | | kg | kgm ² |
| • Cooling: Self-ventilated (IC411) | | | | | | | | | | | | | | | | |
| • Efficiency according to IEC 60034-30: IE4 Super Premium Efficiency | | | | | | | | | | | | | | | | |
| • Insulation: Thermal class 155 (temperature class F), IP55 degree of protection, utilization in accordance with thermal class 130 (temperature class B) | | | | | | | | | | | | | | | | |
| 2-pole: 3000 rpm at 50 Hz | | | | | | | | | | | | | | | | |
| 250 | 315 L | 2986 | 800 | 96.5 | 96.4 | 95.7 | 0.88 | 425 | 3 | 9.3 | 4.2 | 80 | 94 | 1LE5604-3AA6 | 1340 | 2.82 |
| 315 | 315 L | 2986 | 1007 | 96.5 | 96.3 | 95.5 | 0.87 | 540 | 3.5 | 9.9 | 4.2 | 81 | 96 | 1LE5604-3AA7 | 1520 | 3.27 |
| 355 | 355 L | 2988 | 1135 | 96.5 | 96.3 | 95.5 | 0.89 | 600 | 2.6 | 8.9 | 4 | 84 | 99 | 1LE5604-3BA3 | 2100 | 4.74 |
| 400 | 355 L | 2986 | 1279 | 96.5 | 96.4 | 95.9 | 0.92 | 650 | 2.6 | 8.5 | 3.4 | 83 | 98 | 1LE5604-3BA4 | 2240 | 5.36 |
| 500 | 355 L | 2988 | 1598 | 96.5 | 96.4 | 95.8 | 0.89 | 840 | 3 | 8.9 | 3.8 | 84 | 98 | 1LE5604-3BA5 | 2340 | 5.76 |
| 4-pole: 1500 rpm at 50 Hz | | | | | | | | | | | | | | | | |
| 250 | 315 L | 1490 | 1602 | 96.7 | 96.8 | 96.5 | 0.86 | 435 | 2.8 | 7.9 | 3.2 | 75 | 90 | 1LE5604-3AB6 | 1500 | 4.98 |
| 315 | 315 L | 1490 | 2019 | 96.7 | 96.7 | 96.3 | 0.83 | 570 | 3.2 | 8.5 | 3.5 | 75 | 90 | 1LE5604-3AB7 | 1560 | 5.39 |
| 355 | 355 L | 1492 | 2272 | 96.7 | 96.7 | 96.2 | 0.83 | 640 | 2.8 | 7.9 | 2.8 | 81 | 96 | 1LE5604-3BB3 | 2050 | 6.76 |
| 400 | 355 L | 1492 | 2560 | 96.7 | 96.7 | 96.2 | 0.82 | 730 | 3.2 | 7.9 | 2.9 | 81 | 96 | 1LE5604-3BB4 | 2080 | 7.16 |
| 500 | 355 L | 1491 | 3202 | 96.7 | 96.8 | 96.6 | 0.86 | 870 | 3.1 | 8.1 | 3.3 | 80 | 96 | 1LE5604-3BB5 | 2290 | 8.36 |
| 6-pole: 1000 rpm at 50 Hz | | | | | | | | | | | | | | | | |
| 200 | 315 L | 992 | 1925 | 96.3 | 96.4 | 96.1 | 0.82 | 365 | 3 | 7.5 | 3.2 | 68 | 83 | 1LE5604-3AC7 | 1410 | 6.28 |
| 250 | 315 L | 992 | 2407 | 96.5 | 96.6 | 96.3 | 0.81 | 460 | 3.2 | 8.2 | 3.3 | 69 | 84 | 1LE5604-3AC8 | 1700 | 8.00 |
| 315 | 355 L | 993 | 3029 | 96.6 | 96.6 | 96.1 | 0.82 | 570 | 2.9 | 7.8 | 3.2 | 75 | 90 | 1LE5604-3BC2 | 2040 | 11.6 |
| 355 | 355 L | 993 | 3414 | 96.6 | 96.7 | 96.3 | 0.83 | 640 | 2.9 | 8.4 | 3.3 | 74 | 89 | 1LE5604-3BC3 | 2250 | 13.7 |
| 400 | 355 L | 993 | 3847 | 96.6 | 96.7 | 96.5 | 0.84 | 710 | 2.8 | 8.1 | 3 | 75 | 90 | 1LE5604-3BC4 | 2240 | 13.4 |
| 8-pole: 750 rpm at 50 Hz | | | | | | | | | | | | | | | | |
| 160 | 315 L | 741 | 2062 | 95.1 | 95.5 | 95.5 | 0.79 | 305 | 2.5 | 6.3 | 2.5 | 67 | 82 | 1LE5604-3AD7 | 1420 | 6.78 |
| 200 | 315 L | 742 | 2574 | 95.4 | 95.6 | 95.3 | 0.78 | 390 | 2.7 | 6.7 | 2.9 | 72 | 87 | 1LE5604-3AD8 | 1660 | 8.60 |
| 250 | 355 L | 744 | 3209 | 95.4 | 95.8 | 95.8 | 0.80 | 475 | 2.4 | 7.1 | 2.7 | 68 | 83 | 1LE5604-3BD1 | 2280 | 13.3 |
| 315 | 355 L | 744 | 4043 | 95.4 | 95.7 | 95.4 | 0.80 | 600 | 2.5 | 7.3 | 3.0 | 68 | 83 | 1LE5604-3BD2 | 2360 | 14 |
| Voltages ¹⁾ | | | | | | | | | | | | | | | | |
| 50 Hz 400 VΔ/690 VY | | 60 Hz ¹⁾ 460 VΔ | | | | | | | | | | | | Version | Order code | |
| 50 Hz 500 VΔ | | | | | | | | | | | | Standard | 3 4 | - | | |
| 50 Hz 690 VΔ | | | | | | | | | | | | Without additional charge | 4 0 | - | | |
| | | | | | | | | | | | | With additional charge | 4 7 | - | | |
| | | | | | | | | | | | | | | ... | | |
| For other voltages ¹⁾ and more information, see from page 3/21 | | | | | | | | | | | | | | | | |
| Types of construction | | | | | | | | | | | | | | | | |
| Without flange | | IM B3 ²⁾ | | | | | | | | | | | | Version | Order code | |
| With flange | | IM B5 ²⁾ | | | | | | | | | | | | Standard | A | - |
| | | | | | | | | | | | | With additional charge | F | - | | |
| | | | | | | | | | | | | | | ... | | |
| For other types of construction and more information, see from page 3/22 | | | | | | | | | | | | | | | | |
| Motor protection | | | | | | | | | | | | | | | | |
| PTC thermistor with 3 temperature sensors | | | | | | | | | | | | Version | Order code | | | |
| | | | | | | | | | | | | Standard | B | - | | |
| | | | | | | | | | | | | | | ... | | |
| For other motor protection and more information, see from page 3/24 | | | | | | | | | | | | | | | | |
| Terminal box position | | | | | | | | | | | | | | | | |
| Terminal box base left with terminal box 45° | | | | | | | | | | | | Version | Order code | | | |
| Terminal box base right with terminal box 45° | | | | | | | | | | | | Without additional charge | 2 | - | | |
| | | | | | | | | | | | | Standard | 3 | - | | |
| | | | | | | | | | | | | | | ... | | |
| For other terminal box positions and more information, see from page 3/25 | | | | | | | | | | | | | | | | |
| Special versions | | | | | | | | | | | | | | | | |
| Forced-air cooled motors w/o ext. fan/fan cover (IC418) | | | | | | | | | | | | 1LE5604- ... | | -Z F90+...+...+... | | |
| For options, see from page 3/26 | | | | | | | | | | | | | | | | |
| | | | | | | | | | | | | 1LE5604- ... | | -Z ...+...+...+... | | |



¹⁾ Parallel supply lines are required, except in the case of connection to 690 V.

²⁾ For a power rating of 315 kW, 2-pole, 60 Hz and 315 kW, 4-pole, 50 Hz, a larger terminal box can be used (order code **R50**) due to the magnitude of the current. Order code **R50** alters the motor dimensions.

SIMOTICS SD standard motors next generation

IE4 Super Premium Efficiency



Cast-iron series SIMOTICS SD Add 1LE5534 Basic Line – self-ventilated or forced-air cooled

Selection and ordering data

| Operating values at rated power | | | | | | | | | | | | | | Cast-iron series | | |
|--|------------|-------------|-------------|---------------------|---------------------|---------------------|-------------------------|-------------|----------------------------|----------------------------|-------------------------|-----------|----------|--------------------------------|-------------|--------------------|
| P_{rated} | Frame size | n_{rated} | T_{rated} | $\eta_{rated, 4/4}$ | $\eta_{rated, 3/4}$ | $\eta_{rated, 2/4}$ | $\cos\phi_{rated, 4/4}$ | I_{rated} | $\frac{T_{LR}}{T_{rated}}$ | $\frac{I_{LR}}{I_{rated}}$ | $\frac{T_B}{T_{rated}}$ | L_{pFA} | L_{WA} | 1LE5534 Basic Line Article No. | $m_{IM B3}$ | J |
| kW | FS | rpm | Nm | % | % | % | | A | | | | dB(A) | dB(A) | | kg | kgm ² |
| <ul style="list-style-type: none"> Cooling: Self-ventilated (IC411) Efficiency: IE4 Super Premium Efficiency Insulation: Thermal class 155 (temperature class F), IP55 degree of protection, utilization in accordance with thermal class 130 (temperature class B) | | | | | | | | | | | | | | | | |
| 2-pole: 3000 rpm at 50 Hz | | | | | | | | | | | | | | | | |
| 250 | 315 L | 2982 | 801 | 96.5 | 96.6 | 96.4 | 0.91 | 410 | 2.6 | 7.5 | 3 | 80 | 95 | 1LE5534-3AA6 | 1340 | 2.82 |
| 315 | 315 L | 2980 | 1009 | 96.5 | 96.7 | 96.5 | 0.91 | 520 | 2.4 | 7.5 | 2.9 | 81 | 96 | 1LE5534-3AA7 | 1490 | 3.11 |
| 4-pole: 1500 rpm at 50 Hz | | | | | | | | | | | | | | | | |
| 250 | 315 L | 1488 | 1604 | 96.7 | 97 | 97 | 0.86 | 435 | 2.3 | 6.5 | 2.6 | 75 | 90 | 1LE5534-3AB6 | 1520 | 5.09 |
| 315 | 315 L | 1488 | 2022 | 96.7 | 96.9 | 96.8 | 0.85 | 550 | 2.2 | 7.2 | 2.8 | 75 | 90 | 1LE5534-3AB7 | 1530 | 5.28 |
| 6-pole: 1000 rpm at 50 Hz | | | | | | | | | | | | | | | | |
| 200 | 315 L | 992 | 1925 | 96.3 | 96.5 | 96.3 | 0.81 | 370 | 2.8 | 7 | 3 | 68 | 83 | 1LE5534-3AC7 | 1410 | 6.28 |
| 250 | 315 L | 992 | 2407 | 96.5 | 96.6 | 96.3 | 0.81 | 460 | 2.9 | 7.3 | 3 | 68 | 83 | 1LE5534-3AC8 | 1640 | 8.10 |
| 8-pole: 750 rpm at 50 Hz | | | | | | | | | | | | | | | | |
| 160 | 315 L | 741 | 2062 | 95.1 | 95.5 | 95.5 | 0.79 | 305 | 2.4 | 6.2 | 2.4 | 67 | 82 | 1LE5534-3AD7 | 1420 | 6.78 |
| 200 | 315 L | 742 | 2574 | 95.4 | 95.6 | 95.3 | 0.78 | 390 | 2.7 | 6.7 | 2.9 | 72 | 87 | 1LE5534-3AD8 | 1660 | 8.60 |
| Voltages ¹⁾ | | | | | | | | | | | | | | | | |
| 50 Hz 400 VΔ/690 VY 60 Hz ¹⁾ 460 VΔ | | | | | | | | | | | | | | Version | | Order code |
| 50 Hz 500 VΔ | | | | | | | | | | | | | | Standard | | 3 4 |
| 50 Hz 690 VΔ | | | | | | | | | | | | | | Without additional charge | | 4 0 |
| | | | | | | | | | | | | | | With additional charge | | 4 7 |
| For other voltages ¹⁾ and more information, see from page 3/21 | | | | | | | | | | | | | | | | ... |
| Types of construction | | | | | | | | | | | | | | | | |
| Without flange IM B3 ²⁾ | | | | | | | | | | | | | | Version | | Order code |
| With flange IM B5 ²⁾ | | | | | | | | | | | | | | Standard | | A |
| | | | | | | | | | | | | | | With additional charge | | F |
| For other types of construction and more information, see from page 3/22 | | | | | | | | | | | | | | | | ... |
| Motor protection | | | | | | | | | | | | | | | | |
| Without | | | | | | | | | | | | | | Version | | Order code |
| PTC thermistor with 3 temperature sensors | | | | | | | | | | | | | | Standard | | A |
| | | | | | | | | | | | | | | With additional charge | | B |
| For other motor protection and more information, see from page 3/24 | | | | | | | | | | | | | | | | ... |
| Terminal box position | | | | | | | | | | | | | | | | |
| Terminal box base left with terminal box 45° | | | | | | | | | | | | | | Version | | Order code |
| Terminal box base right with terminal box 45° | | | | | | | | | | | | | | Without additional charge | | 2 |
| | | | | | | | | | | | | | | Standard | | 3 |
| For other terminal box positions and more information, see from page 3/25 | | | | | | | | | | | | | | | | ... |
| Special versions | | | | | | | | | | | | | | | | |
| Forced-air cooled motors w/o ext. fan/fan cover (IC418) | | | | | | | | | | | | | | 1LE5534-.... | | -Z F90+...+...+... |
| For options and information, see from page 3/26 | | | | | | | | | | | | | | 1LE5534-.... | | -Z ...+...+...+... |

¹⁾ For frame size 315, parallel supply lines are required, except in the case of connection to 690 V.

²⁾ For frame size 315 with power rating 315 kW, 2-pole, 60 Hz and 315 kW, 4-pole, 50 Hz, a larger terminal box can be used (order code **R50**) due to the magnitude of the current. Order code **R50** alters the motor dimensions.

Selection and ordering data

| P _{rated} | Frame size | Operating values at rated power | | | | | | | | | | | Cast-iron series 1LE5634 Performance Line Article No. | m _{IM B3} | J | | |
|--|------------|---------------------------------|--------------------|-------------------------|-------------------------|-------------------------|-----------------------------|--------------------|-------------------------------------|-------------------------------------|------------------------------------|------------------|--|--------------------|-------------------------------|-----------------|----|
| | | n _{rated} | T _{rated} | η _{rated, 4/4} | η _{rated, 3/4} | η _{rated, 2/4} | cos φ _{rated, 4/4} | I _{rated} | T _{LR} /T _{rated} | I _{LR} /I _{rated} | T _B /T _{rated} | L _{pfA} | | | | L _{WA} | kg |
| kW | FS | rpm | Nm | % | % | % | | A | | | | | | | | | |
| <ul style="list-style-type: none"> Cooling: Self-ventilated (IC411) Efficiency: IE4 Super Premium Efficiency Insulation: Thermal class 155 (temperature class F), IP55 degree of protection, utilization in accordance with thermal class 130 (temperature class B) | | | | | | | | | | | | | | | | | |
| 2-pole: 3000 rpm at 50 Hz | | | | | | | | | | | | | | | | | |
| 250 | 315 L | 2982 | 801 | 96.5 | 96.6 | 96.4 | 0.91 | 410 | 2.6 | 7.5 | 3 | 80 | 95 | 1LE5634-3AA6 | 1340 | 2.82 | |
| 315 | 315 L | 2980 | 1009 | 96.5 | 96.7 | 96.5 | 0.91 | 520 | 2.4 | 7.5 | 2.9 | 81 | 96 | 1LE5634-3AA7 | 1490 | 3.11 | |
| 355 | 355 L | 2984 | 1136 | 96.5 | 96.4 | 95.9 | 0.9 | 590 | 2.3 | 8.4 | 3.1 | 83 | 98 | 1LE5634-3BA3 | 2170 | 5.09 | |
| 400 | 355 L | 2986 | 1279 | 96.5 | 96.5 | 96 | 0.91 | 660 | 2.3 | 7.7 | 3.1 | 83 | 98 | 1LE5634-3BA4 | 2240 | 5.46 | |
| 500 | 355 L | 2988 | 1598 | 96.5 | 96.4 | 95.8 | 0.89 | 840 | 2.8 | 8.5 | 3.7 | 83 | 98 | 1LE5634-3BA5 | 2340 | 5.76 | |
| 4-pole: 1500 rpm at 50 Hz | | | | | | | | | | | | | | | | | |
| 250 | 315 L | 1488 | 1604 | 96.7 | 97 | 97 | 0.86 | 435 | 2.3 | 6.5 | 2.6 | 75 | 90 | 1LE5634-3AB6 | 1520 | 5.09 | |
| 315 | 315 L | 1488 | 2022 | 96.7 | 96.9 | 96.8 | 0.85 | 550 | 2.2 | 7.2 | 2.8 | 75 | 90 | 1LE5634-3AB7 | 1530 | 5.28 | |
| 355 | 355 L | 1491 | 2274 | 96.7 | 96.8 | 96.5 | 0.85 | 620 | 2.2 | 7.5 | 3.2 | 78 | 93 | 1LE5634-3BB3 | 1960 | 6.26 | |
| 400 | 355 L | 1491 | 2562 | 96.7 | 96.9 | 96.6 | 0.85 | 700 | 2.3 | 7.3 | 3.2 | 79 | 95 | 1LE5634-3BB4 | 2080 | 7.06 | |
| 500 | 355 L | 1491 | 3202 | 96.7 | 96.8 | 96.6 | 0.86 | 870 | 3.1 | 7.9 | 3.3 | 80 | 96 | 1LE5634-3BB5 | 2290 | 8.36 | |
| 6-pole: 1000 rpm at 50 Hz | | | | | | | | | | | | | | | | | |
| 200 | 315 L | 992 | 1925 | 96.3 | 96.5 | 96.3 | 0.81 | 370 | 2.8 | 7 | 3 | 68 | 83 | 1LE5634-3AC7 | 1410 | 6.39 | |
| 250 | 315 L | 992 | 2407 | 96.5 | 96.6 | 96.3 | 0.81 | 460 | 2.9 | 7.3 | 3 | 68 | 83 | 1LE5634-3AC8 | 1640 | 8.10 | |
| 315 | 355 L | 992 | 3032 | 96.6 | 96.9 | 96.9 | 0.86 | 550 | 2.4 | 6.8 | 2.8 | 75 | 90 | 1LE5634-3BC2 | 2150 | 12.9 | |
| 355 | 355 L | 993 | 3414 | 96.6 | 96.7 | 96.4 | 0.84 | 630 | 2.6 | 7.4 | 3.2 | 76 | 91 | 1LE5634-3BC3 | 2250 | 13.8 | |
| 400 | 355 L | 994 | 3843 | 96.6 | 96.7 | 96.5 | 0.84 | 710 | 2.7 | 7.7 | 2.9 | 75 | 90 | 1LE5634-3BC4 | 2240 | 13.4 | |
| 8-pole: 750 rpm at 50 Hz | | | | | | | | | | | | | | | | | |
| 160 | 315 L | 741 | 2062 | 95.1 | 95.5 | 95.5 | 0.79 | 305 | 2.4 | 6.2 | 2.4 | 67 | 82 | 1LE5634-3AD7 | 1420 | 6.78 | |
| 200 | 315 L | 742 | 2574 | 95.4 | 95.6 | 95.3 | 0.78 | 390 | 2.7 | 6.7 | 2.9 | 72 | 87 | 1LE5634-3AD8 | 1660 | 8.60 | |
| 250 | 355 L | 744 | 3200 | 95.4 | 95.8 | 95.8 | 0.80 | 475 | 2.4 | 7.1 | 2.7 | 68 | 83 | 1LE5634-3BD1 | 2280 | 13.3 | |
| 315 | 355 L | 744 | 4050 | 95.4 | 95.7 | 95.4 | 0.80 | 600 | 2.4 | 7.0 | 2.9E | 68 | 83 | 1LE5634-3BD2 | 2310 | 14 | |
| Voltages ¹⁾ | | | | | | | | | | | | | | | | | |
| 50 Hz 400 VΔ/690 VY | | | | | | | | | | | 60 Hz ¹⁾ 460 VΔ | | Version | | Order code | | |
| 50 Hz 500 VΔ | | | | | | | | | | | | | Standard | | 3 4 | | |
| 50 Hz 690 VΔ | | | | | | | | | | | | | Without additional charge | | 4 0 | | |
| | | | | | | | | | | | | | With additional charge | | 4 7 | | |
| | | | | | | | | | | | | | | | ... | | |
| For other voltages ¹⁾ and more information, see from page 3/21 | | | | | | | | | | | | | | | | | |
| Types of construction | | | | | | | | | | | | | | | | | |
| Without flange | | | | | | | | | | | IM B3 ²⁾ | | Version | | Order code | | |
| With flange | | | | | | | | | | | IM B5 ²⁾ | | Standard | | A | | |
| | | | | | | | | | | | | | With additional charge | | F | | |
| | | | | | | | | | | | | | | | ... | | |
| For other types of construction and more information, see from page 3/22 | | | | | | | | | | | | | | | | | |
| Motor protection | | | | | | | | | | | | | | | | | |
| PTC thermistor with 3 temperature sensors | | | | | | | | | | | | | Version | | Order code | | |
| | | | | | | | | | | | | | Standard | | B | | |
| | | | | | | | | | | | | | | | ... | | |
| For other motor protection and more information, see from page 3/24 | | | | | | | | | | | | | | | | | |
| Terminal box position | | | | | | | | | | | | | | | | | |
| Terminal box base left with terminal box 45° | | | | | | | | | | | | | Version | | Order code | | |
| Terminal box base right with terminal box 45° | | | | | | | | | | | | | Without additional charge | | 2 | | |
| | | | | | | | | | | | | | Standard | | 3 | | |
| | | | | | | | | | | | | | | | ... | | |
| For other terminal box positions and more information, see from page 3/25 | | | | | | | | | | | | | | | | | |
| Special versions | | | | | | | | | | | | | | | | | |
| Forced-air cooled motors w/o ext. fan/fan cover (IC418) | | | | | | | | | | | | | | | Order code(s) | | |
| | | | | | | | | | | | | | | | 1LE5634-...-Z F90+...+...+... | | |
| For options and information, see from page 3/26 | | | | | | | | | | | | | | | 1LE5634-...-Z ...+...+...+... | | |

¹⁾ Parallel supply lines are required, except in the case of connection to 690 V.

²⁾ For a power rating of 315 kW, 2-pole, 60 Hz and 315 kW, 4-pole, 50 Hz, a larger terminal box can be used (order code **R50**) due to the magnitude of the current.
Order code **R50** alters the motor dimensions.

SIMOTICS SD standard motors next generation

IE4 Super Premium Efficiency



Cast-iron series SIMOTICS SD Add 1LE5534 (frame sizes 400 and 450) – self-ventilated or forced-air cooled

Selection and ordering data

| P _{rated} kW | Frame size FS | Operating values at rated power | | | | | | | | | | | Cast-iron series 1LE5534 Article No. | m _{IM B3} kg | J kgm ² | |
|---|------------------|---------------------------------|--------------------------|------------------------------|------------------------------|------------------------------|-----------------------------|-------------------------|-------------------------------------|-------------------------------------|------------------------------------|---------------------------|--|-----------------------------|-----------------------|--------------------------|
| | | n _{rated} rpm | T _{rated} Nm | η _{rated, 4/4} % | η _{rated, 3/4} % | η _{rated, 2/4} % | cos φ _{rated, 4/4} | I _{rated} A | T _{LR} /I _{rated} | I _{LR} /I _{rated} | T _B /I _{rated} | L _{pFA} dB(A) | | | | L _{WA} dB(A) |
| 2-pole: 3000 rpm at 50 Hz | | | | | | | | | | | | | | | | |
| 560 ^{1) 2)} | 400 | 2988 | 1790 | 97.0 | 96.9 | 96.5 | 0.89 | 940 | 1.6 | 7.3 | 3.1 | 74 | 90 | 1LE5534-4AA3 | 2850 | 8.9 |
| 630 ^{1) 2)} | 400 | 2988 | 2000 | 97.0 | 97.1 | 96.8 | 0.90 | 1040 | 1.6 | 7.3 | 3.0 | 74 | 90 | 1LE5534-4AA5 | 3000 | 9.8 |
| 710 ³⁾ | 400 | 2988 | 2250 | 97.1 | 97.2 | 96.9 | 0.90 | 680 | 1.7 | 7.3 | 2.9 | 74 | 90 | 1LE5534-4AA7 | 3200 | 10.8 |
| 800 ^{1) 2) 3) 4)} | 450 | 2990 | 2550 | 97.4 | 97.4 | 97.1 | 0.87 | 790 | 1.2 | 7.7 | 3.3 | 75 | 91 | 1LE5534-4BA3 | 4000 | 12.3 |
| 900 ^{1) 2) 3) 4)} | 450 | 2988 | 2900 | 97.4 | 97.5 | 97.4 | 0.89 | 870 | 1.2 | 7.2 | 3.0 | 75 | 91 | 1LE5534-4BA5 | 4250 | 13.5 |
| 1000 ^{1) 2) 3) 4)} | 450 | 2988 | 3200 | 97.4 | 97.6 | 97.6 | 0.90 | 950 | 1.2 | 7.0 | 2.7 | 75 | 91 | 1LE5534-4BA7 | 4450 | 14.7 |
| 4-pole: 1500 rpm at 50 Hz | | | | | | | | | | | | | | | | |
| 560 ^{1) 2)} | 400 | 1493 | 3600 | 96.9 | 97.0 | 96.6 | 0.86 | 970 | 2.2 | 7.5 | 3.1 | 72 | 88 | 1LE5534-4AB3 | 3050 | 14.9 |
| 630 ^{1) 2)} | 400 | 1492 | 4050 | 96.8 | 96.9 | 96.6 | 0.87 | 1080 | 2.2 | 6.9 | 2.8 | 74 | 90 | 1LE5534-4AB5 | 3150 | 15.6 |
| 710 ³⁾ | 400 | 1492 | 4550 | 97.0 | 97.0 | 96.8 | 0.87 | 700 | 2.2 | 7.2 | 2.9 | 74 | 90 | 1LE5534-4AB7 | 3250 | 16.9 |
| 800 ³⁾ | 450 | 1492 | 5100 | 96.9 | 97.1 | 96.9 | 0.87 | 790 | 1.4 | 6.5 | 2.4 | 79 | 95 | 1LE5534-4BB3 | 4000 | 24.0 |
| 900 ³⁾ | 450 | 1492 | 5800 | 97.0 | 97.2 | 97.0 | 0.88 | 880 | 1.4 | 6.5 | 2.5 | 79 | 95 | 1LE5534-4BB5 | 4150 | 25.4 |
| 1000 ^{1) 3)} | 450 | 1492 | 6400 | 97.1 | 97.2 | 97.1 | 0.88 | 980 | 1.5 | 6.8 | 2.6 | 79 | 95 | 1LE5534-4BB7 | 4350 | 28.0 |
| 6-pole: 1000 rpm at 50 Hz | | | | | | | | | | | | | | | | |
| 450 | 400 | 994 | 4300 | 96.6 | 96.8 | 96.4 | 0.85 | 790 | 2.2 | 7.2 | 2.7 | 70 | 86 | 1LE5534-4AC3 | 3100 | 25.5 |
| 500 ¹⁾ | 400 | 994 | 4800 | 96.7 | 96.8 | 96.5 | 0.85 | 880 | 2.3 | 7.3 | 2.8 | 70 | 86 | 1LE5534-4AC5 | 3250 | 27.4 |
| 560 | 400 | 994 | 5400 | 96.7 | 96.8 | 96.4 | 0.84 | 1000 | 2.4 | 7.5 | 2.9 | 70 | 86 | 1LE5534-4AC7 | 3300 | 28.6 |
| 630 ^{1) 2)} | 450 | 995 | 6000 | 96.8 | 97.0 | 96.7 | 0.83 | 1130 | 2.0 | 7.0 | 2.8 | 72 | 88 | 1LE5534-4BC3 | 4050 | 38.6 |
| 710 ³⁾ | 450 | 994 | 6800 | 96.8 | 97.0 | 96.9 | 0.84 | 730 | 1.8 | 6.6 | 2.5 | 72 | 88 | 1LE5534-4BC5 | 4200 | 41.0 |
| 800 ^{1) 3)} | 450 | 994 | 7700 | 96.8 | 97.0 | 96.8 | 0.84 | 820 | 1.8 | 6.6 | 2.4 | 74 | 90 | 1LE5534-4BC7 | 4300 | 43.3 |
| 8-pole: 750 rpm at 50 Hz | | | | | | | | | | | | | | | | |
| 355 | 400 | 744 | 4550 | 95.8 | 96.1 | 95.8 | 0.80 | 670 | 2.0 | 6.5 | 2.6 | 64 | 80 | 1LE5534-4AD3 | 2850 | 21.9 |
| 400 | 400 | 744 | 5100 | 96.0 | 96.2 | 95.9 | 0.80 | 750 | 2.1 | 6.8 | 2.7 | 64 | 80 | 1LE5534-4AD5 | 3050 | 24.5 |
| 450 | 400 | 744 | 5800 | 96.0 | 96.3 | 96.0 | 0.80 | 850 | 2.1 | 6.8 | 2.7 | 64 | 80 | 1LE5534-4AD7 | 3250 | 27.5 |
| 500 ⁵⁾ | 450 | 745 | 6400 | 96.2 | 96.4 | 96.1 | 0.79 | 950 | 2.0 | 6.8 | 2.5 | 67 | 83 | 1LE5534-4BD3 | 3800 | 34.0 |
| 560 ⁵⁾ | 450 | 745 | 7200 | 96.3 | 96.5 | 96.1 | 0.79 | 1060 | 2.0 | 6.9 | 2.6 | 67 | 83 | 1LE5534-4BD5 | 4000 | 38.0 |
| 630 ^{1) 5)} | 450 | 745 | 8100 | 96.4 | 96.6 | 96.3 | 0.80 | 1180 | 2.0 | 6.9 | 2.5 | 67 | 83 | 1LE5534-4BD7 | 4250 | 42.5 |
| Ordering options | | | | | | | | | | | | | | | | |
| Voltages | | | | | | | | | | | | Version | | Order code | | |
| 50 Hz 400 VΔ/690 VY | | 60 Hz 460 VΔ | | Standard | | | | 3 4 | | | | - | | | | |
| 50 Hz 500 VΔ | | | | Without additional charge | | | | 4 0 | | | | - | | | | |
| 50 Hz 690 VΔ | | | | With additional charge | | | | 4 7 | | | | - | | | | |
| For other voltages and more information, see from page 3/21 | | | | | | | | | | | | | | ... | | |
| Types of construction | | | | | | | | | | | | Version | | Order code | | |
| Without flange | | IM B3 | | Standard | | | | A | | | | - | | | | |
| With flange | | IM B5 | | With additional charge | | | | F | | | | - | | | | |
| For other types of construction and more information, see from page 3/22 | | | | | | | | | | | | | | ... | | |
| Motor protection | | | | | | | | | | | | Version | | Order code | | |
| Without | | | | Standard | | | | A | | | | - | | | | |
| PTC thermistor with 3 temperature sensors | | | | With additional charge | | | | B | | | | - | | | | |
| For other motor protection and more information, see from page 3/24 | | | | | | | | | | | | | | ... | | |
| Terminal box position | | | | | | | | | | | | Version | | Order code | | |
| Terminal box base left with terminal box 45° | | | | Without additional charge | | | | 2 | | | | - | | | | |
| Terminal box base right with terminal box 45° | | | | Standard | | | | 3 | | | | - | | | | |
| For other terminal box positions and more information, see from page 3/25 | | | | | | | | | | | | | | ... | | |
| Special versions | | | | | | | | | | | | | | Order code(s) | | |
| Forced-air cooled motors w/o ext. fan/fan cover (IC418) | | | | | | | | | | | | 1LE5534- -Z | | F90+ + | | |
| For options and information, see from page 3/26 | | | | | | | | | | | | 1LE5534- -Z | | + + | | |

1) Terminal box 1XB1631.
 2) Terminal box position NDE can only be ordered using order code **H09** (2 × terminal box TB3R61). Order code **H08** not available.
 3) The standard version is 50 Hz 690 VΔ (voltage code **4-7**) or 60 Hz 575 VΔ (voltage code **4-0**).
 4) In the series version, the maximum speed is n_{max} = 3000 rpm. Operation up to 3600 rpm at higher speeds on request for an additional charge.
 5) Utilization with sinusoidal supply in accordance with thermal class 155 (temperature class F).



Cast-iron series SIMOTICS SD 1LE5503 Basic Line – self-ventilated or forced-air cooled

Selection and ordering data

| Operating values at rated power | | | | | | | | | | | | | | Cast-iron series | | |
|--|------------|-------------|-------------|---------------------|---------------------|---------------------|-------------------------|-------------|----------------------------|----------------------------|-------------------------|-----------|----------|--------------------------------|-------------|------------------|
| P_{rated} | Frame size | n_{rated} | T_{rated} | $\eta_{rated, 4/4}$ | $\eta_{rated, 3/4}$ | $\eta_{rated, 2/4}$ | $\cos\phi_{rated, 4/4}$ | I_{rated} | $\frac{T_{LR}}{T_{rated}}$ | $\frac{I_{LR}}{I_{rated}}$ | $\frac{T_B}{T_{rated}}$ | L_{pfA} | L_{WA} | 1LE5503 Basic Line Article No. | $m_{IM B3}$ | J |
| kW | FS | rpm | Nm | % | % | % | | A | | | | dB(A) | dB(A) | | kg | kgm ² |
| <ul style="list-style-type: none"> Cooling: Self-ventilated (IC411) Efficiency according to IEC 60034-30: IE3 Premium Efficiency Insulation: Thermal class 155 (temperature class F), IP55 degree of protection, utilization in accordance with thermal class 130 (temperature class B) | | | | | | | | | | | | | | | | |
| 2-pole: 3000 rpm at 50 Hz | | | | | | | | | | | | | | | | |
| 250 | 315 L | 2986 | 800 | 95.8 | 95.7 | 95 | 0.88 | 430 | 3 | 9.3 | 4.2 | 80 | 94 | 1LE5503-3AA6 | 1340 | 2.82 |
| 315 | 315 L | 2986 | 1007 | 95.8 | 95.6 | 94.8 | 0.87 | 550 | 3.5 | 9.9 | 4.2 | 81 | 96 | 1LE5503-3AA7 | 1520 | 3.27 |
| 4-pole: 1500 rpm at 50 Hz | | | | | | | | | | | | | | | | |
| 250 | 315 L | 1490 | 1602 | 96 | 96.1 | 95.7 | 0.85 | 440 | 2.8 | 7.9 | 3.2 | 75 | 91 | 1LE5503-3AB6 | 1290 | 4.27 |
| 315 | 315 L | 1490 | 2019 | 96 | 96 | 95.6 | 0.83 | 570 | 3.2 | 8.5 | 3.5 | 75 | 90 | 1LE5503-3AB7 | 1560 | 5.39 |
| 6-pole: 1000 rpm at 50 Hz | | | | | | | | | | | | | | | | |
| 200 | 315 L | 992 | 1925 | 95.8 | 95.9 | 95.6 | 0.82 | 365 | 3 | 7.5 | 3.2 | 68 | 83 | 1LE5503-3AC7 | 1410 | 6.28 |
| 250 | 315 L | 992 | 2407 | 95.8 | 95.9 | 95.6 | 0.81 | 465 | 3.2 | 8.2 | 3.3 | 69 | 84 | 1LE5503-3AC8 | 1700 | 8.00 |
| 8-pole: 750 rpm at 50 Hz | | | | | | | | | | | | | | | | |
| 160 | 315 L | 741 | 2062 | 94.3 | 94.7 | 94.7 | 0.79 | 310 | 2.5 | 6.3 | 2.5 | 67 | 82 | 1LE5503-3AD7 | 1420 | 6.78 |
| 200 | 315 L | 742 | 2574 | 94.6 | 94.8 | 94.5 | 0.78 | 390 | 2.7 | 6.7 | 2.9 | 72 | 87 | 1LE5503-3AD8 | 1660 | 8.60 |
| Voltagess ¹⁾ | | | | | | | | | | | | | | | | |
| 50 Hz 400 VΔ/690 VY 60 Hz ¹⁾ 460 VΔ | | | | | | | | | | | | | | Version | | Order code |
| 50 Hz 500 VΔ | | | | | | | | | | | | | | Standard | | 3 4 |
| 50 Hz 690 VΔ | | | | | | | | | | | | | | Without additional charge | | 4 0 |
| | | | | | | | | | | | | | | With additional charge | | 4 7 |
| For other voltages ¹⁾ and more information, see from page 3/21 | | | | | | | | | | | | | | | | |
| Types of construction | | | | | | | | | | | | | | | | |
| Without flange IM B3 ²⁾ | | | | | | | | | | | | | | Version | | Order code |
| With flange IM B5 ²⁾ | | | | | | | | | | | | | | Standard | | A |
| | | | | | | | | | | | | | | With additional charge | | F |
| For other types of construction and more information, see from page 3/22 | | | | | | | | | | | | | | | | |
| Motor protection | | | | | | | | | | | | | | | | |
| Without | | | | | | | | | | | | | | Version | | Order code |
| PTC thermistor with 3 temperature sensors | | | | | | | | | | | | | | Standard | | A |
| | | | | | | | | | | | | | | With additional charge | | B |
| For other motor protection and more information, see from page 3/24 | | | | | | | | | | | | | | | | |
| Terminal box position | | | | | | | | | | | | | | | | |
| Terminal box base left with terminal box 45° | | | | | | | | | | | | | | Version | | Order code |
| Terminal box base right with terminal box 45° | | | | | | | | | | | | | | Without additional charge | | 2 |
| | | | | | | | | | | | | | | Standard | | 3 |
| For other terminal box positions and more information, see from page 3/25 | | | | | | | | | | | | | | | | |
| Special versions | | | | | | | | | | | | | | | | |
| For options, see from page 3/26 | | | | | | | | | | | | | | | | |
| | | | | | | | | | | | | | | 1LE5503- | | -Z |



¹⁾ Parallel supply lines are required, except in the case of connection to 690 V.

²⁾ For a power rating of 315 kW, 2-pole, 60 Hz and 315 kW, 4-pole, 50 Hz, a larger terminal box can be used (order code **R50**) due to the magnitude of the current. Order code **R50** alters the motor dimensions.

SIMOTICS SD standard motors next generation

IE3 Premium Efficiency



Cast-iron series SIMOTICS SD 1LE5603 Performance Line – self-ventilated or forced-air cooled

Selection and ordering data

| P _{rated} | Frame size | Operating values at rated power | | | | | | | | | | | | | Cast-iron series 1LE5603 Performance Line Article No. | m _{IM B3} | J |
|---|--------------|---------------------------------|--------------------|-------------------------|-------------------------|---------------------------|----------------------------|--------------------|-------------------------------------|-------------------------------------|------------------------------------|------------------|------------------|---------------------|--|--------------------|---|
| | | n _{rated} | T _{rated} | η _{rated, 4/4} | η _{rated, 3/4} | η _{rated, 2/4} | cosϕ _{rated, 4/4} | I _{rated} | T _{LR} /T _{rated} | I _{LR} /I _{rated} | T _B /T _{rated} | L _{pfA} | L _{WA} | | | | |
| kW | FS | rpm | Nm | % | % | % | | A | | | | | | | kg | kgm ² | |
| 2-pole: 3000 rpm at 50 Hz | | | | | | | | | | | | | | | | | |
| 250 | 315 L | 2986 | 800 | 95.8 | 95.6 | 95.0 | 0.88 | 430 | 3.0 | 9 | 4.2 | 80 | 94 | 1LE5603-3AA6 | 1340 | 2.82 | |
| 315 | 315 L | 2986 | 1007 | 95.8 | 95.6 | 94.8 | 0.87 | 550 | 3.5 | 9.9 | 4.2 | 81 | 96 | 1LE5603-3AA7 | 1520 | 3.27 | |
| 355 | 355 L | 2988 | 1135 | 95.8 | 95.6 | 94.8 | 0.89 | 600 | 2.6 | 8.9 | 4.0 | 84 | 99 | 1LE5603-3BA3 | 2100 | 4.74 | |
| 400 | 355 L | 2986 | 1279 | 95.8 | 95.7 | 95.2 | 0.92 | 660 | 2.6 | 8.5 | 3.4 | 83 | 98 | 1LE5603-3BA4 | 2240 | 5.36 | |
| 500 | 355 L | 2988 | 1598 | 95.8 | 95.7 | 95.1 | 0.89 | 850 | 3.0 | 8.9 | 3.8 | 84 | 98 | 1LE5603-3BA5 | 2340 | 5.76 | |
| 4-pole: 1500 rpm at 50 Hz | | | | | | | | | | | | | | | | | |
| 250 | 315 L | 1490 | 1602 | 96.0 | 96.1 | 95.7 | 0.85 | 440 | 2.8 | 7.9 | 3.2 | 75 | 91 | 1LE5603-3AB6 | 1290 | 4.27 | |
| 315 | 315 L | 1490 | 2019 | 96.0 | 96.0 | 95.6 | 0.83 | 570 | 3.2 | 8.5 | 3.5 | 75 | 90 | 1LE5603-3AB7 | 1560 | 5.39 | |
| 355 | 355 L | 1492 | 2272 | 96.0 | 96.0 | 95.4 | 0.86 | 620 | 2.9 | 7.9 | 2.8 | 81 | 96 | 1LE5603-3BB3 | 2290 | 6.76 | |
| 400 | 355 L | 1492 | 2560 | 96.0 | 96.0 | 95.5 | 0.84 | 720 | 3.4 | 8.4 | 3.0 | 81 | 96 | 1LE5603-3BB4 | 2110 | 7.16 | |
| 500 | 355 L | 1491 | 3202 | 96.0 | 96.1 | 95.9 | 0.86 | 870 | 3.0 | 8.1 | 3.3 | 82 | 96 | 1LE5603-3BB5 | 2290 | 8.36 | |
| 6-pole: 1000 rpm at 50 Hz | | | | | | | | | | | | | | | | | |
| 200 | 315 L | 992 | 1925 | 95.8 | 95.9 | 95.6 | 0.82 | 365 | 3 | 7.5 | 3.2 | 68 | 83 | 1LE5603-3AC7 | 1410 | 6.28 | |
| 250 | 315 L | 992 | 2407 | 95.8 | 95.9 | 95.6 | 0.81 | 465 | 3.2 | 8.2 | 3.3 | 69 | 84 | 1LE5603-3AC8 | 1700 | 8.00 | |
| 315 | 355 L | 993 | 3029 | 95.8 | 95.8 | 95.3 | 0.82 | 580 | 2.9 | 7.8 | 3.2 | 75 | 90 | 1LE5603-3BC2 | 2040 | 11.6 | |
| 355 | 355 L | 993 | 3414 | 95.8 | 95.9 | 95.5 | 0.83 | 640 | 2.9 | 8.4 | 3.3 | 74 | 89 | 1LE5603-3BC3 | 2250 | 13.7 | |
| 400 | 355 L | 994 | 3843 | 95.8 | 96 | 95.8 | 0.84 | 720 | 2.8 | 8.1 | 3 | 75 | 90 | 1LE5603-3BC4 | 2240 | 13.4 | |
| 8-pole: 750 rpm at 50 Hz | | | | | | | | | | | | | | | | | |
| 160 | 315 L | 741 | 2062 | 94.3 | 94.7 | 94.7 | 0.79 | 310 | 2.5 | 6.3 | 2.5 | 67 | 82 | 1LE5603-3AD7 | 1420 | 6.78 | |
| 200 | 315 L | 742 | 2574 | 94.6 | 94.8 | 94.5 | 0.78 | 390 | 2.7 | 6.7 | 2.9 | 72 | 87 | 1LE5603-3AD8 | 1660 | 8.60 | |
| 250 | 355 L | 744 | 3209 | 94.6 | 95.0 | 95.0 | 0.80 | 475 | 2.4 | 7.1 | 2.7 | 73 | 88 | 1LE5603-3BD1 | 2280 | 13.3 | |
| 315 | 355 L | 744 | 4043 | 94.6 | 94.9 | 94.6 | 0.80 | 600 | 2.5 | 7.3 | 3.0 | 68 | 83 | 1LE5603-3BD2 | 2360 | 14 | |
| Voltages¹⁾ | | | | | | | | | | | | | | | | | |
| 50 Hz 400 VΔ/690 VY | | 60 Hz ¹⁾ 460 VΔ | | | | | Version | | | | | Order code | | | | | |
| 50 Hz 500 VΔ | | | | | | Standard | | | | | | 3 | 4 | - | | | |
| 50 Hz 690 VΔ | | | | | | Without additional charge | | | | | | 4 | 0 | - | | | |
| | | | | | | With additional charge | | | | | | 4 | 7 | - | | | |
| For other voltages ¹⁾ and more information, see from page 3/21 | | | | | | | | | | | | | | | | | |
| Types of construction | | | | | | | | | | | | | | | | | |
| Without flange | | IM B3 ²⁾ | | | | | Version | | | | | Order code | | | | | |
| Standard | | | | | | | | | | | | A | - | | | | |
| With flange | | IM B5 ²⁾ | | | | | With additional charge | | | | | | F | - | | | |
| For other types of construction and more information, see from page 3/22 | | | | | | | | | | | | | | | | | |
| Motor protection | | | | | | | | | | | | | | | | | |
| PTC thermistor with 3 temperature sensors | | | | | | Version | | | | | Order code | | | | | | |
| Standard | | | | | | | | | | | | B | - | | | | |
| For other motor protection and more information, see from page 3/24 | | | | | | | | | | | | | | | | | |
| Terminal box position | | | | | | | | | | | | | | | | | |
| Terminal box base left with terminal box 45° | | Version | | | | | Order code | | | | | | | | | | |
| Without additional charge | | | | | | | | | | | | 2 | - | | | | |
| Terminal box base right with terminal box 45° | | Standard | | | | | | | | | | | 3 | - | | | |
| For other terminal box positions and more information, see from page 3/25 | | | | | | | | | | | | | | | | | |
| Special versions | | | | | | | | | | | | | | | | | |
| For options, see from page 3/26 | | | | | | | | | | | | | | | | | |
| | | | | | | | | | | | | | 1LE5603-...-Z... | | | | |

¹⁾ Parallel supply lines are required, except in the case of connection to 690 V.

²⁾ For a power rating of 315 kW, 2-pole, 60 Hz and 315 kW, 4-pole, 50 Hz, a larger terminal box can be used (order code **R50**) due to the magnitude of the current. Order code **R50** alters the motor dimensions.

Selection and ordering data

| Operating values at rated power | | | | | | | | | | | | | | Cast-iron series | | |
|--|------------|-------------|-------------|---------------------|---------------------|---------------------|-------------------------|-------------|----------------------------|----------------------------|-------------------------|-----------|----------|--------------------------------|-------------|--------------------|
| P_{rated} | Frame size | n_{rated} | T_{rated} | $\eta_{rated, 4/4}$ | $\eta_{rated, 3/4}$ | $\eta_{rated, 2/4}$ | $\cos\phi_{rated, 4/4}$ | I_{rated} | $\frac{T_{LR}}{T_{rated}}$ | $\frac{I_{LR}}{I_{rated}}$ | $\frac{T_B}{T_{rated}}$ | L_{pfA} | L_{WA} | 1LE5533 Basic Line Article No. | $m_{IM B3}$ | J |
| kW | FS | rpm | Nm | % | % | % | | A | | | | dB(A) | dB(A) | | kg | kgm ² |
| <ul style="list-style-type: none"> • Cooling: Self-ventilated (IC411) • Efficiency: IE3 Premium Efficiency • Insulation: Thermal class 155 (temperature class F), IP55 degree of protection, utilization in accordance with thermal class 130 (temperature class B) | | | | | | | | | | | | | | | | |
| 2-pole: 3000 rpm at 50 Hz | | | | | | | | | | | | | | | | |
| 250 | 315 L | 2982 | 801 | 95.8 | 95.9 | 95.6 | 0.91 | 415 | 2.8 | 7.2 | 3 | 80 | 94 | 1LE5533-3AA6 | 1340 | 2.82 |
| 315 | 315 L | 2980 | 1009 | 95.8 | 96 | 95.8 | 0.91 | 520 | 2.4 | 7.5 | 2.9 | 81 | 96 | 1LE5533-3AA7 | 1490 | 3.11 |
| 4-pole: 1500 rpm at 50 Hz | | | | | | | | | | | | | | | | |
| 250 | 315 L | 1490 | 1602 | 96 | 96.2 | 95.9 | 0.87 | 430 | 2.1 | 7.2 | 2.8 | 75 | 91 | 1LE5533-3AB6 | 1400 | 4.55 |
| 315 | 315 L | 1488 | 2022 | 96 | 96.2 | 96.1 | 0.85 | 560 | 2.2 | 7.2 | 2.8 | 75 | 90 | 1LE5533-3AB7 | 1530 | 5.28 |
| 6-pole: 1000 rpm at 50 Hz | | | | | | | | | | | | | | | | |
| 200 | 315 L | 992 | 1925 | 95.8 | 96 | 95.8 | 0.81 | 370 | 2.8 | 7 | 3 | 68 | 83 | 1LE5533-3AC7 | 1410 | 6.39 |
| 250 | 315 L | 992 | 2407 | 95.8 | 95.9 | 95.6 | 0.81 | 465 | 2.9 | 7.2 | 3 | 68 | 83 | 1LE5533-3AC8 | 1640 | 8.10 |
| 8-pole: 750 rpm at 50 Hz | | | | | | | | | | | | | | | | |
| 160 | 315 L | 741 | 2062 | 94.3 | 94.7 | 94.7 | 0.79 | 310 | 2.4 | 6.2 | 2.4 | 67 | 82 | 1LE5533-3AD7 | 1420 | 6.78 |
| 200 | 315 L | 742 | 2574 | 94.6 | 94.8 | 94.5 | 0.78 | 390 | 2.7 | 6.7 | 2.9 | 72 | 87 | 1LE5533-3AD8 | 1660 | 8.60 |
| Voltages ¹⁾ | | | | | | | | | | | | | | | | |
| 50 Hz 400 VΔ/690 VY 60 Hz ¹⁾ 460 VΔ | | | | | | | | | | | | | | Version | | Order code |
| 50 Hz 500 VΔ | | | | | | | | | | | | | | Standard | | 3 4 |
| 50 Hz 690 VΔ | | | | | | | | | | | | | | Without additional charge | | 4 0 |
| | | | | | | | | | | | | | | With additional charge | | 4 7 |
| For other voltages ¹⁾ and more information, see from page 3/21 | | | | | | | | | | | | | | | | ... |
| Types of construction | | | | | | | | | | | | | | | | |
| Without flange IM B3 ²⁾ | | | | | | | | | | | | | | Version | | Order code |
| With flange IM B5 ²⁾ | | | | | | | | | | | | | | Standard | | A |
| | | | | | | | | | | | | | | With additional charge | | F |
| For other types of construction and more information, see from page 3/22 | | | | | | | | | | | | | | | | ... |
| Motor protection | | | | | | | | | | | | | | | | |
| Without | | | | | | | | | | | | | | Version | | Order code |
| PTC thermistor with 3 temperature sensors | | | | | | | | | | | | | | Standard | | A |
| | | | | | | | | | | | | | | With additional charge | | B |
| For other motor protection and more information, see from page 3/24 | | | | | | | | | | | | | | | | ... |
| Terminal box position | | | | | | | | | | | | | | | | |
| Terminal box base left with terminal box 45° | | | | | | | | | | | | | | Version | | Order code |
| Terminal box base right with terminal box 45° | | | | | | | | | | | | | | Without additional charge | | 2 |
| | | | | | | | | | | | | | | Standard | | 3 |
| For other terminal box positions and more information, see from page 3/25 | | | | | | | | | | | | | | | | ... |
| Special versions | | | | | | | | | | | | | | | | |
| Forced-air cooled motors w/o ext. fan/fan cover (IC418) | | | | | | | | | | | | | | 1LE5533-.... | | -Z F90+...+...+... |
| For options and information, see from page 3/26 | | | | | | | | | | | | | | 1LE5533-.... | | -Z ...+...+...+... |

¹⁾ For frame size 315, parallel supply lines are required, except in the case of connection to 690 V.

²⁾ For frame size 315 with power rating 315 kW, 2-pole, 60 Hz and 315 kW, 4-pole, 50 Hz, a larger terminal box can be used (order code **R50**) due to the magnitude of the current. Order code **R50** alters the motor dimensions.

SIMOTICS SD standard motors next generation

IE3 Premium Efficiency

IE3

Cast-iron series SIMOTICS SD Add 1LE5633 Performance Line – self-ventilated or forced-air cooled

Selection and ordering data

| P _{rated} | Frame size | Operating values at rated power | | | | | | | | | | | Cast-iron series 1LE5633 Performance Line Article No. | m _{IM B3} | J | |
|---|------------|---------------------------------|--------------------|-------------------------|-------------------------|-------------------------|-----------------------------|--------------------|-------------------------------------|-------------------------------------|------------------------------------|------------------------------------|--|--------------------|------------|------------------|
| | | n _{rated} | T _{rated} | η _{rated, 4/4} | η _{rated, 3/4} | η _{rated, 2/4} | cos φ _{rated, 4/4} | I _{rated} | T _{LR} /T _{rated} | I _{LR} /I _{rated} | T _B /T _{rated} | L _{pfA} | | | | L _{WA} |
| kW | FS | rpm | Nm | % | % | % | | A | | | | | | | kg | kgm ² |
| • Cooling: Self-ventilated (IC411) | | | | | | | | | | | | | | | | |
| • Efficiency: IE3 Premium Efficiency | | | | | | | | | | | | | | | | |
| • Insulation: Thermal class 155 (temperature class F), IP55 degree of protection, utilization in accordance with thermal class 130 (temperature class B) | | | | | | | | | | | | | | | | |
| 2-pole: 3000 rpm at 50 Hz | | | | | | | | | | | | | | | | |
| 250 | 315 L | 2982 | 801 | 95.8 | 95.9 | 95.6 | 0.91 | 415 | 2.8 | 7.2 | 3 | 80 | 94 | 1LE5633-3AA6 | 1340 | 2.82 |
| 315 | 315 L | 2980 | 1009 | 95.8 | 96 | 95.8 | 0.91 | 520 | 2.4 | 7.5 | 2.9 | 81 | 96 | 1LE5633-3AA7 | 1490 | 3.11 |
| 355 | 355 L | 2984 | 1136 | 95.8 | 95.7 | 95.2 | 0.9 | 590 | 2.3 | 8.4 | 3.1 | 83 | 98 | 1LE5633-3BA3 | 2170 | 5.07 |
| 400 | 355 L | 2986 | 1279 | 95.8 | 95.8 | 95.3 | 0.91 | 660 | 2.3 | 7.7 | 3.1 | 83 | 98 | 1LE5633-3BA4 | 2240 | 5.46 |
| 500 | 355 L | 2988 | 1598 | 95.8 | 95.7 | 95.1 | 0.89 | 850 | 2.8 | 8.5 | 3.7 | 83 | 98 | 1LE5633-3BA5 | 2340 | 5.76 |
| 4-pole: 1500 rpm at 50 Hz | | | | | | | | | | | | | | | | |
| 250 | 315 L | 1490 | 1602 | 96 | 96.2 | 95.9 | 0.87 | 430 | 2.1 | 7.2 | 2.8 | 75 | 91 | 1LE5633-3AB6 | 1400 | 4.55 |
| 315 | 315 L | 1488 | 2022 | 96 | 96.2 | 96.1 | 0.85 | 560 | 2.2 | 7.2 | 2.8 | 75 | 90 | 1LE5633-3AB7 | 1530 | 5.28 |
| 355 | 355 L | 1491 | 2274 | 96 | 96.1 | 95.8 | 0.88 | 610 | 2.2 | 7.5 | 3.1 | 81 | 95 | 1LE5633-3BB3 | 2070 | 6.36 |
| 400 | 355 L | 1491 | 2562 | 96 | 96.1 | 95.9 | 0.87 | 690 | 2.1 | 7.3 | 3 | 80 | 95 | 1LE5633-3BB4 | 2100 | 7.06 |
| 500 | 355 L | 1491 | 3202 | 96 | 96.1 | 95.9 | 0.86 | 870 | 3.1 | 7.9 | 3.3 | 80 | 96 | 1LE5633-3BB5 | 2290 | 8.36 |
| 6-pole: 1000 rpm at 50 Hz | | | | | | | | | | | | | | | | |
| 200 | 315 L | 992 | 1925 | 95.8 | 96 | 95.8 | 0.81 | 370 | 2.8 | 7 | 3 | 68 | 83 | 1LE5633-3AC7 | 1410 | 6.39 |
| 250 | 315 L | 992 | 2407 | 95.8 | 95.9 | 95.6 | 0.81 | 465 | 2.9 | 7.2 | 3 | 68 | 83 | 1LE5633-3AC8 | 1640 | 8.10 |
| 315 | 355 L | 992 | 3032 | 95.8 | 96.1 | 96.1 | 0.86 | 550 | 2.4 | 6.8 | 2.8 | 75 | 90 | 1LE5633-3BC2 | 2150 | 12.9 |
| 355 | 355 L | 993 | 3414 | 95.8 | 95.9 | 95.6 | 0.84 | 640 | 2.6 | 7.4 | 3.2 | 76 | 91 | 1LE5633-3BC3 | 2250 | 13.8 |
| 400 | 355 L | 994 | 3843 | 95.8 | 96 | 95.8 | 0.84 | 720 | 2.7 | 7.7 | 2.9 | 75 | 90 | 1LE5633-3BC4 | 2240 | 13.4 |
| 8-pole: 750 rpm at 50 Hz | | | | | | | | | | | | | | | | |
| 160 | 315 L | 741 | 2062 | 94.3 | 94.7 | 94.7 | 0.79 | 310 | 2.4 | 6.2 | 2.4 | 67 | 82 | 1LE5633-3AD7 | 1420 | 6.78 |
| 200 | 315 L | 742 | 2574 | 94.6 | 94.8 | 94.5 | 0.78 | 390 | 2.7 | 6.7 | 2.9 | 72 | 87 | 1LE5633-3AD8 | 1660 | 8.60 |
| 250 | 355 L | 744 | 3200 | 94.6 | 95.0 | 95.0 | 0.80 | 475 | 2.4 | 7.1 | 2.7 | 68 | 83 | 1LE5633-3BD1 | 2280 | 13.3 |
| 315 | 355 L | 744 | 4050 | 94.6 | 94.9 | 94.6 | 0.80 | 600 | 2.4 | 7.0 | 2.9 | 68 | 83 | 1LE5633-3BD2 | 2310 | 14 |
| Voltages ¹⁾ | | | | | | | | | | | | | | | | |
| 50 Hz 400 VΔ/690 VY | | 60 Hz ¹⁾ 460 VΔ | | | | | | | | | | | | Version | Order code | |
| 50 Hz 500 VΔ | | | | | | | | | | | | Standard | 3 4 | - | | |
| 50 Hz 690 VΔ | | | | | | | | | | | | Without additional charge | 4 0 | - | | |
| | | | | | | | | | | | | With additional charge | 4 7 | - | | |
| | | | | | | | | | | | | | | ... | | |
| For other voltages ¹⁾ and more information, see from page 3/21 | | | | | | | | | | | | | | | | |
| Types of construction | | | | | | | | | | | | | | | | |
| Without flange | | IM B3 ²⁾ | | | | | | | | | | | | Version | Order code | |
| With flange | | IM B5 ²⁾ | | | | | | | | | | | | Standard | A | - |
| | | | | | | | | | | | | With additional charge | F | - | | |
| | | | | | | | | | | | | | | ... | | |
| For other types of construction and more information, see from page 3/22 | | | | | | | | | | | | | | | | |
| Motor protection | | | | | | | | | | | | | | | | |
| PTC thermistor with 3 temperature sensors | | | | | | | | | | | | Version | Order code | | | |
| | | | | | | | | | | | | Standard | B | - | | |
| | | | | | | | | | | | | | | ... | | |
| For other motor protection and more information, see from page 3/24 | | | | | | | | | | | | | | | | |
| Terminal box position | | | | | | | | | | | | | | | | |
| Terminal box base left with terminal box 45° | | | | | | | | | | | | Version | Order code | | | |
| Terminal box base right with terminal box 45° | | | | | | | | | | | | Without additional charge | 2 | - | | |
| | | | | | | | | | | | | Standard | 3 | - | | |
| | | | | | | | | | | | | | | ... | | |
| For other terminal box positions and more information, see from page 3/25 | | | | | | | | | | | | | | | | |
| Special versions | | | | | | | | | | | | | | | | |
| Forced-air cooled motors w/o ext. fan/fan cover (IC418) | | | | | | | | | | | | 1LE5633- -Z F90+ | Order code(s) | | | |
| | | | | | | | | | | | | 1LE5633- -Z | | | | |
| For options and information, see from page 3/26 | | | | | | | | | | | | | | | | |

¹⁾ Parallel supply lines are required, except in the case of connection to 690 V.

²⁾ For a power rating of 315 kW, 2-pole, 60 Hz and 315 kW, 4-pole, 50 Hz, a larger terminal box can be used (order code **R50**) due to the magnitude of the current.
Order code **R50** alters the motor dimensions.



Cast-iron series SIMOTICS SD Add 1LE5533 (frame sizes 400 and 450) – self-ventilated or forced-air cooled

Selection and ordering data

| P _{rated} kW | Frame size FS | Operating values at rated power | | | | | | | | | | | Cast-iron series 1LE5533 | | m _{IM B3} kg | J kgm ² | | |
|---|------------------|---------------------------------|--------------------------|------------------------------|------------------------------|------------------------------|----------------------------------|-------------------------|---|--|--|---------------------------|-----------------------------|-----------------------------|--------------------------|-----------------------|--|--|
| | | n _{rated} rpm | T _{rated} Nm | η _{rated, 4/4} % | η _{rated, 3/4} % | η _{rated, 2/4} % | cos φ _{rated, 4/4} % | I _{rated} A | T _{LR} / T _{rated} | I _L / I _{rated} | T _B / T _{rated} | L _{pfA} dB(A) | L _{WA} dB(A) | Article No. | | | | |
| 2-pole: 3000 rpm at 50 Hz | | | | | | | | | | | | | | | | | | |
| 560 ^{1) 2)} | 400 | 2986 | 1790 | 96.6 | 96.7 | 96.3 | 0.90 | 930 | 1.6 | 7.0 | 2.8 | 74 | 90 | 1LE5533-4AA3 | 2850 | 8.9 | | |
| 630 ^{1) 2)} | 400 | 2986 | 2000 | 96.6 | 96.7 | 96.6 | 0.91 | 1030 | 1.6 | 7.0 | 2.8 | 74 | 90 | 1LE5533-4AA5 | 3000 | 9.8 | | |
| 710 ³⁾ | 400 | 2986 | 2250 | 96.8 | 96.9 | 96.7 | 0.91 | 670 | 1.7 | 7.0 | 2.8 | 74 | 90 | 1LE5533-4AA7 | 3200 | 10.8 | | |
| 800 ^{1) 2) 3) 4)} | 450 | 2988 | 2550 | 97.0 | 97.0 | 96.6 | 0.88 | 780 | 1.1 | 7.5 | 3.1 | 75 | 91 | 1LE5533-4BA3 | 4000 | 12.3 | | |
| 900 ^{1) 2) 3) 4)} | 450 | 2986 | 2900 | 97.0 | 97.1 | 96.9 | 0.90 | 860 | 1.1 | 7.0 | 2.8 | 75 | 91 | 1LE5533-4BA5 | 4250 | 13.5 | | |
| 1000 ^{1) 2) 3) 4)} | 450 | 2984 | 3200 | 97.0 | 97.1 | 97.0 | 0.91 | 950 | 1.1 | 6.8 | 2.6 | 75 | 91 | 1LE5533-4BA7 | 4450 | 14.7 | | |
| 4-pole: 1500 rpm at 50 Hz | | | | | | | | | | | | | | | | | | |
| 560 | 400 | 1492 | 3600 | 96.2 | 96.3 | 95.8 | 0.87 | 970 | 1.8 | 6.5 | 2.7 | 78 | 94 | 1LE5533-4AB3 | 2800 | 12.8 | | |
| 630 ^{1) 2)} | 400 | 1492 | 4050 | 96.4 | 96.5 | 95.9 | 0.87 | 1080 | 1.9 | 6.8 | 2.7 | 78 | 94 | 1LE5533-4AB5 | 3000 | 14.4 | | |
| 710 ³⁾ | 400 | 1492 | 4550 | 96.5 | 96.6 | 96.2 | 0.88 | 700 | 1.9 | 6.8 | 2.7 | 78 | 94 | 1LE5533-4AB7 | 3200 | 16.5 | | |
| 800 ³⁾ | 450 | 1492 | 5100 | 96.5 | 96.6 | 96.1 | 0.88 | 790 | 1.6 | 7.0 | 2.6 | 81 | 97 | 1LE5533-4BB3 | 3850 | 22.2 | | |
| 900 ³⁾ | 450 | 1492 | 5800 | 96.6 | 96.7 | 96.2 | 0.87 | 900 | 1.5 | 7.0 | 2.6 | 81 | 97 | 1LE5533-4BB5 | 4100 | 24.8 | | |
| 1000 ^{1) 3)} | 450 | 1492 | 6400 | 96.6 | 96.7 | 96.3 | 0.89 | 970 | 1.7 | 7.0 | 2.6 | 81 | 97 | 1LE5533-4BB7 | 4300 | 27.4 | | |
| 6-pole: 1000 rpm at 50 Hz | | | | | | | | | | | | | | | | | | |
| 450 | 400 | 992 | 4350 | 96.0 | 96.1 | 95.8 | 0.86 | 790 | 2.1 | 6.5 | 2.7 | 72 | 88 | 1LE5533-4AC3 | 2900 | 22.0 | | |
| 500 | 400 | 992 | 4800 | 96.0 | 96.1 | 95.8 | 0.86 | 870 | 2.2 | 6.5 | 2.7 | 72 | 88 | 1LE5533-4AC5 | 3050 | 24.7 | | |
| 560 ¹⁾ | 400 | 992 | 5400 | 96.2 | 96.3 | 96.0 | 0.86 | 980 | 2.2 | 6.5 | 2.7 | 72 | 88 | 1LE5533-4AC7 | 3250 | 27.8 | | |
| 630 ¹⁾ | 450 | 993 | 6100 | 96.3 | 96.4 | 96.2 | 0.85 | 1110 | 2.0 | 6.5 | 2.6 | 74 | 90 | 1LE5533-4BC3 | 3800 | 34.4 | | |
| 710 ³⁾ | 450 | 993 | 6800 | 96.3 | 96.4 | 96.4 | 0.85 | 730 | 2.0 | 6.5 | 2.5 | 74 | 90 | 1LE5533-4BC5 | 4050 | 38.5 | | |
| 800 ^{1) 3)} | 450 | 993 | 7700 | 96.5 | 96.7 | 96.5 | 0.85 | 820 | 2.0 | 6.5 | 2.5 | 74 | 90 | 1LE5533-4BC7 | 4300 | 43.1 | | |
| 8-pole: 750 rpm at 50 Hz | | | | | | | | | | | | | | | | | | |
| 355 | 400 | 742 | 4550 | 95.6 | 95.7 | 95.5 | 0.81 | 660 | 1.9 | 6.2 | 2.5 | 64 | 80 | 1LE5533-4AD3 | 2850 | 21.9 | | |
| 400 | 400 | 742 | 5100 | 95.7 | 95.8 | 95.5 | 0.81 | 740 | 2.0 | 6.5 | 2.6 | 64 | 80 | 1LE5533-4AD5 | 3050 | 24.5 | | |
| 450 | 400 | 742 | 5800 | 95.8 | 95.9 | 95.8 | 0.81 | 840 | 2.0 | 6.5 | 2.6 | 64 | 80 | 1LE5533-4AD7 | 3250 | 27.5 | | |
| 500 ⁵⁾ | 450 | 744 | 6400 | 95.9 | 96.0 | 95.7 | 0.80 | 940 | 1.9 | 6.5 | 2.4 | 67 | 83 | 1LE5533-4BD3 | 3800 | 34.0 | | |
| 560 ⁵⁾ | 450 | 744 | 7200 | 96.0 | 96.1 | 95.8 | 0.80 | 1050 | 1.9 | 6.5 | 2.4 | 67 | 83 | 1LE5533-4BD5 | 4000 | 38.0 | | |
| 630 ^{1) 5)} | 450 | 744 | 8100 | 96.1 | 96.2 | 95.9 | 0.81 | 1170 | 1.9 | 6.5 | 2.4 | 67 | 83 | 1LE5533-4BD7 | 4250 | 42.5 | | |
| Ordering options | | | | | | | | | | | | | | | | | | |
| Voltagess | | | | | | | | | | | | | Version | Order code | | | | |
| 50 Hz 400 VΔ/690 VY 60 Hz 460 VΔ | | | | | | | | | | | | | Standard | 3 4 | - | | | |
| 50 Hz 500 VΔ | | | | | | | | | | | | | Without additional charge | 4 0 | - | | | |
| 50 Hz 690 VΔ | | | | | | | | | | | | | With additional charge | 4 7 | - | | | |
| For other voltages and more information, see from page 3/21 | | | | | | | | | | | | | | | ... | | | |
| Types of construction | | | | | | | | | | | | | Version | Order code | | | | |
| Without flange IM B3 | | | | | | | | | | | | | Standard | A | - | | | |
| With flange IM B5 | | | | | | | | | | | | | With additional charge | F | - | | | |
| For other types of construction and more information, see from page 3/22 | | | | | | | | | | | | | | | ... | | | |
| Motor protection | | | | | | | | | | | | | Version | Order code | | | | |
| Without | | | | | | | | | | | | | Standard | A | - | | | |
| PTC thermistor with 3 temperature sensors | | | | | | | | | | | | | With additional charge | B | - | | | |
| For other motor protection and more information, see from page 3/24 | | | | | | | | | | | | | | | ... | | | |
| Terminal box position | | | | | | | | | | | | | Version | Order code | | | | |
| Terminal box base left with terminal box 45° | | | | | | | | | | | | | Without additional charge | 2 | - | | | |
| Terminal box base right with terminal box 45° | | | | | | | | | | | | | Standard | 3 | - | | | |
| For other terminal box positions and more information, see from page 3/25 | | | | | | | | | | | | | | | ... | | | |
| Special versions | | | | | | | | | | | | | Order code(s) | | | | | |
| Forced-air cooled motors w/o ext. fan/fan cover (IC418) | | | | | | | | | | | | | 1LE5533- -Z | F90+ + | | | | |
| For options and information, see from page 3/26 | | | | | | | | | | | | | 1LE5533- -Z | + + | | | | |

1) Terminal box 1XB1631.
 2) Terminal box position NDE can only be ordered using order code **H09** (2 × terminal box TB3R61). Order code **H08** not available.
 3) The standard version is 50 Hz 690 VΔ (voltage code **4-7**) or 60 Hz 575 VΔ (voltage code **4-0**).
 4) In the series version, the maximum speed is n_{max} = 3000 rpm. Operation up to 3600 rpm on request for an additional charge.
 5) Utilization with sinusoidal supply in accordance with thermal class 155 (temperature class F).

SIMOTICS SD standard motors next generation

IE3 Premium Efficiency

IE3

Cast-iron series SIMOTICS SD Pro 1LE5583 Basic Line – self-ventilated or forced-air cooled

Selection and ordering data

| Operating values at rated power | | | | | | | | | | | | | | Cast-iron series | | | |
|--|------------|-------------|-------------|----------------------------|---------------------|---------------------|-------------------------|------------------------|----------------------------|----------------------------|-------------------------|-----------|----------|--------------------------------|-------------|------------------------|---|
| P_{rated} | Frame size | n_{rated} | T_{rated} | $\eta_{rated, 4/4}$ | $\eta_{rated, 3/4}$ | $\eta_{rated, 2/4}$ | $\cos\phi_{rated, 4/4}$ | I_{rated} | $\frac{T_{LR}}{T_{rated}}$ | $\frac{I_{LR}}{I_{rated}}$ | $\frac{T_B}{T_{rated}}$ | L_{pfA} | L_{WA} | 1LE5583 Basic Line Article No. | $m_{IM B3}$ | J | |
| kW | FS | rpm | Nm | % | % | % | | A | | | | dB(A) | dB(A) | | kg | kgm ² | |
| <ul style="list-style-type: none"> Cooling: Self-ventilated (IC411) Efficiency: IE3 Premium Efficiency Insulation: Thermal class 155 (temperature class F), IP55 degree of protection, utilization in accordance with thermal class 155 (temperature class F) | | | | | | | | | | | | | | | | | |
| 2-pole: 3000 rpm at 50 Hz | | | | | | | | | | | | | | | | | |
| 250 | 315 L | 2986 | 800 | 95.8 | 95.7 | 95 | 0.88 | 430 | 3 | 9.4 | 3.8 | 81 | 94 | 1LE5583-3AA6 | 1340 | 2.82 | |
| 315 | 315 L | 2988 | 1007 | 95.8 | 95.6 | 94.7 | 0.87 | 550 | 3.7 | 10 | 4.3 | 82 | 96 | 1LE5583-3AA7 | 1510 | 3.27 | |
| 4-pole: 1500 rpm at 50 Hz | | | | | | | | | | | | | | | | | |
| 250 | 315 L | 1491 | 1601 | 96 | 96 | 95.6 | 0.84 | 445 | 3.2 | 8.1 | 3 | 75 | 90 | 1LE5583-3AB6 | 1450 | 4.6 | |
| 315 | 315 L | 1490 | 2019 | 96 | 96.1 | 95.8 | 0.82 | 580 | 3 | 8.4 | 3.1 | 80 | 95 | 1LE5583-3AB7 | 1600 | 5.39 | |
| 6-pole: 1000 rpm at 50 Hz | | | | | | | | | | | | | | | | | |
| 200 | 315 L | 993 | 1923 | 95.8 | 95.9 | 95.5 | 0.83 | 365 | 3.1 | 8.9 | 3.3 | 70 | 85 | 1LE5583-3AC7 | 1500 | 6.89 | |
| 250 | 315 L | 993 | 2404 | 95.8 | 95.9 | 95.6 | 0.81 | 465 | 3.4 | 8.8 | 3.3 | 70 | 84 | 1LE5583-3AC8 | 1630 | 8.0 | |
| Voltages ¹⁾ | | | | | | | | | | | | | | Version | | Order code | |
| 50 Hz 400 VΔ/690 VY | | | | 60 Hz ¹⁾ 460 VΔ | | | | Standard | | | | | | | 3 | 4 | – |
| 50 Hz 500 VΔ | | | | Without additional charge | | | | | | | 4 | | 0 | – | | | |
| 50 Hz 690 VΔ | | | | With additional charge | | | | | | | 4 | | 7 | – | | | |
| For other voltages ¹⁾ and more information, see from page 3/21 | | | | | | | | | | | | | | | | | |
| Types of construction | | | | | | | | | | | | | | Version | | Order code | |
| Without flange | | | | IM B3 ²⁾ | | | | Standard | | | | | | | A | – | |
| With flange | | | | IM B5 ²⁾ | | | | With additional charge | | | | | | | F | – | |
| For other types of construction and more information, see from page 3/22 | | | | | | | | | | | | | | | | | |
| Motor protection | | | | | | | | | | | | | | Version | | Order code | |
| Without | | | | Standard | | | | A | | | | | | | – | | |
| PTC thermistor with 3 temperature sensors | | | | With additional charge | | | | | | | B | | – | | | | |
| For other motor protection and more information, see from page 3/24 | | | | | | | | | | | | | | | | | |
| Terminal box position | | | | | | | | | | | | | | Version | | Order code | |
| Terminal box base left with terminal box 45° | | | | Without additional charge | | | | | | | 2 | | – | | | | |
| Terminal box base right with terminal box 45° | | | | Standard | | | | | | | 3 | | – | | | | |
| For other terminal box positions and more information, see from page 3/25 | | | | | | | | | | | | | | | | | |
| Special versions | | | | | | | | | | | | | | Version | | Order code(s) | |
| Forced-air cooled motors w/o ext. fan/fan cover (IC418) | | | | | | | | | | | | | | 1LE5583- -Z | | F90+ + | |
| For options and information, see from page 3/26 | | | | | | | | | | | | | | | | | |
| 1LE5583- -Z | | | | | | | | | | | | | | + + | | | |

¹⁾ Parallel supply lines are required, except in the case of connection to 690 V.

²⁾ For frame size 315 with power rating 315 kW, 2-pole, 60 Hz and 315 kW, 4-pole, 50 Hz, a larger terminal box can be used (order code **R50**) due to the magnitude of the current. Order code **R50** alters the motor dimensions.

Selection and ordering data

| Operating values at rated power | | | | | | | | | | | | | | Cast-iron series | | | | |
|--|------------|-------------|-------------|----------------------------|---------------------|---------------------|-------------------------|---------------------------|----------------------------|----------------------------|-------------------------|-----------|----------|--------------------------------------|--------------------|-----------------------|---|---|
| P_{rated} | Frame size | n_{rated} | T_{rated} | $\eta_{rated, 4/4}$ | $\eta_{rated, 3/4}$ | $\eta_{rated, 2/4}$ | $\cos\phi_{rated, 4/4}$ | I_{rated} | $\frac{T_{LR}}{T_{rated}}$ | $\frac{I_{LR}}{I_{rated}}$ | $\frac{T_B}{T_{rated}}$ | L_{pfA} | L_{WA} | 1LE5683 Performance Line Article No. | $m_{IM B3}$ | J | | |
| kW | FS | rpm | Nm | % | % | % | | A | | | | dB(A) | dB(A) | | kg | kgm ² | | |
| <ul style="list-style-type: none"> Cooling: Self-ventilated (IC411) Efficiency: IE3 Premium Efficiency Insulation: Thermal class 155 (temperature class F), IP55 degree of protection, utilization in accordance with thermal class 155 (temperature class F) | | | | | | | | | | | | | | | | | | |
| 2-pole: 3000 rpm at 50 Hz | | | | | | | | | | | | | | | | | | |
| 250 | 315 L | 2986 | 800 | 95.8 | 95.7 | 95 | 0.88 | 430 | 3 | 9.4 | 3.8 | 81 | 94 | 1LE5683-3AA6 | 1340 | 2.82 | | |
| 315 | 315 L | 2988 | 1007 | 95.8 | 95.6 | 94.7 | 0.87 | 550 | 3.7 | 10 | 4.3 | 82 | 96 | 1LE5683-3AA7 | 1510 | 3.27 | | |
| 355 | 355 L | 2988 | 1135 | 95.8 | 95.6 | 94.8 | 0.89 | 600 | 2.5 | 10 | 3.8 | 83 | 99 | 1LE5683-3BA3 | 2070 | 4.74 | | |
| 400 | 355 L | 2986 | 1279 | 95.8 | 95.7 | 95.2 | 0.92 | 660 | 2.6 | 8.7 | 3.3 | 83 | 98 | 1LE5683-3BA4 | 2220 | 5.36 | | |
| 500 | 355 L | 2988 | 1598 | 95.8 | 95.8 | 95.3 | 0.89 | 850 | 2.8 | 9.1 | 3.8 | 81 | 96 | 1LE5683-3BA5 | 2330 | 5.76 | | |
| 4-pole: 1500 rpm at 50 Hz | | | | | | | | | | | | | | | | | | |
| 250 | 315 L | 1491 | 1601 | 96 | 96 | 95.6 | 0.84 | 445 | 3.2 | 8.1 | 3 | 75 | 90 | 1LE5683-3AB6 | 1450 | 4.6 | | |
| 315 | 315 L | 1490 | 2019 | 96 | 96.1 | 95.8 | 0.82 | 580 | 3 | 8.4 | 3.1 | 80 | 95 | 1LE5683-3AB7 | 1600 | 5.39 | | |
| 355 | 355 L | 1492 | 2272 | 96 | 96 | 95.5 | 0.86 | 620 | 2.7 | 8.8 | 3.4 | 80 | 95 | 1LE5683-3BB3 | 2010 | 6.76 | | |
| 400 | 355 L | 1490 | 2564 | 96 | 96.2 | 95.9 | 0.87 | 690 | 2.5 | 7.7 | 2.9 | 80 | 95 | 1LE5683-3BB4 | 2080 | 7.06 | | |
| 500 | 355 L | 1491 | 3202 | 96 | 96.1 | 95.8 | 0.85 | 880 | 2.9 | 8.2 | 3.2 | 81 | 96 | 1LE5683-3BB5 | 2310 | 8.36 | | |
| 6-pole: 1000 rpm at 50 Hz | | | | | | | | | | | | | | | | | | |
| 200 | 315 L | 993 | 1923 | 95.8 | 95.9 | 95.5 | 0.83 | 365 | 3.1 | 8.9 | 3.3 | 70 | 85 | 1LE5683-3AC7 | 1500 | 6.89 | | |
| 250 | 315 L | 993 | 2404 | 95.8 | 95.9 | 95.6 | 0.81 | 465 | 3.4 | 8.8 | 3.3 | 70 | 84 | 1LE5683-3AC8 | 1630 | 8.0 | | |
| 315 | 355 L | 994 | 3026 | 95.8 | 95.8 | 95.1 | 0.81 | 590 | 2.9 | 8.2 | 3.2 | 75 | 90 | 1LE5683-3BC2 | 2020 | 11.4 | | |
| 355 | 355 L | 994 | 3410 | 95.8 | 96 | 95.7 | 0.85 | 630 | 2.5 | 8.2 | 3.1 | 75 | 90 | 1LE5683-3BC3 | 2230 | 13.4 | | |
| 400 | 355 L | 993 | 3847 | 95.8 | 96 | 95.7 | 0.84 | 720 | 2.7 | 8 | 2.9 | 77 | 92 | 1LE5683-3BC4 | 2260 | 13.4 | | |
| Voltagess ¹⁾ | | | | | | | | | | | | | | Version | | Order code | | |
| 50 Hz 400 VΔ/690 VY | | | | 60 Hz ¹⁾ 460 VΔ | | | | Standard | | | | | | 3 | 4 | - | | |
| 50 Hz 500 VΔ | | | | | | | | | | Without additional charge | | | | | | 4 | 0 | - |
| 50 Hz 690 VΔ | | | | | | | | | | With additional charge | | | | | | 4 | 7 | - |
| For other voltages ¹⁾ and more information, see from page 3/21 | | | | | | | | | | | | | | | | | | |
| Types of construction | | | | | | | | | | | | | | Version | | Order code | | |
| Without flange | | | | IM B3 ²⁾ | | | | Standard | | | | | | A | - | | | |
| With flange | | | | IM B5 ²⁾ | | | | With additional charge | | | | | | F | - | | | |
| For other types of construction and more information, see from page 3/22 | | | | | | | | | | | | | | | | | | |
| Motor protection | | | | | | | | | | | | | | Version | | Order code | | |
| PTC thermistor with 3 temperature sensors | | | | | | | | Standard | | | | | | B | - | | | |
| For other motor protection and more information, see from page 3/24 | | | | | | | | | | | | | | | | | | |
| Terminal box position | | | | | | | | | | | | | | Version | | Order code | | |
| Terminal box base left with terminal box 45° | | | | | | | | Without additional charge | | | | | | 2 | - | | | |
| Terminal box base right with terminal box 45° | | | | | | | | Standard | | | | | | 3 | - | | | |
| For other terminal box positions and more information, see from page 3/25 | | | | | | | | | | | | | | | | | | |
| Special versions | | | | | | | | | | | | | | Version | | Order code(s) | | |
| Forced-air cooled motors w/o ext. fan/fan cover (IC418) | | | | | | | | | | | | | | 1LE5683- -Z | F90+ . . . + . . . | | | |
| For options and information, see from page 3/26 | | | | | | | | | | | | | | | | | | |
| | | | | | | | | | | | | | | Version | | Order code(s) | | |
| | | | | | | | | | | | | | | 1LE5683- -Z | | . . . + . . . + . . . | | |

¹⁾ Parallel supply lines are required, except in the case of connection to 690 V.

²⁾ For a power rating of 315 kW, 2-pole, 60 Hz and 315 kW, 4-pole, 50 Hz, a larger terminal box can be used (order code **R50**) due to the magnitude of the current.
Order code **R50** alters the motor dimensions.

SIMOTICS SD standard motors next generation
IE3 Premium Efficiency

Cast-iron series SIMOTICS SD Pro 1LE5583 (frame sizes 400 and 450) – self-ventilated or forced-air cooled

Selection and ordering data

| P _{rated} kW | Frame size FS | Operating values at rated power | | | | | | | | | | | Cast-iron series 1LE5583 Article No. | m _{IM B3} kg | J kgm ² | |
|---|---------------------|---------------------------------|--------------------------|------------------------------|------------------------------|------------------------------|----------------------------|-------------------------|-------------------------------------|-------------------------------------|------------------------------------|----------------------------|--|--------------------------|-----------------------|--------------------------|
| | | n _{rated} rpm | T _{rated} Nm | η _{rated, 4/4} % | η _{rated, 3/4} % | η _{rated, 2/4} % | cosφ _{rated, 4/4} | I _{rated} A | T _{LR} /T _{rated} | I _{LR} /I _{rated} | T _B /T _{rated} | L _p fA dB(A) | | | | L _{WA} dB(A) |
| 2-pole: 3000 rpm at 50 Hz | | | | | | | | | | | | | | | | |
| 545 ¹⁾ | 400 | 2988 | 1740 | 96.9 | 96.9 | 96.4 | 0.90 | 900 | 1.6 | 7.3 | 3.1 | 74 | 90 | 1LE5583-4AA3 | 2850 | 8.9 |
| 610 ¹⁾ | 400 | 2988 | 1950 | 97.0 | 97.0 | 96.7 | 0.91 | 1000 | 1.6 | 7.3 | 3.1 | 74 | 90 | 1LE5583-4AA5 | 3000 | 9.8 |
| 680 ²⁾ | 400 | 2988 | 2150 | 97.0 | 97.1 | 96.8 | 0.91 | 640 | 1.7 | 7.3 | 3 | 74 | 90 | 1LE5583-4AA7 | 3200 | 10.8 |
| 775 ¹⁾²⁾³⁾ | 450 | 2990 | 2500 | 97.4 | 97.4 | 97.0 | 0.88 | 760 | 1.2 | 7.7 | 3.4 | 75 | 91 | 1LE5583-4BA3 | 4000 | 12.3 |
| 875 ¹⁾²⁾³⁾ | 450 | 2988 | 2800 | 97.4 | 97.5 | 97.3 | 0.90 | 840 | 1.2 | 7.2 | 3 | 75 | 91 | 1LE5583-4BA5 | 4250 | 13.5 |
| 970 ¹⁾²⁾³⁾ | 450 | 2986 | 3100 | 97.4 | 97.5 | 97.4 | 0.91 | 920 | 1.2 | 7.0 | 2.8 | 75 | 91 | 1LE5583-4BA7 | 4450 | 14.7 |
| 4-pole: 1500 rpm at 50 Hz | | | | | | | | | | | | | | | | |
| 545 | 400 | 1492 | 3500 | 96.4 | 96.4 | 96.0 | 0.87 | 940 | 1.8 | 6.7 | 2.7 | 78 | 94 | 1LE5583-4AB3 | 2800 | 12.8 |
| 615 | 400 | 1492 | 3950 | 96.6 | 96.6 | 96.2 | 0.87 | 1060 | 1.9 | 6.9 | 2.8 | 78 | 94 | 1LE5583-4AB5 | 3000 | 14.4 |
| 690 ²⁾ | 400 | 1492 | 4400 | 96.6 | 96.7 | 96.4 | 0.88 | 680 | 2.0 | 7.0 | 2.7 | 78 | 94 | 1LE5583-4AB7 | 3200 | 16.5 |
| 785 ²⁾ | 450 | 1492 | 5000 | 96.6 | 96.6 | 96.1 | 0.88 | 770 | 1.6 | 7.2 | 2.7 | 81 | 97 | 1LE5583-4BB3 | 3850 | 22.2 |
| 880 ²⁾ | 450 | 1492 | 5600 | 96.8 | 96.8 | 96.3 | 0.87 | 870 | 1.5 | 7.2 | 2.6 | 81 | 97 | 1LE5583-4BB5 | 4100 | 24.8 |
| 980 ²⁾ | 450 | 1492 | 6300 | 96.9 | 96.9 | 96.5 | 0.89 | 950 | 1.7 | 7.1 | 2.6 | 81 | 97 | 1LE5583-4BB7 | 4300 | 27.4 |
| 6-pole: 1000 rpm at 50 Hz | | | | | | | | | | | | | | | | |
| 435 | 400 | 993 | 4200 | 96.2 | 96.3 | 96.0 | 0.85 | 770 | 2.1 | 6.7 | 2.8 | 72 | 88 | 1LE5583-4AC3 | 2900 | 22.0 |
| 485 | 400 | 993 | 4650 | 96.2 | 96.4 | 96.1 | 0.86 | 850 | 2.2 | 6.7 | 2.8 | 72 | 88 | 1LE5583-4AC5 | 3050 | 24.7 |
| 545 ¹⁾ | 400 | 993 | 5200 | 96.3 | 96.5 | 96.2 | 0.86 | 950 | 2.2 | 6.7 | 2.7 | 72 | 88 | 1LE5583-4AC7 | 3250 | 27.8 |
| 615 ¹⁾ | 450 | 993 | 5900 | 96.5 | 96.7 | 96.4 | 0.84 | 1100 | 2.1 | 6.6 | 2.7 | 74 | 90 | 1LE5583-4BC3 | 3800 | 34.4 |
| 690 ²⁾ | 450 | 993 | 6600 | 96.6 | 96.8 | 96.6 | 0.85 | 700 | 2.0 | 6.8 | 2.5 | 74 | 90 | 1LE5583-4BC5 | 4050 | 38.5 |
| 780 ²⁾ | 450 | 993 | 7500 | 96.7 | 96.9 | 96.7 | 0.85 | 790 | 2.0 | 6.7 | 2.6 | 74 | 90 | 1LE5583-4BC7 | 4300 | 43.1 |
| 8-pole: 750 rpm at 50 Hz | | | | | | | | | | | | | | | | |
| 335 | 400 | 744 | 4300 | 95.8 | 96.0 | 95.6 | 0.80 | 630 | 2.0 | 6.9 | 2.6 | 64 | 80 | 1LE5583-4AD3 | 2850 | 21.9 |
| 375 | 400 | 744 | 4800 | 95.9 | 96.1 | 95.7 | 0.80 | 710 | 2.1 | 7.2 | 2.8 | 64 | 80 | 1LE5583-4AD5 | 3050 | 24.5 |
| 425 | 400 | 744 | 5500 | 96.1 | 96.2 | 95.8 | 0.80 | 800 | 2.1 | 7.2 | 2.7 | 64 | 80 | 1LE5583-4AD7 | 3250 | 27.5 |
| 485 | 450 | 745 | 6200 | 96.1 | 96.2 | 95.9 | 0.79 | 920 | 2.0 | 7.0 | 2.6 | 67 | 83 | 1LE5583-4BD3 | 3800 | 34.0 |
| 545 | 450 | 745 | 7000 | 96.2 | 96.4 | 96.0 | 0.79 | 1040 | 2.0 | 7.0 | 2.6 | 67 | 83 | 1LE5583-4BD5 | 4000 | 38.0 |
| 600 ¹⁾ | 450 | 745 | 7700 | 96.3 | 96.5 | 96.1 | 0.80 | 1120 | 2.1 | 7.3 | 2.6 | 67 | 83 | 1LE5583-4BD7 | 4250 | 42.5 |
| Voltages | | | | | | | | | | | | Version | | Order code | | |
| 50 Hz 400 VΔ/690 VY | | 60 Hz 460 VΔ | | Standard | | 3 4 | | - | | | | | | | | |
| 50 Hz 500 VΔ | | | | Without additional charge | | 4 0 | | - | | | | | | | | |
| 50 Hz 690 VΔ | | | | Without additional charge | | 4 7 | | - | | | | | | | | |
| For other voltages and more information, see from page 3/21 | | | | | | | | | | | | ... | | | | |
| Types of construction | | | | | | | | | | | | Version | | Order code | | |
| Without flange | | IM B3 | | Standard | | A | | - | | | | | | | | |
| With flange | | IM B5 | | With additional charge | | F | | - | | | | | | | | |
| For other types of construction and more information, see from page 3/22 | | | | | | | | | | | | ... | | | | |
| Motor protection | | | | | | | | | | | | Version | | Order code | | |
| Without | | | | Standard | | A | | - | | | | | | | | |
| PTC thermistor with 3 temperature sensors | | | | With additional charge | | B | | - | | | | | | | | |
| For other motor protection and more information, see from page 3/24 | | | | | | | | | | | | ... | | | | |
| Terminal box position | | | | | | | | | | | | Version | | Order code | | |
| Terminal box base left with terminal box 45° | | | | Without additional charge | | 2 | | - | | | | | | | | |
| Terminal box base right with terminal box 45° | | | | Standard | | 3 | | - | | | | | | | | |
| For other terminal box positions and more information, see from page 3/25 | | | | | | | | | | | | ... | | | | |
| Special versions | | | | | | | | | | | | | | Order code(s) | | |
| Forced-air cooled motors w/o ext. fan/fan cover (IC418) | | | | | | | | | | | | 1LE5683-... | | -Z F90+...+...+... | | |
| Forced-air cooled motors w/o ext. fan/fan cover (IC416) | | | | | | | | | | | | 1LE5683-... | | -Z F70+...+...+... | | |
| For options and information, see from page 3/26 | | | | | | | | | | | | 1LE5683-... | | -Z ...+...+...+... | | |

3

1) Terminal box 1XB1631.

2) The standard version is 50 Hz 690 VΔ (voltage code 4-7) or 60 Hz 575 VΔ (voltage code 4-0).

3) In the series version, the maximum speed is n_{max} = 3000 rpm. Operation up to 3600 rpm on request.

SIMOTICS SD standard motors next generation

Article No. supplements and special versions · Voltages

Cast-iron series SIMOTICS SD 1LE55, 1LE56

Selection and ordering data

| Voltages | Article No. | supplement Voltage code 12th and 13th posi- tion of the Article No. | Additional identifica- tion code with order code and plain text, if required | Frame size | | | | | | | | Motor version | | | | |
|----------------------------|-------------|--|--|-----------------------------|-----|-----|---------|-------|-------|-------|-------|---------------|-------|-------|-------|-----|
| | | | | 315 | 355 | 400 | | 450 | | | | IEC | IE4 | | | |
| 1LE5 ■ - ■ . . . | | | | 1LE55.4 Basic Line | | | 1LE5534 | -4AA3 | -4AB3 | -4AA7 | -4AB7 | -4BA3 | -4BB3 | -4BC3 | IEC | IE4 |
| | | | | | | | | -4AA5 | -4AB5 | | | -4BA5 | -4BB5 | -4BD3 | | |
| | | | | | | | | | | -4AC3 | | | -4BA7 | -4BB7 | -4BD5 | |
| | | | | | | | | | | | | -4BC5 | -4BD7 | | | |
| | | | | | | | | | | | | -4BC7 | | | | |
| | | | | 1LE56.4 Performance Line | | | | | | | | | | | | |
| | | | | 1LE55.3 Basic Line | | | 1LE55.3 | -4AA3 | -4AB3 | -4AA7 | -4AB7 | -4BA3 | -4BB3 | -4BC3 | IE3 | |
| | | | | | | | | | | | | -4BB5 | -4BD3 | | | |
| | | | | | | | | -4AA5 | -4AB5 | | | -4BA5 | -4BB7 | -4BD5 | | |
| | | | | | | | | -4AC3 | | | | -4BB7 | -4BD5 | | | |
| | | | | | | | | -4AC5 | | | | -4BC5 | -4BD7 | | | |
| | | | | | | | | -4AC7 | | | | -4BC7 | | | | |
| | | | | | | | | -4AD3 | | | | | | | | |
| | | | | | | | | -4AD5 | | | | | | | | |
| | | | | | | | | -4AD7 | | | | | | | | |
| | | | | 1LE56.3 Performance Line | | | | | | | | | | | | |

| Voltage at 50 Hz or 60 Hz | | | | | | | | | | | | |
|--|---|---|--|---|---|-------|---|-------|-------|-------|-------|---|
| 50 Hz 400 VΔ/690 VY, 60 Hz 460 VΔ ¹⁾ | 3 | 4 | – | □ | □ | □ | □ | O. R. | O. R. | O. R. | O | □ |
| 50 Hz 500 VΔ | 4 | 0 | – | ○ | ○ | ○ | ○ | ○ | ○ | ○ | ○ | ○ |
| 60 Hz 575 VΔ | | | – | – | – | ○ | ○ | □ | □ | O. R. | □ | ○ |
| 50 Hz 690 VΔ | 4 | 7 | – | ✓ | ✓ | ○ | ○ | □ | □ | □ | □ | ○ |
| 50 Hz 380 VΔ/660 VY, 60 Hz 440 VΔ ¹⁾ | 3 | 3 | – | ✓ | ✓ | O. R. | ✓ | O. R. | O. R. | O. R. | O. R. | ✓ |
| 50 Hz 415 VΔ, 60 Hz 480 VΔ | 3 | 5 | – | ✓ | ✓ | O. R. | ✓ | O. R. | O. R. | O. R. | O. R. | ✓ |
| 60 Hz 380 VΔ/660 VY ¹⁾ | 3 | 0 | – | ✓ | ✓ | – | – | – | – | – | – | – |
| 60 Hz 400 VΔ/690 VY ¹⁾ | 3 | 1 | – | ✓ | ✓ | – | – | – | – | – | – | – |
| 50 Hz 600 VΔ, 60 Hz 690 VΔ | 4 | 4 | – | – | – | O. R. | ✓ | O. R. | ✓ | O. R. | ✓ | ✓ |
| 50 Hz 660 VΔ | 4 | 6 | – | – | – | ✓ | ✓ | ✓ | ✓ | ✓ | ✓ | ✓ |
| Voltage at 60 Hz and required power | | | | | | | | | | | | |
| 380 VΔ/660 VY; 50 Hz power | 9 | 0 | M2B | ✓ | ✓ | – | – | – | – | – | – | – |
| 380 VΔ; 50 Hz power | | | | ✓ | ✓ | – | – | – | – | – | – | – |
| 440 VΔ; 50 Hz power | 9 | 0 | M2D | ✓ | ✓ | ✓ | ✓ | O. R. | O. R. | O. R. | O. R. | ✓ |
| 440 VΔ; 60 Hz power | 9 | 0 | M1D | – | – | ✓ | ✓ | O. R. | O. R. | O. R. | O. R. | ✓ |
| 460 VΔ; 50 Hz power | 9 | 0 | M2F | ✓ | ✓ | ✓ | ✓ | O. R. | O. R. | O. R. | ✓ | ✓ |
| 460 VΔ; 60 Hz power | 9 | 0 | M1F | – | – | ✓ | ✓ | O. R. | O. R. | O. R. | ✓ | ✓ |
| 575 VΔ; 50 Hz power | 9 | 0 | M2H | ✓ | ✓ | ✓ | ✓ | ✓ | ✓ | ✓ | ✓ | ✓ |
| 575 VΔ; 60 Hz power | 9 | 0 | M1H | – | – | ✓ | ✓ | ✓ | ✓ | O. R. | ✓ | ✓ |
| 400 VΔ/690 VY; 50 Hz power | 9 | 0 | M2J | ✓ | ✓ | O. R. | ✓ | O. R. | O. R. | O. R. | ✓ | ✓ |
| 400 VΔ; 50 Hz power | | | | ✓ | ✓ | – | – | – | – | – | – | – |
| 400 VΔ/690 VY; 60 Hz power | 9 | 0 | M1J | – | – | O. R. | ✓ | O. R. | O. R. | O. R. | ✓ | ✓ |
| 480 VΔ; 50 Hz power | 9 | 0 | M2L | ✓ | ✓ | ✓ | ✓ | O. R. | O. R. | O. R. | O. R. | ✓ |
| 480 VΔ; 60 Hz power | 9 | 0 | M1L | – | – | ✓ | ✓ | O. R. | O. R. | O. R. | O. R. | ✓ |
| Non-standard voltage and/or frequencies | | | | | | | | | | | | |
| Non-standard winding ^{2) 3)} | 9 | 0 | M1Y • and customer specifica- tions | ✓ | ✓ | ✓ | ✓ | ✓ | ✓ | ✓ | ✓ | ✓ |

- Standard version
- Without additional charge
- This order code only determines the price of the version – Additional plain text is required.
- O. R. Possible on request
- ✓ With additional charge

¹⁾ Without additional measures not possible for converter operation at 690 VY and 660 VΔ (valid for 1LE5504, 1LE5604, 1LE5534, 1LE5634, 1LE5503, 1LE5603, 1LE5533 and 1LE5633).

²⁾ Plain text must be specified in the order: Voltage between 200 and 690 V (voltages outside the range are available on request), frequency, circuit, rated power.







³⁾ 2-pole version, frame size 450 for 60 Hz operation on request.

SIMOTICS SD standard motors next generation

Article No. supplements and special versions · Types of construction

Cast-iron series SIMOTICS SD 1LE55, 1LE56

Selection and ordering data

| Types of construction | Article No. supplement Type of construction code letter 14th position of the Article No. | For types of construction with order code(s) Article No. with additional identification code -Z | Frame size | | | | Motor version | |
|---|--|--|--------------------------|-----|---------------------|---------------------|---------------|-----|
| | | | 315 | 355 | 400 | 450 | IEC | IE4 |
| 1LE5 -Z | .. (-Z) | Order code | 1LE55.4 Basic Line | | 1LE5534 | | | |
| | | | 1LE56.4 Performance Line | | | | | |
| | | | 1LE55.3 Basic Line | | 1LE55.3 | | | IE3 |
| | | | 1LE56.3 Performance Line | | | | | |
| Without flange | | | | | | | | |
| IM B3 ^{1) 2)} |  A | - | □ | □ | □ | □ | | |
| IM B6 ²⁾ |  T | - | ○ | ○ | - | - | | |
| IM B7 ²⁾ |  U | - | ○ | ○ | - | - | | |
| IM B8 ²⁾ |  V | - | ○ | ○ | - | - | | |
| IM V6 ²⁾ |  D | - | ○ | ○ | O. R. ⁷⁾ | O. R. ⁷⁾ | | |
| IM V5 without protective cover ²⁾ |  C | - | ○ | ○ | O. R. ⁷⁾ | O. R. ⁷⁾ | | |
| IM V5 with protective cover ^{2) 3) 4)} |  C | H00 | ✓ | ✓ | O. R. ⁷⁾ | O. R. ⁷⁾ | | |







For legends and footnotes, see page 3/23.

SIMOTICS SD standard motors next generation

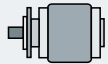
Article No. supplements and special versions · Types of construction

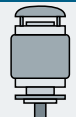
Cast-iron series SIMOTICS SD 1LE55, 1LE56

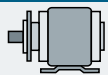
| Types of construction | Article No. supplement Type of construction code letter 14th position of the Article No. | For types of construction with order code(s) Article No. with additional identification code -Z | Frame size | | | | Motor version | |
|---|---|--|---------------------------------|------------------------|-------------------------|--------------------------|-----------------|-----|
| | | | 315 | 355 | 400 | 450 | IEC | IE4 |
| 1LE5 (-Z) | .. (-Z) | Order code | 1LE55.4 Basic Line | | 1LE5534 | | IEC | IE4 |
| | | | 1LE56.4 Performance Line | | | | | |
| | | | 1LE55.3 Basic Line | | 1LE55.3 | | | IE3 |
| | | | 1LE56.3 Performance Line | | | | | |
| With flange | EN 50347 DIN 42948 | | FF740 A 800 | FF840 A 900 | FF940 A 1000 | FF1080 A 1150 | | |
| IM B5 ^{2) 5) 6)} |  | F | - | ✓ | ✓ | ✓ ⁶⁾ | ✓ ⁶⁾ | |
| IM V1 without protective cover ²⁾ |  | G | - | ✓ | ✓ | ✓ ⁷⁾ | ✓ ⁷⁾ | |
| IM V1 with protective cover ^{2) 3) 4)} |  | G | H00 | ✓ | ✓ | ✓ ⁷⁾ | ✓ ⁷⁾ | |
| IM V3 ⁴⁾ |  | H | - | ✓ | ✓ | - | - | |
| IM B35 ³⁾ |  | J | - | ✓ | ✓ | ✓ | ✓ | |

- Standard version
- Without additional charge
- ✓ With additional charge

- 1) The types of construction IM B6/7/8, IM V6 and IM V5 with/without protective cover are also possible as long as no stamping of these types of construction on the rating plate is required. As standard the type of construction IM B3 is then stamped on the rating plate. With type of construction IM V5 with protective cover, the protective cover has to be additionally ordered with order code **H00**. The protective cover is not stamped on the rating plate.
- 2) The type of construction is stamped on the rating plate. If mounted in a different position, the position must be specified to ensure that the condensation drainage holes are positioned correctly.
- 3) In combination with an encoder, it is not necessary to order the protective cover (order code **H00**), as this is delivered as a protection for the encoder as standard. In this case the protective cover is standard design (without additional charge).
- 4) The "Standard cylindrical shaft extension (second shaft extension)" option (order code **L05**) is not possible.

- 5) The types of construction IM V3 and IM V1 with/without protective cover are also possible as long as no stamping of these types of construction on the rating plate is required. As standard the type of construction IM B5 is then stamped on the rating plate. With type of construction IM V1 with protective cover, the protective cover has to be additionally ordered with order code **H00**. The protective cover is not stamped on the rating plate.
- 6) For machines, type of construction IM B5, provide an additional support foot at the NDE. The support foot is not included in the scope of supply. Use an appropriately sized support foot with the appropriate rigidity. The support foot must be able to support the total weight of the machine.
- 7) Not possible for 2-pole 1LE55..-4BA motors.

SIMOTICS SD standard motors next generation

Article No. supplements and special versions · Motor protection

Cast-iron series SIMOTICS SD 1LE55, 1LE56

Selection and ordering data

| Motor protection | Article No. supplement | | Frame size | | | | Motor version | |
|------------------|---|--|-----------------------------|-----|---------|-----|---------------|-----|
| | Motor protection code letter 15th position of the Article No. | Additional identification code with order code and plain text, if required | 315 | 355 | 400 | 450 | IEC | IE4 |
| | | | 1LE55.4 Basic Line | | 1LE5534 | | | |
| | | | 1LE56.4 Performance Line | | | | | |
| | | | 1LE55.3 Basic Line | | 1LE55.3 | | | IE3 |
| | | | 1LE56.3 Performance Line | | | | | |
| | 1LE5 ... - ... - ... | Order code | | | | | | |

| Motor protection | Article No. | Additional identification code with order code and plain text, if required | 315 | 355 | 400 | 450 | Motor version |
|--|-------------|--|-----|-----|-----|-----|----------------------------|
| Without (standard) ¹⁾ | A | - | □ | □ | □ | □ | Only for: 1LE55.4, 1LE55.3 |
| 1 or 3 PTC thermistors – for tripping (2 terminals) ^{1) 2)} | B | - | ✓ | ✓ | ✓ | ✓ | Only for: 1LE55.4, 1LE55.3 |
| 2 or 6 PTC thermistors – for alarm and tripping (4 terminals) ²⁾ | C | - | ✓ | ✓ | ✓ | ✓ | Only for: 1LE56.4, 1LE56.3 |
| 1 KTY84-130 temperature sensor (2 terminals) ²⁾ | F | - | ✓ | ✓ | ✓ | ✓ | |
| 2 KTY84-130 temperature sensor (4 terminals) ²⁾ | G | - | ✓ | ✓ | ✓ | ✓ | |
| 3 Pt100 resistance thermometers – 2-wire input (6 terminals) | H | - | ✓ | ✓ | ✓ | ✓ | |
| 6 Pt100 resistance thermometers – 2-wire input (12 terminals) | J | - | ✓ | ✓ | ✓ | ✓ | |
| 1 Pt1000 resistance thermometer (2 terminals) ²⁾ | K | - | ✓ | ✓ | ✓ | ✓ | |
| 2 Pt1000 resistance thermometers (4 terminals) ²⁾ | L | - | ✓ | ✓ | ✓ | ✓ | |
| 1 Pt100 resistance thermometer – 2-wire input (2 terminals) ²⁾ | P | - | ✓ | ✓ | ✓ | ✓ | |
| 3 Pt100 resistance thermometers – 3-wire input (9 terminals) ²⁾ | Q | - | ✓ | ✓ | ✓ | ✓ | |
| 6 Pt100 resistance thermometers – 3-wire input (18 terminals) ²⁾ | R | - | ✓ | ✓ | ✓ | ✓ | |
| 3 bimetal sensors (NC contacts) for tripping (2 terminals) ²⁾ | Z | Q3A | ✓ | ✓ | ✓ | ✓ | |
| 6 bimetal sensors (NC contacts) for alarm and tripping (4 terminals) ²⁾ | Z | Q9A | ✓ | ✓ | ✓ | ✓ | |

- Standard version
- ✓ With additional charge

Note:

Options are available specifically for bearing protection – for order codes and descriptions, see from page 3/26.

¹⁾ For the Performance Line, motor protection by means of PTC thermistors with 3 built-in temperature sensors for tripping (motor protection code letter B) is already included in the basic price. For the Performance Line, the option "without motor protection" (motor protection code A) is not possible.

²⁾ Evaluation with associated tripping unit (see Catalog IC 10) is recommended.

SIMOTICS SD standard motors next generation

Article No. supplements and special versions · Terminal box position

Cast-iron series SIMOTICS SD 1LE55, 1LE56

Selection and ordering data

| Terminal box position | Article No. supplement | | Frame size | | | | Motor version | |
|-----------------------|---|--|-----------------------------|-----|---------|-----|---------------|-----|
| | Terminal box position code 16th position of the Article No. | Additional identification code with order code and plain text, if required | 315 | 355 | 400 | 450 | IEC | IE4 |
| | | | 1LE55.4 Basic Line | | 1LE5534 | | | |
| | | | 1LE56.4 Performance Line | | | | | |
| | | | 1LE55.3 Basic Line | | 1LE55.3 | | | IE3 |
| | | | 1LE56.3 Performance Line | | | | | |
| | 1LE5 | Order code | | | | | | |

| Terminal box position | | | | | | | |
|---|---|-----|---|---|---|---|--|
| Terminal box base left with terminal box at the top | 0 | – | ✓ | ✓ | ✓ | ✓ | |
| Terminal box base right with terminal box at the top | 1 | – | ✓ | ✓ | ✓ | ✓ | |
| Terminal box base left with oblique terminal box 45° | 2 | – | ○ | ○ | ○ | ○ | |
| Terminal box base right with oblique terminal box 45° | 3 | – | □ | □ | □ | □ | |
| Terminal box right-hand side ¹⁾ | 5 | – | ✓ | ✓ | ✓ | ✓ | |
| Terminal box left-hand side ¹⁾ | 6 | – | ✓ | ✓ | ✓ | ✓ | |
| Terminal box left-hand side (base below) ²⁾ | 9 | R5L | ✓ | ✓ | ✓ | ✓ | |
| Terminal box right-hand side (base below) ²⁾ | 9 | R6R | ✓ | ✓ | ✓ | ✓ | |
| Terminal box bottom left ²⁾ | 9 | R7L | ✓ | ✓ | ✓ | ✓ | |
| Terminal box bottom right ²⁾ | 9 | R7R | ✓ | ✓ | ✓ | ✓ | |

- Standard version
- Without additional charge
- ✓ With additional charge

Note:

On the motors

1LE5583-4AA3,
1LE5583-4AA5,
1LE5583-4BA3,
1LE5583-4BA5,
1LE5583-4BA7,
1LE5583-4AC7,
1LE5583-4BC3,
1LE5583-4BD7,

terminal box type 1XB1631 is mounted.

¹⁾ For types of construction with feet and flange-mounted with feet, cast feet are standard. Screwed-on feet are available on request.

²⁾ Only possible in combination with type of construction IM B5.

SIMOTICS SD standard motors next generation

Article No. supplements and special versions · Options

Cast-iron series SIMOTICS SD 1LE55, 1LE56

Selection and ordering data

| Special versions | Additional identification code -Z with order code and plain text if required | Frame size | | | | Motor version | |
|--|--|-----------------------------|-----|----------|-----|---------------|--|
| | | 315 | 355 | 400 | 450 | IEC | IE4 |
| | | 1LE55.4 Basic Line | | 1LE55.34 | | IEC | IE4 |
| | | 1LE56.4 Performance Line | | | | | |
| | | 1LE55.3 Basic Line | | 1LE55.3 | | | IE3 |
| | | 1LE56.3 Performance Line | | | | | |
| 1LE5 . . . - - -Z | | Order code | | | | | |
| Motor protection | | | | | | | |
| 1 or 3 PTC thermistors – for tripping (2 terminals) ¹⁾ | Q11 | ✓ | ✓ | ✓ | ✓ | Not for: | Combination with motor protection code letter B (15th position of the Article No.) |
| 2 or 6 PTC thermistors – for alarm and tripping (4 terminals) ¹⁾ | Q12 | ✓ | ✓ | ✓ | ✓ | Not for: | Combination with motor protection code letter C (15th position of the Article No.) |
| 1 KTY84-130 temperature sensor (2 terminals) ¹⁾ | Q23 | ✓ | ✓ | ✓ | ✓ | Not for: | Combination with motor protection code letter F (15th position of the Article No.) |
| 2 KTY84-130 temperature sensors (4 terminals) ¹⁾ | Q25 | ✓ | ✓ | ✓ | ✓ | Not for: | Combination with motor protection code letter G (15th position of the Article No.) |
| 3 bimetal sensors (NC contacts) for tripping (2 terminals) | Q31 | ✓ | ✓ | ✓ | ✓ | | |
| 6 bimetal sensors (NC contacts) for alarm and tripping (4 terminals) | Q32 | ✓ | ✓ | ✓ | ✓ | | |
| 3 bimetal sensors (NC contacts) for tripping (6 terminals) | Q33 | ✓ | ✓ | ✓ | ✓ | | |
| 6 bimetal sensors (NC contacts) for alarm and tripping (12 terminals) | Q34 | ✓ | ✓ | ✓ | ✓ | | |
| 1 Pt1000 resistance thermometer (2 terminals) | Q35 | ✓ | ✓ | ✓ | ✓ | | |
| 2 Pt1000 resistance thermometers (4 terminals) | Q36 | ✓ | ✓ | ✓ | ✓ | | |
| 3 Pt100 resistance thermometers – 2-wire input (6 terminals) ¹⁾ | Q60 | ✓ | ✓ | ✓ | ✓ | Not for: | Combination with motor protection code letter H (15th position of the Article No.) |
| 6 Pt100 resistance thermometers – 2-wire input (12 terminals) ¹⁾ | Q61 | ✓ | ✓ | ✓ | ✓ | Not for: | Combination with motor protection code letter J (15th position of the Article No.) |
| 1 Pt100 resistance thermometer – 2-wire input (2 terminals) | Q62 | ✓ | ✓ | ✓ | ✓ | | |
| 3 Pt100 resistance thermometers – 3-wire input (9 terminals) | Q63 | ✓ | ✓ | ✓ | ✓ | | |
| 6 Pt100 resistance thermometers – 3-wire input (18 terminals) | Q64 | ✓ | ✓ | ✓ | ✓ | | |
| 2 Pt100 resistance thermometers in basic configuration for bearings (2 terminals) | Q72 | ✓ | ✓ | ✓ | ✓ | | |
| 2 Pt100 resistance thermometers in 3-wire input for bearings (6 terminals) | Q78 | ✓ | ✓ | ✓ | ✓ | | |
| 2 Pt100 double resistance thermometers in 3-wire input for bearings (12 terminals) | Q79 | ✓ | ✓ | ✓ | ✓ | Not for: | Motors in combination with order codes F40 and F41 |
| Motor connection and terminal box | | | | | | | |
| External grounding | | – | – | □ | □ | | |
| Terminal box at NDE | H08 | ✓ | ✓ | ✓ | ✓ | | |
| Two terminal boxes at NDE ⁴²⁾ | H09 | – | – | ✓ | ✓ | | |
| Second external grounding | H70 | ✓ | ✓ | ✓ | ✓ | | |
| Subsequently rotatable main terminal box | R09 | – | – | ✓ | ✓ | | |
| Rotation of the terminal box through 90°, entry from DE ³⁵⁾ | R10 | ✓ | ✓ | ✓ | ✓ | Not for: | Combination with type of construction code letters F, G, H, J (14th position of the Article No.) |
| Rotation of the terminal box through 90°, entry from NDE | R11 | ✓ | ✓ | ✓ | ✓ | | |
| Rotation of the terminal box through 180° | R12 | ✓ | ✓ | ✓ | ✓ | | |

For legends and footnotes, see page 3/33.

SIMOTICS SD standard motors next generation

Article No. supplements and special versions · Options

Cast-iron series SIMOTICS SD 1LE55, 1LE56

| Special versions | Additional identification code -Z with order code and plain text if required | Frame size | | | | Motor version | |
|--|---|-----------------------------|------------|------------|------------|---------------|---|
| | | 315 | 355 | 400 | 450 | IEC | IE4 |
| | | 1LE55.4 Basic Line | | 1LE5534 | | IEC | IE4 |
| | | 1LE56.4 Performance Line | | | | | |
| | | 1LE55.3 Basic Line | | 1LE55.3 | | IE3 | |
| | | 1LE56.3 Performance Line | | | | | |
| 1LE5 -Z Order code | | | | | | | |
| Motor connection and terminal box (continued) | | | | | | | |
| One EMC cable gland | R14 | ✓ | ✓ | – | – | Not for: | Combination with order codes R51, R53 |
| One metal cable gland | R15 | ✓ | ✓ | – | – | Not for: | Combination with order codes R51, R53 |
| EMC cable gland, maximum configuration | R16 | ✓ | ✓ | ✓ | ✓ | Not for: | Combination with order codes R51, R53 (frame sizes 315 and 355) |
| Stud terminal for cable connection, accessories pack (3 items) | R17 | ✓ | ✓ | – | – | Not for: | Combination with order codes R51, R53 |
| Metal cable gland, maximum configuration | R18 | ✓ | ✓ | ✓ | ✓ | Not for: | Combination with order codes R51, R53 (frame sizes 315 and 355) |
| Saddle terminal for connection without cable lug, accessories pack | R19 | ✓ | ✓ | ✓ | ✓ | Not for: | Combination with order codes R21, R23, R24 (frame sizes 315 and 355) |
| 3 cables protruding, 1.5 m long | R21 | O. R. | O. R. | O. R. | O. R. | Not for: | Combination with order codes R17, R19, R50 (frame sizes 315 and 355) |
| 6 cables protruding, 1.5 m long | R23 | O. R. | O. R. | O. R. | O. R. | Not for: | Combination with order codes R17, R19, R50 (frame sizes 315 and 355) |
| 6 cables protruding, 3 m long | R24 | O. R. | O. R. | O. R. | O. R. | Not for: | Combination with order codes R17, R19, R50 (frame sizes 315 and 355) |
| Larger terminal box ³⁶⁾ | R50 | ✓ | – | ✓ | ✓ | Not for: | Combination with order codes R21, R23, R24 (frame sizes 315 and 355) |
| Terminal box without cable entry opening | R51 | ○ | ○ | – | – | Not for: | Combination with order code R14, R15, R16, R18 |
| Drilled removable entry plate | R52 | ✓ | ✓ | □ | □ | | |
| Undrilled removable entry plate | R53 | ✓ | ✓ | ○ | ○ | Not for: | Combination with order codes R14, R15, R16, R18 (frame sizes 315 and 355) |
| Cast-iron auxiliary terminal box (small) | R62 | ✓ | ✓ | ✓ | ✓ | | |
| Cast-iron auxiliary terminal box (large) | R63 | ✓ | ✓ | ✓ | ✓ | | |
| Stainless steel auxiliary terminal box (large) | R65 | – | – | ✓ | ✓ | | |
| Silicone-free version ²⁸⁾ | R74 | ✓ | ✓ | ✓ | ✓ | | |
| Non-standard threaded through hole (NPT or G thread) ^{2) 28)} | Y61 • and customer specifications | ✓ | ✓ | ✓ | ✓ | | |
| Windings and insulation | | | | | | | |
| Temperature class 155 (F), utilized acc. to 155 (F), with service factor ³⁷⁾ | N01 | ✓ | ✓ | □ | □ | Not for: | 1LE5583, 1LE5683 (frame sizes 315 and 355) |
| Temperature class 155 (F), utilized acc. to 155 (F), with increased power ³⁷⁾ | N02 | ✓ | ✓ | ✓ | ✓ | Not for: | 1LE5583, 1LE5683 (frame sizes 315 and 355) |
| Temperature class 155 (F), utilized acc. to 155 (F), with increased coolant temperature ³⁷⁾ | N03 | ✓ | ✓ | ✓ | ✓ | Not for: | 1LE5583, 1LE5683 (frame sizes 315 and 355) |
| Temperature class 155 (F), used acc. to 130 (B), coolant temperature 45 °C, derating approx. 4 % ^{37) 40)} | N05 | ✓ | ✓ | ✓ | ✓ | | |
| Temperature class 155 (F), used acc. to 130 (B), coolant temperature 50 °C, derating approx. 8 % ^{37) 40)} | N06 | ✓ | ✓ | ✓ | ✓ | | |
| Temperature class 155 (F), used acc. to 130 (B), coolant temperature 55 °C, derating approx. 13 % ^{37) 40)} | N07 | ✓ | ✓ | ✓ | ✓ | | |
| Temperature class 155 (F), used acc. to 130 (B), coolant temperature 60 °C, derating approx. 18 % ^{37) 40)} | N08 | ✓ | ✓ | ✓ | ✓ | | |
| Temperature class 180 (H) ³⁸⁾ | N10 | ✓ | ✓ | ✓ | ✓ | | |
| Temperature class 180 (H) at rated power and max. CT 60 °C ⁴⁾ | N11 | ✓ | ✓ | O. R. | O. R. | | |
| Increased air humidity/temperature with 30 to 60 g water per m ³ of air | N30 | ✓ | ✓ | ✓ | ✓ | | |

For legends and footnotes, see page 3/33.

SIMOTICS SD standard motors next generation

Article No. supplements and special versions · Options

Cast-iron series SIMOTICS SD 1LE55, 1LE56

| Special versions | Additional identification code -Z with order code and plain text if required | Frame size | | | | Motor version | |
|--|---|-----------------------------|------------|------------|------------|---------------|--|
| | | 315 | 355 | 400 | 450 | IEC | IE4 |
| | | 1LE55.4 Basic Line | | 1LE55.34 | | IEC | IE4 |
| | | 1LE56.4 Performance Line | | | | | |
| | | 1LE55.3 Basic Line | | 1LE55.3 | | IE3 | |
| | | 1LE56.3 Performance Line | | | | | |
| 1LE5 ... - ... - ... -Z Order code | | | | | | | |
| Windings and insulation (continued) | | | | | | | |
| Increased air humidity/temperature with 60 to 100 g water per m ³ of air | N31 | | ✓ | ✓ | ✓ | ✓ | |
| Temperature class 155 (F), utilized acc. to 130 (B), with higher coolant temperature and/or installation altitude ³⁰⁾ | Y50 • and spec. power, CT ... °C or IA ... m above sea level | | ✓ | ✓ | ✓ | ✓ | Not for: 1LE5583, 1LE5683 (frame sizes 315 and 355) |
| Temperature class 155 (F), utilized acc. to 155 (F), other requirements ^{4) 30)} | Y52 • and spec. power, CT ... °C or IA ... m above sea level | | ✓ | ✓ | ✓ | ✓ | |
| Temperature class 180 (H), utilized acc. to 155 (F) ³⁰⁾ | Y75 • and spec. power, CT ... °C or IA ... m above sea level | | ✓ | ✓ | O. R. | O. R. | |
| Colors and paint finish | | | | | | | |
| Standard paint finish C2 in RAL 7030 stone gray | | | □ | □ | □ | □ | Only for: Frame sizes 315 and 355 – Basic Line |
| Unpainted (only cast-iron parts primed) | S00 | | ○ | ○ | ○ | ○ | |
| Unpainted, only primed | S01 | | ✓ | ✓ | ✓ | ✓ | |
| Special paint finish C3 | | | □ | □ | ✓ | ✓ | Only for: Frame sizes 315 and 355 – Performance Line |
| | S02 | | ✓ | – | | | Only for: Frame sizes 315 and 355 – Basic Line |
| Special paint finish sea air resistant C4 ³⁹⁾ | S03 | | ✓ | ✓ | ✓ | ✓ | |
| Special paint finish for use offshore C5 ³⁹⁾ | S04 | | ✓ | ✓ | ✓ | ✓ | |
| Internal coating | S05 | | ✓ | ✓ | ✓ | ✓ | |
| Top coat polyurethane ²⁵⁾ | S06 | | ✓ | ✓ | □ | □ | Only for: Combination with order codes S03 or S04 |
| Paint finish in other standard RAL colors: RAL 1002, 1013, 1015, 1019, 2003, 2004, 3000, 3007, 5002, 5007, 5009, 5010, 5012, 5015, 5017, 5018, 5019, 6011, 6019, 6021, 7000, 7001, 7004, 7011, 7016, 7022, 7031, 7032, 7033, 7035, 9001, 9002, 9005 (see Catalog Section 1 "Introduction") | Y53 • and paint finish RAL.... | | ✓ | ✓ | ✓ | ✓ | |
| Paint finish in special RAL colors: For RAL colors, see "Special paint finish in special RAL colors" (see Catalog Section 1 "Introduction") | Y56 • and paint finish RAL.... | | ✓ | ✓ | ✓ | ✓ | |
| Modular technology – Basic versions⁵⁾ | | | | | | | |
| Mounting of holding brake (standard assignment) ^{5) 6) 23) 24) 28)} | F01 | | ✓ | ✓ | ✓ | ✓ | Only for: 4-pole motors for frame sizes 315 and 355 |
| | | | – | – | | | Only for: Combination with order codes D02, F40, F41, L05, L30, L52 |
| Mounting of separately driven fan ³¹⁾ | F70 | | ✓ | ✓ | ✓ | ✓ | Not for: Combination with order codes L05, Y59 (frame sizes 315 and 355) |
| Mounting of Kübler Sendix 5020 HTL, 1024 I rotary pulse encoder ⁵⁾ | G11 | | ✓ | ✓ | – | – | Not for: Combination with order codes D02, L05 |
| Mounting of Kübler Sendix 5020 TTL, 1024 I rotary pulse encoder ⁵⁾ | G12 | | ✓ | ✓ | – | – | |
| Modular technology – Additional versions | | | | | | | |
| Brake supply voltage 24 V DC | F10 | | ✓ | ✓ | – | – | Only for: 4-pole motors for frame sizes 315 and 355 |
| | | | – | – | | | Only for: Combination with order codes D02, F40, F41, L05, L30, L52 |
| Brake supply voltage 230 V AC, 50/60 Hz | F11 | | ○ | ○ | ○ | ○ | Only for: 4-pole motors for frame sizes 315 and 355 |
| | | | – | – | | | Only for: Combination with order codes D02, F40, F41, L05, L30, L52 |

For legends and footnotes, see page 3/33.

SIMOTICS SD standard motors next generation
Article No. supplements and special versions · Options

Cast-iron series SIMOTICS SD 1LE55, 1LE56

| Special versions | Additional identification code -Z with order code and plain text if required | Frame size | | | | Motor version | |
|--|--|--------------------------|-----|---------|-------|---------------|--|
| | | 315 | 355 | 400 | 450 | IEC | IE4 |
| | | 1LE55.4 Basic Line | | 1LE5534 | | | |
| | | 1LE56.4 Performance Line | | | | | |
| | | 1LE55.3 Basic Line | | 1LE55.3 | | | |
| | | | | | | IE3 | |
| | | 1LE56.3 Performance Line | | | | | |
| 1LE5 -Z Order code | | | | | | | |
| Modular technology – Additional versions (continued) | | | | | | | |
| Brake supply voltage 400 V AC, 50/60 Hz | F12 | ✓ | ✓ | ✓ | ✓ | Only for: | 4-pole motors for frame sizes 315 and 355 |
| | | – | – | | | Only for: | Combination with order codes D02, F40, F41, L05, L30, L52 |
| Backstop, counterclockwise motion blocked, clockwise direction of rotation | F40 | ✓ | ✓ | – | – | Not for: | Combination with order codes F01, F10, F11, F12 |
| Backstop, clockwise motion blocked, counterclockwise direction of rotation | F41 | ✓ | ✓ | – | – | | |
| Special technology ⁵⁾ | | | | | | | |
| Mounting of LL 861 900 220 rotary pulse encoder ^{5) 9)} | G04 | ✓ | ✓ | ✓ | ✓ | Not for: | Combination with order codes D02, L05 (frame sizes 315 and 355) |
| Mounting of HQG 9 DN 1024 I rotary pulse encoder ^{5) 9)} | G05 | ✓ | ✓ | ✓ | ✓ | | |
| Mounting of HQG 10 D 1024 I rotary pulse encoder ^{5) 9)} | G06 | ✓ | ✓ | ✓ | ✓ | | |
| Mounting of POG 10 DN rotary pulse encoder (only in combination with separately driven fan or brake) ^{5) 10)} | G07 | ✓ | ✓ | – | – | Not for: | Combination with order codes D02, L05 |
| Mounting of POG 9 rotary pulse encoder (only in combination with separately driven fan or brake) ^{5) 10)} | G08 | ✓ | ✓ | – | – | | |
| Mounting of HOG 10 DN 1024 I rotary pulse encoder, terminal box moisture protection ⁵⁾ | G15 | ✓ | ✓ | ✓ | ✓ | Not for: | Combination with order codes D02, L05 (frame sizes 315 and 355) |
| Mounting of HOG 10 DN 1024 I rotary pulse encoder, terminal box dust protection ⁵⁾ | G16 | ✓ | ✓ | ✓ | ✓ | Not for: | Combination with order codes D02, L04, L05 (frame sizes 315 and 355) |
| Mounting of a special type of rotary pulse encoder | Y70 • and customer specifications | – | – | O. R. | O. R. | | |
| Mounting of rotary pulse encoder HOG 10 DN 1024 I + FSL, (integrated centrifugal switch, speed rpm), terminal box moisture protection ⁵⁾ | Y74 • and spec. speed rpm | ✓ | ✓ | ✓ | ✓ | Not for: | Combination with order codes D02, L05 (frame sizes 315 and 355) |
| Mounting of rotary pulse encoder HOG 10 DN 1024 I + FSL, (integrated centrifugal switch, speed rpm), terminal box dust protection ⁵⁾ | Y76 • and spec. speed rpm | ✓ | ✓ | ✓ | ✓ | | |
| Mounting of rotary pulse encoder HOG 10 DN 1024 I + ESL 93, (integrated electronic speed switch, speed rpm), terminal box dust protection ⁵⁾ | Y79 • and spec. speed (max 3) rpm | ✓ | ✓ | ✓ | ✓ | | |
| Mechanical version and degrees of protection | | | | | | | |
| Low-noise version for 2-pole motors with clockwise direction of rotation | F77 | ✓ | ✓ | ◻ | ◻ | Only for: | 2-pole motors for frame sizes 315 and 355 |
| | | – | – | | | Not for: | Combination with order codes L05, F90 |
| Low-noise version for 2-pole motors with counterclockwise direction of rotation | F78 | ✓ | ✓ | ◯ | ◯ | Only for: | 2-pole motors for frame sizes 315 and 355 |
| | | – | – | | | Not for: | Combination with order codes L05, F90 |
| Prepared for mounted components, centering hole only | G40 | – | – | ◻ | ◻ | | |
| Prepared for mountings with D12 shaft | G41 | ✓ | ✓ | – | – | Not for: | Combination with order codes D02, L05 |
| Prepared for mountings with D16 shaft | G42 | ✓ | ✓ | ✓ | ✓ | Not for: | Combination with order code L05 (frame sizes 315 and 355) |
| Mechanical protection for encoder ^{7) 9)} | G43 | ✓ | ✓ | ✓ | ✓ | Not for: | Combination with order code L05 (frame sizes 315 and 355) |
| Protective cover ^{7) 9) 11)} | H00 | ✓ | ✓ | ✓ | ✓ | | |



For legends and footnotes, see page 3/33.

SIMOTICS SD standard motors next generation

Article No. supplements and special versions · Options

Cast-iron series SIMOTICS SD 1LE55, 1LE56

| Special versions | Additional identification code -Z with order code and plain text if required | Frame size | | | | Motor version | |
|---|---|-----------------------------|-------|---------|-------|---|---|
| | | 315 | 355 | 400 | 450 | IEC | IE4 |
| | | 1LE55.4 Basic Line | | 1LE5534 | | IEC | IE4 |
| | | 1LE56.4 Performance Line | | | | | |
| | | 1LE55.3 Basic Line | | 1LE55.3 | | | IE3 |
| | | 1LE56.3 Performance Line | | | | | |
| 1LE5 - - - Z | | Order code | | | | | |
| Mechanical design and degrees of protection (continued) | | | | | | | |
| Vibration-proof version; vibration resistance to Class 3M4 acc. to IEC 60721-3-3:1994 | H02 | ✓ | ✓ | – | – | | |
| Condensation drainage holes | | □ | □ | □ | □ | | |
| Rust-resistant screws (externally) | H07 | ✓ | ✓ | ✓ | ✓ | | |
| Degree of protection IP65 ¹³⁾ | H20 | ✓ | ✓ | ✓ | ✓ | | |
| Degree of protection IP54 ³³⁾ | H21 | ✓ | ✓ | – | – | | |
| Degree of protection IP56 ¹⁴⁾ | H22 | ✓ | ✓ | ✓ | ✓ | | |
| Drive-end seal for flange-mounting motors, oil-tight to 0.1 bar ^{12) 22)} | H23 | ✓ | ✓ | – | – | Not for: | Combination with type of construction code letters T, U, V (14th position of the Article No.) |
| Sealing ring made of fluoroelastomer (FKM) | H25 | ✓ | ✓ | ✓ | ✓ | Not for: | Combination with order codes D02, D03, D04 (frame sizes 315 and 355) |
| Increased corrosion protection for external components ²⁸⁾ | H90 | – | – | ✓ | ✓ | | |
| Grounding brush for converter operation ^{29) 44)} | L52 | ✓ | ✓ | ✓ | ✓ | Not for: | Combination with order codes F01, F10, F11, F12 (frame sizes 315 and 355) |
| Coolant temperature and installation altitude | | | | | | | |
| Coolant temperature –50 to +40 °C ^{15) 32)} | D02 | ✓ | ✓ | ✓ | ✓ | Not for: | Combination with order codes F01, F10, F11, F12, G04, G05, G06, G07, G11, G12, G15, G16; H25, Y74, Y76, Y79 (frame sizes 315 and 355) |
| Coolant temperature –40 to +40 °C ¹⁵⁾ | D03 | ✓ | ✓ | ✓ | ✓ | Not for: | Combination with order code H25 (frame sizes 315 and 355) |
| Coolant temperature –30 to +40 °C ¹⁵⁾ | D04 | ✓ | ✓ | ✓ | ✓ | | |
| Versions in accordance with standards and specifications | | | | | | | |
| VIK version ⁴⁴⁾ | C02 | – | – | ✓ | ✓ | In combination with order codes F01, F10, F11, F12, G01, G02, G11 or G12 on request | |
| Motor without CE marking for export outside EEA (see EU Regulation 640/2009) | D22 | ○ | ○ | – | – | | |
| Motor exclusively for use in transportation equipment for passenger and freight transportation corresponding to EVPG §1 dated February 27, 2008 | D23 | ○ | ○ | – | – | | |
| Electrical acc. to NEMA MG1-12 ¹⁷⁾ | D30 | ✓ | ✓ | □ | □ | Only for: | 1LE5504, 1LE5604, 1LE5503, 1LE5603 for frame sizes 315 and 355 |
| Design acc. to UL with "Recognition Mark" ¹⁷⁾ | D31 | ✓ | ✓ | □ | □ | | |
| China Energy Efficiency Label | D34 | ○ | ○ | – | – | Not for: | 8-pole motors |
| Canadian regulations (CSA) ¹⁶⁾ | D40 | ✓ | ✓ | □ | □ | Only for: | 1LE5504, 1LE5604, 1LE5503, 1LE5603 for frame sizes 315 and 355 |
| TR CU product safety certificate EAC for Eurasian Customs Union | D47 | ✓ | ✓ | ✓ | ✓ | | |
| Bearings and lubrication | | | | | | | |
| Regreasing device with M10 × 1 grease nipple acc. to DIN 71412-A | L19 | ○ | ○ | ○ | ○ | | |
| Located bearing DE | L20 | ✓ | ✓ | □ | □ | | |
| Located bearing NDE ³⁴⁾ | L21 | – | – | ✓ | ✓ | | |
| Bearing design for increased cantilever forces ^{26) 27)} | L22 | ✓ | ✓ | O. R. | O. R. | | |
| Regreasing device | | – | – | □ | □ | | |
| Hot bearing grease | L24 | O. R. | O. R. | – | – | | |
| Drainage for used grease | | □ | □ | O. R. | O. R. | Only for: | Frame sizes 315 and 355 – Performance Line |
| | L30 | ✓ | – | | | Only for: | Frame sizes 315 and 355 – Basic Line |

For legends and footnotes, see page 3/33.

SIMOTICS SD standard motors next generation

Article No. supplements and special versions · Options

Cast-iron series SIMOTICS SD 1LE55, 1LE56

| Special versions | Additional identification code -Z with order code and plain text if required | Frame size | | | | Motor version | |
|--|---|-----------------------------|------------|------------|------------|---------------|--|
| | | 315 | 355 | 400 | 450 | IEC | IE4 |
| | | 1LE55.4 Basic Line | | 1LE5534 | | | |
| | | 1LE56.4 Performance Line | | | | | |
| | | 1LE55.3 Basic Line | | 1LE55.3 | | IE3 | |
| 1LE56.3 Performance Line | | | | | | | |
| 1LE5 . . . - -Z Order code | | | | | | | |
| Bearings and lubrication (continued) | | | | | | | |
| Special version with higher speeds | L37 | | O. R. | O. R. | O. R. | O. R. | |
| Bearing insulation DE ⁴⁴⁾ | L50 | | ✓ | ✓ | ✓ | ✓ | |
| Bearing insulation NDE ^{29) 44)} | L51 | | ✓ | ✓ | ✓ | ✓ | |
| Measuring nipple for SPM shock pulse measurement for bearing inspection | Q01 | | ✓ | ✓ | ✓ | ✓ | |
| Balance and vibration severity | | | | | | | |
| Vibration severity grade A | | | □ | □ | □ | □ | |
| Vibration severity grade B ¹⁸⁾ | L00 | | ✓ | ✓ | ✓ | ✓ | Only for: 4-pole motors for frame sizes 315 and 355 |
| Half-key balancing (standard) | | | □ | □ | □ | □ | |
| Balancing without feather key ⁴¹⁾ | L01 | | ✓ | ✓ | ✓ | ✓ | Not for: Combination with order code L04 (frame sizes 315 and 355) |
| Full-key balancing ⁴¹⁾ | L02 | | ✓ | ✓ | ✓ | ✓ | |
| Shaft and rotor | | | | | | | |
| Shaft extension with standard dimensions, without feather keyway | L04 | | ✓ | ✓ | ✓ | ✓ | Not for: Combination with order codes L01, L02 (frame sizes 315 and 355) |
| Standard, cylindrical shaft extension (second shaft extension) NDE acc. to EN 50347 | L05 | | ✓ | ✓ | ✓ | ✓ | Not for: Combination with order codes F01, F10, F11, F12, F70, F77, F78, G04, G05, G06, G07, G15, G16, G41, G42, G43, H00, Y74, Y76, Y79 (frame sizes 315 and 355) |
| Standard shaft made of stainless steel (e.g. 1.4021) | L06 | | ✓ | ✓ | – | – | |
| Shaft extension run-out in accordance with IEC 60072-1 precision class | L07 | | ✓ | ✓ | ✓ | ✓ | |
| Shaft extension run-out, concentricity and perpendicularity in accordance with IEC 60072-1 precision class for flange-mounted motors | L08 | | ✓ | ✓ | ✓ | ✓ | Not for: Combination with type of construction code letters A, T, U, V (14th position of the Article No.) for frame sizes 315 and 355 |
| Non-standard cylindrical shaft extension, DE ¹⁹⁾ | Y58 • and customer specifications | | ✓ | ✓ | ✓ | ✓ | |
| Non-standard cylindrical shaft extension, NDE ¹⁹⁾ | Y59 • and customer specifications | | ✓ | ✓ | ✓ | ✓ | Not for: Combination with order code F70 (frame sizes 315 and 355) |
| Special shaft steel | Y60 • and customer specifications | | O. R. | O. R. | O. R. | O. R. | |
| Heating and ventilation | | | | | | | |
| Sheet metal fan cover | F74 | | □ | □ | □ | □ | Only for: Frame sizes 315 and 355 – Performance Line |
| | | | ✓ | – | | | Only for: Frame sizes 315 and 355 – Basic Line |
| Metal external fan | F76 | | – | – | ✓ | ✓ | |
| Without external fan and without fan cover | F90 | | ✓ | ✓ | ✓ | ✓ | Not for: Combination with order codes F74, F77, F78 (frame sizes 315 and 355) |
| Anti-condensation heating for 230 V (2 terminals) | Q02 | | ✓ | ✓ | ✓ | ✓ | Not for: Combination with order codes Q03, Q06 |
| Anti-condensation heating for 115 V (2 terminals) | Q03 | | ✓ | ✓ | ✓ | ✓ | Not for: Combination with order codes Q02, Q06 |
| Anti-condensation heating for 400 V (2 terminals) | Q06 | | ✓ | ✓ | ✓ | ✓ | Not for: Combination with order codes Q02, Q03 |
| Separately driven fan with non-standard voltage and/or frequency | Y81 • and customer specifications | | ✓ | ✓ | ✓ | ✓ | |

SIMOTICS SD standard motors next generation

Article No. supplements and special versions · Options

Cast-iron series SIMOTICS SD 1LE55, 1LE56

| Special versions | Additional identification code -Z with order code and plain text if required | Frame size | | | | Motor version | |
|--|--|-----------------------------|-----|----------|-----|---------------|-----|
| | | 315 | 355 | 400 | 450 | IEC | IE4 |
| | | 1LE55.4 Basic Line | | 1LE55.34 | | IEC | IE4 |
| | | 1LE56.4 Performance Line | | | | | |
| | | 1LE55.3 Basic Line | | 1LE55.3 | | | IE3 |
| | | 1LE56.3 Performance Line | | | | | |
| 1LE5 . . . - - - Z Order code | | | | | | | |
| Rating plate and additional rating plates | | | | | | | |
| Additional rating plate for voltage tolerance | B07 | ✓ | ✓ | ✓ | ✓ | | |
| Second rating plate, loose | M10 | ✓ | ✓ | ✓ | ✓ | | |
| Rating plate, stainless steel | M11 | ✓ | ✓ | □ | □ | | |
| Additional rating plate with deviating rating plate data ⁴³⁾ | Y80 • and customer specifications | ✓ | ✓ | ✓ | ✓ | | |
| Additional rating plate with customer specifications | Y82 • and customer specifications | ✓ | ✓ | ✓ | ✓ | | |
| Additional information on rating plate and on package label (max. 20 characters) | Y84 • and customer specifications | ✓ | ✓ | ✓ | ✓ | | |
| Adhesive label, supplied loose (printed with: Article No., Serial No.: 2 lines of text) | Y85 • and customer specifications | ✓ | ✓ | - | - | | |
| Extension of the liability for defects | | | | | | | |
| Extension of the liability for defects by 12 months to a total of 24 months (2 years) from delivery ²⁰⁾ | Q80 | ✓ | ✓ | ✓ | ✓ | | |
| Extension of the liability for defects by 18 months to a total of 30 months (2.5 years) from delivery ²⁰⁾ | Q81 | ✓ | ✓ | ✓ | ✓ | | |
| Extension of the liability for defects by 24 months to a total of 36 months (3 years) from delivery ²⁰⁾ | Q82 | ✓ | □ | ✓ | ✓ | | |
| Extension of the liability for defects by 30 months to a total of 42 months (3.5 years) from delivery ²⁰⁾ | Q83 | ✓ | ✓ | ✓ | ✓ | | |
| Extension of the liability for defects by 36 months to a total of 48 months (4 years) from delivery ²⁰⁾ | Q84 | ✓ | ✓ | ✓ | ✓ | | |
| Extension of the liability for defects by 48 months to a total of 60 months (5 years) from delivery ²⁰⁾ | Q85 | ✓ | ✓ | ✓ | ✓ | | |
| Packaging, safety notes, documentation and test certificates | | | | | | | |
| Inspection certificate 3.1 acc. to EN 10204 ²⁰⁾ | B02 | ✓ | ✓ | ✓ | ✓ | | |
| Printed German/English Operating Instructions enclosed ²¹⁾ | B04 | ✓ | ✓ | ✓ | ✓ | | |
| Without "Made in manufacturing country" marking | B13 | ○ | ○ | - | - | | |
| Equivalent circuit diagram | B51 | ✓ | ✓ | ✓ | ✓ | | |
| Starting diagram (torque vs. speed and current vs. speed) | B52 | ✓ | ✓ | ✓ | ✓ | | |
| Document - Electrical datasheet | B60 | ✓ | ✓ | ✓ | ✓ | | |
| Document - Order dimensional drawing | B61 | ✓ | ✓ | ✓ | ✓ | | |
| Standard test (routine test) with acceptance | B65 | ✓ | ✓ | ✓ | ✓ | | |
| Temperature test without acceptance | B67 | ✓ | ✓ | ✓ | ✓ | | |
| Temperature test with acceptance | B68 | ✓ | ✓ | ✓ | ✓ | | |
| Type test with heat run for vertical motors, without acceptance | B80 | ✓ | ✓ | ✓ | ✓ | | |
| Type test with heat run for vertical motors, with acceptance | B81 | ✓ | ✓ | ✓ | ✓ | | |
| Type test with heat run for horizontal motors, without acceptance | B82 | ✓ | ✓ | ✓ | ✓ | | |
| Type test with heat run for horizontal motors, with acceptance | B83 | ✓ | ✓ | ✓ | ✓ | | |
| "Basic" documentation package | B90 | ✓ | ✓ | ✓ | ✓ | | |
| "Advanced" documentation package | B91 | ✓ | ✓ | ✓ | ✓ | | |
| "Projects" documentation package | B92 | ✓ | ✓ | ✓ | ✓ | | |
| Connected in star for dispatch | M01 | ✓ | ✓ | ✓ | ✓ | | |
| Connected in delta for dispatch | M02 | ✓ | ✓ | ✓ | ✓ | | |

For legends and footnotes, see page 3/33.

- Standard version
- Without additional charge
- This order code only determines the price of the version – Additional plain text is required.
- ✓ With additional charge
- O. R. Possible on request
- Not possible

- 1) Evaluation with associated tripping unit (see Catalog IC 10) is recommended.
- 2) Parallel Whitworth threaded pipe DIN ISO 228 (DIN 259) BSPP (British Standard Pipe Parallel), threaded pipe for connections not sealed in the thread (cylindrical), external = G.
- 3) The grease lifetime specified in Catalog Section 1 "Introduction" refers to CT 40 °C. If the coolant temperature is increased by 10 K, the grease lifetime and regreasing interval are halved.
- 4) Not possible for 1LE5 motors with increased power.
- 5) A second shaft extension is not possible. Please inquire for mounted brakes.
- 6) For order codes **F10**, **F11**, and **F12**, the brake supply voltage must be specified or ordered.
- 7) The 1XP8 rotary pulse encoders are fitted with a protective cover as standard. The protective cover is omitted at the factory when a rotary pulse encoder is combined with a separately driven fan, because in this case the rotary pulse encoder is installed under the fan cover.
- 8) In combination with a separately driven fan (order code **F70**) the 1XP8032-10 rotary pulse encoder is used instead of 1XP8012-10 or 1XP8032-20 is used instead of 1XP8012-20.
- 9) For frame sizes 315 and 355, LL and HOG rotary pulse encoders are fitted with a protective cover as standard. The protective cover is omitted at the factory when a rotary pulse encoder is combined with a separately driven fan, because in this case the rotary pulse encoder is installed under the fan cover. Protective cover (order code **G43**) possible.
- 10) Option (encoder mounting) is only possible for motors with a mounted separately driven fan or for naturally cooled motors (without an external fan). This option can be used in combination with brakes of type KFB and SFB. This option cannot be used in combination with brakes of type BFK458!
- 11) Order code **H00** provides mechanical protection for encoders.
- 12) Not possible for type of construction IM V3.
- 13) Not possible in combination with HOG 9 D 1024l rotary pulse encoder (order code **G05**) and/or BFK458 brake (order code **F01**).
- 14) Not possible in combination with brake BFK458 (order code **F01**).
- 15) In connection with mountings, the respective technical specifications must be observed, please inquire before ordering.
- 16) The rated voltage is indicated on the rating plate without voltage range.
- 17) Possible up to 600 V max. The rated voltage is indicated on the rating plate without voltage range. Order codes D30 does not authorize importing into USA and Mexico.
- 18) On request for 2-pole motors
- 19) When motors are ordered that have a longer or shorter shaft extension than normal, the required position and length of the feather keyway must be specified in a sketch. It must be ensured that only feather keys in accordance with EN 50347 are used. The feather keyway is positioned centrally on the shaft extension. The length is defined by the manufacturer in accordance with the appropriate standard. Not valid for: Conical shafts, non-standard threaded journals, non-standard shaft tolerances, friction welded journals, extremely "thin" shafts, special geometry dimensions (e.g. square journals), hollow shafts. Valid for non-standard shaft extensions DE or NDE. The feather keys are supplied in every case. For order codes **Y58**, **Y59** and **L05** the following applies:
 - Dimensions D and DA ≤ ball bearing inner diameter (see dimension tables for "Dimensions")
 - Dimensions E and EA ≤ 2 × length E (standard) of the shaft extension.
- 20) The delivery time for the manufacturer's test certificate may differ from the delivery time for the motor.
- 21) The Operating Instructions (Compact) are available in PDF format for all official EU languages at <http://support.automation.siemens.com/WWW/view/en/10803948/133300>
- 22) Not possible in combination with order codes **Q72** and **Q78**.
- 23) Not possible in combination with order codes **N05**, **N06**, **N07**, **N08** and **N11**.
- 24) When order codes **F01** and **F12** are combined, the rectifier for the brake will be supplied separately as a single part.
- 25) Order code **S06** cannot be combined with order code **S00** and **S01**. It can be combined with **Y53** on request.
- 26) A minimum cantilever force F_{min} of $0.5 \cdot F_{max}$ is required for NU bearings (cylindrical roller bearings) in contrast to ball bearings. Cylindrical roller bearings are not suitable for coupling output or for brief periods of no-load operation without cantilever force.
- 27) Supplied with the condensation drainage holes sealed at the drive end DE and non-drive end NDE (IP55, IP56, IP65). If the condensation drainage holes are required for motors of the IM B6, IM B7 or IM B8 type of construction (feet on side or top), the motors must be ordered in the respective type of construction and with order code **H03**, so that the condensation drainage holes will be placed in the correct position.
- 28) For frame sizes 400 and 450, permissible cantilever forces for motors with reinforced bearings are available on request. Please specify cantilever force and lever arm.
- 29) For insulated bearings at the DE, and non-insulated bearings at the NDE, the motor coupling must be insulated.
- 30) For insulated bearings at the DE and NDE, a grounding brush (**L52**) is essential if no grounding is provided in the drive train. Otherwise, it should be omitted.
- 31) Only possible for line operation.
- 32) The separately driven fan motor is implemented with voltage code **34** (400 V/50 Hz; 460 V/60 Hz).
- 33) For frame sizes 400 to 450, the degree of protection changes to IP54.
- 34) For frame size 450, not possible in the vertical type of construction.
- 35) For motors with flange (IM B5, IM B35, IM V1), only possible in conjunction with order code **H08**.
- 36) Restrictions can apply when mounting the terminal box.
- 37) Only possible in conjunction with SIMOTICS SD Add motors (6th position of the Article No.: **3**).
- 38) When compared to utilization, temperature class 155 (F), the power is increased by 5 %.
- 39) Only available for 1LE5 and 1MB551 (Ex tc for Zone 21) and 1MB552 (Ex tc for Zone 22). Not available for 1MB553 (Ex ec for Zone 2).
- 40) Not available for 8-pole motors, frame size 450.
- 41) Not possible in combination with order code **C02**.
- 42) Not possible in combination with order code **R50**.
- 43) Customer specifications: Voltage between 380 and 690 V (voltages outside this range are available on request), frequency, circuit, required rated power in kW.
- 44) For 1LE5, only available for line operation (DOL). For 1LE5 in combination with order code **L50** or **L51** on request (converter operation).

SIMOTICS SD standard motors next generation

Article No. supplements and special versions · Accessories

Overview

Couplings

The motor from Siemens is connected to the machine or gear unit through a coupling. Flender is an important coupling manufacturer with a wide range of products.

For standard applications, Siemens recommends that flexible couplings, types N-EUPEX and RUPEX or torsionally rigid couplings, types ARPEX and ZAPEX are used. For special applications, FLUDEX and ELPEX-S couplings are recommended.

Available from:

Siemens contact partner - ordering from catalog
Siemens MD 10.1 "FLENDER Standard Couplings"

or

Flender GmbH
Kupplungswerk Mussum
Industriepark Bocholt
Schlavenhorst 100
46395 Bocholt, Germany
Phone +49 (2871) 922185
Fax +49 (2871) 922579

www.flender.com

Email: flender-kupplungen-2.pd.de@siemens.com

Taper pins according to DIN 258 with threaded ends and constant taper lengths

Taper pins are used for components that are repeatedly removed. The drilled hole is conically ground using a conical reamer until the pin can be pushed in by hand until the cone shoulder lies approx. 3 to 4 mm above the rim of the hole.

It can then be driven in using a hammer until it is correctly seated. The pin is removed from the drilled hole by screwing on the nut and tightening it.

Standardized taper pins are commercially available.

For instance, available from:

Otto Roth GmbH & Co. KG
Rutesheimer Strasse 22
70499 Stuttgart, Germany
Phone +49 (711) 1388-0
Fax. +49 (711) 1388-233

www.ottoroth.de

Email: info@ottoroth.de

Foundation blocks according to DIN 799

The foundation blocks are inserted into the stone foundation and embedded in concrete. They are used for fixing machines of medium size, slide rails, pedestal bearings, base frames, etc. After the fixing bolts have been unscrewed, the machines can be shifted without them having to be lifted.

When the machine is initially installed, the foundation blocks that are bolted to the machine (without washers) and fitted with taper pins are not embedded with concrete until the machine has been fully aligned. In this case, the machine is positioned 2 to 3 mm lower. The difference in shaft height is compensated by inserting shims on final installation. The taper pins safeguard the exact position of the machine when it is repeatedly removed and replaced without the need for realignment.

Available from:

Lütgert & Co. GmbH
Postfach 42 51
33276 Gütersloh, Germany
Phone +49 (5241) 7407-0
Fax +49 (5241) 7407-90

www.luetgert-antriebe.de

Email: info@luetgert-antriebe.de

Slide rails with fixing bolts and tensioning screws according to DIN 42923

Slide rails are used to tension the belt of a machine easily and conveniently when there is no belt-tensioning pulley. They are fixed to the base using stone bolts or foundation blocks.

The assignment of slide rails to motor size can be found in DIN 42923. For motors of frame sizes 355 to 450, there are no standardized slide rails (please inquire).

Available from:

Lütgert & Co. GmbH
Postfach 42 51
33276 Gütersloh, Germany
Phone +49 (5241) 7407-0
Fax +49 (5241) 7407-90

www.luetgert-antriebe.de

Email: info@luetgert-antriebe.de

More information**Spare motors and repair parts**

- Commitment to provide replacement motors and repair parts following delivery of the motor:
 - For up to 3 years after delivery of the original motor, in the event of total motor failure, Siemens will supply a comparable replacement motor with regard to the mounting dimensions and functions (the type series may vary).
 - If a replacement motor is supplied within the 3-year period, this does not mean that the warranty restarts.
 - Replacement motors delivered after the active production of the machine series are also identified as spare motors on the rating plate.
 - Spare parts are offered only for these spare motors on request; repair and replacement are not possible.
 - After a period of 3 years (after the delivery of the original motor), it is only possible to repair these motors (depending on the availability of the spare parts required).
 - For up to 5 years after the delivery of the original motor, spare parts will be available and for a further 5 years, Siemens will provide information about spare parts and will supply documents when required.
- When repair parts are ordered, the following details must be provided:
 - Designation and part number
 - Article No. and factory number of the motor.
- For bearing types, see Catalog Section 1 "Introduction".
- For standard components, a commitment to supply repaired parts does not apply.
- Support hotline
In Germany
Phone +49 (180) 5050448

You will find telephone numbers for other countries on our Internet site:

www.siemens.com/automation/service&support

SIMOTICS SD standard motors next generation

Dimensions

Notes on the dimensions

Overview

- Dimension designations according to EN 50347 and IEC 60072.

■ Fits

The shaft extensions specified in the dimension tables (DIN 748) and centering spigot diameters (EN 50347) are machined with the following fits:

| Dimension designation | ISO fit | DIN ISO 286-2 |
|-----------------------|---------------|---------------|
| D, DA | to 30 | j6 |
| | over 30 to 50 | k6 |
| | over 50 | m6 |
| N | to 250 | j6 |
| | over 250 | h6 |
| F, FA | | h9 |
| K | | H17 |
| S | flange (FF) | H17 |

The drilled holes of couplings and belt pulleys should have an ISO fit of at least H7.

■ Dimensional tolerances

For the following dimensions, the admissible deviations are given below:

| Dimension designation | Dimension | Admissible deviation |
|-----------------------|-----------|----------------------|
| H | to 250 | - 0.5 |
| | over 250 | - 1.0 |
| E, EA | | - 0.5 |

Keyways and feather keyways (dimensions GA, GC, F, and FA) are made in compliance with DIN 6885 Part 1.

- All dimensions are specified in mm.

SIMOTICS SD standard motors next generation

Dimensions

Dimension sheet generator (within the DT Configurator)

Overview

A dimensional drawing can be created in the "Drive Technology Configurator" (DT Configurator) for every configurable motor. A dimensional drawing can be requested for every other motor.

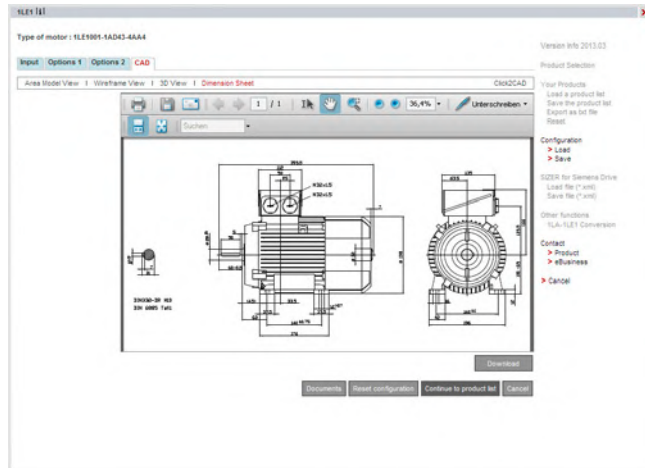

When a complete Article No. is entered with or without order codes, a dimensional drawing can be called up under the "Documentation" tab.

These dimensional drawings can be presented in different views and sections and printed.

The corresponding dimension sheets can be exported, saved and processed further in DXF format (interchange/import format for CAD systems) or as bitmap graphics.

Online access in the Siemens Industry Mall

The DT Configurator is integrated into the Siemens Industry Mall and can be used on the Internet without installation.

German: www.siemens.de/dt-konfigurator
English: www.siemens.com/dt-konfigurator

SIMOTICS SD standard motors next generation

Dimensions · Cast-iron series SIMOTICS SD

IE4, IE3 – self-ventilated · Frame sizes 315 L to 355 L

Dimensional drawings

Type of construction IM B3

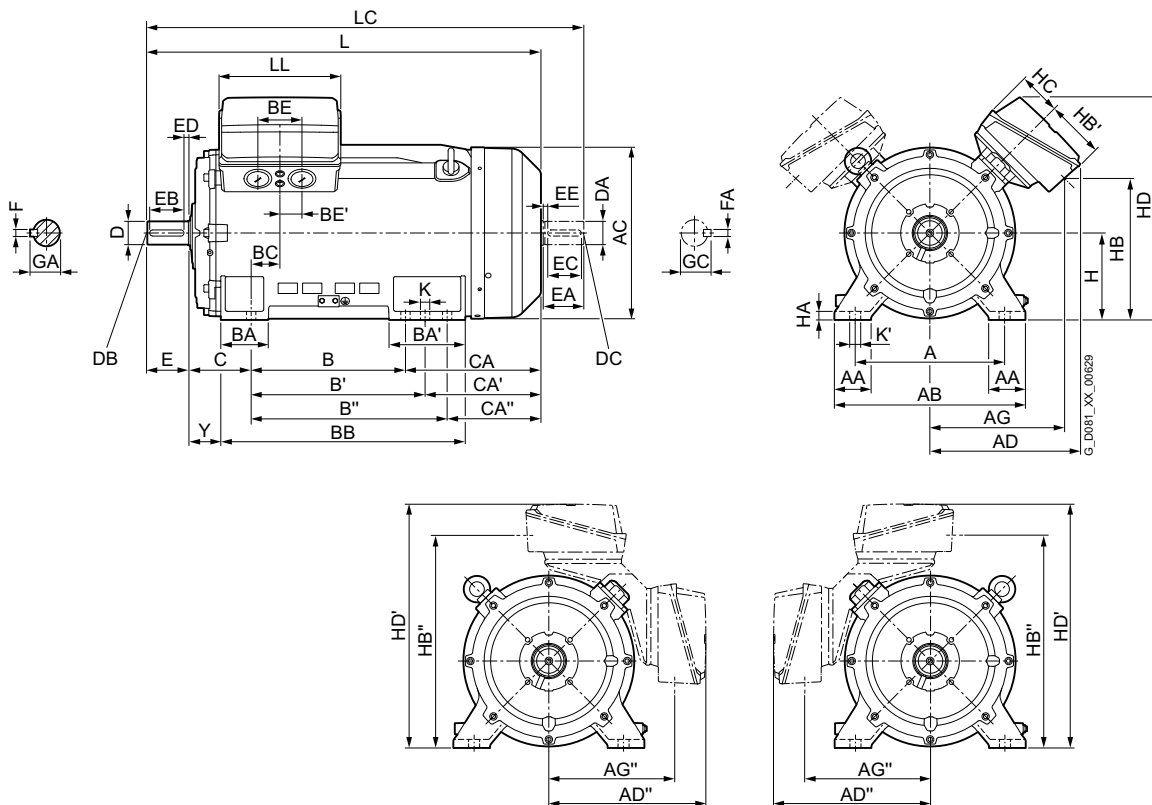

Types of construction IM B5 and IM V1

For flange dimensions, see page 1/47 (Z = the number of retaining holes)

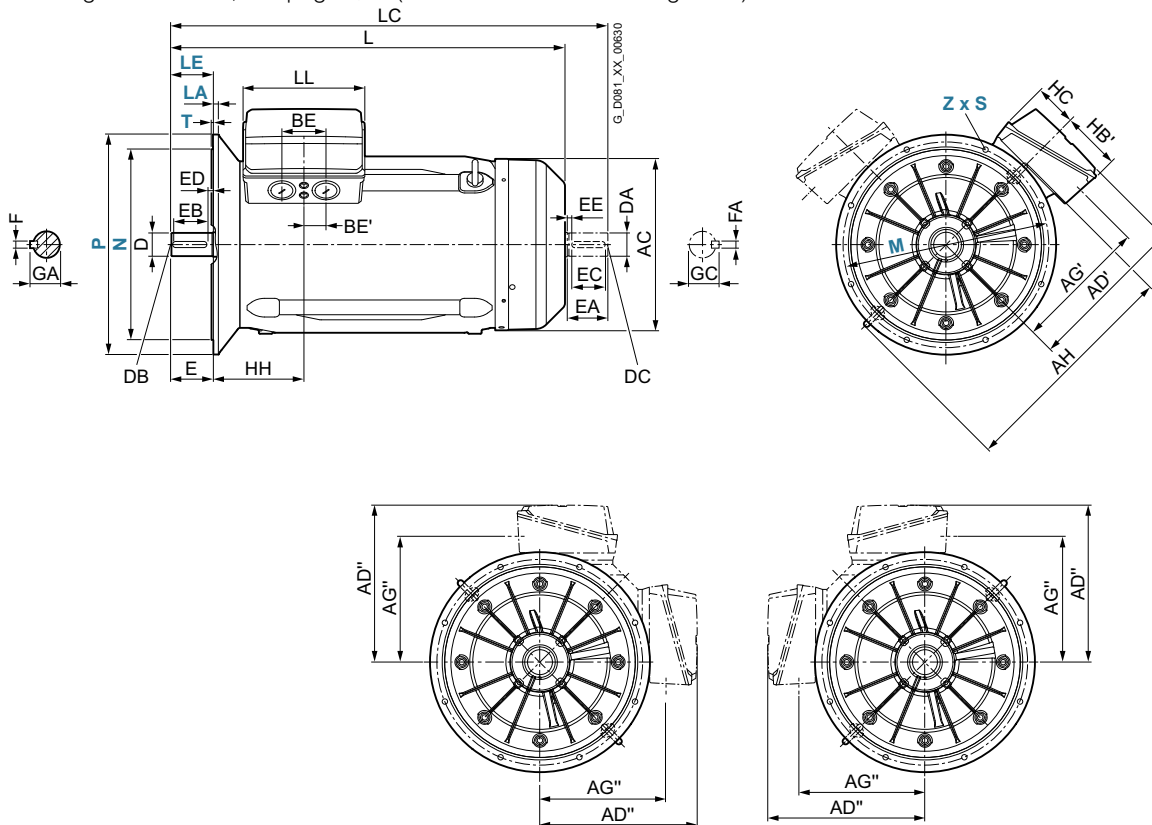

3

SIMOTICS SD standard motors next generation

Dimensions · Cast-iron series SIMOTICS SD

IE4, IE3 – self-ventilated · Frame sizes 315 L to 355 L

Dimensional drawings

Type of construction IM B35

For flange dimensions, see page 1/47 (Z = the number of retaining holes)

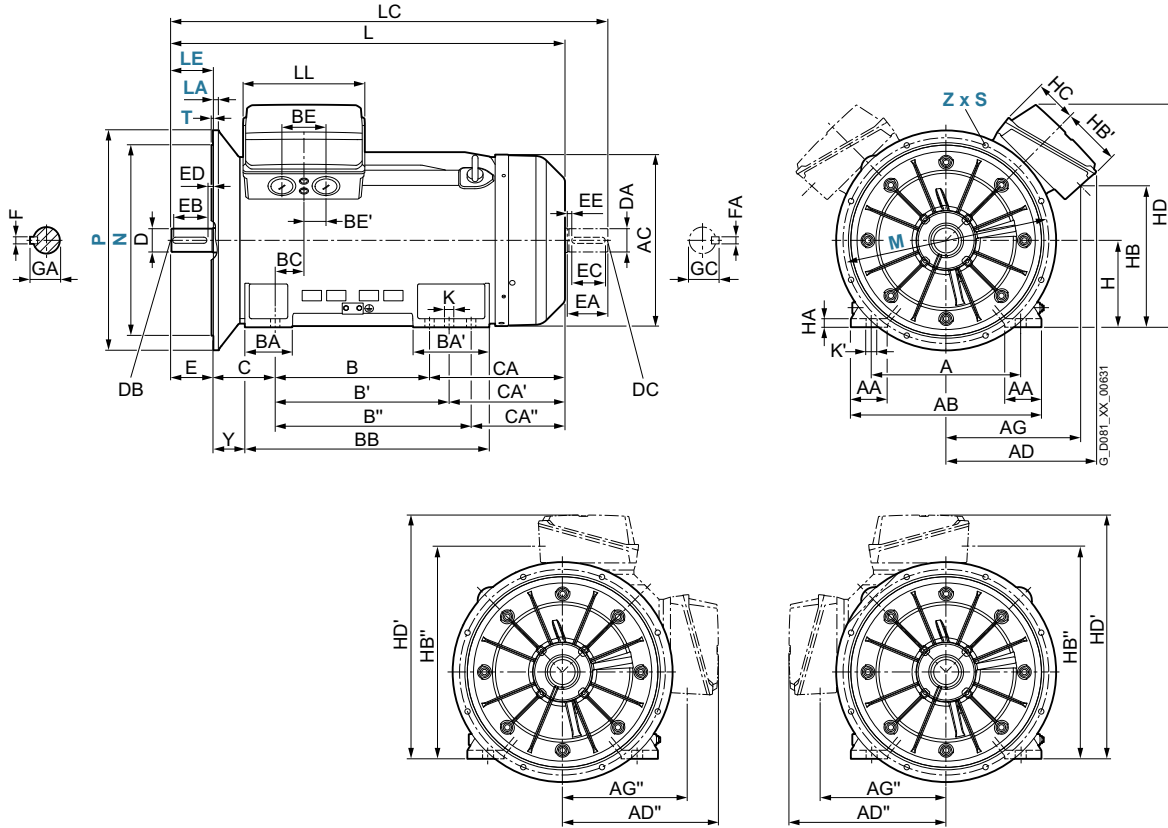

3

| For motor | Dimension designation acc. to IEC | No. of A | AA | AB | AC | AD | AD' | AD'' | AG | AG' | AG'' | AH | B | B' | B'' | BA | BA' | BB | BC | BE | BE' | C | CA | CA' | CA'' | H | HA | HB | |
|-----------|-----------------------------------|----------|-----|-----|------------|------------|------------|------|-----|-----|------|-----|-----|-----|-----|-----|-----|-----|-----|-----|------|-----|-----|-----|------|-----|------------|----|-----|
| 315 L | 3AA6 | 2 | 508 | 120 | 610 | 641 | 590 | 565 | 540 | 553 | 459 | 434 | 890 | 457 | 508 | - | 176 | 227 | 648 | 139 | 120 | 60 | 216 | 469 | 418 | - | 315 | 50 | 412 |
| | 3AB6 | 4 | | | | | | | | | | | | | | | | | | | | | | | | | | | |
| | 3AA7 | 2 | | | | | | | | | | | | 508 | 560 | 630 | | 298 | 770 | | | | | 498 | 446 | 376 | | | |
| | 3AB7 | 4 | | | | | | | | | | | | | | | | | | | | | 528 | 476 | 406 | | | | |
| | 3AC7 | 6 | | | | 542 | | | 491 | 473 | 448 | | | | | | | | | 135 | 67.5 | | | | | | | | 491 |
| | 3AC8 | 6 | | | | 590 | | | 553 | 459 | 434 | | | | | | | | | 120 | 60 | | 618 | 566 | 496 | | | | 412 |
| | 3AD7 | 8 | | | | 543 | | | 491 | 473 | 448 | | | | | | | | | 135 | 67.5 | | 528 | 476 | 406 | | | | 491 |
| | 3AD8 | 8 | | | | | | | | | | | | | | | | | | | | 618 | 566 | 496 | | | | | |
| 355 L | 3BA3, 3BA4, 3BA5 | 2 | 610 | 150 | 780 | 718 | 620 | 657 | 644 | 550 | 542 | 530 | 940 | 630 | 710 | 800 | 198 | 315 | 998 | 116 | 240 | 120 | 254 | 553 | 473 | 383 | 355 | 49 | 574 |
| | 3BB., 3BC., 3BD. | 4, 6, 8 | | | | | | | | | | | | | | 194 | 311 | | | | | | | | | | | | 35 |

| For motor | Dimension designation acc. to IEC | No. of HB' | HB'' | HC | HD | HD' | HH | Y | K | K' | L | LC ¹⁾ | LL | DE shaft extension | NDE shaft extension | D | DB | E | EB | ED | F | GA | DA | DC | EA | EC | EE | FA | GC |
|-----------|-----------------------------------|------------|------|-----|-----|-----|-----|-----|-----|----|----|------------------|------|--------------------|---------------------|-----|-----|-----|----|----|------|----|-----|-----|-----|----|----|------|----|
| 315 L | 3AA6 | 2 | 336 | 749 | 167 | 800 | 855 | 355 | 146 | 28 | 35 | 1282 | 1427 | 327 | 65 | M20 | 140 | 125 | 10 | 18 | 69 | 60 | M20 | 140 | 125 | 10 | 18 | 64 | |
| | 3AB6 | 4 | | | | | | | | | | 1312 | 1457 | 85 | | 170 | 140 | 25 | 22 | 90 | 70 | | | | | | 20 | 74.5 | |
| | 3AA7 | 2 | | | | | | | | | | 1362 | 1507 | 65 | | 140 | 125 | 10 | 18 | 69 | 60 | | | | | | 18 | 64 | |
| | 3AB7 | 4 | | | | | | | | | | 1422 | 1567 | 85 | | 170 | 140 | 25 | 22 | 90 | 70 | | | | | | 20 | 74.5 | |
| | 3AC7 | 6 | 225 | 763 | | | | | | | | | | | | | | | | | | | | | | | | | |
| | 3AC8 | 6 | 336 | 749 | | | | | | | | 1512 | 1657 | | | | | | | | | | | | | | | | |
| | 3AD7 | 8 | 225 | 763 | | | | | | | | 1422 | 1567 | | | | | | | | | | | | | | | | |
| | 3AD8 | 8 | | | | | | | | | | 1512 | 1657 | | | | | | | | | | | | | | | | |
| 355 L | 3BA3, 3BA4, 3BA5 | 2 | 247 | 885 | 188 | 911 | 999 | 370 | 130 | 35 | 42 | 1577 | 1722 | 519 | 75 | M20 | 140 | 125 | 10 | 20 | 79.5 | 60 | M20 | 140 | 125 | 10 | 18 | 64 | |
| | 3BB., 3BC., 3BD. | 4, 6, 8 | | | | | | | | | | 1607 | 1782 | 95 | | M24 | 170 | 140 | 25 | 25 | 100 | 80 | | 170 | 140 | 25 | 22 | 85.5 | |

¹⁾ In the low-noise version, a second shaft extension and/or mounted encoder is not possible.

SIMOTICS SD standard motors next generation

Dimensions · Cast-iron series SIMOTICS SD Add

IE4, IE3 – self-ventilated · Frame sizes 315 L to 355 L

Dimensional drawings

Type of construction IM B3

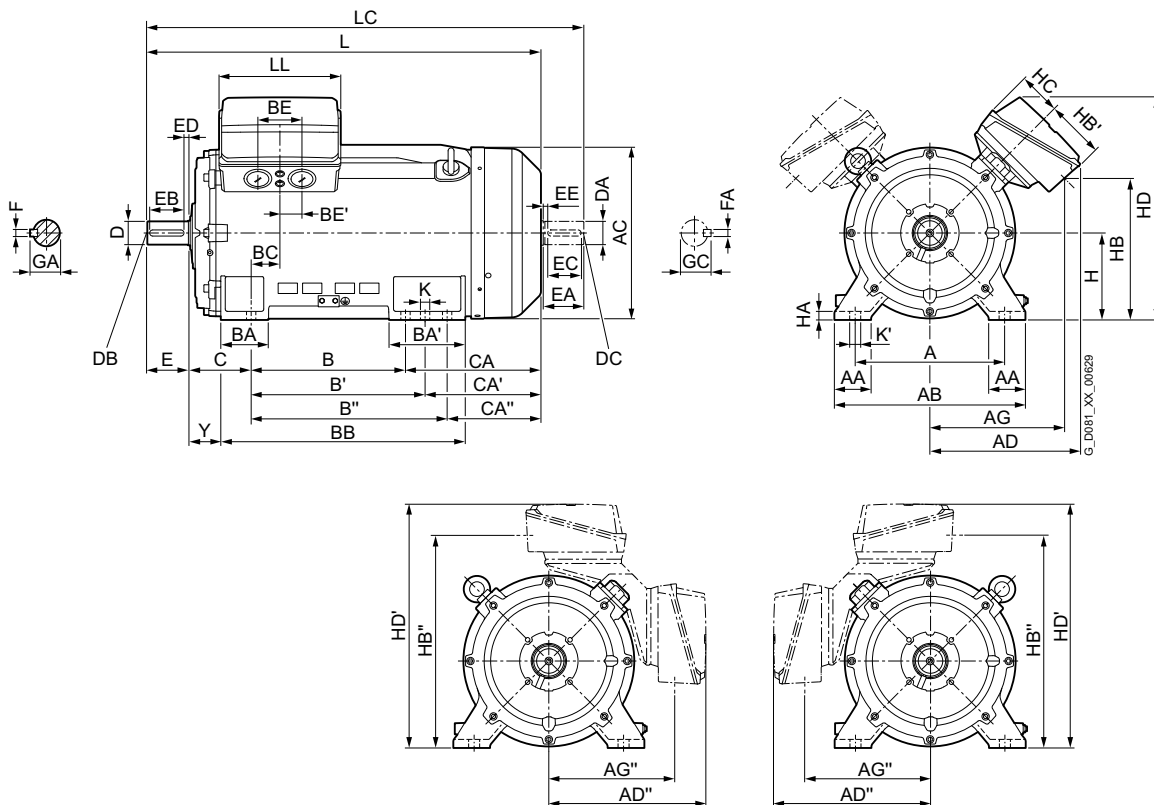

Types of construction IM B5 and IM V1

For flange dimensions, see page 1/47 (Z = the number of retaining holes)

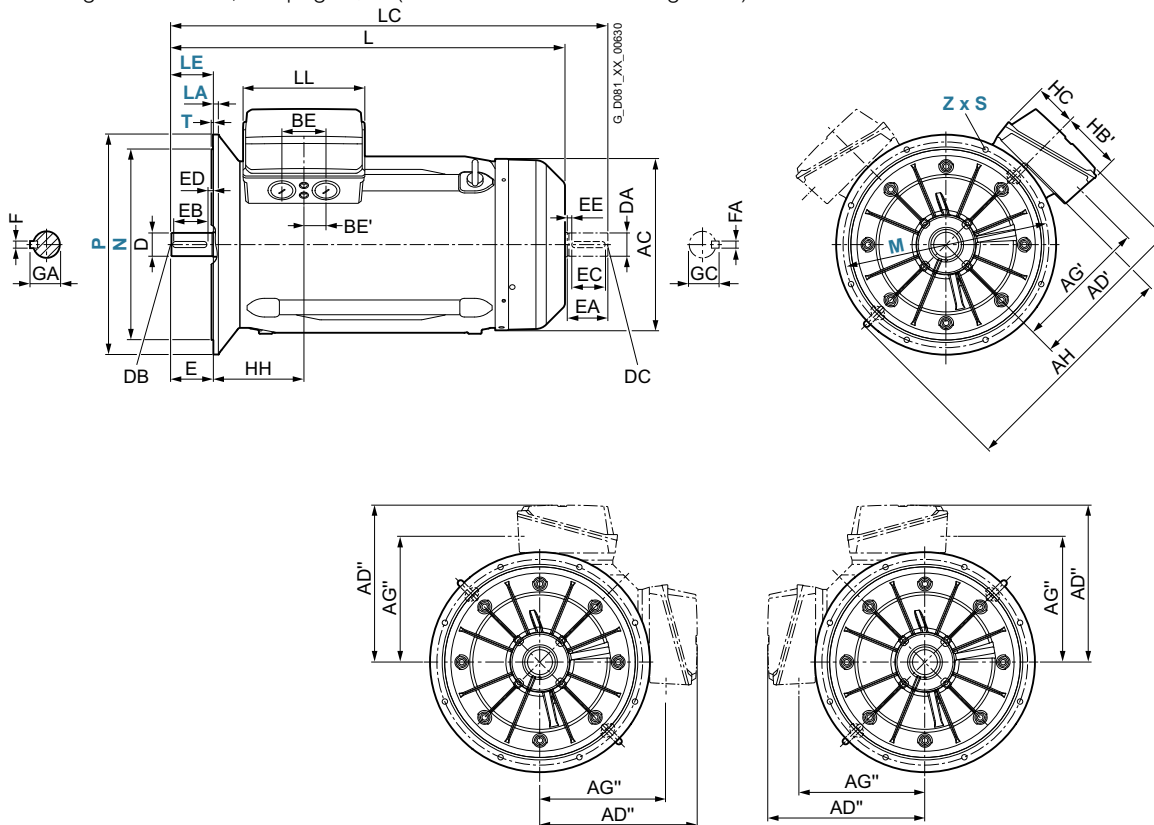

3

SIMOTICS SD standard motors next generation

Dimensions · Cast-iron series SIMOTICS SD Add

IE4, IE3 – self-ventilated · Frame sizes 315 L to 355 L

Dimensional drawings

Type of construction IM B35

For flange dimensions, see page 1/47 (Z = the number of retaining holes)

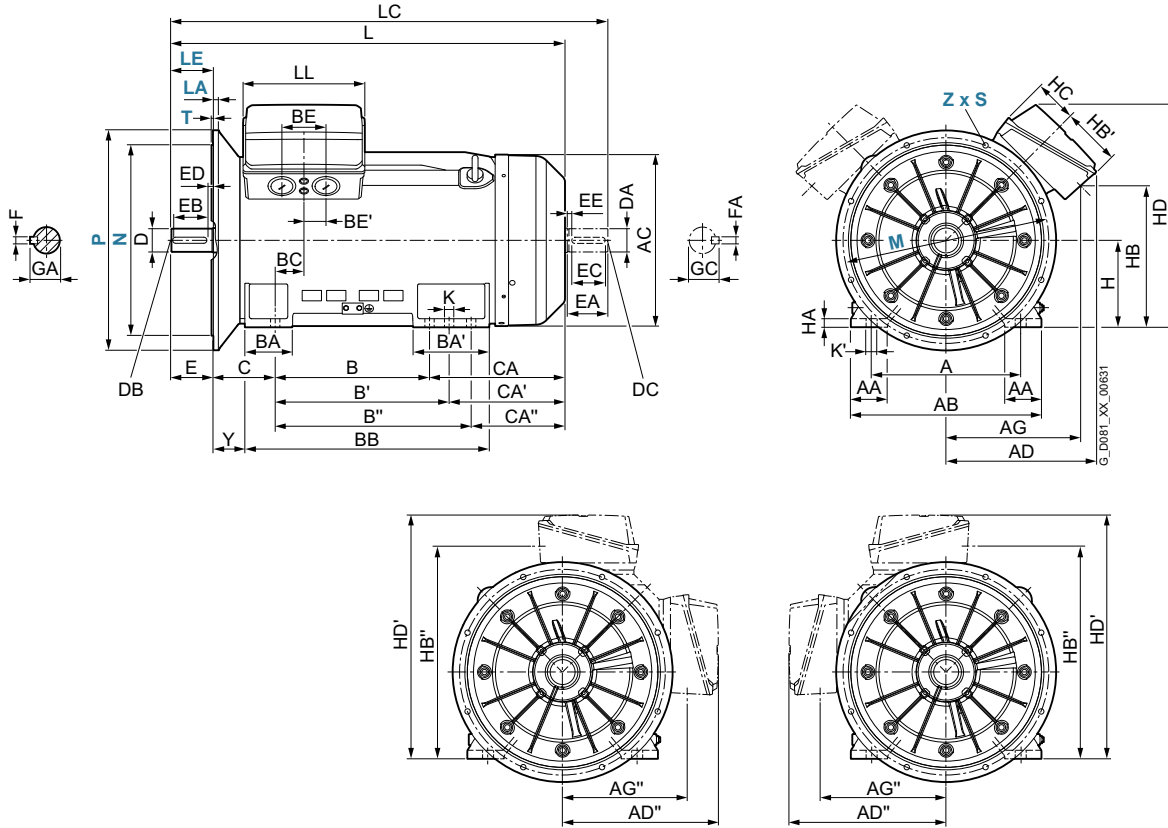

3

| For motor | Dimension designation acc. to IEC | No. of A | AA | AB | AC | AD | AD' | AD'' | AG | AG' | AG'' | AH | B | B' | B'' | BA | BA' | BB | BC | BE | BE' | C | CA | CA' | CA'' | H | HA | HB | | |
|-----------|-----------------------------------|----------|-----|-----|------------|------------|------------|------|-----|-----|------|-----|-----|-----|-----|-----|-----|-----|-----|-----|-----|------|-----|-----|------|-----|------------|----|-----|-----|
| 315 L | 3AA6 | 2 | 508 | 120 | 610 | 641 | 590 | 565 | 540 | 553 | 459 | 434 | 890 | 457 | 508 | - | 176 | 227 | 648 | 139 | 120 | 60 | 216 | 469 | 418 | - | 315 | 50 | 412 | |
| | 3AB6, 3AB7 | 4 | | | | | | | | | | | | 508 | 560 | 630 | | 298 | 770 | | | | | | | | | | | |
| | 3AA7 | 2 | | | | | | | | | | | | | | | | | | | | | | | | | | | | |
| | 3AC8 | 6 | | | | | | | | | | | | | | | | | | | | | | | | | | | | |
| | 3AC7, 3AD7 | 6 | | | | 543 | | | 491 | 473 | 448 | | | | | | | | | | 135 | 67.5 | | | | | | | | 491 |
| | 3AD8 | 8 | | | | | | | | | | | | | | | | | | | | | | | | | | | | |
| 355 L | 3BA3, 3BA4, 3BA5 | 2 | 610 | 150 | 780 | 718 | 620 | 657 | 644 | 550 | 542 | 530 | 940 | 630 | 710 | 800 | 198 | 315 | 998 | 116 | 240 | 120 | 254 | 553 | 473 | 383 | 355 | 49 | 574 | |
| | 3BB., 3BC., 3BD. | 4, 6, 8 | | | | | | | | | | | | | | | 194 | 311 | | | | | | | | | | | | 35 |

| For motor | Dimension designation acc. to IEC | No. of HB' | HB'' | HC | HD | HD' | HH | Y | K | K' | L | LC ¹⁾ | LL | D | DB | E | EB | ED | F | GA | DA | DC | EA | EC | EE | FA | GC | | |
|-----------|-----------------------------------|------------|------|-----|-----|-----|-----|-----|-----|----|----|------------------|------|-----|-----|-----|-----|-----|----|-----|------|----|-----|-----|-----|----|----|------|------|
| 315 L | 3AA6 | 2 | 336 | 749 | 167 | 800 | 855 | 355 | 146 | 28 | 35 | 1282 | 1427 | 327 | 65 | M20 | 140 | 125 | 10 | 18 | 69 | 60 | M20 | 140 | 125 | 10 | 18 | 64 | |
| | 3AB6, 3AB7 | 4 | | | | | | | | | | 1422 | 1567 | 85 | | 170 | 140 | 25 | 22 | 90 | 70 | | | | | | 20 | 74.5 | |
| | 3AA7 | 2 | | | | | | | | | | 1362 | 1507 | 65 | | 140 | 125 | 10 | 18 | 69 | 60 | | | | | | | 18 | 64 |
| | 3AC8 | 6 | | | | | | | | | | 1512 | 1657 | 85 | | 170 | 140 | 25 | 22 | 90 | 70 | | | | | | | 20 | 74.5 |
| | 3AC7, 3AD7 | 6, 8 | 225 | 763 | | | | | | | | 1422 | 1567 | | | | | | | | | | | | | | | | |
| | 3AD8 | 8 | | | | | | | | | | 1512 | 1657 | | | | | | | | | | | | | | | | |
| 355 L | 3BA3, 3BA4, 3BA5 | 2 | 247 | 885 | 188 | 911 | 999 | 370 | 130 | 35 | 42 | 1577 | 1722 | 519 | 75 | M20 | 140 | 125 | 10 | 20 | 79.5 | 60 | M20 | 140 | 125 | 10 | 18 | 64 | |
| | 3BB., 3BC., 3BD. | 4, 6, 8 | | | | | | | | | | 1607 | 1782 | 95 | M24 | 170 | 140 | 25 | 25 | 100 | 80 | | | 170 | 140 | 25 | 22 | 85.5 | |

¹⁾ In the low-noise version, a second shaft extension and/or mounted encoder is not possible.

SIMOTICS SD standard motors next generation

Dimensions · Cast-iron series SIMOTICS SD Pro

IE3 – self-ventilated · Frame sizes 315 L to 355 L

Dimensional drawings

Type of construction IM B3

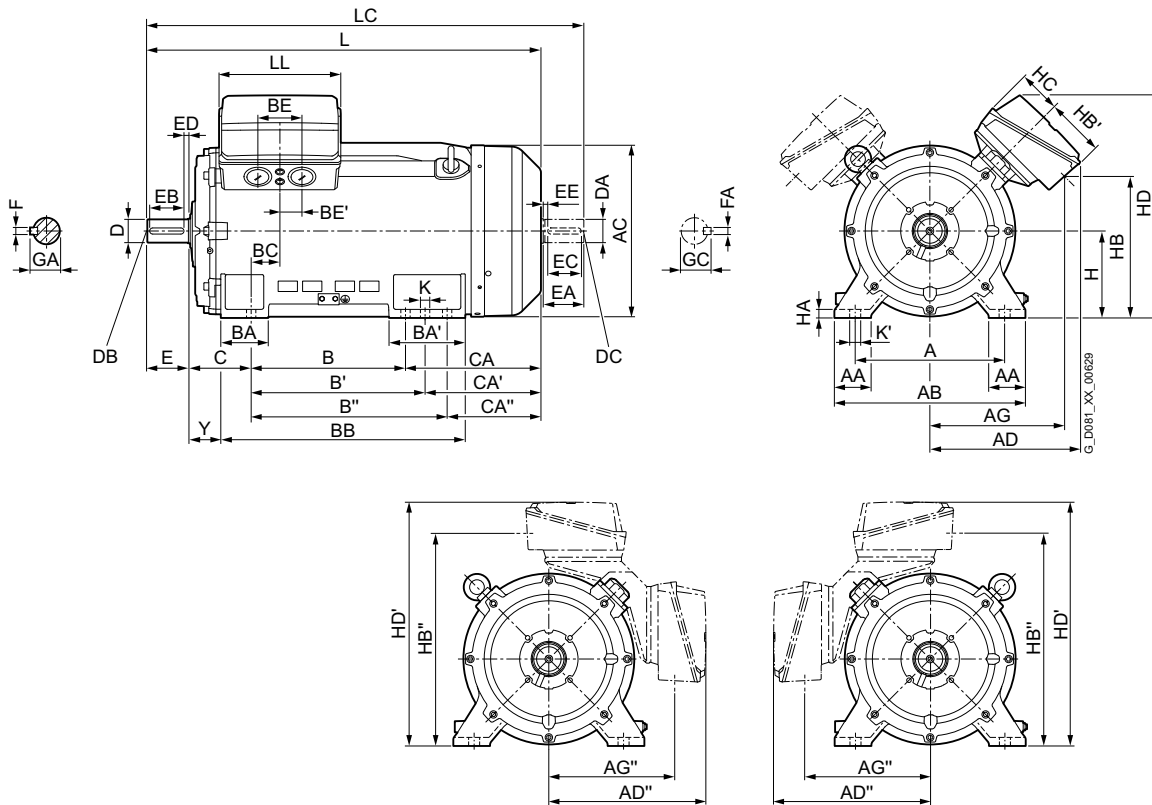

Types of construction IM B5 and IM V1

For flange dimensions, see page 1/47 (Z = the number of retaining holes)

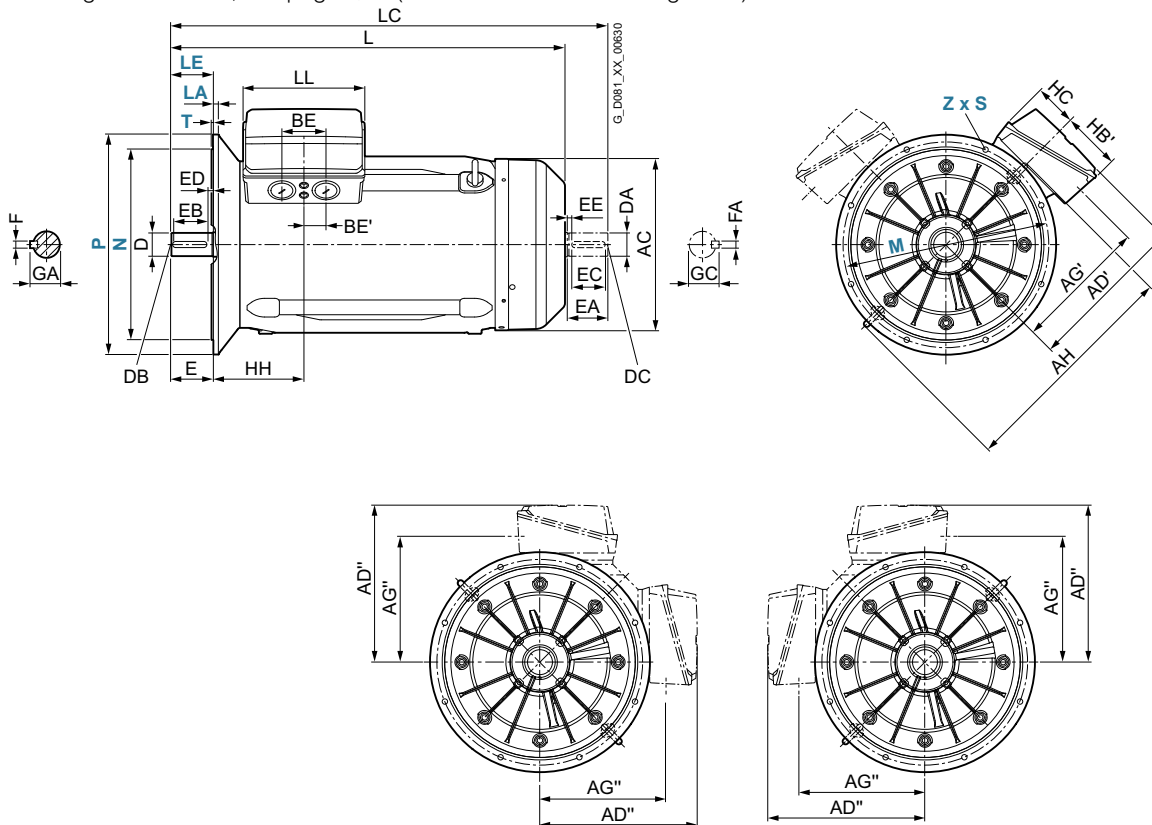

3

SIMOTICS SD standard motors next generation

Dimensions · Cast-iron series SIMOTICS SD Pro

IE3 – self-ventilated · Frame sizes 315 L to 355 L

Dimensional drawings

Type of construction IM B35

For flange dimensions, see page 1/47 (Z = the number of retaining holes)

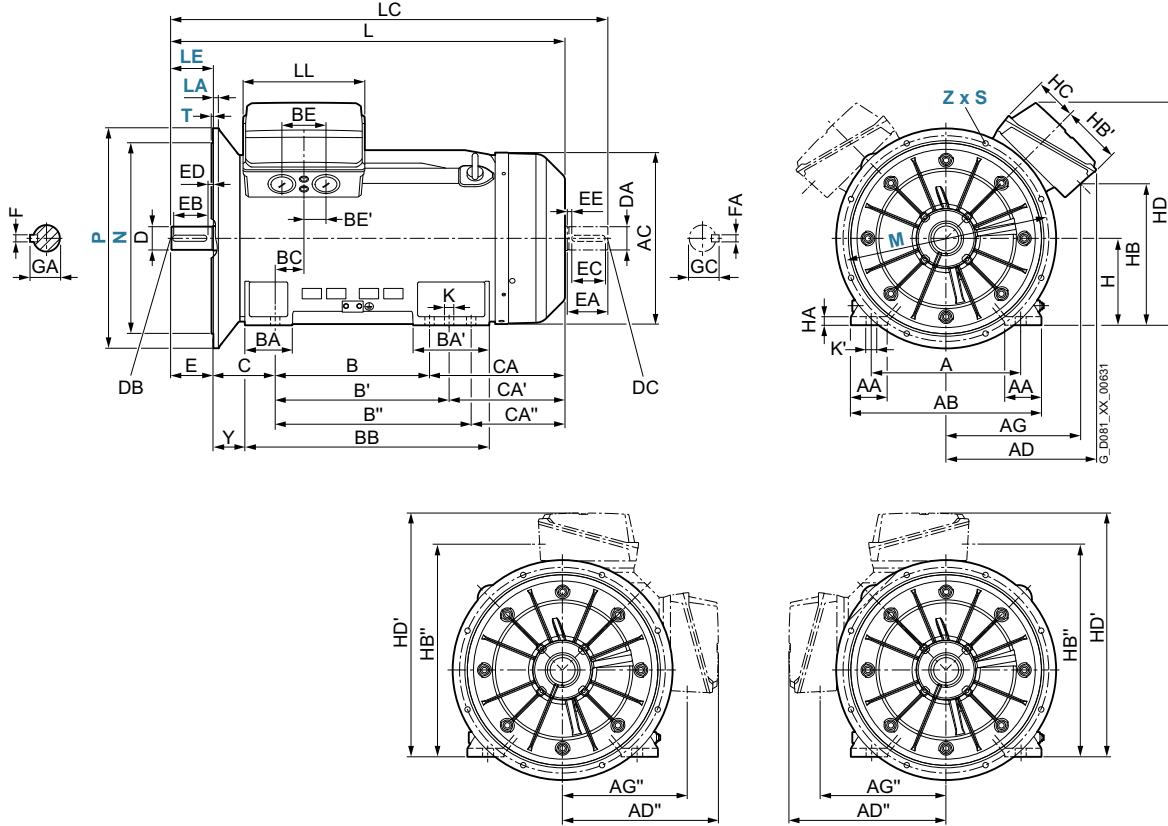

| For motor | Dimension designation acc. to IEC | No. of A | AA | AB | AC | AD | AD' | AD'' | AG | AG' | AG'' | AH | B | B' | B'' | BA | BA' | BB | BC | BE | BE' | C | CA | CA' | CA'' | H | HA | HB | | | | | |
|-----------|-----------------------------------|----------|-----|-----|------------|------------|------------|------|-----|-----|------|-----|-----|-----|-----|-----|-----|-----|-----|-----|------|-----|-----|-----|------|-----|------------|----|-----|--|-----|--|--|
| 315 L | 3AA6 | 2 | 508 | 120 | 610 | 641 | 590 | 565 | 540 | 553 | 459 | 434 | 890 | 457 | 508 | - | 176 | 227 | 648 | 139 | 120 | 60 | 216 | 469 | 418 | - | 315 | 50 | 412 | | | | |
| | 3AB6 | 4 | | | | | | | | | | | | 508 | 560 | 630 | | 298 | 770 | | | | | | | | | | | | | | |
| | 3AA7 | 2 | | | | | | | | | | | | | | | | | | | | | | | | | | | | | | | |
| | 3AB8 | 6 | | | | | | | | | | | | | | | | | | | | | | | | | | | | | | | |
| | 3AC7 | 6 | | | | 543 | | | 491 | 473 | 448 | | | | | | | | | 135 | 67.5 | | | | | | | | | | 491 | | |
| | 3AC8 | 6 | | | | 590 | | | 553 | 459 | 434 | | | | | | | | | 120 | 60 | | | | 618 | 566 | 496 | | | | 412 | | |
| 355 L | 3BA. | 2 | 610 | 150 | 780 | 718 | 620 | 657 | 644 | 550 | 542 | 530 | 940 | 630 | 710 | 800 | 198 | 315 | 998 | 116 | 240 | 120 | 254 | 553 | 473 | 383 | 355 | 49 | 574 | | | | |
| | 3BB3, 3BB4 | 4 | | | | | | | | | | | | | | | | 194 | 311 | | | | | | | | | | | | 35 | | |
| | 3BB5 | 4 | | | | | | | | | | | | | | | | | | | | | | | | | | | | | | | |
| | 3BC2, 3BC3 | 6 | | | | | | | | | | | | | | | | | | | | | | | | | | | | | | | |
| | 3BC4 | 6 | | | | | | | | | | | | | | | | | | | | | | | | | | | | | | | |

| For motor | Dimension designation acc. to IEC | No. of HB' | HB'' | HC | HD | HD' | HH | Y | K | K' | L | LC ¹⁾ | LL | DE shaft extension | | | | NDE shaft extension | | | | | | | | | | |
|------------|-----------------------------------|------------|------|-----|-----|-----|-----|-----|-----|----|----|------------------|------|--------------------|-----|-----|-----|---------------------|----|-----|------|----|-----|-----|-----|----|------|----|
| Frame size | Motor type | poles | | | | | | | | | | | | D | DB | E | EB | ED | F | GA | DA | DC | EA | EC | EE | FA | GC | |
| 315 L | 3AA6 | 2 | 336 | 749 | 167 | 800 | 855 | 355 | 146 | 28 | 35 | 1282 | 1427 | 327 | 65 | M20 | 140 | 125 | 10 | 18 | 69 | 60 | M20 | 140 | 125 | 10 | 18 | 64 |
| | 3AB6 | 4 | | | | | | | | | | 1362 | 1507 | | | | | | | | | | | | | | | |
| | 3AA7 | 2 | | | | | | | | | | 1422 | 1567 | 85 | | 170 | 140 | 25 | 22 | 90 | 70 | | | | | 20 | 74.5 | |
| | 3AB8 | 6 | | | | | | | | | | 1512 | 1657 | | | | | | | | | | | | | | | |
| | 3AC7 | 6, 8 | 225 | 763 | | | | | | | | 1422 | 1567 | | | | | | | | | | | | | | | |
| | 3AC8 | 8 | 336 | 749 | | | | | | | | 1512 | 1657 | | | | | | | | | | | | | | | |
| 355 L | 3BA. | 2 | 247 | 247 | 188 | 911 | 999 | 370 | 130 | 35 | 42 | 1577 | 1722 | 519 | 75 | M20 | 140 | 125 | 10 | 20 | 79.5 | 60 | M20 | 140 | 125 | 10 | 18 | 64 |
| | 3BB3, 3BB4 | 4 | | | | | | | | | | 1607 | 1782 | 95 | M24 | 170 | 140 | 25 | 25 | 100 | 80 | | 170 | 140 | 25 | 22 | 85.5 | |
| | 3BB5 | 4 | | | | | | | | | | 1702 | 1877 | | | | | | | | | | | | | | | |
| | 3BC2, 3BC3 | 6 | | | | | | | | | | 1607 | 1782 | | | | | | | | | | | | | | | |
| | 3BC4 | 6 | | | | | | | | | | 1702 | 1877 | | | | | | | | | | | | | | | |

¹⁾ In the low-noise version, a second shaft extension and/or mounted encoder is not possible.

SIMOTICS SD standard motors next generation

Dimensions · Cast-iron series SIMOTICS SD Pro

IE3 – self-ventilated · Frame sizes 400 and 450

Dimensional drawings

Type of construction IM B3

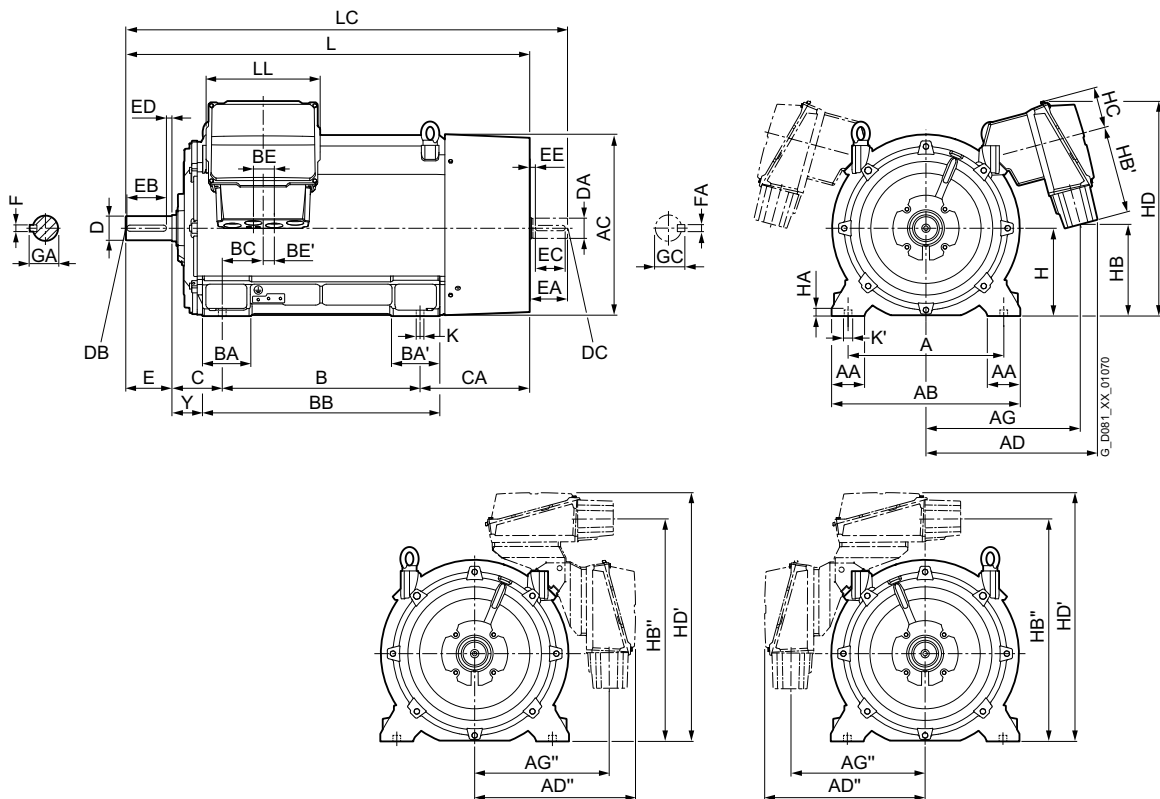

Types of construction IM B5 and IM V1

For flange dimensions, see page 1/47 (Z = the number of retaining holes)

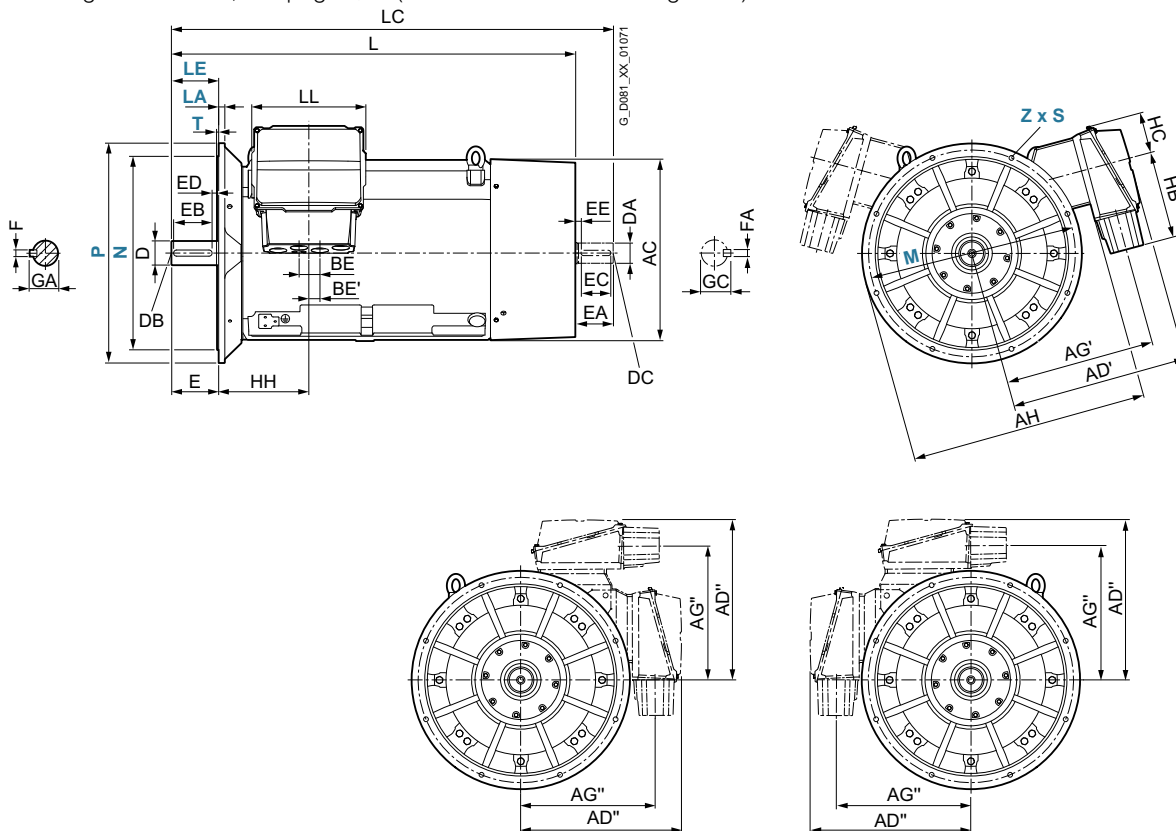

SIMOTICS SD standard motors next generation

Dimensions · Cast-iron series SIMOTICS SD Pro

IE3 – self-ventilated · Frame sizes 400 and 450

Dimensional drawings

Type of construction IM B35

For flange dimensions, see page 1/47 (Z = the number of retaining holes)

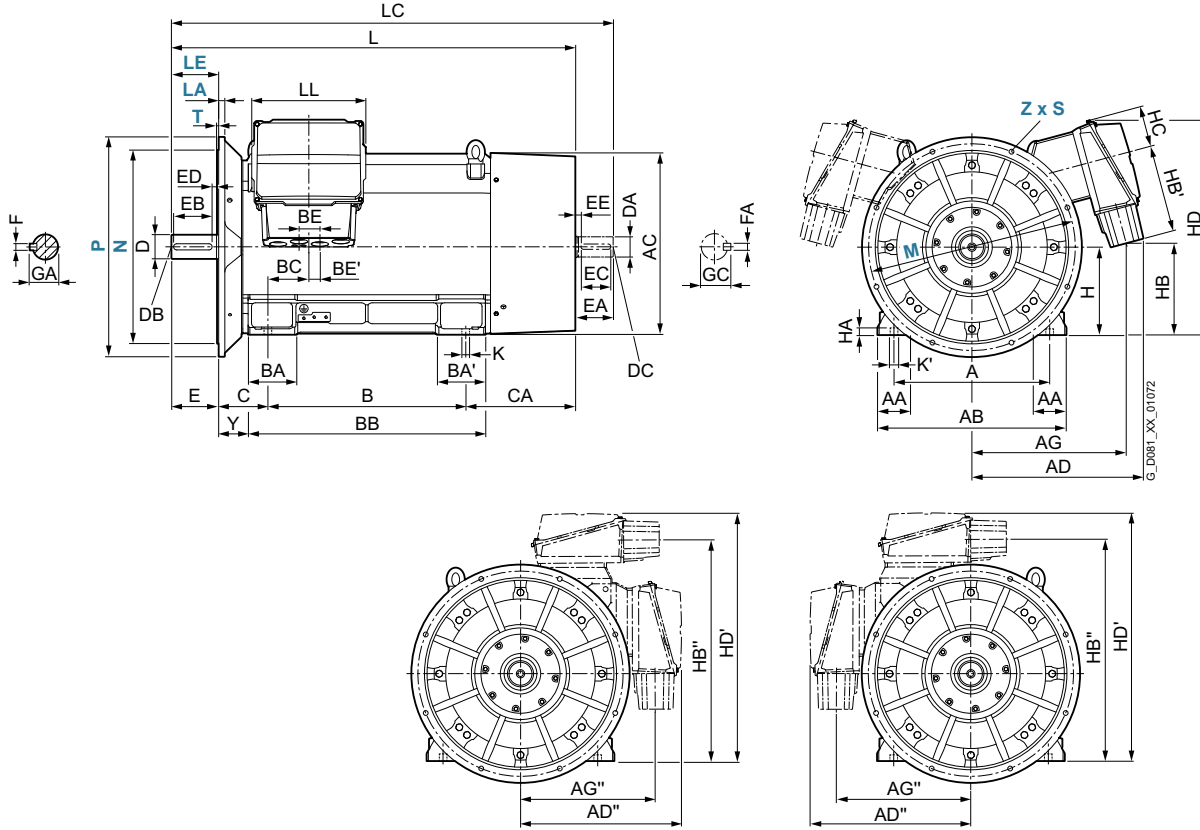

| For motor | Dimension designation acc. to IEC | | | | | | | | | | | | | | | | | | | | | | | | | | | | |
|------------|-----------------------------------|--------------|-----|-----|------------|-----|------------|------|-----|-----|------|-----|------|------|-----|----|-----|-----|------|-----|------|------|-----|------|-------|---|------------|----|------|
| Frame size | Motor type | No. of poles | AA | AB | AC | AD | AD' | AD'' | AG | AG' | AG'' | AH | B | B' | B'' | BA | BA' | BB | BC | BE | BE' | C | CA | C A' | C A'' | H | H A | HB | HB A |
| 400 | 4AA | 2 | 710 | 150 | 860 | 880 | 785 | 845 | 740 | 705 | 720 | 620 | 1110 | 900 | - | - | 220 | 220 | 1080 | 186 | 87.5 | 43.5 | 224 | 501 | - | - | 400 | 35 | 420 |
| | 4AB | 4 | | | | | | | | | | | | | | | | | | | | | | | | | | | |
| | 4AC | 6 | | | | | | | | | | | | | | | | | | | | | | | | | | | |
| | 4AD | 8 | | | | | | | | | | | | | | | | | | | | | | | | | | | |
| 450 | 4BA | 2 | 800 | 180 | 980 | 970 | 820 | 895 | 775 | 740 | 770 | 655 | 1235 | 1000 | - | - | 260 | 260 | 1220 | 170 | 87.5 | 43.5 | 250 | 535 | - | - | 450 | 42 | 505 |
| | 4BB | 4 | | | | | | | | | | | | | | | | | | | | | | | | | | | |
| | 4BC | 6 | | | | | | | | | | | | | | | | | | | | | | | | | | | |
| | 4BD | 8 | | | | | | | | | | | | | | | | | | | | | | | | | | | |

| For motor | Dimension designation acc. to IEC | | | | | | | | | | | DE shaft extension | | | | NDE shaft extension | | | | | | | | | | | | |
|------------|-----------------------------------|--------------|-----|------|-----|------|------|-----|-----|----|----|--------------------|------------------|-----|-----|---------------------|-----|-----|----|----|-----|-----|-----|-----|-----|----|----|------|
| Frame size | Motor type | No. of poles | HB' | HB'' | HC | HD | HD' | HH | Y | K | K' | L | LC ¹⁾ | LL | D | DB | E | EB | ED | F | GA | DA | DC | EA | EC | EE | FA | GC |
| 400 | 4AA | 2 | 400 | 1020 | 190 | 980 | 1140 | 410 | 134 | 35 | 42 | 1795 | 1940 | 519 | 80 | M20 | 170 | 140 | 25 | 22 | 85 | 70 | M20 | 140 | 125 | 10 | 20 | 74.5 |
| | 4AB | 4 | | | | | | | | | | 1835 | 2010 | | 110 | M24 | 210 | 180 | | 28 | 116 | 90 | M24 | 170 | 140 | 25 | 25 | 95 |
| | 4AC | 6 | | | | | | | | | | | | | | | | | | | | | | | | | | |
| | 4AD | 8 | | | | | | | | | | | | | | | | | | | | | | | | | | |
| 450 | 4BA | 2 | 400 | 1105 | 190 | 1065 | 1225 | 420 | 140 | 42 | 50 | 1955 | 2100 | 519 | 90 | M24 | 170 | 140 | 25 | 25 | 95 | 75 | M20 | 140 | 125 | 10 | 20 | 79.5 |
| | 4BB | 4 | | | | | | | | | | 1995 | 2210 | | 120 | | 210 | 180 | | 32 | 127 | 100 | M24 | 210 | 180 | 25 | 28 | 106 |
| | 4BC | 6 | | | | | | | | | | | | | | | | | | | | | | | | | | |
| | 4BD | 8 | | | | | | | | | | | | | | | | | | | | | | | | | | |

¹⁾ In the low-noise version, a second shaft extension and/or mounted encoder is not possible.

SIMOTICS SD standard motors next generation

Notes

3

SIMOTICS VSD motors for converter operation

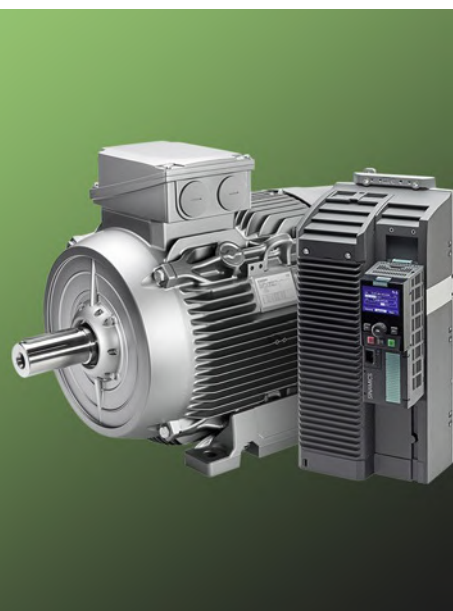

| | |
|------|---|
| 4/2 | Introduction |
| 4/2 | Overview |
| 4/2 | Application |
| 4/2 | Design |
| 4/3 | Technical specifications |
| 4/4 | Synchronous reluctance motors for SINAMICS converters – VSD4000 line |
| 4/4 | Orientation |
| 4/44 | <u>Article number code</u> |
| 4/46 | Super Premium Efficiency |
| 4/46 | <u>Aluminum series SIMOTICS GP 1FP1014</u> |
| 4/46 | • Line voltage 400 V, 50 Hz/480 V, 60 Hz/400 V, 87 Hz – self-ventilated, enclosed |
| 4/48 | <u>Cast-iron series SIMOTICS SD 1FP1514</u> |
| 4/48 | • Line voltage 400 V, 50 Hz/460 V, 60 Hz/400 V, 87 Hz – self-ventilated, enclosed |
| 4/52 | Article No. supplements and special versions |
| | <u>Voltages</u> |
| 4/52 | • Aluminum series SIMOTICS GP 1FP1014 |
| 4/53 | • Cast-iron series SIMOTICS SD 1FP1514 |
| | <u>Types of construction</u> |
| 4/54 | • Aluminum series SIMOTICS GP 1FP1014 |
| 4/57 | • Cast-iron series SIMOTICS SD 1FP1514 |
| | <u>Motor protection</u> |
| 4/62 | • Aluminum series SIMOTICS GP 1FP1014 |
| 4/61 | • Cast-iron series SIMOTICS SD 1FP1514 |
| | <u>Terminal box position</u> |
| 4/62 | • Aluminum series SIMOTICS GP 1FP1014 |
| 4/63 | • Cast-iron series SIMOTICS SD 1FP1514 |
| | <u>Options</u> |
| 4/64 | • Aluminum series SIMOTICS GP 1FP1014 |
| 4/68 | • Cast-iron series SIMOTICS SD 1FP1514 |
| 4/73 | <u>Accessories</u> |
| 4/74 | Dimensions |
| 4/74 | Notes on the dimensions |
| 4/75 | Dimension sheet generator |
| | <u>Aluminum series SIMOTICS GP</u> |
| 4/76 | • Super Premium Efficiency – self-ventilated · Frame sizes 80 M, 90 S, 90 L, 112 M to 200 L |
| | <u>Cast-iron series SIMOTICS SD</u> |
| 4/78 | • Super Premium Efficiency – self-ventilated · Frame sizes 80 M, 90 S, 90 L, 112 M to 160 L |
| 4/80 | • Super Premium Efficiency – self-ventilated · Frame sizes 180 M to 200 L |

| | |
|-------|--|
| 4/82 | Standard induction motors optimized for converter operation – VSD10 line |
| 4/82 | Orientation |
| 4/90 | <u>Article number code</u> |
| 4/92 | Standard Efficiency |
| 4/92 | <u>Aluminum series SIMOTICS GP 1LE1092</u> |
| 4/92 | • Line voltage 400 V, 50 Hz/460 V, 60 Hz/400 V, 87 Hz – self-ventilated, enclosed |
| 4/94 | • Line voltage 500 V, 50 Hz/575 V, 60 Hz/500 V, 87 Hz – self-ventilated, enclosed |
| 4/96 | • Line voltage 690 V, 50 Hz/690 V, 87 Hz – self-ventilated, enclosed |
| | <u>Cast-iron series SIMOTICS SD 1LE1592</u> |
| 4/98 | • Line voltage 400 V, 50 Hz/460 V, 60 Hz/400 V, 87 Hz – self-ventilated, enclosed |
| 4/102 | • Line voltage 500 V, 50 Hz/575 V, 60 Hz/500 V, 87 Hz – self-ventilated, enclosed |
| 4/106 | • Line voltage 690 V, 50 Hz/690 V, 87 Hz – self-ventilated, enclosed |
| 4/108 | Article No. supplements and special versions |
| | <u>Voltages</u> |
| 4/108 | • Aluminum series 1LE1092 |
| 4/109 | • Cast-iron series 1LE1592 |
| | <u>Types of construction</u> |
| 4/110 | • Aluminum series 1LE1092 |
| 4/114 | • Cast-iron series 1LE1592 |
| | <u>Motor protection</u> |
| 4/118 | • Aluminum series 1LE1092 |
| 4/119 | • Cast-iron series 1LE1592 |
| | <u>Terminal box position</u> |
| 4/120 | • Aluminum series 1LE1092 |
| 4/121 | • Cast-iron series 1LE1592 |
| | <u>Options</u> |
| 4/122 | • Aluminum series 1LE1092 |
| 4/126 | • Cast-iron series 1LE1592 |
| 4/131 | <u>Accessories</u> |
| 4/133 | Dimensions |
| 4/133 | <u>Notes on the dimensions</u> |
| 4/133 | Dimension sheet generator |
| | <u>Aluminum series SIMOTICS GP</u> |
| 4/134 | • Standard Efficiency – self-ventilated · Frame sizes 100 L to 160 L – self-ventilated |
| | <u>Cast-iron series SIMOTICS SD</u> |
| 4/136 | • Standard Efficiency – self-ventilated · Frame sizes 100 L to 160 L – self-ventilated |
| 4/138 | • Standard Efficiency – self-ventilated · Frame sizes 180 M to 250 M – self-ventilated |
| 4/140 | • Standard Efficiency – self-ventilated · Frame sizes 280 S to 315 L – self-ventilated |

SIMOTICS VSD motors for converter operation

Introduction

Overview

SIMOTICS GP/SD VSD motors optimized for converter operation (VSD = *Variable Speed Drive*)

In addition to the standard motors optimized for line operation, Siemens also offers two motor lines optimized for converters for variable-speed operation on a frequency converter:

- SIMOTICS VSD10 line – induction motors for converter operation
- SIMOTICS VSD4000 line – reluctance motors for operation with SINAMICS G120/S120 converters

The motors are optionally available with an aluminum housing (SIMOTICS GP) or with a rugged cast-iron housing (SIMOTICS SD).

SIMOTICS VSD motors are characterized by the following features:

- **High energy efficiency:**
Because the SIMOTICS VSD motors are optimized for operation with SINAMICS converters, the system power losses are low and the energy efficiency therefore high. In particular, the SIMOTICS VSD4000 line synchronous reluctance motors in conjunction with optimized control algorithms result in excellent loss-optimized operation in the speed setting range with a full and partial load, and are superior to an induction motor system that has comparable nominal efficiency, especially in the partial-load range.
- **Optimized investment costs:**
The optimized motor active part/power module allocation results in low capital investment costs. The motors and frequency converters are optimally harmonized and coordinated with one another. No power unit upgrade is therefore required. This applies in particular to the SIMOTICS VSD10 line motors on account of their optimized motor design.

- **Low space requirement, low weight:**
The high power density and compact design ensure low space requirements combined with low weight.
- **Very rugged and reliable:**
High availability using the standard protection functions for converter operation (KTY84-130 temperature sensors). As a result of the optimized insulation system, a high degree of reliability is obtained for four-quadrant operation with SINAMICS converters. SIMOTICS VSD10 motors also have insulated bearings at the non-drive end (NDE) in frame sizes 280 and 315.
- **Fast and simple commissioning** by transferring a motor code on the frequency converter.
- **Flexible in use:**
SIMOTICS VSD line motors are designed as standard for operation with a 50 Hz, 60 Hz and 87 Hz characteristic.
- **Wide range of options:**
By consistently utilizing the 1LE1 standard motor platform, almost all options of the 1LE1 line motors can also be used for the SIMOTICS VSD line motors.
- **High level of compatibility:**
Line and converter motors can be easily interchanged due to their identical dimensions and customer interfaces. The connection and operating philosophy is exactly the same as for 1LE1 line motors.
- **International applicability:**
The motors are not subject to any minimum efficiency requirements for specific countries.

Application

The SIMOTICS GP/SD VSD motors can be deployed in all industries and sectors, e.g. paper, steel, energy, chemistry, water/waste water.

The wide field of applications that can be addressed includes, for example, the following:

- Pumps
- Fans
- Compressors
- Cranes
- Conveyor belts

Design

The SIMOTICS GP/SD VSD motors are based on the platform of the SIMOTICS 1LE1 motor type series. For this reason, the principal design is the same as for the 1LE1 line motors – the mechanical parts are identical.

The motors are adapted to the converter by appropriately dimensioning the active part and VSD-specific rating plate data.

Moreover, a large number of the variations available in the SIMOTICS 1LE1 motors (types of construction, motor protection, terminal box position, and options) are also available for the VSD motors.

| SIMOTICS VSD4000 line | SIMOTICS VSD10 line |
|---|--|
| Use in VSD applications with high dynamic requirements | Use in VSD applications |
| Focus on low operating costs | Focus on low investment costs |
| Very low system power losses due to the reluctance principle and optimum coordination of the motor with the converter | Low system power losses due to optimum coordination of the motor with the converter |
| Optimized for operation with SINAMICS G120 and S120 | Optimized for use with SINAMICS G120, G130, G150 |
| 36 month warranty | <ul style="list-style-type: none"> • 12 month warranty for SIMOTICS GP • 24 month warranty for SIMOTICS SD (optionally expandable) |

Technical specifications

Brief overview of the general technical specifications for SIMOTICS VSD4000 line reluctance motors

| Air-cooled, enclosed version with self-ventilation ¹⁾ | |
|--|--|
| Operation | Converter operation – VSD |
| Power at 50 Hz ²⁾ | 0.55 ... 45 kW |
| Rated speed | 1500 rpm, 1800 rpm and 2610 rpm 3000 rpm, 3600 rpm |
| Voltages | 50 Hz line supplies: 400 V 60 Hz line supplies: 460 V |
| Cooling method | IC411, self-ventilated |
| Frame size | SIMOTICS GP: 80/112 ... 200 SIMOTICS SD: 80/112 ... 225 |
| Degree of protection ³⁾ | IP55 |
| Housing | Aluminum or cast-iron version |
| Load characteristic | $T \sim n^2$, $T = \text{const.}$ |
| Motor type | SIMOTICS GP: 1FP10.4 SIMOTICS SD: 1FP15.4 |

Brief overview of the general technical specifications for SIMOTICS VSD10 line standard motors for converter operation

| Air-cooled, enclosed version with self-ventilation ¹⁾ | |
|--|--|
| Operation | Converter operation – VSD |
| Power at 50 Hz | 2.2 ... 200 kW (1500 rpm) 3 ... 90 kW (3000 rpm) |
| Rated speed | 1500 rpm, 1800 rpm and 2610 rpm ⁴⁾ 3000 rpm, 3600 rpm and 5220 rpm ⁴⁾ |
| Voltages | 50 Hz line supplies: 400 V, 500 V, 690 V 60 Hz line supplies: 460 V, 600 V |
| Cooling method | IC411, self-ventilated |
| Frame size | SIMOTICS GP: 100 ... 160 SIMOTICS SD: 100 ... 315 |
| Degree of protection ³⁾ | IP55 |
| Housing | Aluminum or cast-iron version |
| Load characteristic | $T \sim n^2$, $T = \text{const.}$ |
| Motor type | SIMOTICS GP: 1LE1092 SIMOTICS SD: 1LE1592 |

¹⁾ Forced ventilation optionally available.

²⁾ Rated speed 1500 rpm.

³⁾ Other degrees of protection optionally available.

⁴⁾ 87 Hz characteristic not available for all frame sizes.

Synchronous reluctance motors for SINAMICS converters – VSD4000 line

Orientation

Overview

SIMOTICS GP/SD VSD4000 line motor series: 1FP10, 1FP15

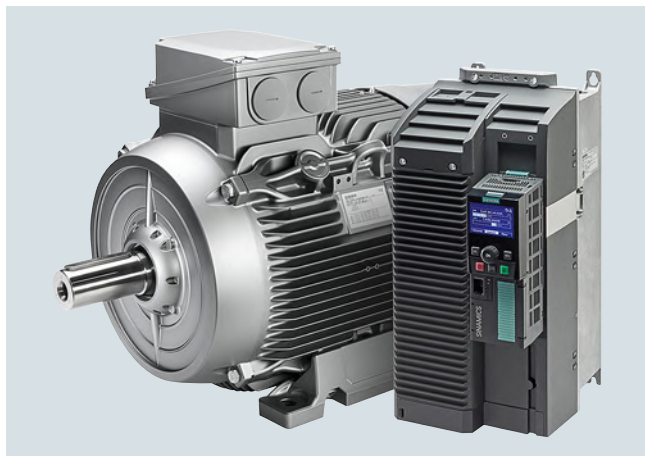

As a result of their flexibility and the wide range of versions, SIMOTICS GP/SD VSD4000 line motors are especially suitable for sectors and industries, where the focus is on minimum lifecycle costs (TCO) and/or operation with a high dynamic performance.

Versions of the SIMOTICS GP/SD VSD4000 line motor series: 1FP10, 1FP15

The motors have compact dimensions in a surface-cooled, enclosed version with self-ventilation. They have been specifically designed for converter operation.

1FP10 General Purpose for converter operation

- Four-quadrant converter operation, optimally harmonized with the SINAMICS G120, PM240-2 and S120 (ALM, BLM) drive system.
- IP55 degree of protection
- IC411 cooling method, self-ventilated (IC416 cooling method, force-ventilated version optional)
- Housing: Aluminum
- Frame sizes: 80/112 to 200 ¹⁾

1FP15 Severe Duty for converter operation

- Four-quadrant converter operation, optimally harmonized with the SINAMICS G120, PM240-2 and S120 (ALM, BLM) drive system.
- IP55 degree of protection
- IC411 cooling method, self-ventilated (IC416 cooling method, force-ventilated version optional)
- Housing: Cast iron
- Frame sizes: 80/112 to 200

Benefits

The SIMOTICS GP/SD VSD4000 line motor series has been specifically developed for operation with SINAMICS G120 converters.

- The synchronous-reluctance motors in conjunction with optimized closed-loop control algorithms result in an excellent, loss-optimized operating behavior in the speed control range at full and partial load. This system is superior to an induction motor-based system with comparable nominal efficiencies, especially in the partial load range.
- As a result of their low intrinsic moment of inertia, synchronous-reluctance motors are also especially suitable for operating modes demanding a high dynamic performance.
- The optimized motor active part/power module allocation results in low capital investment costs.
- The high power density and compact design ensure low space requirements combined with low weight.
- The motors and converters are optimally harmonized and coordinated with one another. It is not therefore necessary to upgrade the power unit.
- SIMOTICS GP motors with aluminum housing or SIMOTICS SD motors with rugged cast-iron housing are available.
- High availability using the standard protection functions for converter operation (KTY84-130 temperature sensors, Pt100/Pt1000 resistance thermometers).
- As a result of the optimized insulation system, a high degree of reliability is obtained for four-quadrant operation with SINAMICS converters.
- Fast and simple commissioning by transferring a motor code into the converter.
- Standard warranty period for synchronous-reluctance motors 36 months.

More power ratings

SIMOTICS GP/SD VSD4000 line motors are designed as standard for operation with a 50 Hz, 60 Hz, and 87 Hz characteristic ²⁾. No special ordering option is required.

Optimized for converter operation

The new motor series has been optimized for operation with SINAMICS G120 converters with regard to converter output currents and voltage utilization. Four-quadrant operation is possible with the SINAMICS G120, PM240-2, and S120 (ALM, BLM) converter families (for line voltages up to 480 V 3 AC).

High degree of flexibility

By consistently utilizing the 1LE1 standard motor platform, almost all options of the 1LE1 line motors can also be used for the SIMOTICS GP/SD VSD4000 line series.

Known and established design

Line and converter motors can be easily interchanged due to their identical dimensions and customer interfaces. The connection and operating philosophy is exactly the same as for 1LE1 line motors.

International applications

The motors are not subject to any minimum efficiency requirements for specific countries. As a consequence, they can be operated without additional MEPS certificates, also in the USA, for example.

System components

System components required:

- SIMOTICS 1FP1 synchronous-reluctance motor
- SINAMICS G120 converter PM240-2 Power Module or SINAMICS S120 (ALM, BLM) converter

¹⁾ For the motor type 1FP10 of the SIMOTICS GP series, frame sizes 180 and 200 on request.

²⁾ With firmware V4.7 SP3, only 1500 rpm can be programmed.

Synchronous reluctance motors for SINAMICS converters – VSD4000 line

Orientation

Benefits

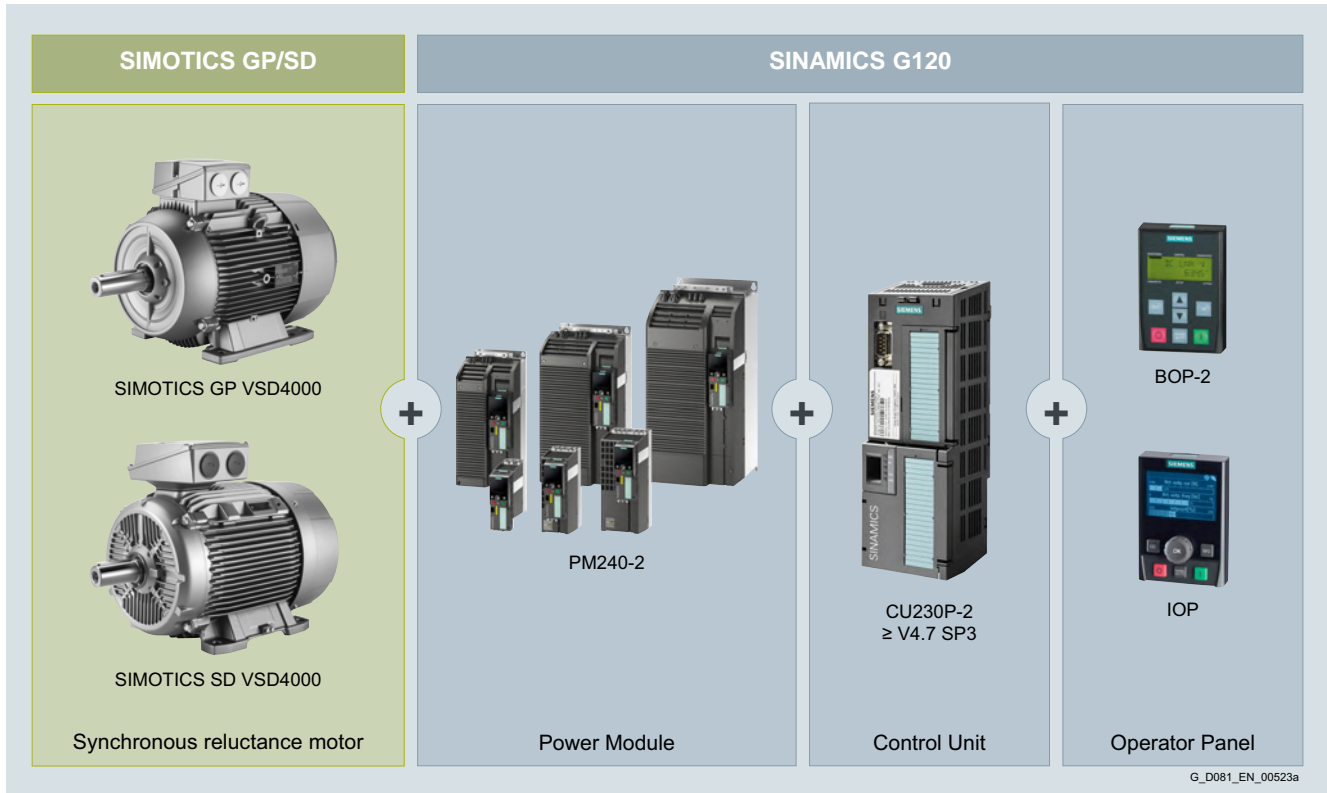

Example configuration SIMOTICS GP/SD VSD4000 with SINAMICS G120

Application

As a result of the wide range of options, the SIMOTICS GP/SD VSD4000 line motor series can be used in all industrial areas and sectors. Paper, steel, energy, chemical, water/waste water are examples of some typical sectors.

Various flange and foot-mounted designs according to EN 60034-7 are available. IP55 is the standard degree of protection (other degrees of protection optionally available).

The wide field of applications that can be addressed includes, for example, the following:

- Pumps
- Fans
- Compressors
- Cranes
- Conveyor belts
- Processing machines that require synchronous operation (e.g. in the textile industry)

Design

The SIMOTICS GP/SD VSD4000 line motors are based on the 1LE1 platform. The basic design of the SIMOTICS GP/SD VSD4000 line motors therefore corresponds to the 1LE1 line motors. The mechanical parts are identical. The motors are adapted to the converter by appropriately dimensioning the active part.

Synchronous reluctance motors for SINAMICS converters – VSD4000 line

Orientation

Technical specifications

Overview of technical specifications

This table lists the most important technical specifications.

| | |
|--|---|
| Type of motor | IEC low-voltage three-phase synchronous-reluctance motors |
| Connection types | Star/delta connection The connection used depends on the particular load characteristic. |
| No. of poles | 4 |
| Frame sizes | 80/112 ... 225 |
| Rated power | 4-pole: 0.55 ... 45 kW (50 Hz characteristic); 0.63 ... 52 kW (60 Hz characteristic), 0.9 ... 78 kW (87 Hz characteristic) |
| Frequencies | Characteristics for 50 Hz, 60 Hz and 87 Hz |
| Versions | Air-cooled, enclosed version: <ul style="list-style-type: none"> • with self ventilation • with forced ventilation (optional) SIMOTICS GP motors in an aluminum version, frame sizes 80/112 ... 200 SIMOTICS SD motors in a cast-iron version, frame sizes 80/112 ... 225 |
| System efficiency | IES2 in accordance with EN 50598 (system with SINAMICS G120 converter, PM240-2) |
| Marking | Only permitted for converter operation. As converter motors, IE classification according to IEC 60034-30-1 is not required. |
| Rated speed | 1500 rpm, 1800 rpm and 2610 rpm (up to frame size 200) 3000 rpm, 3600 rpm (frame sizes 180 and 200) |
| Rated torque | 3.5 ... 191 Nm (50 Hz characteristic); 3.3 ... 183 Nm (60 Hz characteristic), 3.3 ... 176 Nm (87 Hz characteristic) |
| Insulation of the stator winding in accordance with EN 60034-1 (IEC 60034-1) | Temperature class F, utilized acc. to B Reinforced insulation system (Advanced) |
| Degree of protection according to EN 60034-5 (IEC 60034-5) | IP55 as standard Air-cooled, enclosed version |
| Cooling according to EN 60034-6 (IEC 60034-6) | <ul style="list-style-type: none"> • Standard: Self-ventilated (IC411) • Optional: Forced-air cooled (IC416) (132 ... 200) |
| Permissible coolant temperature and installation altitude | -20 ... +40 °C as standard, installation altitude up to 1000 m above sea level |
| Standard voltages according to EN 60038 (IEC 60038) | 50 Hz line supplies: 400 V, 60 Hz line supplies: 480 V The rated motor voltage required is listed in the "Selection and ordering data" for the required motor. |
| Type of construction according to EN 60034-7 (IEC 60034-7) | <ul style="list-style-type: none"> • Without flange: IM B3, IM B6, IM B7, IM B8, IM V5, IM V6 • With flange: IM B35, IM V1, IM V3 |
| Paint finish Suitability of paint finish for climate group according to IEC 60721, Part 2-1 | As standard: color RAL 7030 stone gray |
| Vibration severity grade according to EN 60034-14 (IEC 60034-14) | Grade A (normal) |
| Shaft extension according to DIN 748 (IEC 60072) | Balancing type: half-key balancing as standard |
| Sound pressure level according to EN ISO 1680 (tolerance +3 dB) | The corresponding sound pressure level is listed in the "Selection and ordering data" for the required motor. |
| Weights | The corresponding weight is listed in the "Selection and ordering data" for the required motor. |
| Modular mounting concept | Optional brake and separately driven fan according to ordering data |
| Options | See "Article No. supplements and special versions" |

Synchronous reluctance motors for SINAMICS converters – VSD4000 line

Orientation

Technical specifications

Rating plate

In accordance with EN 60034-1, the approximate total weight is specified on the rating plate. The standard version of the rating plate is the international version in English.

For straightforward and fast commissioning with SINAMICS G converters, a motor code number is stamped on the rating plate (CODE).

| SIEMENS | | | | | | | | | |
|--|---------------|--------------------|------|-------------------------|----|-------|------|-------|--|
| Made in Czech Rep. | | D-90441 Nürnberg | | | | | | | |
| 3~Mot. 1RV4164B | | 1FP10141DB421AA4-Z | | UD 1701/1234567 001 001 | | | | | |
| IEC/EN 60034 160L IMB3 | | IP55 | | | | | | | |
| 90kg | Th.Cl. 155(F) | -20°C <=TAMB<=40°C | | | | | | | |
| Bearing | | | | | | | | | |
| DE | 6209-2ZC3 | | | | | | | | |
| NE | 6209-2ZC3 | | | | | | | | |
| CONVERTER DUTY ONLY VPWM SINAMICS G120 Nmax 4200 1/min | | | | | | | | | |
| V | Hz | A | kW | cos φ | Nm | 1/min | EFF | CODE | |
| 380 Y | 50 | 33.5 | 15.0 | 0.72 | 95 | 1500 | 93.9 | 60004 | |
| 220 Δ | 50 | 58 | 15.0 | 0.72 | 95 | 1500 | 93.9 | | |
| 440 Y | 60 | 33.0 | 17.3 | 0.73 | 92 | 1800 | 94.5 | | |
| 380 Δ | 87 | 59 | 26.0 | 0.72 | 95 | 2610 | 93.3 | | |

Example of a SIMOTICS GP VSD4000 line rating plate, 1FP10

Motors specially designed for converter operation

These motors have been specifically designed for converter operation. The catalog data is applicable for operation on the converter of the SINAMICS G120 series (PM240-2/PM240P-2) and SINAMICS S120 (PM240-2 and Booksize Motor Modules).

SINAMICS G120 system requirements:

- SINAMICS G120, PM240-2/PM240P-2 Power Module, CU230P-2 Control Unit
- V4.7.6 and higher
- The converter is operated with a rated pulse frequency of at least 4 kHz.
- The converter can provide the rated voltage as listed in the catalog.

For SINAMICS G120 converters (from firmware version 4.7) the SIMOTICS GP/SD VSD4000 line series can be selected in the SINAMICS converter via the STARTER software or the operator panel at the converter (Basic Operator Panel (BOP), Intelligent Operator Panel (IOP)) as motor category and can be addressed using the motor code number.

SINAMICS S120 system requirements:

- SINAMICS S120, PM240-2 Power Module and CU310
- SINAMICS S120 Booksize Motor Module and CU320-2
- FW 4.8 and higher

Rated voltage

The tolerance for the rated voltage is in accordance with EN 60034-1. A rated voltage range is not specified. The rated motor voltages are selected so that when operated with a SINAMICS G120 converter, the available voltage is optimally utilized.

Insulation

The motors can be operated with SINAMICS G/S converters up to line voltages of 480 V when the permissible voltage peaks are complied with ($\hat{U}_{LL} \leq 3200$ V, $\hat{U}_{LE} \leq 2800$ V).

For converter operation with the power ratings specified in the catalog, the motors can be utilized corresponding to thermal class 155 (F) (service factor 1.2).

Preferred supply system configurations are TT systems and TN systems with neutral-point grounding. In the case of a fault when connected to an IT system (ground fault), the insulation is excessively stressed. In this case, the process should be terminated as quickly as possible ($t < 2$ h), and the fault resolved. We do not recommend operation in corner-grounded TN systems.

Noise

The maximum sound pressure levels should be taken from the "Selection and ordering data".

Synchronous reluctance motors for SINAMICS converters – VSD4000 line

Orientation

Technical specifications

Separately driven fan

For the technical specifications of the separately driven fans, see page 1/77 "Technical specifications of separately driven fans".

Bearings

For converter operation, as a result of the basic principle employed, electrical bearing stress is created through the bearing lubricant film due to a voltage that is capacitively coupled in.

The physical cause of this is the common-mode voltage at the converter output that is inherent in the control method for a converter:

The sum of the three phase voltages is – in contrast to pure line operation – not equal to zero at every point in time.

In order to apply currents to the motor which are sinusoidal as far as possible (resulting in smoother running, lower oscillation torques, and lower stray losses), a high pulse frequency is required for the converter's output voltage. The related (very steep) switching edges of the converter output voltage (and also, therefore, of the common-mode voltage) cause correspondingly high capacitive currents and voltages on the machine's internal capacitances.

In the worst-case scenario, the capacitive voltage induced via the bearing can lead to random arcing through the bearing lubricating film, thus causing premature bearing aging or damage.

This physical effect, which occurs in isolated cases, has mostly been observed in connection with larger motors.

EMC-compliant installation of the drive system is a basic prerequisite for preventing premature bearing damage via bearing currents.

The most important measures for reducing bearing currents are:

- Insulated motor bearing at the NDE.

Recommended from frame size 225 and higher:

- Use cables with a symmetrical cable cross-section:

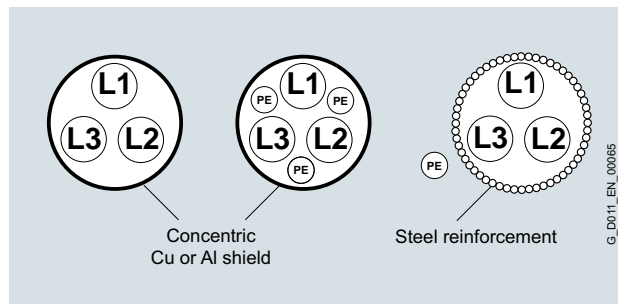

- Preference given to a line supply with isolated neutral point (IT system).
- Using grounding cables with low impedance over a wide frequency range (DC up to approximately 70 MHz): for example, braided copper ribbon cables, HF finely stranded wires.
- Separate HF equipotential-bonding cable between motor housing and driven machine.
- Separate HF equipotential-bonding cable between motor housing and converter PE busbar.
- 360° HF contacting of the cable shield on the motor housing and the converter PE busbar. This can be achieved using EMC screwed glands on the motor side and EMC shield clips on the converter side, for example.

Synchronous reluctance motors for SINAMICS converters – VSD4000 line

Orientation

Technical specifications

Torque limits (continuous duty)

The thermal torque limit characteristics of the SIMOTICS GP/SD VSD4000 line define the maximum load torque for uninterrupted duty (S1) over the complete speed control range. The characteristics are different for all of the cooling methods. The speed control range is limited by the mechanical speed limit, which depends on the motor's mechanical design.

The following statements are valid for the following diagrams:

- Thermally, from $1/10$ of the rated speed up to the full rated speed, the rated torque and the curve of the suitable power unit are possible, utilizing the thermal class 155 (temperature class F).
- At rated speed, SF 1.2 is possible.
- The curves of the next largest power unit and the maximum power curve can be achieved in continuous-operation periodic duty (S6 - x %), and briefly in S9 duty, provided that $P_{2(S9)} = P_{2N}$ is not exceeded.

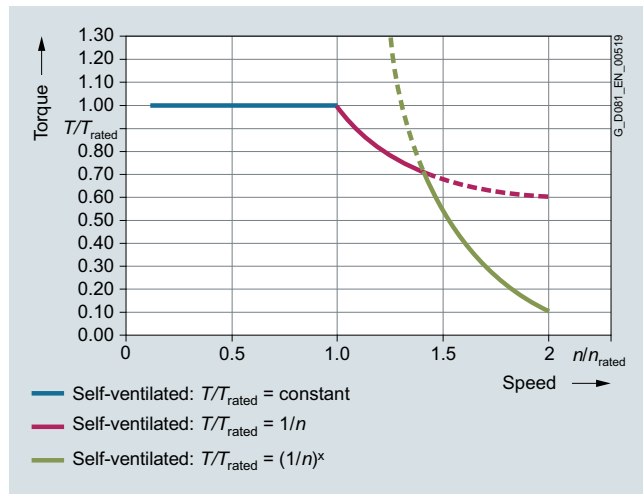

Torque limit for SIMOTICS GP/SD VSD4000 line self-ventilated

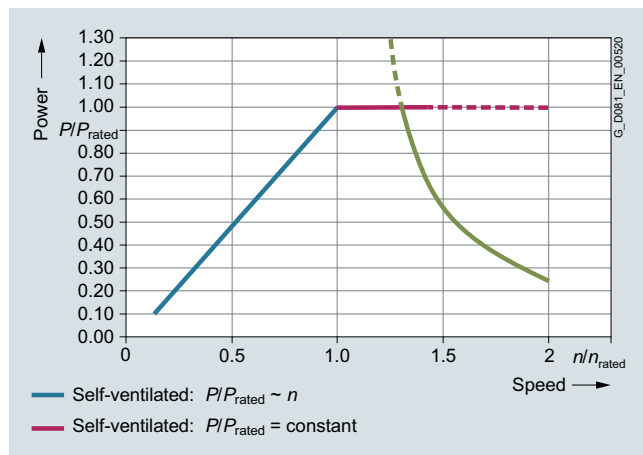

Power limit for SIMOTICS GP/SD VSD4000 line self-ventilated

Maximum overload torques/thermal limit characteristic

The maximum overload torque output from the motor is defined by the limit characteristic and the available converter output current.

Thermally, the motors can have a continuous overload with service factor 1.2 (SF 1.2). However, in this case, the limit torque characteristic must be observed. The speed control range is limited by the mechanical speed limit, which depends on the motor's mechanical design.

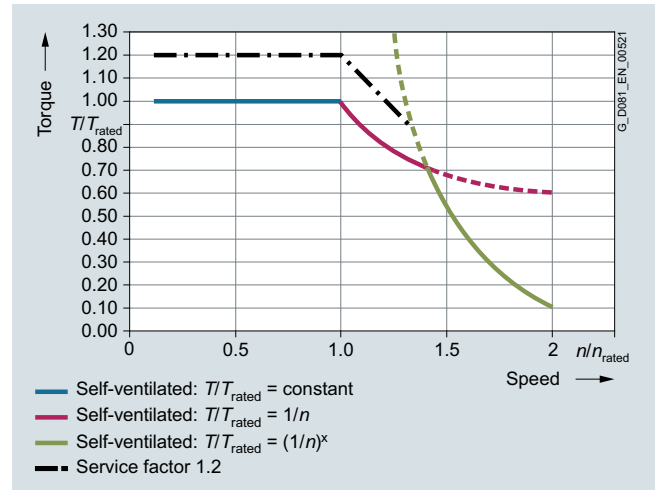

Overload torque characteristic SIMOTICS GP/SD VSD4000 line

Synchronous reluctance motors for SINAMICS converters – VSD4000 line

Orientation

Technical specifications

The torque and power characteristics for converter configuration for the SIMOTICS GP/SD 1FP1.14-0DB2 motor, frame size 80 with the particular motor voltage and circuit:

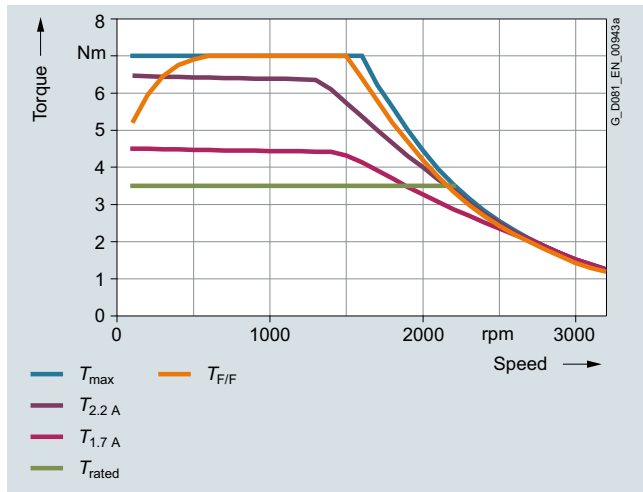

Torque limit for 380 VY (50 Hz characteristic)

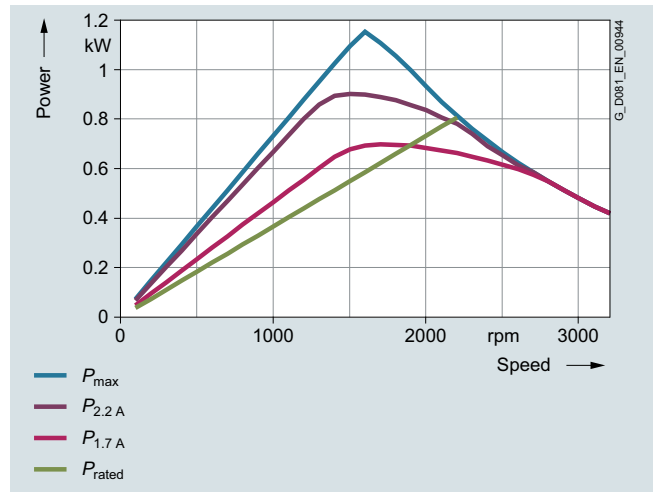

Power limit for 380 VY (50 Hz characteristic)

4

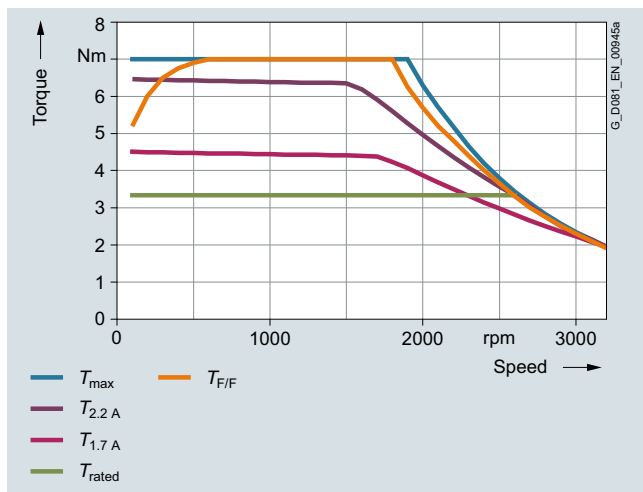

Torque limit for 440 VY (60 Hz characteristic)

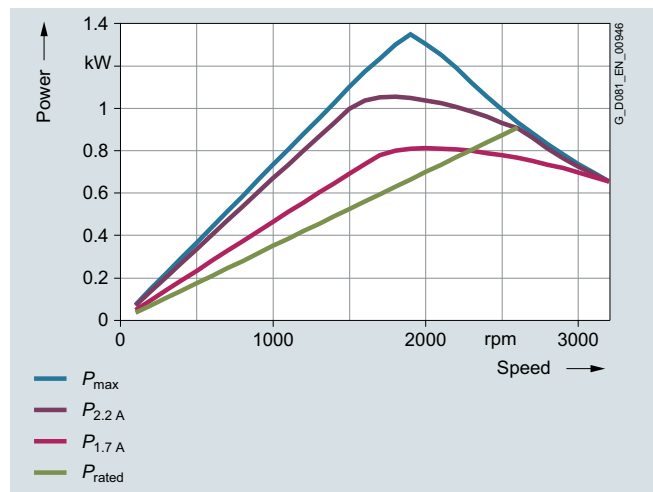

Power limit for 440 VY (60 Hz characteristic)

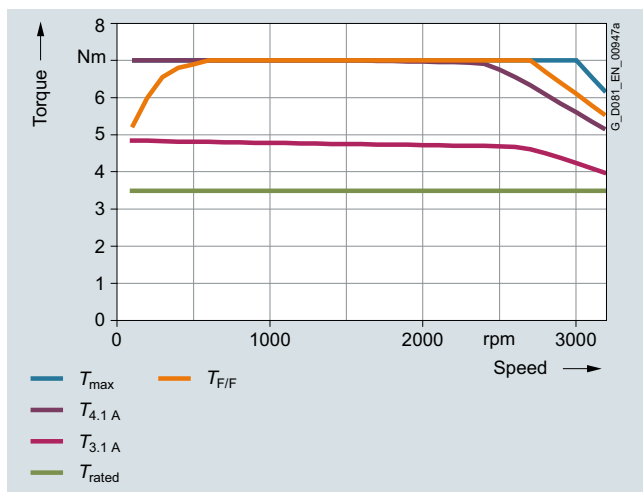

Torque limit for 380 VΔ (87 Hz characteristic)

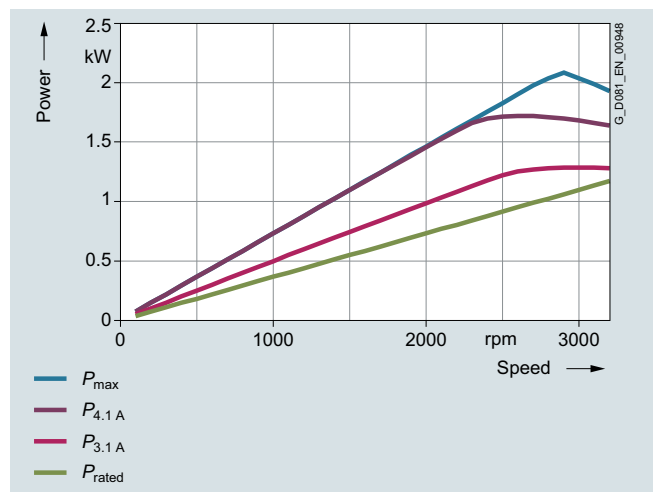

Power limit for 380 VΔ (87 Hz characteristic)

Synchronous reluctance motors for SINAMICS converters – VSD4000 line Orientation

Technical specifications

The torque and power characteristics for converter configuration for the SIMOTICS GP/SD 1FP1.14-0DB3 motor, frame size 80 with the particular motor voltage and circuit:

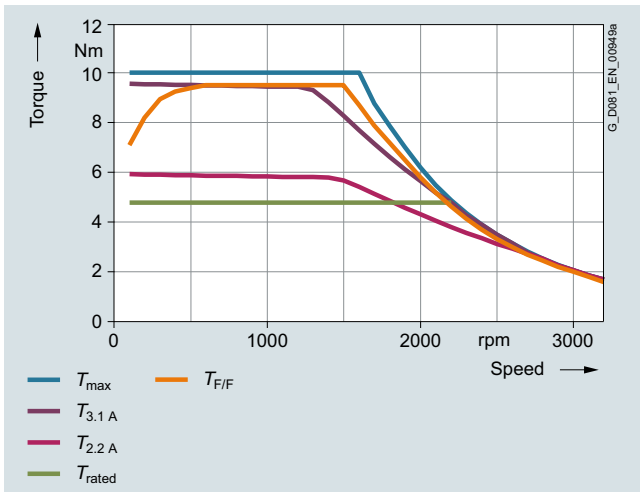

Torque limit for 380 VY (50 Hz characteristic)

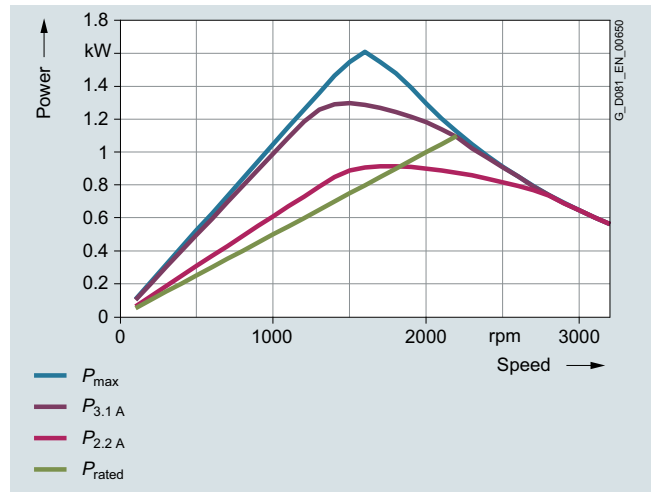

Power limit for 380 VY (50 Hz characteristic)

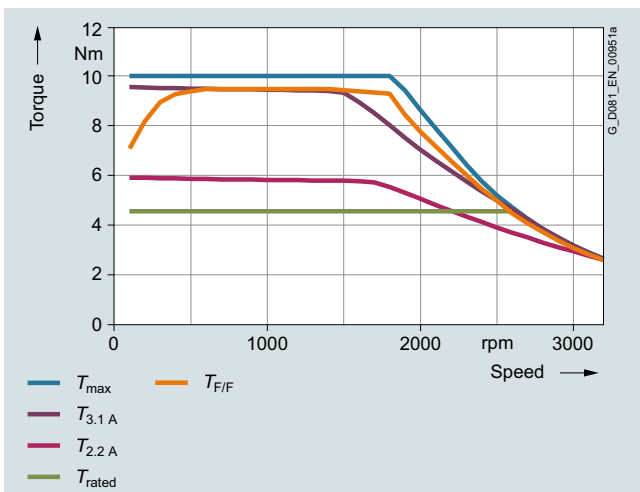

Torque limit for 440 VY (60 Hz characteristic)

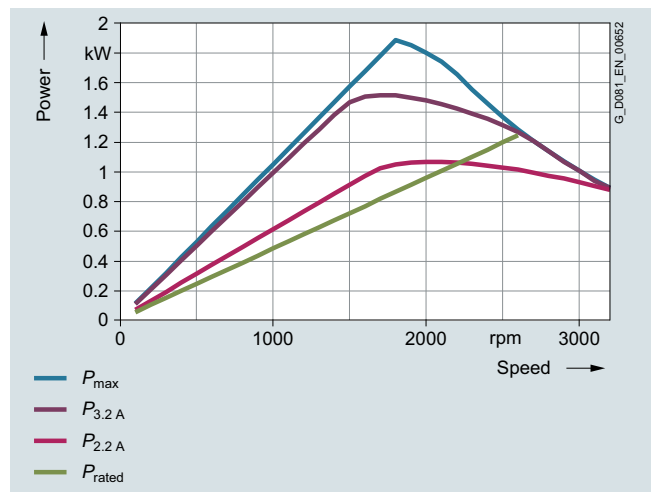

Power limit for 440 VY (60 Hz characteristic)

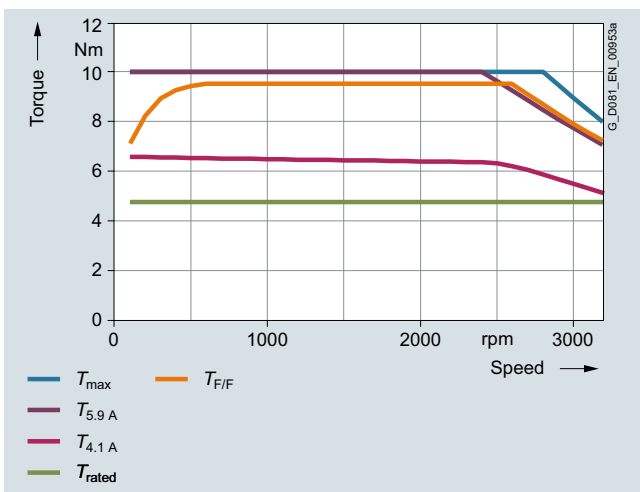

Torque limit for 380 VΔ (87 Hz characteristic)

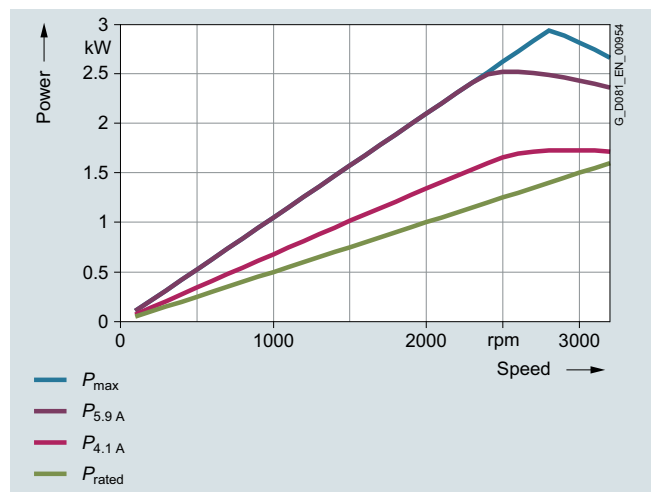

Power limit for 380 VΔ (87 Hz characteristic)

Synchronous reluctance motors for SINAMICS converters – VSD4000 line

Orientation

Technical specifications

The torque and power characteristics for converter configuration for the SIMOTICS GP/SD 1FP1.14-0DF2 motor, frame size 80 with the particular motor voltage and circuit:

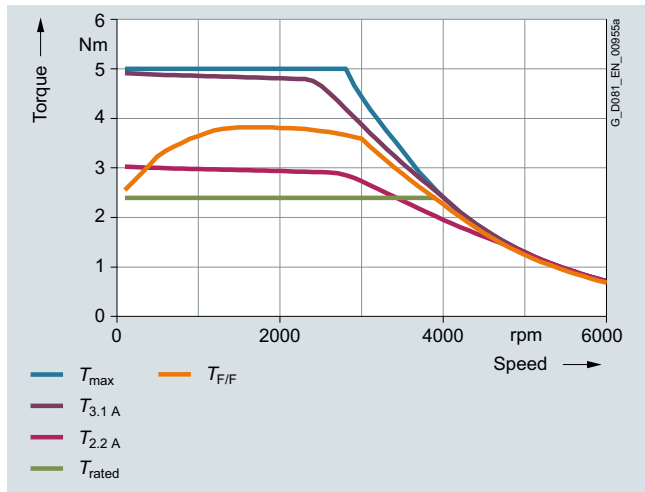

Torque limit for 380 VY (100 Hz characteristic)

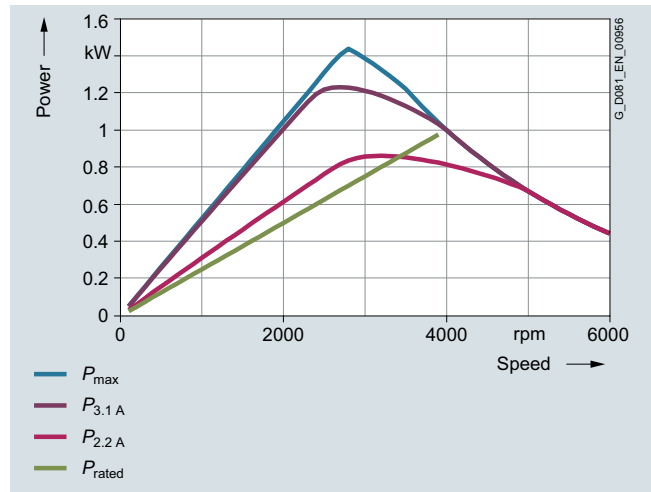

Power limit for 380 VY (100 Hz characteristic)

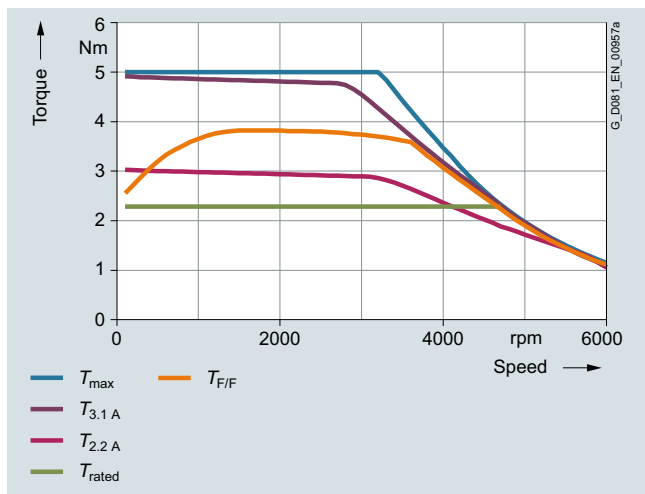

Torque limit for 440 VY (120 Hz characteristic)

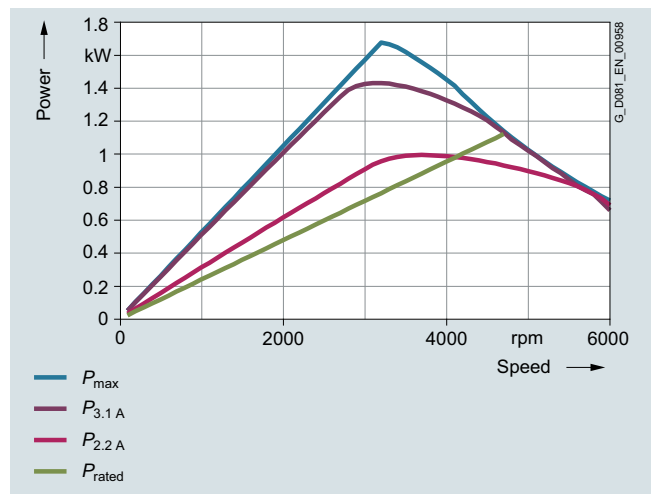

Power limit for 440 VY (120 Hz characteristic)

4

Synchronous reluctance motors for SINAMICS converters – VSD4000 line

Orientation

Technical specifications

The torque and power characteristics for converter configuration for the SIMOTICS GP/SD 1FP1.14-0DF3 motor, frame size 80 with the particular motor voltage and circuit:

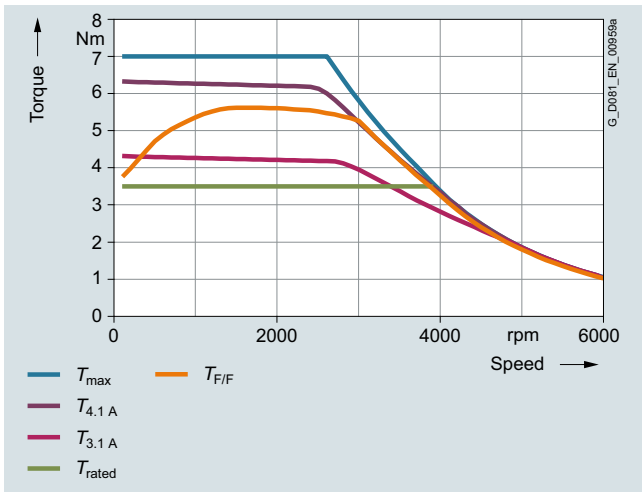

Torque limit for 380 VY (100 Hz characteristic)

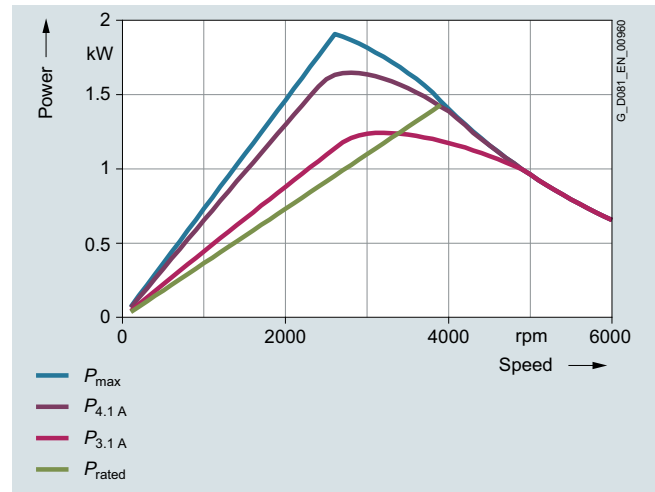

Power limit for 380 VY (100 Hz characteristic)

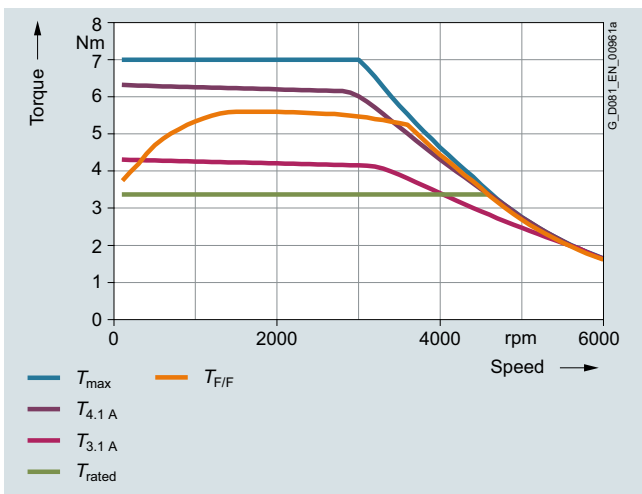

Torque limit for 440 VY (120 Hz characteristic)

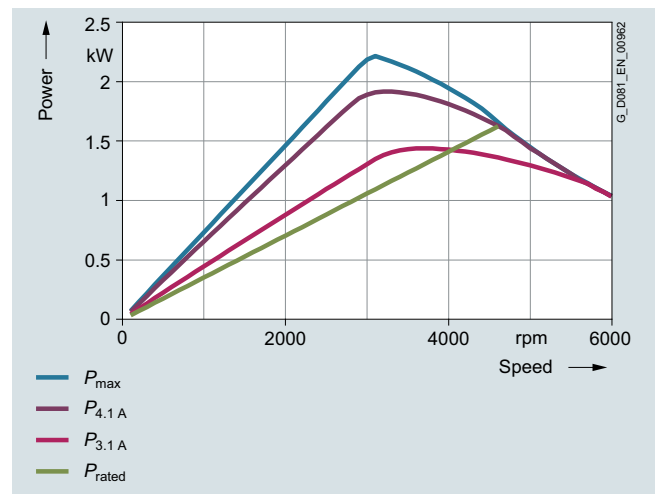

Power limit for 440 VY (120 Hz characteristic)

Synchronous reluctance motors for SINAMICS converters – VSD4000 line

Orientation

Technical specifications

The torque and power characteristics for converter configuration for the SIMOTICS GP/SD 1FP1.14-0EB0 motor, frame size 90 with the particular motor voltage and circuit:

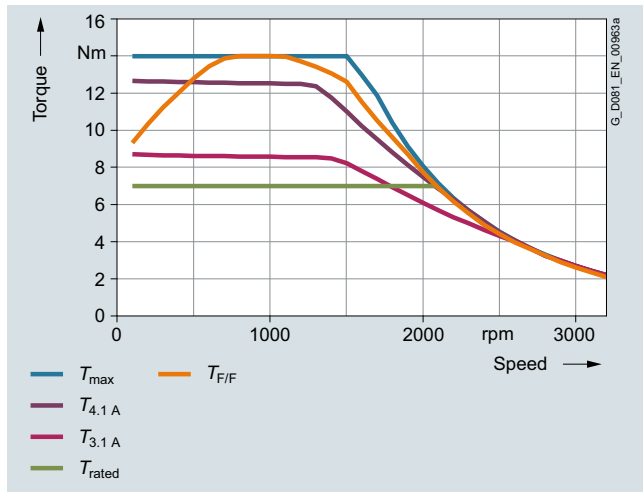

Torque limit for 380 VY (50 Hz characteristic)

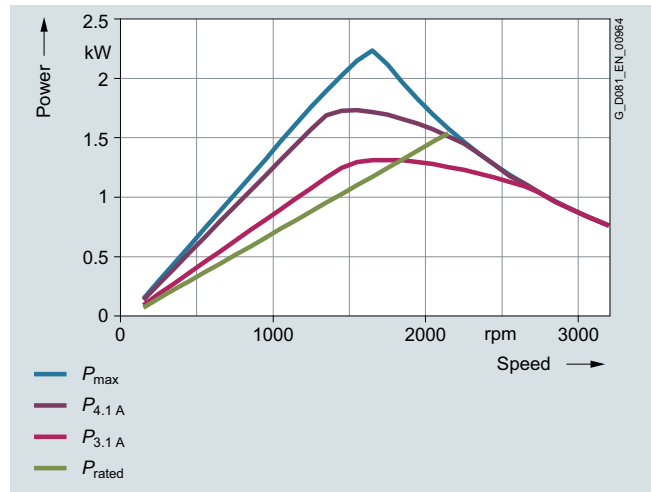

Power limit for 380 VY (50 Hz characteristic)

4

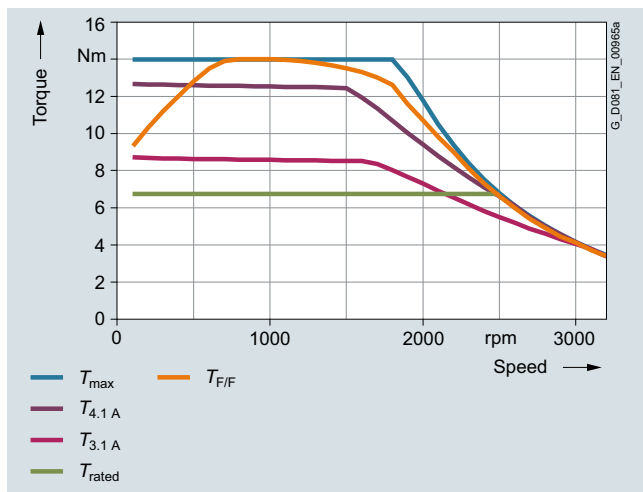

Torque limit for 440 VY (60 Hz characteristic)

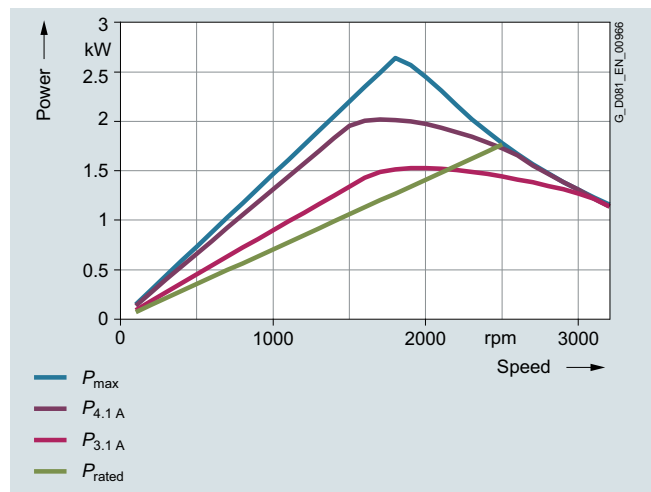

Power limit for 440 VY (60 Hz characteristic)

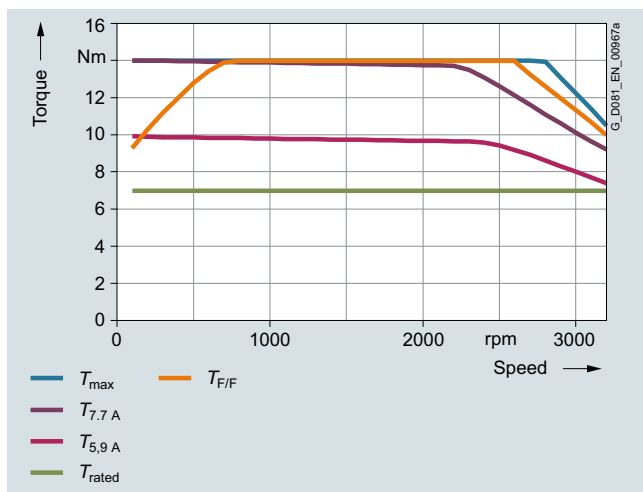

Torque limit for 380 VΔ (87 Hz characteristic)

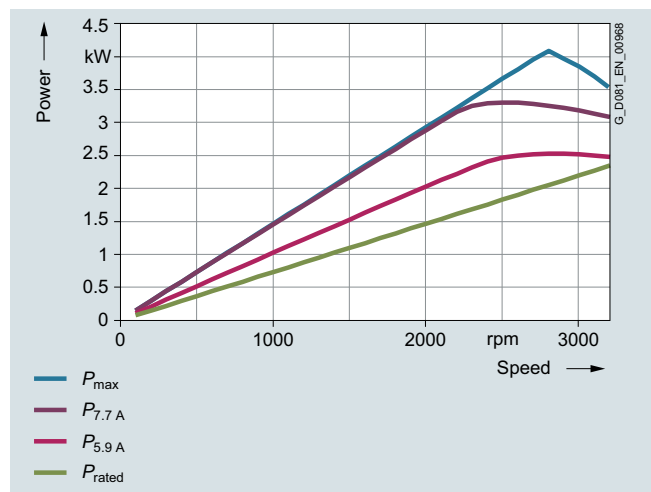

Power limit for 380 VΔ (87 Hz characteristic)

Synchronous reluctance motors for SINAMICS converters – VSD4000 line Orientation

Technical specifications

The torque and power characteristics for converter configuration for the SIMOTICS GP/SD 1FP1.14-0EB4 motor, frame size 90 with the particular motor voltage and circuit:

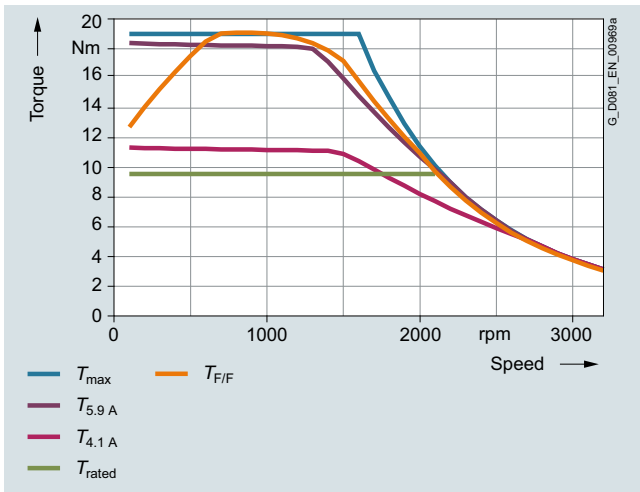

Torque limit for 380 VY (50 Hz characteristic)

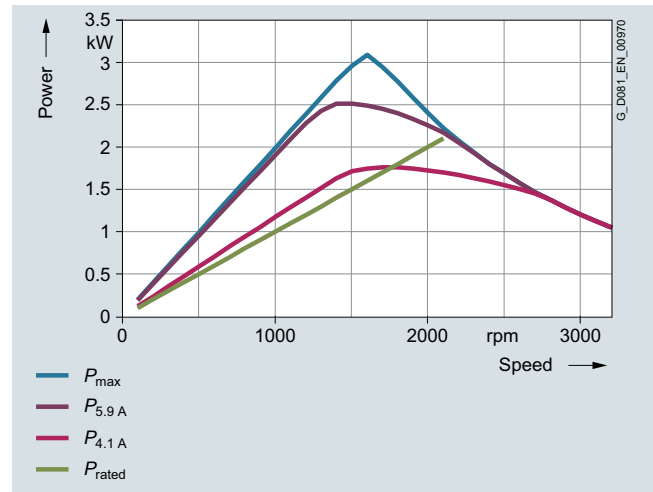

Power limit for 380 VY (50 Hz characteristic)

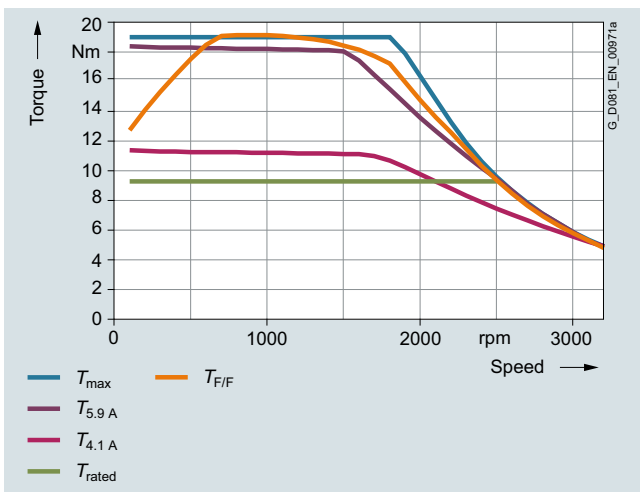

Torque limit for 440 VY (60 Hz characteristic)

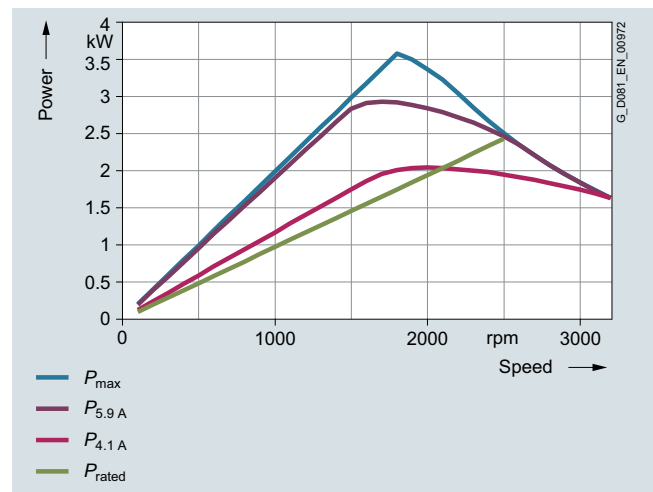

Power limit for 440 VY (60 Hz characteristic)

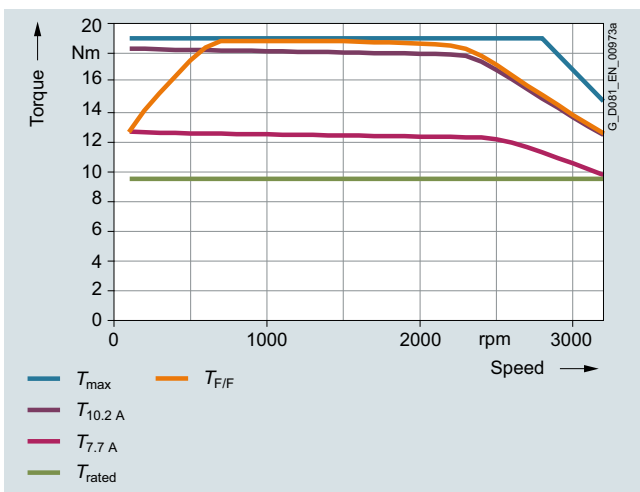

Torque limit for 380 VΔ (87 Hz characteristic)

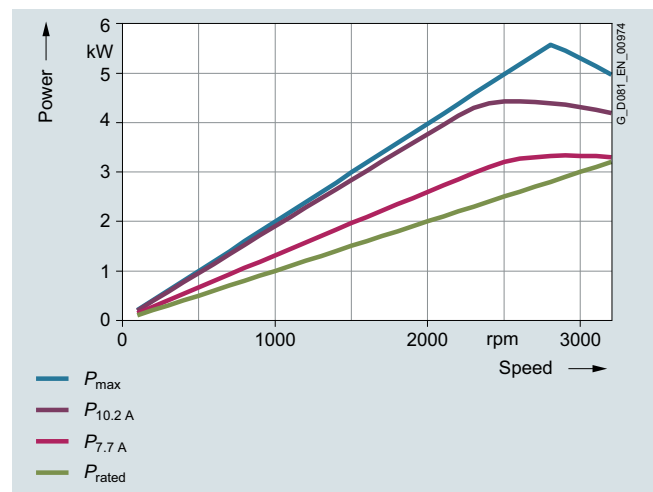

Power limit for 380 VΔ (87 Hz characteristic)

Synchronous reluctance motors for SINAMICS converters – VSD4000 line

Orientation

Technical specifications

The torque and power characteristics for converter configuration for the SIMOTICS GP/SD 1FP1.14-0EF0 motor, frame size 90 with the particular motor voltage and circuit:

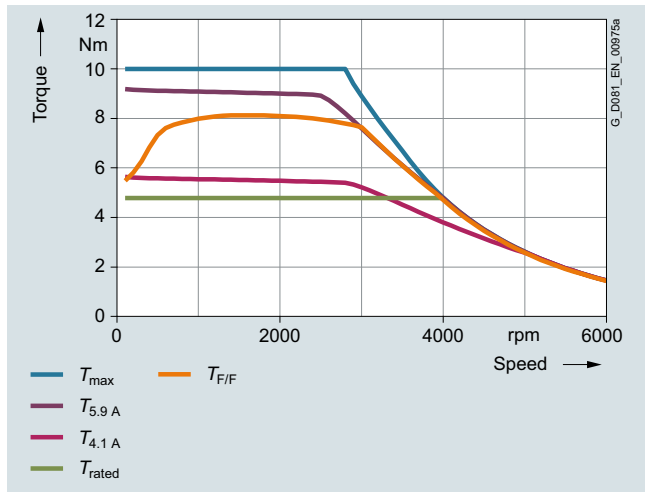

Torque limit for 380 VY (100 Hz characteristic)

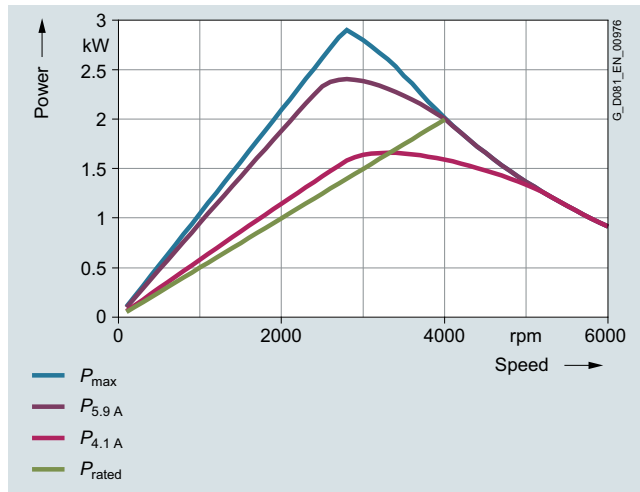

Power limit for 380 VY (100 Hz characteristic)

4

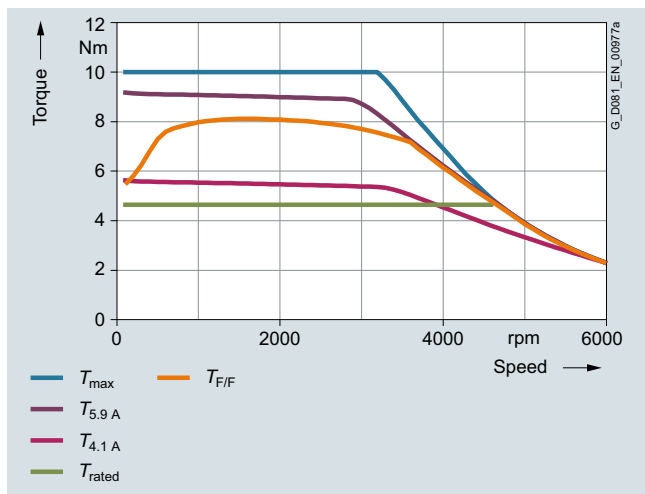

Torque limit for 440 VY (120 Hz characteristic)

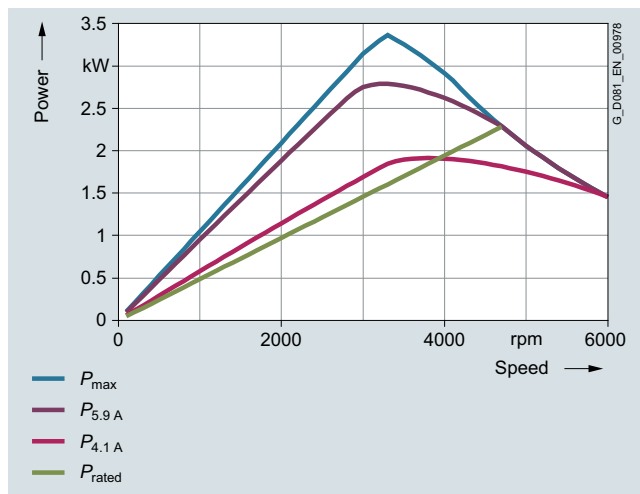

Power limit for 440 VY (120 Hz characteristic)

Synchronous reluctance motors for SINAMICS converters – VSD4000 line Orientation

Technical specifications

The torque and power characteristics for converter configuration for the SIMOTICS GP/SD 1FP1.14-0EF4 motor, frame size 90 with the particular motor voltage and circuit:

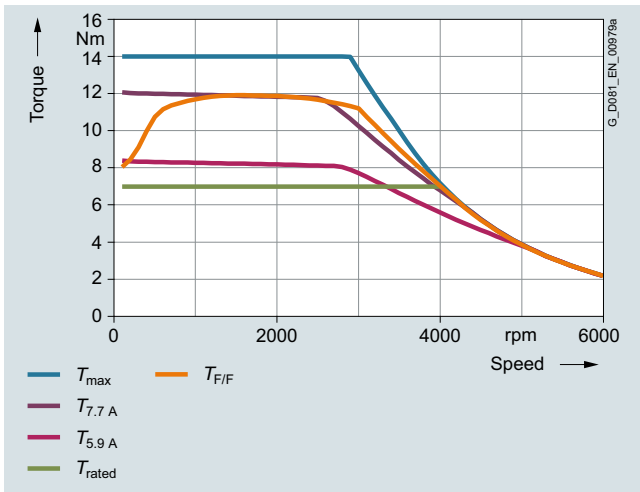

Torque limit for 380 VY (100 Hz characteristic)

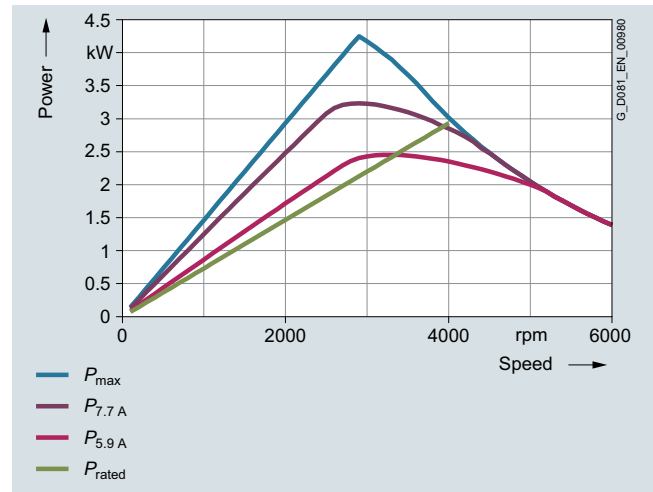

Power limit for 380 VY (100 Hz characteristic)

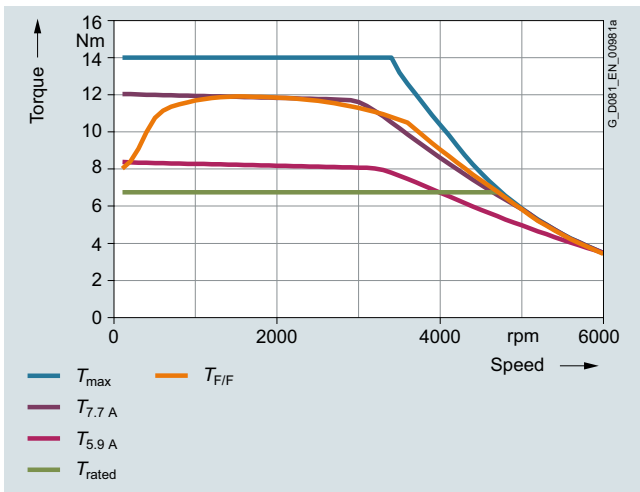

Torque limit for 440 VY (120 Hz characteristic)

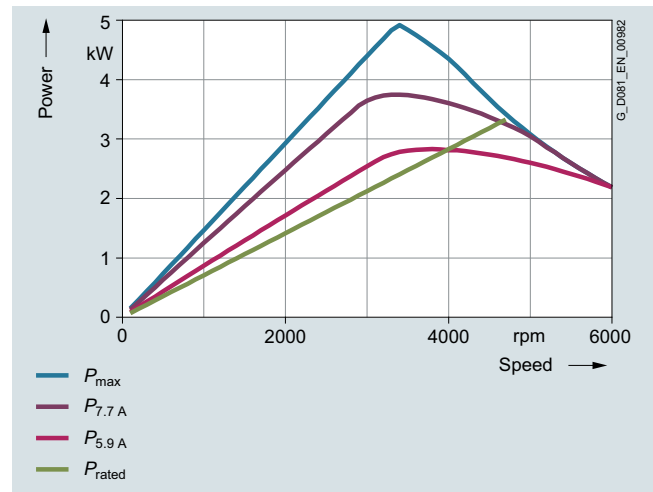

Power limit for 440 VY (120 Hz characteristic)

Synchronous reluctance motors for SINAMICS converters – VSD4000 line

Orientation

Technical specifications

The torque and power characteristics for converter configuration for the SIMOTICS GP/SD 1FP1.14-1BB0 motor, frame size 112 with the particular motor voltage and circuit:

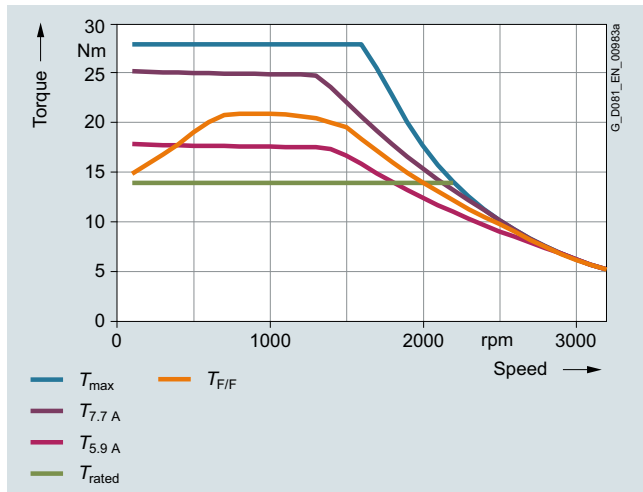

Torque limit for 380 VY (50 Hz characteristic)

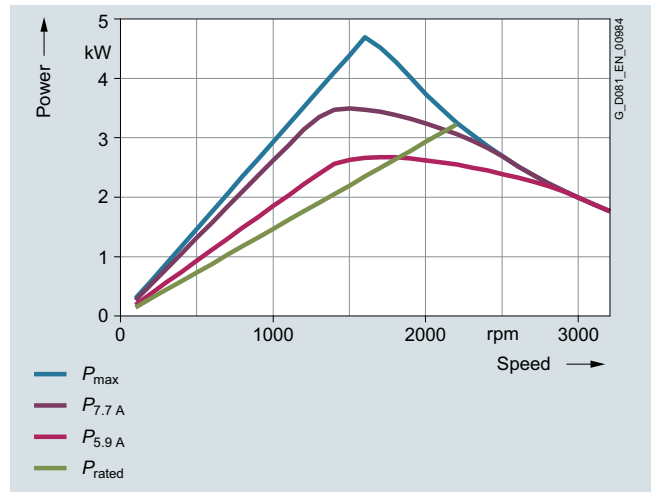

Power limit for 380 VY (50 Hz characteristic)

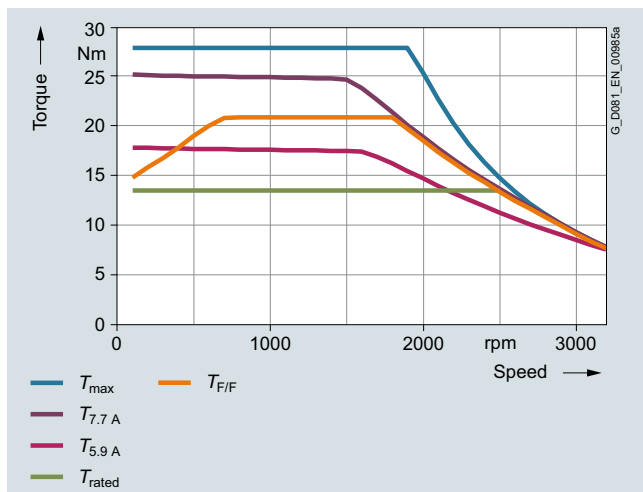

Torque limit for 440 VY (60 Hz characteristic)

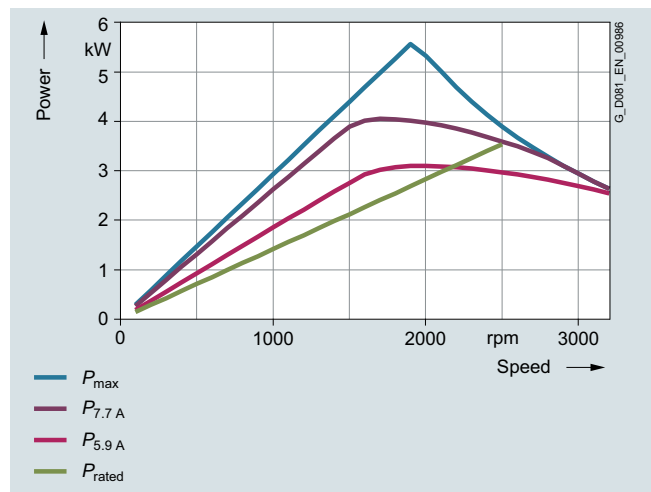

Power limit for 440 VY (60 Hz characteristic)

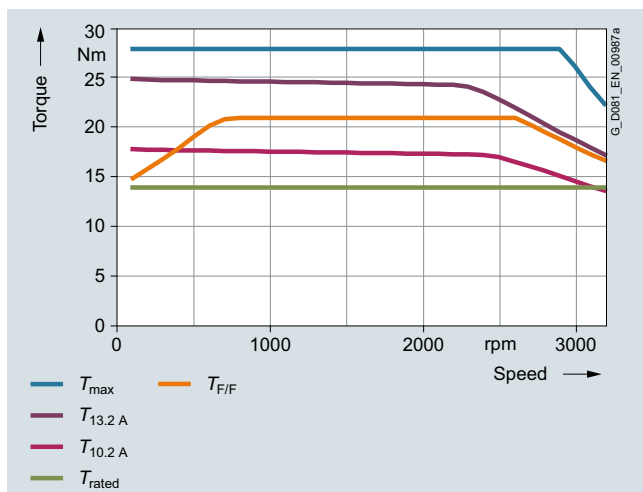

Torque limit for 380 VΔ (87 Hz characteristic)

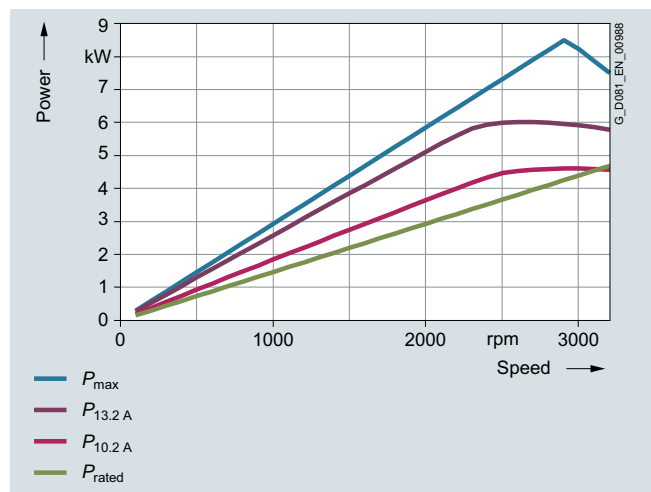

Power limit for 380 VΔ (87 Hz characteristic)

4

Synchronous reluctance motors for SINAMICS converters – VSD4000 line Orientation

Technical specifications

The torque and power characteristics for converter configuration for the SIMOTICS GP/SD 1FP1.14-1BB1 motor, frame size 112 with the particular motor voltage and circuit:

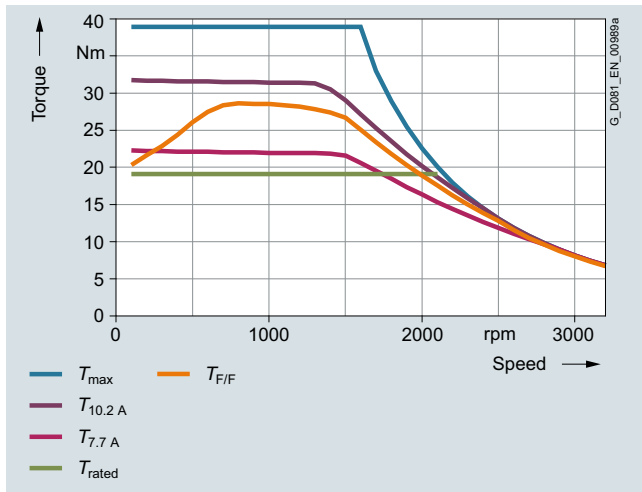

Torque limit for 380 VY (50 Hz characteristic)

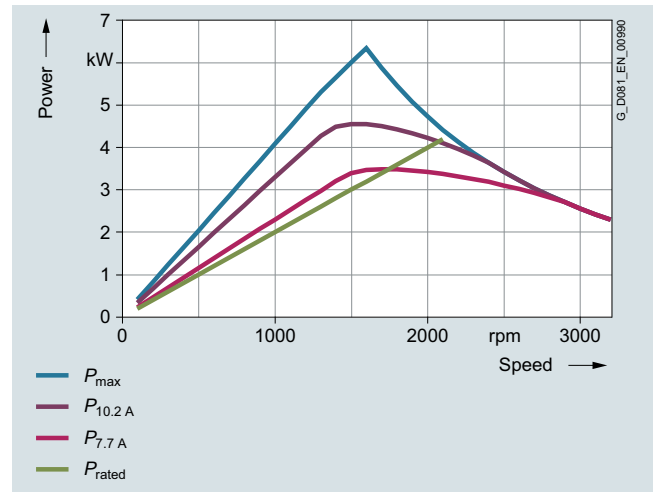

Power limit for 380 VY (50 Hz characteristic)

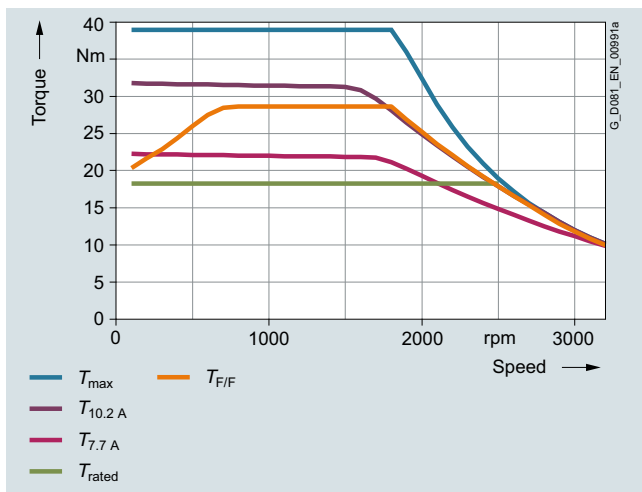

Torque limit for 440 VY (60 Hz characteristic)

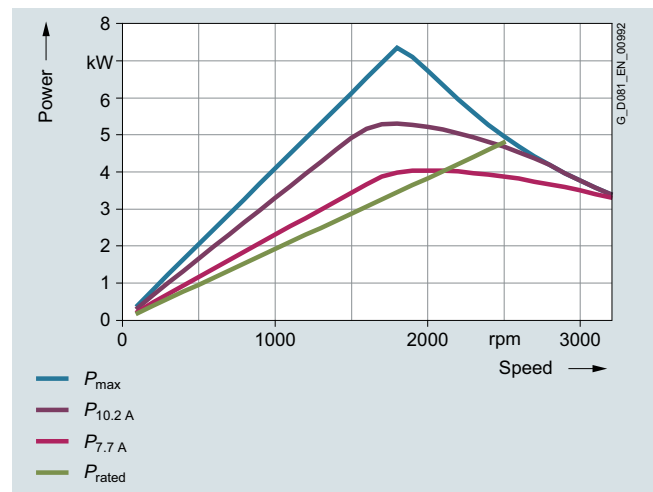

Power limit for 440 VY (60 Hz characteristic)

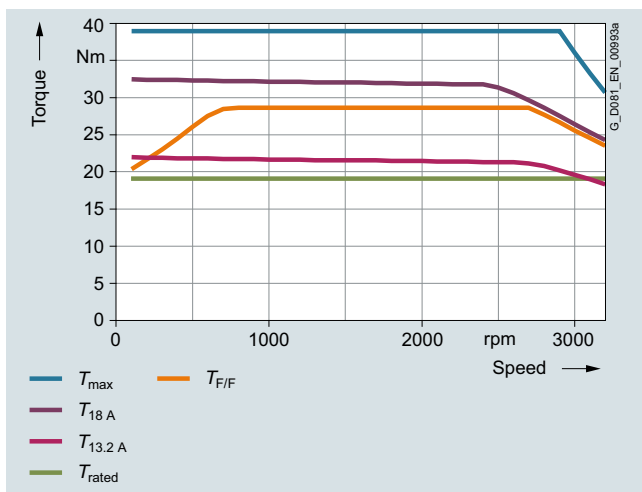

Torque limit for 380 VΔ (87 Hz characteristic)

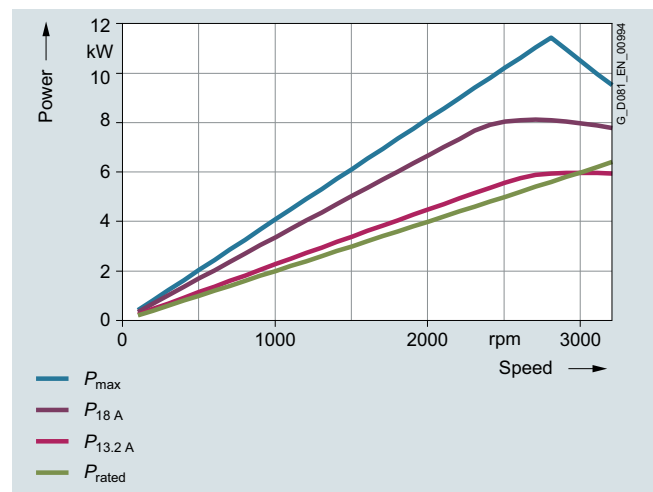

Power limit for 380 VΔ (87 Hz characteristic)

Synchronous reluctance motors for SINAMICS converters – VSD4000 line

Orientation

Technical specifications

The torque and power characteristics for converter configuration for the SIMOTICS GP/SD 1FP1.14-1BB2 motor, frame size 112 with the particular motor voltage and circuit:

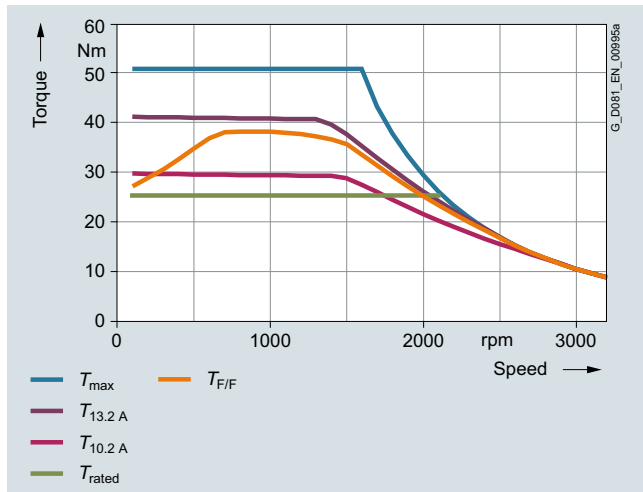

Torque limit for 380 VY (50 Hz characteristic)

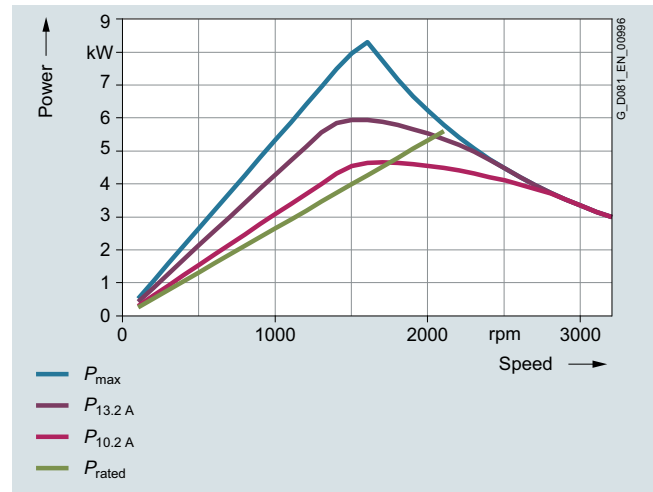

Power limit for 380 VY (50 Hz characteristic)

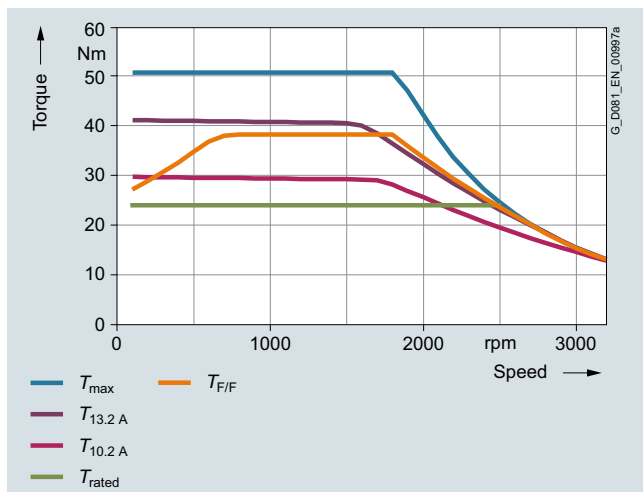

Torque limit for 440 VY (60 Hz characteristic)

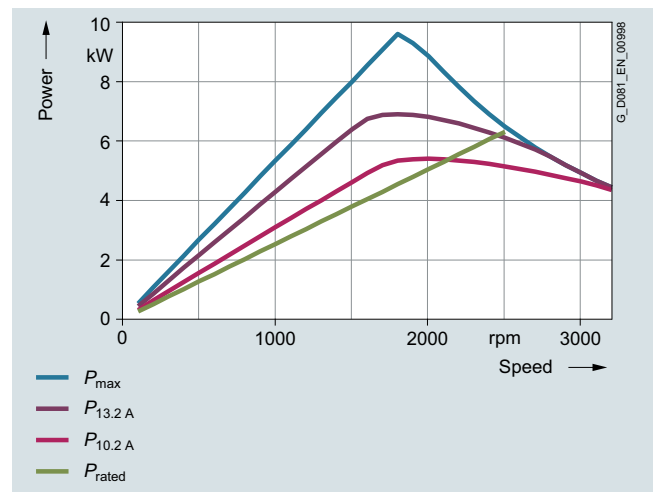

Power limit for 440 VY (60 Hz characteristic)

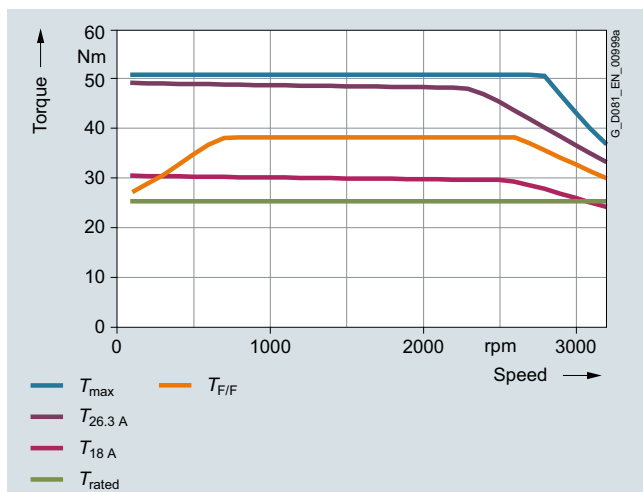

Torque limit for 380 VΔ (87 Hz characteristic)

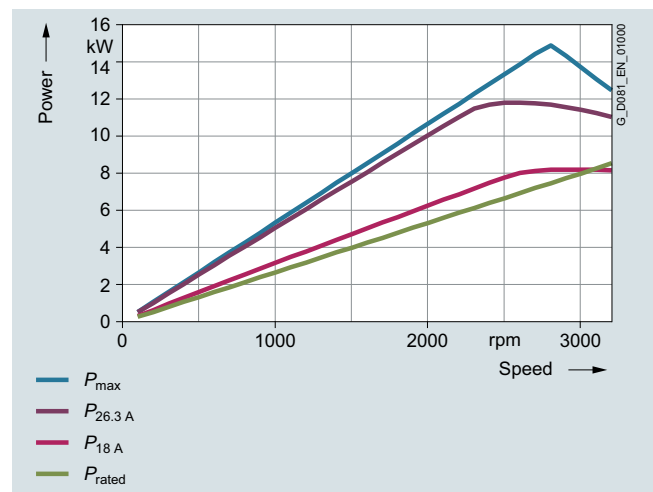

Power limit for 380 VΔ (87 Hz characteristic)

4

Synchronous reluctance motors for SINAMICS converters – VSD4000 line Orientation

Technical specifications

The torque and power characteristics for converter configuration for the SIMOTICS SD 1FP1514-1BF1 motor, frame size 112 with the particular motor voltage and circuit:

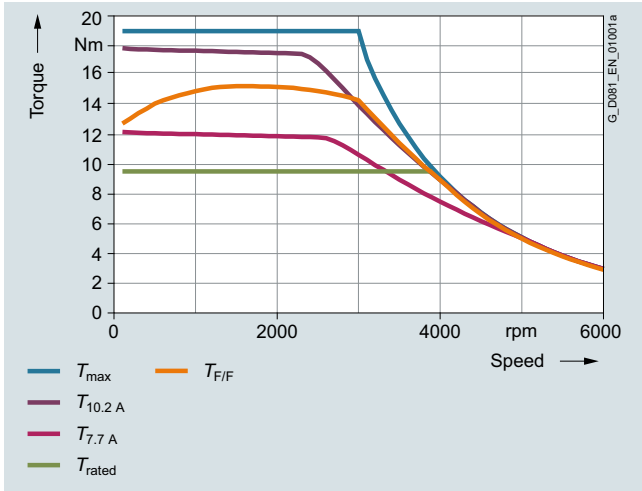

Torque limit for 380 VY (100 Hz characteristic)

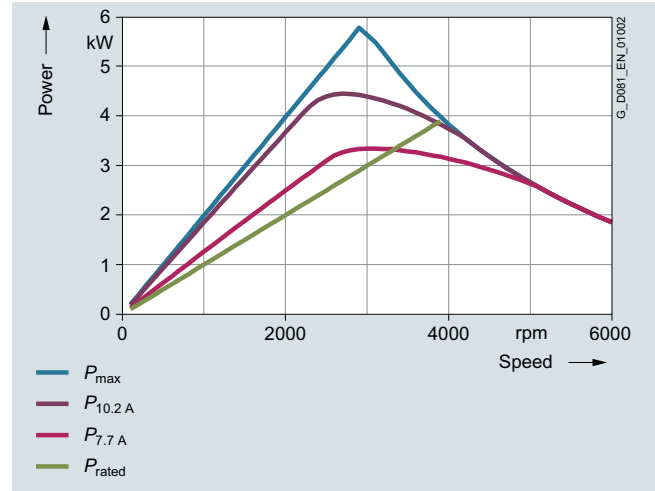

Power limit for 380 VY (100 Hz characteristic)

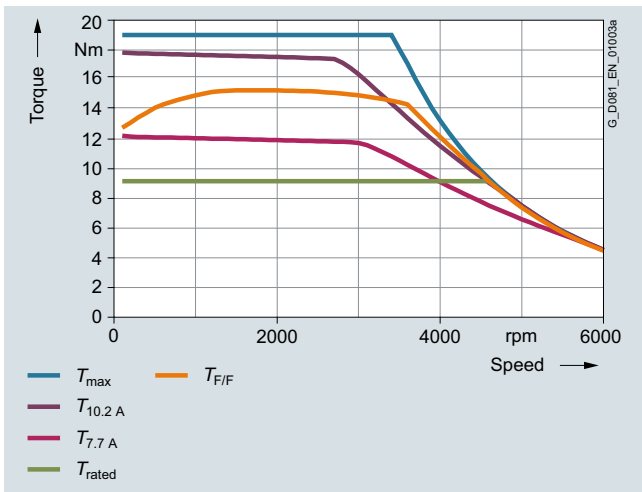

Torque limit for 440 VY (120 Hz characteristic)

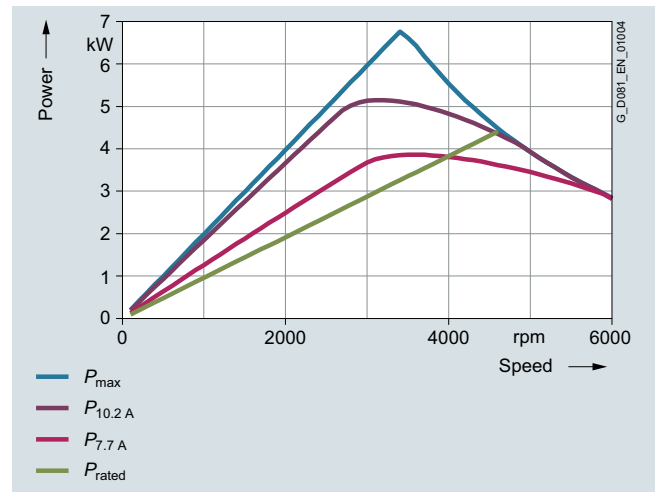

Power limit for 440 VY (120 Hz characteristic)

Synchronous reluctance motors for SINAMICS converters – VSD4000 line

Orientation

Technical specifications

The torque and power characteristics for converter configuration for the SIMOTICS GP/SD 1FP1.14-1BF2 motor, frame size 112 with the particular motor voltage and circuit:

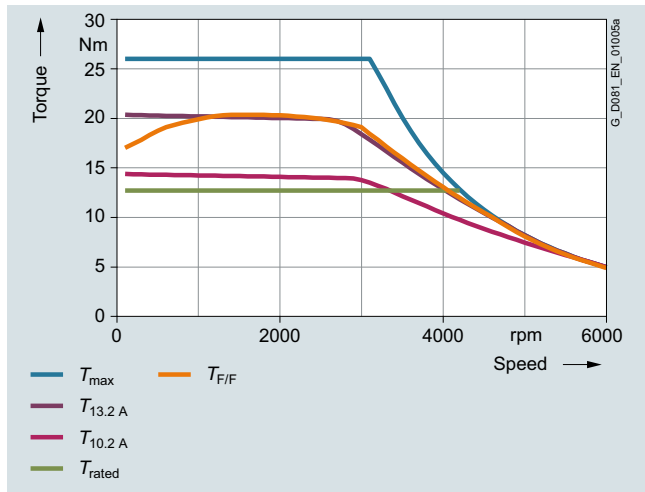

Torque limit for 380 VY (100 Hz characteristic)

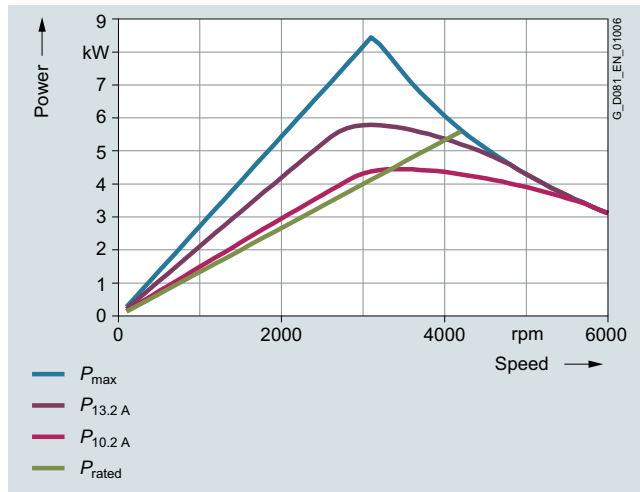

Power limit for 380 VY (100 Hz characteristic)

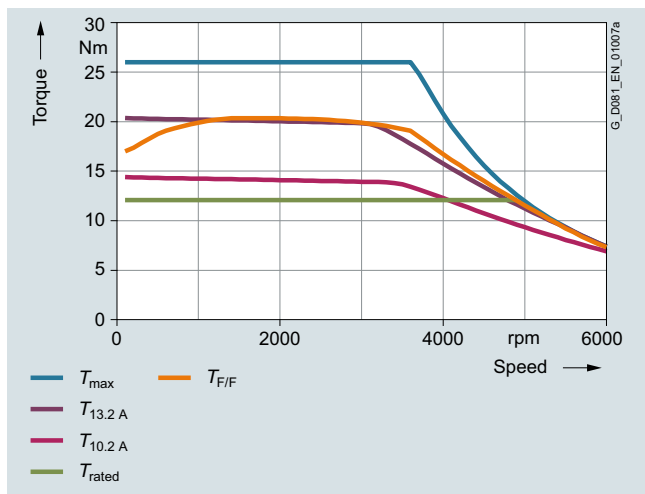

Torque limit for 440 VY (120 Hz characteristic)

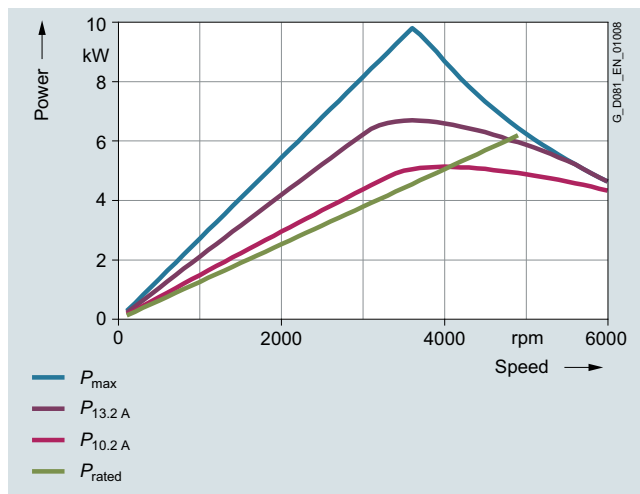

Power limit for 440 VY (120 Hz characteristic)

4

Synchronous reluctance motors for SINAMICS converters – VSD4000 line Orientation

Technical specifications

The torque and power characteristics for converter configuration for the SIMOTICS GP/SD 1FP1.14-1CB0 motor, frame size 132 with the particular motor voltage and circuit:

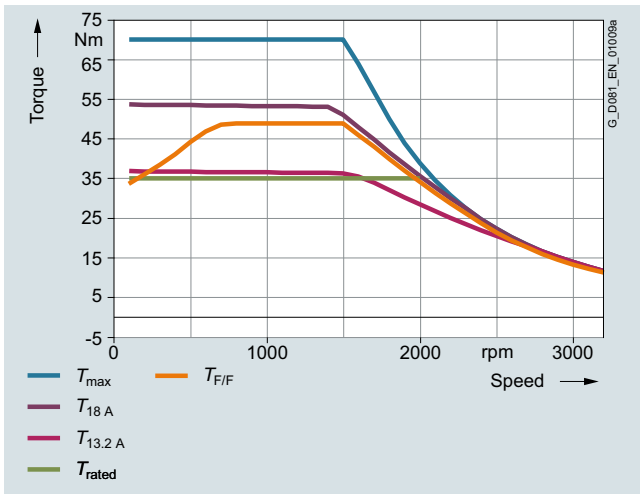

Torque limit for 380 VY (50 Hz characteristic)

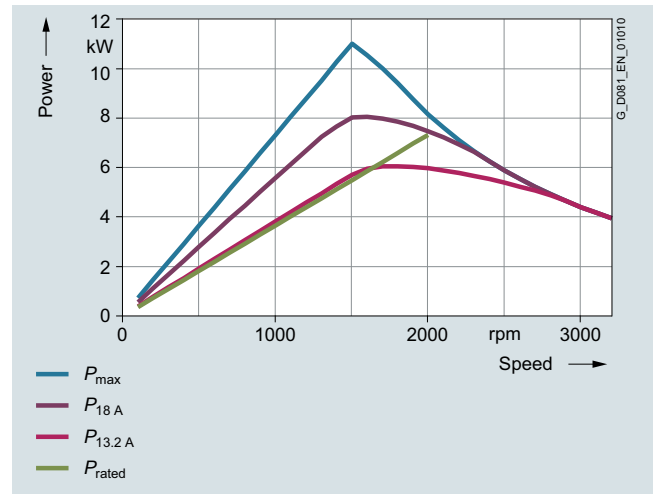

Power limit for 380 VY (50 Hz characteristic)

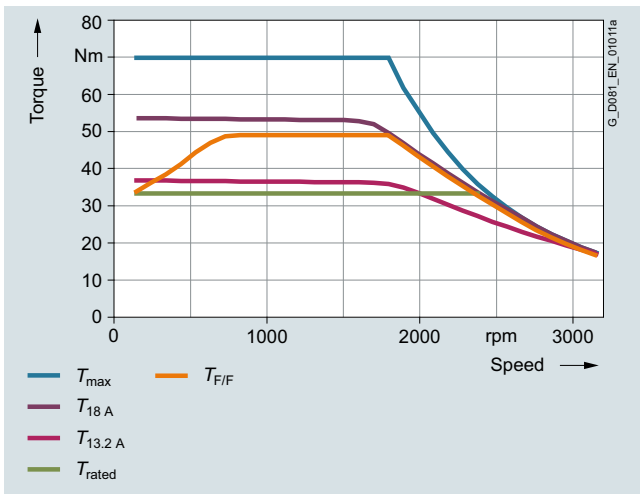

Torque limit for 440 VY (60 Hz characteristic)

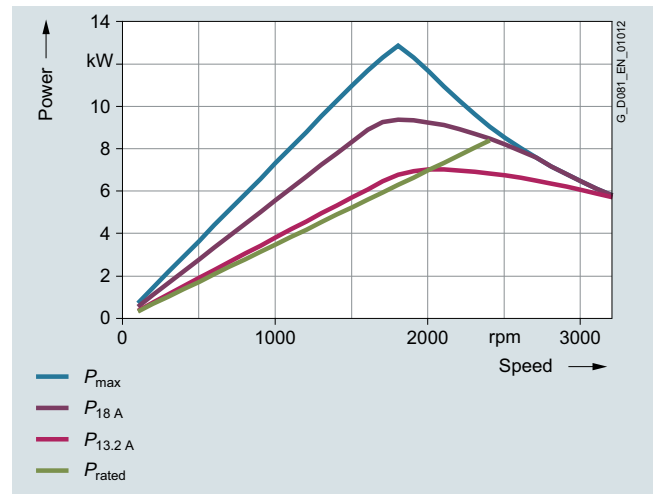

Power limit for 440 VY (60 Hz characteristic)

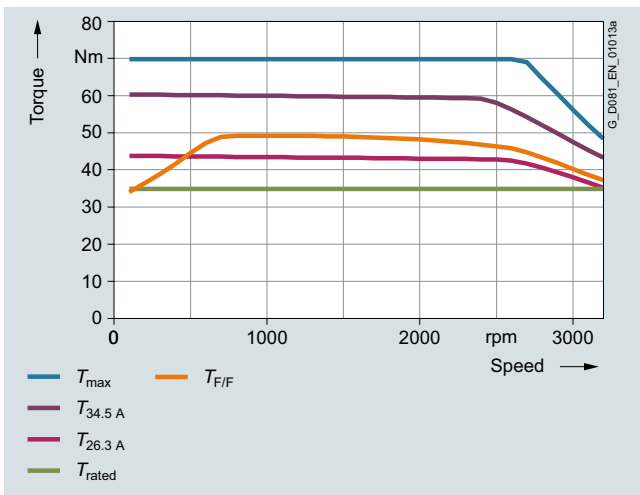

Torque limit for 380 VΔ (87 Hz characteristic)

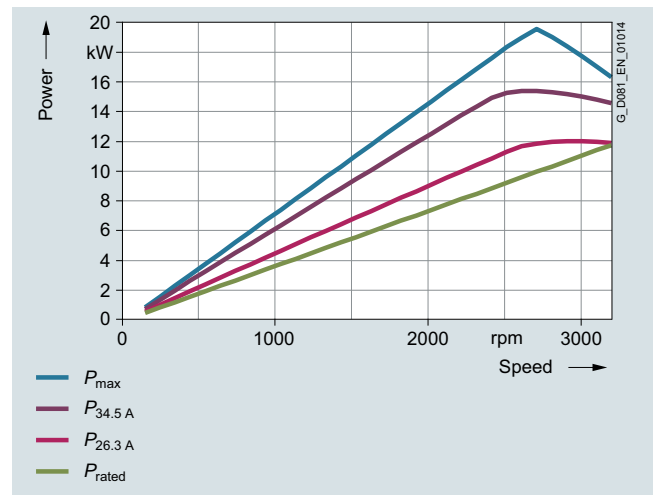

Power limit for 380 VΔ (87 Hz characteristic)

Synchronous reluctance motors for SINAMICS converters – VSD4000 line

Orientation

Technical specifications

The torque and power characteristics for converter configuration for the SIMOTICS GP/SD 1FP1.14-1CB2 motor, frame size 132 with the particular motor voltage and circuit:

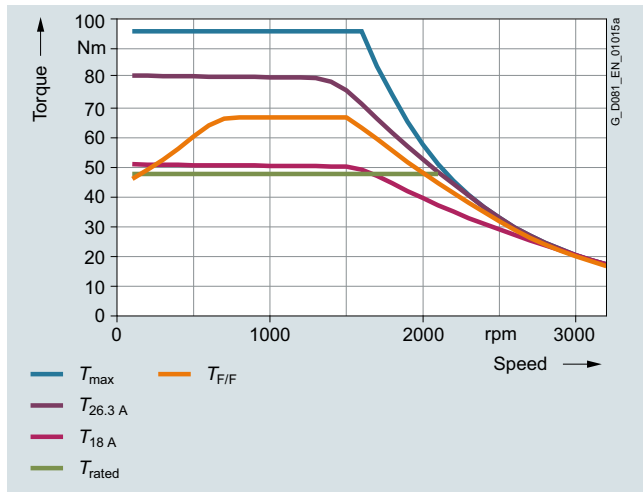

Torque limit for 380 VY (50 Hz characteristic)

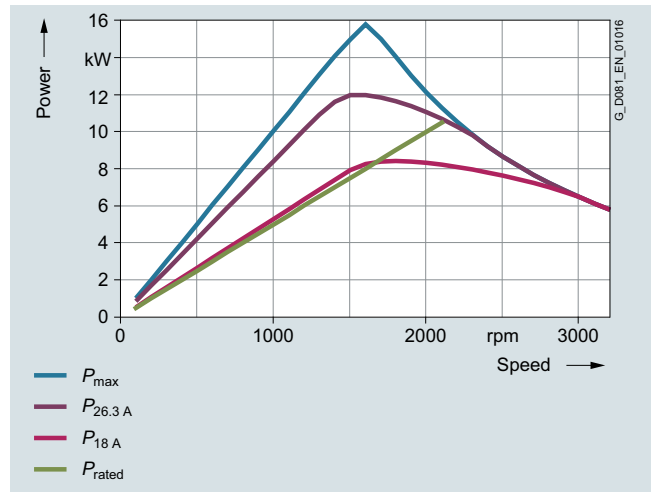

Power limit for 380 VY (50 Hz characteristic)

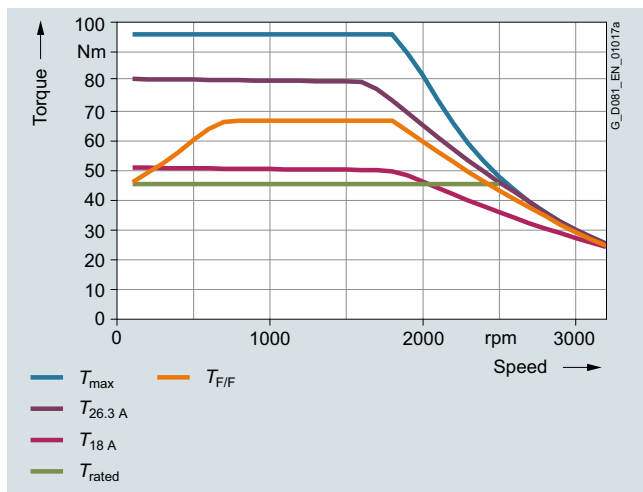

Torque limit for 440 VY (60 Hz characteristic)

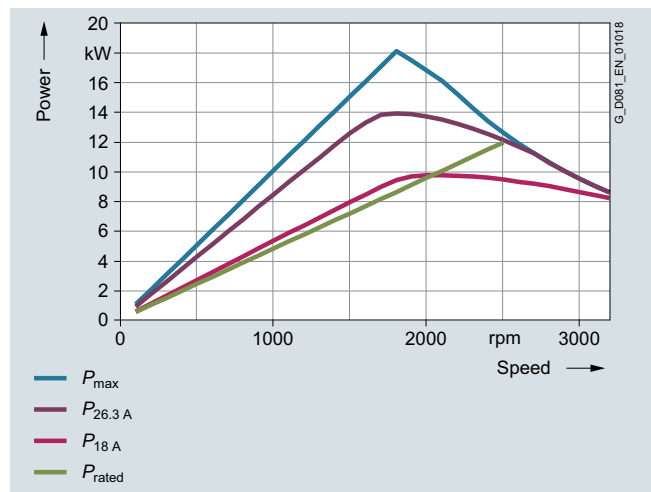

Power limit for 440 VY (60 Hz characteristic)

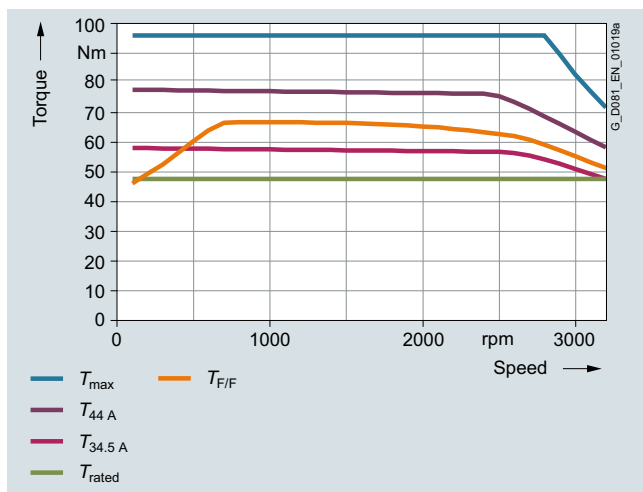

Torque limit for 380 VΔ (87 Hz characteristic)

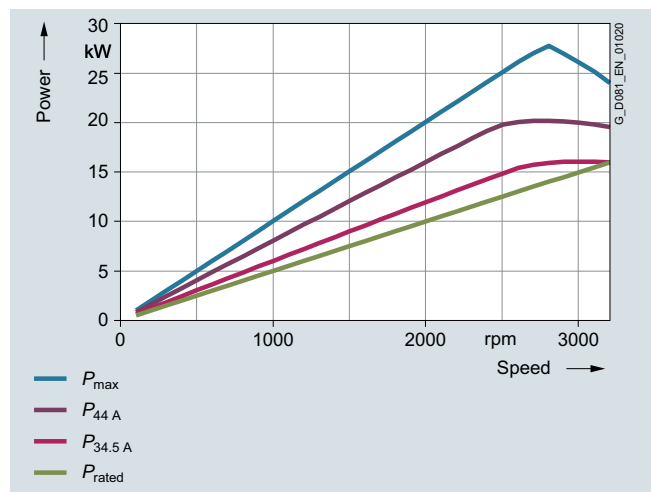

Power limit for 380 VΔ (87 Hz characteristic)

Synchronous reluctance motors for SINAMICS converters – VSD4000 line

Orientation

Technical specifications

The torque and power characteristics for converter configuration for the SIMOTICS GP/SD 1FP1.14-1CF0 motor, frame size 132 with the particular motor voltage and circuit:

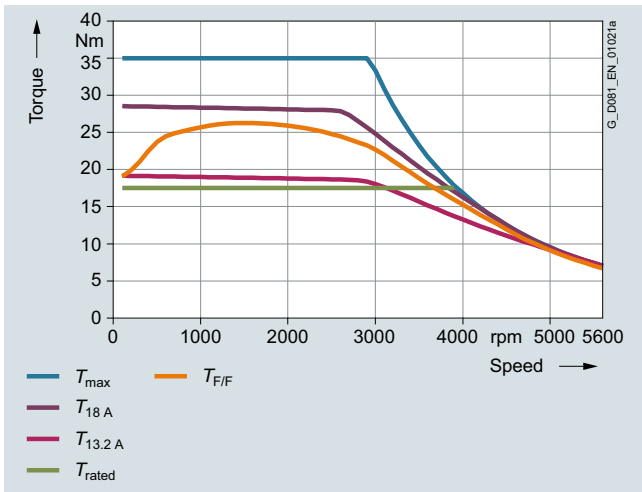

Torque limit for 380 VY (100 Hz characteristic)

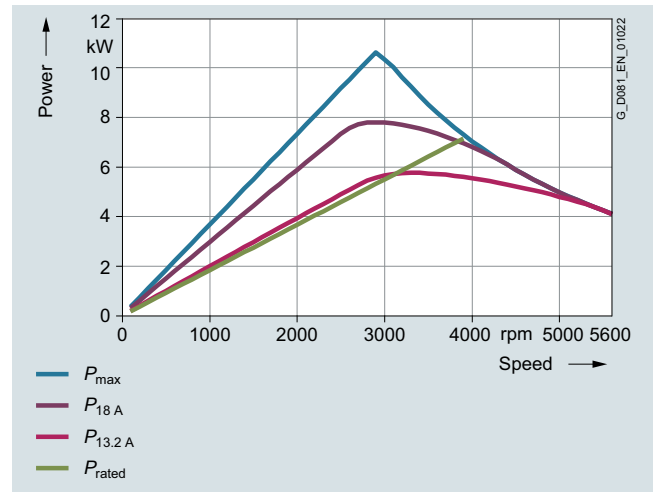

Power limit for 380 VY (100 Hz characteristic)

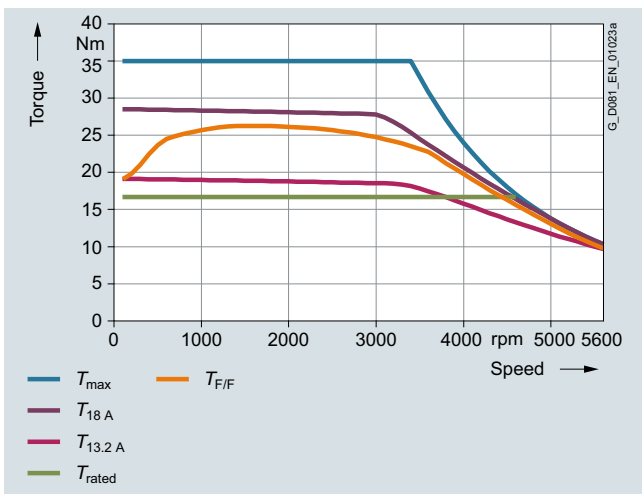

Torque limit for 440 VY (120 Hz characteristic)

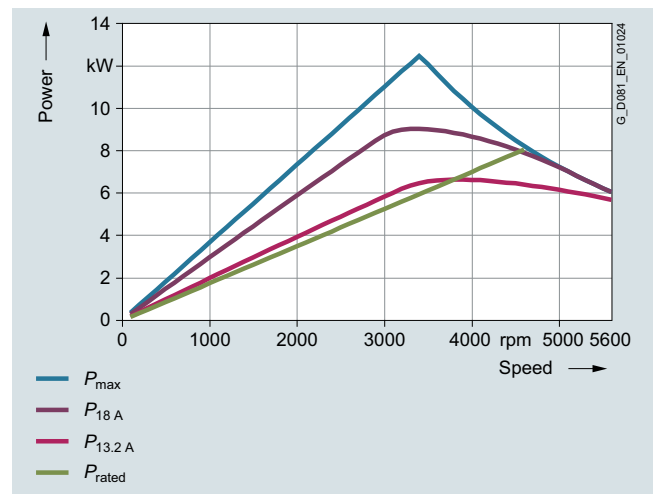

Power limit for 440 VY (120 Hz characteristic)

Synchronous reluctance motors for SINAMICS converters – VSD4000 line

Orientation

Technical specifications

The torque and power characteristics for converter configuration for the SIMOTICS GP/SD 1FP1.14-1CF1 motor, frame size 132 with the particular motor voltage and circuit:

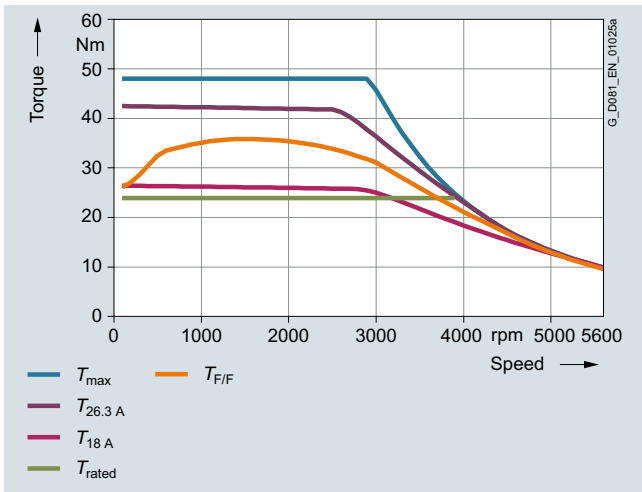

Torque limit for 380 VY (100 Hz characteristic)

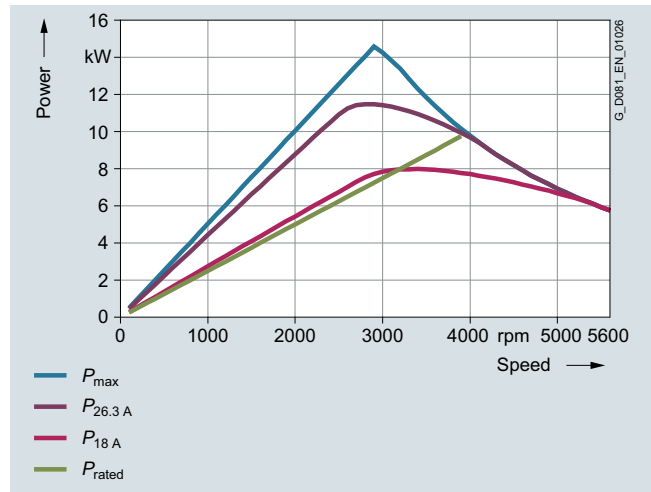

Power limit for 380 VY (100 Hz characteristic)

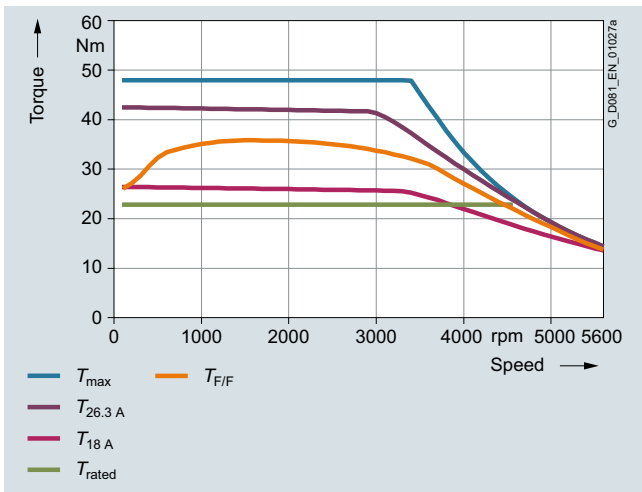

Torque limit for 440 VY (120 Hz characteristic)

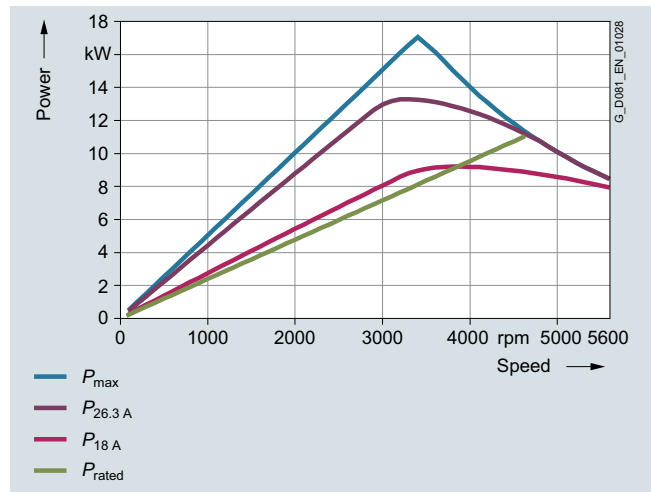

Power limit for 440 VY (120 Hz characteristic)

4

Synchronous reluctance motors for SINAMICS converters – VSD4000 line Orientation

Technical specifications

The torque and power characteristics for converter configuration for the SIMOTICS GP/SD 1FP1.14-1DB2 motor, frame size 160 with the particular motor voltage and circuit:

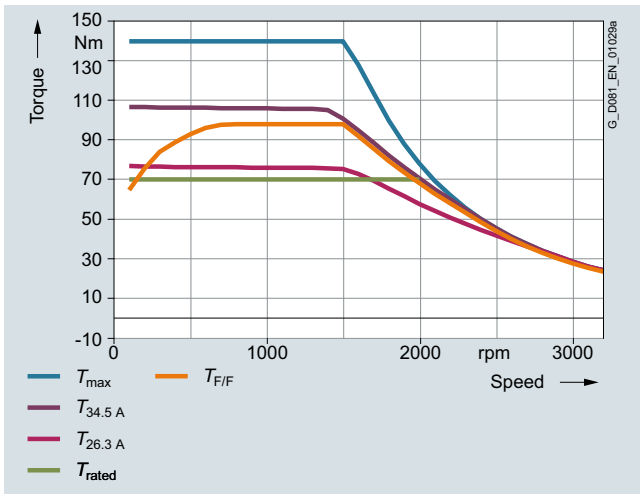

Torque limit for 380 VY (50 Hz characteristic)

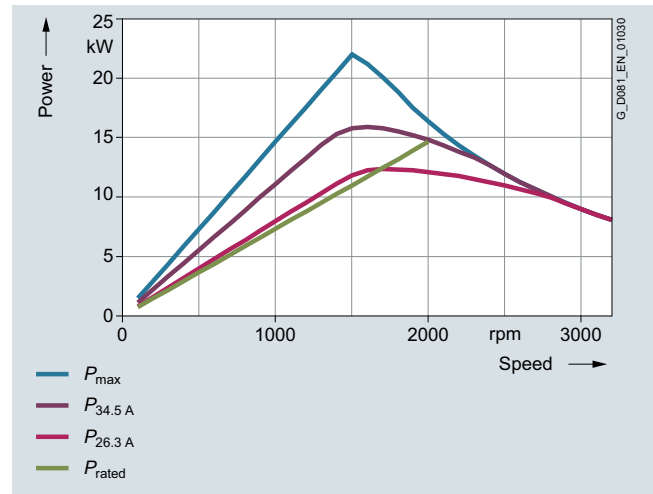

Power limit for 380 VY (50 Hz characteristic)

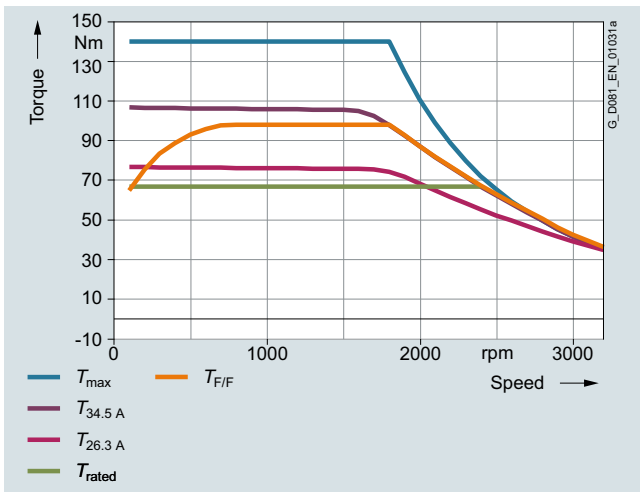

Torque limit for 440 VY (60 Hz characteristic)

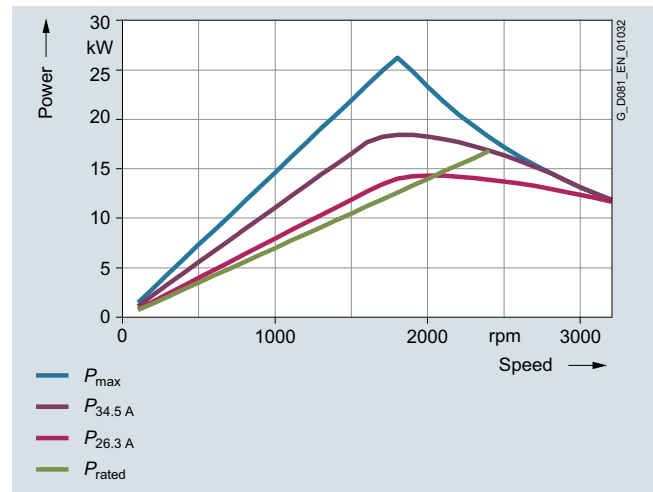

Power limit for 440 VY (60 Hz characteristic)

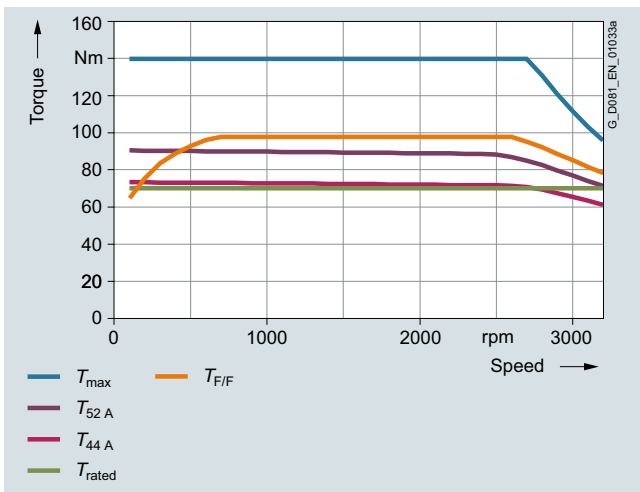

Torque limit for 380 VΔ (87 Hz characteristic)

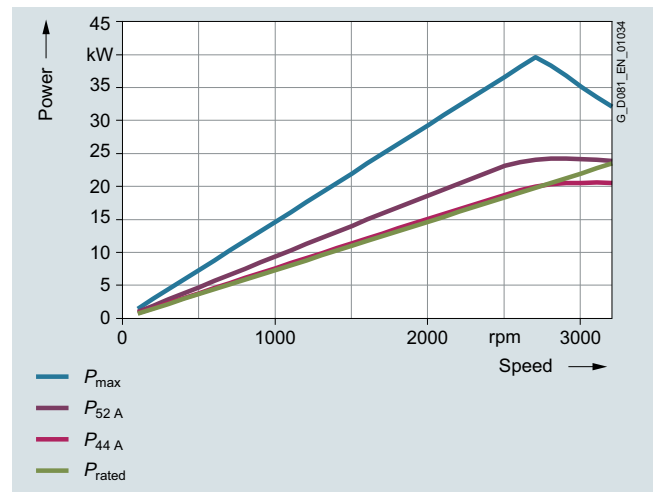

Power limit for 380 VΔ (87 Hz characteristic)

Synchronous reluctance motors for SINAMICS converters – VSD4000 line

Orientation

Technical specifications

The torque and power characteristics for converter configuration for the SIMOTICS GP/SD 1FP1.14-1DB4 motor, frame size 160 with the particular motor voltage and circuit:

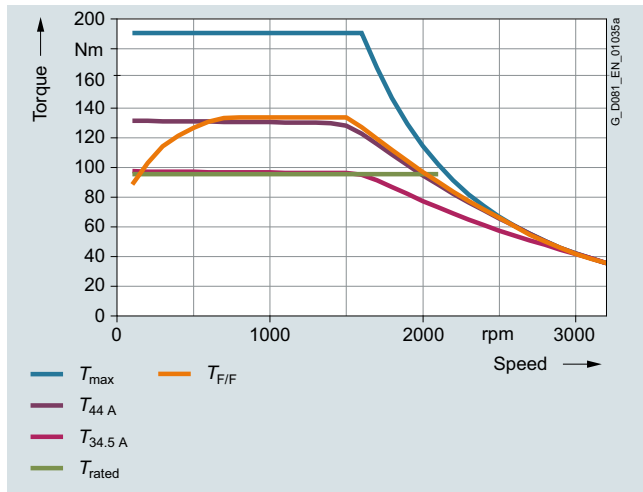

Torque limit for 380 VY (50 Hz characteristic)

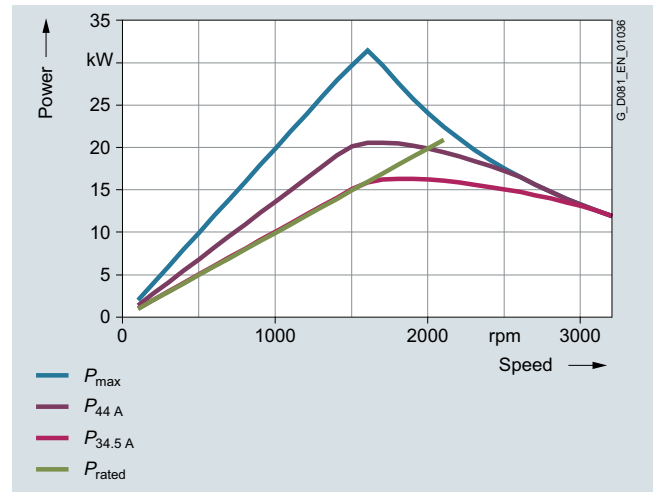

Power limit for 380 VY (50 Hz characteristic)

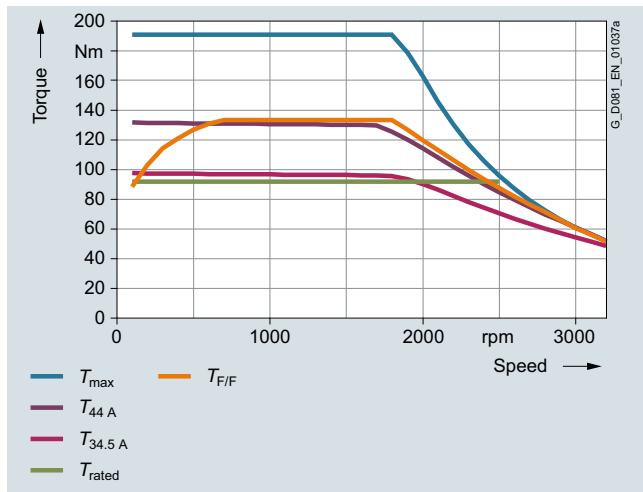

Torque limit for 440 VY (60 Hz characteristic)

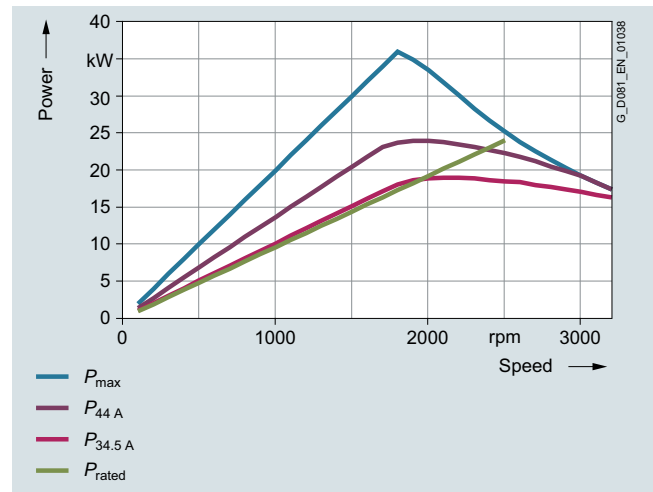

Power limit for 440 VY (60 Hz characteristic)

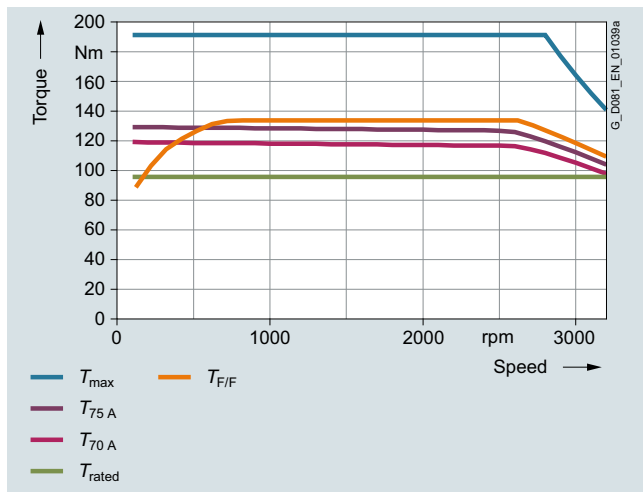

Torque limit for 380 VΔ (87 Hz characteristic)

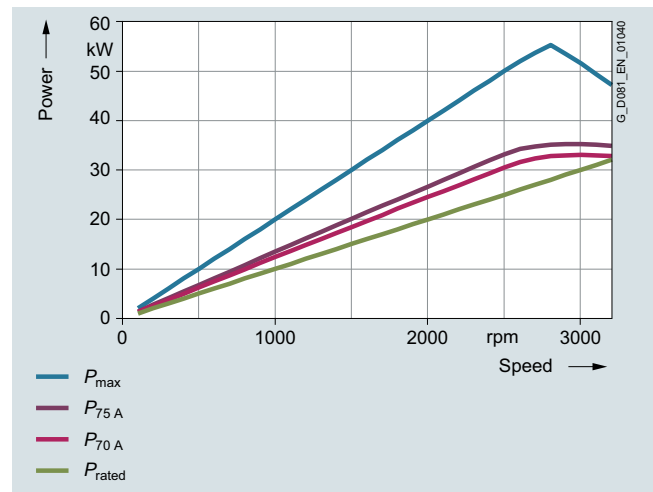

Power limit for 380 VΔ (87 Hz characteristic)

4

Synchronous reluctance motors for SINAMICS converters – VSD4000 line Orientation

Technical specifications

The torque and power characteristics for converter configuration for the SIMOTICS GP/SD 1FP1.14-1DF2 motor, frame size 160 with the particular motor voltage and circuit:

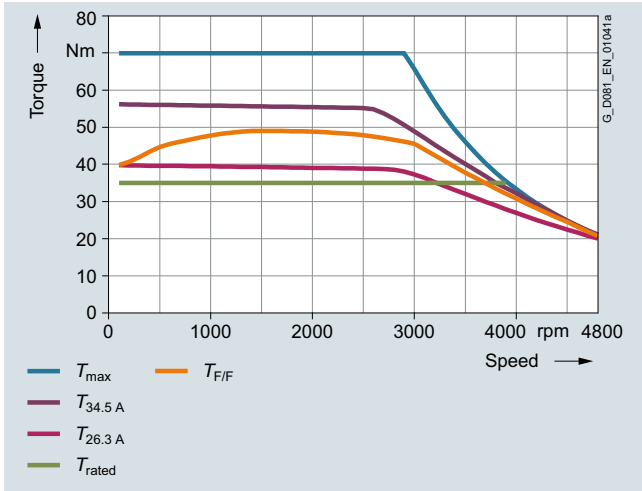

Torque limit for 380 VY (100 Hz characteristic)

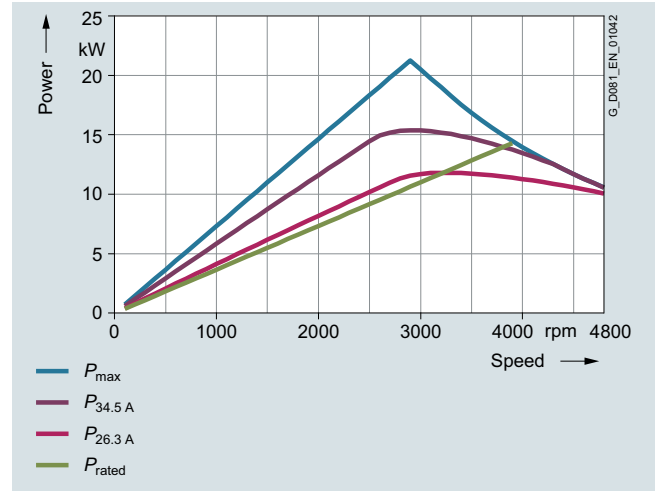

Power limit for 380 VY (100 Hz characteristic)

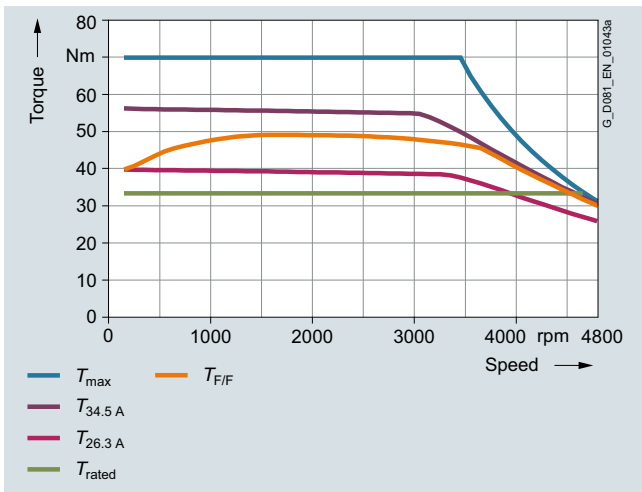

Torque limit for 440 VY (120 Hz characteristic)

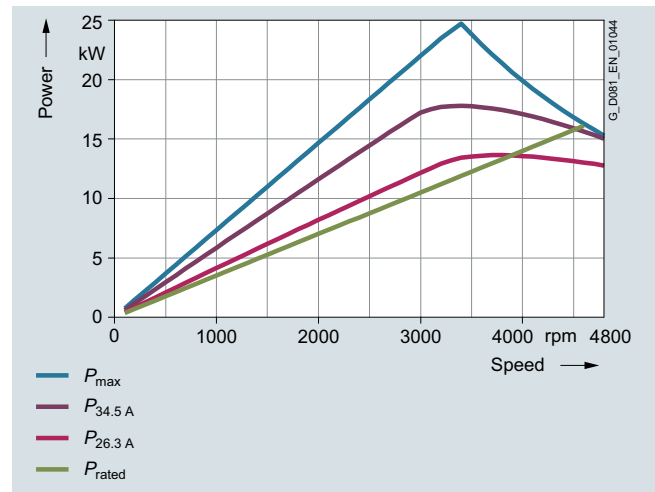

Power limit for 440 VY (120 Hz characteristic)

Synchronous reluctance motors for SINAMICS converters – VSD4000 line

Orientation

Technical specifications

The torque and power characteristics for converter configuration for the SIMOTICS GP/SD 1FP1.14-1DF3 motor, frame size 160 with the particular motor voltage and circuit:

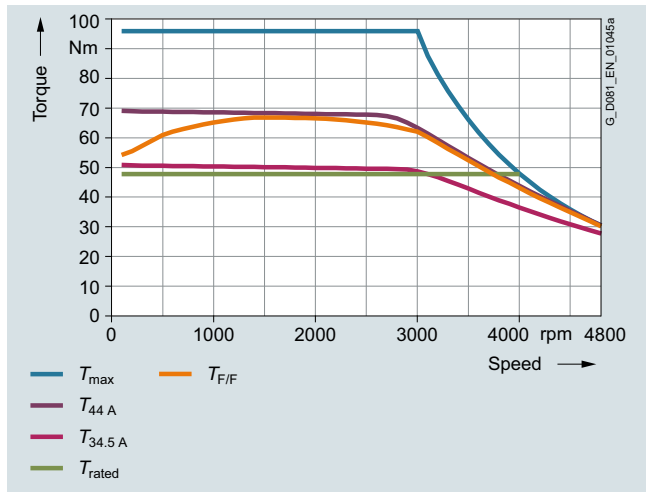

Torque limit for 380 VY (100 Hz characteristic)

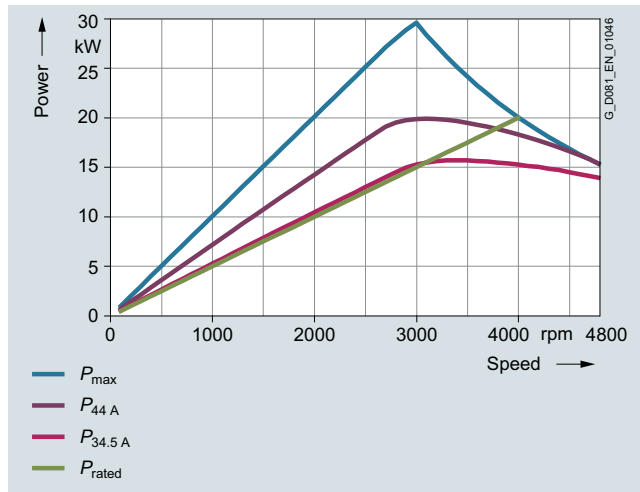

Power limit for 380 VY (100 Hz characteristic)

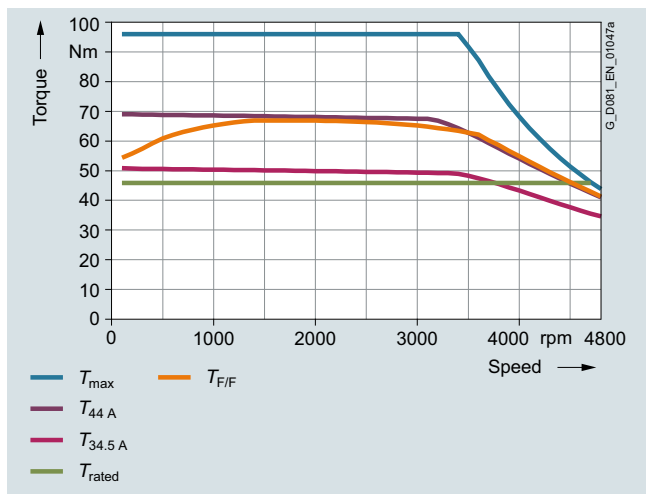

Torque limit for 440 VY (120 Hz characteristic)

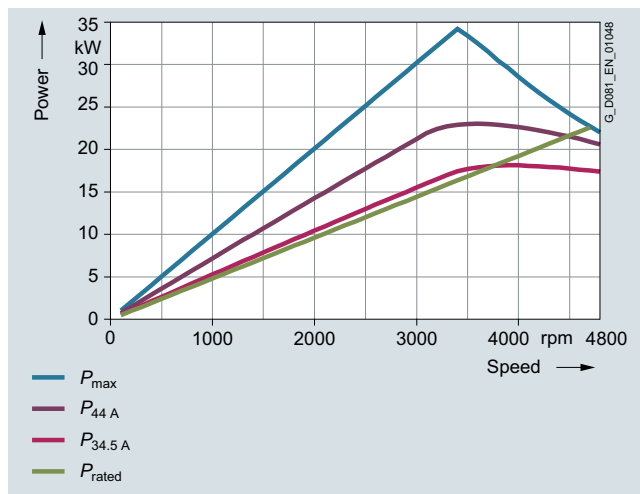

Power limit for 440 VY (120 Hz characteristic)

4

Synchronous reluctance motors for SINAMICS converters – VSD4000 line

Orientation

Technical specifications

The torque and power characteristics for converter configuration for the SIMOTICS GP/SD 1FP1.14-1DF4 motor, frame size 160 with the particular motor voltage and circuit:

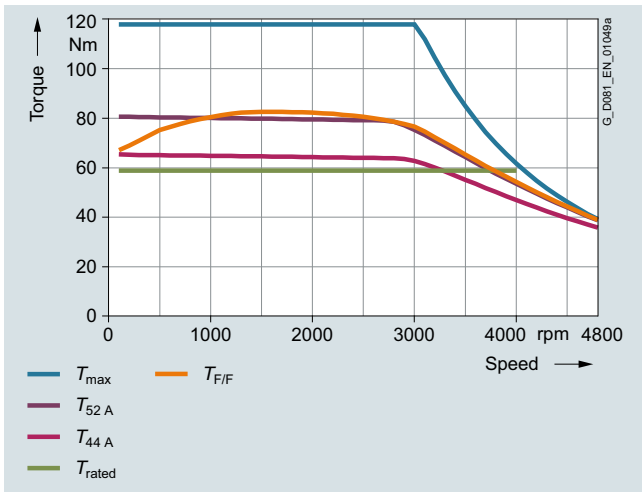

Torque limit for 380 VY (100 Hz characteristic)

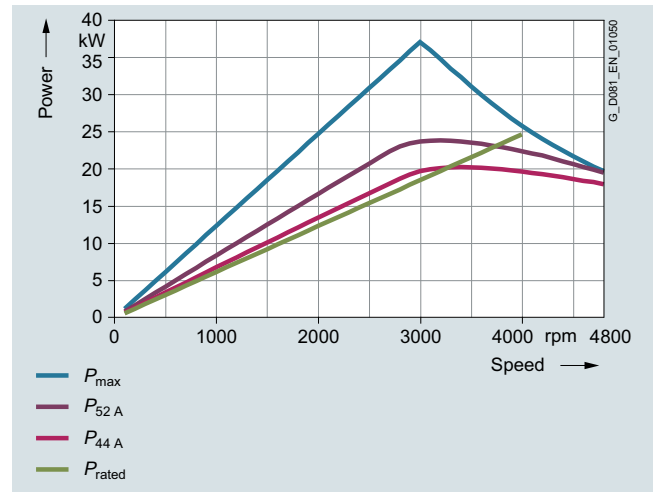

Power limit for 380 VY (100 Hz characteristic)

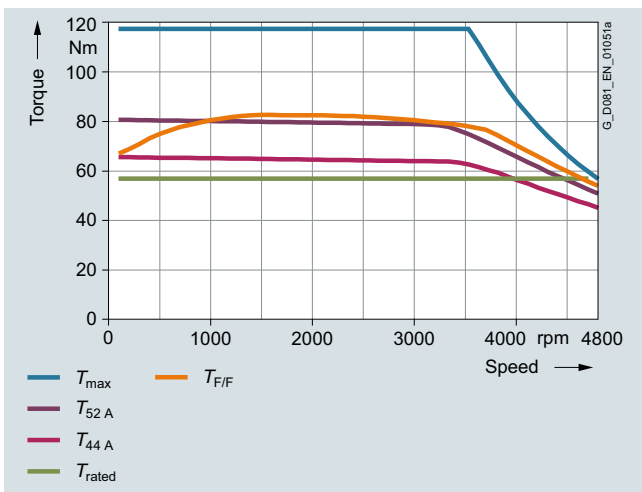

Torque limit for 440 VY (120 Hz characteristic)

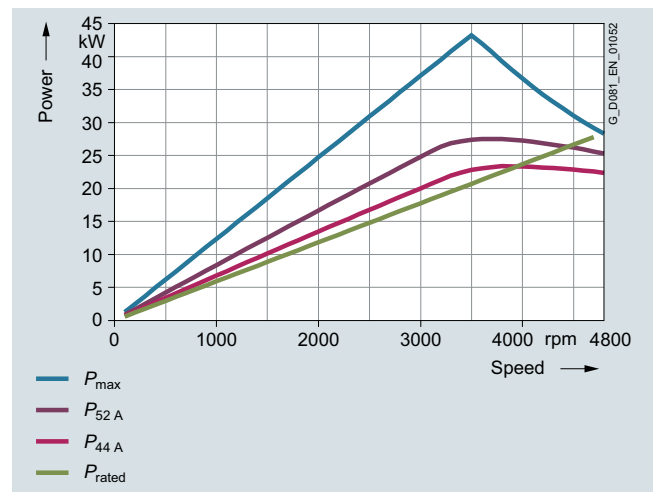

Power limit for 440 VY (120 Hz characteristic)

Synchronous reluctance motors for SINAMICS converters – VSD4000 line

Orientation

Technical specifications

The torque and power characteristics for converter configuration for the SIMOTICS SD 1FP1514-1EB2 motor, frame size 180 with the particular motor voltage and circuit:

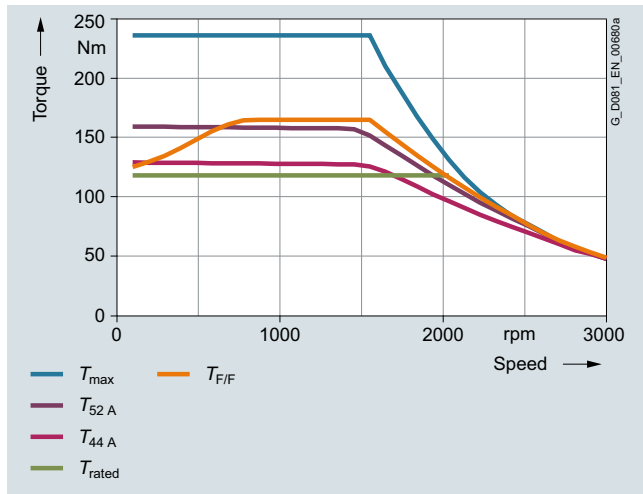

Torque limit for 380 VY (50 Hz characteristic)

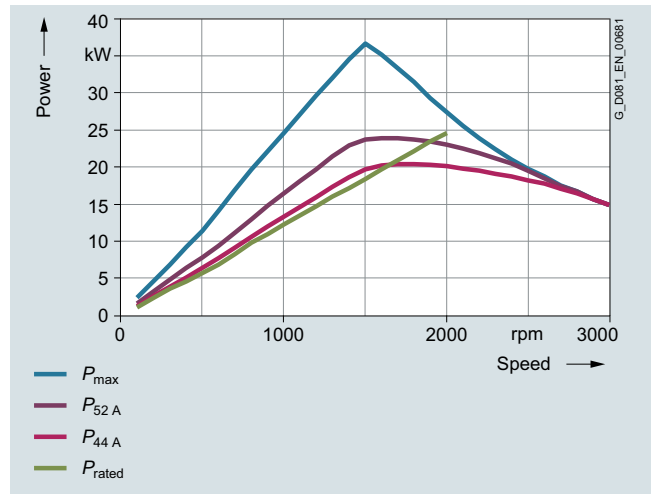

Power limit for 380 VY (50 Hz characteristic)

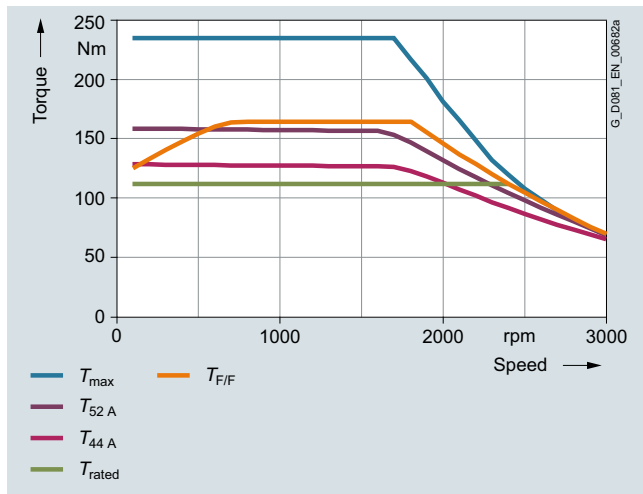

Torque limit for 440 VY (60 Hz characteristic)

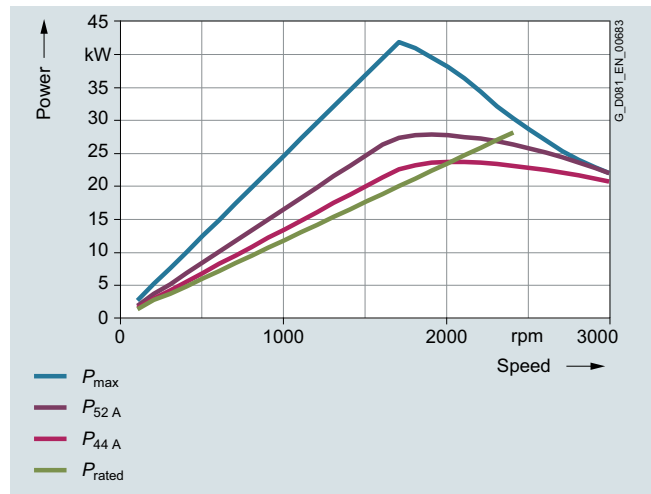

Power limit for 440 VY (60 Hz characteristic)

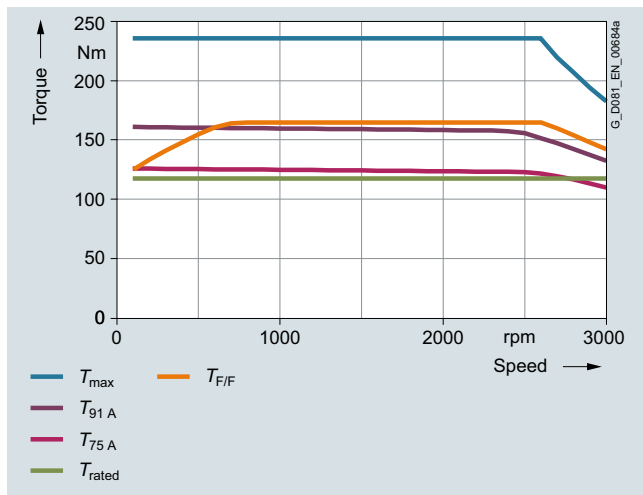

Torque limit for 380 VΔ (87 Hz characteristic)

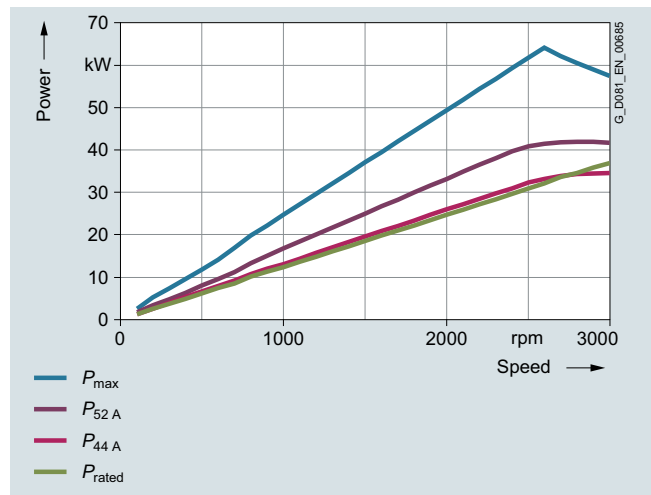

Power limit for 380 VΔ (87 Hz characteristic)

4

Synchronous reluctance motors for SINAMICS converters – VSD4000 line

Orientation

Technical specifications

The torque and power characteristics for converter configuration for the SIMOTICS SD 1FP1514-1EB4 motor, frame size 180 with the particular motor voltage and circuit:

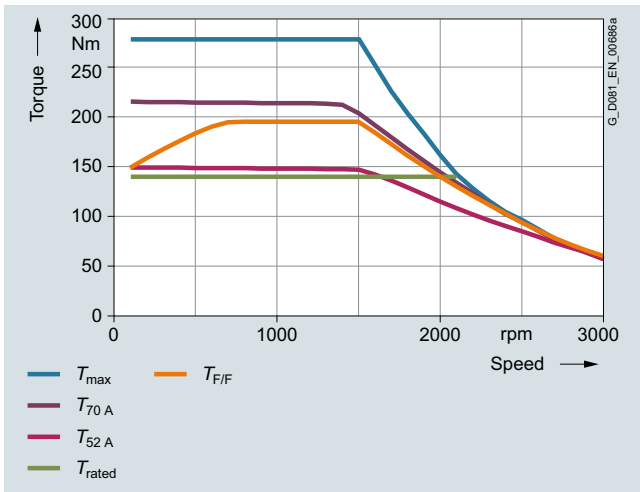

Torque limit for 380 VY (50 Hz characteristic)

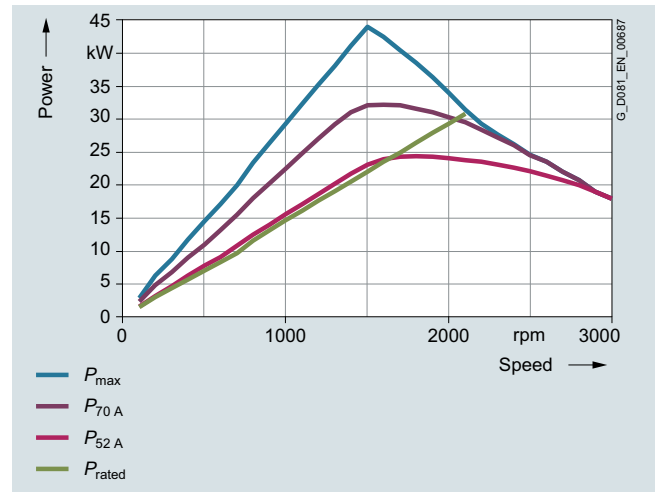

Power limit for 380 VY (50 Hz characteristic)

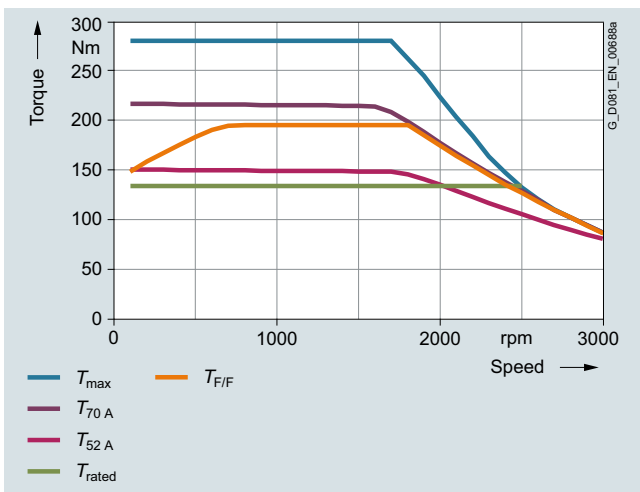

Torque limit for 440 VY (60 Hz characteristic)

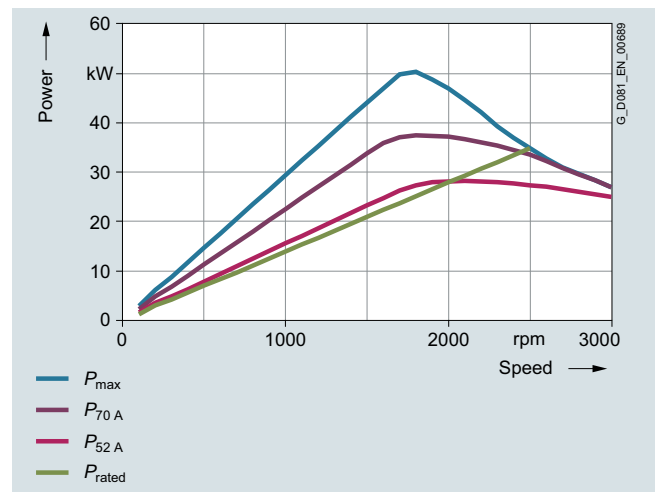

Power limit for 440 VY (60 Hz characteristic)

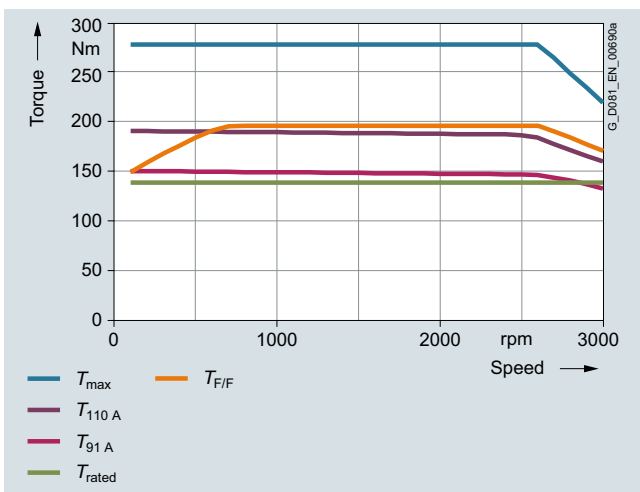

Torque limit for 380 VΔ (87 Hz characteristic)

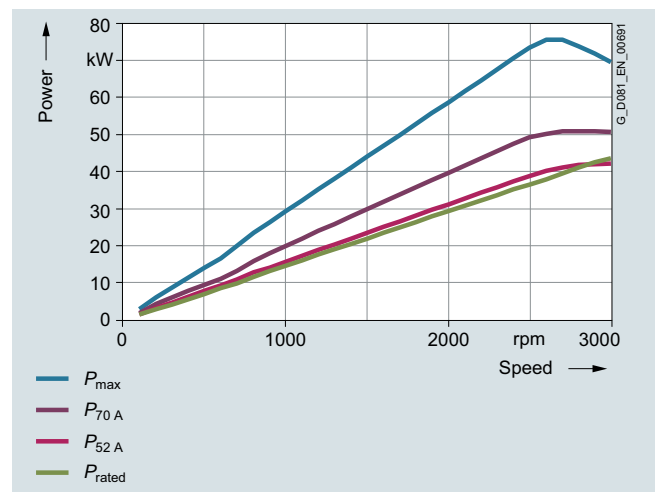

Power limit for 380 VΔ (87 Hz characteristic)



Synchronous reluctance motors for SINAMICS converters – VSD4000 line

Orientation

Technical specifications

The torque and power characteristics for converter configuration for the SIMOTICS SD 1FP1514-1EF2 motor, frame size 180 with the particular motor voltage and circuit:

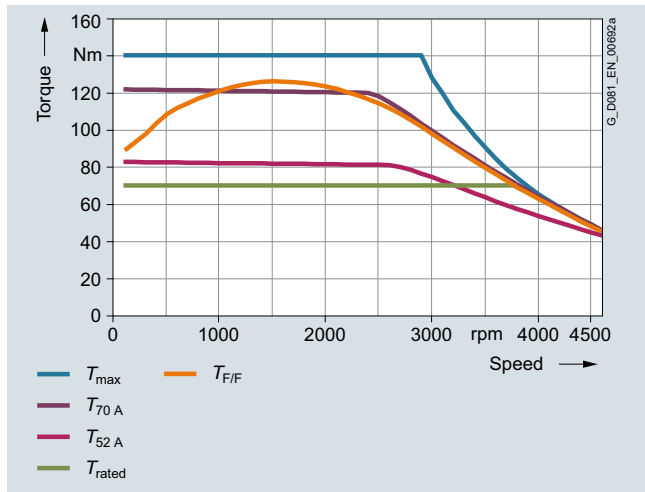

Torque limit for 380 VY (50 Hz characteristic)

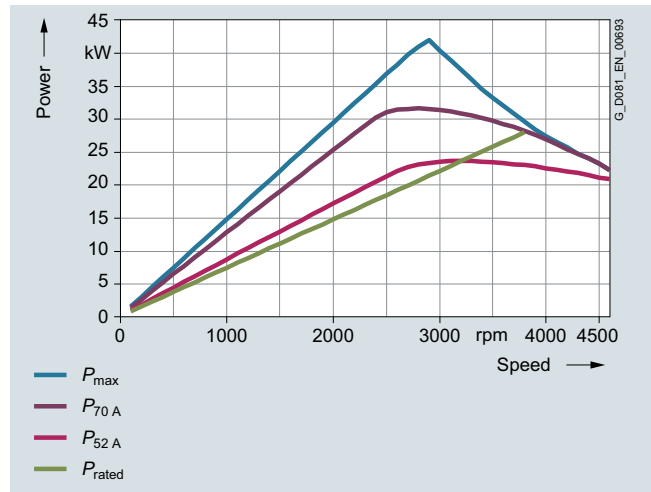

Power limit for 380 VY (50 Hz characteristic)

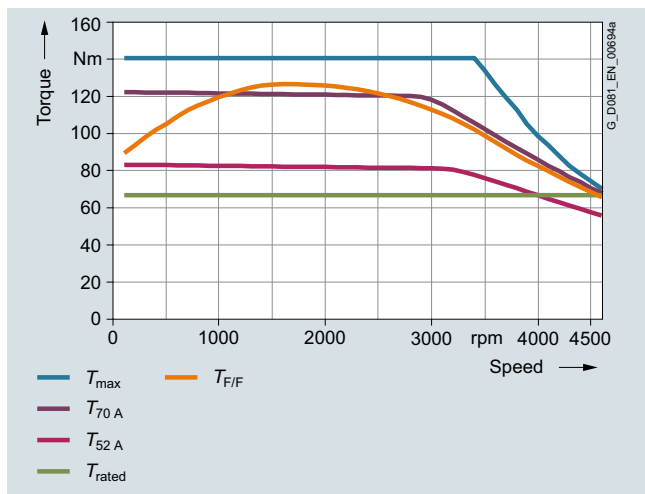

Torque limit for 440 VY (60 Hz characteristic)

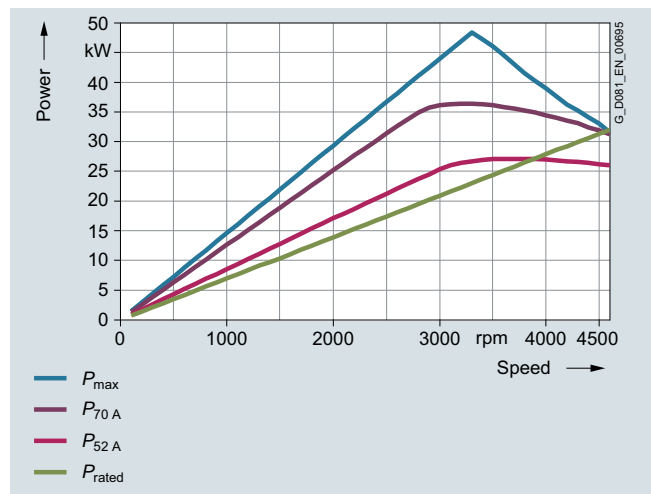

Power limit for 440 VY (60 Hz characteristic)

4

Synchronous reluctance motors for SINAMICS converters – VSD4000 line

Orientation

Technical specifications

The torque and power characteristics for converter configuration for the SIMOTICS SD 1FP1514-2AB5 motor, frame size 200 with the particular motor voltage and circuit:

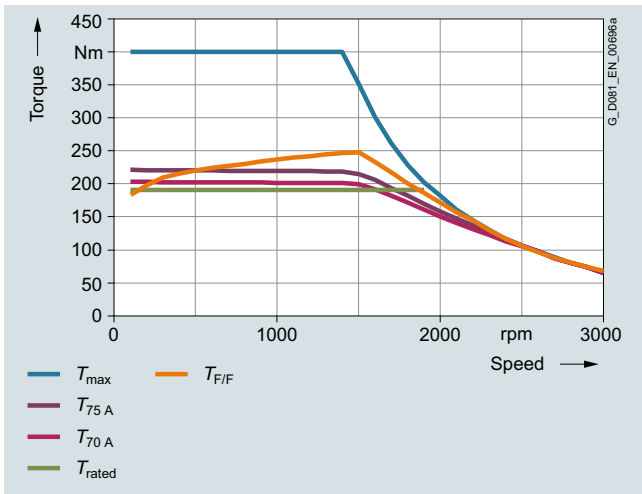

Torque limit for 380 VY (50 Hz characteristic)

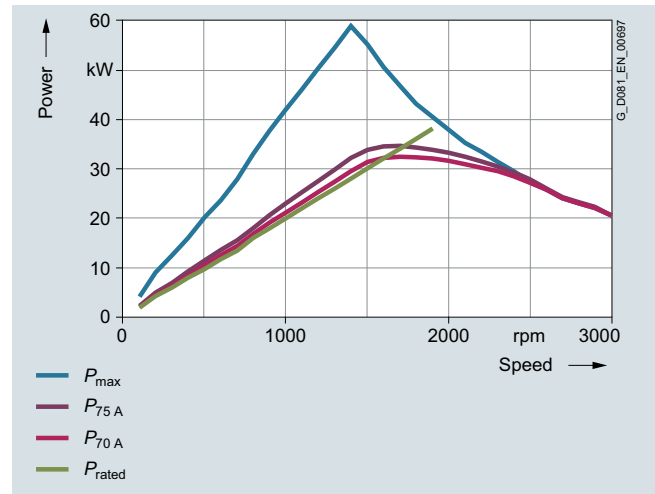

Power limit for 380 VY (50 Hz characteristic)

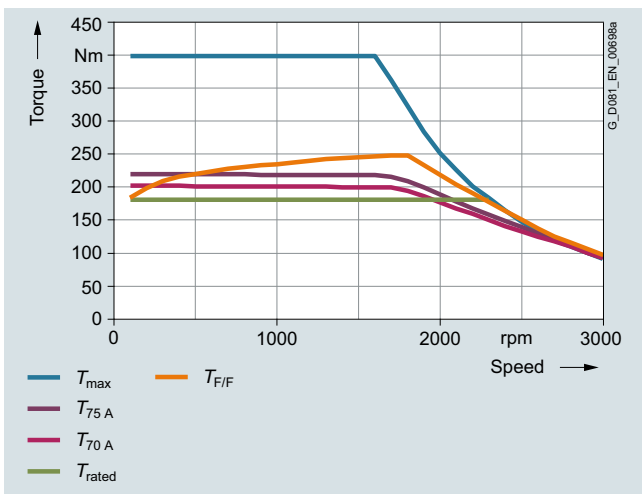

Torque limit for 440 VY (60 Hz characteristic)

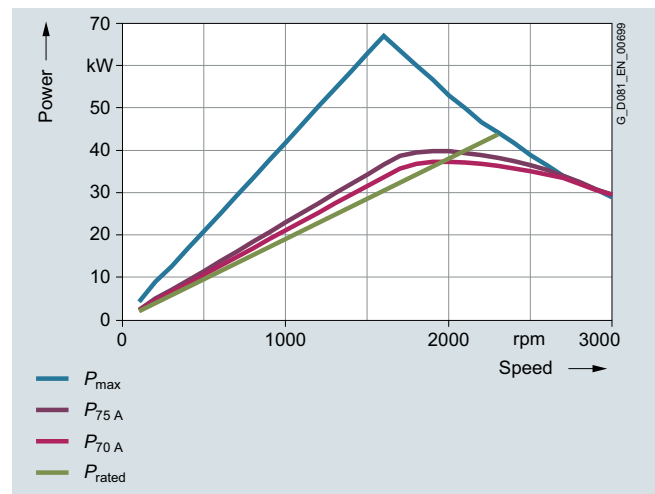

Power limit for 440 VY (60 Hz characteristic)

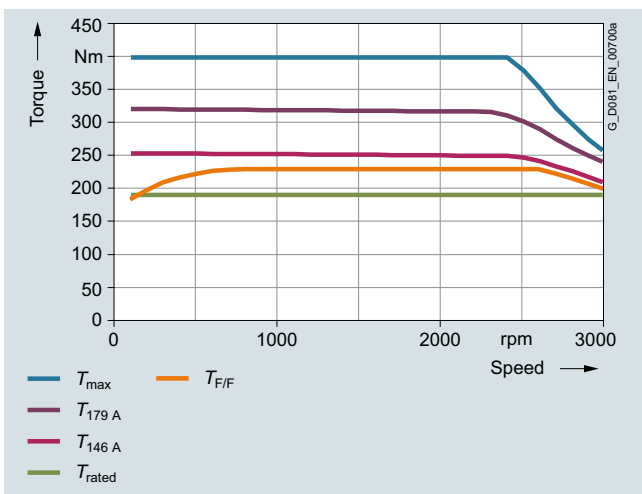

Torque limit for 380 VΔ (87 Hz characteristic)

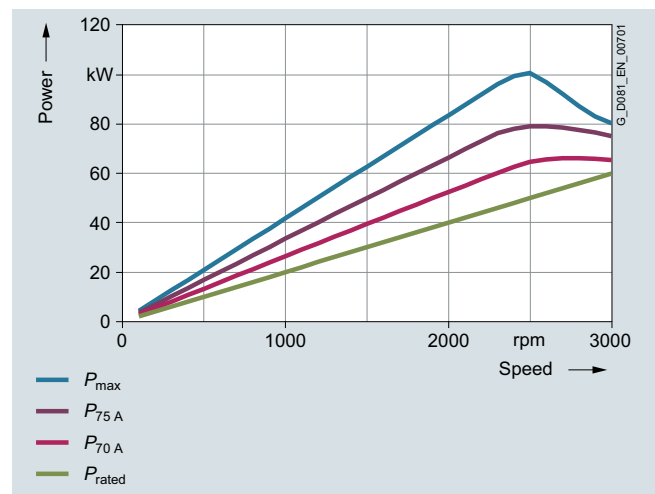

Power limit for 380 VΔ (87 Hz characteristic)



Synchronous reluctance motors for SINAMICS converters – VSD4000 line

Orientation

Technical specifications

The torque and power characteristics for converter configuration for the SIMOTICS SD 1FP1514-2AF4 motor, frame size 200 with the particular motor voltage and circuit:

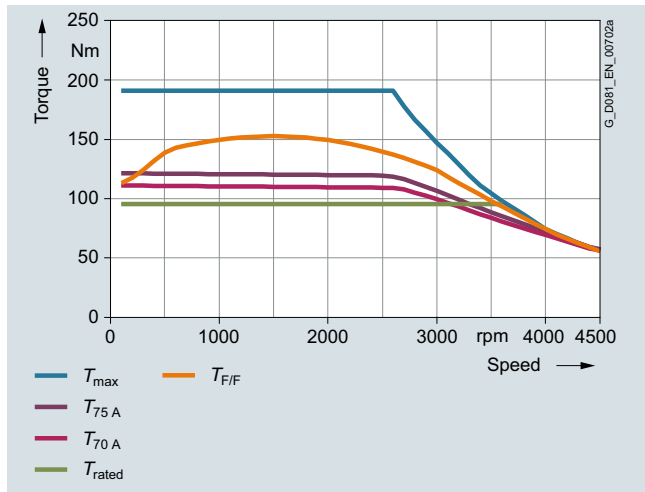

Torque limit for 380 VY (50 Hz characteristic)

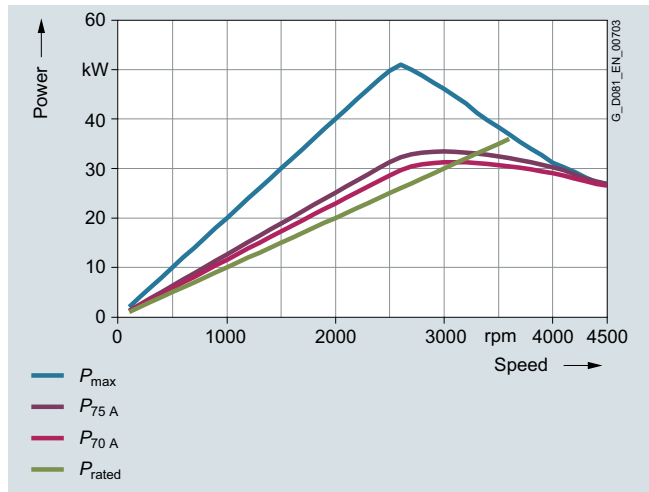

Power limit for 380 VY (50 Hz characteristic)

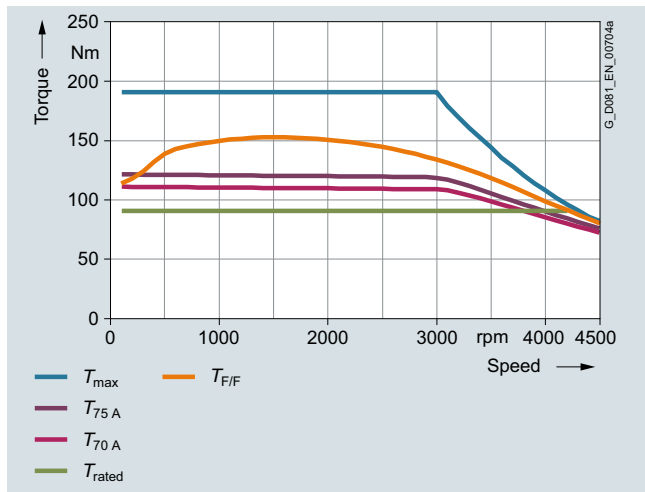

Torque limit for 440 VY (60 Hz characteristic)

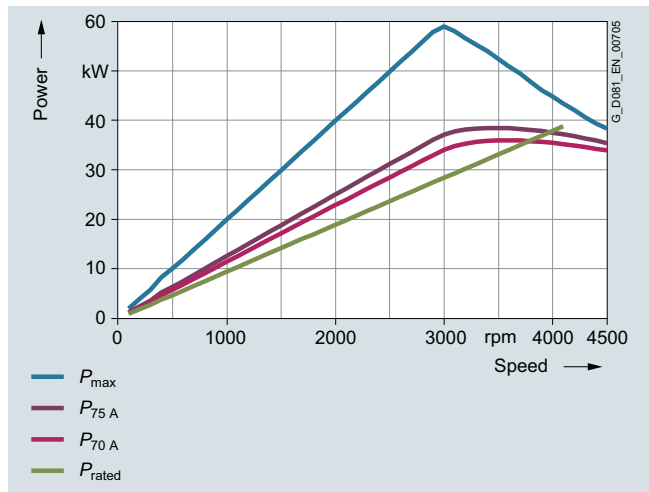

Power limit for 440 VY (60 Hz characteristic)

4

Synchronous reluctance motors for SINAMICS converters – VSD4000 line Orientation

Technical specifications

The torque and power characteristics for converter configuration for the SIMOTICS SD 1FP1514-2AF5 motor, frame size 200 with the particular motor voltage and circuit:

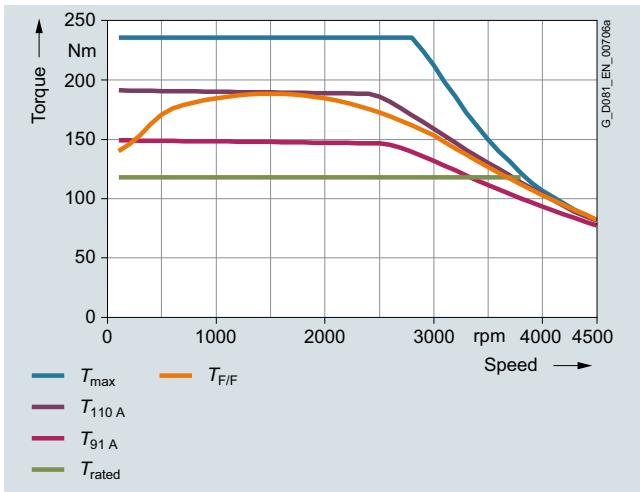

Torque limit for 380 VY (50 Hz characteristic)

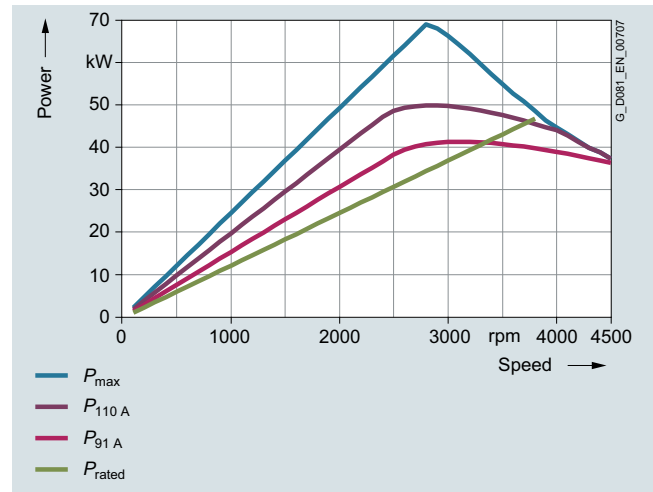

Power limit for 380 VY (50 Hz characteristic)

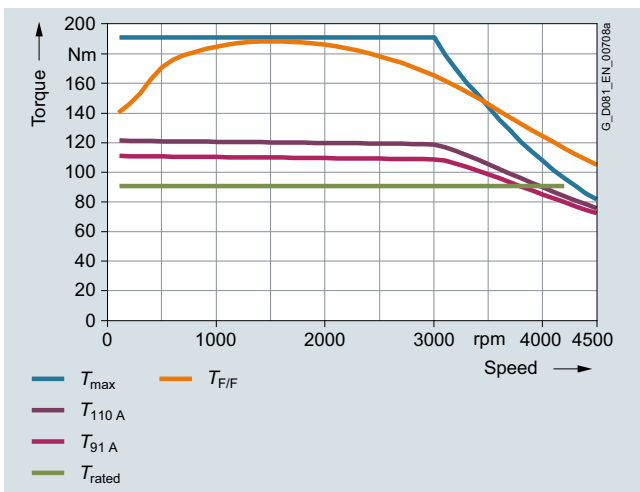

Torque limit for 440 VY (60 Hz characteristic)

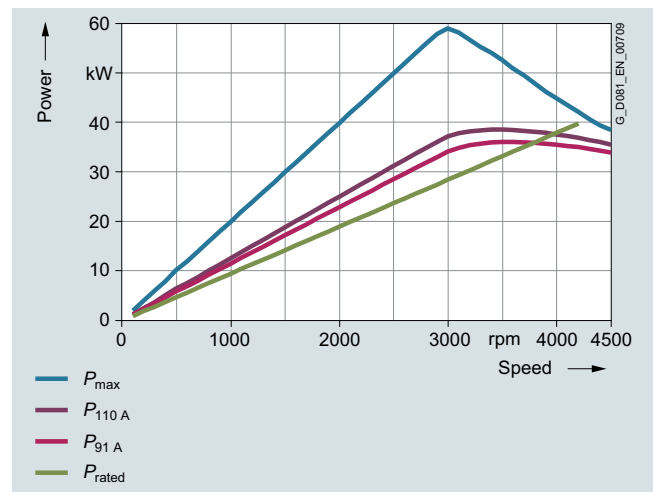

Power limit for 440 VY (60 Hz characteristic)

Synchronous reluctance motors for SINAMICS converters – VSD4000 line

Orientation

Technical specifications

The torque and power characteristics for converter configuration for the SIMOTICS SD 1FP1514-2BB0 motor, frame size 225 with the particular motor voltage and circuit:

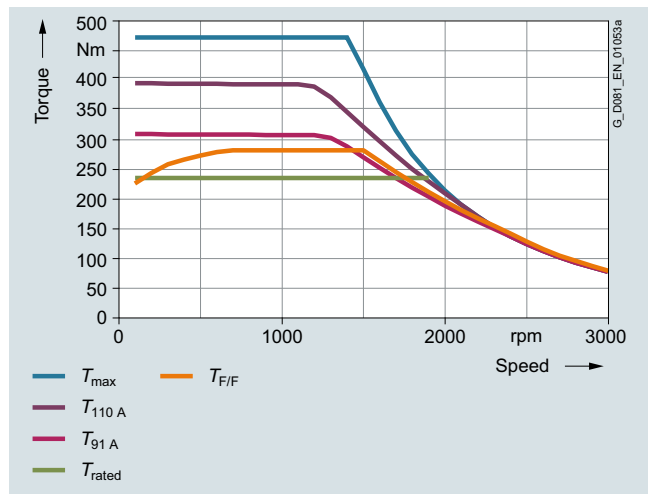

Torque limit for 380 VY (50 Hz characteristic)

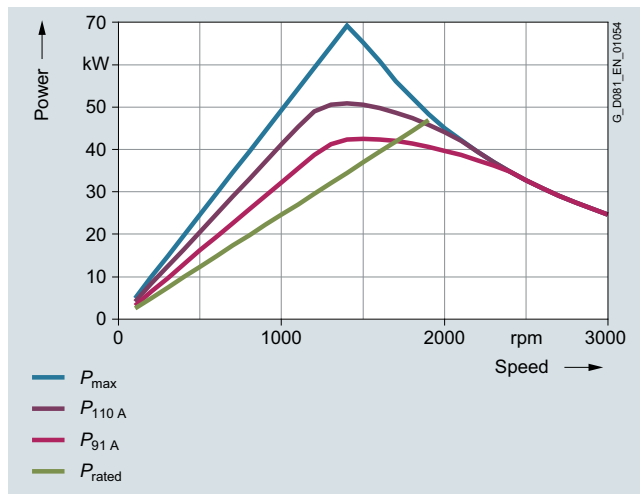

Power limit for 380 VY (50 Hz characteristic)

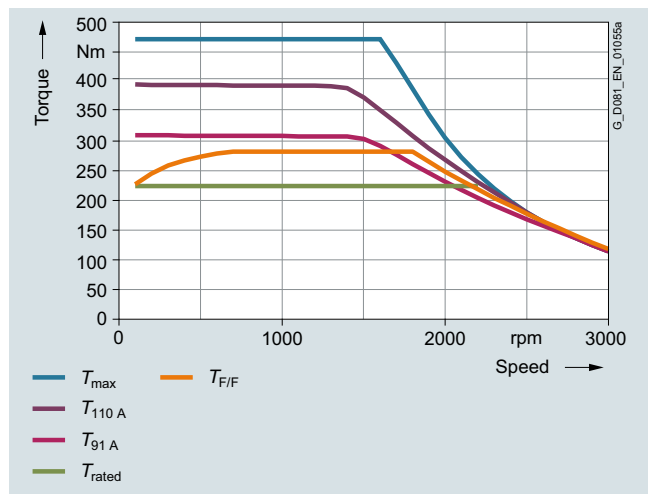

Torque limit for 440 VY (60 Hz characteristic)

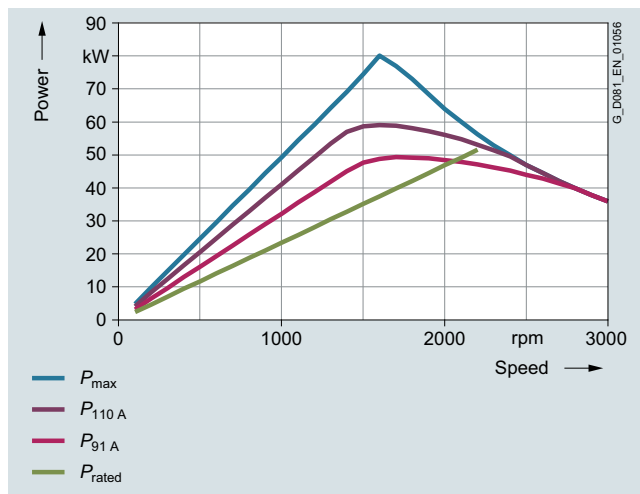

Power limit for 440 VY (60 Hz characteristic)

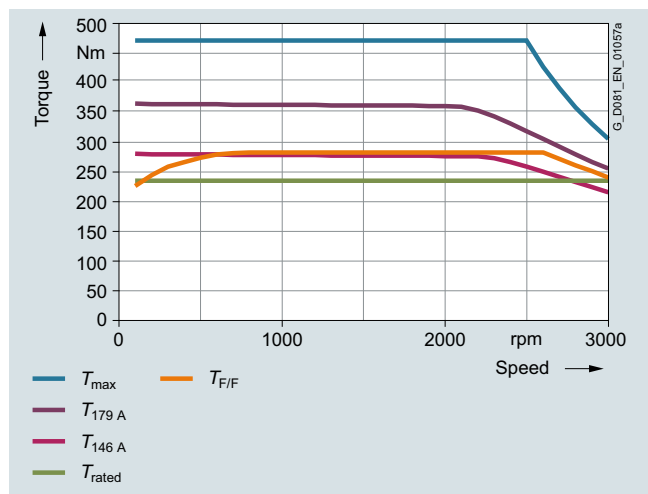

Torque limit for 380 VΔ (87 Hz characteristic)

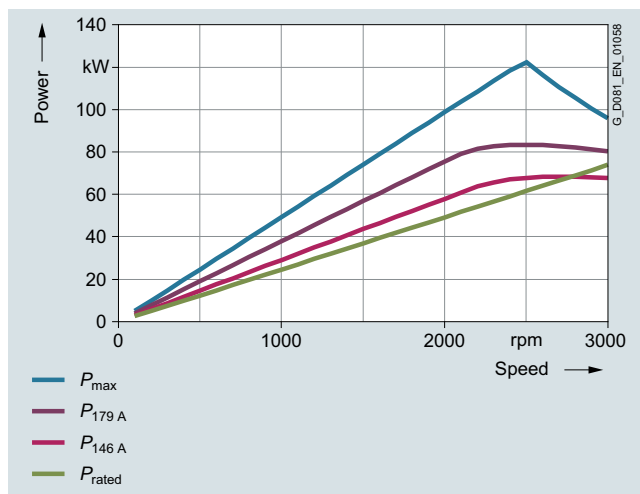

Power limit for 380 VΔ (87 Hz characteristic)

4

Synchronous reluctance motors for SINAMICS converters – VSD4000 line Orientation

Technical specifications

The torque and power characteristics for converter configuration for the SIMOTICS SD 1FP1514-2BB2 motor, frame size 225 with the particular motor voltage and circuit:

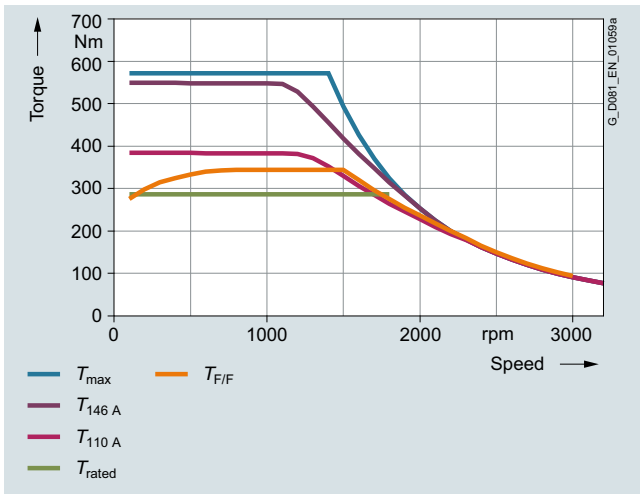

Torque limit for 380 VY (50 Hz characteristic)

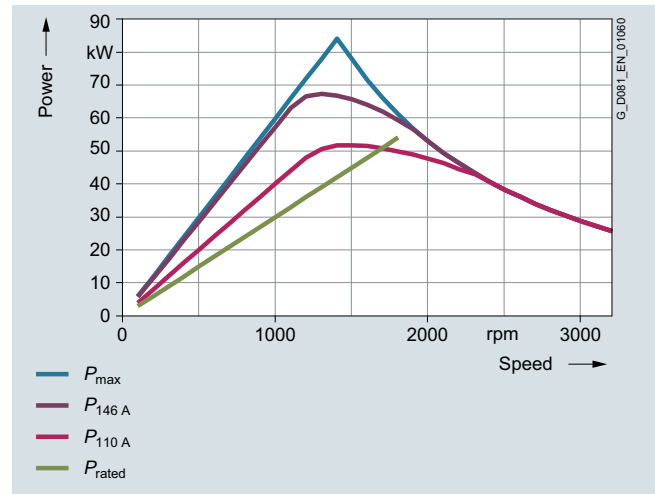

Power limit for 380 VY (50 Hz characteristic)

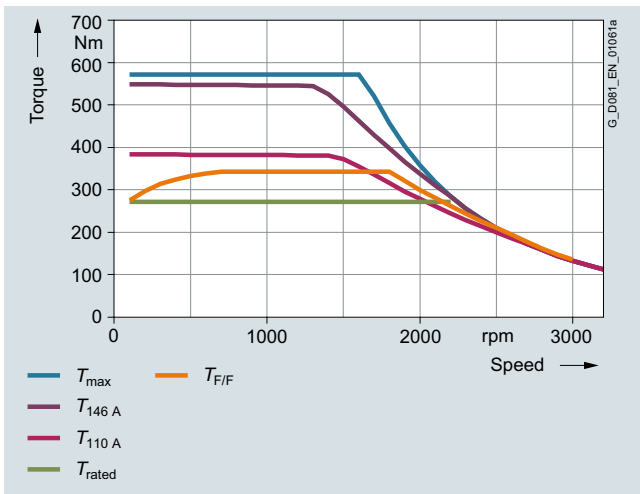

Torque limit for 440 VY (60 Hz characteristic)

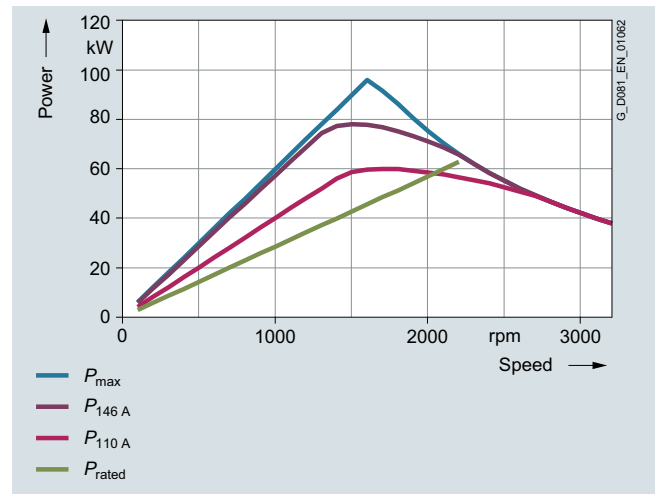

Power limit for 440 VY (60 Hz characteristic)

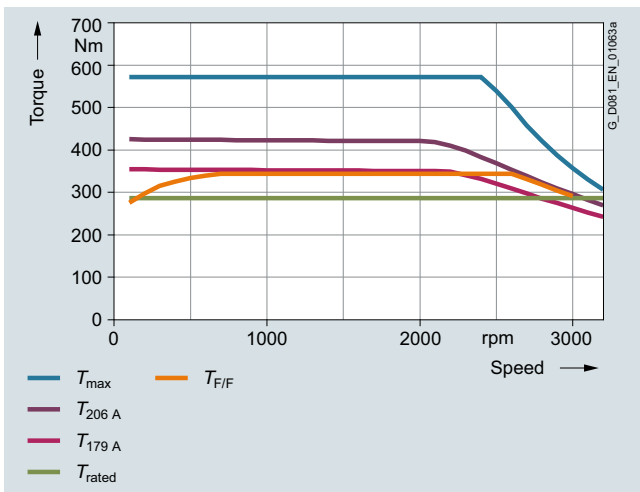

Torque limit for 380 VΔ (87 Hz characteristic)

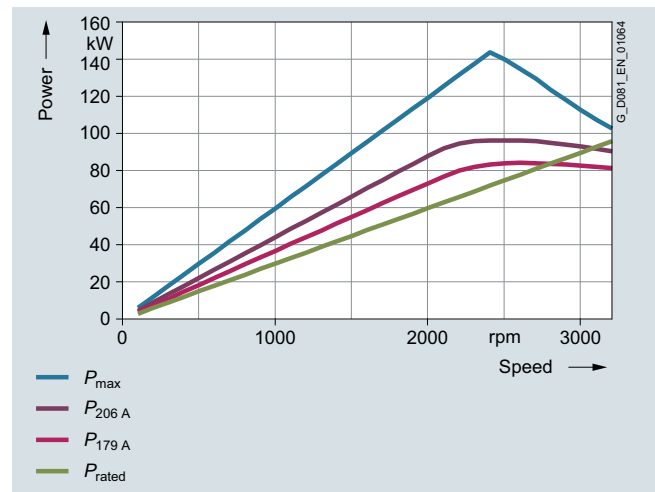

Power limit for 380 VΔ (87 Hz characteristic)

Synchronous reluctance motors for SINAMICS converters – VSD4000 line

Orientation

Technical specifications

The torque and power characteristics for converter configuration for the SIMOTICS SD 1FP1514-2BF2 motor, frame size 225 with the particular motor voltage and circuit:

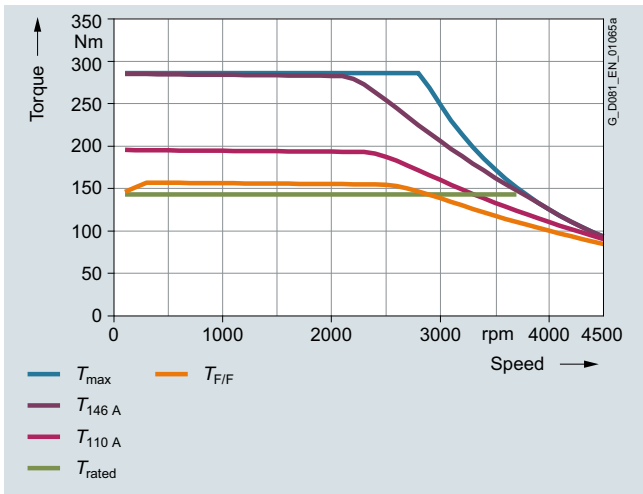

Torque limit for 380 VY (50 Hz characteristic)

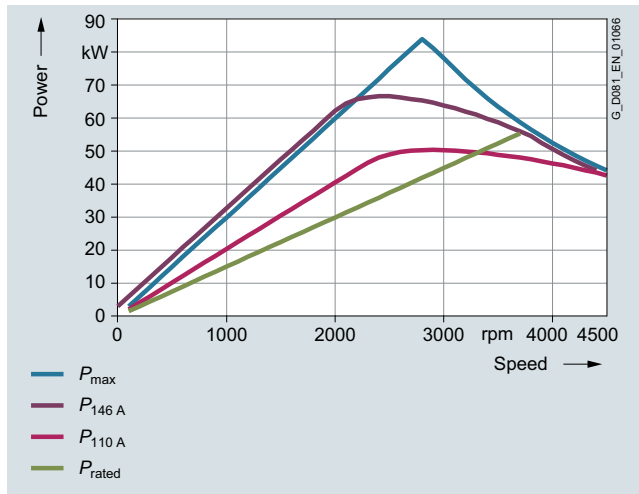

Power limit for 380 VY (50 Hz characteristic)

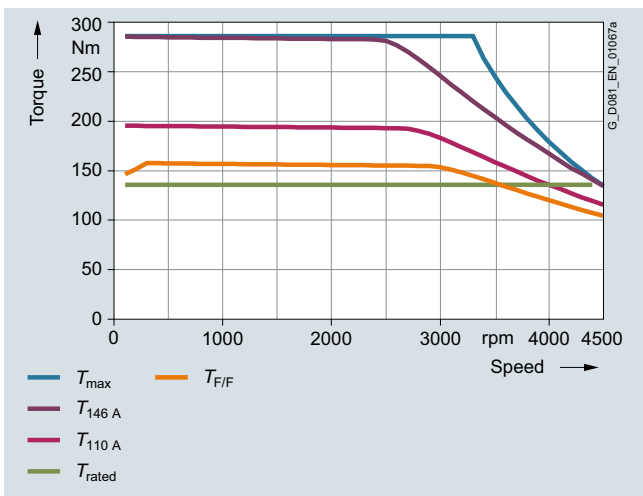

Torque limit for 440 VY (60 Hz characteristic)

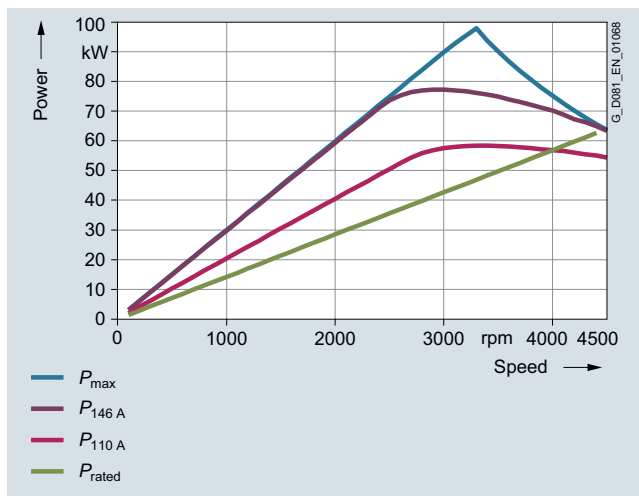

Power limit for 440 VY (60 Hz characteristic)

Synchronous reluctance motors for SINAMICS converters – VSD4000 line

Orientation

Technical specifications

Additional information

Mechanical stress and grease lifetime

When motors are operated at speeds above the rated speed, the mechanical smooth running operation and the bearings are subjected to greater mechanical stress. This reduces the grease lifetime and the bearing lifetime.

Above 100 Hz, the motors must be balanced for twice the rated frequency; it can be expected that the lubrication intervals and bearing lifetime are significantly reduced.

Motor protection

A motor protection function can be implemented using the P_t sensing function implemented in the converter software. If required, more precise motor protection can be afforded by direct temperature measurement using KTY84 sensors (standard scope of delivery) or PTC thermistors in the motor winding. Some converters from Siemens determine the motor temperature using the resistance of the temperature sensor. They can be set to a required temperature for alarm and tripping. When ordering PTC thermistors or other temperature sensors to monitor the cooling temperature, the KTY84 sensors, otherwise provided as standard, are eliminated. As described above, KTY84 sensors are evaluated in the SINAMICS converters.

Motor connection

When connecting the motors, it is important to consider the restrictions for 1LE1 line motors as well as the maximum conductor cross-sections permitted for the converter.

Operating data for 50 Hz/60 Hz/87 Hz characteristics

SIMOTICS GP/SD VSD4000 line motors are designed for operation with 50 Hz, 60 Hz and 87 Hz characteristics (87 Hz characteristic up to frame size 200).

Operation with the 50/60 Hz characteristic requires Y (star or wye) connection; operation with the 87 Hz characteristic requires Δ connection.

The corresponding performance data are stamped on the rating plate as standard. An ordering option is not required.

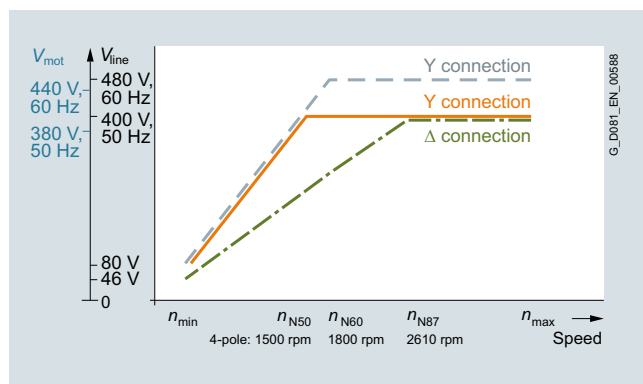

Operating characteristics of SIMOTICS GP/SD VSD4000 line motors ¹⁾

Maximum operating speed

The maximum operating speed is limited by the mechanical speed limit of the motors as well as the available converter output frequency.

A significant increase in the sound pressure level can be expected when operating the motor above its rated speed (field weakening range).

Mechanical speed limits SIMOTICS GP/SD VSD4000 line:

| Frame size | Mechanical speed limit | | |
|------------|------------------------|---------------|-----------------|
| | 50 Hz SIMOTICS | | 100 Hz SIMOTICS |
| | GP | SD | SD |
| | n_{max} rpm | n_{max} rpm | n_{max} rpm |
| 80 | 3200 | 3200 | 6000 |
| 90 | 3200 | 3200 | 6000 |
| 112 | 3200 | 3200 | 6000 |
| 132 | 3200 | 3200 | 5600 |
| 160 | 3000 | 3200 | 4800 |
| 180 | 2610 | 3000 | 4600 |
| 200 | 2610 | 3000 | 4500 |
| 225 | | 3000 | 4500 |

International use

As special converter motors, SIMOTICS GP/SD VSD4000 line motors are presently not subject to any minimum efficiency requirements in the EU and USA/Canada. However, other national certificates may be required (e.g. CSA-S safety in Canada).

¹⁾ With V4.7 SP3, only a 50 Hz characteristic is possible.

Synchronous reluctance motors for SINAMICS converters – VSD4000 line

Orientation

Technical specifications

Load characteristics for the line supply voltage: 400 V 3 AC, 50 Hz

| Load characteristic | | | | | | | SIMOTICS GP/SD VSD4000 line motors | SINAMICS G120 converters Operating mode: Low overload |
|-----------------------------|---------------------|------------------------------|-----------------|-----------------------------|-----------------|-----------------------------|---------------------------------------|--|
| $T \sim n^2$ | $T = \text{const.}$ | | | | | | | |
| | Speed control range | | | | | | | |
| | 1:2 | | 1:4 | | 1:10 | | | |
| P | P | T | P | T | P | T | Motor type | Converter type |
| kW | kW | kW | kW | kW | kW | kW | | |
| Rated speed 1500 rpm | | | | | | | | |
| at 1500 rpm | from 750 rpm | from 750 rpm to 1500 rpm | from 375 rpm | from 375 rpm to 1500 rpm | from 150 rpm | from 150 rpm to 1500 rpm | | |
| 0.55 | 0.28 | 3.5 | 0.14 | 3.5 | 0.06 | 3.5 | 1FP1.14-0DB2-..... | 6SL3210-1PE11-8.L0 |
| 0.75 | 0.38 | 4.8 | 0.19 | 4.8 | 0.08 | 4.8 | 1FP1.14-0DB3-..... | 6SL3210-1PE12-3.L0 |
| 1.1 | 0.55 | 7 | 0.28 | 7 | 0.11 | 7 | 1FP1.14-0EB0-..... | 6SL3210-1PE13-2.L1 |
| 1.5 | 0.75 | 9.5 | 0.38 | 9.5 | 0.15 | 9.5 | 1FP1.14-0EB4-..... | 6SL3210-1PE14-3.L1 |
| 2.2 | 1.1 | 14 | 0.55 | 14 | 0.22 | 14 | 1FP1.14-1BB0-..... | 6SL3210-1PE16-1.L1 |
| 3 | 1.5 | 19.1 | 0.75 | 19.1 | 0.3 | 19.1 | 1FP1.14-1BB1-..... | 6SL3210-1PE18-0.L1 |
| 4 | 2 | 25.5 | 1 | 25.5 | 0.4 | 25.5 | 1FP1.14-1BB2-..... | 6SL3210-1PE21-1.L0 |
| 5.5 | 2.75 | 35 | 1.38 | 35 | 0.55 | 35 | 1FP1.14-1CB0-..... | 6SL3210-1PE21-4.L0 |
| 7.5 | 3.75 | 47.5 | 1.88 | 47.5 | 0.75 | 47.5 | 1FP1.14-1CB2-..... | 6SL3210-1PE21-8.L0 |
| 11 | 5.5 | 70 | 2.75 | 70 | 1.1 | 70 | 1FP1.14-1DB2-..... | 6SL3210-1PE22-7.L0 |
| 15 | 7.5 | 95 | 3.75 | 95 | 1.5 | 95 | 1FP1.14-1DB4-..... | 6SL3210-1PE23-3.L0 |
| 18.5 | 9.25 | 118 | 4.63 | 118 | 1.85 | 118 | 1FP1.14-1EB2-..... | 6SL3210-1PE23-8.L0 |
| 22 | 11 | 140 | 5.5 | 140 | 2.2 | 140 | 1FP1.14-1EB4-..... | 6SL3210-1PE24-5.L0 |
| 30 | 15 | 191 | 7.5 | 191 | 3 | 191 | 1FP1.14-2AB5-..... | 6SL3210-1PE26-0.L0 |
| 37 | 18.5 | 236 | 9.25 | 236 | 3.7 | 236 | 1FP1514-2BB0-..... | 6SL3210-1PE28-8.L0 |
| 45 | 22.5 | 286 | 11.25 | 286 | 4.5 | 286 | 1FP1514-2BB2-..... | 6SL3210-1PE31-1.L0 |
| Rated speed 3000 rpm | | | | | | | | |
| at 3000 rpm | from 1500 rpm | from 1500 rpm to 3000 rpm | from 750 rpm | from 750 rpm to 3000 rpm | from 300 rpm | from 300 rpm to 3000 rpm | | |
| 0.75 | 0.38 | 2.4 | 0.19 | 2.4 | 0.08 | 2.4 | 1FP1514-0DF2-..... | 6SL3210-1PE12-3.L0 |
| 1.1 | 0.55 | 3.5 | 0.28 | 3.5 | 0.11 | 3.5 | 1FP1514-0DF3-..... | 6SL3210-1PE13-2.L1 |
| 1.5 | 0.75 | 4.8 | 0.38 | 4.8 | 0.15 | 4.8 | 1FP1514-0EF0-..... | 6SL3210-1PE14-3.L1 |
| 2.2 | 1.1 | 7 | 0.55 | 7 | 0.22 | 7 | 1FP1514-0EF4-..... | 6SL3210-1PE16-1.L1 |
| 3 | 1.5 | 9.5 | 0.75 | 9.5 | 0.3 | 9.5 | 1FP1514-1BF1-..... | 6SL3210-1PE18-0.L1 |
| 4 | 2 | 12.7 | 1 | 12.7 | 0.4 | 12.7 | 1FP1514-1BF2-..... | 6SL3210-1PE21-1.L0 |
| 5.5 | 2.75 | 17.5 | 1.38 | 17.5 | 0.55 | 17.5 | 1FP1514-1CF0-..... | 6SL3210-1PE21-4.L0 |
| 7.5 | 3.75 | 24 | 1.88 | 24 | 0.75 | 24 | 1FP1514-1CF1-..... | 6SL3210-1PE21-8.L0 |
| 11 | 5.5 | 35 | 2.75 | 35 | 1.1 | 35 | 1FP1514-1DF2-..... | 6SL3210-1PE22-7.L0 |
| 15 | 7.5 | 48 | 3.75 | 48 | 1.5 | 48 | 1FP1514-1DF3-..... | 6SL3210-1PE23-3.L0 |
| 18.5 | 9.25 | 58 | 4.63 | 58 | 1.85 | 58 | 1FP1514-1DF4-..... | 6SL3210-1PE23-8.L0 |
| 22 | 11 | 70 | 5.5 | 70 | 2.2 | 70 | 1FP1514-1EF2-..... | 6SL3210-1PE24-5.L0 |
| 30 | 15 | 96 | 7.5 | 96 | 3 | 96 | 1FP1514-2AF4-..... | 6SL3210-1PE26-0.L0 |
| 37 | 18.5 | 118 | 9.25 | 118 | 3.7 | 118 | 1FP1514-2AF5-..... | 6SL3210-1PE28-8.L0 |
| 45 | 22.5 | 143 | 11.25 | 143 | 4.5 | 143 | 1FP1514-2BF2-..... | 6SL3210-1PE31-1.L0 |

Note:

The converter recommendation applies to standard ambient conditions (40 °C; 1000 m above sea level).

If, as a result of different ambient conditions, the rated motor power is significantly reduced, under certain circumstances, another converter is the optimum solution. Here, please use the configuration options for converters in the DT Configurator.

Synchronous reluctance motors for SINAMICS converters – VSD4000 line

Orientation

Technical specifications

System power loss acc. to IEC 61800-9-2: 2017

The drive system comprising SIMOTICS GP/SD VSD4000 line synchronous-reluctance motors and SINAMICS G120 converters is, as a result of the minimal system power losses, especially suitable for applications in the full and partial load range that are optimized to achieve minimum lifecycle costs.

General conditions:

- CU230P-2 Control Unit
- Line voltage: 400 V 3 AC 50/60 Hz
- Output voltage: Up to 0.95 x line supply input voltage
- Inverter pulse frequency:
4 kHz to 90 kW; 2 kHz from 110 kW
- In the standby mode, the converter does not supply any power to the motor (the inverter pulses are inhibited)
- In the standby operating mode, the Control Unit is operated from the internal or external 24 V DC electronics power supply
- Converters with vector control for synchronous-reluctance motors and flux reduction
- The operating points defined in the subsequent table already take into account the standby portions

SIMOTICS GP/SD VSD4000 line synchronous-reluctance motors with SINAMICS G120 PM240-2 Power Modules

| Rated power kW | SIMOTICS GP/SD VSD4000 1FP10/1FP15 Type | Frame size | PM240-2 Power Module Type | Frame size | System power loss, relative $P_{V,rel}$ as a % referred to P_{rated} Operating points | | | | | | | | IES class acc. to IEC 61800-9-2: 2017 |
|--|--|---------------|------------------------------|---------------|--|-----------|------------|------------|-----------------------------|-------------|-------------|--------------|---|
| | | | | | at partial load ¹⁾ | | | | at rated load ¹⁾ | | | | |
| | | | | | 0/25 % | 0/50 % | 0/100 % | 50/25 % | 50/50 % | 50/100 % | 100/50 % | 100/100 % | |
| Line voltage 400 V 3 AC, 50/60 Hz, rated speed 1500 rpm | | | | | | | | | | | | | |
| 0.55 | 1FP1.14-0DB2-..... | 80 M | 6SL3210-1PE11-8.L0 | FSA | 10.62 | 12.52 | 19.12 | 10.38 | 13.76 | 21.42 | 15.05 | 23.16 | IES2 |
| 0.75 | 1FP1.14-0DB3-..... | 80 M | 6SL3210-1PE12-3.L1 | FSA | 8.59 | 10.28 | 15.78 | 8.38 | 11.32 | 17.78 | 12.64 | 19.59 | IES2 |
| 1.1 | 1FP1.14-0EB0-..... | 90 S | 6SL3210-1PE13-2.L1 | FSA | 6.45 | 8.14 | 13.66 | 6.47 | 9.23 | 15.40 | 10.58 | 17.13 | IES2 |
| 1.5 | 1FP1.14-0EB4-..... | 90 L | 6SL3210-1PE14-3.L1 | FSA | 5.72 | 7.31 | 12.70 | 5.55 | 8.21 | 14.26 | 9.61 | 16.03 | IES2 |
| 2.2 | 1FP1.14-1BB0-..... | 112 M | 6SL3210-1PE16-1.L1 | FSA | 3.91 | 5.01 | 8.71 | 4.17 | 6.10 | 10.45 | 7.62 | 12.43 | IES2 |
| 3 | 1FP1.14-1BB1-..... | 112 M | 6SL3210-1PE18-0.L1 | FSA | 3.63 | 4.90 | 9.45 | 3.81 | 5.84 | 11.09 | 7.36 | 12.99 | IES2 |
| 4 | 1FP1.14-1BB2-..... | 112 M | 6SL3210-1PE21-1.L0 | FSA | 3.21 | 4.41 | 8.65 | 3.31 | 5.21 | 10.04 | 6.45 | 11.75 | IES2 |
| 5.5 | 1FP1.14-1CB0-..... | 132 S | 6SL3210-1PE21-4.L0 | FSB | 2.68 | 3.85 | 7.61 | 2.91 | 4.61 | 9.40 | 5.97 | 10.87 | IES2 |
| 7.5 | 1FP1.14-1CB2-..... | 132 M | 6SL3210-1PE21-8.L0 | FSB | 2.42 | 3.43 | 6.71 | 2.62 | 4.13 | 8.22 | 5.33 | 9.68 | IES2 |
| 11 | 1FP1.14-1DB2-..... | 160 M | 6SL3210-1PE22-7.L0 | FSC | 2.26 | 3.17 | 6.20 | 2.25 | 3.64 | 7.55 | 4.75 | 9.14 | IES2 |
| 15 | 1FP1.14-1DB4-..... | 160 L | 6SL3210-1PE23-3.L0 | FSC | 2.09 | 2.89 | 5.73 | 2.08 | 3.42 | 6.89 | 4.31 | 8.13 | IES2 |
| 18.5 | 1FP1.14-1EB2-..... | 180 M | 6SL3210-1PE23-8.L0 | FSD | 1.76 | 2.42 | 4.65 | 1.86 | 3.01 | 6.00 | 3.99 | 7.56 | IES2 |
| 22 | 1FP1.14-1EB4-..... | 180 L | 6SL3210-1PE24-5.L0 | FSD | 1.67 | 2.34 | 4.46 | 1.74 | 2.84 | 5.73 | 3.82 | 7.15 | IES2 |
| 30 | 1FP1.14-2AB5-..... | 200 L | 6SL3210-1PE26-0.L0 | FSD | 1.65 | 2.41 | 4.82 | 1.53 | 2.60 | 5.58 | 3.36 | 6.80 | IES2 |
| 37 | 1FP1514-2BB0-..... | 225 S | 6SL3210-1PE28-8.L0 | FSE | 1.29 | 2.02 | 4.49 | 1.64 | 2.73 | 5.54 | 3.49 | 6.74 | IES2 |
| 45 | 1FP1514-2BB2-..... | 225 M | 6SL3210-1PE31-1.L0 | FSE | 1.18 | 1.91 | 4.41 | 1.51 | 2.63 | 5.38 | 3.34 | 6.72 | IES2 |
| Line voltage 400 V 3 AC, 50/60 Hz, rated speed 3000 rpm | | | | | | | | | | | | | |
| 0.75 | 1FP1514-0DF2-..... | 80 M | 6SL3210-1PE12-3.L1 | FSA | 8.28 | 10.08 | 15.81 | 8.93 | 11.98 | 18.36 | 14.49 | 21.79 | IES2 |
| 1.1 | 1FP1514-0DF3-..... | 80 M | 6SL3210-1PE13-2.L1 | FSA | 6.39 | 8.17 | 13.83 | 7.08 | 9.91 | 16.17 | 12.44 | 19.32 | IES2 |
| 1.5 | 1FP1514-0EF0-..... | 90 S | 6SL3210-1PE14-3.L1 | FSA | 5.73 | 7.05 | 11.43 | 5.99 | 8.45 | 13.83 | 11.44 | 17.34 | IES2 |
| 2.2 | 1FP1514-0EF4-..... | 90 L | 6SL3210-1PE16-1.L1 | FSA | 4.72 | 5.79 | 9.34 | 4.99 | 7.10 | 11.51 | 9.81 | 14.67 | IES2 |
| 3 | 1FP1514-1BF1-..... | 112 M | 6SL3210-1PE18-0.L1 | FSA | 3.00 | 4.06 | 6.11 | 3.74 | 5.51 | 9.51 | 7.79 | 12.49 | IES2 |
| 4 | 1FP1514-1BF2-..... | 112 M | 6SL3210-1PE21-1.L0 | FSA | 3.04 | 3.91 | 6.86 | 3.53 | 5.16 | 8.74 | 7.56 | 11.62 | IES2 |
| 5.5 | 1FP1514-1CF0-..... | 132 S | 6SL3210-1PE21-4.L0 | FSB | 2.72 | 3.55 | 6.82 | 3.19 | 4.71 | 8.48 | 7.21 | 11.67 | IES2 |
| 7.5 | 1FP1514-1CF1-..... | 132 S | 6SL3210-1PE21-8.L0 | FSB | 2.21 | 3.07 | 6.27 | 2.72 | 4.20 | 8.00 | 6.21 | 10.71 | IES2 |
| 11 | 1FP1514-1DF2-..... | 160 M | 6SL3210-1PE22-7.L0 | FSC | 1.83 | 2.58 | 5.12 | 2.40 | 3.66 | 6.74 | 5.79 | 9.53 | IES2 |
| 15 | 1FP1514-1DF3-..... | 160 M | 6SL3210-1PE23-3.L0 | FSC | 1.84 | 2.58 | 5.18 | 2.32 | 3.54 | 6.77 | 5.43 | 9.10 | IES2 |
| 18.5 | 1FP1514-1DF4-..... | 160 L | 6SL3210-1PE23-8.L0 | FSD | 1.76 | 2.49 | 4.99 | 2.20 | 3.48 | 6.66 | 5.21 | 9.06 | IES2 |
| 22 | 1FP1514-1CF1-..... | 180 M | 6SL3210-1PE24-5.L0 | FSD | 1.39 | 1.93 | 3.72 | 1.90 | 2.95 | 5.24 | 4.69 | 7.67 | IES2 |
| 30 | 1FP1514-2AF4-..... | 200 L | 6SL3210-1PE26-0.L0 | FSD | 1.25 | 1.78 | 3.78 | 1.80 | 2.81 | 5.28 | 4.28 | 7.58 | IES2 |
| 37 | 1FP1514-2AF5-..... | 200 L | 6SL3210-1PE28-8.L0 | FSD | 1.26 | 1.69 | 3.09 | 1.71 | 2.58 | 4.38 | 3.82 | 6.17 | IES2 |
| 45 | 1FP1514-2BF2-..... | 225 M | 6SL3210-1PE31-1.L0 | FSD | 1.16 | 1.70 | 3.46 | 1.63 | 2.55 | 4.59 | 3.66 | 6.29 | IES2 |

¹⁾ Output frequency, rel. [%] referred to the rated speed/
torque, rel. [%] referred to the rated torque T_{rated} .

Synchronous reluctance motors for SINAMICS converters – VSD4000 line

Orientation

Article number code

Selection and ordering data

The article number consists of a combination of digits and letters and is divided into three hyphenated blocks to provide a better overview, e.g.:

1FP1504-1DB42-1GF4-Z
H00

The first block (positions 1 to 7) identifies the motor type. The second block (positions 8 to 12) defines the motor frame size and length, the number of poles and power and in some cases the frequency/voltage. In the third block (positions 13 to 16), the frequency/voltage, type of construction and further design features are encoded.

For deviations in the second and third block from the catalog codes either **Z** or **90** should be used as appropriate.

Ordering data:

- Complete Article No. and order code(s) or plain text
- If a quotation has been requested, please specify the quotation number in addition to the Article No.
- When ordering a complete motor as a spare part, please specify the works serial No. for the previously supplied motor as well as the Article No.

| Structure of the Article No.: | | Position: | 1 | 2 | 3 | 4 | 5 | 6 | 7 | - | 8 | 9 | 10 | 11 | 12 | - | 13 | 14 | 15 | 16 |
|--------------------------------|---|-----------|---|---|---|---|---|---|---|---|-----|-----|----|----|----|---|----|----|-----|-----|
| 1st to 4th position: | Three-phase synchronous-reluctance motor | | | | | | | | | | | | | | | | | | | |
| Digit, letter, letter, digit | Self-ventilated by fan mounted on and driven by the rotor | | 1 | F | P | 1 | | | | | | | | | | | | | | |
| 5th position: | SIMOTICS GP – aluminum housing | | | | | | 0 | | | | | | | | | | | | | |
| Digit | SIMOTICS SD – cast-iron housing | | | | | | 5 | | | | | | | | | | | | | |
| 6th position: | Standard version Gen 2 | | | | | | | 1 | | | | | | | | | | | | |
| Digit | | | | | | | | | | | | | | | | | | | | |
| 7th position: | Efficiency class | | | | | | | | | | | | | | | | | | | |
| Digit | Super Premium Efficiency | | | | | | | | 4 | | | | | | | | | | | |
| 8th and 9th position: | Motor frame size | | | | | | | | | | 0 | A | | | | | | | | |
| Digit, letter | (frame size as a combination of shaft height and overall length, encoded) | | | | | | | | | | ... | ... | | | | | | | | |
| | | | | | | | | | | | 2 | E | | | | | | | | |
| 10th position: | No. of poles | | | | | | | | | | | | B | | | | | | | |
| Letter | B, F: 4-pole | | | | | | | | | | | | F | | | | | | | |
| 11th position: | Laminated core length | | | | | | | | | | | | | 0 | | | | | | |
| Digit | | | | | | | | | | | | | | 2 | | | | | | |
| | | | | | | | | | | | | | | 4 | | | | | | |
| | | | | | | | | | | | | | | 5 | | | | | | |
| 12th and 13th position: | Motor voltage and frequency | | | | | | | | | | | | | | | | | | | |
| 2 digits | 380 V 3 AC, 50 Hz/440 V 3 AC, 60 Hz/380 V 3 AC, 87 Hz | | | | | | | | | | | | | | 2 | | 1 | | | |
| 14th position: | Type of construction | | | | | | | | | | | | | | | | | | A | |
| Letter | (encoded with A ... V) | | | | | | | | | | | | | | | | | | ... | |
| | | | | | | | | | | | | | | | | | | | V | |
| 15th position: | Motor protection | | | | | | | | | | | | | | | | | | | B |
| Letter | (encoded with B ... Z; Z requires order code Q.. (e.g. Q3A); F = standard version with integrated KTY84 temperature sensor) | | | | | | | | | | | | | | | | | | | ... |
| | | | | | | | | | | | | | | | | | | | | Z |
| 16th position: | Terminal box position | | | | | | | | | | | | | | | | | | | |
| Digit | 4: Terminal box top (normal version), 5: Terminal box right, 6: Terminal box left | | | | | | | | | | | | | | | | | | | 4 |
| | | | | | | | | | | | | | | | | | | | | ... |
| | | | | | | | | | | | | | | | | | | | | 6 |
| | Special order versions: encoded – additional order code required not encoded – additional plain text required | | | | | | | | | | | | | | | | | | | |
| | | | | | | | | | | | | | | | | | | | | - |
| | | | | | | | | | | | | | | | | | | | | Z |

Synchronous reluctance motors for SINAMICS converters – VSD4000 line

Orientation

Article number code

Selection and ordering data

Ordering example:

| Selection criteria | Requirement | Structure of the Article No. |
|---|---|--|
| 1FP10 motor type | Standard motor for converter operation SIMOTICS GP VSD4000 line, aluminum version, rated power at $P_{rated\ 50}$ with 15 kW, $P_{rated\ 60}$ with 17.3 kW or $P_{rated\ 87}$ with 23.5 kW | 1FP1014-■■■■■-■■■■■ |
| Motor frame size | 160 L | 1FP1014-1D■4■-■■■■■ |
| No. of poles | 4-pole | 1FP1014-1DB4■-■■■■■ |
| Motor voltage and frequency | 380 V 3 AC, 50 Hz/440 V 3 AC, 60 Hz/380 V 3 AC, 87 Hz | 1FP1014-1DB42-1■■■■■ |
| Type of construction with special version | IM V5 with protective cover ¹⁾ | 1FP1014-1DB42-1C■■■-Z H00 |
| Motor protection | Motor protection with PTC thermistors with 1 or 3 embedded temperature sensors for tripping | 1FP1014-1DB42-1CB■-Z H00 |
| Terminal box position | Terminal box right (viewed from DE) | 1FP1014-1DB42-1CB5-Z H00 |

4

¹⁾ Standard without protective cover – the protective cover is defined with order code **H00** and must be ordered in addition to the Article No. with **-Z** and this order code.

Synchronous reluctance motors for SINAMICS converters – VSD4000 line

Super Premium Efficiency

Aluminum series SIMOTICS GP 1FP1014, line voltage 400 V, 50 Hz/480 V, 60 Hz/400 V, 87 Hz – self-ventilated

Selection and ordering data

| P _{rated} , 50 Hz, 400 V | P _{rated} , 60 Hz, 480 V | P _{rated} , 87 Hz, 400 V | Frame size | Connection | Operating values at rated power | | | | | Article No. |
|---|--------------------------------------|--------------------------------------|------------|------------|---------------------------------|--------------------|---|------------------------------|--------------------|----------------------|
| | | | | | f _{rated} | T _{rated} | η _{rated} , 4/4 for converter operation | cos φ _{rated} , 4/4 | I _{rated} | |
| kW | kW | kW | | | Hz | Nm | % | | A | |
| <ul style="list-style-type: none"> Insulation: Thermal class 155 (temperature class F), IP55 degree of protection, utilization in accordance with thermal class F according to B Operation with a SINAMICS G120 converter with uncontrolled infeed – rated voltage 380 V, 50 Hz/440 V, 60 Hz/380 V, 87 Hz | | | | | | | | | | |
| 1500 rpm | 1800 rpm | 2610 rpm | 4-pole | | | | | | | |
| 0.55 | | | 80 M | Y | 50 | 3.5 | 83.9 | 0.67 | 1.49 | 1FP1014-0DB2 ■-■■■■■ |
| | 0.63 | | | Y | 60 | 3.4 | 84.0 | 0.66 | 1.49 | |
| | | 0.95 | | Δ | 87 | 3.5 | 87.5 | 0.65 | 2.55 | |
| 0.75 | | | 80 M | Y | 50 | 4.8 | 85.7 | 0.67 | 1.98 | 1FP1014-0DB3 ■-■■■■■ |
| | 0.86 | | | Y | 60 | 4.6 | 85.5 | 0.66 | 2.0 | |
| | | 1.3 | | Δ | 87 | 4.8 | 89.0 | 0.64 | 3.45 | |
| 1.1 | | | 90 S | Y | 50 | 7.0 | 87.2 | 0.69 | 2.8 | 1FP1014-0EB0 ■-■■■■■ |
| | 1.27 | | | Y | 60 | 6.7 | 87.5 | 0.69 | 2.75 | |
| | | 1.9 | | Δ | 87 | 7.0 | 89.0 | 0.68 | 4.8 | |
| 1.5 | | | 90 M | Y | 50 | 9.5 | 88.2 | 0.69 | 3.75 | 1FP1014-0EB4 ■-■■■■■ |
| | 1.75 | | | Y | 60 | 9.0 | 88.5 | 0.68 | 3.8 | |
| | | 2.6 | | Δ | 87 | 9.5 | 90.5 | 0.67 | 6.5 | |
| 2.2 | | | 112 M | Y | 50 | 14 | 89.5 | 0.71 | 5.3 | 1FP1014-1BB0 ■-■■■■■ |
| | 2.55 | | | Y | 60 | 13.3 | 91.0 | 0.71 | 5.2 | |
| | | 3.85 | | Δ | 87 | 14 | 92.0 | 0.69 | 9.2 | |
| 3 | | | 112 M | Y | 50 | 19.1 | 90.4 | 0.71 | 7.1 | 1FP1014-1BB1 ■-■■■■■ |
| | 3.45 | | | Y | 60 | 18.1 | 91.0 | 0.72 | 6.9 | |
| | | 5.2 | | Δ | 87 | 19.1 | 91.8 | 0.70 | 12.3 | |
| 4 | | | 112 M | Y | 50 | 25.5 | 91.1 | 0.72 | 9.3 | 1FP1014-1BB2 ■-■■■■■ |
| | 4.55 | | | Y | 60 | 24.0 | 91.0 | 0.73 | 9.0 | |
| | | 6.9 | | Δ | 87 | 25.5 | 92.3 | 0.71 | 16.0 | |
| 5.5 | | | 132 S | Y | 50 | 35 | 91.9 | 0.72 | 12.6 | 1FP1014-1CB0 ■-■■■■■ |
| | 6.3 | | | Y | 60 | 33.5 | 92.4 | 0.73 | 12.3 | |
| | | 9.6 | | Δ | 87 | 35 | 92.8 | 0.71 | 22 | |
| 7.5 | | | 132 M | Y | 50 | 47.5 | 92.6 | 0.72 | 17.1 | 1FP1014-1CB2 ■-■■■■■ |
| | 8.6 | | | Y | 60 | 45.5 | 92.4 | 0.73 | 16.7 | |
| | | 13.1 | | Δ | 87 | 47.5 | 93.3 | 0.70 | 30.5 | |
| 11 | | | 160 M | Y | 50 | 70 | 93.3 | 0.72 | 25.0 | 1FP1014-1DB2 ■-■■■■■ |
| | 12.6 | | | Y | 60 | 67 | 93.6 | 0.73 | 24.0 | |
| | | 19.1 | | Δ | 87 | 70 | 93.6 | 0.71 | 43.5 | |
| 15 | | | 160 L | Y | 50 | 95 | 93.9 | 0.71 | 34.0 | 1FP1014-1DB4 ■-■■■■■ |
| | 17.3 | | | Y | 60 | 90 | 94.5 | 0.72 | 33.5 | |
| | | 26 | | Δ | 87 | 95 | 94.1 | 0.71 | 59.0 | |
| 18.5 | | | 180 M | Y | 50 | 118.0 | 94.2 | 0.71 | 42.0 | 1FP1014-1EB2 ■-■■■■■ |
| | 21.3 | | | Y | 60 | 113.0 | 94.5 | 0.72 | 41.0 | |
| | | 32 | | Δ | 87 | 118.0 | 95.0 | 0.71 | 73.0 | |
| 22 | | | 180 L | Y | 50 | 140.0 | 94.5 | 0.71 | 50.0 | 1FP1014-1EB4 ■-■■■■■ |
| | 25.3 | | | Y | 60 | 134.0 | 94.5 | 0.72 | 49.0 | |
| | | 38.1 | | Δ | 87 | 140.0 | 93.9 | 0.70 | 87.0 | |
| 30 | | | 200 L | Y | 50 | 191.0 | 95.2 | 0.71 | 68.0 | 1FP1014-2AB5 ■-■■■■■ |
| | 34.5 | | | Y | 60 | 183.0 | 95.4 | 0.72 | 66.0 | |
| | | 52 | | Δ | 87 | 191.0 | 94.4 | 0.71 | 118.0 | |

For versions, see Article No. supplements and special versions.

■-■■■■■

All technical specifications refer to converter operation.

Synchronous reluctance motors for SINAMICS converters – VSD4000 line

Super Premium Efficiency

Aluminum series SIMOTICS GP 1FP1014, line voltage 400 V, 50 Hz/480 V, 60 Hz/400 V, 87 Hz – self-ventilated

| Motor type | $m_{IM B3}$ | J | L_{pfA} , tolerance +3 dB(A) load | L_{WA} , tolerance +3 dB(A) load | Mech. speed limit | Terminal box | Converter SINAMICS G120 – PM240-2 | Frame size | IES class acc. to EN 50598-2 |
|--------------------|-------------|------------------|--|---|----------------------|-----------------|--------------------------------------|------------|------------------------------------|
| | | | | | | | Operating mode: Low overload | | |
| | kg | kgm ² | dB(A) | dB(A) | rpm | Type | Type ¹⁾ | | |
| 1FP1014-0DB2.-.... | 12 | 0.0019 | 66.0 | 78.0 | 3200 | TB1D00 | 6SL3210-1PE11-8.L0 | FSA | IES 2 |
| | | | 67.0 | 79.0 | | | 6SL3210-1PE11-8.L0 | FSA | IES 2 |
| | | | 69.0 | 81.0 | | | 6SL3210-1PE13-2.L0 | FSA | IES 2 |
| 1FP1014-0DB3.-.... | 15 | 0.0025 | 66.0 | 78.0 | 3200 | TB1D00 | 6SL3210-1PE12-3.L0 | FSA | IES 2 |
| | | | 67.0 | 79.0 | | | 6SL3210-1PE12-3.L0 | FSA | IES 2 |
| | | | 69.0 | 81.0 | | | 6SL3210-1PE14-3.L0 | FSA | IES 2 |
| 1FP1014-0EB0.-.... | 18 | 0.0034 | 58.0 | 70.0 | 3200 | TB1D00 | 6SL3210-1PE13-2.L1 | FSA | IES 2 |
| | | | 59.0 | 71.0 | | | 6SL3210-1PE13-2.L1 | FSA | IES 2 |
| | | | 69.0 | 81.0 | | | 6SL3210-1PE16-1.L1 | FSA | IES 2 |
| 1FP1014-0EB4.-.... | 22 | 0.0043 | 58.0 | 70.0 | 3200 | TB1D00 | 6SL3210-1PE14-3.L1 | FSA | IES 2 |
| | | | 59.0 | 71.0 | | | 6SL3210-1PE14-3.L1 | FSA | IES 2 |
| | | | 69.0 | 81.0 | | | 6SL3210-1PE18-0.L1 | FSA | IES 2 |
| 1FP1014-1BB0.-.... | 34 | 0.0092 | 58.0 | 70.0 | 3200 | TB1F00 | 6SL3210-1PE16-1.L1 | FSA | IES 2 |
| | | | 58.0 | 70.0 | | | 6SL3210-1PE16-1.L1 | FSA | IES 2 |
| | | | 65.0 | 77.0 | | | 6SL3210-1PE21-1.L0 | FSA | IES 2 |
| 1FP1014-1BB1.-.... | 34 | 0.0092 | 59.0 | 71.0 | 3200 | TB1F00 | 6SL3210-1PE18-0.L1 | FSA | IES 2 |
| | | | 59.0 | 71.0 | | | 6SL3210-1PE18-0.L1 | FSA | IES 2 |
| | | | 65.0 | 77.0 | | | 6SL3210-1PE21-4.L0 | FSA | IES 2 |
| 1FP1014-1BB2.-.... | 39 | 0.0114 | 59.0 | 71.0 | 3200 | TB1F00 | 6SL3210-1PE21-1.L0 | FSA | IES 2 |
| | | | 60.0 | 72.0 | | | 6SL3210-1PE21-1.L0 | FSA | IES 2 |
| | | | 69.0 | 81.0 | | | 6SL3210-1PE21-8.L0 | FSB | IES 2 |
| 1FP1014-1CB0.-.... | 52 | 0.0200 | 69.0 | 81.0 | 3200 | TB1H00 | 6SL3210-1PE21-4.L0 | FSB | IES 2 |
| | | | 68.0 | 80.0 | | | 6SL3210-1PE21-4.L0 | FSB | IES 2 |
| | | | 69.0 | 81.0 | | | 6SL3210-1PE22-7.L0 | FSC | IES 2 |
| 1FP1014-1CB2.-.... | 66 | 0.0277 | 62.0 | 74.0 | 3200 | TB1H00 | 6SL3210-1PE21-8.L0 | FSB | IES 2 |
| | | | 64.0 | 76.0 | | | 6SL3210-1PE21-8.L0 | FSB | IES 2 |
| | | | 68.0 | 80.0 | | | 6SL3210-1PE23-3.L0 | FSC | IES 2 |
| 1FP1014-1DB2.-.... | 86 | 0.0485 | 69.0 | 81.0 | 3000 | TB1J00 | 6SL3210-1PE22-7.L0 | FSC | IES 2 |
| | | | 70.0 | 82.0 | | | 6SL3210-1PE22-7.L0 | FSC | IES 2 |
| | | | 75.0 | 87.0 | | | 6SL3210-1PE23-8.L0 | FSD | IES 2 |
| 1FP1014-1DB4.-.... | 104 | 0.0624 | 71.0 | 83.0 | 3000 | TB1J00 | 6SL3210-1PE23-3.L0 | FSC | IES 2 |
| | | | 72.0 | 84.0 | | | 6SL3210-1PE23-3.L0 | FSC | IES 2 |
| | | | 76.0 | 88.0 | | | 6SL3210-1PE26-0.L0 | FSD | IES 2 |
| 1FP1014-1EB2.-.... | 132 | 0.1155 | 69.0 | 82.0 | 2610 | TB1J00 | 6SL3210-1PE23-8.L0 | FSD | IES 2 |
| | | | 70.0 | 83.0 | | | 6SL3210-1PE24-5.L0 | FSD | IES 2 |
| | | | 76.0 | 89.0 | | | 6SL3210-1PE27-5.L0 | FSE | IES 2 |
| 1FP1014-1EB4.-.... | 144 | 0.1315 | 69.0 | 82.0 | 2610 | TB1J00 | 6SL3210-1PE24-5.L0 | FSD | IES 2 |
| | | | 70.0 | 83.0 | | | 6SL3210-1PE26-0.L0 | FSD | IES 2 |
| | | | 76.0 | 89.0 | | | 6SL3210-1PE28-8.L0 | FSE | IES 2 |
| 1FP1014-2AB5.-.... | 171 | 0.1884 | 68.0 | 81.0 | 2610 | TB1L00 | 6SL3210-1PE26-0.L0 | FSE | IES 2 |
| | | | 70.0 | 83.0 | | | 6SL3210-1PE27-5.L0 | FSD | IES 2 |
| | | | 73.0 | 86.0 | | | 6SL3210-1PE31-5.L0 | FSF | IES 2 |

¹⁾ In addition to the Power Module, a CU230P-2 Control Unit and an Operator Panel are required (see Catalog D 31 and/or D 35).

Synchronous reluctance motors for SINAMICS converters – VSD4000 line

Super Premium Efficiency

Cast-iron series SIMOTICS SD 1FP1514, line voltage 400 V, 50 Hz/460 V, 60 Hz/400 V, 87 Hz – self-ventilated

Selection and ordering data

| P _{rated} , 50 Hz, 400 V | P _{rated} , 60 Hz, 480 V | P _{rated} , 87 Hz, 400 V | Frame size | Connection | Operating values at rated power | | | | Article No. | |
|---|--------------------------------------|--------------------------------------|------------|------------|---------------------------------|--------------------|---|-----------------------------|-------------|----------------------|
| | | | | | f _{rated} | T _{rated} | η _{rated} , 4/4 for converter operation | cosφ _{rated} , 4/4 | | I _{rated} |
| kW | kW | kW | | | Hz | Nm | % | A | | |
| <ul style="list-style-type: none"> Insulation: Thermal class 155 (temperature class F), IP55 degree of protection, utilization in accordance with thermal class F according to B Operation with a SINAMICS G120 converter with uncontrolled infeed – rated voltage 380 V, 50 Hz/440 V, 60 Hz/380 V, 87 Hz | | | | | | | | | | |
| 3000 rpm | 3600 rpm | | 4-pole | | | | | | | |
| 0.75 | | | 80 M | Y | 100 | 2.4 | 0.65 | 83.5 | 2.1 | 1FP1514-0DF2 ■-■■■■■ |
| | 0.86 | | | Y | 120 | 2.3 | 0.65 | 82.5 | 2.1 | |
| 1.1 | | | 80 M | Y | 100 | 3.5 | 0.66 | 85.2 | 2.95 | 1FP1514-0DF3 ■-■■■■■ |
| | 1.27 | | | Y | 120 | 6.7 | 0.66 | 85.5 | 2.95 | |
| 1.5 | | | 90 S | Y | 100 | 4.8 | 0.66 | 86.5 | 4 | 1FP1514-0EF0 ■-■■■■■ |
| | 1.75 | | | Y | 120 | 4.6 | 0.67 | 86.5 | 3.95 | |
| 2.2 | | | 90 L | Y | 100 | 7 | 0.66 | 88 | 5.8 | 1FP1514-0EF4 ■-■■■■■ |
| | 2.55 | | | Y | 120 | 13.5 | 0.68 | 88.5 | 5.6 | |
| 3.0 | | | 112 M | Y | 100 | 9.5 | 0.71 | 89.1 | 7.2 | 1FP1514-1BF1 ■-■■■■■ |
| | 3.45 | | | Y | 120 | 9.2 | 0.71 | 89.5 | 7.1 | |
| 4.0 | | | 112 M | Y | 100 | 12.7 | 0.69 | 90 | 9.8 | 1FP1514-1BF2 ■-■■■■■ |
| | 4.55 | | | Y | 120 | 12.1 | 0.7 | 89.5 | 9.5 | |
| 5.5 | | | 132 S | Y | 100 | 17.5 | 90.9 | 0.71 | 12.9 | 1FP1514-1CF0 ■-■■■■■ |
| | 6.3 | | | Y | 120 | 16.7 | 90.2 | 0.72 | 12.7 | |
| 7.5 | | | 132 S | Y | 100 | 24.0 | 91.7 | 0.72 | 17.3 | 1FP1514-1CF1 ■-■■■■■ |
| | 8.6 | | | Y | 120 | 23.0 | 91.7 | 0.72 | 17.1 | |
| 11 | | | 160 M | Y | 100 | 35 | 92.6 | 0.73 | 24.5 | 1FP1514-1DF2 ■-■■■■■ |
| | 12.6 | | | Y | 120 | 33.5 | 91.4 | 0.73 | 24.5 | |
| 15 | | | 160 M | Y | 100 | 48.0 | 93.3 | 0.72 | 34 | 1FP1514-1DF3 ■-■■■■■ |
| | 17.3 | | | Y | 120 | 46.0 | 93.0 | 0.73 | 33.5 | |
| 18.5 | | | 160 L | Y | 100 | 58 | 93.7 | 0.72 | 41.5 | 1FP1514-1DF4 ■-■■■■■ |
| | 21.3 | | | Y | 120 | 56.5 | 93.0 | 0.73 | 41.0 | |
| 22 | | | 180 M | Y | 100 | 70 | 94.0 | 0.71 | 50 | 1FP1514-1EF2 ■-■■■■■ |
| | 25.3 | | | Y | 120 | 67 | 93.0 | 0.71 | 50 | |
| 30 | | | 200 L | Y | 100 | 96 | 94.5 | 0.72 | 67 | 1FP1514-2AF4 ■-■■■■■ |
| | 34.5 | | | Y | 120 | 91 | 94.1 | 0.72 | 67 | |
| 37 | | | 200 L | Y | 100 | 118 | 94.8 | 0.72 | 82 | 1FP1514-2AF5 ■-■■■■■ |
| | 42.5 | | | Y | 120 | 112 | 94.5 | 0.73 | 81 | |
| 45 | | | 225 M | Y | 100 | 143 | 95.0 | 0.73 | 99 | 1FP1514-2BF2 ■-■■■■■ |
| | 52 | | | Y | 120 | 136 | 94.4 | 0.73 | 99 | |

For versions, see Article No. supplements and special versions.

■-■■■■■

All technical specifications refer to converter operation.

Synchronous reluctance motors for SINAMICS converters – VSD4000 line

Super Premium Efficiency

Cast-iron series SIMOTICS SD 1FP1514, line voltage 400 V, 50 Hz/460 V, 60 Hz/400 V, 87 Hz – self-ventilated

| Motor type | $m_{IM B3}$ | J | L_{pA} , tolerance +3 dB(A) load | L_{WA} , tolerance +3 dB(A) load | Mech. speed limit | Terminal box | Converter SINAMICS G120 – PM240-2 | Frame size | IES class acc. to EN 50598-2 |
|---------------------|-------------|------------------|---|---|----------------------|-----------------|--------------------------------------|------------|------------------------------------|
| | | | | | | | Operating mode: Low overload | | |
| | kg | kgm ² | dB(A) | dB(A) | rpm | Type | Type ¹⁾ | | |
| 1FP1514-0DF2.-..... | 17 | 0.0013 | 68.0 | 80.0 | 6000 | TB1D00 | 6SL3210-1PE12-3.L0 | FSA | IES 2 |
| | | | | | | | 6SL3210-1PE12-3.L0 | FSA | IES 2 |
| 1FP1514-0DF3.-..... | 18 | 0.0015 | 68.0 | 80.0 | 6000 | TB1D00 | 6SL3210-1PE13-2.L1 | FSA | IES 2 |
| | | | | | | | 6SL3210-1PE13-2.L1 | FSA | IES 2 |
| 1FP1514-0EF0.-..... | 24 | 0.0022 | 66.0 | 78.0 | 6000 | TB1D00 | 6SL3210-1PE14-3.L1 | FSA | IES 2 |
| | | | 70.0 | 82.0 | | | 6SL3210-1PE14-3.L1 | FSA | IES 2 |
| 1FP1514-0EF4.-..... | 27 | 0.0031 | 66.0 | 78.0 | 6000 | TB1D00 | 6SL3210-1PE16-1.L1 | FSA | IES 2 |
| | | | 70.0 | 82.0 | | | 6SL3210-1PE16-1.L1 | FSA | IES 2 |
| 1FP1514-1BF1.-..... | 39 | 0.0064 | 63.0 | 75.0 | 6000 | TB1F00 | 6SL3210-1PE18-0.L1 | FSA | IES 2 |
| | | | 67.0 | 79.0 | | | 6SL3210-1PE18-0.L1 | FSA | IES 2 |
| 1FP1514-1BF2.-..... | 41 | 0.0071 | 69.0 | 81.0 | 6000 | TB1F00 | 6SL3210-1PE21-1.L0 | FSA | IES 2 |
| | | | | | | | 6SL3210-1PE21-1.L0 | FSA | IES 2 |
| 1FP1514-1CF0.-..... | 53 | 0.0133 | 70.0 | 82.0 | 5600 | TB1H01 | 6SL3210-1PE21-4.L0 | FSB | IES 2 |
| | | | 72.0 | 84.0 | | | 6SL3210-1PE21-4.L0 | FSB | IES 2 |
| 1FP1514-1CF1.-..... | 56 | 0.0160 | 70.0 | 82.0 | 5600 | TB1H01 | 6SL3210-1PE21-8.L0 | FSB | IES 2 |
| | | | 72.0 | 84.0 | | | 6SL3210-1PE21-8.L0 | FSB | IES 2 |
| 1FP1514-1DF2.-..... | 89 | 0.0323 | 72.0 | 84.0 | 4800 | TB1J01 | 6SL3210-1PE22-7.L0 | FSC | IES 2 |
| | | | 76.0 | 88.0 | | | 6SL3210-1PE22-7.L0 | FSC | IES 2 |
| 1FP1514-1DF3.-..... | 96 | 0.0377 | 72.0 | 84.0 | 4800 | TB1J01 | 6SL3210-1PE23-3.L0 | FSC | IES 2 |
| | | | 76.0 | 88.0 | | | 6SL3210-1PE23-3.L0 | FSC | IES 2 |
| 1FP1514-1DF4.-..... | 102 | 0.0444 | 75.0 | 87.0 | 4800 | TB1J01 | 6SL3210-1PE23-8.L0 | FSC | IES 2 |
| | | | 76.0 | 88.0 | | | 6SL3210-1PE24-5.L0 | FSC | IES 2 |
| 1FP1514-1EF2.-..... | 144 | 0.087 | 73.0 | 86.0 | 4600 | TB1J00 | 6SL3210-1PE24-5.L0 | | IES 2 |
| | | | 75.0 | 88.0 | | | 6SL3210-1PE26-0.L0 | | IES 2 |
| 1FP1514-2AF4.-..... | 187 | 0.1277 | 73.0 | 86.0 | 4500 | TB1L01 | 6SL3210-1PE26-0.L0 | | IES 2 |
| | | | 76.0 | 89.0 | | | 6SL3210-1PE27-5.L0 | | IES 2 |
| 1FP1514-2AF5.-..... | 222 | 0.1884 | 73.0 | 86.0 | 4500 | TB1L01 | 6SL3210-1PE28-8.L0 | | IES 2 |
| | | | 76.0 | 89.0 | | | 6SL3210-1PE28-8.L0 | | IES 2 |
| 1FP1514-2BF2.-..... | 286 | 0.3599 | 78.0 | 92.0 | 4500 | TB1L01 | 6SL3210-1PE31-1.L0 | | IES 2 |
| | | | 81.0 | 95.0 | | | 6SL3210-1PE31-1.L0 | | IES 2 |

¹⁾ In addition to the Power Module, a CU230P-2 Control Unit and an Operator Panel are required (see Catalog D 31 and/or D 35).

Synchronous reluctance motors for SINAMICS converters – VSD4000 line

Super Premium Efficiency

Cast-iron series SIMOTICS SD 1FP1514, line voltage 400 V, 50 Hz/460 V, 60 Hz/400 V, 87 Hz – self-ventilated

Selection and ordering data

| P _{rated} , 50 Hz, 400 V | P _{rated} , 60 Hz, 480 V | P _{rated} , 87 Hz, 400 V | Frame size | Connection | Operating values at rated power | | | | Article No. | |
|---|--------------------------------------|--------------------------------------|------------|------------|---------------------------------|--------------------|---|-----------------------------|-------------|--------------------|
| | | | | | f _{rated} | T _{rated} | η _{rated} , 4/4 for converter operation | cosφ _{rated} , 4/4 | | I _{rated} |
| kW | kW | kW | | | Hz | Nm | % | A | | |
| <ul style="list-style-type: none"> Insulation: Thermal class 155 (temperature class F), IP55 degree of protection, utilization in accordance with thermal class F according to B Operation with a SINAMICS G120 converter with uncontrolled infeed – rated voltage 380 V, 50 Hz/440 V, 60 Hz/380 V, 87 Hz | | | | | | | | | | |
| 1500 rpm | 1800 rpm | 2610 rpm | 4-pole | | | | | | | |
| 0.55 | | | 80 M | Y | 50 | 3.5 | 83.9 | 0.67 | 1.49 | 1FP1514-0DB2 ■■■■■ |
| | 0.63 | | | Y | 60 | 3.4 | 84.0 | 0.66 | 1.49 | |
| | | 0.95 | | Δ | 87 | 3.5 | 87.5 | 0.65 | 2.55 | |
| 0.75 | | | 80 M | Y | 50 | 4.8 | 85.7 | 0.67 | 1.98 | 1FP1514-0DB3 ■■■■■ |
| | 0.86 | | | Y | 60 | 4.6 | 85.5 | 0.66 | 2.0 | |
| | | 1.3 | | Δ | 87 | 4.8 | 89.0 | 0.64 | 3.45 | |
| 1.1 | | | 90 S | Y | 50 | 7.0 | 87.2 | 0.69 | 2.8 | 1FP1514-0EB0 ■■■■■ |
| | 1.27 | | | Y | 60 | 6.7 | 87.5 | 0.69 | 2.75 | |
| | | 1.9 | | Δ | 87 | 7.0 | 89.0 | 0.68 | 4.8 | |
| 1.5 | | | 90 M | Y | 50 | 9.5 | 88.2 | 0.69 | 3.75 | 1FP1514-0EB4 ■■■■■ |
| | 1.75 | | | Y | 60 | 9.0 | 88.5 | 0.68 | 3.8 | |
| | | 2.6 | | Δ | 87 | 9.5 | 90.5 | 0.67 | 6.5 | |
| 2.2 | | | 112 M | Y | 50 | 14 | 89.5 | 0.71 | 5.3 | 1FP1514-1BB0 ■■■■■ |
| | 2.55 | | | Y | 60 | 13.3 | 91.0 | 0.71 | 5.2 | |
| | | 3.85 | | Δ | 87 | 14 | 92.0 | 0.69 | 9.2 | |
| 3 | | | 112 M | Y | 50 | 19.1 | 90.4 | 0.71 | 7.1 | 1FP1514-1BB1 ■■■■■ |
| | 3.45 | | | Y | 60 | 18.1 | 91.0 | 0.72 | 6.9 | |
| | | 5.2 | | Δ | 87 | 19.1 | 91.8 | 0.70 | 12.3 | |
| 4 | | | 112 M | Y | 50 | 25.5 | 91.1 | 0.72 | 9.3 | 1FP1514-1BB2 ■■■■■ |
| | 4.55 | | | Y | 60 | 24.0 | 91.0 | 0.73 | 9.0 | |
| | | 6.9 | | Δ | 87 | 25.5 | 92.3 | 0.71 | 16.2 | |
| 5.5 | | | 132 S | Y | 50 | 35 | 91.9 | 0.72 | 12.6 | 1FP1514-1CB0 ■■■■■ |
| | 6.3 | | | Y | 60 | 33.5 | 92.4 | 0.73 | 12.3 | |
| | | 9.6 | | Δ | 87 | 35 | 92.8 | 0.71 | 22 | |
| 7.5 | | | 132 M | Y | 50 | 47.5 | 92.6 | 0.72 | 17.1 | 1FP1514-1CB2 ■■■■■ |
| | 8.6 | | | Y | 60 | 45.5 | 92.4 | 0.73 | 16.7 | |
| | | 13.1 | | Δ | 87 | 47.5 | 93.3 | 0.70 | 30.5 | |
| 11 | | | 160 M | Y | 50 | 70 | 93.3 | 0.72 | 25.0 | 1FP1514-1DB2 ■■■■■ |
| | 12.6 | | | Y | 60 | 67 | 93.6 | 0.73 | 24.0 | |
| | | 19.1 | | Δ | 87 | 70 | 93.6 | 0.71 | 43.5 | |
| 15 | | | 160 L | Y | 50 | 95 | 93.9 | 0.71 | 34.0 | 1FP1514-1DB4 ■■■■■ |
| | 17.3 | | | Y | 60 | 90 | 94.5 | 0.72 | 33.5 | |
| | | 26 | | Δ | 87 | 95 | 94.1 | 0.71 | 59.0 | |
| 18.5 | | | 180 M | Y | 50 | 118.0 | 94.2 | 0.71 | 42.0 | 1FP1514-1EB2 ■■■■■ |
| | 21.3 | | | Y | 60 | 113.0 | 94.5 | 0.72 | 41.0 | |
| | | 32 | | Δ | 87 | 118.0 | 95.0 | 0.71 | 73.0 | |
| 22 | | | 180 L | Y | 50 | 140.0 | 94.5 | 0.71 | 50.0 | 1FP1514-1EB4 ■■■■■ |
| | 25.3 | | | Y | 60 | 134.0 | 94.5 | 0.72 | 49.0 | |
| | | 38.1 | | Δ | 87 | 140.0 | 93.9 | 0.70 | 87.0 | |
| 30 | | | 200 L | Y | 50 | 191.0 | 95.2 | 0.71 | 68.0 | 1FP1514-2AB5 ■■■■■ |
| | 34.5 | | | Y | 60 | 183.0 | 95.4 | 0.72 | 66.0 | |
| | | 52 | | Δ | 87 | 191.0 | 94.4 | 0.71 | 118.0 | |
| 37 | | | 225 S | Y | 50 | 236 | 95.2 | 0.75 | 79 | 1FP1514-2BB0 ■■■■■ |
| | 42.5 | | | Y | 60 | 225 | 95.4 | 0.75 | 78 | |
| | | 64 | | Δ | 87 | 236 | 95.4 | 0.75 | 136 | |
| 45 | | | 225 M | Y | 50 | 286 | 95.4 | 0.75 | 96 | 1FP1514-2BB2 ■■■■■ |
| | 52 | | | Y | 60 | 276 | 95.8 | 0.75 | 95 | |
| | | 78 | | Δ | 87 | 286 | 95.6 | 0.75 | 165 | |

For versions, see Article No. supplements and special versions.

■■■■■

All technical specifications refer to converter operation.

Synchronous reluctance motors for SINAMICS converters – VSD4000 line

Super Premium Efficiency

Cast-iron series SIMOTICS SD 1FP1514, line voltage 400 V, 50 Hz/460 V, 60 Hz/400 V, 87 Hz – self-ventilated

| Motor type | $m_{IM B3}$ | J | L_{pFA} , tolerance +3 dB(A) load | L_{WA} , tolerance +3 dB(A) load | Mech. speed limit | Terminal box | Converter | Frame size | IES class acc. to EN 50598-2 |
|--------------------|-------------|------------------|--|---|----------------------|-----------------|---|------------|------------------------------------|
| | | | | | | | SINAMICS G120 – PM240-2 Operating mode: Low overload | | |
| | kg | kgm ² | dB(A) | dB(A) | rpm | Type | Type ¹⁾ | | |
| 1FP1514-0DB2-..... | 19 | 0.0019 | 66.0 | 78.0 | 3200 | TB1D01 | 6SL3210-1PE11-8.L0 | FSA | IES 2 |
| | | | 67.0 | 79.0 | | | 6SL3210-1PE11-8.L0 | FSA | IES 2 |
| | | | 69.0 | 81.0 | | | 6SL3210-1PE13-2.L0 | FSA | IES 2 |
| 1FP1514-0DB3-..... | 22.5 | 0.0025 | 66.0 | 78.0 | 3200 | TB1D01 | 6SL3210-1PE12-3.L0 | FSA | IES 2 |
| | | | 67.0 | 79.0 | | | 6SL3210-1PE12-3.L0 | FSA | IES 2 |
| | | | 69.0 | 81.0 | | | 6SL3210-1PE14-3.L0 | FSA | IES 2 |
| 1FP1514-0EB0-..... | 18 | 0.0034 | 58.0 | 70.0 | 3200 | TB1D01 | 6SL3210-1PE13-2.L1 | FSA | IES 2 |
| | | | 59.0 | 71.0 | | | 6SL3210-1PE13-2.L1 | FSA | IES 2 |
| | | | 69.0 | 81.0 | | | 6SL3210-1PE16-1.L1 | FSA | IES 2 |
| 1FP1514-0EB4-..... | 26 | 0.0043 | 58.0 | 70.0 | 3200 | TB1D01 | 6SL3210-1PE14-3.L1 | FSA | IES 2 |
| | | | 59.0 | 71.0 | | | 6SL3210-1PE14-3.L1 | FSA | IES 2 |
| | | | 69.0 | 81.0 | | | 6SL3210-1PE18-0.L1 | FSA | IES 2 |
| 1FP1514-1BB0-..... | 46 | 0.0092 | 58.0 | 70.0 | 3200 | TB1F01 | 6SL3210-1PE16-1.L1 | FSA | IES 2 |
| | | | 58.0 | | | | 6SL3210-1PE16-1.L1 | FSA | IES 2 |
| | | | 65.0 | 77.0 | | | 6SL3210-1PE21-1.L0 | FSA | IES 2 |
| 1FP1514-1BB1-..... | 46 | 0.0092 | 59.0 | 71.0 | 3200 | TB1F01 | 6SL3210-1PE18-0.L1 | FSA | IES 2 |
| | | | 59.0 | | | | 6SL3210-1PE18-0.L1 | FSA | IES 2 |
| | | | 65.0 | 77.0 | | | 6SL3210-1PE21-4.L0 | FSA | IES 2 |
| 1FP1514-1BB2-..... | 51 | 0.0114 | 59.0 | 71.0 | 3200 | TB1F01 | 6SL3210-1PE21-1.L0 | FSA | IES 2 |
| | | | 60.0 | 72.0 | | | 6SL3210-1PE21-1.L0 | FSA | IES 2 |
| | | | 69.0 | 81.0 | | | 6SL3210-1PE21-8.L0 | FSB | IES 2 |
| 1FP1514-1CB0-..... | 68 | 0.0200 | 69.0 | 81.0 | 3200 | TB1H01 | 6SL3210-1PE21-4.L0 | FSB | IES 2 |
| | | | 68.0 | 80.0 | | | 6SL3210-1PE21-4.L0 | FSB | IES 2 |
| | | | 69.0 | 81.0 | | | 6SL3210-1PE22-7.L0 | FSC | IES 2 |
| 1FP1514-1CB2-..... | 80 | 0.0277 | 62.0 | 74.0 | 3200 | TB1H01 | 6SL3210-1PE21-8.L0 | FSB | IES 2 |
| | | | 64.0 | 76.0 | | | 6SL3210-1PE21-8.L0 | FSB | IES 2 |
| | | | 68.0 | 80.0 | | | 6SL3210-1PE23-3.L0 | FSC | IES 2 |
| 1FP1514-1DB2-..... | 105 | 0.0485 | 69.0 | 81.0 | 3200 | TB1J01 | 6SL3210-1PE22-7.L0 | FSC | IES 2 |
| | | | 70.0 | 82.0 | | | 6SL3210-1PE22-7.L0 | FSC | IES 2 |
| | | | 75.0 | 87.0 | | | 6SL3210-1PE23-8.L0 | FSD | IES 2 |
| 1FP1514-1DB4-..... | 120 | 0.0624 | 71.0 | 83.0 | 3200 | TB1J01 | 6SL3210-1PE23-3.L0 | FSC | IES 2 |
| | | | 72.0 | 84.0 | | | 6SL3210-1PE23-3.L0 | FSC | IES 2 |
| | | | 76.0 | 88.0 | | | 6SL3210-1PE26-0.L0 | FSD | IES 2 |
| 1FP1514-1EB2-..... | 166 | 0.1155 | 69.0 | 82.0 | 3000 | TB1J01 | 6SL3210-1PE23-8.L0 | FSD | IES 2 |
| | | | 70.0 | 83.0 | | | 6SL3210-1PE24-5.L0 | FSD | IES 2 |
| | | | 76.0 | 89.0 | | | 6SL3210-1PE27-5.L0 | FSE | IES 2 |
| 1FP1514-1EB4-..... | 182 | 0.1315 | 69.0 | 82.0 | 3000 | TB1J01 | 6SL3210-1PE24-5.L0 | FSD | IES 2 |
| | | | 70.0 | 83.0 | | | 6SL3210-1PE26-0.L0 | FSD | IES 2 |
| | | | 76.0 | 89.0 | | | 6SL3210-1PE28-8.L0 | FSE | IES 2 |
| 1FP1514-2AB5-..... | 220 | 0.1884 | 68.0 | 81.0 | 3000 | TB1L01 | 6SL3210-1PE26-0.L0 | FSE | IES 2 |
| | | | 70.0 | 83.0 | | | 6SL3210-1PE27-5.L0 | FSD | IES 2 |
| | | | 73.0 | 86.0 | | | 6SL3210-1PE31-5.L0 | FSF | IES 2 |
| 1FP1514-2BB0-..... | 320 | 0.442 | 70.0 | 84.0 | 3000 | TB1L01 | 6SL3210-1PE28-8.L0 | FSE | IES 2 |
| | | | 71.0 | 85.0 | | | 6SL3210-1PE28-8.L0 | FSE | IES 2 |
| | | | 77.0 | 91.0 | | | 6SL3210-1PE31-5.L0 | FSF | IES 2 |
| 1FP1514-2BB2-..... | 365 | 0.518 | 70.0 | 84.0 | 3000 | TB1L01 | 6SL3210-1PE31-1.L0 | FSE | IES 2 |
| | | | 71.0 | 85.0 | | | 6SL3210-1PE31-1.L0 | FSE | IES 2 |
| | | | 77.0 | 91.0 | | | 6SL3210-1PE31-8.L0 | FSF | IES 2 |

¹⁾ In addition to the Power Module, a CU230P-2 Control Unit and an Operator Panel are required (see Catalog D 31 and/or D 35).

Synchronous reluctance motors for SINAMICS converters – VSD4000 line

Article No. supplements and special versions · Voltages

Aluminum series SIMOTICS GP 1FP1014

Selection and ordering data

| Voltages | Article No. | supplement | Frame size | | | | | | Motor version |
|---------------------------|---|---|----------------|--------------------------|--------------------------|--------------------------|--------------------------|--------------------------|--------------------------|
| | | | 80 | 90 | 112 | 132 | 160 | 180 | |
| | Voltage code | Additional identification code with order code and plain text if required | 1FP1014 | | | | | | Super Premium Efficiency |
| | 12th and 13th position of the Article No. | | | | | | | | |
| | 1FP1014-... - ... | | Order code | | | | | | |
| Voltage at 50 Hz or 60 Hz | | | | | | | | | |
| Line voltage: | 2 | 1 | - | <input type="checkbox"/> | <input type="checkbox"/> | <input type="checkbox"/> | <input type="checkbox"/> | <input type="checkbox"/> | <input type="checkbox"/> |
| 50 Hz, 400 V | | | | | | | | | |
| 60 Hz, 480 V | | | | | | | | | |

Standard version

Synchronous reluctance motors for SINAMICS converters – VSD4000 line

Article No. supplements and special versions · Voltages

Cast-iron series SIMOTICS SD 1FP1514

Selection and ordering data

| Voltages | Article No. supplement | Voltage code 12th and 13th posi- tion of the Article No. | Additional identifica- tion code with order code and plain text if required | Frame size | | | | | | | Motor version |
|---------------------------|------------------------|--|---|--------------------------|--------------------------|--------------------------|--------------------------|--------------------------|--------------------------|--------------------------|--------------------------|
| | | | | 80 | 90 | 112 | 132 | 160 | 180 | 200 | 225 |
| | | | | 1FP1514 | | | | | | | |
| | 1FP1514- | ■ - ■ . . . | Order code | | | | | | | | |
| Voltage at 50 Hz or 60 Hz | | | | | | | | | | | |
| Line voltage: | 2 | 1 | - | <input type="checkbox"/> | <input type="checkbox"/> | <input type="checkbox"/> | <input type="checkbox"/> | <input type="checkbox"/> | <input type="checkbox"/> | <input type="checkbox"/> | <input type="checkbox"/> |
| 50 Hz, 400 V | | | | | | | | | | | |
| 60 Hz, 480 V | | | | | | | | | | | |













Standard version

Synchronous reluctance motors for SINAMICS converters – VSD4000 line

Article No. supplements and special versions · Types of construction

Aluminum series SIMOTICS GP 1FP1014

Selection and ordering data

| Types of construction | Article No. supplement | Type of construction code letter 14th position of the Article No. | For types of construction with order code(s) Article No. with additional identification code -Z | Frame size | | | | | | Motor version |
|---|---|---|--|-------------------------------------|-------------------------------------|-------------------------------------|-------------------------------------|-------------------------------------|-------------------------------------|-------------------------------------|
| | | | | 80 | 90 | 112 | 132 | 160 | 180 | |
| | | | | 1FP1014 | | | | | | Super Premium Efficiency |
| | | 1FP1014- | .. (-Z) | | | | | | | |
| Without flange | | | | | | | | | | |
| IM B3 ^{1) 2)} |  | A | - | <input type="checkbox"/> | <input type="checkbox"/> | <input type="checkbox"/> | <input type="checkbox"/> | <input type="checkbox"/> | <input type="checkbox"/> | <input type="checkbox"/> |
| IM B6 ²⁾ |  | T | - | <input type="checkbox"/> | <input type="checkbox"/> | <input type="checkbox"/> | <input type="checkbox"/> | <input type="checkbox"/> | <input type="checkbox"/> | <input type="checkbox"/> |
| IM B7 ²⁾ |  | U | - | <input type="checkbox"/> | <input type="checkbox"/> | <input type="checkbox"/> | <input type="checkbox"/> | <input type="checkbox"/> | <input type="checkbox"/> | <input type="checkbox"/> |
| IM B8 ²⁾ |  | V | - | <input type="checkbox"/> | <input type="checkbox"/> | <input type="checkbox"/> | <input type="checkbox"/> | <input type="checkbox"/> | <input type="checkbox"/> | <input type="checkbox"/> |
| IM V6 ²⁾ |  | D | - | <input type="checkbox"/> | <input type="checkbox"/> | <input type="checkbox"/> | <input type="checkbox"/> | <input type="checkbox"/> | <input type="checkbox"/> | <input type="checkbox"/> |
| IM V5 without protective cover ²⁾ |  | C | - | <input type="checkbox"/> | <input type="checkbox"/> | <input type="checkbox"/> | <input type="checkbox"/> | <input type="checkbox"/> | <input type="checkbox"/> | <input type="checkbox"/> |
| IM V5 with protective cover ^{2) 3) 4)} |  | C | H00 | <input checked="" type="checkbox"/> | <input checked="" type="checkbox"/> | <input checked="" type="checkbox"/> | <input checked="" type="checkbox"/> | <input checked="" type="checkbox"/> | <input checked="" type="checkbox"/> | <input checked="" type="checkbox"/> |
| With flange | | | | | | | | | | |
| | | Acc. to EN 50347 | | FF165 | FF165 | FF215 | FF265 | FF300 | FF300 | FF350 |
| | | Acc. to DIN 42948 | | A 200 | A 200 | A 250 | A 300 | A 350 | A 350 | A 400 |
| IM B5 ^{2) 5)} |  | F | - | <input checked="" type="checkbox"/> | <input checked="" type="checkbox"/> | <input checked="" type="checkbox"/> | <input checked="" type="checkbox"/> | <input checked="" type="checkbox"/> | <input checked="" type="checkbox"/> | <input checked="" type="checkbox"/> |
| IM V1 without protective cover ²⁾ |  | G | - | <input checked="" type="checkbox"/> | <input checked="" type="checkbox"/> | <input checked="" type="checkbox"/> | <input checked="" type="checkbox"/> | <input checked="" type="checkbox"/> | <input checked="" type="checkbox"/> | <input checked="" type="checkbox"/> |
| IM V1 with protective cover ^{2) 4)} |  | G | H00 | <input checked="" type="checkbox"/> | <input checked="" type="checkbox"/> | <input checked="" type="checkbox"/> | <input checked="" type="checkbox"/> | <input checked="" type="checkbox"/> | <input checked="" type="checkbox"/> | <input checked="" type="checkbox"/> |
| IM V3 ³⁾ |  | H | - | <input checked="" type="checkbox"/> | <input checked="" type="checkbox"/> | <input checked="" type="checkbox"/> | <input checked="" type="checkbox"/> | <input checked="" type="checkbox"/> | <input checked="" type="checkbox"/> | <input checked="" type="checkbox"/> |
| IM B35 |  | J | - | <input checked="" type="checkbox"/> | <input checked="" type="checkbox"/> | <input checked="" type="checkbox"/> | <input checked="" type="checkbox"/> | <input checked="" type="checkbox"/> | <input checked="" type="checkbox"/> | <input checked="" type="checkbox"/> |

For legends and footnotes, see page 4/56.

Synchronous reluctance motors for SINAMICS converters – VSD4000 line

Article No. supplements and special versions · Types of construction

Aluminum series SIMOTICS GP 1FP1014

| Types of construction | Article No. supplement | Frame size | Motor version | | | | | | | |
|---|---|--|----------------|-------|-------|-------|-------|-------|-------|--------------------------|
| | | | 80 | 90 | 112 | 132 | 160 | 180 | 200 | |
| | Type of construction code letter 14th position of the Article No. | For types of construction with order code(s) Article No. with additional identification code -Z | 1FP1014 | | | | | | | Super Premium Efficiency |
| 1FP1014-.....-.. (-Z) | .. (-Z) | Order code | | | | | | | | |
| With flange next largest | Acc. to EN 50347 | | | FF215 | FF265 | FF300 | - | - | - | |
| | Acc. to DIN 42948 | | | A 250 | A 300 | A 350 | - | - | - | |
| IM B5 ^{2) 5)} | F | P01 | - | ✓ | ✓ | ✓ | - | - | - | |
| IM V1 without protective cover ²⁾ | G | P01 | - | ✓ | ✓ | ✓ | - | - | - | |
| IM V1 with protective cover ^{2) 4) 5) 6)} | G | P01+H00 | - | ✓ | ✓ | ✓ | - | - | - | |
| IM V3 ⁴⁾ | H | P01 | - | ✓ | ✓ | ✓ | - | - | - | |
| IM V18 with protective cover ^{2) 3) 4) 5)} | M | H00 | - | ✓ | ✓ | ✓ | - | - | - | |
| With flange next smallest | Acc. to EN 50347 | | FF130 | - | FF165 | FF215 | FF265 | FF265 | FF300 | |
| | Acc. to DIN 42948 | | A 160 | - | A 200 | A 250 | A 300 | A 300 | A 350 | |
| IM B5 ^{2) 6)} | F | P02 | ✓ | - | ✓ | ✓ | ✓ | ✓ | ✓ | |
| IM V1 without protective cover ²⁾ | G | P02 | ✓ | - | ✓ | ✓ | ✓ | ✓ | ✓ | |
| IM V1 with protective cover ^{2) 4) 5) 6)} | G | P02+H00 | ✓ | - | ✓ | ✓ | ✓ | ✓ | ✓ | |
| IM V3 ⁴⁾ | H | P02 | ✓ | - | ✓ | ✓ | ✓ | ✓ | ✓ | |
| IM B35 ³⁾ | J | P02 | ✓ | - | ✓ | ✓ | ✓ | ✓ | ✓ | |

Synchronous reluctance motors for SINAMICS converters – VSD4000 line

Article No. supplements and special versions · Types of construction

Aluminum series SIMOTICS GP 1FP1014

| Types of construction | Article No. supplement | Frame size | Motor version | | | | | | |
|---|---|--|--------------------------|----------------|----------------|----------------|-----|-----|-----|
| | | | 80 | 90 | 112 | 132 | 160 | 180 | 200 |
| | Type of construction code letter 14th position of the Article No. | For types of construction with order code(s) Article No. with additional identification code -Z | 1FP1014 | | | | | | |
| | Order code | | Super Premium Efficiency | | | | | | |
| 1FP1014-.....-..-..(-Z) | | | | | | | | | |
| With flange | Acc. to EN 50347 Acc. to DIN 42948 | FT100 C 120 | FT115 C 140 | FT130 C 160 | FT165 C 200 | FT215 C 250 | - | - | |
| IM B14 ^{2) 6)} | K | ✓ | ✓ | ✓ | ✓ | ✓ | - | - | |
| IM V19 ²⁾ | L | ✓ | ✓ | ✓ | ✓ | ✓ | - | - | |
| IM V18 without protective cover ²⁾ | M | ✓ | ✓ | ✓ | ✓ | ✓ | - | - | |
| IM V18 with protective cover ^{2) 4) 5) 6)} | M | H00 | ✓ | ✓ | ✓ | ✓ | - | - | |
| IM B34 ³⁾ | N | ✓ | ✓ | ✓ | ✓ | ✓ | - | - | |
| With flange next largest | Acc. to EN 50347 Acc. to DIN 42948 | FT130 C 160 | FT130 C 160 | FT165 C 200 | FT215 C 250 | - | - | - | |
| IM B14 ^{2) 6)} | K | P01 | ✓ | ✓ | ✓ | ✓ | - | - | |
| IM V19 ²⁾ | L | P01 | ✓ | ✓ | ✓ | ✓ | - | - | |
| IM V18 without protective cover ²⁾ | M | P01 | ✓ | ✓ | ✓ | ✓ | - | - | |
| IM V18 with protective cover ^{2) 4) 5) 6)} | M | P01+H00 | ✓ | ✓ | ✓ | ✓ | - | - | |
| IM B34 ³⁾ | N | P01 | ✓ | ✓ | ✓ | ✓ | - | - | |

- Standard version
- ✓ With additional charge
- O. R. Possible on request
- Not possible

- 1) The types of construction IM B6/7/8, IM V6, and IM V5 with/without protective cover are also possible as long as no condensation drainage holes (order code **H03**) and no stamping of these types of construction on the rating plate are required. As standard the type of construction IM B3 is then stamped on the rating plate. With type of construction IM V5 with protective cover, the protective cover has to be additionally ordered with order code **H00**. The protective cover is not stamped on the rating plate.
- 2) The type of construction is stamped on the rating plate. For orders with condensation drainage holes (order code **H03**), if mounted in a different position, the position must be specified to ensure that the condensation drainage holes are positioned correctly.
- 3) The "Second shaft extension" option (order code **L05**) is not possible.
- 4) In combination with an encoder, it is not necessary to order the protective cover (order code **H00**), as this is delivered as a protection for the encoder as standard. In this case the protective cover is standard version (without additional charge).













- 5) The types of construction IM V3 and IM V1 with/without protective cover are also possible as long as no condensation drainage holes (order code **H03**) and no stamping of these types of construction on the rating plate are required. As standard the type of construction IM B5 is then stamped on the rating plate. With type of construction IM V1 with protective cover, the protective cover has to be additionally ordered with order code **H00**. The protective cover is not stamped on the rating plate.
- 6) The types of construction IM V19 and IM V18 with/without protective cover are also possible as long as no condensation drainage holes (order code **H03**) and no stamping of these types of construction on the rating plate are required. As standard the type of construction IM B14 is then stamped on the rating plate. With type of construction IM V18 with protective cover, the protective cover has to be additionally ordered with order code **H00**. The protective cover is not stamped on the rating plate.

Synchronous reluctance motors for SINAMICS converters – VSD4000 line

Article No. supplements and special versions · Types of construction

Cast-iron series SIMOTICS SD 1FP1514

Selection and ordering data

| Types of construction | Article No. supplement | Type of construction code letter 14th position of the Article No. | For types of construction with order code(s) Article No. with additional identification code -Z Order code | Frame size | | | | | | | | Motor version |
|---|---|--|---|-------------------------------------|-------------------------------------|-------------------------------------|-------------------------------------|-------------------------------------|-------------------------------------|-------------------------------------|-------------------------------------|--------------------------|
| | | | | 80 | 90 | 112 | 132 | 160 | 180 | 200 | 225 | |
| 1FP1514-.....-...(-Z) | | | | 1FP1514 | | | | | | | | Super Premium Efficiency |
| Without flange | | | | | | | | | | | | |
| IM B3 ^{1) 2)} |  | A | - | <input type="checkbox"/> | <input type="checkbox"/> | <input type="checkbox"/> | <input type="checkbox"/> | <input type="checkbox"/> | <input type="checkbox"/> | <input type="checkbox"/> | <input type="checkbox"/> | |
| IM B6 ²⁾ |  | T | - | <input type="checkbox"/> | <input type="checkbox"/> | <input type="checkbox"/> | <input type="checkbox"/> | <input type="checkbox"/> | <input type="checkbox"/> | <input type="checkbox"/> | <input type="checkbox"/> | |
| IM B7 ²⁾ |  | U | - | <input type="checkbox"/> | <input type="checkbox"/> | <input type="checkbox"/> | <input type="checkbox"/> | <input type="checkbox"/> | <input type="checkbox"/> | <input type="checkbox"/> | <input type="checkbox"/> | |
| IM B8 ²⁾ |  | V | - | <input type="checkbox"/> | <input type="checkbox"/> | <input type="checkbox"/> | <input type="checkbox"/> | <input type="checkbox"/> | <input type="checkbox"/> | <input type="checkbox"/> | <input type="checkbox"/> | |
| IM V6 ²⁾ |  | D | - | <input type="checkbox"/> | <input type="checkbox"/> | <input type="checkbox"/> | <input type="checkbox"/> | <input type="checkbox"/> | <input type="checkbox"/> | <input type="checkbox"/> | <input type="checkbox"/> | |
| IM V5 without protective cover ²⁾ |  | C | - | <input type="checkbox"/> | <input type="checkbox"/> | <input type="checkbox"/> | <input type="checkbox"/> | <input type="checkbox"/> | <input type="checkbox"/> | <input type="checkbox"/> | <input type="checkbox"/> | |
| IM V5 with protective cover ^{2) 3) 4)} |  | C | H00 | <input checked="" type="checkbox"/> | <input checked="" type="checkbox"/> | <input checked="" type="checkbox"/> | <input checked="" type="checkbox"/> | <input checked="" type="checkbox"/> | <input checked="" type="checkbox"/> | <input checked="" type="checkbox"/> | <input checked="" type="checkbox"/> | |
| With flange | | | | FF165 | FF165 | FF215 | FF265 | FF300 | FF300 | FF350 | FF400 | |
| | | | | A 200 | A 200 | A 250 | A 300 | A 350 | A 350 | A 400 | A 450 | |
| IM B5 ^{2) 5)} |  | F | - | <input checked="" type="checkbox"/> | <input checked="" type="checkbox"/> | <input checked="" type="checkbox"/> | <input checked="" type="checkbox"/> | <input checked="" type="checkbox"/> | <input checked="" type="checkbox"/> | <input checked="" type="checkbox"/> | <input checked="" type="checkbox"/> | |
| IM V1 without protective cover ²⁾ |  | G | - | <input checked="" type="checkbox"/> | <input checked="" type="checkbox"/> | <input checked="" type="checkbox"/> | <input checked="" type="checkbox"/> | <input checked="" type="checkbox"/> | <input checked="" type="checkbox"/> | <input checked="" type="checkbox"/> | <input checked="" type="checkbox"/> | |
| IM V1 with protective cover ^{2) 3) 4)} |  | G | H00 | <input checked="" type="checkbox"/> | <input checked="" type="checkbox"/> | <input checked="" type="checkbox"/> | <input checked="" type="checkbox"/> | <input checked="" type="checkbox"/> | <input checked="" type="checkbox"/> | <input checked="" type="checkbox"/> | <input checked="" type="checkbox"/> | |
| IM V3 ⁴⁾ |  | H | - | <input checked="" type="checkbox"/> | <input checked="" type="checkbox"/> | <input checked="" type="checkbox"/> | <input checked="" type="checkbox"/> | <input checked="" type="checkbox"/> | <input checked="" type="checkbox"/> | <input checked="" type="checkbox"/> | <input checked="" type="checkbox"/> | |
| IM B35 |  | J | - | <input checked="" type="checkbox"/> | <input checked="" type="checkbox"/> | <input checked="" type="checkbox"/> | <input checked="" type="checkbox"/> | <input checked="" type="checkbox"/> | <input checked="" type="checkbox"/> | <input checked="" type="checkbox"/> | <input checked="" type="checkbox"/> | |

Synchronous reluctance motors for SINAMICS converters – VSD4000 line

Article No. supplements and special versions · Types of construction

Cast-iron series SIMOTICS SD 1FP1514

| Types of construction | Article No. supplement | Frame size | Motor version | | | | | | | |
|---|--|---|----------------|----------------|----------------|----------------|----------------|----------------|----------------|--------------------------|
| | | | 80 | 90 | 112 | 132 | 160 | 180 | 200 | 225 |
| | Type of construction code letter 14th position of the Article No. | For types of construction with order code(s) Article No. with additional identification code -Z Order code | 1FP1514 | | | | | | | Super Premium Efficiency |
| 1FP1514-.....-...(-Z) | | | | | | | | | | |
| With flange next largest | Acc. to EN 50347 Acc. to DIN 42948 | | – | FF215 A 250 | FF265 A 300 | FF300 A 350 | – | – | – | – |
| IM B5 ^{2) 6)} | F | P01 | – | ✓ | ✓ | ✓ | – | – | – | – |
| IM V1 without protective cover ²⁾ | G | P01 | – | ✓ | ✓ | ✓ | – | – | – | – |
| IM V1 with protective cover ^{2) 4) 5)} | G | P01+H00 | – | ✓ | ✓ | ✓ | – | – | – | – |
| IM V3 ³⁾ | H | P01 | – | ✓ | ✓ | ✓ | – | – | – | – |
| IM B35 ³⁾ | J | P01 | – | ✓ | ✓ | ✓ | – | – | – | – |
| With flange next smallest | Acc. to EN 50347 Acc. to DIN 42948 | | FF130 A 160 | – | FF165 A 200 | FF215 A 250 | FF265 A 300 | FF265 A 300 | FF300 A 350 | – |
| IM B5 ^{2) 6)} | F | P02 | ✓ | – | ✓ | ✓ | ✓ | ✓ | ✓ | – |
| IM V1 without protective cover ²⁾ | G | P02 | ✓ | – | ✓ | ✓ | ✓ | ✓ | ✓ | – |
| IM V1 with protective cover ^{2) 4) 5)} | G | P02+H00 | ✓ | – | ✓ | ✓ | ✓ | ✓ | ✓ | – |
| IM V3 ⁴⁾ | H | P02 | ✓ | – | ✓ | ✓ | ✓ | ✓ | ✓ | – |
| IM B35 ³⁾ | J | P02 | ✓ | – | ✓ | ✓ | ✓ | ✓ | ✓ | – |











4

For legends and footnotes, see page 4/59.

Synchronous reluctance motors for SINAMICS converters – VSD4000 line

Article No. supplements and special versions · Types of construction

Cast-iron series SIMOTICS SD 1FP1514

| Types of construction | Article No. supplement | Frame size | Motor version | | | | | | | |
|--|--|---|----------------|----------------|----------------|-----|-----|-----|-----|--------------------------|
| | | | 80 | 90 | 112 | 132 | 160 | 180 | 200 | 225 |
| | Type of construction code letter 14th position of the Article No. | For types of construction with order code(s) Article No. with additional identification code -Z | 1FP1514 | | | | | | | Super Premium Efficiency |
| 1FP1514-.....-..-.. (-Z) | .. (-Z) | Order code | | | | | | | | |
| With flange | Acc. to EN 50347 Acc. to DIN 42948 | FT100 C 120 | FT130 C 160 | FT165 C 200 | FT215 C 250 | - | - | - | - | |
| IM B14 ^{2) 6)} |  K | - | - | ✓ | ✓ | ✓ | - | - | - | |
| IM V19 ²⁾ |  L | - | - | ✓ | ✓ | ✓ | - | - | - | |
| IM V18 without protective cover ²⁾ |  M | - | - | ✓ | ✓ | ✓ | - | - | - | |
| IM V18 with protective cover ^{2) 3) 4)} |  M | H00 | - | - | ✓ | ✓ | ✓ | - | - | |
| IM B34 |  N | - | ✓ | ✓ | ✓ | ✓ | ✓ | - | - | |
| With flange next largest | Acc. to EN 50347 Acc. to DIN 42948 | FT130 C 160 | FT130 C 160 | FT165 C 200 | FT215 C 250 | - | - | - | - | |
| IM B14 ^{2) 6)} |  K | P01 | ✓ | ✓ | ✓ | ✓ | - | - | - | |
| IM V19 ²⁾ |  L | P01 | ✓ | ✓ | ✓ | ✓ | - | - | - | |
| IM V18 without protective cover ²⁾ |  M | P01 | ✓ | ✓ | ✓ | ✓ | - | - | - | |
| IM V18 with protective cover ^{2) 3) 4)} |  M | P01+H00 | ✓ | ✓ | ✓ | ✓ | - | - | - | |
| IM B34 |  N | P01 | ✓ | ✓ | ✓ | ✓ | - | - | - | |

- Standard version
- ✓ With additional charge
- O. R. Possible on request
- Not possible

¹⁾ The types of construction IM B6/7/8, IM V6 and IM V5 with/without protective cover are also possible as long as no stamping of these types of construction on the rating plate is required. As standard the type of construction IM B3 is then stamped on the rating plate. With type of construction IM V5 with protective cover, the protective cover has to be additionally ordered with order code **H00**. The protective cover is not stamped on the rating plate.

²⁾ The type of construction is stamped on the rating plate. If mounted in a different position, the position must be specified to ensure that the condensation drainage holes are positioned correctly.

³⁾ In combination with an encoder, it is not necessary to order the protective cover (order code **H00**), as this is delivered as a protection for the encoder as standard. In this case the protective cover is standard design (without additional charge).

⁴⁾ The "Second shaft extension" option (order code **L05**) is not possible.

⁵⁾ The types of construction IM V3 and IM V1 with/without protective cover are also possible as long as no stamping of these types of construction on the rating plate is required. As standard the type of construction IM B5 is then stamped on the rating plate. With type of construction IM V1 with protective cover, the protective cover has to be additionally ordered with order code **H00**. The protective cover is not stamped on the rating plate.

⁶⁾ The types of construction IM V19 and IM V18 with/without protective cover are also possible as long as no stamping of these types of construction on the rating plate is required. As standard the type of construction IM B14 is then stamped on the rating plate. With type of construction IM V18 with protective cover, the protective cover has to be additionally ordered with order code **H00**. The protective cover is not stamped on the rating plate.

Synchronous reluctance motors for SINAMICS converters – VSD4000 line

Article No. supplements and special versions · Motor protection

Aluminum series SIMOTICS GP 1FP1014

Selection and ordering data

| Motor protection | Article No. supplement Motor protection code letter 15th position of the Article No. | Additional identification code with order code and plain text if required Order code | Frame size | | | | | | | Motor version |
|---|---|---|----------------|----|-----|-----|-----|-----|-----|--------------------------|
| | | | 80 | 90 | 112 | 132 | 160 | 180 | 200 | |
| | | | 1FP1014 | | | | | | | Super Premium Efficiency |
| 1FP1014- ■ . | | | | | | | | | | |
| Motor protection | | | | | | | | | | |
| 1 or 3 PTC thermistors – for tripping (2 terminals) ¹⁾ | B | – | ✓ | ✓ | ✓ | ✓ | ✓ | ✓ | ✓ | ✓ |
| 2 or 6 PTC thermistors – for alarm and tripping (4 terminals) ¹⁾ | C | – | ✓ | ✓ | ✓ | ✓ | ✓ | ✓ | ✓ | ✓ |
| 1 KTY84-130 temperature sensor (2 terminals) ¹⁾ | F | – | ✓ | ✓ | ✓ | ✓ | ✓ | ✓ | ✓ | ✓ |
| 2 KTY84-130 temperature sensors (4 terminals) ¹⁾ | G | – | ✓ | ✓ | ✓ | ✓ | ✓ | ✓ | ✓ | ✓ |
| 3 Pt100 resistance thermometers 2-wire input (6 terminals) ¹⁾ | H | – | – | – | ✓ | ✓ | ✓ | ✓ | ✓ | ✓ |
| 1 Pt1000 resistance thermometer (2 terminals) ²⁾ | K | – | ○ | ○ | ○ | ○ | ○ | ○ | ○ | ○ |
| 2 Pt1000 resistance thermometers (4 terminals) ²⁾ | L | – | ✓ | ✓ | ✓ | ✓ | ✓ | ✓ | ✓ | ✓ |
| 1 Pt100 resistance thermometer 2-wire input (2 terminals) | P | – | – | – | ✓ | ✓ | ✓ | ✓ | ✓ | ✓ |
| 3 Pt100 resistance thermometers 3-wire input (9 terminals) | Q | – | – | – | ✓ | ✓ | ✓ | ✓ | ✓ | ✓ |
| 6 Pt100 resistance thermometers 3-wire input (18 terminals) ¹⁾ | R | – | – | – | ✓ | ✓ | ✓ | ✓ | ✓ | ✓ |
| 3 bimetal sensors (NC contacts) for tripping (2 terminals) ¹⁾ | Z | Q3A | ✓ | ✓ | ✓ | ✓ | ✓ | ✓ | ✓ | ✓ |

- Without additional charge
- ✓ With additional charge
- Not possible

¹⁾ Evaluation with associated tripping unit (see Catalog IC 10) is recommended.

²⁾ Not UL-certified. Not in combination with option **D39**.

Synchronous reluctance motors for SINAMICS converters – VSD4000 line

Article No. supplements and special versions · Motor protection

Cast-iron series SIMOTICS SD 1FP1514

Selection and ordering data

| Motor protection | Article No. supplement | | Frame size | | | | | | | | Motor version |
|--|---|---|----------------|----|-----|-----|-----|-----|-----|-----|--------------------------|
| | Motor protection code letter 15th position of the Article No. | Additional identification code with order code and plain text if required | 80 | 90 | 112 | 132 | 160 | 180 | 200 | 225 | |
| | | | 1FP1514 | | | | | | | | Super Premium Efficiency |
| 1FP1514-.....-... ■ . | | Order code | | | | | | | | | |
| Motor protection | | | | | | | | | | | |
| 1 or 3 PTC thermistors – for tripping (2 terminals) ¹⁾ | B | – | ✓ | ✓ | ✓ | ✓ | ✓ | ✓ | ✓ | ✓ | ✓ |
| 2 or 6 PTC thermistors – for alarm and tripping (4 terminals) ¹⁾ | C | – | ✓ | ✓ | ✓ | ✓ | ✓ | ✓ | ✓ | ✓ | ✓ |
| 1 KTY84-130 temperature sensor (2 terminals) ¹⁾ | F | – | ✓ | ✓ | ✓ | ✓ | ✓ | ✓ | ✓ | ✓ | ✓ |
| 2 KTY84-130 temperature sensors (4 terminals) ¹⁾ | G | – | ✓ | ✓ | ✓ | ✓ | ✓ | ✓ | ✓ | ✓ | ✓ |
| 3 Pt100 resistance thermometers 2-wire input (6 terminals) ¹⁾ | H | – | ✓ | ✓ | ✓ | ✓ | ✓ | ✓ | ✓ | ✓ | ✓ |
| 1 Pt1000 resistance thermometer (2 terminals) ²⁾ | K | – | ○ | ○ | ○ | ○ | ○ | ○ | ○ | ○ | ✓ |
| 2 Pt1000 resistance thermometers (4 terminals) ²⁾ | L | – | – | – | ✓ | ✓ | ✓ | ✓ | ✓ | ✓ | ✓ |
| 1 Pt100 resistance thermometer – 2-wire input (2 terminals) | P | – | – | – | ✓ | ✓ | ✓ | ✓ | ✓ | ✓ | ✓ |
| 3 Pt100 resistance thermometers – 3-wire input (9 terminals) | Q | – | – | – | ✓ | ✓ | ✓ | ✓ | ✓ | ✓ | ✓ |
| 6 Pt100 resistance thermometers – 3-wire input (18 terminals) | R | – | – | – | ✓ | ✓ | ✓ | ✓ | ✓ | ✓ | ✓ |
| 3 NTC thermistors – for tripping (6 terminals) ²⁾ | Z | Q2A | ✓ | ✓ | ✓ | ✓ | ✓ | – | – | – | – |
| 3 bimetal sensors (NC contacts) for tripping (2 terminals) ¹⁾ | Z | Q3A | ✓ | ✓ | ✓ | ✓ | ✓ | ✓ | ✓ | ✓ | ✓ |
| 6 × bimetal sensors (NC contacts) for alarm and tripping (4 terminals) ¹⁾ | Z | Q9A | – | – | ✓ | ✓ | ✓ | ✓ | ✓ | ✓ | ✓ |

- Without additional charge
- ✓ With additional charge
- Not possible

¹⁾ Evaluation with associated tripping unit (see Catalog IC 10) is recommended.

²⁾ Not UL-certified. Not in combination with option **D39**.

Synchronous reluctance motors for SINAMICS converters – VSD4000 line

Article No. supplements and special versions · Terminal box position

Aluminum series SIMOTICS GP 1FP1014

Selection and ordering data

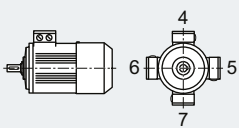
| Terminal box position | Article No. supplement | Frame size | Motor version |
|--|--|--|--------------------------|
|  1FP1014-.....-.... | Terminal box position code 16th position of the Article No. Additional identification code with order code and plain text if required Order code | 80 90 112 132 160 180 200 | Super Premium Efficiency |
| | | 1FP1014 | |

| Terminal box position | | 80 | 90 | 112 | 132 | 160 | 180 | 200 |
|--|---|----|----|-----|-----|-----|-----|-----|
| Terminal box top ¹⁾ | 4 | ☐ | ☐ | ☐ | ☐ | ☐ | ☐ | ☐ |
| Terminal box right-hand side ²⁾ | 5 | ✓ | ✓ | ✓ | ✓ | ✓ | ✓ | ✓ |
| Terminal box left-hand side ²⁾ | 6 | ✓ | ✓ | ✓ | ✓ | ✓ | ✓ | ✓ |
| Terminal box bottom ²⁾ | 7 | – | – | ✓ | ✓ | – | – | – |

- ☐ Standard version
 ✓ With additional charge

¹⁾ For types of construction with feet, cast feet are standard. Screwed-on feet are available with order code **H01**.

²⁾ For types of construction with feet, screwed-on feet are standard.

Synchronous reluctance motors for SINAMICS converters – VSD4000 line

Article No. supplements and special versions · Terminal box position

Cast-iron series SIMOTICS SD 1FP1514

Selection and ordering data

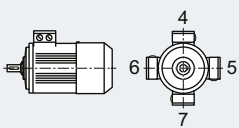
| Terminal box position | Article No. supplement | Frame size | | | | | | | Motor version |
|--|---|------------|----|-----|-----|-----|-----|-----|--------------------------|
| | | 80 | 90 | 112 | 132 | 160 | 180 | 200 | |
|  1FP1514-.....-.... | Terminal box position code 16th position of the Article No. | 1FP1514 | | | | | | | Super Premium Efficiency |
| | Additional identification code with order code and plain text if required | | | | | | | | |
| | Order code | | | | | | | | |

| Terminal box position | | | | | | | | | | | |
|--|---|---|---|---|---|---|---|---|---|---|---|
| Terminal box top ¹⁾ | 4 | – | ☐ | ☐ | ☐ | ☐ | ☐ | ☐ | ☐ | ☐ | ☐ |
| Terminal box right-hand side ²⁾ | 5 | – | ✓ | ✓ | ✓ | ✓ | ✓ | ✓ | ✓ | ✓ | ✓ |
| Terminal box left-hand side ²⁾ | 6 | – | ✓ | ✓ | ✓ | ✓ | ✓ | ✓ | ✓ | ✓ | ✓ |
| Terminal box bottom ²⁾ | 7 | – | – | – | ✓ | ✓ | ✓ | – | – | – | – |

- ☐ Standard version
 ✓ With additional charge

¹⁾ For types of construction with feet, cast feet are standard. Screwed-on feet are available with order code **H01**.

²⁾ For types of construction with feet, screwed-on feet are standard.

Synchronous reluctance motors for SINAMICS converters – VSD4000 line

Article No. supplements and special versions · Options

Aluminum series SIMOTICS GP 1FP1014**Selection and ordering data**

| Special versions | Additional identification code -Z with order code and plain text if required | Frame size | | | | | | | Motor version |
|--|--|----------------|----|-------|-------|-------|-------|-------|--------------------------|
| | | 80 | 90 | 112 | 132 | 160 | 180 | 200 | |
| | | 1FP1014 | | | | | | | Super Premium Efficiency |
| 1FP1014-.....-.....-Z | Order code | | | | | | | | |
| Motor protection | | | | | | | | | |
| 1 or 3 PTC thermistors – for tripping (2 terminals) ^{2) 3)} | Q11 | ✓ | ✓ | ✓ | ✓ | ✓ | ✓ | ✓ | |
| 2 or 6 PTC thermistors – for alarm and tripping (4 terminals) ³⁾ | Q12 | ✓ | ✓ | ✓ | ✓ | ✓ | ✓ | ✓ | |
| 1 KTY84-130 temperature sensor (2 terminals) ³⁾ | Q23 | ✓ | ✓ | ✓ | ✓ | ✓ | ✓ | ✓ | |
| 2 KTY84-130 temperature sensor (4 terminals) ³⁾ | Q25 | ✓ | ✓ | ✓ | ✓ | ✓ | ✓ | ✓ | |
| 3 bimetal sensors (NC contacts) for tripping (2 terminals) ³⁾ | Q31 | ✓ | ✓ | ✓ | ✓ | ✓ | ✓ | ✓ | |
| 6 bimetal sensors (NC contacts) for alarm and tripping (4 terminals) | Q32 | ✓ | ✓ | ✓ | ✓ | ✓ | ✓ | ✓ | |
| 3 bimetal sensors (NC contacts) for tripping (6 terminals) | Q33 | – | – | – | – | – | ✓ | ✓ | |
| 6 bimetal sensors (NC contacts) for alarm and tripping (12 terminals) | Q34 | – | – | – | – | – | ✓ | ✓ | |
| 1 Pt1000 resistance thermometer (2 terminals) ¹⁹⁾ | Q35 | ○ | ○ | ○ | ○ | ○ | ○ | ○ | |
| 2 Pt1000 resistance thermometers (4 terminals) ¹⁹⁾ | Q36 | ✓ | ✓ | ✓ | ✓ | ✓ | ✓ | ✓ | |
| 3 Pt100 resistance thermometers – 2-wire input (6 terminals) | Q60 | – | – | ✓ | ✓ | ✓ | ✓ | ✓ | |
| 6 Pt100 resistance thermometers – 2-wire input (12 terminals) | Q61 | – | – | ✓ | ✓ | ✓ | ✓ | ✓ | |
| 1 Pt100 resistance thermometer – 2-wire input (2 terminals) | Q62 | – | – | ✓ | ✓ | ✓ | ✓ | ✓ | |
| 3 Pt100 resistance thermometers – 3-wire input (9 terminals) | Q63 | – | – | ✓ | ✓ | ✓ | ✓ | ✓ | |
| 6 Pt100 resistance thermometers – 3-wire input (18 terminals) | Q64 | – | – | ✓ | ✓ | ✓ | ✓ | – | |
| 2 Pt100 resistance thermometers in basic configuration for bearings (2 terminals) | Q72 | – | – | O. R. | O. R. | O. R. | ✓ | ✓ | |
| 2 Pt100 resistance thermometers in 3-wire input for bearings (6 terminals) | Q78 | – | – | O. R. | O. R. | O. R. | ✓ | ✓ | |
| 2 Pt100 double resistance thermometers in 3-wire input for bearings (12 terminals) | Q79 | – | – | O. R. | O. R. | O. R. | ✓ | ✓ | |
| Motor connection and terminal box | | | | | | | | | |
| External grounding | H04 | ✓ | ✓ | ✓ | ✓ | ✓ | ✓ | ✓ | |
| Terminal box on NDE ¹⁾ | H08 | ✓ | ✓ | ✓ | ✓ | ✓ | ✓ | ✓ | |
| Rotation of the terminal box through 90°, entry from DE ²⁾ | R10 | ○ | ○ | ○ | ○ | ○ | ✓ | ✓ | |
| Rotation of the terminal box through 90°, entry from NDE | R11 | ○ | ○ | ○ | ○ | ○ | ✓ | ✓ | |
| Rotation of the terminal box through 180° | R12 | ○ | ○ | ○ | ○ | ○ | ✓ | ✓ | |
| Terminal box in position 0°; connection from right ²⁰⁾ | R13 | ○ | ○ | ○ | ○ | – | – | – | |
| One metal cable gland | R15 | ✓ | ✓ | ✓ | ✓ | ✓ | ✓ | ✓ | |
| Metal cable gland, maximum configuration | R18 | ✓ | ✓ | ✓ | ✓ | ✓ | ✓ | ✓ | |
| 3 cables protruding, 0.5 m long | R20 | ✓ | ✓ | ✓ | ✓ | ✓ | – | – | |
| 3 cables protruding, 1.5 m long | R21 | ✓ | ✓ | ✓ | ✓ | ✓ | O. R. | O. R. | |
| 6 cables protruding, 0.5 m long | R22 | ✓ | ✓ | ✓ | O. R. | O. R. | O. R. | O. R. | |
| 6 cables protruding, 1.5 m long | R23 | ✓ | ✓ | ✓ | ✓ | ✓ | O. R. | O. R. | |
| 6 cables protruding, 3 m long | R24 | ✓ | ✓ | ✓ | ✓ | ✓ | O. R. | O. R. | |
| Larger terminal box | R50 | ✓ | ✓ | ✓ | ✓ | ✓ | ✓ | ✓ | |
| Motor connector Han-Drive 10e for 230 VΔ/400 VY | R70 | ✓ | ✓ | ✓ | ✓ | – | – | – | |
| Motor connector EMC Han-Drive 10e for 230 VΔ/400 VY | R71 | ✓ | ✓ | ✓ | ✓ | – | – | – | |

For legends and footnotes, see page 4/67.

Synchronous reluctance motors for SINAMICS converters – VSD4000 line

Article No. supplements and special versions · Options

Aluminum series SIMOTICS GP 1FP1014

| Special versions | Additional identification code -Z with order code and plain text if required | Frame size | | | | | | | Motor version |
|--|--|----------------|-------|-------|-------|-------|-----|-----|--------------------------------|
| | | 80 | 90 | 112 | 132 | 160 | 180 | 200 | |
| | | 1FP1014 | | | | | | | Super Premium Efficiency |
| 1FP1014-.....-.....-Z | Order code | | | | | | | | |
| Windings and insulation | | | | | | | | | |
| Temperature class 180 (H) at rated power and max. CT 60 °C ³⁾ | N11 | ✓ | ✓ | ✓ | ✓ | ✓ | ✓ | ✓ | |
| Increased air humidity/temperature with 30 to 60 g water per m ³ of air | N30 | ✓ | ✓ | ✓ | ✓ | ✓ | ✓ | ✓ | |
| Increased air humidity/temperature with 60 to 100 g water per m ³ of air | N31 | ✓ | ✓ | ✓ | ✓ | ✓ | ✓ | ✓ | |
| Colors and paint finish | | | | | | | | | |
| Standard paint finish C2 in RAL 7030 stone gray | | □ | □ | □ | □ | □ | □ | □ | |
| Unpainted (only cast-iron parts primed) | S00 | ○ | ○ | ○ | ○ | ○ | ○ | ○ | |
| Unpainted, only primed | S01 | ✓ | ✓ | ✓ | ✓ | ✓ | ✓ | ✓ | |
| Special paint finish C3 | S02 | ✓ | ✓ | ✓ | ✓ | ✓ | ✓ | ✓ | |
| Special paint finish sea air resistant C4 | S03 | ✓ | ✓ | ✓ | ✓ | ✓ | ✓ | ✓ | |
| Internal coating | S05 | ✓ | ✓ | ✓ | ✓ | ✓ | ✓ | ✓ | |
| Paint finish in other standard RAL colors: RAL 1002, 1013, 1015, 1019, 2003, 2004, 3000, 3007, 5002, 5007, 5009, 5010, 5012, 5015, 5017, 5018, 5019, 6011, 6019, 6021, 7000, 7001, 7004, 7011, 7016, 7022, 7031, 7032, 7033, 7035, 9001, 9002, 9005 (see Catalog Section 1 "Introduction") | Y53 • and paint finish RAL..... | ✓ | ✓ | ✓ | ✓ | ✓ | ✓ | ✓ | |
| Paint finish in special RAL colors: For RAL colors, see "Special paint finish in special RAL colors" (see Catalog Section 1 "Introduction") | Y56 • and paint finish RAL..... | ✓ | ✓ | ✓ | ✓ | ✓ | ✓ | ✓ | |
| Modular technology – Basic versions⁴⁾ | | | | | | | | | |
| Mounting of holding brake (standard assignment) ⁵⁾ | F01 | ✓ | ✓ | ✓ | ✓ | ✓ | ✓ | ✓ | |
| Mounting of brake for higher switching frequency (operating brake) | F02 | O. R. | O. R. | O. R. | O. R. | O. R. | – | – | |
| Mounted separately driven fan | F70 | ✓ | ✓ | ✓ | ✓ | ✓ | ✓ | ✓ | |
| Mounting of Kübler Sendix 5020 HTL, 1024 I rotary pulse encoder | G11 | ✓ | ✓ | ✓ | ✓ | ✓ | ✓ | ✓ | |
| Mounting of Kübler Sendix 5020 TTL, 1024 I rotary pulse encoder | G12 | ✓ | ✓ | ✓ | ✓ | ✓ | ✓ | ✓ | |
| Modular technology – Additional versions | | | | | | | | | |
| Brake supply voltage 24 V DC | F10 | ✓ | ✓ | ✓ | ✓ | ✓ | ✓ | ✓ | |
| Brake supply voltage 230 V AC, 50/60 Hz | F11 | ✓ | ✓ | ○ | ○ | ○ | ○ | ○ | |
| Brake supply voltage 400 V AC, 50/60 Hz | F12 | ✓ | ✓ | ✓ | ✓ | ✓ | ✓ | ✓ | |
| Brake supply voltage 180 V DC | F17 | ✓ | ✓ | ✓ | ✓ | ✓ | ✓ | ✓ | Only for: Combination with F01 |
| Brake supply voltage 205 V DC | F18 | ✓ | ✓ | ✓ | ✓ | ✓ | ✓ | ✓ | Only for: Combination with F01 |
| Mechanical manual brake release with lever (no locking) | F50 | ✓ | ✓ | ✓ | ✓ | ✓ | ✓ | ✓ | |
| Special technology³⁾ | | | | | | | | | |
| Mounting of LL 861 900 220 rotary pulse encoder ⁶⁾ | G04 | – | – | ✓ | ✓ | ✓ | ✓ | ✓ | |
| Mounting of HQG 9 DN 1024 I rotary pulse encoder ⁶⁾ | G05 | – | – | ✓ | ✓ | ✓ | ✓ | ✓ | |
| Mounting of HQG 10 D 1024 I rotary pulse encoder ⁶⁾ | G06 | – | – | ✓ | ✓ | ✓ | ✓ | ✓ | |
| Mounting of Kübler Sendix 5834FS2 1024, SIL-2 rotary pulse encoder | G21 | – | – | – | – | – | ✓ | ✓ | |
| Mounting of Kübler Sendix 5834FS3 1024, SIL-3 rotary pulse encoder | G22 | – | – | – | – | – | ✓ | ✓ | |
| Mounting of HOGS100S-B76.626.01024.1 rotary pulse encoder | G25 | – | – | – | – | – | ✓ | ✓ | |
| Mounting of LL FSI 862-184560-1024, SIL-2 rotary pulse encoder | G27 | – | – | – | – | – | ✓ | ✓ | |
| Mechanical version and degrees of protection | | | | | | | | | |
| Prepared for mountings, centering hole only ⁷⁾ | G40 | ✓ | ✓ | ✓ | ✓ | ✓ | □ | □ | |
| Prepared for mountings with D12 shaft ¹²⁾ | G41 | ✓ | ✓ | ✓ | ✓ | ✓ | ✓ | ✓ | |
| Prepared for mountings with D16 shaft ¹²⁾ | G42 | O. R. | O. R. | ✓ | ✓ | ✓ | ✓ | ✓ | |
| Mechanical protection for encoder | G43 | ✓ | ✓ | ✓ | ✓ | ✓ | ✓ | ✓ | |
| Protective cover ^{6) 8)} | H00 | ✓ | ✓ | ✓ | ✓ | ✓ | ✓ | ✓ | |

For legends and footnotes, see page 4/67.

Synchronous reluctance motors for SINAMICS converters – VSD4000 line

Article No. supplements and special versions · Options

Aluminum series SIMOTICS GP 1FP1014

| Special versions | Additional identification code -Z with order code and plain text if required | Frame size | | | | | | | Motor version |
|--|--|----------------|----|-----|-----|-----|-----|-----|--------------------------|
| | | 80 | 90 | 112 | 132 | 160 | 180 | 200 | |
| | | 1FP1014 | | | | | | | Super Premium Efficiency |
| 1FP1014-.....-.....-Z | Order code | | | | | | | | |
| Mechanical design and degrees of protection (continued) | | | | | | | | | |
| Screwed-on (instead of cast) feet | H01 | ✓ | ✓ | ✓ | ✓ | ✓ | □ | □ | |
| Vibration-proof version; vibration resistance to Class 3M4 according to IEC 60721-3-3:1994 | H02 | ✓ | ✓ | ✓ | ✓ | ✓ | ✓ | ✓ | |
| Condensation drainage holes ⁹⁾ | H03 | ✓ | ✓ | ✓ | ✓ | ✓ | ✓ | ✓ | |
| Rust-resistant screws (externally) | H07 | ✓ | ✓ | ✓ | ✓ | ✓ | ✓ | ✓ | |
| Housing with screw mounting | H10 | ✓ | ✓ | – | – | – | ✓ | ✓ | |
| IP65 degree of protection ¹⁰⁾ | H20 | ✓ | ✓ | ✓ | ✓ | ✓ | ✓ | ✓ | |
| IP56 degree of protection ¹¹⁾ | H22 | ✓ | ✓ | ✓ | ✓ | ✓ | ✓ | ✓ | |
| Drive-end seal for flange-mounted motors, oil-tight to 0.1 bar ⁸⁾ | H23 | ✓ | ✓ | ✓ | ✓ | ✓ | ✓ | ✓ | |
| Coolant temperature and installation altitude | | | | | | | | | |
| Coolant temperature –40 to +40 °C ¹³⁾ | D03 | ✓ | ✓ | ✓ | ✓ | ✓ | ✓ | ✓ | |
| Coolant temperature –30 to +40 °C ¹³⁾ | D04 | ✓ | ✓ | ✓ | ✓ | ✓ | ✓ | ✓ | |
| Versions in accordance with standards and specifications | | | | | | | | | |
| Version according to UL and CSA (Canadian regulation) | D39 | ✓ | ✓ | ✓ | ✓ | ✓ | ✓ | ✓ | |
| TR CU product safety certificate EAC for Eurasian Customs Union | D47 | ✓ | ✓ | ✓ | ✓ | ✓ | ✓ | ✓ | |
| Bearings and lubrication | | | | | | | | | |
| Located bearing DE | L20 | ✓ | ✓ | ✓ | ✓ | ✓ | ✓ | ✓ | |
| Located bearing NDE | L21 | ✓ | ✓ | ✓ | ✓ | □ | □ | □ | |
| Bearing design for increased cantilever forces | L22 | ✓ | ✓ | ✓ | ✓ | ✓ | ✓ | ✓ | |
| Regreasing device ¹⁴⁾ | L23 | – | – | ✓ | ✓ | ✓ | ✓ | ✓ | |
| Bearings reinforced at both ends for DE and NDE, bearing size 63 | L25 | ✓ | ✓ | ✓ | ✓ | ✓ | ✓ | ✓ | |
| Bearing insulation NDE | L51 | – | – | ✓ | ✓ | ✓ | ✓ | ✓ | |
| Measuring nipple for SPM shock pulse measurement for bearing inspection ¹⁴⁾ | Q01 | – | – | ✓ | ✓ | ✓ | ✓ | ✓ | |
| Balance and vibration severity | | | | | | | | | |
| Half-key balancing (standard) | | □ | □ | □ | □ | □ | □ | □ | |
| Balancing without feather key | L01 | ✓ | ✓ | ✓ | ✓ | ✓ | ✓ | ✓ | |
| Full-key balancing | L02 | ✓ | ✓ | ✓ | ✓ | ✓ | ✓ | ✓ | |
| Shaft and rotor | | | | | | | | | |
| Shaft extension with standard dimensions, without feather keyway | L04 | ✓ | ✓ | ✓ | ✓ | ✓ | ✓ | ✓ | |
| Standard, cylindrical shaft extension (second shaft extension) NDE acc. to EN 50347 | L05 | ✓ | ✓ | ✓ | ✓ | ✓ | ✓ | ✓ | |
| Standard shaft made of stainless steel (e.g. 1.4021) | L06 | ✓ | ✓ | – | ✓ | ✓ | ✓ | ✓ | |
| Shaft extension run-out in accordance with IEC 60072-1 precision class | L07 | ✓ | ✓ | ✓ | ✓ | ✓ | ✓ | ✓ | |
| Shaft extension run-out, concentricity and perpendicularity in accordance with IEC 60072-1 precision class for flange-mounted motors | L08 | ✓ | ✓ | ✓ | ✓ | ✓ | ✓ | ✓ | |
| Non-standard cylindrical shaft extension, DE ¹⁵⁾ | Y58 • and customer specifications | ✓ | ✓ | ✓ | ✓ | ✓ | ✓ | ✓ | |
| Non-standard cylindrical shaft extension, NDE ¹⁵⁾ | Y59 • and customer specifications | ✓ | ✓ | ✓ | ✓ | ✓ | ✓ | ✓ | |
| Heating and ventilation | | | | | | | | | |
| Sheet metal fan cover | F74 | ✓ | ✓ | ✓ | ✓ | ✓ | ✓ | ✓ | |
| Fan cover for textile industry ¹⁶⁾ | F75 | ✓ | ✓ | ✓ | ✓ | ✓ | ✓ | ✓ | |
| Metal external fan | F76 | ✓ | ✓ | ✓ | ✓ | ✓ | ✓ | ✓ | |
| Without external fan and without fan cover | F90 | ✓ | ✓ | ✓ | ✓ | ✓ | ✓ | ✓ | |
| Anti-condensation heating for 230 V (2 terminals) | Q02 | ✓ | ✓ | ✓ | ✓ | ✓ | ✓ | ✓ | |
| Anti-condensation heating for 115 V (2 terminals) | Q03 | ✓ | ✓ | ✓ | ✓ | ✓ | ✓ | ✓ | |
| Rating plate and additional rating plates | | | | | | | | | |
| Second rating plate, loose | M10 | ✓ | ✓ | ✓ | ✓ | ✓ | ✓ | ✓ | |
| Rating plate, stainless steel | M11 | ✓ | ✓ | ✓ | ✓ | ✓ | ✓ | ✓ | |

For legends and footnotes, see page 4/67.

Synchronous reluctance motors for SINAMICS converters – VSD4000 line

Article No. supplements and special versions · Options

Aluminum series SIMOTICS GP 1FP1014

| Special versions | Additional identification code -Z with order code and plain text if required | Frame size | | | | | | | Motor version |
|---|--|----------------|----|-----|-----|-----|-----|-----|--------------------------|
| | | 80 | 90 | 112 | 132 | 160 | 180 | 200 | |
| | | 1FP1014 | | | | | | | Super Premium Efficiency |
| 1FP1014-.....-.....-Z | Order code | | | | | | | | |
| Rating plate and additional rating plates (continued) | | | | | | | | | |
| Additional rating plate with customer specifications | Y82 • and customer specifications | ✓ | ✓ | ✓ | ✓ | ✓ | ✓ | ✓ | |
| Additional information on rating plate and on package label (max. 20 characters) | Y84 • and customer specifications | ✓ | ✓ | ✓ | ✓ | ✓ | ✓ | ✓ | |
| Adhesive label, supplied loose (printed with: Article No., Serial No.; 2 lines of text) | Y85 • and customer specifications | – | – | ✓ | ✓ | ✓ | ✓ | ✓ | |
| Extension of the liability for defects | | | | | | | | | |
| Extension of the liability for defects by 24 months to a total of 36 months (3 years) from delivery ²⁰⁾ | | □ | □ | □ | □ | □ | □ | □ | |
| Packaging, safety notes, documentation and test certificates | | | | | | | | | |
| A printed version of the safety notes in German/English and safety notes in the language of the country of use is supplied in each wire-lattice pallet ¹⁷⁾ | B01 | ○ | ○ | ○ | ○ | ○ | ○ | ○ | |
| Inspection certificate 3.1 according to EN 10204 ¹⁸⁾ | B02 | ✓ | ✓ | ✓ | ✓ | ✓ | ✓ | ✓ | |
| Document - Electrical datasheet | B60 | ✓ | ✓ | ✓ | ✓ | ✓ | ✓ | ✓ | |
| Document - Order dimensional drawing | B61 | ✓ | ✓ | ✓ | ✓ | ✓ | ✓ | ✓ | |
| Type test with heat run for horizontal motors, with acceptance | B83 | ✓ | ✓ | ✓ | ✓ | ✓ | ✓ | ✓ | |
| "Basic" documentation package | B90 | ✓ | ✓ | ✓ | ✓ | ✓ | ✓ | ✓ | |
| "Advanced" documentation package | B91 | ✓ | ✓ | ✓ | ✓ | ✓ | ✓ | ✓ | |
| "Projects" documentation package | B92 | ✓ | ✓ | ✓ | ✓ | ✓ | ✓ | ✓ | |
| Wire-lattice pallet packaging | B99 | ○ | ○ | ○ | ○ | ○ | ○ | ○ | |
| Connected in star for dispatch | M01 | ✓ | ✓ | ✓ | ✓ | ✓ | ✓ | ✓ | |
| Connected in delta for dispatch | M02 | ✓ | ✓ | ✓ | ✓ | ✓ | ✓ | ✓ | |

- Standard version
- Without additional charge
- ✓ With additional charge
- R. Possible on request

- Not possible
- This order code only determines the price of the version – Additional plain text is required.

- 1) For order code **H08**, feet dimensions differing from EN 50347. Further information is available in the DT Configurator (see Appendix, "Tools and engineering").
- 2) With IM B5 flange, only possible in combination with order code **H08**.
- 3) The grease lifetime specified in Catalog Section 1 "Introduction" refers to CT 40 °C. If the coolant temperature is increased by 10 K, the grease lifetime and regreasing interval are halved.
- 4) A second shaft extension is not possible. Please inquire for mounted brakes.
- 5) The brake supply voltage must be specified or ordered with order codes **F10**, **F11**, **F12**, **F17**, and **F18**.
- 6) In combination with a separately driven fan (order code **F70**) the 1XP8032-10 rotary pulse encoder is used instead of 1XP8012-10 or 1XP8032-20 is used instead of 1XP8012-20.
- 7) As standard, motors that are prepared for additional mounted components (order codes **G40**, **G41**, **G42**) are shipped without protective cover. If a protective cover is requested as a cover or mechanical protection for mounted components provided by the customer, this can be ordered with order code **G43**. Not possible in combination with order code **L00** vibration severity grade B. In combination with a separately driven fan (order code **F70**) the 1XP8032-10 rotary pulse encoder is used instead of 1XP8012-10 or 1XP8032-20 is used instead of 1XP8012-20.
- 8) Order code **H00** provides mechanical protection for encoders.
- 9) Supplied with the condensation drainage holes sealed at the drive end DE and non-drive end NDE (IP55, IP56, IP65). If the condensation drainage holes are required for motors of the IM B6, IM B7 or IM B8 type of construction (feet on side or top), the motors must be ordered in the respective type of construction and with order code **H03**, so that the condensation drainage holes will be placed in the correct position.
- 10) Not possible in combination with HOG 9 DN 1024 I rotary pulse encoder (order code **G05**) and/or brake BFK458 (order code **F01**).
- 11) Not possible in combination with brake BFK458 (order code **F01**).

- 12) As standard, motors that are prepared for additional mounted components (order codes **G40**, **G41**, **G42**) are shipped without protective cover. If a protective cover is requested as a cover or mechanical protection for mounted components provided by the customer, this can be ordered with order code **G43**. Not possible in combination with order code **L00** vibration severity grade B.
- 13) Not possible for type of construction IM V3.
- 14) Not possible when brake is mounted.
- 15) When motors are ordered that have a longer or shorter shaft extension than normal, the required position and length of the feather keyway must be specified in a sketch. It must be ensured that only feather keys in accordance with DIN 6885, Form A are permitted to be used. The feather keyway is positioned centrally on the shaft extension. The length is defined by the manufacturer in accordance with the appropriate standard. Not valid for: Conical shafts, non-standard threaded journals, non-standard shaft tolerances, friction welded journals, extremely "thin" shafts, special geometry dimensions (e.g. square journals), hollow shafts. Valid for non-standard shaft extensions DE or NDE. The feather keys are supplied in every case. For order codes **Y58**, **Y59** and **L05** the following applies:
 - Dimensions D and DA ≤ ball bearing inner diameter (see dimension tables for "Dimensions")
 - Dimensions E and EA ≤ 2 × length E (standard) of the shaft extension. For an explanation of the order codes, see Catalog Section 1 "Introduction".
- 16) The special requirements of the textile industry regarding the sheet metal cover open up the possibility that a finger may be inserted between the cover and housing. The customer must implement appropriate measures to ensure that the installed system is "finger-safe".
- 17) The Operating Instructions (Compact) are available in PDF format for all official EU languages at <http://support.automation.siemens.com/WWW/view/en/40761976>
- 18) The delivery time for the manufacturer's test certificate may differ from the delivery time for the motor and will be dispatched by e-mail.
- 19) Not UL-certified. Not in combination with option **D31**.
- 20) Only possible in combination with order codes **R70** and **R71**.

Synchronous reluctance motors for SINAMICS converters – VSD4000 line

Article No. supplements and special versions · Options

Cast-iron series SIMOTICS SD 1FP1514

Selection and ordering data

| Special versions | Additional identification code -Z with order code and plain text if required | Frame size | | | | | | | | Motor version |
|---|---|----------------|----|-----|-----|-----|-----|-----|-----|--|
| | | 80 | 90 | 112 | 132 | 160 | 180 | 200 | 225 | Super Premium Efficiency |
| 1FP15.4-.....-.....-Z | Order code | 1FP15.4 | | | | | | | | |
| Motor protection | | | | | | | | | | |
| 1 or 3 PTC thermistors – for tripping (2 terminals) ^{2) 3)} | Q11 | – | – | – | ✓ | ✓ | ✓ | ✓ | ✓ | |
| 2 or 6 PTC thermistors – for alarm and tripping (4 terminals) ³⁾ | Q12 | – | – | – | ✓ | ✓ | ✓ | ✓ | ✓ | |
| 1 KTY84-130 temperature sensor (2 terminals) ³⁾ | Q23 | – | – | – | ✓ | ✓ | ✓ | ✓ | ✓ | |
| 2 KTY84-130 temperature sensor (4 terminals) ³⁾ | Q25 | – | – | – | ✓ | ✓ | ✓ | ✓ | ✓ | |
| 3 bimetal sensors (NC contacts) for tripping (2 terminals) ³⁾ | Q31 | – | – | – | ✓ | ✓ | ✓ | ✓ | ✓ | |
| 6 bimetal sensors (NC contacts) for alarm and tripping (4 terminals) | Q32 | – | – | – | – | – | ✓ | ✓ | ✓ | |
| 3 bimetal sensors (NC contacts) for tripping (6 terminals) | Q33 | – | – | – | ✓ | ✓ | ✓ | ✓ | ✓ | |
| 6 bimetal sensors (NC contacts) thermostat for alarm and tripping (12 terminals) | Q34 | – | – | – | ✓ | ✓ | ✓ | ✓ | ✓ | |
| 1 Pt1000 resistance thermometer (2 terminals) ¹⁹⁾ | Q35 | ○ | ○ | ○ | ○ | ○ | ○ | ○ | ○ | |
| 2 Pt1000 resistance thermometers (4 terminals) ¹⁹⁾ | Q36 | – | – | – | ✓ | ✓ | ✓ | ✓ | ✓ | |
| 3 Pt100 resistance thermometers – 2-wire input (6 terminals) | Q60 | – | – | – | ✓ | ✓ | ✓ | ✓ | ✓ | |
| 1 Pt100 resistance thermometer – 2-wire input (2 terminals) | Q62 | – | – | – | ✓ | ✓ | ✓ | ✓ | ✓ | |
| 3 Pt100 resistance thermometers – 3-wire input (9 terminals) | Q63 | – | – | – | ✓ | ✓ | ✓ | ✓ | ✓ | |
| 6 Pt100 resistance thermometers – 3-wire input (18 terminals) | Q64 | – | – | – | ✓ | ✓ | ✓ | ✓ | ✓ | |
| 2 Pt100 resistance thermometers in basic configuration for bearings (2 terminals) ¹⁾ | Q72 | – | – | – | – | – | ✓ | ✓ | ✓ | |
| 2 Pt100 resistance thermometers in 3-wire input for bearings (6 terminals) | Q78 | – | – | – | – | – | ✓ | ✓ | ✓ | |
| 2 Pt100 double resistance thermometers in 3-wire input for bearings (12 terminals) | Q79 | – | – | – | – | – | ✓ | ✓ | ✓ | Not for: Motors in combination with order codes F40 and F41 (frame size 225) |
| Motor connection and terminal box | | | | | | | | | | |
| External grounding | H04 | ✓ | ✓ | ✓ | ✓ | ✓ | □ | □ | □ | |
| Terminal box on NDE ²⁾ | H08 | ✓ | ✓ | ✓ | ✓ | ✓ | ✓ | ✓ | ✓ | |
| Second external grounding | H70 | – | – | ✓ | ✓ | ✓ | ✓ | ✓ | ✓ | |
| Rotation of the terminal box through 90°, entry from DE | R10 | ○ | ○ | ○ | ○ | ○ | ✓ | ✓ | ✓ | |
| Rotation of the terminal box through 90°, entry from NDE | R11 | ○ | ○ | ○ | ○ | ○ | ✓ | ✓ | ✓ | |
| Rotation of the terminal box through 180° | R12 | ○ | ○ | ○ | ○ | ○ | ✓ | ✓ | ✓ | |
| One EMC cable gland | R14 | ✓ | ✓ | ✓ | ✓ | ✓ | ✓ | ✓ | ✓ | |
| One metal cable gland | R15 | ✓ | ✓ | ✓ | ✓ | ✓ | ✓ | ✓ | ✓ | |
| EMC cable gland, maximum configuration | R16 | ✓ | ✓ | ✓ | ✓ | ✓ | ✓ | ✓ | ✓ | |
| Larger terminal box | R50 | ✓ | ✓ | ✓ | ✓ | ✓ | ✓ | ✓ | ✓ | |
| Terminal box without cable entry opening | R51 | – | – | ○ | ○ | ○ | ○ | ○ | ○ | |
| Drilled removable entry plate | R52 | – | – | – | – | – | ✓ | ✓ | ✓ | |
| Undrilled removable entry plate | R53 | – | – | – | – | – | ✓ | ✓ | ✓ | |
| Cast-iron auxiliary terminal box (small) | R62 | – | – | ✓ | ✓ | ✓ | ✓ | ✓ | ✓ | |
| Silicone-free version | | – | – | □ | □ | □ | □ | □ | □ | |
| Non-standard threaded through hole (NPT or G thread) | Y61 • and customer specifications | – | – | ✓ | ✓ | ✓ | ✓ | ✓ | ✓ | |

For legend, see page 4/71 and for footnotes, see page 4/72.

Synchronous reluctance motors for SINAMICS converters – VSD4000 line

Article No. supplements and special versions · Options

Cast-iron series SIMOTICS SD 1FP1514

| Special versions | Additional identification code -Z with order code and plain text if required | Frame size | | | | | | | | Motor version |
|--|--|------------|----|-----|-----|-----|-----|-----|-----|--------------------------------|
| | | 80 | 90 | 112 | 132 | 160 | 180 | 200 | 225 | |
| | | 1FP15.4 | | | | | | | | Super Premium Efficiency |
| 1FP15.4-.....-.....-Z | Order code | | | | | | | | | |
| Windings and insulation | | | | | | | | | | |
| Temperature class 180 (H) at rated power and max. CT 60 °C ³⁾ | N11 | ✓ | ✓ | ✓ | ✓ | ✓ | ✓ | ✓ | ✓ | |
| Increased air humidity/temperature with 30 to 60 g water per m ³ of air | N30 | ✓ | ✓ | ✓ | ✓ | ✓ | ✓ | ✓ | ✓ | |
| Increased air humidity/temperature with 60 to 100 g water per m ³ of air | N31 | ✓ | ✓ | ✓ | ✓ | ✓ | ✓ | ✓ | ✓ | |
| Colors and paint finish | | | | | | | | | | |
| Standard paint finish C2 in RAL 7030 stone gray | | □ | □ | □ | □ | □ | □ | □ | □ | |
| Unpainted (only cast-iron parts primed) | S00 | ○ | ○ | ○ | ○ | ○ | ○ | ○ | ○ | |
| Unpainted, only primed | S01 | ✓ | ✓ | ✓ | ✓ | ✓ | ✓ | ✓ | ✓ | |
| Special paint finish C3 | S02 | ✓ | ✓ | ✓ | ✓ | ✓ | ✓ | ✓ | ✓ | |
| Special paint finish sea air resistant C4 | S03 | ✓ | ✓ | ✓ | ✓ | ✓ | ✓ | ✓ | ✓ | |
| Special paint finish for use offshore C5 | S04 | ✓ | ✓ | ✓ | ✓ | ✓ | ✓ | ✓ | ✓ | |
| Internal coating | S05 | – | – | – | ✓ | ✓ | ✓ | ✓ | ✓ | |
| Paint finish in other standard RAL colors: RAL 1002, 1013, 1015, 1019, 2003, 2004, 3000, 3007, 5002, 5007, 5009, 5010, 5012, 5015, 5017, 5018, 5019, 6011, 6019, 6021, 7000, 7001, 7004, 7011, 7016, 7022, 7031, 7032, 7033, 7035, 9001, 9002, 9005 (see Catalog Section 1 "Introduction") | Y53 • and paint finish RAL..... | ✓ | ✓ | ✓ | – | ✓ | ✓ | ✓ | ✓ | |
| Paint finish in special RAL colors: For RAL colors, see "Special paint finish in special RAL colors" (see Catalog Section 1 "Introduction") | Y56 • and paint finish RAL..... | ✓ | ✓ | ✓ | ✓ | ✓ | ✓ | ✓ | ✓ | |
| Modular technology – Basic versions⁴⁾ | | | | | | | | | | |
| Mounting of holding brake (standard assignment) ⁵⁾ | F01 | – | – | ✓ | ✓ | ✓ | ✓ | ✓ | ✓ | |
| Mounted separately driven fan | F70 | – | – | – | ✓ | ✓ | ✓ | ✓ | ✓ | |
| Mounting of Kübler Sendix 5020 HTL, 1024 l rotary pulse encoder | G11 | ✓ | ✓ | ✓ | ✓ | ✓ | ✓ | ✓ | ✓ | |
| Mounting of Kübler Sendix 5020 TTL, 1024 l rotary pulse encoder | G12 | ✓ | ✓ | ✓ | ✓ | ✓ | ✓ | ✓ | ✓ | |
| Modular technology – Additional versions | | | | | | | | | | |
| Brake supply voltage 24 V DC | F10 | – | – | ✓ | ✓ | ✓ | ✓ | ✓ | ✓ | |
| Brake supply voltage 230 V AC, 50/60 Hz | F11 | – | – | ○ | ○ | ○ | ○ | ○ | ○ | |
| Brake supply voltage 400 V AC, 50/60 Hz | F12 | – | – | ✓ | ✓ | ✓ | ✓ | ✓ | ✓ | |
| Brake supply voltage 180 V DC | F17 | – | – | ✓ | ✓ | ✓ | ✓ | ✓ | ✓ | Only for: Combination with F01 |
| Brake supply voltage 205 V DC | F18 | – | – | ✓ | ✓ | ✓ | ✓ | ✓ | ✓ | Only for: Combination with F01 |
| Backstop, counterclockwise motion blocked, clockwise direction of rotation | F40 | – | – | – | ✓ | ✓ | ✓ | ✓ | ✓ | |
| Backstop, clockwise motion blocked, counterclockwise direction of rotation | F41 | – | – | – | ✓ | ✓ | ✓ | ✓ | ✓ | |
| Mechanical manual brake release with lever (no locking) | F50 | – | – | ✓ | ✓ | ✓ | ✓ | ✓ | ✓ | |
| Special technology⁵⁾ | | | | | | | | | | |
| Mounting of LL 861 900 220 rotary pulse encoder ⁸⁾ | G04 | – | – | ✓ | ✓ | ✓ | ✓ | ✓ | ✓ | |
| Mounting of HQG 9 DN 1024 l rotary pulse encoder ⁸⁾ | G05 | – | – | ✓ | ✓ | ✓ | ✓ | ✓ | ✓ | |
| Mounting of HQG 10 D 1024 l rotary pulse encoder ⁸⁾ | G06 | – | – | ✓ | ✓ | ✓ | ✓ | ✓ | ✓ | |
| Mounting of POG 10 DN rotary pulse encoder (only in combination with separately driven fan or brake) ¹⁸⁾ | G07 | – | – | – | – | – | ✓ | ✓ | ✓ | |
| Mounting of POG 9 rotary pulse encoder (only in combination with separately driven fan or brake) ¹⁸⁾ | G08 | – | – | – | – | – | ✓ | ✓ | ✓ | |
| Mounting of Kübler Sendix 5834FS2 1024, SIL-2 rotary pulse encoder | G21 | ✓ | ✓ | ✓ | ✓ | ✓ | ✓ | ✓ | ✓ | |
| Mounting of Kübler Sendix 5834FS3 1024, SIL-3 rotary pulse encoder | G22 | ✓ | ✓ | ✓ | ✓ | ✓ | ✓ | ✓ | ✓ | |
| Mounting of HOGS100S-B76.626.01024.1 rotary pulse encoder | G25 | – | – | – | – | – | ✓ | ✓ | ✓ | |
| Mounting of LL FSI 862-184560-1024, SIL-2 rotary pulse encoder | G27 | – | – | – | – | – | ✓ | ✓ | ✓ | |

For legend, see page 4/71 and for footnotes, see page 4/72.

Synchronous reluctance motors for SINAMICS converters – VSD4000 line

Article No. supplements and special versions · Options

Cast-iron series SIMOTICS SD 1FP1514

| Special versions | Additional identification code -Z with order code and plain text if required | Frame size | | | | | | | | Motor version |
|--|---|------------|----|-----|-----|-----|------|------|------|--------------------------|
| | | 80 | 90 | 112 | 132 | 160 | 180 | 200 | 225 | |
| | | 1FP15.4 | | | | | | | | Super Premium Efficiency |
| 1FP15.4-.....-Z | Order code | | | | | | | | | |
| Special technology ⁵⁾ (continued) | | | | | | | | | | |
| Mounting of a special type of rotary pulse encoder | Y70 • and customer specifications | – | – | – | – | – | O.R. | O.R. | O.R. | |
| Mechanical version and degrees of protection | | | | | | | | | | |
| Prepared for mountings, centering hole only | G40 | ✓ | ✓ | ✓ | ✓ | ✓ | □ | □ | □ | |
| Prepared for mountings with D12 shaft | G41 | ✓ | ✓ | ✓ | ✓ | ✓ | ✓ | ✓ | ✓ | |
| Prepared for mountings with D16 shaft | G42 | ✓ | ✓ | ✓ | ✓ | ✓ | ✓ | ✓ | ✓ | |
| Mechanical protection for encoder | G43 | ✓ | ✓ | ✓ | ✓ | ✓ | ✓ | ✓ | ✓ | |
| Protective cover ^{6) 8) 9)} | H00 | ✓ | ✓ | ✓ | ✓ | ✓ | ✓ | ✓ | ✓ | |
| Screwed-on (instead of cast) feet | H01 | – | – | ✓ | ✓ | ✓ | ✓ | ✓ | ✓ | |
| Vibration-proof version; vibration resistance to Class 3M4 according to IEC 60721-3-3:1994 | H02 | ✓ | ✓ | ✓ | ✓ | ✓ | ✓ | ✓ | ✓ | |
| Condensation drainage holes | | ✓ | ✓ | □ | □ | □ | □ | □ | □ | |
| Rust-resistant screws (externally) | H07 | ✓ | ✓ | ✓ | ✓ | ✓ | ✓ | ✓ | ✓ | |
| Housing with screw mounting | H10 | ✓ | ✓ | ✓ | ✓ | ✓ | ✓ | ✓ | ✓ | |
| IP65 degree of protection ¹⁰⁾ | H20 | ✓ | ✓ | ✓ | ✓ | ✓ | ✓ | ✓ | ✓ | |
| IP54 degree of protection | H21 | – | – | – | – | – | ✓ | ✓ | ✓ | |
| IP56 degree of protection ¹¹⁾ | H22 | ✓ | ✓ | ✓ | ✓ | ✓ | ✓ | ✓ | ✓ | |
| Drive-end seal for flange-mounted motors, oil-tight to 0.1 bar ¹²⁾ | H23 | ✓ | ✓ | ✓ | ✓ | ✓ | ✓ | ✓ | ✓ | |
| Coolant temperature and installation altitude | | | | | | | | | | |
| Coolant temperature –50 to +40 °C | D02 | – | – | ✓ | ✓ | ✓ | ✓ | ✓ | ✓ | |
| Coolant temperature –40 to +40 °C ¹³⁾ | D03 | ✓ | ✓ | ✓ | ✓ | ✓ | ✓ | ✓ | ✓ | |
| Coolant temperature –30 to +40 °C | D04 | ✓ | ✓ | ✓ | ✓ | ✓ | ✓ | ✓ | ✓ | |
| Versions in accordance with standards and specifications | | | | | | | | | | |
| Version according to UL and CSA (Canadian regulation) | D39 | ✓ | ✓ | ✓ | ✓ | ✓ | ✓ | ✓ | ✓ | |
| TR CU product safety certificate EAC for Eurasian Customs Union | D47 | ✓ | ✓ | ✓ | ✓ | ✓ | ✓ | ✓ | ✓ | |
| Bearings and lubrication | | | | | | | | | | |
| Regreasing device with M10 × 1 grease nipple according to DIN 71412 A ¹⁴⁾ | L19 | – | – | – | – | – | ✓ | ✓ | ✓ | |
| Located bearing DE | L20 | ✓ | ✓ | ✓ | ✓ | ✓ | ✓ | ✓ | ✓ | |
| Located bearing NDE | L21 | ✓ | ✓ | ✓ | ✓ | □ | □ | □ | □ | |
| Bearing design for increased cantilever forces | L22 | ✓ | ✓ | ✓ | ✓ | ✓ | ✓ | ✓ | ✓ | |
| Regreasing device ¹⁴⁾ | L23 | – | – | ✓ | ✓ | ✓ | ✓ | ✓ | ✓ | |
| Bearings reinforced at both ends for DE and NDE, bearing size 63 | L25 | ✓ | ✓ | ✓ | ✓ | ✓ | ✓ | ✓ | ✓ | |
| Reinforced bearings at both DE and NDE, DE bearing for increased cantilever forces | L28 | – | – | – | – | – | ✓ | ✓ | ✓ | |
| Bearing insulation NDE | L51 | – | – | ✓ | ✓ | ✓ | ✓ | ✓ | ✓ | |
| Measuring nipple for SPM shock pulse measurement for bearing inspection ¹⁴⁾ | Q01 | – | – | ✓ | ✓ | ✓ | ✓ | ✓ | ✓ | |
| Balance and vibration severity | | | | | | | | | | |
| Half-key balancing (standard) | | □ | □ | □ | □ | □ | □ | □ | □ | |
| Balancing without feather key | L01 | ✓ | ✓ | ✓ | ✓ | ✓ | ✓ | ✓ | ✓ | |
| Full-key balancing | L02 | ✓ | ✓ | ✓ | ✓ | ✓ | ✓ | ✓ | ✓ | |
| Shaft and rotor | | | | | | | | | | |
| Shaft extension with standard dimensions, without feather keyway | L04 | ✓ | ✓ | ✓ | ✓ | ✓ | ✓ | ✓ | ✓ | |
| Standard, cylindrical shaft extension (second shaft extension) NDE acc. to EN 50347 | L05 | ✓ | ✓ | ✓ | ✓ | ✓ | ✓ | ✓ | ✓ | |
| Standard shaft made of stainless steel (e.g. 1.4021) | L06 | ✓ | ✓ | ✓ | ✓ | ✓ | ✓ | ✓ | ✓ | |
| Shaft extension run-out in accordance with IEC 60072-1 precision class | L07 | ✓ | ✓ | ✓ | ✓ | ✓ | ✓ | ✓ | ✓ | |
| Shaft extension run-out, concentricity and perpendicularity in accordance with IEC 60072-1 precision class for flange-mounted motors | L08 | ✓ | ✓ | ✓ | ✓ | ✓ | ✓ | ✓ | ✓ | |

For legend, see page 4/71 and for footnotes, see page 4/72.

Synchronous reluctance motors for SINAMICS converters – VSD4000 line

Article No. supplements and special versions · Options

Cast-iron series SIMOTICS SD 1FP1514

| Special versions | Additional identification code -Z with order code and plain text if required | Frame size | | | | | | | | Motor version |
|--|---|----------------|----|-------|-------|-------|-------|-------|-------|--------------------------|
| | | 80 | 90 | 112 | 132 | 160 | 180 | 200 | 225 | |
| | | 1FP15.4 | | | | | | | | Super Premium Efficiency |
| 1FP15.4-.....-.....-Z | Order code | | | | | | | | | |
| Shaft and rotor (continued) | | | | | | | | | | |
| Non-standard cylindrical shaft extension, DE ¹⁵⁾ | Y58 • and customer specifications | ✓ | ✓ | ✓ | ✓ | ✓ | ✓ | ✓ | ✓ | |
| Non-standard cylindrical shaft extension, NDE ¹⁵⁾ | Y59 • and customer specifications | ✓ | ✓ | ✓ | ✓ | ✓ | ✓ | ✓ | ✓ | |
| Special shaft steel | Y60 • and customer specifications | – | – | O. R. | O. R. | O. R. | O. R. | O. R. | O. R. | |
| Heating and ventilation | | | | | | | | | | |
| Sheet metal fan cover | F74 | □ | □ | ✓ | ✓ | ✓ | ✓ | ✓ | ✓ | |
| Metal external fan | F76 | ✓ | ✓ | ✓ | ✓ | ✓ | ✓ | ✓ | ✓ | |
| Anti-condensation heating for 230 V (2 terminals) | Q02 | ✓ | ✓ | ✓ | ✓ | ✓ | ✓ | ✓ | ✓ | |
| Anti-condensation heating for 115 V (2 terminals) | Q03 | ✓ | ✓ | ✓ | ✓ | ✓ | ✓ | ✓ | ✓ | |
| Rating plate and additional rating plates | | | | | | | | | | |
| Second rating plate, loose | M10 | ✓ | ✓ | ✓ | ✓ | ✓ | ✓ | ✓ | ✓ | |
| Rating plate, stainless steel | M11 | ✓ | ✓ | ✓ | ✓ | ✓ | ✓ | ✓ | ✓ | |
| Additional rating plate with customer specifications | Y82 • and customer specifications | ✓ | ✓ | ✓ | ✓ | ✓ | ✓ | ✓ | ✓ | |
| Additional information on rating plate and on package label (max. 20 characters) | Y84 • and customer specifications | ✓ | ✓ | ✓ | ✓ | ✓ | ✓ | ✓ | ✓ | |
| Adhesive label, supplied loose (printed with: Article No., Serial No.; 2 lines of text) | Y85 • and customer specifications | – | – | ✓ | ✓ | ✓ | ✓ | ✓ | ✓ | |
| Extension of the liability for defects | | | | | | | | | | |
| Extension of the liability for defects by 24 months to a total of 36 months (3 years) from delivery ¹⁶⁾ | | □ | □ | □ | □ | □ | □ | □ | □ | |
| Packaging, safety notes, documentation and test certificates | | | | | | | | | | |
| Inspection certificate 3.1 according to EN 10204 ¹⁷⁾ | B02 | ✓ | ✓ | ✓ | ✓ | ✓ | ✓ | ✓ | ✓ | |
| Document - Electrical datasheet | B60 | ✓ | ✓ | ✓ | ✓ | ✓ | ✓ | ✓ | ✓ | |
| Document - Order dimensional drawing | B61 | ✓ | ✓ | ✓ | ✓ | ✓ | ✓ | ✓ | ✓ | |
| Standard test (routine test) with acceptance | B65 | – | – | ✓ | ✓ | ✓ | ✓ | ✓ | ✓ | |
| Type test with heat run for horizontal motors, with acceptance | B83 | ✓ | ✓ | ✓ | ✓ | ✓ | ✓ | ✓ | ✓ | |
| "Basic" documentation package | B90 | ✓ | ✓ | ✓ | ✓ | ✓ | ✓ | ✓ | ✓ | |
| "Advanced" documentation package | B91 | ✓ | ✓ | ✓ | ✓ | ✓ | ✓ | ✓ | ✓ | |
| "Projects" documentation package | B92 | ✓ | ✓ | ✓ | ✓ | ✓ | ✓ | ✓ | ✓ | |
| Connected in star for dispatch | M01 | ✓ | ✓ | ✓ | ✓ | ✓ | ✓ | ✓ | ✓ | |
| Connected in delta for dispatch | M02 | ✓ | ✓ | ✓ | ✓ | ✓ | ✓ | ✓ | ✓ | |

- Standard version
- Without additional charge
- This order code only determines the price of the version – Additional plain text is required.
- ✓ With additional charge
- O. R. Possible on request
- Not possible

Synchronous reluctance motors for SINAMICS converters – VSD4000 line

Article No. supplements and special versions · Options

Cast-iron series SIMOTICS SD 1FP1514

4

- 1) Evaluation with associated tripping unit (see Catalog IC 10) is recommended.
- 2) For order code **H08**, feet dimensions differing from EN 50347 Further information is available in the DT Configurator (see Appendix, "Tools and engineering").
- 3) The grease lifetime specified in Catalog Section 1 "Introduction" refers to CT 40 °C. If the coolant temperature is increased by 10 K, the grease lifetime and regreasing interval are halved.
- 4) A second shaft extension is not possible. Please inquire for mounted brakes.
- 5) The brake supply voltage must be specified or ordered with order codes **F10**, **F11**, **F12**, **F17**, and **F18**.
- 6) The 1XP8 rotary pulse encoders are fitted with a protective cover as standard. The protective cover is omitted at the factory when a rotary pulse encoder is combined with a separately driven fan, because in this case the rotary pulse encoder is installed under the fan cover.
- 7) In combination with a separately driven fan (order code **F70**) the 1XP8032-10 rotary pulse encoder is used instead of 1XP8012-10 or 1XP8032-20 is used instead of 1XP8012-20.
- 8) LL and HOG rotary pulse encoders up to frame size 160 are fitted with a protective cover as standard. The protective cover is omitted at the factory when a rotary pulse encoder is combined with a separately driven fan, because in this case the rotary pulse encoder is installed under the fan cover.
- 9) Order code **H00** provides mechanical protection for encoders.
- 10) Not possible in combination with HOG 9 DN 1024 I rotary pulse encoder (order code **G05**) and/or brake BFK458 (order code **F01**).
- 11) Not possible in combination with brake BFK458 – order code **F01**.
- 12) Not possible for type of construction IM V3.
- 13) In connection with mountings, the respective technical specifications must be observed, please inquire before ordering.
- 14) Up to frame size 160 not possible when brake is mounted.
- 15) When motors are ordered that have a longer or shorter shaft extension than normal, the required position and length of the feather keyway must be specified in a sketch. It must be ensured that only feather keys in accordance with DIN 6885, Form A are permitted to be used. The feather keyway is positioned centrally on the shaft extension. The length is defined by the manufacturer in accordance with the appropriate standard. Not valid for: Conical shafts, non-standard threaded journals, non-standard shaft tolerances, friction welded journals, extremely "thin" shafts, special geometry dimensions (e.g. square journals), hollow shafts. Valid for non-standard shaft extensions DE or NDE. The feather keys are supplied in every case. For order codes **Y58**, **Y59** and **L05** the following applies:
 - Dimensions D and DA ≤ ball bearing inner diameter (see dimension tables for "Dimensions")
 - Dimensions E and EA ≤ 2 × length E (standard) of the shaft extension. For an explanation of the order codes, see Catalog Section 1 "Introduction".
- 16) Wearing parts (bearings) are excluded from the warranty extension.
- 17) The delivery time for the manufacturer's test certificate may differ from the delivery time for the motor.
- 18) Option (encoder mounting) is only possible for motors with a mounted separately driven fan or for naturally cooled motors (without an external fan). This option can be used in combination with brakes of type KFB. This option cannot be used in combination with brakes of type BFK458!
- 19) Not UL and CSA certified. Not available in combination with order code **D31**.

Synchronous reluctance motors for SINAMICS converters – VSD4000 line

Article No. supplements and special versions · Accessories

Overview

Slide rails with fixing bolts and tensioning screws according to DIN 42923

Slide rails are used to tension the belt of a machine easily and conveniently when there is no belt-tensioning pulley. They are fixed to the base using stone bolts or foundation blocks.

The assignment of slide rails to motor size can be found in DIN 42923. For motors of frame sizes 355 to 450, there are no standardized slide rails (please inquire).

Available from:

Lütgert & Co. GmbH
Postfach 42 51
33276 Gütersloh, Germany
Phone +49 (5241) 7407-0
Fax +49 (5241) 7407-90

www.luetgert-antriebe.de
Email: info@luetgert-antriebe.de

Taper pins according to DIN 258 with threaded ends and constant taper lengths

Taper pins are used for components that are repeatedly removed. The drilled hole is conically ground using a conical reamer until the pin can be pushed in by hand until the cone shoulder lies approx. 3 to 4 mm above the rim of the hole.

It can then be driven in using a hammer until it is correctly seated. The pin is removed from the drilled hole by screwing on the nut and tightening it.

Standardized taper pins are commercially available.

For instance, available from:

Otto Roth GmbH & Co. KG
Rutesheimer Strasse 22
70499 Stuttgart, Germany
Phone +49 711 1388-0
Fax +49 711 1388-233

www.ottoroth.de
Email: info@ottoroth.de

Foundation blocks according to DIN 799

The foundation blocks are inserted into the stone foundation and embedded in concrete. They are used for fixing machines of medium size, slide rails, pedestal bearings, base frames, etc. After the fixing bolts have been unscrewed, the machines can be shifted without them having to be lifted.

When the machine is initially installed, the foundation blocks that are bolted to the machine (without washers) and fitted with taper pins are not embedded with concrete until the machine has been fully aligned. In this case, the machine is positioned 2 to 3 mm lower. The difference in shaft height is compensated by inserting shims on final installation. The taper pins safeguard the exact position of the machine when it is repeatedly removed and replaced without the need for realignment.

Available from:

Lütgert & Co. GmbH
Postfach 42 51
33276 Gütersloh, Germany
Phone +49 (5241) 7407-0
Fax +49 (5241) 7407-90

www.luetgert-antriebe.de
Email: info@luetgert-antriebe.de

More information

Replacement motors and repair parts

- Commitment to provide replacement motors and repair parts following delivery of the motor:
 - for up to 3 years after delivery of the original motor, in the event of total motor failure, Siemens will supply a comparable spare motor with regard to the mounting dimensions and functions (the type series may vary).
 - if a spare motor is provided within the 3-year period, this will not mean that the warranty restarts.
 - Replacement motors delivered after the active production of the motor series are also identified as spare motors on the rating plate.
 - Spare parts are offered only for these spare motors on request; repair and replacement are not possible.
 - after a period of 3 years (after the delivery of the original motor), it is only possible to repair these motors (depending on the availability of the spare parts required).
 - for up to 5 years after the delivery of the original motor, spare parts will be available and for a further 5 years, Siemens will provide information about spare parts and will supply documents when required.

- When repair parts are ordered, the following details must be provided:
 - Designation and part number
 - Article No. and factory number of the motor.
- For bearing types, see Catalog Section 1 "Introduction".
- For standard components, a commitment to supply repaired parts does not apply.
- Support hotline
In Germany
Phone +49 911 895 7 222

You will find telephone numbers for other countries on our Internet site:

www.siemens.com/automation/service&support

Synchronous reluctance motors for SINAMICS converters – VSD4000 line

Dimensions

Notes on the dimensions

Overview

- Dimension designations according to EN 50347 and IEC 60072.

- Fits

The shaft extensions specified in the dimension tables (DIN 748) and centering spigot diameters (EN 50347) are machined with the following fits:

| Dimension designation | ISO fit EN ISO 286-2 | |
|-----------------------|----------------------|-----|
| D, DA | to 30 | j6 |
| | over 30 to 50 | k6 |
| | over 50 | m6 |
| N | to 250 | j6 |
| | over 250 | h6 |
| F, FA | | h9 |
| K | | H17 |
| S | flange (FF) | H17 |

The drilled holes of couplings and belt pulleys should have an ISO fit of at least H7.

- Dimensional tolerances

For the following dimensions, the admissible deviations are given below:

| Dimension designation | Dimension | Admissible deviation |
|-----------------------|-----------|----------------------|
| H | to 250 | – 0.5 |
| | over 250 | – 1.0 |
| E, EA | | – 0.5 |

Keyways and feather keyways (dimensions GA, GC, F and FA) are made in compliance with DIN 6885 Part 1.

- All dimensions are specified in mm.

Synchronous reluctance motors for SINAMICS converters – VSD4000 line

Dimensions

Dimension sheet generator (within the DT Configurator)

Overview

A dimensional drawing can be created in the "Drive Technology Configurator" (DT Configurator) for every configurable motor. A dimensional drawing can be requested for every other motor.

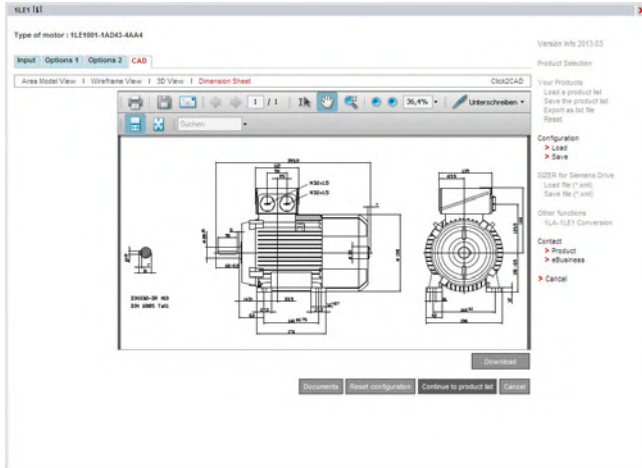

When a complete Article No. is entered with or without order codes, a dimensional drawing can be called up under the "Documentation" tab.

These dimensional drawings can be presented in different views and sections and printed.

The corresponding dimension sheets can be exported, saved and processed further in DXF format (interchange/import format for CAD systems) or as bitmap graphics.

Online access in the Siemens Industry Mall

The DT Configurator is integrated in the Siemens Industry Mall and can be used on the Internet without installation.

German: www.siemens.de/dt-konfigurator

English: www.siemens.com/dt-configurator

Synchronous reluctance motors for SINAMICS converters – VSD4000 line

Dimensions · Aluminum series SIMOTICS GP

Super Premium Efficiency – self-ventilated · Frame sizes 80 M, 90 S, 90 L, 112 M to 200 L

Dimensional drawings

Type of construction IM B3

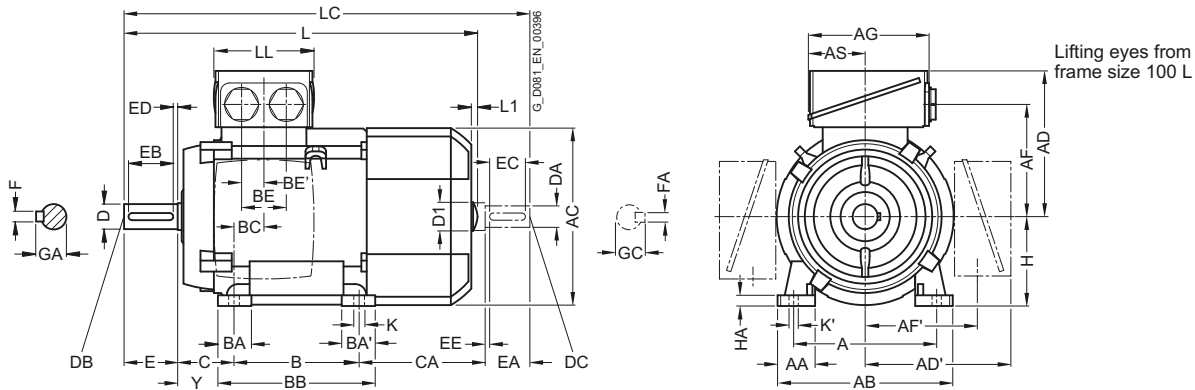

Types of construction IM B5 and IM V1

For flange dimensions, see page 1/47 (Z = the number of retaining holes)

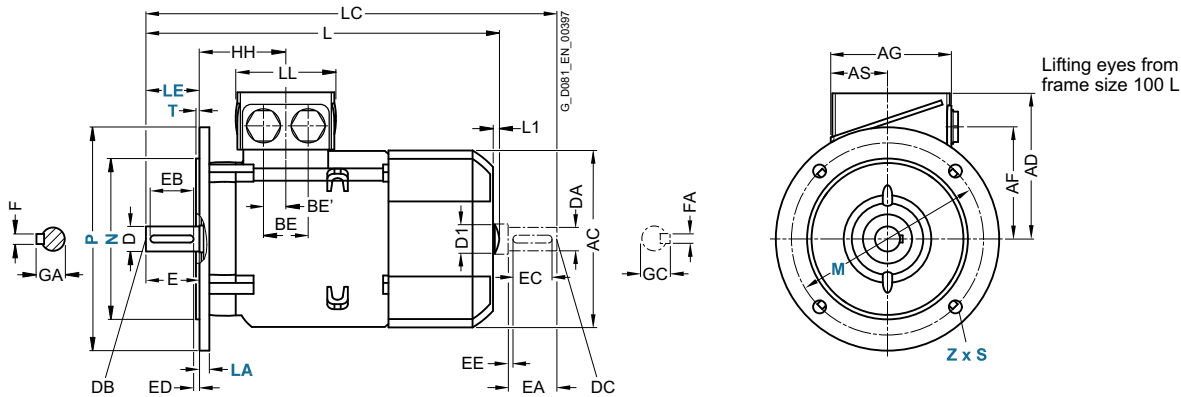

| For motor | | | Dimension designation acc. to IEC | | | | | | | | | | | | | | | | | | | | | |
|------------|---------------------|--------------|-----------------------------------|------|------------|-----|--------------|-------|-------|-------|-----|-------|-----|------|------------------|-------------------|------|-----------------|------------------|-----|-------|------------|----|-----|
| Frame size | Motor type 1FP1014- | No. of poles | A | AA | AB | AC | AD | AD' | AF | AF' | AG | AS | B | BA | BA' | BB | BC | BE | BE' | C | CA | H | HA | Y |
| 80 M | 0DB2, 0DB3 | 4 | 125 | 30.5 | 150 | 159 | 121.5 | 121.5 | 96.5 | 96.5 | 93 | 43 | 100 | 32 | 32 | 118 | 23 | - | 18 ¹⁾ | 50 | 113 | 80 | 8 | 41 |
| 90 S | 0EB0 | 4 | 140 | 30.5 | 165 | 178 | 126 | 126 | 101.5 | 101.5 | 93 | 43 | 100 | 33 | - | 143 | 22.5 | - ¹⁾ | 18 ¹⁾ | 56 | 159 | 90 | 10 | 47 |
| 90 L | 0EB4 | 4 | 140 | 30.5 | 165 | 178 | 126 | 126 | 101.5 | 101.5 | 93 | 43 | 125 | 33 | - | 143 | 22.5 | - ¹⁾ | 18 ¹⁾ | 56 | 154 | 90 | 10 | 47 |
| 112 M | 1BB0, 1BB1, 1BB2 | 4 | 190 | 46 | 226 | 222 | 177 | 177 | 136.5 | 136.5 | 135 | 63.5 | 140 | 37.5 | 37.5 | 176 | 26 | 50 | 25 | 70 | 155 | 112 | 12 | 52 |
| 132 S | 1CB0 | 4 | 216 | 53 | 256 | 262 | 202 | 202 | 159.5 | 159.5 | 155 | 70.5 | 140 | 38 | 76 ²⁾ | 218 ⁴⁾ | 26.5 | 48 | 24 | 89 | 166.5 | 132 | 15 | 69 |
| 132 M | 1CB2 | 4 | 216 | 53 | 256 | 262 | 202 | 202 | 159.5 | 159.5 | 155 | 70.5 | 178 | 38 | 76 | 218 | 26.5 | 48 | 24 | 89 | 178.5 | 132 | 15 | 69 |
| 160 M | 1DB2 | 4 | 254 | 60 | 300 | 314 | 236.5 | 236.5 | 190 | 190 | 175 | 77.5 | 210 | 44 | 89 ³⁾ | 300 ⁵⁾ | 47 | 57 | 28.5 | 108 | 192 | 160 | 18 | 85 |
| 160 L | 1DB4 | 4 | 254 | 60 | 300 | 314 | 236.5 | 236.5 | 190 | 190 | 175 | 77.5 | 254 | 44 | 89 | 300 | 47 | 57 | 28.5 | 108 | 208 | 160 | 18 | 85 |
| 180 M | 1EB2 | 4 | 279 | 65 | 339 | 356 | 259 | 259 | 212.5 | 212.5 | 175 | 77.5 | 241 | 80 | 100 | 328 | 30 | 57 | 28.5 | 121 | 232 | 180 | 20 | 95 |
| 180 L | 1EB4 | 4 | 279 | 65 | 339 | 356 | 259 | 259 | 212.5 | 212.5 | 175 | 77.5 | 279 | 80 | 100 | 328 | 30 | 57 | 28.5 | 121 | 194 | 180 | 20 | 95 |
| 200 L | 2AB5 | 4 | 318 | 70 | 378 | 396 | 296 | 296 | 238 | 238 | 225 | 102.5 | 305 | 90 | 100 | 355 | 45 | 75 | 37.5 | 133 | 202 | 200 | 25 | 108 |

1) Connecting hole for terminal box is on the side at the rear of the terminal box.

2) With screwed-on feet, dimension BA' is 38 mm.

3) With screwed-on feet, dimension BA' is 44 mm.

4) With screwed-on feet, dimension BB is 180 mm.

5) With screwed-on feet, dimension BB is 256 mm.

Synchronous reluctance motors for SINAMICS converters – VSD4000 line

Dimensions · Aluminum series SIMOTICS GP

Super Premium Efficiency – self-ventilated · Frame sizes 80 M, 90 S, 90 L, 112 M to 200 L

Dimensional drawings

Type of construction IM B35

For flange dimensions, see page 1/47 (**Z** = the number of retaining holes)

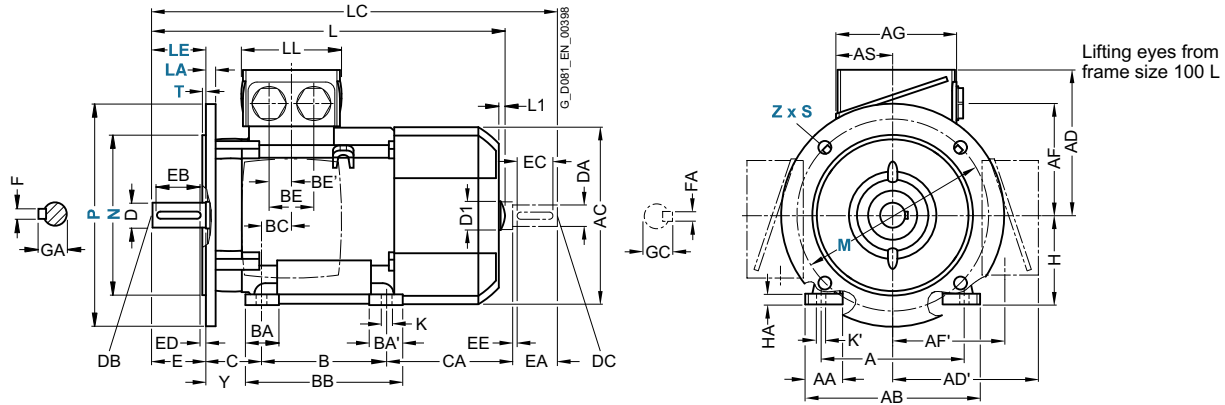

Type of construction IM B14

For flange dimensions, see page 1/47 (**Z** = the number of retaining holes)

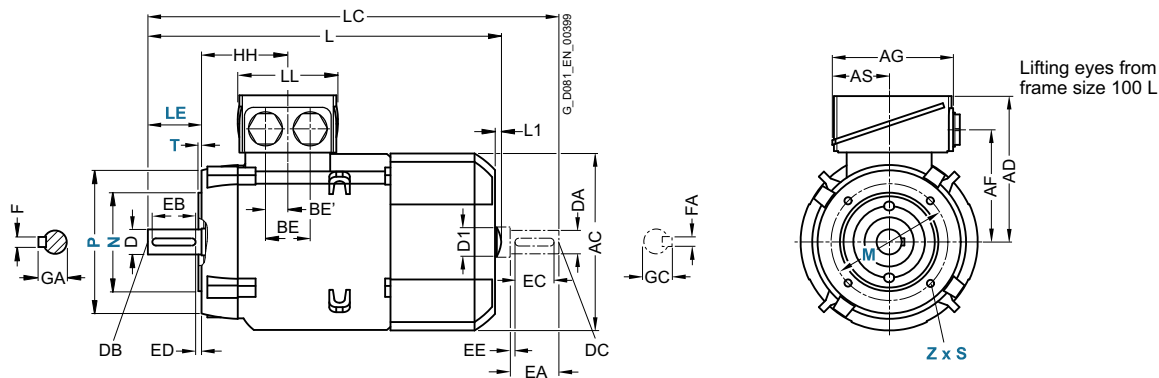

| For motor | | Dimension designation acc. to IEC | | | | | | | | | | DE shaft extension | | | | | NDE shaft extension | | | | | | | |
|------------|---------------------|-----------------------------------|-------|------|------|-----------------|-----|----|-------|-----|----|--------------------|-----|-----|----|----|---------------------|----|-----|-----|-----|----|----|------|
| Frame size | Motor type 1FP10.4- | No. of poles | HH | K | K' | L ¹⁾ | L1 | D1 | LC | LL | D | DB | E | EB | ED | F | GA | DA | DC | EA | EC | EE | FA | GC |
| 80 M | 0DB2, | 4 | 73 | 9.5 | 13.5 | 292 | - | - | 343 | 79 | 19 | M6 | 40 | 32 | 4 | 6 | 21.5 | 19 | M6 | 40 | 32 | 4 | 6 | 21.5 |
| | 0DB3 | | | | | 327 | | | | | | | | | | | | | | | | | | |
| 90 S | 0EB0 | 4 | 78.5 | 10 | 14 | 347 | - | - | 405 | 79 | 24 | M8 | 50 | 40 | 5 | 8 | 27 | 19 | M6 | 40 | 32 | 4 | 6 | 21.5 |
| 90 L | 0EB4 | 4 | 78.5 | 10 | 14 | 387 | - | - | 445 | 79 | 24 | M8 | 50 | 40 | 5 | 8 | 27 | 19 | M6 | 40 | 32 | 4 | 6 | 21.5 |
| 112 M | 1BB0, | 4 | 96 | 12 | 16 | 389 | 7 | 32 | 475 | 112 | 28 | M10 | 60 | 50 | 5 | 8 | 31 | 24 | M8 | 50 | 40 | 5 | 8 | 27 |
| | 1BB1, | | | | | | | | | | | | | | | | | | | | | | | |
| | 1BB2 | | | | | | | | | | | | | | | | | | | | | | | |
| 132 S | 1CB0 | 4 | 115.5 | 12 | 16 | 465 | 8.5 | 39 | 535.5 | 130 | 38 | M12 | 80 | 70 | 5 | 10 | 41 | 28 | M10 | 60 | 50 | 5 | 8 | 31 |
| 132 M | 1CB2 | 4 | 115.5 | 12 | 16 | 515 | 8.5 | 39 | 585.5 | 130 | 38 | M12 | 80 | 70 | 5 | 10 | 41 | 28 | M10 | 60 | 50 | 5 | 8 | 31 |
| 160 M | 1DB2 | 4 | 155 | 15 | 19 | 606 | 10 | 45 | 730 | 145 | 42 | M16 | 110 | 90 | 10 | 12 | 45 | 42 | M16 | 110 | 90 | 10 | 12 | 45 |
| 160 L | 1DB4 | 4 | 155 | 15 | 19 | 666 | 10 | 45 | 790 | 145 | 42 | M16 | 110 | 90 | 10 | 12 | 45 | 42 | M16 | 110 | 90 | 10 | 12 | 45 |
| 180 M | 1EB2 | 4 | 151 | 14.5 | 19 | 698 | - | - | 814 | 145 | 48 | M16 | 110 | 100 | 5 | 14 | 52 | 48 | M16 | 110 | 100 | 5 | 14 | 52 |
| 180 L | 1EB4 | 4 | 151 | 14.5 | 19 | 698 | - | - | 814 | 145 | 48 | M16 | 110 | 100 | 5 | 14 | 52 | 48 | M16 | 110 | 100 | 5 | 14 | 52 |
| 200 L | 2AB5 | 4 | 178 | 18.5 | 25 | 746 | - | - | 860 | 185 | 55 | M20 | 110 | 100 | 5 | 16 | 59 | 55 | M20 | 110 | 100 | 5 | 16 | 59 |

¹⁾ The length is specified as far as the tip of the fan cover.

Synchronous reluctance motors for SINAMICS converters – VSD4000 line

Dimensions · Cast-iron series SIMOTICS SD

Super Premium Efficiency – self-ventilated · Frame sizes 80 M, 90 S, 90 L, 112 M to 160 L

Dimensional drawings

Type of construction IM B3

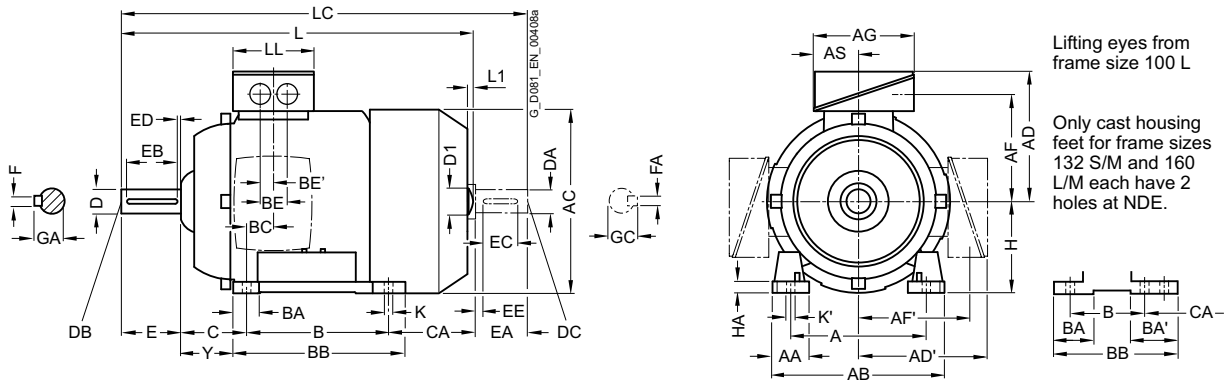

Types of construction IM B5 and IM V1

For flange dimensions, see page 1/47 (Z = the number of retaining holes)

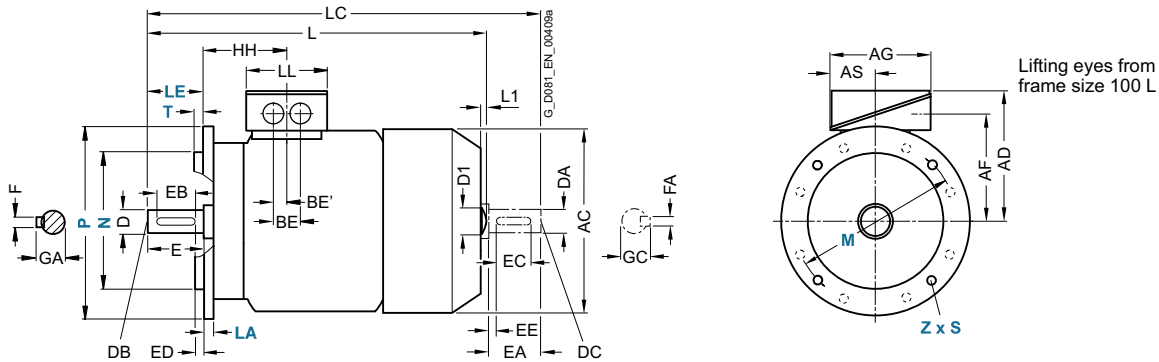

4

| For motor | | | Dimension designation acc. to IEC | | | | | | | | | | | | | | | | | | | | | |
|------------|------------------------------|--------------|-----------------------------------|------|-----|-------|-------|-------|-----|-----|-----|------|-----|------------------|-------------------|-------------------|------|----|-----|-----|------------|-----|----|----|
| Frame size | Motor type 1FP15.4- | No. of poles | A | AA | AB | AC | AD | AD' | AF | AF' | AG | AS | B | BA | BA' | BB | BC | BE | BE' | C | CA | H | HA | Y |
| 80 M | 0DB2, 0DF2, 0DF3, 0DB3 | 4 | 125 | 30.5 | 150 | 162 | 159 | 159 | 122 | 122 | 126 | 62 | 100 | 32 | 32 | 118 | 22.5 | 36 | 18 | 50 | 112.5 | 80 | 8 | 41 |
| 90 S | 0EB0, 0EF0, | 4 | 140 | 30.5 | 165 | 180 | 164 | 164 | 127 | 127 | 126 | 62 | 100 | 33 | 54 | 143 | 24.5 | 36 | 18 | 56 | 159 | 90 | 11 | 47 |
| 90 L | 0EF4, 0EB4 | 4 | 140 | 30.5 | 165 | 180 | 164 | 164 | 127 | 127 | 126 | 62 | 125 | 33 | 54 | 143 | 24.5 | 36 | 18 | 56 | 159 134 | 90 | 11 | 47 |
| 112 M | 1BB0, 1BB1, 1BF1, 1BF2, 1BB2 | 4 | 190 | 46 | 226 | 239 | 195 | 195 | 150 | 150 | 163 | 80.5 | 140 | 48 | 48 | 176 | 30 | 48 | 24 | 70 | 130 | 112 | 12 | 52 |
| 132 S | 1CB0, 1CF0, 1CF1 | 4 | 216 | 53 | 256 | 281 | 214.5 | 214.5 | 169 | 169 | 163 | 80.5 | 140 | 52 ¹⁾ | 89 ³⁾ | 218 ⁵⁾ | 26.5 | 48 | 24 | 89 | 166.5 | 132 | 15 | 69 |
| 132 M | 1CB2 | 4 | 216 | 53 | 256 | 281 | 214.5 | 214.5 | 169 | 169 | 163 | 80.5 | 140 | 52 ¹⁾ | - | 218 ⁵⁾ | 26.5 | 48 | 24 | 89 | 178.5 | 132 | 15 | 69 |
| 160 M | 1DB2, 1DF2, 1DF3 | 4 | 254 | 60 | 300 | 333.5 | 261 | 261 | 213 | 213 | 190 | 92 | 210 | 73 ²⁾ | 117 ⁴⁾ | 300 ⁶⁾ | 37 | 60 | 30 | 108 | 192 | 160 | 18 | 85 |
| 160 L | 1DF4, 1DB4 | 4 | 254 | 60 | 300 | 333.5 | 261 | 261 | 213 | 213 | 190 | 92 | 254 | 73 ²⁾ | 117 ⁴⁾ | 300 ⁶⁾ | 37 | 60 | 30 | 108 | 192 208 | 160 | 18 | 85 |

1) With screwed-on feet, dimension BA is 41 mm.
 2) With screwed-on feet, dimension BA is 51 mm.
 3) With screwed-on feet, dimension BA' is 41 mm.

4) With screwed-on feet, dimension BA' is 51 mm.
 5) With screwed-on feet, dimension BB is 180 mm.
 6) With screwed-on feet, dimension BB is 256 mm.

Synchronous reluctance motors for SINAMICS converters – VSD4000 line

Dimensions · Cast-iron series SIMOTICS SD

Super Premium Efficiency – self-ventilated · Frame sizes 180 M to 200 L

Dimensional drawings

Type of construction IM B3

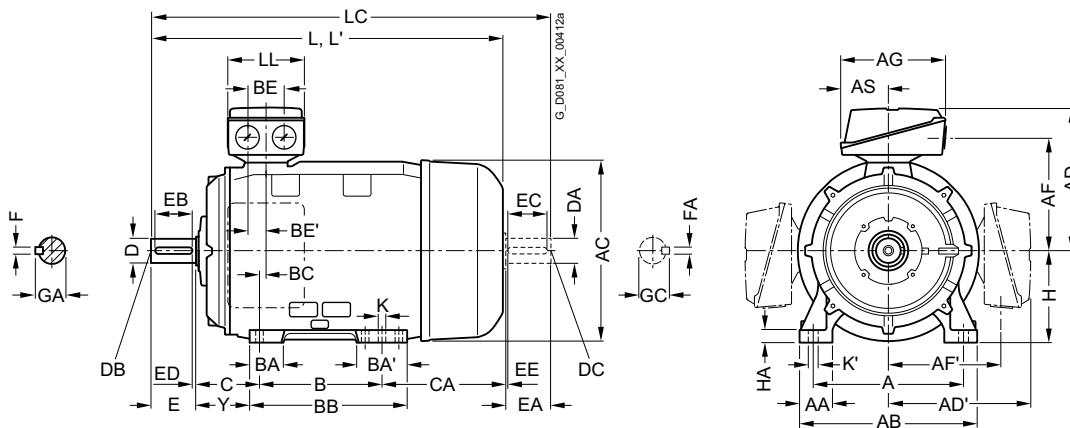

Types of construction IM B5 and IM V1

For flange dimensions, see page 1/47 (Z = the number of retaining holes)

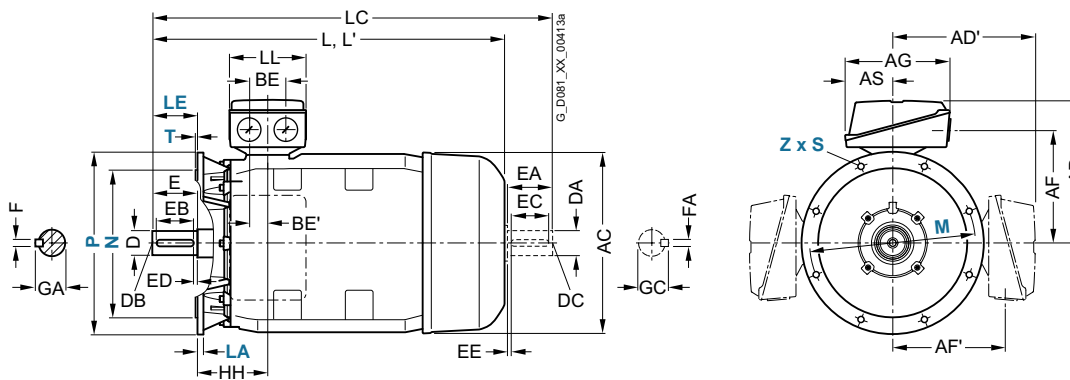

| For motor | | | Dimension designation acc. to IEC | | | | | | | | | | | | | | | | | | |
|-----------------|---------------------|--------------|-----------------------------------|----|------------|-----|------------|-----|-----|-----|-----|-----|-----|-----|-----|-----|----|----|------|-----|-----|
| Frame size | Motor type | No. of poles | A | AA | AB | AC | AD | AD' | AF | AF' | AG | AS | B | BA | BA' | BB | BC | BE | BE' | C | CA |
| 180 M/ 180 L | 1EB2, 1EF2 1EB4 | 4 | 279 | 65 | 339 | 356 | 286 | 286 | 234 | 234 | 190 | 92 | 241 | 85 | 120 | 328 | 34 | 60 | 30 | 121 | 202 |
| 200 L | 2AF4, 2AF5, 2AB5 | 4 | 318 | 70 | 378 | 396 | 315 | 315 | 259 | 259 | 266 | 112 | 305 | 104 | 104 | 355 | 31 | 85 | 42.5 | 133 | 177 |
| 225 S | 2BB0 | 4 | 356 | 80 | 436 | 449 | 338 | 338 | 282 | 282 | 266 | 112 | 286 | 92 | 117 | 361 | 15 | 85 | 42.5 | 149 | 273 |
| 225 M | 2BF2 2BB2 | 4 | 356 | 80 | 436 | 449 | 338 | 338 | 282 | 282 | 266 | 112 | 311 | 92 | 117 | 361 | 15 | 85 | 42.5 | 149 | 248 |

Synchronous reluctance motors for SINAMICS converters – VSD4000 line

Dimensions · Cast-iron series SIMOTICS SD

Cast-iron series, self-ventilated – Super Premium Efficiency · Frame sizes 180 M to 200 L

Dimensional drawings

Type of construction IM B35

For flange dimensions, see page 1/47 (Z = the number of retaining holes)

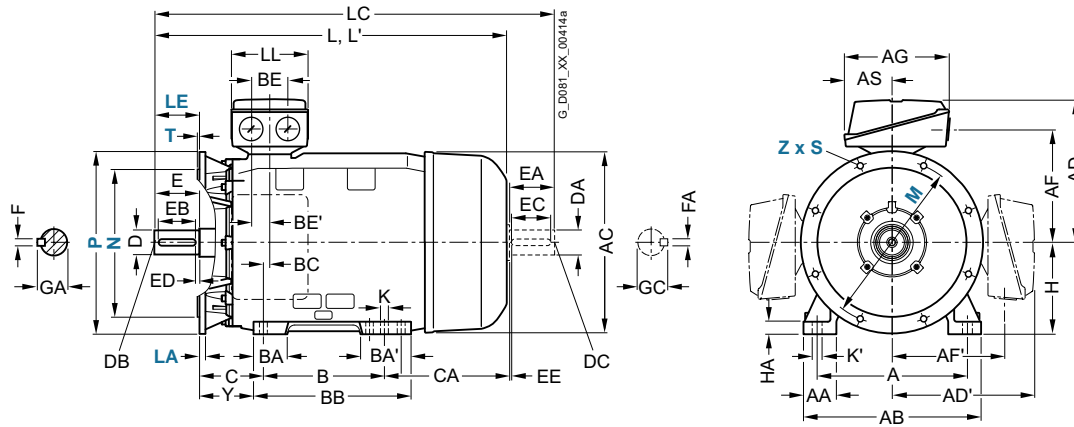

| For motor | | Dimension designation acc. to IEC | | | | | | | | | | DE shaft extension | | | | | NDE shaft extension | | | | | | | | |
|-----------------|---------------------|-----------------------------------|------------|----|-----|-----|----|----|--------------------------|------------------|-----------|--------------------|-----|------------|------------|---------|---------------------|----------|----------|------------|-----|-----|----|----------|------------|
| Frame size | Motor type 1FP15.4- | No. of poles | H | HA | Y | HH | K | K' | L | LC ¹⁾ | LL | D | DB | E | EB | ED | F | GA | DA | DC | EA | EC | EE | FA | GC |
| 180 M/ 180 L | 1EB2, 1EF2 1EB4 | 4 | 180 | 20 | 95 | 155 | 15 | 19 | 668 698 | 784 814 | 164 | 48 | M16 | 110 | 100 | 5 | 14 | 51.5 | 48 | M16 | 110 | 100 | 5 | 14 | 51.5 |
| 200 L | 2AF4, 2AF5, 2AB5 | 4 | 200 | 25 | 108 | 164 | 19 | 25 | 721 | 835 | 197 | 55 | M20 | 110 | 100 | 5 | 16 | 59 | 55 | M20 | 110 | 100 | 5 | 16 | 59 |
| 225 S | 2BB0 | 4 | 225 | 34 | 124 | 164 | 19 | 25 | 848 | 903 | 197 | 60 | M20 | 140 | 125 | 10 | 18 | 64 | 55 | M20 | 110 | 100 | 5 | 16 | 59 |
| 225 M | 2BF2 2BB2 | 4 | 225 | 34 | 124 | 164 | 19 | 25 | 848 928 | 903 963 | 197 60 | 55 | M20 | 110 140 | 100 125 | 5 10 | 16 18 | 59 64 | 48 55 | M16 M20 | 110 | 100 | 5 | 14 16 | 51.5 59 |

¹⁾ In the low-noise version, a second shaft extension and/or mounted encoder is not possible.

Standard induction motors optimized for converter operation – VSD10 line

Orientation

Overview

SIMOTICS GP/SD VSD10 line motor series:
1LE109, 1LE159



SIMOTICS GP/SD VSD10 line motors are suitable for all sectors of industry as a result of their flexibility and the wide range of versions available.

Versions of the
SIMOTICS GP/SD VSD10 line motor series: 1LE109, 1LE159

The motors are squirrel-cage induction motors with compact dimensions in a surface-cooled, enclosed version with self-ventilation. They have been specifically designed for converter operation.

1LE109 General Purpose for converter operation

- Four-quadrant operation with a converter, optimally coordinated to the SINAMICS G drive system. Can be operated with SINAMICS S (ALM, SLM) in four-quadrant operation.
- IP55 degree of protection
- IC411 cooling method, self-ventilated (IC416 cooling method, force-ventilated version optional)
- Housing: Aluminum
- Frame sizes 100 to 160

1LE159 Severe Duty for converter operation

- Four-quadrant operation with a converter, optimally coordinated to the SINAMICS G drive system. Can be operated with SINAMICS S (ALM, SLM) in four-quadrant operation.
- IP55 degree of protection
- IC411 cooling method, self-ventilated (IC416 cooling method, force-ventilated version optional)
- Housing: Cast iron
- Frame sizes 100 to 315

Benefits

The SIMOTICS GP/SD VSD10 line motor series has been specifically developed for operation with SINAMICS G converters.

- Optimizing the assignment of the motor active part to the Power Module results in low capital investment costs.
- The high power density and compact design ensure low space requirements combined with low weight.
- An optimally harmonized drive system is created as the motor is optimally coordinated and harmonized with the converter. For instance, the converter does not have to be derated or there is low temperature rise.
- Optionally, SIMOTICS GP motors with an aluminum housing (frame sizes 100 to 160) or SIMOTICS SD motors with a rugged cast-iron housing (frame sizes 100 to 315) are available.
- High degree of availability based on standard protection functions for converter operation – KTY 84-130 temperature sensors, Pt1000 resistance thermometers (all frame sizes) and NDE insulated bearings (frame sizes 280 and 315).
- As a result of the optimized insulation system, a high degree of reliability is obtained for four-quadrant operation with SINAMICS converters.
- Fast and simple commissioning by transferring a motor code into the converter.

More power ratings

SIMOTICS GP/SD VSD10 line motors are designed as standard for operation with a 50 Hz, 60 Hz, and 87 Hz characteristic (up to frame size 200). No special ordering option is required.

Optimized for converter operation

The new motor series has been optimized for operation with SINAMICS G120, G130, and G150 converters with regard to converter output currents and voltage utilization. Four-quadrant operation is possible without restrictions with the SINAMICS G120 and SINAMICS S120 converter families. The motors can also be operated on other SINAMICS converters (SINAMICS G120P, SINAMICS G120C, SINAMICS G120D).

High degree of flexibility

By consistently utilizing the 1LE1 standard motor platform, almost all options of the 1LE1 line motors can also be used for the SIMOTICS GP/SD VSD10 line series.

Known and established design

Line and converter motors can be easily interchanged due to their identical dimensions and customer interfaces. The connection and operating philosophy is exactly the same as for 1LE1 line motors.

International applications

The motors are not subject to any minimum efficiency requirements for specific countries. As a consequence, they can be operated without additional MEPS certificates, also in the USA, for example.

Standard induction motors optimized for converter operation – VSD10 line

Orientation

Application

As a result of the wide range of options, the SIMOTICS GP/SD VSD10 line motor series can be deployed in all industrial areas and sectors. Paper, steel, energy, chemical, water/waste water are examples of some typical sectors.

Various flange and foot-mounted designs according to EN 60034-7 are available. IP55 is the standard degree of protection (other degrees of protection optionally available).

The wide field of applications that can be addressed includes, for example, the following:

- Pumps
- Fans
- Compressors
- Cranes
- Conveyor belts

Design

The SIMOTICS GP/SD VSD10 line motors are based on the 1LE1 platform. The principle design of the SIMOTICS GP/SD VSD10 line motors therefore corresponds to the 1LE1 line motors.

The mechanical parts are identical. The motors are adapted to the converter by appropriately dimensioning the active part and VSD-specific rating plate data.

Technical specifications

Overview of technical specifications

This table lists the most important technical specifications.

| | |
|---|---|
| Type of motor | SIMOTICS GP/SD VSD10 line IEC Low-Voltage Motors; three-phase induction motors |
| Connection types | Star/delta connection The connection used depends on the particular load characteristic. |
| No. of poles | 2, 4 |
| Frame sizes | 100 ... 315 |
| Rated power | <ul style="list-style-type: none"> • 2-pole: 3 ... 90 kW (50 Hz characteristic); 3.45 ... 101 kW (60 Hz characteristic), 4.5 ... 12.5 kW (87 Hz characteristic) • 4-pole: 2.2 ... 200 kW (50 Hz characteristic); 2.55 ... 230 kW (60 Hz characteristic), 3.7 ... 48 kW (87 Hz characteristic) |
| Frequencies | Characteristics for 50 Hz, 60 Hz and 87 Hz |
| Versions | Air-cooled, enclosed version: <ul style="list-style-type: none"> • with self ventilation • with forced ventilation (optional) SIMOTICS GP motors in an aluminum version, frame sizes 100 ... 160 SIMOTICS SD motors in a cast-iron version, frame sizes 100 ... 315 |
| Marking | Only permitted for converter operation. As converter motors, IE classification according to IEC 60034-30-1 is not required. |
| Rated speed | <ul style="list-style-type: none"> • 1500 rpm, 1800 rpm (up to frame size 315), and 2610 rpm (up to frame size 200) • 3000 rpm, 3600 rpm (up to frame size 280), and 5220 rpm (up to frame size 112) |
| Rated torque | 9.6 ... 1273 Nm (50 Hz characteristic); 9.2 ... 1220 Nm (60 Hz characteristic), 8.2 ... 176 Nm (87 Hz characteristic) |
| Insulation of the stator winding in accordance with EN 60034-1 (IEC 60034-1) | Temperature class F Reinforced insulation system (Advanced) up to 440 V motor connection voltage Special insulation system (Premium) up to 480 V motor connection voltage |
| Degree of protection acc. to EN 60034-5 (IEC 60034-5) | Standard IP55 optionally IP56 and IP65 Air-cooled, enclosed version |
| Cooling acc. to EN 60034-6 (IEC 60034-6) | <ul style="list-style-type: none"> • Standard: Self-ventilated (IC411) • Optional: Forced-air cooled (IC416) |
| Permissible coolant temperature and installation altitude | -20 ... +40 °C as standard, installation altitude up to 1000 m above sea level |
| Standard voltages acc. to EN 60038 (IEC 60038) | 50 Hz line supplies: 400 V, 500 V, 690 V 60 Hz line supplies: 460 V, 600 V The rated motor voltage required is listed in the "Selection and ordering data" for the required motor. |
| Type of construction acc. to EN 60034-7 (IEC 60034-7) | <ul style="list-style-type: none"> • Without flange: IM B3, IM B6, IM B7, IM B8, IM V5, IM V6 • With flange: IM B5, IM B35, IM V1, IM V3 |
| Paint finish Suitability of paint finish for climate group acc. to IEC 60721, Part 2-1 | As standard: color RAL 7030 stone gray |
| Vibration severity grade acc. to EN 60034-14 (IEC 60034-14) | Grade A (normal) |
| Shaft extension acc. to DIN 748 (IEC 60072) | Balancing type: half-key balancing as standard |
| Sound pressure level acc. to EN ISO 1680 (tolerance +3 dB) | The corresponding sound pressure level is listed in the "Selection and ordering data" for the required motor. |
| Weights | The corresponding weight is listed in the "Selection and ordering data" for the required motor. |
| Modular mounting concept | Optional pulse encoder, brake, and separately driven fan according to ordering data |
| Options | See "Article No. supplements and special versions" |

Standard induction motors optimized for converter operation – VSD10 line

Orientation

Technical specifications

Rating plate

In accordance with EN 60034-1, the approximate total weight is specified on the rating plate. The standard version of the rating plate is the international version in English.

For straightforward and fast commissioning with SINAMICS G converters, a motor code number is stamped on the rating plate (CODE). The rated frequencies deviate, depending on the slip, from 50 Hz, 60 Hz, and 87 Hz.

| SIEMENS | | Made in Czech Rep. D-90441 Nürnberg | | 3-Mot. 1AV1164B 1LE10921DB421AF4 UD 1701/1234567 001 001 | | IEC/EN 60034 160L IMB3 IP55 | | 73kg Th.Cl. 155(F) -20°C ≤ TAMB ≤ 40°C | | Bearing DE 6209-2ZC3 NE 6209-2ZC3 | | CONVERTER DUTY ONLY VPWM SINAMICS G120 Nmax 4200 1/min | | CODE 17026 | |
|---------|------|-------------------------------------|------|--|----|-----------------------------|------|--|--|-----------------------------------|--|--|--|------------|--|
| V | Hz | A | kW | cos φ | Nm | 1/min | EFF | | | | | | | | |
| 380 Y | 51.4 | 31.5 | 15.0 | 0.82 | 95 | 1500 | 88.7 | | | | | | | | |
| 220 Δ | 51.4 | 54 | 15.0 | 0.82 | 95 | 1500 | 88.7 | | | | | | | | |
| 440 Y | 61.4 | 30.5 | 17.3 | 0.82 | 92 | 1800 | 90.5 | | | | | | | | |
| 380 Δ | 88.2 | 51 | 23.5 | 0.77 | 86 | 2610 | 90.5 | | | | | | | | |

Example of a rating plate for SIMOTICS GP VSD10 line

Motors specially designed for converter operation

These motors have been specifically designed for converter operation. The catalog data apply for operation with Siemens SINAMICS G and SINAMICS S converters.

When operated with an alternative converter, the catalog data apply (thermal torque limits, maximum overload torques), approximately for the following general conditions:

- Minimum rated pulse frequencies:
 - 4 kHz at 400 V, up to 90 kW
 - 2 kHz at 500 V to 690 V, up to 132 kW
 - 1.25 kHz at 500 V to 690 V, 160 and 200 kW
- The converter can provide the rated voltage as listed in the catalog.
- Permissible voltage peaks for reinforced insulation system (Advanced):
 $\hat{U}_{\text{phase-to-phase}} \leq 1600 \text{ V}$, $\hat{U}_{\text{phase-to-ground}} \leq 1400 \text{ V}$, $t_s > 0.1 \mu\text{s}$
- Permissible voltage peaks for special insulation system (Premium):
 $\hat{U}_{\text{phase-to-phase}} \leq 2200 \text{ V}$, $\hat{U}_{\text{phase-to-ground}} \leq 1500 \text{ V}$, $t_s > 0.1 \mu\text{s}$

For SINAMICS G120 converters (from firmware version 4.7 and higher), the SIMOTICS GP/SD VSD10 line can be selected as the motor category and addressed using the motor code No. in the SINAMICS converter using the STARTER software or at the converter operator panel (Advanced Operator Panel (AOP), Basic Operator Panel (BOP)).

Rated voltage

The tolerance for the rated voltage is in accordance with EN 60034-1. A rated voltage range is not specified. The rated motor voltages are selected so that when operated with a SINAMICS G120 converter, the available voltage is optimally utilized.

Insulation

The motors can be operated with line voltages up to 690 V 3 AC with SINAMICS G converters and SINAMICS S converters (uncontrolled and controlled infeed) when maintaining the permissible peak voltages specified above.

Depending on the selected motor connection voltage, a special insulation system is used for converter operation.

- Up to 440 V motor voltage (480 V line voltage) reinforced insulation system (Advanced)
- From 480 V motor voltage (500 V line voltage) special insulation system (Premium)

For converter operation with the power ratings specified in the catalog, the motors can be utilized corresponding to thermal class 155 (F) (service factor 1.0).

Preferred supply system configurations are TT systems and TN systems with neutral-point grounding. In the case of a fault when connected to an IT system (ground fault), the insulation is excessively stressed. In this case, the process should be terminated as quickly as possible ($t < 2 \text{ h}$), and the fault resolved. We do not recommend operation in corner-grounded TN systems.

Noise

The maximum sound pressure levels should be taken from the selection and ordering data.

Standard induction motors optimized for converter operation – VSD10 line

Orientation

Technical specifications

Separately driven fan

For the technical specifications of the separately driven fans, see page 1/77 "Technical specifications of separately driven fans".

Bearings

To prevent bearing current damage, converter motors are equipped with insulated bearing cartridges at the NDE, available as standard for frame sizes 280 and 315.

Insulated NDE bearings are optionally available for frame sizes 100 to 250. We recommend their use depending on the particular plant or system.

For converter operation, as a result of the basic principle employed, electrical bearing stress is created through the bearing lubricant film due to a voltage that is capacitively coupled in.

The physical cause of this is the common-mode voltage at the converter output that is inherent in the control method for a converter:

The sum of the three phase voltages is – in contrast to pure line operation – not equal to zero at every point in time.

In order to apply currents to the motor which are sinusoidal as far as possible (resulting in smoother running, lower oscillation torques, and lower stray losses), a high pulse frequency is required for the converter's output voltage. The related (very steep) switching edges of the converter output voltage (and also, therefore, of the common-mode voltage) cause correspondingly high capacitive currents and voltages on the machine's internal capacitances.

In the worst-case scenario, the capacitive voltage induced via the bearing can lead to random arcing through the bearing lubricating film, thus causing premature bearing aging or damage.

This physical effect, which occurs in isolated cases, has mostly been observed in connection with larger motors.

EMC-compliant installation of the drive system is a basic prerequisite for preventing premature bearing damage via bearing currents.

The most important measures for reducing bearing currents are:

- Insulated motor bearing at the NDE.
- Use cables with a symmetrical cable cross-section:

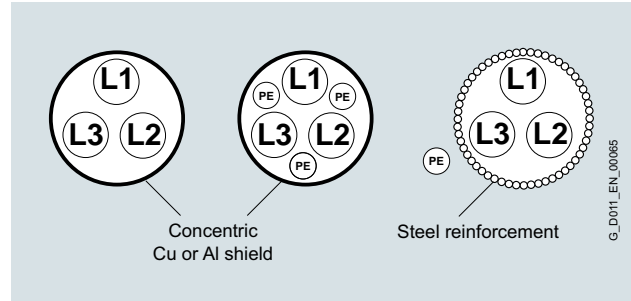

- Preference given to a line supply with isolated neutral point (IT system).
- Using grounding cables with low impedance over a wide frequency range (DC up to approximately 70 MHz): for example, braided copper ribbon cables, HF finely stranded wires.
- Separate HF equipotential-bonding cable between motor housing and driven machine.
- Separate HF equipotential-bonding cable between motor housing and converter PE busbar.
- 360° HF contacting of the cable shield on the motor housing and the converter PE busbar. This can be achieved using EMC screwed glands on the motor side and EMC shield clips on the converter side, for example.

Standard induction motors optimized for converter operation – VSD10 line

Orientation

Technical specifications

Torque limits (continuous duty)

The thermal torque limit characteristics of the SIMOTICS GP/SD VSD10 line define the maximum load torque for uninterrupted duty (S1) over the complete speed control range. The characteristics are different for all of the cooling methods. The speed control range is limited by the mechanical speed limit, which depends on the motor's mechanical design.

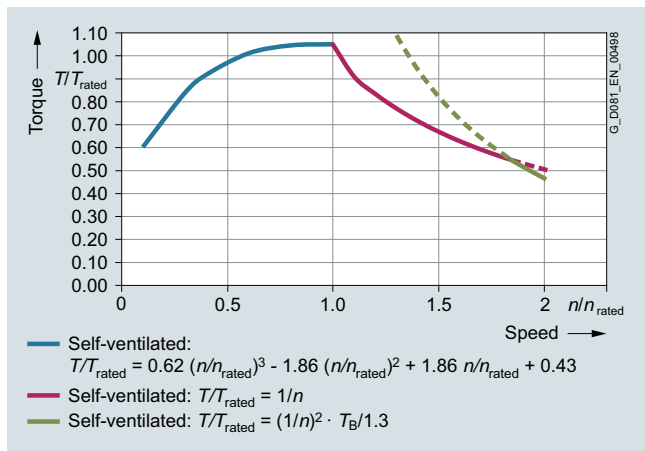

Torque limit characteristic for SIMOTICS GP/SD VSD10 line, self-ventilated

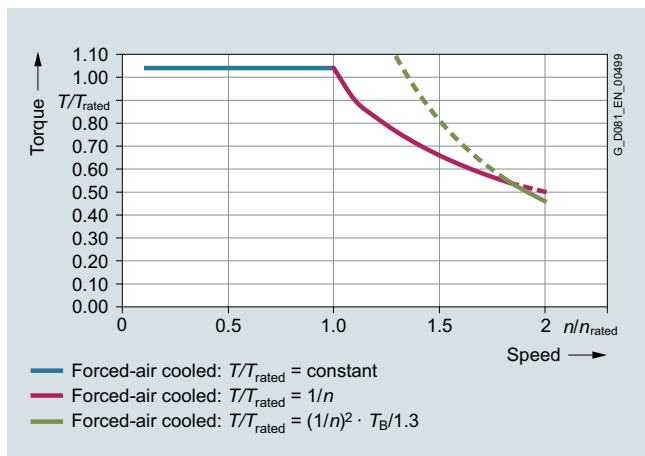

Torque limit characteristic for SIMOTICS GP/SD VSD10 line, forced-air cooled

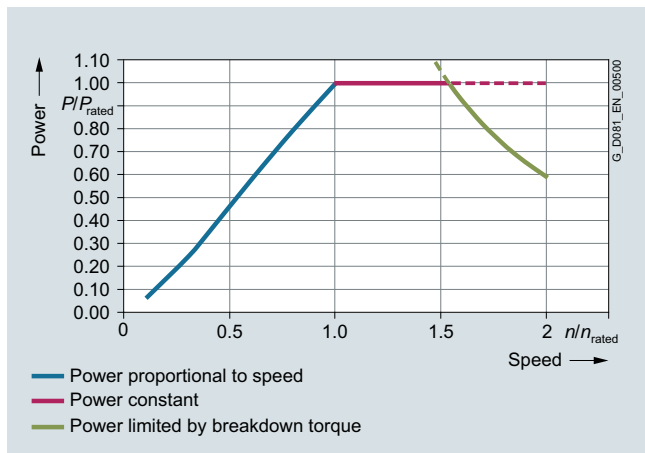

Power limit for SIMOTICS GP/SD VSD10 line, self-ventilated

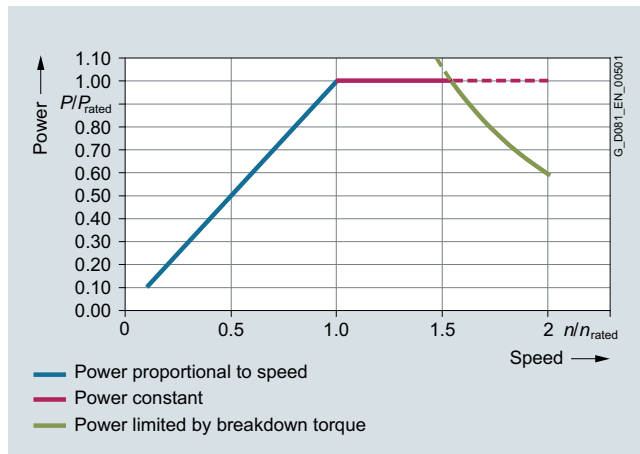

Power limit for SIMOTICS GP/SD VSD10 line, forced-air cooled

Maximum overload torques

The maximum overload torque output from the motor is defined by the overload torque characteristic over the complete speed control range. The reference variable is the breakdown torque at rated speed. The breakdown torque is calculated from the breakdown torque ratio and the rated torque. Operation at the maximum overload torque is only briefly permissible, for instance, when accelerating. The speed control range is limited by the mechanical speed limit, which depends on the motor's mechanical design.

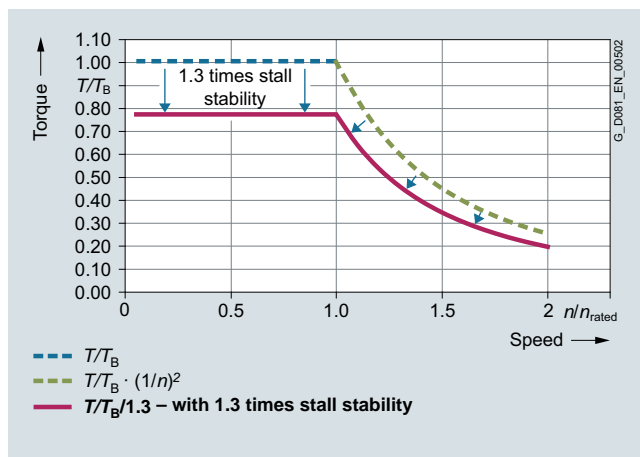

Overload torque characteristic for SIMOTICS GP/SD VSD10 line

Standard induction motors optimized for converter operation – VSD10 line

Orientation

Technical specifications

Additional information

Mechanical stress and grease lifetime

When motors are operated at speeds above the rated speed, the mechanical smooth running operation and the bearings are subjected to greater mechanical stress. This reduces the grease lifetime and the bearing lifetime.

Above 100 Hz, the motors must be balanced for twice the rated frequency.

Motor protection

A motor protection function can be implemented using the Rt sensing function implemented in the converter software. If required, more precise motor protection can be afforded by direct temperature measurement using KTY84 sensors, PTC thermistors, or Pt100/1000 resistance thermometers in the motor winding. Some converters from Siemens determine the motor temperature using the resistance of the temperature sensor. They can be set to a required temperature for alarm and tripping. When ordering PTC thermistors, Pt100 resistance thermistors or other temperature sensors to monitor the cooling temperature, the KTY84 sensors, otherwise provided as standard, are omitted. As described above, KTY84 sensors are evaluated in the SINAMICS converters.

Motor connection

When connecting the motors, it is important to consider the restrictions for 1LE1 line motors as well as the maximum conductor cross-sections permitted for the converter.

Operating data for 50 Hz/60 Hz/87 Hz characteristics

SIMOTICS GP/SD VSD10 line motors are designed for operation with 50 Hz, 60 Hz and 87 Hz characteristics (87 Hz characteristic up to frame size 200).

Operation with the 50/60 Hz characteristic requires Y (star or wye) connection; operation with the 87 Hz characteristic requires Δ connection.

The corresponding power data are stamped on the rating plate as standard. An ordering option is not required.

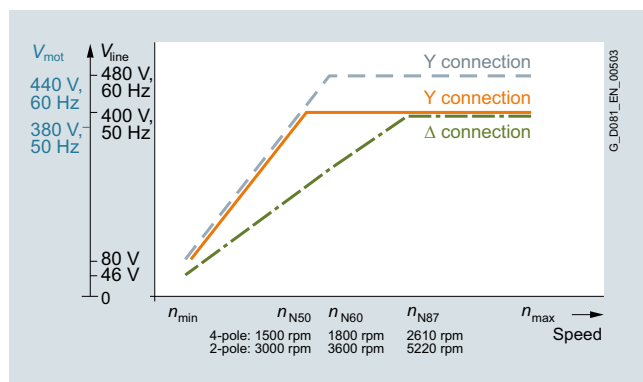

Operating characteristics of SIMOTICS GP/SD VSD10 line motors

Maximum operating speed

The maximum operating speed is limited by the mechanical speed limit of the motors as well as the available converter output frequency.

A significant increase in the sound pressure level can be expected when operating the motor above its rated speed (field weakening range).

Mechanical speed limits SIMOTICS GP/SD VSD10 line:

| Frame size | Mechanical speed limits for 1LE1.92 motors | |
|------------|--|------------------|
| | 2-pole | 4-pole |
| | n_{max} rpm | n_{max} rpm |
| 100 | 5500 | 4200 |
| 112 | 5500 | 4200 |
| 132 | 4500 | 4200 |
| 160 | 4500 | 4200 |
| 180 | 4500 | 4200 |
| 200 | 4500 | 4200 |
| 225 | 4500 | 4500 |
| 250 | 3900 | 3700 |
| 280 | 3600 | 3000 |
| 315 | – | 2600 |

International use:

As special converter motors, SIMOTICS GP/SD VSD10 line motors are presently not subject to any minimum efficiency requirements in the EU and USA/Canada. However, other national certificates may be required (e.g. CSA-S safety in Canada).

Therefore, for use in USA, Canada and Mexico, we recommend:

Ordering with order code **D39** (version according to UL and CSA-S).

Note:

At the present time, national Chinese regulations regarding converter motors are being revised. A conclusive interpretation relating to the design still cannot be made. As a consequence, until further notice, for China we recommend that line motors suitable for converter operation are used with CEL (China Energy Label) (e.g. 1LE100. with order code **D34**).

Standard induction motors optimized for converter operation – VSD10 line

Orientation

Technical specifications

Load characteristics for the line supply voltage: 400 V 3 AC, 50 Hz

| Rated speed 3000 rpm | | | | SIMOTICS GP/SD VSD10 line motors | SINAMICS G120 converters |
|-----------------------------|---------------------------|--------------------------|---------------------------|-------------------------------------|-----------------------------|
| Load characteristic | Speed control range | | | | |
| $T \sim n^2$ | $T = \text{const.}$ | | | | |
| | from 1500 rpm 1 : 2 | from 750 rpm 1 : 4 | from 300 rpm 1 : 10 | | |
| P_{max} | P_{max} | P_{max} | P_{max} | Motor type | Converter type |
| kW | kW | kW | kW | | |
| 3 | 1.47 | 0.63 | 0.21 | 1LE1.92-1AA42-1... | 6SL3210-1PE18-0.L1 |
| 4 | 1.97 | 0.84 | 0.27 | 1LE1.92-1BA22-1... | 6SL3210-1PE21-1.L0 |
| 5.5 | 2.69 | 1.17 | 0.39 | 1LE1.92-1CA02-1... | 6SL3210-1PE21-4.L0 |
| 7.5 | 3.64 | 1.59 | 0.54 | 1LE1.92-1CA12-1... | 6SL3210-1PE21-8.L0 |
| 11 | 5.38 | 2.34 | 0.79 | 1LE1.92-1DA22-1... | 6SL3210-1PE22-7.L0 |
| 15 | 7.33 | 3.19 | 1.08 | 1LE1.92-1DA32-1... | 6SL3210-1PE23-3.L0 |
| 18.5 | 9.05 | 3.93 | 1.32 | 1LE1.92-1DA42-1... | 6SL3210-1PE23-8.L0 |
| 22 | 10.77 | 4.69 | 1.59 | 1LE1592-1EA22-1... | 6SL3210-1PE24-5.L0 |
| 30 | 14.64 | 6.37 | 2.13 | 1LE1592-2AA42-1... | 6SL3210-1PE26-0.L0 |
| 37 | 18.08 | 7.86 | 2.66 | 1LE1592-2AA52-1... | 6SL3210-1PE27-5.L0 |
| 45 | 21.99 | 9.54 | 3.21 | 1LE1592-2BA22-1... | 6SL3210-1PE28-8.L0 |
| 55 | 26.86 | 11.65 | 3.91 | 1LE1592-2CA22-1... | 6SL3210-1PE31-1.L0 |
| 75 | 36.63 | 15.85 | 5.33 | 1LE1592-2DA02-1... | 6SL3210-1PE31-5.L0 |
| 90 | 43.91 | 19.00 | 6.38 | 1LE1592-2DA22-1... | 6SL3210-1PE31-8.L0 |

| Rated speed 1500 rpm | | | | SIMOTICS GP/SD VSD10 line motors | SINAMICS converters |
|-----------------------------|------------------------|------------------------|-------------------------|-------------------------------------|------------------------|
| Load characteristic | Speed control range | | | | |
| $T \sim n^2$ | $T = \text{const.}$ | | | | |
| | from 750 rpm 1:2 | from 375 rpm 1:4 | from 150 rpm 1:10 | | |
| P_{max} | P_{max} | P_{max} | P_{max} | Motor type | Converter type |
| kW | kW | kW | kW | | |
| 2.2 | 1.06 | 0.43 | 0.13 | 1LE1.92-1AB42-1... | 6SL3210-1PE16-1.L1 |
| 3 | 1.45 | 0.59 | 0.18 | 1LE1.92-1AB52-1... | 6SL3210-1PE18-0.L1 |
| 4 | 1.93 | 0.78 | 0.24 | 1LE1.92-1BB22-1... | 6SL3210-1PE21-1.L0 |
| 5.5 | 2.65 | 1.07 | 0.33 | 1LE1.92-1CB02-1... | 6SL3210-1PE21-4.L0 |
| 7.5 | 3.60 | 1.45 | 0.45 | 1LE1.92-1CB22-1... | 6SL3210-1PE21-8.L0 |
| 11 | 5.31 | 2.14 | 0.66 | 1LE1.92-1DB22-1... | 6SL3210-1PE22-7.L0 |
| 15 | 7.20 | 2.91 | 0.90 | 1LE1.92-1DB42-1... | 6SL3210-1PE23-3.L0 |
| 18.5 | 8.94 | 3.61 | 1.11 | 1LE1592-1EB22-1... | 6SL3210-1PE23-8.L0 |
| 22 | 10.61 | 4.29 | 1.32 | 1LE1592-1EB42-1... | 6SL3210-1PE24-5.L0 |
| 30 | 14.48 | 5.85 | 1.80 | 1LE1592-2AB52-1... | 6SL3210-1PE26-0.L0 |
| 37 | 17.89 | 7.23 | 2.22 | 1LE1592-2BB02-1... | 6SL3210-1PE27-5.L0 |
| 45 | 21.68 | 8.76 | 2.70 | 1LE1592-2BB22-1... | 6SL3210-1PE28-8.L0 |
| 55 | 26.53 | 10.72 | 3.30 | 1LE1592-2CB22-1... | 6SL3210-1PE31-1.L0 |
| 75 | 36.15 | 14.61 | 4.50 | 1LE1592-2DB02-1... | 6SL3210-1PE31-5.L0 |
| 90 | 43.43 | 17.55 | 5.40 | 1LE1592-2DB22-1... | 6SL3210-1PE31-8.L0 |
| 106 | 53.05 | 21.44 | 6.60 | 1LE1592-3AB02-1... | 6SL3210-1PE32-1.L0 |
| 130 | 63.66 | 25.73 | 7.92 | 1LE1592-3AB22-1... | 6SL3210-1PE32-5.L0 |
| 160 | 77.23 | 31.21 | 9.60 | 1LE1592-3AB42-1... | 6SL3224-OXE41-3.A0 |
| 200 | 96.48 | 38.99 | 12.00 | 1LE1592-3AB52-1... | 6SL3224-OXE41-6.A0 |

Note:

The converter recommendation applies to standard ambient conditions (40 °C; 1000 m above sea level).

If, as a result of different ambient conditions, the rated motor power is significantly reduced, under certain circumstances, another converter is the optimum solution. Here, please use the configuration options for converters in the DT Configurator.

Standard induction motors optimized for converter operation – VSD10 line

Orientation

Technical specifications

SIMOTICS GP/SD VSD10 line standard motors for converter operation with converter SINAMICS G120 Power Modules PM240-2

| Rated power kW | SIMOTICS GP/SD VSD10 1LE109/1LE159 | Frame size | SINAMICS G120 Power Module PM240-2 | Pulse fre- quency kHz | Frame size | System power loss, relative $P_{V,rel}$ as a % referred to P_{rated} | | | | | | | | | | IES class acc. to EN 50598-2 |
|--|--|---------------|--|--------------------------------|---------------|--|-----------|------------|------------|------------|-------------|-------------|--------------|-----------------------------|--|------------------------------------|
| | | | | | | Operating points at partial load ¹⁾ | | | | | | | | | | |
| Type | Type | Type | Type | | | 0/25 % | 0/50 % | 0/100 % | 50/25 % | 50/50 % | 50/100 % | 100/50 % | 100/100 % | at rated load ¹⁾ | | |
| Line voltage 400 V 3 AC, 50/60 Hz, rated speed 3000 rpm | | | | | | | | | | | | | | | | |
| 3 | 1LE1.92-1AA42-1... | 100 L | 6SL3210-1PE18-0.L1 | 4 | FSA | 3.433 | 6.367 | 17.333 | 5.4 | 8.533 | 21.433 | 13.567 | 27.833 | IES 1 | | |
| 4 | 1LE1.92-1BA22-1... | 112 M | 6SL3210-1PE21-1.L0 | 4 | FSB | 3.775 | 5.8 | 14.35 | 5.65 | 8.025 | 17.6 | 13.375 | 24.45 | IES 1 | | |
| 5.5 | 1LE1.92-1CA02-1... | 132 S | 6SL3210-1PE21-4.L0 | 4 | FSB | 3.109 | 5.218 | 13.836 | 4.109 | 6.564 | 16.6 | 10.309 | 21.6 | IES 1 | | |
| 7.5 | 1LE1.92-1CA12-1... | 132 S | 6SL3210-1PE21-8.L0 | 4 | FSB | 2.56 | 4.333 | 11.587 | 3.653 | 5.693 | 13.84 | 9.093 | 18.533 | IES 2 | | |
| 11 | 1LE1.92-1DA22-1... | 160 M | 6SL3210-1PE22-7.L0 | 4 | FSC | 2.664 | 4.364 | 11.2 | 3.973 | 5.936 | 13.845 | 10.255 | 19.555 | IES 1 | | |
| 15 | 1LE1.92-1DA32-1... | 160 M | 6SL3210-1PE23-3.L0 | 4 | FSC | 1.96 | 3.68 | 10.227 | 3.153 | 5.04 | 12.693 | 8.547 | 17.4 | IES 1 | | |
| 18.5 | 1LE1592-1DA42-1... | 160 L | 6SL3210-1PE23-8.L0 | 4 | FSD | 2.308 | 3.649 | 8.854 | 3.53 | 5.022 | 10.865 | 8.059 | 15.07 | IES 2 | | |
| 22 | 1LE1592-1EA22-1... | 180 M | 6SL3210-1PE24-5.L0 | 4 | FSD | 1.695 | 3.027 | 8.345 | 2.586 | 4.073 | 9.741 | 6.482 | 13.255 | IES 2 | | |
| 30 | 1LE1592-2AA42-1... | 200 L | 6SL3210-1PE26-0.L0 | 4 | FSD | 1.33 | 2.703 | 7.327 | 2.233 | 3.737 | 8.88 | 6.233 | 12.797 | IES 2 | | |
| 37 | 1LE1592-2AA52-1... | 200 L | 6SL3210-1PE27-5.L0 | 4 | FSD | 1.276 | 2.3 | 6.238 | 2.108 | 3.276 | 7.611 | 5.257 | 10.678 | IES 2 | | |
| 45 | 1LE1592-2BA22-1... | 225 M | 6SL3210-1PE28-8.L0 | 4 | FSE | 1.127 | 2.093 | 5.749 | 2.044 | 3.144 | 7.016 | 5.538 | 10.471 | IES 2 | | |
| 55 | 1LE1592-2CA22-1... | 250 M | 6SL3210-1PE31-1.L0 | 4 | FSE | 1.056 | 1.991 | 5.467 | 1.869 | 2.945 | 6.771 | 5.396 | 10.253 | IES 2 | | |
| 75 | 1LE1592-2DA02-1... | 280 S | 6SL3210-1PE31-5.L0 | 4 | FSF | 1.064 | 1.847 | 4.784 | 2.064 | 2.971 | 6.207 | 5.564 | 9.799 | IES 2 | | |
| 90 | 1LE1592-2DA22-1... | 280 M | 6SL3210-1PE31-8.L0 | 4 | FSF | 0.932 | 1.643 | 4.241 | 1.696 | 2.527 | 5.473 | 4.523 | 8.412 | IES 2 | | |
| Line voltage 400 V 3 AC, 50/60 Hz, rated speed 1500 rpm | | | | | | | | | | | | | | | | |
| 2.2 | 1LE1.92-1AB42-1... | 100 L | 6SL3210-1PE16-1.L1 | 4 | FSA | 5.273 | 8.273 | 19.273 | 6.682 | 10.364 | 27.682 | 14.364 | 32.091 | IES 1 | | |
| 3 | 1LE1.92-1AB52-1... | 100 L | 6SL3210-1PE18-0.L1 | 4 | FSA | 4.433 | 7.233 | 16.4 | 5.867 | 9 | 22.367 | 12.433 | 27 | IES 1 | | |
| 4 | 1LE1.92-1BB22-1... | 112 M | 6SL3210-1PE21-1.L0 | 4 | FSB | 4.45 | 6.9 | 16.1 | 5.675 | 8.425 | 20.025 | 11.5 | 24.3 | IES 1 | | |
| 5.5 | 1LE1.92-1CB02-1... | 132 S | 6SL3210-1PE21-4.L0 | 4 | FSB | 3.618 | 6 | 15.618 | 4.764 | 7.455 | 18.818 | 10.545 | 23.036 | IES 1 | | |
| 7.5 | 1LE1.92-1CB22-1... | 132 M | 6SL3210-1PE21-8.L0 | 4 | FSB | 3.413 | 5.24 | 12.533 | 4.787 | 6.84 | 15.24 | 10.013 | 19.733 | IES 1 | | |
| 11 | 1LE1.92-1DB22-1... | 160 M | 6SL3210-1PE22-7.L0 | 4 | FSC | 3.255 | 4.918 | 11.445 | 4.482 | 6.355 | 13.936 | 9.418 | 18.336 | IES 1 | | |
| 15 | 1LE1.92-1DB42-1... | 160 L | 6SL3210-1PE23-3.L0 | 4 | FSC | 2.94 | 4.387 | 10.073 | 4.013 | 5.627 | 12.06 | 8.14 | 15.8 | IES 2 | | |
| 18.5 | 1LE1592-1EB22-1... | 180 M | 6SL3210-1PE23-8.L0 | 4 | FSD | 2.205 | 3.665 | 9.092 | 3.465 | 5.076 | 11.292 | 7.514 | 14.843 | IES 2 | | |
| 22 | 1LE1592-1EB42-1... | 180 L | 6SL3210-1PE24-5.L0 | 4 | FSD | 2.232 | 3.527 | 8.5 | 3.1 | 4.545 | 10.145 | 6.15 | 12.841 | IES 2 | | |
| 30 | 1LE1592-2AB52-1... | 200 L | 6SL3210-1PE26-0.L0 | 4 | FSD | 1.99 | 3.167 | 7.903 | 2.877 | 4.197 | 9.32 | 6.06 | 12.26 | IES 2 | | |
| 37 | 1LE1592-2BB02-1... | 225 S | 6SL3210-1PE27-5.L0 | 4 | FSD | 1.53 | 2.635 | 6.938 | 2.551 | 3.797 | 8.568 | 6.051 | 11.924 | IES 2 | | |
| 45 | 1LE1592-2BB22-1... | 225 M | 6SL3210-1PE28-8.L0 | 4 | FSE | 1.413 | 2.493 | 6.644 | 2.291 | 3.504 | 8.053 | 5.447 | 10.982 | IES 2 | | |
| 55 | 1LE1592-2CB22-1... | 250 M | 6SL3210-1PE31-1.L0 | 4 | FSE | 1.298 | 2.427 | 7.129 | 2.104 | 3.36 | 8.082 | 5.3 | 11.051 | IES 2 | | |
| 75 | 1LE1592-2DB02-1... | 280 S | 6SL3210-1PE31-5.L0 | 4 | FSF | 1.317 | 2.135 | 5.216 | 2.441 | 3.373 | 6.811 | 5.909 | 10.315 | IES 2 | | |
| 90 | 1LE1592-2DB22-1... | 280 M | 6SL3210-1PE31-8.L0 | 4 | FSF | 1.224 | 2.033 | 5.132 | 2.002 | 2.92 | 6.357 | 4.579 | 8.95 | IES 2 | | |
| 106 | 1LE1592-3AB02-1... | 315 S | 6SL3210-1PE32-1.L0 | 2 | FSF | 1.021 | 1.711 | 4.398 | 1.959 | 2.765 | 5.781 | 4.811 | 8.863 | IES 2 | | |
| 130 | 1LE1592-3AB22-1... | 315 M | 6SL3210-1PE32-5.L0 | 2 | FSF | 0.947 | 1.543 | 3.828 | 1.754 | 2.468 | 5.094 | 4.256 | 7.9 | IES 2 | | |
| 160 | 1LE1592-3AB42-1... | 315 L | 6SL3224-OXE41-3.A0 | 2 | FSGX | 1.343 | 1.981 | 4.441 | 2.224 | 2.974 | 5.771 | 4.762 | 8.614 | IES 2 | | |
| 200 | 1LE1592-3AB52-1... | 315 L | 6SL3224-OXE41-6.A0 | 2 | FSGX | 1.149 | 1.879 | 4.737 | 1.871 | 2.703 | 5.838 | 4.154 | 8.251 | IES 2 | | |

¹⁾ Output frequency, rel. [%] referred to the rated speed/
Torque, rel. [%] referred to the rated torque T_{rated} .

Standard induction motors optimized for converter operation – VSD10 line

Orientation

Article number code

Selection and ordering data

The article number consists of a combination of digits and letters and is divided into three hyphenated blocks to provide a better overview, e.g.:

**1LE1592-1DB42-1GF4-Z
H00**

The first block (positions 1 to 7) identifies the motor type. The second block (positions 8 to 12) defines the motor frame size and length, the number of poles and power and in some cases the frequency/voltage. In the third block (positions 13 to 16), the frequency/voltage, type of construction and further design features are encoded.

For deviations in the second and third block from the catalog codes either **Z** or **90** should be used as appropriate.

Ordering data:

- Complete Article No. and order code(s) or plain text
- If a quotation has been requested, please specify the quotation number in addition to the Article No.
- When ordering a complete motor as a spare part, please specify the works serial No. for the previously supplied motor as well as the Article No.

| Structure of the Article No.: | | Position: | 1 | 2 | 3 | 4 | 5 | 6 | 7 | - | 8 | 9 | 10 | 11 | 12 | - | 13 | 14 | 15 | 16 | |
|---|---|-----------|---|---|---|---|--------|---|---|---|---------------|---------------|----------------------------|----|------------------|---|----|---------------|----|---------------|-----|
| 1st to 4th position: Digit, letter, letter, digit | Self-ventilated by fan mounted on and driven by the rotor | | 1 | L | E | 1 | | | | | | | | | | | | | | | |
| 5th position: Digit | SIMOTICS GP – aluminum housing SIMOTICS SD – cast-iron housing | | | | | | 0 5 | | | | | | | | | | | | | | |
| 6th position: Digit | VSD10 line motor (motor for converter operation) | | | | | | | 9 | | | | | | | | | | | | | |
| 7th position: Digit | Standard efficiency class | | | | | | | | 2 | | | | | | | | | | | | |
| 8th and 9th position: Digit, letter | Motor frame size (frame size as a combination of shaft height and overall length, encoded) | | | | | | | | | | 1 ... 3 | A ... D | | | | | | | | | |
| 10th position: Letter | No. of poles A: 2-pole B: 4-pole | | | | | | | | | | | | A B | | | | | | | | |
| 11th position: Digit | Laminated core length | | | | | | | | | | | | 0 1 2 3 4 5 | | | | | | | | |
| 12th and 13th position: 2 digits | Voltage and frequency ¹⁾ 380 V 3 AC, 50 Hz/440 V 3 AC, 60 Hz/380 V 3 AC, 87Hz 480 V 3 AC, 50 Hz/550 V 3 AC, 60 Hz/480 V 3 AC, 87Hz 660 V 3 AC, 50 Hz/660 V 3 AC, 87 Hz Non-standard winding, requires order code M.. (e.g. M1Y) | | | | | | | | | | | | 2 2 3 9 | | 1 6 3 0 | | | | | | |
| 14th position: Letter | Type of construction (encoded with A ... V) | | | | | | | | | | | | | | | | | A ... V | | | |
| 15th position: Letter | Motor protection (encoded with B ... Z; Z requires order code Q.. (e.g. Q3A); F = standard version with integrated KTY 84 temperature sensor) | | | | | | | | | | | | | | | | | B ... Z | | | |
| 16th position: Digit | Terminal box position 4: Terminal box top (normal version), 5: Terminal box right, 6: Terminal box left | | | | | | | | | | | | | | | | | | | 4 ... 6 | |
| | Special order versions: encoded – additional order code required not encoded – additional plain text required | | | | | | | | | | | | | | | | | | | | - Z |

¹⁾ Depending on slip, the rated frequency is above 50 Hz, 60 Hz, or 87 Hz (see Technical specifications).

Standard induction motors optimized for converter operation – VSD10 line

Orientation

Article number code

Selection and ordering data

Ordering example:

| Selection criteria | Requirement | Structure of the Article No. |
|---|--|------------------------------|
| Motor type 1LE1 | Standard motor for converter operation SIMOTICS GP VSD10 line, aluminum version | 1LE1092-■■■■■-■■■■■ |
| Motor frame size | 160 L | 1LE1092-1DB■■■-■■■■■ |
| No. of poles | 4-pole | 1LE1092-1DB4■-■■■■■ |
| Rated power | $P_{\text{rated } 50}$: 15 kW $P_{\text{rated } 60}$: 17.3 kW $P_{\text{rated } 87}$: 23.5 kW | |
| Voltage and frequency | 380 V 3 AC, 50 Hz/440 V 3 AC, 60 Hz/380 V 3 AC, 87 Hz | 1LE1092-1DB42-1■■■■■ |
| Type of construction with special version | IM V5 with protective cover ¹⁾ | 1LE1092-1DB42-1C■■■-Z H00 |
| Motor protection | Motor protection with PTC thermistors with 1 or 3 embedded temperature sensors for tripping | 1LE1092-1DB42-1CB■-Z H00 |
| Terminal box position | Terminal box right (viewed from DE) | 1LE1092-1DB42-1CB5-Z H00 |

¹⁾ Standard without protective cover – the protective cover is defined with order code **H00** and must be ordered in addition to the Article No. with **-Z** and this order code.

Standard induction motors optimized for converter operation – VSD10 line

Standard Efficiency

Aluminum series SIMOTICS GP 1LE1092, line voltage 400 V, 50 Hz/460 V, 60 Hz/400 V, 87 Hz – self-ventilated

Selection and ordering data

| $P_{\text{rated, 50 Hz}}$ 400 V | $P_{\text{rated, 60 Hz}}$ 460 V | $P_{\text{rated, 87 Hz}}$ 400 V | Frame size | Connection | Operating values at rated power | | | | I_{rated} | 1LE1092 aluminum series Version specifically for converter operation |
|---|------------------------------------|------------------------------------|--------------|------------|---------------------------------|--------------------|---|--------------------------------|--------------------|--|
| | | | | | f_{rated} | T_{rated} | $\eta_{\text{rated, 4/4}}$ for converter operation | $\cos\phi_{\text{rated, 4/4}}$ | | |
| kW | kW | kW | | | Hz | Nm | % | A | Article No. | |
| <ul style="list-style-type: none"> Insulation: Thermal class 155 (temperature class F), IP55 degree of protection, utilization in accordance with thermal class 155 (temperature class F) Operation with a SINAMICS G converter with uncontrolled infeed – rated motor voltage 380 V, 50 Hz/440 V, 60 Hz/380 V, 87 Hz | | | | | | | | | | |
| 3000 rpm | 3600 rpm | 5220 rpm | 2-pole | | | | | | | |
| 3 | | | 100 L | Y | 52.9 | 9.6 | 81.5 | 0.87 | 6.4 | 1LE1092-1AA42-1 ■■■ |
| | 3.45 | | | Y | 62.8 | 9.2 | 84.5 | 0.88 | 6.1 | |
| | | 4.5 | | Δ | 89.4 | 8.2 | 84.5 | 0.82 | 9.9 | |
| 4 | | | 112 M | Y | 51.2 | 12.7 | 83.1 | 0.86 | 8.5 | 1LE1092-1BA22-1 ■■■ |
| | 4.55 | | | Y | 61.2 | 12.1 | 84.5 | 0.88 | 8 | |
| | | 6.6 | | Δ | 88.2 | 12.1 | 84.5 | 0.83 | 14.2 | |
| 5.5 | | | 132 S | Y | 51.4 | 17.5 | 84.7 | 0.89 | 11.1 | 1LE1092-1CA02-1 ■■■ |
| | 6.3 | | | Y | 61.4 | 16.7 | 86.0 | 0.90 | 10.7 | |
| 7.5 | | | 132 S | Y | 51.2 | 23.9 | 86.0 | 0.87 | 15.2 | 1LE1092-1CA12-1 ■■■ |
| | 8.6 | | | Y | 61.2 | 22.8 | 88.7 | 0.88 | 14.7 | |
| 11 | | | 160 M | Y | 51.3 | 35.0 | 87.6 | 0.85 | 22.5 | 1LE1092-1DA22-1 ■■■ |
| | 12.6 | | | Y | 61.2 | 33.4 | 87.5 | 0.86 | 22 | |
| 15 | | | 160 M | Y | 51.4 | 47.8 | 88.7 | 0.84 | 30.5 | 1LE1092-1DA32-1 ■■■ |
| | 17.3 | | | Y | 61.4 | 45.9 | 89.5 | 0.86 | 29.5 | |
| 18.5 | | | 160 L | Y | 51.1 | 58.9 | 89.3 | 0.86 | 36.5 | 1LE1092-1DA42-1 ■■■ |
| | 21.3 | | | Y | 61.1 | 56.5 | 89.5 | 0.87 | 36 | |
| 1500 rpm | 1800 rpm | 2610 rpm | 4-pole | | | | | | | |
| 2.2 | | | 100 L | Y | 52.9 | 14.0 | 79.7 | 0.81 | 5.2 | 1LE1092-1AB42-1 ■■■ |
| | 2.55 | | | Y | 62.8 | 13.5 | 83.0 | 0.82 | 4.9 | |
| | | 3.7 | | Δ | 89.3 | 13.5 | 83.0 | 0.79 | 8.6 | |
| 3 | | | 100 L | Y | 52.7 | 19.1 | 81.5 | 0.85 | 6.6 | 1LE1092-1AB52-1 ■■■ |
| | 3.45 | | | Y | 62.6 | 18.3 | 85.0 | 0.86 | 6.2 | |
| | | 5 | | Δ | 89.3 | 18.3 | 85.0 | 0.79 | 11.3 | |
| 4 | | | 112 M | Y | 52.3 | 25.5 | 83.1 | 0.85 | 8.6 | 1LE1092-1BB22-1 ■■■ |
| | 4.55 | | | Y | 62.2 | 24.0 | 85.0 | 0.85 | 8.3 | |
| | | 6.6 | | Δ | 89.0 | 24.0 | 85.0 | 0.81 | 14.6 | |
| 5.5 | | | 132 S | Y | 52.1 | 35.0 | 84.7 | 0.82 | 12 | 1LE1092-1CB02-1 ■■■ |
| | 6.3 | | | Y | 62.0 | 33.5 | 87.0 | 0.84 | 11.3 | |
| | | 9 | | Δ | 88.8 | 33.0 | 87.0 | 0.81 | 19.4 | |
| 7.5 | | | 132 M | Y | 51.7 | 47.5 | 86.0 | 0.82 | 16.2 | 1LE1092-1CB22-1 ■■■ |
| | 8.6 | | | Y | 61.7 | 45.5 | 87.5 | 0.84 | 15.4 | |
| | | 12.5 | | Δ | 88.8 | 45.5 | 87.5 | 0.80 | 27.1 | |
| 11 | | | 160 M | Y | 51.5 | 70.0 | 87.6 | 0.82 | 23.5 | 1LE1092-1DB22-1 ■■■ |
| | 12.6 | | | Y | 61.4 | 67.0 | 88.5 | 0.82 | 23 | |
| | | 17 | | Δ | 88.3 | 62.0 | 88.5 | 0.78 | 37.5 | |
| 15 | | | 160 L | Y | 51.4 | 95.0 | 88.7 | 0.82 | 31.5 | 1LE1092-1DB42-1 ■■■ |
| | 17.3 | | | Y | 61.4 | 92.0 | 90.5 | 0.82 | 30.5 | |
| | | 23.5 | | Δ | 88.2 | 86.0 | 90.5 | 0.77 | 51 | |

For versions, see Article No. supplements and special versions.

All technical specifications refer to converter operation.

Standard induction motors optimized for converter operation – VSD10 line

Standard Efficiency

Aluminum series SIMOTICS GP 1LE1092, line voltage 400 V, 50 Hz/460 V, 60 Hz/400 V, 87 Hz – self-ventilated

| Motor type | $m_{IM\ B3}$ kg | J kgm ² | L_{pFA} , tolerance +3 dB(A) load dB(A) | L_{WA} , tolerance +3 dB(A) load dB(A) | Mech. speed limit rpm | Terminal box | Preferred SINAMICS G120 – PM240(-2) Other SINAMICS converters also possible Operating mode: Low overload Type ¹⁾ | Frame size | IES class acc. to EN 50598-2 |
|--------------------|--------------------|-------------------------|---|--|-----------------------------|-----------------|---|------------|------------------------------------|
| 1LE1092-1AA42-1... | 20 | 0.0034 | 79.0 | 91.1 | 5500 | TB1F00 | 6SL3210-1PE18-0.L1 | FSA | IES 1 |
| | 20 | 0.0034 | 79.0 | 91.1 | 5500 | | 6SL3210-1PE18-0.L1 | FSA | IES 1 |
| | 20 | 0.0034 | 83.0 | 95.1 | 5500 | | 6SL3210-1PE21-4.L0 | FSB | IES 1 |
| 1LE1092-1BA22-1... | 25 | 0.0067 | 78.0 | 90.1 | 5500 | TB1F00 | 6SL3210-1PE21-1.L0 | FSB | IES 1 |
| | 25 | 0.0067 | 78.0 | 90.1 | 5500 | | 6SL3210-1PE21-1.L0 | FSB | IES 1 |
| | 25 | 0.0067 | 83.0 | 95.2 | 5500 | | 6SL3210-1PE21-8.L0 | FSB | IES 1 |
| 1LE1092-1CA02-1... | 35 | 0.013 | 76.0 | 88.3 | 4500 | TB1F00 | 6SL3210-1PE21-4.L0 | FSB | IES 1 |
| | 35 | 0.013 | 76.0 | 88.3 | 4500 | | 6SL3210-1PE21-4.L0 | FSB | IES 1 |
| 1LE1092-1CA12-1... | 40 | 0.016 | 76.0 | 88.4 | 4500 | TB1H00 | 6SL3210-1PE21-8.L0 | FSB | IES 2 |
| | 40 | 0.016 | 76.0 | 88.4 | 4500 | | 6SL3210-1PE21-8.L0 | FSB | IES 2 |
| 1LE1092-1DA22-1... | 60 | 0.03 | 79.0 | 91.4 | 4500 | TB1H00 | 6SL3210-1PE22-7.L0 | FSC | IES 1 |
| | 60 | 0.03 | 78.0 | 90.4 | 4500 | | 6SL3210-1PE22-7.L0 | FSC | IES 1 |
| 1LE1092-1DA32-1... | 68 | 0.036 | 79.0 | 91.8 | 4500 | TB1J00 | 6SL3210-1PE23-3.L0 | FSC | IES 1 |
| | 68 | 0.036 | 78.0 | 90.8 | 4500 | | 6SL3210-1PE23-3.L0 | FSC | IES 1 |
| 1LE1092-1DA42-1... | 78 | 0.044 | 79.0 | 91.8 | 4500 | TB1J00 | 6SL3210-1PE23-8.L0 | FSD | IES 2 |
| | 78 | 0.044 | 78.0 | 90.8 | 4500 | | 6SL3210-1PE23-8.L0 | FSD | IES 2 |
| 1LE1092-1AB42-1... | 15 | 0.0059 | 79.0 | 91.0 | 4200 | TB1F00 | 6SL3210-1PE16-1.L1 | FSA | IES 1 |
| | 15 | 0.0059 | 79.0 | 91.0 | 4200 | | 6SL3210-1PE16-1.L1 | FSA | IES 1 |
| | 15 | 0.0059 | 81.0 | 93.0 | 4200 | | 6SL3210-1PE21-1.L0 | FSB | IES 1 |
| 1LE1092-1AB52-1... | 21 | 0.0078 | 79.0 | 91.0 | 4200 | TB1F00 | 6SL3210-1PE18-0.L1 | FSA | IES 1 |
| | 21 | 0.0078 | 79.0 | 91.0 | 4200 | | 6SL3210-1PE18-0.L1 | FSA | IES 1 |
| | 21 | 0.0078 | 81.0 | 93.0 | 4200 | | 6SL3210-1PE21-4.L0 | FSB | IES 1 |
| 1LE1092-1BB22-1... | 27 | 0.01 | 77.4 | 89.4 | 4200 | TB1F00 | 6SL3210-1PE21-1.L0 | FSB | IES 1 |
| | 27 | 0.01 | 77.2 | 89.2 | 4200 | | 6SL3210-1PE21-1.L0 | FSB | IES 1 |
| | 27 | 0.01 | 78.4 | 90.4 | 4200 | | 6SL3210-1PE21-8.L0 | FSB | IES 1 |
| 1LE1092-1CB02-1... | 39 | 0.019 | 76.0 | 88.0 | 4200 | TB1H00 | 6SL3210-1PE21-4.L0 | FSB | IES 1 |
| | 39 | 0.019 | 76.0 | 88.0 | 4200 | | 6SL3210-1PE21-4.L0 | FSB | IES 1 |
| | 39 | 0.019 | 83.0 | 95.0 | 4200 | | 6SL3210-1PE22-7.L0 | FSC | IES 1 |
| 1LE1092-1CB22-1... | 43 | 0.024 | 76.0 | 88.0 | 4200 | TB1H00 | 6SL3210-1PE21-8.L0 | FSB | IES 1 |
| | 43 | 0.024 | 76.0 | 88.0 | 4200 | | 6SL3210-1PE21-8.L0 | FSB | IES 1 |
| | 43 | 0.024 | 83.0 | 95.0 | 4200 | | 6SL3210-1PE23-3.L0 | FSC | IES 1 |
| 1LE1092-1DB22-1... | 67 | 0.044 | 83.5 | 95.5 | 4200 | TB1J00 | 6SL3210-1PE22-7.L0 | FSC | IES 1 |
| | 67 | 0.044 | 82.3 | 94.3 | 4200 | | 6SL3210-1PE22-7.L0 | FSC | IES 1 |
| | 67 | 0.044 | 85.8 | 97.8 | 4200 | | 6SL3210-1PE24-5.L0 | FSD | IES 1 |
| 1LE1092-1DB42-1... | 75 | 0.056 | 83.5 | 95.5 | 4200 | TB1J00 | 6SL3210-1PE23-3.L0 | FSC | IES 2 |
| | 75 | 0.056 | 82.3 | 94.3 | 4200 | | 6SL3210-1PE23-3.L0 | FSC | IES 2 |
| | 75 | 0.056 | 85.8 | 97.8 | 4200 | | 6SL3210-1PE26-0.L0 | FSD | IES 2 |

¹⁾ In addition to the Power Module, a Control Unit and an Operator Panel are required (see Catalog D 31 and/or D 35).

Standard induction motors optimized for converter operation – VSD10 line

Standard Efficiency

Aluminum series SIMOTICS GP 1LE1092, line voltage 500 V, 50 Hz/575 V, 60 Hz/500 V, 87 Hz – self-ventilated

Selection and ordering data

| $P_{\text{rated, 50 Hz}}$ 500 V | $P_{\text{rated, 60 Hz}}$ 575 V | $P_{\text{rated, 87 Hz}}$ 500 V | Frame size | Connection | Operating values at rated power | | | | I_{rated} | 1LE1092 aluminum series Version specifically for converter operation |
|---|------------------------------------|------------------------------------|------------|------------|---------------------------------|--------------------|---|--------------------------------|--------------------|--|
| | | | | | f_{rated} | T_{rated} | $\eta_{\text{rated, 4/4}}$ for converter operation | $\cos\phi_{\text{rated, 4/4}}$ | | |
| kW | kW | kW | | | Hz | Nm | % | A | Article No. | |
| <ul style="list-style-type: none"> Insulation: Thermal class 155 (temperature class F), IP55 degree of protection, utilization in accordance with thermal class 155 (temperature class F) Operation with a SINAMICS G converter with uncontrolled infeed – rated motor voltage 480 V, 50 Hz/550 V, 60 Hz/480 V, 87 Hz | | | | | | | | | | |
| 3000 rpm | 3600 rpm | 5220 rpm | 2-pole | | | | | | | |
| 3 | 3.45 | 5 | 100 L | Y | 52.9 | 9.6 | 81.5 | 0.87 | 5.1 | 1LE1092-1AA42-6 ■■■ |
| | | | | Y | 63.0 | 9.2 | 84.5 | 0.88 | 4.85 | |
| | | | | Δ | 89.6 | 9.1 | 84.5 | 0.85 | 8.4 | |
| 4 | 4.55 | 6.6 | 112 M | Y | 51.3 | 12.7 | 83.1 | 0.86 | 6.7 | 1LE1092-1BA22-6 ■■■ |
| | | | | Y | 61.3 | 12.1 | 84.5 | 0.88 | 6.4 | |
| | | | | Δ | 88.2 | 12.1 | 84.5 | 0.84 | 11.1 | |
| 5.5 | 6.3 | | 132 S | Y | 51.6 | 17.5 | 84.7 | 0.89 | 8.8 | 1LE1092-1CA02-6 ■■■ |
| | | | | Y | 61.6 | 16.7 | 86.0 | 0.90 | 8.5 | |
| 7.5 | 8.6 | | 132 S | Y | 51.2 | 23.9 | 86.0 | 0.87 | 12.1 | 1LE1092-1CA12-6 ■■■ |
| | | | | Y | 61.2 | 22.8 | 88.7 | 0.88 | 11.7 | |
| 11.0 | 12.6 | | 160 M | Y | 51.3 | 35.0 | 87.6 | 0.85 | 17.8 | 1LE1092-1DA22-6 ■■■ |
| | | | | Y | 61.3 | 33.4 | 87.5 | 0.86 | 17.6 | |
| 14 | 16.5 | | 160 M | Y | 51.1 | 44.6 | 88.7 | 0.84 | 22.5 | 1LE1092-1DA32-6 ■■■ |
| | | | | Y | 61.2 | 43.8 | 89.5 | 0.86 | 22.5 | |
| 17 | 19.5 | | 160 L | Y | 51.1 | 54.1 | 89.3 | 0.85 | 27 | 1LE1092-1DA42-6 ■■■ |
| | | | | Y | 61.1 | 51.7 | 89.5 | 0.86 | 26.5 | |
| 1500 rpm | 1800 rpm | 2610 rpm | 4-pole | | | | | | | |
| 2.2 | 2.55 | 3.7 | 100 L | Y | 52.8 | 14.0 | 79.7 | 0.81 | 4.1 | 1LE1092-1AB42-6 ■■■ |
| | | | | Y | 62.8 | 13.5 | 83.0 | 0.82 | 3.95 | |
| | | | | Δ | 89.6 | 13.5 | 83.0 | 0.79 | 6.8 | |
| 3 | 3.45 | 5 | 100 L | Y | 52.6 | 19.1 | 81.5 | 0.85 | 5.2 | 1LE1092-1AB52-6 ■■■ |
| | | | | Y | 62.6 | 18.3 | 85.0 | 0.86 | 4.95 | |
| | | | | Δ | 89.3 | 18.3 | 85.0 | 0.79 | 8.7 | |
| 4 | 4.55 | 6.6 | 112 M | Y | 52.4 | 25.5 | 83.1 | 0.85 | 6.8 | 1LE1092-1BB22-6 ■■■ |
| | | | | Y | 62.3 | 24.1 | 85.0 | 0.85 | 6.6 | |
| | | | | Δ | 89.1 | 24.1 | 85.0 | 0.81 | 12 | |
| 5.5 | 6.3 | 9 | 132 S | Y | 52.0 | 35.0 | 84.7 | 0.82 | 9.5 | 1LE1092-1CB02-6 ■■■ |
| | | | | Y | 62.0 | 33.4 | 87.0 | 0.84 | 9 | |
| | | | | Δ | 88.8 | 32.9 | 87.0 | 0.81 | 15.4 | |
| 7.5 | 8.6 | 12.5 | 132 M | Y | 51.9 | 47.8 | 86.0 | 0.82 | 12.8 | 1LE1092-1CB22-6 ■■■ |
| | | | | Y | 61.9 | 45.6 | 87.5 | 0.84 | 12.3 | |
| | | | | Δ | 88.7 | 45.7 | 87.5 | 0.80 | 21.5 | |
| 11 | 12.6 | 17 | 160 M | Y | 51.5 | 70.0 | 87.6 | 0.82 | 18.4 | 1LE1092-1DB22-6 ■■■ |
| | | | | Y | 61.5 | 66.9 | 88.5 | 0.82 | 18.2 | |
| | | | | Δ | 88.4 | 62.2 | 88.5 | 0.78 | 29.5 | |
| 13.5 | 15.6 | 23.5 | 160 L | Y | 51.2 | 86.0 | 88.7 | 0.79 | 23 | 1LE1092-1DB42-6 ■■■ |
| | | | | Y | 61.2 | 82.8 | 90.5 | 0.81 | 22.5 | |
| | | | | Δ | 88.3 | 86.0 | 90.5 | 0.77 | 40.5 | |

For versions, see Article No. supplements and special versions.

All technical specifications refer to converter operation.

Standard induction motors optimized for converter operation – VSD10 line

Standard Efficiency

Aluminum series SIMOTICS GP 1LE1092, line voltage 500 V, 50 Hz/575 V, 60 Hz/500 V, 87 Hz – self-ventilated

| Motor type | m_{IMB3} kg | J kgm ² | L_{pFA} , tolerance +3 dB(A) load dB(A) | L_{WA} , tolerance +3 dB(A) load dB(A) | Mech. speed limit rpm | Terminal box | Preferred SINAMICS G120 – PM240(-2) Other SINAMICS converters also possible Operating mode: Low overload Type ¹⁾ | Frame size | IES class acc. to EN 50598-2 |
|--------------------|------------------|-------------------------|---|--|-----------------------------|-----------------|---|------------|------------------------------------|
| 1LE1092-1AA42-6... | 20 | 0.0034 | 80.0 | 92.1 | 5500 | TB1F00 | | | |
| | 20 | 0.0034 | 80.0 | 92.1 | 5500 | | | | |
| | 20 | 0.0034 | 85.0 | 92.1 | 5500 | | | | |
| 1LE1092-1BA22-6... | 25 | 0.0067 | 79.0 | 91.1 | 5500 | TB1F00 | | | |
| | 25 | 0.0067 | 79.0 | 91.1 | 5500 | | | | |
| | 25 | 0.0067 | 85.0 | 91.1 | 5500 | | 6SL3210-1PH21-4.L0 | FSD | |
| 1LE1092-1CA02-6... | 35 | 0.013 | 77.0 | 89.3 | 4500 | TB1F00 | 6SL3210-1PH21-4.L0 | FSD | |
| | 35 | 0.013 | 77.0 | 89.3 | 4500 | | 6SL3210-1PH21-4.L0 | FSD | |
| 1LE1092-1CA12-6... | 40 | 0.016 | 77.0 | 89.4 | 4500 | TB1H00 | 6SL3210-1PH21-4.L0 | FSD | |
| | 40 | 0.016 | 77.0 | 89.4 | 4500 | | 6SL3210-1PH21-4.L0 | FSD | |
| 1LE1092-1DA22-6... | 60 | 0.03 | 80.0 | 92.4 | 4500 | TB1H00 | 6SL3210-1PH22-0.L0 | FSD | |
| | 60 | 0.03 | 80.0 | 92.4 | 4500 | | 6SL3210-1PH22-0.L0 | FSD | |
| 1LE1092-1DA32-6... | 68 | 0.036 | 80.0 | 92.8 | 4500 | TB1J00 | 6SL3210-1PH22-3.L0 | FSD | |
| | 68 | 0.036 | 80.0 | 92.8 | 4500 | | 6SL3210-1PH22-3.L0 | FSD | |
| 1LE1092-1DA42-6... | 78 | 0.044 | 80.0 | 92.8 | 4500 | TB1J00 | 6SL3210-1PH22-7.L0 | FSD | |
| | 78 | 0.044 | 80.0 | 92.8 | 4500 | | 6SL3210-1PH22-7.L0 | FSD | |
| 1LE1092-1AB42-6... | 18 | 0.0059 | 80.0 | 92.1 | 4200 | TB1F00 | | | |
| | 18 | 0.0059 | 80.0 | 92.1 | 4200 | | | | |
| | 18 | 0.0059 | 81.0 | 93.1 | 4200 | | | | |
| 1LE1092-1AB52-6... | 22 | 0.0078 | 80.0 | 92.1 | 4200 | TB1F00 | | | |
| | 22 | 0.0078 | 80.0 | 92.1 | 4200 | | | | |
| | 22 | 0.0078 | 81.0 | 93.1 | 4200 | | | | |
| 1LE1092-1BB22-6... | 27 | 0.01 | 79.0 | 91.3 | 4200 | TB1F00 | | | |
| | 27 | 0.01 | 79.0 | 91.3 | 4200 | | | | |
| | 27 | 0.01 | 80.0 | 92.3 | 4200 | | 6SL3210-1PH21-4.L0 | FSD | |
| 1LE1092-1CB02-6... | 38 | 0.019 | 77.0 | 89.4 | 4200 | TB1H00 | 6SL3210-1PH21-4.L0 | FSD | |
| | 38 | 0.019 | 77.0 | 89.4 | 4200 | | 6SL3210-1PH21-4.L0 | FSD | |
| | 38 | 0.019 | 83.0 | 95.4 | 4200 | | 6SL3210-1PH22-0.L0 | FSD | |
| 1LE1092-1CB22-6... | 44 | 0.024 | 77.0 | 89.4 | 4200 | TB1H00 | 6SL3210-1PH21-4.L0 | FSD | |
| | 44 | 0.024 | 77.0 | 89.4 | 4200 | | 6SL3210-1PH21-4.L0 | FSD | |
| | 44 | 0.024 | 83.0 | 95.4 | 4200 | | 6SL3210-1PH22-3.L0 | FSD | |
| 1LE1092-1DB22-6... | 62 | 0.044 | 85.0 | 97.8 | 4200 | TB1J00 | 6SL3210-1PH22-0.L0 | FSD | |
| | 62 | 0.044 | 85.0 | 97.8 | 4200 | | 6SL3210-1PH22-0.L0 | FSD | |
| | 62 | 0.044 | 85.0 | 97.8 | 4200 | | 6SL3210-1PH23-5.L0 | FSD | |
| 1LE1092-1DB42-6... | 73 | 0.056 | 85.0 | 97.8 | 4200 | TB1J00 | 6SL3210-1PH22-3.L0 | FSD | |
| | 73 | 0.056 | 85.0 | 97.8 | 4200 | | 6SL3210-1PH22-3.L0 | FSD | |
| | 73 | 0.056 | 85.0 | 97.8 | 4200 | | 6SL3210-1PH24-2.L0 | FSD | |

¹⁾ In addition to the Power Module, a Control Unit and an Operator Panel are required (see Catalog D 31 and/or D 35).

Standard induction motors optimized for converter operation – VSD10 line

Standard Efficiency

Aluminum series SIMOTICS GP 1LE1092, line voltage 690 V, 50 Hz/690 V, 87 Hz – self-ventilated

Selection and ordering data

| $P_{\text{rated, 50 Hz, 690 V}}$ | $P_{\text{rated, 60 Hz}}$ | $P_{\text{rated, 87 Hz, 690 V}}$ | Frame size | Connection | Operating values at rated power | | | | | Article No. |
|---|---------------------------|----------------------------------|--------------|------------|---------------------------------|--------------------|---|-----------------------------------|--------------------|----------------------------|
| | | | | | f_{rated} | T_{rated} | $\eta_{\text{rated, 4/4}}$ for converter operation | $\cos\varphi_{\text{rated, 4/4}}$ | I_{rated} | |
| kW | kW | kW | | | Hz | Nm | % | | A | |
| <ul style="list-style-type: none"> Insulation: Thermal class 155 (temperature class F), IP55 degree of protection, utilization in accordance with thermal class 155 (temperature class F) Operation with a SINAMICS G converter with uncontrolled infeed – rated motor voltage 660 V/50 Hz/660 V, 87 Hz | | | | | | | | | | |
| 3000 rpm | 3600 rpm | 5220 rpm | 2-pole | | | | | | | |
| 3 | | | 100 L | Y | 52.7 | 9.6 | 81.5 | 0.87 | 3.7 | 1LE1092-1AA43-3 ■■■ |
| | 5 | | | Δ | 89.5 | 9.1 | 84.5 | 0.81 | 6.4 | |
| 4 | | | 112 M | Y | 51.2 | 12.7 | 83.1 | 0.86 | 4.9 | 1LE1092-1BA23-3 ■■■ |
| | 6.6 | | | Δ | 88.2 | 12.1 | 84.5 | 0.83 | 8.2 | |
| 5.5 | | | 132 S | Y | 51.6 | 17.5 | 84.7 | 0.89 | 6.4 | 1LE1092-1CA03-3 ■■■ |
| 7.5 | | | 132 S | Y | 51.2 | 23.9 | 86.0 | 0.87 | 8.8 | 1LE1092-1CA13-3 ■■■ |
| 11 | | | 160 M | Y | 51.3 | 35.0 | 87.6 | 0.85 | 12.9 | 1LE1092-1DA23-3 ■■■ |
| 15 | | | 160 M | Y | 51.4 | 47.8 | 88.7 | 0.84 | 17.6 | 1LE1092-1DA33-3 ■■■ |
| 18.5 | | | 160 L | Y | 51.3 | 58.9 | 89.3 | 0.86 | 20.5 | 1LE1092-1DA43-3 ■■■ |
| 1500 rpm | 1800 rpm | 2610 rpm | 4-pole | | | | | | | |
| 2.2 | | | 100 L | Y | 52.9 | 14.0 | 79.7 | 0.81 | 3 | 1LE1092-1AB43-3 ■■■ |
| | 3.7 | | | Δ | 89.5 | 13.5 | 83.0 | 0.79 | 4.95 | |
| 3 | | | 100 L | Y | 52.5 | 19.1 | 81.5 | 0.85 | 3.8 | 1LE1092-1AB53-3 ■■■ |
| | 5 | | | Δ | 89.5 | 18.3 | 85.0 | 0.79 | 6.5 | |
| 4 | | | 112 M | Y | 52.5 | 25.5 | 83.1 | 0.85 | 5 | 1LE1092-1BB23-3 ■■■ |
| | 6.6 | | | Δ | 89.2 | 24.1 | 85.0 | 0.81 | 8.4 | |
| 5.5 | | | 132 S | Y | 52.0 | 35.0 | 84.7 | 0.82 | 6.9 | 1LE1092-1CB03-3 ■■■ |
| | 9 | | | Δ | 88.7 | 32.9 | 87.0 | 0.81 | 11.2 | |
| 7.5 | | | 132 M | Y | 51.7 | 47.8 | 86.0 | 0.82 | 9.3 | 1LE1092-1CB23-3 ■■■ |
| | 12.5 | | | Δ | 88.6 | 45.7 | 87.5 | 0.80 | 15.6 | |
| 11 | | | 160 M | Y | 51.5 | 70.0 | 87.6 | 0.82 | 13.4 | 1LE1092-1DB23-3 ■■■ |
| | 17 | | | Δ | 88.3 | 62.2 | 88.5 | 0.78 | 21.5 | |
| 15 | | | 160 L | Y | 51.4 | 95.5 | 88.7 | 0.82 | 18 | 1LE1092-1DB43-3 ■■■ |
| | 23.5 | | | Δ | 88.2 | 86.0 | 90.5 | 0.77 | 29.5 | |

For versions, see Article No. supplements and special versions. ■■■

All technical specifications refer to converter operation.

Standard induction motors optimized for converter operation – VSD10 line

Standard Efficiency

Aluminum series SIMOTICS GP 1LE1092, line voltage 690 V, 50 Hz/690 V, 87 Hz – self-ventilated

| Motor type | $m_{IM\ B3}$ kg | J kgm ² | L_{pA} , tolerance +3 dB(A) load dB(A) | L_{WA} , tolerance +3 dB(A) load dB(A) | Mech. speed limit rpm | Terminal box | Preferred SINAMICS G120 – PM240(-2) Other SINAMICS converters also possible Operating mode: Low overload Type ¹⁾ | Frame size | IES class acc. to EN 50598-2 |
|--------------------|--------------------|-------------------------|--|--|-----------------------------|-----------------|---|------------|------------------------------------|
| 1LE1092-1AA43-3... | 20 | 0.0034 | 80.0 | 92.1 | 5500 | TB1F00 | | | |
| | 20 | 0.0034 | 85.0 | 97.1 | 5500 | | | | |
| 1LE1092-1BA23-3... | 25 | 0.0067 | 79.0 | 91.1 | 5500 | TB1F00 | | | |
| | 25 | 0.0067 | 85.0 | 97.2 | 5500 | | 6SL3210-1PH21-4.L0 | FSD | |
| 1LE1092-1CA03-3... | 35 | 0.013 | 77.0 | 89.3 | 4500 | TB1F00 | 6SL3210-1PH21-4.L0 | FSD | |
| 1LE1092-1CA13-3... | 40 | 0.016 | 77.0 | 89.4 | 4500 | TB1H00 | 6SL3210-1PH21-4.L0 | FSD | |
| 1LE1092-1DA23-3... | 60 | 0.03 | 80.0 | 92.4 | 4500 | TB1H00 | 6SL3210-1PH21-4.L0 | FSD | |
| 1LE1092-1DA33-3... | 68 | 0.036 | 80.0 | 92.8 | 4500 | TB1J00 | 6SL3210-1PH22-0.L0 | FSD | |
| 1LE1092-1DA43-3... | 78 | 0.044 | 80.0 | 92.8 | 4500 | TB1J00 | 6SL3210-1PH22-3.L0 | FSD | |
| 1LE1092-1AB43-3... | 18 | 0.0059 | 80.0 | 92.1 | 4200 | TB1F00 | | | |
| | 18 | 0.0059 | 81.0 | 93.1 | 4200 | | | | |
| 1LE1092-1AB53-3... | 22 | 0.0078 | 80.0 | 92.1 | 4200 | TB1F00 | | | |
| | 22 | 0.0078 | 81.0 | 93.1 | 4200 | | | | |
| 1LE1092-1BB23-3... | 27 | 0.01 | 79.0 | 91.3 | 4200 | TB1F00 | | | |
| | 27 | 0.01 | 80.0 | 92.3 | 4200 | | 6SL3210-1PH21-4.L0 | FSD | |
| 1LE1092-1CB03-3... | 38 | 0.019 | 77.0 | 89.4 | 4200 | TB1H00 | 6SL3210-1PH21-4.L0 | FSD | |
| | 38 | 0.019 | 83.0 | 95.4 | 4200 | | 6SL3210-1PH21-4.L0 | FSD | |
| 1LE1092-1CB23-3... | 44 | 0.024 | 77.0 | 89.4 | 4200 | TB1H00 | 6SL3210-1PH21-4.L0 | FSD | |
| | 44 | 0.024 | 83.0 | 95.4 | 4200 | | 6SL3210-1PH22-0.L0 | FSD | |
| 1LE1092-1DB23-3... | 62 | 0.044 | 85.0 | 97.8 | 4200 | TB1J00 | 6SL3210-1PH21-4.L0 | FSD | |
| | 62 | 0.044 | 85.0 | 97.8 | 4200 | | 6SL3210-1PH22-7.L0 | FSD | |
| 1LE1092-1DB43-3... | 73 | 0.056 | 85.0 | 97.8 | 4200 | TB1J00 | 6SL3210-1PH22-0.L0 | FSD | |
| | 73 | 0.056 | 85.0 | 97.8 | 4200 | | 6SL3210-1PH23-5.L0 | FSD | |

¹⁾ In addition to the Power Module, a Control Unit and an Operator Panel are required (see Catalog D 31 and/or D 35).

Standard induction motors optimized for converter operation – VSD10 line

Standard Efficiency

Cast-iron series SIMOTICS SD 1LE1592, line voltage 400 V, 50 Hz/460 V, 60 Hz/400 V, 87 Hz – self-ventilated

Selection and ordering data

| $P_{\text{rated, 50 Hz}}$ 400 V | $P_{\text{rated, 60 Hz}}$ 460 V | $P_{\text{rated, 87 Hz}}$ 400 V | Frame size | Connection | Operating values at rated power | | | | I_{rated} | 1LE1592 cast-iron series Version specifically for converter operation |
|---|------------------------------------|------------------------------------|------------|------------|---------------------------------|--------------------|---|-----------------------------------|--------------------|---|
| | | | | | f_{rated} | T_{rated} | $\eta_{\text{rated, 4/4}}$ for converter operation | $\cos\varphi_{\text{rated, 4/4}}$ | | |
| kW | kW | kW | | | Hz | Nm | % | A | Article No. | |
| <ul style="list-style-type: none"> Insulation: Thermal class 155 (temperature class F), IP55 degree of protection, utilization in accordance with thermal class 155 (temperature class F) Operation with a SINAMICS G converter with uncontrolled infeed – rated motor voltage 380 V, 50 Hz/440 V, 60 Hz/380 V, 87 Hz | | | | | | | | | | |
| 3000 rpm | 3600 rpm | 5220 rpm | 2-pole | | | | | | | |
| 3 | | | 100 L | Y | 52.9 | 9.6 | 81.5 | 0.87 | 6.4 | 1LE1592-1AA42-1 ■■■ |
| | 3.45 | | | Y | 62.8 | 9.2 | 84.5 | 0.88 | 6.1 | |
| | | 4.5 | | Δ | 89.4 | 8.2 | 84.5 | 0.82 | 9.9 | |
| 4.0 | | | 112 M | Y | 51.2 | 12.7 | 83.1 | 0.86 | 8.5 | 1LE1592-1BA22-1 ■■■ |
| | 4.6 | | | Y | 61.2 | 12.1 | 84.5 | 0.88 | 8 | |
| | | 6.6 | | Δ | 88.2 | 12.1 | 84.5 | 0.83 | 14.2 | |
| 5.5 | | | 132 S | Y | 51.4 | 17.5 | 84.7 | 0.89 | 11.1 | 1LE1592-1CA02-1 ■■■ |
| | 6.3 | | | Y | 61.4 | 16.7 | 86.0 | 0.90 | 10.7 | |
| 7.5 | | | 132 S | Y | 51.2 | 23.9 | 86.0 | 0.87 | 15.2 | 1LE1592-1CA12-1 ■■■ |
| | 8.6 | | | Y | 61.2 | 22.8 | 88.7 | 0.88 | 14.7 | |
| 11 | | | 160 M | Y | 51.3 | 35.0 | 87.6 | 0.85 | 22.5 | 1LE1592-1DA22-1 ■■■ |
| | 12.6 | | | Y | 61.2 | 33.4 | 87.5 | 0.86 | 22 | |
| 15.0 | | | 160 M | Y | 51.4 | 47.8 | 88.7 | 0.84 | 30.5 | 1LE1592-1DA32-1 ■■■ |
| | 17.3 | | | Y | 61.4 | 45.9 | 89.5 | 0.86 | 29.5 | |
| 18.5 | | | 160 L | Y | 51.1 | 58.9 | 89.3 | 0.86 | 36.5 | 1LE1592-1DA42-1 ■■■ |
| | 21.3 | | | Y | 61.1 | 56.5 | 89.5 | 0.87 | 36 | |
| 22 | | | 180 M | Y | 51.0 | 70 | 89.9 | 0.87 | 42.5 | 1LE1592-1EA22-1 ■■■ |
| | 24.5 | | | Y | 60.9 | 65.0 | 89.5 | 0.87 | 41.5 | |
| 30 | | | 200 L | Y | 50.9 | 96 | 90.7 | 0.84 | 60 | 1LE1592-2AA42-1 ■■■ |
| | 33.5 | | | Y | 60.9 | 88.9 | 91.5 | 0.84 | 57 | |
| 37 | | | 200 L | Y | 50.8 | 118 | 91.2 | 0.88 | 70 | 1LE1592-2AA52-1 ■■■ |
| | 41.5 | | | Y | 60.7 | 110.1 | 91.7 | 0.89 | 67 | |
| 45 | | | 225 M | Y | 50.7 | 143 | 91.7 | 0.88 | 85 | 1LE1592-2BA22-1 ■■■ |
| | 51 | | | Y | 60.7 | 135.0 | 92.4 | 0.88 | 82 | |
| 55 | | | 250 M | Y | 50.6 | 175 | 92.1 | 0.88 | 103 | 1LE1592-2CA22-1 ■■■ |
| | 62 | | | Y | 60.6 | 164.0 | 92.4 | 0.88 | 100 | |
| 75 | | | 280 S | Y | 50.5 | 239 | 92.7 | 0.87 | 141 | 1LE1592-2DA02-1 ■■■ |
| | 84 | | | Y | 60.5 | 223.0 | 93.0 | 0.87 | 136 | |
| 90 | | | 280 M | Y | 50.4 | 286 | 93.0 | 0.88 | 167 | 1LE1592-2DA22-1 ■■■ |
| | 101 | | | Y | 60.4 | 268 | 93.0 | 0.88 | 162 | |

For versions, see Article No. supplements and special versions. ■■■

All technical specifications refer to converter operation.

Standard induction motors optimized for converter operation – VSD10 line

Standard Efficiency

Cast-iron series SIMOTICS SD 1LE1592, line voltage 400 V, 50 Hz/460 V, 60 Hz/400 V, 87 Hz – self-ventilated

| Motor type | m_{IMB3} kg | J kgm ² | L_{pA} , tolerance +3 dB(A) load dB(A) | L_{WA} , tolerance +3 dB(A) load dB(A) | Mech. speed limit rpm | Terminal box | Preferred SINAMICS G120 – PM240(-2) Other SINAMICS converters also possible Operating mode: Low overload Type ¹⁾ | Frame size | IES class acc. to EN 50598-2 |
|--------------------|------------------|-------------------------|--|--|-----------------------------|-----------------|---|------------|------------------------------------|
| 1LE1592-1AA42-1... | 31 | 0.0034 | 79.0 | 91.1 | 5500 | TB1F01 | 6SL3210-1PE18-0.L1 | FSA | IES 1 |
| | 31 | 0.0034 | 79.0 | 91.1 | 5500 | | 6SL3210-1PE18-0.L1 | | |
| | 31 | 0.0034 | 83.0 | 95.1 | 5500 | | 6SL3210-1PE21-4.L0 | | |
| 1LE1592-1BA22-1... | 36 | 0.0067 | 78.0 | 90.1 | 5500 | TB1F01 | 6SL3210-1PE21-4.L0 | FSB | IES 1 |
| | 36 | 0.0067 | 78.0 | 90.1 | 5500 | | 6SL3210-1PE21-4.L0 | | |
| | 36 | 0.0067 | 83.0 | 95.2 | 5500 | | 6SL3210-1PE22-7.L0 | | |
| 1LE1592-1CA02-1... | 53 | 0.013 | 76.0 | 88.3 | 4500 | TB1H01 | 6SL3210-1PE21-8.L0 | FSB | IES 1 |
| | 53 | 0.013 | 76.0 | 88.3 | 4500 | | 6SL3210-1PE21-8.L0 | | |
| 1LE1592-1CA12-1... | 58 | 0.016 | 76.0 | 88.4 | 4500 | TB1H01 | 6SL3210-1PE22-7.L0 | FSC | IES 2 |
| | 58 | 0.016 | 76.0 | 88.4 | 4500 | | 6SL3210-1PE22-7.L0 | | |
| 1LE1592-1DA22-1... | 87 | 0.03 | 79.0 | 91.4 | 4500 | TB1J01 | 6SL3210-1PE23-3.L0 | FSC | IES 1 |
| | 87 | 0.03 | 78.0 | 90.4 | 4500 | | 6SL3210-1PE23-3.L0 | | |
| 1LE1592-1DA32-1... | 95 | 0.036 | 79.0 | 91.8 | 4500 | TB1J01 | 6SL3210-1PE23-8.L0 | FSD | IES 1 |
| | 95 | 0.036 | 78.0 | 90.8 | 4500 | | 6SL3210-1PE23-8.L0 | | |
| 1LE1592-1DA42-1... | 105 | 0.044 | 79.0 | 91.8 | 4500 | TB1J01 | 6SL3210-1PE23-8.L0 | FSD | IES 2 |
| | 105 | 0.044 | 78.0 | 90.8 | 4500 | | 6SL3210-1PE23-8.L0 | | |
| 1LE1592-1EA22-1... | 150 | 0.069 | 79.0 | 92.0 | 4500 | TB1J01 | 6SL3210-1PE24-5.L0 | FSD | IES 2 |
| | 150 | 0.069 | 78.0 | 91.0 | 4500 | | 6SL3210-1PE24-5.L0 | | |
| 1LE1592-2AA42-1... | 195 | 0.124 | 78.0 | 91.0 | 4500 | TB1L01 | 6SL3210-1PE26-0.L0 | FSD | IES 2 |
| | 195 | 0.124 | 78.0 | 91.0 | 4500 | | 6SL3210-1PE26-0.L0 | | |
| 1LE1592-2AA52-1... | 230 | 0.15 | 76.0 | 89.1 | 4500 | TB1L01 | 6SL3210-1PE27-5.L0 | FSD | IES 2 |
| | 230 | 0.15 | 76.0 | 89.1 | 4500 | | 6SL3210-1PE27-5.L0 | | |
| 1LE1592-2BA22-1... | 280 | 0.22 | 78.0 | 90.0 | 4500 | TB1L01 | 6SL3210-1PE28-8.L0 | FSE | IES 2 |
| | 280 | 0.22 | 80.0 | 93.0 | 4500 | | 6SL3210-1PE28-8.L0 | | |
| 1LE1592-2CA22-1... | 360 | 0.4 | 78.0 | 92.0 | 3900 | TB1N01 | 6SL3210-1PE31-1.L0 | FSE | IES 2 |
| | 360 | 0.4 | 82.0 | 96.0 | 3900 | | 6SL3210-1PE31-1.L0 | | |
| 1LE1592-2DA02-1... | 470 | 0.72 | 78.0 | 92.0 | 3600 | TB1N01 | 6SL3210-1PE31-5.L0 | FSF | IES 2 |
| | 470 | 0.72 | 82.0 | 96.0 | 3600 | | 6SL3210-1PE31-5.L0 | | |
| 1LE1592-2DA22-1... | 530 | 0.83 | 78.0 | 92.0 | 3600 | TB1N01 | 6SL3210-1PE31-8.L0 | FSF | IES 2 |
| | 530 | 0.83 | 82.0 | 96.0 | 3600 | | 6SL3210-1PE31-8.L0 | | |

¹⁾ In addition to the Power Module, a Control Unit and an Operator Panel are required (see Catalog D 31 and/or D 35).

Standard induction motors optimized for converter operation – VSD10 line

Standard Efficiency

Cast-iron series SIMOTICS SD 1LE1592, line voltage 400 V, 50 Hz/460 V, 60 Hz/400 V, 87 Hz – self-ventilated

Selection and ordering data

| P _{rated} , 50 Hz, 400 V | P _{rated} , 60 Hz, 460 V | P _{rated} , 87 Hz, 400 V | Frame size | Connection | Operating values at rated power | | | | I _{rated} | 1LE1592 cast-iron series Version specifically for converter operation |
|---|--------------------------------------|--------------------------------------|------------|------------|---------------------------------|--------------------|---|------------------------------|--------------------|---|
| | | | | | f _{rated} | T _{rated} | η _{rated} , 4/4 for converter operation | cos φ _{rated} , 4/4 | | |
| kW | kW | kW | | | Hz | Nm | % | A | Article No. | |
| <ul style="list-style-type: none"> Insulation: Thermal class 155 (temperature class F), IP55 degree of protection, utilization in accordance with thermal class 155 (temperature class F) Operation with a SINAMICS G converter with uncontrolled infeed – rated motor voltage 380 V, 50 Hz/440 V, 60 Hz/380 V, 87 Hz | | | | | | | | | | |
| 1500 rpm | 1800 rpm | 2610 rpm | 4-pole | | | | | | | |
| 2.2 | | | 100 L | Y | 52.9 | 14.0 | 79.7 | 0.81 | 5.2 | 1LE1592-1AB42-1 ■■■ |
| | 2.55 | | | Y | 62.8 | 13.5 | 83.0 | 0.82 | 4.9 | |
| | | 3.7 | | Δ | 89.3 | 13.5 | 83.0 | 0.79 | 8.6 | |
| 3 | | | 100 L | Y | 52.7 | 19.1 | 81.5 | 0.85 | 6.6 | 1LE1592-1AB52-1 ■■■ |
| | 3.45 | | | Y | 62.6 | 18.3 | 85.0 | 0.86 | 6.2 | |
| | | 5 | | Δ | 89.3 | 18.3 | 85.0 | 0.79 | 11.3 | |
| 4 | | | 112 M | Y | 52.3 | 25.5 | 83.1 | 0.85 | 8.6 | 1LE1592-1BB22-1 ■■■ |
| | 4.55 | | | Y | 62.2 | 24.0 | 85.0 | 0.85 | 8.3 | |
| | | 6.6 | | Δ | 89.0 | 24.0 | 85.0 | 0.81 | 14.6 | |
| 5.5 | | | 132 S | Y | 52.1 | 35.0 | 84.7 | 0.82 | 12 | 1LE1592-1CB02-1 ■■■ |
| | 6.3 | | | Y | 62.0 | 33.5 | 87.0 | 0.84 | 11.3 | |
| | | 9 | | Δ | 88.8 | 33.0 | 87.0 | 0.81 | 19.4 | |
| 7.5 | | | 132 M | Y | 51.7 | 47.5 | 86.0 | 0.82 | 16.2 | 1LE1592-1CB22-1 ■■■ |
| | 8.6 | | | Y | 61.7 | 45.5 | 87.5 | 0.84 | 15.4 | |
| | | 12.5 | | Δ | 88.8 | 45.5 | 87.5 | 0.80 | 27.1 | |
| 11 | | | 160 M | Y | 51.5 | 70.0 | 87.6 | 0.82 | 23.5 | 1LE1592-1DB22-1 ■■■ |
| | 12.6 | | | Y | 61.4 | 67.0 | 88.5 | 0.82 | 23 | |
| | | 17 | | Δ | 88.3 | 62.0 | 88.5 | 0.78 | 37.5 | |
| 15 | | | 160 L | Y | 51.4 | 95.0 | 88.7 | 0.82 | 31.5 | 1LE1592-1DB42-1 ■■■ |
| | 17.3 | | | Y | 61.4 | 92.0 | 90.5 | 0.82 | 30.5 | |
| | | 23.5 | | Δ | 88.2 | 86.0 | 90.5 | 0.77 | 51 | |
| 18.5 | | | 180 M | Y | 51.1 | 118 | 89.3 | 0.85 | 37 | 1LE1592-1EB22-1 ■■■ |
| | 21.3 | | | Y | 61.1 | 113 | 91.0 | 0.85 | 36 | |
| | | 31 | | Δ | 88.1 | 113 | 91.0 | 0.84 | 62 | |
| 22 | | | 180 L | Y | 51.1 | 140 | 89.9 | 0.83 | 45 | 1LE1592-1EB42-1 ■■■ |
| | 25.3 | | | Y | 61.1 | 134 | 91.0 | 0.84 | 43.5 | |
| | | 36.5 | | Δ | 88.0 | 134 | 91.0 | 0.82 | 74 | |
| 30 | | | 200 L | Y | 50.9 | 191 | 90.7 | 0.83 | 60 | 1LE1592-2AB52-1 ■■■ |
| | 34.5 | | | Y | 60.9 | 183 | 92.4 | 0.84 | 58 | |
| | | 48 | | Δ | 87.8 | 176 | 92.4 | 0.81 | 97 | |
| 37 | | | 225 S | Y | 50.9 | 236 | 91.4 | 0.85 | 72 | 1LE1592-2BB02-1 ■■■ |
| | 42.5 | | | Y | 60.9 | 225 | 92.4 | 0.86 | 70 | |
| 45 | | | 225 M | Y | 50.9 | 286 | 92.4 | 0.88 | 84 | 1LE1592-2BB22-1 ■■■ |
| | 52 | | | Y | 60.9 | 276 | 93.0 | 0.83 | 84 | |
| 55 | | | 250 M | Y | 50.8 | 350 | 92.3 | 0.86 | 105 | 1LE1592-2CB22-1 ■■■ |
| | 63 | | | Y | 60.8 | 334 | 93.0 | 0.86 | 103 | |
| 75 | | | 280 S | Y | 50.6 | 477 | 92.7 | 0.86 | 143 | 1LE1592-2DB02-1 ■■■ |
| | 86 | | | Y | 60.6 | 456 | 93.2 | 0.87 | 139 | |
| 90 | | | 280 M | Y | 50.6 | 573 | 93.0 | 0.87 | 169 | 1LE1592-2DB22-1 ■■■ |
| | 104 | | | Y | 60.6 | 552 | 93.2 | 0.87 | 168 | |
| 106 | | | 315 S | Y | 50.4 | 675 | 94.0 | 0.84 | 205 | 1LE1592-3AB02-1 ■■■ |
| | 125 | | | Y | 60.4 | 663 | 94.2 | 0.85 | 205 | |
| 130 | | | 315 M | Y | 50.4 | 828 | 94.4 | 0.84 | 250 | 1LE1592-3AB22-1 ■■■ |
| | 152 | | | Y | 60.4 | 806 | 94.8 | 0.85 | 250 | |
| 160 | | | 315 L | Y | 50.4 | 1019 | 95.0 | 0.87 | 295 | 1LE1592-3AB42-1 ■■■ |
| | 184 | | | Y | 60.4 | 976 | 95.0 | 0.87 | 290 | |
| 200 | | | 315 L | Y | 50.5 | 1273 | 95.5 | 0.89 | 360 | 1LE1592-3AB52-1 ■■■ |
| | 230 | | | Y | 60.5 | 1220 | 95.0 | 0.89 | 355 | |

For versions, see Article No. supplements and special versions. ■■■

All technical specifications refer to converter operation.

Standard induction motors optimized for converter operation – VSD10 line

Standard Efficiency

Cast-iron series SIMOTICS SD 1LE1592, line voltage 400 V, 50 Hz/460 V, 60 Hz/400 V, 87 Hz – self-ventilated

| Motor type | m_{IMB3} kg | J kgm ² | L_{pA} , tolerance +3 dB(A) load dB(A) | L_{WA} , tolerance +3 dB(A) load dB(A) | Mech. speed limit rpm | Terminal box | Preferred SINAMICS G120 – PM240(-2) Other SINAMICS converters also possible Operating mode: Low overload Type ¹⁾ | Frame size | IES class acc. to EN 50598-2 |
|--------------------|------------------|-------------------------|--|--|-----------------------------|-----------------|--|------------|------------------------------------|
| 1LE1592-1AB42-1... | 29 | 0.0059 | 79.0 | 91.0 | 4200 | TB1F01 | 6SL3210-1PE16-1.L1 | FSA | IES 1 |
| | 29 | 0.0059 | 79.0 | 91.0 | 4200 | | 6SL3210-1PE16-1.L1 | FSA | IES 1 |
| | 29 | 0.0059 | 81.0 | 93.0 | 4200 | | 6SL3210-1PE21-1.L0 | FSB | IES 1 |
| 1LE1592-1AB52-1... | 33 | 0.0078 | 79.0 | 91.0 | 4200 | TB1F01 | 6SL3210-1PE18-0.L1 | FSA | IES 1 |
| | 33 | 0.0078 | 79.0 | 91.0 | 4200 | | 6SL3210-1PE18-0.L1 | FSA | IES 1 |
| | 33 | 0.0078 | 81.0 | 93.0 | 4200 | | 6SL3210-1PE21-4.L0 | FSB | IES 1 |
| 1LE1592-1BB22-1... | 38 | 0.01 | 77.4 | 89.4 | 4200 | TB1F01 | 6SL3210-1PE21-1.L0 | FSB | IES 1 |
| | 38 | 0.01 | 77.2 | 89.2 | 4200 | | 6SL3210-1PE21-1.L0 | FSB | IES 1 |
| | 38 | 0.01 | 78.4 | 90.4 | 4200 | | 6SL3210-1PE21-8.L0 | FSB | IES 1 |
| 1LE1592-1CB02-1... | 60 | 0.019 | 76.0 | 88.0 | 4200 | TB1H01 | 6SL3210-1PE21-4.L0 | FSB | IES 1 |
| | 60 | 0.019 | 76.0 | 88.0 | 4200 | | 6SL3210-1PE21-4.L0 | FSB | IES 1 |
| | 60 | 0.019 | 83.0 | 95.0 | 4200 | | 6SL3210-1PE22-7.L0 | FSC | IES 1 |
| 1LE1592-1CB22-1... | 62 | 0.024 | 76.0 | 88.0 | 4200 | TB1H01 | 6SL3210-1PE21-8.L0 | FSB | IES 1 |
| | 62 | 0.024 | 76.0 | 88.0 | 4200 | | 6SL3210-1PE21-8.L0 | FSB | IES 1 |
| | 62 | 0.024 | 83.0 | 95.0 | 4200 | | 6SL3210-1PE23-3.L0 | FSC | IES 1 |
| 1LE1592-1DB22-1... | 89 | 0.044 | 83.5 | 95.5 | 4200 | TB1J01 | 6SL3210-1PE22-7.L0 | FSC | IES 1 |
| | 89 | 0.044 | 82.3 | 94.3 | 4200 | | 6SL3210-1PE22-7.L0 | FSC | IES 1 |
| | 89 | 0.044 | 85.8 | 97.8 | 4200 | | 6SL3210-1PE24-5.L0 | FSD | IES 1 |
| 1LE1592-1DB42-1... | 100 | 0.056 | 83.5 | 95.5 | 4200 | TB1J01 | 6SL3210-1PE23-3.L0 | FSC | IES 2 |
| | 100 | 0.056 | 82.3 | 94.3 | 4200 | | 6SL3210-1PE23-3.L0 | FSC | IES 2 |
| | 100 | 0.056 | 85.8 | 97.8 | 4200 | | 6SL3210-1PE26-0.L0 | FSD | IES 2 |
| 1LE1592-1EB22-1... | 170 | 0.13 | 71.0 | 83.0 | 4200 | TB1J01 | 6SL3210-1PE23-8.L0 | FSD | IES 2 |
| | 170 | 0.13 | 73.0 | 85.0 | 4200 | | 6SL3210-1PE23-8.L0 | FSD | IES 2 |
| | 170 | 0.13 | 84.0 | 96.0 | 4200 | | 6SL3210-1PE27-5.L0 | FSD | IES 2 |
| 1LE1592-1EB42-1... | 170 | 0.13 | 71.0 | 83.0 | 4200 | TB1J01 | 6SL3210-1PE24-5.L0 | FSD | IES 2 |
| | 170 | 0.13 | 73.0 | 85.0 | 4200 | | 6SL3210-1PE24-5.L0 | FSD | IES 2 |
| | 170 | 0.13 | 84.0 | 96.0 | 4200 | | 6SL3210-1PE28-8.L0 | FSE | IES 2 |
| 1LE1592-2AB52-1... | 220 | 0.2 | 76.3 | 88.3 | 4200 | TB1L01 | 6SL3210-1PE26-0.L0 | FSD | IES 2 |
| | 220 | 0.2 | 77.7 | 89.7 | 4200 | | 6SL3210-1PE26-0.L0 | FSD | IES 2 |
| | 220 | 0.2 | 83.1 | 95.1 | 4200 | | 6SL3210-1PE31-1.L0 | FSE | IES 2 |
| 1LE1592-2BB02-1... | 260 | 0.37 | 67.0 | 83.0 | 4500 | TB1L01 | 6SL3210-1PE27-5.L0 | FSD | IES 2 |
| | 260 | 0.37 | 70.0 | 86.0 | 4500 | | 6SL3210-1PE27-5.L0 | FSD | IES 2 |
| 1LE1592-2BB22-1... | 290 | 0.45 | 70.0 | 83.0 | 4500 | TB1L01 | 6SL3210-1PE28-8.L0 | FSE | IES 2 |
| | 290 | 0.45 | 72.0 | 86.0 | 4500 | | 6SL3210-1PE28-8.L0 | FSE | IES 2 |
| 1LE1592-2CB22-1... | 360 | 0.69 | 70.0 | 83.0 | 3700 | TB1N01 | 6SL3210-1PE31-1.L0 | FSE | IES 2 |
| | 360 | 0.69 | 72.0 | 86.0 | 3700 | | 6SL3210-1PE31-1.L0 | FSE | IES 2 |
| 1LE1592-2DB02-1... | 540 | 1.2 | 75.0 | 90.0 | 3000 | TB1N01 | 6SL3210-1PE31-5.L0 | FSF | IES 2 |
| | 540 | 1.2 | 76.0 | 91.0 | 3000 | | 6SL3210-1PE31-5.L0 | FSF | IES 2 |
| 1LE1592-2DB22-1... | 560 | 1.4 | 75.0 | 90.0 | 3000 | TB1N01 | 6SL3210-1PE31-8.L0 | FSF | IES 2 |
| | 560 | 1.4 | 76.0 | 91.0 | 3000 | | 6SL3210-1PE31-8.L0 | FSF | IES 2 |
| 1LE1592-3AB02-1... | 730 | 1.9 | 79.0 | 94.0 | 2600 | TB1Q01 | 6SL3210-1PE32-1.L0 | FSF | IES 2 |
| | 730 | 1.9 | 82.0 | 96.0 | 2600 | | 6SL3210-1PE32-1.L0 | FSF | IES 2 |
| 1LE1592-3AB22-1... | 760 | 2.2 | 79.0 | 94.0 | 2600 | TB1Q01 | 6SL3210-1PE32-5.L0 | FSF | IES 2 |
| | 760 | 2.2 | 82.0 | 96.0 | 2600 | | 6SL3210-1PE32-5.L0 | FSF | IES 2 |
| 1LE1592-3AB42-1... | 940 | 2.8 | 79.0 | 94.0 | 2600 | TB1Q01 | 6SL3224-0XE41-3.A0 | FSGX | IES 2 |
| | 940 | 2.8 | 80.0 | 95.0 | 2600 | | 6SL3224-0XE41-3.A0 | FSGX | IES 2 |
| 1LE1592-3AB52-1... | 1140 | 3.5 | 81.0 | 96.0 | 2600 | TB1Q01 | 6SL3224-0XE41-6.A0 | FSGX | IES 2 |
| | 1140 | 3.5 | 82.0 | 96.0 | 2600 | | 6SL3224-0XE41-6.A0 | FSGX | IES 2 |

¹⁾ In addition to the Power Module, a Control Unit and an Operator Panel are required (see Catalog D 31 and/or D 35).

Standard induction motors optimized for converter operation – VSD10 line

Standard Efficiency

Cast-iron series SIMOTICS SD 1LE1592, line voltage 500 V, 50 Hz/575 V, 60 Hz/500 V, 87 Hz – self-ventilated

Selection and ordering data

| $P_{\text{rated, 50 Hz}}$ 500 V | $P_{\text{rated, 60 Hz}}$ 575 V | $P_{\text{rated, 87 Hz}}$ 500 V | Frame size | Connection | Operating values at rated power | | | | | 1LE1592 cast-iron series Version specifically for converter operation |
|---|------------------------------------|------------------------------------|------------|------------|---------------------------------|--------------------|---|-----------------------------------|--------------------|---|
| | | | | | f_{rated} | T_{rated} | $\eta_{\text{rated, 4/4}}$ for converter operation | $\cos\varphi_{\text{rated, 4/4}}$ | I_{rated} | |
| kW | kW | kW | | | Hz | Nm | % | | A | |
| <ul style="list-style-type: none"> Insulation: Thermal class 155 (temperature class F), IP55 degree of protection, utilization in accordance with thermal class 155 (temperature class F) Operation with a SINAMICS G converter with uncontrolled infeed – rated motor voltage 480 V, 50 Hz/550 V, 60 Hz/480 V, 87 Hz | | | | | | | | | | |
| 3000 rpm | 3600 rpm | 5220 rpm | 2-pole | | | | | | | |
| 3 | | | 100 L | Y | 52.9 | 9.6 | 81.5 | 0.87 | 5.1 | 1LE1592-1AA42-6 ■■■ |
| | 3.45 | | | Y | 63.0 | 9.2 | 84.5 | 0.88 | 4.85 | |
| | | 5 | | Δ | 89.6 | 9.1 | 84.5 | 0.85 | 8.4 | |
| 4 | | | 112 M | Y | 51.3 | 12.7 | 83.1 | 0.86 | 6.7 | 1LE1592-1BA22-6 ■■■ |
| | 4.55 | | | Y | 61.3 | 12.1 | 84.5 | 0.88 | 6.4 | |
| | | 6.6 | | Δ | 88.2 | 12.1 | 84.5 | 0.84 | 11.1 | |
| 5.5 | | | 132 S | Y | 51.6 | 17.5 | 84.7 | 0.89 | 8.8 | 1LE1592-1CA02-6 ■■■ |
| | 6.3 | | | Y | 61.6 | 16.7 | 86.0 | 0.90 | 8.5 | |
| 7.5 | | | 132 S | Y | 51.2 | 23.9 | 86.0 | 0.87 | 12.1 | 1LE1592-1CA12-6 ■■■ |
| | 8.6 | | | Y | 61.2 | 22.8 | 88.7 | 0.88 | 11.7 | |
| 11 | | | 160 M | Y | 51.3 | 35.0 | 87.6 | 0.85 | 17.8 | 1LE1592-1DA22-6 ■■■ |
| | 12.6 | | | Y | 61.3 | 33.4 | 87.5 | 0.86 | 17.6 | |
| 14 | | | 160 M | Y | 51.1 | 44.6 | 88.7 | 0.84 | 22.5 | 1LE1592-1DA32-6 ■■■ |
| | 16.5 | | | Y | 61.2 | 43.8 | 89.5 | 0.86 | 22.5 | |
| 17 | | | 160 L | Y | 51.1 | 54.1 | 89.3 | 0.85 | 27 | 1LE1592-1DA42-6 ■■■ |
| | 19.5 | | | Y | 61.1 | 51.7 | 89.5 | 0.86 | 26.5 | |
| 22 | | | 180 M | Y | 50.9 | 70 | 89.9 | 0.87 | 34 | 1LE1592-1EA22-6 ■■■ |
| | 24.5 | | | Y | 60.9 | 65 | 89.5 | 0.87 | 33 | |
| 30 | | | 200 L | Y | 50.8 | 96 | 90.7 | 0.82 | 48.5 | 1LE1592-2AA42-6 ■■■ |
| | 33.5 | | | Y | 60.8 | 89 | 91.5 | 0.82 | 47 | |
| 34 | | | 200 L | Y | 50.7 | 108 | 91.2 | 0.87 | 52 | 1LE1592-2AA52-6 ■■■ |
| | 40 | | | Y | 60.8 | 106 | 91.7 | 0.89 | 51 | |
| 41 | | | 225 M | Y | 50.6 | 131 | 91.7 | 0.88 | 61 | 1LE1592-2BA22-6 ■■■ |
| | 48 | | | Y | 60.6 | 127 | 91.7 | 0.88 | 62 | |
| 53 | | | 250 M | Y | 50.5 | 169 | 92.1 | 0.88 | 79 | 1LE1592-2CA22-6 ■■■ |
| | 60 | | | Y | 60.5 | 159 | 92.4 | 0.88 | 77 | |
| 75 | | | 280 S | Y | 50.5 | 239 | 92.7 | 0.87 | 112 | 1LE1592-2DA02-6 ■■■ |
| | 84 | | | Y | 60.5 | 223 | 93.0 | 0.87 | 109 | |
| 90 | | | 280 M | Y | 50.4 | 286 | 93.0 | 0.88 | 132 | 1LE1592-2DA22-6 ■■■ |
| | 101 | | | Y | 60.4 | 268 | 93.0 | 0.88 | 130 | |

For versions, see Article No. supplements and special versions. ■■■

All technical specifications refer to converter operation.

Standard induction motors optimized for converter operation – VSD10 line

Standard Efficiency

Cast-iron series SIMOTICS SD 1LE1592, line voltage 500 V, 50 Hz/575 V, 60 Hz/500 V, 87 Hz – self-ventilated

| Motor type | m_{IMB3} | J | L_{pFA} , tolerance +3 dB(A) load dB(A) | L_{WA} , tolerance +3 dB(A) load dB(A) | Mech. speed limit rpm | Terminal box | Preferred SINAMICS G120 – PM240(-2) Other SINAMICS converters also possible Operating mode: Low overload Type ¹⁾ | Frame size | IES class acc. to EN 50598-2 |
|--------------------|------------|------------------|---|--|-----------------------------|-----------------|---|------------|------------------------------------|
| | kg | kgm ² | | | | | | | |
| 1LE1592-1AA42-6... | 31 | 0.0034 | 80.0 | 92.1 | 5500 | TB1F01 | | | |
| | 31 | 0.0034 | 80.0 | 92.1 | 5500 | | | | |
| | 31 | 0.0034 | 85.0 | 97.1 | 5500 | | | | |
| 1LE1592-1BA22-6... | 36 | 0.0067 | 79.0 | 91.1 | 5500 | TB1F01 | | | |
| | 36 | 0.0067 | 79.0 | 91.1 | 5500 | | | | |
| | 36 | 0.0067 | 85.0 | 97.2 | 5500 | | 6SL3210-1PH21-4.L0 | FSD | |
| 1LE1592-1CA02-6... | 53 | 0.013 | 77.0 | 89.3 | 4500 | TB1H01 | 6SL3210-1PH21-4.L0 | FSD | |
| | 53 | 0.013 | 77.0 | 89.3 | 4500 | | 6SL3210-1PH21-4.L0 | FSD | |
| 1LE1592-1CA12-6... | 58 | 0.016 | 77.0 | 89.4 | 4500 | TB1H01 | 6SL3210-1PH21-4.L0 | FSD | |
| | 58 | 0.016 | 77.0 | 89.4 | 4500 | | 6SL3210-1PH21-4.L0 | FSD | |
| 1LE1592-1DA22-6... | 87 | 0.03 | 80.0 | 92.4 | 4500 | TB1J01 | 6SL3210-1PH22-0.L0 | FSD | |
| | 87 | 0.03 | 80.0 | 92.4 | 4500 | | 6SL3210-1PH22-0.L0 | FSD | |
| 1LE1592-1DA32-6... | 95 | 0.036 | 80.0 | 92.8 | 4500 | TB1J01 | 6SL3210-1PH22-3.L0 | FSD | |
| | 95 | 0.036 | 80.0 | 92.8 | 4500 | | 6SL3210-1PH22-3.L0 | FSD | |
| 1LE1592-1DA42-6... | 105 | 0.044 | 80.0 | 92.8 | 4500 | TB1J01 | 6SL3210-1PH22-7.L0 | FSD | |
| | 105 | 0.044 | 80.0 | 92.8 | 4500 | | 6SL3210-1PH22-7.L0 | FSD | |
| 1LE1592-1EA22-6... | 150 | 0.069 | 80.0 | 93.0 | 4500 | TB1J01 | 6SL3210-1PH23-5.L0 | FSD | |
| | 150 | 0.069 | 80.0 | 93.0 | 4500 | | 6SL3210-1PH23-5.L0 | FSD | |
| 1LE1592-2AA42-6... | 195 | 0.124 | 79.0 | 92.0 | 4500 | TB1L01 | 6SL3210-1PH25-2.L0 | FSE | |
| | 195 | 0.124 | 79.0 | 92.0 | 4500 | | 6SL3210-1PH25-2.L0 | FSE | |
| 1LE1592-2AA52-6... | 230 | 0.15 | 77.0 | 90.1 | 4500 | TB1L01 | 6SL3210-1PH25-2.L0 | FSE | |
| | 230 | 0.15 | 77.0 | 90.1 | 4500 | | 6SL3210-1PH25-2.L0 | FSE | |
| 1LE1592-2BA22-6... | 280 | 0.22 | 78.0 | 90.0 | 4500 | TB1L01 | 6SL3210-1PH26-2.L0 | FSE | |
| | 280 | 0.22 | 80.0 | 93.0 | 4500 | | 6SL3210-1PH26-2.L0 | FSE | |
| 1LE1592-2CA22-6... | 360 | 0.4 | 78.0 | 92.0 | 3900 | TB1N01 | 6SL3210-1PH28-0.L0 | FSF | |
| | 360 | 0.4 | 82.0 | 96.0 | 3900 | | 6SL3210-1PH28-0.L0 | FSF | |
| 1LE1592-2DA02-6... | 470 | 0.72 | 78.0 | 92.0 | 3600 | TB1N01 | 6SL3210-1PH31-2.L0 | FSF | |
| | 470 | 0.72 | 82.0 | 96.0 | 3600 | | 6SL3210-1PH31-2.L0 | FSF | |
| 1LE1592-2DA22-6... | 530 | 0.83 | 78.0 | 92.0 | 3600 | TB1N01 | 6SL3210-1PH31-4.L0 | FSF | |
| | 530 | 0.83 | 82.0 | 96.0 | 3600 | | 6SL3210-1PH31-4.L0 | FSF | |

¹⁾ In addition to the Power Module, a Control Unit and an Operator Panel are required (see Catalog D 31 and/or D 35).

Standard induction motors optimized for converter operation – VSD10 line

Standard Efficiency

Cast-iron series SIMOTICS SD 1LE1592, line voltage 500 V, 50 Hz/575 V, 60 Hz/500 V, 87 Hz – self-ventilated

Selection and ordering data

| P _{rated} , 50 Hz, 500 V | P _{rated} , 60 Hz, 575 V | P _{rated} , 87 Hz, 500 V | Frame size | Connection | Operating values at rated power | | | | I _{rated} | 1LE1592 cast-iron series Version specifically for converter operation |
|---|--------------------------------------|--------------------------------------|------------|------------|---------------------------------|--------------------|---|------------------------------|--------------------|---|
| | | | | | f _{rated} | T _{rated} | η _{rated} , 4/4 for converter operation | cos φ _{rated} , 4/4 | | |
| kW | kW | kW | | | Hz | Nm | % | A | Article No. | |
| <ul style="list-style-type: none"> Insulation: Thermal class 155 (temperature class F), IP55 degree of protection, utilization in accordance with thermal class 155 (temperature class F) Operation with a SINAMICS G converter with uncontrolled infeed – rated motor voltage 480 V, 50 Hz/550 V, 60 Hz/480 V, 87 Hz | | | | | | | | | | |
| 1500 rpm | 1800 rpm | 2610 rpm | 4-pole | | | | | | | |
| 2.2 | | | 100 L | Y | 52.8 | 14.0 | 79.7 | 0.81 | 4.1 | 1LE1592-1AB42-6 ■■■ |
| | 2.55 | | | Y | 62.8 | 13.5 | 83.0 | 0.82 | 3.95 | |
| | | 4 | | Δ | 89.6 | 13.5 | 83.0 | 0.79 | 6.8 | |
| 3 | | | 100 L | Y | 52.6 | 19.1 | 81.5 | 0.85 | 5.2 | 1LE1592-1AB52-6 ■■■ |
| | 3.45 | | | Y | 62.6 | 18.3 | 85.0 | 0.86 | 4.95 | |
| | | 5 | | Δ | 89.3 | 18.3 | 85.0 | 0.79 | 8.7 | |
| 4 | | | 112 M | Y | 52.4 | 25.5 | 83.1 | 0.85 | 6.8 | 1LE1592-1BB22-6 ■■■ |
| | 4.55 | | | Y | 62.3 | 24.1 | 85.0 | 0.85 | 6.6 | |
| | | 7 | | Δ | 89.1 | 24.1 | 85.0 | 0.81 | 12 | |
| 5.5 | | | 132 S | Y | 52.0 | 35.0 | 84.7 | 0.82 | 9.5 | 1LE1592-1CB02-6 ■■■ |
| | 6.3 | | | Y | 62.0 | 33.4 | 87.0 | 0.84 | 9 | |
| | | 9 | | Δ | 88.8 | 32.9 | 87.0 | 0.81 | 15.4 | |
| 7.5 | | | 132 M | Y | 51.9 | 47.8 | 86.0 | 0.82 | 12.8 | 1LE1592-1CB22-6 ■■■ |
| | 8.6 | | | Y | 61.9 | 45.6 | 87.5 | 0.84 | 12.3 | |
| | | 13 | | Δ | 88.7 | 45.7 | 87.5 | 0.80 | 21.5 | |
| 11 | | | 160 M | Y | 51.5 | 70.0 | 87.6 | 0.82 | 18.4 | 1LE1592-1DB22-6 ■■■ |
| | 12.6 | | | Y | 61.5 | 66.9 | 88.5 | 0.82 | 18.2 | |
| | | 17 | | Δ | 88.4 | 62.2 | 88.5 | 0.78 | 29.5 | |
| 13.5 | | | 160 L | Y | 51.2 | 86.0 | 88.7 | 0.79 | 23 | 1LE1592-1DB42-6 ■■■ |
| | 15.6 | | | Y | 61.2 | 82.8 | 90.5 | 0.81 | 22.5 | |
| | | 24 | | Δ | 88.3 | 86.0 | 90.5 | 0.77 | 40.5 | |
| 16.7 | | | 180 M | Y | 51.0 | 106 | 89.3 | 0.84 | 27 | 1LE1592-1EB22-6 ■■■ |
| | 19.2 | | | Y | 61.0 | 102 | 91.0 | 0.84 | 26.5 | |
| | | 31 | | Δ | 88.0 | 113 | 91.0 | 0.84 | 49 | |
| 21.5 | | | 180 L | Y | 51.1 | 137 | 89.9 | 0.83 | 34.5 | 1LE1592-1EB42-6 ■■■ |
| | 25.3 | | | Y | 61.2 | 134 | 91.0 | 0.84 | 34.5 | |
| | | 37 | | Δ | 88.1 | 134 | 91.0 | 0.82 | 59 | |
| 30 | | | 200 L | Y | 51.0 | 191 | 90.7 | 0.83 | 48 | 1LE1592-2AB52-6 ■■■ |
| | 34.5 | | | Y | 61.0 | 183 | 92.4 | 0.84 | 46.5 | |
| | | 48 | | Δ | 87.9 | 176 | 92.4 | 0.81 | 77 | |
| 33 | | | 225 S | Y | 50.6 | 210 | 92.0 | 0.84 | 51 | 1LE1592-2BB02-6 ■■■ |
| | 38 | | | Y | 60.6 | 202 | 92.4 | 0.84 | 51 | |
| 41 | | | 225 M | Y | 50.7 | 261 | 92.4 | 0.87 | 61 | 1LE1592-2BB22-6 ■■■ |
| | 47 | | | Y | 60.7 | 249 | 93.0 | 0.87 | 61 | |
| 52 | | | 250 M | Y | 50.7 | 331 | 92.3 | 0.85 | 80 | 1LE1592-2CB22-6 ■■■ |
| | 59 | | | Y | 60.7 | 313 | 93.0 | 0.85 | 78 | |
| 75 | | | 280 S | Y | 50.5 | 477 | 92.7 | 0.85 | 114 | 1LE1592-2DB02-6 ■■■ |
| | 86 | | | Y | 60.5 | 456 | 93.2 | 0.86 | 113 | |
| 90 | | | 280 M | Y | 50.6 | 573 | 93.0 | 0.87 | 134 | 1LE1592-2DB22-6 ■■■ |
| | 102 | | | Y | 60.6 | 541 | 93.2 | 0.87 | 132 | |
| 110 | | | 315 S | Y | 50.4 | 700 | 94.0 | 0.84 | 168 | 1LE1592-3AB02-6 ■■■ |
| | 127 | | | Y | 60.4 | 674 | 94.2 | 0.84 | 168 | |
| 132 | | | 315 M | Y | 50.4 | 840 | 94.4 | 0.85 | 198 | 1LE1592-3AB22-6 ■■■ |
| | 152 | | | Y | 60.4 | 806 | 94.8 | 0.85 | 198 | |
| 160 | | | 315 L | Y | 50.3 | 1019 | 95.0 | 0.86 | 235 | 1LE1592-3AB42-6 ■■■ |
| | 184 | | | Y | 60.3 | 976 | 95.0 | 0.86 | 235 | |
| 200 | | | 315 L | Y | 50.4 | 1273 | 95.0 | 0.88 | 290 | 1LE1592-3AB52-6 ■■■ |
| | 230 | | | Y | 60.4 | 1220 | 95.0 | 0.88 | 290 | |

For versions, see Article No. supplements and special versions. ■■■

All technical specifications refer to converter operation.

Standard induction motors optimized for converter operation – VSD10 line

Standard Efficiency

Cast-iron series SIMOTICS SD 1LE1592, line voltage 500 V, 50 Hz/575 V, 60 Hz/500 V, 87 Hz – self-ventilated

| Motor type | m_{IMB3} | J | L_{pFA} , tolerance +3 dB(A) load | L_{WA} , tolerance +3 dB(A) load | Mech. speed limit | Terminal box | Preferred SINAMICS G120 – PM240(-2) Other SINAMICS converters also possible Operating mode: Low overload Type ¹⁾ | Frame size | IES class acc. to EN 50598-2 |
|--------------------|------------|------------------|--|---|----------------------|-----------------|---|------------|------------------------------------|
| | kg | kgm ² | dB(A) | dB(A) | rpm | | | | |
| 1LE1592-1AB42-6... | 29 | 0.0059 | 80.0 | 92.1 | 4200 | TB1F01 | | | |
| | 29 | 0.0059 | 80.0 | 92.1 | 4200 | | | | |
| | 29 | 0.0059 | 81.0 | 93.1 | 4200 | | | | |
| 1LE1592-1AB52-6... | 33 | 0.0078 | 80.0 | 92.1 | 4200 | TB1F01 | | | |
| | 33 | 0.0078 | 80.0 | 92.1 | 4200 | | | | |
| | 33 | 0.0078 | 81.0 | 93.1 | 4200 | | | | |
| 1LE1592-1BB22-6... | 38 | 0.01 | 79.0 | 91.3 | 4200 | TB1F01 | | | |
| | 38 | 0.01 | 79.0 | 91.3 | 4200 | | | | |
| | 38 | 0.01 | 80.0 | 92.3 | 4200 | | 6SL3210-1PH21-4.L0 | FSD | |
| 1LE1592-1CB02-6... | 60 | 0.019 | 77.0 | 89.4 | 4200 | TB1H01 | 6SL3210-1PH21-4.L0 | FSD | |
| | 60 | 0.019 | 77.0 | 89.4 | 4200 | | 6SL3210-1PH21-4.L0 | FSD | |
| | 60 | 0.019 | 83.0 | 95.4 | 4200 | | 6SL3210-1PH22-0.L0 | FSD | |
| 1LE1592-1CB22-6... | 62 | 0.024 | 77.0 | 89.4 | 4200 | TB1H01 | 6SL3210-1PH21-4.L0 | FSD | |
| | 62 | 0.024 | 77.0 | 89.4 | 4200 | | 6SL3210-1PH21-4.L0 | FSD | |
| | 62 | 0.024 | 83.0 | 95.4 | 4200 | | 6SL3210-1PH22-3.L0 | FSD | |
| 1LE1592-1DB22-6... | 89 | 0.044 | 85.0 | 97.8 | 4200 | TB1J01 | 6SL3210-1PH22-0.L0 | FSD | |
| | 89 | 0.044 | 85.0 | 97.8 | 4200 | | 6SL3210-1PH22-0.L0 | FSD | |
| | 89 | 0.044 | 85.0 | 97.8 | 4200 | | 6SL3210-1PH23-5.L0 | FSD | |
| 1LE1592-1DB42-6... | 100 | 0.056 | 85.0 | 97.8 | 4200 | TB1J01 | 6SL3210-1PH22-3.L0 | FSD | |
| | 100 | 0.056 | 85.0 | 97.8 | 4200 | | 6SL3210-1PH22-3.L0 | FSD | |
| | 100 | 0.056 | 85.0 | 97.8 | 4200 | | 6SL3210-1PH24-2.L0 | FSD | |
| 1LE1592-1EB22-6... | 170 | 0.13 | 72.0 | 85.0 | 4200 | TB1J01 | 6SL3210-1PH22-7.L0 | FSD | |
| | 170 | 0.13 | 72.0 | 85.0 | 4200 | | 6SL3210-1PH22-7.L0 | FSD | |
| | 170 | 0.13 | 84.0 | 97.0 | 4200 | | 6SL3210-1PH25-2.L0 | FSE | |
| 1LE1592-1EB42-6... | 170 | 0.13 | 72.0 | 85.0 | 4200 | TB1J01 | 6SL3210-1PH23-5.L0 | FSD | |
| | 170 | 0.13 | 72.0 | 85.0 | 4200 | | 6SL3210-1PH23-5.L0 | FSD | |
| | 170 | 0.13 | 84.0 | 97.0 | 4200 | | 6SL3210-1PH26-2.L0 | FSE | |
| 1LE1592-2AB52-6... | 220 | 0.2 | 78.0 | 91.3 | 4200 | TB1L01 | 6SL3210-1PH25-2.L0 | FSE | |
| | 220 | 0.2 | 78.0 | 91.3 | 4200 | | 6SL3210-1PH25-2.L0 | FSE | |
| | 220 | 0.2 | 84.0 | 97.3 | 4200 | | 6SL3210-1PH31-0.L0 | FSF | |
| 1LE1592-2BB02-6... | 260 | 0.37 | 70.0 | 84.0 | 4500 | TB1L01 | 6SL3210-1PH25-2.L0 | FSE | |
| | 260 | 0.37 | 70.0 | 84.0 | 4500 | | 6SL3210-1PH25-2.L0 | FSE | |
| 1LE1592-2BB22-6... | 290 | 0.45 | 71.0 | 84.0 | 4500 | TB1L01 | 6SL3210-1PH26-2.L0 | FSE | |
| | 290 | 0.45 | 71.0 | 84.0 | 4500 | | 6SL3210-1PH26-2.L0 | FSE | |
| 1LE1592-2CB22-6... | 360 | 0.69 | 71.0 | 84.0 | 3700 | TB1N01 | 6SL3210-1PH28-0.L0 | FSF | |
| | 360 | 0.69 | 71.0 | 84.0 | 3700 | | 6SL3210-1PH28-0.L0 | FSF | |
| 1LE1592-2DB02-6... | 540 | 1.2 | 76.0 | 91.0 | 3000 | TB1N01 | 6SL3210-1PH31-2.L0 | FSF | |
| | 540 | 1.2 | 76.0 | 91.0 | 3000 | | 6SL3210-1PH31-2.L0 | FSF | |
| 1LE1592-2DB22-6... | 560 | 1.4 | 76.0 | 91.0 | 3000 | TB1N01 | 6SL3210-1PH31-4.L0 | FSF | |
| | 560 | 1.4 | 76.0 | 91.0 | 3000 | | 6SL3210-1PH31-4.L0 | FSF | |
| 1LE1592-3AB02-6... | 730 | 1.9 | 80.0 | 95.0 | 2600 | TB1Q01 | 6SL3710-1GF31-8.A3 | – | |
| | 730 | 1.9 | 80.0 | 95.0 | 2600 | | 6SL3710-1GF31-8.A3 | – | |
| 1LE1592-3AB22-6... | 760 | 2.2 | 80.0 | 95.0 | 2600 | TB1Q01 | 6SL3710-1GF32-2.A3 | – | |
| | 760 | 2.2 | 80.0 | 95.0 | 2600 | | 6SL3710-1GF32-2.A3 | – | |
| 1LE1592-3AB42-6... | 940 | 2.8 | 80.0 | 95.0 | 2600 | TB1Q01 | 6SL3710-1GF32-6.A3 | – | |
| | 940 | 2.8 | 80.0 | 95.0 | 2600 | | 6SL3710-1GF32-6.A3 | – | |
| 1LE1592-3AB52-6... | 1140 | 3.5 | 82.0 | 96.0 | 2600 | TB1Q01 | 6SL3710-1GF33-3.A3 | – | |
| | 1140 | 3.5 | 82.0 | 96.0 | 2600 | | 6SL3710-1GF33-3.A3 | – | |

¹⁾ In addition to the Power Module, a Control Unit and an Operator Panel are required (see Catalog D 31 and/or D 35).

Standard induction motors optimized for converter operation – VSD10 line

Standard Efficiency

Cast-iron series SIMOTICS SD 1LE1592, line voltage 690 V, 50 Hz/690 V, 87 Hz – self-ventilated

Selection and ordering data

| $P_{\text{rated, 50 Hz}}$ 690 V | $P_{\text{rated, 60 Hz}}$ 690 V | $P_{\text{rated, 87 Hz}}$ 690 V | Frame size | Connection | Operating values at rated power | | | | $\cos\varphi_{\text{rated, 4/4}}$ | I_{rated} | 1LE1592 cast-iron series Version specifically for converter operation |
|--|------------------------------------|------------------------------------|------------|------------|---------------------------------|--------------------|---|--------------------|-----------------------------------|---------------------|---|
| | | | | | f_{rated} | T_{rated} | $\eta_{\text{rated, 4/4}}$ for converter operation | I_{rated} | | | |
| kW | kW | kW | | | Hz | Nm | % | A | Article No. | | |
| <ul style="list-style-type: none"> Insulation: Thermal class 155 (temperature class F), IP55 degree of protection, utilization in accordance with thermal class 155 (temperature class F) Operation with a SINAMICS G converter with uncontrolled infeed – rated motor voltage 660 V, 50 Hz/660 V, 87 Hz | | | | | | | | | | | |
| 3000 rpm | 3600 rpm | 5220 rpm | 2-pole | | | | | | | | |
| 3 | | | 100 L | Y | 52.7 | 9.6 | 81.5 | 0.87 | 3.7 | 1LE1592-1AA43-3 ■■■ | |
| | 5 | | | Δ | 89.5 | 9.1 | 84.5 | 0.81 | 6.4 | | |
| 4 | | | 112 M | Y | 51.2 | 12.7 | 83.1 | 0.86 | 4.9 | 1LE1592-1BA23-3 ■■■ | |
| | 6.6 | | | Δ | 88.2 | 12.1 | 84.5 | 0.83 | 8.2 | | |
| 5.5 | | | 132 S | Y | 51.6 | 17.5 | 84.7 | 0.89 | 6.4 | 1LE1592-1CA03-3 ■■■ | |
| 7.5 | | | 132 S | Y | 51.2 | 23.9 | 86.0 | 0.87 | 8.8 | 1LE1592-1CA13-3 ■■■ | |
| 11 | | | 160 M | Y | 51.3 | 35.0 | 87.6 | 0.85 | 12.9 | 1LE1592-1DA23-3 ■■■ | |
| 15 | | | 160 M | Y | 51.4 | 47.8 | 88.7 | 0.84 | 17.6 | 1LE1592-1DA33-3 ■■■ | |
| 18.5 | | | 160 L | Y | 51.3 | 58.9 | 89.3 | 0.86 | 20.5 | 1LE1592-1DA43-3 ■■■ | |
| 22 | | | 180 M | Y | 51.0 | 70 | 89.9 | 0.87 | 24.5 | 1LE1592-1EA23-3 ■■■ | |
| 30 | | | 200 L | Y | 50.9 | 96 | 90.7 | 0.84 | 34.5 | 1LE1592-2AA43-3 ■■■ | |
| 37 | | | 200 L | Y | 50.9 | 118 | 91.2 | 0.88 | 40.5 | 1LE1592-2AA53-3 ■■■ | |
| 45 | | | 225 M | Y | 50.7 | 143 | 91.7 | 0.88 | 49 | 1LE1592-2BA23-3 ■■■ | |
| 55 | | | 250 M | Y | 50.6 | 175 | 92.1 | 0.88 | 59 | 1LE1592-2CA23-3 ■■■ | |
| 75 | | | 280 S | Y | 50.5 | 239 | 92.7 | 0.88 | 80 | 1LE1592-2DA03-3 ■■■ | |
| 90 | | | 280 M | Y | 50.4 | 286 | 93.0 | 0.88 | 96 | 1LE1592-2DA23-3 ■■■ | |
| 1500 rpm | 1800 rpm | 2610 rpm | 4-pole | | | | | | | | |
| 2.2 | | | 100 L | Y | 52.9 | 14.0 | 79.7 | 0.81 | 3 | 1LE1592-1AB43-3 ■■■ | |
| | 3.7 | | | Δ | 89.5 | 13.5 | 83.0 | 0.79 | 4.95 | | |
| 3 | | | 100 L | Y | 52.5 | 19.1 | 81.5 | 0.85 | 3.8 | 1LE1592-1AB53-3 ■■■ | |
| | 5 | | | Δ | 89.5 | 18.3 | 85.0 | 0.79 | 6.5 | | |
| 4 | | | 112 M | Y | 52.5 | 25.5 | 83.1 | 0.85 | 5 | 1LE1592-1BB23-3 ■■■ | |
| | 6.6 | | | Δ | 89.2 | 24.1 | 85.0 | 0.81 | 8.4 | | |
| 5.5 | | | 132 S | Y | 52.0 | 35.0 | 84.7 | 0.82 | 6.9 | 1LE1592-1CB03-3 ■■■ | |
| | 9 | | | Δ | 88.7 | 32.9 | 87.0 | 0.81 | 11.2 | | |
| 7.5 | | | 132 M | Y | 51.7 | 47.8 | 86.0 | 0.82 | 9.3 | 1LE1592-1CB23-3 ■■■ | |
| | 12.5 | | | Δ | 88.6 | 45.7 | 87.5 | 0.80 | 15.6 | | |
| 11 | | | 160 M | Y | 51.5 | 70.0 | 87.6 | 0.82 | 13.4 | 1LE1592-1DB23-3 ■■■ | |
| | 17 | | | Δ | 88.3 | 62.2 | 88.5 | 0.78 | 21.5 | | |
| 15 | | | 160 L | Y | 51.4 | 95.5 | 88.7 | 0.82 | 18 | 1LE1592-1DB43-3 ■■■ | |
| | 23.5 | | | Δ | 88.2 | 86.0 | 90.5 | 0.77 | 29.5 | | |
| 18.5 | | | 180 M | Y | 51.1 | 117.8 | 89.3 | 0.85 | 21.5 | 1LE1592-1EB23-3 ■■■ | |
| | 31 | | | Δ | 88.0 | 112 | 91.0 | 0.84 | 35 | | |
| 22 | | | 180 L | Y | 51.2 | 140 | 89.9 | 0.85 | 25 | 1LE1592-1EB43-3 ■■■ | |
| | 36.5 | | | Δ | 88.2 | 134 | 91.0 | 0.84 | 42 | | |
| 30 | | | 200 L | Y | 51.0 | 191 | 90.7 | 0.83 | 35 | 1LE1592-2AB53-3 ■■■ | |
| | 48 | | | Δ | 87.9 | 176 | 92.4 | 0.81 | 56 | | |
| 37 | | | 225 S | Y | 50.8 | 236 | 91.4 | 0.85 | 41.5 | 1LE1592-2BB03-3 ■■■ | |
| 45 | | | 225 M | Y | 50.8 | 286 | 92.4 | 0.88 | 48.5 | 1LE1592-2BB23-3 ■■■ | |
| 55 | | | 250 M | Y | 50.8 | 350 | 92.3 | 0.86 | 61 | 1LE1592-2CB23-3 ■■■ | |
| 72 | | | 280 S | Y | 50.5 | 458 | 92.7 | 0.85 | 80 | 1LE1592-2DB03-3 ■■■ | |
| 90 | | | 280 M | Y | 50.6 | 573 | 93.0 | 0.87 | 97 | 1LE1592-2DB23-3 ■■■ | |
| 105 | | | 315 S | Y | 50.4 | 668 | 94.0 | 0.85 | 115 | 1LE1592-3AB03-3 ■■■ | |
| 130 | | | 315 M | Y | 50.4 | 828 | 94.4 | 0.85 | 142 | 1LE1592-3AB23-3 ■■■ | |
| 160 | | | 315 L | Y | 50.3 | 1019 | 95.0 | 0.87 | 169 | 1LE1592-3AB43-3 ■■■ | |
| 200 | | | 315 L | Y | 50.4 | 1273 | 95.0 | 0.89 | 205 | 1LE1592-3AB53-3 ■■■ | |

For versions, see Article No. supplements and special versions.

All technical specifications refer to converter operation.

Standard induction motors optimized for converter operation – VSD10 line

Standard Efficiency

Cast-iron series SIMOTICS SD 1LE1592, line voltage 690 V, 50 Hz/690 V, 87 Hz – self-ventilated

| Motor type | $m_{IM\ B3}$ | J | L_{pFA} , tolerance +3 dB(A) load dB(A) | L_{WA} , tolerance +3 dB(A) load dB(A) | Mech. speed limit rpm | Terminal box | Preferred SINAMICS G120 – PM240(-2) Other SINAMICS converters also possible Operating mode: Low overload Type ¹⁾ | Frame size | IES class acc. to EN 50598-2 |
|--------------------|--------------|------------------|---|--|-----------------------------|-----------------|---|------------|------------------------------------|
| | kg | kgm ² | | | | | | | |
| 1LE1592-1AA43-3... | 31 | 0.0034 | 80.0 | 92.1 | 5500 | TB1F01 | | | |
| | 31 | 0.0034 | 85.0 | 97.1 | 5500 | | | | |
| 1LE1592-1BA23-3... | 36 | 0.0067 | 79.0 | 91.1 | 5500 | TB1F01 | | | |
| | 36 | 0.0067 | 85.0 | 97.2 | 5500 | | 6SL3210-1PH21-4.L0 | FSD | |
| 1LE1592-1CA03-3... | 53 | 0.013 | 77.0 | 89.3 | 4500 | TB1H01 | 6SL3210-1PH21-4.L0 | FSD | |
| 1LE1592-1CA13-3... | 58 | 0.016 | 77.0 | 89.4 | 4500 | TB1H01 | 6SL3210-1PH21-4.L0 | FSD | |
| 1LE1592-1DA23-3... | 87 | 0.03 | 80.0 | 92.4 | 4500 | TB1J01 | 6SL3210-1PH21-4.L0 | FSD | |
| 1LE1592-1DA33-3... | 95 | 0.036 | 80.0 | 92.8 | 4500 | TB1J01 | 6SL3210-1PH22-0.L0 | FSD | |
| 1LE1592-1DA43-3... | 105 | 0.044 | 80.0 | 92.8 | 4500 | TB1J01 | 6SL3210-1PH22-3.L0 | FSD | |
| 1LE1592-1EA23-3... | 150 | 0.069 | 80.0 | 93.0 | 4500 | TB1J01 | 6SL3210-1PH22-7.L0 | FSD | |
| 1LE1592-2AA43-3... | 195 | 0.124 | 79.0 | 92.0 | 4500 | TB1L01 | 6SL3210-1PH23-5.L0 | FSD | |
| 1LE1592-2AA53-3... | 230 | 0.15 | 77.0 | 90.1 | 4500 | TB1L01 | 6SL3210-1PH24-2.L0 | FSD | |
| 1LE1592-2BA23-3... | 280 | 0.22 | 78.0 | 90.0 | 4500 | TB1L01 | 6SL3210-1PH25-2.L0 | FSE | |
| 1LE1592-2CA23-3... | 360 | 0.4 | 78.0 | 92.0 | 3900 | TB1N01 | 6SL3210-1PH26-2.L0 | FSE | |
| 1LE1592-2DA03-3... | 470 | 0.72 | 78.0 | 92.0 | 3600 | TB1N01 | 6SL3210-1PH28-0.L0 | FSF | |
| 1LE1592-2DA23-3... | 530 | 0.83 | 78.0 | 92.0 | 3600 | TB1N01 | 6SL3210-1PH31-0.L0 | FSF | |
| 1LE1592-1AB43-3... | 29 | 0.0059 | 80.0 | 92.1 | 4200 | TB1F01 | | | |
| | 29 | 0.0059 | 81.0 | 93.1 | 4200 | | | | |
| 1LE1592-1AB53-3... | 33 | 0.0078 | 80.0 | 92.1 | 4200 | TB1F01 | | | |
| | 33 | 0.0078 | 81.0 | 93.1 | 4200 | | | | |
| 1LE1592-1BB23-3... | 38 | 0.01 | 79.0 | 91.3 | 4200 | TB1F01 | | | |
| | 38 | 0.01 | 80.0 | 92.3 | 4200 | | 6SL3210-1PH21-4.L0 | FSD | |
| 1LE1592-1CB03-3... | 60 | 0.019 | 77.0 | 89.4 | 4200 | TB1H01 | 6SL3210-1PH21-4.L0 | FSD | |
| | 60 | 0.019 | 83.0 | 95.4 | 4200 | | 6SL3210-1PH21-4.L0 | FSD | |
| 1LE1592-1CB23-3... | 62 | 0.024 | 77.0 | 89.4 | 4200 | TB1H01 | 6SL3210-1PH21-4.L0 | FSD | |
| | 62 | 0.024 | 83.0 | 95.4 | 4200 | | 6SL3210-1PH22-0.L0 | FSD | |
| 1LE1592-1DB23-3... | 89 | 0.044 | 85.0 | 97.8 | 4200 | TB1J01 | 6SL3210-1PH21-4.L0 | FSD | |
| | 89 | 0.044 | 85.0 | 97.8 | 4200 | | 6SL3210-1PH22-7.L0 | FSD | |
| 1LE1592-1DB43-3... | 100 | 0.056 | 85.0 | 97.8 | 4200 | TB1J01 | 6SL3210-1PH22-0.L0 | FSD | |
| | 100 | 0.056 | 85.0 | 97.8 | 4200 | | 6SL3210-1PH23-5.L0 | FSD | |
| 1LE1592-1EB23-3... | 170 | 0.13 | 72.0 | 85.0 | 4200 | TB1J01 | 6SL3210-1PH22-3.L0 | FSD | |
| | 170 | 0.13 | 84.0 | 97.0 | 4200 | | 6SL3210-1PH24-2.L0 | FSD | |
| 1LE1592-1EB43-3... | 170 | 0.13 | 72.0 | 85.0 | 4200 | TB1J01 | 6SL3210-1PH22-7.L0 | FSD | |
| | 170 | 0.13 | 84.0 | 97.0 | 4200 | | 6SL3210-1PH25-2.L0 | FSE | |
| 1LE1592-2AB53-3... | 220 | 0.2 | 78.0 | 91.3 | 4200 | TB1L01 | 6SL3210-1PH23-5.L0 | FSD | |
| | 220 | 0.2 | 84.0 | 97.3 | 4200 | | 6SL3210-1PH26-2.L0 | FSE | |
| 1LE1592-2BB03-3... | 260 | 0.37 | 70.0 | 84.0 | 4500 | TB1L01 | 6SL3210-1PH24-2.L0 | FSD | |
| 1LE1592-2BB23-3... | 290 | 0.45 | 71.0 | 84.0 | 4500 | TB1L01 | 6SL3210-1PH25-2.L0 | FSE | |
| 1LE1592-2CB23-3... | 360 | 0.69 | 71.0 | 84.0 | 3700 | TB1N01 | 6SL3210-1PH26-2.L0 | FSE | |
| 1LE1592-2DB03-3... | 540 | 1.2 | 76.0 | 91.0 | 3000 | TB1N01 | 6SL3210-1PH28-0.L0 | FSF | |
| 1LE1592-2DB23-3... | 560 | 1.4 | 76.0 | 91.0 | 3000 | TB1N01 | 6SL3210-1PH31-0.L0 | FSF | |
| 1LE1592-3AB03-3... | 730 | 1.9 | 80.0 | 95.0 | 2600 | TB1Q01 | 6SL3710-1GH31-2.A3 | – | |
| 1LE1592-3AB23-3... | 760 | 2.2 | 80.0 | 95.0 | 2600 | TB1Q01 | 6SL3710-1GH31-5.A3 | – | |
| 1LE1592-3AB43-3... | 940 | 2.8 | 80.0 | 95.0 | 2600 | TB1Q01 | 6SL3710-1GH31-8.A3 | – | |
| 1LE1592-3AB53-3... | 1140 | 3.5 | 82.0 | 96.0 | 2600 | TB1Q01 | 6SL3710-1GH32-2.A3 | – | |

¹⁾ In addition to the Power Module, a Control Unit and an Operator Panel are required (see Catalog D 31 and/or D 35).

Standard induction motors optimized for converter operation – VSD10 line

Article No. supplements and special versions · Voltages

Aluminum series SIMOTICS GP 1LE1092

Selection and ordering data

| Voltages | Article No. | | supplement | Frame size | | | | Motor version |
|--|-------------------------|---|---|-------------------------------------|-------------------------------------|-------------------------------------|-------------------------------------|---------------------|
| | Voltage code | 12th and 13th position of the Article No. | | 100 | 112 | 132 | 160 | |
| | | | Additional identification code with order code and plain text if required | 1LE1092 | | | | Standard Efficiency |
| | 1LE1092- | ■ - ■ . . . | Order code | | | | | |
| Voltage at 50 Hz or 60 Hz | | | | | | | | |
| Line voltage: 50 Hz, 400 V 60 Hz, 480 V | 2 | 1 | – | <input type="checkbox"/> | <input type="checkbox"/> | <input type="checkbox"/> | <input type="checkbox"/> | |
| Line voltage: 50 Hz, 690 V | 3 | 3 | – | <input checked="" type="checkbox"/> | <input checked="" type="checkbox"/> | <input checked="" type="checkbox"/> | <input checked="" type="checkbox"/> | |
| Non-standard voltage and/or frequencies | | | | | | | | |
| Non-standard winding Reinforced insulation system (Advanced) | 9 | 0 | M1Y • and customer specifications | <input checked="" type="checkbox"/> | <input checked="" type="checkbox"/> | <input checked="" type="checkbox"/> | <input checked="" type="checkbox"/> | |
| Non-standard winding Special insulation system (Premium) | 9 | 0 | M2Y • and customer specifications | <input checked="" type="checkbox"/> | <input checked="" type="checkbox"/> | <input checked="" type="checkbox"/> | <input checked="" type="checkbox"/> | |

- Standard version
- With additional charge
- This order code only determines the price of the version – Additional plain text is required.

Standard induction motors optimized for converter operation – VSD10 line

Article No. supplements and special versions · Voltages

Cast-iron series SIMOTICS SD 1LE1592

Selection and ordering data

| Voltages | Article No. | | supplement | Frame size | | | | | | | | | | Motor version |
|--|------------------|---|---|------------|-----|-----|-----|-----|-----|-----|-----|-----|-----|---------------------|
| | Voltage code | 12th and 13th position of the Article No. | | 100 | 112 | 132 | 160 | 180 | 200 | 225 | 250 | 280 | 315 | |
| | | | Additional identification code with order code and plain text if required | 1LE1592 | | | | | | | | | | Standard Efficiency |
| | 1LE1592- | - ■ - ■ . . . | Order code | | | | | | | | | | | |
| Voltage at 50 Hz or 60 Hz | | | | | | | | | | | | | | |
| Line voltage: 50 Hz, 400 V 60 Hz, 480 V | 2 | 1 | – | □ | □ | □ | □ | □ | □ | □ | □ | □ | □ | |
| Line voltage: 50 Hz, 500 V 60 Hz, 600 V | 2 | 6 | – | ✓ | ✓ | ✓ | ✓ | ✓ | ✓ | ✓ | ✓ | ✓ | ✓ | |
| Line voltage: 50 Hz, 690 V | 3 | 3 | – | ✓ | ✓ | ✓ | ✓ | ✓ | ✓ | ✓ | ✓ | ✓ | ✓ | |
| Non-standard voltage and/or frequencies | | | | | | | | | | | | | | |
| Non-standard winding Reinforced insulation system (Advanced) | 9 | 0 | M1Y • and customer specifications | ✓ | ✓ | ✓ | ✓ | ✓ | ✓ | ✓ | ✓ | ✓ | ✓ | |
| Non-standard winding Special insulation system (Premium) | 9 | 0 | M2Y • and customer specifications | ✓ | ✓ | ✓ | ✓ | ✓ | ✓ | ✓ | ✓ | ✓ | ✓ | |





- Standard version
- ✓ With additional charge
- This order code only determines the price of the version – Additional plain text is required.

Standard induction motors optimized for converter operation – VSD10 line

Article No. supplements and special versions · Types of construction

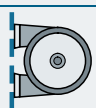
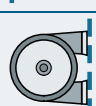
Aluminum series SIMOTICS GP 1LE1092

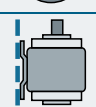
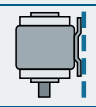
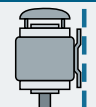
Selection and ordering data

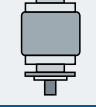
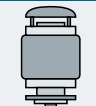
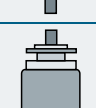
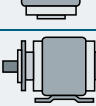





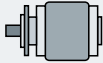

| Types of construction | Article No. supplement Type of construction code letter 14th position of the Article No. | For types of construction with order code(s) Article No. with additional identification code -Z Order code | Frame size | | | | Motor version |
|--|--|---|-------------------------------------|-------------------------------------|-------------------------------------|-------------------------------------|---------------------|
| | | | 100 1LE1092 | 112 | 132 | 160 | |
| Without flange | | | | | | | |
| IM B3 ^{1) 2)}  | A | – | <input type="checkbox"/> | <input type="checkbox"/> | <input type="checkbox"/> | <input type="checkbox"/> | Standard Efficiency |
| IM B6 ²⁾  | T | – | <input type="checkbox"/> | <input type="checkbox"/> | <input type="checkbox"/> | <input type="checkbox"/> | |
| IM B7 ²⁾  | U | – | <input type="checkbox"/> | <input type="checkbox"/> | <input type="checkbox"/> | <input type="checkbox"/> | |
| IM B8 ²⁾  | V | – | <input type="checkbox"/> | <input type="checkbox"/> | <input type="checkbox"/> | <input type="checkbox"/> | |
| IM V6 ²⁾  | D | – | <input type="checkbox"/> | <input type="checkbox"/> | <input type="checkbox"/> | <input type="checkbox"/> | |
| IM V5 without protective cover ²⁾  | C | – | <input type="checkbox"/> | <input type="checkbox"/> | <input type="checkbox"/> | <input type="checkbox"/> | |
| IM V5 with protective cover ^{2) 3) 4) 5)}  | C | H00 | <input checked="" type="checkbox"/> | <input checked="" type="checkbox"/> | <input checked="" type="checkbox"/> | <input checked="" type="checkbox"/> | |
| With flange | | | | | | | |
| | Acc. to EN 50347 | | FF215 A 250 | FF215 A 250 | FF265 A 300 | FF300 A 350 | |
| | Acc. to DIN 42948 | | | | | | |
| IM B5 ^{2) 6)}  | F | – | <input checked="" type="checkbox"/> | <input checked="" type="checkbox"/> | <input checked="" type="checkbox"/> | <input checked="" type="checkbox"/> | |
| IM V1 without protective cover ²⁾  | G | – | <input checked="" type="checkbox"/> | <input checked="" type="checkbox"/> | <input checked="" type="checkbox"/> | <input checked="" type="checkbox"/> | |
| IM V1 with protective cover ^{2) 3) 4) 5)}  | G | H00 | <input checked="" type="checkbox"/> | <input checked="" type="checkbox"/> | <input checked="" type="checkbox"/> | <input checked="" type="checkbox"/> | |
| IM V3 ³⁾  | H | – | <input checked="" type="checkbox"/> | <input checked="" type="checkbox"/> | <input checked="" type="checkbox"/> | <input checked="" type="checkbox"/> | |
| IM B35  | J | – | <input checked="" type="checkbox"/> | <input checked="" type="checkbox"/> | <input checked="" type="checkbox"/> | <input checked="" type="checkbox"/> | |

For legends and footnotes, see page 4/113.

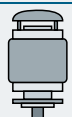
Standard induction motors optimized for converter operation – VSD10 line

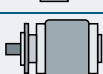
Article No. supplements and special versions · Types of construction



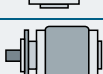







Aluminum series SIMOTICS GP 1LE1092

| Types of construction | Article No. supplement | | Frame size | | | | Motor version |
|--|----------------------------------|--|----------------|------------|------------|------------|---------------------|
| | Type of construction code letter | For types of construction with order code(s) Article No. with additional identification code -Z | 100 | 112 | 132 | 160 | |
| | | | 1LE1092 | | | | Standard Efficiency |
| 1LE1092-.....-...(-Z) | | Order code | | | | | |
| With flange next largest | Acc. to EN 50347 | | FF265 | FF265 | FF300 | FF350 | |
| | Acc. to DIN 42948 | | A 300 | A 300 | A 350 | A 400 | |
| IM B5 ^{2) 6)}  | F | P01 | ✓ | ✓ | ✓ | – | |
| IM V1 without protective cover ²⁾  | G | P01 | ✓ | ✓ | ✓ | – | |
| IM V1 with protective cover ^{2) 3) 4) 5)}  | G | P01+H00 | ✓ | ✓ | ✓ | – | |
| IM V3 ³⁾  | H | P01 | ✓ | ✓ | ✓ | – | |
| IM B35  | J | P01 | ✓ | ✓ | ✓ | – | |
| With flange next smallest | Acc. to EN 50347 | | FF165 | FF165 | FF215 | FF265 | |
| | Acc. to DIN 42948 | | A 200 | A 200 | A 250 | A 300 | |
| IM B5 ^{2) 6)}  | F | P02 | ✓ | ✓ | ✓ | ✓ | |
| IM V1 without protective cover ²⁾  | G | P02 | ✓ | ✓ | ✓ | ✓ | |
| IM V1 with protective cover ^{2) 3) 4) 5)}  | G | P02+H00 | ✓ | ✓ | ✓ | ✓ | |
| IM V3 ³⁾  | H | P02 | ✓ | ✓ | ✓ | ✓ | |
| IM B35  | J | P02 | ✓ | ✓ | ✓ | ✓ | |

Standard induction motors optimized for converter operation – VSD10 line

Article No. supplements and special versions · Types of construction

Aluminum series SIMOTICS GP 1LE1092





| Types of construction | Article No. supplement | | Frame size | | | | Motor version |
|--|--|--|----------------|-------|-------|-----|---------------------|
| | Type of construction code letter | For types of construction with order code(s) Article No. with additional identification code -Z | 100 | 112 | 132 | 160 | |
| | | | 1LE1092 | | | | Standard Efficiency |
| 1LE1092-..... | ...(-Z) | Order code | | | | | |
| With flange | Acc. to EN 50347 | | FT130 | FT130 | FT165 | – | |
| | Acc. to DIN 42948 | | C 160 | C 160 | C 200 | – | |
| IM B14 2) 7) |  K | – | ✓ | ✓ | ✓ | ✓ | |
| IM V19 ²⁾ |  L | – | ✓ | ✓ | ✓ | ✓ | |
| IM V18 without protective cover ²⁾ |  M | – | ✓ | ✓ | ✓ | ✓ | |
| IM V18 with protective cover 2) 3) 4) 5) |  M | – | ✓ | ✓ | ✓ | ✓ | |
| IM B34 |  N | – | ✓ | ✓ | ✓ | ✓ | |
| With flange next largest | Acc. to EN 50347 | | FT165 | FT165 | FT215 | – | |
| | Acc. to DIN 42948 | | C 200 | C 200 | C 250 | – | |
| IM B14 2) 7) |  K | P01 | ✓ | ✓ | ✓ | – | |
| IM V19 ²⁾ |  L | P01 | ✓ | ✓ | ✓ | – | |
| IM V18 without protective cover ²⁾ |  M | P01 | ✓ | ✓ | ✓ | – | |
| IM V18 with protective cover 2) 3) 4) 5) |  M | P01+H00 | ✓ | ✓ | ✓ | – | |
| IM B34 |  N | P01 | ✓ | ✓ | ✓ | – | |

For legends and footnotes, see page 4/113.

Standard induction motors optimized for converter operation – VSD10 line

Article No. supplements and special versions · Types of construction

Aluminum series SIMOTICS GP 1LE1092

| Types of construction | Article No. supplement | | Frame size | | | | Motor version |
|---|--|--|----------------|--------------|--------------|------------|---------------------|
| | Type of construction code letter | For types of construction with order code(s) Article No. with additional identification code -Z | 100 | 112 | 132 | 160 | |
| | | 14th position of the Article No. | 1LE1092 | | | | Standard Efficiency |
| 1LE1092-..... | ■ ...(-Z) | Order code | | | | | |
| With flange next smallest | Acc. to EN 50347 | FT115 | FT115 | FT115 | FT130 | – | |
| | Acc. to DIN 42948 | C 140 | C 140 | C 140 | C 160 | – | |
| IM B14 2) 7) |  | K | P02 | ✓ | O. R. | O. R. | – |
| IM V19 ²⁾ |  | L | P02 | ✓ | O. R. | O. R. | – |
| IM V18 without protective cover ²⁾ |  | M | P02 | ✓ | O. R. | O. R. | – |
| IM V18 with protective cover ^{2) 3) 4) 5)} |  | M | P02+H00 | ✓ | O. R. | O. R. | – |
| IM B34 |  | N | P02 | ✓ | O. R. | O. R. | – |

- Standard version
- ✓ With additional charge
- Not possible
- O. R. Possible on request







- 1) The types of construction IM B6/7/8, IM V6 and IM V5 with/without protective cover are also possible as long as there are no condensation drainage holes (order code **H03**) and these types of construction do not have to be stamped on the rating plate. As standard the type of construction IM B3 is then stamped on the rating plate. With type of construction IM V5 with protective cover, the protective cover has to be additionally ordered with order code **H00**. The protective cover is not stamped on the rating plate.
- 2) The type of construction is stamped on the rating plate. For orders with condensation drainage holes (order code **H03**), if mounted in a different position, the position must be specified to ensure that the condensation drainage holes are positioned correctly.
- 3) The "Second shaft extension" option (order code **L05**) is not possible.
- 4) In combination with an encoder, it is not necessary to order the protective cover (order code **H00**), as this is delivered as a protection for the encoder as standard. In this case the protective cover is standard version (without additional charge).
- 5) Not possible for forced-air cooled motors with order code **F90** without external fan and fan cover.
- 6) The types of construction IM V3 and IM V1 with/without protective cover are also possible as long as there are no condensation drainage holes (order code **H03**) and these types of construction do not have to be stamped on the rating plate. As standard the type of construction IM B5 is then stamped on the rating plate. With type of construction IM V1 with protective cover, the protective cover has to be additionally ordered with order code **H00**. The protective cover is not stamped on the rating plate.
- 7) The types of construction IM V19 and IM V18 with/without protective cover are also possible as long as there are no condensation drainage holes (order code **H03**) and these types of construction do not have to be stamped on the rating plate. As standard the type of construction IM B14 is then stamped on the rating plate. With type of construction IM V18 with protective cover, the protective cover has to be additionally ordered with order code **H00**. The protective cover is not stamped on the rating plate.

Standard induction motors optimized for converter operation – VSD10 line

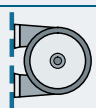
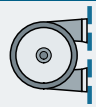
Article No. supplements and special versions · Types of construction

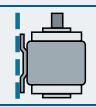
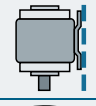
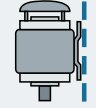
Cast-iron series SIMOTICS SD 1LE1592

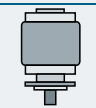
Selection and ordering data

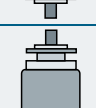
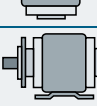
| Types of construction | Article No. supplement Type of construction code letter 14th position of the Article No. | For types of construction with order code(s) Article No. with additional identification code -Z Order code | Frame size | | | | | | | | | | | | Motor version |
|---|--|---|-------------------|-----|-------|-------|-------|-------|-------|-------|-------|---------|-------|-------|---------------------|
| | | | 100 | 112 | 132 | 160 | 180 | 200 | 225 | 250 | 280 | 315 S/M | 315 L | | |
| 1LE1592-.....-...(-Z) | | | 1LE1592 | | | | | | | | | | | | Standard Efficiency |
| Without flange | | | | | | | | | | | | | | | |
| IM B3 ^{1) 2)} |  A | – | □ | □ | □ | □ | □ | □ | □ | □ | □ | □ | □ | □ | |
| IM B6 ²⁾ |  T | – | □ | □ | □ | □ | □ | □ | □ | □ | □ | □ | □ | □ | |
| IM B7 ²⁾ |  U | – | □ | □ | □ | □ | □ | □ | □ | □ | □ | □ | □ | □ | |
| IM B8 ²⁾ |  V | – | □ | □ | □ | □ | □ | □ | □ | □ | □ | □ | □ | □ | |
| IM V6 ²⁾ |  D | – | □ | □ | □ | □ | □ | □ | □ | □ | □ | □ | □ | □ | |
| IM V5 without protective cover ²⁾ |  C | – | □ | □ | □ | □ | □ | □ | □ | □ | □ | □ | □ | □ | |
| IM V5 with protective cover ^{2) 3) 4)} |  C | H00 | ✓ | ✓ | ✓ | ✓ | ✓ | ✓ | ✓ | ✓ | ✓ | ✓ | ✓ | ✓ | |
| With flange | | | Acc. to EN 50347 | | FF215 | FF215 | FF265 | FF300 | FF300 | FF350 | FF400 | FF500 | FF500 | FF600 | – |
| | | | Acc. to DIN 42948 | | A 250 | A 250 | A 300 | A 350 | A 350 | A 400 | A 450 | A 550 | A 550 | A 660 | A 660 |
| IM B5 ^{2) 5)} |  F | – | ✓ | ✓ | ✓ | ✓ | ✓ | ✓ | ✓ | ✓ | ✓ | ✓ | ✓ | ✓ | – |
| IM V1 without protective cover ²⁾ |  G | – | ✓ | ✓ | ✓ | ✓ | ✓ | ✓ | ✓ | ✓ | ✓ | ✓ | ✓ | ✓ | ✓ |
| IM V1 with protective cover ^{2) 3) 4)} |  G | H00 | ✓ | ✓ | ✓ | ✓ | ✓ | ✓ | ✓ | ✓ | ✓ | ✓ | ✓ | ✓ | ✓ |
| IM V3 ⁴⁾ |  H | – | ✓ | ✓ | ✓ | ✓ | ✓ | ✓ | ✓ | ✓ | ✓ | ✓ | ✓ | ✓ | – |
| IM B35 |  J | – | ✓ | ✓ | ✓ | ✓ | ✓ | ✓ | ✓ | ✓ | ✓ | ✓ | ✓ | ✓ | ✓ |

For legends and footnotes, see page 4/117.

Standard induction motors optimized for converter operation – VSD10 line

Article No. supplements and special versions · Types of construction











Cast-iron series SIMOTICS SD 1LE1592

| Types of construction | Article No. supplement | Frame size | Motor version | | | | | | | | | | | |
|---|--|---|---------------|-------|-------|-------|-------|-------|-----|-----|-----|---------|-------|---------------------|
| | | | 100 | 112 | 132 | 160 | 180 | 200 | 225 | 250 | 280 | 315 S/M | 315 L | |
| | Type of construction code letter 14th position of the Article No. | For types of construction with order code(s) Article No. with additional identification code -Z Order code | 1LE1592 | | | | | | | | | | | Standard Efficiency |
| 1LE1592-.....-...(-Z) | | | | | | | | | | | | | | |
| With flange next largest | Acc. to EN 50347 Acc. to DIN 42948 | FF265 FF265 FF300 – – – – – – – – – – | A 300 | A 300 | A 350 | – | – | – | – | – | – | – | – | – |
| IM B5 2) 5) | F | P01 | ✓ | ✓ | ✓ | – | – | – | – | – | – | – | – | – |
| IM V1 without protective cover 2) | G | P01 | ✓ | ✓ | ✓ | – | – | – | – | – | – | – | – | – |
| IM V1 with protective cover 2) 3) 4) | G | P01+H00 | ✓ | ✓ | ✓ | – | – | – | – | – | – | – | – | – |
| IM V3 4) | H | P01 | ✓ | ✓ | ✓ | – | – | – | – | – | – | – | – | – |
| IM B35 | J | P01 | ✓ | ✓ | ✓ | – | – | – | – | – | – | – | – | – |
| With flange next smallest | Acc. to EN 50347 Acc. to DIN 42948 | FF165 FF215 FF215 FF265 FF265 FF300 – – – – – | A 200 | A 250 | A 250 | A 300 | A 300 | A 350 | – | – | – | – | – | – |
| IM B5 2) 5) | F | P02 | ✓ | ✓ | ✓ | ✓ | ✓ | ✓ | – | – | – | – | – | – |
| IM V1 without protective cover 2) | G | P02 | ✓ | ✓ | ✓ | ✓ | ✓ | ✓ | – | – | – | – | – | – |
| IM V1 with protective cover 2) 3) 4) | G | P02+H00 | ✓ | ✓ | ✓ | ✓ | ✓ | ✓ | – | – | – | – | – | – |
| IM V3 4) | H | P02 | ✓ | ✓ | ✓ | ✓ | ✓ | ✓ | – | – | – | – | – | – |
| IM B35 | J | P02 | ✓ | ✓ | ✓ | ✓ | ✓ | ✓ | – | – | – | – | – | – |

Standard induction motors optimized for converter operation – VSD10 line

Article No. supplements and special versions · Types of construction

Cast-iron series SIMOTICS SD 1LE1592

| Types of construction | Article No. supplement | | Frame size | | | | | | | | | | Motor version |
|---|---|--|----------------|-------|-------|-------|-----|-----|-----|-----|-----|---------|---------------------|
| | Type of construction code letter | For types of construction with order code(s) Article No. with additional identification code -Z | 100 | 112 | 132 | 160 | 180 | 200 | 225 | 250 | 280 | 315 S/M | |
| | | | 1LE1592 | | | | | | | | | | Standard Efficiency |
| 1LE1592-..... | ■ ...(-Z) | Order code | | | | | | | | | | | |
| With flange | Acc. to EN 50347 Acc. to DIN 42948 | | FT130 | FT130 | FT165 | FT215 | - | - | - | - | - | - | - |
| | | | C 160 | C 160 | C 200 | C 250 | - | - | - | - | - | - | - |
| IM B14 2) 6) |  | K | - | ✓ | ✓ | ✓ | ✓ | - | - | - | - | - | - |
| IM V19 ²⁾ |  | L | - | ✓ | ✓ | ✓ | ✓ | - | - | - | - | - | - |
| IM V18 without protective cover ²⁾ |  | M | - | ✓ | ✓ | ✓ | ✓ | - | - | - | - | - | - |
| IM V18 with protective cover ^{2) 3) 4)} |  | M | H00 | ✓ | ✓ | ✓ | ✓ | - | - | - | - | - | - |
| IM B34 |  | N | - | ✓ | ✓ | ✓ | ✓ | - | - | - | - | - | - |
| With flange next largest | Acc. to EN 50347 Acc. to DIN 42948 | | FT165 | FT165 | FT215 | - | - | - | - | - | - | - | - |
| | | | C 200 | C 200 | C 250 | - | - | - | - | - | - | - | - |
| IM B14 2) 6) |  | K | P01 | ✓ | ✓ | ✓ | - | - | - | - | - | - | - |
| IM V19 ²⁾ |  | L | P01 | ✓ | ✓ | ✓ | - | - | - | - | - | - | - |
| IM V18 without protective cover ²⁾ |  | M | P01 | ✓ | ✓ | ✓ | - | - | - | - | - | - | - |
| IM V18 with protective cover ^{2) 3) 4)} |  | M | P01+H00 | ✓ | ✓ | ✓ | - | - | - | - | - | - | - |
| IM B34 |  | N | P01 | ✓ | ✓ | ✓ | - | - | - | - | - | - | - |

For legends and footnotes, see page 4/117.

Standard induction motors optimized for converter operation – VSD10 line

Article No. supplements and special versions · Types of construction

Cast-iron series SIMOTICS SD 1LE1592

| Types of construction | Article No. supplement | Frame size | Motor version | | | | | | | | | | |
|--|--|--|---------------------|-----|-----|-----|-----|-----|-----|-----|-----|---------|-------|
| | | | 100 | 112 | 132 | 160 | 180 | 200 | 225 | 250 | 280 | 315 S/M | 315 L |
| | Type of construction code letter 14th position of the Article No. | For types of construction with order code(s) Article No. with additional identification code -Z | 1LE1592 | | | | | | | | | | |
| | Order code | | Standard Efficiency | | | | | | | | | | |
| 1LE1592-.....-...(-Z) | | | | | | | | | | | | | |
| With flange next smallest | Acc. to EN 50347 | FT115 | - | - | - | - | - | - | - | - | - | - | - |
| | Acc. to DIN 42948 | C 140 | - | - | - | - | - | - | - | - | - | - | - |
| IM B14 2) 6) | K | P02 | ✓ | - | - | - | - | - | - | - | - | - | - |
| IM V19 ²⁾ | L | P02 | ✓ | - | - | - | - | - | - | - | - | - | - |
| IM V18 without protective cover ²⁾ | M | P02 | ✓ | - | - | - | - | - | - | - | - | - | - |
| IM V18 with protective cover ^{2) 3) 4)} | M | P02+H00 | ✓ | - | - | - | - | - | - | - | - | - | - |
| IM B34 | N | P02 | ✓ | - | - | - | - | - | - | - | - | - | - |

- Standard version
- ✓ With additional charge
- Not possible

- 1) The types of construction IM B6/7/8, IM V6 and IM V5 with/without protective cover are also possible as long as no stamping of these types of construction on the rating plate is required. As standard the type of construction IM B3 is then stamped on the rating plate. With type of construction IM V5 with protective cover, the protective cover has to be additionally ordered with order code **H00**. The protective cover is not stamped on the rating plate.
- 2) The type of construction is stamped on the rating plate. If mounted in a different position, the position must be specified to ensure that the condensation drainage holes are positioned correctly.
- 3) In combination with an encoder, it is not necessary to order the protective cover (order code **H00**), as this is delivered as a protection for the encoder as standard. In this case the protective cover is standard design (without additional charge).
- 4) The "Second shaft extension" option (order code **L05**) is not possible.
- 5) The types of construction IM V3 and IM V1 with/without protective cover are also possible as long as no stamping of these types of construction on the rating plate is required. As standard the type of construction IM B5 is then stamped on the rating plate. With type of construction IM V1 with protective cover, the protective cover has to be additionally ordered with order code **H00**. The protective cover is not stamped on the rating plate.
- 6) The types of construction IM V19 and IM V18 with/without protective cover are also possible as long as no stamping of these types of construction on the rating plate is required. As standard the type of construction IM B14 is then stamped on the rating plate. With type of construction IM V18 with protective cover, the protective cover has to be additionally ordered with order code **H00**. The protective cover is not stamped on the rating plate.

Standard induction motors optimized for converter operation – VSD10 line

Article No. supplements and special versions · Motor protection

Aluminum series SIMOTICS GP 1LE1092

Selection and ordering data

| Motor protection | Article No. Motor protection code letter 15th position of the Article No. | supplement Additional identifica- tion code with order code and plain text if required Order code | Frame size | | | | Motor version |
|--|--|---|----------------|-----|-----|-----|---|
| | | | 100 | 112 | 132 | 160 | |
| | | | 1LE1092 | | | | Standard Efficiency |
| 1LE1092- - | | | | | | | |
| Motor protection | | | | | | | |
| 1 or 3 PTC thermistors – for tripping (2 terminals) ¹⁾ | B | – | ✓ | ✓ | ✓ | ✓ | |
| 2 or 6 PTC thermistors – for alarm and tripping (4 terminals) ¹⁾ | C | – | ✓ | ✓ | ✓ | ✓ | |
| 1 KTY84-130 temperature sensor (2 terminals) ¹⁾ | F | – | ✓ | ✓ | ✓ | ✓ | |
| 2 KTY84-130 temperature sensors (4 terminals) ¹⁾ | G | – | ✓ | ✓ | ✓ | ✓ | |
| 3 Pt100 resistance thermometers – 2-wire input (6 terminals) ¹⁾ | H | – | ✓ | ✓ | ✓ | ✓ | |
| 1 Pt1000 resistance thermometer (2 terminals) ²⁾ | K | – | ○ | ○ | ○ | ○ | |
| 2 Pt1000 resistance thermometers (4 terminals) ²⁾ | L | – | ✓ | ✓ | ✓ | ✓ | |
| 1 Pt100 resistance thermometers – 2-wire input (2 terminals) ¹⁾ | P | – | ✓ | ✓ | ✓ | ✓ | |
| 3 Pt100 resistance thermometers – 3-wire input (9 terminals) ¹⁾ | Q | – | ✓ | ✓ | ✓ | ✓ | |
| 6 Pt100 resistance thermometers – 3-wire input (18 terminals) ¹⁾ | R | – | ✓ | ✓ | ✓ | ✓ | |
| 3 bimetal sensors (NC contacts) for tripping (2 terminals) ¹⁾ | Z | Q3A | ✓ | ✓ | ✓ | ✓ | Only for: Voltage code 2-1 (12th and 13th position of the Article No.) |

- Without additional charge
✓ With additional charge

¹⁾ Evaluation with associated tripping unit (see Catalog IC 10) is recommended.

²⁾ Not UL-certified. Not in combination with option **D39**.

Standard induction motors optimized for converter operation – VSD10 line

Article No. supplements and special versions · Motor protection

Cast-iron series SIMOTICS SD 1LE1592

Selection and ordering data

| Motor protection | Article No. supplement | Motor protection code letter 15th position of the Article No. | Additional identification code with order code and plain text if required | Frame size | | | | | | | | | | | Motor version | | |
|---|---------------------------------------|---|---|----------------|-----|-----|-----|-----|-----|-----|-----|-----|-----|---|---------------------|---|--|
| | | | | 100 | 112 | 132 | 160 | 180 | 200 | 225 | 250 | 280 | 315 | | | | |
| | | | | 1LE1592 | | | | | | | | | | | Standard Efficiency | | |
| | 1LE1592- - | | Order code | | | | | | | | | | | | | | |
| Motor protection | | | | | | | | | | | | | | | | | |
| 1 or 3 PTC thermistors – for tripping (2 terminals) ¹⁾ | B | – | | ✓ | ✓ | ✓ | ✓ | ✓ | ✓ | ✓ | ✓ | ✓ | ✓ | ✓ | ✓ | ✓ | |
| 2 or 6 PTC thermistors – for alarm and tripping (4 terminals) ¹⁾ | C | – | | ✓ | ✓ | ✓ | ✓ | ✓ | ✓ | ✓ | ✓ | ✓ | ✓ | ✓ | ✓ | ✓ | |
| 1 KTY84-130 temperature sensor (2 terminals) ¹⁾ | F | – | | ✓ | ✓ | ✓ | ✓ | ✓ | ✓ | ✓ | ✓ | ✓ | ✓ | ✓ | ✓ | ✓ | |
| 2 KTY84-130 temperature sensors (4 terminals) ¹⁾ | G | – | | ✓ | ✓ | ✓ | ✓ | ✓ | ✓ | ✓ | ✓ | ✓ | ✓ | ✓ | ✓ | ✓ | |
| 3 Pt100 resistance thermometers – 2-wire input (6 terminals) | H | – | | ✓ | ✓ | ✓ | ✓ | ✓ | ✓ | ✓ | ✓ | ✓ | ✓ | ✓ | ✓ | ✓ | |
| 1 Pt1000 resistance thermometers (2 terminals) ³⁾ | K | – | | ○ | ○ | ○ | ○ | ○ | ○ | ○ | ○ | ○ | ○ | ○ | ○ | ○ | |
| 2 Pt1000 resistance thermometers (4 terminals) ³⁾ | L | – | | ✓ | ✓ | ✓ | ✓ | ✓ | ✓ | ✓ | ✓ | ✓ | ✓ | ✓ | ✓ | ✓ | |
| 1 Pt100 resistance thermometer – 2-wire input (2 terminals) | P | – | | ✓ | ✓ | ✓ | ✓ | ✓ | ✓ | ✓ | ✓ | ✓ | ✓ | ✓ | ✓ | ✓ | |
| 3 Pt100 resistance thermometers – 3-wire input (9 terminals) | Q | – | | ✓ | ✓ | ✓ | ✓ | ✓ | ✓ | ✓ | ✓ | ✓ | ✓ | ✓ | ✓ | ✓ | |
| 6 Pt100 resistance thermometers – 3-wire input (18 terminals) | R | – | | ✓ | ✓ | ✓ | ✓ | ✓ | ✓ | ✓ | ✓ | ✓ | ✓ | ✓ | ✓ | ✓ | |
| 3 bimetal sensors (NC contacts) for tripping (2 terminals) ²⁾ | Z | Q3A | | ✓ | ✓ | ✓ | ✓ | ✓ | ✓ | ✓ | ✓ | ✓ | ✓ | ✓ | ✓ | ✓ | Only for: Voltage code 2-1 (12th and 13th position of the Article No.) |

- Without additional charge
 ✓ With additional charge

¹⁾ Evaluation with associated tripping unit (see Catalog IC 10) is recommended.

²⁾ Only applicable for voltage code (12th and 13th position of the Article No.) 2-1.

³⁾ Not possible in combination with UL.

Standard induction motors optimized for converter operation – VSD10 line

Article No. supplements and special versions · Terminal box position

Aluminum series SIMOTICS GP 1LE1092

Selection and ordering data

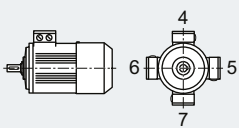
| Terminal box position | Article No. supplement | Frame size | Motor version |
|--|---|---|---------------------|
|  1LE1092-.....-.... | Terminal box position code 16th position of the Article No. | 100 112 132 160 | Standard Efficiency |
| | Additional identification code with order code and plain text if required | 1LE1092 | |
| | Order code | | |

| Terminal box position | | | |
|--|----------|---|-------------------------------------|
| Terminal box top ¹⁾ | 4 | – | <input type="checkbox"/> |
| Terminal box right-hand side ²⁾ | 5 | – | <input checked="" type="checkbox"/> |
| Terminal box left-hand side ²⁾ | 6 | – | <input checked="" type="checkbox"/> |
| Terminal box bottom ²⁾ | 7 | – | <input checked="" type="checkbox"/> |

- Standard version
 With additional charge

¹⁾ For types of construction with feet, cast feet are standard. Screwed-on feet are available with order code **H01**.

²⁾ For types of construction with feet, screwed-on feet are standard.

Standard induction motors optimized for converter operation – VSD10 line

Article No. supplements and special versions · Terminal box position

Cast-iron series SIMOTICS SD 1LE1592

Selection and ordering data

| Terminal box position | Article No. | supplement | Frame size | | | | | | | | | | | Motor version |
|-----------------------|---|---|------------|-----|-----|-----|-----|-----|-----|-----|-----|-----|---------------------|---------------|
| | Terminal box position code 16th position of the Article No. | Additional identification code with order code and plain text if required | 100 | 112 | 132 | 160 | 180 | 200 | 225 | 250 | 280 | 315 | Standard Efficiency | |
| | | | 1LE1592 | | | | | | | | | | | |
| 1LE1592-.....-.... | | | Order code | | | | | | | | | | | |

| Terminal box position | | | | | | | | | | | | | |
|--|---|---|---|---|---|---|---|---|---|---|---|---|---|
| Terminal box top ¹⁾ | 4 | – | ☐ | ☐ | ☐ | ☐ | ☐ | ☐ | ☐ | ☐ | ☐ | ☐ | ☐ |
| Terminal box right-hand side ²⁾ | 5 | – | ✓ | ✓ | ✓ | ✓ | ✓ | ✓ | ✓ | ✓ | ✓ | ✓ | ✓ |
| Terminal box left-hand side ²⁾ | 6 | – | ✓ | ✓ | ✓ | ✓ | ✓ | ✓ | ✓ | ✓ | ✓ | ✓ | ✓ |
| Terminal box bottom ²⁾ | 7 | – | ✓ | ✓ | ✓ | ✓ | – | – | – | – | – | – | – |

- ☐ Standard version
 ✓ With additional charge

¹⁾ For types of construction with feet, cast feet are standard. Screwed-on feet are available with order code **H01**.

²⁾ For types of construction with feet, screwed-on feet are standard.

Standard induction motors optimized for converter operation – VSD10 line

Article No. supplements and special versions · Options

Aluminum series SIMOTICS GP 1LE1092

Selection and ordering data

| Special versions | Additional identification code -Z with order code and plain text if required | Frame size | | | | Motor version |
|--|---|------------|-------|-------|-------|--|
| | | 100 | 112 | 132 | 160 | |
| | | 1LE1092 | | | | Standard Efficiency |
| 1LE1092-.....-.....-Z | Order code | | | | | |
| Motor protection | | | | | | |
| 1 or 3 PTC thermistors – for tripping (2 terminals) ^{2) 3)} | Q11 | ✓ | ✓ | ✓ | ✓ | |
| 2 or 6 PTC thermistors – for alarm and tripping (4 terminals) ³⁾ | Q12 | ✓ | ✓ | ✓ | ✓ | |
| 1 KTY84-130 temperature sensor (2 terminals) ³⁾ | Q23 | ✓ | ✓ | ✓ | ✓ | |
| 2 KTY84-130 temperature sensor (4 terminals) ³⁾ | Q25 | ✓ | ✓ | ✓ | ✓ | |
| 3 bimetal sensors (NC contacts) for tripping (2 terminals) ³⁾ | Q31 | ✓ | ✓ | ✓ | ✓ | |
| 6 bimetal sensors (NC contacts) for alarm and tripping (4 terminals) | Q32 | ✓ | ✓ | ✓ | ✓ | |
| 3 bimetal sensors (NC contacts) for tripping (6 terminals) | Q33 | O. R. | O. R. | O. R. | O. R. | |
| 1 Pt1000 resistance thermometer (2 terminals) ²⁰⁾ | Q35 | ○ | ○ | ○ | ○ | |
| 2 Pt1000 resistance thermometers (4 terminals) ²⁰⁾ | Q36 | ✓ | ✓ | ✓ | ✓ | |
| 3 Pt100 resistance thermometers – 2-wire input (6 terminals) | Q60 | ✓ | ✓ | ✓ | ✓ | |
| 6 Pt100 resistance thermometers – 2-wire input (12 terminals) | Q61 | ✓ | ✓ | ✓ | ✓ | |
| 1 Pt100 resistance thermometer – 2-wire input (2 terminals) | Q62 | ✓ | ✓ | ✓ | ✓ | |
| 3 Pt100 resistance thermometers – 3-wire input (9 terminals) | Q63 | ✓ | ✓ | ✓ | ✓ | |
| 6 Pt100 resistance thermometers – 3-wire input (18 terminals) | Q64 | ✓ | ✓ | ✓ | ✓ | |
| 2 Pt100 resistance thermometers in basic configuration for bearings (2 terminals) | Q72 | O. R. | O. R. | O. R. | O. R. | |
| 2 Pt100 resistance thermometers in 3-wire input for bearings (6 terminals) | Q78 | O. R. | O. R. | O. R. | O. R. | |
| 2 Pt100 double resistance thermometers in 3-wire input for bearings (12 terminals) | Q79 | O. R. | O. R. | O. R. | O. R. | Not for: Motors in combination with order codes F40 and F41 (frame sizes 225 to 315) |
| Motor connection and terminal box | | | | | | |
| External grounding | H04 | ✓ | ✓ | ✓ | ✓ | |
| Terminal box on NDE ¹⁾ | H08 | ✓ | ✓ | ✓ | ✓ | |
| Rotation of the terminal box through 90°, entry from DE ²⁾ | R10 | ○ | ○ | ○ | ○ | |
| Rotation of the terminal box through 90°, entry from NDE | R11 | ○ | ○ | ○ | ○ | |
| Rotation of the terminal box through 180° | R12 | ○ | ○ | ○ | ○ | |
| Terminal box in position 0°; connection from right ²¹⁾ | R13 | ○ | ○ | ○ | – | |
| One metal cable gland | R15 | ✓ | ✓ | ✓ | ✓ | |
| Metal cable gland, maximum configuration | R18 | ✓ | ✓ | ✓ | ✓ | |
| 3 cables protruding, 0.5 m long | R20 | ✓ | ✓ | ✓ | ✓ | |
| 6 cables protruding, 0.5 m long | R22 | ✓ | ✓ | ✓ | ✓ | |
| Larger terminal box | R50 | ✓ | ✓ | ✓ | ✓ | |
| Motor connector Han-Drive 10e for 230 VΔ/400 VY | R70 | ✓ | ✓ | ✓ | – | |
| Motor connector EMC Han-Drive 10e for 230 VΔ/400 VY | R71 | ✓ | ✓ | ✓ | – | |
| Windings and insulation | | | | | | |
| Increased air humidity/temperature with 30 to 60 g water per m ³ of air | N30 | ✓ | ✓ | ✓ | ✓ | |

For legends and footnotes, see page 4/125.

Standard induction motors optimized for converter operation – VSD10 line

Article No. supplements and special versions · Options

Aluminum series SIMOTICS GP 1LE1092

| Special versions | Additional identification code -Z with order code and plain text if required | Frame size | | | | Motor version |
|--|---|----------------|-------|-------|-------|--------------------------------|
| | | 100 | 112 | 132 | 160 | |
| | | 1LE1092 | | | | Standard Efficiency |
| 1LE1092-.....-.....-Z | Order code | | | | | |
| Colors and paint finish | | | | | | |
| Standard paint finish C2 in RAL 7030 stone gray | | □ | □ | □ | □ | |
| Unpainted (only cast-iron parts primed) | S00 | ○ | ○ | ○ | ○ | |
| Unpainted, only primed | S01 | ✓ | ✓ | ✓ | ✓ | |
| Special paint finish C3 | S02 | ✓ | ✓ | ✓ | ✓ | |
| Special paint finish sea air resistant C4 | S03 | ✓ | ✓ | ✓ | ✓ | |
| Internal coating | S05 | ✓ | ✓ | ✓ | ✓ | |
| Paint finish in other standard RAL colors: RAL 1002, 1013, 1015, 1019, 2003, 2004, 3000, 3007, 5002, 5007, 5009, 5010, 5012, 5015, 5017, 5018, 5019, 6011, 6019, 6021, 7000, 7001, 7004, 7011, 7016, 7022, 7031, 7032, 7033, 7035, 9001, 9002, 9005 (see Catalog Section 1 "Introduction") | Y53 • and paint finish RAL.... | ✓ | ✓ | ✓ | ✓ | |
| Paint finish in special RAL colors: For RAL colors, see "Special paint finish in special RAL colors" (see Catalog Section 1 "Introduction") | Y56 • and paint finish RAL.... | ✓ | ✓ | ✓ | ✓ | |
| Modular technology – Basic versions ⁴⁾ | | | | | | |
| Mounting of holding brake (standard assignment) ⁵⁾ | F01 | ✓ | ✓ | ✓ | ✓ | |
| Mounting of brake for higher switching frequency (operating brake) | F02 | O. R. | O. R. | O. R. | O. R. | |
| Mounted separately driven fan | F70 | ✓ | ✓ | ✓ | ✓ | |
| Mounting of Kübler Sendix 5020 HTL, 1024 I rotary pulse encoder | G11 | ✓ | ✓ | ✓ | ✓ | |
| Mounting of Kübler Sendix 5020 TTL, 1024 I rotary pulse encoder | G12 | ✓ | ✓ | ✓ | ✓ | |
| Modular technology – Additional versions | | | | | | |
| Brake supply voltage 24 V DC | F10 | ✓ | ✓ | ✓ | ✓ | |
| Brake supply voltage 230 V AC, 50/60 Hz | F11 | ○ | ○ | ○ | ○ | |
| Brake supply voltage 400 V AC, 50/60 Hz | F12 | ✓ | ✓ | ✓ | ✓ | |
| Brake supply voltage 180 V DC | F17 | ✓ | ✓ | ✓ | ✓ | Only for: Combination with F01 |
| Brake supply voltage 205 V DC | F18 | ✓ | ✓ | ✓ | ✓ | Only for: Combination with F01 |
| Mechanical manual brake release with lever (no locking) | F50 | ✓ | ✓ | ✓ | ✓ | |
| Special technology ³⁾ | | | | | | |
| Mounting of LL 861 900 220 rotary pulse encoder ⁶⁾ | G04 | ✓ | ✓ | ✓ | ✓ | |
| Mounting of HOG 9 DN 1024 I rotary pulse encoder ⁶⁾ | G05 | ✓ | ✓ | ✓ | ✓ | |
| Mounting of HOG 10 D 1024 I rotary pulse encoder ⁶⁾ | G06 | ✓ | ✓ | ✓ | ✓ | |
| Mounting of Kübler Sendix 5834FS2 1024, SIL-2 rotary pulse encoder | G21 | ✓ | ✓ | ✓ | ✓ | |
| Mounting of Kübler Sendix 5834FS3 1024, SIL-3 rotary pulse encoder | G22 | ✓ | ✓ | ✓ | ✓ | |
| Mechanical version and degrees of protection | | | | | | |
| Prepared for mountings, centering hole only ⁷⁾ | G40 | ✓ | ✓ | ✓ | ✓ | |
| Prepared for mountings with D12 shaft ¹²⁾ | G41 | ✓ | ✓ | ✓ | ✓ | |
| Prepared for mountings with D16 shaft ¹²⁾ | G42 | ✓ | ✓ | ✓ | ✓ | |
| Mechanical protection for encoder | G43 | ✓ | ✓ | ✓ | ✓ | |
| Protective cover ⁶⁾ ⁸⁾ | H00 | ✓ | ✓ | ✓ | ✓ | |
| Screwed-on (instead of cast) feet | H01 | ✓ | ✓ | ✓ | ✓ | |
| Vibration-proof version; vibration resistance to Class 3M4 according to IEC 60721-3-3:1994 | H02 | ✓ | ✓ | ✓ | ✓ | |
| Condensation drainage holes ⁹⁾ | H03 | ✓ | ✓ | ✓ | ✓ | |
| Rust-resistant screws (externally) | H07 | ✓ | ✓ | ✓ | ✓ | |
| IP65 degree of protection ¹⁰⁾ | H20 | ✓ | ✓ | ✓ | ✓ | |
| IP56 degree of protection ¹¹⁾ | H22 | ✓ | ✓ | ✓ | ✓ | |
| Drive-end seal for flange-mounted motors, oil-tight to 0.1 bar ¹³⁾ | H23 | ✓ | ✓ | ✓ | ✓ | |

For legends and footnotes, see page 4/125.

Standard induction motors optimized for converter operation – VSD10 line

Article No. supplements and special versions · Options

Aluminum series SIMOTICS GP 1LE1092

| Special versions | Additional identification code -Z with order code and plain text if required | Frame size | | | | Motor version |
|--|---|----------------|-----|-----|-----|---------------------|
| | | 100 | 112 | 132 | 160 | |
| | | 1LE1092 | | | | Standard Efficiency |
| 1LE1092-.....-.....-Z | Order code | | | | | |
| Coolant temperature and installation altitude | | | | | | |
| Coolant temperature –40 to +40 °C ¹⁹⁾ | D03 | ✓ | ✓ | ✓ | ✓ | |
| Coolant temperature –30 to +40 °C ¹⁹⁾ | D04 | ✓ | ✓ | ✓ | ✓ | |
| Versions in accordance with standards and specifications | | | | | | |
| Version according to UL and CSA (Canadian regulation) | D39 | ✓ | ✓ | ✓ | ✓ | |
| TR CU product safety certificate EAC for Eurasian Customs Union | D47 | ✓ | ✓ | ✓ | ✓ | |
| Bearings and lubrication | | | | | | |
| Located bearing DE | L20 | ✓ | ✓ | ✓ | ✓ | |
| Located bearing NDE | L21 | ✓ | ✓ | ✓ | □ | |
| Bearing design for increased cantilever forces | L22 | ✓ | ✓ | ✓ | ✓ | |
| Regreasing device ¹⁴⁾ | L23 | ✓ | ✓ | ✓ | ✓ | |
| Bearings reinforced at both ends for DE and NDE, bearing size 63 | L25 | ✓ | ✓ | ✓ | ✓ | |
| Bearing insulation NDE | L51 | ✓ | ✓ | ✓ | ✓ | |
| Measuring nipple for SPM shock pulse measurement for bearing inspection ¹⁴⁾ | Q01 | ✓ | ✓ | ✓ | ✓ | |
| Balance and vibration severity | | | | | | |
| Vibration severity grade A | | □ | □ | □ | □ | |
| Half-key balancing (standard) | | □ | □ | □ | □ | |
| Balancing without feather key | L01 | ✓ | ✓ | ✓ | ✓ | |
| Full-key balancing | L02 | ✓ | ✓ | ✓ | ✓ | |
| Shaft and rotor | | | | | | |
| Shaft extension with standard dimensions, without feather keyway | L04 | ✓ | ✓ | ✓ | ✓ | |
| Standard, cylindrical shaft extension (second shaft extension) NDE acc. to EN 50347 | L05 | ✓ | ✓ | ✓ | ✓ | |
| Standard shaft made of stainless steel (e.g. 1.4021) | L06 | ✓ | ✓ | ✓ | ✓ | |
| Shaft extension run-out in accordance with IEC 60072-1 precision class | L07 | ✓ | ✓ | ✓ | ✓ | |
| Shaft extension run-out, concentricity and perpendicularity in accordance with IEC 60072-1 precision class for flange-mounted motors | L08 | ✓ | ✓ | ✓ | ✓ | |
| Non-standard cylindrical shaft extension, DE ¹⁵⁾ | Y58 • and customer specifications | ✓ | ✓ | ✓ | ✓ | |
| Non-standard cylindrical shaft extension, NDE ¹⁵⁾ | Y59 • and customer specifications | ✓ | ✓ | ✓ | ✓ | |
| Heating and ventilation | | | | | | |
| Sheet metal fan cover | F74 | ✓ | ✓ | ✓ | ✓ | |
| Fan cover for textile industry ¹⁶⁾ | F75 | ✓ | ✓ | ✓ | ✓ | |
| Metal external fan | F76 | ✓ | ✓ | ✓ | ✓ | |
| Without external fan and without fan cover | F90 | ✓ | ✓ | ✓ | ✓ | |
| Anti-condensation heating for 230 V (2 terminals) | Q02 | ✓ | ✓ | ✓ | ✓ | |
| Anti-condensation heating for 115 V (2 terminals) | Q03 | ✓ | ✓ | ✓ | ✓ | |
| Rating plate and additional rating plates | | | | | | |
| Second rating plate, loose | M10 | ✓ | ✓ | ✓ | ✓ | |
| Rating plate, stainless steel | M11 | ✓ | ✓ | ✓ | ✓ | |
| Additional rating plate with customer specifications | Y82 • and customer specifications | ✓ | ✓ | ✓ | ✓ | |
| Additional information on rating plate and on package label (max. 20 characters) | Y84 • and customer specifications | ✓ | ✓ | ✓ | ✓ | |
| Adhesive label, supplied loose (printed with: Article No., Serial No.; 2 lines of text) | Y85 • and customer specifications | ✓ | ✓ | ✓ | ✓ | |

For legends and footnotes, see page 4/125.

Standard induction motors optimized for converter operation – VSD10 line

Article No. supplements and special versions · Options

Aluminum series SIMOTICS GP 1LE1092

| Special versions | Additional identification code -Z with order code and plain text if required | Frame size | | | | Motor version |
|---|---|----------------|-----|-----|-----|---------------------|
| | | 100 | 112 | 132 | 160 | |
| | | 1LE1092 | | | | Standard Efficiency |
| 1LE1092-.....-.....-Z | Order code | | | | | |
| Packaging, safety notes, documentation and test certificates | | | | | | |
| A printed version of the safety notes in German/English and safety notes in the language of the country of use is supplied in each wire-lattice pallet ¹⁷⁾ | B01 | ○ | ○ | ○ | ○ | |
| Inspection certificate 3.1 according to EN 10204 ¹⁸⁾ | B02 | ✓ | ✓ | ✓ | ✓ | |
| Document - Electrical datasheet | B60 | ✓ | ✓ | ✓ | ✓ | |
| Document - Order dimensional drawing | B61 | ✓ | ✓ | ✓ | ✓ | |
| Type test with heat run for horizontal motors, with acceptance | B83 | ✓ | ✓ | ✓ | ✓ | |
| "Basic" documentation package | B90 | ✓ | ✓ | ✓ | ✓ | |
| "Advanced" documentation package | B91 | ✓ | ✓ | ✓ | ✓ | |
| "Projects" documentation package | B92 | ✓ | ✓ | ✓ | ✓ | |
| Wire-lattice pallet packaging | B99 | ○ | ○ | ○ | ○ | |
| Connected in star for dispatch | M01 | ✓ | ✓ | ✓ | ✓ | |
| Connected in delta for dispatch | M02 | ✓ | ✓ | ✓ | ✓ | |

- Standard version
- Without additional charge
- This order code only determines the price of the version – Additional plain text is required.
- ✓ With additional charge
- R. Possible on request
- Not possible

- 1) For order code **H08** mounting feet dimensions deviate from EN 50347. Further information is available in the DT Configurator (see Appendix, "Tools and engineering").
- 2) With IM B5 flange, only possible in combination with order code **H08**.
- 3) The grease lifetime specified in Catalog Section 1 "Introduction" refers to CT 40 °C. If the coolant temperature is increased by 10 K, the grease life-time and regreasing interval are halved.
- 4) A second shaft extension is not possible. Please inquire for mounted brakes.
- 5) The brake supply voltage must be specified or ordered with order codes **F10**, **F11**, **F12**, **F17**, and **F18**.
- 6) In combination with a separately driven fan (order code **F70**) the 1XP8032-10 rotary pulse encoder is used instead of 1XP8012-10 or 1XP8032-20 is used instead of 1XP8012-20.
- 7) As standard, motors that are prepared for additional mounted components (order codes **G40**, **G41**, **G42**) are shipped without protective cover. If a protective cover is requested as a cover or mechanical protection for mounted components provided by the customer, this can be ordered with order code **G43**. In combination with a separately driven fan (order code **F70**) the 1XP8032-10 rotary pulse encoder is used instead of 1XP8012-10 or 1XP8032-20 is used instead of 1XP8012-20.
- 8) Order code **H00** provides mechanical protection for encoders.
- 9) Supplied with the condensation drainage holes sealed at the drive end DE and non-drive end NDE (IP55, IP56, IP65). If the condensation drainage holes are required for motors of the IM B6, IM B7 or IM B8 type of construction (feet on side or top), the motors must be ordered in the respective type of construction and with order code **H03**, so that the condensation drainage holes will be placed in the correct position.
- 10) Not possible in combination with HOG 9 DN 1024 I rotary pulse encoder (order code **G05**) and/or brake BFK458 (order code **F01**).
- 11) Not possible in combination with brake BFK458 (order code **F01**).
- 12) As standard, motors that are prepared for additional mounted components (order codes **G40**, **G41**, **G42**) are shipped without protective cover. If a protective cover is requested as a cover or mechanical protection for mountings provided by the customer, this can be ordered with order code **G43**.
- 13) Not possible for type of construction IM V3.
- 14) Not possible when a brake is mounted.
- 15) When motors are ordered that have a longer or shorter shaft extension than normal, the required position and length of the feather keyway must be specified in a sketch. It must be ensured that only feather keys in accordance with DIN 6885, Form A are permitted to be used. The feather keyway is positioned centrally on the shaft extension. The length is defined by the manufacturer in accordance with the appropriate standard. Not valid for: Conical shafts, non-standard threaded journals, non-standard shaft tolerances, friction welded journals, extremely "thin" shafts, special geometry dimensions (e.g. square journals), hollow shafts. Valid for non-standard shaft extensions DE or NDE. The feather keys are supplied in every case. For order codes **Y58**, **Y59** and **L05** the following applies:
 - Dimensions D and DA ≤ ball bearing inner diameter (see dimension tables for "Dimensions")
 - Dimensions E and EA ≤ 2 × length E (standard) of the shaft extension. For an explanation of the order codes, see Catalog Section 1 "Introduction".
- 16) The special requirements of the textile industry regarding the sheet metal cover open up the possibility that a finger may be inserted between the cover and housing. The customer must implement appropriate measures to ensure that the installed system is "finger-safe".
- 17) The Operating Instructions (compact) are available in PDF format for all official EU languages at <http://support.automation.siemens.com/WWW/view/en/40761976>.
- 18) The delivery time for the manufacturer's test certificate may differ from the delivery time for the motor and will be dispatched by e-mail.
- 19) In connection with mountings, the respective technical specifications must be observed, please inquire before ordering.
- 20) Not possible in combination with UL.
- 21) Only possible in combination with order codes **R70** and **R71**.

Standard induction motors optimized for converter operation – VSD10 line

Article No. supplements and special versions · Options

Cast-iron series SIMOTICS SD 1LE1592

Selection and ordering data

| Special versions | Additional identification code -Z with order code and plain text if required | Frame size | | | | | | | | | | Motor version |
|---|---|------------|-----|-----|-----|-----|-----|-----|-----|-----|-----|--|
| | | 100 | 112 | 132 | 160 | 180 | 200 | 225 | 250 | 280 | 315 | Standard Efficiency |
| 1LE1592-.....-.....-Z | Order code | | | | | | | | | | | |
| Motor protection | | | | | | | | | | | | |
| 1 or 3 PTC thermistors – for tripping (2 terminals) ^{2) 3)} | Q11 | ✓ | ✓ | ✓ | ✓ | ✓ | ✓ | ✓ | ✓ | ✓ | ✓ | |
| 2 or 6 PTC thermistors – for alarm and tripping (4 terminals) ³⁾ | Q12 | ✓ | ✓ | ✓ | ✓ | ✓ | ✓ | ✓ | ✓ | ✓ | ✓ | |
| 1 KTY84-130 temperature sensor (2 terminals) ³⁾ | Q23 | ✓ | ✓ | ✓ | ✓ | ✓ | ✓ | ✓ | ✓ | ✓ | ✓ | |
| 2 KTY84-130 temperature sensor (4 terminals) ³⁾ | Q25 | ✓ | ✓ | ✓ | ✓ | ✓ | ✓ | ✓ | ✓ | ✓ | ✓ | |
| 3 bimetal sensors (NC contacts) for tripping (2 terminals) ³⁾ | Q31 | ✓ | ✓ | ✓ | ✓ | ✓ | ✓ | ✓ | ✓ | ✓ | ✓ | |
| 6 bimetal sensors (NC contacts) for alarm and tripping (4 terminals) | Q32 | ✓ | ✓ | ✓ | ✓ | ✓ | ✓ | ✓ | ✓ | ✓ | ✓ | Only for: Voltage code 2-1 (12th and 13th position of the Article No.) |
| 3 bimetal sensors (NC contacts) for tripping (6 terminals) | Q33 | ✓ | ✓ | ✓ | ✓ | ✓ | ✓ | ✓ | ✓ | ✓ | ✓ | |
| 6 bimetal sensors (NC contacts) thermostat for alarm and tripping (12 terminals) | Q34 | – | – | – | – | ✓ | ✓ | ✓ | ✓ | ✓ | ✓ | |
| 1 Pt1000 resistance thermometer (2 terminals) ²⁰⁾ | Q35 | ○ | ○ | ○ | ○ | ○ | ○ | ○ | ○ | ○ | ○ | |
| 2 Pt1000 resistance thermometers (4 terminals) ²⁰⁾ | Q36 | ✓ | ✓ | ✓ | ✓ | ✓ | ✓ | ✓ | ✓ | ✓ | ✓ | |
| 3 Pt100 resistance thermometers – 2-wire input (6 terminals) | Q60 | ✓ | ✓ | ✓ | ✓ | ✓ | ✓ | ✓ | ✓ | ✓ | ✓ | |
| 1 Pt100 resistance thermometer – 2-wire input (2 terminals) | Q62 | ✓ | ✓ | ✓ | ✓ | ✓ | ✓ | ✓ | ✓ | ✓ | ✓ | |
| 3 Pt100 resistance thermometers – 3-wire input (9 terminals) | Q63 | ✓ | ✓ | ✓ | ✓ | ✓ | ✓ | ✓ | ✓ | ✓ | ✓ | |
| 6 Pt100 resistance thermometers – 3-wire input (18 terminals) | Q64 | ✓ | ✓ | ✓ | ✓ | ✓ | ✓ | ✓ | ✓ | ✓ | ✓ | |
| 2 Pt100 resistance thermometers in basic configuration for bearings (2 terminals) ¹⁾ | Q72 | – | – | – | – | ✓ | ✓ | ✓ | ✓ | ✓ | ✓ | |
| 2 Pt100 resistance thermometers in 3-wire input for bearings (6 terminals) | Q78 | – | – | – | – | ✓ | ✓ | ✓ | ✓ | ✓ | ✓ | |
| 2 Pt100 double resistance thermometers in 3-wire input for bearings (12 terminals) | Q79 | – | – | – | – | ✓ | ✓ | ✓ | ✓ | ✓ | ✓ | |
| Motor connection and terminal box | | | | | | | | | | | | |
| External grounding | H04 | ✓ | ✓ | ✓ | ✓ | □ | □ | □ | □ | □ | □ | |
| Terminal box on NDE ²⁾ | H08 | ✓ | ✓ | ✓ | ✓ | ✓ | ✓ | ✓ | ✓ | ✓ | ✓ | |
| Second external grounding | H70 | ✓ | ✓ | ✓ | ✓ | ✓ | ✓ | ✓ | ✓ | ✓ | ✓ | |
| Rotation of the terminal box through 90°, entry from DE | R10 | ✓ | ✓ | ✓ | ✓ | ✓ | ✓ | ✓ | ✓ | ✓ | ✓ | |
| Rotation of the terminal box through 90°, entry from NDE | R11 | ✓ | ✓ | ✓ | ✓ | ✓ | ✓ | ✓ | ✓ | ✓ | ✓ | |
| Rotation of the terminal box through 180° | R12 | ○ | ○ | ○ | ○ | ✓ | ✓ | ✓ | ✓ | ✓ | ✓ | |
| One EMC cable gland | R14 | – | – | – | – | ✓ | ✓ | ✓ | ✓ | ✓ | ✓ | |
| One metal cable gland | R15 | ✓ | ✓ | ✓ | ✓ | ✓ | ✓ | ✓ | ✓ | ✓ | ✓ | |
| EMC cable gland, maximum configuration | R16 | – | – | – | – | ✓ | ✓ | ✓ | ✓ | ✓ | ✓ | |
| Stud terminal for cable connection, accessories pack (3 items) | R17 | – | – | – | – | – | – | ✓ | ✓ | ✓ | ✓ | |
| Saddle terminal for connection without cable lug, accessories pack | R19 | – | – | – | – | – | – | ✓ | ✓ | ✓ | ✓ | |
| Larger terminal box | R50 | ✓ | ✓ | ✓ | ✓ | ✓ | ✓ | ✓ | ✓ | ✓ | ✓ | |
| Terminal box without cable entry opening | R51 | ○ | ○ | ○ | ○ | ○ | ○ | ○ | ○ | ○ | ○ | |
| Drilled removable entry plate | R52 | – | – | – | – | ✓ | ✓ | ✓ | ✓ | ✓ | ✓ | |
| Undrilled removable entry plate | R53 | – | – | – | – | ✓ | ✓ | ✓ | ✓ | ✓ | ✓ | |
| Cast-iron auxiliary terminal box (small) | R62 | ✓ | ✓ | ✓ | ✓ | ✓ | ✓ | ✓ | ✓ | ✓ | ✓ | |
| Silicone-free version | R74 | □ | □ | □ | □ | □ | □ | □ | ✓ | ✓ | ✓ | |
| Non-standard threaded through hole (NPT or G thread) | Y61 • and customer specifications | ✓ | ✓ | ✓ | ✓ | ✓ | ✓ | ✓ | ✓ | ✓ | ✓ | |

For legend, see page 4/129, for footnotes, see page 4/130.

Standard induction motors optimized for converter operation – VSD10 line

Article No. supplements and special versions · Options

Cast-iron series SIMOTICS SD 1LE1592

| Special versions | Additional identification code -Z with order code and plain text if required | Frame size | | | | | | | | | | Motor version |
|--|---|----------------|-----|-----|-----|------|------|------|------|------|------|--------------------------------|
| | | 100 | 112 | 132 | 160 | 180 | 200 | 225 | 250 | 280 | 315 | |
| | | 1LE1592 | | | | | | | | | | Standard Efficiency |
| 1LE1592-.....-.....-Z | Order code | | | | | | | | | | | |
| Windings and insulation | | | | | | | | | | | | |
| Increased air humidity/temperature with 30 to 60 g water per m ³ of air | N30 | ✓ | ✓ | ✓ | ✓ | ✓ | ✓ | ✓ | ✓ | ✓ | ✓ | ✓ |
| Increased air humidity/temperature with 60 to 100 g water per m ³ of air | N31 | ✓ | ✓ | ✓ | ✓ | ✓ | ✓ | ✓ | ✓ | ✓ | ✓ | ✓ |
| Colors and paint finish | | | | | | | | | | | | |
| Standard paint finish C2 in RAL 7030 stone gray | | □ | □ | □ | □ | □ | □ | □ | □ | □ | □ | □ |
| Unpainted (only cast-iron parts primed) | S00 | ○ | ○ | ○ | ○ | ○ | ○ | ○ | ○ | ○ | ○ | ○ |
| Unpainted, only primed | S01 | ✓ | ✓ | ✓ | ✓ | ✓ | ✓ | ✓ | ✓ | ✓ | ✓ | ✓ |
| Special paint finish C3 | S02 | ✓ | ✓ | ✓ | ✓ | ✓ | ✓ | ✓ | ✓ | ✓ | ✓ | ✓ |
| Special paint finish sea air resistant C4 | S03 | ✓ | ✓ | ✓ | ✓ | ✓ | ✓ | ✓ | ✓ | ✓ | ✓ | ✓ |
| Special paint finish for use offshore C5 | S04 | ✓ | ✓ | ✓ | ✓ | ✓ | ✓ | ✓ | ✓ | ✓ | ✓ | ✓ |
| Internal coating | S05 | ✓ | ✓ | ✓ | ✓ | ✓ | ✓ | ✓ | ✓ | ✓ | ✓ | ✓ |
| Paint finish in other standard RAL colors: RAL 1002, 1013, 1015, 1019, 2003, 2004, 3000, 3007, 5002, 5007, 5009, 5010, 5012, 5015, 5017, 5018, 5019, 6011, 6019, 6021, 7000, 7001, 7004, 7011, 7016, 7022, 7031, 7032, 7033, 7035, 9001, 9002, 9005 (see Catalog Section 1 "Introduction") | Y53 • and paint finish RAL.... | ✓ | ✓ | ✓ | ✓ | ✓ | ✓ | ✓ | ✓ | ✓ | ✓ | ✓ |
| Paint finish in special RAL colors: For RAL colors, see "Special paint finish in special RAL colors" (see Catalog Section 1 "Introduction") | Y56 • and paint finish RAL.... | ✓ | ✓ | ✓ | ✓ | ✓ | ✓ | ✓ | ✓ | ✓ | ✓ | ✓ |
| Modular technology – Basic versions ⁴⁾ | | | | | | | | | | | | |
| Mounting of holding brake (standard assignment) ⁵⁾ | F01 | ✓ | ✓ | ✓ | ✓ | ✓ | ✓ | ✓ | ✓ | ✓ | ✓ | ✓ |
| Mounted separately driven fan | F70 | ✓ | ✓ | ✓ | ✓ | ✓ | ✓ | ✓ | ✓ | ✓ | ✓ | ✓ |
| Mounting of Kübler Sendix 5020 HTL, 1024 I rotary pulse encoder | G11 | ✓ | ✓ | ✓ | ✓ | ✓ | ✓ | ✓ | ✓ | ✓ | ✓ | ✓ |
| Mounting of Kübler Sendix 5020 TTL, 1024 I rotary pulse encoder | G12 | ✓ | ✓ | ✓ | ✓ | ✓ | ✓ | ✓ | ✓ | ✓ | ✓ | ✓ |
| Modular technology – Additional versions | | | | | | | | | | | | |
| Brake supply voltage 24 V DC | F10 | ✓ | ✓ | ✓ | ✓ | ✓ | ✓ | ✓ | ✓ | ✓ | ✓ | ✓ |
| Brake supply voltage 230 V AC, 50/60 Hz | F11 | ○ | ○ | ○ | ○ | ○ | ○ | ○ | ○ | ○ | ○ | ○ |
| Brake supply voltage 400 V AC, 50/60 Hz | F12 | ✓ | ✓ | ✓ | ✓ | ✓ | ✓ | ✓ | ✓ | ✓ | ✓ | ✓ |
| Brake supply voltage 180 V DC | F17 | ✓ | ✓ | ✓ | ✓ | ✓ | ✓ | ✓ | – | – | – | Only for: Combination with F01 |
| Brake supply voltage 205 V DC | F18 | ✓ | ✓ | ✓ | ✓ | ✓ | ✓ | ✓ | – | – | – | Only for: Combination with F01 |
| Mechanical manual brake release with lever (no locking) | F50 | ✓ | ✓ | ✓ | ✓ | ✓ | ✓ | ✓ | ✓ | ✓ | ✓ | ✓ |
| Special technology ⁵⁾ | | | | | | | | | | | | |
| Mounting of LL 861 900 220 rotary pulse encoder ⁸⁾ | G04 | ✓ | ✓ | ✓ | ✓ | ✓ | ✓ | ✓ | ✓ | ✓ | ✓ | ✓ |
| Mounting of HOG 9 DN 1024 I rotary pulse encoder ⁸⁾ | G05 | ✓ | ✓ | ✓ | ✓ | ✓ | ✓ | ✓ | ✓ | ✓ | ✓ | ✓ |
| Mounting of HOG 10 D 1024 I rotary pulse encoder ⁸⁾ | G06 | ✓ | ✓ | ✓ | ✓ | ✓ | ✓ | ✓ | ✓ | ✓ | ✓ | ✓ |
| Mounting of POG 10 DN rotary pulse encoder (only in combination with separately driven fan or brake) ⁹⁾ | G07 | – | – | – | – | ✓ | ✓ | ✓ | ✓ | ✓ | ✓ | ✓ |
| Mounting of POG 9 rotary pulse encoder (only in combination with separately driven fan or brake) ⁹⁾ | G08 | – | – | – | – | ✓ | ✓ | ✓ | ✓ | ✓ | ✓ | ✓ |
| Mounting of Kübler Sendix 5834FS2 1024, SIL-2 rotary pulse encoder | G21 | ✓ | ✓ | ✓ | ✓ | ✓ | ✓ | ✓ | ✓ | ✓ | ✓ | ✓ |
| Mounting of Kübler Sendix 5834FS3 1024, SIL-3 rotary pulse encoder | G22 | ✓ | ✓ | ✓ | ✓ | ✓ | ✓ | ✓ | ✓ | ✓ | ✓ | ✓ |
| Mounting of HOGS100S-B76.626.01024.1 rotary pulse encoder | G25 | – | – | – | – | ✓ | ✓ | ✓ | ✓ | ✓ | ✓ | ✓ |
| Mounting of LL FSI 862-184560-1024, SIL-2 rotary pulse encoder | G27 | – | – | – | – | ✓ | ✓ | ✓ | ✓ | ✓ | ✓ | ✓ |
| Mounting of a special type of rotary pulse encoder | Y70 • and customer specifications | – | – | – | – | O.R. | O.R. | O.R. | O.R. | O.R. | O.R. | O.R. |

For legend, see page 4/129, for footnotes, see page 4/130.

Standard induction motors optimized for converter operation – VSD10 line

Article No. supplements and special versions · Options

Cast-iron series SIMOTICS SD 1LE1592

| Special versions | Additional identification code -Z with order code and plain text if required | Frame size | | | | | | | | | | Motor version |
|--|---|------------|-----|-----|-----|-----|-----|-----|-----|-----|-----|---------------------|
| | | 100 | 112 | 132 | 160 | 180 | 200 | 225 | 250 | 280 | 315 | |
| | | 1LE1592 | | | | | | | | | | Standard Efficiency |
| 1LE1592-.....-.....-Z | Order code | | | | | | | | | | | |
| Mechanical version and degrees of protection | | | | | | | | | | | | |
| Prepared for mountings, centering hole only | G40 | ✓ | ✓ | ✓ | ✓ | □ | □ | □ | □ | □ | □ | |
| Prepared for mountings with D12 shaft | G41 | ✓ | ✓ | ✓ | ✓ | ✓ | ✓ | ✓ | ✓ | ✓ | ✓ | |
| Prepared for mountings with D16 shaft | G42 | ✓ | ✓ | ✓ | ✓ | ✓ | ✓ | ✓ | ✓ | ✓ | ✓ | |
| Mechanical protection for encoder | G43 | ✓ | ✓ | ✓ | ✓ | ✓ | ✓ | ✓ | ✓ | ✓ | ✓ | |
| Protective cover ^{6) 8) 10)} | H00 | ✓ | ✓ | ✓ | ✓ | ✓ | ✓ | ✓ | ✓ | ✓ | ✓ | |
| Screwed-on (instead of cast) feet | H01 | ✓ | ✓ | ✓ | ✓ | ✓ | ✓ | ✓ | ✓ | ✓ | ✓ | |
| Vibration-proof version; vibration resistance to Class 3M4 according to IEC 60721-3-3:1994 | H02 | ✓ | ✓ | ✓ | ✓ | ✓ | ✓ | ✓ | ✓ | ✓ | ✓ | |
| Condensation drainage holes | | □ | □ | □ | □ | □ | □ | □ | □ | □ | □ | |
| Rust-resistant screws (externally) | H07 | ✓ | ✓ | ✓ | ✓ | ✓ | ✓ | ✓ | ✓ | ✓ | ✓ | |
| IP65 degree of protection ¹¹⁾ | H20 | ✓ | ✓ | ✓ | ✓ | ✓ | ✓ | ✓ | ✓ | ✓ | ✓ | |
| IP54 degree of protection | H21 | – | – | – | – | ✓ | ✓ | ✓ | ✓ | ✓ | ✓ | |
| IP56 degree of protection ¹²⁾ | H22 | ✓ | ✓ | ✓ | ✓ | ✓ | ✓ | ✓ | ✓ | ✓ | ✓ | |
| Drive-end seal for flange-mounted motors, oil-tight to 0.1 bar ¹³⁾ | H23 | ✓ | ✓ | ✓ | ✓ | ✓ | ✓ | ✓ | ✓ | ✓ | ✓ | |
| Grounding brush for converter operation | L52 | – | – | – | – | – | – | – | – | ✓ | ✓ | |
| Coolant temperature and installation altitude | | | | | | | | | | | | |
| Coolant temperature –50 to +40 °C | D02 | ✓ | ✓ | ✓ | ✓ | ✓ | ✓ | ✓ | ✓ | ✓ | ✓ | |
| Coolant temperature –40 to +40 °C ¹⁴⁾ | D03 | ✓ | ✓ | ✓ | ✓ | ✓ | ✓ | ✓ | ✓ | ✓ | ✓ | |
| Coolant temperature –30 to +40 °C | D04 | ✓ | ✓ | ✓ | ✓ | ✓ | ✓ | ✓ | ✓ | ✓ | ✓ | |
| Versions in accordance with standards and specifications | | | | | | | | | | | | |
| Version according to UL and CSA (Canadian regulation) | D39 | ✓ | ✓ | ✓ | ✓ | ✓ | ✓ | ✓ | ✓ | ✓ | ✓ | |
| TR CU product safety certificate EAC for Eurasian Customs Union | D47 | ✓ | ✓ | ✓ | ✓ | ✓ | ✓ | ✓ | ✓ | ✓ | ✓ | |
| Bearings and lubrication | | | | | | | | | | | | |
| Regreasing device with M10 × 1 grease nipple according to DIN 71412 A | L19 | – | – | – | – | ✓ | ✓ | ✓ | ✓ | ○ | ○ | |
| Located bearing DE | L20 | ✓ | ✓ | ✓ | ✓ | ✓ | ✓ | ✓ | ✓ | ✓ | ✓ | |
| Located bearing NDE | L21 | ✓ | ✓ | ✓ | □ | □ | □ | □ | □ | □ | □ | |
| Bearing design for increased cantilever forces | L22 | ✓ | ✓ | ✓ | ✓ | ✓ | ✓ | ✓ | ✓ | ✓ | ✓ | |
| Regreasing device ¹⁵⁾ | L23 | ✓ | ✓ | ✓ | ✓ | ✓ | ✓ | ✓ | ✓ | □ | □ | |
| Bearings reinforced at both ends for DE and NDE, bearing size 63 ¹⁶⁾ | L25 | ✓ | ✓ | ✓ | ✓ | ✓ | ✓ | ✓ | ✓ | □ | □ | |
| Reinforced bearings at both DE and NDE, DE bearing for increased cantilever forces | L28 | – | – | – | – | ✓ | ✓ | ✓ | ✓ | – | – | |
| Bearing insulation DE | L50 | – | – | – | – | – | – | ✓ | ✓ | ✓ | ✓ | |
| Bearing insulation NDE | L51 | ✓ | ✓ | ✓ | ✓ | ✓ | ✓ | ✓ | ✓ | □ | □ | |
| Measuring nipple for SPM shock pulse measurement for bearing inspection ¹⁵⁾ | Q01 | ✓ | ✓ | ✓ | ✓ | ✓ | ✓ | ✓ | ✓ | ✓ | ✓ | |
| Balance and vibration severity | | | | | | | | | | | | |
| Vibration severity grade A | | □ | □ | □ | □ | □ | □ | □ | □ | □ | □ | |
| Half-key balancing (standard) | | □ | □ | □ | □ | □ | □ | □ | □ | □ | □ | |
| Balancing without feather key | L01 | ✓ | ✓ | ✓ | ✓ | ✓ | ✓ | ✓ | ✓ | ✓ | ✓ | |
| Full-key balancing | L02 | ✓ | ✓ | ✓ | ✓ | ✓ | ✓ | ✓ | ✓ | ✓ | ✓ | |
| Shaft and rotor | | | | | | | | | | | | |
| Shaft extension with standard dimensions, without feather keyway | L04 | ✓ | ✓ | ✓ | ✓ | ✓ | ✓ | ✓ | ✓ | ✓ | ✓ | |
| Standard, cylindrical shaft extension (second shaft extension) NDE acc. to EN 50347 | L05 | ✓ | ✓ | ✓ | ✓ | ✓ | ✓ | ✓ | ✓ | ✓ | ✓ | |
| Standard shaft made of stainless steel (e.g. 1.4021) | L06 | ✓ | ✓ | ✓ | ✓ | ✓ | ✓ | ✓ | ✓ | ✓ | ✓ | |
| Shaft extension run-out in accordance with IEC 60072-1 precision class | L07 | ✓ | ✓ | ✓ | ✓ | ✓ | ✓ | ✓ | ✓ | ✓ | ✓ | |
| Shaft extension run-out, concentricity and perpendicularity in accordance with IEC 60072-1 precision class for flange-mounted motors | L08 | ✓ | ✓ | ✓ | ✓ | ✓ | ✓ | ✓ | ✓ | ✓ | ✓ | |

For legend, see page 4/129, for footnotes, see page 4/130.

Standard induction motors optimized for converter operation – VSD10 line

Article No. supplements and special versions · Options

Cast-iron series SIMOTICS SD 1LE1592

| Special versions | Additional identification code -Z with order code and plain text if required | Frame size | | | | | | | | | | Motor version |
|--|---|----------------|-------|-------|-------|-------|-------|-------|-------|-------|-------|---------------------|
| | | 100 | 112 | 132 | 160 | 180 | 200 | 225 | 250 | 280 | 315 | |
| | | 1LE1592 | | | | | | | | | | Standard Efficiency |
| 1LE1592-.....-.....-Z | Order code | | | | | | | | | | | |
| Shaft and rotor (continued) | | | | | | | | | | | | |
| Non-standard cylindrical shaft extension, DE ¹⁷⁾ | Y58 • and customer specifications | ✓ | ✓ | ✓ | ✓ | ✓ | ✓ | ✓ | ✓ | ✓ | ✓ | ✓ |
| Non-standard cylindrical shaft extension, NDE ¹⁷⁾ | Y59 • and customer specifications | ✓ | ✓ | ✓ | ✓ | ✓ | ✓ | ✓ | ✓ | ✓ | ✓ | ✓ |
| Special shaft steel | Y60 • and customer specifications | O. R. | O. R. | O. R. | O. R. | O. R. | O. R. | O. R. | O. R. | O. R. | O. R. | O. R. |
| Heating and ventilation | | | | | | | | | | | | |
| Sheet metal fan cover | F74 | ✓ | ✓ | ✓ | ✓ | ✓ | ✓ | ✓ | ✓ | ✓ | ✓ | ✓ |
| Metal external fan | F76 | ✓ | ✓ | ✓ | ✓ | ✓ | ✓ | ✓ | ✓ | ✓ | ✓ | ✓ |
| Anti-condensation heating for 230 V (2 terminals) | Q02 | ✓ | ✓ | ✓ | ✓ | ✓ | ✓ | ✓ | ✓ | ✓ | ✓ | ✓ |
| Anti-condensation heating for 115 V (2 terminals) | Q03 | ✓ | ✓ | ✓ | ✓ | ✓ | ✓ | ✓ | ✓ | ✓ | ✓ | ✓ |
| Separately driven fan with non-standard voltage and/or frequency | Y81 • and customer specifications | – | – | – | – | – | – | ✓ | ✓ | ✓ | ✓ | ✓ |
| Rating plate and additional rating plates | | | | | | | | | | | | |
| Second rating plate, loose | M10 | ✓ | ✓ | ✓ | ✓ | ✓ | ✓ | ✓ | ✓ | ✓ | ✓ | ✓ |
| Rating plate, stainless steel | M11 | ✓ | ✓ | ✓ | ✓ | ✓ | ✓ | ✓ | ✓ | ✓ | ✓ | ✓ |
| Additional rating plate with customer specifications | Y82 • and customer specifications | ✓ | ✓ | ✓ | ✓ | ✓ | ✓ | ✓ | ✓ | ✓ | ✓ | ✓ |
| Additional information on rating plate and on package label (max. 20 characters) | Y84 • and customer specifications | ✓ | ✓ | ✓ | ✓ | ✓ | ✓ | ✓ | ✓ | ✓ | ✓ | ✓ |
| Adhesive label, supplied loose (printed with: Article No., Serial No.; 2 lines of text) | Y85 • and customer specifications | ✓ | ✓ | ✓ | ✓ | ✓ | ✓ | ✓ | ✓ | ✓ | ✓ | ✓ |
| Extension of the liability for defects | | | | | | | | | | | | |
| Extension of the liability for defects by 12 months to a total of 24 months (2 years) from delivery ¹⁸⁾ | Q80 | – | – | – | – | ✓ | ✓ | ✓ | ✓ | ✓ | ✓ | ✓ |
| Extension of the liability for defects by 24 months to a total of 36 months (3 years) from delivery ¹⁸⁾ | Q82 | – | – | – | – | ✓ | ✓ | ✓ | ✓ | ✓ | ✓ | ✓ |
| Packaging, safety notes, documentation and test certificates | | | | | | | | | | | | |
| Inspection certificate 3.1 according to EN 10204 ¹⁹⁾ | B02 | ✓ | ✓ | ✓ | ✓ | ✓ | ✓ | ✓ | ✓ | ✓ | ✓ | ✓ |
| Document - Electrical datasheet | B60 | ✓ | ✓ | ✓ | ✓ | ✓ | ✓ | ✓ | ✓ | ✓ | ✓ | ✓ |
| Document - Order dimensional drawing | B61 | ✓ | ✓ | ✓ | ✓ | ✓ | ✓ | ✓ | ✓ | ✓ | ✓ | ✓ |
| Standard test (routine test) with acceptance | B65 | ✓ | ✓ | ✓ | ✓ | ✓ | ✓ | ✓ | ✓ | ✓ | ✓ | ✓ |
| Type test with heat run for horizontal motors, with acceptance | B83 | ✓ | ✓ | ✓ | ✓ | ✓ | ✓ | ✓ | ✓ | ✓ | ✓ | ✓ |
| "Basic" documentation package | B90 | ✓ | ✓ | ✓ | ✓ | ✓ | ✓ | ✓ | ✓ | ✓ | ✓ | ✓ |
| "Advanced" documentation package | B91 | ✓ | ✓ | ✓ | ✓ | ✓ | ✓ | ✓ | ✓ | ✓ | ✓ | ✓ |
| "Projects" documentation package | B92 | ✓ | ✓ | ✓ | ✓ | ✓ | ✓ | ✓ | ✓ | ✓ | ✓ | ✓ |
| Connected in star for dispatch | M01 | ✓ | ✓ | ✓ | ✓ | ✓ | ✓ | ✓ | ✓ | ✓ | ✓ | ✓ |
| Connected in delta for dispatch | M02 | ✓ | ✓ | ✓ | ✓ | ✓ | ✓ | ✓ | ✓ | ✓ | ✓ | ✓ |

- Standard version
- Without additional charge
- This order code only determines the price of the version – Additional plain text is required.
- ✓ With additional charge
- O. R. Possible on request
- Not possible

For footnotes, see page 4/130.

Standard induction motors optimized for converter operation – VSD10 line

Article No. supplements and special versions · Options

Cast-iron series SIMOTICS SD 1LE1592

4

- 1) Evaluation with associated tripping unit (see Catalog IC 10) is recommended.
- 2) For order code **H08** mounting feet dimensions deviate from EN 50347. Further information is available in the DT Configurator (see Appendix, "Tools and engineering").
- 3) The grease lifetime specified in Catalog Section 1 "Introduction" refers to CT 40 °C. If the coolant temperature is increased by 10 K, the grease life-time and regreasing interval are halved.
- 4) A second shaft extension is not possible. Please inquire for mounted brakes.
- 5) The brake supply voltage must be specified or ordered with order codes **F10, F11, F12, F17, and F18**.
- 6) The 1XP8 rotary pulse encoders are fitted with a protective cover as standard. The protective cover is omitted at the factory when a rotary pulse encoder is combined with a separately driven fan, because in this case the rotary pulse encoder is installed under the fan cover.
- 7) In combination with a separately driven fan (order code **F70**) the 1XP8032-10 rotary pulse encoder is used instead of 1XP8012-10 or 1XP8032-20 is used instead of 1XP8012-20.
- 8) LL and HOG rotary pulse encoders up to frame size 160 are fitted with a protective cover as standard. The protective cover is omitted at the factory when a rotary pulse encoder is combined with a separately driven fan, because in this case the rotary pulse encoder is installed under the fan cover.
- 9) Option (encoder mounting) is only possible for motors with a mounted separately driven fan or for naturally cooled motors (without an external fan). This option can be used in combination with brakes of type KFB! This option cannot be used in combination with brakes of type BFK458!
- 10) Order code **H00** provides mechanical protection for encoders.
- 11) Not possible in combination with HOG 9 DN 1024 I rotary pulse encoder (order code **G05**) and/or brake BFK458 (order code **F01**).
- 12) Not possible in combination with brake BFK458 (order code **F01**).
- 13) Not possible for type of construction IM V3.
- 14) In connection with mountings, the respective technical specifications must be observed, please inquire before ordering.
- 15) Up to frame size 160 not possible when brake is mounted.
- 16) Standard version for motors from frame size 280 and higher.
- 17) When motors are ordered that have a longer or shorter shaft extension than normal, the required position and length of the feather keyway must be specified in a sketch. It must be ensured that only feather keys in accordance with DIN 6885, Form A are permitted to be used. The feather keyway is positioned centrally on the shaft extension. The length is defined by the manufacturer in accordance with the appropriate standard. Not valid for: Conical shafts, non-standard threaded journals, non-standard shaft tolerances, friction welded journals, extremely "thin" shafts, special geometry dimensions (e.g. square journals), hollow shafts. Valid for non-standard shaft extensions DE or NDE. The feather keys are supplied in every case. For order codes **Y58, Y59** and **L05** the following applies:
 - Dimensions D and DA ≤ ball bearing inner diameter (see dimension tables for "Dimensions")
 - Dimensions E and EA ≤ 2 × length E (standard) of the shaft extension. For an explanation of the order codes, see Catalog Section 1 "Introduction".
- 18) Wearing parts (bearings) are excluded from the warranty extension.
- 19) The delivery time for the manufacturer's test certificate may differ from the delivery time for the motor.
- 20) Not possible in combination with UL.

Overview**Slide rails with fixing bolts and tensioning screws according to DIN 42923**

Slide rails are used to tension the belt of a machine easily and conveniently when there is no belt-tensioning pulley. They are fixed to the base using stone bolts or foundation blocks.

The assignment of slide rails to motor size can be found in DIN 42923. For motors of frame sizes 355 to 450, there are no standardized slide rails (please inquire).

Available from:

Lütgert & Co. GmbH
Postfach 42 51
33276 Gütersloh, Germany
Phone +49 (5241) 7407-0
Fax +49 (5241) 7407-90

www.luetgert-antriebe.de
Email: info@luetgert-antriebe.de

Foundation blocks according to DIN 799

The foundation blocks are inserted into the stone foundation and embedded in concrete. They are used for fixing machines of medium size, slide rails, pedestal bearings, base frames, etc. After the fixing bolts have been unscrewed, the machines can be shifted without them having to be lifted.

When the machine is initially installed, the foundation blocks that are bolted to the machine (without washers) and fitted with taper pins are not embedded with concrete until the machine has been fully aligned. In this case, the machine is positioned 2 to 3 mm lower. The difference in shaft height is compensated by inserting shims on final installation. The taper pins safeguard the exact position of the machine when it is repeatedly removed and replaced without the need for realignment.

Available from:

Lütgert & Co. GmbH
Postfach 42 51
33276 Gütersloh, Germany
Phone +49 (5241) 7407-0
Fax +49 (5241) 7407-90

www.luetgert-antriebe.de
Email: info@luetgert-antriebe.de

Taper pins according to DIN 258 with threaded ends and constant taper lengths

Taper pins are used for components that are repeatedly removed. The drilled hole is conically ground using a conical reamer until the pin can be pushed in by hand until the cone shoulder lies approx. 3 to 4 mm above the rim of the hole.

It can then be driven in using a hammer until it is correctly seated. The pin is removed from the drilled hole by screwing on the nut and tightening it.

Standardized taper pins are commercially available.

For instance, available from:

Otto Roth GmbH & Co. KG
Rutesheimer Strasse 22
70499 Stuttgart, Germany
Phone +49 (711) 1388-0
Fax +49 (711) 1388-233

www.ottoroth.de
Email: info@ottoroth.de

Couplings

The motor from Siemens is connected to the machine or gear unit through a coupling. Flender is an important coupling manufacturer with a wide range of products.

For standard applications, Siemens recommends that flexible couplings, types N-EUPEX and RUPEX or torsionally rigid couplings, types ARPEX and ZAPEX are used. For special applications, FLUDEX and ELPEX-S couplings are recommended.

Available from:

Siemens contact partner - ordering from catalog
Siemens MD 10.1 "FLENDER Standard Couplings"

or

Flender GmbH
Kupplungswerk Mussum
Industriepark Bocholt
Schlavenhorst 100
46395 Bocholt, Germany
Phone +49 (2871) 922185
Fax +49 (2871) 922579

www.flender.com
Email: flender-kupplungen-2.pd.de@siemens.com

Standard induction motors optimized for converter operation – VSD10 line

Article No. supplements and special versions · Accessories

More information

Replacement motors and repair parts

- Commitment to provide replacement motors and repair parts following delivery of the motor:
 - For up to 3 years after delivery of the original motor, in the event of total motor failure, Siemens will supply a comparable spare motor with regard to the mounting dimensions and functions (the type series may vary).
 - If a spare motor is provided within the 3-year period, this will not mean that the warranty restarts.
 - Replacement motors delivered after the active production of the motor series are also identified as spare motors on the rating plate.
 - Spare parts are offered only for these spare motors on request; repair and replacement are not possible.
 - After a period of 3 years (after the delivery of the original motor), it is only possible to repair these motors (depending on the availability of the spare parts required).
 - For up to 5 years after the delivery of the original motor, spare parts will be available and for a further 5 years, Siemens will provide information about spare parts and will supply documents when required.
- When repair parts are ordered, the following details must be provided:
 - Designation and part number
 - Article No. and factory number of the motor.
- For bearing types, see Catalog Section 1 "Introduction".
- For standard components, a commitment to supply repaired parts does not apply.
- Support hotline
In Germany
Phone +49 (0) 911 895 7222

You will find telephone numbers for other countries on our Internet site:

www.siemens.com/automation/service&support

Standard induction motors optimized for converter operation – VSD10 line

Dimensions

Notes on the dimensions

Overview

- Dimensional designations according to EN 50347 and IEC 60072.
- Fits
The shaft extensions specified in the dimension tables (DIN 748) and centering spigot diameters (EN 50347) are machined with the following fits:

| Dimension designation | ISO fit | DIN ISO 286-2 |
|-----------------------|---------------|---------------|
| D, DA | to 30 | j6 |
| | over 30 to 50 | k6 |
| | over 50 | m6 |
| N | to 250 | j6 |
| | over 250 | h6 |
| F, FA | | h9 |
| K | | H17 |
| S | flange (FF) | H17 |

The drilled holes of couplings and belt pulleys should have an ISO fit of at least H7.

- Dimensional tolerances
For the following dimensions, the admissible deviations are given below:

| Dimension designation | Dimension | Admissible deviation |
|-----------------------|-----------|----------------------|
| H | to 250 | - 0.5 |
| | over 250 | - 1.0 |
| E, EA | | - 0.5 |

- Keyways and feather keyways (dimensions GA, GC, F, and FA) are made in compliance with DIN 6885 Part 1.

- All dimensions are specified in mm.

Dimension sheet generator (within the DT Configurator)

Overview

A dimensional drawing can be created in the "Drive Technology Configurator" (DT Configurator) for every configurable motor. A dimensional drawing can be requested for every other motor.

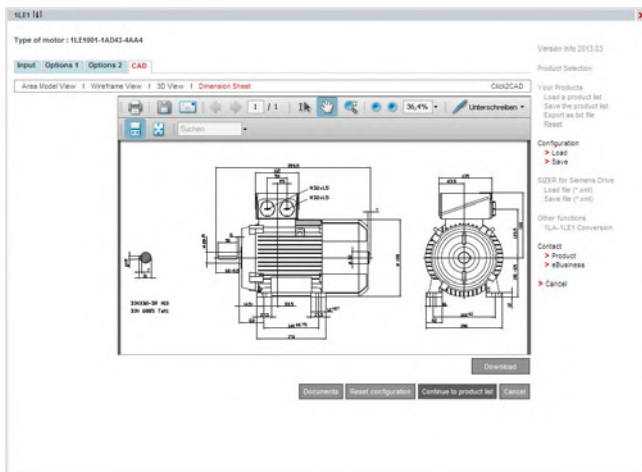

When a complete Article No. is entered with or without order codes, a dimensional drawing can be called up under the "Documentation" tab.

These dimensional drawings can be presented in different views and sections and printed. The corresponding dimension sheets can be exported, saved and processed further in DXF format (interchange/import format for CAD systems) or as bitmap graphics.

Online access in the Siemens Industry Mall

The DT Configurator is integrated into the Siemens Industry Mall and can be used on the Internet without installation.

German: www.siemens.de/dt-konfigurator
English: www.siemens.com/dt-configurator

Standard induction motors optimized for converter operation – VSD10 line

Dimensions · Aluminum series SIMOTICS GP

Standard Efficiency – self-ventilated · Frame sizes 100 L to 160 L

Dimensional drawings

Type of construction IM B3

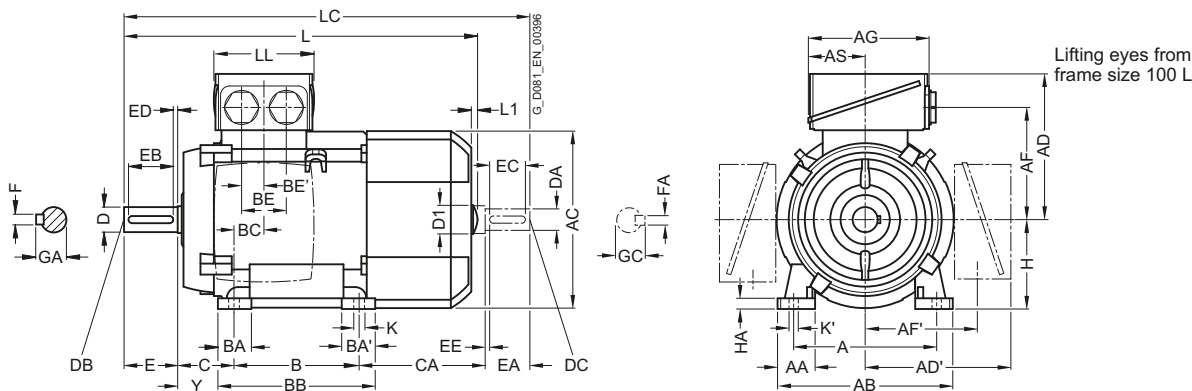

Types of construction IM B5 and IM V1

For flange dimensions, see page 1/47 (Z = the number of retaining holes)

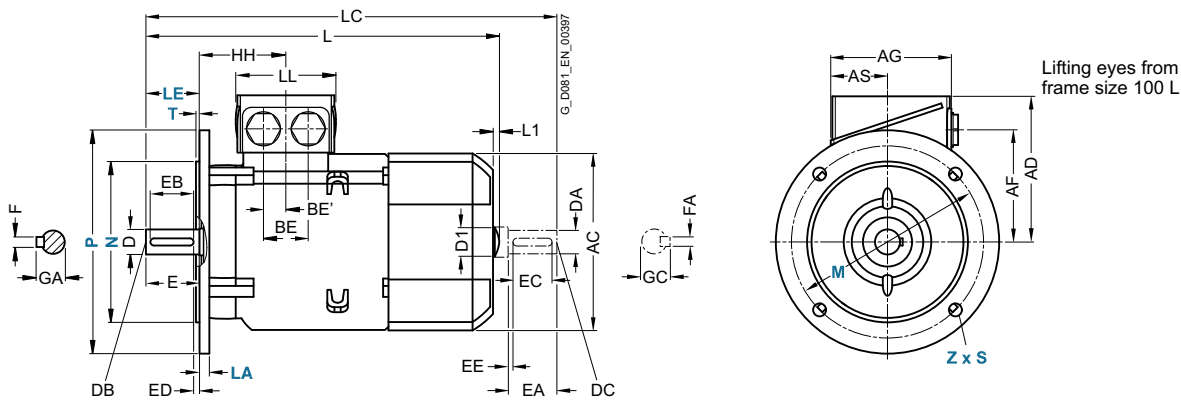

| For motor | | Dimension designation acc. to IEC | | | | | | | | | | | | | | | | | | | | | | |
|------------|--------------------|-----------------------------------|-----|----|-----|-----|-------|-------|-------|-------|-----|------|-----|------|------|-----|------|----|------|-----|-------|-----|----|----|
| Frame size | Motor type 1LE1092 | No. of poles | A | AA | AB | AC | AD | AD' | AF | AF' | AG | AS | B | BA | BA' | BB | BC | BE | BE' | C | CA | H | HA | Y |
| 100 L | All | 2, 4 | 160 | 42 | 196 | 198 | 166 | 166 | 125.5 | 125.5 | 135 | 63.5 | 140 | 37.5 | 37.5 | 176 | 33.5 | 50 | 25 | 63 | 141 | 100 | 12 | 45 |
| 112 M | All | 2, 4 | 190 | 46 | 226 | 222 | 177 | 177 | 136.5 | 136.5 | 135 | 63.5 | 140 | 37.5 | 37.5 | 176 | 26 | 50 | 25 | 70 | 129.7 | 112 | 12 | 52 |
| 132 S | All | 2, 4 | 216 | 53 | 256 | 262 | 202 | 202 | 159.5 | 159.5 | 155 | 70.5 | 140 | 38 | 76 | 218 | 26.5 | 48 | 24 | 89 | 128.5 | 132 | 15 | 69 |
| 132 M | All | 2, 4 | 216 | 53 | 256 | 262 | 202 | 202 | 159.5 | 159.5 | 155 | 70.5 | 178 | 38 | 76 | 218 | 26.5 | 48 | 24 | 89 | 128.5 | 132 | 15 | 69 |
| 160 M | All | 2, 4 | 254 | 60 | 300 | 314 | 236.5 | 236.5 | 190 | 190 | 175 | 77.5 | 210 | 44 | 89 | 300 | 47 | 57 | 28.5 | 108 | 148 | 160 | 18 | 85 |
| 160 L | All | 2, 4 | 254 | 60 | 300 | 314 | 236.5 | 236.5 | 190 | 190 | 175 | 77.5 | 254 | 44 | 89 | 300 | 47 | 57 | 28.5 | 108 | 148 | 160 | 18 | 85 |

Standard induction motors optimized for converter operation – VSD10 line

Dimensions · Aluminum series SIMOTICS GP

Standard Efficiency – self-ventilated · Frame sizes 100 L to 160 L

Dimensional drawings

Type of construction IM B35

For flange dimensions, see page 1/47 (Z = the number of retaining holes)

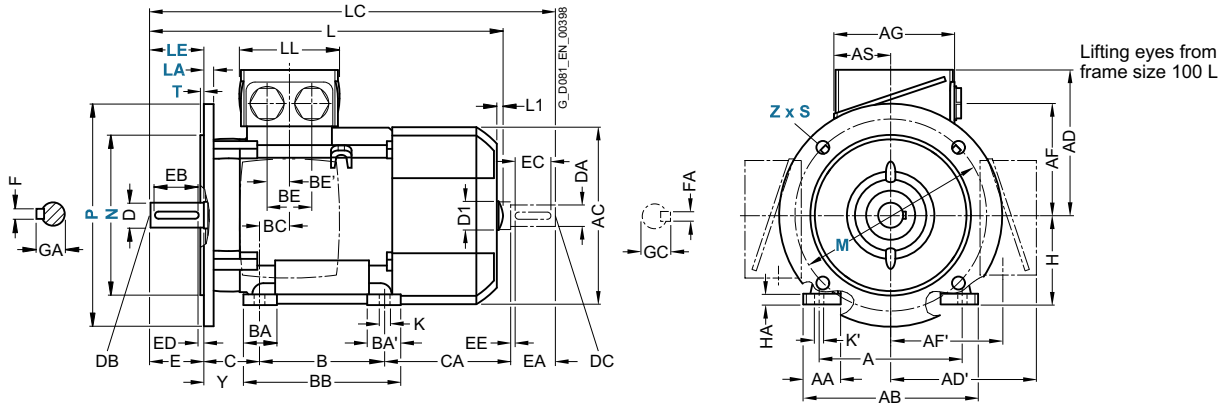

Type of construction IM B14

For flange dimensions, see page 1/47 (Z = the number of retaining holes)

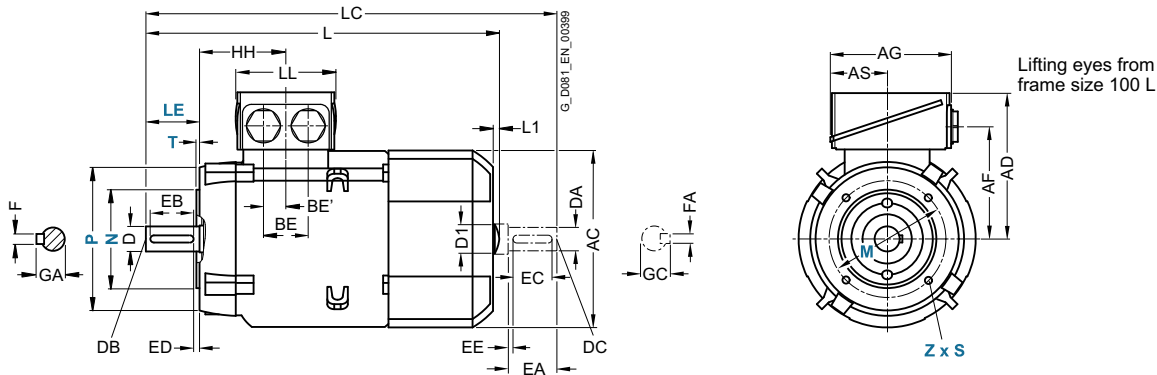

| For motor | | Dimension designation acc. to IEC | | | | | | | DE shaft extension | | | | | | NDE shaft extension | | | | | | | | | |
|------------|--------------------|-----------------------------------|-------|----|----|-----------------|-----|----|--------------------|-----|----|-----|-----|----|---------------------|----|----|----|-----|-----|----|----|----|----|
| Frame size | Motor type 1LE1092 | No. of poles | HH | K | K' | L ¹⁾ | L1 | D1 | LC | LL | D | DB | E | EB | ED | F | GA | DA | DC | EA | EC | EE | FA | GC |
| 100 L | All | 2, 4 | 96.5 | 12 | 16 | 395.5 | 7 | 32 | 454 | 112 | 28 | M10 | 60 | 50 | 5 | 8 | 31 | 24 | M8 | 50 | 40 | 5 | 8 | 27 |
| 112 M | All | 2, 4 | 96 | 12 | 16 | 389 | 7 | 32 | 450 | 112 | 28 | M10 | 60 | 50 | 5 | 8 | 31 | 24 | M8 | 50 | 40 | 5 | 8 | 27 |
| 132 S | All | 2, 4 | 115.5 | 12 | 16 | 465 | 8.5 | 39 | 535.5 | 130 | 38 | M12 | 80 | 70 | 5 | 10 | 41 | 28 | M10 | 60 | 50 | 5 | 8 | 31 |
| 132 M | All | 2, 4 | 115.5 | 12 | 16 | 465 | 8.5 | 39 | 535.5 | 130 | 38 | M12 | 80 | 70 | 5 | 10 | 41 | 28 | M10 | 60 | 50 | 5 | 8 | 31 |
| 160 M | All | 2, 4 | 155 | 15 | 19 | 604 | 10 | 45 | 730 | 145 | 42 | M16 | 110 | 90 | 10 | 12 | 45 | 42 | M16 | 110 | 90 | 10 | 12 | 45 |
| 160 L | All | 2, 4 | 155 | 15 | 19 | 604 | 10 | 45 | 730 | 145 | 42 | M16 | 110 | 90 | 10 | 12 | 45 | 42 | M16 | 110 | 90 | 10 | 12 | 45 |

¹⁾ The length is specified as far as the tip of the fan cover.

Standard induction motors optimized for converter operation – VSD10 line

Dimensions · Cast-iron series SIMOTICS SD

Standard Efficiency – self-ventilated · Frame sizes 100 L to 160 L

Dimensional drawings

Type of construction IM B3

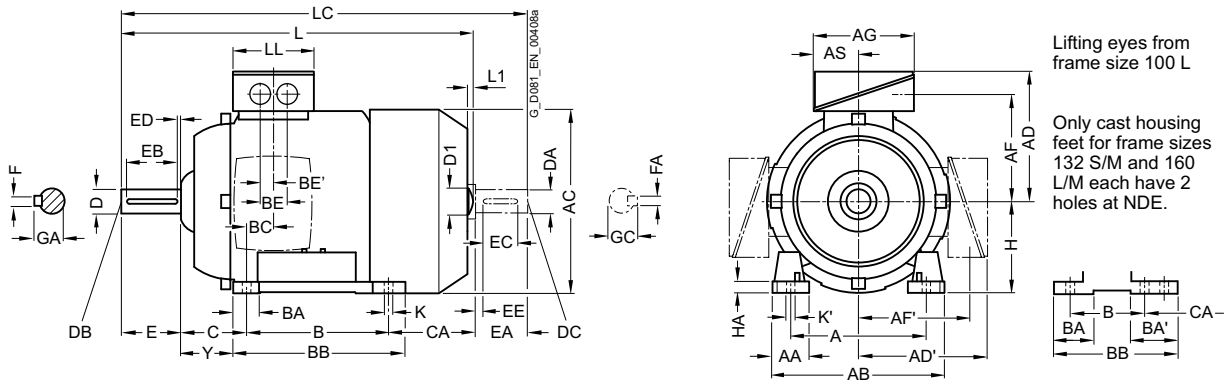

Types of construction IM B5 and IM V1

For flange dimensions, see page 1/47 (Z = the number of retaining holes)

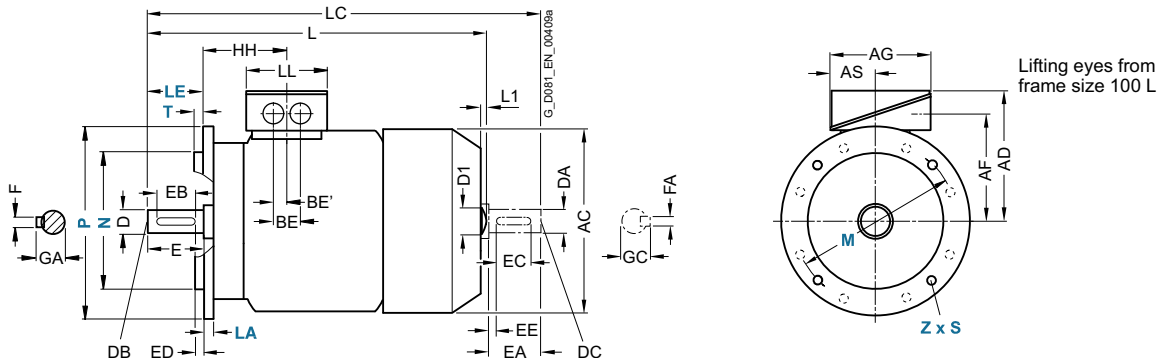

4

| For motor | Dimension designation acc. to IEC | | | | | | | | | | | | | | | | | | | | | | | |
|------------|-----------------------------------|--------------|-----|----|------------|-------|--------------|-------|-----|-----|-----|------|-----|------------------|-------------------|-------------------|------|----|-----|-----|-------|------------|----|----|
| Frame size | Motor type 1LE1592 | No. of poles | A | AA | AB | AC | AD | AD' | AF | AF' | AG | AS | B | BA | BA' | BB | BC | BE | BE' | C | CA | H | HA | Y |
| 100 L | All | 2, 4 | 160 | 42 | 196 | 217 | 193 | 193 | 147 | 147 | 163 | 80.5 | 140 | 48 | 48 | 176 | 37.5 | 48 | 24 | 63 | 141 | 100 | 12 | 45 |
| 112 M | All | 2, 4 | 190 | 46 | 226 | 239 | 195 | 195 | 150 | 150 | 163 | 80.5 | 140 | 48 | 48 | 176 | 30 | 48 | 24 | 70 | 130 | 112 | 12 | 52 |
| 132 S | All | 2, 4 | 216 | 53 | 256 | 281 | 214.5 | 214.5 | 169 | 169 | 163 | 80.5 | 140 | 52 ¹⁾ | 89 ¹⁾ | 218 ²⁾ | 26.5 | 48 | 24 | 89 | 166.5 | 132 | 15 | 69 |
| 132 M | All | 2, 4 | 216 | 53 | 256 | 281 | 214.5 | 214.5 | 169 | 169 | 163 | 80.5 | 178 | 52 ¹⁾ | 89 ³⁾ | 218 | 26.5 | 48 | 24 | 89 | 128.5 | 132 | 15 | 69 |
| 160 M | All | 2, 4 | 254 | 60 | 300 | 333.5 | 265 | 265 | 213 | 213 | 190 | 92 | 210 | 73 ⁴⁾ | 117 ⁴⁾ | 300 ⁵⁾ | 37 | 60 | 30 | 108 | 192 | 160 | 18 | 85 |
| 160 L | All | 2, 4 | 254 | 60 | 300 | 333.5 | 265 | 265 | 213 | 213 | 190 | 92 | 254 | 73 ⁴⁾ | 117 ⁶⁾ | 300 | 37 | 60 | 30 | 108 | 148 | 160 | 18 | 85 |

1) With screwed-on feet, this dimension is 41 mm.
 2) With screwed-on feet, this dimension is 180 mm.
 3) With screwed-on feet, this dimension is 79 mm.

4) With screwed-on feet, this dimension is 51 mm.
 5) With screwed-on feet, this dimension is 256 mm.
 6) With screwed-on feet, this dimension is 95 mm.

Standard induction motors optimized for converter operation – VSD10 line

Dimensions · Cast-iron series SIMOTICS SD

Standard Efficiency – self-ventilated · Frame sizes 180 M to 250 M

Dimensional drawings

Type of construction IM B35

For flange dimensions, see page 1/47 (**Z** = the number of retaining holes)

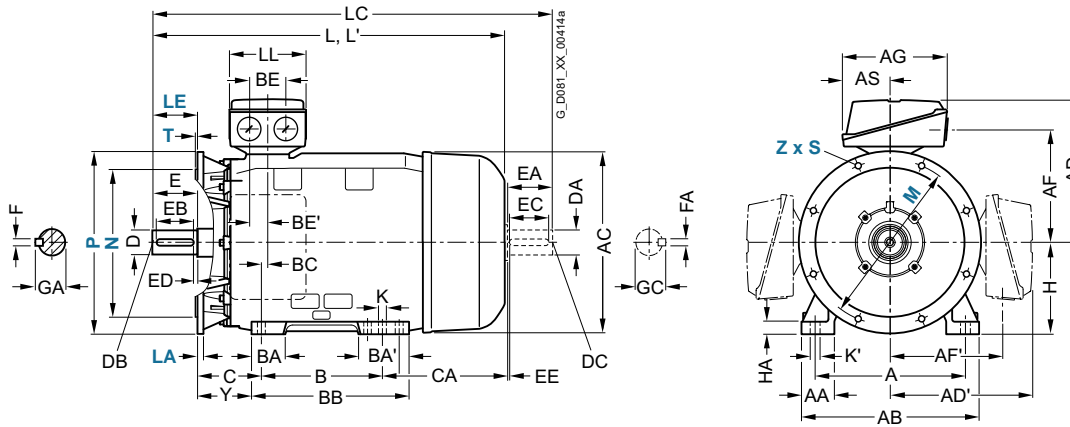

| For motor | | No. of poles | Dimension designation acc. to IEC | | | | | | | | | | DE shaft extension | | | | | NDE shaft extension | | | | | | | | |
|------------|---------------------|--------------|-----------------------------------|----|-----|-----|----|----|------------|-----|------|-----|--------------------|-----|-----|-----|----|---------------------|----|----|-----|-----|-----|----|----|------|
| Frame size | Motor type 1LE1592- | | H | HA | Y | HH | K | K' | L | L' | LC | LL | D | DB | E | EB | ED | F | GA | DA | DC | EA | EC | EE | FA | GC |
| 180 M | 1EA2 | 2 | 180 | 20 | 95 | 155 | 15 | 19 | 668 | 668 | 784 | 165 | 48 | M16 | 110 | 100 | 5 | 14 | 52 | 48 | M16 | 110 | 100 | 5 | 14 | 51.5 |
| | 1EB2 | 4 | | | | | | | 698 | 698 | 814 | | | | | | | | | | | | | | | |
| 180 L | 1EB4 | 4 | | | | | | | | | | | | | | | | | | | | | | | | |
| 200 L | 2AA4 | 2 | 200 | 25 | 108 | 164 | 19 | 25 | 721 | 755 | 835 | 197 | 55 | M20 | 110 | 100 | 5 | 16 | 59 | 55 | M20 | 110 | 100 | 5 | 16 | 59 |
| | 2AA5 | 2 | | | | | | | | | | | | | | | | | | | | | | | | |
| | 2AB5 | 4 | | | | | | | | | | | | | | | | | | | | | | | | |
| 225 S | 2BB0 | 4 | 225 | 34 | 124 | 164 | 19 | 25 | 788 | – | 903 | 197 | 60 | M20 | 140 | 125 | 10 | 18 | 64 | 55 | M20 | 110 | 100 | 5 | 16 | 59 |
| 225 M | 2BA2 | 2 | | | | | | | 818 | 852 | 933 | | 55 | | 110 | 100 | 5 | 16 | 59 | 48 | M16 | | | | 14 | 51.5 |
| | 2BB2 | 4 | | | | | | | 848 | – | 963 | | 60 | | 140 | 125 | 10 | 18 | 64 | 55 | M20 | | | | 16 | 59 |
| 250 M | 2CA2 | 2 | 250 | 40 | 138 | 192 | 24 | 30 | 887 | 924 | 1002 | 233 | 60 | M20 | 140 | 125 | 10 | 18 | 64 | 55 | M20 | 110 | 100 | 5 | 16 | 59 |
| | 2CB2 | 4 | | | | | | | – | – | 1032 | | 65 | | | | | | 69 | 60 | | 140 | 125 | 10 | 18 | 64 |

Standard induction motors optimized for converter operation – VSD10 line

Dimensions · Cast-iron series SIMOTICS SD

Standard Efficiency – self-ventilated · Frame sizes 280 S to 315 L

Dimensional drawings

Type of construction IM B3

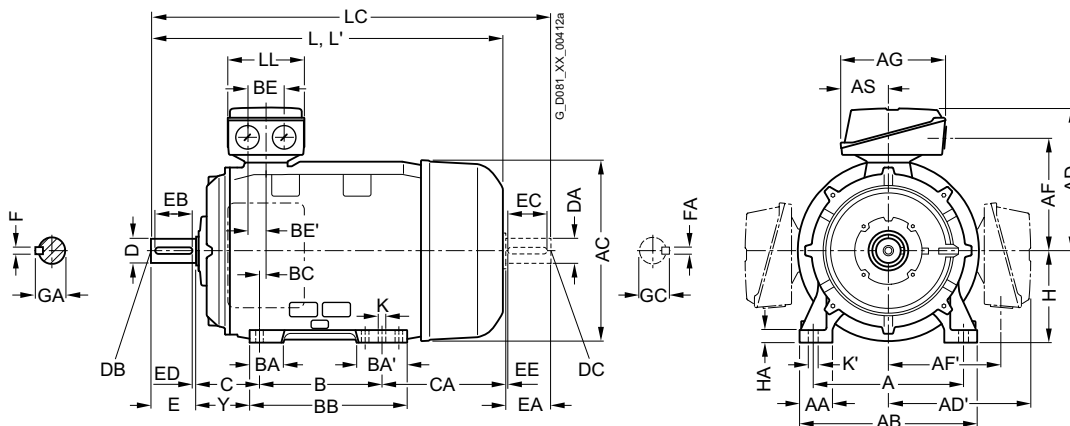

Types of construction IM B5 and IM V1

For flange dimensions, see page 1/47 (Z = the number of retaining holes)

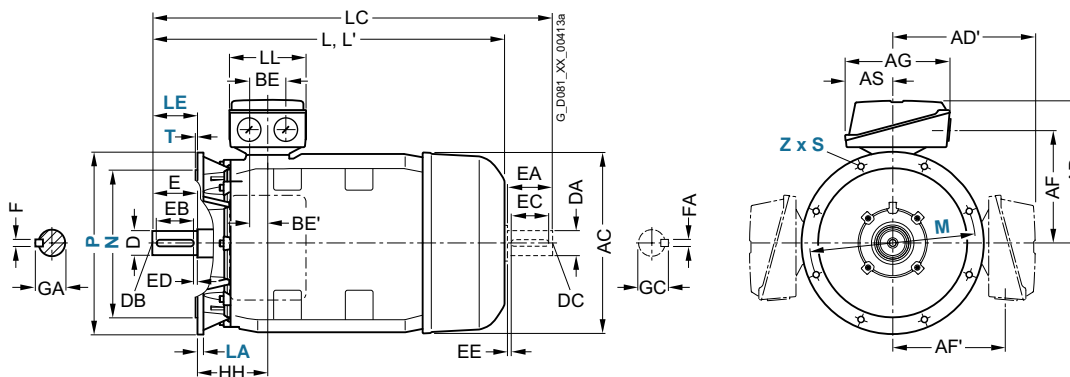

4

| For motor | | | Dimension designation acc. to IEC | | | | | | | | | | | | | | | | | | |
|---------------------|--------------------|--------------|-----------------------------------|-----|-----|-----|-----|-----|-----|-----|-----|-----|-----|-----|-----|-----|----|-----|-----|-----|-----|
| Frame size | Motor type | No. of poles | A | AA | AB | AC | AD | AD' | AF | AF' | AG | AS | B | BA | BA' | BB | BC | BE | BE' | C | CA |
| 280 S | 2DA0 | 2 | 457 | 100 | 540 | 551 | 433 | 433 | 345 | 345 | 319 | 145 | 368 | 101 | 152 | 479 | 20 | 110 | 55 | 190 | 267 |
| | 2DB0 | 4 | | | | | | | | | | | | | | | | | | | |
| 280 M | 2DA2 | 2 | 457 | 100 | 540 | 551 | 433 | 433 | 345 | 345 | 319 | 145 | 419 | 101 | 152 | 479 | 20 | 110 | 55 | 190 | 216 |
| | 2DB2 | 4 | | | | | | | | | | | | | | | | | | | |
| 315 S | 3AB0 | 4 | 508 | 120 | 610 | 616 | 515 | 515 | 404 | 404 | 374 | 164 | 406 | 113 | 170 | 527 | 22 | 110 | 55 | 216 | 295 |
| 315 M | 3AB2 ¹⁾ | 4 | 508 | 120 | 610 | 616 | 515 | 515 | 404 | 404 | 374 | 164 | 457 | 113 | 170 | 578 | 22 | 110 | 55 | 216 | 409 |
| 315 L ¹⁾ | 3AB4 | 4 | 508 | 120 | 610 | 616 | 515 | 515 | 404 | 404 | 374 | 164 | 508 | 113 | 170 | 578 | 22 | 110 | 55 | 216 | 358 |
| | 3AB5 | 4 | | | | | | | | | | | | | | | | | | | |

¹⁾ For orders with screwed-on feet (order code **H01**), these screwed-on feet have 3 drilled holes on the NDE side with the dimension B 406 mm, 457 mm, and 508 mm respectively; the dimension BB is 666 mm.

Standard induction motors optimized for converter operation – VSD10 line

Dimensions · Cast-iron series SIMOTICS SD

Standard Efficiency – self-ventilated · Frame sizes 280 S to 315 L

Dimensional drawings

Type of construction IM B35

For flange dimensions, see page 1/47 (**Z** = the number of retaining holes)

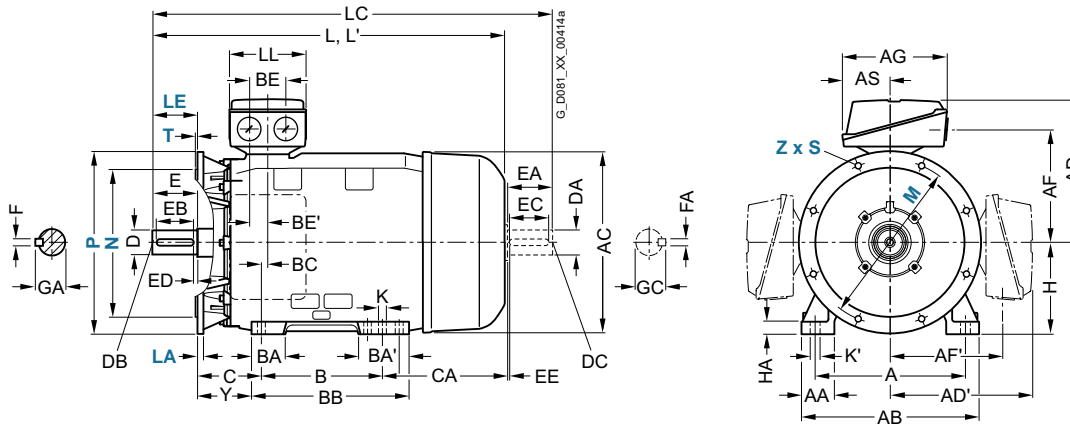

| For motor | | | Dimension designation acc. to IEC | | | | | | | | | | DE shaft extension | | | | | NDE shaft extension | | | | | | | | |
|---------------------|---------------------|--------------|-----------------------------------|----|-----|-----|----|----|-------------|-----|------|-----|--------------------|-----|-----|-----|----|---------------------|----|----|-----|-----|-----|----|----|------|
| Frame size | Motor type 1LE1592- | No. of poles | H | HA | Y | HH | K | K' | L | L' | LC | LL | D | DB | E | EB | ED | F | GA | DA | DC | EA | EC | EE | FA | GC |
| 280 S | 2DA0 | 2 | 280 | 40 | 160 | 210 | 24 | 30 | 960 | 998 | 1105 | 233 | 65 | M20 | 140 | 125 | 10 | 18 | 69 | 60 | M20 | 140 | 125 | 10 | 18 | 64 |
| | 2DB0 | 4 | | | | | | | | | | | | | | | | | | | | | | | | |
| 280 M | 2DA2 | 2 | 280 | 40 | 160 | 210 | 24 | 30 | 960 | 998 | 1105 | 233 | 65 | M20 | 140 | 125 | 10 | 18 | 69 | 60 | M20 | 140 | 125 | 10 | 18 | 64 |
| | 2DB2 | 4 | | | | | | | | | | | | | | | | | | | | | | | | |
| 315 S | 3AB0 | 4 | 315 | 50 | 181 | 238 | 28 | 35 | 1082 | – | 1227 | 299 | 80 | M20 | 170 | 140 | 25 | 22 | 85 | 70 | M20 | 140 | 125 | 10 | 20 | 74.5 |
| 315 M | 3AB2 ¹⁾ | 4 | 315 | 50 | 181 | 238 | 28 | 35 | 1247 | – | 1392 | 299 | 80 | M20 | 170 | 140 | 25 | 22 | 85 | 70 | M20 | 140 | 125 | 10 | 20 | 74.5 |
| 315 L ¹⁾ | 3AB4 | 4 | 315 | 50 | 146 | 238 | 28 | 35 | 1247 | – | 1547 | 299 | 80 | M20 | 170 | 140 | 25 | 22 | 85 | 70 | M20 | 140 | 125 | 10 | 20 | 74.5 |
| | 3AB5 | 4 | | | | | | | | | | | | | | | | | | | | | | | | |

¹⁾ For orders with screwed-on feet (order code **H01**), these screwed-on feet have 3 drilled holes on the NDE side with the dimension B 406 mm, 457 mm, and 508 mm respectively; the dimension BB is 666 mm.

Standard induction motors optimized for converter operation – VSD10 line

Notes



| | |
|-------------|---|
| 5/2 | Orientation |
| 5/25 | Article number code |
| 5/26 | Zones 21, 22, and 2 with types of protection Ex tb, Ex tc, Ex ec |
| 5/26 | IE4 Super Premium Efficiency |
| 5/26 | • Cast-iron series 1MB55 – self-ventilated |
| 5/27 | IE3 Premium Efficiency |
| 5/27 | • Aluminum series 1MB10 – self-ventilated |
| 5/28 | • Cast-iron series 1MB15, 1MB16 – self-ventilated |
| 5/31 | • Cast-iron series 1MB55, 1MB58 – self-ventilated |
| 5/33 | IE2 High Efficiency |
| 5/33 | • Aluminum series 1MB10 – self-ventilated |
| 5/35 | • Cast-iron series 1MB15, 1MB16 – self-ventilated |
| 5/39 | IE1 Standard Efficiency |
| 5/39 | • Aluminum series 1MB10 – self-ventilated |
| 5/41 | Zone 1 with type of protection Ex eb |
| 5/41 | IE3 Premium Efficiency |
| 5/41 | • Cast-iron series 1MB1543, 1MB1643, 1MB5543, 1MB5643 – self-ventilated |
| 5/47 | Zone 1 with types of protection Ex db, Ex db eb |
| 5/47 | IE3 Premium Efficiency |
| 5/47 | • Cast-iron series 1MB15, 1MB55 self-ventilated |
| 5/51 | Article No. supplements and special versions |
| 5/51 | Voltages |
| 5/56 | Types of construction |
| 5/68 | Motor protection |
| 5/73 | Terminal box position |
| 5/78 | Options |
| 5/101 | Accessories |

| | |
|--------------|--|
| 5/102 | Dimensions |
| 5/102 | Notes on the dimensions |
| 5/103 | Dimension sheet generator |
| 5/104 | Dimensions · Aluminum series SIMOTICS XP |
| 5/104 | IE3 – 1MB1 with types of protection Ex tb, Ex tc, Ex ec – self-ventilated |
| 5/104 | • Frame sizes 80 M to 160 L |
| 5/106 | IE2, IE1 – 1MB1 with types of protection Ex tb, Ex tc, Ex ec – self-ventilated |
| 5/106 | • Frame sizes 80 M to 160 L |
| 5/108 | Dimensions · Cast-iron series SIMOTICS XP |
| 5/108 | IE4, IE3 – 1MB5 with types of protection Ex tb, Ex tc, Ex ec – self-ventilated |
| 5/108 | • Frame sizes 400 and 450 |
| 5/110 | IE3 – 1MB1 with types of protection Ex tb, Ex tc, Ex ec – self-ventilated |
| 5/112 | • Frame sizes 71 M to 160 L |
| 5/112 | • Frame sizes 180 M to 315 L |
| 5/114 | IE3 – 1MB1 with type of protection Ex eb – self-ventilated |
| 5/114 | • Frame sizes 71 M to 160 L |
| 5/116 | • Frame sizes 180 M to 280 M |
| 5/118 | IE3 – 1MB5 with type of protection Ex eb – self-ventilated |
| 5/118 | • Frame sizes 315 S to 315 L |
| 5/120 | IE3 – 1MB1 with type of protection Ex db, Ex db eb – self-ventilated |
| 5/122 | • Frame sizes 71 M to 160 L |
| 5/122 | • Frame sizes 180 M to 280 M |
| 5/124 | IE3 – 1MB5 with type of protection Ex db, Ex db eb – self-ventilated |
| 5/124 | • Frame sizes 315 S to 355 L |
| 5/126 | IE2 – 1MB1 with types of protection Ex tb, Ex tc, Ex ec – self-ventilated |
| 5/128 | • Frame sizes 71 M to 160 L |
| 5/130 | • Frame sizes 180 M to 250 M |
| 5/130 | • Frame sizes 280 S to 315 L |

SIMOTICS XP 1MB1, 1MB5 explosion-protected motors

Orientation

Overview

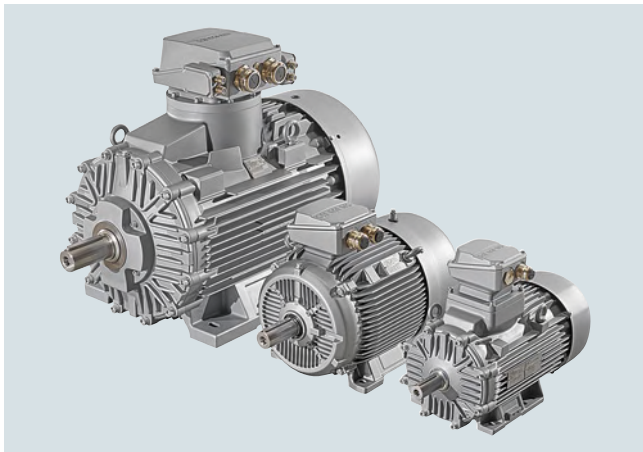

In many industrial and public sectors, explosion protection or explosion hazards are ever-present, e.g. in the chemicals industry, in refineries, on drilling platforms, at gas stations, in feed manufacturing and in sewage treatment plants.

The risk of explosion is always present when gases, fumes, mist or dust are mixed with oxygen in the air in an explosive ratio close to sources of ignition that are able to release the so-called minimum ignition energy.

In the chemical and petrochemical industries in particular, when crude oil and natural gas are transported, or in mining, milling (e.g. grain and granular solids), this can result in serious injury to persons and damage to equipment.

To ensure maximum safety in these areas, legislators in most countries have implemented appropriate stipulations in the form of laws and regulations based on national and international standards.

Explosion-protected equipment is designed such that an explosion can be prevented when it is used properly.

The explosion-protected equipment can be designed in accordance with various types of protection.

The local conditions must be subdivided into specified zones by the user with the assistance of the responsible authorities in accordance with the frequency of occurrence of an explosion hazard. Device (equipment) categories are assigned to these zones. The zones are then subdivided into possible types of protection and therefore into possible equipment (product) types.

Classification of zones

Areas subject to explosion hazard are divided into zones. Division into zones depends on the chronological and geographical probability of the presence of a hazardous, potentially explosive atmosphere. Information and specifications for classification of the zones are laid down in the following standards:

- IEC/EN 60079-10-1 for gas atmospheres
- IEC/EN 60079-10-2 for dust atmospheres

Further, a distinction is made between various explosion groups as well as temperature classes and these are included in the hazard assessment.

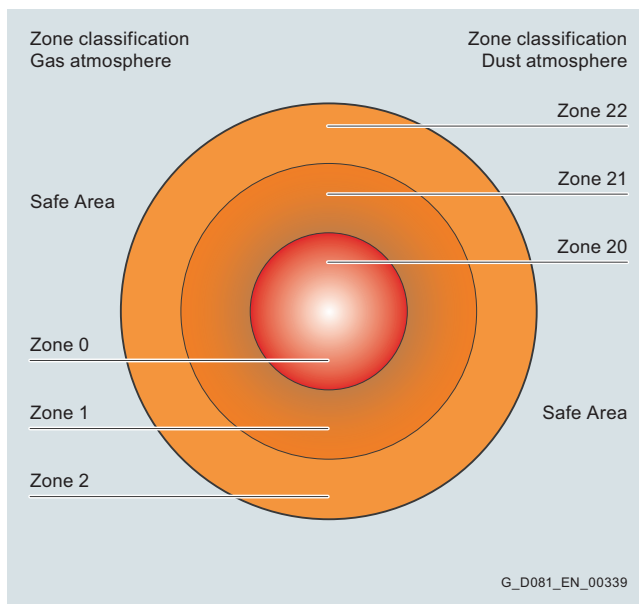

Depending on the particular zone and therefore the associated hazard, operating equipment must comply with defined minimum requirements regarding the type of protection. The different types of protection require corresponding measures to prevent ignition that should be implemented at the motor in order to prevent a surrounding explosive atmosphere from being ignited.

Note:

According to the standard IEC/EN 60079-7:2015, the previous designations of the types of protection Ex e and Ex nA have been changed to **Ex eb** and **Ex ec** respectively. The expiration date of the previous designations was July 31, 2018.

Overview

| Zone | Zone definition acc. to | Assigned types of protection | Category according to 2014/34/EU | Equipment protection level acc. to IEC/EN 60079-0 |
|----------------------|--|---|----------------------------------|---|
| Gas 1) 2) Dust 1) 2) | IEC/EN 60079-10-1 for gas atmospheres IEC/EN 60079-10-2 for dust atmospheres | | | |
| 0 | - An area in which an explosive gas atmosphere is present continuously, over a long period or frequently . | Low-voltage motors not permitted | 1 | Ga |
| 1 | - An area in which it is expected that an explosive gas atmosphere will be present occasionally during normal operation. | Ex eb (previously Ex e), EX db eb (previously EX de); Ex db (previously Ex d) | 2 | Gb |
| 2 | - An area in which it is expected that an explosive gas atmosphere will be present only rarely and then only for a short period during normal operation. | Ex ec (previously, Ex nA) | 3 | Gc |
| - 20 | An area in which there is an explosive gas atmosphere comprising a dust-air mixture continuously, over long periods or frequently . | Low-voltage motors not permitted | 1 | Da |
| - 21 | An area in which it is expected that an explosive gas atmosphere comprising a dust-air mixture will be present occasionally during normal operation. | Ex tb ³⁾ | 2 | Db |
| - 22 | An area in which it is expected that an explosive gas atmosphere in the form of a cloud of combustible dust in air will be present only rarely and then only for a short period during normal operation. | Ex tc ⁴⁾ | 3 | Dc |

Changes to the Ex marking

In accordance with the latest edition of the standards for "Flameproof enclosure" and "Increased safety" types of protection, there is a change to how devices and equipment are marked. The type of protection "Non-sparking" Ex nA acc. to IEC/EN 60079-15 has been integrated into the latest edition of the standard for "Increased safety" according to IEC/EN 60079-7 as Ex ec. This has the following effect on the Ex marking:

- "Increased safety" for Zone 1 and Zone 2 (previously Ex e):
II 2G Ex eb IIC T3 Gb
- "Increased safety" for Zone 2 (previously Ex nA):
II 3G Ex ec IIC T3 Gc
- Flameproof enclosure for Zone 1 and Zone 2 (previously Ex d):
II 2G Ex db IIC T4 Gb

There are no changes for the user other than the device marking.

Overview of standards for explosion protection

The explosion-protected three-phase motors comply with European standards. The European standards are recognized by all member states of CENELEC (European Committee for Electrotechnical Standardization). The national electrotechnical committees of Austria, Belgium, Czech Republic, Denmark, Finland, France, Germany, Greece, Iceland, Ireland, Italy, Luxembourg, Netherlands, Norway, Spain, Sweden, Switzerland, Portugal, and United Kingdom (UK) are members of CENELEC.

| Title | European standard |
|---|-------------------|
| General provisions | EN 60079-0 |
| Flameproof enclosure "d" | EN 60079-1 |
| Increased safety "e" | EN 60079-7 |
| Zone classification (gases, vapors, mist) | EN 60079-10-1 |
| Zone classification (dust) | EN 60079-10-2 |
| Intrinsic safety "i" | EN 60079-11 |
| Electrical equipment in potentially explosive atmospheres (gases, vapors, mist) | EN 60079-14 |
| Maintenance of Ex equipment | EN 60079-17 |
| Intrinsically safe electrical systems | EN 60079-25 |
| Equipment "Dust" (dust explosion protection by housing) "t" | EN 60079-31 |
| Equipment "Dust" | EN 50281-2-1 |
| Equipment "Dust" | EN 61241-2-2 |
| Basic concepts and methodology | EN 1127-1 |

1) Motors of
- Zone 1 can also be used in Zone 2
- Zone 21 can also be used in Zone 22

2) Motors which are certified for gas or dust protection must not be used in hybrid mixtures! Hybrid mixtures:
Explosive gas and dust atmospheres are present simultaneously.

3) SIMOTICS XP motors with type of protection Ex tb are intended for group IIIC as a general rule, i.e. they are permitted for operation in environments with conductive and non-conductive dust.

4) SIMOTICS XP motors with type of protection Ex tc are intended for group IIIB as a general rule, i.e. they are not permitted for operation in environments with conductive dust.

SIMOTICS XP 1MB1, 1MB5 explosion-protected motors

Orientation

Overview

Temperature classes and groups

Combustible gases and vapors are divided into temperature classes according to their ignitability and into groups according to their spark ignition capacity. The marking of a three-phase motor with the codes for the type of protection, group and temperature class specifies that it can be used without danger in hazardous areas depending on the zone classification. The numerical sequence of the codes for the group and temperature class has been selected so that motors that satisfy the requirements for a certain group and temperature class also satisfy the requirements for lower groups and classes.

Temperature classes

| Temperature class of electrical equipment | Maximum surface temperature of electrical equipment | Ignition temperature of gases or vapors |
|---|---|---|
| T1 | 450 °C | > 450 °C |
| T2 | 300 °C | > 300 °C |
| T3 | 200 °C | > 200 °C |
| T4 | 135 °C | > 135 °C |
| T5 | 100 °C | > 100 °C |
| T6 | 85 °C | > 85 °C |

Examples of the assignment of combustible gases and vapors

| Group | Temperature classes | | | | | | | | | | | | |
|-------------------|----------------------|-------------------------|----------------------|-------------------------|----------------------------|-------------------------|----------------------|-------------------------|----------------------|-------------------------|----------------------|-------------------------|--|
| | T1 | | T2 | | T3 | | T4 | | T5 | | T6 | | |
| | Material designation | Ignition temperature °C | Material designation | Ignition temperature °C | Material designation | Ignition temperature °C | Material designation | Ignition temperature °C | Material designation | Ignition temperature °C | Material designation | Ignition temperature °C | |
| IIA ¹⁾ | Acetone | 540 | i-Amyl acetate | 380 | Naphthas | | Acetaldehyde | 140 | | | | | |
| | Ethane | 515 | n-Butane | 365 | Petrol fuels ²⁾ | | | | | | | | |
| | Ethyl acetate | 460 | n-Butyl alcohol | 340 | Mineral spirits | | | | | | | | |
| | Ethyl chloride | 510 | Cyclohexanone | 430 | Diesel fuels ²⁾ | | | | | | | | |
| | Ammonia | 630 | 1,2-Dichloroethane | 440 | Heating oils ²⁾ | | | | | | | | |
| | Benzene | 555 | Acetic anhydride | 330 | n-Hexane | 240 | | | | | | | |
| | Acetic acid | 485 | | | | | | | | | | | |
| | Carbon monoxide | 605 | | | | | | | | | | | |
| | Methane | 595 | | | | | | | | | | | |
| | Methanol | 455 | | | | | | | | | | | |
| | Methyl chloride | 625 | | | | | | | | | | | |
| | Naphtalene | 520 | | | | | | | | | | | |
| | Phenol | 595 | | | | | | | | | | | |
| | Propane | 470 | | | | | | | | | | | |
| Toluene | 535 | | | | | | | | | | | | |
| IIB ¹⁾ | Coal gas (town gas) | 560 | Ethanol | 425 | Hydrogen sulfide | 270 | Ethyl ether | 180 | | | | | |
| | | | Ethylene | 425 | | | | | | | | | |
| | | | Ethylene oxide | 440 | | | | | | | | | |
| IIC ¹⁾ | Hydrogen | 560 | Acetylene | 305 | | | | | Carbon disulfide | | | 95 | |

Explosion Protection Directive 2014/34/EU

Explosion protection has been fully harmonized by Directive 2014/34/EU in Germany and in the other member states of the European Union. The requirements of the new law came into force on April 20, 2016. Since then only those devices and protection systems that comply with Directive 2014/34/EU are permitted to be placed on the market.

Directive 2014/34/EU and Directive 1999/92/EC specify that only specific electrical equipment and devices are permitted to be used in the zones. The devices are assigned to equipment groups and categories.

Use of electrical equipment in accordance with EN 60079-14

Electrical equipment used in potentially explosive workshops and storage areas must comply with EN 60079-14/ VDE 0165-1 "Explosive atmospheres - Part 14: Electrical installations design, selection and erection". All other general regulations issued by the responsible supervisory authorities and the Employer's Liability Insurance Association or any specifically issued for individual case are also applicable. A plant or system subject to inspection is not permitted to be commissioned initially or following a significant modification until the plant or system has been inspected by an approved inspection agency for correctness of assembly, installation, site conditions and safe operation, taking into account the intended mode of operation. Devices compliant with Directive 2014/34/EU are permitted to be commissioned in accordance with the responsible supervisory authority. (cf. German Health and Safety at Work Regulations (BetrSichV), section 3, § 14)

¹⁾ Subgroups IIA, IIB and IIC must be specified for the types of protection Ex db, Ex eb and Ex ec described in this list in accordance with EN 60079-0.

²⁾ The minimum ignition temperature depends on the composition and lies between 220 to 300 °C, over 300 °C in special cases.

Overview

Device marking

The equipment group and category are specified in the device marking.

The device marking is defined as follows:

e.g. CE 0158 $\langle \text{Ex} \rangle$ II 2G Ex eb IIC T3 Gb

- **CE** conformity marking
CE stands for "Communautés Européennes" (European Communities)
The manufacturer of the explosion-protected devices declares by means of CE marking that the relevant product has been manufactured in accordance with all applicable regulations and requirements of the EU and the requirements laid down in Directive 2014/34/EU and the product has been subjected to the relevant conformity evaluation process.
- **0158** identification number of the inspecting authority (DEKRA)
- $\langle \text{Ex} \rangle$ Marking for prevention of explosions in accordance with Directive 2014/34/EU

Example "increased safety":

| | CE | 0158 | $\langle \text{Ex} \rangle$ | II | 3 | G | Ex | ec | IIC | T3 | Gc |
|--|----|------|-----------------------------|----|---|---|----|----|-----|----|----|
| CE marking | | | | | | | | | | | |
| Number of the certifying "notified" body (0158 = DEKRA) | | | | | | | | | | | |
| Explosion protection marking | | | | | | | | | | | |
| Equipment group: I = Underground II = All other areas | | | | | | | | | | | |
| Category: 2 (Zone 1/21) 3 (Zone 2/22) | | | | | | | | | | | |
| Ex atmosphere G = Gas D = Dust | | | | | | | | | | | |
| Explosion-protected equipment | | | | | | | | | | | |
| Type of protection Ex db, db eb, eb, ec, tb or tc (db eb = motor housing Ex db with terminal box Ex eb) | | | | | | | | | | | |
| Explosion group and explosion subgroup II = Gas (IIA, IIB or IIC) III = Dust (IIIA, IIIB or IIIC) | | | | | | | | | | | |
| Temperature class with max. surface temperature T1 = 450 °C T4 = 135 °C T2 = 300 °C T5 = 100 °C T3 = 200 °C T6 = 85 °C | | | | | | | | | | | |
| Equipment protection level (G = Gas; D = Dust): Ga = Very high protection, Da = Very high protection, Gb = High protection, Db = High protection, Gc = Increased protection, Dc = Increased protection | | | | | | | | | | | |

SIMOTICS XP 1MB1, 1MB5 explosion-protected motors

Orientation

Overview

Overview of SIMOTICS XP 1MB1, 1MB5 explosion-protected motors

The table below contains a complete overview of our products, their types of protection and the assignment of motor types to categories. It is important to note that depending on whether the

motor is used for converter operation or line operation, different order codes are required for unique selection of the required product.

| Sector | Cate- gory | Zone | Frequency of occurrence of the Ex atmosphere | Type of protection | Tempera- ture class | Equip- ment protec- tion level | Degree of pro- tection | Motor type and if applica- ble order code | Operation | Order code | Utilization according to tem- perature class | Standard |
|---|----------------|---------------|---|--|---|--|------------------------------|---|--------------------------|--------------------------|--|-----------------------------------|
| Gases and vapors (G) | 1G | 0 | constantly or long-term | Not admissible with low-voltage motors | | | | | | | | |
| | 2G | 1 | occasionally | Ex db eb IIC ¹⁾ (flameproof enclosure) | T1 – T4 | Gb | IP55 | 1MB1.5, 1MB5.5 | Line | – | 130 (B) | IEC/EN 60079-0 |
| | | | | Ex eb IIC ¹⁾ (increased safety) | T1 – T3 | | | | Converter | B43 B44 | 130 (B) 155 (F) | IEC/EN 60079-1 IEC/EN 60079-7 |
| | 3G | 2 | rarely or for a short period | Ex ec IIC ¹⁾ (increased safety) | | Gc | | 1MB103, 1MB153, 1MB163 | Line | – | 130 (B) | IEC/EN 60079-0 |
| | | | | | Converter | | | | B40 B41 | | IEC/EN 60079-7 | |
| Dust (D) | 1D | 20 | constantly or long-term | Not admissible with low-voltage motors | | | | | | | | |
| | 2D | 21 | occasionally | Ex tb IIIC ¹⁾ : Conductive and non-conductive dust | Max. housing temperature T120 °C ⁴⁾ | Db | IP65 | 1MB101, 1MB151, 1MB161 | Line | – | 130 (B) | IEC/EN 60079-0 |
| | | | | Ex tc IIIB ¹⁾ : non-conductive dust | | | | | Dc | IP55 | 1MB102, 1MB152, 1MB162 | Converter |
| Gases and vapors (G) and dusts (D) ³⁾ | 2G or 2D | 1 or 21 | occasionally | Ex db eb IIC ¹⁾ (flameproof enclosure)/ Ex tb IIIC ¹⁾ : Conductive and non-conductive dust | T1 – T4/ Max. housing temperature T130 °C | Gb Db | IP65 | 1MB1.5 +B32, 1MB5.5 +B32 | Line | – | 130 (B) | IEC/EN 60079-0 |
| | 3G or 3D | 2 or 22 | rarely or for a short period | Ex ec IIC ¹⁾ (increased safety)/ Ex tc IIIB: non-conductive dust | T1 – T3/ Max. housing temperature T120 °C ⁴⁾ | Gc Dc | IP55 | 1MB103 +B30 1MB153 +B30 1MB163 +B30 | Line | – | 130 (B) | IEC/EN 60079-0 |
| | | | | | | | | | Converter | B40 B41 | | IEC/EN 60079-1 IEC/EN 60079-31 |

¹⁾ Highest explosion group IIC includes IIB and IIA.
IIIA stands for lint, IIIB for non-conductive dust and IIIC for conductive dust. 1MB155, 1MB555 motors optionally with Ex db terminal box.

²⁾ See EU type-examination certificate.

³⁾ The Ex motor is not admissible in an explosive atmosphere of dust and air (hybrid). A standard is not currently available that describes the product requirements for a hybrid mixture.

⁴⁾ For 1MB1 IE1: T140 °C
IE2: T120 °C (except T130 °C for 1MB1.11-1AD5,
1MB1.11-3AD6, 1MB1.21-1AD5 and 1MB1.21-3AD6)
IE3: T120 °C.
For 1MB5 frame sizes 400 and 450: T125 °C.

Benefits

The explosion-protected motors from Siemens offer the user numerous advantages:

- The motors are designed and constructed in accordance with Directive 2014/34/EU. As product supplier, Siemens accepts responsibility for compliance with the applicable product standards for the selected equipment.
- By using this product, the plant operating company complies with Directive 1999/92/EC in accordance with Appendix II B (ATEX 137 previously ATEX 118a). The plant manufacturer or plant operating company is responsible for correct selection and proper usage of the equipment.
- Comprehensive series of Ex motors for protection against gas and dust.
- Individual versions of motors are possible thanks to the numerous catalog options.
- Further special versions are possible on request.
- Declarations of compliance with the order 2.1 are available for a defined spectrum of Siemens motors/converters.
- The operating instructions are available in all 23 official EU languages as well as Russian, Turkish and Chinese.
- Certificates: ATEX, IECEx, CQST, EACEx

For applications in harsh environments: SIMOTICS XP motors with a cast-iron housing

The right motor for various challenges

The following motor series are available with cast-iron housings for applications in harsh, hazardous environments:

- **Basic Line:**
Rugged, reliable motors for machine construction
- **Performance Line:**
Motors for the process industry with reinforced bearings and a more rugged coating – for requirements that extend beyond the Basic Line

Comparison: Basic Line versus Performance Line

| Function | Basic Line – 1MB15 | Performance Line – 1MB16 |
|--------------------------------------|--|---|
| Bearing size | 62, 63 from frame size 280 upwards | 63 |
| Relubrication | Optional, standard from frame size 280 upwards | Standard from frame size 160 upwards, optional for frame sizes 100 to 132 |
| Paint system | Standard paint finish, corrosivity category C2 | Special paint finish, corrosivity category C3 |
| Drainage | Drain plug from frame size 100 upwards | Drain plug from frame size 100 upwards |
| Rating plate made of stainless steel | Standard from frame size 225 upwards, optional for frame sizes 71 to 200 | Standard from frame size 100 upwards |
| Motor protection | Optional | PTC |
| Fan cover | Steel | Steel |
| Warranty | 12 months | 36 months |

Application

The explosion-protected motors are used in the following sectors to prevent explosion hazards that result in serious injury to persons and severe damage to equipment.

- Chemical and petrochemical industry
- Production of mineral oil and gas
- Gas works
- Gas utility companies
- Gas stations
- Coking plants
- Mills (e.g. grain, solids)
- Sewage treatment plants
- Wood processing (e.g. sawdust, tree resin)
- Other industries subject to explosion hazards

Technical specifications

General information

Ex motors are suitable for operation in electrical power systems with a voltage tolerance of $\pm 10\%$.

Ex motors in vertical type of construction with shaft extension pointing down must have a protective cover.

Standard certificate: EU type-examination certificate (ATEX) and EU declaration of conformity, optionally IECEx, CQST and EACEx.

Note:

For all explosion-protected motors, designs according to UL and CSA are not possible.

Operating instructions are supplied as standard with explosion-protected motors in English and German. Translations are also available in all the other official EU languages as well as in Russian, Turkish, and Chinese online and on DVD.

Ambient temperature

- Standard: -20 to $+40$ °C
- Optional: -40 to $+40$ °C (order code **D03**)
- Optional: -20 to $+60$ °C (order codes **N05, N06, N07, N08**)

From 40 °C, the power is reduced. Other temperatures are available on request.

Note on Ex eb (1MB1.4):

Order codes **N05, N06, N07, N08** currently on request.

Motor connection

Certified metric cable glands/sealing plugs are included in the scope of supply of 1MB1 and 1MB5 motors.

The certificates for the motors for hazardous areas are stored with the documentation in the DT Configurator.

Certified motor protection switches/tripping units must always be used for motor protection, see Catalog IC 10.

SIMOTICS XP 1MB1, 1MB5 explosion-protected motors

Orientation

Technical specifications

Type of protection "Dust explosion protection" Ex tb, Ex tc acc. to IEC/EN 60079-31 for use in Zone 21, Zone 22.

The types of protection **Ex tb** and **Ex tc** apply to electrical equipment protected using a housing and with limited surface temperature for use in areas in which combustible dust can be present in concentration levels that could cause a fire or an explosion.

Measures are taken to prevent impermissibly high temperatures and to prevent sparks or arcs from occurring on external components of the motor.

Ex tb motors are used in areas where it is expected that an explosive atmosphere comprising dust/air mixtures will be present occasionally and for a short period.

These motors are assigned to Equipment Group II – Category 2D (corresponding to Zone 21). SIMOTICS XP motors with type of protection Ex tb are intended for group IIIC, i.e. they are permitted for operation in environments with conductive and non-conductive dust.

Ex tc motors are used in areas where it is expected that a potentially-explosive atmosphere will be caused by dust that is stirred up. If this does occur, in all probability rarely and for a short period. These motors are assigned to Equipment Group II – Category 3D (corresponding to Zone 22). SIMOTICS XP motors with type of protection Ex tc are intended for group IIIB as a general rule, i.e. they are only permitted for operation in environments with non-conductive dust.

Ex tb IIIC T120 °C Gb for use in Zone 21:



Design for Zone 21, as well as Zone 22 for conductive dust (degree of protection: IP65) equipment category 2D. Motors Ex tb IIIC T120 °C Db ¹⁾: 1MB1.1 and 1MB5.1 are suitable for use in explosive dust atmospheres with conductive or non-conductive dust that are present occasionally (Zone 21) or rarely (Zone 22). For rated operation, the surface temperature is 120 °C ¹⁾.

Ex tc IIIB T120 °C Gc for use in Zone 22:

Version for Zone 22 with non-conductive dust (degree of protection IP55) equipment category 3D. Motors Ex tc IIIB T120 °C Dc ¹⁾: 1MB1.2 and 1MB5.2 are suitable for use in explosive dust atmospheres with non-conductive dust that are present rarely (Zone 22). For rated operation, the surface temperature is 120 °C ¹⁾.

The motors have a terminal box, a sealing system, an external grounding terminal, a metal fan cover and a metal external fan according to standard IEC/EN 60079-0.

Identification on the rating plate:

- Zone 21:  II 2D Ex tb IIIC T120 °C Db ¹⁾
- Zone 22:  II 3D Ex tc IIIB T120 °C Dc ¹⁾

Number of the EU type-examination certificate

Pole-changing versions:

- Ex tb (Zone 21): Not possible
- Ex tc (Zone 22): Possible on request.

Type of protection "increased safety" Ex ec acc. to IEC/EN 60079-7 for use in Zone 2

Type of protection **Ex ec** ensures that a motor in normal operation as well as when operated under deviating conditions as specified in the standard is not able to ignite a surrounding explosive gas atmosphere. The maximum surface temperature that can occur during operation must be below the limit temperature of the temperature class marked on the motor, e.g. T3.

Measures are taken to prevent impermissibly high temperatures and to prevent sparks or arcs from occurring on the inside and on external components of the motor.

Motors with type of protection **Ex ec** are used in an explosive atmosphere where this atmosphere is expected to reach a level that poses a risk **only rarely** and then also **only for a short period**. These motors are assigned to Equipment Group II – Category 3G (corresponding to Zone 2).

Ex ec motors can additionally optionally have type of protection Ex tc with Group IIIB (non-conductive dust) acc. to IEC/EN 60079-31 for use in Zone 22 (present rarely).

Ex ec IIC T3 Gc

➔ Standard version for paint film thicknesses < 200 µm.

Optional Ex ec IIB T3 Gc (order code B31)

➔ Optional version for paint film thicknesses > 200 µm to < 2 mm.

For further information about paint and paint film thicknesses, see page 1/14 onwards.

Optional type of protection **Ex ec/Ex tc** for use in Zone 2/22 ²⁾

The motors must be ordered with:

Version additionally for dust Ex tc - Zone 22 – order code **B30** ²⁾



Motors

- Ex ec IIC T3 Gc: 1MB1.3 and 1MB5.3
- Ex ec IIB T3 Gc: 1MB1.3 and 1MB5.3 (order code **B31**) have a terminal box (similar to Ex eb), a sealing system, an external grounding terminal and a metal fan cover according to standard IEC/EN 60079-0. The temperature class is T1-T3.

With optional order with order code **B30** additionally a metal external fan.

The combination **B30+B31** is possible.

Identification on the rating plate:

- Zone 2:  II 3G Ex ec IIC T3 Gc
- Zone 2/22:  II 3G Ex ec IIC T3 Gc
-  II 3D Ex tc IIIB T120 °C Dc ²⁾

Number of the EU type-examination certificate

Please inquire in the case of:

- Utilization according to temperature class 155 (F)
- For pole-changing versions

¹⁾ IE1: T140 °C
IE2: T120 °C (except T130 °C for 1MB1.11-1AD5, 1MB1.11-3AD6, 1MB1.21-1AD5 and 1MB1.21-3AD6)
IE3: T120 °C

²⁾ Hybrid mixtures:
For certification of the motors according to the usual standards, the suitability test for use in explosive gas atmospheres is performed separately from the suitability test for use in explosive dust atmospheres. This enables marking for explosive gas or dust atmospheres, but not for use of the motor in hybrid mixtures.
The owner can certify the motor for hybrid mixtures despite the statements in the Operating Instructions. Information on operation in hybrid mixtures is provided in IEC 60079-14:2013 Annex M.

Technical specifications

Type of protection "increased safety" Ex eb acc. to IEC/EN 60079-7 for use in Zone 1

With type of protection **Ex eb**, additional measures are taken to prevent the possibility of high temperatures and to prevent sparks or arcs from occurring on the inside and on external components of the motor.

In case of a malfunction, the drive must be switched off within the time t_E . This ensures that none of the motor's components reaches the ignition temperature of the surrounding gas in the event of a malfunction.

Motors with type of protection **Ex eb** are used in an explosive atmosphere where a hazardous explosive atmosphere is expected occasionally to reach a level that poses a risk. These motors are assigned to Equipment Group II – Category 2G (corresponding to Zone 1). They ensure a high degree of safety.

Optionally Ex eb motors can additionally have type of protection Ex tb with Group IIIC (conductive and non-conductive dust) acc. to IEC/EN 60079-31 for use in Zone 21 (occasionally present).

Ex eb IIC T3 Gb

→ Standard version for paint film thicknesses < 200 µm.

Optional Ex eb IIB T3 Gb (order code **B31**)

→ Optional version for paint film thicknesses > 200 µm to < 2 mm.

For further information about paint and paint film thicknesses, see page 1/14 onwards.

Optional type of protection Ex eb/Ex tb for use in Zone 1/21 ²⁾

The motors must be ordered with:

Version additionally for dust Ex tb - Zone 21 – order code **B32** ²⁾

Motors



- Ex eb IIC T3 Gb: 1MB1.4 and 1MB5.4
- Ex eb IIB T3 Gb: 1MB1.4 and 1MB5.4 (order code **B31**)

have a terminal box (Ex eb), a sealing system, an external grounding terminal and a metal fan cover according to standard IEC/EN 60079-0. The winding is specially designed and tested for the temperature class T1/T2 or T3.

With optional order with order code **B32** additionally a metal external fan.

The combination **B32+B31** is possible.

Identification on the rating plate:

- Zone 1:  II 2G Ex eb IIC T3 Gb
- Zone 1/21:  II 2G Ex eb IIC T3 Gb
-  II 2D Ex tb IIIC T120 °C Db ¹⁾

Number of the EU type-examination certificate

Please inquire in the case of:

- Increased coolant temperatures
- Marine certificates

Type of protection "flameproof enclosure" Ex db eb and Ex db acc. to IEC/EN 60079-1 for use in Zone 1

Type of protection **Ex db** is achieved by ensuring that any explosion is contained within the motor. The housing must resist the pressure of the explosion and also prevent ignition from the internal to the external atmospheres.

Motors with type of protection **Ex db** are used in an explosive atmosphere where a hazardous explosive atmosphere is expected occasionally to reach a level that poses a risk. These motors are assigned to Equipment Group II – Category 2G (corresponding to Zone 1). They ensure a high degree of safety.

To define the risk posed by a potentially explosive gas, the minimum ignition temperature of a dust cloud is required as well as details of the possibility of a flame exiting through a narrow slit in the motor housing. This is achieved by classification in explosion groups IIA, IIB and IIC, whereby IIC represents the highest requirements (see the table "Assignment of combustible gases and vapors").

Ex db eb IIC T4 Gb

→ Standard version for paint film thicknesses < 200 µm.

Optional Ex db eb IIB T4 Gb (order code **B31**)

→ Optional version for paint film thicknesses > 200 µm to < 2 mm.

Alternatively, a paint finish certified in accordance with the Ex Directive can be used. For further information about paint and paint film thicknesses, see page 1/14 onwards.

Optional type of protection

- **Ex db eb/Ex tb** for use in Zone 1/21 ²⁾
- **Ex db eb/Ex tc** for use in Zone 1/22 ²⁾

The motors must be ordered with:

- Version additionally for dust Ex tb IIIC - Zone 21 – order code **B32** ²⁾
- Version additionally for dust Ex tb IIIB - Zone 22 – order code **B30** ²⁾

Motors

- Ex db eb IIC T4 Gb: 1MB155 and 1MB555
- Ex db eb IIB T4 Gb: 1MB155 and 1MB555 (order code **B31**)





are suitable for use in explosive gas atmospheres with occasionally present gases or vapors in Zone 1 for temperature classes T1 to T4. The maximum surface temperature that can occur during operation must lie below the limit temperature of the respective temperature class.

The motors have a terminal box (Ex eb), optional Ex db (order code **R48**), a sealing system, an external grounding terminal and a metal fan cover according to standard IEC/EN 60079-0. The motor housing is designed with type of protection "flameproof enclosure" and has temperature class T4.

With optional order with order code **B32** additionally a metal external fan.

The combination **B32+B31** is possible.

Identification on the rating plate:

- Zone 1:  II 2G Ex db eb IIC T4 Gb or  II 2G Ex db IIC T4 Gb (R48)
- Zone 1/21:  II 2G Ex db eb IIC T4 Gb
-  II 2D Ex tb IIIC T130 °C Db ²⁾

Number of the EU type-examination certificate

Please inquire in the case of: Reduced starting currents

¹⁾ IE1: T140 °C
IE2: T120 °C (except T130 °C for 1MB1.11-1AD5, 1MB1.11-3AD6, 1MB1.21-1AD5 and 1MB1.21-3AD6)
IE3: T120 °C

²⁾ Hybrid mixtures:
For certification of the motors according to the usual standards, the suitability test for use in explosive gas atmospheres is performed separately from the suitability test for use in explosive dust atmospheres. This enables marking for explosive gas or dust atmospheres, but not for use of the motor in hybrid mixtures.
The owner can certify the motor for hybrid mixtures despite the statements in the Operating Instructions. Information on operation in hybrid mixtures is provided in IEC 60079-14:2013 Annex M.

SIMOTICS XP 1MB1, 1MB5 explosion-protected motors

Orientation

Technical specifications

Line operation

Insulation system

The insulation system of SIMOTICS XP 1MB1 and 1MB5 motors is suitable for line voltages up to 690 V. The connection system (terminal box, terminals) is also designed for this rated voltage.

The motors are equipped with 6 terminals. They can therefore be operated in any star or delta connection. If a voltage variant with dual voltage e.g. 400VΔ/690VY is selected, the rated data of all voltage levels will be stamped on the rating plate.

SIMOTICS XP 1MB1 and 1MB5 motors have an insulation system with a thermal class of 155 °C (F). Utilization at rated operation corresponds to thermal class 130 °C (B).

For deviations in use for frame sizes 400 and 450, see "Winding and insulation version with regard to temperature class", on page 1/27.

Voltage tolerances

The motors are suitable for operation with voltage and frequency tolerances according to EN 60034-1.

In addition, tests are to be performed to ensure that the permissible temperature limits for the inner and outer surfaces of the motor according to the relevant standard are not exceeded during continuous operation at the voltage limits ($\pm 10\%$). For 8-pole motors of frame size 450, continuous duty is only possible with $\pm 5\%$.

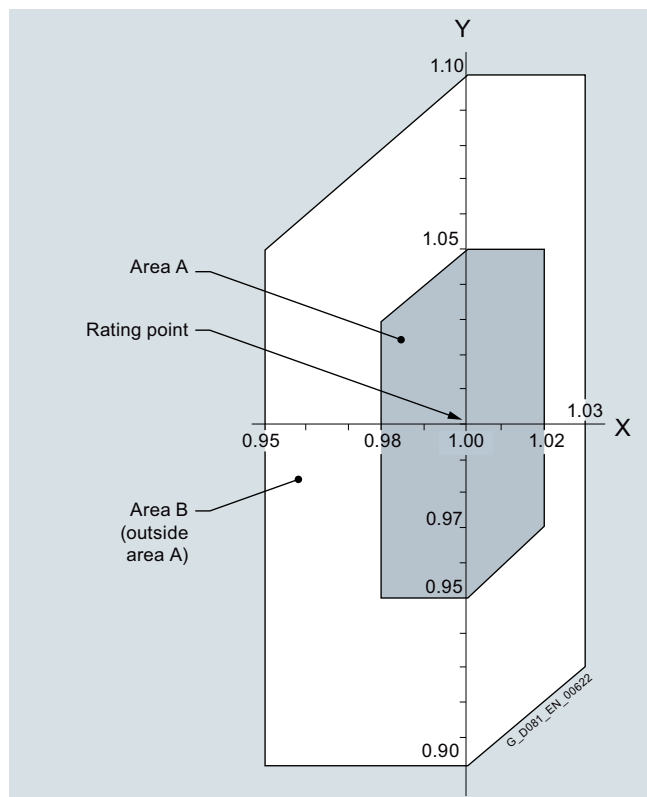

Y-axis: Voltage tolerance
Z-axis: Frequency tolerance

Motor protection

Motor protection must always be realized with a certified motor circuit breaker, see Catalog IC 10, taking into account the inrush current ratio and the maximum startup time.

Note:

For Ex eb motors in line operation, motor protection is alternatively possible as protection by PTC thermistors only, taking into account the inrush current ratio $I_{\text{startup}}/I_{\text{rated}}$ and time t_E . When the motor shaft is locked, the motor circuit breaker must disconnect the motor from the line supply within time t_E so that the maximum ignition temperature of the specific temperature class is not exceeded. Optionally on some motors up to frame size 200, full motor protection with a PTC thermistor is possible. The information about full motor protection with a PTC thermistor is documented in the EU type-examination certificate. The tripping devices required for this purpose, see Catalog IC 10, must always be certified.

Operation on a frequency converter

General information

Basically, explosion-protected motors (except for Ex eb) can be fed from converters. Particular attention must be paid to the interaction between the motor and converter system, especially with regard to the following aspects:

- The harmonic content of the supply voltage raises the motor temperature, so the motor power must be reduced
- Less cooling of the motor at speeds below the rated speed
- Voltage stress on the motor winding
- Bearing currents

The general use of high-quality insulation systems enables converter operation. When operated with a converter, the motor with explosion protection must be fitted with PTC thermistors. These are installed in the stator winding and, in combination with an ex-certified trip unit (EU type-examination certificate), they perform sole motor protection in the case of converter operation.

The permissible speed and torque range is stamped on an additional rating plate.

These rated operating points stamped on the additional rating plate apply for both constant torque drives and fluid-flow machines with a square-law load torque. For constant torque drives, the resulting thermal motor torques in the positioning range must be taken into account.

During converter operation, the reduced torques for constant torque and drives for fans, pumps and compressors must be observed due to the harmonic content of the supply.

This data is available in the "Drive Technology Configurator" (DT Configurator) at

www.siemens.com/dtconfigurator

Technical specifications

Higher noise levels must be expected than for 50 Hz line operation for motors operating with converters due to the harmonic content of the supply.

Maximum voltage stress on the motor winding in converter operation:

Frame sizes: 71 to 355:

- $\hat{U}_{\text{phase-to-phase}} \leq 1500 \text{ V}$ (3000 V peak-peak values ($V_{\text{pk/pk}}$))
- $\hat{U}_{\text{phase-to-ground}} \leq 1100 \text{ V}$ (2200 V peak-peak values ($V_{\text{pk/pk}}$))

The following generally applies to Siemens converters (SINAMICS):

- $U_{\text{line}} = 480 \text{ V} \pm 10 \%$ (BLM = Basic Line Module; DFE = Direct Front End)
- $U_{\text{line}} \leq 480 \text{ V} \pm 10 \%$ (ALM = Active Line Module; AFE = Active Front End); $U_{\text{dc}} < 720 \text{ V}$
- $U_{\text{line}} = 690 \text{ V} \pm 10 \%$ (only permissible with a suitable dv/dt or sine-wave filter)
Ex db: Certificate valid for general PWM converter
Ex ec, Ex tb, Ex tc certificate valid only in combination with a SINAMICS G180 that has an amplified dv/dt filter (standard option G180: **L10**).

Motors of the 1MB55 series with frame sizes 400 and 450 with the IVIC-C advanced insulation system:

- $\hat{U}_{\text{phase-to-phase}} \leq 1600 \text{ V}$ (3200 V peak-peak values ($V_{\text{pk/pk}}$))
- $\hat{U}_{\text{phase-to-ground}} \leq 1400 \text{ V}$ (2800 V peak-peak values ($V_{\text{pk/pk}}$))

Motors of the 1MB.8 series with frame sizes 71 to 450 with the IVIC-C premium insulation system:

- $\hat{U}_{\text{phase-to-phase}} \leq 2200 \text{ V}$ (4400 V peak-peak values ($V_{\text{pk/pk}}$))
- $\hat{U}_{\text{phase-to-ground}} \leq 1500 \text{ V}$ (3000 V peak-peak values ($V_{\text{pk/pk}}$))

Motors with the advanced insulation system can be operated on the converter without an additional dv/dt or sine-wave filter if the following limits are observed:

- $U_{\text{line}} \leq 480 \text{ V}$
- $U_{\text{DC}} \leq 720 \text{ V}$

Converter operation requires a dv/dt or sine-wave filter or a motor with PREMIUM insulation system (motor types 1MB18, or 1MB58.) if at least one of the following limits is exceeded:

- $U_{\text{line}} > 480 \text{ V}$
- $U_{\text{DC}} > 720 \text{ V}$

The voltage limits are chosen such that safe operation is ensured without knowledge of the converter or the converter infeed. If it is ensured that the motor is powered through a converter with uncontrolled infeed (e.g. SINAMICS G), the 1MB15 and 1MB55 motors can be operated up to $U_{\text{line}} = 480 \text{ V}$ as an exception because the limits $U_{\text{DC}} \leq 720 \text{ V}$ are then observed.

In configuration of the drive system, it must be considered that the DC-link voltage UDC exceeds the limit of $U_{\text{DC, max}} = 720 \text{ V}$ (continuous duty) during braking where converters without energy recovery capability, such as SINAMICS G, are used. Exceeding this limit is permissible for a short time, for example, if the $U_{\text{DC, max}}$ controller or braking chopper ensures that the DC-link voltage does not exceed the following limits:

- 1MB.5 (advanced): $U_{\text{DC, max}} = 890 \text{ V}$ (short-time duty)
- 1MB.8 (premium): $U_{\text{DC, max}} = 1225 \text{ V}$ (short-time duty)

Further configuration notes are documented in the declaration of compliance with the order 2.1 and in the EU type-examination certificates.

Order processing of 1MB1, 1MB5 motors with Ex db, Ex ec, Ex tb and Ex tc for converter operation

PTC thermistor

For converter operation, Ex motors must always be monitored using PTC thermistors. The motors must therefore be ordered with the 15th position of the Article No.

- **B** – PTC thermistor for tripping – or alternatively
- **C** – PTC thermistor for alarm and tripping.

General information regarding the PTC thermistors:

- **B** in 15th position of the Article No.:
The motors are equipped with 3 PTC thermistors for tripping in the motor winding.
- **C** in 15th position of the Article No.:
The motors are equipped with 3 PTC thermistors for alarm and 3 PTC thermistors for tripping in the motor winding.

Certified tripping units are required for this purpose, see Catalog IC 10.

To ensure unambiguous order handling for the voltage, each approved voltage code/voltage order code is assigned only "one" voltage/frequency, as seen below:

| Voltage code 12th and 13th position of the Article No. | Order code | Line frequency | Line voltage |
|---|---|----------------|--|
| 27 | – | 50 Hz | 500 VY, 50 Hz power |
| 40 | – | 50 Hz | 500 VΔ, 50 Hz power |
| 90 | M4A | 50 Hz | 400 VY, 50 Hz power |
| 90 | M4B | 50 Hz | 400 VΔ, 50 Hz power |
| 90 | M2C | 60 Hz | 440 VY, 50 Hz power |
| 90 | M1C | 60 Hz | 440 VY, 60 Hz power |
| 90 | M2D | 60 Hz | 440 VΔ, 50 Hz power |
| 90 | M1D | 60 Hz | 440 VΔ, 60 Hz power |
| 90 | M2E | 60 Hz | 460 VY, 50 Hz power |
| 90 | M1E | 60 Hz | 460 VY, 60 Hz power |
| 90 | M2F | 60 Hz | 460 VΔ, 50 Hz power |
| 90 | M1F | 60 Hz | 460 VΔ, 60 Hz power |
| 90 | M2G | 60 Hz | 575 VY, 50 Hz power |
| 90 | M1G | 60 Hz | 575 VY, 60 Hz power |
| 90 | M2H | 60 Hz | 575 VΔ, 50 Hz power |
| 90 | M1H | 60 Hz | 575 VΔ, 60 Hz power |
| 90 | M2K | 60 Hz | 480 VY; 50 Hz power |
| 90 | M1K | 60 Hz | 480 VY; 60 Hz power |
| 90 | M2L | 60 Hz | 480 VΔ, 50 Hz power |
| 90 | M1L | 60 Hz | 480 VΔ, 60 Hz power |
| 90 | M1Y (non-standard winding) | 50 or 60 Hz | Plain text (observe max. voltage stress) |
| 90 | M3A ¹⁾ | 87 Hz | At 87 Hz, 400 VΔ: (4-pole to 8-pole) |

¹⁾ The motor contains winding version 50 Hz 230 VΔ.

SIMOTICS XP 1MB1, 1MB5 explosion-protected motors

Orientation

Technical specifications

Converter operation specially for motors in type of protection "Ex ec" (Zone 2) and VIK-Ex ec version

IEC/EN 60079-7 specifies that the motor and converter must be tested as a unit (individual test). The individual test is available for motors of "Ex ec" type of protection on the specified converters SINAMICS G, SINAMICS S and SINAMICS V20.

For details, see declaration of compliance with the order 2.1. Not possible for frame sizes 400 and 450.

Individual testing can be performed for non-Siemens converters on request (additional charge). The customer may be required to supply the external converter for individual tests.

The test will cost more when using non-Siemens converters (especially on commissioning). Commissioning personnel must be provided by the customer for setup and operation during the test, if required.

Converter operation specially for motors in type of protection "Ex tb" (Zone 21) and "Ex tc" (Zone 22)¹⁾

The drive system comprising motors protected against dust explosions operating on SINAMICS G, SINAMICS S and SINAMICS V20 converters has been tested. For details, see declaration of compliance with the order 2.1. Please inquire about operation with non-Siemens converters. Not possible for frame sizes 400 and 450.

Converter operation specially for motors with type of protection "Ex ec/Ex tc" (Zone 2/22)²⁾

For the 1MB..3 Ex ec motors, the order code **B30** version (IP55) for Zones 2 and 22 must also be specified in the case of non-conductive dust. Declaration of compliance with the order 2.1 analogous to that for Zones 2, 21 and 22. Please inquire about non-Siemens converters.

1MB1, 1MB5 in Ex ec, Ex tb and Ex tc: Selection of the frequency converters

The SINAMICS frequency converters are categorized into 2 product groups (order code **B40** and **B41**). Each product group is a data record with motor operating data each assigned to one frequency converter. The converter type is stamped on the rating plate. Alternative, approved SINAMICS converters can be selected, by adding the order code **Y68**.

Product group 1 (basic version):

Order code **B40** - version for converter operation in basic version with operating data SINAMICS G120 with PM240-2

Product group 1 (alternative SINAMICS converter):

Order codes **B40 + Y68**

Operating data such as the **B40** order code with alternative SINAMICS converter on the rating plate:

- **Y68** with plain text (C-text) G120 with PM230
- **Y68** with plain text (C-text) G120 with PM240
- **Y68** with plain text (C-text) G120C
- **Y68** with plain text (C-text) G120P with PM230
- **Y68** with plain text (C-text) G120P with PM240-2
- **Y68** with plain text (C-text) G120P with PM240P-2
- **Y68** with plain text (C-text) G120P with PM330
- **Y68** with plain text (C-text) G130
- **Y68** with plain text (C-text) G150
- **Y68** with plain text (C-text) G180
- **Y68** with plain text (C-text) S120 (BLM/SLM)
- **Y68** with plain text (C-text) V20

Product group 2 (basic version):

Order code **B41** - version for converter operation in basic version with operating data SINAMICS S150.

Product group 2 (alternative SINAMICS converter):

Order codes **B41 + Y68**

Operating data such as the **B41** order code with alternative SINAMICS converter on the rating plate:

- Order code **Y68** with plain text (C-text) S120 (ALM)

1MB155 and 1MB555 with Ex db, Ex db eb: Selection of the frequency converter

The SIMOTICS 1MB..5. motors are suitable and certified for operation on the PWM frequency converter. The only distinction made is whether the maximum permitted temperature rise of the winding is 130(B) – order code **B43** or 155(F) – order code **B44**. The power with utilization of 155(F) is approx. 10 % higher than with utilization 130(B) and the order code **B43** is usually approximately equal to the line power.

Combination with SINAMICS converters as stated in the list under Ex ec has been pretested and is recommended. For other converter types and non-Siemens converters, operation according to the Ex specifications is possible if the requirements of the certificate are met.

Defining the power for converter operation

The optimum power data are marked on the motors. These data are universally valid and can be viewed in the "Drive Technology Configurator" (DT Configurator) and used as the basis for configuration.

In specific applications, e.g. for very long motor cables, if a sine-wave filter is being used - or for converter types that cannot reach the full rated voltage at rated frequency as a result of the inherent design, then at rated voltage there is a voltage drop at the motor terminals. Under this operating condition, in order that the motor temperature rise is not inadmissibly high, at the maximum permissible current, it is possible that the motor power is reduced (derating). For example, for use of sine-wave filters and the consequential reduction of the motor voltage by 10 to 15 %, the permissible power ratings for converter operation must be similarly reduced by 10 to 15 % at rated frequency because the corner frequency for determining the power is reduced accordingly. Operation below the reduced corner frequency is possible without reducing the torque.

¹⁾ Zone 21 includes conductive and non-conductive dust.

²⁾ The Ex motor is not admissible in an explosive atmosphere of dust and air (hybrid). A standard is not currently available that describes the product requirements for a hybrid mixture.

SIMOTICS XP 1MB1, 1MB5 explosion-protected motors

Orientation

Technical specifications

Rating plate

The operating data for line operation is specified on the rating plate - on an additional rating plate, according to the selected product, 4 rated operating points are possible in the following variants:

| Possible variants | Rated operating points in Hz | | | | Additional identification code voltage code 12th and 13th position of the Article No. and order code |
|-----------------------------|------------------------------|----|----|-----------|--|
| 50 Hz field weakening range | 5 | 25 | 50 | f_{max} | 50 Hz voltage: e.g. '90' and M4A |
| 60 Hz field weakening range | 6 | 30 | 60 | f_{max} | 60 Hz voltage: e.g. '90' and M1E |
| 87 Hz characteristic | 5 | 25 | 87 | f_{max} | 87 Hz at 400 VΔ: '90' and M3A |

f_{max} see page 5/17 "Mechanical limit speeds of the SIMOTICS XP 1MB15, 1MB5 Ex db, Ex ec, Ex tb and Ex tc explosion-protected motors".

Other voltages can be selected with the voltage code **90** (12th, 13th position of the Article No.) and order code **M1Y** Special winding.

Special case: Line operation data in two voltage levels plus converter data in one voltage level: **M1Y + Y80** e.g. 400 VΔ/690 VY 50Hz DOL + 400 VΔ VSD

Insulated bearings

Frame sizes 225 and 250:

For converter operation it is recommended that an "insulated bearing cartridge NDE" – order code **L51** be used.

Frame sizes 280 to 355:

For ordering with order codes **B40/B41/B43/B44**, the "insulated bearing cartridge NDE" is included as standard.

Frame sizes 400 and 450:

For ordering with order codes **B40/B41/B43**, the "insulated bearing cartridge NDE" is included as standard.

The data on the separate rating plate for converter operation apply to both constant torque drives and pump/fan/compressor drives. For a constant torque drive, the resulting thermal motor torques in the positioning range must be taken into account.

Example motor ID:

Motor rating plate with line operation data and additional rating plate with converter operation data:

Increased safety motor Ex ec (Zone 2) for operation on SINAMICS G180:

1MB15331CB002AB4-Z
M4A+B40+Y68

Plain text Y68: SINAMICS G180

| SIEMENS | | IE3 | | CE | | | |
|------------------------------------|---------------|-------------------------|-----|-------------------|---------|-------|-------|
| D-90441 Nürnberg | | Made in Czech Rep. | | 0158 | | | |
| 3-Mot. 1CV3130B 1MB15331CB002AB4-Z | | UD 1701/1234567 001 001 | | | | | |
| IEC/EN 60034 132S IMB3 IP55 | | II 3 G | | Ex ec IIC T3 Gc | | | |
| 67kg | Th.Cl. 155(F) | -20°C <=TAMB<=40°C | | FTZU 13 ATEX 0055 | | | |
| Bearing | | | | | | | |
| DE | 6208-2ZC3 | | | | | | |
| NE | 6208-2ZC3 | | | | | | |
| V | Hz | A | kW | cos φ | NOM.EFF | 1/min | IE-CL |
| 400 Y | 50 | 10.8 | 5.5 | 0.82 | 89.6 | 1470 | IE3 |

| SIEMENS | | IE3 | | CE | | | |
|------------------------------------|-----|--|------|-------|------|-------|--|
| D-90441 Nürnberg | | Made in Czech Rep. | | 0158 | | | |
| 3-Mot. 1CV3130B 1MB15331CB002AB4-Z | | UD 1701/1234567 001 001 | | | | | |
| IEC/EN 60034 | | | | | | | |
| For converter supply | | Converter parameter settings according to DOL plate! | | | | | |
| Duty S9 SINAMICS G180 | | CONVERTER INPUT: 400V VPWM Fp ≥ 4 kHz | | | | | |
| V | Hz | A | kW | cos φ | Nm | 1/min | |
| 49 Y | 5 | 10.6 | 0.29 | 0.84 | 20.5 | 134 | |
| 205 Y | 25 | 9.2 | 2.35 | 0.81 | 30.5 | 730 | |
| 380 Y | 50 | 8.9 | 4.40 | 0.81 | 28.0 | 1475 | |
| 380 Y | 100 | 8.4 | 4.10 | 0.85 | 13.1 | 2955 | |

For all motors, an additional rating plate complete with the operating data for the motor on the converter is fitted.

The converter type and the associated operating data are on the rating plate.

The reasons for stamping the converter type on the additional rating plate are the different control levels for the converter output voltage, pulse frequency, output frequency, harmonic content and the associated derating for the motor.

For compliance with the permissible temperature class 130 (B), derating is necessary for converter operation below the power for direct line operation! The reduction in torque depends on the choice of converter type. The data can be viewed in the "Drive Technology Configurator" (DT Configurator) and used as the basis for configuration.

The declaration of compliance with the order 2.1 for the specified converters is stored with the documentation for low-voltage motors in the "Drive Technology Configurator" (DT Configurator).

SIMOTICS XP 1MB1, 1MB5 explosion-protected motors

Orientation

Technical specifications

Configuration notes for converter operation

Permissible voltage stress

More stress is placed on the insulation of the motor winding with converter operation than with line operation. The voltage stress also depends on the type of converter used.

Voltage stress on a converter with pulse width modulation (PWM)

The PWM converter subjects the motor windings to wear and tear mainly by quickly applying voltage pulses. Each switching process of the converter releases a voltage wave onto the motor supply cable that can result in excessive motor voltages due to reflection (see diagram).

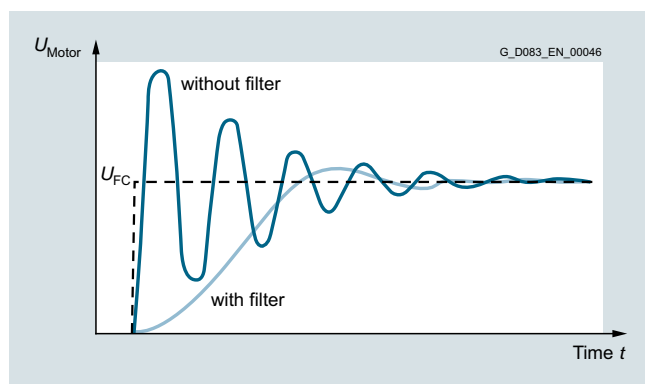

The maximum voltage is influenced by the rise time of the pulses and by the length of cable used between motor and converter. A dv/dt output filter at the converter can reduce the maximum motor voltage to uncritical values. If the permitted limits of the peak voltage for standard insulation $1500 V_{peak}$ or for premium insulation $2200 V_{peak}$ is exceeded in operation, premature motor failures can occur.

For SIMOTICS XP motors, the limits according to the certificate apply additionally and take precedence.

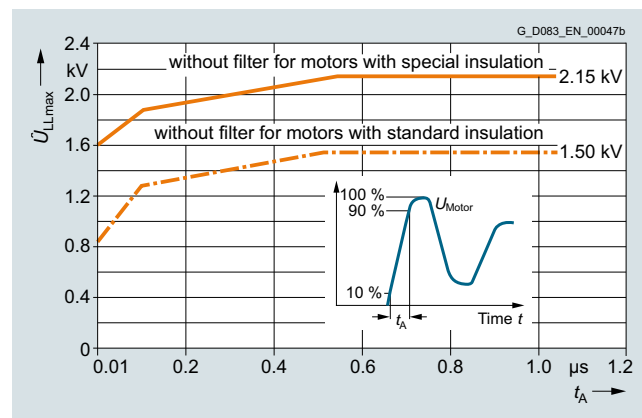

SIMOTICS XP 1MB1, 1MB5 explosion-protected motors

Orientation

Technical specifications

Individual drive check of variable speed drive (VSD) systems (IC411 self-ventilated motors) with configuration characteristics for converter operation – 1MB1/1MB5 motors (all types of protection).

Limits for example control ranges are listed in the power tables on the following pages. For individual drive checks, the following configuration characteristics apply to frame sizes 71 to 355.

For driven machine power or torque less than or equal to rated data, operation up to f_{max} in accordance with the power tables is possible. This applies to configurations with any load torques and control ranges.

The maximum admissible speed in field weakening can be calculated by dividing $f_{max} \times 120$ by the motor's number of poles.

Checking the feasibility of the required operating point

To do this, (derived from reference point A)

- The desired load/power P_2 must be divided by the VSD power P_{VSD}
- The desired control speed n must be divided by the VSD asynchronous speed $n_{asyn VSD}$
- The desired load/torque T_D must be divided by the VSD torque T_{VSD} .

These calculated values should be checked afterwards against the following diagrams to determine whether the desired operating point (from speed 0) is below the VSD load/torque limit T_D/T_{VSD} and the load/power limit P_2/P_{VSD} .

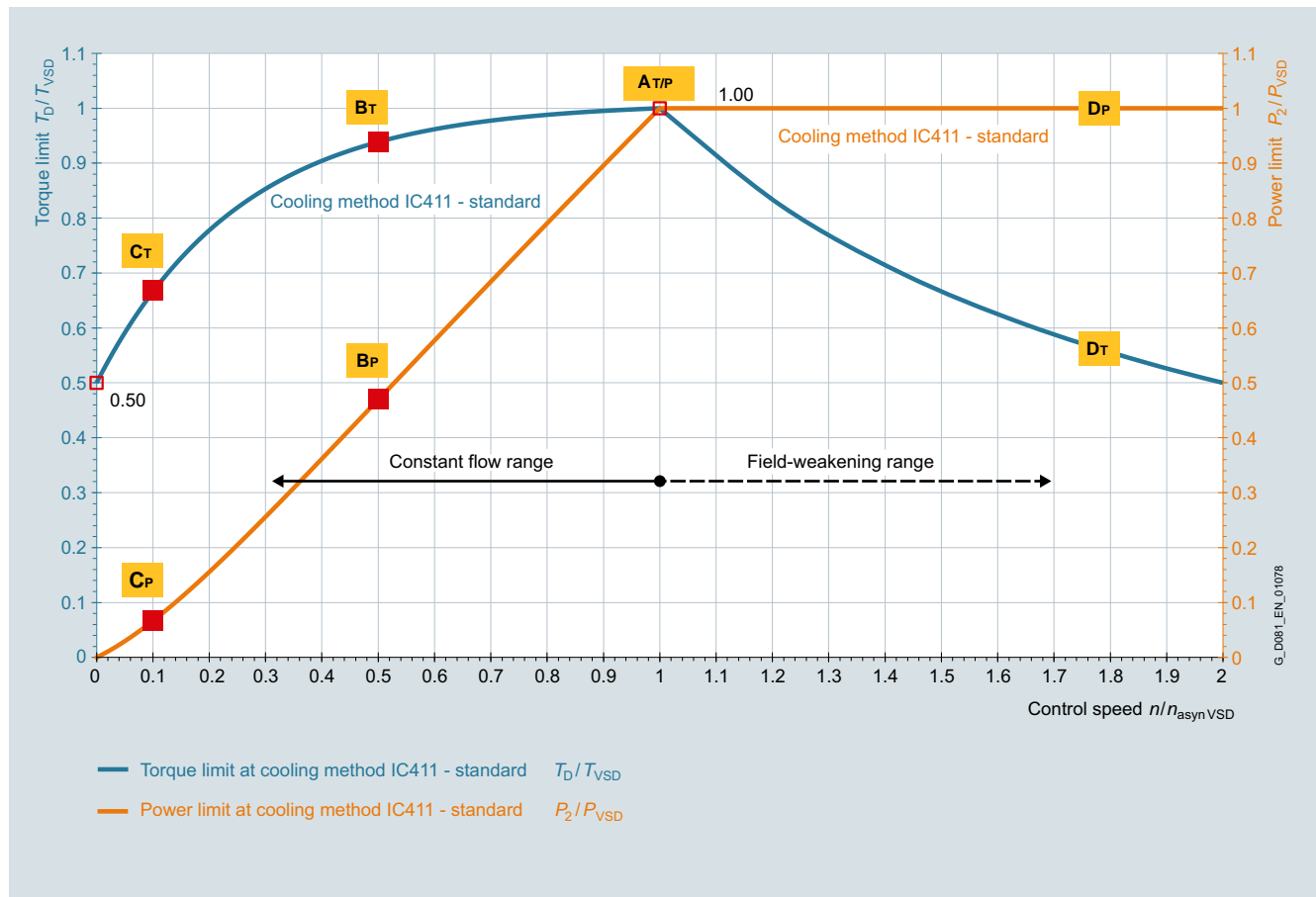

Configuration characteristics for frame sizes 71 to 200

- AM/P: Reference point for general selecting/dimensioning
- AP: Typical load point for applications with square-law load torque, e.g. fans and pumps
- BM/CM: Typical load point for applications with constant load torque, e.g. hoisting gear, conveyor belts etc.
- DM/DP: Typical load point for applications with increased speed/frequency

SIMOTICS XP 1MB1, 1MB5 explosion-protected motors

Orientation

Technical specifications

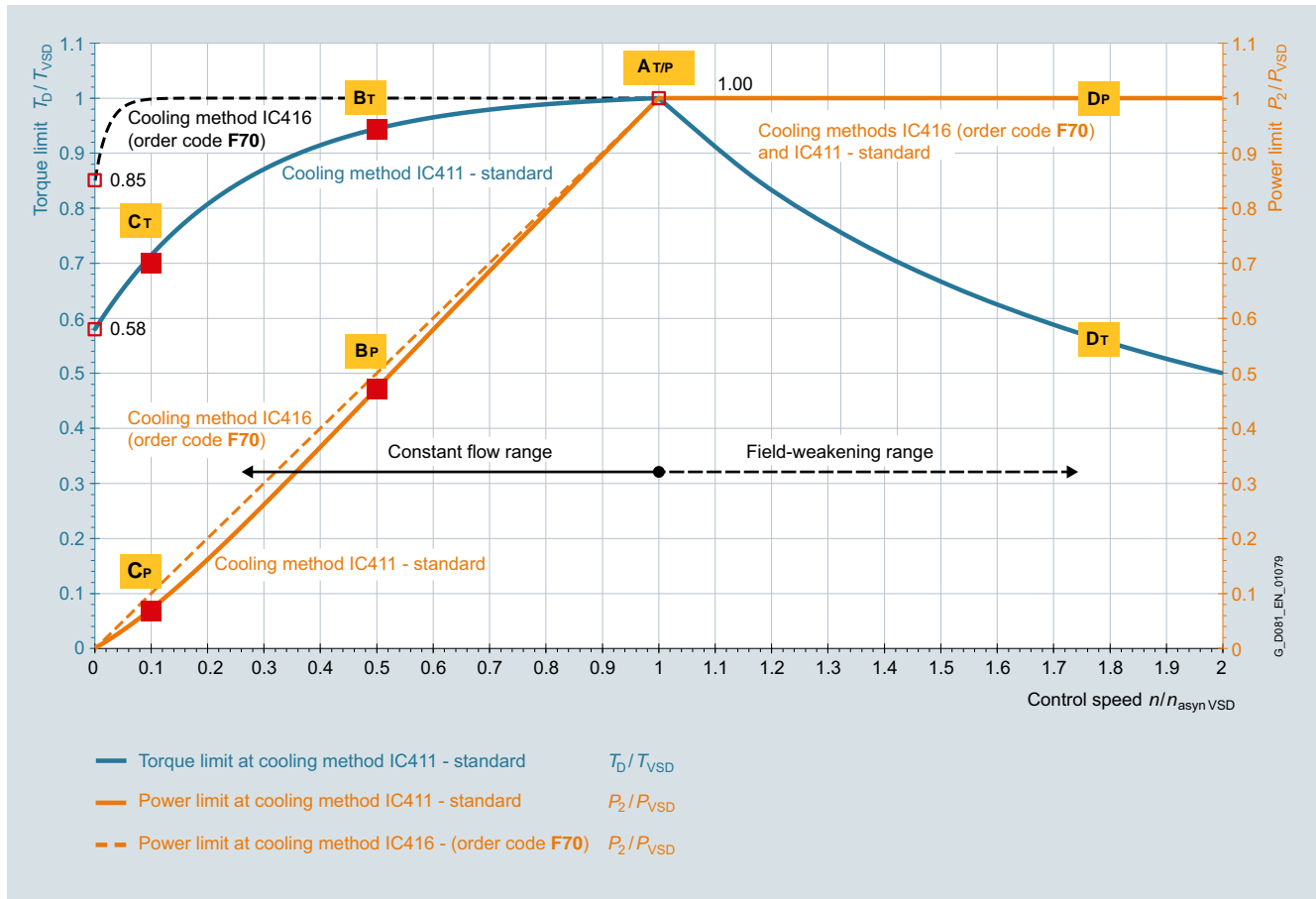

Configuration characteristics for frame sizes 225 to 355

AM/P: Reference point for general selecting/dimensioning

AP: Typical load point for applications with square-law load torque, e.g. fans and pumps

BM/CM: Typical load point for applications with constant load torque, e.g. hoisting gear, conveyor belts etc.

DM/DP: Typical load point for applications with increased speed/frequency

Fan

For version of the fan and the fan cover

| Motor series | Frame size | Type of protection | | | |
|--------------|---------------------|--------------------|-----------------------|---------|-------------|
| | | Ex tb, Ex tc | Ex ec | Ex eb | Ex db eb |
| 1MB1 | 63 | Aluminum | Plastic | – | – |
| | 71 ... 90 | Aluminum | Plastic | Plastic | Plastic |
| | 100 ... 160 | Aluminum | Plastic ¹⁾ | Plastic | Plastic |
| | 180 ... 280 | Sheet steel | Plastic | Plastic | Plastic |
| | 315 | Sheet steel | Plastic | – | – |
| 1MB5 | 315 | Sheet steel | Sheet steel | Plastic | Plastic |
| | 355 (2-pole) | Sheet steel | Sheet steel | – | Plastic |
| | 355 (4- ... 8-pole) | Sheet steel | Sheet steel | – | Sheet steel |
| | 400 ... 450 | Cast iron | Cast iron | – | – |

Note: For Ex ec, Ex eb and Ex db eb motors in combination with order code

• **B30** – Version additionally for dust Ex tc – Zone 22

• **B32** – Version additionally for dust Ex tb – Zone 21

Fan material as for Ex tb, Ec tc.

¹⁾ The fan material for 1MB1032 (IE1) is aluminum.

Low-noise version

Clockwise rotation: Order code **F77**

Counterclockwise rotation: Order code **F78**

| Low-noise version | | | |
|-------------------|------------|---------------|--------------------|
| Motor series | Frame size | 2-pole motors | |
| | | LpfA db (A) | LWA db (A) |
| 1MB155 | 225 | 69.5 | 83.4 ²⁾ |
| | 250 | 72.5 | 86.5 ²⁾ |
| | 280 | 73.4 | 85 |
| 1MB555 | 315 | 73.5 | 88.3 |
| | 355 | 79.6 | 94.9 |

A version with a second shaft extension is not possible.

²⁾ These sound power levels are above the set values in the VIK recommendation in the "reduced noise" version. This difference must be agreed between the manufacturer and the operator.

SIMOTICS XP 1MB1, 1MB5 explosion-protected motors

Orientation

Technical specifications

Mechanical limit speeds

Mechanical limit speeds of the SIMOTICS XP 1MB10, 1MB15, 1MB16 Ex ec, Ex tb and Ex tc explosion-protected motors

| Motor frame size | Motor type | 2-pole ¹⁾ n_{max} rpm | f_{max} Hz | 4-pole n_{max} rpm | f_{max} Hz | 6-pole n_{max} rpm | f_{max} Hz | 8-pole n_{max} rpm | f_{max} Hz |
|----------------------------|---------------------|--|-----------------|----------------------------|-----------------|----------------------------|-----------------|----------------------------|-----------------|
| 1MB10, 1MB15, 1MB16 | | | | | | | | | |
| 71 M | 1MB15 | 6000 | 100 | 3000 | 100 | 2000 | 100 | 1500 | 100 |
| 80 M | 1MB15 | 6000 | 100 | 3000 | 100 | 2000 | 100 | 1500 | 100 |
| 90 L | 1MB15 | 6000 | 100 | 3000 | 100 | 2000 | 100 | 1500 | 100 |
| 100 L | 1MB10, 1MB15, 1MB16 | 5100 | 85 | 3000 | 100 | 2000 | 100 | 1500 | 100 |
| 112 M | 1MB10, 1MB15, 1MB16 | 5100 | 85 | 3000 | 100 | 2000 | 100 | 1500 | 100 |
| 132 S/M | 1MB10, 1MB15, 1MB16 | 3800 | 63.3 | 3000 | 100 | 2000 | 100 | 1500 | 100 |
| 160 M/L | 1MB10, 1MB15, 1MB16 | 4500 | 75 | 3000 | 100 | 2000 | 100 | 1500 | 100 |
| 180 M/L | 1MB15, 1MB16 | 4500 | 75 | 3000 | 100 | 2000 | 100 | 1500 | 100 |
| 200 L | 1MB15, 1MB16 | 4500 | 75 | 3000 | 100 | 2000 | 100 | 1500 | 100 |
| 225 S/M | 1MB15, 1MB16 | 3600 | 60 | 3000 | 100 | 2000 | 100 | 1500 | 100 |
| 250 M | 1MB15, 1MB16 | 3600 | 60 | 3000 | 100 | 2000 | 100 | 1500 | 100 |
| 280 S/M | 1MB15, 1MB16 | 3600 | 60 | 3000 | 100 | 2000 | 100 | 1500 | 100 |
| 315 S/M/L | 1MB15, 1MB16 | – ²⁾ | – ²⁾ | 2600 | 87 | 2000 | 100 | 1500 | 100 |

Mechanical limit speeds of the SIMOTICS XP 1MB..5 Ex db, Ex db eb explosion-protected motors

| Motor frame size | Motor type | 2-pole ¹⁾ n_{max} rpm | f_{max} Hz | 4-pole n_{max} rpm | f_{max} Hz | 6-pole n_{max} rpm | f_{max} Hz | 8-pole n_{max} rpm | f_{max} Hz |
|-----------------------|------------|--|-----------------|----------------------------|-----------------|----------------------------|-----------------|----------------------------|-----------------|
| 1MB1.5, 1MB5.5 | | | | | | | | | |
| 71 M | 1MB1.5 | 6000 | 100 | 3000 | 100 | 2000 | 100 | 1500 | 100 |
| 80 M | 1MB1.5 | 6000 | 100 | 3000 | 100 | 2000 | 100 | 1500 | 100 |
| 90 L | 1MB1.5 | 6000 | 100 | 3000 | 100 | 2000 | 100 | 1500 | 100 |
| 100 L | 1MB1.5 | 6000 | 100 | 3000 | 100 | 2000 | 100 | 1500 | 100 |
| 112 M | 1MB1.5 | 6000 | 100 | 3000 | 100 | 2000 | 100 | 1500 | 100 |
| 132 S/M | 1MB1.5 | 5400 | 90 | 3000 | 100 | 2000 | 100 | 1500 | 100 |
| 160 M/L | 1MB1.5 | 4800 | 80 | 3000 | 100 | 2000 | 100 | 1500 | 100 |
| 180 M/L | 1MB1.5 | 4560 | 76 | 3000 | 100 | 2000 | 100 | 1500 | 100 |
| 200 L | 1MB1.5 | 4500 | 75 | 3000 | 100 | 2000 | 100 | 1500 | 100 |
| 225 S/M | 1MB1.5 | 4500 | 75 | 2610 | 87 | 2000 | 100 | 1500 | 100 |
| 250 M | 1MB1.5 | 3900 | 65 | 2400 | 80 | 2000 | 100 | 1500 | 100 |
| 280 S/M | 1MB1.5 | 3600 | 60 | 2250 | 75 | 2000 | 100 | 1500 | 100 |
| 315 S/M/L | 1MB5.5 | 3600 | 60 | 1950 | 65 | 2000 | 100 | 1500 | 100 |
| 355 M/L | 1MB5.5 | 3600 | 60 | 1800 | 60 | 2000 | 100 | 1500 | 100 |

¹⁾ For continuous operation in the range f_{max} (n_{max}), an inquiry is required.

²⁾ For frame size 315, converter operation is not permissible with 2 poles.

SIMOTICS XP 1MB1, 1MB5 explosion-protected motors

Orientation

Technical specifications

Special technology

"Special technology" comprises technology that is compatible with explosion-protected motors.

Explosion-protected motors can be implemented in a broader range of applications when explosion-protected rotary pulse encoders or explosion-protected separately driven fans are mounted.

The use of a separately driven fan is recommended to increase motor utilization at low speeds and to limit noise generation at speeds significantly higher than the synchronous speed.

The following explosion-protected motor versions are available with explosion-protected rotary pulse encoders:

| Type of protection | Motor type + order code | Frame size | Order code for explosion-protected rotary pulse encoder |
|-------------------------------|-------------------------|-----------------|---|
| Ex tb (Zone 21) | 1MB101... | 100 L ... 160 L | G30: Mounting of LL 841 (HTL); 1024 explosion-protected rotary pulse encoder |
| | 1MB151... | 100 L ... 315 L | |
| | 1MB161... | 100 L ... 315 L | |
| | 1MB551... | 400 ... 450 | |
| | 1MB581... | 400 ... 450 | |
| Ex tc (Zone 22) | 1MB102... | 100 L ... 160 L | |
| | 1MB152... | 100 L ... 315 L | |
| | 1MB162... | 100 L ... 315 L | |
| | 1MB552... | 400 ... 450 | |
| | 1MB582... | 400 ... 450 | |
| Ex ec (Zone 2) | 1MB103... | 100 L ... 160 L | |
| | 1MB153... | 100 L ... 315 L | |
| | 1MB163... | 100 L ... 315 L | |
| | 1MB553... | 400 ... 450 | |
| | 1MB583... | 400 ... 450 | |
| Ex ec or Ex tc (Zone 2/22) | 1MB103... + B30 | 100 L ... 160 L | |
| | 1MB153... + B30 | 100 L ... 315 L | |
| | 1MB163... + B30 | 100 L ... 315 L | |
| | 1MB553... + B30 | 400 ... 450 | |
| | 1MB583... + B30 | 400 ... 450 | |
| Ex db or Ex db eb (Zone 1) | 1MB155... | 100 L ... 355 L | |
| | 1MB555... | | |
| Ex db or Ex db eb (Zone 1/21) | 1MB155... + B32 | 100 L ... 355 L | |
| | 1MB555... + B32 | | |

Note:

The maximum speed of the rotary pulse encoder is limited to $n_{\max} = 4200$ rpm.

The following explosion-protected motor versions are available with explosion-protected separately driven fans:

| Type of protection | Motor type + order code | Frame size | Order code for explosion-protected separately driven fan |
|-------------------------------|-------------------------|-----------------|--|
| Ex tb (Zone 21) | 1MB151... | 225 S ... 315 L | F70: "Mounted separately driven fan". |
| | 1MB161... | 225 S ... 315 L | |
| | 1MB551... | 400 ... 450 | |
| | 1MB581... | 400 ... 450 | |
| Ex tc (Zone 22) | 1MB102... | 100 L ... 160 L | |
| | 1MB152... | 100 L ... 315 L | |
| | 1MB162... | 100 L ... 315 L | |
| | 1MB552... | 400 ... 450 | |
| | 1MB582... | 400 ... 450 | |
| Ex ec (Zone 2) | 1MB103... | 100 L ... 160 L | |
| | 1MB153... | 100 L ... 315 L | |
| | 1MB163... | 100 L ... 315 L | |
| | 1MB553... | 400 ... 450 | |
| | 1MB583... | 400 ... 450 | |
| Ex ec or Ex tc (Zone 2/22) | 1MB103... + B30 | 100 L ... 160 L | |
| | 1MB153... + B30 | 100 L ... 315 L | |
| | 1MB163... + B30 | 100 L ... 315 L | |
| | 1MB553... + B30 | 400 ... 450 | |
| | 1MB583... + B30 | 400 ... 450 | |
| Ex db or Ex db eb (Zone 1) | 1MB155... | 225 S ... 355 L | |
| | 1MB555... | | |
| Ex db or Ex db eb (Zone 1/21) | 1MB155... + B32 | 225 S ... 355 L | |
| | 1MB555... + B32 | | |

Notes:

- The motor operating data with the explosion-protected separately driven fan is available in the "Drive Technology Configurator" (DT Configurator).
- Alternatively, explosion-protected separately driven fans can also be used in line operation for special applications.

Technical specifications

Explosion-protected rotary pulse encoder

The rotary pulse encoder can only be mounted on a standard non-drive end (NDE), i.e. a second shaft extension cannot be supplied.

By virtue of its design, the explosion-protected rotary pulse encoder does not have insulated bearings (please inquire).

The degree of protection of the rotary pulse encoder must be observed. The relevant data are stamped on the rating plate of the rotary pulse encoder.

Attaching an explosion-protected rotary pulse encoder increases the length of the motor by Δl .

For an explanation of the additional dimensions and weights, see "Dimensions and weights of explosion-protected rotary pulse encoders".

LL 841 910 013 rotary pulse encoder (HTL version)

This encoder has a rugged construction and is therefore also suitable for difficult operating conditions. It is resistant to shock and vibration.

The LL 841 910 013 explosion-protected rotary pulse encoder is supplied with the already mounted ADS diagnostic system for early detection of errors in the encoder.

Order code **G30**

Technical specifications for LL 841 910 013 (HTL version)

| | |
|--|--|
| Supply voltage U_B | +9 ... +30 V |
| Current input without load | max. 80 mA |
| Admissible load current per output | 40 mA |
| Pulses per revolution | 1024 |
| Outputs | 6 short-circuit proof square-wave pulses A, A', B, B', O, O', high current HTL Floating switching output for ADS signal |
| Pulse offset between the two outputs | 90° ±2 5° el. |
| Output amplitude | $U_{High} > U_B - 4 V$ $U_{Low} < 2.5 V$ |
| Mark space ratio | 1:1 ± 10 % |
| Maximum frequency | 100 kHz with 350 m cable length |
| Maximum speed | 4200 rpm (the maximum permissible speed must be observed during the configuration) |
| Temperature range | -40 ... +70 °C |
| Degree of protection | IP65 |
| Maximum adm. radial cantilever force | 150 N |
| Maximum adm. axial force | 100 N |
| Connection system | Terminal strips in encoder/cable connection M20 x 1.5 radial (screw terminals) |
| Weight, approx. | 1.7 kg |

Manufacturer:
Leine und Linde AG
Olivehällsvägen 8
64542 Strängnäs, Sweden
Phone: +46 152 265 00
Fax +46 152 265 05

www.leinelinde.com
Email: info@leinelinde.de

Dimensions and weights of the explosion-protected rotary pulse encoders

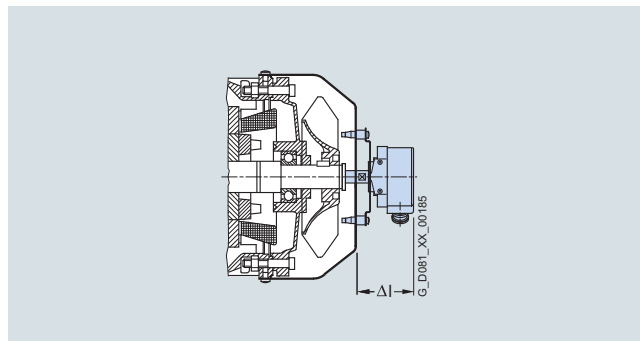

Explosion-protected rotary pulse encoder (on cover), order code **G30**

1MB10, 1MB15, 1MB16, 1MB55, 1MB56, 1MB58 motors

| Frame size | Δl | Weight approx. |
|------------|------------|----------------|
| | mm | kg |
| 100 | 110 | 2 |
| 112 | 110 | 2 |
| 132 | 110 | 2 |
| 160 | 110 | 2 |
| 180 | 110 | 2 |
| 200 | 110 | 2 |
| 225 | 100 | 3 |
| 250 | 100 | 3 |
| 280 | 100 | 3 |
| 315 | 100 | 3 |
| 355 | 100 | 3 |
| 400 | 100 | 3 |
| 450 | 100 | 3 |

A protective cover of non-corrosive sheet steel is available for the explosion-protected rotary pulse encoders from the "special technology".

For motors in the shaft heights

- 100 to 200: a protective cover is always provided
- 225 to 450: Order code **G43** – "Mechanical protection for encoder" (protective cover analogous to order code **H00**)

The length of the motor is also increased in the case of the following shaft heights:

- 100 to 200 by up to 146 mm
- 225 to 315 by up to 25 mm

SIMOTICS XP 1MB1, 1MB5 explosion-protected motors

Orientation

Technical specifications

Explosion-protected separately driven fan

The use of a separately driven fan is recommended to increase motor utilization at low speeds or to limit noise generation at speeds significantly higher than the synchronous speed. Both of these results can only be achieved with converter operation. Please inquire about traction and vibratory operation.

In the case of explosion-protected motors, the explosion-protected separately driven fan is available already mounted. Order code **F70**

Notes:

- The order code **F70** applies to all types of protection because the type of protection is already defined by the article number of the motor. Order code **F70** determines the additional charge for the separately driven fan in the assigned type of protection.
- The motor operating data with the explosion-protected separately driven fan is available in the "Drive Technology Configurator" (DT Configurator).

The supply voltage for the explosion-protected motors with separately driven fan is specified as follows:

Type 2CW2 has a wide-range voltage winding (see page 5/21 "Technical specifications of separately driven fans for 1MB1 explosion-protected motors (frame sizes 100 to 200) in the Ex tc (Zone 22) and Ex ec (Zone 2) versions"). These explosion-protected motors with separately driven fan up to frame size 200 have a rated voltage (rated voltage range) with tolerances according to IEC/EN 60034-1, range A.

Technical specifications of separately driven fans for 1MB1.5 and 1MB5.5 explosion-protected motors (frame sizes 225 to 355) in the Ex db eb (Zone 1) versions

| Frame size | Voltage V | Frequency Hz | P_{\max} kW | I_{\max} A |
|------------|--------------|-----------------|------------------|-----------------|
| 225 | 400 | 50 | 0.55 | 1.34 |
| 250 | | | | |
| 280 | 460 | 60 | | 1.23 |
| 315 | | | | |
| 355 | 400 | 50 | 1.1 | 2.25 |
| | 460 | 60 | | 1.98 |

A rating plate with the operating data is fitted to each explosion-protected motor with separately driven fan.

The type of protection of the explosion-protected motor with separately driven fan corresponds to that of the associated explosion-protected basic motor. Please note the direction of rotation of the separately driven fan (axial-flow fan) when connecting it.

Please inquire regarding coolant temperatures outside the range -20 to $+40$ °C.

The Ex ec/Ex tc motor with separately driven fan has the degree of protection IP55 as standard; Ex tb: IP65 (higher degrees of protection with Ex ec are available on request).

Motors with a separately driven fan must be equipped with a PTC thermistor as motor protection (15th position of the Article No.): In the event of a fault in the separately driven fan, the PTC thermistor must reliably trip the 1MB1 or 1MB5 explosion-protected motors.

For assignments and article numbers, see the tables "Technical specifications of separately driven fans for explosion-protected motors 1MB1..." on the following pages. A rating plate listing all the important data is fitted to the separately driven fan. Please inquire in the case of supply voltages outside of the rated voltage range. Please note the direction of rotation of the separately driven fan (axial-flow fan) when connecting it. The permissible coolant temperatures are $CT_{\min} -20$ °C and $CT_{\max} +40$ °C. Lower coolant temperatures are available on request.

When the separately driven fan is mounted, the length of the motor increases by Δl . For an explanation of the additional dimensions and weights, see "Dimensions and weights of explosion-protected separately driven fans".

SIMOTICS XP 1MB1, 1MB5 explosion-protected motors

Orientation

Technical specifications

Technical specifications of separately driven fans for 1MB1 explosion-protected motors (frame sizes 100 to 200) in the Ex tc (Zone 22) and Ex ec (Zone 2) versions

| Technical specifications of separately driven fans (according to tolerances of EN 60034-1) | | | | |
|--|--------------------------|-----------------|-------------------------|--------------------|
| Frame size | Rated voltage range V | Frequency Hz | Power consumption kW | Rated current A |
| 100 | 1 AC 220 ... 277 | 50 | 0.066 | 0.28 |
| | 3 AC 200 ... 303 Δ | 50 | 0.091 | 0.37 |
| | 3 AC 346 ... 525 Y | 50 | 0.091 | 0.22 |
| | 1 AC 220 ... 277 | 60 | 0.075 | 0.30 |
| | 3 AC 220 ... 332 Δ | 60 | 0.087 | 0.31 |
| | 3 AC 380 ... 575 Y | 60 | 0.087 | 0.18 |
| 112 | 1 AC 220 ... 277 | 50 | 0.071 | 0.28 |
| | 3 AC 200 ... 303 Δ | 50 | 0.097 | 0.35 |
| | 3 AC 346 ... 525 Y | 50 | 0.097 | 0.20 |
| | 1 AC 220 ... 277 | 60 | 0.094 | 0.37 |
| | 3 AC 220 ... 332 Δ | 60 | 0.103 | 0.31 |
| | 3 AC 380 ... 575 Y | 60 | 0.103 | 0.18 |
| 132 | 1 AC 230 ... 277 | 50 | 0.098 | 0.40 |
| | 3 AC 200 ... 303 Δ | 50 | 0.124 | 0.58 |
| | 3 AC 346 ... 525 Y | 50 | 0.124 | 0.33 |
| | 1 AC 230 ... 277 | 60 | 0.149 | 0.57 |
| | 3 AC 220 ... 332 Δ | 60 | 0.148 | 0.44 |
| | 3 AC 380 ... 575 Y | 60 | 0.148 | 0.25 |
| 160 ... 200 | 1 AC 230 ... 277 | 50 | 0.253 | 0.97 |
| | 3 AC 200 ... 303 Δ | 50 | 0.247 | 0.87 |
| | 3 AC 346 ... 525 Y | 50 | 0.247 | 0.50 |
| | 3 AC 220 ... 332 Δ | 60 | 0.360 | 0.93 |
| | 3 AC 380 ... 575 Y | 60 | 0.360 | 0.56 |

Technical specifications of separately driven fans for 1MB1 explosion-protected motors (frame sizes 225 to 315) in the Ex tb (Zone 21), Ex tc (Zone 22) and Ex ec (Zone 2) versions

| Frame size | Designation on rating plate of separately driven fan | Rated voltage range | Frequency | Rated speed | Power consumption | Rated current for rated voltage |
|--------------------|---|---------------------|-----------|-------------|-------------------|------------------------------------|
| | | V | Hz | rpm | kW | A |
| 225 M ... 280 M | 1LA7073-2AA62-Z | 3 AC 230 Δ | 50 | 2800 | 0.550 | 1.36 |
| | | 3 AC 400 Y | 50 | 2800 | 0.550 | 0.79 |
| | | 3 AC 460 Y | 60 | 3400 | 0.630 | 1.32 |
| 315 – 2-pole | 1LA9073-2LA92-Z | 3 AC 230 Δ | 50 | 2780 | 0.700 | 1.73 |
| | | 3 AC 400 Y | 50 | 2780 | 0.700 | 1.00 |
| | | 3 AC 460 Y | 60 | 3385 | 0.700 | 1.64 |
| 315 – 4, 6, 8-pole | 1LA7073-2AA62-Z | 3 AC 230 Δ | 50 | 2800 | 0.550 | 1.36 |
| | | 3 AC 400 Y | 50 | 2800 | 0.550 | 0.79 |
| | | 3 AC 460 Y | 60 | 3400 | 0.630 | 1.32 |

SIMOTICS XP 1MB1, 1MB5 explosion-protected motors

Orientation

Technical specifications

Dimensions and weights of the explosion-protected separately driven fans (order code **F70**)

1MB102, 1MB152, 1MB162, 1MB103, 1MB153, 1MB163 Frame sizes 100 to 200

Explosion-protected separately driven fans
Ex tc, Ex ec

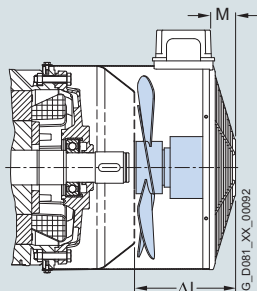

Type of protection/motor type

Ex tc (Zone 22)/1MB102, 1MB152, 1MB162

Ex ec (Zone 2)/1MB103, 1MB153, 1MB163

| Frame size | Δl | Weight approx. |
|------------|-----|----------------|
| | mm | kg |
| 100 | 141 | 4 |
| 112 | 158 | 4.5 |
| 132 | 177 | 5.5 |
| 160 | 227 | 7 |
| 180 | 269 | 10 |
| 200 | 272 | 11 |

1MB151, 1MB161, 1MB152, 1MB162, 1MB153, 1MB163 Frame sizes 225 to 315

Explosion-protected separately driven fans
Ex tb, Ex tc, Ex ec

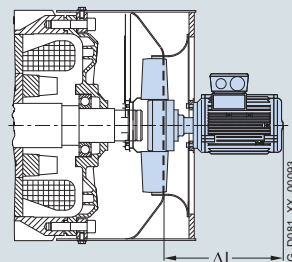

Type of protection/motor type

Ex tb (Zone 21)/1MB151, 1MB161

Ex tc (Zone 22)/1MB152, 1MB162

Ex ec (Zone 2)/1MB153, 1MB163

| Frame size | Δl | Weight approx. |
|------------|-----|----------------|
| | mm | kg |
| 225 | 267 | 24.5 |
| 250 | 272 | 27.5 |
| 280 | 270 | 30.5 |
| 315 | 280 | 38.5 |

1MB..5 Frame sizes 225 to 355

Explosion-protected separately driven fan
Ex db eb

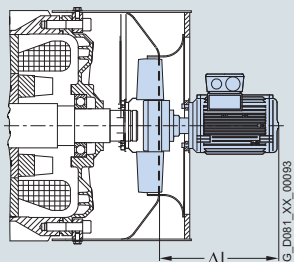

Type of protection/motor type

Ex db eb (Zone 1)/1MB155, 1MB555

| Frame size | Δl | Weight approx. |
|------------|-----|----------------|
| | mm | kg |
| 225 | 555 | |
| 250 | | |
| 280 | | |
| 315 | | |
| 355 | 370 | |

Technical specifications

Version 1MB..5 motors (Ex db, Ex db eb) with mounted brake

The brake is located at drive-end of the motor and can be mounted with flange B5 or B14 depending on the motor – 14th position of the Article No. **F** (flange B5); **K** (flange B14).

The shaft extension is implemented in the same way as the standard shaft extension of the motor. A special shaft extension or special bearings are not possible.

The motor, including the brake, is available ATEX-certified as standard and optionally with IECEx (order code **D37**) and EACEx (order code **D35**).

The spring-operated brake (order code **F20**) is a single-disk brake with two friction surfaces. The compression springs produce the braking torque by means of friction that opposes the disk. The brake is released electromagnetically.

The degree of protection of the brake is IP66 (IEC/EN 60034-5 and IEC/EN 60079-0).

The braking voltage supply 24 V DC (order code **F10**), 230 V AC (order code **F11**) and 400 V AC (order code **F12**) have to be ordered together with order code **F20**.

In the standard version, the brake is equipped with a bimetal protection device for thermal protection with a limit value for the temperature class of the brake.

Dynamic application of the brake in accordance with the permissible energy and frequency of braking (duty cycles) can be determined by the formula "Calculation of the slipping time of the friction disk" and table "Frequency of braking".

For special operating characteristics in accordance with the permissible energy and the frequency of braking (braking cycles), calculation of new values by Siemens is necessary.

The possibility of manual release of the brake can be ordered optionally (order code **F50**). In this case, the brake can be released in the de-energized state (no lock).

Further options for controlling the brake, such as a PTC thermistor for monitoring the brake temperature, are available on request

Overview of the brake selection for 1MB1553 motors, 2 to 8-pole

| | | Frame size | | | | | | | |
|--|------------------|------------|-----------|-----------|-----------|------------|-------------------|-------------------|-------------------|
| | | 80 | 90 | 100 | 112 | 132 | 160 ¹⁾ | 180 ²⁾ | 200 ²⁾ |
| Flange of the brake system with B5 flange at DE ³⁾ | | FF165 | FF165 | FF215 | FF215 | FF265 | FF300 | FF300 | FF350 |
| Flange of the brake system with B14 flange at DE ³⁾ | | FT100 | FT115 | FT130 | FT130 | FT165 | FT215 | – | – |
| Max. diameter of the shaft extension | mm | 19 j6 | 24 j6 | 28 j6 | 28 j6 | 38 k6 | 42 k6 | 48 k6 | 55 m6 |
| Brake type | | VIS80 | VIS90 | VIS100 | VIS112 | VIS132 | VIS160 | VIS180 | VIS200 |
| Permissible radial force of the point of application $x = 0.5$ ⁴⁾ | N | 380 | 380 | 550 | 550 | 790 | 790 | 1700 | 1700 |
| Rated braking torque (T_f) ⁵⁾ (static torque) | Nm | 12 | 20 | 40 | 50 | 100 | 160 | 260 | 350 |
| Possible range of the torque (on request) | Nm | 12 ... 22 | 12 ... 22 | 24 ... 40 | 30 ... 60 | 70 ... 150 | 100 ... 160 | 180 ... 350 | 300 ... 460 |
| Maximum speed n_{max} - (S1 duty) | rpm | 3600 | 3600 | 3600 | 3600 | 3600 | 2900 | 2500 | 2500 |
| Maximum speed n_{max} - (S3-40 % load) | rpm | 4320 | 4320 | 4000 | 4000 | 4000 | 3600 | 2800 | 2800 |
| Power supply unit power | W | 50 | 50 | 80 | 80 | 105 | 105 | 180 | 180 |
| Current at 24 V DC | A | 2.7 | 2.7 | 2.1 | 2.1 | 2.8 | 2.8 | 3.5 | 3.5 |
| Current at 230 V AC – (207 V DC coil voltage) ⁶⁾ | A | 0.45 | 0.45 | 0.2 | 0.2 | 0.35 | 0.35 | 0.6 | 0.6 |
| Current at 400 V AC – (180 V DC coil voltage) ⁷⁾ | A | 0.22 | 0.22 | 0.18 | 0.18 | 0.2 | 0.2 | 0.35 | 0.35 |
| Weight, approx. | kg | 32 | 34 | 50 | 50 | 78 | 82 | 135 | 150 |
| Brake engagement time t_1 ⁸⁾ | ms | 40 | 40 | 90 | 90 | 180 | 180 | 230 | 230 |
| Disengagement time t_2 ⁹⁾ | ms | 18 | 18 | 18 | 18 | 23 | 23 | 30 | 30 |
| VIS brake moment of inertia | kgm ² | 0.00088 | 0.00088 | 0.00323 | 0.00323 | 0.00831 | 0.00885 | 0.0385 | 0.0397 |
| Lifetime of the brake lining (time to inspection) | kJ | 50000 | 50000 | 75000 | 75000 | 90000 | 90000 | 120000 | 120000 |

Dynamic application of the brake

Due to dynamic application of the brake, the permissible energy is limited by the maximum frequency of brake application and the maximum slipping time of the friction disk for one brake application.

- 1) Due to the limited maximum braking velocity, 2-pole motors are not suitable for S1 duty.
- 2) Due to the limited maximum braking velocity, 2-pole motors are not possible.
- 3) The brake is mounted at the drive-end. The motor with brake can be mounted with a B5 or B14 flange, depending on the motor. Flange B5 (14th position of the Article No. **F**) mounting of types of construction IM B5, IM V1, IM B35, IM V15; Flange B14 (14th position of the Article No. **K**) mounting of types of construction IM B14, IM V18, IM B34. It is not possible to mount IM V3 and IM V35.
- 4) The bearing lifetime of the brake is the same as the bearing lifetime of the motor.

- 5) The dynamic braking torque is lower because the rated braking torque depends on the speed. (The technical specifications must be stated for the dynamic braking torque.)
- 6) For a voltage of 230 V AC, a bridge rectifier is used, which is contained in the scope of supply.
- 7) For a voltage of 400 V AC, a half-wave rectifier is used, which is contained in the scope of supply.
- 8) Time until the braking torque is reached after the voltage supply is switched off.
- 9) Time until the braking torque has decayed after the voltage supply is switched on.

SIMOTICS XP 1MB1, 1MB5 explosion-protected motors

Orientation

Technical specifications

Calculation of the slipping time t_3 of the friction disk ¹⁾

$$t_3 = \frac{J_{\text{total}} \cdot n}{9.55 \cdot (T_f \pm T_{\text{load}})}$$

J_{total} Total moment of inertia on the motor shaft

$J_{\text{brake}} + J_{\text{motor}} + J_{\text{load}}$ in kgm^2

n Motor speed in rpm

T_f Rated braking torque in Nm

T_{load} Instantaneous load torque in Nm positive or negative, depending on the conformity with the braking torque

t_3 Slipping time in s

Frequency and slipping time t_3 (duty cycles)

| Brake type | Frequency of operations per cycle (1/h) ²⁾ | |
|------------|---|---|
| | Slipping time t_3 ≤ 0.5 s | Slipping time t_3 ≥ 0.5 s to ≤ 0.8 s |
| VIS80 | 1800 | 900 |
| VIS90 | 1800 | 900 |
| VIS100 | 1300 | 650 |
| VIS112 | 1300 | 650 |
| VIS132 | 900 | 450 |
| VIS160 | 900 | 450 |
| VIS180 | 600 | 300 |
| VIS200 | 600 | 300 |

VIK version

VIK = Verband der Industriellen Energie- und Kraftwirtschaft e.V. (German Association of the Energy and Power Supply Industry)

- **VIK standard version** – 1LE1, 1LE5 + order code **C02**
"VIK" identification on rating plate.
→ Product range in Catalog Section 2.
- **VIK-Ex ec version for line operation** – 1MB1.3, 1MB5 + order code **C02**
"VIK" and "Ex ec IIC T3 Gc" marking on the rating plate according to Directive 2014/34/EU (ATEX).
→ Product range in this Catalog Section.
- **VIK Ex ec version for converter operation** – 1MB1.3, 1MB5 + order code **C02+B40/B41+...**
"VIK" and "Ex ec IIC T3 Gc" markings on the rating plate and motor operating data for converter operation on the additional rating plate according to Directive 2014/34/EU (ATEX).

VIK standard version and VIK Ex ec versions include technology for Zone 2 with type of protection Ex ec IIC T3 Gc. Motors up to frame size 355 can be supplied in accordance with the technical requirements of the VIK recommendation.

Minimum efficiency class:

For VIK standard, VIK Ex ec and VIK-Ex db version, the minimum efficiency class IE3 for line operation and IE2 for converter operation must be complied with according to EC Directive 640/2009 EC. For the VIK Ex eb version, the minimum efficiency class is IE2.

Note:

8-pole motors or all motors < 0.75 kW are still possible as these motors are outside the power range specified for IE stamping.

Ex certification EAC for the Eurasian Customs Union (Russia, Belarus, and Kazakhstan, Armenia, Kyrgyzstan) EAC = Eurasian Conformity

For the import and commissioning of explosion-protected motors in the Eurasian Customs Union, approval is required from a named Russian testing authority.

"Ex certificate EAC for the Eurasian Customs Union"
Order code **D35**

When motors are ordered with order code **D35**, they are fitted with an additional rating plate displaying the logo "EAC Ex" and the Russian Ex marking.

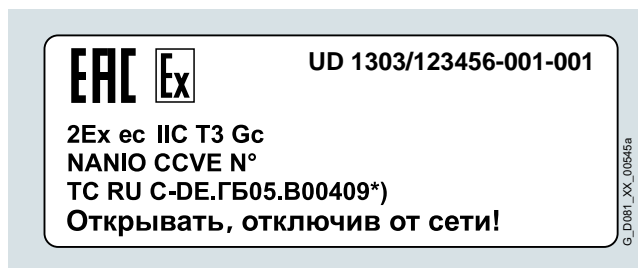

Example: Additional rating plate

The "EAC Ex" logo can also be found on the package label. The motor must have an "EAC Ex certificate", although the certificate does not generally have to be shipped with the motor. The customs authorities use the motor article number to check the motor certification.

A copy of the EAC Ex certificate must be in the customer's possession before the motor is commissioned.

The certificates are available from the SIOS (Siemens Industry Online Support) portal
<https://support.industry.siemens.com/cs/ww/en/>
as well as the "Drive Technology Configurator" (DT Configurator) www.siemens.com/dt-configurator

Coolant temperature

Coolant temperature -40 to $+40$ °C for explosion-protected motor

For all SIMOTICS XP 1MB. motors of frame sizes 71 to 450, the operating temperature can optionally be extended up to -40 °C. Extensive technical measures are necessary in this case.

Order code **D03**

Order code **D03** is not possible in combination with order code **H02** "Vibration-proof version".

¹⁾ The slipping time t_3 is the friction time until the motor stops (≤ 0.8 s); slipping time > 0.8 s on request.

²⁾ Maximum frequency of braking (duty cycles) per hour (> 0.8 s on request).

SIMOTICS XP 1MB1, 1MB5 explosion-protected motors

Orientation

Article number code

Selection and ordering data

The article number consists of a combination of digits and letters and is divided into three hyphenated blocks to provide a better overview, e.g.:

1MB1511-1DB22-2AB4-Z
R10

The first block (positions 1 to 7) identifies the motor type. The second block (positions 8 to 12) defines the motor frame size and length, the number of poles and power and in some cases the frequency/voltage. In the third block (positions 13 to 16), the frequency/voltage, type of construction and further design features are encoded.

For deviations in the second and third block from the catalog codes either **Z** or **90** should be used as appropriate.

Ordering data:

- Complete Article No. and order code(s) or plain text
- If a quotation has been requested, please specify the quotation number in addition to the Article No.
- When ordering a complete motor as a spare part, please specify the works serial No. for the previously supplied motor as well as the Article No.

| Structure of the Article No.: | | Position: | 1 | 2 | 3 | 4 | 5 | 6 | 7 | - | 8 | 9 | 10 | 11 | 12 | - | 13 | 14 | 15 | 16 | | |
|---|--|-----------|---|---|---|---|--|---|---------------|---------------|---|---------------|---------------|----|---------------|---|---------------|---------------|---------------|---------------|--|-----|
| 1st to 4th position: Digit, letter, letter, digit | Explosion-protected – Self-ventilated by fan mounted on and driven by rotor | | 1 | M | B | 1 | | | | | | | | | | | | | | | | |
| 5th position: Digit | Aluminum housing Cast-iron housing Basic Line Cast-iron housing Performance Line Cast-iron housing – Premium insulation system | | | | | | 0 5 6 8 | | | | | | | | | | | | | | | |
| 6th to 7th position: 2 digits | Ex tb IIIC (Ex-Zone 21) Motors with IE2 High Efficiency Motors with IE1 Standard Efficiency Motors with IE3 Premium Efficiency Motors with IE4 Super Premium Efficiency Ex tc IIIB (Ex-Zone 22) Motors with IE2 High Efficiency Motors with IE1 Standard Efficiency Motors with IE3 Premium Efficiency Motors with IE4 Super Premium Efficiency Ex ec IIC T3 (Ex Zone 2) Motors with IE2 High Efficiency Motors with IE1 Standard Efficiency Motors with IE3 Premium Efficiency Motors with IE4 Super Premium Efficiency Ex eb IIC T3 (Ex Zone 1) Motors with IE3 Premium Efficiency Ex db, Ex db ed IIC T4 (Ex Zone 1) Motors with IE3 Premium Efficiency | | | | | | 1 1 1 2 1 3 1 4 2 1 2 2 2 3 2 4 3 1 3 2 3 3 3 4 4 3 5 3 | | | | | | | | | | | | | | | |
| 8th, 9th and 11th position: Digit, letter, digit | Motor frame size (frame size as a combination of shaft height and overall length, encoded) | | | | | | | | 0 ... 4 | A ... B | | | 0 ... 7 | | | | | | | | | |
| 10th position: Letter | No. of poles A: 2-pole, B: 4-pole, C: 6-pole, D: 8-pole | | | | | | | | | | | A ... D | | | | | | | | | | |
| 12th and 13th position: 2 digits | Voltage, circuit and frequency (encoded with two digits, 9-0 requires order code M.. (e.g. M1Y)) | | | | | | | | | | | | | | 0 ... 9 | | 0 ... 8 | | | | | |
| 14th position: Letter | Type of construction (encoded with A ... V) | | | | | | | | | | | | | | | | | A ... V | | | | |
| 15th position: Letter | Motor protection (encoded with A ... J) | | | | | | | | | | | | | | | | | | A ... J | | | |
| 16th position: Digit | Terminal box position 0: Terminal box, top left, 1: Terminal box, top right, 2: Terminal box, 45° left, 3: Terminal box, 45° right, 4: Terminal box, at top, 5: Terminal box, on right side, 6: Terminal box, on left side, 7: Terminal box, at bottom, 9: Special mounted components | | | | | | | | | | | | | | | | | | | 0 ... 9 | | |
| | Special order versions: encoded – additional order code required not encoded – additional plain text required | | | | | | | | | | | | | | | | | | | | | - Z |

Ordering example

| Selection criteria | Requirement | Structure of the Article No. |
|---|---|------------------------------|
| Motor type 1MB1 | Self-ventilated motor with explosion protection of type Ex tb IIIC (Ex Zone 21), cast-iron version, with IE2 High Efficiency, IP55 degree of protection | 1MB1511-■■■■■■-■■■■■ |
| Motor frame size/No. of poles/Speed | 160 M/4-pole/1500 rpm | 1MB1511-1DB2■-■■■■■ |
| Rated power | 11 kW | |
| Voltage and frequency | 230 VΔ/400 VY, 50 Hz | 1MB1511-1DB22-2■■■■■ |
| Type of construction with special version | IM B3 | 1MB1511-1DB22-2A■■■ |
| Motor protection | Motor protection with PTC thermistor with 3 embedded temperature sensors for tripping | 1MB1511-1DB22-2AB■ |
| Terminal box position | Terminal box at top | 1MB1511-1DB22-2AB4 |
| Special version | Rotation of the terminal box through 90°, entry from DE | 1MB1511-1DB22-2AB4-Z R10 |

5

SIMOTICS XP 1MB1, 1MB5 explosion-protected motors

Zones 21, 22, and 2 with types of protection Ex tb, Ex tc, Ex ec · IE4 Super Premium Efficiency



Cast-iron series 1MB5.4 – self-ventilated or forced-air cooled

Selection and ordering data

| P _{rated} , 50 Hz | Frame size | Operating values at rated power | | | | | | | | | | | Cast-iron series 1MB5.4 | | m _{IM B3} | J | |
|---|------------|---------------------------------|--------------------|--------------------------|--------------------------|--------------------------|-----------------------------|--------------------|-------------------------------------|-------------------------------------|------------------------------------|------------------|-------------------------|----------------|--------------------|---------------------------|---------------------|
| | | n _{rated} | T _{rated} | η _{rated} , 4/4 | η _{rated} , 3/4 | η _{rated} , 2/4 | cosφ _{rated} , 4/4 | I _{rated} | T _{LR} /T _{rated} | I _{LR} /I _{rated} | T _B /T _{rated} | L _{pfA} | L _{WA} | Article No. | | | ▲ New |
| kW | FS | rpm | Nm | % | % | % | A | | | | | dB(A) | dB(A) | | | | |
| 2-pole: 3000 rpm at 50 Hz | | | | | | | | | | | | | | | | | |
| 560 ⁽¹⁾²⁾ | 400 | 2988 | 1790 | 97.0 | 96.9 | 96.5 | 0.89 | 940 | 1.6 | 7.3 | 3.1 | 74 | 90 | ▲ 1MB55 4-4AA3 | 2850 | 8.9 | |
| 630 ⁽¹⁾²⁾ | 400 | 2988 | 2000 | 97.0 | 97.1 | 96.8 | 0.90 | 1040 | 1.6 | 7.3 | 3.0 | 74 | 90 | ▲ 1MB55 4-4AA5 | 3000 | 9.8 | |
| 710 ⁽³⁾ | 400 | 2988 | 2250 | 97.1 | 97.2 | 96.9 | 0.90 | 680 | 1.7 | 7.3 | 2.9 | 74 | 90 | ▲ 1MB55 4-4AA7 | 3200 | 10.8 | |
| 800 ⁽¹⁾²⁾³⁾⁴⁾ | 450 | 2990 | 2550 | 97.4 | 97.4 | 97.1 | 0.87 | 790 | 1.2 | 7.7 | 3.3 | 75 | 91 | ▲ 1MB55 4-4BA3 | 4000 | 12.3 | |
| 900 ⁽¹⁾²⁾³⁾⁴⁾ | 450 | 2988 | 2900 | 97.4 | 97.5 | 97.4 | 0.89 | 870 | 1.2 | 7.2 | 3.0 | 75 | 91 | ▲ 1MB55 4-4BA5 | 4250 | 13.5 | |
| 1000 ⁽¹⁾²⁾³⁾⁴⁾ | 450 | 2988 | 3200 | 97.4 | 97.6 | 97.6 | 0.90 | 950 | 1.2 | 7.0 | 2.7 | 75 | 91 | ▲ 1MB55 4-4BA7 | 4450 | 14.7 | |
| 4-pole: 1500 rpm at 50 Hz | | | | | | | | | | | | | | | | | |
| 560 ⁽¹⁾²⁾ | 400 | 1493 | 3600 | 96.9 | 97.0 | 96.6 | 0.86 | 970 | 2.2 | 7.5 | 3.1 | 72 | 88 | ▲ 1MB55 4-4AB3 | 3050 | 14.9 | |
| 630 ⁽¹⁾²⁾ | 400 | 1492 | 4050 | 96.8 | 96.9 | 96.6 | 0.87 | 1080 | 2.2 | 6.9 | 2.8 | 74 | 90 | ▲ 1MB55 4-4AB5 | 3150 | 15.6 | |
| 710 ⁽³⁾ | 400 | 1492 | 4550 | 97.0 | 97.0 | 96.8 | 0.87 | 700 | 2.2 | 7.2 | 2.9 | 74 | 90 | ▲ 1MB55 4-4AB7 | 3250 | 16.9 | |
| 800 ⁽³⁾ | 450 | 1492 | 5100 | 96.9 | 97.1 | 96.9 | 0.87 | 790 | 1.4 | 6.5 | 2.4 | 79 | 95 | ▲ 1MB55 4-4BB3 | 4000 | 24.0 | |
| 900 ⁽³⁾ | 450 | 1492 | 5800 | 97.0 | 97.2 | 97.0 | 0.88 | 880 | 1.4 | 6.5 | 2.5 | 79 | 95 | ▲ 1MB55 4-4BB5 | 4150 | 25.4 | |
| 1000 ⁽¹⁾³⁾ | 450 | 1492 | 6400 | 97.1 | 97.2 | 97.1 | 0.88 | 980 | 1.5 | 6.8 | 2.6 | 79 | 95 | ▲ 1MB55 4-4BB7 | 4350 | 28.0 | |
| 6-pole: 1000 rpm at 50 Hz | | | | | | | | | | | | | | | | | |
| 450 | 400 | 994 | 4300 | 96.6 | 96.8 | 96.4 | 0.85 | 790 | 2.2 | 7.2 | 2.7 | 70 | 86 | ▲ 1MB55 4-4AC3 | 3100 | 25.5 | |
| 500 ⁽¹⁾ | 400 | 994 | 4800 | 96.7 | 96.8 | 96.5 | 0.85 | 880 | 2.3 | 7.3 | 2.8 | 70 | 86 | ▲ 1MB55 4-4AC5 | 3250 | 27.4 | |
| 560 | 400 | 994 | 5400 | 96.7 | 96.8 | 96.4 | 0.84 | 1000 | 2.4 | 7.5 | 2.9 | 70 | 86 | ▲ 1MB55 4-4AC7 | 3300 | 28.6 | |
| 630 ⁽¹⁾²⁾ | 450 | 995 | 6000 | 96.8 | 97.0 | 96.7 | 0.83 | 1130 | 2.0 | 7.0 | 2.8 | 72 | 88 | ▲ 1MB55 4-4BC3 | 4050 | 38.6 | |
| 710 ⁽³⁾ | 450 | 994 | 6800 | 96.8 | 97.0 | 96.9 | 0.84 | 730 | 1.8 | 6.6 | 2.5 | 72 | 88 | ▲ 1MB55 4-4BC5 | 4200 | 41.0 | |
| 800 ⁽¹⁾³⁾ | 450 | 994 | 7700 | 96.8 | 97.0 | 96.8 | 0.84 | 820 | 1.8 | 6.6 | 2.4 | 74 | 90 | ▲ 1MB55 4-4BC7 | 4300 | 43.3 | |
| 8-pole: 750 rpm at 50 Hz | | | | | | | | | | | | | | | | | |
| 355 | 400 | 744 | 4550 | 95.8 | 96.1 | 95.8 | 0.80 | 670 | 2.0 | 6.5 | 2.6 | 64 | 80 | ▲ 1MB55 4-4AD3 | 2850 | 21.9 | |
| 400 | 400 | 744 | 5100 | 96.0 | 96.2 | 95.9 | 0.80 | 750 | 2.1 | 6.8 | 2.7 | 64 | 80 | ▲ 1MB55 4-4AD5 | 3050 | 24.5 | |
| 450 | 400 | 744 | 5800 | 96.0 | 96.3 | 96.0 | 0.80 | 850 | 2.1 | 6.8 | 2.7 | 64 | 80 | ▲ 1MB55 4-4AD7 | 3250 | 27.5 | |
| 500 ⁽⁵⁾ | 450 | 745 | 6400 | 96.2 | 96.4 | 96.1 | 0.79 | 950 | 2.0 | 6.8 | 2.5 | 67 | 83 | ▲ 1MB55 4-4BD3 | 3800 | 34.0 | |
| 560 ⁽⁵⁾ | 450 | 745 | 7200 | 96.3 | 96.5 | 96.1 | 0.79 | 1060 | 2.0 | 6.9 | 2.6 | 67 | 83 | ▲ 1MB55 4-4BD5 | 4000 | 38.0 | |
| 630 ⁽¹⁾⁵⁾ | 450 | 745 | 8100 | 96.4 | 96.6 | 96.3 | 0.80 | 1180 | 2.0 | 6.9 | 2.5 | 67 | 83 | ▲ 1MB55 4-4BD7 | 4250 | 42.5 | |
| Zones | | | | | | | | | | | | | | | | | |
| Zone 21 (conductive and non-conductive dust occasionally) Ex tb IIC | | | | | | | | | | | | | | 1 | | | |
| Zone 22 (non-conductive dust rarely or for a short period) Ex tc IIIB | | | | | | | | | | | | | | 2 | | | |
| Zone 2 (explosive gases rarely or for a short period) Ex ec IIC | | | | | | | | | | | | | | 3 | | | |
| Voltages | | | | | | | | | | | | | | | | | |
| 50 Hz 400 VΔ/690 VY | | | | | | | | | | | | | | 60 Hz 460 VΔ | | Version | Order code |
| 50 Hz 500 VΔ | | | | | | | | | | | | | | 60 Hz 575 VΔ | | Standard | 3 4 |
| 50 Hz 690 VΔ | | | | | | | | | | | | | | | | Without additional charge | 4 0 |
| | | | | | | | | | | | | | | | | Without additional charge | 4 7 |
| For other voltages and more information, see from page 5/55 | | | | | | | | | | | | | | | | | |
| Types of construction | | | | | | | | | | | | | | | | | |
| Without flange | | | | | | | | | | | | | | IM B3 | | Version | Order code |
| With flange | | | | | | | | | | | | | | IM B5 | | Standard | A |
| | | | | | | | | | | | | | | | | With additional charge | F |
| For other types of construction and more information, see from page 5/67 | | | | | | | | | | | | | | | | | |
| Motor protection | | | | | | | | | | | | | | | | | |
| Without | | | | | | | | | | | | | | | | Version | Order code |
| PTC thermistor with 3 temperature sensors | | | | | | | | | | | | | | | | Standard | A |
| | | | | | | | | | | | | | | | | With additional charge | B |
| For other motor protection and more information, see from page 5/72 | | | | | | | | | | | | | | | | | |
| Terminal box position | | | | | | | | | | | | | | | | | |
| Terminal box base left with terminal box 45° | | | | | | | | | | | | | | | | Version | Order code |
| Terminal box base right with terminal box 45° | | | | | | | | | | | | | | | | Standard | 2 |
| For other terminal box positions and more information, see from page 5/77 | | | | | | | | | | | | | | | | | |
| Special versions | | | | | | | | | | | | | | | | | |
| Forced-air cooled (IC416) | | | | | | | | | | | | | | | | Version | Order code(s) |
| For options and information, see from page 5/96 | | | | | | | | | | | | | | | | | |
| | | | | | | | | | | | | | | | | 1MB55 4- | -Z F90+. .+. .+. .+ |
| | | | | | | | | | | | | | | | | 1MB55 4- | -Z . .+. .+. .+. .+ |

1) Terminal box 1XB1631.
 2) Terminal box position NDE can only be ordered using order code **H09** (2 × terminal box TB3R61). Order code **H08** not available.
 3) The standard version is 50 Hz 690 VΔ (voltage code **4-7**) or 60 Hz 575 VΔ (voltage code **4-0**).
 4) In the series version, the maximum speed is n_{max} = 3000 rpm. Converter operation at higher speeds on request for an additional charge.
 5) Utilization with sinusoidal supply in accordance with thermal class 155 (temperature class F).



SIMOTICS XP 1MB1, 1MB5 explosion-protected motors

Zones 21, 22, and 2 with types of protection Ex tb, Ex tc, Ex ec · IE3 Premium Efficiency

Aluminum series 1MB10 – self-ventilated

Selection and ordering data

| Operating values at rated power | | | | | | | | | | | | | | Aluminum series | | | | | | |
|--|------------------------|---------------|------------------------|------------------------|------------------------------------|--------------------------------|--------------------------------|--------------------------------|------------------------------------|----------------------------------|--------------------|--------------------|-----------------|---------------------------|---------------------|-------|--------------------|------------|----------------------------------|--|
| P_{rated} , 50 Hz | P_{rated} , 60 Hz | Frame size | n_{rated} , 50 Hz | T_{rated} , 50 Hz | Different IE class 60 Hz/P60 | η_{rated} , 50 Hz, 4/4 | η_{rated} , 50 Hz, 3/4 | η_{rated} , 50 Hz, 2/4 | $\cos\phi_{rated}$, 50 Hz, 4/4 | I_{rated} , 50 Hz, 400 V | T_{LR}/I_{rated} | I_{LR}/I_{rated} | T_B/I_{rated} | L_{pFA} , 50 Hz | L_{WA} , 50 Hz | 1MB1 | $m_{IM B3}$ | J | | |
| kW | kW | FS | rpm | Nm | | % | % | % | | A | | | | | dB(A) | dB(A) | Article No. | kg | kgm ² | |
| <ul style="list-style-type: none"> • Cooling: self-ventilated (IC411) • Efficiency according to IEC 60034-30: IE3 Premium Efficiency • Insulation: Thermal class 155 (temperature class F), IP55 degree of protection, utilization in accordance with thermal class 130 (temperature class B) | | | | | | | | | | | | | | | | | | | | |
| 2-pole: 3000 rpm at 50 Hz, 3600 rpm at 60 Hz ¹⁾ | | | | | | | | | | | | | | | | | | | | |
| 0.75 | 0.86 | 80 M | 2850 | 2.5 | | 80.7 | 82.2 | 81.9 | 0.86 | 1.56 | 2.6 | 6.2 | 3 | 60 | 71 | | 1MB10 3-0DA2 | 11 | 0.0011 | |
| 1.1 | 1.27 | 80 M | 2885 | 3.6 | | 82.7 | 83.9 | 83.1 | 0.85 | 2.25 | 3 | 7.1 | 3.3 | 60 | 71 | | 1MB10 3-0DA3 | 12 | 0.0013 | |
| 1.5 | 1.75 | 90 S | 2910 | 4.9 | | 84.2 | 84.6 | 83.2 | 0.86 | 3 | 2.7 | 8.1 | 4.2 | 65 | 77 | | 1MB10 3-0EA0 | 15 | 0.0021 | |
| 2.2 | 2.55 | 90 L | 2910 | 7.2 | | 85.9 | 86.8 | 86.1 | 0.88 | 4.2 | 2.6 | 8.3 | 4 | 65 | 77 | | 1MB10 3-0EA4 | 19 | 0.0031 | |
| 3 | 3.45 | 100 L | 2920 | 9.8 | | 87.1 | 87.9 | 87.5 | 0.88 | 5.6 | 3.2 | 8.1 | 4.6 | 67 | 79 | | 1MB10 3-1AA4 | 26 | 0.0054 | |
| 4 | 4.55 | 112 M | 2950 | 13 | | 88.1 | 88.7 | 88.2 | 0.89 | 7.4 | 2.5 | 8.7 | 4 | 69 | 81 | | 1MB10 3-1BA2 | 34 | 0.012 | |
| 5.5 | 6.3 | 132 S | 2950 | 18 | | 89.2 | 90.1 | 89.7 | 0.9 | 9.9 | 1.9 | 7.3 | 3.7 | 68 | 80 | | 1MB10 3-1CA0 | 43 | 0.024 | |
| 7.5 | 8.6 | 132 S | 2950 | 24 | | 90.1 | 90.9 | 90.7 | 0.92 | 13.1 | 2.1 | 8.3 | 4 | 68 | 80 | | 1MB10 3-1CA1 | 57 | 0.031 | |
| 11 | 12.6 | 160 M | 2955 | 36 | | 91.2 | 91.3 | 90.2 | 0.87 | 20 | 2.5 | 7.6 | 3.8 | 70 | 82 | | 1MB10 3-1DA2 | 75 | 0.053 | |
| 15 | 17.3 | 160 M | 2960 | 48 | | 91.9 | 91.9 | 91 | 0.87 | 27 | 2.8 | 8.8 | 4.3 | 70 | 82 | | 1MB10 3-1DA3 | 84 | 0.061 | |
| 18.5 | 21.3 | 160 L | 2955 | 60 | | 92.4 | 92.8 | 92.3 | 0.9 | 32 | 2.8 | 8.3 | 3.9 | 70 | 82 | | 1MB10 3-1DA4 | 94 | 0.068 | |
| 4-pole: 1500 rpm at 50 Hz, 1800 rpm at 60 Hz ¹⁾ | | | | | | | | | | | | | | | | | | | | |
| 0.55 | 0.63 | 80 M | 1440 | 3.6 | | 80.8 | 81.1 | 79.3 | 0.78 | 1.26 | 2.1 | 5.9 | 3.1 | 53 | 64 | | 1MB10 3-0DB2 | 11 | 0.0021 | |
| 0.75 | 0.86 | 80 M | 1450 | 4.9 | | 82.5 | 82.3 | 79.9 | 0.75 | 1.75 | 2.7 | 7.1 | 3.9 | 53 | 64 | | 1MB10 3-0DB3 | 14 | 0.0029 | |
| 1.1 | 1.27 | 90 S | 1440 | 7.3 | | 84.1 | 84.7 | 83.4 | 0.78 | 2.4 | 2.9 | 6.9 | 3.6 | 56 | 68 | | 1MB10 3-0EB0 | 16 | 0.0036 | |
| 1.5 | 1.75 | 90 L | 1445 | 9.9 | | 85.3 | 86 | 85.2 | 0.8 | 3.15 | 2.9 | 7.3 | 3.5 | 60 | 68 | | 1MB10 3-0EB4 | 19 | 0.0049 | |
| 2.2 | 2.55 | 100 L | 1465 | 14.3 | | 86.7 | 87 | 85.9 | 0.83 | 4.4 | 3.2 | 8.4 | 4.4 | 60 | 72 | | 1MB10 3-1AB4 | 30 | 0.014 | |
| 3 | 3.45 | 100 L | 1460 | 19.6 | | 87.7 | 88.5 | 87.9 | 0.83 | 5.9 | 2.5 | 8.3 | 3.9 | 60 | 72 | | 1MB10 3-1AB5 | 30 | 0.014 | |
| 4 | 4.55 | 112 M | 1460 | 26 | | 88.6 | 89.2 | 88.6 | 0.82 | 7.9 | 2.4 | 7.1 | 3.7 | 58 | 70 | | 1MB10 3-1BB2 | 34 | 0.017 | |
| 5.5 | 6.3 | 132 S | 1470 | 36 | | 89.6 | 90 | 89.4 | 0.82 | 10.8 | 2.9 | 8.6 | 3.7 | 64 | 76 | | 1MB10 3-1CB0 | 64 | 0.046 | |
| 7.5 | 8.6 | 132 M | 1465 | 49 | | 90.4 | 91.1 | 90.8 | 0.84 | 14.3 | 2.6 | 8.2 | 3.7 | 64 | 76 | | 1MB10 3-1CB2 | 64 | 0.046 | |
| 11 | 12.6 | 160 M | 1475 | 71 | | 91.4 | 91.8 | 91.2 | 0.84 | 20.5 | 2.6 | 7.6 | 3.4 | 65 | 77 | | 1MB10 3-1DB2 | 83 | 0.083 | |
| 15 | 17.3 | 160 L | 1475 | 97 | | 92.1 | 92.3 | 91.5 | 0.82 | 28.5 | 2.5 | 8.5 | 3.8 | 65 | 77 | | 1MB10 3-1DB4 | 100 | 0.099 | |
| 6-pole: 1000 rpm at 50 Hz, 1200 rpm at 60 Hz ¹⁾ | | | | | | | | | | | | | | | | | | | | |
| 0.37 | 0.43 | 80 M | 940 | 3.8 | | 73.5 | 73.1 | 69.4 | 0.66 | 1.1 | 2.3 | 4.2 | 2.7 | 42 | 53 | | 1MB10 3-0DC2 | 12 | 0.0025 | |
| 0.55 | 0.63 | 80 M | 935 | 5.6 | | 77.2 | 77 | 73.9 | 0.67 | 1.53 | 2.5 | 4.5 | 2.8 | 42 | 53 | | 1MB10 3-0DC3 | 14 | 0.0031 | |
| 0.75 | 0.86 | 90 S | 945 | 7.6 | | 78.9 | 80 | 78.8 | 0.7 | 1.96 | 2.2 | 4.6 | 2.6 | 43 | 55 | | 1MB10 3-0EC0 | 16 | 0.004 | |
| 1.1 | 1.27 | 90 L | 950 | 11 | IE1 | 81 | 81.4 | 79.3 | 0.66 | 2.95 | 2.8 | 5 | 3 | 57 | 65 | | 1MB10 3-0EC4 | 19 | 0.0052 | |
| 1.5 | 1.75 | 100 L | 970 | 14.8 | IE2 | 82.5 | 83.1 | 81.5 | 0.73 | 3.6 | 1.9 | 5.2 | 2.8 | 59 | 71 | | 1MB10 3-1AC4 | 30 | 0.014 | |
| 2.2 | 2.55 | 112 M | 970 | 22 | IE2 | 84.3 | 85 | 83.9 | 0.75 | 5 | 2.2 | 5.6 | 2.8 | 65 | 74 | | 1MB10 3-1BC2 | 39 | 0.014 | |
| 3 | 3.45 | 132 S | 975 | 29 | | 85.6 | 86.1 | 84.9 | 0.73 | 6.9 | 2.3 | 6.6 | 3.2 | 58 | 66 | | 1MB10 3-1CC0 | 42 | 0.034 | |
| 4 | 4.55 | 132 M | 975 | 39 | | 86.8 | 87.1 | 86.2 | 0.73 | 9.1 | 2.2 | 6.2 | 3 | 67 | 75 | | 1MB10 3-1CC2 | 46 | 0.039 | |
| 5.5 | 6.3 | 132 M | 975 | 54 | | 88.0 | 88.3 | 87.2 | 0.72 | 12.5 | 2.7 | 6.8 | 3.4 | 64 | 72 | | 1MB10 3-1CC3 | 58 | 0.05 | |
| 7.5 | 8.6 | 160 M | 985 | 73 | | 89.1 | 89.5 | 88.6 | 0.81 | 15 | 2.3 | 7.9 | 3.2 | 71 | 79 | | 1MB10 3-1DC2 | 95 | 0.132 | |
| 11 | 12.6 | 160 L | 980 | 107 | | 90.3 | 90.8 | 90.2 | 0.80 | 22 | 2.9 | 6.8 | 2.8 | 66 | 74 | | 1MB10 3-1DC4 | 106 | 0.164 | |
| Zones | | | | | | | | | | | | | | | | | | | | |
| Zone 21 (conductive and non-conductive dust occasionally) Ex tb IIC | | | | | | | | | | | | | | | | | 1 | | | |
| Zone 22 (non-conductive dust rarely or for a short period) Ex tc IIIB | | | | | | | | | | | | | | | | | 2 | | | |
| Zone 2 (explosive gases rarely or for a short period) Ex ec IIC | | | | | | | | | | | | | | | | | 3 | | | |
| Voltages | | | | | | | | | | | | | | | | | | | | |
| 50 Hz 230 VΔ/400 VY | | | | | | | | | | | | | | Version | | | | Order code | | |
| 60 Hz ¹⁾ 460 VY | | | | | | | | | | | | | | Standard | | 2 2 | | - | | |
| 50 Hz 400 VΔ/690 VY | | | | | | | | | | | | | | Standard | | 3 4 | | - | | |
| 50 Hz 500 VY | | | | | | | | | | | | | | Without additional charge | | 2 7 | | - | | |
| 50 Hz 500 VΔ | | | | | | | | | | | | | | Without additional charge | | 4 0 | | - | | |
| | | | | | | | | | | | | | | | | 9 0 | | ... | | |
| For other voltages ¹⁾ and more information, see from page 5/51 | | | | | | | | | | | | | | | | | | | | |
| Types of construction | | | | | | | | | | | | | | | | | | | | |
| Without flange | | | | | | | | | | | | | | Version | | | | Order code | | |
| IM B3 ²⁾ | | | | | | | | | | | | | | Standard | | A | | - | | |
| With flange | | | | | | | | | | | | | | With additional charge | | F | | - | | |
| IM B5 ²⁾ | | | | | | | | | | | | | | With additional charge | | K | | - | | |
| With flange | | | | | | | | | | | | | | With additional charge | | B | | ... | | |
| IM B14 ²⁾ | | | | | | | | | | | | | | | | | | | | |
| For other types of construction and more information, see from page 5/56 | | | | | | | | | | | | | | | | | | | | |
| Motor protection | | | | | | | | | | | | | | | | | | | | |
| Without | | | | | | | | | | | | | | Version | | | | | | |
| Standard | | | | | | | | | | | | | | Standard | | A | | | | |
| 3 temperature sensors (frame sizes 80, 90 or 100 to 200) | | | | | | | | | | | | | | With additional charge | | B | | | | |
| For other motor protection and more information, see from page 5/68 | | | | | | | | | | | | | | | | | | | | |
| Terminal box position | | | | | | | | | | | | | | | | | | | | |
| Terminal box at top | | | | | | | | | | | | | | Version | | | | | | |
| Standard | | | | | | | | | | | | | | Standard | | 4 | | | | |
| For other terminal box positions and more information, see from page 5/73 | | | | | | | | | | | | | | | | | | | | |
| Special versions | | | | | | | | | | | | | | | | | | | | |
| For options, see from page 5/78 | | | | | | | | | | | | | | | | | 1MB10 3- - | | -Z . . . + . . . + . . . + . . . | |



For footnotes, see page 5/40

SIMOTICS XP 1MB1, 1MB5 explosion-protected motors

Zones 21, 22, and 2 with types of protection Ex tb, Ex tc, Ex ec · IE3 Premium Efficiency



Cast-iron series 1MB15, 1MB16 – self-ventilated

Selection and ordering data

| Operating values at rated power | | | | | | | | | | | | | | Cast-iron series | | | | | |
|--|----------------------|---------------|----------------------|----------------------|------------------------------------|-------------------------|-------------------------|-------------------------|----------------------------------|---------------------------|--------------------|--------------------|-----------------|--------------------|-------------------|--------------|-------------|------------------|--|
| P_{rated} 50 Hz | P_{rated} 60 Hz | Frame size | n_{rated} 50 Hz | T_{rated} 50 Hz | Different IE class 60 Hz/P60 | η_{rated} 50 Hz | η_{rated} 50 Hz | η_{rated} 50 Hz | $\cos\phi_{rated}$ 50 Hz, 4/4 | I_{rated} 50 Hz, 4/4 | T_{LR}/T_{rated} | I_{LR}/I_{rated} | T_B/T_{rated} | L_{pFA} 50 Hz | L_{WA} 50 Hz | Article No. | $m_{IM B3}$ | J | |
| kW | kW | FS | rpm | Nm | | % | % | % | | A | | | | | | | kg | kgm ² | |
| <ul style="list-style-type: none"> • Cooling: self-ventilated (IC411) • Efficiency according to IEC 60034-30: IE3 Premium Efficiency • Insulation: Thermal class 155 (temperature class F), IP55 degree of protection, utilization in accordance with thermal class 130 (temperature class B) | | | | | | | | | | | | | | | | | | | |
| 2-pole: 3000 rpm at 50 Hz, 3600 rpm at 60 Hz ¹⁾ | | | | | | | | | | | | | | | | | | | |
| 0.37 | 0.43 | 71 M | 2850 | 1.2 | | 73.8 | 73.3 | 69.7 | 0.76 | 0.95 | 3.5 | 5.8 | 3.5 | 52 | 63 | 1MB15-3-0CA2 | 13 | 0.0045 | |
| 0.55 | 0.63 | 71 M | 2860 | 1.8 | | 77.8 | 77.5 | 74.5 | 0.76 | 1.34 | 3.7 | 6.1 | 3.7 | 57 | 68 | 1MB15-3-0CA3 | 14.5 | 0.0056 | |
| 0.75 | 0.88 | 80 M | 2850 | 2.5 | | 80.7 | 82.2 | 81.9 | 0.86 | 1.56 | 2.6 | 6.2 | 3 | 60 | 71 | 1MB15-3-0DA2 | 18 | 0.011 | |
| 1.1 | 1.27 | 80 M | 2885 | 3.6 | | 82.7 | 83.9 | 83.1 | 0.85 | 2.25 | 3 | 7.1 | 3.3 | 60 | 71 | 1MB15-3-0DA3 | 21 | 0.013 | |
| 1.5 | 1.75 | 90 S | 2910 | 4.9 | | 84.2 | 84.6 | 83.2 | 0.86 | 3 | 2.7 | 8.1 | 4.2 | 65 | 77 | 1MB15-3-0EA0 | 25.5 | 0.021 | |
| 2.2 | 2.55 | 90 L | 2910 | 7.2 | | 85.9 | 86.8 | 86.1 | 0.88 | 4.2 | 2.6 | 8.3 | 4 | 65 | 77 | 1MB15-3-0EA4 | 32 | 0.031 | |
| 3 | 3.45 | 100 L | 2920 | 9.8 | | 87.1 | 87.9 | 87.5 | 0.88 | 5.6 | 3.2 | 8.1 | 4.6 | 67 | 79 | 1MB1-3-1AA4 | 36 | 0.054 | |
| 4 | 4.55 | 112 M | 2950 | 13 | | 88.1 | 88.7 | 88.2 | 0.89 | 7.4 | 2.5 | 8.7 | 4 | 69 | 81 | 1MB1-3-1BA2 | 45 | 0.12 | |
| 5.5 | 6.3 | 132 S | 2950 | 18 | | 89.2 | 90.1 | 89.7 | 0.9 | 9.9 | 1.9 | 7.3 | 3.7 | 68 | 80 | 1MB1-3-1CA0 | 58 | 0.24 | |
| 7.5 | 8.6 | 132 S | 2950 | 24 | | 90.1 | 90.9 | 90.7 | 0.92 | 13.1 | 2.1 | 8.3 | 4 | 68 | 80 | 1MB1-3-1CA1 | 73 | 0.31 | |
| 11 | 12.6 | 160 M | 2955 | 36 | | 91.2 | 91.3 | 90.2 | 0.87 | 20 | 2.5 | 7.6 | 3.8 | 70 | 82 | 1MB1-3-1DA2 | 100 | 0.053 | |
| 15 | 17.3 | 160 M | 2960 | 48 | | 91.9 | 91.9 | 91 | 0.87 | 27 | 2.8 | 8.8 | 4.3 | 70 | 82 | 1MB1-3-1DA3 | 110 | 0.061 | |
| 18.5 | 21.3 | 160 L | 2955 | 60 | | 92.4 | 92.8 | 92.3 | 0.9 | 32 | 2.8 | 8.3 | 3.9 | 70 | 82 | 1MB1-3-1DA4 | 127 | 0.068 | |
| 22 | 24.5 | 180 M | 2950 | 71 | | 92.7 | 93 | 92.4 | 0.89 | 38.5 | 2.3 | 7.5 | 3.5 | 67 | 80 | 1MB1-3-1EA2 | 160 | 0.08 | |
| 30 | 33.5 | 200 L | 2955 | 97 | | 93.3 | 93.6 | 93.3 | 0.87 | 53 | 2.5 | 7 | 3.3 | 67 | 80 | 1MB1-3-2AA4 | 225 | 0.134 | |
| 37 | 41.5 | 200 L | 2955 | 120 | | 93.7 | 93.9 | 93.5 | 0.88 | 65 | 2.5 | 7.1 | 3.2 | 67 | 80 | 1MB1-3-2AA5 | 250 | 0.158 | |
| 45 | 51 | 225 M | 2960 | 145 | | 94 | 94.5 | 94.4 | 0.89 | 78 | 2.4 | 6.9 | 3.3 | 73 | 87 | 1MB1-3-2BA2 | 315 | 0.26 | |
| 55 | 62 | 250 M | 2975 | 177 | | 94.3 | 94.5 | 93.9 | 0.89 | 95 | 2.3 | 6.7 | 3.1 | 73 | 87 | 1MB1-3-2CA2 | 385 | 0.46 | |
| 75 | 84 | 280 S | 2975 | 241 | IE2 | 94.7 | 94.8 | 94.1 | 0.89 | 128 | 2.4 | 6.8 | 3 | 74 | 88 | 1MB1-3-2DA0 | 510 | 0.77 | |
| 90 | 101 | 280 M | 2975 | 289 | IE2 | 95 | 95.1 | 94.6 | 0.9 | 152 | 2.4 | 7.2 | 3.1 | 74 | 88 | 1MB1-3-2DA2 | 590 | 0.94 | |
| 110 | 123 | 315 S | 2982 | 352 | | 95.2 | 95.4 | 94.9 | 0.91 | 183 | 2.4 | 7.1 | 3.1 | 75 | 89 | 1MB1-3-3AA0 | 750 | 1.4 | |
| 132 | 148 | 315 M | 2982 | 423 | | 95.4 | 95.5 | 95.2 | 0.91 | 220 | 2.5 | 7.2 | 3.1 | 75 | 89 | 1MB1-3-3AA2 | 880 | 1.6 | |
| 160 | 180 | 315 L | 2982 | 512 | IE2 | 95.6 | 95.7 | 95.2 | 0.92 | 265 | 2.8 | 7.8 | 3.3 | 77 | 91 | 1MB1-3-3AA4 | 980 | 1.9 | |
| 200 | 224 | 315 L | 2982 | 640 | | 95.8 | 95.9 | 95.5 | 0.92 | 330 | 2.5 | 7.2 | 3 | 77 | 91 | 1MB1-3-3AA5 | 1150 | 2.3 | |
| Basic Line | | | | | | | | | | | | | | | | 5 | | | |
| Performance Line | | | | | | | | | | | | | | | | 6 | | | |
| Zones | | | | | | | | | | | | | | | | | | | |
| Zone 21 (conductive and non-conductive dust occasionally) Ex tb IIC | | | | | | | | | | | | | | | | 1 | | | |
| Zone 22 (non-conductive dust rarely or for a short period) Ex tc IIIB | | | | | | | | | | | | | | | | 2 | | | |
| Zone 2 (explosive gases rarely or for a short period) Ex ec IIC | | | | | | | | | | | | | | | | 3 | | | |
| Voltages ³⁾ | | | | | | | | | | | | | | | | | | | |
| 50 Hz 230 VΔ/400 VY | | | | | | | | | | | | | | | | | | | |
| 60 Hz ¹⁾ 460 VY | | | | | | | | | | | | | | | | | | | |
| 50 Hz 400 VΔ/690 VY | | | | | | | | | | | | | | | | | | | |
| 60 Hz ¹⁾ 460 VΔ | | | | | | | | | | | | | | | | | | | |
| 50 Hz 500 VY | | | | | | | | | | | | | | | | | | | |
| 50 Hz 500 VΔ | | | | | | | | | | | | | | | | | | | |
| For other voltages ¹⁾ and more information, see from page 5/52 | | | | | | | | | | | | | | | | | | | |
| Types of construction | | | | | | | | | | | | | | | | | | | |
| Without flange IM B3 ²⁾ | | | | | | | | | | | | | | | | | | | |
| With flange IM B5 ²⁾ | | | | | | | | | | | | | | | | | | | |
| With flange IM B14 ²⁾ | | | | | | | | | | | | | | | | | | | |
| For other types of construction and more information, see from page 5/59 | | | | | | | | | | | | | | | | | | | |
| Motor protection | | | | | | | | | | | | | | | | | | | |
| Without | | | | | | | | | | | | | | | | | | | |
| PTC thermistor with 3 temperature sensors | | | | | | | | | | | | | | | | | | | |
| Line | | | | | | | | | | | | | | | | | | | |
| Only possible for Basic Line | | | | | | | | | | | | | | | | | | | |
| Basic Line | | | | | | | | | | | | | | | | | | | |
| Performance Line | | | | | | | | | | | | | | | | | | | |
| Version | | | | | | | | | | | | | | | | | | | |
| Standard | | | | | | | | | | | | | | | | | | | |
| Without additional charge | | | | | | | | | | | | | | | | | | | |
| With additional charge | | | | | | | | | | | | | | | | | | | |
| For other motor protection and more information, see from page 5/69 | | | | | | | | | | | | | | | | | | | |
| Terminal box position | | | | | | | | | | | | | | | | | | | |
| Terminal box at top | | | | | | | | | | | | | | | | | | | |
| Version | | | | | | | | | | | | | | | | | | | |
| Standard | | | | | | | | | | | | | | | | | | | |
| For other terminal box positions and more information, see from page 5/74 | | | | | | | | | | | | | | | | | | | |
| Special versions | | | | | | | | | | | | | | | | | | | |
| For options, see from page 5/82 | | | | | | | | | | | | | | | | | | | |
| 1MB1-3-...-...-Z-...+...+...+... | | | | | | | | | | | | | | | | | | | |

5



SIMOTICS XP 1MB1, 1MB5 explosion-protected motors

Zones 21, 22, and 2 with types of protection Ex tb, Ex tc, Ex ec · IE3 Premium Efficiency

Cast-iron series 1MB15, 1MB16 – self-ventilated

Selection and ordering data

| Operating values at rated power | | | | | | | | | | | | | | | Cast-iron series | | $m_{IM\ B3}$ | J | | | | | |
|--|---------------------|------------|---------------------|---------------------|--------------------|------------------------|------------------------|------------------------|----------------------------|---------------------|--------------------|--------------------|-----------------|-------------------|------------------|--------------|--------------|------------------|-------------------------------------|------------------------|---|--|------------------------------|
| $P_{rated, 50\ Hz}$ | $P_{rated, 60\ Hz}$ | Frame size | $n_{rated, 50\ Hz}$ | $T_{rated, 50\ Hz}$ | Different IE class | $\eta_{rated, 50\ Hz}$ | $\eta_{rated, 50\ Hz}$ | $\eta_{rated, 50\ Hz}$ | $\cos\phi_{rated, 50\ Hz}$ | $I_{rated, 50\ Hz}$ | T_{LR}/I_{rated} | I_{LR}/I_{rated} | T_B/I_{rated} | $L_{pFA, 50\ Hz}$ | $L_{WA, 50\ Hz}$ | Article No. | | | $m_{IM\ B3}$ | J | | | |
| kW | kW | FS | rpm | Nm | | % | % | % | | A | | | | | | | kg | kgm ² | | | | | |
| <ul style="list-style-type: none"> • Cooling: self-ventilated (IC411) • Efficiency according to IEC 60034-30: IE3 Premium Efficiency • Insulation: Thermal class 155 (temperature class F), IP55 degree of protection, utilization in accordance with thermal class 130 (temperature class B) | | | | | | | | | | | | | | | | | | | | | | | |
| 4-pole: 1500 rpm at 50 Hz, 1800 rpm at 60 Hz ¹⁾ | | | | | | | | | | | | | | | | | | | | | | | |
| 0.25 | 0.29 | 71 M | 1395 | 1.7 | | 73.5 | 73.6 | 70.4 | 0.72 | 0.68 | 2.5 | 4.2 | 2.6 | 44 | 55 | 1MB15-3-0CB2 | 13 | 0.0095 | | | | | |
| 0.37 | 0.43 | 71 M | 1410 | 2.6 | | 77.3 | 76.8 | 73.2 | 0.7 | 0.99 | 3.1 | 4.8 | 3.1 | 56 | 67 | 1MB15-3-0CB3 | 16 | 0.0014 | | | | | |
| 0.55 | 0.63 | 80 M | 1440 | 3.6 | | 80.8 | 81.1 | 79.3 | 0.78 | 1.26 | 2.1 | 5.9 | 3.1 | 53 | 64 | 1MB15-3-0DB2 | 18.5 | 0.0021 | | | | | |
| 0.75 | 0.88 | 80 M | 1450 | 4.9 | | 82.5 | 82.3 | 79.9 | 0.75 | 1.75 | 2.7 | 7.1 | 3.9 | 53 | 64 | 1MB15-3-0DB3 | 22.5 | 0.0029 | | | | | |
| 1.1 | 1.27 | 90 S | 1440 | 7.3 | | 84.1 | 84.7 | 83.4 | 0.78 | 2.4 | 2.9 | 6.9 | 3.6 | 56 | 68 | 1MB15-3-0EB0 | 25 | 0.0036 | | | | | |
| 1.5 | 1.75 | 90 L | 1445 | 9.9 | | 85.3 | 86 | 85.2 | 0.8 | 3.15 | 2.9 | 7.3 | 3.5 | 60 | 68 | 1MB15-3-0EB4 | 31 | 0.0049 | | | | | |
| 2.2 | 2.55 | 100 L | 1465 | 14.3 | | 86.7 | 87 | 85.9 | 0.83 | 4.4 | 3.2 | 8.4 | 4.4 | 60 | 72 | 1MB1-3-1AB4 | 40 | 0.014 | | | | | |
| 3 | 3.45 | 100 L | 1460 | 19.6 | | 87.7 | 88.5 | 87.9 | 0.83 | 5.9 | 2.5 | 8.3 | 3.9 | 60 | 72 | 1MB1-3-1AB5 | 40 | 0.014 | | | | | |
| 4 | 4.55 | 112 M | 1460 | 26 | | 88.6 | 89.2 | 88.6 | 0.82 | 7.9 | 2.4 | 7.1 | 3.7 | 58 | 70 | 1MB1-3-1BB2 | 46 | 0.017 | | | | | |
| 5.5 | 6.3 | 132 S | 1470 | 36 | | 89.6 | 90 | 89.4 | 0.82 | 10.8 | 2.9 | 8.6 | 3.7 | 64 | 76 | 1MB1-3-1CB0 | 74 | 0.046 | | | | | |
| 7.5 | 8.6 | 132 M | 1465 | 49 | | 90.4 | 91.1 | 90.8 | 0.84 | 14.3 | 2.6 | 8.2 | 3.7 | 64 | 76 | 1MB1-3-1CB2 | 80 | 0.046 | | | | | |
| 11 | 12.6 | 160 M | 1475 | 71 | | 91.4 | 91.8 | 91.2 | 0.84 | 20.5 | 2.6 | 7.6 | 3.4 | 65 | 77 | 1MB1-3-1DB2 | 109 | 0.083 | | | | | |
| 15 | 17.3 | 160 L | 1475 | 97 | | 92.1 | 92.3 | 91.5 | 0.82 | 28.5 | 2.5 | 8.5 | 3.8 | 65 | 77 | 1MB1-3-1DB4 | 127 | 0.099 | | | | | |
| 18.5 | 21.3 | 180 M | 1470 | 120 | | 92.6 | 93.1 | 93 | 0.82 | 35 | 2.5 | 7.2 | 3.3 | 66 | 73 | 1MB1-3-1EB2 | 165 | 0.13 | | | | | |
| 22 | 25.3 | 180 L | 1470 | 143 | | 93 | 93.6 | 93.6 | 0.83 | 41 | 2.3 | 6.8 | 3.3 | 68 | 75 | 1MB1-3-1EB4 | 170 | 0.14 | | | | | |
| 30 | 34.5 | 200 L | 1470 | 195 | IE2 | 93.6 | 94.2 | 94.2 | 0.84 | 55 | 2.6 | 7.3 | 3.1 | 65 | 72 | 1MB1-3-2AB5 | 240 | 0.22 | | | | | |
| 37 | 42.5 | 225 S | 1478 | 239 | IE2 | 93.9 | 94.5 | 94.4 | 0.86 | 66 | 2.5 | 6.4 | 2.7 | 65 | 78 | 1MB1-3-2BB0 | 285 | 0.42 | | | | | |
| 45 | 52 | 225 M | 1478 | 291 | IE2 | 94.2 | 94.9 | 95 | 0.86 | 80 | 2.6 | 6.6 | 2.6 | 66 | 79 | 1MB1-3-2BB2 | 340 | 0.52 | | | | | |
| 55 | 63 | 250 M | 1482 | 354 | IE2 | 94.6 | 95.1 | 95 | 0.87 | 96 | 2.5 | 6.8 | 2.9 | 66 | 79 | 1MB1-3-2CB2 | 420 | 0.85 | | | | | |
| 75 | 86 | 280 S | 1485 | 482 | IE2 | 95 | 95.3 | 95 | 0.86 | 133 | 2.5 | 6.9 | 3 | 69 | 83 | 1MB1-3-2DB0 | 570 | 1.4 | | | | | |
| 90 | 104 | 280 M | 1485 | 579 | IE2 | 95.2 | 95.5 | 95.3 | 0.87 | 157 | 2.6 | 7.2 | 3 | 70 | 84 | 1MB1-3-2DB2 | 670 | 1.7 | | | | | |
| 110 | 127 | 315 S | 1488 | 706 | | 95.4 | 95.8 | 95.5 | 0.87 | 191 | 2.6 | 6.8 | 2.9 | 70 | 84 | 1MB1-3-3AB0 | 760 | 2.2 | | | | | |
| 132 | 152 | 315 M | 1490 | 846 | | 95.6 | 95.9 | 95.9 | 0.87 | 230 | 2.8 | 7.3 | 3 | 73 | 87 | 1MB1-3-3AB2 | 960 | 2.9 | | | | | |
| 160 | 184 | 315 L | 1490 | 1025 | | 95.8 | 96.1 | 96.1 | 0.87 | 275 | 2.9 | 7.3 | 3.1 | 73 | 87 | 1MB1-3-3AB4 | 990 | 3.1 | | | | | |
| 200 | 230 | 315 L | 1488 | 1284 | IE2 | 96 | 96.3 | 96.1 | 0.88 | 340 | 3.2 | 7.4 | 3 | 73 | 87 | 1MB1-3-3AB5 | 1190 | 3.7 | | | | | |
| Basic Line | | | | | | | | | | | | | | | 5 | | | | | | | | |
| Performance Line | | | | | | | | | | | | | | | 6 | | | | | | | | |
| Zones | | | | | | | | | | | | | | | | | | | | | | | |
| Zone 21 (conductive and non-conductive dust occasionally) Ex tb IIIC | | | | | | | | | | | | | | | 1 | | | | | | | | |
| Zone 22 (non-conductive dust rarely or for a short period) Ex tc IIIB | | | | | | | | | | | | | | | 2 | | | | | | | | |
| Zone 2 (explosive gases rarely or for a short period) Ex ec IIC | | | | | | | | | | | | | | | 3 | | | | | | | | |
| Voltages ³⁾ | | | | | | | | | | | | | | | | | | | | | | | |
| Version | | | | | | | | | | | | | | | | | | | Order code | | | | |
| 50 Hz 230 VΔ/400 VY 60 Hz ¹⁾ 460 VY | | | | | | | | | | | | | | | | | | | Standard | 2 2 | | | - |
| 50 Hz 400 VΔ/690 VY 60 Hz ¹⁾ 460 VΔ | | | | | | | | | | | | | | | | | | | Standard | 3 4 | | | - |
| 50 Hz 500 VY | | | | | | | | | | | | | | | | | | | Without additional charge | 2 7 | | | - |
| 50 Hz 500 VΔ | | | | | | | | | | | | | | | | | | | Without additional charge | 4 0 | | | - |
| For other voltages ¹⁾ and more information, see from page 5/52 | | | | | | | | | | | | | | | | | | | | 9 0 | | | ... |
| Types of construction | | | | | | | | | | | | | | | | | | | | | | | Order code |
| Version | | | | | | | | | | | | | | | | | | | | | | | |
| Without flange IM B3 ²⁾ | | | | | | | | | | | | | | | | | | | Standard | A | | | - |
| With flange IM B5 ²⁾ | | | | | | | | | | | | | | | | | | | With additional charge | F | | | - |
| With flange IM B14 ²⁾ | | | | | | | | | | | | | | | | | | | With additional charge | K | | | - |
| For other types of construction and more information, see from page 5/59 | | | | | | | | | | | | | | | | | | | | | | | ... |
| Motor protection | | | | | | | | | | | | | | | | | | | | | | | Order code |
| Version | | | | | | | | | | | | | | | | | | | | | | | |
| Without | | | | | | | | | | | | | | | | | | | Only possible for Basic Line | Standard | A | | |
| PTC thermistor with 3 temperature sensors | | | | | | | | | | | | | | | | | | | Basic Line | With additional charge | B | | |
| For other motor protection and more information, see from page 5/69 | | | | | | | | | | | | | | | | | | | Performance Line | Standard | B | | |
| Terminal box position | | | | | | | | | | | | | | | | | | | | | | | Order code(s) |
| Version | | | | | | | | | | | | | | | | | | | | | | | |
| Terminal box at top | | | | | | | | | | | | | | | | | | | Standard | 4 | | | |
| For other terminal box positions and more information, see from page 5/74 | | | | | | | | | | | | | | | | | | | | | | | |
| Special versions | | | | | | | | | | | | | | | | | | | | | | | Order code(s) |
| For options, see from page 5/82 | | | | | | | | | | | | | | | | | | | | | | | |
| | | | | | | | | | | | | | | | | | | | | | | | 1MB1-3-...-Z-...+...+...+... |



SIMOTICS XP 1MB1, 1MB5 explosion-protected motors

Zones 21, 22, and 2 with types of protection Ex tb, Ex tc, Ex ec · IE3 Premium Efficiency



Cast-iron series 1MB15, 1MB16 – self-ventilated

Selection and ordering data

| Operating values at rated power | | | | | | | | | | | | | | | Cast-iron series | | m _{IM B3} | J |
|--|-----------------------------|---------------|-----------------------------|-----------------------------|------------------------------------|----------------------------------|----------------------------------|----------------------------------|--------------------------------------|------------------------------------|--|--|--------------------------------------|---------------------------|--------------------------|--------------|--------------------|--------|
| P _{rated} 50 Hz | P _{rated} 60 Hz | Frame size | n _{rated} 50 Hz | T _{rated} 50 Hz | Different IE class 60 Hz/P60 | η _{rated} 50 Hz, 4/4 | η _{rated} 50 Hz, 3/4 | η _{rated} 50 Hz, 2/4 | cos φ _{rated} 50 Hz, 4/4 | I _{rated} 50 Hz, 400 V | T _{L/R} I _{rated} | I _{L/R} I _{rated} | T _B I _{rated} | L _{pfA} 50 Hz | L _{WA} 50 Hz | Article No. | | |
| kW | kW | FS | rpm | Nm | | % | % | % | | A | | | | dB(A) | dB(A) | | | |
| • Cooling: self-ventilated (IC411) • Efficiency according to IEC 60034-30: IE3 Premium Efficiency • Insulation: Thermal class 155 (temperature class F), IP55 degree of protection, utilization in accordance with thermal class 130 (temperature class B) | | | | | | | | | | | | | | | | | | |
| 6-pole: 1000 rpm at 50 Hz, 1200 rpm at 60 Hz ¹⁾ | | | | | | | | | | | | | | | | | | |
| 0.18 | 0.21 | 71 M | 885 | 1.9 | | 63.9 | 64.6 | 60.8 | 0.69 | 0.59 | 2.3 | 2.8 | 2.3 | 39 | 50 | 1MB15-3-0CC2 | 12.5 | 0.001 |
| 0.25 | 0.29 | 71 M | 900 | 2.7 | | 68.6 | 69.5 | 66.2 | 0.69 | 0.76 | 2.6 | 3.2 | 2.6 | 46 | 57 | 1MB15-3-0CC3 | 15.5 | 0.0015 |
| 0.37 | 0.43 | 80 M | 940 | 3.8 | | 73.5 | 73.1 | 69.4 | 0.66 | 1.1 | 2.3 | 4.2 | 2.7 | 42 | 53 | 1MB15-3-0DC2 | 18.5 | 0.0025 |
| 0.55 | 0.63 | 80 M | 935 | 5.6 | | 77.2 | 77 | 73.9 | 0.67 | 1.53 | 2.5 | 4.5 | 2.8 | 42 | 53 | 1MB15-3-0DC3 | 22.5 | 0.0031 |
| 0.75 | 0.88 | 90 S | 945 | 7.6 | | 78.9 | 80 | 78.8 | 0.7 | 1.96 | 2.2 | 4.6 | 2.6 | 43 | 55 | 1MB15-3-0C0 | 26.5 | 0.004 |
| 1.1 | 1.27 | 90 L | 950 | 11 | IE1 | 81 | 81.4 | 79.3 | 0.66 | 2.95 | 2.8 | 5 | 3 | 57 | 65 | 1MB15-3-0EC4 | 32 | 0.0052 |
| 1.5 | 1.75 | 100 L | 970 | 14.8 | IE2 | 82.5 | 83.1 | 81.5 | 0.73 | 3.6 | 1.9 | 5.2 | 2.8 | 59 | 71 | 1MB1-3-1AC4 | 36 | 0.011 |
| 2.2 | 2.55 | 112 M | 970 | 22 | IE2 | 84.3 | 85 | 83.9 | 0.75 | 5 | 2.2 | 5.6 | 2.8 | 65 | 74 | 1MB1-3-1BC2 | 53 | 0.017 |
| 3 | 3.45 | 132 S | 975 | 29 | | 85.6 | 86.1 | 84.9 | 0.73 | 6.9 | 2.3 | 6.6 | 3.2 | 58 | 66 | 1MB1-3-1CC0 | 60 | 0.034 |
| 4 | 4.55 | 132 M | 975 | 39 | | 86.8 | 87.1 | 86.2 | 0.73 | 9.1 | 2.2 | 6.2 | 3 | 67 | 75 | 1MB1-3-1CC2 | 64 | 0.039 |
| 5.5 | 6.3 | 132 M | 975 | 54 | | 88.0 | 88.3 | 87.2 | 0.72 | 12.5 | 2.7 | 6.8 | 3.4 | 64 | 72 | 1MB1-3-1CC3 | 76 | 0.05 |
| 7.5 | 8.6 | 160 M | 985 | 73 | | 89.1 | 89.5 | 88.6 | 0.81 | 15 | 2.3 | 7.9 | 3.2 | 71 | 79 | 1MB1-3-1DC2 | 124 | 0.132 |
| 11 | 12.6 | 160 L | 980 | 107 | | 90.3 | 90.8 | 90.2 | 0.80 | 22 | 2.9 | 6.8 | 2.8 | 66 | 74 | 1MB1-3-1DC4 | 138 | 0.164 |
| 15 | 18 | 180 L | 975 | 147 | IE2 | 91.2 | 91.9 | 91.9 | 0.8 | 29.5 | 2.3 | 5.9 | 2.8 | 61 | 68 | 1MB1-3-1EC4 | 180 | 0.19 |
| 18.5 | 22 | 200 L | 978 | 181 | IE2 | 91.7 | 92.5 | 92.5 | 0.79 | 37 | 2.5 | 5.6 | 2.6 | 64 | 71 | 1MB1-3-2AC4 | 215 | 0.28 |
| 22 | 26.5 | 200 L | 978 | 215 | IE2 | 92.2 | 93.1 | 93.2 | 0.79 | 43.5 | 2.5 | 5.6 | 2.6 | 61 | 68 | 1MB1-3-2AC5 | 230 | 0.32 |
| 30 | 36 | 225 M | 982 | 292 | IE2 | 92.9 | 93.6 | 93.5 | 0.83 | 56 | 2.6 | 6.6 | 3 | 64 | 77 | 1MB1-3-2BC2 | 325 | 0.67 |
| 37 | 44.5 | 250 M | 985 | 359 | IE2 | 93.3 | 94 | 94 | 0.85 | 67 | 2.7 | 7 | 2.9 | 62 | 75 | 1MB1-3-2CC2 | 405 | 1 |
| 45 | 54 | 280 S | 988 | 435 | IE2 | 93.7 | 94.3 | 94.2 | 0.85 | 82 | 3 | 6.8 | 2.8 | 60 | 74 | 1MB1-3-2DC0 | 510 | 1.4 |
| 55 | 66 | 280 M | 988 | 532 | IE2 | 94.1 | 94.5 | 94.4 | 0.85 | 99 | 3.3 | 7.2 | 3 | 65 | 79 | 1MB1-3-2DC2 | 560 | 1.64 |
| 75 | 90 | 315 S | 990 | 723 | | 94.6 | 94.9 | 94.4 | 0.84 | 136 | 2.6 | 7.5 | 3.1 | 63 | 78 | 1MB1-3-3AC0 | 750 | 2.6 |
| 90 | 108 | 315 M | 991 | 867 | IE2 | 94.9 | 95.2 | 94.9 | 0.85 | 161 | 2.5 | 6.7 | 2.8 | 63 | 78 | 1MB1-3-3AC2 | 890 | 3.1 |
| 110 | 132 | 315 L | 991 | 1060 | IE2 | 95.1 | 95.5 | 95.3 | 0.84 | 199 | 2.8 | 7.2 | 3 | 63 | 78 | 1MB1-3-3AC4 | 990 | 3.9 |
| 132 | 158 | 315 L | 992 | 1271 | IE2 | 95.4 | 95.7 | 95.4 | 0.82 | 245 | 3.3 | 8 | 3.3 | 66 | 81 | 1MB1-3-3AC5 | 1130 | 4.48 |
| 160 | 192 | 315 L | 992 | 1540 | IE2 | 95.6 | 95.8 | 95.5 | 0.82 | 295 | 3.5 | 8.5 | 3.6 | 66 | 81 | 1MB1-3-3AC6 | 1260 | 5.41 |

Basic Line

Performance Line

Zones

Zone 21 (conductive and non-conductive dust occasionally) Ex tb IIC

Zone 22 (non-conductive dust rarely or for a short period) Ex tc IIIB

Zone 2 (explosive gases rarely or for a short period) Ex ec IIC

Voltages ³⁾

50 Hz 230 VΔ/400 VY 60 Hz ¹⁾ 460 VY

50 Hz 400 VΔ/690 VY 60 Hz ¹⁾ 460 VΔ

50 Hz 500 VY

50 Hz 500 VΔ

For other voltages ¹⁾ and more information, see from page 5/52

Types of construction

Without flange IM B3 ²⁾

With flange IM B5 ²⁾

With flange IM B14 ²⁾

For other types of construction and more information, see from page 5/59

Motor protection

Without Only possible for **Basic Line**

PTC thermistor with 3 temperature sensors **Basic Line**

Performance Line

For other motor protection and more information, see from page 5/69

Terminal box position

Terminal box at top

For other terminal box positions and more information, see from page 5/74

Special versions

For options, see from page 5/82

1MB1-3-...-Z...+...+...+...

5



SIMOTICS XP 1MB1, 1MB5 explosion-protected motors

Zones 21, 22, and 2 with types of protection Ex tb, Ex tc, Ex ec · IE3 Premium Efficiency

Cast-iron series 1MB5.3 – self-ventilated or forced-air cooled – Advanced insulation system

Selection and ordering data

| P _{rated} , 50 Hz kW | Frame size FS | Operating values at rated power | | | | | | | | | | L _{pfA} dB(A) | L _{WA} dB(A) | Cast-iron series 1MB5.3 Article No. | m _{IM B3} kg | J kgm ² | |
|--|------------------|---------------------------------|--------------------------|---------------------------|---------------------------|---------------------------|------------------------------|-------------------------|-------------------------------------|-------------------------------------|------------------------------------|---------------------------|--------------------------|---|--------------------------|-----------------------|--|
| | | n _{rated} rpm | T _{rated} Nm | η _{rated} 4/4 | η _{rated} 3/4 | η _{rated} 2/4 | cosφ _{rated} 4/4 | I _{rated} A | T _{LR} /T _{rated} | I _{LR} /I _{rated} | T _B /T _{rated} | | | | | | |
| <ul style="list-style-type: none"> • Cooling: self-ventilated (IC411) • Efficiency: IE3 Premium Efficiency, service factor with sinusoidal supply (SF) 1.05 • Insulation: Thermal class 155 (temperature class F), IP55 degree of protection, utilization with sinusoidal supply in accordance with thermal class 130 (temperature class B) • Optional and suitable for converter operation with insulated bearings (L51) for f_p ≥ 2.5 kHz; U_{line} ≤ 480 V; U_{motor} ≤ 500 V; U_{DC} ≤ 720 V - IVIC-C advanced insulation system | | | | | | | | | | | | | | | | | |
| 2-pole: 3000 rpm at 50 Hz | | | | | | | | | | | | | | | | | |
| 560 ¹⁾²⁾ | 400 | 2986 | 1790 | 96.6 | 96.7 | 96.3 | 0.90 | 930 | 1.6 | 7.0 | 2.8 | 74 | 90 | ▲ 1MB55 3-4AA3 | 2850 | 8.9 | |
| 630 ¹⁾²⁾ | 400 | 2986 | 2000 | 96.6 | 96.7 | 96.6 | 0.91 | 1030 | 1.6 | 7.0 | 2.8 | 74 | 90 | ▲ 1MB55 3-4AA5 | 3000 | 9.8 | |
| 710 ³⁾ | 400 | 2986 | 2250 | 96.8 | 96.9 | 96.7 | 0.91 | 670 | 1.7 | 7.0 | 2.8 | 74 | 90 | ▲ 1MB55 3-4AA7 | 3200 | 10.8 | |
| 800 ¹⁾²⁾³⁾⁴⁾ | 450 | 2988 | 2550 | 97.0 | 97.0 | 96.6 | 0.88 | 780 | 1.1 | 7.5 | 3.1 | 75 | 91 | ▲ 1MB55 3-4BA3 | 4000 | 12.3 | |
| 900 ¹⁾²⁾³⁾⁴⁾ | 450 | 2986 | 2900 | 97.0 | 97.1 | 96.9 | 0.90 | 860 | 1.1 | 7.0 | 2.8 | 75 | 91 | ▲ 1MB55 3-4BA5 | 4250 | 13.5 | |
| 1000 ¹⁾²⁾³⁾⁴⁾ | 450 | 2984 | 3200 | 97.0 | 97.1 | 97.0 | 0.91 | 950 | 1.1 | 6.8 | 2.6 | 75 | 91 | ▲ 1MB55 3-4BA7 | 4450 | 14.7 | |
| 4-pole: 1500 rpm at 50 Hz | | | | | | | | | | | | | | | | | |
| 560 | 400 | 1492 | 3600 | 96.2 | 96.3 | 95.8 | 0.87 | 970 | 1.8 | 6.5 | 2.7 | 78 | 94 | ▲ 1MB55 3-4AB3 | 2800 | 12.8 | |
| 630 ¹⁾²⁾ | 400 | 1492 | 4050 | 96.4 | 96.5 | 95.9 | 0.87 | 1080 | 1.9 | 6.8 | 2.7 | 78 | 94 | ▲ 1MB55 3-4AB5 | 3000 | 14.4 | |
| 710 ³⁾ | 400 | 1492 | 4550 | 96.5 | 96.6 | 96.2 | 0.88 | 700 | 1.9 | 6.8 | 2.7 | 78 | 94 | ▲ 1MB55 3-4AB7 | 3200 | 16.5 | |
| 800 ³⁾ | 450 | 1492 | 5100 | 96.5 | 96.6 | 96.1 | 0.88 | 790 | 1.6 | 7.0 | 2.6 | 81 | 97 | ▲ 1MB55 3-4BB3 | 3850 | 22.2 | |
| 900 ³⁾ | 450 | 1492 | 5800 | 96.6 | 96.7 | 96.2 | 0.87 | 900 | 1.5 | 7.0 | 2.6 | 81 | 97 | ▲ 1MB55 3-4BB5 | 4100 | 24.8 | |
| 1000 ¹⁾³⁾ | 450 | 1492 | 6400 | 96.6 | 96.7 | 96.3 | 0.89 | 970 | 1.7 | 7.0 | 2.6 | 81 | 97 | ▲ 1MB55 3-4BB7 | 4300 | 27.4 | |
| 6-pole: 1000 rpm at 50 Hz | | | | | | | | | | | | | | | | | |
| 450 | 400 | 992 | 4350 | 96.0 | 96.1 | 95.8 | 0.86 | 790 | 2.1 | 6.5 | 2.7 | 72 | 88 | ▲ 1MB55 3-4AC3 | 2900 | 22.0 | |
| 500 | 400 | 992 | 4800 | 96.0 | 96.1 | 95.8 | 0.86 | 870 | 2.2 | 6.5 | 2.7 | 72 | 88 | ▲ 1MB55 3-4AC5 | 3050 | 24.7 | |
| 560 ¹⁾ | 400 | 992 | 5400 | 96.2 | 96.3 | 96.0 | 0.86 | 980 | 2.2 | 6.5 | 2.7 | 72 | 88 | ▲ 1MB55 3-4AC7 | 3250 | 27.8 | |
| 630 ¹⁾ | 450 | 993 | 6100 | 96.3 | 96.4 | 96.2 | 0.85 | 1110 | 2.0 | 6.5 | 2.6 | 74 | 90 | ▲ 1MB55 3-4BC3 | 3800 | 34.4 | |
| 710 ³⁾ | 450 | 993 | 6800 | 96.3 | 96.4 | 96.4 | 0.85 | 730 | 2.0 | 6.5 | 2.5 | 74 | 90 | ▲ 1MB55 3-4BC5 | 4050 | 38.5 | |
| 800 ¹⁾³⁾ | 450 | 993 | 7700 | 96.5 | 96.7 | 96.5 | 0.85 | 820 | 2.0 | 6.5 | 2.5 | 74 | 90 | ▲ 1MB55 3-4BC7 | 4300 | 43.1 | |
| 8-pole: 750 rpm at 50 Hz | | | | | | | | | | | | | | | | | |
| 355 | 400 | 742 | 4550 | 95.6 | 95.7 | 95.5 | 0.81 | 660 | 1.9 | 6.2 | 2.5 | 64 | 80 | ▲ 1MB55 3-4AD3 | 2850 | 21.9 | |
| 400 | 400 | 742 | 5100 | 95.7 | 95.8 | 95.5 | 0.81 | 740 | 2.0 | 6.5 | 2.6 | 64 | 80 | ▲ 1MB55 3-4AD5 | 3050 | 24.5 | |
| 450 | 400 | 742 | 5800 | 95.8 | 95.9 | 95.8 | 0.81 | 840 | 2.0 | 6.5 | 2.6 | 64 | 80 | ▲ 1MB55 3-4AD7 | 3250 | 27.5 | |
| 500 ⁵⁾ | 450 | 744 | 6400 | 95.9 | 96.0 | 95.7 | 0.80 | 940 | 1.9 | 6.5 | 2.4 | 67 | 83 | ▲ 1MB55 3-4BD3 | 3800 | 34.0 | |
| 560 ⁵⁾ | 450 | 744 | 7200 | 96.0 | 96.1 | 95.8 | 0.80 | 1050 | 1.9 | 6.5 | 2.4 | 67 | 83 | ▲ 1MB55 3-4BD5 | 4000 | 38.0 | |
| 630 ¹⁾⁵⁾ | 450 | 744 | 8100 | 96.1 | 96.2 | 95.9 | 0.81 | 1170 | 1.9 | 6.5 | 2.4 | 67 | 83 | ▲ 1MB55 3-4BD7 | 4250 | 42.5 | |
| Zones | | | | | | | | | | | | | | | | | |
| Zone 21 (conductive and non-conductive dust occasionally) Ex tb IIC | | | | | | | | | | | | | | | | | |
| Zone 22 (non-conductive dust rarely or for a short period) Ex tc IIIB | | | | | | | | | | | | | | | | | |
| Zone 2 (explosive gases rarely or for a short period) Ex ec IIC | | | | | | | | | | | | | | | | | |
| Voltages | | | | | | | | | | | | | | | | | |
| 50 Hz 400 VΔ/690 VY | | | | | | | | | | | | 60 Hz 460 VΔ | | Version | | Order code | |
| 50 Hz 500 VΔ | | | | | | | | | | | | 60 Hz 575 VΔ | | Standard | | 3 4 | |
| 50 Hz 690 VΔ | | | | | | | | | | | | | | Without additional charge | | 4 0 | |
| | | | | | | | | | | | | | | Without additional charge | | 4 7 | |
| For other voltages and more information, see from page 5/55 | | | | | | | | | | | | | | | | | |
| Types of construction | | | | | | | | | | | | | | | | | |
| Without flange | | | | | | | | | | | | IM B3 | | Version | | Order code | |
| With flange | | | | | | | | | | | | IM B5 | | Standard | | A | |
| | | | | | | | | | | | | | | With additional charge | | F | |
| For other types of construction and more information, see from page 5/67 | | | | | | | | | | | | | | | | | |
| Motor protection | | | | | | | | | | | | | | | | | |
| Without | | | | | | | | | | | | | | Version | | Order code | |
| PTC thermistor with 3 temperature sensors | | | | | | | | | | | | | | Standard | | A | |
| | | | | | | | | | | | | | | With additional charge | | B | |
| For other motor protection and more information, see from page 5/72 | | | | | | | | | | | | | | | | | |
| Terminal box position | | | | | | | | | | | | | | | | | |
| Terminal box base left with terminal box 45° | | | | | | | | | | | | | | Version | | Order code | |
| Terminal box base right with terminal box 45° | | | | | | | | | | | | | | Standard | | 2 | |
| | | | | | | | | | | | | | | Without additional charge | | 3 | |
| For other terminal box positions and more information, see from page 5/77 | | | | | | | | | | | | | | | | | |
| Special versions | | | | | | | | | | | | | | | | | |
| Forced-air cooled (IC416) | | | | | | | | | | | | | | Version | | Order code(s) | |
| | | | | | | | | | | | | | | 1MB55 3-...-Z | | F90+...+...+... | |
| For options and information, see from page 5/96 | | | | | | | | | | | | | | | | | |
| | | | | | | | | | | | | | | 1MB55 3-...-Z | | ...+...+...+... | |

1) Terminal box 1XB1631.
 2) Terminal box position NDE can only be ordered using order code **H09** (2 × terminal box TB3R61). Order code **H08** not available.
 3) The standard version is 50 Hz 690 VΔ (voltage code **4-7**) or 60 Hz 575 VΔ (voltage code **4-0**).
 4) In the series version, the maximum speed is n_{max} = 3000 rpm. Converter operation at higher speeds on request for an additional charge.
 5) Utilization with sinusoidal supply in accordance with thermal class 155 (temperature class F).



SIMOTICS XP 1MB1, 1MB5 explosion-protected motors

Zones 21, 22, and 2 with types of protection Ex tb, Ex tc, Ex ec · IE3 Premium Efficiency



Cast-iron series 1MB58.3 – self-ventilated or forced-air cooled – Premium insulation system

Selection and ordering data

| P _{rated, 50 Hz} kW | Frame size FS | Operating values at rated power | | | | | | | | | | Cast-iron series 1MB58.3 | | m _{IM B3} kg | J kgm ² | | |
|---|------------------|---------------------------------|--------------------------|------------------------------|------------------------------|------------------------------|----------------------------------|-------------------------|-------------------------------------|-------------------------------------|------------------------------------|---------------------------|--------------------------|--------------------------|-----------------------|-------------|-------|
| | | n _{rated} rpm | T _{rated} Nm | η _{rated, 4/4} % | η _{rated, 3/4} % | η _{rated, 2/4} % | cos φ _{rated, 4/4} % | I _{rated} A | T _{LR} /T _{rated} | I _{LR} /I _{rated} | T _B /T _{rated} | L _{pfA} dB(A) | L _{WA} dB(A) | | | Article No. | ▲ New |
| 2-pole: 3000 rpm at 50 Hz | | | | | | | | | | | | | | | | | |
| 545 ¹⁾ | 400 | 2988 | 1740 | 96.9 | 96.9 | 96.4 | 0.90 | 900 | 1.6 | 7.3 | 3.1 | 74 | 90 | ▲ 1MB58 3-4AA3 | 2850 | 8.9 | |
| 610 ¹⁾ | 400 | 2988 | 1950 | 97.0 | 97.0 | 96.7 | 0.91 | 1000 | 1.6 | 7.3 | 3.1 | 74 | 90 | ▲ 1MB58 3-4AA5 | 3000 | 9.8 | |
| 680 ²⁾ | 400 | 2988 | 2150 | 97.0 | 97.1 | 96.8 | 0.91 | 640 | 1.7 | 7.3 | 3 | 74 | 90 | ▲ 1MB58 3-4AA7 | 3200 | 10.8 | |
| 775 ^{1) 2) 3)} | 450 | 2990 | 2500 | 97.4 | 97.4 | 97.0 | 0.88 | 760 | 1.2 | 7.7 | 3.4 | 75 | 91 | ▲ 1MB58 3-4BA3 | 4000 | 12.3 | |
| 875 ^{1) 2) 3)} | 450 | 2988 | 2800 | 97.4 | 97.5 | 97.3 | 0.90 | 840 | 1.2 | 7.2 | 3 | 75 | 91 | ▲ 1MB58 3-4BA5 | 4250 | 13.5 | |
| 970 ^{1) 2) 3)} | 450 | 2986 | 3100 | 97.4 | 97.5 | 97.4 | 0.91 | 920 | 1.2 | 7.0 | 2.8 | 75 | 91 | ▲ 1MB58 3-4BA7 | 4450 | 14.7 | |
| 4-pole: 1500 rpm at 50 Hz | | | | | | | | | | | | | | | | | |
| 545 | 400 | 1492 | 3500 | 96.4 | 96.4 | 96.0 | 0.87 | 940 | 1.8 | 6.7 | 2.7 | 78 | 94 | ▲ 1MB58 3-4AB3 | 2800 | 12.8 | |
| 615 | 400 | 1492 | 3950 | 96.6 | 96.6 | 96.2 | 0.87 | 1060 | 1.9 | 6.9 | 2.8 | 78 | 94 | ▲ 1MB58 3-4AB5 | 3000 | 14.4 | |
| 690 ²⁾ | 400 | 1492 | 4400 | 96.6 | 96.7 | 96.4 | 0.88 | 680 | 2.0 | 7.0 | 2.7 | 78 | 94 | ▲ 1MB58 3-4AB7 | 3200 | 16.5 | |
| 785 ²⁾ | 450 | 1492 | 5000 | 96.6 | 96.6 | 96.1 | 0.88 | 770 | 1.6 | 7.2 | 2.7 | 81 | 97 | ▲ 1MB58 3-4BB3 | 3850 | 22.2 | |
| 880 ²⁾ | 450 | 1492 | 5600 | 96.8 | 96.8 | 96.3 | 0.87 | 870 | 1.5 | 7.2 | 2.6 | 81 | 97 | ▲ 1MB58 3-4BB5 | 4100 | 24.8 | |
| 980 ²⁾ | 450 | 1492 | 6300 | 96.9 | 96.9 | 96.5 | 0.89 | 950 | 1.7 | 7.1 | 2.6 | 81 | 97 | ▲ 1MB58 3-4BB7 | 4300 | 27.4 | |
| 6-pole: 1000 rpm at 50 Hz | | | | | | | | | | | | | | | | | |
| 435 | 400 | 993 | 4200 | 96.2 | 96.3 | 96.0 | 0.85 | 770 | 2.1 | 6.7 | 2.8 | 72 | 88 | ▲ 1MB58 3-4AC3 | 2900 | 22.0 | |
| 485 | 400 | 993 | 4650 | 96.2 | 96.4 | 96.1 | 0.86 | 850 | 2.2 | 6.7 | 2.8 | 72 | 88 | ▲ 1MB58 3-4AC5 | 3050 | 24.7 | |
| 545 ¹⁾ | 400 | 993 | 5200 | 96.3 | 96.5 | 96.2 | 0.86 | 950 | 2.2 | 6.7 | 2.7 | 72 | 88 | ▲ 1MB58 3-4AC7 | 3250 | 27.8 | |
| 615 ¹⁾ | 450 | 993 | 5900 | 96.5 | 96.7 | 96.4 | 0.84 | 1100 | 2.1 | 6.6 | 2.7 | 74 | 90 | ▲ 1MB58 3-4BC3 | 3800 | 34.4 | |
| 690 ²⁾ | 450 | 993 | 6600 | 96.6 | 96.8 | 96.6 | 0.85 | 700 | 2.0 | 6.8 | 2.5 | 74 | 90 | ▲ 1MB58 3-4BC5 | 4050 | 38.5 | |
| 780 ²⁾ | 450 | 993 | 7500 | 96.7 | 96.9 | 96.7 | 0.85 | 790 | 2.0 | 6.7 | 2.6 | 74 | 90 | ▲ 1MB58 3-4BC7 | 4300 | 43.1 | |
| 8-pole: 750 rpm at 50 Hz | | | | | | | | | | | | | | | | | |
| 335 | 400 | 744 | 4300 | 95.8 | 96.0 | 95.6 | 0.80 | 630 | 2.0 | 6.9 | 2.6 | 64 | 80 | ▲ 1MB58 3-4AD3 | 2850 | 21.9 | |
| 375 | 400 | 744 | 4800 | 95.9 | 96.1 | 95.7 | 0.80 | 710 | 2.1 | 7.2 | 2.8 | 64 | 80 | ▲ 1MB58 3-4AD5 | 3050 | 24.5 | |
| 425 | 400 | 744 | 5500 | 96.1 | 96.2 | 95.8 | 0.80 | 800 | 2.1 | 7.2 | 2.7 | 64 | 80 | ▲ 1MB58 3-4AD7 | 3250 | 27.5 | |
| 485 ⁴⁾ | 450 | 745 | 6200 | 96.1 | 96.2 | 95.9 | 0.79 | 920 | 2.0 | 7.0 | 2.6 | 67 | 83 | ▲ 1MB58 3-4BD3 | 3800 | 34.0 | |
| 545 ⁴⁾ | 450 | 745 | 7000 | 96.2 | 96.4 | 96.0 | 0.79 | 1040 | 2.0 | 7.0 | 2.6 | 67 | 83 | ▲ 1MB58 3-4BD5 | 4000 | 38.0 | |
| 600 ^{1) 4)} | 450 | 745 | 7700 | 96.3 | 96.5 | 96.1 | 0.80 | 1120 | 2.1 | 7.3 | 2.6 | 67 | 83 | ▲ 1MB58 3-4BD7 | 4250 | 42.5 | |
| Zones | | | | | | | | | | | | | | | | | |
| Zone 21 (conductive and non-conductive dust occasionally) Ex tb IIIC | | | | | | | | | | | | | | | | | |
| Zone 22 (non-conductive dust rarely or for a short period) Ex tc IIIB | | | | | | | | | | | | | | | | | |
| Zone 2 (explosive gases rarely or for a short period) Ex ec IIC | | | | | | | | | | | | | | | | | |
| Voltages | | | | | | | | | | | | | | | | | |
| 50 Hz 400 VΔ/690 VY | | 60 Hz 460 VΔ | | Version | | | | | | | | | | | | Order code | |
| | | | | Standard | | | | | | | | | | | | - | |
| 50 Hz 500 VΔ | | 60 Hz 575 VΔ | | Without additional charge | | | | | | | | | | | | 4 0 | |
| 50 Hz 690 VΔ | | | | Without additional charge | | | | | | | | | | | | 4 7 | |
| For other voltages and more information, see from page 5/55 | | | | | | | | | | | | | | | | | |
| Types of construction | | | | | | | | | | | | | | | | | |
| Without flange | | IM B3 | | Version | | | | | | | | | | | | Order code | |
| | | | | Standard | | | | | | | | | | | | - | |
| With flange | | IM B5 | | With additional charge | | | | | | | | | | | | A F | |
| For other types of construction and more information, see from page 5/67 | | | | | | | | | | | | | | | | | |
| Motor protection | | | | | | | | | | | | | | | | | |
| Without | | | | Version | | | | | | | | | | | | Order code | |
| | | | | Standard | | | | | | | | | | | | - | |
| PTC thermistor with 3 temperature sensors | | | | With additional charge | | | | | | | | | | | | A B | |
| For other motor protection and more information, see from page 5/72 | | | | | | | | | | | | | | | | | |
| Terminal box position | | | | | | | | | | | | | | | | | |
| Terminal box base left with terminal box 45° | | | | Version | | | | | | | | | | | | Order code | |
| | | | | Without additional charge | | | | | | | | | | | | 2 | |
| Terminal box base right with terminal box 45° | | | | Standard | | | | | | | | | | | | 3 | |
| For other terminal box positions and more information, see from page 5/77 | | | | | | | | | | | | | | | | | |
| Special versions | | | | | | | | | | | | | | | | | |
| Forced-air cooled (IC416) | | | | | | | | | | | | 1MB58 3- ... | | -Z F90+ | | | |
| For options and information, see from page 5/96 | | | | | | | | | | | | | | | | | |
| | | | | | | | | | | | | 1MB58 3- ... | | -Z | | | |

5

1) Terminal box 1XB1631.
 2) The standard version is 50 Hz 690 VΔ (voltage code 4-7) or 60 Hz 575 VΔ (voltage code 4-0).
 3) In the series version, the maximum speed is n_{max} = 3000 rpm. Converter operation at higher speeds on request for an additional charge.
 4) Utilization with sinusoidal supply in accordance with thermal class 155 (temperature class F).



SIMOTICS XP 1MB1, 1MB5 explosion-protected motors

Zones 21, 22, and 2 with types of protection Ex tb, Ex tc, Ex ec · IE2 High Efficiency

Aluminum series 1MB10 – self-ventilated

Selection and ordering data

| Operating values at rated power | | | | | | | | | | | | | | Aluminum series 1MB1 | | $m_{IM\ B3}$ | J | |
|---|---------------------|------------|---------------------|---------------------|--------------------|------------------------|------------------------|------------------------|----------------------------|---------------------|--------------------|--------------------|-----------------|---------------------------|------------------|-------------------------------|-----|---------|
| $P_{rated, 50\ Hz}$ | $P_{rated, 60\ Hz}$ | Frame size | $n_{rated, 50\ Hz}$ | $T_{rated, 50\ Hz}$ | Different IE class | $\eta_{rated, 50\ Hz}$ | $\eta_{rated, 50\ Hz}$ | $\eta_{rated, 50\ Hz}$ | $\cos\phi_{rated, 50\ Hz}$ | $I_{rated, 50\ Hz}$ | T_{LR}/T_{rated} | I_{LR}/I_{rated} | T_p/T_{rated} | $L_{pfA, 50\ Hz}$ | $L_{WA, 50\ Hz}$ | Article No. | kg | kgm^2 |
| kW | kW | FS | rpm | Nm | | % | % | % | | A | | | | dB(A) | dB(A) | | | |
| <ul style="list-style-type: none"> • Cooling: self-ventilated (IC411) • Efficiency according to IEC 60034-30: IE2 High Efficiency • Insulation: Thermal class 155 (temperature class F), IP55 degree of protection, utilization in accordance with thermal class 130 (temperature class B) | | | | | | | | | | | | | | | | | | |
| 2-pole: 3000 rpm at 50 Hz, 3600 rpm at 60 Hz ¹⁾ | | | | | | | | | | | | | | | | | | |
| 0.75 | 0.86 | 80 M | 2805 | 2.6 | | 77.4 | 80 | 80.1 | 0.84 | 1.67 | 1.9 | 4.9 | 2.3 | 60 | 71 | 1MB10 1-0DA2 | 9 | 0.0008 |
| 1.1 | 1.27 | 80 M | 2835 | 3.7 | | 79.6 | 81.3 | 80.9 | 0.83 | 2.4 | 2.7 | 6 | 3.1 | 60 | 71 | 1MB10 1-0DA3 | 11 | 0.0011 |
| 1.5 | 1.75 | 90 S | 2885 | 4.9 | | 81.3 | 81.7 | 79.8 | 0.84 | 3.15 | 2.7 | 6.9 | 3.6 | 65 | 77 | 1MB10 1-0EA0 | 13 | 0.0017 |
| 2.2 | 2.55 | 90 L | 2890 | 7.3 | | 82.2 | 83.7 | 82 | 0.85 | 4.5 | 2.5 | 7.1 | 3.7 | 65 | 77 | 1MB10 1-0EA4 | 15 | 0.0021 |
| 3 | 3.45 | 100 L | 2905 | 9.9 | | 84.6 | 85.5 | 84.6 | 0.84 | 6.1 | 2.3 | 7 | 3.3 | 67 | 79 | 1MB10 1-1AA4 | 21 | 0.0044 |
| 4 | 4.55 | 112 M | 2945 | 13 | | 85.8 | 86.2 | 85.1 | 0.85 | 7.9 | 2.1 | 8 | 3.6 | 69 | 81 | 1MB10 1-1BA2 | 27 | 0.0092 |
| 5.5 | 6.3 | 132 S | 2950 | 18 | | 87 | 88 | 87.6 | 0.87 | 10.5 | 1.8 | 6.6 | 2.9 | 68 | 80 | 1MB10 1-1CA0 | 39 | 0.02 |
| 7.5 | 8.6 | 132 S | 2950 | 24 | | 88.1 | 88.5 | 87.6 | 0.87 | 14.1 | 2.2 | 7.5 | 3.1 | 68 | 80 | 1MB10 1-1CA1 | 43 | 0.024 |
| 11 | 12.6 | 160 M | 2955 | 36 | | 89.4 | 89.3 | 88 | 0.87 | 20.5 | 2.1 | 7.4 | 3.2 | 70 | 82 | 1MB10 1-1DA2 | 67 | 0.045 |
| 15 | 17.3 | 160 M | 2955 | 48 | | 90.3 | 90.7 | 90 | 0.88 | 27 | 2.4 | 7.6 | 3.4 | 70 | 82 | 1MB10 1-1DA3 | 75 | 0.053 |
| 18.5 | 21.3 | 160 L | 2955 | 60 | | 90.9 | 91.3 | 90.6 | 0.88 | 33.5 | 2.9 | 7.9 | 3.6 | 70 | 82 | 1MB10 1-1DA4 | 84 | 0.061 |
| 4-pole: 1500 rpm at 50 Hz, 1800 rpm at 60 Hz ¹⁾ | | | | | | | | | | | | | | | | | | |
| 0.55 | 0.63 | 80 M | 1440 | 3.6 | | 77.1 | 76.8 | 73.7 | 0.74 | 1.39 | 2.2 | 5.3 | 3.1 | 53 | 64 | 1MB10 1-0DB2 | 10 | 0.0017 |
| 0.75 | 0.86 | 80 M | 1440 | 5 | | 79.6 | 79.9 | 77.5 | 0.76 | 1.79 | 2.2 | 5.6 | 3.1 | 53 | 64 | 1MB10 1-0DB3 | 11 | 0.0021 |
| 1.1 | 1.27 | 90 S | 1425 | 7.4 | | 81.4 | 81.8 | 80 | 0.78 | 2.5 | 2.3 | 5.6 | 2.9 | 56 | 68 | 1MB10 1-0EB0 | 13 | 0.0028 |
| 1.5 | 1.75 | 90 L | 1435 | 10 | | 82.8 | 83.5 | 82.2 | 0.79 | 3.3 | 2.6 | 6.4 | 3.4 | 56 | 68 | 1MB10 1-0EB4 | 16 | 0.0036 |
| 2.2 | 2.55 | 100 L | 1455 | 14 | | 84.3 | 85.1 | 84.2 | 0.81 | 4.65 | 2.1 | 6.9 | 3.3 | 60 | 72 | 1MB10 1-1AB4 | 21 | 0.0086 |
| 3 | 3.45 | 100 L | 1455 | 20 | | 85.5 | 86.4 | 85.6 | 0.82 | 6.2 | 2 | 6.9 | 3.1 | 60 | 72 | 1MB10 1-1AB5 | 25 | 0.011 |
| 4 | 4.55 | 112 M | 1460 | 26 | | 86.6 | 87.3 | 86.4 | 0.81 | 8.2 | 2.5 | 7.1 | 3.2 | 58 | 70 | 1MB10 1-1BB2 | 29 | 0.014 |
| 5.5 | 6.3 | 132 S | 1465 | 36 | | 87.7 | 88.4 | 87.6 | 0.8 | 11.3 | 2.3 | 6.9 | 2.9 | 64 | 76 | 1MB10 1-1CB0 | 42 | 0.027 |
| 7.5 | 8.6 | 132 M | 1465 | 49 | | 88.7 | 89.8 | 89.8 | 0.83 | 14.7 | 2.3 | 6.9 | 2.9 | 64 | 76 | 1MB10 1-1CB2 | 49 | 0.034 |
| 11 | 12.6 | 160 M | 1470 | 71 | | 89.8 | 91 | 90.9 | 0.85 | 21 | 2.1 | 6.7 | 2.8 | 65 | 77 | 1MB10 1-1DB2 | 71 | 0.065 |
| 15 | 17.3 | 160 L | 1475 | 97 | | 90.6 | 91.2 | 90.8 | 0.85 | 28 | 2.3 | 7.3 | 3 | 65 | 77 | 1MB10 1-1DB4 | 83 | 0.083 |
| Zones | | | | | | | | | | | | | | | | | | |
| Zone 21 (conductive and non-conductive dust occasionally) Ex tb IIIC | | | | | | | | | | | | | | | | | | |
| Zone 22 (non-conductive dust rarely or for a short period) Ex tc IIIB | | | | | | | | | | | | | | | | | | |
| Zone 2 (explosive gases rarely or for a short period) Ex ec IIC | | | | | | | | | | | | | | | | | | |
| Voltages | | | | | | | | | | | | | | | | | | |
| 50 Hz 230 VΔ/400 VY | | | | | | | | | | | | | | Version | | Order code | | |
| 60 Hz ¹⁾ 460 VY | | | | | | | | | | | | | | Standard | | 2 2 | | |
| 50 Hz 400 VΔ/690 VY | | | | | | | | | | | | | | Standard | | 3 4 | | |
| 50 Hz 500 VY | | | | | | | | | | | | | | Without additional charge | | 2 7 | | |
| 50 Hz 500 VΔ | | | | | | | | | | | | | | Without additional charge | | 4 0 | | |
| For other voltages ¹⁾ and more information, see from page 5/51 | | | | | | | | | | | | | | | | 9 0 | | |
| Types of construction | | | | | | | | | | | | | | | | | | |
| Without flange | | | | | | | | | | | | | | Version | | Order code | | |
| IM B3 ²⁾ | | | | | | | | | | | | | | Standard | | A | | |
| With flange | | | | | | | | | | | | | | With additional charge | | F | | |
| IM B5 ²⁾ | | | | | | | | | | | | | | With additional charge | | K | | |
| With flange | | | | | | | | | | | | | | With additional charge | | ... | | |
| IM B14 ²⁾ | | | | | | | | | | | | | | | | | | |
| For other types of construction and more information, see from page 5/56 | | | | | | | | | | | | | | | | | | |
| Motor protection | | | | | | | | | | | | | | | | | | |
| Without | | | | | | | | | | | | | | Version | | Order code | | |
| Standard | | | | | | | | | | | | | | | | A | | |
| 3 temperature sensors (frame sizes 80, 90 or 100 to 200) | | | | | | | | | | | | | | With additional charge | | B | | |
| For other motor protection and more information, see from page 5/68 | | | | | | | | | | | | | | | | | | |
| Terminal box position | | | | | | | | | | | | | | | | | | |
| Terminal box at top | | | | | | | | | | | | | | Version | | Order code | | |
| Standard | | | | | | | | | | | | | | | | 4 | | |
| For other terminal box positions and more information, see from page 5/73 | | | | | | | | | | | | | | | | | | |
| Special versions | | | | | | | | | | | | | | | | | | |
| For options, see from page 5/78 | | | | | | | | | | | | | | | | Order code(s) | | |
| | | | | | | | | | | | | | | | | 1MB10 1-...-Z ...+...+...+... | | |



SIMOTICS XP 1MB1, 1MB5 explosion-protected motors

Zones 21, 22, and 2 with types of protection Ex tb, Ex tc, Ex ec · IE2 High Efficiency



Aluminum series 1MB10 – self-ventilated

Selection and ordering data

| Operating values at rated power | | | | | | | | | | | | | | | Aluminum series | | | |
|---|--------------------|------------|--------------------|--------------------|--------------------|-----------------------|-----------------------|-----------------------|---------------------------|--------------------|--------------------|--------------------|-----------------|------------------|---------------------------|--------------|------------------|--------|
| $P_{rated, 50 Hz}$ | $P_{rated, 60 Hz}$ | Frame size | $n_{rated, 50 Hz}$ | $T_{rated, 50 Hz}$ | Different IE class | $\eta_{rated, 50 Hz}$ | $\eta_{rated, 50 Hz}$ | $\eta_{rated, 50 Hz}$ | $\cos\phi_{rated, 50 Hz}$ | $I_{rated, 50 Hz}$ | T_{LR}/I_{rated} | I_{LR}/I_{rated} | T_p/I_{rated} | $L_{p/A, 50 Hz}$ | $L_{WA, 50 Hz}$ | 1MB1 | $m_{IM B3}$ | J |
| kW | kW | FS | rpm | Nm | | % | % | % | | A | | | | | Article No. | kg | kgm ² | |
| <ul style="list-style-type: none"> • Cooling: self-ventilated (IC411) • Efficiency according to IEC 60034-30: IE2 High Efficiency • Insulation: Thermal class 155 (temperature class F), IP55 degree of protection, utilization in accordance with thermal class 130 (temperature class B) | | | | | | | | | | | | | | | | | | |
| 6-pole: 1000 rpm at 50 Hz, 1200 rpm at 60 Hz ¹⁾ | | | | | | | | | | | | | | | | | | |
| 0.37 | 0.43 | 80 M | 925 | 3.8 | | 67.6 | 67.9 | 64.4 | 0.69 | 1.14 | 2.1 | 4 | 2.4 | 42 | 53 | 1MB10-1-0DC2 | 9 | 0.0017 |
| 0.55 | 0.63 | 80 M | 935 | 5.6 | | 73.1 | 73.8 | 70.8 | 0.66 | 1.65 | 2.5 | 4.4 | 2.9 | 42 | 53 | 1MB10-1-0DC3 | 12 | 0.0025 |
| 0.75 | 0.86 | 90 S | 935 | 7.7 | | 75.9 | 76.8 | 74.5 | 0.7 | 2.05 | 2 | 4.1 | 2.5 | 43 | 55 | 1MB10-1-0EC0 | 13 | 0.003 |
| 1.1 | 1.27 | 90 L | 935 | 11 | IE1 | 78.1 | 79.3 | 77.7 | 0.7 | 2.9 | 2.2 | 4.4 | 2.6 | 43 | 55 | 1MB10-1-0EC4 | 16 | 0.004 |
| 1.5 | 1.75 | 100 L | 970 | 15 | | 79.8 | 80.5 | 79 | 0.73 | 3.7 | 2 | 5.4 | 2.8 | 59 | 71 | 1MB10-1-1AC4 | 25 | 0.011 |
| 2.2 | 2.55 | 112 M | 965 | 22 | | 81.8 | 82.7 | 81.7 | 0.75 | 5.2 | 2 | 5 | 2.8 | 62 | 74 | 1MB10-1-1BC2 | 29 | 0.014 |
| 3 | 3.45 | 132 S | 970 | 30 | | 83.3 | 83.4 | 81 | 0.72 | 7.2 | 1.6 | 5 | 2.5 | 63 | 75 | 1MB10-1-1CC0 | 38 | 0.024 |
| 4 | 4.55 | 132 M | 970 | 39 | | 84.6 | 85.5 | 84.3 | 0.75 | 9.1 | 1.6 | 5 | 2.3 | 63 | 75 | 1MB10-1-1CC2 | 43 | 0.029 |
| 5.5 | 6.3 | 132 M | 970 | 54 | | 86 | 87.1 | 86.4 | 0.76 | 12.1 | 1.9 | 5.6 | 2.6 | 63 | 75 | 1MB10-1-1CC3 | 52 | 0.037 |
| 7.5 | 8.6 | 160 M | 975 | 73 | | 87.2 | 87.9 | 87.2 | 0.74 | 16.8 | 1.9 | 4.7 | 2.2 | 67 | 79 | 1MB10-1-1DC2 | 77 | 0.075 |
| 11 | 12.6 | 160 L | 975 | 108 | | 88.7 | 89.7 | 89.3 | 0.76 | 23.5 | 1.9 | 4.8 | 2.2 | 67 | 79 | 1MB10-1-1DC4 | 93 | 0.098 |
| 8-pole: 750 rpm at 50 Hz, 900 rpm at 60 Hz ¹⁾ | | | | | | | | | | | | | | | | | | |
| 0.75 | 0.86 | 100 L | 705 | 10 | | 66.2 | 65.7 | 61.6 | 0.61 | 2.7 | 1.5 | 3.2 | 2.1 | 60 | 72 | 1MB10-1-1AD4 | 21 | 0.0086 |
| 1.1 | 1.27 | 100 L | 695 | 15 | | 70.8 | 72.3 | 69.6 | 0.65 | 3.45 | 1.4 | 3.2 | 1.9 | 60 | 72 | 1MB10-1-1AD5 | 25 | 0.011 |
| 1.5 | 1.75 | 112 M | 725 | 20 | | 74.1 | 73.9 | 71.2 | 0.63 | 4.65 | 1.6 | 4 | 2.4 | 63 | 75 | 1MB10-1-1BD2 | 34 | 0.017 |
| 2.2 | 2.55 | 132 S | 725 | 29 | | 77.6 | 78.2 | 76.6 | 0.62 | 6.6 | 1.4 | 3.5 | 2 | 63 | 75 | 1MB10-1-1CD0 | 46 | 0.034 |
| 3 | 3.45 | 132 M | 720 | 40 | IE1 | 80 | 80.7 | 79.2 | 0.62 | 8.7 | 1.4 | 3.7 | 2 | 63 | 75 | 1MB10-1-1CD2 | 52 | 0.037 |
| 4 | 4.55 | 160 M | 730 | 52 | | 81.9 | 82.6 | 81.4 | 0.67 | 10.5 | 1.6 | 3.7 | 1.9 | 63 | 75 | 1MB10-1-1DD2 | 69 | 0.065 |
| 5.5 | 6.3 | 160 M | 730 | 72 | | 83.8 | 84.2 | 83 | 0.67 | 14.1 | 1.7 | 3.9 | 2 | 63 | 75 | 1MB10-1-1DD3 | 82 | 0.083 |
| 7.5 | 8.6 | 160 L | 725 | 99 | | 85.3 | 86.4 | 86 | 0.7 | 18.1 | 1.6 | 3.8 | 1.9 | 63 | 75 | 1MB10-1-1DD4 | 94 | 0.098 |
| Zones | | | | | | | | | | | | | | | | | | |
| Zone 21 (conductive and non-conductive dust occasionally) Ex tb IIIC | | | | | | | | | | | | | | | | | | |
| Zone 22 (non-conductive dust rarely or for a short period) Ex tc IIIB | | | | | | | | | | | | | | | | | | |
| Zone 2 (explosive gases rarely or for a short period) Ex ec IIC | | | | | | | | | | | | | | | | | | |
| Voltages | | | | | | | | | | | | | | | | | | |
| 50 Hz 230 VΔ/400 VY | | | | | | | | | | | | | | | Version | | Order code | |
| 60 Hz ¹⁾ 460 VY | | | | | | | | | | | | | | | Standard | | 2 2 | |
| 50 Hz 400 VΔ/690 VY | | | | | | | | | | | | | | | Standard | | 3 4 | |
| 50 Hz 500 VY | | | | | | | | | | | | | | | Without additional charge | | 2 7 | |
| 50 Hz 500 VΔ | | | | | | | | | | | | | | | Without additional charge | | 4 0 | |
| For other voltages ¹⁾ and more information, see from page 5/51 | | | | | | | | | | | | | | | | | 9 0 | |
| Types of construction | | | | | | | | | | | | | | | | | | |
| Without flange | | | | | | | | | | | | | | | Version | | Order code | |
| IM B3 ²⁾ | | | | | | | | | | | | | | | Standard | | A | |
| With flange | | | | | | | | | | | | | | | With additional charge | | F | |
| IM B5 ²⁾ | | | | | | | | | | | | | | | With additional charge | | K | |
| With flange | | | | | | | | | | | | | | | | | ... | |
| IM B14 ²⁾ | | | | | | | | | | | | | | | | | | |
| For other types of construction and more information, see from page 5/56 | | | | | | | | | | | | | | | | | | |
| Motor protection | | | | | | | | | | | | | | | | | | |
| Without | | | | | | | | | | | | | | | Version | | Order code | |
| Standard | | | | | | | | | | | | | | | Standard | | A | |
| 3 temperature sensors (frame sizes 80, 90 or 100 to 200) | | | | | | | | | | | | | | | With additional charge | | B | |
| For other motor protection and more information, see from page 5/68 | | | | | | | | | | | | | | | | | | |
| Terminal box position | | | | | | | | | | | | | | | | | | |
| Terminal box at top | | | | | | | | | | | | | | | Version | | Order code | |
| Standard | | | | | | | | | | | | | | | Standard | | 4 | |
| For other terminal box positions and more information, see from page 5/73 | | | | | | | | | | | | | | | | | | |
| Special versions | | | | | | | | | | | | | | | | | | |
| For options, see from page 5/78 | | | | | | | | | | | | | | | 1MB10-1-...-Z | | ...+...+...+... | |

5



SIMOTICS XP 1MB1, 1MB5 explosion-protected motors

Zones 21, 22, and 2 with types of protection Ex tb, Ex tc, Ex ec · IE2 High Efficiency

Cast-iron series 1MB15, 1MB16 – self-ventilated

Selection and ordering data

| Operating values at rated power | | | | | | | | | | | | | | Cast-iron series | | | | |
|---|--------------------|------------|--------------------|--------------------|--------------------|-----------------------|-----------------------|-----------------------|---------------------------|--------------------|-----------------|-----------------|------------------|------------------|---------------------------|-------------------------------------|------------------|--------|
| $P_{rated, 50 Hz}$ | $P_{rated, 60 Hz}$ | Frame size | $n_{rated, 50 Hz}$ | $T_{rated, 50 Hz}$ | Different IE class | $\eta_{rated, 50 Hz}$ | $\eta_{rated, 50 Hz}$ | $\eta_{rated, 50 Hz}$ | $\cos\phi_{rated, 50 Hz}$ | $I_{rated, 50 Hz}$ | T_{LR}/I_{LR} | T_B/I_{rated} | $L_{pFA, 50 Hz}$ | $L_{WA, 50 Hz}$ | 1MB15.1 – Basic Line | $m_{IM B3}$ | J | |
| kW | kW | FS | rpm | Nm | | % | % | % | | A | | | dB(A) | dB(A) | Article No. | kg | kgm ² | |
| <ul style="list-style-type: none"> • Cooling: self-ventilated (IC411) • Efficiency according to IEC 60034-30: IE2 High Efficiency • Insulation: Thermal class 155 (temperature class F), IP55 degree of protection, utilization in accordance with thermal class 130 (temperature class B) | | | | | | | | | | | | | | | | | | |
| 2-pole: 3000 rpm at 50 Hz, 3600 rpm at 60 Hz ¹⁾ | | | | | | | | | | | | | | | | | | |
| 0.37 | 0.43 | 71 M | 2770 | 1.3 | | 69.5 | 70.5 | 67.9 | 0.81 | 0.95 | 2.5 | 4.1 | 2.5 | 58 | 63 | 1MB1511-0CA2 | 11.5 | 0.0035 |
| 0.55 | 0.63 | 71 M | 2780 | 1.9 | | 74.1 | 75.2 | 72.9 | 0.8 | 1.34 | 2.6 | 4.6 | 2.6 | 58 | 63 | 1MB1511-0CA3 | 13 | 0.0045 |
| 0.75 | 0.86 | 80 M | 2805 | 2.6 | | 77.4 | 80 | 80.1 | 0.84 | 1.67 | 1.9 | 4.9 | 2.3 | 60 | 71 | 1MB1511-0DA2 | 16 | 0.0008 |
| 1.1 | 1.27 | 80 M | 2835 | 3.7 | | 79.6 | 81.3 | 80.9 | 0.83 | 2.4 | 2.7 | 6 | 3.1 | 60 | 71 | 1MB1511-0DA3 | 18 | 0.0011 |
| 1.5 | 1.75 | 90 S | 2885 | 4.9 | | 81.3 | 81.7 | 79.8 | 0.84 | 3.15 | 2.7 | 6.9 | 3.6 | 65 | 77 | 1MB1511-0EA0 | 23 | 0.0017 |
| 2.2 | 2.55 | 90 L | 2890 | 7.3 | | 83.2 | 83.7 | 82 | 0.85 | 4.5 | 2.5 | 7.1 | 3.7 | 65 | 77 | 1MB1511-0EA4 | 25.5 | 0.0021 |
| 3 | 3.45 | 100 L | 2905 | 9.9 | | 84.6 | 85.5 | 84.6 | 0.84 | 6.1 | 2.3 | 7 | 3.3 | 67 | 79 | 1MB1111-1AA4 | 32 | 0.0044 |
| 4 | 4.55 | 112 M | 2945 | 13 | | 85.8 | 86.2 | 85.1 | 0.85 | 7.9 | 2.1 | 8 | 3.6 | 69 | 81 | 1MB1111-1BA2 | 39 | 0.0092 |
| 5.5 | 6.3 | 132 S | 2950 | 18 | | 87 | 88 | 87.6 | 0.87 | 10.5 | 1.8 | 6.6 | 2.9 | 68 | 80 | 1MB1111-1CA0 | 57 | 0.02 |
| 7.5 | 8.6 | 132 S | 2950 | 24 | | 88.1 | 88.5 | 87.6 | 0.87 | 14.1 | 2.2 | 7.5 | 3.1 | 68 | 80 | 1MB1111-1CA1 | 61 | 0.024 |
| 11 | 12.6 | 160 M | 2955 | 36 | | 89.4 | 89.3 | 88 | 0.87 | 20.5 | 2.1 | 7.4 | 3.2 | 70 | 82 | 1MB1111-1DA2 | 96 | 0.045 |
| 15 | 17.3 | 160 M | 2955 | 48 | | 90.3 | 90.7 | 90 | 0.88 | 27 | 2.4 | 7.6 | 3.4 | 70 | 82 | 1MB1111-1DA3 | 104 | 0.053 |
| 18.5 | 21.3 | 160 L | 2955 | 60 | | 90.9 | 91.3 | 90.6 | 0.88 | 33.5 | 2.9 | 7.9 | 3.6 | 70 | 82 | 1MB1111-1DA4 | 113 | 0.061 |
| 22 | 24.5 | 180 M | 2940 | 71 | | 91.3 | 91.6 | 90.9 | 0.87 | 40 | 2.7 | 7.4 | 3.6 | 77 | 84 | 1MB1111-1EA2 | 145 | 0.069 |
| 30 | 33.5 | 200 L | 2960 | 97 | | 92 | 92.1 | 91.5 | 0.87 | 54 | 2.5 | 6.9 | 3.3 | 78 | 85 | 1MB1111-2AA4 | 200 | 0.13 |
| 37 | 41.5 | 200 L | 2960 | 119 | | 92.5 | 92.7 | 92.1 | 0.88 | 66 | 2.7 | 7.4 | 3.5 | 78 | 85 | 1MB1111-2AA5 | 225 | 0.15 |
| 45 | 51 | 225 M | 2965 | 145 | | 92.9 | 93.1 | 92.5 | 0.88 | 79 | 2.7 | 7.8 | 3.7 | 76 | 89 | 1MB1111-2BA2 | 295 | 0.23 |
| 55 | 62 | 250 M | 2970 | 177 | | 93.2 | 93.3 | 92.4 | 0.88 | 97 | 2.3 | 6.8 | 3.1 | 76 | 89 | 1MB1111-2CA2 | 360 | 0.4 |
| 75 | 84 | 280 S | 2978 | 240 | | 93.8 | 93.6 | 92.4 | 0.86 | 134 | 2.5 | 7.2 | 3.2 | 76 | 89 | 1MB1111-2DA0 | 490 | 0.71 |
| 90 | 101 | 280 M | 2975 | 289 | | 94.1 | 94.2 | 93.5 | 0.88 | 157 | 2.5 | 7.1 | 3.1 | 76 | 89 | 1MB1111-2DA2 | 530 | 0.83 |
| 110 | 123 | 315 S | 2982 | 352 | | 94.3 | 94.2 | 93.3 | 0.9 | 187 | 2.4 | 7.3 | 3 | 77 | 91 | 1MB1111-3AA0 | 720 | 1.3 |
| 132 | 148 | 315 M | 2982 | 423 | | 94.6 | 94.7 | 94.1 | 0.91 | 220 | 2.4 | 7.2 | 3.1 | 77 | 91 | 1MB1111-3AA2 | 880 | 1.6 |
| 160 | 180 | 315 L | 2982 | 512 | | 94.8 | 94.9 | 94.3 | 0.92 | 265 | 2.3 | 7 | 3.1 | 80 | 95 | 1MB1111-3AA4 | 930 | 1.8 |
| 200 | 224 | 315 L | 2982 | 640 | | 95 | 95.2 | 94.8 | 0.92 | 330 | 2.5 | 7.3 | 3 | 80 | 95 | 1MB1111-3AA5 | 1130 | 2.2 |
| Basic Line | | | | | | | | | | | | | | 5 | | | | |
| Performance Line | | | | | | | | | | | | | | 6 | | | | |
| Zones | | | | | | | | | | | | | | | | | | |
| Zone 21 (conductive and non-conductive dust occasionally) Ex tb IIC | | | | | | | | | | | | | | 1 | | | | |
| Zone 22 (non-conductive dust rarely or for a short period) Ex tc IIIB | | | | | | | | | | | | | | 2 | | | | |
| Zone 2 (explosive gases rarely or for a short period) Ex ec IIC | | | | | | | | | | | | | | 3 | | | | |
| Voltages ³⁾ | | | | | | | | | | | | | | | | | | |
| 50 Hz 230 VΔ/400 VY | | | | | | | | | | | | | | | Standard | 2 2 | | |
| 60 Hz ¹⁾ 460 VY | | | | | | | | | | | | | | | Standard | 3 4 | | |
| 50 Hz 400 VΔ/690 VY | | | | | | | | | | | | | | | Without additional charge | 2 7 | | |
| 60 Hz ¹⁾ 460 VΔ | | | | | | | | | | | | | | | Without additional charge | 4 0 | | |
| 50 Hz 500 VY | | | | | | | | | | | | | | | | 9 0 | | |
| 50 Hz 500 VΔ | | | | | | | | | | | | | | | | | | |
| For other voltages ¹⁾ and more information, see from page 5/52 | | | | | | | | | | | | | | | | | | |
| Types of construction | | | | | | | | | | | | | | | | | | |
| Without flange IM B3 ²⁾ | | | | | | | | | | | | | | | Standard | A | | |
| With flange IM B5 ²⁾ | | | | | | | | | | | | | | | With additional charge | F | | |
| With flange IM B14 ²⁾ | | | | | | | | | | | | | | | With additional charge | K | | |
| For other types of construction and more information, see from page 5/59 | | | | | | | | | | | | | | | | | | |
| Motor protection | | | | | | | | | | | | | | | | | | |
| Without | | | | | | | | | | | | | | | Line | Only possible for Basic Line | | |
| PTC thermistor with 3 temperature sensors | | | | | | | | | | | | | | | Version | Standard | | |
| | | | | | | | | | | | | | | | | A | | |
| | | | | | | | | | | | | | | | | B | | |
| | | | | | | | | | | | | | | | | B | | |
| For other motor protection and more information, see from page 5/69 | | | | | | | | | | | | | | | | | | |
| Terminal box position | | | | | | | | | | | | | | | | | | |
| Terminal box at top | | | | | | | | | | | | | | | Version | Standard | | |
| | | | | | | | | | | | | | | | | 4 | | |
| For other terminal box positions and more information, see from page 5/74 | | | | | | | | | | | | | | | | | | |
| Special versions | | | | | | | | | | | | | | | | | | |
| For options, see from page 5/82 | | | | | | | | | | | | | | | | | | |
| | | | | | | | | | | | | | | | | 1MB1111-...-Z-...+...+...+... | | |





SIMOTICS XP 1MB1, 1MB5 explosion-protected motors

Zones 21, 22, and 2 with types of protection Ex tb, Ex tc, Ex ec · IE2 High Efficiency

Cast-iron series 1MB15, 1MB16 – self-ventilated

Selection and ordering data

| Operating values at rated power | | | | | | | | | | | | | | | Cast-iron series | | m _{IM B3} | J |
|---|-----------------------------|---------------|-----------------------------|-----------------------------|-----------------------|-----------------------------|-----------------------------|-----------------------------|--------------------------------|-----------------------------|---|---|--|---------------------------|--------------------------|---------------------|--------------------|--------|
| P _{rated} 50 Hz | P _{rated} 60 Hz | Frame size | n _{rated} 50 Hz | T _{rated} 50 Hz | Different IE class | η _{rated} 50 Hz | η _{rated} 50 Hz | η _{rated} 50 Hz | cosφ _{rated} 50 Hz | I _{rated} 50 Hz | T _{LR} / T _{rated} | I _{LR} / I _{rated} | T _B / T _{rated} | L _{pFA} 50 Hz | L _{WA} 50 Hz | Article No. | | |
| kW | kW | FS | rpm | Nm | | % | % | % | | A | | | | dB(A) | dB(A) | | | |
| <ul style="list-style-type: none"> • Cooling: self-ventilated (IC411) • Efficiency according to IEC 60034-30: IE2 High Efficiency • Insulation: Thermal class 155 (temperature class F), IP55 degree of protection, utilization in accordance with thermal class 130 (temperature class B) | | | | | | | | | | | | | | | | | | |
| 6-pole: 1000 rpm at 50 Hz, 1200 rpm at 60 Hz ¹⁾ | | | | | | | | | | | | | | | | | | |
| 0.18 | 0.21 | 71 M | 875 | 2 | | 56.6 | 56.9 | 52.7 | 0.68 | 0.68 | 2.2 | 2.5 | 2.3 | 46 | 57 | 1MB15■1-0CC2■-■■■■■ | 11.5 | 0.0008 |
| 0.25 | 0.29 | 71 M | 870 | 2.7 | | 61.6 | 62.7 | 59.2 | 0.7 | 0.84 | 2.3 | 2.6 | 2.3 | 46 | 57 | 1MB15■1-0CC3■-■■■■■ | 12.5 | 0.0010 |
| 0.37 | 0.43 | 80 M | 925 | 3.8 | | 67.6 | 67.9 | 64.4 | 0.69 | 1.14 | 2.1 | 4 | 2.4 | 42 | 53 | 1MB15■1-0DC2■-■■■■■ | 16.5 | 0.0017 |
| 0.55 | 0.63 | 80 M | 935 | 5.6 | | 73.1 | 73.8 | 70.8 | 0.66 | 1.65 | 2.5 | 4.4 | 2.9 | 42 | 53 | 1MB15■1-0DC3■-■■■■■ | 18.5 | 0.0025 |
| 0.75 | 0.86 | 90 S | 935 | 7.7 | | 75.9 | 76.8 | 74.5 | 0.7 | 2.05 | 2 | 4.1 | 2.5 | 43 | 55 | 1MB15■1-0EC0■-■■■■■ | 23 | 0.003 |
| 1.1 | 1.27 | 90 L | 935 | 11 | IE1 | 78.1 | 79.3 | 77.7 | 0.7 | 2.9 | 2.2 | 4.4 | 2.6 | 43 | 55 | 1MB15■1-0EC4■-■■■■■ | 26.5 | 0.004 |
| 1.5 | 1.75 | 100 L | 970 | 15 | | 79.8 | 80.5 | 79 | 0.73 | 3.7 | 2 | 5.4 | 2.8 | 59 | 71 | 1MB1■1-1AC4■-■■■■■ | 36 | 0.011 |
| 2.2 | 2.55 | 112 M | 965 | 22 | | 81.8 | 82.7 | 81.7 | 0.75 | 5.2 | 2 | 5 | 2.8 | 62 | 74 | 1MB1■1-1BC2■-■■■■■ | 41 | 0.014 |
| 3 | 3.45 | 132 S | 970 | 30 | | 83.3 | 83.4 | 81 | 0.72 | 7.2 | 1.6 | 5 | 2.5 | 63 | 75 | 1MB1■1-1CC0■-■■■■■ | 56 | 0.024 |
| 4 | 4.55 | 132 M | 970 | 39 | | 84.6 | 85.5 | 84.3 | 0.75 | 9.1 | 1.6 | 5 | 2.3 | 63 | 75 | 1MB1■1-1CC2■-■■■■■ | 61 | 0.029 |
| 5.5 | 6.3 | 132 M | 970 | 54 | | 86 | 87.1 | 86.4 | 0.76 | 12.1 | 1.9 | 5.6 | 2.6 | 63 | 75 | 1MB1■1-1CC3■-■■■■■ | 70 | 0.037 |
| 7.5 | 8.6 | 160 M | 975 | 73 | | 87.2 | 87.9 | 87.2 | 0.74 | 16.8 | 1.9 | 4.7 | 2.2 | 67 | 79 | 1MB1■1-1DC2■-■■■■■ | 106 | 0.075 |
| 11 | 12.6 | 160 L | 975 | 108 | | 88.7 | 89.7 | 89.3 | 0.76 | 23.5 | 1.9 | 4.8 | 2.2 | 67 | 79 | 1MB1■1-1DC4■-■■■■■ | 122 | 0.098 |
| 15 | 18 | 180 L | 975 | 147 | | 89.7 | 90.1 | 89.5 | 0.78 | 31 | 2.5 | 6 | 3.1 | 57 | 70 | 1MB1■1-1EC4■-■■■■■ | 155 | 0.17 |
| 18.5 | 22 | 200 L | 978 | 181 | IE1 | 90.4 | 91.3 | 91.2 | 0.82 | 36 | 2.4 | 5.8 | 2.6 | 63 | 76 | 1MB1■1-2AC4■-■■■■■ | 200 | 0.25 |
| 22 | 26.5 | 200 L | 978 | 215 | IE1 | 90.9 | 91.7 | 91.4 | 0.82 | 42.5 | 2.5 | 6.2 | 2.6 | 63 | 76 | 1MB1■1-2AC5■-■■■■■ | 220 | 0.3 |
| 30 | 36 | 225 M | 980 | 292 | IE1 | 91.7 | 92.5 | 92.3 | 0.83 | 57 | 2.5 | 5.6 | 2.7 | 65 | 78 | 1MB1■1-2BC2■-■■■■■ | 300 | 0.58 |
| 37 | 44.5 | 250 M | 982 | 360 | IE1 | 92.2 | 93.1 | 93.1 | 0.83 | 70 | 2.8 | 6 | 2.5 | 62 | 77 | 1MB1■1-2CC2■-■■■■■ | 370 | 0.86 |
| 45 | 54 | 280 S | 985 | 436 | IE1 | 92.7 | 93.4 | 93.2 | 0.84 | 83 | 2.7 | 6.3 | 2.6 | 65 | 79 | 1MB1■1-2DC0■-■■■■■ | 460 | 1.1 |
| 55 | 66 | 280 M | 985 | 533 | IE1 | 93.1 | 93.9 | 94 | 0.86 | 99 | 2.5 | 6.4 | 2.6 | 65 | 79 | 1MB1■1-2DC2■-■■■■■ | 510 | 1.4 |
| 75 | 90 | 315 S | 988 | 725 | IE1 | 93.7 | 94 | 93.6 | 0.84 | 138 | 2.5 | 6.7 | 2.8 | 65 | 79 | 1MB1■1-3AC0■-■■■■■ | 660 | 2.1 |
| 90 | 108 | 315 M | 988 | 870 | IE1 | 94 | 94.3 | 93.6 | 0.84 | 165 | 2.6 | 6.9 | 2.8 | 65 | 79 | 1MB1■1-3AC2■-■■■■■ | 730 | 2.5 |
| 110 | 132 | 315 L | 988 | 1063 | IE1 | 94.3 | 94.6 | 94.5 | 0.86 | 196 | 2.7 | 7 | 2.8 | 68 | 82 | 1MB1■1-3AC4■-■■■■■ | 940 | 3.6 |
| 132 | 158 | 315 L | 988 | 1276 | | 94.6 | 94.9 | 94.7 | 0.86 | 235 | 3 | 7.5 | 2.9 | 69 | 84 | 1MB1■1-3AC5■-■■■■■ | 990 | 4.0 |
| 160 | 192 | 315 L | 988 | 1546 | | 94.8 | 94.7 | 94.4 | 0.86 | 285 | 3.1 | 7.7 | 3.3 | 69 | 84 | 1MB1■1-3AC6■-■■■■■ | 1160 | 4.7 |

| | | | | | | | | | | | | | | | | | | |
|---|---|-------------------------------------|--|--|--|--|--|--|--|--|--|--|--|--|--|--|--|--|
| Basic Line | 5 | | | | | | | | | | | | | | | | | |
| Performance Line | 6 | | | | | | | | | | | | | | | | | |
| Zones | | | | | | | | | | | | | | | | | | |
| Zone 21 (conductive and non-conductive dust occasionally) Ex tb IIIC | 1 | | | | | | | | | | | | | | | | | |
| Zone 22 (non-conductive dust rarely or for a short period) Ex tc IIIB | 2 | | | | | | | | | | | | | | | | | |
| Zone 2 (explosive gases rarely or for a short period) Ex ec IIC | 3 | | | | | | | | | | | | | | | | | |
| Voltages ³⁾ | | | | | | | | | | | | | | | | | | |
| 50 Hz 230 VΔ/400 VY | | 60 Hz ¹⁾ 460 VY | | | | | | | | | | | | | | | | |
| 50 Hz 400 VΔ/690 VY | | 60 Hz ¹⁾ 460 VΔ | | | | | | | | | | | | | | | | |
| 50 Hz 500 VY | | | | | | | | | | | | | | | | | | |
| 50 Hz 500 VΔ | | | | | | | | | | | | | | | | | | |
| For other voltages ¹⁾ and more information, see from page 5/52 | | | | | | | | | | | | | | | | | | |
| Types of construction | | | | | | | | | | | | | | | | | | |
| Without flange | | IM B3 ²⁾ | | | | | | | | | | | | | | | | |
| With flange | | IM B5 ²⁾ | | | | | | | | | | | | | | | | |
| With flange | | IM B14 ²⁾ | | | | | | | | | | | | | | | | |
| For other types of construction and more information, see from page 5/59 | | | | | | | | | | | | | | | | | | |
| Motor protection | | | | | | | | | | | | | | | | | | |
| Without | | Only possible for Basic Line | | | | | | | | | | | | | | | | |
| PTC thermistor with 3 temperature sensors | | Basic Line | | | | | | | | | | | | | | | | |
| | | Performance Line | | | | | | | | | | | | | | | | |
| For other motor protection and more information, see from page 5/69 | | | | | | | | | | | | | | | | | | |
| Terminal box position | | | | | | | | | | | | | | | | | | |
| Terminal box at top | | | | | | | | | | | | | | | | | | |
| For other terminal box positions and more information, see from page 5/74 | | | | | | | | | | | | | | | | | | |
| Special versions | | | | | | | | | | | | | | | | | | |
| For options, see from page 5/82 | | | | | | | | | | | | | | | | | | |
| | | | | | | | | | | | | | | | | | | |

1MB1■1-...■-■■■■■-Z...+...+...+...



SIMOTICS XP 1MB1, 1MB5 explosion-protected motors

Zones 21, 22, and 2 with types of protection Ex tb, Ex tc, Ex ec · IE2 High Efficiency



Cast-iron series 1MB15, 1MB16 – self-ventilated

Selection and ordering data

| Operating values at rated power | | | | | | | | | | | | | | | Cast-iron series | | | |
|---|--------------------|------------|--------------------|--------------------|--------------------|-----------------------|-----------------------|-----------------------|---------------------------|--------------------|--------------------|--------------------|-----------------|------------------|------------------|----------------------|-------------|------------------|
| $P_{rated, 50 Hz}$ | $P_{rated, 60 Hz}$ | Frame size | $n_{rated, 50 Hz}$ | $T_{rated, 50 Hz}$ | Different IE class | $\eta_{rated, 50 Hz}$ | $\eta_{rated, 50 Hz}$ | $\eta_{rated, 50 Hz}$ | $\cos\phi_{rated, 50 Hz}$ | $I_{rated, 50 Hz}$ | T_{LR}/I_{rated} | I_{LR}/I_{rated} | T_B/I_{rated} | $L_{pFA, 50 Hz}$ | $L_{WA, 50 Hz}$ | 1MB15.1 – Basic Line | $m_{IM B3}$ | J |
| kW | kW | FS | rpm | Nm | | % | % | % | | A | | | | | | Article No. | kg | kgm ² |
| <ul style="list-style-type: none"> • Cooling: self-ventilated (IC411) • Efficiency according to IEC 60034-30: IE2 High Efficiency • Insulation: Thermal class 155 (temperature class F), IP55 degree of protection, utilization in accordance with thermal class 130 (temperature class B) | | | | | | | | | | | | | | | | | | |
| 8-pole: 750 rpm at 50 Hz, 900 rpm at 60 Hz ¹⁾ | | | | | | | | | | | | | | | | | | |
| 0.09 | 0.11 | 71 M | 630 | 1.4 | 4) | 40.1 | 40.6 | 35.8 | 0.67 | 0.50 | 1.7 | 1.6 | 1.7 | 59 | 63 | 1MB1511-0CD2 | 11.5 | 0.0077 |
| 0.12 | 0.14 | 71 M | 640 | 1.8 | | 40.1 | 39.6 | 34.7 | 0.66 | 0.65 | 1.8 | 1.8 | 1.8 | 48 | 59 | 1MB1511-0CD3 | 12.5 | 0.0100 |
| 0.18 | 0.21 | 80 M | 690 | 2.5 | | 45.9 | 43.6 | 37.8 | 0.60 | 0.93 | 1.7 | 2.2 | 2.1 | 51 | 62 | 1MB1511-0DD2 | 16.5 | 0.0175 |
| 0.25 | 0.29 | 80 M | 705 | 3.4 | | 50.6 | 48.1 | 41.9 | 0.55 | 1.30 | 2.0 | 2.5 | 2.5 | 51 | 62 | 1MB1511-0DD3 | 18.5 | 0.0246 |
| 0.37 | 0.43 | 90 S | 675 | 5.2 | | 56.1 | 55.6 | 49.6 | 0.71 | 1.34 | 1.4 | 2.6 | 1.7 | 53 | 65 | 1MB1511-0ED0 | 20 | 0.0225 |
| 0.55 | 0.63 | 90 L | 665 | 7.9 | | 61.7 | 63.4 | 59.8 | 0.74 | 1.74 | 1.5 | 2.7 | 1.7 | 53 | 65 | 1MB1511-0ED4 | 21.5 | 0.0305 |
| 0.75 | 0.86 | 100 L | 705 | 10 | | 66.2 | 65.7 | 61.6 | 0.61 | 2.7 | 1.5 | 3.2 | 2.1 | 60 | 72 | 1MB1511-1AD4 | 32 | 0.0086 |
| 1.1 | 1.27 | 100 L | 695 | 15 | | 70.8 | 72.3 | 69.6 | 0.65 | 3.45 | 1.4 | 3.2 | 1.9 | 60 | 72 | 1MB1511-1AD5 | 36 | 0.011 |
| 1.5 | 1.75 | 112 M | 725 | 20 | | 74.1 | 73.9 | 71.2 | 0.63 | 4.65 | 1.6 | 4 | 2.4 | 63 | 72 | 1MB1511-1BD2 | 53 | 0.017 |
| 2.2 | 2.55 | 132 S | 725 | 29 | | 77.6 | 78.2 | 76.6 | 0.62 | 6.6 | 1.4 | 3.5 | 2 | 63 | 75 | 1MB1511-1CD0 | 64 | 0.034 |
| 3 | 3.45 | 132 M | 720 | 40 | IE1 | 80 | 80.7 | 79.2 | 0.62 | 8.7 | 1.4 | 3.7 | 2 | 63 | 75 | 1MB1511-1CD2 | 67 | 0.037 |
| 4 | 4.55 | 160 M | 730 | 52 | | 81.9 | 82.6 | 81.4 | 0.67 | 10.5 | 1.6 | 3.7 | 1.9 | 63 | 75 | 1MB1511-1DD2 | 98 | 0.065 |
| 5.5 | 6.3 | 160 M | 730 | 72 | | 83.8 | 84.2 | 83 | 0.67 | 14.1 | 1.7 | 3.9 | 2 | 63 | 75 | 1MB1511-1DD3 | 111 | 0.083 |
| 7.5 | 8.6 | 160 L | 725 | 99 | | 85.3 | 86.4 | 86 | 0.7 | 18.1 | 1.6 | 3.8 | 1.9 | 63 | 75 | 1MB1511-1DD4 | 123 | 0.098 |
| 11 | 13.2 | 180 L | 720 | 146 | IE1 | 86.9 | 88 | 87.6 | 0.7 | 26 | 2.3 | 4.9 | 2.6 | 72 | 75 | 1MB1511-1ED4 | 155 | 0.195 |
| 15 | 18 | 200 L | 718 | 199 | | 88 | 89.5 | 89.9 | 0.76 | 32.5 | 2.4 | 5.4 | 2.8 | 58 | 80 | 1MB1511-2AD5 | 220 | 0.344 |
| 18.5 | 22 | 225 S | 730 | 242 | IE1 | 89 | 89.9 | 89.5 | 0.78 | 38.5 | 2.2 | 5.4 | 2.7 | 59 | 72 | 1MB1511-2BD0 | 250 | 0.43 |
| 22 | 26.5 | 225 M | 730 | 288 | | 90.3 | 91.3 | 91.1 | 0.8 | 44 | 2.3 | 5.5 | 2.7 | 58 | 71 | 1MB1511-2BD2 | 270 | 0.5 |
| 30 | 36 | 250 M | 732 | 391 | | 91.3 | 92.2 | 92 | 0.8 | 59 | 2.4 | 5.6 | 2.7 | 60 | 73 | 1MB1511-2CD2 | 370 | 0.86 |
| 37 | 44.5 | 280 S | 736 | 480 | | 91.9 | 92.5 | 92.1 | 0.78 | 75 | 2.3 | 5.4 | 2.4 | 63 | 77 | 1MB1511-2DD0 | 460 | 1.1 |
| 45 | 54 | 280 M | 738 | 582 | | 92.4 | 92.8 | 92.4 | 0.79 | 89 | 2.5 | 5.7 | 2.5 | 66 | 80 | 1MB1511-2DD2 | 510 | 1.4 |
| 55 | 66 | 315 S | 740 | 710 | | 92.9 | 93.3 | 92.9 | 0.8 | 107 | 2.2 | 5.8 | 2.6 | 69 | 83 | 1MB1511-3AD0 | 640 | 2 |
| 75 | 90 | 315 M | 738 | 970 | | 93.5 | 94.4 | 94.5 | 0.81 | 143 | 2.3 | 5.9 | 2.7 | 69 | 84 | 1MB1511-3AD2 | 720 | 2.5 |
| 90 | 108 | 315 L | 740 | 1161 | | 93.5 | 94.3 | 94.4 | 0.83 | 167 | 2.2 | 5.8 | 2.5 | 69 | 84 | 1MB1511-3AD4 | 860 | 3.1 |
| 110 | 132 | 315 L | 740 | 1419 | | 94.2 | 95 | 95.1 | 0.82 | 205 | 2.7 | 6.7 | 2.9 | 74 | 88 | 1MB1511-3AD5 | 980 | 3.9 |
| 132 | 158 | 315 L | 740 | 1703 | | 94.4 | 94.8 | 94.4 | 0.81 | 250 | 2.9 | 7.2 | 3.3 | 76 | 90 | 1MB1511-3AD6 | 1070 | 4.5 |

| | | | | | | | | | | | | | | | | | | |
|---|---|--|--|--|--|--|--|--|--|--|--|--|--|--|--|---|---|------------|
| Basic Line | 5 | | | | | | | | | | | | | | | | | |
| Performance Line | 6 | | | | | | | | | | | | | | | | | |
| Zones | | | | | | | | | | | | | | | | | | |
| Zone 21 (conductive and non-conductive dust occasionally) Ex tb IIIC | 1 | | | | | | | | | | | | | | | | | |
| Zone 22 (non-conductive dust rarely or for a short period) Ex tc IIIB | 2 | | | | | | | | | | | | | | | | | |
| Zone 2 (explosive gases rarely or for a short period) Ex ec IIC | 3 | | | | | | | | | | | | | | | | | |
| Voltages ³⁾ | | | | | | | | | | | | | | | | | | |
| 50 Hz 230 VΔ/400 VY | | | | | | | | | | | | | | | | 2 | 2 | Order code |
| 50 Hz 400 VΔ/690 VY | | | | | | | | | | | | | | | | 3 | 4 | – |
| 50 Hz 500 VY | | | | | | | | | | | | | | | | 2 | 7 | – |
| 50 Hz 500 VΔ | | | | | | | | | | | | | | | | 4 | 0 | – |
| For other voltages ¹⁾ and more information, see from page 5/52 | | | | | | | | | | | | | | | | 9 | 0 | ... |
| Types of construction | | | | | | | | | | | | | | | | | | |
| Without flange | | | | | | | | | | | | | | | | | | |
| With flange | | | | | | | | | | | | | | | | | | |
| With flange | | | | | | | | | | | | | | | | | | |
| For other types of construction and more information, see from page 5/59 | | | | | | | | | | | | | | | | | | |
| Motor protection | | | | | | | | | | | | | | | | | | |
| Without | | | | | | | | | | | | | | | | | | |
| PTC thermistor with 3 temperature sensors | | | | | | | | | | | | | | | | | | |
| For other motor protection and more information, see from page 5/69 | | | | | | | | | | | | | | | | | | |
| Terminal box position | | | | | | | | | | | | | | | | | | |
| Terminal box at top | | | | | | | | | | | | | | | | | | |
| For other terminal box positions and more information, see from page 5/74 | | | | | | | | | | | | | | | | | | |
| Special versions | | | | | | | | | | | | | | | | | | |
| For options, see from page 5/82 | | | | | | | | | | | | | | | | | | |

5



SIMOTICS XP 1MB1, 1MB5 explosion-protected motors

Zones 21, 22, and 2 with types of protection Ex tb, Ex tc, Ex ec · IE1 Standard Efficiency

Aluminum series 1MB10 – self-ventilated

Selection and ordering data

| Operating values at rated power | | | | | | | | | | | | | | Aluminum series | | | | | |
|---|--------------------|------------|--------------------|----------------------------|----------------------------|----------------------------|----------------------------|--------------------------------|---------------------------|---------------------------|--------------------|-----------------|------------------|-----------------|---------------|-------------|------------------|-----------------|--|
| $P_{rated, 50 Hz}$ | $P_{rated, 60 Hz}$ | Frame size | $n_{rated, 50 Hz}$ | $T_{rated, 50 Hz}$ | $\eta_{rated, 50 Hz, 4/4}$ | $\eta_{rated, 50 Hz, 3/4}$ | $\eta_{rated, 50 Hz, 2/4}$ | $\cos\phi_{rated, 50 Hz, 4/4}$ | $I_{rated, 50 Hz, 400 V}$ | T_{LR}/T_{rated} | I_{LR}/I_{rated} | T_B/T_{rated} | $L_{pfA, 50 Hz}$ | $L_{WA, 50 Hz}$ | 1MB1 | $m_{IM B3}$ | J | | |
| kW | kW | FS | rpm | Nm | % | % | % | | A | | | | dB(A) | dB(A) | Article No. | kg | kgm ² | | |
| <ul style="list-style-type: none"> Cooling: self-ventilated (IC411) Efficiency according to IEC 60034-30: IE1 Standard Efficiency Insulation: Thermal class 155 (temperature class F), IP55 degree of protection, utilization in accordance with thermal class 130 (temperature class B) | | | | | | | | | | | | | | | | | | | |
| 2-pole: 3000 rpm at 50 Hz, 3600 rpm at 60 Hz ¹⁾ | | | | | | | | | | | | | | | | | | | |
| 3 | 3.45 | 100 L | 2835 | 10 | 81.5 | 83.2 | 82.8 | 0.87 | 6.1 | 3.2 | 6.4 | 3.5 | 67 | 79 | 1MB10-2-1AA4 | 20 | 0.0034 | | |
| 4 | 4.55 | 112 M | 2935 | 13 | 83.1 | 83 | 80.8 | 0.85 | 8.2 | 3.3 | 8.3 | 4.2 | 69 | 81 | 1MB10-2-1BA2 | 25 | 0.0067 | | |
| 5.5 | 6.3 | 132 S | 2910 | 18 | 84.7 | 85.9 | 85.7 | 0.88 | 10.7 | 1.8 | 5.7 | 2.6 | 68 | 80 | 1MB10-2-1CA0 | 35 | 0.013 | | |
| 7.5 | 8.6 | 132 S | 2925 | 24 | 86 | 86.7 | 86.1 | 0.88 | 14.3 | 2.2 | 6.8 | 3.1 | 68 | 80 | 1MB10-2-1CA1 | 40 | 0.016 | | |
| 11 | 12.6 | 160 M | 2925 | 36 | 87.6 | 88 | 87.1 | 0.86 | 21 | 2 | 5.7 | 2.7 | 70 | 82 | 1MB10-2-1DA2 | 60 | 0.03 | | |
| 15 | 17.3 | 160 M | 2935 | 49 | 88.7 | 88.9 | 87.7 | 0.85 | 28.5 | 2.4 | 6.8 | 3.2 | 70 | 82 | 1MB10-2-1DA3 | 68 | 0.036 | | |
| 18.5 | 21.3 | 160 L | 2935 | 60 | 89.3 | 89.7 | 89.3 | 0.87 | 34.5 | 2.7 | 7.6 | 3.4 | 70 | 82 | 1MB10-2-1DA4 | 78 | 0.044 | | |
| 4-pole: 1500 rpm at 50 Hz, 1800 rpm at 60 Hz ¹⁾ | | | | | | | | | | | | | | | | | | | |
| 2.2 | 2.55 | 100 L | 1425 | 15 | 79.7 | 80.3 | 78.1 | 0.81 | 4.9 | 2.3 | 5.1 | 2.7 | 60 | 72 | 1MB10-2-1AB4 | 18 | 0.0059 | | |
| 3 | 3.45 | 100 L | 1425 | 20 | 81.5 | 82.6 | 81.5 | 0.85 | 6.3 | 2.4 | 5.4 | 2.6 | 60 | 72 | 1MB10-2-1AB5 | 22 | 0.0078 | | |
| 4 | 4.55 | 112 M | 1435 | 27 | 83.1 | 84.3 | 83.7 | 0.83 | 8.4 | 2.5 | 6.1 | 2.9 | 58 | 70 | 1MB10-2-1BB2 | 27 | 0.010 | | |
| 5.5 | 6.3 | 132 S | 1450 | 36 | 84.7 | 85.3 | 84.2 | 0.82 | 11.4 | 2.3 | 5.7 | 2.7 | 64 | 76 | 1MB10-2-1CB0 | 38 | 0.019 | | |
| 7.5 | 8.6 | 132 M | 1450 | 49 | 86 | 86.5 | 85.4 | 0.82 | 15.4 | 2.6 | 6.6 | 3.1 | 64 | 76 | 1MB10-2-1CB2 | 44 | 0.024 | | |
| 11 | 12.6 | 160 M | 1460 | 72 | 87.6 | 87.9 | 86.7 | 0.81 | 22.5 | 2.7 | 6.9 | 3.3 | 65 | 77 | 1MB10-2-1DB2 | 62 | 0.044 | | |
| 15 | 17.3 | 160 L | 1460 | 98 | 88.7 | 89.1 | 88 | 0.82 | 30 | 3 | 7.5 | 3.6 | 65 | 77 | 1MB10-2-1DB4 | 73 | 0.056 | | |
| Zones | | | | | | | | | | | | | | | | | | | |
| Zone 21 (conductive and non-conductive dust occasionally) Ex tb IIIC | | | | | | | | | | | | | | | 1 | | | | |
| Zone 22 (non-conductive dust rarely or for a short period) Ex tc IIIB | | | | | | | | | | | | | | | 2 | | | | |
| Zone 2 (explosive gases rarely or for a short period) Ex ec IIC | | | | | | | | | | | | | | | 3 | | | | |
| Voltages | | | | | | | | | | | | | | | | | | | |
| Version | | | | | | | | | | | | | | Order code | | | | | |
| 50 Hz 230 VΔ/400 VY | | | | 60 Hz ¹⁾ 460 VY | | | | | | Standard | | | | 2 | 2 | - | | | |
| 50 Hz 400 VΔ/690 VY | | | | 60 Hz ¹⁾ 460 VΔ | | | | | | Standard | | | | 3 | 4 | - | | | |
| 50 Hz 500 VY | | | | | | | | | | Without additional charge | | | | 2 | 7 | - | | | |
| 50 Hz 500 VΔ | | | | | | | | | | Without additional charge | | | | 4 | 0 | - | | | |
| For other voltages ¹⁾ and more information, see from page 5/51 | | | | | | | | | | | | | | | | | | | |
| Types of construction | | | | | | | | | | | | | | | | | | | |
| Version | | | | | | | | | | | | | | Order code | | | | | |
| Without flange | | | | IM B3 ²⁾ | | | | | | Standard | | | | A | - | | | | |
| With flange | | | | IM B5 ²⁾ | | | | | | With additional charge | | | | F | - | | | | |
| With flange | | | | IM B14 ²⁾ | | | | | | With additional charge | | | | K | - | | | | |
| For other types of construction and more information, see from page 5/56 | | | | | | | | | | | | | | | | | | | |
| Motor protection | | | | | | | | | | | | | | | | | | | |
| Version | | | | | | | | | | | | | | Order code | | | | | |
| Without | | | | | | | | | | Standard | | | | A | - | | | | |
| PTC thermistor with 3 temperature sensors | | | | | | | | | | With additional charge | | | | B | - | | | | |
| For other motor protection and more information, see from page 5/68 | | | | | | | | | | | | | | | | | | | |
| Terminal box position | | | | | | | | | | | | | | | | | | | |
| Version | | | | | | | | | | | | | | Order code | | | | | |
| Terminal box at top | | | | | | | | | | Standard | | | | 4 | - | | | | |
| For other terminal box positions and more information, see from page 5/73 | | | | | | | | | | | | | | | | | | | |
| Special versions | | | | | | | | | | | | | | | | | | | |
| For options, see from page 5/78 | | | | | | | | | | | | | | | 1MB10-2-...-Z | | | ...+...+...+... | |



SIMOTICS XP 1MB1, 1MB5 explosion-protected motors

Zones 21, 22, and 2 with types of protection Ex tb, Ex tc, Ex ec · IE1 Standard Efficiency



Aluminum series 1MB10 – self-ventilated

Selection and ordering data

| Operating values at rated power | | | | | | | | | | | | | | | Aluminum series | | | | |
|---|--------------------|------------|--------------------|--------------------|----------------------------|----------------------------|----------------------------|--------------------------------|---------------------------|--------------------|--------------------|-----------------|------------------|-----------------|---------------------------|-------------|------------------|--|--|
| $P_{rated, 50 Hz}$ | $P_{rated, 60 Hz}$ | Frame size | $n_{rated, 50 Hz}$ | $T_{rated, 50 Hz}$ | $\eta_{rated, 50 Hz, 4/4}$ | $\eta_{rated, 50 Hz, 3/4}$ | $\eta_{rated, 50 Hz, 2/4}$ | $\cos\phi_{rated, 50 Hz, 4/4}$ | $I_{rated, 50 Hz, 400 V}$ | T_{LR}/T_{rated} | I_{LR}/I_{rated} | T_B/T_{rated} | $L_{pFA, 50 Hz}$ | $L_{WA, 50 Hz}$ | 1MB1 | $m_{IM B3}$ | J | | |
| kW | kW | FS | rpm | Nm | % | % | % | | A | | | | | | Article No. | kg | kgm ² | | |
| <ul style="list-style-type: none"> Cooling: self-ventilated (IC411) Efficiency according to IEC 60034-30: IE1 Standard Efficiency Insulation: Thermal class 155 (temperature class F), IP55 degree of protection, utilization in accordance with thermal class 130 (temperature class B) | | | | | | | | | | | | | | | | | | | |
| 6-pole: 1000 rpm at 50 Hz, 1200 rpm at 60 Hz ¹⁾ | | | | | | | | | | | | | | | | | | | |
| 1.5 | 1.75 | 100 L | 940 | 15 | 75.2 | 75.6 | 72.3 | 0.74 | 3.9 | 2 | 4 | 2.2 | 59 | 71 | 1MB10 2-1AC4 | 19 | 0.0065 | | |
| 2.2 | 2.55 | 112 M | 940 | 22 | 77.7 | 78.5 | 76.3 | 0.72 | 5.7 | 2.6 | 4.6 | 2.7 | 57 | 69 | 1MB10 2-1BC2 | 25 | 0.0092 | | |
| 3 | 3.45 | 132 S | 955 | 30 | 79.7 | 79.9 | 77.1 | 0.74 | 7.3 | 2 | 4.6 | 2.6 | 63 | 75 | 1MB10 2-1CC0 | 34 | 0.017 | | |
| 4 | 4.55 | 132 M | 955 | 40 | 81.4 | 82.6 | 81.9 | 0.76 | 9.3 | 2.3 | 5.2 | 2.6 | 63 | 75 | 1MB10 2-1CC2 | 39 | 0.021 | | |
| 5.5 | 6.3 | 132 M | 955 | 55 | 83.1 | 84 | 83 | 0.75 | 12.7 | 2.7 | 5.7 | 3 | 63 | 75 | 1MB10 2-1CC3 | 48 | 0.027 | | |
| 7.5 | 8.6 | 160 M | 970 | 74 | 84.7 | 84.8 | 83.2 | 0.73 | 17.5 | 2.1 | 5.5 | 2.9 | 67 | 79 | 1MB10 2-1DC2 | 72 | 0.056 | | |
| 11 | 12.6 | 160 L | 965 | 109 | 86.4 | 86.8 | 85.9 | 0.77 | 24 | 1.9 | 5.9 | 2.7 | 67 | 79 | 1MB10 2-1DC4 | 92 | 0.078 | | |
| 8-pole: 750 rpm at 50 Hz, 900 rpm at 60 Hz ¹⁾ | | | | | | | | | | | | | | | | | | | |
| 0.75 | 0.86 | 100 L | 705 | 10 | 61.2 | 58.1 | 50.5 | 0.62 | 2.85 | 1.9 | 3 | 2.2 | 60 | 72 | 1MB10 2-1AD4 | 17 | 0.0056 | | |
| 1.1 | 1.27 | 100 L | 690 | 15 | 66.5 | 66 | 61.8 | 0.61 | 3.9 | 2 | 3.2 | 2.3 | 60 | 72 | 1MB10 2-1AD5 | 22 | 0.0078 | | |
| 1.5 | 1.75 | 112 M | 700 | 20 | 70.2 | 71.1 | 68.7 | 0.66 | 4.65 | 1.9 | 3.5 | 2.1 | 63 | 75 | 1MB10 2-1BD2 | 29 | 0.0094 | | |
| 2.2 | 2.55 | 132 S | 715 | 29 | 74.2 | 74.1 | 71.4 | 0.66 | 6.5 | 1.7 | 3.9 | 2.4 | 63 | 75 | 1MB10 2-1CD0 | 37 | 0.019 | | |
| 3 | 3.45 | 132 M | 715 | 40 | 77 | 77.4 | 75.2 | 0.68 | 8.3 | 1.8 | 3.9 | 2.2 | 63 | 75 | 1MB10 2-1CD2 | 44 | 0.024 | | |
| 4 | 4.55 | 160 M | 720 | 53 | 79.2 | 79.3 | 76.3 | 0.67 | 10.9 | 1.6 | 4.1 | 2.3 | 63 | 75 | 1MB10 2-1DD2 | 60 | 0.044 | | |
| 5.5 | 6.3 | 160 M | 720 | 73 | 81.4 | 81.9 | 80.3 | 0.68 | 14.3 | 1.6 | 4 | 2.2 | 63 | 75 | 1MB10 2-1DD3 | 72 | 0.056 | | |
| 7.5 | 8.6 | 160 L | 715 | 100 | 83.1 | 83.7 | 82.4 | 0.69 | 18.9 | 1.7 | 3.8 | 2.2 | 63 | 75 | 1MB10 2-1DD4 | 91 | 0.077 | | |
| Zones | | | | | | | | | | | | | | | | | | | |
| Zone 21 (conductive and non-conductive dust occasionally) Ex tb IIIC | | | | | | | | | | | | | | | 1 | | | | |
| Zone 22 (non-conductive dust rarely or for a short period) Ex tc IIIB | | | | | | | | | | | | | | | 2 | | | | |
| Zone 2 (explosive gases rarely or for a short period) Ex ec IIC | | | | | | | | | | | | | | | 3 | | | | |
| Voltages | | | | | | | | | | | | | | | | | | | |
| 50 Hz 230 VΔ/400 VY | | | | | | | | | | | | | | | Version | | Order code | | |
| 60 Hz ¹⁾ 460 VY | | | | | | | | | | | | | | | Standard | | 2 2 | | |
| 50 Hz 400 VΔ/690 VY | | | | | | | | | | | | | | | Standard | | 3 4 | | |
| 50 Hz 500 VY | | | | | | | | | | | | | | | Without additional charge | | 2 7 | | |
| 50 Hz 500 VΔ | | | | | | | | | | | | | | | Without additional charge | | 4 0 | | |
| For other voltages ¹⁾ and more information, see from page 5/51 | | | | | | | | | | | | | | | | | 9 0 | | |
| Types of construction | | | | | | | | | | | | | | | | | | | |
| Without flange IM B3 ²⁾ | | | | | | | | | | | | | | | Version | | Order code | | |
| With flange IM B5 ²⁾ | | | | | | | | | | | | | | | Standard | | A | | |
| With flange IM B14 ²⁾ | | | | | | | | | | | | | | | With additional charge | | F | | |
| | | | | | | | | | | | | | | | With additional charge | | K | | |
| For other types of construction and more information, see from page 5/56 | | | | | | | | | | | | | | | | | ... | | |
| Motor protection | | | | | | | | | | | | | | | | | | | |
| Without | | | | | | | | | | | | | | | Version | | Order code | | |
| PTC thermistor with 3 temperature sensors | | | | | | | | | | | | | | | Standard | | A | | |
| For other motor protection and more information, see from page 5/68 | | | | | | | | | | | | | | | With additional charge | | B | | |
| Terminal box position | | | | | | | | | | | | | | | | | | | |
| Terminal box at top | | | | | | | | | | | | | | | Version | | Order code | | |
| For other terminal box positions and more information, see from page 5/73 | | | | | | | | | | | | | | | Standard | | 4 | | |
| Special versions | | | | | | | | | | | | | | | | | | | |
| For options, see from page 5/78 | | | | | | | | | | | | | | | 1MB10 2- ... -Z | | ...+...+...+... | | |

5

¹⁾ Operating values at rated power for 60 Hz are stored in the Drive Technology Configurator (DT Configurator; see Appendix, "Tools and engineering").

²⁾ Types derived from IM B3 (IM B6/7/8, IM V6 and IM V5), from IM B5 (IM V3 and IM V1) and from IM B14 (IM V19 and IM V18) are possible, provided that no requirements exist for condensation drainage holes (H03) or stamping of the type on the rating plate. The basic type IM B3, IM B5 or IM B14 is stamped as standard on the rating plate. For orders with condensation drainage holes (H03), the type must be specified.

³⁾ Parallel supply lines are required in the case of connection to ≤ 240 V. For frame size 315 with connection to ≤ 240 V, due to the high current, a drilled, removable entry plate (order code R52) or a larger terminal box (order code R50) can be used. Order codes R52 and R50 alter the motor dimensions.

⁴⁾ No IE class for 50 and 60 Hz because the motor is outside the validity for the efficiency classes according to IEC 60034-30-1:2014.

SIMOTICS XP 1MB1, 1MB5 explosion-protected motors

Zone 1 with type of protection Ex eb · IE3 Premium Efficiency



Cast-iron series 1MB1543, 1MB1643, 1MB5543, 1MB5643 – self-ventilated

Selection and ordering data

| P _{rated} , 50 Hz kW | Tem- pera- ture class | Frame size | Operating values at rated power | | | | | | | | | | | | | Cast-iron series | | m _{IM B3} J | |
|--|--------------------------------|---------------|--------------------------------------|-------------------------------------|--|--|--|--|--|--|--|---|-------------------------------------|----------------------------------|------------------------------------|-----------------------------------|----------------------|----------------------|----------------------------|
| | | | n _{rated} , 50 Hz rpm | T _{rated} , 50 Hz Nm | η _{rated} , 50 Hz, 4/4 % | η _{rated} , 50 Hz, 3/4 % | η _{rated} , 50 Hz, 2/4 % | cosφ _{rated} , 50 Hz, 4/4 | I _{rated} , 50 Hz, 400 V A | T _{LP} / I _{rated} , 50 Hz | I _{LP} / I _{rated} , 50 Hz | T _P / I _{rated} , 50 Hz | t _E , 50 Hz, T1/T2 | t _E , 50 Hz, T3 | L _{pfA} , 50 Hz, 1) | L _{WA} , 50 Hz, 1) | 1MB1543 – Basic Line | | 1MB1643 – Performance Line |
| <ul style="list-style-type: none"> Cooling: self-ventilated (IC411) Efficiency according to IEC 60034-30: IE3 Premium Efficiency Insulation: Thermal class 155 (temperature class F), IP55 degree of protection, utilization in accordance with thermal class 130 (temperature class B) | | | | | | | | | | | | | | | | | | | |
| 2-pole: 3000 rpm at 50 Hz, temperature classes T1 and T2 with second rating plate (T1/T2 and T3) | | | | | | | | | | | | | | | | | | | |
| 6.5 ²⁾ | T1, T2 | 132 S | 2930 | 21 | 87.6 | 88.8 | 90.1 | 0.93 | 12.2 | 1.6 | 6.5 | 2.5 | 13 | – | 72 | 79 | ▲ 1MB1 43-1CA1 | 75 | 0.031 |
| 9.5 | T1, T2 | 160 M | 2935 | 31 | 90.8 | 91.4 | 91.6 | 0.91 | 17.4 | 1.8 | 6.4 | 2.5 | 32 | – | 78 | 85 ³⁾ | ▲ 1MB1 43-1DA2 | 100 | 0.053 |
| 13 ²⁾ | T1, T2 | 160 M | 2925 | 42.5 | 89.9 | 90.9 | 91.4 | 0.92 | 23.5 | 1.8 | 6.1 | 2.4 | 22 | – | 78 | 85 ³⁾ | ▲ 1MB1 43-1DA3 | 110 | 0.061 |
| 16 ²⁾ | T1, T2 | 160 L | 2910 | 53 | 90.5 | 91.9 | 92.4 | 0.92 | 29.5 | 1.7 | 5.8 | 2.2 | 17 | – | 78 | 85 ³⁾ | ▲ 1MB1 43-1DA4 | 125 | 0.068 |
| 19 | T1, T2 | 180 M | 2935 | 62 | 92.4 | 93.1 | 92.9 | 0.91 | 34.5 | 2.0 | 6.6 | 2.8 | 16 | – | 74 | 81 | ▲ 1MB1 43-1EA2 | 165 | 0.08 |
| 25 | T1, T2 | 200 L | 2955 | 81 | 93.0 | 93.7 | 94.0 | 0.86 | 46.5 | 1.5 | 5.7 | 2.5 | 21 | – | 76 | 83 | ▲ 1MB1 43-2AA4 | 220 | 0.12 |
| 31 | T1, T2 | 200 L | 2950 | 100 | 93.4 | 93.9 | 94.2 | 0.88 | 57 | 1.5 | 5.4 | 2.3 | 23 | – | 75 | 82 | ▲ 1MB1 43-2AA5 | 245 | 0.15 |
| Basic Line 5 Performance Line 6 | | | | | | | | | | | | | | | | | | | |
| Voltages | | | | | | | | | | | | | | | | | | | |
| 50 Hz 230 VΔ/400 VY 60 Hz 460 VY | | | | | | | | | | | | | Version | | Order code | | | | |
| 50 Hz 400 VΔ/690 VY 60 Hz 460 VΔ | | | | | | | | | | | | | Standard | | – | | | | |
| 50 Hz 500 VY | | | | | | | | | | | | | Standard | | – | | | | |
| 50 Hz 500 VΔ | | | | | | | | | | | | | Without additional charge | | – | | | | |
| | | | | | | | | | | | | | Without additional charge | | – | | | | |
| For other voltages and more information, see from page 5/53 | | | | | | | | | | | | | | | | | | | |
| Types of construction | | | | | | | | | | | | | | | | | | | |
| Without flange IM B3 ⁴⁾ | | | | | | | | | | | | | Version | | Order code | | | | |
| With flange IM B5 ⁴⁾ | | | | | | | | | | | | | Standard | | – | | | | |
| With flange IM B14 ⁴⁾ | | | | | | | | | | | | | With additional charge | | – | | | | |
| | | | | | | | | | | | | | With additional charge | | – | | | | |
| For other types of construction and more information, see from page 5/62 | | | | | | | | | | | | | | | | | | | |
| Motor protection | | | | | | | | | | | | | | | | | | | |
| Without | | | | | | | | | | | | | Version | | Order code | | | | |
| PTC thermistor with 3 temperature sensors | | | | | | | | | | | | | Standard | | – | | | | |
| | | | | | | | | | | | | | With additional charge | | – | | | | |
| For other motor protection and more information, see from page 5/70 | | | | | | | | | | | | | | | | | | | |
| Terminal box position | | | | | | | | | | | | | | | | | | | |
| Terminal box at top | | | | | | | | | | | | | Version | | Order code | | | | |
| | | | | | | | | | | | | | Standard | | – | | | | |
| For other terminal box positions and more information, see from page 5/75 | | | | | | | | | | | | | | | | | | | |
| Special versions | | | | | | | | | | | | | | | | | | | |
| For options, see from page 5/87 | | | | | | | | | | | | | | | | | | | |
| 1MB1 43- - - Z | | | | | | | | | | | | | | | | | | | |

5

1) Noise values for line operation under load, tolerance + 3dB(A).

2) Only complies with efficiency classification IE2.

3) These sound power levels are above the set values in the VIK recommendation in the "standard" version. This difference must be agreed between the manufacturer and the operator.

4) Types derived from IM B3 (IM B6/7/8, IM V6 and IM V5), from IM B5 (IM V3 and IM V1) and from IM B14 (IM V19 and IM V18) are possible. The basic type IM B3, IM B5 or IM B14 is stamped as standard on the rating plate.



SIMOTICS XP 1MB1, 1MB5 explosion-protected motors

Zone 1 with type of protection Ex eb · IE3 Premium Efficiency

Cast-iron series 1MB1543, 1MB1643, 1MB5543, 1MB5643 – self-ventilated

Selection and ordering data

| P _{rated} 50 Hz | Tem- perature class | Frame size | Operating values at rated power | | | | | | | | | | | L _{ptA} 50 Hz ¹⁾ | L _{WA} 50 Hz ¹⁾ | Cast-iron series 1MB1543 – Basic Line 1MB5543 – Basic Line 1MB1643 – Performance Line 1MB5643 – Performance Line Article No. | m _{IM B3} J | | |
|--|---------------------------|---------------|---------------------------------|-----------------------------|----------------------------------|----------------------------------|----------------------------------|-------------------------------------|------------------------------------|--|--|---|--------------------------------|---|--|---|----------------------|-----------------------------|---------|
| | | | n _{rated} 50 Hz | T _{rated} 50 Hz | η _{rated} 50 Hz, 4/4 | η _{rated} 50 Hz, 3/4 | η _{rated} 50 Hz, 2/4 | cosφ _{rated} 50 Hz, 4/4 | I _{rated} 50 Hz, 400 V | T _{LP} /I _{rated} 50 Hz | I _{LP} /I _{rated} 50 Hz | T _P /I _{rated} 50 Hz | t _E 50 Hz, T1/T2 | | | | | t _E 50 Hz, T3 | dB(A) |
| <ul style="list-style-type: none"> • Cooling: self-ventilated (IC411) • Efficiency according to IEC 60034-30: IE3 Premium Efficiency • Insulation: Thermal class 155 (temperature class F), IP55 degree of protection, utilization in accordance with thermal class 130 (temperature class B) | | | | | | | | | | | | | | | | | | | |
| 4-pole: 1500 rpm at 50 Hz, temperature classes T1 to T3 | | | | | | | | | | | | | | | | | | | |
| 0.25 | T1, T2, T3 | 71 M | 1385 | 1.72 | 73.5 | 72.7 | 68.3 | 0.72 | 0.75 | 2.4 | 4.1 | 2.6 | 73 | 65 | 59 | 66 ³⁾ | ▲ 1MB1 5 43-0CB2 | 13 | 0.00095 |
| 0.37 | T1, T2, T3 | 71 M | 1400 | 2.5 | 77.3 | 76.7 | 73 | 0.7 | 1.02 | 3.3 | 4.9 | 3.1 | 66 | 59 | 56 | 63 ³⁾ | ▲ 1MB1 5 43-0CB3 | 16 | 0.0014 |
| 0.55 | T1, T2, T3 | 80 M | 1435 | 3.7 | 80.8 | 80.7 | 77.7 | 0.77 | 1.37 | 2.2 | 5.4 | 2.8 | 34 | 30 | 57 | 64 ³⁾ | ▲ 1MB1 5 43-0DB2 | 18 | 0.0021 |
| 0.75 | T1, T2, T3 | 80 M | 1440 | 4.95 | 82.5 | 82.6 | 80.8 | 0.76 | 1.8 | 2.7 | 6.4 | 3.2 | 28 | 25 | 60 | 67 ³⁾ | ▲ 1MB1 5 43-0DB3 | 22 | 0.0029 |
| 1 | T1, T2, T3 | 90 S | 1435 | 6.7 | 83.7 | 84.3 | 82.8 | 0.78 | 2.3 | 3 | 6.7 | 3.4 | 35 | 31 | 57 | 64 ³⁾ | ▲ 1MB1 5 43-0EB0 | 25 | 0.0036 |
| 1.35 | T1, T2, T3 | 90 L | 1440 | 9 | 84.9 | 85.1 | 83.7 | 0.78 | 3.05 | 3 | 7 | 3.6 | 30 | 27 | 62 | 69 ³⁾ | ▲ 1MB1 5 43-0EB4 | 31 | 0.0049 |
| 2 | T1, T2, T3 | 100 L | 1455 | 13.1 | 86.3 | 86.7 | 86 | 0.85 | 4 | 2.4 | 7.7 | 3.3 | 28 | 25 | 61 | 68 | ▲ 1MB1 43-1AB4 | 40 | 0.014 |
| 2.5 | T1, T2, T3 | 100 L | 1455 | 16 | 87.1 | 88.1 | 87.6 | 0.85 | 5.1 | 2.4 | 7.9 | 3.2 | 18 | 16 | 63 | 70 ³⁾ | ▲ 1MB1 43-1AB5 | 40 | 0.014 |
| 3.6 | T1, T2, T3 | 112 M | 1460 | 24 | 88.3 | 88.8 | 88 | 0.83 | 7.3 | 2.2 | 8 | 3.4 | 14 | 13 | 59 | 66 | ▲ 1MB1 43-1BB2 | 43 | 0.017 |
| 5 | T1, T2, T3 | 132 S | 1470 | 32 | 89.3 | 90.1 | 89.8 | 0.84 | 9.8 | 2.1 | 7.5 | 3 | 27 | 23 | 62 | 69 | ▲ 1MB1 43-1CB0 | 67 | 0.034 |
| 6.8 | T1, T2, T3 | 132 M | 1470 | 44 | 90.2 | 90.7 | 90.4 | 0.84 | 13.4 | 2.2 | 7.7 | 3.1 | 26 | 23 | 66 | 73 | ▲ 1MB1 43-1CB2 | 82 | 0.046 |
| 10 | T1, T2, T3 | 160 M | 1475 | 65 | 91.2 | 91.6 | 90.9 | 0.84 | 19.6 | 1.7 | 6.6 | 2.8 | 28 | 21 | 66 | 73 | ▲ 1MB1 43-1DB2 | 110 | 0.083 |
| 13.5 | T1, T2, T3 | 160 L | 1475 | 87 | 91.9 | 92.1 | 91.4 | 0.84 | 26.5 | 2.7 | 7.4 | 3.1 | 23 | 11 | 66 | 73 | ▲ 1MB1 43-1DB4 | 130 | 0.099 |
| 15 | T3 | 180 M | 1470 | 97 | 92.1 | 92.5 | 92.5 | 0.82 | 30 | 2.4 | 7.6 | 3.4 | 22 | 8 | 67 | 74 | ▲ 1MB1 43-1EB2 | 165 | 0.13 |
| 17.5 | T3 | 180 L | 1470 | 114 | 92.5 | 93 | 93 | 0.83 | 34.5 | 2.3 | 7.5 | 3.3 | 23 | 7 ²⁾ | 69 | 76 | ▲ 1MB1 43-1EB4 | 180 | 0.14 |
| 24 | T3 | 200 L | 1475 | 155 | 93.1 | 93.4 | 93 | 0.84 | 46.5 | 2.4 | 7.6 | 3.3 | 20 | 6 ²⁾ | 65 | 72 | ▲ 1MB1 43-2AB5 | 240 | 0.22 |
| 30 | T3 | 225 S | 1485 | 193 | 93.6 | 93.7 | 93.1 | 0.84 | 57 | 3 | 7.3 | 3.1 | 32 | 13 | 66 | 79 | ▲ 1MB1 43-2BB0 | 300 | 0.417 |
| 36 | T3 | 225 M | 1482 | 230 | 93.9 | 94.3 | 94.2 | 0.85 | 67 | 3 | 7.1 | 2.9 | 31 | 11 | 66 | 79 | ▲ 1MB1 43-2BB2 | 370 | 0.545 |
| 44 | T3 | 250 M | 1486 | 285 | 94.2 | 94.5 | 94.2 | 0.86 | 80 | 3.1 | 7.6 | 3.1 | 37 | 18 | 69 | 83 | ▲ 1MB1 43-2CB2 | 480 | 0.975 |
| 58 | T3 | 280 S | 1488 | 370 | 94.6 | 94.8 | 94.3 | 0.87 | 106 | 2.8 | 7.2 | 3 | 45 | 20 | 68 | 82 | ▲ 1MB1 43-2DB0 | 680 | 1.7 |
| 70 | T3 | 280 M | 1490 | 450 | 94.9 | 95.1 | 94.9 | 0.86 | 129 | 3.1 | 7.6 | 2.9 | 29 | 13 | 69 | 83 | ▲ 1MB1 43-2BB2 | 670 | 1.61 |
| 84 | T3 | 315 S | 1492 | 540 | 95.1 | 95.1 | 94.6 | 0.85 | 156 | 2.2 | 7.1 | 2.8 | 22 | 9 | 69 | 84 | ▲ 1MB5 43-3AB0 | 900 | 2.38 |
| 100 | T3 | 315 M | 1491 | 640 | 95.3 | 95.4 | 94.9 | 0.86 | 184 | 2.2 | 7 | 2.7 | 33 | 16 | 70 | 85 | ▲ 1MB5 43-3AB2 | 980 | 2.88 |
| 115 | T3 | 315 L | 1492 | 740 | 95.5 | 95.5 | 95 | 0.85 | 215 | 2.5 | 7.1 | 3 | 35 | 15 | 72 | 86 | ▲ 1MB5 43-3AB4 | 1110 | 3.18 |
| 135 | T3 | 315 L | 1492 | 860 | 95.7 | 95.8 | 95.3 | 0.85 | 250 | 2.4 | 7.1 | 2.9 | 22 | 9 | 70 | 85 | ▲ 1MB5 43-3AB5 | 1190 | 3.67 |

| Basic Line | | 5 | 6 | Order code |
|---|----------------------|--|---|---------------|
| Performance Line | | | | |
| Voltages | | Version | | Order code |
| 50 Hz 230 VΔ/400 VY | 60 Hz 460 VY | Standard | | 2 2 |
| 50 Hz 400 VΔ/690 VY | 60 Hz 460 VΔ | Standard | | 3 4 |
| 50 Hz 500 VY | | Without additional charge | | 2 7 |
| 50 Hz 500 VΔ | | Without additional charge | | 4 0 |
| For other voltages and more information, see from page 5/53 | | | | 9 0 |
| Types of construction | | Version | | Order code |
| Without flange | IM B3 ⁴⁾ | Standard | | A |
| With flange | IM B5 ⁴⁾ | With additional charge | | F |
| With flange | IM B14 ⁴⁾ | With additional charge | | K |
| For other types of construction and more information, see from page 5/62 | | | | |
| Motor protection | | Version | | Order code |
| Without | | Standard | | A |
| PTC thermistor with 3 temperature sensors | | With additional charge | | B |
| For other motor protection and more information, see from page 5/70 | | | | |
| Terminal box position | | Version | | Order code |
| Terminal box at top | | Standard | | 4 |
| For other terminal box positions and more information, see from page 5/75 | | | | |
| Special versions | | | | Order code(s) |
| For options, see from page 5/87 | | 1MB . ■43- ■- -Z | | |

1) Noise values for line operation under load, tolerance + 3dB(A).
 2) The tE time T3 of
 - 1MB1543-1EB4 at 7s falls below the set value of 7.2s from the VIK recommendation
 - 1MB1543-2AB5 at 6s falls below the set value of 7.1s from the VIK recommendation.
 These differences must be agreed between the manufacturer and the operator.
 3) These sound power levels are above the set values in the VIK recommendation in the "standard" version. This difference must be agreed between the manufacturer and the operator.
 4) Types derived from IM B3 (IM B6/7/8, IM V6 and IM V5), from IM B5 (IM V3 and IM V1) and from IM B14 (IM V19 and IM V18) are possible. The basic type IM B3, IM B5 or IM B14 is stamped as standard on the rating plate.



SIMOTICS XP 1MB1, 1MB5 explosion-protected motors

Zone 1 with type of protection Ex eb · IE3 Premium Efficiency



Cast-iron series 1MB1543, 1MB1643, 1MB5543, 1MB5643 – self-ventilated

Selection and ordering data

| Operating values at rated power | | | | | | | | | | | | | | | Cast-iron series | | m _{IM B3} J | | | | | | | | | | | | |
|--|---------------------------|---------------|-------------------------------|-------------------------------|---------------------------------------|---------------------------------------|---------------------------------------|--|---|--|--|---|-------------------------------------|----------------------------------|------------------------------------|-----------------------------------|----------------------------|----------------------|----------------------------|----------------------------|-------------|------|------------------|--|--|--|--|--|--|
| P _{rated} , 50 Hz | Tem- perature class | Frame size | n _{rated} , 50 Hz | T _{rated} , 50 Hz | η _{rated} , 50 Hz, 4/4 | η _{rated} , 50 Hz, 3/4 | η _{rated} , 50 Hz, 2/4 | cosφ _{rated} , 50 Hz, 4/4 | I _{rated} , 50 Hz, 400 V | T _{LP} / I _{rated} , 50 Hz | I _{LP} / I _{rated} , 50 Hz | T _P / I _{rated} , 50 Hz | t _E , 50 Hz, T1/T2 | t _E , 50 Hz, T3 | L _{pfA} , 50 Hz, 1) | L _{WA} , 50 Hz, 1) | 1MB1543 – Basic Line | 1MB5543 – Basic Line | 1MB1643 – Performance Line | 1MB5643 – Performance Line | Article No. | kg | kgm ² | | | | | | |
| kW | FS | rpm | Nm | % | % | % | A | | | | | | | | | | ▲ New | | | | | | | | | | | | |
| <ul style="list-style-type: none"> • Cooling: self-ventilated (IC411) • Efficiency according to IEC 60034-30: IE3 Premium Efficiency • Insulation: Thermal class 155 (temperature class F), IP55 degree of protection, utilization in accordance with thermal class 130 (temperature class B) | | | | | | | | | | | | | | | | | | | | | | | | | | | | | |
| 4-pole: 1500 rpm at 50 Hz, temperature classes T1 and T2 with second rating plate (T1/T2 and T3) | | | | | | | | | | | | | | | | | | | | | | | | | | | | | |
| 17 | T1, T2 | 180 M | 1465 | 111 | 92.4 | 93.3 | 93.4 | 0.83 | 33.5 | 2.1 | 6.9 | 2.9 | 19 | - | 67 | 74 | ▲ 1MB1 | ▲ 43-1EB2 | - | - | - | 165 | 0.13 | | | | | | |
| 20 | T1, T2 | 180 L | 1465 | 130 | 92.8 | 93.9 | 94.2 | 0.84 | 39.0 | 2 | 6.6 | 2.9 | 18 | - | 71 | 78 | ▲ 1MB1 | ▲ 43-1EB4 | - | - | - | 180 | 0.14 | | | | | | |
| 27 | T1, T2 | 200 L | 1470 | 175 | 93.4 | 94.0 | 94.1 | 0.85 | 52 | 2.1 | 6.9 | 2.9 | 16 | - | 66 | 73 | ▲ 1MB1 | ▲ 43-2AB5 | - | - | - | 240 | 0.22 | | | | | | |
| 33 | T1, T2 | 225 S | 1482 | 215 | 93.6 | 93.9 | 93.5 | 0.85 | 62 | 2.7 | 6.7 | 2.8 | 30 | - | 65 | 79 | ▲ 1MB1 | ▲ 43-2BB0 | - | - | - | 300 | 0.417 | | | | | | |
| 40 | T1, T2 | 225 M | 1480 | 260 | 94.1 | 94.7 | 94.8 | 0.86 | 75 | 2.7 | 6.3 | 2.6 | 27 | - | 66 | 79 | ▲ 1MB1 | ▲ 43-2BB2 | - | - | - | 370 | 0.545 | | | | | | |
| 50 | T1, T2 | 250 M | 1485 | 320 | 94.4 | 94.9 | 94.9 | 0.87 | 91 | 2.7 | 6.7 | 2.7 | 35 | - | 70 | 84 | ▲ 1MB1 | ▲ 43-2CB2 | - | - | - | 480 | 0.975 | | | | | | |
| 68 | T1, T2 | 280 S | 1485 | 435 | 94.9 | 95.3 | 95.2 | 0.88 | 124 | 2.4 | 6.1 | 2.6 | 40 | - | 69 | 83 | ▲ 1MB1 | ▲ 43-2DB0 | - | - | - | 680 | 1.7 | | | | | | |
| 80 | T1, T2 | 280 M | 1490 | 510 | 95.1 | 95.6 | 95.6 | 0.87 | 146 | 2.7 | 6.7 | 2.5 | 23 | - | 69 | 83 | ▲ 1MB1 | ▲ 43-2DB2 | - | - | - | 670 | 1.61 | | | | | | |
| 100 | T1, T2 | 315 S | 1490 | 640 | 95.3 | 95.6 | 95.4 | 0.86 | 185 | 1.8 | 6 | 2.3 | 19 | - | 71 | 85 | ▲ 1MB5 | ▲ 43-3AB0 | - | - | - | 900 | 2.38 | | | | | | |
| 120 | T1, T2 | 315 M | 1488 | 770 | 95.5 | 95.8 | 95.7 | 0.86 | 220 | 1.8 | 5.8 | 2.2 | 28 | - | 76 | 91 | ▲ 1MB5 | ▲ 43-3AB2 | - | - | - | 980 | 2.88 | | | | | | |
| 135 | T1, T2 | 315 L | 1490 | 870 | 95.7 | 96 | 95.8 | 0.86 | 250 | 2.1 | 6.1 | 2.5 | 23 | - | 74 | 89 | ▲ 1MB5 | ▲ 43-3AB4 | - | - | - | 1110 | 3.18 | | | | | | |
| 165 | T1, T2 | 315 L | 1488 | 1060 | 95.8 | 96.1 | 96.0 | 0.86 | 305 | 2 | 5.8 | 2.3 | 17 | - | 72 | 87 | ▲ 1MB5 | ▲ 43-3AB5 | - | - | - | 1190 | 3.67 | | | | | | |
| Basic Line | | | | | | | | | | | | | | | | | 5 | | | | | | | | | | | | |
| Performance Line | | | | | | | | | | | | | | | | | 6 | | | | | | | | | | | | |
| Voltages | | | | | | | | | | | | | | | | | Version | | Order code | | | | | | | | | | |
| 50 Hz 230 VΔ/400 VY | | | 60 Hz 460 VY | | | Standard | | 2 2 | | - | | | | | | | | | | | | | | | | | | | |
| 50 Hz 400 VΔ/690 VY | | | 60 Hz 460 VΔ | | | Standard | | 3 4 | | - | | | | | | | | | | | | | | | | | | | |
| 50 Hz 500 VY | | | | | | | Without additional charge | | 2 7 | | - | | | | | | | | | | | | | | | | | | |
| 50 Hz 500 VΔ | | | | | | | Without additional charge | | 4 0 | | - | | | | | | | | | | | | | | | | | | |
| For other voltages and more information, see from page 5/53 | | | | | | | | | | | | | | | | | | | | | | | | | | | | | |
| Types of construction | | | | | | | | | | | | | | | | | Version | | Order code | | | | | | | | | | |
| Without flange | | | IM B3 ²⁾ | | | Standard | | A | | - | | | | | | | | | | | | | | | | | | | |
| With flange | | | IM B5 ²⁾ | | | With additional charge | | F | | - | | | | | | | | | | | | | | | | | | | |
| With flange | | | IM B14 ²⁾ | | | With additional charge | | K | | - | | | | | | | | | | | | | | | | | | | |
| For other types of construction and more information, see from page 5/62 | | | | | | | | | | | | | | | | | | | | | | | | | | | | | |
| Motor protection | | | | | | | | | | | | | | | | | Version | | Order code | | | | | | | | | | |
| Without | | | | | | Standard | | A | | | | | | | | | | | | | | | | | | | | | |
| PTC thermistor with 3 temperature sensors | | | | | | With additional charge | | B | | | | | | | | | | | | | | | | | | | | | |
| For other motor protection and more information, see from page 5/70 | | | | | | | | | | | | | | | | | | | | | | | | | | | | | |
| Terminal box position | | | | | | | | | | | | | | | | | Version | | Order code | | | | | | | | | | |
| Terminal box at top | | | | | | Standard | | 4 | | | | | | | | | | | | | | | | | | | | | |
| For other terminal box positions and more information, see from page 5/75 | | | | | | | | | | | | | | | | | | | | | | | | | | | | | |
| Special versions | | | | | | | | | | | | | | | | | Order code(s) | | | | | | | | | | | | |
| For options, see from page 5/87 | | | | | | | | | | | | | | | | | 1MB . ■43- ■-■■■■■ | | -Z . . . + | | | | | | | | | | |

5

¹⁾ Noise values for line operation under load, tolerance + 3dB(A).

²⁾ Types derived from IM B3 (IM B6/7/8, IM V6 and IM V5), from IM B5 (IM V3 and IM V1) and from IM B14 (IM V19 and IM V18) are possible. The basic type IM B3, IM B5 or IM B14 is stamped as standard on the rating plate.



SIMOTICS XP 1MB1, 1MB5 explosion-protected motors

Zone 1 with type of protection Ex eb · IE3 Premium Efficiency

Cast-iron series 1MB1543, 1MB1643, 1MB5543, 1MB5643 – self-ventilated

Selection and ordering data

| P _{rated} 50 Hz kW | Tem- perature class | Frame size | Operating values at rated power | | | | | | | | | | | | | Cast-iron series 1MB1543 – Basic Line 1MB5543 – Basic Line 1MB1643 – Performance Line 1MB5643 – Performance Line Article No. | m _{IM B3} J | | |
|--|---------------------------|---------------|------------------------------------|-----------------------------------|----------------------------------|----------------------------------|----------------------------------|-------------------------------------|----------------------------------|--|--|---|----------------------------------|-------------------------------|------------------------------------|---|-------------------------|-----------------------------------|---------|
| | | | n _{rated} 50 Hz rpm | T _{rated} 50 Hz Nm | η _{rated} 50 Hz % | η _{rated} 50 Hz % | η _{rated} 50 Hz % | cosφ _{rated} 50 Hz % | I _{rated} 50 Hz A | T _{LP} /I _{rated} 50 Hz | I _{LP} /I _{rated} 50 Hz | T _p /I _{rated} 50 Hz | t _E 50 Hz T1/T2 | t _E 50 Hz T3 | L _{pfA} 50 Hz dB(A) | | | L _{WA} 50 Hz dB(A) | |
| <ul style="list-style-type: none"> Cooling: self-ventilated (IC411) Efficiency according to IEC 60034-30: IE3 Premium Efficiency Insulation: Thermal class 155 (temperature class F), IP55 degree of protection, utilization in accordance with thermal class 130 (temperature class B) | | | | | | | | | | | | | | | | | | | |
| 6-pole: 1000 rpm at 50 Hz, temperature classes T1 to T3 | | | | | | | | | | | | | | | | | | | |
| 0.25 | T1, T2, T3 | 71 M | 875 | 2.75 | 68.6 | 69.8 | 67.9 | 0.72 | 0.72 | 2.4 | 3.4 | 2.4 | 500 | 233 | 58 | 65 ²⁾ | ▲ 1MB1 5 43-0CC3 ■■■■■■ | 16 | 0.00015 |
| 0.37 | T1, T2, T3 | 80 M | 935 | 3.8 | 73.5 | 72.6 | 68 | 0.64 | 1.16 | 2.3 | 4.2 | 2.7 | 73 | 65 | 55 | 62 ²⁾ | ▲ 1MB1 5 43-0DC2 ■■■■■■ | 19 | 0.00025 |
| 0.55 | T1, T2, T3 | 80 M | 925 | 5.7 | 77.2 | 77.1 | 74.3 | 0.65 | 1.65 | 2.6 | 4.4 | 2.9 | 94 | 82 | 60 | 67 ²⁾ | ▲ 1MB1 5 43-0DC3 ■■■■■■ | 22 | 0.0031 |
| 0.65 | T1, T2, T3 | 90 S | 940 | 6.6 | 78.3 | 79.3 | 77.8 | 0.7 | 1.8 | 1.8 | 4.2 | 2.4 | 87 | 77 | 61 | 68 ²⁾ | ▲ 1MB1 5 43-0EC0 ■■■■■■ | 26 | 0.004 |
| 0.95 | T1, T2, T3 | 90 L | 935 | 9.7 | 80.2 | 81.3 | 79.9 | 0.71 | 2.5 | 2.2 | 4.7 | 2.5 | 64 | 56 | 60 | 67 ²⁾ | ▲ 1MB1 5 43-0EC4 ■■■■■■ | 31 | 0.0048 |
| 1.3 | T1, T2, T3 | 100 L | 955 | 13 | 81.8 | 82.5 | 80.5 | 0.71 | 3.4 | 2.5 | 5.3 | 2.8 | 63 | 55 | 58 | 65 | ▲ 1MB1 ■ 43-1AC4 ■■■■■■ | 36 | 0.011 |
| 1.9 | T1, T2, T3 | 112 M | 960 | 18.9 | 83.6 | 84.5 | 83.7 | 0.74 | 4.5 | 2.6 | 6.6 | 3.2 | 45 | 40 | 60 | 67 | ▲ 1MB1 ■ 43-1BC2 ■■■■■■ | 46 | 0.017 |
| 2.6 | T1, T2, T3 | 132 S | 980 | 25.5 | 85 | 85.8 | 85.3 | 0.75 | 5.8 | 2.1 | 6.5 | 2.8 | 54 | 48 | 63 | 70 | ▲ 1MB1 ■ 43-1CC0 ■■■■■■ | 70 | 0.029 |
| 3.5 | T1, T2, T3 | 132 M | 975 | 34.5 | 86.3 | 87.4 | 87.3 | 0.76 | 7.8 | 1.8 | 5.8 | 2.5 | 31 | 27 | 68 | 75 | ▲ 1MB1 ■ 43-1CC2 ■■■■■■ | 70 | 0.037 |
| 4.8 | T1, T2, T3 | 132 M | 975 | 47 | 87.5 | 88.4 | 88.3 | 0.76 | 10.5 | 2.1 | 6.2 | 2.7 | 34 | 30 | 69 | 76 | ▲ 1MB1 ■ 43-1CC3 ■■■■■■ | 82 | 0.046 |
| 6.6 | T1, T2, T3 | 160 M | 980 | 64 | 88.6 | 88.7 | 87.8 | 0.8 | 13.8 | 2.4 | 6.8 | 2.8 | 37 | 33 | 67 | 74 | ▲ 1MB1 ■ 43-1DC2 ■■■■■■ | 120 | 0.098 |
| 9.7 | T1, T2, T3 | 160 L | 980 | 95 | 89.9 | 90 | 89 | 0.79 | 20.5 | 2.7 | 7.1 | 2.9 | 22 | 19 | 70 | 77 | ▲ 1MB1 ■ 43-1DC4 ■■■■■■ | 145 | 0.12 |
| 13.2 | T1, T2, T3 | 180 L | 975 | 129 | 90.8 | 91.4 | 91.6 | 0.77 | 28 | 2.1 | 6.2 | 2.8 | 38 | 17 | 66 | 73 | ▲ 1MB1 ■ 43-1EC4 ■■■■■■ | 180 | 0.19 |
| 16.5 | T1, T2, T3 | 200 L | 975 | 162 | 91.4 | 92.3 | 92.5 | 0.8 | 34.5 | 2 | 5.4 | 2.3 | 52 | 12 | 60 | 67 | ▲ 1MB1 ■ 43-2AC4 ■■■■■■ | 215 | 0.28 |
| 20 | T1, T2, T3 | 200 L | 985 | 194 | 91.9 | 92.1 | 91.3 | 0.79 | 43 | 1.7 | 6.5 | 3 | 40 | 16 | 69 | 76 | ▲ 1MB1 ■ 43-2AC5 ■■■■■■ | 265 | 0.33 |
| 27 | T1, T2, T3 | 225 M | 985 | 220 | 92.7 | 93.2 | 93.1 | 0.82 | 52 | 2.8 | 6.9 | 3.1 | 61 | 24 | 64 | 77 | ▲ 1MB1 ■ 43-2BC2 ■■■■■■ | 390 | 0.845 |
| 33 | T1, T2, T3 | 250 M | 985 | 265 | 93.1 | 93.9 | 94 | 0.85 | 63 | 2.4 | 6.3 | 2.6 | 61 | 22 | 65 | 78 | ▲ 1MB1 ■ 43-2CC2 ■■■■■■ | 480 | 1.27 |
| 40 | T1, T2, T3 | 280 S | 988 | 320 | 93.5 | 94.1 | 94 | 0.86 | 75 | 2.8 | 6.3 | 2.5 | 47 | 13 | 66 | 80 | ▲ 1MB1 ■ 43-2DC0 ■■■■■■ | 570 | 1.64 |
| 46 | T3 | 280 M | 990 | 370 | 93.8 | 94.2 | 94.1 | 0.84 | 87 | 3.4 | 7.5 | 3 | 28 | 13 | 63 | 77 | ▲ 1MB1 ■ 43-2DC2 ■■■■■■ | 570 | 1.64 |
| 64 | T3 | 315 S | 992 | 510 | 94.4 | 94.6 | 94.1 | 0.86 | 118 | 2.4 | 7.5 | 3.3 | 32 | 15 | 65 | 79 | ▲ 1MB5 ■ 43-3AC0 ■■■■■■ | 870 | 3.25 |
| 76 | T3 | 315 M | 992 | 610 | 94.6 | 94.9 | 94.6 | 0.87 | 139 | 2.3 | 7.4 | 3.2 | 28 | 11 | 65 | 79 | ▲ 1MB5 ■ 43-3AC2 ■■■■■■ | 900 | 3.54 |
| 92 | T3 | 315 L | 991 | 740 | 94.9 | 95.2 | 95.1 | 0.88 | 167 | 2.3 | 6.9 | 3 | 37 | 13 | 69 | 83 | ▲ 1MB5 ■ 43-3AC4 ■■■■■■ | 1090 | 4.52 |
| 110 | T3 | 315 L | 992 | 880 | 95.1 | 95.3 | 95.1 | 0.87 | 198 | 2.5 | 7.6 | 3.3 | 26 | 9 | 71 | 86 | ▲ 1MB5 ■ 43-3AC5 ■■■■■■ | 1170 | 5.16 |
| 125 | T3 | 315 L | 992 | 1000 | 95.3 | 95.5 | 95.1 | 0.85 | 230 | 2.4 | 6.7 | 2.7 | 28 | 9 | 70 | 84 | ▲ 1MB5 ■ 43-3AC6 ■■■■■■ | 1180 | 4.89 |
| Basic Line 5 | | | | | | | | | | | | | | | | | | | |
| Performance Line 6 | | | | | | | | | | | | | | | | | | | |
| Voltages | | | | | | | | | | | | | | | | | | | |
| 50 Hz 230 VΔ/400 VY 60 Hz 460 VY | | | | | | | | | | | | | | | | | | | |
| 50 Hz 400 VΔ/690 VY 60 Hz 460 VΔ | | | | | | | | | | | | | | | | | | | |
| 50 Hz 500 VY | | | | | | | | | | | | | | | | | | | |
| 50 Hz 500 VΔ | | | | | | | | | | | | | | | | | | | |
| For other voltages and more information, see from page 5/53 | | | | | | | | | | | | | | | | | | | |
| Types of construction | | | | | | | | | | | | | | | | | | | |
| Without flange IM B3 ³⁾ | | | | | | | | | | | | | | | | | | | |
| With flange IM B5 ³⁾ | | | | | | | | | | | | | | | | | | | |
| With flange IM B14 ³⁾ | | | | | | | | | | | | | | | | | | | |
| For other types of construction and more information, see from page 5/62 | | | | | | | | | | | | | | | | | | | |
| Motor protection | | | | | | | | | | | | | | | | | | | |
| Without | | | | | | | | | | | | | | | | | | | |
| PTC thermistor with 3 temperature sensors | | | | | | | | | | | | | | | | | | | |
| For other motor protection and more information, see from page 5/70 | | | | | | | | | | | | | | | | | | | |
| Terminal box position | | | | | | | | | | | | | | | | | | | |
| Terminal box at top | | | | | | | | | | | | | | | | | | | |
| For other terminal box positions and more information, see from page 5/75 | | | | | | | | | | | | | | | | | | | |
| Special versions | | | | | | | | | | | | | | | | | | | |
| For options, see from page 5/87 | | | | | | | | | | | | | | | | | | | |
| 1MB . ■43- ■■■■■■ -Z | | | | | | | | | | | | | | | | | | | |



1) Noise values for line operation under load, tolerance + 3dB(A).

2) These sound power levels are above the set values in the VIK recommendation in the "standard" version. This difference must be agreed between the manufacturer and the operator.

3) Types derived from IM B3 (IM B6/7/8, IM V6 and IM V5), from IM B5 (IM V3 and IM V1) and from IM B14 (IM V19 and IM V18) are possible. The basic type IM B3, IM B5 or IM B14 is stamped as standard on the rating plate.

SIMOTICS XP 1MB1, 1MB5 explosion-protected motors

Zone 1 with type of protection Ex eb · IE3 Premium Efficiency



Cast-iron series 1MB1543, 1MB1643, 1MB5543, 1MB5643 – self-ventilated

Selection and ordering data

| Operating values at rated power | | | | | | | | | | | | | | | Cast-iron series | | m _{IM B3} J | | |
|--|---------------------------|---------------|-------------------------------|-------------------------------|---------------------------------------|---------------------------------------|---------------------------------------|--|---|--|--|---|-------------------------------------|----------------------------------|------------------------------------|-----------------------------------|----------------------|------|------------------|
| P _{rated} , 50 Hz | Tem- perature class | Frame size | n _{rated} , 50 Hz | T _{rated} , 50 Hz | η _{rated} , 50 Hz, 4/4 | η _{rated} , 50 Hz, 3/4 | η _{rated} , 50 Hz, 2/4 | cosφ _{rated} , 50 Hz, 4/4 | I _{rated} , 50 Hz, 400 V | T _{LR} / I _{rated} , 50 Hz | I _{LR} / I _{rated} , 50 Hz | T _P / I _{rated} , 50 Hz | t _E , 50 Hz, T1/T2 | t _E , 50 Hz, T3 | L _{pfA} , 50 Hz, 1) | L _{WA} , 50 Hz, 1) | Article No. | kg | kgm ² |
| kW | FS | rpm | Nm | % | % | % | A | | | | | | dB(A) | dB(A) | ▲ New | | | | |
| <ul style="list-style-type: none"> • Cooling: self-ventilated (IC411) • Efficiency according to IEC 60034-30: IE3 Premium Efficiency • Insulation: Thermal class 155 (temperature class F), IP55 degree of protection, utilization in accordance with thermal class 130 (temperature class B) | | | | | | | | | | | | | | | | | | | |
| 6-pole: 1000 rpm at 50 Hz, temperature classes T1 and T2 with second rating plate (T1/T2 and T3) | | | | | | | | | | | | | | | | | | | |
| 50 | T1, T2 | 280 M | 988 | 485 | 93.9 | 94.5 | 94.5 | 0.85 | 94 | 3.1 | 6.9 | 2.8 | 27 | - | 63 | 77 | ▲ 1MB1 43-2DC2 | 570 | 1.64 |
| 68 | T1, T2 | 315 S | 991 | 660 | 94.5 | 94.7 | 94.4 | 0.87 | 125 | 2.3 | 7 | 3.1 | 31 | - | 66 | 80 | ▲ 1MB5 43-3AC0 | 870 | 3.25 |
| 82 | T1, T2 | 315 M | 991 | 790 | 94.7 | 95.1 | 94.9 | 0.88 | 149 | 2.2 | 6.9 | 3 | 25 | - | 65 | 79 | ▲ 1MB5 43-3AC2 | 900 | 3.54 |
| 98 | T1, T2 | 315 L | 990 | 950 | 95 | 95.4 | 95.4 | 0.88 | 179 | 2.2 | 6.5 | 2.8 | 34 | - | 69 | 84 | ▲ 1MB5 43-3AC4 | 1090 | 4.52 |
| 120 | T1, T2 | 315 L | 991 | 1160 | 95.2 | 95.6 | 95.5 | 0.88 | 218 | 2.3 | 6.9 | 3.1 | 23 | - | 71 | 86 | ▲ 1MB5 43-3AC5 | 1170 | 5.16 |
| 135 | T1, T2 | 315 L | 991 | 1300 | 95.4 | 95.7 | 95.5 | 0.85 | 250 | 2.2 | 6.2 | 2.5 | 24 | - | 70 | 85 | ▲ 1MB5 43-3AC6 | 1180 | 4.89 |
| Basic Line | | | | | | | | | | | | | | | | | 5 | | |
| Performance Line | | | | | | | | | | | | | | | | | 6 | | |
| Voltages | | | | | | | | | | | | | | | Version | | Order code | | |
| 50 Hz 230 VΔ/400 VY | | | 60 Hz 460 VY | | | Standard | | | 2 2 | | - | | | | | | | | |
| 50 Hz 400 VΔ/690 VY | | | 60 Hz 460 VΔ | | | Standard | | | 3 4 | | - | | | | | | | | |
| 50 Hz 500 VY | | | | | | Without additional charge | | | 2 7 | | - | | | | | | | | |
| 50 Hz 500 VΔ | | | | | | Without additional charge | | | 4 0 | | - | | | | | | | | |
| For other voltages and more information, see from page 5/53 | | | | | | | | | | | | | | | | | | | |
| Types of construction | | | | | | | | | | | | | | | Version | | Order code | | |
| Without flange | | | IM B3 ²⁾ | | | Standard | | | A | | - | | | | | | | | |
| With flange | | | IM B5 ²⁾ | | | With additional charge | | | F | | - | | | | | | | | |
| With flange | | | IM B14 ²⁾ | | | With additional charge | | | K | | - | | | | | | | | |
| For other types of construction and more information, see from page 5/62 | | | | | | | | | | | | | | | | | | | |
| Motor protection | | | | | | | | | | | | | | | Version | | Order code | | |
| Without | | | | | | Standard | | | A | | - | | | | | | | | |
| PTC thermistor with 3 temperature sensors | | | | | | With additional charge | | | B | | - | | | | | | | | |
| For other motor protection and more information, see from page 5/70 | | | | | | | | | | | | | | | | | | | |
| Terminal box position | | | | | | | | | | | | | | | Version | | Order code | | |
| Terminal box at top | | | | | | Standard | | | 4 | | - | | | | | | | | |
| For other terminal box positions and more information, see from page 5/75 | | | | | | | | | | | | | | | | | | | |
| Special versions | | | | | | | | | | | | | | | | | Order code(s) | | |
| For options, see from page 5/87 | | | | | | | | | | | | | | | | | | | |
| 1MB . ■43- ■-■■■■ -Z . . . + | | | | | | | | | | | | | | | | | | | |

5

¹⁾ Noise values for line operation under load, tolerance + 3dB(A).

²⁾ Types derived from IM B3 (IM B6/7/8, IM V6 and IM V5), from IM B5 (IM V3 and IM V1) and from IM B14 (IM V19 and IM V18) are possible. The basic type IM B3, IM B5 or IM B14 is stamped as standard on the rating plate.



SIMOTICS XP 1MB1, 1MB5 explosion-protected motors

Zone 1 with types of protection Ex db, Ex db eb · IE3 Premium Efficiency

Cast-iron series 1MB15/1MB55 – self-ventilated

Selection and ordering data

| P _{rated} 50 Hz | | P _{rated} 60 Hz | | Frame size | Operating values at rated power | | | | | | | | | | Cast-iron series 1MB1553/1MB5553 | m _{IM B3} | J |
|--|-------|-----------------------------|-------|----------------------|---------------------------------|--------------------|--------------------|---------------------------|-----------------------|--------------------|-------------------------------------|-------------------------------------|------------------------------------|----------------------------------|-------------------------------------|--------------------|------------------|
| kW | kW | FS | rpm | Nm | % | % | % | A | | | | | | | | kg | kgm ² |
| 50 Hz | 60 Hz | | 50 Hz | 50 Hz | 50 Hz | 50 Hz | 50 Hz | 50 Hz | 50 Hz | 50 Hz | 50 Hz | 50 Hz | 50 Hz | 50 Hz | 50 Hz | | |
| | | | | η _{rated} | T _{rated} | η _{rated} | η _{rated} | η _{rated} | cosφ _{rated} | I _{rated} | T _{LR} /T _{rated} | I _{LR} /I _{rated} | T _B /T _{rated} | L _{pfA, 1)} | L _{WA, 1)} | Article No. | |
| | | | | 4/4 | 50 Hz | 3/4 | 2/4 | 4/4 | 400 V | | | | | 50 Hz | 50 Hz | ▲ New | |
| <ul style="list-style-type: none"> • Cooling: self-ventilated (IC411) • Efficiency according to IEC 60034-30: IE3 Premium Efficiency • Insulation: Thermal class 155 (temperature class F), IP55 degree of protection, utilization in accordance with thermal class 130 (temperature class B) | | | | | | | | | | | | | | | | | |
| 2-pole: 3000 rpm at 50 Hz, 3600 rpm at 60 Hz ¹⁾ | | | | | | | | | | | | | | | | | |
| 0.37 | 0.37 | 71 M | 2850 | 1.2 | 73.8 | 73.3 | 69.7 | 0.76 | 0.95 | 3.5 | 5.8 | 3.5 | 57 | 64 | ▲ 1MB1553-0CA2 | 24 | 0.00045 |
| 0.55 | 0.55 | 71 M | 2850 | 1.8 | 77.8 | 77.5 | 74.5 | 0.76 | 1.34 | 3.7 | 6.1 | 3.7 | 57 | 68 | ▲ 1MB1553-0CA3 | 25 | 0.00056 |
| 0.75 | 0.75 | 80 M | 2850 | 2.5 | 80.7 | 82.2 | 81.9 | 0.86 | 1.56 | 2.6 | 6.2 | 3 | 58 | 69 | ▲ 1MB1553-0DA2 | 30 | 0.0011 |
| 1.1 | 1.1 | 80 M | 2885 | 3.6 | 82.7 | 83.9 | 83.1 | 0.85 | 2.25 | 3 | 7.1 | 3.3 | 58 | 78 | ▲ 1MB1553-0DA3 | 32 | 0.0013 |
| 1.5 | 1.5 | 90 S | 2910 | 4.9 | 84.2 | 84.6 | 83.2 | 0.86 | 3 | 2.7 | 8.1 | 4.2 | 60 | 71 | ▲ 1MB1553-0EA0 | 41 | 0.0021 |
| 2.2 | 2.2 | 90 L | 2910 | 7.2 | 85.9 | 86.8 | 86.1 | 0.88 | 4.2 | 2.6 | 8.3 | 4 | 60 | 73 | ▲ 1MB1553-0EA4 | 45 | 0.0031 |
| 3 | 3 | 100 L | 2920 | 9.8 | 87.1 | 87.9 | 87.5 | 0.88 | 5.6 | 3.2 | 8.1 | 4.6 | 65 | 82 | ▲ 1MB1553-1AA4 | 64 | 0.0054 |
| 4 | 4 | 112 M | 2950 | 13 | 88.1 | 88.7 | 88.2 | 0.89 | 7.4 | 2.5 | 8.7 | 4 | 65 | 77 | ▲ 1MB1553-1BA2 | 74 | 0.012 |
| 5.5 | 5.5 | 132 S | 2950 | 18 | 89.2 | 90.1 | 89.7 | 0.9 | 9.9 | 1.9 | 7.3 | 3.7 | 68 | 80 | ▲ 1MB1553-1CA0 | 95 | 0.024 |
| 7.5 | 7.5 | 132 S | 2950 | 24 | 90.1 | 90.9 | 90.7 | 0.92 | 13.1 | 2.1 | 8.3 | 4 | 68 | 78 | ▲ 1MB1553-1CA1 | 106 | 0.031 |
| 11 | 11 | 160 M | 2955 | 36 | 91.2 | 91.3 | 90.2 | 0.87 | 20 | 2.5 | 7.6 | 3.8 | 68 | 80 | ▲ 1MB1553-1DA2 | 169 | 0.053 |
| 15 | 15 | 160 M | 2960 | 48 | 91.9 | 91.9 | 91 | 0.87 | 27 | 2.8 | 8.8 | 4.3 | 70 | 82 | ▲ 1MB1553-1DA3 | 179 | 0.061 |
| 18.5 | 18.5 | 160 L | 2955 | 60 | 92.4 | 92.8 | 92.3 | 0.9 | 32 | 2.8 | 8.3 | 3.9 | 70 | 84 | ▲ 1MB1553-1DA4 | 190 | 0.068 |
| 22 | 22 | 180 M | 2950 | 71 | 92.7 | 93 | 92.4 | 0.89 | 38.5 | 2.3 | 7.5 | 3.5 | 70 | 80 | ▲ 1MB1553-1EA2 | 238 | 0.08 |
| 30 | 30 | 200 L | 2955 | 97 | 93.3 | 93.6 | 93.3 | 0.87 | 53 | 2.5 | 7 | 3.3 | 69 | 81 | ▲ 1MB1553-2AA4 | 324 | 0.134 |
| 37 | 37 | 200 L | 2955 | 120 | 93.7 | 93.9 | 93.5 | 0.88 | 65 | 2.5 | 7.1 | 3.2 | 69 | 82 | ▲ 1MB1553-2AA5 | 348 | 0.158 |
| 45 | 45 | 225 M | 2960 | 145 | 94 | 94.5 | 94.4 | 0.89 | 78 | 2.4 | 6.9 | 3.3 | 73 | 87 | ▲ 1MB1553-2BA2 | 447 | 0.26 |
| 55 | 55 | 250 M | 2975 | 177 | 94.3 | 94.5 | 93.9 | 0.89 | 95 | 2.3 | 6.7 | 3.1 | 73 | 87 | ▲ 1MB1553-2CA2 | 532 | 0.46 |
| 75 | 75 | 280 S | 2975 | 241 | 94.7 | 94.8 | 94.2 | 0.89 | 128 | 2.5 | 7.3 | 2.7 | 78 | 92 | ▲ 1MB1553-2DA0 | 729 | 0.77 |
| 90 | 90 | 280 M | 2975 | 289 | 95 | 95.2 | 94.8 | 0.9 | 152 | 2.4 | 7.5 | 3.1 | 79 | 93 | ▲ 1MB1553-2DA2 | 763 | 0.926 |
| 110 | 110 | 315 S | 2982 | 352 | 95.2 | 95.3 | 94.7 | 0.91 | 183 | 2.3 | 7.2 | 3.2 | 80 | 94 | ▲ 1MB5553-3AA0 | 1100 | 1.76 |
| 132 | 132 | 315 M | 2984 | 422 | 95.4 | 95.4 | 94.7 | 0.91 | 220 | 1.9 | 7.5 | 2.5 | 80 | 94 | ▲ 1MB5553-3AA2 | 1230 | 1.99 |
| 160 | 160 | 315 L | 2980 | 513 | 95.6 | 95.7 | 95.3 | 0.91 | 265 | 1.8 | 6.9 | 2.3 | 80 | 94 | ▲ 1MB5553-3AA4 | 1300 | 2.29 |
| 200 | 200 | 315 L | 2980 | 641 | 95.8 | 96 | 95.7 | 0.92 | 330 | 1.9 | 6.9 | 2.4 | 80 | 94 | ▲ 1MB5553-3AA5 | 1430 | 2.65 |
| 250 | 250 | 315 L | 2982 | 801 | 95.8 | 95.9 | 95.6 | 0.91 | 415 | 2.8 | 7.2 | 3 | 80 | 94 | ▲ 1MB5553-3AA6 | 1590 | 2.82 |
| 315 | 315 | 355 M | 2986 | 1007 | 95.8 | 95.9 | 95.4 | 0.9 | 530 | 2.1 | 7.8 | 2.8 | 83 | 98 | ▲ 1MB5553-3BA2 | 2130 | 4.31 |
| 355 | 355 | 355 M | 2975 | 1139 | 95.8 | 96.1 | 96 | 0.92 | 580 | 2.4 | 6.6 | 2.5 | 83 | 98 | ▲ 1MB5553-3BA3 | 2340 | 5.8 |
| 400 | 400 | 355 L | 2986 | 1279 | 95.8 | 96 | 95.7 | 0.89 | 680 | 2.3 | 7.6 | 2.9 | 83 | 98 | ▲ 1MB5553-3BA4 | 2610 | 5.9 |
| 460 | 460 | 355 L | 2990 | 1469 | 95.8 | 95.8 | 95.3 | 0.89 | 780 | 2.8 | 9 | 3.5 | 83 | 98 | ▲ 1MB5553-3BA5 | 2620 | 5.9 |
| Voltagess | | | | | | | | | | | | Version | | Order code | | | |
| 50 Hz 230 VΔ/400 VY | | | | 60 Hz 460 VY | | | | Standard | | | | 2 2 | | - | | | |
| 50 Hz 400 VΔ/690 VY | | | | 60 Hz 460 VΔ | | | | Standard | | | | 3 4 | | - | | | |
| 50 Hz 500 VY | | | | | | | | Without additional charge | | | | 2 7 | | - | | | |
| 50 Hz 500 VΔ | | | | | | | | Without additional charge | | | | 4 0 | | - | | | |
| For other voltages and more information, see from page 5/54 | | | | | | | | | | | | 9 0 | | ... | | | |
| Types of construction | | | | | | | | | | | | Version | | Order code | | | |
| Without flange | | | | IM B3 ²⁾ | | | | Standard | | | | A | | - | | | |
| With flange | | | | IM B5 ²⁾ | | | | With additional charge | | | | F | | - | | | |
| With flange | | | | IM B14 ²⁾ | | | | With additional charge | | | | K | | - | | | |
| For other types of construction and more information, see from page 5/65 | | | | | | | | | | | | | | ... | | | |
| Motor protection | | | | | | | | | | | | Version | | Order code | | | |
| Without | | | | | | | | Standard | | | | A | | | | | |
| PTC thermistor with 3 temperature sensors | | | | | | | | With additional charge | | | | B | | | | | |
| For other motor protection and more information, see from page 5/71 | | | | | | | | | | | | | | | | | |
| Terminal box position | | | | | | | | | | | | Version | | Order code | | | |
| Terminal box at top | | | | | | | | Standard | | | | 4 | | | | | |
| For other terminal box positions and more information, see from page 5/76 | | | | | | | | | | | | | | | | | |
| Special versions | | | | | | | | | | | | Version | | Order code(s) | | | |
| For options, see from page 5/91 | | | | | | | | | | | | 1MB.553- | | -Z . . . + . . . + . . . + . . . | | | |



SIMOTICS XP 1MB1, 1MB5 explosion-protected motors

Zone 1 with types of protection Ex db, Ex db eb · IE3 Premium Efficiency



Cast-iron series 1MB15/1MB55 – self-ventilated

Selection and ordering data

| Operating values at rated power | | | | | | | | | | | | | | Cast-iron series | | $m_{IM\ B3}$ | J | | |
|--|----------------------|---------------|----------------------|----------------------|-------------------------|-------------------------|-------------------------|-------------------------|-----------------------------|----------------------|--------------------------|--------------------------|-----------------------------|------------------------|----------------------|--------------|------|-----------------|-------------|
| P_{rated} 50 Hz | P_{rated} 60 Hz | Frame size | n_{rated} 50 Hz | T_{rated} 50 Hz | η_{rated} 50 Hz | η_{rated} 50 Hz | η_{rated} 50 Hz | η_{rated} 50 Hz | $\cos\phi_{rated}$ 50 Hz | I_{rated} 50 Hz | $T_{LR}/$ T_{rated} | $I_{LR}/$ I_{rated} | $T_{\beta}/$ T_{rated} | $L_{pf(A,1)}$ 50 Hz | $L_{WA,1)}$ 50 Hz | | | 1MB1553/1MB5553 | Article No. |
| kW | kW | FS | rpm | Nm | % | % | % | % | A | A | | | | | | ▲ New | | | |
| • Cooling: self-ventilated (IC411) • Efficiency according to IEC 60034-30: IE3 Premium Efficiency • Insulation: Thermal class 155 (temperature class F), IP55 degree of protection, utilization in accordance with thermal class 130 (temperature class B) | | | | | | | | | | | | | | | | | | | |
| 4-pole: 1500 rpm at 50 Hz, 1800 rpm at 60 Hz ¹⁾ | | | | | | | | | | | | | | | | | | | |
| 0.25 | 0.25 | 71 M | 1395 | 1.7 | 73.5 | 73.7 | 70.4 | 0.72 | 0.68 | 2.5 | 4.2 | 2.6 | 64 | 64 | ▲ 1MB1553-0CB2 | ■-■■■■■ | 25 | 0.0095 | |
| 0.37 | 0.37 | 71 M | 1410 | 2.5 | 77.3 | 76.8 | 73.2 | 0.70 | 0.99 | 3.1 | 4.8 | 3.1 | 70 | 70 | ▲ 1MB1553-0CB3 | ■-■■■■■ | 27 | 0.0014 | |
| 0.55 | 0.55 | 80 M | 1440 | 3.6 | 80.8 | 81.1 | 79.3 | 0.78 | 1.26 | 2.1 | 5.9 | 3.1 | 69 | 69 | ▲ 1MB1553-0DB2 | ■-■■■■■ | 30 | 0.0021 | |
| 0.75 | 0.75 | 80 M | 1450 | 4.9 | 82.5 | 82.3 | 79.9 | 0.75 | 1.75 | 2.7 | 7.1 | 3.9 | 70 | 70 | ▲ 1MB1553-0DB3 | ■-■■■■■ | 33 | 0.0029 | |
| 1.1 | 1.1 | 90 S | 1440 | 7.3 | 84.1 | 84.7 | 83.4 | 0.78 | 2.4 | 2.9 | 6.9 | 3.6 | 72 | 72 | ▲ 1MB1553-0EB0 | ■-■■■■■ | 42 | 0.0036 | |
| 1.5 | 1.5 | 90 L | 1445 | 10 | 85.3 | 85.9 | 84.9 | 0.80 | 3.15 | 2.7 | 7.2 | 3.6 | 63 | 63 | ▲ 1MB1553-0EB4 | ■-■■■■■ | 45 | 0.0049 | |
| 2.2 | 2.2 | 100 L | 1465 | 14 | 86.7 | 87.0 | 85.9 | 0.83 | 4.4 | 3.2 | 8.4 | 4.4 | 77 | 77 | ▲ 1MB1553-1AB4 | ■-■■■■■ | 67 | 0.014 | |
| 3 | 3 | 100 M | 1460 | 20 | 87.7 | 88.5 | 87.9 | 0.83 | 5.9 | 2.5 | 8.3 | 3.9 | 69 | 69 | ▲ 1MB1553-1AB5 | ■-■■■■■ | 68 | 0.014 | |
| 4 | 4 | 112 S | 1460 | 26 | 88.6 | 89.2 | 88.6 | 0.82 | 7.9 | 2.4 | 7.1 | 3.7 | 69 | 69 | ▲ 1MB1553-1BB2 | ■-■■■■■ | 76 | 0.017 | |
| 5.5 | 5.5 | 132 S | 1470 | 36 | 89.6 | 90.0 | 89.4 | 0.82 | 10.8 | 2.9 | 8.6 | 3.7 | 80 | 80 | ▲ 1MB1553-1CB0 | ■-■■■■■ | 109 | 0.034 | |
| 7.5 | 7.5 | 132 M | 1465 | 49 | 90.4 | 91.1 | 90.8 | 0.84 | 14.3 | 2.6 | 8.2 | 3.7 | 76 | 76 | ▲ 1MB1553-1CB2 | ■-■■■■■ | 120 | 0.046 | |
| 11 | 11 | 160 M | 1475 | 71 | 91.4 | 91.8 | 91.2 | 0.84 | 20.5 | 2.6 | 7.6 | 3.4 | 81 | 81 | ▲ 1MB1553-1DB2 | ■-■■■■■ | 179 | 0.071 | |
| 15 | 15 | 160 L | 1475 | 97 | 92.1 | 92.3 | 91.5 | 0.82 | 28.5 | 2.5 | 8.5 | 3.8 | 71 | 71 | ▲ 1MB1553-1DB4 | ■-■■■■■ | 191 | 0.085 | |
| 18.5 | 18.5 | 180 M | 1470 | 120 | 92.6 | 93.1 | 93.0 | 0.82 | 35 | 2.5 | 7.2 | 3.3 | 82 | 82 | ▲ 1MB1553-1EB2 | ■-■■■■■ | 240 | 0.13 | |
| 22 | 22 | 180 L | 1470 | 143 | 93.0 | 93.6 | 93.6 | 0.83 | 41 | 2.3 | 6.8 | 3.3 | 76 | 76 | ▲ 1MB1553-1EB4 | ■-■■■■■ | 249 | 0.14 | |
| 30 | 30 | 200 L | 1470 | 195 | 93.6 | 94.2 | 94.2 | 0.84 | 55 | 2.6 | 7.3 | 3.1 | 75 | 75 | ▲ 1MB1553-2AB5 | ■-■■■■■ | 346 | 0.24 | |
| 37 | 37 | 225 S | 1480 | 239 | 93.9 | 94.5 | 94.4 | 0.86 | 66 | 2.5 | 6.4 | 2.7 | 63 | 77 | ▲ 1MB1553-2BB0 | ■-■■■■■ | 456 | 0.467 | |
| 45 | 45 | 225 M | 1475 | 291 | 94.2 | 94.7 | 94.6 | 0.86 | 80 | 2.6 | 6.4 | 2.7 | 64 | 78 | ▲ 1MB1553-2BB2 | ■-■■■■■ | 466 | 0.52 | |
| 55 | 55 | 250 M | 1482 | 354 | 94.6 | 95.1 | 95 | 0.87 | 96 | 2.5 | 6.8 | 2.9 | 66 | 79 | ▲ 1MB1553-2CB2 | ■-■■■■■ | 563 | 0.85 | |
| 75 | 75 | 280 S | 1486 | 482 | 95 | 95.3 | 95 | 0.86 | 133 | 2.5 | 6.9 | 3 | 72 | 86 | ▲ 1MB1553-2DB0 | ■-■■■■■ | 782 | 1.4 | |
| 90 | 90 | 280 M | 1485 | 579 | 95.2 | 95.5 | 95.3 | 0.87 | 157 | 2.6 | 7.2 | 3 | 70 | 84 | ▲ 1MB1553-2DB2 | ■-■■■■■ | 818 | 1.7 | |
| 110 | 110 | 315 S | 1490 | 705 | 95.4 | 95.7 | 95.4 | 0.85 | 196 | 2.4 | 6.6 | 2.6 | 75 | 91 | ▲ 1MB5553-3AB0 | ■-■■■■■ | 1150 | 2.48 | |
| 132 | 132 | 315 M | 1490 | 846 | 95.6 | 95.9 | 95.7 | 0.86 | 230 | 2.1 | 7 | 2.7 | 75 | 91 | ▲ 1MB5553-3AB2 | ■-■■■■■ | 1270 | 2.79 | |
| 160 | 160 | 315 L | 1491 | 1025 | 95.8 | 96 | 95.6 | 0.85 | 285 | 2.3 | 7.5 | 3 | 75 | 91 | ▲ 1MB5553-3AB4 | ■-■■■■■ | 1330 | 3.17 | |
| 200 | 200 | 315 L | 1490 | 1282 | 96 | 96.4 | 96.3 | 0.86 | 350 | 2.3 | 7.6 | 2.8 | 75 | 91 | ▲ 1MB5553-3AB5 | ■-■■■■■ | 1480 | 3.79 | |
| 250 | 250 | 315 L | 1490 | 1602 | 96 | 96.2 | 95.9 | 0.87 | 430 | 2.1 | 7.2 | 2.8 | 75 | 91 | ▲ 1MB5553-3AB6 | ■-■■■■■ | 1660 | 4.55 | |
| 315 | 315 | 355 M | 1491 | 2017 | 96 | 96.2 | 95.8 | 0.86 | 550 | 2.3 | 8 | 2.9 | 81 | 95 | ▲ 1MB5553-3BB2 | ■-■■■■■ | 2140 | 5.6 | |
| 355 | 355 | 355 M | 1491 | 2274 | 96 | 96.1 | 95.8 | 0.88 | 610 | 2.2 | 7.5 | 3.1 | 81 | 95 | ▲ 1MB5553-3BB3 | ■-■■■■■ | 2240 | 6.36 | |
| 400 | 400 | 355 L | 1491 | 2562 | 96 | 96.1 | 95.9 | 0.87 | 690 | 2.1 | 7.3 | 3 | 80 | 95 | ▲ 1MB5553-3BB4 | ■-■■■■■ | 2420 | 7.06 | |
| 460 | 460 | 355 L | 1492 | 2944 | 96 | 96.2 | 96 | 0.85 | 810 | 3.1 | 8.4 | 3.3 | 80 | 96 | ▲ 1MB5553-3BB5 | ■-■■■■■ | 2720 | 8.5 | |

| Voltagess | Version | Order code |
|---|---------------------------|---------------------------------------|
| 50 Hz 230 VΔ/400 VY | Standard | 2 2 |
| 50 Hz 400 VΔ/690 VY | Standard | 3 4 |
| 50 Hz 500 VY | Without additional charge | 2 7 |
| 50 Hz 500 VΔ | Without additional charge | 4 0 |
| For other voltages and more information, see from page 5/54 | | |
| Types of construction | Version | Order code |
| Without flange IM B3 ²⁾ | Standard | A |
| With flange IM B5 ²⁾ | With additional charge | F |
| With flange IM B14 ²⁾ | With additional charge | K |
| For other types of construction and more information, see from page 5/65 | | |
| Motor protection | Version | Order code |
| Without | Standard | A |
| PTC thermistor with 3 temperature sensors | With additional charge | B |
| For other motor protection and more information, see from page 5/71 | | |
| Terminal box position | Version | Order code |
| Terminal box at top | Standard | 4 |
| For other terminal box positions and more information, see from page 5/76 | | |
| Special versions | | Order code(s) |
| For options, see from page 5/91 | | 1MB.553-... ■-■■■■■-Z ...+...+...+... |

5



SIMOTICS XP 1MB1, 1MB5 explosion-protected motors

Zone 1 with types of protection Ex db, Ex db eb · IE3 Premium Efficiency

Cast-iron series 1MB15/1MB55 – self-ventilated

Selection and ordering data

| Operating values at rated power | | | | | | | | | | | | | | Cast-iron series | | $m_{IM\ B3}$ | J | | |
|--|----------------------|------------|----------------------|----------------------|-------------------------|-------------------------|-------------------------|---------------------------|-----------------------------|----------------------|--------------------|--------------------|-----------------------|------------------------|---------------------|--------------------------|--------|-----------------|-------------|
| P_{rated} 50 Hz | P_{rated} 60 Hz | Frame size | n_{rated} 50 Hz | T_{rated} 50 Hz | η_{rated} 50 Hz | η_{rated} 50 Hz | η_{rated} 50 Hz | η_{rated} 50 Hz | $\cos\phi_{rated}$ 50 Hz | I_{rated} 50 Hz | T_{LR}/T_{rated} | I_{LR}/I_{rated} | T_{β}/T_{rated} | $L_{pf(A,1)}$ 50 Hz | $L_{WA,1}$ 50 Hz | | | 1MB1553/1MB5553 | Article No. |
| kW | kW | FS | rpm | Nm | % | % | % | % | A | | | | | | | ▲ New | | | |
| • Cooling: self-ventilated (IC411) • Efficiency according to IEC 60034-30: IE3 Premium Efficiency • Insulation: Thermal class 155 (temperature class F), IP55 degree of protection, utilization in accordance with thermal class 130 (temperature class B) | | | | | | | | | | | | | | | | | | | |
| 6-pole: 1000 rpm at 50 Hz, 1200 rpm at 60 Hz ¹⁾ | | | | | | | | | | | | | | | | | | | |
| 0.18 | 0.18 | 71 M | 885 | 1.94 | 63.9 | 64.6 | 60.8 | 0.69 | 0.59 | 2.3 | 2.8 | 2.3 | 39 | 68 | ▲ 1MB1553-0CC2 | 24 | 0.001 | | |
| 0.25 | 0.25 | 71 M | 885 | 2.70 | 68.6 | 69.5 | 66.2 | 0.69 | 0.76 | 2.6 | 3.2 | 2.6 | 39 | 50 | ▲ 1MB1553-0CC3 | 26 | 0.0015 | | |
| 0.37 | 0.37 | 80 M | 940 | 3.76 | 73.1 | 69.4 | 69.4 | 0.66 | 1.10 | 2.3 | 4.2 | 2.7 | 46 | 57 | ▲ 1MB1553-0DC2 | 31 | 0.0025 | | |
| 0.55 | 0.55 | 80 M | 935 | 5.60 | 77.2 | 77.0 | 73.9 | 0.67 | 1.53 | 2.5 | 4.5 | 2.8 | 42 | 68 | ▲ 1MB1553-0DC3 | 34 | 0.0031 | | |
| 0.75 | 0.75 | 90 S | 945 | 7.60 | 78.9 | 80.0 | 78.8 | 0.70 | 1.96 | 2.2 | 4.6 | 2.6 | 42 | 66 | ▲ 1MB1553-0EC0 | 43 | 0.004 | | |
| 1.1 | 1.1 | 100 L | 965 | 10.9 | 81 | 81.1 | 79.4 | 0.74 | 2.65 | 2.6 | 7.2 | 3.7 | 62 | 69 | ▲ 1MB1553-1AC3 | 67 | 0.014 | | |
| 1.5 | 1.5 | 112 L | 975 | 14.7 | 82.5 | 82.5 | 81.0 | 0.70 | 3.75 | 3.7 | 7.9 | 4.1 | 57 | 64 | ▲ 1MB1553-1BC1 | 75 | 0.017 | | |
| 2.2 | 2.2 | 132 S | 975 | 29.4 | 85.6 | 86.6 | 86.3 | 0.75 | 6.7 | 2.4 | 7.3 | 3.5 | 59 | 66 | ▲ 1MB1553-1CC1 | 96 | 0.037 | | |
| 3 | 3 | 132 S | 975 | 21.5 | 84.3 | 85.2 | 84.7 | 0.74 | 5.1 | 2.5 | 7.3 | 3.6 | 59 | 66 | ▲ 1MB1553-1CC0 | 96 | 0.037 | | |
| 4 | 4 | 132 M | 970 | 39.3 | 86.8 | 87.9 | 87.7 | 0.76 | 8.8 | 2.4 | 7 | 3.4 | 59 | 66 | ▲ 1MB1553-1CC2 | 101 | 0.037 | | |
| 5.5 | 5.5 | 132 M | 975 | 54 | 88 | 88.8 | 88.4 | 0.77 | 11.7 | 2.5 | 7.4 | 3.6 | 59 | 66 | ▲ 1MB1553-1CC3 | 115 | 0.046 | | |
| 7.5 | 7.5 | 160 M | 982 | 73 | 89.1 | 89.7 | 89.2 | 0.81 | 15 | 2.9 | 7.2 | 3 | 62 | 69 | ▲ 1MB1553-1DC2 | 184 | 0.098 | | |
| 11 | 11 | 160 L | 982 | 107 | 90.3 | 90.7 | 89.9 | 0.81 | 21.5 | 3.1 | 7.6 | 3.2 | 62 | 69 | ▲ 1MB1553-1DC4 | 200 | 0.12 | | |
| 15 | 15 | 180 L | 975 | 147 | 91.2 | 91.9 | 91.9 | 0.80 | 29.5 | 2.3 | 5.9 | 2.8 | 67 | 68 | ▲ 1MB1553-1EC4 | 236 | 0.19 | | |
| 18.5 | 18.5 | 200 L | 978 | 181 | 91.7 | 92.5 | 92.5 | 0.79 | 37.0 | 2.5 | 5.6 | 2.6 | 61 | 71 | ▲ 1MB1553-2AC4 | 325 | 0.28 | | |
| 22 | 22 | 200 L | 978 | 215 | 92.2 | 93.1 | 93.2 | 0.79 | 43.5 | 2.5 | 5.6 | 2.6 | 64 | 72 | ▲ 1MB1553-2AC5 | 339 | 0.32 | | |
| 30 | 30 | 225 M | 982 | 292 | 92.9 | 93.6 | 93.5 | 0.83 | 56 | 2.6 | 6.6 | 3 | 64 | 77 | ▲ 1MB1553-2BC2 | 458 | 0.67 | | |
| 37 | 37 | 250 M | 986 | 358 | 93.3 | 93.9 | 93.8 | 0.84 | 68 | 2.7 | 7.2 | 2.9 | 58 | 72 | ▲ 1MB1553-2CC2 | 533 | 1.01 | | |
| 45 | 45 | 280 S | 988 | 435 | 93.7 | 94.4 | 94.3 | 0.85 | 82 | 3 | 6.8 | 2.8 | 60 | 75 | ▲ 1MB1553-2DC0 | 729 | 1.4 | | |
| 55 | 55 | 280 M | 988 | 532 | 94.1 | 94.6 | 94.4 | 0.85 | 99 | 3.2 | 7.2 | 3 | 60 | 74 | ▲ 1MB1553-2DC2 | 748 | 1.6 | | |
| 75 | 75 | 315 S | 992 | 722 | 94.6 | 94.8 | 94.2 | 0.8 | 143 | 2.4 | 7.6 | 2.9 | 68 | 83 | ▲ 1MB5553-3AC0 | 1070 | 2.98 | | |
| 90 | 90 | 315 M | 992 | 866 | 94.9 | 95.2 | 94.8 | 0.82 | 167 | 2.5 | 7.7 | 2.9 | 68 | 83 | ▲ 1MB5553-3AC2 | 1130 | 3.54 | | |
| 110 | 110 | 315 L | 992 | 1059 | 95.1 | 95.4 | 95.1 | 0.83 | 200 | 2.4 | 7.7 | 2.8 | 68 | 83 | ▲ 1MB5553-3AC4 | 1270 | 4.25 | | |
| 132 | 132 | 315 L | 992 | 1271 | 95.4 | 95.7 | 95.5 | 0.83 | 240 | 2.5 | 7.8 | 2.9 | 68 | 83 | ▲ 1MB5553-3AC5 | 1380 | 4.89 | | |
| 160 | 160 | 315 L | 992 | 1540 | 95.6 | 96 | 96.1 | 0.82 | 295 | 2.5 | 7.3 | 2.8 | 68 | 83 | ▲ 1MB5553-3AC6 | 1520 | 5.7 | | |
| 200 | 200 | 315 L | 992 | 1925 | 95.8 | 96 | 95.8 | 0.81 | 370 | 2.8 | 7 | 3 | 68 | 83 | ▲ 1MB5553-3AC7 | 1670 | 6.39 | | |
| 250 | 250 | 355 S | 993 | 2404 | 95.8 | 96.2 | 96.1 | 0.84 | 450 | 2.5 | 8 | 3.1 | 75 | 90 | ▲ 1MB5553-3BC1 | 2340 | 11.3 | | |
| 315 | 315 | 355 M | 992 | 3032 | 95.8 | 96.3 | 96.4 | 0.86 | 550 | 2.4 | 6.8 | 2.8 | 75 | 90 | ▲ 1MB5553-3BC2 | 2630 | 13.8 | | |
| 355 | 355 | 355 M | 993 | 3414 | 95.8 | 95.9 | 95.6 | 0.84 | 640 | 2.6 | 7.4 | 3.2 | 76 | 91 | ▲ 1MB5553-3BC3 | 2650 | 13.8 | | |
| 380 | 380 | 355 L | 993 | 3654 | 95.8 | 96.1 | 95.9 | 0.84 | 680 | 2.7 | 7.7 | 2.9 | 75 | 90 | ▲ 1MB5553-3BC4 | 2650 | 13.5 | | |
| Voltages | | | | | | | | | | | | | | Version | | Order code | | | |
| 50 Hz 230 VΔ/400 VY | | | | 60 Hz 460 VY | | | | Standard | | | | 2 | 2 | - | | | | | |
| 50 Hz 400 VΔ/690 VY | | | | 60 Hz 460 VΔ | | | | Standard | | | | 3 | 4 | - | | | | | |
| 50 Hz 500 VY | | | | | | | | Without additional charge | | | | 2 | 7 | - | | | | | |
| 50 Hz 500 VΔ | | | | | | | | Without additional charge | | | | 4 | 0 | - | | | | | |
| For other voltages and more information, see from page 5/54 | | | | | | | | | | | | | | 9 | 0 | ... | | | |
| Types of construction | | | | | | | | | | | | | | Version | | Order code | | | |
| Without flange | | | | IM B3 ²⁾ | | | | Standard | | | | A | | - | | | | | |
| With flange | | | | IM B5 ²⁾ | | | | With additional charge | | | | F | | - | | | | | |
| With flange | | | | IM B14 ²⁾ | | | | With additional charge | | | | K | | - | | | | | |
| For other types of construction and more information, see from page 5/65 | | | | | | | | | | | | | | | | ... | | | |
| Motor protection | | | | | | | | | | | | | | Version | | Order code | | | |
| Without | | | | | | | | Standard | | | | A | | | | | | | |
| PTC thermistor with 3 temperature sensors | | | | | | | | With additional charge | | | | B | | | | | | | |
| For other motor protection and more information, see from page 5/71 | | | | | | | | | | | | | | | | | | | |
| Terminal box position | | | | | | | | | | | | | | Version | | Order code | | | |
| Terminal box at top | | | | | | | | Standard | | | | 4 | | | | | | | |
| For other terminal box positions and more information, see from page 5/76 | | | | | | | | | | | | | | | | | | | |
| Special versions | | | | | | | | | | | | | | | | Order code(s) | | | |
| For options, see from page 5/91 | | | | | | | | | | | | | | 1MB553- | | -Z . . . + . . . + . . . | | | |



For footnotes, see page 5/50

SIMOTICS XP 1MB1, 1MB5 explosion-protected motors

Zone 1 with types of protection Ex db, Ex db eb · IE3 Premium Efficiency



Cast-iron series 1MB15/1MB55 – self-ventilated

Selection and ordering data

| Operating values at rated power | | | | | | | | | | | | | | Cast-iron series | | | | |
|--|----------------------|---------------|----------------------|----------------------|-------------------------|-------------------------|-------------------------|-------------------------|-----------------------------|----------------------|--------------------|--------------------|-----------------------|-----------------------|---------------------|-----------------|-------------|------------------|
| P_{rated} 50 Hz | P_{rated} 60 Hz | Frame size | n_{rated} 50 Hz | T_{rated} 50 Hz | η_{rated} 50 Hz | η_{rated} 50 Hz | η_{rated} 50 Hz | η_{rated} 50 Hz | $\cos\phi_{rated}$ 50 Hz | I_{rated} 50 Hz | T_{LR}/T_{rated} | I_{LR}/I_{rated} | T_{β}/T_{rated} | $L_{p(A,1)}$ 50 Hz | $L_{WA,1}$ 50 Hz | 1MB1553/1MB5553 | $m_{IM B3}$ | J |
| kW | kW | FS | rpm | Nm | % | % | % | % | A | A | | | | dB(A) | dB(A) | Article No. | kg | kgm ² |
| • Cooling: self-ventilated (IC411) • Efficiency according to IEC 60034-30: IE3 Premium Efficiency • Insulation: Thermal class 155 (temperature class F), IP55 degree of protection, utilization in accordance with thermal class 130 (temperature class B) | | | | | | | | | | | | | | | | | | |
| 8-pole: 750 rpm at 50 Hz, 900 rpm at 60 Hz ¹⁾ | | | | | | | | | | | | | | | | | | |
| 0.09 | 0.09 | 71 M | 650 | 1.3 | 44.1 | 42.8 | 37.3 | 0.64 | 0.81 | 1.9 | 2.2 | 1.9 | 58 | 61 | ▲ 1MB1553-0CD2 | ■-■■■■■ | 25 | |
| 0.12 | 0.12 | 71 M | 660 | 1.7 | 50.7 | 49.9 | 44.8 | 0.63 | 0.95 | 2.1 | 2.5 | 2.1 | 58 | 61 | ▲ 1MB1553-0CD3 | ■-■■■■■ | 27 | |
| 0.18 | 0.18 | 80 M | 715 | 2.4 | 58.7 | 54.8 | 47.3 | 0.51 | 1.51 | 1.9 | 2.9 | 2.6 | 59 | 65 | ▲ 1MB1553-0DD2 | ■-■■■■■ | 30 | |
| 0.25 | 0.25 | 80 M | 695 | 3.4 | 64.1 | 62.7 | 57.8 | 0.57 | 1.72 | 1.8 | 2.9 | 2.1 | 59 | 65 | ▲ 1MB1553-0DD3 | ■-■■■■■ | 33 | |
| 0.37 | 0.37 | 90 S | 710 | 5 | 69.3 | 68.3 | 63.7 | 0.55 | 2.45 | 1.6 | 3.2 | 2.3 | 60 | 73 | ▲ 1MB1553-0ED0 | ■-■■■■■ | 43 | |
| 0.55 | 0.55 | 90 L | 715 | 7.3 | 73 | 71.2 | 66.5 | 0.52 | 3.65 | 2.3 | 3.6 | 2.7 | 60 | 73 | ▲ 1MB1553-0ED4 | ■-■■■■■ | 44 | |
| 0.75 | 0.75 | 100 L | 700 | 10.2 | 75 | 77.3 | 76.2 | 0.70 | 2.05 | 1.7 | 4 | 2.2 | 60 | 67 | ▲ 1MB1553-1AD4 | ■-■■■■■ | 59 | |
| 1.1 | 1.1 | 100 L | 710 | 14.9 | 77.7 | 79.4 | 78.2 | 0.70 | 2.9 | 1.9 | 4.8 | 2.5 | 60 | 67 | ▲ 1MB1553-1AD5 | ■-■■■■■ | 64 | |
| 1.5 | 1.5 | 112 M | 720 | 19.9 | 79.7 | 80.3 | 78.6 | 0.70 | 3.9 | 2.1 | 5 | 2.8 | 60 | 70 | ▲ 1MB1553-1BD2 | ■-■■■■■ | 74 | |
| 2.2 | 2.2 | 132 S | 720 | 29.1 | 81.9 | 83.4 | 82.9 | 0.73 | 5.3 | 2.1 | 6.1 | 2.7 | 62 | 76 | ▲ 1MB1553-1CD0 | ■-■■■■■ | 96 | |
| 3 | 3 | 132 M | 725 | 39.5 | 83.5 | 84.4 | 83.6 | 0.74 | 7 | 2.4 | 6.4 | 2.9 | 62 | 76 | ▲ 1MB1553-1CD2 | ■-■■■■■ | 104 | |
| 4 | 4 | 160 M | 728 | 52 | 84.5 | 86.0 | 86.2 | 0.74 | 9.2 | 1.9 | 5.4 | 2.4 | 61 | 68 | ▲ 1MB1553-1DD2 | ■-■■■■■ | 157 | |
| 5.5 | 5.5 | 160 M | 732 | 72 | 86.2 | 87.3 | 86.6 | 0.74 | 12.5 | 2.1 | 5.9 | 2.6 | 61 | 68 | ▲ 1MB1553-1DD3 | ■-■■■■■ | 169 | |
| 7.5 | 7.5 | 160 L | 735 | 98 | 87.3 | 87.9 | 87.0 | 0.77 | 16.1 | 1.8 | 6.3 | 2.7 | 61 | 68 | ▲ 1MB1553-1DD4 | ■-■■■■■ | 183 | |
| 11 | 11 | 180 L | 725 | 145 | 88.6 | 89.7 | 89.6 | 0.74 | 24 | 2.1 | 5.1 | 2.4 | 67 | 82 | ▲ 1MB1553-1ED4 | ■-■■■■■ | 259 | |
| 15 | 15 | 200 L | 730 | 196 | 89.6 | 90.1 | 89.4 | 0.73 | 33.5 | 3 | 6.8 | 3.7 | 65 | 70 | ▲ 1MB1553-2AD5 | ■-■■■■■ | 357 | |
| 18.5 | 18.5 | 225 S | 732 | 241 | 90.1 | 90.6 | 90 | 0.75 | 39.5 | 2.5 | 5.9 | 3 | 56 | 70 | ▲ 1MB1553-2BD0 | ■-■■■■■ | 417 | 0.5 |
| 22 | 22 | 225 M | 732 | 287 | 90.6 | 91.4 | 91.2 | 0.77 | 45.5 | 2.6 | 5.9 | 2.9 | 56 | 70 | ▲ 1MB1553-2BD2 | ■-■■■■■ | 425 | 0.55 |
| 30 | 30 | 250 M | 735 | 390 | 91.3 | 91.8 | 91.5 | 0.79 | 60 | 2.6 | 6.1 | 3 | 60 | 74 | ▲ 1MB1553-2CD2 | ■-■■■■■ | 512 | 0.86 |
| 37 | 37 | 280 S | 736 | 480 | 91.8 | 92.5 | 92.4 | 0.78 | 75 | 2.3 | 5.4 | 2.4 | 63 | 77 | ▲ 1MB1553-2DD0 | ■-■■■■■ | 680 | 1.1 |
| 45 | 45 | 280 M | 738 | 582 | 92.2 | 92.8 | 92.6 | 0.8 | 88 | 2.5 | 5.9 | 2.5 | 65 | 79 | ▲ 1MB1553-2DD2 | ■-■■■■■ | 743 | 1.6 |
| 55 | 55 | 315 S | 744 | 706 | 92.5 | 92.8 | 92.4 | 0.81 | 106 | 2.4 | 6.4 | 2.6 | 67 | 82 | ▲ 1MB5553-3AD0 | ■-■■■■■ | 1020 | 3.14 |
| 75 | 75 | 315 M | 743 | 964 | 93.1 | 93.5 | 93.2 | 0.81 | 144 | 2.5 | 6.3 | 2.6 | 67 | 82 | ▲ 1MB5553-3AD2 | ■-■■■■■ | 1090 | 3.14 |
| 90 | 90 | 315 L | 742 | 1158 | 93.4 | 93.9 | 93.7 | 0.82 | 170 | 2.4 | 6.3 | 2.5 | 67 | 82 | ▲ 1MB5553-3AD4 | ■-■■■■■ | 1150 | 3.76 |
| 110 | 110 | 315 L | 742 | 1416 | 94.7 | 95.1 | 94.9 | 0.82 | 205 | 2.6 | 6.6 | 2.7 | 67 | 82 | ▲ 1MB5553-3AD5 | ■-■■■■■ | 1290 | 4.48 |
| 132 | 132 | 315 L | 741 | 1701 | 94 | 94.4 | 94.2 | 0.82 | 245 | 2.4 | 6 | 2.5 | 67 | 82 | ▲ 1MB5553-3AD6 | ■-■■■■■ | 1370 | 5.1 |
| 160 | 160 | 315 L | 741 | 2062 | 94.3 | 94.7 | 94.7 | 0.79 | 310 | 2.4 | 6.2 | 2.4 | 67 | 82 | ▲ 1MB5553-3AD7 | ■-■■■■■ | 1650 | 6.78 |
| 200 | 200 | 355 M | 744 | 2567 | 94.6 | 95 | 95 | 0.8 | 380 | 2.3 | 7.1 | 2.7 | 73 | 88 | ▲ 1MB5553-3BD0 | ■-■■■■■ | 2340 | 11.3 |
| 250 | 250 | 355 M | 744 | 3209 | 94.6 | 95 | 95 | 0.8 | 475 | 2.4 | 7.2 | 2.9 | 73 | 88 | ▲ 1MB5553-3BD1 | ■-■■■■■ | 2600 | 13.8 |
| 315 | 315 | 355 L | 744 | 4043 | 94.6 | 94.9 | 94.6 | 0.8 | 600 | 2.4 | 7 | 2.9 | 73 | 88 | ▲ 1MB5553-3BD2 | ■-■■■■■ | 2610 | 13.8 |

| Voltagess | Version | Order code |
|---|---------------------------|---------------------------------------|
| 50 Hz 230 VΔ/400 VY | Standard | 2 2 |
| 50 Hz 400 VΔ/690 VY | Standard | 3 4 |
| 50 Hz 500 VY | Without additional charge | 2 7 |
| 50 Hz 500 VΔ | Without additional charge | 4 0 |
| For other voltages and more information, see from page 5/54 | | |
| ... | | 9 0 |
| Types of construction | Version | Order code |
| Without flange IM B3 ²⁾ | Standard | A |
| With flange IM B5 ²⁾ | With additional charge | F |
| With flange IM B14 ²⁾ | With additional charge | K |
| For other types of construction and more information, see from page 5/65 | | |
| Motor protection | Version | Order code |
| Without | Standard | A |
| PTC thermistor with 3 temperature sensors | With additional charge | B |
| For other motor protection and more information, see from page 5/71 | | |
| Terminal box position | Version | Order code |
| Terminal box at top | Standard | 4 |
| For other terminal box positions and more information, see from page 5/76 | | |
| Special versions | | Order code(s) |
| For options, see from page 5/91 | | 1MB.553-... ■-■■■■■-Z ...+...+...+... |

5

¹⁾ Noise values for line operation under load, tolerance +3dB(A).

²⁾ Types derived from IM B3 (IM B6/7/8, IM V6 and IM V5), from IM B5 (IM V3 and IM V1) and from IM B14 (IM V19 and IM V18) are possible. The basic type IM B3, IM B5 or IM B14 is stamped as standard on the rating plate.

SIMOTICS XP 1MB1, 1MB5 explosion-protected motors

Article No. supplements and special versions · Voltages

Aluminum series 1MB10

Selection and ordering data

| Voltages | Article No. | | supplement | Frame size | | | | | | Motor version | | |
|--|--------------|---|--------------------------------------|------------|----|-----|---------|-----|-----|---------------|--|-------------------|
| | Voltage code | 12th and 13th position of the Article No. | | 80 | 90 | 100 | 112 | 132 | 160 | IEC | Ex tb (Zone 21), Ex tc (Zone 22), Ex ec (Zone 2) | IE3 IE2 IE1 |
| | | | | 1MB10.3 | | | | | | | | |
| | | | | 1MB10.1 | | | | | | | | |
| | | | | | | | 1MB10.2 | | | | | |
| | 1MB10-.... | ■ - ■ ... | Order code | | | | | | | | | |
| Voltage at 50 Hz or 60 Hz (50 Hz power) | | | | | | | | | | | | |
| 50 Hz 230 VΔ/400 VY, 60 Hz 460 VY | 2 | 2 | – | □ | □ | □ | □ | □ | □ | | | |
| 50 Hz 400 VΔ/690 VY, 60 Hz 460 VΔ | 3 | 4 | – | □ | □ | □ | □ | □ | □ | | | |
| 50 Hz 500 VY | 2 | 7 | – | ○ | ○ | ○ | ○ | ○ | ○ | | | |
| 50 Hz 500 VΔ | 4 | 0 | – | – | – | – | ○ | ○ | ○ | | | |
| 50 Hz 220 VΔ/380 VY, 60 Hz 440 VY | 2 | 1 | – | ✓ | ✓ | ✓ | ✓ | ✓ | ✓ | | | |
| 50 Hz 380 VΔ/660 VY, 60 Hz 440 VΔ | 3 | 3 | – | ✓ | ✓ | ✓ | ✓ | ✓ | ✓ | | | |
| 50 Hz 240 VΔ/415 VY, 60 Hz 480 VY | 2 | 3 | – | ✓ | ✓ | ✓ | ✓ | ✓ | ✓ | | | |
| 50 Hz 415 VΔ, 60 Hz 480 VΔ | 3 | 5 | – | ✓ | ✓ | ✓ | ✓ | ✓ | ✓ | | | |
| 50 Hz 400 VY, 60 Hz 460 VY ¹⁾ | 0 | 2 | – | ○ | ○ | ○ | ○ | ○ | ○ | | | |
| 50 Hz 400 VΔ, 60 Hz 460 VΔ ²⁾ | 0 | 4 | – | ○ | ○ | ○ | ○ | ○ | ○ | | | |
| 60 Hz 220 VΔ/380 VY | 1 | 7 | – | ✓ | ✓ | ✓ | ✓ | ✓ | ✓ | | Not for: | 1MB10.2 |
| 60 Hz 230 VΔ/400 VY | 1 | 8 | – | ✓ | ✓ | ✓ | ✓ | ✓ | ✓ | | Not for: | 1MB10.2 |
| 60 Hz 380 VΔ/660 VY | 3 | 0 | – | ✓ | ✓ | ✓ | ✓ | ✓ | ✓ | | Not for: | 1MB10.2 |
| 60 Hz 400 VΔ/690 VY | 3 | 1 | – | ✓ | ✓ | ✓ | ✓ | ✓ | ✓ | | Not for: | 1MB10.2 |
| 50 Hz 400 VY | 9 | 0 | M4A | ○ | ○ | ○ | ○ | ○ | ○ | | | |
| 50 Hz 400 VΔ | 9 | 0 | M4B | ○ | ○ | ○ | ○ | ○ | ○ | | | |
| Voltage at 60 Hz (50 Hz power) | | | | | | | | | | | | |
| 220 VΔ/380 VY; 50 Hz power ³⁾ | 9 | 0 | M2A | ✓ | ✓ | ✓ | ✓ | ✓ | ✓ | | | |
| 220 VΔ/380 VY; 60 Hz power | 9 | 0 | M1A | ✓ | ✓ | ✓ | ✓ | ✓ | ✓ | | | |
| 380 VΔ/660 VY; 50 Hz power ³⁾ | 9 | 0 | M2B | ✓ | ✓ | ✓ | ✓ | ✓ | ✓ | | | |
| 380 VΔ/660 VY; 60 Hz power | 9 | 0 | M1B | ✓ | ✓ | ✓ | ✓ | ✓ | ✓ | | | |
| 440 VY; 50 Hz power ³⁾ | 9 | 0 | M2C | ✓ | ✓ | ✓ | ✓ | ✓ | ✓ | | | |
| 440 VY; 60 Hz power | 9 | 0 | M1C | ✓ | ✓ | ✓ | ✓ | ✓ | ✓ | | | |
| 440 VΔ; 50 Hz power ³⁾ | 9 | 0 | M2D | ✓ | ✓ | ✓ | ✓ | ✓ | ✓ | | | |
| 440 VΔ; 60 Hz power | 9 | 0 | M1D | ✓ | ✓ | ✓ | ✓ | ✓ | ✓ | | | |
| 460 VY; 50 Hz power ³⁾ | 9 | 0 | M2E | ✓ | ✓ | ✓ | ✓ | ✓ | ✓ | | | |
| 460 VY; 60 Hz power | 9 | 0 | M1E | ○ | ○ | ○ | ○ | ○ | ○ | | | |
| 460 VΔ; 50 Hz power ³⁾ | 9 | 0 | M2F | ✓ | ✓ | ✓ | ✓ | ✓ | ✓ | | | |
| 460 VΔ; 60 Hz power | 9 | 0 | M1F | ○ | ○ | ○ | ○ | ○ | ○ | | | |
| 575 VY; 50 Hz power ³⁾ | 9 | 0 | M2G | ✓ | ✓ | ✓ | ✓ | ✓ | ✓ | | | |
| 575 VY; 60 Hz power | 9 | 0 | M1G | ✓ | ✓ | ✓ | ✓ | ✓ | ✓ | | | |
| 575 VΔ; 50 Hz power ³⁾ | 9 | 0 | M2H | ✓ | ✓ | ✓ | ✓ | ✓ | ✓ | | | |
| 575 VΔ; 60 Hz power | 9 | 0 | M1H | ✓ | ✓ | ✓ | ✓ | ✓ | ✓ | | | |
| 400 VΔ/690 VY; 50 Hz power ³⁾ | 9 | 0 | M2J | ✓ | ✓ | ✓ | ✓ | ✓ | ✓ | | | |
| 400 VΔ/690 VY; 60 Hz power | 9 | 0 | M1J | ✓ | ✓ | ✓ | ✓ | ✓ | ✓ | | | |
| 480 VY; 50 Hz power ³⁾ | 9 | 0 | M2K | ✓ | ✓ | ✓ | ✓ | ✓ | ✓ | | | |
| 480 VY; 60 Hz power | 9 | 0 | M1K | ✓ | ✓ | ✓ | ✓ | ✓ | ✓ | | | |
| 480 VΔ; 50 Hz power ³⁾ | 9 | 0 | M2L | ✓ | ✓ | ✓ | ✓ | ✓ | ✓ | | | |
| 480 VΔ; 60 Hz power | 9 | 0 | M1L | ✓ | ✓ | ✓ | ✓ | ✓ | ✓ | | | |
| 230 VΔ/400 VY; 50 Hz power ³⁾ | 9 | 0 | M2M | ✓ | ✓ | ✓ | ✓ | ✓ | ✓ | | | |
| 230 VΔ/400 VY; 60 Hz power | 9 | 0 | M1M | ✓ | ✓ | ✓ | ✓ | ✓ | ✓ | | | |
| Voltage at 87 Hz (87 Hz power) | | | | | | | | | | | | |
| 400 VΔ ⁵⁾ | 9 | 0 | M3A | ✓ | ✓ | ✓ | ✓ | ✓ | ✓ | | | |
| Non-standard voltage and/or frequencies | | | | | | | | | | | | |
| Non-standard winding ⁴⁾ | 9 | 0 | M1Y • and customer specifications | ✓ | ✓ | ✓ | ✓ | ✓ | ✓ | | | |

- Standard version
○ Without additional charge
✓ With additional charge

- Not possible
• This order code only determines the price of the version – Additional plain text is required.

1) Delta connection is not possible.
2) Star connection is not possible.
3) A power of 3.7 kW is stamped on the rating plate for versions 1MB1... - 1BA2, 1MB1... - 1BB2, 1MB1... - 1CC2 and 1MB1... - 1DD2 at 60 Hz with 50 Hz power in accordance with the international efficiency classification to IEC 60034-30.

4) Plain text must be specified in the order: Voltage between 200 and 690 V (voltages outside this range are available on request), frequency, circuit, for 60 Hz additionally required rated power in kW.
5) Only possible for 4-pole, 6-pole and 8-pole motors and in combination with the order codes B40 and B41. The operating data for converter operation is also provided in a table on the additional rating plate. The motor contains winding version 50 Hz 230 VΔ.

SIMOTICS XP 1MB1, 1MB5 explosion-protected motors

Article No. supplements and special versions · Voltages

Cast-iron series 1MB15 Basic Line, 1MB16 Performance Line

Selection and ordering data

| Voltages | Article No. supplement | | Frame size | | | | | | | | | | | | | Motor version | | |
|--|--|---|---------------------------------|----|----|-----|-----|-----|-----|-----|-----|-----|-----|-----|-----|---------------|--|------------|
| | Voltage code 12th and 13th position of the Article No. | Additional identification code with order code and plain text if required | 71 | 80 | 90 | 100 | 112 | 132 | 160 | 180 | 200 | 225 | 250 | 280 | 315 | IEC | Ex tb (Zone 21), Ex tc (Zone 22), Ex ec (Zone 2) | IE3 IE2 |
| | | | 1MB15.3 Basic Line | | | | | | | | | | | | | IEC | Ex tb (Zone 21), Ex tc (Zone 22), Ex ec (Zone 2) | IE3 IE2 |
| | | | 1MB16.3 Performance Line | | | | | | | | | | | | | | | |
| | | | 1MB15.1 Basic Line | | | | | | | | | | | | | | | |
| | | | 1MB16.1 Performance Line | | | | | | | | | | | | | | | |
| | 1MB15 | Order code | | | | | | | | | | | | | | | | |
| | 1MB16 | | | | | | | | | | | | | | | | | |
| Voltage at 50 Hz or 60 Hz | | | | | | | | | | | | | | | | | | |
| 50 Hz 230 VΔ/400 VY, 60 Hz 460 VY | 2 | 2 | □ | □ | □ | □ | □ | □ | □ | □ | □ | □ | □ | □ | □ | □ | □ | □ |
| 50 Hz 400 VΔ/690 VY, 60 Hz 460 VΔ | 3 | 4 | □ | □ | □ | □ | □ | □ | □ | □ | □ | □ | □ | □ | □ | □ | □ | □ |
| 50 Hz 400 VY, 60 Hz 460 VY ¹⁾ | 0 | 2 | ○ | ○ | ○ | ○ | ○ | ○ | ○ | ○ | ○ | ○ | ○ | ○ | ○ | ○ | ○ | ○ |
| 50 Hz 400 VΔ, 60 Hz 460 VΔ ²⁾ | 0 | 4 | ○ | ○ | ○ | ○ | ○ | ○ | ○ | ○ | ○ | ○ | ○ | ○ | ○ | ○ | ○ | ○ |
| 50 Hz 500 VY | 2 | 7 | ○ | ○ | ○ | ○ | ○ | ○ | ○ | ○ | ○ | ○ | ○ | ○ | ○ | ○ | ○ | ○ |
| 50 Hz 500 VΔ | 4 | 0 | – | – | – | ○ | ○ | ○ | ○ | ○ | ○ | ○ | ○ | ○ | ○ | ○ | ○ | ○ |
| 50 Hz 220 VΔ/380 VY, 60 Hz 440 VY | 2 | 1 | ✓ | ✓ | ✓ | ✓ | ✓ | ✓ | ✓ | ✓ | ✓ | ✓ | ✓ | ✓ | ✓ | ✓ | ✓ | ✓ |
| 50 Hz 380 VΔ/660 VY, 60 Hz 440 VΔ | 3 | 3 | ✓ | ✓ | ✓ | ✓ | ✓ | ✓ | ✓ | ✓ | ✓ | ✓ | ✓ | ✓ | ✓ | ✓ | ✓ | ✓ |
| 50 Hz 240 VΔ/415 VY, 60 Hz 480 VY | 2 | 3 | ✓ | ✓ | ✓ | ✓ | ✓ | ✓ | ✓ | ✓ | ✓ | ✓ | ✓ | ✓ | ✓ | ✓ | ✓ | ✓ |
| 50 Hz 415 VΔ, 60 Hz 480 VΔ | 3 | 5 | ✓ | ✓ | ✓ | ✓ | ✓ | ✓ | ✓ | ✓ | ✓ | ✓ | ✓ | ✓ | ✓ | ✓ | ✓ | ✓ |
| 60 Hz 220 VΔ/380 VY | 1 | 7 | ✓ | ✓ | ✓ | ✓ | ✓ | ✓ | ✓ | ✓ | ✓ | ✓ | ✓ | ✓ | ✓ | ✓ | ✓ | ✓ |
| 60 Hz 230 VΔ/400 VY | 1 | 8 | ✓ | ✓ | ✓ | ✓ | ✓ | ✓ | ✓ | ✓ | ✓ | ✓ | ✓ | ✓ | ✓ | ✓ | ✓ | ✓ |
| 60 Hz 380 VΔ/660 VY | 3 | 0 | ✓ | ✓ | ✓ | ✓ | ✓ | ✓ | ✓ | ✓ | ✓ | ✓ | ✓ | ✓ | ✓ | ✓ | ✓ | ✓ |
| 60 Hz 400 VΔ/690 VY | 3 | 1 | ✓ | ✓ | ✓ | ✓ | ✓ | ✓ | ✓ | ✓ | ✓ | ✓ | ✓ | ✓ | ✓ | ✓ | ✓ | ✓ |
| 50 Hz 400 VY | 9 | 0 | ○ | ○ | ○ | ○ | ○ | ○ | ○ | ○ | ○ | ○ | ○ | ○ | ○ | ○ | ○ | ○ |
| 50 Hz 400 VΔ | 9 | 0 | ○ | ○ | ○ | ○ | ○ | ○ | ○ | ○ | ○ | ○ | ○ | ○ | ○ | ○ | ○ | ○ |
| Voltage at 60 Hz and required power | | | | | | | | | | | | | | | | | | |
| 220 VΔ/380 VY; 50 Hz power ³⁾ | 9 | 0 | ✓ | ✓ | ✓ | ✓ | ✓ | ✓ | ✓ | ✓ | ✓ | ✓ | ✓ | ✓ | ✓ | ✓ | ✓ | ✓ |
| 220 VΔ/380 VY; 60 Hz power | 9 | 0 | ✓ | ✓ | ✓ | ✓ | ✓ | ✓ | ✓ | ✓ | ✓ | ✓ | ✓ | ✓ | ✓ | ✓ | ✓ | ✓ |
| 380 VΔ/660 VY; 50 Hz power ³⁾ | 9 | 0 | – | – | – | ✓ | ✓ | ✓ | ✓ | ✓ | ✓ | ✓ | ✓ | ✓ | ✓ | ✓ | ✓ | ✓ |
| 380 VΔ/660 VY; 60 Hz power | 9 | 0 | – | – | – | ✓ | ✓ | ✓ | ✓ | ✓ | ✓ | ✓ | ✓ | ✓ | ✓ | ✓ | ✓ | ✓ |
| 440 VY; 50 Hz power ³⁾ | 9 | 0 | – | – | – | ✓ | ✓ | ✓ | ✓ | ✓ | ✓ | ✓ | ✓ | ✓ | ✓ | ✓ | ✓ | ✓ |
| 440 VY; 60 Hz power | 9 | 0 | – | – | – | ✓ | ✓ | ✓ | ✓ | ✓ | ✓ | ✓ | ✓ | ✓ | ✓ | ✓ | ✓ | ✓ |
| 440 VΔ; 50 Hz power ³⁾ | 9 | 0 | – | – | – | ✓ | ✓ | ✓ | ✓ | ✓ | ✓ | ✓ | ✓ | ✓ | ✓ | ✓ | ✓ | ✓ |
| 440 VΔ; 60 Hz power | 9 | 0 | – | – | – | ✓ | ✓ | ✓ | ✓ | ✓ | ✓ | ✓ | ✓ | ✓ | ✓ | ✓ | ✓ | ✓ |
| 460 VY; 50 Hz power ³⁾ | 9 | 0 | – | – | – | ✓ | ✓ | ✓ | ✓ | ✓ | ✓ | ✓ | ✓ | ✓ | ✓ | ✓ | ✓ | ✓ |
| 460 VY; 60 Hz power | 9 | 0 | – | – | – | ○ | ○ | ○ | ○ | ○ | ○ | ○ | ○ | ○ | ○ | ○ | ○ | ○ |
| 460 VΔ; 50 Hz power ³⁾ | 9 | 0 | – | – | – | ✓ | ✓ | ✓ | ✓ | ✓ | ✓ | ✓ | ✓ | ✓ | ✓ | ✓ | ✓ | ✓ |
| 460 VΔ; 60 Hz power | 9 | 0 | – | – | – | ○ | ○ | ○ | ○ | ○ | ○ | ○ | ○ | ○ | ○ | ○ | ○ | ○ |
| 575 VY; 50 Hz power ³⁾ | 9 | 0 | – | – | – | ✓ | ✓ | ✓ | ✓ | ✓ | ✓ | ✓ | ✓ | ✓ | ✓ | ✓ | ✓ | ✓ |
| 575 VY; 60 Hz power | 9 | 0 | – | – | – | ✓ | ✓ | ✓ | ✓ | ✓ | ✓ | ✓ | ✓ | ✓ | ✓ | ✓ | ✓ | ✓ |
| 575 VΔ; 50 Hz power ³⁾ | 9 | 0 | – | – | – | ✓ | ✓ | ✓ | ✓ | ✓ | ✓ | ✓ | ✓ | ✓ | ✓ | ✓ | ✓ | ✓ |
| 575 VΔ; 60 Hz power | 9 | 0 | – | – | – | ✓ | ✓ | ✓ | ✓ | ✓ | ✓ | ✓ | ✓ | ✓ | ✓ | ✓ | ✓ | ✓ |
| 400 VΔ/690 VY; 50 Hz power ³⁾ | 9 | 0 | ✓ | ✓ | ✓ | ✓ | ✓ | ✓ | ✓ | ✓ | ✓ | ✓ | ✓ | ✓ | ✓ | ✓ | ✓ | ✓ |
| 400 VΔ/690 VY; 60 Hz power | 9 | 0 | ✓ | ✓ | ✓ | ✓ | ✓ | ✓ | ✓ | ✓ | ✓ | ✓ | ✓ | ✓ | ✓ | ✓ | ✓ | ✓ |
| 480 VY; 50 Hz power ³⁾ | 9 | 0 | ✓ | ✓ | ✓ | ✓ | ✓ | ✓ | ✓ | ✓ | ✓ | ✓ | ✓ | ✓ | ✓ | ✓ | ✓ | ✓ |
| 480 VY; 60 Hz power | 9 | 0 | ✓ | ✓ | ✓ | ✓ | ✓ | ✓ | ✓ | ✓ | ✓ | ✓ | ✓ | ✓ | ✓ | ✓ | ✓ | ✓ |
| 480 VΔ; 50 Hz power ³⁾ | 9 | 0 | ✓ | ✓ | ✓ | ✓ | ✓ | ✓ | ✓ | ✓ | ✓ | ✓ | ✓ | ✓ | ✓ | ✓ | ✓ | ✓ |
| 480 VΔ; 60 Hz power | 9 | 0 | ✓ | ✓ | ✓ | ✓ | ✓ | ✓ | ✓ | ✓ | ✓ | ✓ | ✓ | ✓ | ✓ | ✓ | ✓ | ✓ |
| 230 VΔ/400 VY; 50 Hz power ³⁾ | 9 | 0 | ✓ | ✓ | ✓ | ✓ | ✓ | ✓ | ✓ | ✓ | ✓ | ✓ | ✓ | ✓ | ✓ | ✓ | ✓ | ✓ |
| 230 VΔ/400 VY; 60 Hz power | 9 | 0 | ✓ | ✓ | ✓ | ✓ | ✓ | ✓ | ✓ | ✓ | ✓ | ✓ | ✓ | ✓ | ✓ | ✓ | ✓ | ✓ |
| Voltage at 87 Hz (87 Hz power) | | | | | | | | | | | | | | | | | | |
| 400 VΔ ⁵⁾ | 9 | 0 | ✓ | ✓ | ✓ | ✓ | ✓ | ✓ | ✓ | ✓ | ✓ | – | – | – | – | – | – | – |
| Non-standard voltage and/or frequencies | | | | | | | | | | | | | | | | | | |
| Non-standard winding ⁴⁾ | 9 | 0 | ✓ | ✓ | ✓ | ✓ | ✓ | ✓ | ✓ | ✓ | ✓ | ✓ | ✓ | ✓ | ✓ | ✓ | ✓ | ✓ |

- Standard version
- Without additional charge
- ✓ With additional charge
- Not possible
- This order code only determines the price of the version – Additional plain text is required.

1) Delta connection is not possible.
 2) Star connection is not possible.
 3) A power of 3.7 kW is stamped on the rating plate for versions 1MB1... - 1BA2, 1MB1... - 1BB2, 1MB1... - 1CC2 and 1MB1... - 1DD2 at 60 Hz with 50 Hz power in accordance with the international efficiency classification to IEC 60034-30.
 4) Plain text must be specified in the order: Voltage between 200 and 690 V (voltages outside the range on request). Frequency, connection, for 60 Hz, additionally required rated power in kW.
 5) Only possible for 4-pole, 6-pole and 8-pole motors and in combination with the order codes **B40** and **B41**. The operating data for converter operation is also provided in a table on the additional rating plate. The motor contains winding version 50 Hz 230 VΔ.

5

SIMOTICS XP 1MB1, 1MB5 explosion-protected motors

Article No. supplements and special versions · Voltages

Cast-iron series 1MB1543, 1MB5543 Basic Line and 1MB1643, 1MB5643 Performance Line

Selection and ordering data

| Voltages | Article No. supplement | | Frame size | | | | | | | | | | | | | Motor version | | |
|--|--|---|--------------------------|----|----|-----|-----|-----|-----|-----|-----|-----|-----|-----|-----|---------------|----------------|-----|
| | Voltage code 12th and 13th position of the Article No. | Additional identification code with order code and plain text if required | 71 | 80 | 90 | 100 | 112 | 132 | 160 | 180 | 200 | 225 | 250 | 280 | 315 | IEC | Ex eb (Zone 1) | IE3 |
| | | | 1MB1543 Basic Line | | | | | | | | | | | | | | | |
| | | | 1MB1643 Performance Line | | | | | | | | | | | | | | | |
| | | | 1MB5543 Basic Line | | | | | | | | | | | | | | | |
| | | | 1MB5643 Performance Line | | | | | | | | | | | | | | | |
| | 1MB1543 - - | | | | | | | | | | | | | | | | | |
| | 1MB1643 - - | | | | | | | | | | | | | | | | | |
| | 1MB5543 - - | | | | | | | | | | | | | | | | | |
| | 1MB5643 - - | | | | | | | | | | | | | | | | | |
| | | Order code | | | | | | | | | | | | | | | | |
| Voltage at 50 Hz or 60 Hz ³⁾ | | | | | | | | | | | | | | | | | | |
| 50 Hz 230 VΔ/400 VY | 2 2 | - | □ | □ | □ | □ | □ | □ | □ | □ | □ | □ | □ | □ | □ | □ | □ | □ |
| 50 Hz 400 VΔ/690 VY | 3 4 | - | □ | □ | □ | □ | □ | □ | □ | □ | □ | □ | □ | □ | □ | □ | □ | □ |
| 50 Hz 500 VY | 2 7 | - | ○ | ○ | ○ | ○ | ○ | ○ | ○ | ○ | ○ | ○ | ○ | ○ | ○ | ○ | ○ | ○ |
| 50 Hz 500 VΔ ¹⁾ | 4 0 | - | - | - | - | ○ | ○ | ○ | ○ | ○ | ○ | ○ | ○ | ○ | ○ | ○ | ○ | ○ |
| 50 Hz 220 VΔ/380 VY | 2 1 | - | ✓ | ✓ | ✓ | ✓ | ✓ | ✓ | ✓ | ✓ | ✓ | ✓ | ✓ | ✓ | ✓ | ✓ | ✓ | ✓ |
| 50 Hz 230 VΔ | 0 1 | - | ○ | ○ | ○ | ○ | ○ | ○ | ○ | ○ | ○ | ○ | ○ | ○ | ○ | ○ | ○ | ○ |
| 50 Hz 380 VΔ/660 VY | 3 3 | - | ✓ | ✓ | ✓ | ✓ | ✓ | ✓ | ✓ | ✓ | ✓ | ✓ | ✓ | ✓ | ✓ | ✓ | ✓ | ✓ |
| 50 Hz 240 VΔ ¹⁾ | 2 3 | - | ✓ | ✓ | ✓ | ✓ | ✓ | ✓ | ✓ | ✓ | ✓ | ✓ | ✓ | ✓ | ✓ | ✓ | ✓ | ✓ |
| 50 Hz 415 VΔ | 3 5 | - | ✓ | ✓ | ✓ | ✓ | ✓ | ✓ | ✓ | ✓ | ✓ | ✓ | ✓ | ✓ | ✓ | ✓ | ✓ | ✓ |
| 50 Hz 400 VY | 9 0 | M4A | ○ | ○ | ○ | ○ | ○ | ○ | ○ | ○ | ○ | ○ | ○ | ○ | ○ | ○ | ○ | ○ |
| 50 Hz 400 VΔ | 9 0 | M4B | ○ | ○ | ○ | ○ | ○ | ○ | ○ | ○ | ○ | ○ | ○ | ○ | ○ | ○ | ○ | ○ |
| Voltage at 60 Hz and required power | | | | | | | | | | | | | | | | | | |
| 220 VΔ/380 VY; 50 Hz power | 9 0 | M2A | ✓ | ✓ | ✓ | ✓ | ✓ | ✓ | ✓ | ✓ | ✓ | ✓ | ✓ | ✓ | ✓ | ✓ | ✓ | ✓ |
| 380 VΔ/660 VY; 50 Hz power ²⁾ | 9 0 | M2B | ✓ | ✓ | ✓ | ✓ | ✓ | ✓ | ✓ | ✓ | ✓ | ✓ | ✓ | ✓ | ✓ | ✓ | ✓ | ✓ |
| 440 VY; 50 Hz power | 9 0 | M2C | ✓ | ✓ | ✓ | ✓ | ✓ | ✓ | ✓ | ✓ | ✓ | ✓ | ✓ | ✓ | ✓ | ✓ | ✓ | ✓ |
| 440 VΔ; 50 Hz power | 9 0 | M2D | ✓ | ✓ | ✓ | ✓ | ✓ | ✓ | ✓ | ✓ | ✓ | ✓ | ✓ | ✓ | ✓ | ✓ | ✓ | ✓ |
| 460 VY; 50 Hz power | 9 0 | M2E | ✓ | ✓ | ✓ | ✓ | ✓ | ✓ | ✓ | ✓ | ✓ | ✓ | ✓ | ✓ | ✓ | ✓ | ✓ | ✓ |
| 460 VΔ; 50 Hz power | 9 0 | M2F | ✓ | ✓ | ✓ | ✓ | ✓ | ✓ | ✓ | ✓ | ✓ | ✓ | ✓ | ✓ | ✓ | ✓ | ✓ | ✓ |
| 575 VY; 50 Hz power ²⁾ | 9 0 | M2G | ✓ | ✓ | ✓ | ✓ | ✓ | ✓ | ✓ | ✓ | ✓ | ✓ | ✓ | ✓ | ✓ | ✓ | ✓ | ✓ |
| 575 VΔ; 50 Hz power | 9 0 | M2H | ✓ | ✓ | ✓ | ✓ | ✓ | ✓ | ✓ | ✓ | ✓ | ✓ | ✓ | ✓ | ✓ | ✓ | ✓ | ✓ |
| Non-standard voltage and/or frequencies | | | | | | | | | | | | | | | | | | |
| Non-standard winding ²⁾ | 9 0 | M1Y • and customer specifications | ✓ | ✓ | ✓ | ✓ | ✓ | ✓ | ✓ | ✓ | ✓ | ✓ | ✓ | ✓ | ✓ | ✓ | ✓ | ✓ |

- Standard version
- Without additional charge
- ✓ With additional charge
- Not possible
- This order code only determines the price of the version – Additional plain text is required.

¹⁾ Special certification is required for 60 Hz.

²⁾ Plain text must be specified in the order: Voltage between 200 V and 690 V (voltages outside this range are available on request), frequency, circuit, for 60 Hz additionally required rated power in kW.

³⁾ Motors in these frame sizes have a second rating plate (T1/T2 and T3) as standard. The T3 power is stamped on the rating plate as standard if the following motors are selected with PTC thermistor (protection by PTC thermistor only) or voltage code **90**:
 – 2-pole motors: Frame sizes 132 to 160
 – 4-pole motors: Frame size 180
 Alternatively, with order code **B33**, the "T1/T2 power is stamped on the rating plate".
 – 2-pole motors: Frame sizes 132 to 200
 – 4-pole motors: Frame sizes 180 to 200

SIMOTICS XP 1MB1, 1MB5 explosion-protected motors

Article No. supplements and special versions · Voltages

Cast-iron series 1MB1553, 1MB5553

Selection and ordering data

| Voltages | Article No. supplement | | Frame size | | | | | | | | | | | | | Motor version | | | | | |
|--|--|---|-----------------------------------|----|----|-----|-----|-----|-----|-----|---------|-----|-----|-----|-----|---------------|-----|-------|----------|--------------|--|
| | Voltage code 12th and 13th position of the Article No. | Additional identification code with order code and plain text if required | 71 | 80 | 90 | 100 | 112 | 132 | 160 | 180 | 200 | 225 | 250 | 280 | 315 | 355 | IEC | Ex db | Ex db eb | IE3 (Zone 1) | |
| | | | 1MB1553 | | | | | | | | | | | | | | | | | | |
| | | | | | | | | | | | 1MB5553 | | | | | | | | | | |
| | 1MB.553 - | | | | | | | | | | | | | | | | | | | | |
| Voltage at 50 Hz or 60 Hz | | | | | | | | | | | | | | | | | | | | | |
| 50 Hz 230 VΔ/400 VY, 60 Hz 460 VY | 2 | 2 | – | □ | □ | □ | □ | □ | □ | □ | □ | □ | □ | □ | □ | – | – | | | | |
| 50 Hz 400 VΔ/690 VY, 60 Hz 460 VΔ | 3 | 4 | – | □ | □ | □ | □ | □ | □ | □ | □ | □ | □ | □ | □ | □ | □ | | | | |
| 50 Hz 500 VY | 2 | 7 | – | ○ | ○ | ○ | ○ | ○ | ○ | ○ | ○ | ○ | ○ | ○ | ○ | – | – | | | | |
| 50 Hz 500 VΔ | 4 | 0 | – | – | – | ○ | ○ | ○ | ○ | ○ | ○ | ○ | ○ | ○ | ○ | ○ | ○ | | | | |
| 50 Hz 220 VΔ/380 VY, 60 Hz 440 VY | 2 | 1 | – | ✓ | ✓ | ✓ | ✓ | ✓ | ✓ | ✓ | ✓ | ✓ | ✓ | ✓ | ✓ | – | – | | | | |
| 50 Hz 380 VΔ/660 VY, 60 Hz 440 VΔ | 3 | 3 | – | ✓ | ✓ | ✓ | ✓ | ✓ | ✓ | ✓ | ✓ | ✓ | ✓ | ✓ | ✓ | ✓ | ✓ | | | | |
| 50 Hz 240 VΔ/415 VY, 60 Hz 480 VY | 2 | 3 | – | ✓ | ✓ | ✓ | ✓ | ✓ | ✓ | ✓ | ✓ | ✓ | ✓ | ✓ | ✓ | – | – | | | | |
| 50 Hz 415 VΔ, 60 Hz 480 VΔ | 3 | 5 | – | ✓ | ✓ | ✓ | ✓ | ✓ | ✓ | ✓ | ✓ | ✓ | ✓ | ✓ | ✓ | ✓ | ✓ | | | | |
| 50 Hz 400 VY | 9 | 0 | M4A | ○ | ○ | ○ | ○ | ○ | ○ | ○ | ○ | ○ | ○ | ○ | ○ | – | – | | | | |
| 50 Hz 400 VΔ | 9 | 0 | M4B | ○ | ○ | ○ | ○ | ○ | ○ | ○ | ○ | ○ | ○ | ○ | ○ | ○ | ○ | | | | |
| 50 Hz 230 VΔ | 0 | 1 | – | ○ | ○ | ○ | ○ | ○ | ○ | ○ | ○ | ○ | ○ | ○ | ○ | – | – | | | | |
| 50 Hz 400 VY ¹⁾ | 0 | 2 | – | ○ | ○ | ○ | ○ | ○ | ○ | ○ | ○ | ○ | ○ | ○ | ○ | – | – | | | | |
| 50 Hz 400 VΔ ²⁾ | 0 | 4 | – | ○ | ○ | ○ | ○ | ○ | ○ | ○ | ○ | ○ | ○ | ○ | ○ | ○ | ○ | | | | |
| Voltage at 60 Hz and required power | | | | | | | | | | | | | | | | | | | | | |
| 220 VΔ/380 VY; 50 Hz power ³⁾ | 9 | 0 | M2A | ✓ | ✓ | ✓ | ✓ | ✓ | ✓ | ✓ | ✓ | ✓ | ✓ | ✓ | ✓ | – | – | | | | |
| 380 VΔ/660 VY; 50 Hz power ³⁾ | 9 | 0 | M2B | – | – | – | ✓ | ✓ | ✓ | ✓ | ✓ | ✓ | ✓ | ✓ | ✓ | ✓ | ✓ | | | | |
| 440 VY; 50 Hz power ³⁾ | 9 | 0 | M2C | ✓ | ✓ | ✓ | ✓ | ✓ | ✓ | ✓ | ✓ | ✓ | ✓ | ✓ | ✓ | – | – | | | | |
| 440 VΔ; 50 Hz power ³⁾ | 9 | 0 | M2D | ✓ | ✓ | ✓ | ✓ | ✓ | ✓ | ✓ | ✓ | ✓ | ✓ | ✓ | ✓ | ✓ | ✓ | | | | |
| 460 VY; 50 Hz power ³⁾ | 9 | 0 | M2E | ✓ | ✓ | ✓ | ✓ | ✓ | ✓ | ✓ | ✓ | ✓ | ✓ | ✓ | ✓ | – | – | | | | |
| 460 VΔ; 50 Hz power ³⁾ | 9 | 0 | M2F | ✓ | ✓ | ✓ | ✓ | ✓ | ✓ | ✓ | ✓ | ✓ | ✓ | ✓ | ✓ | ✓ | ✓ | | | | |
| 575 VY; 50 Hz power ³⁾ | 9 | 0 | M2G | – | – | – | ✓ | ✓ | ✓ | ✓ | ✓ | ✓ | ✓ | ✓ | ✓ | – | – | | | | |
| 575 VΔ; 50 Hz power ³⁾ | 9 | 0 | M2H | – | – | – | ✓ | ✓ | ✓ | ✓ | ✓ | ✓ | ✓ | ✓ | ✓ | ✓ | ✓ | | | | |
| Voltage at 87 Hz (87 Hz power) | | | | | | | | | | | | | | | | | | | | | |
| 400 VΔ ⁵⁾ | 9 | 0 | M3A | ✓ | ✓ | ✓ | ✓ | ✓ | ✓ | ✓ | ✓ | – | – | – | – | – | – | | | | |
| Non-standard voltage and/or frequencies | | | | | | | | | | | | | | | | | | | | | |
| Non-standard winding ⁴⁾ | 9 | 0 | M1Y • and customer specifications | ✓ | ✓ | ✓ | ✓ | ✓ | ✓ | ✓ | ✓ | ✓ | ✓ | ✓ | ✓ | ✓ | ✓ | | | | |

- Standard version
- Without additional charge
- ✓ With additional charge
- Not possible
- This order code only determines the price of the version
 - Additional plain text is required.

1) Delta connection is not possible.

2) Star connection is not possible.

3) Power at 60 Hz according to the specification in the selection and ordering data of the basic motor.

4) Plain text must be specified in the order: Voltage between 200 and 690 V (voltages outside this range are available on request), frequency, circuit, for 60 Hz additionally required rated power in kW.

5) Only possible for 4-pole, 6-pole and 8-pole motors and in combination with the order codes **B40** and **B41**. The operating data for converter operation is also provided in a table on the additional rating plate. The motor contains winding version 50 Hz 230 VΔ.

SIMOTICS XP 1MB1, 1MB5 explosion-protected motors

Article No. supplements and special versions · Voltages

Cast-iron series 1MB55.4, 1MB55.3, 1MB58.3

Selection and ordering data

| Voltages | Article No. supplement | | Frame size | Motor version | | | | |
|--|--|--|---|---------------------------------|------------------------------|-----|--|------------|
| | Voltage code 12th and 13th position of the Article No. | Additional identification code with order code and plain text, if required | | $P_{rated} \leq 630 \text{ kW}$ | $P_{rated} > 630 \text{ kW}$ | IEC | Ex ec, Ex tc, Ex tb (Zones 2, 22 and 21) | IE4 IE3 |
| 1MB5 | ■ - ■ | Order code | 400, 450 | 1MB55 . 4 | | | | |
| Voltage at 50 Hz or 60 Hz | | | | | | | | |
| 50 Hz 400 VΔ/690 VY, 60 Hz 460 VΔ | 3 | 4 | – | □ | O. R. | | | |
| 50 Hz 500 VΔ | 4 | 0 | – | ○ | ○ | | | |
| 60 Hz 575 VΔ | | | | ○ | □ ²⁾ | | | |
| 50 Hz 690 VΔ | 4 | 7 | – | ✓ | □ | | | |
| 50 Hz 380 VΔ/660 VY, 60 Hz 440 VΔ | 3 | 3 | – | ✓ | O. R. | | | |
| 50 Hz 415 VΔ, 60 Hz 480 VΔ | 3 | 5 | – | ✓ | O. R. | | | |
| 50 Hz 600 VΔ, 60 Hz 690 VΔ | 4 | 4 | – | ✓ | ✓ | | | |
| 50 Hz 660 VΔ | 4 | 6 | – | ✓ | ✓ | | | |
| Voltage at 50 Hz and required power | | | | | | | | |
| 400 VΔ; 50 Hz power | 9 | 0 | M4B | ✓ | O. R. | | | |
| Voltage at 60 Hz and required power | | | | | | | | |
| 440 VΔ; 60 Hz power | 9 | 0 | M1D | ✓ | O. R. | | | |
| 460 VΔ; 60 Hz power | 9 | 0 | M1F | ✓ | O. R. | | | |
| 575 VΔ; 60 Hz power | 9 | 0 | M1H | ✓ | ✓ ²⁾ | | | |
| 400 VΔ/690 VY; 60 Hz power | 9 | 0 | M1J | O. R. | O. R. | | | |
| 480 VΔ; 60 Hz power | 9 | 0 | M1L | ✓ | O. R. | | | |
| 440 VΔ; 50 Hz power | 9 | 0 | M2D | ✓ | O. R. | | | |
| 460 VΔ; 50 Hz power | 9 | 0 | M2F | ✓ | O. R. | | | |
| 575 VΔ; 50 Hz power | 9 | 0 | M2H | ✓ | ✓ ²⁾ | | | |
| 400 VΔ/690 VY; 50 Hz power | 9 | 0 | M2J | O. R. | O. R. | | | |
| 480 VΔ; 50 Hz power | 9 | 0 | M2L | ✓ | O. R. | | | |
| Non-standard voltage and/or frequencies | | | | | | | | |
| Non-standard winding ¹⁾ | 9 | 0 | M1Y • and customer specifications | ✓ | ✓ | | | |

- Standard version
- Without additional charge
- This order code only determines the price of the version – Additional plain text is required.
- O. R. Possible on request
- ✓ With additional charge

¹⁾ Plain text must be specified in the order: Voltage between 380 and 690 V (voltages outside this range are available on request), frequency, circuit, rated power in kW.







²⁾ 2-pole version, frame size 450 for 60 Hz operation on request.

SIMOTICS XP 1MB1, 1MB5 explosion-protected motors

Article No. supplements and special versions · Types of construction

Aluminum series 1MB10

Selection and ordering data







| Types of construction | Article No. supplement | Type of construction code letter | For types of construction with order code(s) | Frame size | | | | | | Motor version | |
|--|------------------------|---|---|------------|-------------------------------------|-------------------------------------|-------------------------------------|-------------------------------------|-------------------------------------|--|-----|
| | | | | 80 | 90 | 100 | 112 | 132 | 160 | | |
| | | 14th position of the Article No. | Article No. with additional identification code -Z | 1MB10.3 | | | | | | IEC Ex tb (Zone 21), Ex tc (Zone 22), Ex ec (Zone 2) | IE3 |
| | | | | 1MB10.1 | | | | | | | IE2 |
| | | | | | | 1MB10.2 | | | | | IE1 |
| 1MB10 (-Z) | | | | | | | | | | | |
| Without flange | | | | | | | | | | | |
| IM B3 | |  | A | - | <input type="checkbox"/> | <input type="checkbox"/> | <input type="checkbox"/> | <input type="checkbox"/> | <input type="checkbox"/> | <input type="checkbox"/> | |
| IM B6 ¹⁾ | |  | T | - | <input type="checkbox"/> | <input type="checkbox"/> | <input type="checkbox"/> | <input type="checkbox"/> | <input type="checkbox"/> | <input type="checkbox"/> | |
| IM B7 ¹⁾ | |  | U | - | <input type="checkbox"/> | <input type="checkbox"/> | <input type="checkbox"/> | <input type="checkbox"/> | <input type="checkbox"/> | <input type="checkbox"/> | |
| IM B8 ¹⁾ | |  | V | - | <input type="checkbox"/> | <input type="checkbox"/> | <input type="checkbox"/> | <input type="checkbox"/> | <input type="checkbox"/> | <input type="checkbox"/> | |
| IM V6 ¹⁾ | |  | D | - | <input type="checkbox"/> | <input type="checkbox"/> | <input type="checkbox"/> | <input type="checkbox"/> | <input type="checkbox"/> | <input type="checkbox"/> | |
| IM V5 with protective cover ^{1) 2)} | |  | C | H00 | <input checked="" type="checkbox"/> | <input checked="" type="checkbox"/> | <input checked="" type="checkbox"/> | <input checked="" type="checkbox"/> | <input checked="" type="checkbox"/> | <input checked="" type="checkbox"/> | |

SIMOTICS XP 1MB1, 1MB5 explosion-protected motors

Article No. supplements and special versions · Types of construction

Cast-iron series 1MB15 Basic Line, 1MB16 Performance Line







Selection and ordering data

| Types of construction | Article No. supplement | Type of construction code letter 14th position of the Article No. | For types of construction with order code(s) Article No. with additional identification code -Z | Frame size | | | | | | | | | | | | | | Motor version |
|---|---|--|--|-------------------------------------|-------------------------------------|-------------------------------------|-------------------------------------|-------------------------------------|-------------------------------------|-------------------------------------|-------------------------------------|-------------------------------------|-------------------------------------|-------------------------------------|-------------------------------------|-------------------------------------|-------|---|
| | | | | 71 | 80 | 90 | 100 | 112 | 132 | 160 | 180 | 200 | 225 | 250 | 280 | 315 S/M | 315 L | |
| | | | | 1MB15.3 Basic Line | | | | | | | | | | | | | | IEC Ex tb (Zone 21), IE3 Ex tc (Zone 22), Ex ec (Zone 2) IE2 |
| | | | | 1MB16.3 Performance Line | | | | | | | | | | | | | | |
| | | | | 1MB15.1 Basic Line | | | | | | | | | | | | | | |
| | | | | 1MB16.1 Performance Line | | | | | | | | | | | | | | |
| 1MB15 | | .. (-Z) | | | | | | | | | | | | | | | | |
| 1MB16 | | .. (-Z) | Order code | | | | | | | | | | | | | | | |
| Without flange | | | | | | | | | | | | | | | | | | |
| IM B3 |  | A | - | <input type="checkbox"/> | <input type="checkbox"/> | <input type="checkbox"/> | <input type="checkbox"/> | <input type="checkbox"/> | <input type="checkbox"/> | <input type="checkbox"/> | <input type="checkbox"/> | <input type="checkbox"/> | <input type="checkbox"/> | <input type="checkbox"/> | <input type="checkbox"/> | <input type="checkbox"/> | | |
| IM B6 1) |  | T | - | <input type="checkbox"/> | <input type="checkbox"/> | <input type="checkbox"/> | <input type="checkbox"/> | <input type="checkbox"/> | <input type="checkbox"/> | <input type="checkbox"/> | <input type="checkbox"/> | <input type="checkbox"/> | <input type="checkbox"/> | <input type="checkbox"/> | <input type="checkbox"/> | <input type="checkbox"/> | | |
| IM B7 1) |  | U | - | <input type="checkbox"/> | <input type="checkbox"/> | <input type="checkbox"/> | <input type="checkbox"/> | <input type="checkbox"/> | <input type="checkbox"/> | <input type="checkbox"/> | <input type="checkbox"/> | <input type="checkbox"/> | <input type="checkbox"/> | <input type="checkbox"/> | <input type="checkbox"/> | <input type="checkbox"/> | | |
| IM B8 1) |  | V | - | <input type="checkbox"/> | <input type="checkbox"/> | <input type="checkbox"/> | <input type="checkbox"/> | <input type="checkbox"/> | <input type="checkbox"/> | <input type="checkbox"/> | <input type="checkbox"/> | <input type="checkbox"/> | <input type="checkbox"/> | <input type="checkbox"/> | <input type="checkbox"/> | <input type="checkbox"/> | | |
| IM V6 1) |  | D | - | <input type="checkbox"/> | <input type="checkbox"/> | <input type="checkbox"/> | <input type="checkbox"/> | <input type="checkbox"/> | <input type="checkbox"/> | <input type="checkbox"/> | <input type="checkbox"/> | <input type="checkbox"/> | <input type="checkbox"/> | <input type="checkbox"/> | <input type="checkbox"/> | <input type="checkbox"/> | | |
| IM V5 with protective cover 1) 2) |  | C | H00 | <input checked="" type="checkbox"/> | <input checked="" type="checkbox"/> | <input checked="" type="checkbox"/> | <input checked="" type="checkbox"/> | <input checked="" type="checkbox"/> | <input checked="" type="checkbox"/> | <input checked="" type="checkbox"/> | <input checked="" type="checkbox"/> | <input checked="" type="checkbox"/> | <input checked="" type="checkbox"/> | <input checked="" type="checkbox"/> | <input checked="" type="checkbox"/> | <input checked="" type="checkbox"/> | | |

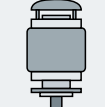
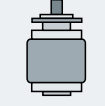
SIMOTICS XP 1MB1, 1MB5 explosion-protected motors

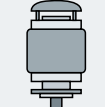
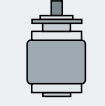
Article No. supplements and special versions · Types of construction

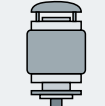
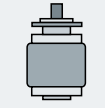
Cast-iron series 1MB15 Basic Line, 1MB16 Performance Line











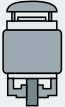

| Types of construction | Article No. | supplement | Frame size | | | | | | | | | | | | | | Motor version | |
|-----------------------------------|---|---|--------------------------|-------|-------|-------|-------|-------|-------|-------|-------|-------|-------|-------|---------|-------|--|------------|
| | | | 71 | 80 | 90 | 100 | 112 | 132 | 160 | 180 | 200 | 225 | 250 | 280 | 315 S/M | 315 L | | |
| | | For types of construction with order code(s) Article No. with additional identification code -Z | 1MB15.3 Basic Line | | | | | | | | | | | | | | IEC Ex tb (Zone 21), Ex tc (Zone 22), Ex ec (Zone 2) | IE3 IE2 |
| | | | 1MB16.3 Performance Line | | | | | | | | | | | | | | | |
| | | | 1MB15.1 Basic Line | | | | | | | | | | | | | | | |
| | | | 1MB16.1 Performance Line | | | | | | | | | | | | | | | |
| 1MB15 | ■ .. (-Z) | | | | | | | | | | | | | | | | | |
| 1MB16 | ■ .. (-Z) | Order code | | | | | | | | | | | | | | | | |
| With flange | Acc. to EN 50347 | Acc. to DIN 42 948 | FF130 | FF165 | FF165 | FF215 | FF215 | FF265 | FF300 | FF300 | FF350 | FF400 | FF500 | FF500 | FF600 | FF600 | | |
| | | | A 160 | A 200 | A 200 | A 250 | A 250 | A 300 | A 350 | A 350 | A 400 | A 450 | A 550 | A 550 | A 660 | A 660 | | |
| IM B5 |  | F | ✓ | ✓ | ✓ | ✓ | ✓ | ✓ | ✓ | ✓ | ✓ | ✓ | ✓ | ✓ | ✓ | ✓ | - | |
| IM V1 with protective cover 1) 2) |  | G | H00 | ✓ | ✓ | ✓ | ✓ | ✓ | ✓ | ✓ | ✓ | ✓ | ✓ | ✓ | ✓ | ✓ | ✓ | |
| IM V3 1) |  | H | - | ✓ | ✓ | ✓ | ✓ | ✓ | ✓ | ✓ | ✓ | ✓ | ✓ | ✓ | ✓ | ✓ | - | |
| IM B35 1) |  | J | - | ✓ | ✓ | ✓ | ✓ | ✓ | ✓ | ✓ | ✓ | ✓ | ✓ | ✓ | ✓ | ✓ | ✓ | |
| With flange next largest | Acc. to EN 50347 | Acc. to DIN 42 948 | - | - | FF215 | FF265 | FF265 | FF300 | - | - | - | - | - | - | - | - | - | |
| | | | - | - | A 250 | A 300 | A 300 | A 350 | - | - | - | - | - | - | - | - | - | |
| IM B5 |  | F | P01 | - | ✓ | ✓ | ✓ | ✓ | - | - | - | - | - | - | - | - | - | |
| IM V1 with protective cover 1) 2) |  | G | P01+H00 | - | ✓ | ✓ | ✓ | ✓ | - | - | - | - | - | - | - | - | - | |
| IM V3 1) |  | H | P01 | - | ✓ | ✓ | ✓ | ✓ | - | - | - | - | - | - | - | - | - | |
| IM B35 1) |  | J | P01 | - | ✓ | ✓ | ✓ | ✓ | - | - | - | - | - | - | - | - | - | |
| With flange next smallest | Acc. to EN 50347 | Acc. to DIN 42 948 | - | FF130 | - | FF165 | FF165 | FF215 | FF265 | FF265 | FF300 | - | - | - | - | - | - | |
| | | | - | A 160 | - | A 200 | A 200 | A 250 | A 300 | A 300 | A 350 | - | - | - | - | - | - | |
| IM B5 |  | F | P02 | ✓ | - | ✓ | ✓ | ✓ | ✓ | ✓ | ✓ | ✓ | - | - | - | - | - | |
| IM V1 with protective cover 1) 2) |  | G | P02+H00 | ✓ | ✓ | ✓ | ✓ | ✓ | ✓ | ✓ | ✓ | ✓ | - | - | - | - | - | |
| IM V3 1) |  | H | P02 | ✓ | ✓ | ✓ | ✓ | ✓ | ✓ | ✓ | ✓ | ✓ | - | - | - | - | - | |
| IM B35 1) |  | J | P02 | ✓ | ✓ | ✓ | ✓ | ✓ | ✓ | ✓ | ✓ | ✓ | - | - | - | - | - | |

For legends and footnotes, see page 5/61.

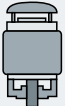
SIMOTICS XP 1MB1, 1MB5 explosion-protected motors

Article No. supplements and special versions · Types of construction

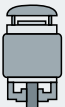
Cast-iron series 1MB15 Basic Line, 1MB16 Performance Line

| Types of construction | Article No. | supplement | Frame size | | | | | | | | | | | | | Motor version | | |
|--|---|---|--|----------------|----------------|----------------|----------------|----------------|----------------|-----|-----|-----|-----|-----|---------|---------------|-----|--|
| | | | 71 | 80 | 90 | 100 | 112 | 132 | 160 | 180 | 200 | 225 | 250 | 280 | 315 S/M | 315 L | IEC | Ex tb (Zone 21), Ex tc (Zone 22), Ex ec (Zone 2) |
| | | For types of construction with order code(s) Article No. with additional identification code -Z | 1MB15.3 Basic Line 1MB16.3 Performance Line 1MB15.1 Basic Line 1MB16.1 Performance Line | | | | | | | | | | | | | | | |
| 1MB15 | ■ . . (-Z) | Order code | | | | | | | | | | | | | | | | |
| 1MB16 | ■ . . (-Z) | | | | | | | | | | | | | | | | | |
| With flange | Acc. to EN 50347 Acc. to DIN 42 948 | | FT85 C 105 | FT100 C 120 | FT115 C 140 | FT130 C 160 | FT130 C 160 | FT165 C 200 | FT215 C 250 | - | - | - | - | - | - | - | - | - |
| IM B14 1) |  | K | - | ✓ | ✓ | ✓ | ✓ | ✓ | ✓ | - | - | - | - | - | - | - | - | - |
| IM V19 1) |  | L | - | ✓ | ✓ | ✓ | ✓ | ✓ | ✓ | - | - | - | - | - | - | - | - | - |
| IM V18 with protective cover 1) 2) |  | M | H00 | ✓ | ✓ | ✓ | ✓ | ✓ | ✓ | - | - | - | - | - | - | - | - | - |
| IM B34 |  | N | - | ✓ | ✓ | ✓ | ✓ | ✓ | ✓ | - | - | - | - | - | - | - | - | - |
| With flange next largest | Acc. to EN 50347 Acc. to DIN 42 948 | | FT115 C 140 | FT130 C 160 | FT130 C 160 | FT165 C 200 | FT165 C 200 | FT215 C 250 | - | - | - | - | - | - | - | - | - | - |
| IM B14 1) |  | K | P01 | ✓ | ✓ | ✓ | ✓ | ✓ | - | - | - | - | - | - | - | - | - | - |
| IM V19 1) |  | L | P01 | ✓ | ✓ | ✓ | ✓ | ✓ | - | - | - | - | - | - | - | - | - | - |
| IM V18 with protective cover 1) 2) |  | M | P01+H00 | ✓ | ✓ | ✓ | ✓ | ✓ | - | - | - | - | - | - | - | - | - | - |
| IM B34 |  | N | P01 | ✓ | ✓ | ✓ | ✓ | ✓ | - | - | - | - | - | - | - | - | - | - |
| With flange next smallest | Acc. to EN 50347 Acc. to DIN 42 948 | | - | - | - | FT115 C 140 | - | - | - | - | - | - | - | - | - | - | - | - |
| IM B14 1) |  | K | P02 | - | - | - | ✓ | - | - | - | - | - | - | - | - | - | - | - |
| IM V19 1) |  | L | P02+H00 | - | - | - | ✓ | - | - | - | - | - | - | - | - | - | - | - |
| IM V18 with protective cover 1) 2) |  | M | P02 | - | - | - | ✓ | - | - | - | - | - | - | - | - | - | - | - |
| IM B34 |  | N | P02 | - | - | - | ✓ | - | - | - | - | - | - | - | - | - | - | - |

- Standard version
- ✓ With additional charge
- Not possible

1) The following applies for explosion-protected motors: In the case of the types of construction with shaft extension down, the version "with protective cover" is required. For types of construction with shaft extension pointing upwards, a suitable cover must be implemented to prevent small parts from falling into the fan cover (see the standard IEC/EN 60079-0). The cover must not block the cooling air flow.

2) The "Standard cylindrical shaft extension (second shaft extension)" option (order code **L05**) is not possible.













SIMOTICS XP 1MB1, 1MB5 explosion-protected motors

Article No. supplements and special versions · Types of construction

Cast-iron series 1MB1543, 1MB5543 Basic Line and 1MB1643, 1MB5643 Performance Line

Selection and ordering data

| Types of construction | Article No. supplement | Frame size | Motor version | | | | | | | | | | | | | | | | |
|---|---|---|-------------------------------------|-------------------------------------|-------------------------------------|-------------------------------------|-------------------------------------|-------------------------------------|-------------------------------------|-------------------------------------|-------------------------------------|-------------------------------------|-------------------------------------|-------------------------------------|-------------------------------------|-------------------------------------|-------------------------------------|----------------|-----|
| | | | 71 | 80 | 90 | 100 | 112 | 132 | 160 | 180 | 200 | 225 | 250 | 280 | 315 S/M | 315 L | IEC | Ex eb (Zone 1) | IE3 |
| | Type of construction code letter 14th position of the Article No. | For types of construction with order code(s) Article No. with additional identification code -Z | 1MB1543 Basic Line | | | | | | | | | | | | | | IEC Ex eb (Zone 1) IE3 | | |
| | | | 1MB1643 Performance Line | | | | | | | | | | | | | | | | |
| | | | 1MB5543 Basic Line | | | | | | | | | | | | | | | | |
| | | | 1MB5643 Performance Line | | | | | | | | | | | | | | | | |
| | Order code | | | | | | | | | | | | | | | | | | |
| Without flange | | | | | | | | | | | | | | | | | | | |
| IM B3 2) |  A | - | <input type="checkbox"/> | <input type="checkbox"/> | <input type="checkbox"/> | <input type="checkbox"/> | <input type="checkbox"/> | <input type="checkbox"/> | <input type="checkbox"/> | <input type="checkbox"/> | <input type="checkbox"/> | <input type="checkbox"/> | <input type="checkbox"/> | <input type="checkbox"/> | <input type="checkbox"/> | <input type="checkbox"/> | <input type="checkbox"/> | | |
| IM B6 1) 2) |  T | - | <input type="checkbox"/> | <input type="checkbox"/> | <input type="checkbox"/> | <input type="checkbox"/> | <input type="checkbox"/> | <input type="checkbox"/> | <input type="checkbox"/> | <input type="checkbox"/> | <input type="checkbox"/> | <input type="checkbox"/> | <input type="checkbox"/> | <input type="checkbox"/> | <input type="checkbox"/> | <input type="checkbox"/> | <input type="checkbox"/> | | |
| IM B7 1) 2) |  U | - | <input type="checkbox"/> | <input type="checkbox"/> | <input type="checkbox"/> | <input type="checkbox"/> | <input type="checkbox"/> | <input type="checkbox"/> | <input type="checkbox"/> | <input type="checkbox"/> | <input type="checkbox"/> | <input type="checkbox"/> | <input type="checkbox"/> | <input type="checkbox"/> | <input type="checkbox"/> | <input type="checkbox"/> | <input type="checkbox"/> | | |
| IM B8 1) 2) |  V | - | <input type="checkbox"/> | <input type="checkbox"/> | <input type="checkbox"/> | <input type="checkbox"/> | <input type="checkbox"/> | <input type="checkbox"/> | <input type="checkbox"/> | <input type="checkbox"/> | <input type="checkbox"/> | <input type="checkbox"/> | <input type="checkbox"/> | <input type="checkbox"/> | <input type="checkbox"/> | <input type="checkbox"/> | <input type="checkbox"/> | | |
| IM V6 1) 2) |  D | - | <input type="checkbox"/> | <input type="checkbox"/> | <input type="checkbox"/> | <input type="checkbox"/> | <input type="checkbox"/> | <input type="checkbox"/> | <input type="checkbox"/> | <input type="checkbox"/> | <input type="checkbox"/> | <input type="checkbox"/> | <input type="checkbox"/> | <input type="checkbox"/> | <input type="checkbox"/> | <input type="checkbox"/> | <input type="checkbox"/> | | |
| IM V5 with protective cover 1) 2) |  C | H00 | <input checked="" type="checkbox"/> | <input checked="" type="checkbox"/> | <input checked="" type="checkbox"/> | <input checked="" type="checkbox"/> | <input checked="" type="checkbox"/> | <input checked="" type="checkbox"/> | <input checked="" type="checkbox"/> | <input checked="" type="checkbox"/> | <input checked="" type="checkbox"/> | <input checked="" type="checkbox"/> | <input checked="" type="checkbox"/> | <input checked="" type="checkbox"/> | <input checked="" type="checkbox"/> | <input checked="" type="checkbox"/> | <input checked="" type="checkbox"/> | | |
| With flange | | Acc. to EN 50347 Acc. to DIN 42 948 | FF130 A 160 | FF165 A 200 | FF165 A 200 | FF215 A 250 | FF215 A 250 | FF265 A 300 | FF300 A 350 | FF300 A 350 | FF350 A 400 | FF400 A 450 | FF500 A 550 | FF500 A 550 | FF600 A 660 | FF600 A 660 | | | |
| IM B5 2) |  F | - | <input checked="" type="checkbox"/> | <input checked="" type="checkbox"/> | <input checked="" type="checkbox"/> | <input checked="" type="checkbox"/> | <input checked="" type="checkbox"/> | <input checked="" type="checkbox"/> | <input checked="" type="checkbox"/> | <input checked="" type="checkbox"/> | <input checked="" type="checkbox"/> | <input checked="" type="checkbox"/> | <input checked="" type="checkbox"/> | <input checked="" type="checkbox"/> | <input checked="" type="checkbox"/> | <input checked="" type="checkbox"/> | <input checked="" type="checkbox"/> | | |
| IM V1 with protective cover 1) 2) 3) |  G | H00 | <input checked="" type="checkbox"/> | <input checked="" type="checkbox"/> | <input checked="" type="checkbox"/> | <input checked="" type="checkbox"/> | <input checked="" type="checkbox"/> | <input checked="" type="checkbox"/> | <input checked="" type="checkbox"/> | <input checked="" type="checkbox"/> | <input checked="" type="checkbox"/> | <input checked="" type="checkbox"/> | <input checked="" type="checkbox"/> | <input checked="" type="checkbox"/> | <input checked="" type="checkbox"/> | <input checked="" type="checkbox"/> | <input checked="" type="checkbox"/> | | |
| IM V3 1) 2) |  H | - | <input checked="" type="checkbox"/> | <input checked="" type="checkbox"/> | <input checked="" type="checkbox"/> | <input checked="" type="checkbox"/> | <input checked="" type="checkbox"/> | <input checked="" type="checkbox"/> | <input checked="" type="checkbox"/> | <input checked="" type="checkbox"/> | <input checked="" type="checkbox"/> | <input checked="" type="checkbox"/> | <input checked="" type="checkbox"/> | <input checked="" type="checkbox"/> | <input checked="" type="checkbox"/> | <input checked="" type="checkbox"/> | <input checked="" type="checkbox"/> | | |
| IM B35 1) 2) |  J | - | <input checked="" type="checkbox"/> | <input checked="" type="checkbox"/> | <input checked="" type="checkbox"/> | <input checked="" type="checkbox"/> | <input checked="" type="checkbox"/> | <input checked="" type="checkbox"/> | <input checked="" type="checkbox"/> | <input checked="" type="checkbox"/> | <input checked="" type="checkbox"/> | <input checked="" type="checkbox"/> | <input checked="" type="checkbox"/> | <input checked="" type="checkbox"/> | <input checked="" type="checkbox"/> | <input checked="" type="checkbox"/> | <input checked="" type="checkbox"/> | | |
| IM V15 1) 2) |  W | - | <input checked="" type="checkbox"/> | <input checked="" type="checkbox"/> | <input checked="" type="checkbox"/> | <input checked="" type="checkbox"/> | <input checked="" type="checkbox"/> | <input checked="" type="checkbox"/> | <input checked="" type="checkbox"/> | <input checked="" type="checkbox"/> | <input checked="" type="checkbox"/> | <input checked="" type="checkbox"/> | <input checked="" type="checkbox"/> | <input checked="" type="checkbox"/> | <input checked="" type="checkbox"/> | <input checked="" type="checkbox"/> | <input checked="" type="checkbox"/> | | |











5

For legends and footnotes, see page 5/64.

SIMOTICS XP 1MB1, 1MB5 explosion-protected motors

Article No. supplements and special versions · Types of construction

Cast-iron series 1MB1543, 1MB5543 Basic Line and 1MB1643, 1MB5643 Performance Line

| Types of construction | Article No. supplement | Frame size | Motor version | | | | | | | | | | | | | | | | |
|--|---|---|--------------------------|----|--------------------|-----|----------------|----------------|----------------|----------------|----------------|----------------|-----|-----|---------|------------------------|-----|----------------|-----|
| | | | 71 | 80 | 90 | 100 | 112 | 132 | 160 | 180 | 200 | 225 | 250 | 280 | 315 S/M | 315 L | IEC | Ex eb (Zone 1) | IE3 |
| | Type of construction code letter 14th position of the Article No. | For types of construction with order code(s) Article No. with additional identification code -Z | 1MB1543 Basic Line | | | | | | | | | | | | | IEC Ex eb (Zone 1) IE3 | | | |
| | | | 1MB1643 Performance Line | | | | | | | | | | | | | | | | |
| | | | 1MB5543 Basic Line | | | | | | | | | | | | | | | | |
| | | | 1MB5643 Performance Line | | | | | | | | | | | | | | | | |
| | Order code | | | | | | | | | | | | | | | | | | |
| With flange next largest | Acc. to EN 50347 Acc. to DIN 42 948 | | - | - | - | - | - | - | - | - | - | - | - | - | - | - | - | - | - |
| IM B5 2) |  | F | P01 | | | | ✓ | ✓ | ✓ | ✓ | - | - | - | - | - | - | - | - | - |
| IM V1 with protec- tive cover 1) 2) 3) |  | G | P01+H00 | - | - | - | ✓ | ✓ | ✓ | ✓ | - | - | - | - | - | - | - | - | - |
| IM V3 1) 2) |  | H | P01 | - | - | - | ✓ | ✓ | ✓ | ✓ | - | - | - | - | - | - | - | - | - |
| IM B35 1) 2) |  | J | P01 | - | - | - | ✓ | ✓ | ✓ | ✓ | - | - | - | - | - | - | - | - | - |
| IM V15 1) 2) |  | W | P01 | - | - | - | ✓ | ✓ | ✓ | ✓ | - | - | - | - | - | - | - | - | - |
| With flange next smallest | Acc. to EN 50347 Acc. to DIN 42 948 | | | - | FF130 - A 160 - | - | FF165 A 200 | FF165 A 200 | FF215 A 250 | FF265 A 300 | FF265 A 300 | FF300 A 350 | - | - | - | - | - | - | - |
| IM B5 2) |  | F | P02 | - | ✓ | - | ✓ | ✓ | ✓ | ✓ | ✓ | ✓ | - | - | - | - | - | - | - |
| IM V1 with protec- tive cover 1) 2) 3) |  | G | P02+H00 | - | ✓ | - | ✓ | ✓ | ✓ | ✓ | ✓ | ✓ | - | - | - | - | - | - | - |
| IM V3 1) 2) |  | H | P02 | - | ✓ | - | ✓ | ✓ | ✓ | ✓ | ✓ | ✓ | - | - | - | - | - | - | - |
| IM B35 1) 2) |  | J | P02 | - | ✓ | - | ✓ | ✓ | ✓ | ✓ | ✓ | ✓ | - | - | - | - | - | - | - |
| IM V15 1) 2) |  | W | P02 | - | ✓ | - | ✓ | ✓ | ✓ | ✓ | ✓ | ✓ | - | - | - | - | - | - | - |

SIMOTICS XP 1MB1, 1MB5 explosion-protected motors

Article No. supplements and special versions · Types of construction

Cast-iron series 1MB1543, 1MB5543 Basic Line and 1MB1643, 1MB5643 Performance Line

| Types of construction | Article No. supplement | Frame size | Motor version | | | | | | | | | | | | | | | | |
|---|---|----------------|--------------------------|----------------|----------------|----------------|----------------|----------------|----------------|-----|-----|-----|-----|-----|---------|-------|-----|----------------|-----|
| | | | 71 | 80 | 90 | 100 | 112 | 132 | 160 | 180 | 200 | 225 | 250 | 280 | 315 S/M | 315 L | IEC | Ex eb (Zone 1) | IE3 |
| | Type of construction code letter 14th position of the Article No. | | 1MB1543 Basic Line | | | | | | | | | | | | | | | | |
| | For types of construction with order code(s) Article No. with additional identification code -Z | | 1MB1643 Performance Line | | | | | | | | | | | | | | | | |
| | | | 1MB5543 Basic Line | | | | | | | | | | | | | | | | |
| | | | 1MB5643 Performance Line | | | | | | | | | | | | | | | | |
| | Order code | | | | | | | | | | | | | | | | | | |
| 1MB1543 - ■ . . (-Z) | | | | | | | | | | | | | | | | | | | |
| 1MB1643 - ■ . . (-Z) | | | | | | | | | | | | | | | | | | | |
| 1MB5543 - ■ . . (-Z) | | | | | | | | | | | | | | | | | | | |
| 1MB5643 - ■ . . (-Z) | | | | | | | | | | | | | | | | | | | |
| With flange | Acc. to EN 50347 Acc. to DIN 42 948 | | FT85 C 105 | FT100 C 120 | FT115 C 140 | FT130 C 160 | FT130 C 160 | FT165 C 200 | FT215 C 250 | - | - | - | - | - | - | - | - | - | |
| IM B14 1) 2) | K | - | ✓ | ✓ | ✓ | ✓ | ✓ | ✓ | ✓ | - | - | - | - | - | - | - | - | - | |
| IM V19 1) 2) | L | - | ✓ | ✓ | ✓ | ✓ | ✓ | ✓ | ✓ | - | - | - | - | - | - | - | - | - | |
| IM V18 with protec- tive cover 1) 2) 3) | M | H00 | ✓ | ✓ | ✓ | ✓ | ✓ | ✓ | ✓ | - | - | - | - | - | - | - | - | - | |
| IM B34 1) 2) | N | - | ✓ | ✓ | ✓ | ✓ | ✓ | ✓ | ✓ | - | - | - | - | - | - | - | - | - | |
| With flange next largest | Acc. to EN 50347 Acc. to DIN 42 948 | | FT115 C 140 | FT130 C 160 | FT130 C 160 | FT165 C 200 | FT165 C 200 | FT215 C 250 | - | - | - | - | - | - | - | - | - | - | |
| IM B14 1) 2) 4) | K | P01 | ✓ | ✓ | ✓ | ✓ | ✓ | ✓ | - | - | - | - | - | - | - | - | - | - | |
| IM V19 1) 2) 4) | L | P01 | ✓ | ✓ | ✓ | ✓ | ✓ | ✓ | - | - | - | - | - | - | - | - | - | - | |
| IM V18 with protec- tive cover 1) 2) 3) 4) | M | P01+H00 | ✓ | ✓ | ✓ | ✓ | ✓ | ✓ | - | - | - | - | - | - | - | - | - | - | |
| IM B34 1) 2) 4) | N | P01 | ✓ | ✓ | ✓ | ✓ | ✓ | ✓ | - | - | - | - | - | - | - | - | - | - | |
| With flange next smallest | Acc. to EN 50347 Acc. to DIN 42 948 | | - | - | - | FT115 C 140 | - | - | - | - | - | - | - | - | - | - | - | - | |
| IM B14 1) 2) 4) | K | P02 | - | - | - | ✓ | - | - | - | - | - | - | - | - | - | - | - | - | |
| IM V19 1) 2) 4) | L | P02 | - | - | - | ✓ | - | - | - | - | - | - | - | - | - | - | - | - | |
| IM V18 with protec- tive cover 1) 2) 3) 4) | M | P02+H00 | - | - | - | ✓ | - | - | - | - | - | - | - | - | - | - | - | - | |
| IM B34 1) 2) 4) | N | P02 | - | - | - | ✓ | - | - | - | - | - | - | - | - | - | - | - | - | |

□ Standard version ✓ With additional charge - Not possible

- The following applies for explosion-protected motors: In the case of the types of construction with shaft extension down, the version "with protective cover" is required. For types of construction with shaft extension pointing upwards, a suitable cover must be implemented to prevent small parts from falling into the fan cover (see the standard IEC/EN 60079-0). The cover must not block the cooling air flow.
- The type of construction is stamped on the rating plate. For orders with condensation drainage holes (order code **H03**), if mounted in a different position, the position must be specified to ensure that the condensation drainage holes are positioned correctly.
- The "Standard cylindrical shaft extension (second shaft extension)" option (order code **L05**) is not possible.
- With reference to standard EN 50347, flanges that are 2 steps larger are used with option P01 in the frame sizes 71 and 80.











5

SIMOTICS XP 1MB1, 1MB5 explosion-protected motors

Article No. supplements and special versions · Types of construction

Cast-iron series 1MB1553, 1MB5553

Selection and ordering data

| Types of construction | Article No. supplement | | Frame size | | | | | | | | | | | | | Motor version | | | | | | |
|--|---|---|----------------|----------------|----------------|----------------|----------------|----------------|----------------|----------------|----------------|----------------|----------------|----------------|----------------|----------------|-----|-------|----------|--------------|--|--|
| | Type of construction code letter 14th position of the Article No. | For types of construction with order code(s) Article No. with additional identification code -Z Order code | 71 | 80 | 90 | 100 | 112 | 132 | 160 | 180 | 200 | 225 | 250 | 280 | 315 | 355 | IEC | Ex db | Ex db eb | IE3 (Zone 1) | | |
| 1MB.553 - - . . . (-Z) | | | 1MB1553 | | | | | | | | | | | | | 1MB5553 | | | | | | |
| Without flange | | | | | | | | | | | | | | | | | | | | | | |
| IM B3  | A | - | □ | □ | □ | □ | □ | □ | □ | □ | □ | □ | □ | □ | □ | □ | | | | | | |
| IM B6 ¹⁾  | T | - | □ | □ | □ | □ | □ | □ | □ | □ | □ | □ | □ | □ | □ | □ | - | | | | | |
| IM B7 ¹⁾  | U | - | □ | □ | □ | □ | □ | □ | □ | □ | □ | □ | □ | □ | □ | □ | - | | | | | |
| IM B8  | V | - | □ | □ | □ | □ | □ | □ | □ | □ | □ | □ | □ | □ | □ | □ | - | | | | | |
| IM V6 ^{1) 3)}  | D | - | □ | □ | □ | □ | □ | □ | □ | □ | □ | □ | □ | □ | □ | □ | - | | | | | |
| IM V5 with protective cover ^{1) 3)}  | C | H00 | ✓ | ✓ | ✓ | ✓ | ✓ | ✓ | ✓ | ✓ | ✓ | ✓ | ✓ | ✓ | ✓ | ✓ | - | | | | | |
| With flange | | Acc. to EN 50347 Acc. to DIN 42 948 | FF130 A 160 | FF165 A 200 | FF165 A 200 | FF215 A 250 | FF215 A 250 | FF265 A 300 | FF300 A 350 | FF300 A 350 | FF350 A 400 | FF400 A 450 | FF500 A 550 | FF500 A 550 | FF600 A 660 | FF740 A 800 | | | | | | |
| IM B5 ¹⁾  | F | - | ✓ | ✓ | ✓ | ✓ | ✓ | ✓ | ✓ | ✓ | ✓ | ✓ | ✓ | ✓ | ✓ | ✓ | - | | | | | |
| IM V1 with protective cover ^{2) 3)}  | G | H00 | ✓ | ✓ | ✓ | ✓ | ✓ | ✓ | ✓ | ✓ | ✓ | ✓ | ✓ | ✓ | ✓ | ✓ | ✓ | | | | | |
| IM V3 ³⁾  | H | - | ✓ | ✓ | ✓ | ✓ | ✓ | ✓ | ✓ | ✓ | ✓ | ✓ | ✓ | ✓ | ✓ | ✓ | - | | | | | |
| IM B35  | J | - | ✓ | ✓ | ✓ | ✓ | ✓ | ✓ | ✓ | ✓ | ✓ | ✓ | ✓ | ✓ | ✓ | ✓ | ✓ | | | | | |
| IM V15 ^{2) 3)}  | W | - | ✓ | ✓ | ✓ | ✓ | ✓ | ✓ | ✓ | ✓ | ✓ | ✓ | ✓ | ✓ | ✓ | ✓ | - | | | | | |

5

For legends and footnotes, see page 5/66.

SIMOTICS XP 1MB1, 1MB5 explosion-protected motors

Article No. supplements and special versions · Types of construction

Cast-iron series 1MB1553, 1MB5553

| Types of construction | Article No. supplement | | Frame size | | | | | | | | | | | | | Motor version | | | | |
|---|---|---|----------------|----------------|----------------|----------------|----------------|----------------|----------------|-----|-----|-----|----------------|-----|-----|---------------|-----|-------|----------|-----|
| | Type of construction code letter 14th position of the Article No. | For types of construction with order code(s) Article No. with additional identification code -Z Order code | 71 | 80 | 90 | 100 | 112 | 132 | 160 | 180 | 200 | 225 | 250 | 280 | 315 | 355 | IEC | Ex db | Ex db eb | IE3 |
| | | | 1MB1553 | | | | | | | | | | | | | | | | | |
| | | | | | | | | | | | | | 1MB5553 | | | | | | | |
| 1MB.553 - - . . . (-Z) | | | | | | | | | | | | | | | | | | | | |
| With flange | Acc. to EN 50347 Acc. to DIN 42 948 | | FT85 C 105 | FT100 C 120 | FT115 C 140 | FT130 C 160 | FT130 C 160 | FT165 C 200 | FT215 C 250 | - | - | - | - | - | - | - | - | - | - | |
| IM B14 3) | K | - | ✓ | ✓ | ✓ | ✓ | ✓ | ✓ | ✓ | - | - | - | - | - | - | - | - | - | - | |
| IM V19 3) | L | - | ✓ | ✓ | ✓ | ✓ | ✓ | ✓ | ✓ | - | - | - | - | - | - | - | - | - | - | |
| IM V18 with protec- tive cover 2) 3) | M | H00 | ✓ | ✓ | ✓ | ✓ | ✓ | ✓ | ✓ | - | - | - | - | - | - | - | - | - | - | |
| IM B34 | N | - | ✓ | ✓ | ✓ | ✓ | ✓ | ✓ | ✓ | - | - | - | - | - | - | - | - | - | - | |

- Standard version
- ✓ With additional charge
- Not possible

¹⁾ Only possible for frame size 315 S/M (horizontal mounting).
²⁾ The "Standard cylindrical shaft extension (second shaft extension)" option (order code **L05**) is not possible.









³⁾ The following applies for explosion-protected motors: In the case of the types of construction with shaft extension down, the version "with protective cover" is required. For types of construction with shaft extension pointing upwards, a suitable cover must be implemented to prevent small parts from falling into the fan cover (see the standard IEC/EN 60079-0). The cover must not block the cooling air flow.

SIMOTICS XP 1MB1, 1MB5 explosion-protected motors

Article No. supplements and special versions · Types of construction

Cast-iron series 1MB55.4, 1MB55.3, 1MB58.3

Selection and ordering data

| Types of construction | Article No. supplement Type of construction code letter 14th position of the Article No. | For types of construction with order code(s) Article No. with additional identification code -Z Order code | Frame size | | Motor version |
|---|--|---|-------------------------|--------------------------|---|
| | | | 400 | 450 | |
| | | | 1MB55 . 4 | | IEC Ex ec, Ex tc, Ex tb (Zones 2, 22 and 21) IE4 IE3 |
| | | | 1MB55 . 3 | | |
| | | | 1MB58 . 3 | | |
| 1MB5 -Z | | | | | |
| Without flange | | | | | |
| IM B3 ^{1) 2)} |  A | – | □ | □ | |
| IM V6 ²⁾ |  D | – | O. R. ⁷⁾ | O. R. ⁷⁾ | |
| IM V5 without protective cover ²⁾ |  C | – | O. R. ⁷⁾ | O. R. ⁷⁾ | |
| IM V5 with protective cover ^{2) 3) 4)} |  C | H00 | O. R. ⁷⁾ | O. R. ⁷⁾ | |
| With flange | | | | | |
| | EN 50347 DIN 42948 | | FF940 A 1000 | FF1080 A 1150 | |
| IM B5 ^{2) 5)} |  F | – | ✓ ⁶⁾ | ✓ ⁶⁾ | |
| IM V1 without protective cover ²⁾ |  G | – | ✓ ⁷⁾ | ✓ ⁷⁾ | |
| IM V1 with protective cover ^{2) 3) 4)} |  G | H00 | ✓ ⁷⁾ | ✓ ⁷⁾ | |
| IM B35 ³⁾ |  J | – | ✓ | ✓ | |

- Standard version
- Without additional charge
- ✓ With additional charge

¹⁾ The types of construction IM B6/7/8, IM V6 and IM V5 with/without protective cover are also possible as long as no stamping of these types of construction on the rating plate is required. As standard the type of construction IM B3 is then stamped on the rating plate. With type of construction IM V5 with protective cover, the protective cover has to be additionally ordered with order code **H00**. The protective cover is not stamped on the rating plate.

²⁾ The type of construction is stamped on the rating plate. If mounted in a different position, the position must be specified to ensure that the condensation drainage holes are positioned correctly.

³⁾ In combination with an encoder, it is not necessary to order the protective cover (order code **H00**), as this is delivered as a protection for the encoder as standard. In this case the protective cover is standard design (without additional charge).

⁴⁾ The "Standard cylindrical shaft extension (second shaft extension)" option (order code **L05**) is not possible.

⁵⁾ The types of construction IM V3 and IM V1 with/without protective cover are also possible as long as no stamping of these types of construction on the rating plate is required. As standard the type of construction IM B5 is then stamped on the rating plate. With type of construction IM V1 with protective cover, the protective cover has to be additionally ordered with order code **H00**. The protective cover is not stamped on the rating plate.

⁶⁾ For machines, type of construction IM B5, provide an additional support foot at the NDE. The support foot is not included in the scope of supply. Use an appropriately sized support foot with the appropriate rigidity. The support foot must be able to support the total weight of the machine.

⁷⁾ Not available for 2-pole motors.

SIMOTICS XP 1MB1, 1MB5 explosion-protected motors

Article No. supplements and special versions · Motor protection

Aluminum series 1MB10**Selection and ordering data**

| Motor protection | Article No. supplement | | Frame size | | | | | | Motor version |
|---------------------|---|--|------------|----|---------|-----|-----|-----|--|
| | Motor protection code letter 15th position of the Article No. | Additional identification code with order code and plain text, if required | 80 | 90 | 100 | 112 | 132 | 160 | |
| 1MB10 ■ . | | | 1MB10.3 | | | | | | IEC Ex tb (Zone 21), IE3 Ex tc (Zone 22), IE2 Ex ec (Zone 2) IE1 |
| | | | 1MB10.1 | | | | | | |
| | | | | | 1MB10.2 | | | | |
| | | Order code | | | | | | | |

| Motor protection | | | | | | | | | |
|---|----------|---|---|---|---|---|---|---|--|
| None (standard) | A | – | □ | □ | □ | □ | □ | □ | |
| 3 PTC thermistors – for tripping (2 terminals) ¹⁾ | B | – | ✓ | ✓ | ✓ | ✓ | ✓ | ✓ | |
| 6 PTC thermistors – for warning and tripping (4 terminals) ¹⁾ | C | – | ✓ | ✓ | ✓ | ✓ | ✓ | ✓ | |
| 1 KTY84-130 temperature sensor (2 terminals) ¹⁾ | F | – | ✓ | ✓ | ✓ | ✓ | ✓ | ✓ | |
| 2 KTY84-130 temperature sensors (4 terminals) ¹⁾ | G | – | ✓ | ✓ | ✓ | ✓ | ✓ | ✓ | |
| 3 Pt100 resistance thermometers – 2-wire input (6 terminals) ^{1) 2)} | H | – | – | – | ✓ | ✓ | ✓ | ✓ | |
| 1 Pt1000 resistance thermometer (2 terminals) ¹⁾ | K | – | ✓ | ✓ | ✓ | ✓ | ✓ | ✓ | |
| 2 Pt1000 resistance thermometers (4 terminals) ¹⁾ | L | – | ✓ | ✓ | ✓ | ✓ | ✓ | ✓ | |

- Standard version
- ✓ With additional charge
- Not possible

¹⁾ Evaluation with associated tripping unit (see Catalog IC 10) is recommended. In converter operation, PTC thermistor motor protection is always required.

²⁾ In combination with the 15th position of the Article No. 'H', the order codes **Q02** and **Q03** are not possible for frame sizes 100 to 160. It can only be supplied with a star or delta winding for direct switch-on (3 terminals).

SIMOTICS XP 1MB1, 1MB5 explosion-protected motors

Article No. supplements and special versions · Motor protection

Cast-iron series 1MB15 Basic Line, 1MB16 Performance Line

Selection and ordering data

| Motor protection | Article No. supplement | | Frame size | | | | | | | | | | | | | Motor version | |
|------------------|---|--|--------------------------|----|----|-----|-----|-----|-----|-----|-----|-----|-----|-----|-----|---------------|--|
| | Motor protection code letter 15th position of the Article No. | Additional identification code with order code and plain text, if required | 71 | 80 | 90 | 100 | 112 | 132 | 160 | 180 | 200 | 225 | 250 | 280 | 315 | IEC | Ex tb (Zone 21), IE3 Ex tc (Zone 22), Ex ec (Zone 2) |
| | | | 1MB15.3 Basic Line | | | | | | | | | | | | | IEC | Ex tb (Zone 21), IE3 Ex tc (Zone 22), Ex ec (Zone 2) |
| | | | 1MB16.3 Performance Line | | | | | | | | | | | | | | |
| | | | 1MB15.1 Basic Line | | | | | | | | | | | | | | |
| | | | 1MB16.1 Performance Line | | | | | | | | | | | | | | |
| | | Order code | | | | | | | | | | | | | | | |

| Motor protection | Article No. | Additional identification code with order code and plain text, if required | 71 | 80 | 90 | 100 | 112 | 132 | 160 | 180 | 200 | 225 | 250 | 280 | 315 | Notes |
|--|-------------|--|----|----|----|-----|-----|-----|-----|-----|-----|-----|-----|-----|-----|-----------------------------------|
| None (standard) | A | – | □ | □ | □ | □ | □ | □ | □ | □ | □ | □ | □ | □ | □ | Only for: 1MB15.. Basic Line |
| 3 PTC thermistors – for tripping (2 terminals) ¹⁾ | B | – | ✓ | ✓ | ✓ | ✓ | ✓ | ✓ | ✓ | ✓ | ✓ | ✓ | ✓ | ✓ | ✓ | |
| 6 PTC thermistors – for warning and tripping (4 terminals) ²⁾ | C | – | ✓ | ✓ | ✓ | ✓ | ✓ | ✓ | ✓ | ✓ | ✓ | ✓ | ✓ | ✓ | ✓ | Only for: 1MB15.. Basic Line |
| | | | – | – | – | □ | □ | □ | □ | □ | □ | □ | □ | □ | □ | Only for: MB16.. Performance Line |
| 1 KTY84-130 temperature sensor (2 terminals) ²⁾ | F | – | ✓ | ✓ | ✓ | ✓ | ✓ | ✓ | ✓ | ✓ | ✓ | ✓ | ✓ | ✓ | ✓ | |
| 2 KTY84-130 temperature sensors (4 terminals) ²⁾ | G | – | ✓ | ✓ | ✓ | ✓ | ✓ | ✓ | ✓ | ✓ | ✓ | ✓ | ✓ | ✓ | ✓ | |
| 3 Pt100 resistance thermometers – 2-wire input (6 terminals) ²⁾³⁾ | H | – | ✓ | ✓ | ✓ | ✓ | ✓ | ✓ | ✓ | ✓ | ✓ | ✓ | ✓ | ✓ | ✓ | |
| 6 Pt100 resistance thermometers – 2-wire input (12 terminals) ²⁾ | J | – | – | – | – | – | – | – | – | ✓ | ✓ | ✓ | ✓ | ✓ | ✓ | |
| 1 Pt1000 resistance thermometer (2 terminals) ²⁾ | K | – | ✓ | ✓ | ✓ | ✓ | ✓ | ✓ | ✓ | ✓ | ✓ | ✓ | ✓ | ✓ | ✓ | |
| 2 Pt1000 resistance thermometers (4 terminals) ²⁾ | L | – | ✓ | ✓ | ✓ | ✓ | ✓ | ✓ | ✓ | ✓ | ✓ | ✓ | ✓ | ✓ | ✓ | |

- Standard version
- ✓ With additional charge
- Not possible

¹⁾ For the Performance Line, motor protection by means of PTC thermistors with 3 built-in temperature sensors for tripping (motor protection code letter B) is already included in the basic price. For the Performance Line, the option "without motor protection" (motor protection code letter A) is not possible.

²⁾ Evaluation with associated tripping unit (see Catalog IC 10) is recommended. In converter operation, PTC thermistor motor protection is always required.

³⁾ In combination with the 15th position of the Article No. "H", the order codes **Q02** and **Q03** are not possible for frame sizes 100 to 160. It can only be supplied with a star or delta winding for direct switch-on (3 terminals).

SIMOTICS XP 1MB1, 1MB5 explosion-protected motors

Article No. supplements and special versions · Motor protection

Cast-iron series 1MB1543, 1MB5543 Basic Line and 1MB1643, 1MB5643 Performance Line

Selection and ordering data

| Motor protection | Article No. supplement | | Frame size | | | | | | | | | | | | | Motor version | |
|--------------------------------|---|--|--------------------------|----|----|-----|-----|-----|-----|-----|-----|-----|-----|-----|-----|---------------|--------------------|
| | Motor protection code letter 15th position of the Article No. | Additional identification code with order code and plain text, if required | 71 | 80 | 90 | 100 | 112 | 132 | 160 | 180 | 200 | 225 | 250 | 280 | 315 | IEC | Ex eb (Zone 1) IE3 |
| | | | 1MB1543 Basic Line | | | | | | | | | | | | | | |
| | | | 1MB1643 Performance Line | | | | | | | | | | | | | | |
| | | | 1MB5543 Basic Line | | | | | | | | | | | | | | |
| | | | 1MB5643 Performance Line | | | | | | | | | | | | | | |
| 1MB1543 - ■ . | | | | | | | | | | | | | | | | | |
| 1MB1643 - ■ . | | | | | | | | | | | | | | | | | |
| 1MB5543 - ■ . | | | | | | | | | | | | | | | | | |
| 1MB5643 - ■ . | | | | | | | | | | | | | | | | | |
| | | Order code | | | | | | | | | | | | | | | |

| Motor protection | | | | | | | | | | | | | | | | | |
|---|----------|---|-------------------------------------|-------------------------------------|-------------------------------------|-------------------------------------|-------------------------------------|-------------------------------------|-------------------------------------|-------------------------------------|-------------------------------------|-------------------------------------|-------------------------------------|-------------------------------------|-------------------------------------|-------------------------------------|-----------------------------------|
| Without (standard) ¹⁾ | A | – | <input type="checkbox"/> | <input type="checkbox"/> | <input type="checkbox"/> | <input type="checkbox"/> | <input type="checkbox"/> | <input type="checkbox"/> | <input type="checkbox"/> | <input type="checkbox"/> | <input type="checkbox"/> | <input type="checkbox"/> | <input type="checkbox"/> | <input type="checkbox"/> | <input type="checkbox"/> | <input type="checkbox"/> | Only for: 1MB.5.. Basic Line |
| 3 PTC thermistors – for tripping (2 terminals) ^{1) 2) 3)} | B | – | <input checked="" type="checkbox"/> | <input checked="" type="checkbox"/> | <input checked="" type="checkbox"/> | <input checked="" type="checkbox"/> | <input checked="" type="checkbox"/> | <input checked="" type="checkbox"/> | <input checked="" type="checkbox"/> | <input checked="" type="checkbox"/> | <input checked="" type="checkbox"/> | <input checked="" type="checkbox"/> | <input checked="" type="checkbox"/> | <input checked="" type="checkbox"/> | <input checked="" type="checkbox"/> | <input checked="" type="checkbox"/> | Only for: 1MB.5.. Basic Line |
| | | | <input type="checkbox"/> | <input type="checkbox"/> | <input type="checkbox"/> | <input type="checkbox"/> | <input type="checkbox"/> | <input type="checkbox"/> | <input type="checkbox"/> | <input type="checkbox"/> | <input type="checkbox"/> | <input type="checkbox"/> | <input type="checkbox"/> | <input type="checkbox"/> | <input type="checkbox"/> | <input type="checkbox"/> | Only for: MB.6.. Performance Line |
| 6 PTC thermistors – for warning and tripping (4 terminals) ^{2) 3)} | C | – | <input checked="" type="checkbox"/> | <input checked="" type="checkbox"/> | <input checked="" type="checkbox"/> | <input checked="" type="checkbox"/> | <input checked="" type="checkbox"/> | <input checked="" type="checkbox"/> | <input checked="" type="checkbox"/> | <input checked="" type="checkbox"/> | <input checked="" type="checkbox"/> | <input checked="" type="checkbox"/> | <input checked="" type="checkbox"/> | <input checked="" type="checkbox"/> | <input checked="" type="checkbox"/> | <input checked="" type="checkbox"/> | |

- Standard version
 With additional charge

5

¹⁾ For the Performance Line, motor protection by means of PTC thermistors with 3 built-in temperature sensors for tripping (motor protection code letter B) is already included in the basic price. For the Performance Line, the option "without motor protection" (motor protection code letter A) is not possible.

²⁾ Evaluation with associated tripping unit (see Catalog IC 10) is recommended.

³⁾ Motors in these frame sizes have a second rating plate (T1/T2 and T3) as standard.

The T3 power is stamped on the rating plate as standard if the following motors are selected with PTC thermistor (protection by PTC thermistor only) or voltage code **'90'**:

– 2-pole motors: Frame sizes 132 to 160

– 4-pole motors: Frame size 180

Alternatively, with order code **B33**, the "T1/T2 power is stamped on the rating plate".

– 2-pole motors: Frame sizes 132 to 200

– 4-pole motors: Frame sizes 180 to 200

SIMOTICS XP 1MB1, 1MB5 explosion-protected motors

Article No. supplements and special versions · Motor protection

Cast-iron series 1MB1553, 1MB5553

Selection and ordering data

| Motor protection | Article No. supplement | | Frame size | | | | | | | | | | | | | Motor version | | | |
|--|---|--|-------------------------------------|-------------------------------------|-------------------------------------|-------------------------------------|-------------------------------------|-------------------------------------|-------------------------------------|-------------------------------------|-------------------------------------|-------------------------------------|-------------------------------------|-------------------------------------|-------------------------------------|-------------------------------------|-----|--------------------------|-----|
| | Motor protection code letter 15th position of the Article No. | Additional identification code with order code and plain text, if required | 71 | 80 | 90 | 100 | 112 | 132 | 160 | 180 | 200 | 225 | 250 | 280 | 315 | 355 | IEC | Ex db, Ex db eb (Zone 1) | IE3 |
| | | | 1MB1553 | | | | | | | | | | | | | | | | |
| | | | 1MB5553 | | | | | | | | | | | | | | | | |
| | 1MB.553 - | Order code | | | | | | | | | | | | | | | | | |
| Motor protection | | | | | | | | | | | | | | | | | | | |
| None (standard) | A | – | <input type="checkbox"/> | <input type="checkbox"/> | <input type="checkbox"/> | <input type="checkbox"/> | <input type="checkbox"/> | <input type="checkbox"/> | <input type="checkbox"/> | <input type="checkbox"/> | <input type="checkbox"/> | <input type="checkbox"/> | <input type="checkbox"/> | <input type="checkbox"/> | <input type="checkbox"/> | <input type="checkbox"/> | | | |
| 3 PTC thermistors – for tripping (2 terminals) ¹⁾ | B | – | <input checked="" type="checkbox"/> | <input checked="" type="checkbox"/> | <input checked="" type="checkbox"/> | <input checked="" type="checkbox"/> | <input checked="" type="checkbox"/> | <input checked="" type="checkbox"/> | <input checked="" type="checkbox"/> | <input checked="" type="checkbox"/> | <input checked="" type="checkbox"/> | <input checked="" type="checkbox"/> | <input checked="" type="checkbox"/> | <input checked="" type="checkbox"/> | <input checked="" type="checkbox"/> | <input checked="" type="checkbox"/> | | | |
| 6 PTC thermistors – for warning and tripping (4 terminals) ^{1) 2)} | C | – | <input checked="" type="checkbox"/> | <input checked="" type="checkbox"/> | <input checked="" type="checkbox"/> | <input checked="" type="checkbox"/> | <input checked="" type="checkbox"/> | <input checked="" type="checkbox"/> | <input checked="" type="checkbox"/> | <input checked="" type="checkbox"/> | <input checked="" type="checkbox"/> | <input checked="" type="checkbox"/> | <input checked="" type="checkbox"/> | <input checked="" type="checkbox"/> | <input checked="" type="checkbox"/> | <input checked="" type="checkbox"/> | | | |
| 3 Pt100 resistance thermometers – 2-wire input (6 terminals) ²⁾ | H | Q60 | – | – | – | <input checked="" type="checkbox"/> | <input checked="" type="checkbox"/> | <input checked="" type="checkbox"/> | <input checked="" type="checkbox"/> | <input checked="" type="checkbox"/> | <input checked="" type="checkbox"/> | <input checked="" type="checkbox"/> | <input checked="" type="checkbox"/> | <input checked="" type="checkbox"/> | <input checked="" type="checkbox"/> | <input checked="" type="checkbox"/> | | | |
| 6 Pt100 resistance thermometers – 2-wire input (12 terminals) ^{2) 3)} | J | Q61 | – | – | – | – | – | – | <input checked="" type="checkbox"/> | <input checked="" type="checkbox"/> | <input checked="" type="checkbox"/> | <input checked="" type="checkbox"/> | <input checked="" type="checkbox"/> | <input checked="" type="checkbox"/> | <input checked="" type="checkbox"/> | <input checked="" type="checkbox"/> | | | |
| 1 Pt1000 resistance thermometers (2 terminals) ¹⁾ | K | Q35 | <input checked="" type="checkbox"/> | <input checked="" type="checkbox"/> | <input checked="" type="checkbox"/> | <input checked="" type="checkbox"/> | <input checked="" type="checkbox"/> | <input checked="" type="checkbox"/> | <input checked="" type="checkbox"/> | <input checked="" type="checkbox"/> | <input checked="" type="checkbox"/> | <input checked="" type="checkbox"/> | <input checked="" type="checkbox"/> | <input checked="" type="checkbox"/> | <input checked="" type="checkbox"/> | <input checked="" type="checkbox"/> | | | |
| 2 Pt1000 resistance thermometers (4 terminals) ²⁾ | L | Q36 | <input checked="" type="checkbox"/> | <input checked="" type="checkbox"/> | <input checked="" type="checkbox"/> | <input checked="" type="checkbox"/> | <input checked="" type="checkbox"/> | <input checked="" type="checkbox"/> | <input checked="" type="checkbox"/> | <input checked="" type="checkbox"/> | <input checked="" type="checkbox"/> | <input checked="" type="checkbox"/> | <input checked="" type="checkbox"/> | <input checked="" type="checkbox"/> | <input checked="" type="checkbox"/> | <input checked="" type="checkbox"/> | | | |
| 3 Pt100 resistance thermometers – 3-wire input (9 terminals) ^{2) 3)} | Q | Q63 | – | – | – | – | – | – | <input checked="" type="checkbox"/> | <input checked="" type="checkbox"/> | <input checked="" type="checkbox"/> | <input checked="" type="checkbox"/> | <input checked="" type="checkbox"/> | <input checked="" type="checkbox"/> | <input checked="" type="checkbox"/> | <input checked="" type="checkbox"/> | | | |
| 6 Pt100 resistance thermometers – 3-wire input (18 terminals) ^{2) 3)} | R | Q64 | – | – | – | – | – | – | <input checked="" type="checkbox"/> | <input checked="" type="checkbox"/> | <input checked="" type="checkbox"/> | <input checked="" type="checkbox"/> | <input checked="" type="checkbox"/> | <input checked="" type="checkbox"/> | <input checked="" type="checkbox"/> | <input checked="" type="checkbox"/> | | | |

- Standard version
- With additional charge
- Not possible

¹⁾ Mandatory winding monitoring of the motors suitable for converter operation.
²⁾ Maximum number of terminals for accessories, see the terminal box concept.

³⁾ Auxiliary terminal box required; option in Ex eb with order code **R62** or **R63**

SIMOTICS XP 1MB1, 1MB5 explosion-protected motors

Article No. supplements and special versions · Motor protection

Cast-iron series 1MB55.4, 1MB55.3, 1MB58.3**Selection and ordering data**

| Motor protection | Article No. supplement | | Frame size | | Motor version | |
|-----------------------|---|--|------------------|-----|---------------|--|
| | Motor protection code letter 15th position of the Article No. | Additional identification code with order code and plain text, if required | 400 | 450 | IEC | Ex ec, Ex tc, Ex tb (Zones 2, 22 and 21) |
| | | | 1MB55 . 4 | | | |
| | | | 1MB55 . 3 | | | IE3 |
| | | | 1MB58 . 3 | | | |
| 1MB5 | ■ | Order code | | | | |

| Motor protection | | | | | | |
|---|----------|------------|-------------------------------------|-------------------------------------|--|--|
| None (standard) | A | – | <input type="checkbox"/> | <input type="checkbox"/> | | |
| 1 or 3 PTC thermistors – for tripping (2 terminals) ¹⁾ | B | – | <input checked="" type="checkbox"/> | <input checked="" type="checkbox"/> | | |
| 2 or 6 PTC thermistors – for alarm and tripping (4 terminals) ¹⁾ | C | – | <input checked="" type="checkbox"/> | <input checked="" type="checkbox"/> | | |
| 1 KTY84-130 temperature sensor (2 terminals) ¹⁾ | F | – | <input checked="" type="checkbox"/> | <input checked="" type="checkbox"/> | | |
| 2 KTY84-130 temperature sensors (4 terminals) ¹⁾ | G | – | <input checked="" type="checkbox"/> | <input checked="" type="checkbox"/> | | |
| 3 Pt100 resistance thermometers – 2-wire input (6 terminals) | H | – | <input checked="" type="checkbox"/> | <input checked="" type="checkbox"/> | | |
| 6 Pt100 resistance thermometers – 2-wire input (12 terminals) | J | – | <input checked="" type="checkbox"/> | <input checked="" type="checkbox"/> | | |
| 1 Pt1000 resistance thermometer (2 terminals) | K | – | <input checked="" type="checkbox"/> | <input checked="" type="checkbox"/> | | |
| 2 Pt1000 resistance thermometers (4 terminals) | L | – | <input checked="" type="checkbox"/> | <input checked="" type="checkbox"/> | | |
| 1 Pt100 resistance thermometer – 2-wire input (2 terminals) | P | – | <input checked="" type="checkbox"/> | <input checked="" type="checkbox"/> | | |
| 3 Pt100 resistance thermometers – 3-wire input (9 terminals) | Q | – | <input checked="" type="checkbox"/> | <input checked="" type="checkbox"/> | | |
| 6 Pt100 resistance thermometers – 3-wire input (18 terminals) | R | – | <input checked="" type="checkbox"/> | <input checked="" type="checkbox"/> | | |
| 3 NTC thermistors – for tripping (6 terminals) | Z | Q2A | <input checked="" type="checkbox"/> | <input checked="" type="checkbox"/> | | |

- Standard version
- With additional charge

Note:

Options are available specifically for bearing protection – for order codes and descriptions, see from page 5/96.

5

¹⁾ Evaluation with associated tripping unit (see Catalog IC 10) is recommended.

SIMOTICS XP 1MB1, 1MB5 explosion-protected motors

Article No. supplements and special versions · Terminal box position

Aluminum series 1MB10

Selection and ordering data

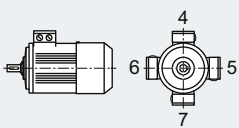
| Terminal box position | Article No. supplement | Frame size | | | | | | Motor version | |
|---|--|------------|----|---------|-----|-----|-----|---------------|----------------------|
| | | 80 | 90 | 100 | 112 | 132 | 160 | | |
|  | Terminal box position code 16th position of the Article No. | | | | | | | IEC | Ex tb (Zone 21), IE3 |
| | Additional identification code with order code and plain text, if required | 1MB10.3 | | | | | | | Ex tc (Zone 22), IE2 |
| | Order code | 1MB10.1 | | 1MB10.2 | | | | | Ex ec (Zone 2) IE1 |

| Terminal box position | | | | | | | | | | |
|--|---|---|-------------------------------------|-------------------------------------|-------------------------------------|-------------------------------------|-------------------------------------|-------------------------------------|-------------------------------------|--|
| Terminal box top ¹⁾ | 4 | – | <input type="checkbox"/> | <input type="checkbox"/> | <input type="checkbox"/> | <input type="checkbox"/> | <input type="checkbox"/> | <input type="checkbox"/> | <input type="checkbox"/> | |
| Terminal box right-hand side ²⁾ | 5 | – | <input checked="" type="checkbox"/> | <input checked="" type="checkbox"/> | <input checked="" type="checkbox"/> | <input checked="" type="checkbox"/> | <input checked="" type="checkbox"/> | <input checked="" type="checkbox"/> | <input checked="" type="checkbox"/> | |
| Terminal box left-hand side ²⁾ | 6 | – | <input checked="" type="checkbox"/> | <input checked="" type="checkbox"/> | <input checked="" type="checkbox"/> | <input checked="" type="checkbox"/> | <input checked="" type="checkbox"/> | <input checked="" type="checkbox"/> | <input checked="" type="checkbox"/> | |
| Terminal box at bottom ^{2) 3)} | 7 | – | – | – | <input checked="" type="checkbox"/> | <input checked="" type="checkbox"/> | <input checked="" type="checkbox"/> | <input checked="" type="checkbox"/> | <input checked="" type="checkbox"/> | |

- Standard version
- With additional charge

¹⁾ For types of construction with feet, cast feet are standard.

²⁾ For types of construction with feet, screwed-on feet are standard.

³⁾ Not generally possible for motors with feet.

SIMOTICS XP 1MB1, 1MB5 explosion-protected motors

Article No. supplements and special versions · Terminal box position

Cast-iron series 1MB15 Basic Line, 1MB16 Performance Line

Selection and ordering data

| Terminal box position | Article No. supplement | Frame size | | | | | | | | | | | Motor version | | | | |
|--|--|--------------------------|----|----|-----|-----|-----|-----|-----|-----|-----|-----|---------------|--|------------|--|------------|
| | | 71 | 80 | 90 | 100 | 112 | 132 | 160 | 180 | 200 | 225 | 250 | 280 | 315 | IEC | Ex tb (Zone 21), Ex tc (Zone 22), Ex ec (Zone 2) | IE3 IE2 |
| | Terminal box position code 16th position of the Article No. | 1MB15.3 Basic Line | | | | | | | | | | | IEC | Ex tb (Zone 21), Ex tc (Zone 22), Ex ec (Zone 2) | IE3 IE2 | | |
| | Additional identification code with order code and plain text, if required | 1MB16.3 Performance Line | | | | | | | | | | | | | | | |
| | | 1MB15.1 Basic Line | | | | | | | | | | | | | | | |
| | | 1MB16.1 Performance Line | | | | | | | | | | | | | | | |
| 1MB15 | Order code | | | | | | | | | | | | | | | | |
| Terminal box position | | | | | | | | | | | | | | | | | |
| Terminal box top ¹⁾ | 4 | - | □ | □ | □ | □ | □ | □ | □ | □ | □ | □ | □ | □ | □ | □ | □ |
| Terminal box right-hand side ²⁾ | 5 | - | - | ✓ | ✓ | ✓ | ✓ | ✓ | ✓ | ✓ | ✓ | ✓ | ✓ | ✓ | ✓ | ✓ | ✓ |
| Terminal box left-hand side ²⁾ | 6 | - | - | ✓ | ✓ | ✓ | ✓ | ✓ | ✓ | ✓ | ✓ | ✓ | ✓ | ✓ | ✓ | ✓ | ✓ |
| Terminal box bottom ³⁾ | 7 | - | - | - | ✓ | ✓ | ✓ | ✓ | - | - | - | - | - | - | - | - | - |

- Standard version
- ✓ With additional charge
- Not possible

¹⁾ For types of construction with feet, cast feet are standard.

²⁾ For types of construction with feet, screwed-on feet are standard.

³⁾ Not generally possible for motors with feet.

SIMOTICS XP 1MB1, 1MB5 explosion-protected motors

Article No. supplements and special versions · Terminal box position

Cast-iron series 1MB1543, 1MB5543 Basic Line and 1MB1643, 1MB5643 Performance Line

Selection and ordering data

| Terminal box position | Article No. supplement | | Frame size | | | | | | | | | | | Motor version | | | | |
|---|---|--|--------------------------|----|----|-----|-----|-----|-----|-----|-----|-----|-----|---------------|-----|-----|----------------|-----|
| | Terminal box position code 16th position of the Article No. | Additional identification code with order code and plain text, if required | 71 | 80 | 90 | 100 | 112 | 132 | 160 | 180 | 200 | 225 | 250 | 280 | 315 | IEC | Ex eb (Zone 1) | IE3 |
| | | | 1MB1543 Basic Line | | | | | | | | | | | | | | | |
| | | | 1MB1643 Performance Line | | | | | | | | | | | | | | | |
| | | | 1MB5543 Basic Line | | | | | | | | | | | | | | | |
| | | | 1MB5643 Performance Line | | | | | | | | | | | | | | | |
| 1MB15 | ■ | | | | | | | | | | | | | | | | | |
| 1MB16 | ■ | | | | | | | | | | | | | | | | | |
| 1MB55 | ■ | | | | | | | | | | | | | | | | | |
| 1MB56 | ■ | | | | | | | | | | | | | | | | | |
| | | Order code | | | | | | | | | | | | | | | | |
| Terminal box position | | | | | | | | | | | | | | | | | | |
| Terminal box base left with terminal box at the top | 0 | – | – | – | – | – | – | – | – | – | – | – | – | – | – | – | – | ✓ |
| Terminal box base right with terminal box at the top | 1 | – | – | – | – | – | – | – | – | – | – | – | – | – | – | – | – | ✓ |
| Terminal box base left with oblique terminal box 45° | 2 | – | – | – | – | – | – | – | – | – | – | – | – | – | – | – | – | ○ |
| Terminal box base right with oblique terminal box 45° | 3 | – | – | – | – | – | – | – | – | – | – | – | – | – | – | – | – | ◻ |
| Terminal box top ¹⁾ | 4 | – | ◻ | ◻ | ◻ | ◻ | ◻ | ◻ | ◻ | ◻ | ◻ | ◻ | ◻ | ◻ | ◻ | ◻ | ◻ | – |
| Terminal box right-hand side ²⁾ | 5 | – | – | ✓ | ✓ | ✓ | ✓ | ✓ | ✓ | ✓ | ✓ | ✓ | ✓ | ✓ | ✓ | ✓ | ✓ | ✓ |
| Terminal box left-hand side ²⁾ | 6 | – | – | ✓ | ✓ | ✓ | ✓ | ✓ | ✓ | ✓ | ✓ | ✓ | ✓ | ✓ | ✓ | ✓ | ✓ | ✓ |
| Terminal box at bottom ^{2) 3)} | 7 | – | – | – | – | ✓ | ✓ | ✓ | ✓ | – | – | – | – | – | – | – | – | – |
| Terminal box on left-hand side (base below) | 9 | R5L | – | – | – | – | – | – | – | – | – | – | – | – | – | – | – | ✓ |
| Terminal box on right-hand side (base below) | 9 | R6R | – | – | – | – | – | – | – | – | – | – | – | – | – | – | – | ✓ |
| Terminal box bottom left | 9 | R7L | – | – | – | – | – | – | – | – | – | – | – | – | – | – | – | ✓ |
| Terminal box bottom right | 9 | R7R | – | – | – | – | – | – | – | – | – | – | – | – | – | – | – | ✓ |

- ◻ Standard version
- Without additional charge
- ✓ With additional charge
- Not possible

¹⁾ For types of construction with feet, cast feet are standard. Screwed-on feet are available with order code **H01**.

²⁾ For types of construction with feet, screwed-on feet are standard.

³⁾ Not generally possible for motors with feet.

SIMOTICS XP 1MB1, 1MB5 explosion-protected motors

Article No. supplements and special versions · Terminal box position

Cast-iron series 1MB1553, 1MB5553**Selection and ordering data**

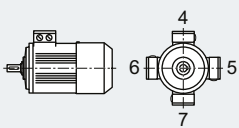
| Terminal box position | Article No. supplement | | Frame size | | | | | | | | | | | | | Motor version | | |
|---|---|--|------------|----|----|-----|-----|-----|-----|-----|-----|-----|-----|-----|-----|---------------|-----|-----------------|
| | Terminal box position code 16th position of the Article No. | Additional identification code with order code and plain text, if required | 71 | 80 | 90 | 100 | 112 | 132 | 160 | 180 | 200 | 225 | 250 | 280 | 315 | 355 | IEC | Ex db, Ex db eb |
|  | | | 1MB1553 | | | | | | | | | | | | | | | |
| | | | 1MB5553 | | | | | | | | | | | | | | | |
| 1MB.553 - ■ | | | Order code | | | | | | | | | | | | | | | |
| Terminal box position | | | | | | | | | | | | | | | | | | |
| Terminal box top ¹⁾ | 4 | - | □ | □ | □ | □ | □ | □ | □ | □ | □ | □ | □ | □ | □ | □ | □ | □ |
| Terminal box right-hand side ¹⁾ | 5 | - | - | - | - | - | ✓ | ✓ | ✓ | ✓ | ✓ | ✓ | ✓ | ✓ | ✓ | ✓ | ✓ | ✓ |
| Terminal box left-hand side ¹⁾ | 6 | - | - | - | - | - | ✓ | ✓ | ✓ | ✓ | ✓ | ✓ | ✓ | ✓ | ✓ | - | - | - |
| Terminal box bottom ²⁾ | 7 | - | - | - | ✓ | ✓ | ✓ | ✓ | - | - | - | - | - | - | - | - | - | - |

- Standard version
- ✓ With additional charge
- Not possible

Standard version:

Cable entry from right, as seen looking onto the shaft, with terminal box position left, entry from below, on frame size 355 and with terminal box on the right-hand side, cable entry is from the NDE.

¹⁾ For types of construction with feet, cast feet are standard.

²⁾ Not generally possible for motors with feet.

SIMOTICS XP 1MB1, 1MB5 explosion-protected motors

Article No. supplements and special versions · Terminal box position

Cast-iron series 1MB55.4, 1MB55.3, 1MB58.3

Selection and ordering data

| Terminal box position | Article No. supplement | | Frame size | | Motor version | |
|---|---|--|------------|-----|---------------|--|
| | Terminal box position code 16th position of the Article No. | Additional identification code with order code and plain text, if required | 400 | 450 | IEC | Ex ec, Ex tc, Ex tb (Zones 2, 22 and 21) |
| | | | 1MB55 . 4 | | | IE4 |
| | | | 1MB55 . 3 | | | IE3 |
| | | | 1MB58 . 3 | | | |
| 1MB5 | | Order code | | | | |
| Terminal box position | | | | | | |
| Terminal box base left with terminal box at the top | 0 | – | ✓ | ✓ | | |
| Terminal box base right with terminal box at the top | 1 | – | ✓ | ✓ | | |
| Terminal box base left with oblique terminal box 45° | 2 | – | ○ | ○ | | |
| Terminal box base right with oblique terminal box 45° | 3 | – | ◻ | ◻ | | |
| Terminal box on right-hand side | 5 | – | ✓ | ✓ | | |
| Terminal box on left-hand side | 6 | – | ✓ | ✓ | | |
| Terminal box left-hand side (base below) ¹⁾ | 9 | R5L | ✓ | ✓ | | |
| Terminal box right-hand side (base below) ¹⁾ | 9 | R6R | ✓ | ✓ | | |
| Terminal box bottom left ¹⁾ | 9 | R7L | ✓ | ✓ | | |
| Terminal box bottom right ¹⁾ | 9 | R7R | ✓ | ✓ | | |

- ◻ Standard version
- Without additional charge
- ✓ With additional charge

¹⁾ Only possible in combination with type of construction IM V1.

SIMOTICS XP 1MB1, 1MB5 explosion-protected motors

Article No. supplements and special versions · Options

Aluminum series 1MB10

Selection and ordering data

| Special versions | Additional identification code -Z with order code and plain text if required | Frame size | | | | | | Motor version | | |
|--|---|------------|----|---------|-----|-----|-----|---------------|--|-------------------|
| | | 80 | 90 | 100 | 112 | 132 | 160 | IEC | Ex tb (Zone 21), Ex tc (Zone 22), Ex ec (Zone 2) | IE3 IE2 IE1 |
| | | 1MB10.3 | | | | | | | | |
| | | 1MB10.1 | | | | | | | | |
| | | | | 1MB10.2 | | | | | | |
| 1MB10 -Z | Order code | | | | | | | | | |
| Explosion-protected version | | | | | | | | | | |
| Version additionally for dust Ex tc – Zone 22 ^{1) 14) 22)} | B30 | ✓ | ✓ | ✓ | ✓ | ✓ | ✓ | ✓ | Only for: 1MB103 – Ex ec (Zone 2) | |
| Version IIC with stamping of IIB ²²⁾ | B31 | ○ | ○ | ○ | ○ | ○ | ○ | ○ | Only for: 1MB103 – Ex ec (Zone 2) | |
| VIK version | C02 | ✓ | ✓ | ✓ | ✓ | ✓ | ✓ | ✓ | Only for: 1MB1033 – Ex ec IE3 (Zone 2) | |
| Version for converter operation | | | | | | | | | | |
| Version for converter operation in basic version with operating data SINAMICS G120 with PM240-2. ¹⁵⁾ | B40 | ✓ | ✓ | ✓ | ✓ | ✓ | ✓ | ✓ | | |
| Version for converter operation in basic version with operating data SINAMICS S150 ¹⁵⁾ | B41 | ✓ | ✓ | ✓ | ✓ | ✓ | ✓ | ✓ | | |
| Operating data such as the B40 order code with alternative SINAMICS converter on the rating plate • G120 with PM230 • G120 with PM240 • G120C • G120P with PM230 • G120P with PM240-2 • G120P with PM240P-2 • G120P with PM330 • G130, G150, G180 • S120 (BLM/SLM) • V20 Operating data such as order code B41 with alternative SINAMICS converters on the rating plate • S120 (ALM) | Y68 • and converter type | ○ | ○ | ○ | ○ | ○ | ○ | ○ | | |
| Motor protection | | | | | | | | | | |
| 1 Pt1000 resistance thermometer (2 terminals) | Q35 | ✓ | ✓ | ✓ | ✓ | ✓ | ✓ | ✓ | | |
| 2 Pt1000 resistance thermometers (4 terminals) | Q36 | ✓ | ✓ | ✓ | ✓ | ✓ | ✓ | ✓ | | |
| Motor connection and terminal box | | | | | | | | | | |
| External grounding | | □ | □ | □ | □ | □ | □ | □ | | |
| Rotation of the terminal box through 90°, entry from DE | R10 | ○ | ○ | ○ | ○ | ○ | ○ | ○ | | |
| Rotation of the terminal box through 90°, entry from NDE | R11 | ○ | ○ | ○ | ○ | ○ | ○ | ○ | | |
| Rotation of the terminal box through 180° | R12 | ○ | ○ | ○ | ○ | ○ | ○ | ○ | | |
| Metal cable gland, maximum configuration | R18 | ✓ | ✓ | ✓ | ✓ | ✓ | ✓ | ✓ | | |
| Larger terminal box | R50 | □ | □ | – | – | – | – | – | | |
| Windings and insulation | | | | | | | | | | |
| Temperature class 155 (F), utilized acc. to 130 (B), coolant temperature 45 °C, derating approx. 4 % ²⁾ | N05 | ✓ | ✓ | ✓ | ✓ | ✓ | ✓ | ✓ | | |
| Temperature class 155 (F), utilized acc. to 130 (B), coolant temperature 50 °C, derating approx. 8 % ²⁾ | N06 | ✓ | ✓ | ✓ | ✓ | ✓ | ✓ | ✓ | | |
| Temperature class 155 (F), utilized acc. to 130 (B), coolant temperature 55 °C, derating approx. 13 % ²⁾ | N07 | ✓ | ✓ | ✓ | ✓ | ✓ | ✓ | ✓ | | |
| Temperature class 155 (F), utilized acc. to 130 (B), coolant temperature 60 °C, derating approx. 18 % | N08 | ✓ | ✓ | ✓ | ✓ | ✓ | ✓ | ✓ | | |
| Increased air humidity/temperature with 30 to 60 g water per m ³ of air | N30 | ✓ | ✓ | ✓ | ✓ | ✓ | ✓ | ✓ | | |
| Increased air humidity/temperature with 60 to 100 g water per m ³ of air | N31 | ✓ | ✓ | ✓ | ✓ | ✓ | ✓ | ✓ | | |
| Temperature class 155 (F), utilized acc. to 130 (B), with higher coolant temperature and/or installation altitude | Y50 • and spec. power, CT .. °C or IA m above sea level | ✓ | ✓ | ✓ | ✓ | ✓ | ✓ | ✓ | | |

For legends and footnotes, see page 5/81.

SIMOTICS XP 1MB1, 1MB5 explosion-protected motors

Article No. supplements and special versions · Options

Aluminum series 1MB10

| Special versions | Additional identification code -Z with order code and plain text if required | Frame size | | | | | | Motor version | | |
|--|---|------------|---------|---------|-----|-----|-----|---------------|--|-------------------|
| | | 80 | 90 | 100 | 112 | 132 | 160 | IEC | Ex tb (Zone 21), Ex tc (Zone 22), Ex ec (Zone 2) | IE3 IE2 IE1 |
| | | 1MB10.3 | 1MB10.1 | 1MB10.2 | | | | | | |
| 1MB10 -Z | Order code | | | | | | | | | |
| Colors and paint finish | | | | | | | | | | |
| Special paint finish in RAL 7030 stone gray | | ☐ | ☐ | ☐ | ☐ | ☐ | ☐ | | | |
| Unpainted (only cast-iron parts primed) | S00 | ○ | ○ | ○ | ○ | ○ | ○ | | | |
| Unpainted, only primed | S01 | ✓ | ✓ | ✓ | ✓ | ✓ | ✓ | | | |
| Special paint finish C3 | S02 | ✓ | ✓ | ✓ | ✓ | ✓ | ✓ | | | |
| Special paint finish sea air resistant C4 | S03 | ✓ | ✓ | ✓ | ✓ | ✓ | ✓ | | | |
| Top coat polyurethane ¹²⁾ | S06 | ✓ | ✓ | ✓ | ✓ | ✓ | ✓ | Only for: | 1MB103. – Ex ec (Zone 2) | |
| Paint finish in other standard RAL colors: RAL 1002, 1013, 1015, 1019, 2003, 2004, 3000, 3007, 5002, 5007, 5009, 5010, 5012, 5015, 5017, 5018, 5019, 6011, 6019, 6021, 7000, 7001, 7004, 7011, 7016, 7022, 7031, 7032, 7033, 7035, 9001, 9002, 9005 (see Catalog Section 1 "Introduction") | Y53 • and paint finish RAL | ✓ | ✓ | ✓ | ✓ | ✓ | ✓ | | | |
| Paint finish in special RAL colors: For RAL colors, see "Special paint finish in special RAL colors" (see Catalog Section 1 "Introduction") | Y56 • and paint finish RAL | ✓ | ✓ | ✓ | ✓ | ✓ | ✓ | | | |
| Modular technology – Basic versions | | | | | | | | | | |
| Mounting of separately driven fan ¹⁷⁾ | F70 | – | – | – | – | – | – | Only for: | 1MB101. – Ex tb (Zone 21) | |
| | | – | – | ✓ | ✓ | ✓ | ✓ | Only for: | 1MB102. – Ex tc (Zone 22), 1MB103. – Ex ec (Zone 2) | |
| Special technology | | | | | | | | | | |
| Mounting of LL 841 (HTL); 1024 l explosion-protected rotary pulse encoder ¹⁶⁾ | G30 | – | – | ✓ | ✓ | ✓ | ✓ | | | |
| Mechanical version and degrees of protection | | | | | | | | | | |
| Low-noise version for 2-pole motors with clockwise direction of rotation | F77 | – | – | – | – | ✓ | ✓ | | | |
| Low-noise version for 2-pole motors with counterclockwise direction of rotation | F78 | – | – | – | – | ✓ | ✓ | | | |
| Mechanical protection for encoder | G43 | ☐ | ☐ | ☐ | ☐ | ☐ | ☐ | | | |
| Protective cover | H00 | ✓ | ✓ | ✓ | ✓ | ✓ | ✓ | | | |
| Screwed-on (instead of cast) feet | H01 | ✓ | ✓ | ✓ | ✓ | ✓ | ✓ | | | |
| Vibration-proof version; vibration resistance to Class 3M4 according to IEC 60721-3-3:1994 | H02 | ✓ | ✓ | ✓ | ✓ | ✓ | ✓ | | | |
| Condensation drainage holes ⁶⁾ | H03 | ✓ | ✓ | ✓ | ✓ | ✓ | ✓ | | | |
| Rust-resistant screws (externally) | H07 | ✓ | ✓ | ✓ | ✓ | ✓ | ✓ | | | |
| IP65 degree of protection ⁴⁾ | H20 | ✓ | ✓ | ✓ | ✓ | ✓ | ✓ | Only for: | 1MB103. – Ex ec (Zone 2) | |
| IP56 degree of protection ⁵⁾ | H22 | ✓ | ✓ | ✓ | ✓ | ✓ | ✓ | Only for: | 1MB103. – Ex ec (Zone 2) | |
| Drive-end seal for flange-mounting motors, oil-tight to 0.1 bar ³⁾ | H23 | ✓ | ✓ | ✓ | ✓ | ✓ | ✓ | | | |
| Coolant temperature and installation altitude | | | | | | | | | | |
| Coolant temperature –40 to +40 °C ²⁰⁾ | D03 | ✓ | ✓ | ✓ | ✓ | ✓ | ✓ | | | |
| Versions in accordance with standards and specifications | | | | | | | | | | |
| Ex certification for China | D32 | ✓ | ✓ | ✓ | ✓ | ✓ | ✓ | | | |
| China Energy Efficiency Label | D34 | ✓ | ✓ | ✓ | ✓ | ✓ | ✓ | | | |
| EAC Ex certificate for the Eurasian Customs Union ¹⁸⁾ | D35 | ✓ | ✓ | ✓ | ✓ | ✓ | ✓ | | | |
| IECEx certification | D37 | ✓ | ✓ | – | – | – | – | Only for: | 1MB101. – Ex tb (Zone 21) | |
| | | ✓ | ✓ | ✓ | ✓ | ✓ | ✓ | Only for: | 1MB102. – Ex tc (Zone 22), 1MB103. – Ex ec (Zone 2) | |

For legends and footnotes, see page 5/81.

SIMOTICS XP 1MB1, 1MB5 explosion-protected motors

Article No. supplements and special versions · Options

Aluminum series 1MB10

| Special versions | Additional identification code -Z with order code and plain text if required | Frame size | | | | | | Motor version | | |
|--|---|----------------|----|----------------|-----|-----|-----|--|--|-------------------|
| | | 80 | 90 | 100 | 112 | 132 | 160 | IEC | Ex tb (Zone 21), Ex tc (Zone 22), Ex ec (Zone 2) | IE3 IE2 IE1 |
| | | 1MB10.3 | | | | | | | | |
| | | 1MB10.1 | | | | | | | | |
| | | | | 1MB10.2 | | | | | | |
| 1MB10 -Z | Order code | | | | | | | | | |
| Bearings and lubrication | | | | | | | | | | |
| Located bearing DE | L20 | ✓ | ✓ | ✓ | ✓ | ✓ | ✓ | | | |
| Located bearing NDE | L21 | ✓ | ✓ | ✓ | ✓ | ✓ | ☐ | | | |
| Bearing design for increased cantilever forces ⁽³⁾ | L22 | – | – | ✓ | ✓ | ✓ | ✓ | | | |
| Regreasing device | L23 | – | – | ✓ | ✓ | ✓ | ✓ | | | |
| Bearings reinforced at both ends for DE and NDE, bearing size 63 | L25 | – | – | ✓ | ✓ | ✓ | ✓ | | | |
| Bearing insulation NDE | L51 | – | – | ✓ | ✓ | ✓ | ✓ | | | |
| Measuring nipple for SPM shock pulse measurement for bearing inspection | Q01 | – | – | ✓ | ✓ | ✓ | ✓ | | | |
| Balance and vibration severity | | | | | | | | | | |
| Vibration severity grade A | | ☐ | ☐ | ☐ | ☐ | ☐ | ☐ | | | |
| Vibration severity grade B ⁽⁹⁾ | L00 | ✓ | ✓ | ✓ | ✓ | ✓ | ✓ | | | |
| Half-key balancing | | ☐ | ☐ | ☐ | ☐ | ☐ | ☐ | | | |
| Balancing without feather key | L01 | ✓ | ✓ | ✓ | ✓ | ✓ | ✓ | | | |
| Full-key balancing | L02 | ✓ | ✓ | ✓ | ✓ | ✓ | ✓ | | | |
| Shaft and rotor | | | | | | | | | | |
| Shaft extension with standard dimensions, without feather keyway | L04 | ✓ | ✓ | ✓ | ✓ | ✓ | ✓ | | | |
| Standard, cylindrical shaft extension (second shaft extension) NDE acc. to EN 50347 | L05 | ✓ | ✓ | ✓ | ✓ | ✓ | ✓ | | | |
| Standard shaft made of stainless steel (e.g. 1.4021) | L06 | ✓ | ✓ | ✓ | ✓ | ✓ | ✓ | | | |
| Shaft extension run-out in accordance with IEC 60072-1 precision class | L07 | ✓ | ✓ | ✓ | ✓ | ✓ | ✓ | | | |
| Shaft extension run-out, concentricity and perpendicularity in accordance with IEC 60072-1 precision class for flange-mounted motors | L08 | ✓ | ✓ | ✓ | ✓ | ✓ | ✓ | | | |
| Non-standard cylindrical shaft extension, DE ⁽⁷⁾ | Y58 • and customer specifications | ✓ | ✓ | ✓ | ✓ | ✓ | ✓ | | | |
| Non-standard cylindrical shaft extension, NDE ⁽⁷⁾ | Y59 • and customer specifications | ✓ | ✓ | ✓ | ✓ | ✓ | ✓ | | | |
| Heating and ventilation | | | | | | | | | | |
| Metal external fan ⁽⁸⁾ | F76 | ☐ | ☐ | – | – | – | – | Only for: 1MB103. – Ex ec (Zone 2) | | |
| | | ☐ | ☐ | ✓ | ✓ | ✓ | ✓ | Only for: 1MB101. – Ex tb (Zone 21), 1MB102. – Ex tc (Zone 22) | | |
| Anti-condensation heating for 230 V (2 terminals) ⁽⁹⁾ | Q02 | ✓ | ✓ | ✓ | ✓ | ✓ | ✓ | | | |
| Anti-condensation heating for 115 V (2 terminals) ⁽⁹⁾ | Q03 | ✓ | ✓ | ✓ | ✓ | ✓ | ✓ | | | |
| Rating plate and additional rating plates | | | | | | | | | | |
| Second rating plate, loose | M10 | ✓ | ✓ | ✓ | ✓ | ✓ | ✓ | | | |
| Rating plate, stainless steel | M11 | ✓ | ✓ | ✓ | ✓ | ✓ | ✓ | | | |
| Additional rating plate with deviating rating plate data | Y80 • and customer specifications | ✓ | ✓ | ✓ | ✓ | ✓ | ✓ | | | |
| Additional rating plate with customer specifications | Y82 • and customer specifications | ✓ | ✓ | ✓ | ✓ | ✓ | ✓ | | | |
| Additional information on rating plate and on package label (max. 20 characters) | Y84 • and customer specifications | ✓ | ✓ | ✓ | ✓ | ✓ | ✓ | | | |

For legends and footnotes, see page 5/81.

SIMOTICS XP 1MB1, 1MB5 explosion-protected motors

Article No. supplements and special versions · Options

Aluminum series 1MB10

| Special versions | Additional identification code -Z with order code and plain text if required | Frame size | | | | | | Motor version | | |
|--|---|------------|----|---------|-----|-----|-----|---------------|--|-------------------|
| | | 80 | 90 | 100 | 112 | 132 | 160 | IEC | Ex tb (Zone 21), Ex tc (Zone 22), Ex ec (Zone 2) | IE3 IE2 IE1 |
| | | 1MB10.3 | | | | | | | | |
| | | 1MB10.1 | | | | | | | | |
| | | | | 1MB10.2 | | | | | | |
| | 1MB10 -Z | Order code | | | | | | | | |
| Packaging, safety notes, documentation and test certificates | | | | | | | | | | |
| Printed Operating Instructions in German/English and a DVD with all official EU languages as well as Norwegian, Russian, Turkish, and Chinese ¹¹⁾ | | | □ | □ | □ | □ | □ | □ | | |
| Inspection certificate 3.1 according to EN 10204 ¹⁰⁾ | B02 | | ✓ | ✓ | ✓ | ✓ | ✓ | ✓ | | |
| Document – Electrical datasheet | B60 | | ✓ | ✓ | ✓ | ✓ | ✓ | ✓ | | |
| Document – Order dimensional drawing | B61 | | ✓ | ✓ | ✓ | ✓ | ✓ | ✓ | | |
| Type test with heat run for horizontal motors, with acceptance | B83 | | ✓ | ✓ | ✓ | ✓ | ✓ | ✓ | | |
| "Basic" documentation package | B90 | | ✓ | ✓ | ✓ | ✓ | ✓ | ✓ | | |
| "Advanced" documentation package | B91 | | ✓ | ✓ | ✓ | ✓ | ✓ | ✓ | | |
| "Projects" documentation package | B92 | | ✓ | ✓ | ✓ | ✓ | ✓ | ✓ | | |
| Wire-lattice pallet packaging | B99 | | ○ | ○ | ○ | ○ | ○ | ○ | | |
| Connected in star for dispatch | M01 | | ✓ | ✓ | ✓ | ✓ | ✓ | ✓ | | |
| Connected in delta for dispatch | M02 | | ✓ | ✓ | ✓ | ✓ | ✓ | ✓ | | |

- Standard version
- Without additional charge
- This order code only determines the price of the version – Additional plain text is required.
- ✓ With additional charge
- Not possible

- 1) Please inquire regarding combination with order codes **D03** and **C02**. Not possible in combination with order codes **H20** and **H22**.
- 2) There is no derating in combination with order codes **M2A**, **M2B**, **M2C**, **M2D**, **M2E**, **M2F**, **M2G**, **M2H**.
- 3) Not possible for type of construction IM V3.
- 4) For Zone 21, IP65 degree of protection is standard. Not possible for Zone 22, because only IP55 degree of protection is required.
- 5) Not admissible for Zone 21 (IP65 degree of protection) and Zone 22 (IP55 degree of protection).
- 6) Supplied with the condensation drainage holes sealed at the drive end DE and non-drive end NDE (IP55, IP56, IP65). If the condensation drainage holes are required for motors of the IM B6, IM B7 or IM B8 type of construction (feet on side or top), the motors must be ordered in the respective type of construction and with order code **H03**, so that the condensation drainage holes will be placed in the correct position.
- 7) When motors are ordered that have a longer or shorter shaft extension than normal, the required position and length of the feather keyway must be specified in a sketch. It must be ensured that only feather keys in accordance with DIN 6885, Form A are permitted to be used. The feather keyway is positioned centrally on the shaft extension. The length is defined by the manufacturer in accordance with the appropriate standard. Not valid for: Conical shafts, non-standard threaded journals, non-standard shaft tolerances, friction welded journals, extremely "thin" shafts, special geometry dimensions (e.g. square journals), hollow shafts. Valid for non-standard shaft extensions DE or NDE. The feather keys are supplied in every case. For order codes **Y58**, **Y59** and **L05** the following applies:
 - Dimensions D and DA ≤ ball bearing inner diameter (see dimension tables for "Dimensions")
 - Dimensions E and EA ≤ 2 × length E (standard) of the shaft extension
 For an explanation of the order codes, see Catalog Section 1 "Introduction".
- 8) The metal external fan is not possible in combination with the low-noise version – order code **F77** or **F78**.
- 9) In combination with the 15th position of the article number "**H**", the order codes **Q02** and **Q03** are not possible for frame sizes 100 to 160. It can only be supplied with a star or delta winding for direct switch-on (3 terminals).
- 10) The delivery time for the inspection certificate may differ from the delivery time for the motor.
- 11) The Operating Instructions are available on the Internet in PDF format for all official EU languages at <http://support.automation.siemens.com/WWW/view/en/10803948/133300>.

- 12) Order code **S06** cannot be combined with order code **B30**.
- 13) A minimum cantilever force F_{\min} of $0.5 \cdot F_{\max}$ is required for NU bearings (cylindrical roller bearings) in contrast to ball bearings. Cylindrical roller bearings are not suitable for coupling output or for brief periods of no-load operation without cantilever force.
- 14) The Ex motor is not admissible in an explosive atmosphere of dust and air (hybrid). A standard is not currently available that describes the product requirements for a hybrid mixture.
- 15) In combination with order codes **B40** and **B41**, "**B**" or "**C**" must be added to the 15th position of the Article No. . For compliance with the admissible temperature class 130 (B), derating is necessary in the case of converter operation in Zones 2, 21 and 22. The operating data for SINAMICS converters from Siemens are on the rating plate – the torque is reduced in contrast to line operation. The motor operating data for converter operation is available in the DTC selection and ordering tool (www.siemens.com/dt-configurator). For converter operation, voltage codes/order codes are only admissible with one voltage only. When used in hazardous zones, the frequency converter must have a certified trip unit for motors of equipment category 1 (Zone 21). A certified trip unit is also recommended for motors of device category 3 (Zones 2 and 22). Alternatively, an external, certified trip unit can be used (see Catalog IC 10).
- 16) Can be combined with order codes **N30**, **N31**, **L51** and **F70** on request. Not admissible in combination with order code **L05**. Combination with protective cover as standard for frame sizes 100 to 200. Protective cover not possible for frame sizes 225 to 315.
- 17) In combination with order codes **N05**, **N06**, **N07**, **N08**, **N30**, **N31**, **D03**, **G30**, **C02**, **H20** and **H22** on request. Not admissible with order code **L05**. The degree of protection of the separately driven fan must match that of the motor.
- 18) Not admissible in combination with anti-condensation heating (order code **Q02/Q03**). For this component, no TR CU certificate is available yet.
- 19) Vibration severity grade B not admissible in combination with converter operation (order code **B40/B41**).
- 20) Not possible in combination with order codes **Q02** or **Q03**.
- 21) Not possible in vertical version with downward shaft extension DE.
- 22) Permissible paint film thickness up to 2 mm.

SIMOTICS XP 1MB1, 1MB5 explosion-protected motors

Article No. supplements and special versions · Options

Cast-iron series 1MB15 Basic Line, 1MB16 Performance Line

Selection and ordering data

| Special versions | Additional identification code - Z with order code and plain text if required | Frame size | | | | | | | | | | | Motor version | | | | |
|---|---|--------------------------|----|----|-----|-----|-----|-----|-----|-----|-----|-----|---------------|-----|------------------|--|---|
| | | 71 | 80 | 90 | 100 | 112 | 132 | 160 | 180 | 200 | 225 | 250 | 280 | 315 | IEC | Ex tb (Zone 21), Ex tc (Zone 22), Ex ec (Zone 2) | IE3 IE2 |
| | | 1MB15.3 Basic Line | | | | | | | | | | | | | | | |
| | | 1MB16.3 Performance Line | | | | | | | | | | | | | | | |
| 1MB15 -Z | | 1MB15.1 Basic Line | | | | | | | | | | | | | | | |
| 1MB16 -Z | Order code | 1MB16.1 Performance Line | | | | | | | | | | | | | | | |
| Explosion-protected version | | | | | | | | | | | | | | | | | |
| Version additionally for dust Ex tc – Zone 22 ^{1) 16)} | B30 | ✓ | ✓ | ✓ | ✓ | ✓ | ✓ | ✓ | ✓ | ✓ | ✓ | ✓ | ✓ | ✓ | ✓ | ✓ | Only for: 1MB1.3. – Ex ec (Zone 2) |
| Version IIC with stamping of IIB ²⁴⁾ | B31 | ○ | ○ | ○ | ○ | ○ | ○ | ○ | ○ | ○ | ○ | ○ | ○ | ○ | ○ | ○ | Only for: 1MB1.3. – Ex ec (Zone 2) |
| VIK version | C02 | ✓ | ✓ | ✓ | ✓ | ✓ | ✓ | ✓ | ✓ | ✓ | ✓ | ✓ | ✓ | ✓ | ✓ | ✓ | Only for: 1MB1.33 – Ex ec (Zone 2) |
| Version for converter operation | | | | | | | | | | | | | | | | | |
| Version for converter operation in basic version with operating data SINAMICS G120 with PM240-2. ^{17) 20) 21) 22)} | B40 | ✓ | ✓ | ✓ | ✓ | ✓ | ✓ | ✓ | ✓ | ✓ | ✓ | ✓ | ✓ | ✓ | ✓ ²⁰⁾ | ✓ ²⁰⁾ | |
| Version for converter operation in basic version with operating data SINAMICS S150 ^{17) 20) 21)} | B41 | ✓ | ✓ | ✓ | ✓ | ✓ | ✓ | ✓ | ✓ | ✓ | ✓ | ✓ | ✓ | ✓ | ✓ ²⁰⁾ | ✓ ²⁰⁾ | |
| Operating data such as order code B40 with alternative SINAMICS converters on the rating plate ²⁰⁾ | Y68 • and converter type | ○ | ○ | ○ | ○ | ○ | ○ | ○ | ○ | ○ | ○ | ○ | ○ | ○ | ○ | ○ | |
| Operating data such as order code B41 with alternative SINAMICS converters on the rating plate ²⁰⁾ | | ○ | ○ | ○ | ○ | ○ | ○ | ○ | ○ | ○ | ○ | ○ | ○ | ○ | ○ | ○ | ○ |
| Motor protection | | | | | | | | | | | | | | | | | |
| 1 Pt1000 resistance thermometer (2 terminals) | Q35 | – | – | – | ✓ | ✓ | ✓ | ✓ | ✓ | ✓ | ✓ | ✓ | ✓ | ✓ | ✓ | ✓ | |
| 2 Pt1000 resistance thermometers (4 terminals) | Q36 | – | – | – | ✓ | ✓ | ✓ | ✓ | ✓ | ✓ | ✓ | ✓ | ✓ | ✓ | ✓ | ✓ | |
| 2 Pt100 resistance thermometers in basic configuration for bearings (2 terminals) ^{2) 3)} | Q72 | – | – | – | – | – | – | – | ✓ | ✓ | ✓ | ✓ | ✓ | ✓ | ✓ | ✓ | |
| 2 Pt100 resistance thermometers in 3-wire input for bearings (6 terminals) ^{2) 3)} | Q78 | – | – | – | – | – | – | – | ✓ | ✓ | ✓ | ✓ | ✓ | ✓ | ✓ | ✓ | |
| 2 Pt100 double resistance thermometers in 3-wire input for bearings (12 terminals) ^{2) 3)} | Q79 | – | – | – | – | – | – | – | – | – | – | – | – | – | ✓ | ✓ | |
| Motor connection and terminal box | | | | | | | | | | | | | | | | | |
| External grounding | | □ | □ | □ | □ | □ | □ | □ | □ | □ | □ | □ | □ | □ | □ | □ | |
| Rotation of the terminal box through 90°, entry from DE | R10 | ○ | ○ | ○ | ○ | ○ | ○ | ○ | ✓ | ✓ | ✓ | ✓ | ✓ | ✓ | ✓ | ✓ | |
| Rotation of the terminal box through 90°, entry from NDE | R11 | ○ | ○ | ○ | ○ | ○ | ○ | ○ | ✓ | ✓ | ✓ | ✓ | ✓ | ✓ | ✓ | ✓ | |
| Rotation of the terminal box through 180° | R12 | ○ | ○ | ○ | ○ | ○ | ○ | ○ | ✓ | ✓ | ✓ | ✓ | ✓ | ✓ | ✓ | ✓ | |
| Stud terminal for cable connection, accessories pack (3 items) | R17 | – | – | – | – | – | – | – | – | – | – | – | – | – | ✓ | ✓ | Only for: 1MB1.1. – Ex tb (Zone 21), 1MB1.2. – Ex tc (Zone 22) |
| Metal cable gland, maximum configuration | R18 | ✓ | ✓ | ✓ | ✓ | ✓ | ✓ | ✓ | ✓ | ✓ | ✓ | ✓ | ✓ | ✓ | ✓ | ✓ | |
| Saddle terminal for connection without cable lug, accessories pack | R19 | – | – | – | – | – | – | – | – | – | – | – | – | – | ✓ | ✓ | Only for: 1MB1.1. – Ex tb (Zone 21), 1MB1.2. – Ex tc (Zone 22) |
| | | □ | □ | □ | □ | □ | □ | □ | □ | □ | □ | □ | □ | □ | □ | □ | Only for: 1MB1.3. – Ex ec (Zone 2) |
| Larger terminal box ¹⁵⁾ | R50 | ✓ | ✓ | ✓ | ✓ | ✓ | ✓ | ✓ | ✓ | ✓ | ✓ | ✓ | ✓ | ✓ | ✓ | ✓ | |
| Cast-iron auxiliary terminal box (small) | R62 | – | – | – | – | – | – | – | – | – | – | – | – | – | – | – | |

For legends and footnotes, see page 5/86.

SIMOTICS XP 1MB1, 1MB5 explosion-protected motors

Article No. supplements and special versions · Options

Cast-iron series 1MB15 Basic Line, 1MB16 Performance Line

| Special versions | Additional identification code - Z with order code and plain text if required | Frame size | | | | | | | | | | | | Motor version | | | |
|--|---|---------------------------------|----|----|-----|-----|-----|-----|-----|-----|-----|-----|-----|---------------|--|--|-------------------------------------|
| | | 71 | 80 | 90 | 100 | 112 | 132 | 160 | 180 | 200 | 225 | 250 | 280 | 315 | IEC | Ex tb (Zone 21), Ex tc (Zone 22), Ex ec (Zone 2) | IE3 IE2 |
| | | 1MB15.3 Basic Line | | | | | | | | | | | | IEC | Ex tb (Zone 21), Ex tc (Zone 22), Ex ec (Zone 2) | IE3 IE2 | |
| | | 1MB16.3 Performance Line | | | | | | | | | | | | | | | |
| | | 1MB15.1 Basic Line | | | | | | | | | | | | | | | |
| | | 1MB16.1 Performance Line | | | | | | | | | | | | | | | |
| Windings and insulation | | | | | | | | | | | | | | | | | |
| Temperature class 155 (F), utilized acc. to 130 (B), coolant temperature 45 °C, derating approx. 4 % ⁴⁾ | N05 | ✓ | ✓ | ✓ | ✓ | ✓ | ✓ | ✓ | ✓ | ✓ | ✓ | ✓ | ✓ | ✓ | ✓ | ✓ | |
| Temperature class 155 (F), utilized acc. to 130 (B), coolant temperature 50 °C, derating approx. 8 % ⁴⁾ | N06 | ✓ | ✓ | ✓ | ✓ | ✓ | ✓ | ✓ | ✓ | ✓ | ✓ | ✓ | ✓ | ✓ | ✓ | ✓ | |
| Temperature class 155 (F), utilized acc. to 130 (B), coolant temperature 55 °C, derating approx. 13 % ⁴⁾ | N07 | ✓ | ✓ | ✓ | ✓ | ✓ | ✓ | ✓ | ✓ | ✓ | ✓ | ✓ | ✓ | ✓ | ✓ | ✓ | |
| Temperature class 155 (F), utilized acc. to 130 (B), coolant temperature 60 °C, derating approx. 18 % | N08 | ✓ | ✓ | ✓ | ✓ | ✓ | ✓ | ✓ | ✓ | ✓ | ✓ | ✓ | ✓ | ✓ | ✓ | ✓ | |
| Increased air humidity/temperature with 30 to 60 g water per m ³ of air | N30 | ✓ | ✓ | ✓ | ✓ | ✓ | ✓ | ✓ | ✓ | ✓ | ✓ | ✓ | ✓ | ✓ | ✓ | ✓ | |
| Increased air humidity/temperature with 60 to 100 g water per m ³ of air | N31 | ✓ | ✓ | ✓ | ✓ | ✓ | ✓ | ✓ | ✓ | ✓ | ✓ | ✓ | ✓ | ✓ | ✓ | ✓ | |
| Temperature class 155 (F), utilized acc. to 130 (B), with higher coolant temperature and/or installation altitude | Y50 • and spec. power, CT .. °C or IA m above sea level | ✓ | ✓ | ✓ | ✓ | ✓ | ✓ | ✓ | ✓ | ✓ | ✓ | ✓ | ✓ | ✓ | ✓ | ✓ | |
| Colors and paint finish | | | | | | | | | | | | | | | | | |
| Standard paint finish C2 in RAL 7030 stone gray | | □ | □ | □ | □ | □ | □ | □ | □ | □ | □ | □ | □ | □ | □ | □ | Only for: 1MB15.. |
| Unpainted (only cast-iron parts primed) | S00 | ○ | ○ | ○ | ○ | ○ | ○ | ○ | ○ | ○ | ○ | ○ | ○ | ○ | ○ | ○ | |
| Unpainted, only primed | S01 | ✓ | ✓ | ✓ | ✓ | ✓ | ✓ | ✓ | ✓ | ✓ | ✓ | ✓ | ✓ | ✓ | ✓ | ✓ | |
| Special paint finish C3 | S02 | ✓ | ✓ | ✓ | ✓ | ✓ | ✓ | ✓ | ✓ | ✓ | ✓ | ✓ | ✓ | ✓ | ✓ | ✓ | Only for: 1MB15.. |
| | | - | - | - | □ | □ | □ | □ | □ | □ | □ | □ | □ | □ | □ | □ | Only for: 1MB16.. |
| Special paint finish sea air resistant C4 | S03 | ✓ | ✓ | ✓ | ✓ | ✓ | ✓ | ✓ | ✓ | ✓ | ✓ | ✓ | ✓ | ✓ | ✓ | ✓ | |
| Special paint finish for use offshore C5 | S04 | ✓ | ✓ | ✓ | ✓ | ✓ | ✓ | ✓ | ✓ | ✓ | ✓ | ✓ | ✓ | ✓ | ✓ | ✓ | |
| Top coat polyurethane ¹²⁾ | S06 | ✓ | ✓ | ✓ | ✓ | ✓ | ✓ | ✓ | ✓ | ✓ | ✓ | ✓ | ✓ | ✓ | ✓ | ✓ | Only for: 1MB1.3. – Ex ec (Zone 2) |
| Paint finish in other standard RAL colors: RAL 1002, 1013, 1015, 1019, 2003, 2004, 3000, 3007, 5002, 5007, 5009, 5010, 5012, 5015, 5017, 5018, 5019, 6011, 6019, 6021, 7000, 7001, 7004, 7011, 7016, 7022, 7031, 7032, 7033, 7035, 9001, 9002, 9005 (see Catalog Section 1 "Introduction") | Y53 • and paint finish RAL | ✓ | ✓ | ✓ | ✓ | ✓ | ✓ | ✓ | ✓ | ✓ | ✓ | ✓ | ✓ | ✓ | ✓ | ✓ | Only for: 1MB15.. |
| Paint finish in special RAL colors: For RAL colors, see "Special paint finish in special RAL colors" (see Catalog Section 1 "Introduction") | Y56 • and paint finish RAL | ✓ | ✓ | ✓ | ✓ | ✓ | ✓ | ✓ | ✓ | ✓ | ✓ | ✓ | ✓ | ✓ | ✓ | ✓ | |
| Modular technology – Basic versions | | | | | | | | | | | | | | | | | |
| Mounting of separately driven fan ¹⁹⁾ | F70 | - | - | - | - | - | - | - | - | - | ✓ | ✓ | ✓ | ✓ | ✓ | ✓ | Only for: 1MB1.1. – Ex tb (Zone 21) |
| | | - | - | - | ✓ | ✓ | ✓ | ✓ | ✓ | ✓ | ✓ | ✓ | ✓ | ✓ | ✓ | ✓ | Only for: 1MB1.2. – Ex tc (Zone 22) |
| | | - | - | - | ✓ | ✓ | ✓ | ✓ | ✓ | ✓ | ✓ | ✓ | ✓ | ✓ | ✓ | ✓ | ✓ |
| Special technology | | | | | | | | | | | | | | | | | |
| Mounting of LL 841 (HTL); 1024 l explosion-protected rotary pulse encoder ¹⁸⁾ | G30 | - | - | - | ✓ | ✓ | ✓ | ✓ | ✓ | ✓ | ✓ | ✓ | ✓ | ✓ | ✓ | ✓ | |



SIMOTICS XP 1MB1, 1MB5 explosion-protected motors

Article No. supplements and special versions · Options

Cast-iron series 1MB15 Basic Line, 1MB16 Performance Line

| Special versions | Additional identification code - Z with order code and plain text if required | Frame size | | | | | | | | | | | | Motor version | | | |
|---|---|--------------------------|----|----|-----|-----|-----|-----|-----|-----|-----|-----|------------------|------------------|--|--|-------------------------------------|
| | | 71 | 80 | 90 | 100 | 112 | 132 | 160 | 180 | 200 | 225 | 250 | 280 | 315 | IEC | Ex tb (Zone 21), Ex tc (Zone 22), Ex ec (Zone 2) | IE3 <hr/> IE2 |
| | | 1MB15.3 Basic Line | | | | | | | | | | | | IEC | Ex tb (Zone 21), Ex tc (Zone 22), Ex ec (Zone 2) | IE3 <hr/> IE2 | |
| | | 1MB16.3 Performance Line | | | | | | | | | | | | | | | |
| | | 1MB15.1 Basic Line | | | | | | | | | | | | | | | |
| | | 1MB16.1 Performance Line | | | | | | | | | | | | | | | |
| | Order code | | | | | | | | | | | | | | | | |
| Mechanical version and degrees of protection | | | | | | | | | | | | | | | | | |
| Low-noise version for 2-pole motors with clockwise direction of rotation | F77 | - | - | - | - | - | ✓ | ✓ | ✓ | ✓ | ✓ | ✓ | ✓ | ✓ | ✓ | ✓ | |
| Low-noise version for 2-pole motors with counterclockwise direction of rotation | F78 | - | - | - | - | - | ✓ | ✓ | ✓ | ✓ | ✓ | ✓ | ✓ | ✓ | ✓ | ✓ | |
| Mechanical protection for encoder | G43 | - | - | - | □ | □ | □ | □ | □ | □ | □ | □ | □ | □ | □ | □ | |
| Protective cover | H00 | ✓ | ✓ | ✓ | ✓ | ✓ | ✓ | ✓ | ✓ | ✓ | ✓ | ✓ | ✓ | ✓ | ✓ | ✓ | |
| Screwed-on (instead of cast) feet | H01 | - | - | - | ✓ | ✓ | ✓ | ✓ | ✓ | ✓ | ✓ | ✓ | ✓ | ✓ | ✓ | ✓ | |
| Vibration-proof version; vibration resistance to Class 3M4 according to IEC 60721-3-3:1994 ²⁷⁾ | H02 | ✓ | ✓ | ✓ | ✓ | ✓ | ✓ | ✓ | ✓ | ✓ | ✓ | ✓ | ✓ | ✓ | ✓ | ✓ | |
| Condensation drainage holes ⁷⁾ | H03 | ✓ | ✓ | ✓ | □ | □ | □ | □ | □ | □ | □ | □ | □ | □ | □ | □ | |
| Rust-resistant screws (externally) | H07 | ✓ | ✓ | ✓ | ✓ | ✓ | ✓ | ✓ | ✓ | ✓ | ✓ | ✓ | ✓ | ✓ | ✓ | ✓ | |
| IP65 degree of protection ⁵⁾ | H20 | ✓ | ✓ | ✓ | ✓ | ✓ | ✓ | ✓ | ✓ | ✓ | ✓ | ✓ | ✓ | ✓ | ✓ | ✓ | Only for: 1MB1.3. – Ex ec (Zone 2) |
| IP56 degree of protection ⁶⁾ | H22 | ✓ | ✓ | ✓ | ✓ | ✓ | ✓ | ✓ | ✓ | ✓ | ✓ | ✓ | ✓ | ✓ | ✓ | ✓ | Only for: 1MB1.3. – Ex ec (Zone 2) |
| Drive-end seal for flange-mounting motors, oil-tight to 0.1 bar | H23 | ✓ | ✓ | ✓ | ✓ | ✓ | ✓ | ✓ | ✓ | ✓ | ✓ | ✓ | ✓ | ✓ | ✓ | ✓ | Not for: Type of construction IM V3 |
| Coolant temperature and installation altitude | | | | | | | | | | | | | | | | | |
| Coolant temperature -40 to +40 °C ²⁶⁾ | D03 | ✓ | ✓ | ✓ | ✓ | ✓ | ✓ | ✓ | ✓ | ✓ | ✓ | ✓ | ✓ | ✓ | ✓ | ✓ | |
| Versions in accordance with standards and specifications | | | | | | | | | | | | | | | | | |
| Ex certification for China | D32 | ✓ | ✓ | ✓ | ✓ | ✓ | ✓ | ✓ | ✓ | ✓ | ✓ | ✓ | ✓ | ✓ | ✓ | ✓ | Only for: 1MB15.. |
| | | - | - | - | ✓ | ✓ | ✓ | ✓ | ✓ | ✓ | ✓ | ✓ | ✓ | ✓ | ✓ | ✓ | Only for: 1MB16.. |
| China Energy Efficiency Label | D34 | ○ | ○ | ○ | ○ | ○ | ○ | ○ | ○ | ○ | ○ | ○ | ○ | ○ | ○ | ○ | Only for: 1MB15.. |
| | | - | - | - | ○ | ○ | ○ | ○ | ○ | ○ | ○ | ○ | ○ | ○ | ○ | ○ | Only for: 1MB16.. |
| EAC Ex certificate for the Eurasian Customs Union ¹³⁾ | D35 | ✓ | ✓ | ✓ | ✓ | ✓ | ✓ | ✓ | ✓ | ✓ | ✓ | ✓ | ✓ | ✓ | ✓ | ✓ | |
| IECEx certification | D37 | ✓ | ✓ | ✓ | ✓ | ✓ | ✓ | ✓ | ✓ | ✓ | ✓ | ✓ | ✓ | ✓ | ✓ | ✓ | |
| Bearings and lubrication | | | | | | | | | | | | | | | | | |
| Regreasing device with M10 × 1 grease nipple according to DIN 71412-A | L19 | - | - | - | - | - | - | - | ✓ | ✓ | ✓ | ✓ | ✓ | ○ | ○ | | |
| Located bearing DE | L20 | ✓ | ✓ | ✓ | ✓ | ✓ | ✓ | ✓ | ✓ | ✓ | ✓ | ✓ | ✓ | ✓ | ✓ | ✓ | |
| Located bearing NDE | L21 | ✓ | ✓ | ✓ | ✓ | ✓ | ✓ | □ | □ | □ | □ | □ | □ | □ | □ | | |
| Bearing design for increased cantilever forces ¹⁴⁾ | L22 | ✓ | ✓ | ✓ | ✓ | ✓ | ✓ | ✓ | ✓ | ✓ | ✓ | ✓ | ✓ | ✓ | ✓ | ✓ | |
| Regreasing device | L23 | - | - | - | ✓ | ✓ | ✓ | ✓ | ✓ | ✓ | ✓ | ✓ | ✓ | □ | □ | | Only for: 1MB15.. |
| | | - | - | - | ✓ | ✓ | ✓ | □ | □ | □ | □ | □ | □ | □ | □ | | Only for: 1MB16.. |
| Bearings reinforced at both ends for DE and NDE, bearing size 63 | L25 | ✓ | ✓ | ✓ | ✓ | ✓ | ✓ | ✓ | ✓ | ✓ | ✓ | ✓ | ✓ | □ | □ | | Only for: 1MB15.. |
| | | - | - | - | □ | □ | □ | □ | □ | □ | □ | □ | □ | □ | □ | | Only for: 1MB16.. |
| Bearing insulation NDE ²⁰⁾ | L51 | - | - | - | - | - | - | - | - | ✓ | ✓ | ✓ | ✓ ²⁰⁾ | ✓ ²⁰⁾ | | | |
| Measuring nipple for SPM shock pulse measurement for bearing inspection | Q01 | ✓ | ✓ | ✓ | ✓ | ✓ | ✓ | ✓ | ✓ | ✓ | ✓ | ✓ | ✓ | ✓ | ✓ | | |
| Balance and vibration severity | | | | | | | | | | | | | | | | | |
| Vibration severity grade A ²¹⁾ | | □ | □ | □ | □ | □ | □ | □ | □ | □ | □ | □ | □ | □ | □ | | |
| Vibration severity grade B ^{21) 22) 23)} | L00 | ✓ | ✓ | ✓ | ✓ | ✓ | ✓ | ✓ | ✓ | ✓ | ✓ | ✓ | ✓ | ✓ | ✓ | | |
| Half-key balancing | | □ | □ | □ | □ | □ | □ | □ | □ | □ | □ | □ | □ | □ | □ | | |
| Balancing without feather key | L01 | ✓ | ✓ | ✓ | ✓ | ✓ | ✓ | ✓ | ✓ | ✓ | ✓ | ✓ | ✓ | ✓ | ✓ | | |
| Full-key balancing | L02 | ✓ | ✓ | ✓ | ✓ | ✓ | ✓ | ✓ | ✓ | ✓ | ✓ | ✓ | ✓ | ✓ | ✓ | | |

5

For legends and footnotes, see page 5/86.

SIMOTICS XP 1MB1, 1MB5 explosion-protected motors

Article No. supplements and special versions · Options

Cast-iron series 1MB15 Basic Line, 1MB16 Performance Line

| Special versions | Additional identification code - Z with order code and plain text if required | Frame size | | | | | | | | | | | | Motor version | | | |
|--|---|--------------------------|----|----|-----|-----|-----|-----|-----|-----|-----|-----|-----|---------------|--|--|------------------|
| | | 71 | 80 | 90 | 100 | 112 | 132 | 160 | 180 | 200 | 225 | 250 | 280 | 315 | IEC | Ex tb (Zone 21), Ex tc (Zone 22), Ex ec (Zone 2) | IE3 <hr/> IE2 |
| | | 1MB15.3 Basic Line | | | | | | | | | | | | IEC | Ex tb (Zone 21), Ex tc (Zone 22), Ex ec (Zone 2) | IE3 <hr/> IE2 | |
| | | 1MB16.3 Performance Line | | | | | | | | | | | | | | | |
| | 1MB15 -Z | 1MB15.1 Basic Line | | | | | | | | | | | | | | | |
| | 1MB16 -Z | 1MB16.1 Performance Line | | | | | | | | | | | | | | | |
| Shaft and rotor | | | | | | | | | | | | | | | | | |
| Shaft extension with standard dimensions, without feather keyway | L04 | - | - | - | ✓ | ✓ | ✓ | ✓ | ✓ | ✓ | ✓ | ✓ | ✓ | ✓ | ✓ | ✓ | ✓ |
| Standard, cylindrical shaft extension (second shaft extension) NDE acc. to EN 50347 ²⁵⁾ | L05 | ✓ | ✓ | ✓ | ✓ | ✓ | ✓ | ✓ | ✓ | ✓ | ✓ | ✓ | ✓ | ✓ | ✓ | ✓ | ✓ |
| Standard shaft made of stainless steel (e.g. 1.4021) | L06 | ✓ | ✓ | ✓ | ✓ | ✓ | ✓ | ✓ | ✓ | ✓ | ✓ | ✓ | ✓ | ✓ | ✓ | ✓ | ✓ |
| Shaft extension run-out in accordance with IEC 60072-1 precision class | L07 | ✓ | ✓ | ✓ | ✓ | ✓ | ✓ | ✓ | ✓ | ✓ | ✓ | ✓ | ✓ | ✓ | ✓ | ✓ | ✓ |
| Shaft extension run-out, concentricity and perpendicularity in accordance with IEC 60072-1 precision class for flange-mounted motors | L08 | ✓ | ✓ | ✓ | ✓ | ✓ | ✓ | ✓ | ✓ | ✓ | ✓ | ✓ | ✓ | ✓ | ✓ | ✓ | ✓ |
| Non-standard cylindrical shaft extension, DE ⁸⁾ | Y58 • and customer specifications | ✓ | ✓ | ✓ | ✓ | ✓ | ✓ | ✓ | ✓ | ✓ | ✓ | ✓ | ✓ | ✓ | ✓ | ✓ | ✓ |
| Non-standard cylindrical shaft extension, NDE ⁸⁾ | Y59 • and customer specifications | ✓ | ✓ | ✓ | ✓ | ✓ | ✓ | ✓ | ✓ | ✓ | ✓ | ✓ | ✓ | ✓ | ✓ | ✓ | ✓ |
| Heating and ventilation | | | | | | | | | | | | | | | | | |
| Metal external fan ⁹⁾ | F76 | ✓ | ✓ | ✓ | ✓ | ✓ | ✓ | ✓ | ✓ | ✓ | ✓ | ✓ | ✓ | ✓ | ✓ | ✓ | ✓ |
| Anti-condensation heating for 230 V (2 terminals) ³⁾ | Q02 | ✓ | ✓ | ✓ | ✓ | ✓ | ✓ | ✓ | ✓ | ✓ | ✓ | ✓ | ✓ | ✓ | ✓ | ✓ | ✓ |
| Anti-condensation heating for 115 V (2 terminals) ³⁾ | Q03 | ✓ | ✓ | ✓ | ✓ | ✓ | ✓ | ✓ | ✓ | ✓ | ✓ | ✓ | ✓ | ✓ | ✓ | ✓ | ✓ |
| Rating plate and additional rating plates | | | | | | | | | | | | | | | | | |
| Second rating plate, loose | M10 | ✓ | ✓ | ✓ | ✓ | ✓ | ✓ | ✓ | ✓ | ✓ | ✓ | ✓ | ✓ | ✓ | ✓ | ✓ | ✓ |
| Rating plate, stainless steel | M11 | ✓ | ✓ | ✓ | ✓ | ✓ | ✓ | ✓ | ✓ | ✓ | ✓ | ✓ | ✓ | ✓ | ✓ | ✓ | ✓ |
| | | - | - | - | □ | □ | □ | □ | □ | □ | □ | □ | □ | □ | □ | □ | □ |
| Additional rating plate with deviating rating plate data | Y80 • and customer specifications | ✓ | ✓ | ✓ | ✓ | ✓ | ✓ | ✓ | ✓ | ✓ | ✓ | ✓ | ✓ | ✓ | ✓ | ✓ | ✓ |
| Additional rating plate with customer specifications | Y82 • and customer specifications | ✓ | ✓ | ✓ | ✓ | ✓ | ✓ | ✓ | ✓ | ✓ | ✓ | ✓ | ✓ | ✓ | ✓ | ✓ | ✓ |
| Additional information on rating plate and on package label (max. 20 characters) | Y84 • and customer specifications | ✓ | ✓ | ✓ | ✓ | ✓ | ✓ | ✓ | ✓ | ✓ | ✓ | ✓ | ✓ | ✓ | ✓ | ✓ | ✓ |
| Packaging, safety notes, documentation and test certificates | | | | | | | | | | | | | | | | | |
| Printed Operating Instructions in German/English and a DVD with all official EU languages as well as Norwegian, Russian, Turkish, and Chinese ¹¹⁾ | | □ | □ | □ | □ | □ | □ | □ | □ | □ | □ | □ | □ | □ | □ | □ | □ |
| Inspection certificate 3.1 according to EN 10204 ¹⁰⁾ | B02 | ✓ | ✓ | ✓ | ✓ | ✓ | ✓ | ✓ | ✓ | ✓ | ✓ | ✓ | ✓ | ✓ | ✓ | ✓ | ✓ |
| Document – Electrical datasheet | B60 | ✓ | ✓ | ✓ | ✓ | ✓ | ✓ | ✓ | ✓ | ✓ | ✓ | ✓ | ✓ | ✓ | ✓ | ✓ | ✓ |
| Document – Order dimensional drawing | B61 | ✓ | ✓ | ✓ | ✓ | ✓ | ✓ | ✓ | ✓ | ✓ | ✓ | ✓ | ✓ | ✓ | ✓ | ✓ | ✓ |
| Type test with heat run for horizontal motors, with acceptance | B83 | ✓ | ✓ | ✓ | ✓ | ✓ | ✓ | ✓ | ✓ | ✓ | ✓ | ✓ | ✓ | ✓ | ✓ | ✓ | ✓ |
| "Basic" documentation package | B90 | ✓ | ✓ | ✓ | ✓ | ✓ | ✓ | ✓ | ✓ | ✓ | ✓ | ✓ | ✓ | ✓ | ✓ | ✓ | ✓ |
| "Advanced" documentation package | B91 | ✓ | ✓ | ✓ | ✓ | ✓ | ✓ | ✓ | ✓ | ✓ | ✓ | ✓ | ✓ | ✓ | ✓ | ✓ | ✓ |
| "Projects" documentation package | B92 | ✓ | ✓ | ✓ | ✓ | ✓ | ✓ | ✓ | ✓ | ✓ | ✓ | ✓ | ✓ | ✓ | ✓ | ✓ | ✓ |
| Wire-lattice pallet packaging | B99 | ○ | ○ | ○ | ○ | ○ | ○ | ○ | ○ | - | - | - | - | - | - | - | - |
| Connected in star for dispatch | M01 | ✓ | ✓ | ✓ | ✓ | ✓ | ✓ | ✓ | ✓ | ✓ | ✓ | ✓ | ✓ | ✓ | ✓ | ✓ | ✓ |
| Connected in delta for dispatch | M02 | ✓ | ✓ | ✓ | ✓ | ✓ | ✓ | ✓ | ✓ | ✓ | ✓ | ✓ | ✓ | □ | □ | □ | □ |



SIMOTICS XP 1MB1, 1MB5 explosion-protected motors

Article No. supplements and special versions · Options

Cast-iron series 1MB15 Basic Line, 1MB16 Performance Line

- Standard version
- Without additional charge
- This order code only determines the price of the version – Additional plain text is required.
- ✓ With additional charge
- Not possible

- 1) Please inquire regarding combination with order codes **D03** and **C02**. Not possible in combination with order codes **H20** and **H22**.
- 2) Evaluation with associated tripping unit (see Catalog IC 10) is recommended. A certified tripping unit is necessary for use in hazardous areas.
- 3) In combination with the 15th position of the Article No. "**H**", the order codes **Q02** and **Q03** are not possible for frame sizes 100 to 160. It can only be supplied with a star or delta winding for direct switch-on (3 terminals).
- 4) There is no derating in combination with order codes **M2A, M2B, M2C, M2D, M2E, M2F, M2G, M2H**.
- 5) Order code **H20** (IP65 degree of protection) can only be ordered for Zone 2.
For Zone 21, IP65 degree of protection is standard. Not possible for Zone 22, because only IP55 degree of protection is required.
- 6) Order code **H22** IP56 degree of protection is only possible for Zone 2. Degree of protection IP56 is not permissible for Zone 21 (IP65 degree of protection) and Zone 22 (IP55 degree of protection).
- 7) Supplied with the condensation drainage holes sealed at the drive end DE and non-drive end NDE (IP55, IP56, IP65). If the condensation drainage holes are required for motors of the IM B6, IM B7 or IM B8 type of construction (feet on side or top), the motors must be ordered in the respective type of construction and with order code **H03**, so that the condensation drainage holes will be placed in the correct position.
- 8) When motors are ordered that have a longer or shorter shaft extension than normal, the required position and length of the feather keyway must be specified in a sketch. It must be ensured that only feather keys in accordance with DIN 6885, Form A are permitted to be used. The feather keyway is positioned centrally on the shaft extension. The length is defined by the manufacturer in accordance with the appropriate standard. Not valid for: Conical shafts, non-standard threaded journals, non-standard shaft tolerances, friction welded journals, extremely "thin" shafts, special geometry dimensions (e.g. square journals), hollow shafts. Valid for non-standard shaft extensions DE or NDE. The feather keys are supplied in every case.
For order codes **Y58, Y59** and **L05** the following applies:
– Dimensions D and DA ≤ ball bearing inner diameter (see dimension tables in "Dimensions")
– Dimensions E and EA ≤ 2 × length E (standard) of the shaft extension
For an explanation of the order codes, see Catalog Section 1 "Introduction".
- 9) The metal external fan is not possible in combination with the low-noise version – order code **F77** or **F78**.
- 10) The delivery time for the manufacturer's test certificate may differ from the delivery time for the motor.
- 11) The Operating Instructions are available on the Internet in PDF format for all official EU languages at <http://support.automation.siemens.com/WW/view/en/10803948/133300>.
- 12) Order code **S06** not possible in combination with order code **B30**.
- 13) Not admissible in combination with anti-condensation heating (order code **Q02/Q03**). For this component, no TR CU certificate is available yet.
- 14) A minimum cantilever force F_{\min} of $0.5 \cdot F_{\max}$ is required for NU bearings (cylindrical roller bearings) in contrast to ball bearings. Cylindrical roller bearings are not suitable for coupling output or for brief periods of no-load operation without cantilever force.
- 15) A larger terminal box is the standard version in combination with the order code **Q02, Q03** and/or 15th position of the Article No. "**H**" for frame sizes 71 to 90.
- 16) The Ex motor is not admissible in an explosive atmosphere of dust and air (hybrid). A standard is not currently available that describes the product requirements for a hybrid mixture.
- 17) In combination with order codes **B40** and **B41**, "**B**" or "**C**" must be added to the 15th position of the Article No. . For compliance with the admissible temperature class 130 (B), derating is necessary in the case of converter operation in Zones 2, 21 and 22. The operating data for SINAMICS converters from Siemens are on the rating plate – the torque is reduced in contrast to line operation. The motor operating data for converter operation is available in the DTC selection and ordering tool (www.siemens.com/dt-configurator).
For converter operation, voltage codes/order codes are only admissible with one voltage only. When used in hazardous zones, the frequency converter must have a certified trip unit for motors of equipment category 1 (Zone 21). A certified trip unit is also recommended for motors of device category 3 (Zones 2 and 22). Alternatively, an external, certified trip unit can be used (see Catalog IC 10).
- 18) Can be combined with order codes **N30, N31, L51** and **F70** on request. Not admissible in combination with order code **L05**. Combination with protective cover as standard for FS 100 to 200. Protective cover not possible for FS 225 to 315.
- 19) In combination with order codes **N05, N06, N07, N08, N30, N31, D03, G30, C02, H20** and **H22** on request. Not admissible with order code **L05**. The degree of protection of the separately driven fan must match that of the motor.
- 20) The frame sizes 280 and 315 in combination with order code **B40** or **B41** are equipped with "Bearing insulation NDE" as standard (order code **L51** is included in **B40/B41**).
- 21) Not admissible for frame size 315, 2-pole. An exception is elastic installation (please inquire).
- 22) Not admissible in combination with converter operation (order code **B40, B41**).
- 23) On request for 2-pole motors for line operation (concerns frame sizes 315).
- 24) Permissible paint film thickness up to 2 mm.
- 25) Not possible in vertical version with downward shaft extension DE.
- 26) Not possible in combination with order code **Q02** or **Q03**.
- 27) Not possible in combination with order code **R50**.

SIMOTICS XP 1MB1, 1MB5 explosion-protected motors

Article No. supplements and special versions · Options

Cast-iron series 1MB1543, 1MB5543 Basic Line and 1MB1643, 1MB5643 Performance Line

Selection and ordering data

| Special versions | Additional identification code -Z with order code and plain text if required | Frame size | | | | | | | | | | | | Motor version | | | |
|---|--|--------------------------|----|----|------------------|------------------|------------------|-----|-----|-----|-----|-----|-----|---------------|-----|----------------|-----|
| | | 71 | 80 | 90 | 100 | 112 | 132 | 160 | 180 | 200 | 225 | 250 | 280 | 315 | IEC | Ex eb (Zone 1) | IE3 |
| | | 1MB1543 Basic Line | | | | | | | | | | | | | | | |
| | | 1MB1643 Performance Line | | | | | | | | | | | | | | | |
| | | 1MB5543 Basic Line | | | | | | | | | | | | | | | |
| | | 1MB5643 Performance Line | | | | | | | | | | | | | | | |
| 1MB1543 - -Z | | | | | | | | | | | | | | | | | |
| 1MB1643 - -Z | | | | | | | | | | | | | | | | | |
| 1MB5543 - -Z | | | | | | | | | | | | | | | | | |
| 1MB5643 - -Z | Order code | | | | | | | | | | | | | | | | |
| Explosion-protected version | | | | | | | | | | | | | | | | | |
| Version IIC with stamping of IIB ¹⁾ | B31 | ○ | ○ | ○ | ○ | ○ | ○ | ○ | ○ | ○ | ○ | ○ | ○ | ○ | | | |
| Version additionally for dust Ex tb – Zone 21; IP65 ²⁾ | B32 | ✓ | ✓ | ✓ | ✓ | ✓ | ✓ | ✓ | ✓ | ✓ | ✓ | ✓ | ✓ | ✓ | | | |
| T1/T2 on rating plate ³⁾ | B33 | – | – | – | – | – | ○ | ○ | ○ | ○ | ○ | ○ | ○ | ○ | | | |
| VIK version ¹⁹⁾ | C02 | ✓ | ✓ | ✓ | ✓ | ✓ | ✓ | ✓ | ✓ | ✓ | ✓ | ✓ | ✓ | ✓ | | | |
| Motor protection | | | | | | | | | | | | | | | | | |
| 2 Pt100 resistance thermometers in basic configuration for bearings (2 terminals) ⁴⁾ | Q72 | – | – | – | – | – | – | – | – | ✓ | ✓ | ✓ | ✓ | ✓ | | | |
| 2 Pt100 resistance thermometers in 3-wire input for bearings (6 terminals) ⁴⁾ | Q78 | – | – | – | – | – | – | – | – | ✓ | ✓ | ✓ | ✓ | ✓ | | | |
| 2 Pt100 double resistance thermometers in 3-wire input for bearings (12 terminals) ⁴⁾ | Q79 | – | – | – | – | – | – | – | – | – | – | – | – | ✓ | ✓ | | |
| Motor connection and terminal box | | | | | | | | | | | | | | | | | |
| External grounding | | □ | □ | □ | □ | □ | □ | □ | □ | □ | □ | □ | □ | □ | | | |
| Second external grounding | H70 | – | – | – | ✓ | ✓ | ✓ | ✓ | ✓ | ✓ | ✓ | ✓ | ✓ | ✓ | | | |
| Rotation of the terminal box through 90°, entry from DE | R10 | ○ | ○ | ○ | ○ | ○ | ○ | ○ | ✓ | ✓ | ✓ | ✓ | ✓ | ✓ | | | |
| Rotation of the terminal box through 90°, entry from NDE | R11 | ○ | ○ | ○ | ○ | ○ | ○ | ○ | ✓ | ✓ | ✓ | ✓ | ✓ | ✓ | | | |
| Rotation of the terminal box through 180° | R12 | ○ | ○ | ○ | ○ | ○ | ○ | ○ | ✓ | ✓ | ✓ | ✓ | ✓ | ✓ | | | |
| Metal cable gland, maximum configuration | R18 | ✓ | ✓ | ✓ | ✓ | ✓ | ✓ | ✓ | ✓ | ✓ | ✓ | ✓ | ✓ | ✓ | | | |
| Saddle terminal for connection without cable lug, accessories pack | R19 | – | – | – | – | – | – | – | – | – | – | – | – | □ | □ | □ | □ |
| Larger terminal box | R50 | ✓ | ✓ | ✓ | ✓ | ✓ | ✓ | ✓ | ✓ | ✓ | ✓ | ✓ | ✓ | ✓ | | | |
| Drilled removable entry plate | R52 | – | – | – | – | – | – | – | – | – | – | – | – | ✓ | ✓ | ✓ | ✓ |
| Undrilled removable entry plate | R53 | – | – | – | – | – | – | – | – | – | – | – | – | ✓ | ✓ | ✓ | ✓ |
| Cast-iron auxiliary terminal box (small) | R62 | – | – | – | ✓ | ✓ | ✓ | ✓ | ✓ | ✓ | ✓ | ✓ | ✓ | ✓ | ✓ | ✓ | ✓ |
| Cast-iron auxiliary terminal box (large) | R63 | – | – | – | – | – | – | – | – | – | – | – | – | ✓ | ✓ | ✓ | ✓ |
| 2 small cast-iron auxiliary terminal boxes | R67 | – | – | – | ✓ ²²⁾ | ✓ ²²⁾ | ✓ ²²⁾ | ✓ | ✓ | ✓ | ✓ | ✓ | ✓ | ✓ | ✓ | ✓ | ✓ |
| Windings and insulation | | | | | | | | | | | | | | | | | |
| Temperature class 155 (F), utilized acc. to 130 (B), coolant temperature 45 °C, derating approx. 4 % ⁵⁾ | N05 | ✓ | ✓ | ✓ | ✓ | ✓ | ✓ | ✓ | ✓ | ✓ | ✓ | ✓ | ✓ | ✓ | ✓ | ✓ | ✓ |
| Temperature class 155 (F), utilized acc. to 130 (B), coolant temperature 50 °C, derating approx. 8 % ⁵⁾ | N06 | ✓ | ✓ | ✓ | ✓ | ✓ | ✓ | ✓ | ✓ | ✓ | ✓ | ✓ | ✓ | ✓ | ✓ | ✓ | ✓ |
| Temperature class 155 (F), utilized acc. to 130 (B), coolant temperature 55 °C, derating approx. 13 % ⁵⁾ | N07 | ✓ | ✓ | ✓ | ✓ | ✓ | ✓ | ✓ | ✓ | ✓ | ✓ | ✓ | ✓ | ✓ | ✓ | ✓ | ✓ |
| Temperature class 155 (F), utilized acc. to 130 (B), coolant temperature 60 °C, derating approx. 18 % ⁵⁾ | N08 | ✓ | ✓ | ✓ | ✓ | ✓ | ✓ | ✓ | ✓ | ✓ | ✓ | ✓ | ✓ | ✓ | ✓ | ✓ | ✓ |
| Increased air humidity/temperature with 30 to 60 g water per m ³ of air | N30 | ✓ | ✓ | ✓ | ✓ | ✓ | ✓ | ✓ | ✓ | ✓ | ✓ | ✓ | ✓ | ✓ | ✓ | ✓ | ✓ |
| Increased air humidity/temperature with 60 to 100 g water per m ³ of air | N31 | ✓ | ✓ | ✓ | ✓ | ✓ | ✓ | ✓ | ✓ | ✓ | ✓ | ✓ | ✓ | ✓ | ✓ | ✓ | ✓ |

For legends and footnotes, see page 5/90.

SIMOTICS XP 1MB1, 1MB5 explosion-protected motors

Article No. supplements and special versions · Options

Cast-iron series 1MB1543, 1MB5543 Basic Line and 1MB1643, 1MB5643 Performance Line

| Special versions | Additional identification code -Z with order code and plain text if required | Frame size | | | | | | | | | | | | Motor version | | | | |
|--|--|--------------------------|----|----|-----|-----|-----|-----|-----|-----|-----|-----|-----|---------------|-----------|----------------|---------|--|
| | | 71 | 80 | 90 | 100 | 112 | 132 | 160 | 180 | 200 | 225 | 250 | 280 | 315 | IEC | Ex eb (Zone 1) | IE3 | |
| | | 1MB1543 Basic Line | | | | | | | | | | | | | | | | |
| | | 1MB1643 Performance Line | | | | | | | | | | | | | | | | |
| | | 1MB5543 Basic Line | | | | | | | | | | | | | | | | |
| | | 1MB5643 Performance Line | | | | | | | | | | | | | | | | |
| | | Order code | | | | | | | | | | | | | | | | |
| Colors and paint finish | | | | | | | | | | | | | | | | | | |
| Standard paint finish C2 in RAL 7030 stone gray | | □ | □ | □ | □ | □ | □ | □ | □ | □ | □ | □ | □ | □ | □ | Only for: | 1MB.5.. | |
| Unpainted (only cast-iron parts primed) | S00 | ○ | ○ | ○ | ○ | ○ | ○ | ○ | ○ | ○ | ○ | ○ | ○ | ○ | ○ | | | |
| Unpainted, only primed | S01 | ✓ | ✓ | ✓ | ✓ | ✓ | ✓ | ✓ | ✓ | ✓ | ✓ | ✓ | ✓ | ✓ | ✓ | | | |
| Special paint finish C3 | S02 | ✓ | ✓ | ✓ | ✓ | ✓ | ✓ | ✓ | ✓ | ✓ | ✓ | ✓ | ✓ | ✓ | ✓ | Only for: | 1MB.5.. | |
| | | - | - | - | □ | □ | □ | □ | □ | □ | □ | □ | □ | □ | □ | Only for: | 1MB.6.. | |
| Special paint finish sea air resistant C4 | S03 | ✓ | ✓ | ✓ | ✓ | ✓ | ✓ | ✓ | ✓ | ✓ | ✓ | ✓ | ✓ | ✓ | ✓ | | | |
| Special paint finish for use offshore C5 | S04 | ✓ | ✓ | ✓ | ✓ | ✓ | ✓ | ✓ | ✓ | ✓ | ✓ | ✓ | ✓ | ✓ | ✓ | | | |
| Internal coating | S05 | - | - | - | ✓ | ✓ | ✓ | ✓ | ✓ | ✓ | ✓ | ✓ | ✓ | ✓ | ✓ | | | |
| Top coat polyurethane ⁶⁾ | S06 | ✓ | ✓ | ✓ | ✓ | ✓ | ✓ | ✓ | ✓ | ✓ | ✓ | ✓ | ✓ | ✓ | ✓ | | | |
| Paint finish in other standard RAL colors: RAL 1002, 1013, 1015, 1019, 2003, 2004, 3000, 3007, 5002, 5007, 5009, 5010, 5012, 5015, 5017, 5018, 5019, 6011, 6019, 6021, 7000, 7001, 7004, 7011, 7016, 7022, 7031, 7032, 7033, 7035, 9001, 9002, 9005 (see Catalog Section 1 "Introduction") | Y53 • and paint finish RAL | ✓ | ✓ | ✓ | ✓ | ✓ | ✓ | ✓ | ✓ | ✓ | ✓ | ✓ | ✓ | ✓ | ✓ | Only for: | 1MB.5.. | |
| Paint finish in special RAL colors: For RAL colors, see "Special paint finish in special RAL colors" (see Catalog Section 1 "Introduction") | Y56 • and paint finish RAL | ✓ | ✓ | ✓ | ✓ | ✓ | ✓ | ✓ | ✓ | ✓ | ✓ | ✓ | ✓ | ✓ | ✓ | | | |
| Mechanical version and degrees of protection | | | | | | | | | | | | | | | | | | |
| Low-noise version for 2-pole motors with clockwise direction of rotation ^{7) 19)} | F77 | - | - | - | - | - | O | R | O | R | O | R | ✓ | ✓ | ✓ | ✓ | | |
| Low-noise version for 2-pole motors with anti-clockwise direction of rotation ^{7) 19)} | F78 | - | - | - | - | - | O | R | O | R | O | R | ✓ | ✓ | ✓ | ✓ | | |
| Protective cover | H00 | ✓ | ✓ | ✓ | ✓ | ✓ | ✓ | ✓ | ✓ | ✓ | ✓ | ✓ | ✓ | ✓ | ✓ | | | |
| Screwed-on (instead of cast) feet | H01 | - | - | - | ✓ | ✓ | ✓ | ✓ | ✓ | ✓ | ✓ | ✓ | ✓ | ✓ | ✓ | | | |
| Vibration-proof version; vibration resistance to Class 3M4 according to IEC 60721-3-3:1994 | H02 | ✓ | ✓ | ✓ | ✓ | ✓ | ✓ | ✓ | ✓ | ✓ | ✓ | ✓ | ✓ | ✓ | ✓ | | | |
| Condensation drainage holes ⁸⁾ | H03 | ✓ | ✓ | ✓ | □ | □ | □ | □ | □ | □ | □ | □ | □ | □ | □ | | | |
| Rust-resistant screws (externally) | H07 | ✓ | ✓ | ✓ | ✓ | ✓ | ✓ | ✓ | ✓ | ✓ | ✓ | ✓ | ✓ | ✓ | ✓ | | | |
| IP65 degree of protection ⁹⁾ | H20 | ✓ | ✓ | ✓ | ✓ | ✓ | ✓ | ✓ | ✓ | ✓ | ✓ | ✓ | ✓ | ✓ | ✓ | | | |
| IP56 degree of protection ⁹⁾ | H22 | ✓ | ✓ | ✓ | ✓ | ✓ | ✓ | ✓ | ✓ | ✓ | ✓ | ✓ | ✓ | ✓ | ✓ | | | |
| Drive-end seal for flange-mounting motors, oil-tight to 0.1 bar Not possible for type of construction IM V3 | H23 | ✓ | ✓ | ✓ | ✓ | ✓ | ✓ | ✓ | ✓ | ✓ | ✓ | ✓ | ✓ | ✓ | ✓ | | | |
| Coolant temperature and installation altitude | | | | | | | | | | | | | | | | | | |
| Coolant temperature -40 to +40 °C ¹⁰⁾ | D03 | ✓ | ✓ | ✓ | ✓ | ✓ | ✓ | ✓ | ✓ | ✓ | ✓ | ✓ | ✓ | ✓ | ✓ | | | |
| Versions in accordance with standards and specifications | | | | | | | | | | | | | | | | | | |
| IECEx certification | D37 | ✓ | ✓ | ✓ | ✓ | ✓ | ✓ | ✓ | ✓ | ✓ | ✓ | ✓ | ✓ | ✓ | ✓ | | | |
| Bearings and lubrication | | | | | | | | | | | | | | | | | | |
| Regreasing device with M10 × 1 grease nipple according to DIN 71412-A | L19 | - | - | - | - | - | - | - | ✓ | ✓ | ✓ | ✓ | ○ | ○ | | | | |
| Located bearing DE | L20 | ✓ | ✓ | ✓ | ✓ | ✓ | ✓ | ✓ | ✓ | ✓ | ✓ | ✓ | ✓ | ✓ | | | | |
| Located bearing NDE | L21 | ✓ | ✓ | ✓ | ✓ | ✓ | □ | □ | □ | □ | □ | □ | □ | □ | | | | |
| Bearing design for increased cantilever forces ¹¹⁾ | L22 | ✓ | ✓ | ✓ | ✓ | ✓ | ✓ | ✓ | ✓ | ✓ | ✓ | ✓ | ✓ | ✓ | | | | |
| Regreasing device | L23 | - | - | - | ✓ | ✓ | ✓ | ✓ | ✓ | ✓ | ✓ | ✓ | □ | □ | Only for: | 1MB.5.. | | |
| | | - | - | - | ✓ | ✓ | ✓ | □ | □ | □ | □ | □ | □ | □ | Only for: | 1MB.6.. | | |
| Bearings reinforced at both ends for DE and NDE, bearing size 63 | L25 | ✓ | ✓ | ✓ | ✓ | ✓ | ✓ | ✓ | ✓ | ✓ | ✓ | ✓ | □ | □ | Only for: | 1MB.5.. | | |
| | | - | - | - | □ | □ | □ | □ | □ | □ | □ | □ | □ | □ | Only for: | 1MB.6.. | | |
| Reinforced bearings at both DE and NDE, DE bearing for increased cantilever forces | L28 | - | - | - | - | - | - | ✓ | ✓ | ✓ | ✓ | - | - | | | | | |
| Bearing insulation DE ²³⁾ | L50 | - | - | - | - | - | - | - | - | - | ✓ | ✓ | ✓ | ✓ | | | | |
| Bearing insulation NDE ²³⁾ | L51 | - | - | - | - | - | - | - | - | - | ✓ | ✓ | ✓ | ✓ | | | | |
| Measuring nipple for SPM shock pulse measurement for bearing inspection | Q01 | - | - | - | ✓ | ✓ | ✓ | ✓ | ✓ | ✓ | ✓ | ✓ | ✓ | ✓ | | | | |

For legends and footnotes, see page 5/90.

SIMOTICS XP 1MB1, 1MB5 explosion-protected motors

Article No. supplements and special versions · Options

Cast-iron series 1MB1543, 1MB5543 Basic Line and 1MB1643, 1MB5643 Performance Line

| Special versions | Additional identification code -Z with order code and plain text if required | Frame size | | | | | | | | | | | | Motor version | | | |
|---|--|-------------------------------------|-------------------------------------|-------------------------------------|-------------------------------------|-------------------------------------|-------------------------------------|-------------------------------------|-------------------------------------|-------------------------------------|-------------------------------------|-------------------------------------|-------------------------------------|-------------------------------------|-------------------|----------------|-----|
| | | 71 | 80 | 90 | 100 | 112 | 132 | 160 | 180 | 200 | 225 | 250 | 280 | 315 | IEC | Ex eb (Zone 1) | IE3 |
| | | 1MB1543 Basic Line | | | | | | | | | | | | | | | |
| | | 1MB1643 Performance Line | | | | | | | | | | | | | | | |
| | | | | | | | | 1MB5543 Basic Line | | | | | | | | | |
| | | | | | | | | 1MB5643 Performance Line | | | | | | | | | |
| | | Order code | | | | | | | | | | | | | | | |
| Balance and vibration severity | | | | | | | | | | | | | | | | | |
| Vibration severity grade A ²¹⁾ | | <input type="checkbox"/> | <input type="checkbox"/> | <input type="checkbox"/> | <input type="checkbox"/> | <input type="checkbox"/> | <input type="checkbox"/> | <input type="checkbox"/> | <input type="checkbox"/> | <input type="checkbox"/> | <input type="checkbox"/> | <input type="checkbox"/> | <input type="checkbox"/> | <input type="checkbox"/> | | | |
| Vibration severity grade B ²¹⁾ | L00 | <input checked="" type="checkbox"/> | <input checked="" type="checkbox"/> | <input checked="" type="checkbox"/> | <input checked="" type="checkbox"/> | <input checked="" type="checkbox"/> | <input checked="" type="checkbox"/> | <input checked="" type="checkbox"/> | <input checked="" type="checkbox"/> | <input checked="" type="checkbox"/> | <input checked="" type="checkbox"/> | <input checked="" type="checkbox"/> | <input checked="" type="checkbox"/> | <input checked="" type="checkbox"/> | | | |
| Half-key balancing | | <input type="checkbox"/> | <input type="checkbox"/> | <input type="checkbox"/> | <input type="checkbox"/> | <input type="checkbox"/> | <input type="checkbox"/> | <input type="checkbox"/> | <input type="checkbox"/> | <input type="checkbox"/> | <input type="checkbox"/> | <input type="checkbox"/> | <input type="checkbox"/> | <input type="checkbox"/> | | | |
| Balancing without feather key | L01 | <input checked="" type="checkbox"/> | <input checked="" type="checkbox"/> | <input checked="" type="checkbox"/> | <input checked="" type="checkbox"/> | <input checked="" type="checkbox"/> | <input checked="" type="checkbox"/> | <input checked="" type="checkbox"/> | <input checked="" type="checkbox"/> | <input checked="" type="checkbox"/> | <input checked="" type="checkbox"/> | <input checked="" type="checkbox"/> | <input checked="" type="checkbox"/> | <input checked="" type="checkbox"/> | | | |
| Full-key balancing | L02 | <input checked="" type="checkbox"/> | <input checked="" type="checkbox"/> | <input checked="" type="checkbox"/> | <input checked="" type="checkbox"/> | <input checked="" type="checkbox"/> | <input checked="" type="checkbox"/> | <input checked="" type="checkbox"/> | <input checked="" type="checkbox"/> | <input checked="" type="checkbox"/> | <input checked="" type="checkbox"/> | <input checked="" type="checkbox"/> | <input checked="" type="checkbox"/> | <input checked="" type="checkbox"/> | | | |
| Shaft and rotor | | | | | | | | | | | | | | | | | |
| Shaft extension with standard dimensions, without feather keyway | L04 | <input checked="" type="checkbox"/> | <input checked="" type="checkbox"/> | <input checked="" type="checkbox"/> | <input checked="" type="checkbox"/> | <input checked="" type="checkbox"/> | <input checked="" type="checkbox"/> | <input checked="" type="checkbox"/> | <input checked="" type="checkbox"/> | <input checked="" type="checkbox"/> | <input checked="" type="checkbox"/> | <input checked="" type="checkbox"/> | <input checked="" type="checkbox"/> | <input checked="" type="checkbox"/> | | | |
| Standard, cylindrical shaft extension (second shaft extension) NDE acc. to EN 50347 ¹²⁾ | L05 | <input checked="" type="checkbox"/> | <input checked="" type="checkbox"/> | <input checked="" type="checkbox"/> | <input checked="" type="checkbox"/> | <input checked="" type="checkbox"/> | <input checked="" type="checkbox"/> | <input checked="" type="checkbox"/> | <input checked="" type="checkbox"/> | <input checked="" type="checkbox"/> | <input checked="" type="checkbox"/> | <input checked="" type="checkbox"/> | <input checked="" type="checkbox"/> | <input checked="" type="checkbox"/> | | | |
| Standard shaft made of stainless steel (e.g. 1.4021) | L06 | <input checked="" type="checkbox"/> | <input checked="" type="checkbox"/> | <input checked="" type="checkbox"/> | <input checked="" type="checkbox"/> | <input checked="" type="checkbox"/> | <input checked="" type="checkbox"/> | <input checked="" type="checkbox"/> | <input checked="" type="checkbox"/> | <input checked="" type="checkbox"/> | <input checked="" type="checkbox"/> | <input checked="" type="checkbox"/> | <input checked="" type="checkbox"/> | <input checked="" type="checkbox"/> | | | |
| Shaft extension run-out in accordance with IEC 60072-1 precision class ¹³⁾ | L07 | <input checked="" type="checkbox"/> | <input checked="" type="checkbox"/> | <input checked="" type="checkbox"/> | <input checked="" type="checkbox"/> | <input checked="" type="checkbox"/> | <input checked="" type="checkbox"/> | <input checked="" type="checkbox"/> | <input checked="" type="checkbox"/> | <input checked="" type="checkbox"/> | <input checked="" type="checkbox"/> | <input checked="" type="checkbox"/> | <input checked="" type="checkbox"/> | <input checked="" type="checkbox"/> | | | |
| Shaft extension run-out, concentricity and perpendicularity in accordance with IEC 60072-1 precision class for flange-mounted motors ¹³⁾ | L08 | <input checked="" type="checkbox"/> | <input checked="" type="checkbox"/> | <input checked="" type="checkbox"/> | <input checked="" type="checkbox"/> | <input checked="" type="checkbox"/> | <input checked="" type="checkbox"/> | <input checked="" type="checkbox"/> | <input checked="" type="checkbox"/> | <input checked="" type="checkbox"/> | <input checked="" type="checkbox"/> | <input checked="" type="checkbox"/> | <input checked="" type="checkbox"/> | <input checked="" type="checkbox"/> | | | |
| Non-standard cylindrical shaft extension, DE ¹⁴⁾ | Y58 • and customer specifications | <input checked="" type="checkbox"/> | <input checked="" type="checkbox"/> | <input checked="" type="checkbox"/> | <input checked="" type="checkbox"/> | <input checked="" type="checkbox"/> | <input checked="" type="checkbox"/> | <input checked="" type="checkbox"/> | <input checked="" type="checkbox"/> | <input checked="" type="checkbox"/> | <input checked="" type="checkbox"/> | <input checked="" type="checkbox"/> | <input checked="" type="checkbox"/> | <input checked="" type="checkbox"/> | | | |
| Non-standard cylindrical shaft extension, NDE ¹⁴⁾ | Y59 • and customer specifications | <input checked="" type="checkbox"/> | <input checked="" type="checkbox"/> | <input checked="" type="checkbox"/> | <input checked="" type="checkbox"/> | <input checked="" type="checkbox"/> | <input checked="" type="checkbox"/> | <input checked="" type="checkbox"/> | <input checked="" type="checkbox"/> | <input checked="" type="checkbox"/> | <input checked="" type="checkbox"/> | <input checked="" type="checkbox"/> | <input checked="" type="checkbox"/> | <input checked="" type="checkbox"/> | | | |
| Heating and ventilation | | | | | | | | | | | | | | | | | |
| Sheet metal fan cover | | <input type="checkbox"/> | <input type="checkbox"/> | <input type="checkbox"/> | <input type="checkbox"/> | <input type="checkbox"/> | <input type="checkbox"/> | <input type="checkbox"/> | <input type="checkbox"/> | <input type="checkbox"/> | <input type="checkbox"/> | <input type="checkbox"/> | <input type="checkbox"/> | <input type="checkbox"/> | | | |
| Metal external fan ¹⁵⁾ | F76 | <input type="checkbox"/> | <input type="checkbox"/> | <input type="checkbox"/> | <input type="checkbox"/> | <input type="checkbox"/> | <input type="checkbox"/> | <input type="checkbox"/> | <input type="checkbox"/> | <input type="checkbox"/> | <input type="checkbox"/> | <input type="checkbox"/> | <input type="checkbox"/> | <input type="checkbox"/> | | | |
| Anti-condensation heating for 230 V (2 terminals) ²⁰⁾ | Q02 | <input checked="" type="checkbox"/> | <input checked="" type="checkbox"/> | <input checked="" type="checkbox"/> | <input checked="" type="checkbox"/> | <input checked="" type="checkbox"/> | <input checked="" type="checkbox"/> | <input checked="" type="checkbox"/> | <input checked="" type="checkbox"/> | <input checked="" type="checkbox"/> | <input checked="" type="checkbox"/> | <input checked="" type="checkbox"/> | <input checked="" type="checkbox"/> | <input checked="" type="checkbox"/> | | | |
| Anti-condensation heating for 115 V (2 terminals) ²⁰⁾ | Q03 | <input checked="" type="checkbox"/> | <input checked="" type="checkbox"/> | <input checked="" type="checkbox"/> | <input checked="" type="checkbox"/> | <input checked="" type="checkbox"/> | <input checked="" type="checkbox"/> | <input checked="" type="checkbox"/> | <input checked="" type="checkbox"/> | <input checked="" type="checkbox"/> | <input checked="" type="checkbox"/> | <input checked="" type="checkbox"/> | <input checked="" type="checkbox"/> | <input checked="" type="checkbox"/> | | | |
| Rating plate and additional rating plates | | | | | | | | | | | | | | | | | |
| Second rating plate, loose | M10 | <input checked="" type="checkbox"/> | <input checked="" type="checkbox"/> | <input checked="" type="checkbox"/> | <input checked="" type="checkbox"/> | <input checked="" type="checkbox"/> | <input checked="" type="checkbox"/> | <input checked="" type="checkbox"/> | <input checked="" type="checkbox"/> | <input checked="" type="checkbox"/> | <input checked="" type="checkbox"/> | <input checked="" type="checkbox"/> | <input checked="" type="checkbox"/> | <input checked="" type="checkbox"/> | | | |
| Rating plate, stainless steel | M11 | <input checked="" type="checkbox"/> | <input checked="" type="checkbox"/> | <input checked="" type="checkbox"/> | <input checked="" type="checkbox"/> | <input checked="" type="checkbox"/> | <input checked="" type="checkbox"/> | <input checked="" type="checkbox"/> | <input checked="" type="checkbox"/> | <input checked="" type="checkbox"/> | <input checked="" type="checkbox"/> | <input checked="" type="checkbox"/> | <input checked="" type="checkbox"/> | <input checked="" type="checkbox"/> | Only for: 1MB.5.. | | |
| | | - | - | - | <input type="checkbox"/> | <input type="checkbox"/> | <input type="checkbox"/> | <input type="checkbox"/> | <input type="checkbox"/> | <input type="checkbox"/> | <input type="checkbox"/> | <input type="checkbox"/> | <input type="checkbox"/> | <input type="checkbox"/> | Only for: 1MB.6.. | | |
| Additional rating plate with deviating rating plate data | Y80 • and customer specifications | <input checked="" type="checkbox"/> | <input checked="" type="checkbox"/> | <input checked="" type="checkbox"/> | <input checked="" type="checkbox"/> | <input checked="" type="checkbox"/> | <input checked="" type="checkbox"/> | <input checked="" type="checkbox"/> | <input checked="" type="checkbox"/> | <input checked="" type="checkbox"/> | <input checked="" type="checkbox"/> | <input checked="" type="checkbox"/> | <input checked="" type="checkbox"/> | <input checked="" type="checkbox"/> | | | |
| Additional rating plate with customer specifications | Y82 • and customer specifications | <input checked="" type="checkbox"/> | <input checked="" type="checkbox"/> | <input checked="" type="checkbox"/> | <input checked="" type="checkbox"/> | <input checked="" type="checkbox"/> | <input checked="" type="checkbox"/> | <input checked="" type="checkbox"/> | <input checked="" type="checkbox"/> | <input checked="" type="checkbox"/> | <input checked="" type="checkbox"/> | <input checked="" type="checkbox"/> | <input checked="" type="checkbox"/> | <input checked="" type="checkbox"/> | | | |
| Additional information on rating plate and on package label (max. 20 characters) | Y84 • and customer specifications | <input checked="" type="checkbox"/> | <input checked="" type="checkbox"/> | <input checked="" type="checkbox"/> | <input checked="" type="checkbox"/> | <input checked="" type="checkbox"/> | <input checked="" type="checkbox"/> | <input checked="" type="checkbox"/> | <input checked="" type="checkbox"/> | <input checked="" type="checkbox"/> | <input checked="" type="checkbox"/> | <input checked="" type="checkbox"/> | <input checked="" type="checkbox"/> | <input checked="" type="checkbox"/> | | | |
| Extension of the liability for defects | | | | | | | | | | | | | | | | | |
| Extension of the liability for defects by 12 months to a total of 24 months (2 years) from delivery ¹⁵⁾ | Q80 | - | - | - | - | - | - | <input checked="" type="checkbox"/> | <input checked="" type="checkbox"/> | <input checked="" type="checkbox"/> | <input checked="" type="checkbox"/> | <input checked="" type="checkbox"/> | <input checked="" type="checkbox"/> | <input checked="" type="checkbox"/> | Only for: 1MB.5.. | | |
| | | - | - | - | <input type="checkbox"/> | <input type="checkbox"/> | <input type="checkbox"/> | <input type="checkbox"/> | <input type="checkbox"/> | <input type="checkbox"/> | <input type="checkbox"/> | <input type="checkbox"/> | <input type="checkbox"/> | <input type="checkbox"/> | Only for: 1MB.6.. | | |
| Extension of the liability for defects by 24 months to a total of 36 months (3 years) from delivery ¹⁶⁾ | Q82 | - | - | - | - | - | - | <input checked="" type="checkbox"/> | <input checked="" type="checkbox"/> | <input checked="" type="checkbox"/> | <input checked="" type="checkbox"/> | <input checked="" type="checkbox"/> | <input checked="" type="checkbox"/> | <input checked="" type="checkbox"/> | Only for: 1MB.5.. | | |
| | | - | - | - | <input type="checkbox"/> | <input type="checkbox"/> | <input type="checkbox"/> | <input type="checkbox"/> | <input type="checkbox"/> | <input type="checkbox"/> | <input type="checkbox"/> | <input type="checkbox"/> | <input type="checkbox"/> | <input type="checkbox"/> | Only for: 1MB.6.. | | |

SIMOTICS XP 1MB1, 1MB5 explosion-protected motors

Article No. supplements and special versions · Options

Cast-iron series 1MB1543, 1MB5543 Basic Line and 1MB1643, 1MB5643 Performance Line

| Special versions | Additional identification code -Z with order code and plain text if required | Frame size | | | | | | | | | | | | Motor version | | | |
|-------------------|--|--------------------------|----|----|-----|-----|-----|-----|-----|-----|-----|-----|-----|---------------|----------------|-----|--|
| | | 71 | 80 | 90 | 100 | 112 | 132 | 160 | 180 | 200 | 225 | 250 | 280 | 315 | | | |
| | | 1MB1543 Basic Line | | | | | | | | | | | | IEC | Ex eb (Zone 1) | IE3 | |
| | | 1MB1643 Performance Line | | | | | | | | | | | | | | | |
| | | 1MB5543 Basic Line | | | | | | | | | | | | | | | |
| | | 1MB5643 Performance Line | | | | | | | | | | | | | | | |
| 1MB1543 --Z | | | | | | | | | | | | | | | | | |
| 1MB1643 --Z | | | | | | | | | | | | | | | | | |
| 1MB5543 --Z | | | | | | | | | | | | | | | | | |
| 1MB5643 --Z | Order code | | | | | | | | | | | | | | | | |

Packaging, safety notes, documentation and test certificates

| | | 71 | 80 | 90 | 100 | 112 | 132 | 160 | 180 | 200 | 225 | 250 | 280 | 315 |
|--|------------|----|----|----|-----|-----|-----|-----|-----|-----|-----|-----|-----|-----|
| Printed Operating Instructions in German/English and a DVD with all official EU languages as well as Norwegian, Russian, Turkish, and Chinese ¹⁷⁾ | | ☐ | ☐ | ☐ | ☐ | ☐ | ☐ | ☐ | ☐ | ☐ | ☐ | ☐ | ☐ | ☐ |
| Inspection certificate 3.1 according to EN 10204 ¹⁸⁾ | B02 | ✓ | ✓ | ✓ | ✓ | ✓ | ✓ | ✓ | ✓ | ✓ | ✓ | ✓ | ✓ | ✓ |
| Document – Electrical datasheet | B60 | ✓ | ✓ | ✓ | ✓ | ✓ | ✓ | ✓ | ✓ | ✓ | ✓ | ✓ | ✓ | ✓ |
| Document – Order dimensional drawing | B61 | ✓ | ✓ | ✓ | ✓ | ✓ | ✓ | ✓ | ✓ | ✓ | ✓ | ✓ | ✓ | ✓ |
| Standard test (routine test) with acceptance | B65 | ✓ | ✓ | ✓ | ✓ | ✓ | ✓ | ✓ | ✓ | ✓ | ✓ | ✓ | ✓ | ✓ |
| Type test with heat run for horizontal motors, without acceptance | B82 | ✓ | ✓ | ✓ | ✓ | ✓ | ✓ | ✓ | ✓ | ✓ | ✓ | ✓ | ✓ | ✓ |
| Type test with heat run for horizontal motors, with acceptance | B83 | ✓ | ✓ | ✓ | ✓ | ✓ | ✓ | ✓ | ✓ | ✓ | ✓ | ✓ | ✓ | ✓ |
| "Basic" documentation package | B90 | ✓ | ✓ | ✓ | ✓ | ✓ | ✓ | ✓ | ✓ | ✓ | ✓ | ✓ | ✓ | ✓ |
| "Advanced" documentation package | B91 | ✓ | ✓ | ✓ | ✓ | ✓ | ✓ | ✓ | ✓ | ✓ | ✓ | ✓ | ✓ | ✓ |
| "Projects" documentation package | B92 | ✓ | ✓ | ✓ | ✓ | ✓ | ✓ | ✓ | ✓ | ✓ | ✓ | ✓ | ✓ | ✓ |
| Connected in star for dispatch | M01 | ✓ | ✓ | ✓ | ✓ | ✓ | ✓ | ✓ | ✓ | ✓ | ✓ | ✓ | ✓ | ✓ |
| Connected in delta for dispatch | M02 | ✓ | ✓ | ✓ | ✓ | ✓ | ✓ | ✓ | ✓ | ☐ | ☐ | ☐ | ☐ | ☐ |

- ☐ Standard version
- Without additional charge
- This order code only determines the price of the version – Additional plain text is required.
- ✓ With additional charge
- R. Possible on request
- Not possible

5

- 1) Permissible paint film thickness up to 2 mm.
- 2) Please inquire regarding combination with order codes **D03** and **C02**. Not possible in combination with order codes **H20** and **H22**.
- 3) Motors in these frame sizes have a second rating plate (T1/T2 and T3) as standard. The T3 power is stamped on the rating plate as standard if the following motors are selected with PTC thermistor (protection by PTC thermistor only) or voltage code "90":
 - 2-pole motors: Frame sizes 132 to 160
 - 4-pole motors: Frame size 180
 Alternatively, with order code **B33**, the "T1/T2 power is stamped on the rating plate".
 - 2-pole motors: Frame sizes 132 to 200
 - 4-pole motors: Frame sizes 180 to 200
- 4) Evaluation with associated tripping unit (see Catalog IC 10) is recommended. A certified tripping unit is necessary for use in hazardous areas.
- 5) The maximum possible certified power will be supplied. For motors with T1/T2, T3 power, T3 power is supplied. The T1/T2 power must be ordered with the order code B33.
- 6) Order code **S06** cannot be combined with order code **B32**.
- 7) The motors are up to 80 mm longer than normal. A second shaft extension is not possible.
- 8) Supplied with the condensation drainage holes sealed at the drive end DE and non-drive end NDE for IP55, IP56 and IP65 degrees of protection. If condensation drainage holes are required in motors of the IM B6, IM B7 or IM B8 type of construction (feet located on side or top), it is necessary to relocate the bearing shields at the drive end (DE) and non-drive end (NDE) so that the condensation drainage holes situated between the feet on delivery are underneath.
- 9) Not possible in combination with version additionally for dust Ex tb – Zone 21; IP65 - order code **B32**. IP65 degree of protection is prescribed for the version for Zone 21.
- 10) Not possible in combination with vibration-proof version, order code **H02**.
- 11) Not possible for 2-pole motors, frame size 315 L in vertical frame sizes; bearings for increased cantilever forces for vibration severity grade B are available on request for motors of frame size 225 M and above. Not possible for motors of frame size 225 M and above in combination with shaft extension run-out, concentricity and perpendicularity according to DIN 42955 tolerance R for flange-mounting types.
- 12) For motors of frame size 180 M and above in vertical type of construction in version with second shaft extension on request. Not possible for low-noise version (2-pole) for frame sizes 132 S to 160 L. Version with protective cover not possible.
- 13) Can be combined with deep-groove bearings of series 60.., 62.. and 63... Not possible in combination with cylindrical roller bearings (e.g. bearings for increased cantilever forces, order code **L22**).
- 14) When motors are ordered that have a longer or shorter shaft extension than normal, the required position and length of the feather keyway must be specified in a sketch. It must be ensured that only feather keys in accordance with DIN 6885, Form A are permitted to be used. The feather keyway is positioned centrally on the shaft extension. The length is defined by the manufacturer in accordance with the appropriate standard. Not valid for: Conical shafts, non-standard threaded journals, non-standard shaft tolerances, friction welded journals, extremely "thin" shafts, special geometry dimensions (e.g. square journals), hollow shafts. Valid for non-standard shaft extensions DE or NDE. The feather keys are supplied in every case. For order codes **Y58**, **Y59** and **L05** the following applies:
 - Dimensions D and DA ≤ ball bearing inner diameter (see dimension tables in "Dimensions")
 - Dimensions E and EA ≤ 2 × length E (standard) of the shaft extension
 For an explanation of the order codes, see Catalog Section 1 "Introduction".
- 15) The metal external fan is not possible in combination with the low-noise version – order code **F77** or **F78**.
- 16) Wearing parts (bearings) are excluded from the warranty extension.
- 17) The Operating Instructions are available on the Internet in SIOS too: <http://support.automation.siemens.com/WWW/view/en/10803948/133300>
- 18) The delivery time for the manufacturer's test certificate may differ from the delivery time for the motor.
- 19) The motors may exceed the noise levels defined by VIK.
- 20) For frame sizes 71 to 90 in combination with the order codes **Q02** and **Q03**, **R50** is the standard version (the additional charge **R50** is already contained in **Q02** and **Q03**).
- 21) Not permissible for frame size 315, 2-pole, except for elastic installation.
- 22) For frame sizes 100 and 112, only permissible in combination with order code **R50**.
- 23) It is not permissible to combine order codes **L50** and **L51**.

SIMOTICS XP 1MB1, 1MB5 explosion-protected motors

Article No. supplements and special versions · Options

Cast-iron series 1MB1553, 1MB5553

Selection and ordering data

| Special versions | Additional identification code -Z with order code and plain text if required | Frame size | | | | | | | | | | | | | | Motor version | | |
|--|--|------------------|------------------|------------------|------------------|------------------|------------------|-----|-----|-----|-----|-----|-----|-----|-----|----------------|--------------------------|-----|
| | | 71 | 80 | 90 | 100 | 112 | 132 | 160 | 180 | 200 | 225 | 250 | 280 | 315 | 355 | IEC | Ex db, Ex db eb (Zone 1) | IE3 |
| 1MB.553 - -Z | Order code | 1MB1553 | | | | | | | | | | | | | | 1MB5553 | | |
| Explosion-protected version | | | | | | | | | | | | | | | | | | |
| Version IIC with stamping of IIB | B31 | ○ | ○ | ○ | ○ | ○ | ○ | ○ | ○ | ○ | ○ | ○ | ○ | ○ | ○ | | | |
| Version additionally for dust Ex tb – Zone 21; IP65 | B32 | ✓ | ✓ | ✓ | ✓ | ✓ | ✓ | ✓ | ✓ | ✓ | ✓ | ✓ | ✓ | ✓ | ✓ | | | |
| VIK version ¹⁸⁾ | C02 | ✓ | ✓ | ✓ | ✓ | ✓ | ✓ | ✓ | ✓ | ✓ | ✓ | ✓ | ✓ | ✓ | ✓ | | | |
| Version for converter operation | | | | | | | | | | | | | | | | | | |
| Version for converter operation with power data on the PWM converter ⁶⁾ | B43 | ✓ | ✓ | ✓ | ✓ | ✓ | ✓ | ✓ | ✓ | ✓ | ✓ | ✓ | ✓ | ✓ | ✓ | | | |
| Version for converter operation with power data on the PWM converter, utilization in accordance with temperature class 155 (F) ⁶⁾ | B44 | ✓ | ✓ | ✓ | ✓ | ✓ | ✓ | ✓ | ✓ | ✓ | ✓ | ✓ | ✓ | ✓ | ✓ | | | |
| Motor protection | | | | | | | | | | | | | | | | | | |
| 2 Pt100 resistance thermometers in basic configuration for bearings (2 terminals) ¹⁾ | Q72 | – | – | – | – | – | – | – | – | – | – | – | – | – | – | – | – | – |
| 2 Pt100 resistance thermometers in 3-wire input for bearings (6 terminals) ¹⁾ | Q78 | – | – | – | – | – | – | – | – | – | – | – | – | – | – | – | – | – |
| 2 Pt100 double resistance thermometers in 3-wire input for bearings (12 terminals) ¹⁾ | Q79 | – | – | – | – | – | – | – | – | – | – | – | – | – | – | – | – | – |
| Motor connection and terminal box | | | | | | | | | | | | | | | | | | |
| External grounding | | □ | □ | □ | □ | □ | □ | □ | □ | □ | □ | □ | □ | □ | □ | □ | □ | □ |
| Second external grounding | H70 | ✓ | ✓ | ✓ | ✓ | ✓ | ✓ | ✓ | ✓ | ✓ | ✓ | ✓ | ✓ | ✓ | ✓ | ✓ | ✓ | ✓ |
| Rotation of the terminal box through 90°, entry from DE | R10 | ✓ | ✓ | ✓ | ✓ | ✓ | ✓ | ✓ | ✓ | ✓ | ✓ | ✓ | ✓ | ✓ | ✓ | ✓ | ✓ | ✓ |
| Rotation of the terminal box through 90°, entry from NDE | R11 | ✓ | ✓ | ✓ | ✓ | ✓ | ✓ | ✓ | ✓ | ✓ | ✓ | ✓ | ✓ | ✓ | ✓ | ✓ | ✓ | ✓ |
| Rotation of the terminal box through 180° | R12 | ✓ | ✓ | ✓ | ✓ | ✓ | ✓ | ✓ | ✓ | ✓ | ✓ | ✓ | ✓ | ✓ | ✓ | ✓ | ✓ | ✓ |
| Metal cable gland, maximum configuration ¹⁷⁾ | R18 | ✓ | ✓ | ✓ | ✓ | ✓ | ✓ | ✓ | ✓ | ✓ | ✓ | ✓ | ✓ | ✓ | ✓ | ✓ | ✓ | ✓ |
| 1 cable gland, Ex eb, for armored cable, line feeder cable | R45 | ✓ | ✓ | ✓ | ✓ | ✓ | ✓ | ✓ | ✓ | ✓ | ✓ | ✓ | ✓ | ✓ | ✓ | ✓ | ✓ | ✓ |
| 2 cable glands, Ex eb, for armored cable, line feeder cable | R46 | – | – | – | – | – | – | – | – | – | – | – | – | – | – | – | – | – |
| Main terminal box in Ex db IIC ²⁷⁾ | R48 | ✓ | ✓ | ✓ | ✓ | ✓ | ✓ | ✓ | ✓ | ✓ | ✓ | ✓ | ✓ | ✓ | ✓ | ✓ | ✓ | ✓ |
| Auxiliary terminal box in Ex db IIC ²⁷⁾ | R49 | – | – | – | – | – | – | – | – | – | – | – | – | – | – | – | – | – |
| Larger terminal box ¹⁷⁾ | R50 | ✓ | ✓ | ✓ | ✓ | ✓ | ✓ | ✓ | ✓ | ✓ | ✓ | ✓ | ✓ | ✓ | ✓ | ✓ | ✓ | ✓ |
| Enlarged connection system for main terminal box ¹⁷⁾ | R54 | ✓ | ✓ | ✓ | ✓ | ✓ | ✓ | ✓ | ✓ | ✓ | ✓ | ✓ | ✓ | ✓ | ✓ | ✓ | ✓ | ✓ |
| Cast-iron auxiliary terminal box (small) | R62 | ✓ ²⁴⁾ | ✓ ²⁴⁾ | ✓ ²⁴⁾ | ✓ ²³⁾ | ✓ ²³⁾ | ✓ ²³⁾ | ✓ | ✓ | ✓ | ✓ | ✓ | ✓ | ✓ | ✓ | ✓ | ✓ | ✓ |
| Cast-iron auxiliary terminal box (large) | R63 | – | – | – | – | – | – | – | – | – | – | – | – | – | – | – | – | – |
| 2 small cast-iron auxiliary terminal boxes | R67 | ✓ ²⁴⁾ | ✓ ²⁴⁾ | ✓ ²⁴⁾ | ✓ ²³⁾ | ✓ ²³⁾ | ✓ ²³⁾ | ✓ | ✓ | ✓ | ✓ | ✓ | ✓ | ✓ | ✓ | ✓ | ✓ | ✓ |
| Non-standard threaded through hole (NPT or G thread) | Y61 • and customer specifications | ✓ | ✓ | ✓ | ✓ | ✓ | ✓ | ✓ | ✓ | ✓ | ✓ | ✓ | ✓ | ✓ | ✓ | ✓ | ✓ | ✓ |
| Windings and insulation | | | | | | | | | | | | | | | | | | |
| Temperature class 155 (F), utilized acc. to 130 (B), coolant temperature 45 °C, derating approx. 4 % | N05 | ✓ | ✓ | ✓ | ✓ | ✓ | ✓ | ✓ | ✓ | ✓ | ✓ | ✓ | ✓ | ✓ | ✓ | ✓ | ✓ | ✓ |
| Temperature class 155 (F), utilized acc. to 130 (B), coolant temperature 50 °C, derating approx. 8 % | N06 | ✓ | ✓ | ✓ | ✓ | ✓ | ✓ | ✓ | ✓ | ✓ | ✓ | ✓ | ✓ | ✓ | ✓ | ✓ | ✓ | ✓ |
| Temperature class 155 (F), utilized acc. to 130 (B), coolant temperature 55 °C, derating approx. 13 % | N07 | ✓ | ✓ | ✓ | ✓ | ✓ | ✓ | ✓ | ✓ | ✓ | ✓ | ✓ | ✓ | ✓ | ✓ | ✓ | ✓ | ✓ |
| Temperature class 155 (F), utilized acc. to 130 (B), coolant temperature 60 °C, derating approx. 18 % | N08 | ✓ | ✓ | ✓ | ✓ | ✓ | ✓ | ✓ | ✓ | ✓ | ✓ | ✓ | ✓ | ✓ | ✓ | ✓ | ✓ | ✓ |
| Increased air humidity/temperature with 30 to 60 g water per m ³ of air | N30 | ✓ | ✓ | ✓ | ✓ | ✓ | ✓ | ✓ | ✓ | ✓ | ✓ | ✓ | ✓ | ✓ | ✓ | ✓ | ✓ | ✓ |
| Increased air humidity/temperature with 60 to 100 g water per m ³ of air ²²⁾ | N31 | ✓ | ✓ | ✓ | ✓ | ✓ | ✓ | ✓ | ✓ | ✓ | ✓ | ✓ | ✓ | ✓ | ✓ | ✓ | ✓ | ✓ |

For legends and footnotes, see page 5/95.

SIMOTICS XP 1MB1, 1MB5 explosion-protected motors

Article No. supplements and special versions · Options

Cast-iron series 1MB1553, 1MB5553

| Special versions | Additional identification code -Z with order code and plain text if required | Frame size | | | | | | | | | | | | | | Motor version | | |
|--|--|------------|----|----|-----|-----|-----|-----|-----|-----|---------|-----|-----|-----|-----|---------------|--|-----|
| | | 71 | 80 | 90 | 100 | 112 | 132 | 160 | 180 | 200 | 225 | 250 | 280 | 315 | 355 | IEC | Ex db, Ex db eb (Zone 1) | IE3 |
| | | 1MB1553 | | | | | | | | | | | | | | | | |
| | | | | | | | | | | | 1MB5553 | | | | | | | |
| 1MB.553 - - -Z | | Order code | | | | | | | | | | | | | | | | |
| Windings and insulation (continued) | | | | | | | | | | | | | | | | | | |
| Temperature class 155 (F), utilized acc. to 130 (B), with higher coolant temperature and/or installation altitude | Y50 • and spec. power, CT... °C or IA m above sea level | | ✓ | ✓ | ✓ | ✓ | ✓ | ✓ | ✓ | ✓ | ✓ | ✓ | ✓ | ✓ | ✓ | ✓ | | |
| Colors and paint finish | | | | | | | | | | | | | | | | | | |
| Standard paint finish C2 in RAL 7030 stone gray | | □ | □ | □ | □ | □ | □ | □ | □ | □ | □ | □ | □ | □ | □ | □ | | |
| Unpainted (only cast-iron parts primed) | S00 | ○ | ○ | ○ | ○ | ○ | ○ | ○ | ○ | ○ | ○ | ○ | ○ | ○ | ○ | ○ | | |
| Unpainted, only primed | S01 | ✓ | ✓ | ✓ | ✓ | ✓ | ✓ | ✓ | ✓ | ✓ | ✓ | ✓ | ✓ | ✓ | ✓ | ✓ | | |
| Special paint finish C3 | S02 | ✓ | ✓ | ✓ | ✓ | ✓ | ✓ | ✓ | ✓ | ✓ | ✓ | ✓ | ✓ | ✓ | ✓ | ✓ | | |
| Special paint finish sea air resistant C4 | S03 | ✓ | ✓ | ✓ | ✓ | ✓ | ✓ | ✓ | ✓ | ✓ | ✓ | ✓ | ✓ | ✓ | ✓ | ✓ | | |
| Special paint finish for use offshore C5 | S04 | ✓ | ✓ | ✓ | ✓ | ✓ | ✓ | ✓ | ✓ | ✓ | ✓ | ✓ | ✓ | ✓ | ✓ | ✓ | | |
| Internal coating | S05 | ✓ | ✓ | ✓ | ✓ | ✓ | ✓ | ✓ | ✓ | ✓ | ✓ | ✓ | ✓ | ✓ | ✓ | ✓ | | |
| Top coat polyurethane ¹⁶⁾ | S06 | ✓ | ✓ | ✓ | ✓ | ✓ | ✓ | ✓ | ✓ | ✓ | ✓ | ✓ | ✓ | ✓ | ✓ | ✓ | | |
| Paint finish in other standard RAL colors: RAL 1002, 1013, 1015, 1019, 2003, 2004, 3000, 3007, 5002, 5007, 5009, 5010, 5012, 5015, 5017, 5018, 5019, 6011, 6019, 6021, 7000, 7001, 7004, 7011, 7016, 7022, 7031, 7032, 7033, 7035, 9001, 9002, 9005 (see Catalog Section 1 "Introduction") | Y53 • and paint finish RAL | ✓ | ✓ | ✓ | ✓ | ✓ | ✓ | ✓ | ✓ | ✓ | ✓ | ✓ | ✓ | ✓ | ✓ | ✓ | | |
| Paint finish in special RAL colors: For RAL colors, see "Special paint finish in special RAL colors" (see Catalog Section 1 "Introduction") | Y56 • and paint finish RAL | ✓ | ✓ | ✓ | ✓ | ✓ | ✓ | ✓ | ✓ | ✓ | ✓ | ✓ | ✓ | ✓ | ✓ | ✓ | | |
| Modular technology – Basic versions | | | | | | | | | | | | | | | | | | |
| Mounting of separately driven fan ²⁶⁾ | F70 | - | - | - | - | - | - | - | - | - | ✓ | ✓ | ✓ | ✓ | ✓ | | | |
| Modular technology – Additional versions | | | | | | | | | | | | | | | | | | |
| Brake supply voltage 24 V DC | F10 | - | ○ | ○ | ○ | ○ | ○ | ○ | ○ | ○ | - | - | - | - | - | | | |
| Brake supply voltage 230 V AC, 50/60 Hz | F11 | - | ○ | ○ | ○ | ○ | ○ | ○ | ○ | ○ | - | - | - | - | - | | | |
| Brake supply voltage 400 V AC, 50/60 Hz | F12 | - | ○ | ○ | ○ | ○ | ○ | ○ | ○ | ○ | - | - | - | - | - | | | |
| Mechanical manual brake release with lever (no locking) | F50 | - | ✓ | ✓ | ✓ | ✓ | ✓ | ✓ | ✓ | ✓ | - | - | - | - | - | | | |
| Special technology | | | | | | | | | | | | | | | | | | |
| Mounting of brake in Ex db version ²⁸⁾ | F20 | - | ✓ | ✓ | ✓ | ✓ | ✓ | ✓ | ✓ | ✓ | - | - | - | - | - | | | |
| Mounting of LL 841 (HTL); 1024 I explosion-protected rotary pulse encoder | G30 | - | - | - | ✓ | ✓ | ✓ | ✓ | ✓ | ✓ | ✓ | ✓ | ✓ | ✓ | ✓ | | | |
| Mechanical version and degrees of protection | | | | | | | | | | | | | | | | | | |
| Low-noise version for 2-pole motors with clockwise direction of rotation ²⁶⁾ | F77 | - | - | - | - | - | ✓ | ✓ | ✓ | ✓ | ✓ | ✓ | ✓ | ✓ | ✓ | | | |
| Low-noise version for 2-pole motors with counterclockwise direction of rotation ²⁶⁾ | F78 | - | - | - | - | - | ✓ | ✓ | ✓ | ✓ | ✓ | ✓ | ✓ | ✓ | ✓ | | | |
| Protective cover ⁴⁾ | H00 | ✓ | ✓ | ✓ | ✓ | ✓ | ✓ | ✓ | ✓ | ✓ | ✓ | ✓ | ✓ | ✓ | ✓ | | | |
| Vibration-proof version; vibration resistance to Class 3M4 according to IEC 60721-3-3:1994 | H02 | ✓ | ✓ | ✓ | ✓ | ✓ | ✓ | ✓ | ✓ | ✓ | ✓ | ✓ | ✓ | ✓ | ✓ | | Not for: Combination with order code F20, F70, R50 | |
| External screws, bolts and unpainted materials made of stainless steel (V4A) ⁵⁾ | H06 | ✓ | ✓ | ✓ | ✓ | ✓ | ✓ | ✓ | ✓ | ✓ | ✓ | ✓ | ✓ | ✓ | ✓ | | | |
| Rust-resistant screws (externally) | H07 | ✓ | ✓ | ✓ | ✓ | ✓ | ✓ | ✓ | ✓ | ✓ | ✓ | ✓ | ✓ | ✓ | ✓ | | | |
| IP65 degree of protection | H20 | ✓ | ✓ | ✓ | ✓ | ✓ | ✓ | ✓ | ✓ | ✓ | ✓ | ✓ | ✓ | ✓ | ✓ | | | |
| IP56 degree of protection | H22 | ✓ | ✓ | ✓ | ✓ | ✓ | ✓ | ✓ | ✓ | ✓ | ✓ | ✓ | ✓ | ✓ | ✓ | | | |
| Drive-end seal for flange-mounting motors, oil-tight to 0.1 bar | H23 | ✓ | ✓ | ✓ | ✓ | ✓ | ✓ | ✓ | ✓ | ✓ | ✓ | ✓ | ✓ | ✓ | ✓ | | | |
| Adjustment screws for feet in horizontal installation ⁷⁾ | H30 | - | - | - | - | - | - | - | - | ✓ | ✓ | ✓ | ✓ | ✓ | ✓ | | | |
| Coolant temperature and installation altitude | | | | | | | | | | | | | | | | | | |
| Coolant temperature -40 to +40 °C | D03 | ✓ | ✓ | ✓ | ✓ | ✓ | ✓ | ✓ | ✓ | ✓ | ✓ | ✓ | ✓ | ✓ | ✓ | | | |

For legends and footnotes, see page 5/95.

SIMOTICS XP 1MB1, 1MB5 explosion-protected motors

Article No. supplements and special versions · Options

Cast-iron series 1MB1553, 1MB5553

| Special versions | Additional identification code -Z with order code and plain text if required | Frame size | | | | | | | | | | | | | Motor version | | | |
|--|--|------------|----|----|-----|-----|-----|-----|-----|-----|---------|-----|-----|-----|---------------|-----|--------------------------|-----|
| | | 71 | 80 | 90 | 100 | 112 | 132 | 160 | 180 | 200 | 225 | 250 | 280 | 315 | 355 | IEC | Ex db, Ex db eb (Zone 1) | IE3 |
| | | 1MB1553 | | | | | | | | | | | | | | | | |
| | | | | | | | | | | | 1MB5553 | | | | | | | |
| 1MB.553 - -Z | Order code | | | | | | | | | | | | | | | | | |
| Versions in accordance with standards and specifications | | | | | | | | | | | | | | | | | | |
| Ex certification for China ²⁵⁾ | D32 | ✓ | ✓ | ✓ | ✓ | ✓ | ✓ | ✓ | ✓ | ✓ | ✓ | ✓ | ✓ | ✓ | ✓ | | | |
| China Energy Efficiency Label ²⁵⁾ | D34 | ○ | ○ | ○ | ○ | ○ | ○ | ○ | ○ | ○ | ○ | ○ | ○ | ○ | ○ | | | |
| EAC Ex certificate for the Eurasian Customs Union ²⁵⁾ | D35 | ✓ | ✓ | ✓ | ✓ | ✓ | ✓ | ✓ | ✓ | ✓ | ✓ | ✓ | ✓ | ✓ | ✓ | | | |
| IECEx certification | D37 | ✓ | ✓ | ✓ | ✓ | ✓ | ✓ | ✓ | ✓ | ✓ | ✓ | ✓ | ✓ | ✓ | ✓ | | | |
| MEPS Australia ²⁵⁾ | D70 | ✓ | ✓ | ✓ | ✓ | ✓ | ✓ | ✓ | ✓ | ✓ | ✓ | ✓ | ✓ | ✓ | ✓ | | | |
| Bearings and lubrication | | | | | | | | | | | | | | | | | | |
| Preparation for SPM measuring nipple – thread M8 | G50 | – | – | – | ✓ | ✓ | ✓ | ✓ | ✓ | ✓ | ✓ | ✓ | ✓ | ✓ | ✓ | | | |
| Regreasing device with M10 × 1 grease nipple according to DIN 71412-A | L19 | – | – | – | – | – | – | ✓ | ✓ | ✓ | ✓ | ✓ | ○ | ○ | ○ | | | |
| Located bearing DE | L20 | □ | □ | □ | □ | □ | □ | □ | □ | □ | □ | □ | □ | □ | □ | | | |
| Located bearing NDE | L21 | ✓ | ✓ | ✓ | ✓ | ✓ | ✓ | ✓ | ✓ | ✓ | ✓ | ✓ | ✓ | ✓ | ✓ | | | |
| Bearing design for increased cantilever forces ⁹⁾ | L22 | – | – | – | – | – | – | ✓ | ✓ | ✓ | ✓ | ✓ | ✓ | ✓ | ✓ | | | |
| Regreasing device | L23 | – | – | – | – | – | – | ✓ | ✓ | ✓ | ✓ | ✓ | ✓ | □ | □ | □ | | |
| Bearing insulation NDE ³⁾ | L51 | – | – | – | – | – | – | ✓ | ✓ | ✓ | ✓ | ✓ | ✓ | ✓ | ✓ | | | |
| Measuring nipple for SPM shock pulse measurement for bearing inspection | Q01 | – | – | – | ✓ | ✓ | ✓ | ✓ | ✓ | ✓ | ✓ | ✓ | ✓ | ✓ | ✓ | | | |
| Balance and vibration severity | | | | | | | | | | | | | | | | | | |
| Vibration severity grade A | | □ | □ | □ | □ | □ | □ | □ | □ | □ | □ | □ | □ | □ | □ | | | |
| Vibration severity grade B ²⁾ | L00 | ✓ | ✓ | ✓ | ✓ | ✓ | ✓ | ✓ | ✓ | ✓ | ✓ | ✓ | ✓ | ✓ | ✓ | | | |
| Half-key balancing | | □ | □ | □ | □ | □ | □ | □ | □ | □ | □ | □ | □ | □ | □ | | | |
| Balancing without feather key | L01 | ✓ | ✓ | ✓ | ✓ | ✓ | ✓ | ✓ | ✓ | ✓ | ✓ | ✓ | ✓ | ✓ | ✓ | | | |
| Full-key balancing | L02 | ✓ | ✓ | ✓ | ✓ | ✓ | ✓ | ✓ | ✓ | ✓ | ✓ | ✓ | ✓ | ✓ | ✓ | | | |
| Shaft and rotor | | | | | | | | | | | | | | | | | | |
| Shaft extension with standard dimensions, without feather keyway | L04 | ✓ | ✓ | ✓ | ✓ | ✓ | ✓ | ✓ | ✓ | ✓ | ✓ | ✓ | ✓ | ✓ | ✓ | | | |
| Standard, cylindrical shaft extension (second shaft extension) NDE acc. to EN 50347 | L05 | ✓ | ✓ | ✓ | ✓ | ✓ | ✓ | ✓ | ✓ | ✓ | ✓ | ✓ | ✓ | ✓ | ✓ | | | |
| Standard shaft made of stainless steel (e.g. 1.4021) | L06 | ✓ | ✓ | ✓ | ✓ | ✓ | ✓ | ✓ | ✓ | ✓ | ✓ | ✓ | ✓ | ✓ | ✓ | | | |
| Shaft extension run-out in accordance with IEC 60072-1 precision class | L07 | ✓ | ✓ | ✓ | ✓ | ✓ | ✓ | ✓ | ✓ | ✓ | ✓ | ✓ | ✓ | ✓ | ✓ | | | |
| Shaft extension run-out, concentricity and perpendicularity in accordance with IEC 60072-1 precision class for flange-mounted motors | L08 | ✓ | ✓ | ✓ | ✓ | ✓ | ✓ | ✓ | ✓ | ✓ | ✓ | ✓ | ✓ | ✓ | ✓ | | | |
| Non-standard cylindrical shaft extension, DE ⁸⁾ | Y58 • and customer specifications | ✓ | ✓ | ✓ | ✓ | ✓ | ✓ | ✓ | ✓ | ✓ | ✓ | ✓ | ✓ | ✓ | ✓ | | | |
| Non-standard cylindrical shaft extension, NDE ⁸⁾ | Y59 • and customer specifications | ✓ | ✓ | ✓ | ✓ | ✓ | ✓ | ✓ | ✓ | ✓ | ✓ | ✓ | ✓ | ✓ | ✓ | | | |
| Heating and ventilation | | | | | | | | | | | | | | | | | | |
| Metal fan cover | | □ | □ | □ | □ | □ | □ | □ | □ | □ | □ | □ | □ | □ | □ | | | |
| Metal fan made of brass | F68 | ✓ | ✓ | ✓ | ✓ | ✓ | ✓ | ✓ | ✓ | ✓ | ✓ | ✓ | ✓ | ✓ | ✓ | | | |
| Metal external fan ⁹⁾ | F76 | ✓ | ✓ | ✓ | ✓ | ✓ | ✓ | ✓ | ✓ | ✓ | ✓ | ✓ | ✓ | ✓ | ✓ | | | |
| Anti-condensation heating for 230 V (2 terminals) ^{1) 10)} | Q02 | ✓ | ✓ | ✓ | ✓ | ✓ | ✓ | ✓ | ✓ | ✓ | ✓ | ✓ | ✓ | ✓ | ✓ | | | |
| Anti-condensation heating for 115 V (2 terminals) ^{1) 10)} | Q03 | ✓ | ✓ | ✓ | ✓ | ✓ | ✓ | ✓ | ✓ | ✓ | ✓ | ✓ | ✓ | ✓ | ✓ | | | |
| Anti-condensation heating for 220 V (2 terminals) ^{1) 10)} | Q04 | ✓ | ✓ | ✓ | ✓ | ✓ | ✓ | ✓ | ✓ | ✓ | ✓ | ✓ | ✓ | ✓ | ✓ | | | |
| Separately driven fan with non-standard voltage and/or frequency | Y81 • and customer specifications | – | – | – | – | – | – | – | – | – | – | – | – | – | – | ✓ | ✓ | ✓ |

SIMOTICS XP 1MB1, 1MB5 explosion-protected motors

Article No. supplements and special versions · Options

Cast-iron series 1MB1553, 1MB5553

| Special versions | Additional identification code -Z with order code and plain text if required | Frame size | | | | | | | | | | | | | | Motor version | | |
|--|--|------------|----|----|-----|-----|-----|-----|-----|-----|-----|-----|-----|-----|-----|---------------|--------------------------|-----|
| | | 71 | 80 | 90 | 100 | 112 | 132 | 160 | 180 | 200 | 225 | 250 | 280 | 315 | 355 | IEC | Ex db, Ex db eb (Zone 1) | IE3 |
| | | 1MB1553 | | | | | | | | | | | | | | | | |
| | | 1MB5553 | | | | | | | | | | | | | | | | |
| 1MB.553 - - -Z | Order code | | | | | | | | | | | | | | | | | |
| Rating plate and additional rating plates | | | | | | | | | | | | | | | | | | |
| Second rating plate, loose | M10 | ✓ | ✓ | ✓ | ✓ | ✓ | ✓ | ✓ | ✓ | ✓ | ✓ | ✓ | ✓ | ✓ | ✓ | ✓ | | |
| Rating plate, stainless steel | M11 | □ | □ | □ | □ | □ | □ | □ | □ | □ | □ | □ | □ | □ | □ | □ | | |
| Additional rating plate with deviating rating plate data | Y80 • and customer specifications | ✓ | ✓ | ✓ | ✓ | ✓ | ✓ | ✓ | ✓ | ✓ | ✓ | ✓ | ✓ | ✓ | ✓ | ✓ | | |
| Additional rating plate with customer specifications | Y82 • and customer specifications | ✓ | ✓ | ✓ | ✓ | ✓ | ✓ | ✓ | ✓ | ✓ | ✓ | ✓ | ✓ | ✓ | ✓ | ✓ | | |
| Additional information on rating plate and on package label (max. 20 characters) | Y84 • and customer specifications | ✓ | ✓ | ✓ | ✓ | ✓ | ✓ | ✓ | ✓ | ✓ | ✓ | ✓ | ✓ | ✓ | ✓ | ✓ | | |
| Extension of the liability for defects | | | | | | | | | | | | | | | | | | |
| Extension of the liability for defects period by 12 months to a total of 24 months (2 years) from delivery | Q80 | ✓ | ✓ | ✓ | ✓ | ✓ | ✓ | ✓ | ✓ | ✓ | ✓ | ✓ | ✓ | ✓ | ✓ | ✓ | | |
| Extension of the liability for defects period by 24 months to a total of 36 months (3 years) from delivery | Q82 | ✓ | ✓ | ✓ | ✓ | ✓ | ✓ | ✓ | ✓ | ✓ | ✓ | ✓ | ✓ | ✓ | ✓ | ✓ | | |
| Packaging, safety notes, documentation and test certificates | | | | | | | | | | | | | | | | | | |
| Printed Operating Instructions in German/English and a DVD with all official EU languages as well as Norwegian, Russian, Turkish, and Chinese ¹¹⁾ | | □ | □ | □ | □ | □ | □ | □ | □ | □ | □ | □ | □ | □ | □ | □ | | |
| Inspection certificate 3.1 according to EN 10204 ¹²⁾ | B02 | ✓ | ✓ | ✓ | ✓ | ✓ | ✓ | ✓ | ✓ | ✓ | ✓ | ✓ | ✓ | ✓ | ✓ | ✓ | | |
| Document – Electrical datasheet | B60 | ✓ | ✓ | ✓ | ✓ | ✓ | ✓ | ✓ | ✓ | ✓ | ✓ | ✓ | ✓ | ✓ | ✓ | ✓ | | |
| Document – Order dimensional drawing | B61 | ✓ | ✓ | ✓ | ✓ | ✓ | ✓ | ✓ | ✓ | ✓ | ✓ | ✓ | ✓ | ✓ | ✓ | ✓ | | |
| Standard test (routine test) with acceptance | B65 | ✓ | ✓ | ✓ | ✓ | ✓ | ✓ | ✓ | ✓ | ✓ | ✓ | ✓ | ✓ | ✓ | ✓ | ✓ | | |
| Noise measurement without load with octave band analysis, without acceptance ¹³⁾ | B71 | ✓ | ✓ | ✓ | ✓ | ✓ | ✓ | ✓ | ✓ | ✓ | ✓ | ✓ | ✓ | ✓ | ✓ | ✓ | | |
| Noise measurement without load with octave band analysis, with acceptance ¹⁴⁾ | B72 | ✓ | ✓ | ✓ | ✓ | ✓ | ✓ | ✓ | ✓ | ✓ | ✓ | ✓ | ✓ | ✓ | ✓ | ✓ | | |
| Type test with heat run for vertical motors, without acceptance ¹³⁾ | B80 | ✓ | ✓ | ✓ | ✓ | ✓ | ✓ | ✓ | ✓ | ✓ | ✓ | ✓ | ✓ | ✓ | ✓ | ✓ | | |
| Type test with heat run for vertical motors, with acceptance ¹⁴⁾ | B81 | ✓ | ✓ | ✓ | ✓ | ✓ | ✓ | ✓ | ✓ | ✓ | ✓ | ✓ | ✓ | ✓ | ✓ | ✓ | | |
| Type test with heat run for horizontal motors, without acceptance ¹³⁾ | B82 | ✓ | ✓ | ✓ | ✓ | ✓ | ✓ | ✓ | ✓ | ✓ | ✓ | ✓ | ✓ | ✓ | ✓ | ✓ | | |
| Type test with heat run for horizontal motors, with acceptance ¹⁴⁾ | B83 | ✓ | ✓ | ✓ | ✓ | ✓ | ✓ | ✓ | ✓ | ✓ | ✓ | ✓ | ✓ | ✓ | ✓ | ✓ | | |
| "Basic" documentation package ¹⁵⁾ | B90 | ✓ | ✓ | ✓ | ✓ | ✓ | ✓ | ✓ | ✓ | ✓ | ✓ | ✓ | ✓ | ✓ | ✓ | ✓ | | |
| "Advanced" documentation package ¹⁵⁾ | B91 | ✓ | ✓ | ✓ | ✓ | ✓ | ✓ | ✓ | ✓ | ✓ | ✓ | ✓ | ✓ | ✓ | ✓ | ✓ | | |
| "Projects" documentation package ¹⁵⁾ | B92 | ✓ | ✓ | ✓ | ✓ | ✓ | ✓ | ✓ | ✓ | ✓ | ✓ | ✓ | ✓ | ✓ | ✓ | ✓ | | |
| Wire-lattice pallet packaging | B99 | ○ | ○ | ○ | ○ | ○ | ○ | ○ | ○ | ○ | ○ | ○ | ○ | ○ | ○ | ○ | | |
| Connected in star for dispatch | M01 | ✓ | ✓ | ✓ | ✓ | ✓ | ✓ | ✓ | ✓ | ✓ | ✓ | ✓ | ✓ | ✓ | ✓ | ✓ | | |
| Connected in delta for dispatch | M02 | ✓ | ✓ | ✓ | ✓ | ✓ | ✓ | ✓ | ✓ | ✓ | ✓ | ✓ | ✓ | ✓ | ✓ | ✓ | | |

For legends and footnotes, see page 5/95.

SIMOTICS XP 1MB1, 1MB5 explosion-protected motors

Article No. supplements and special versions · Options

Cast-iron series 1MB1553, 1MB5553

- Standard version
- Without additional charge
- This order code only determines the price of the version – Additional plain text is required.
- ✓ With additional charge
- Not possible

- 1) Maximum number of connections for accessories, see terminal box concept.
- 2) Not admissible in combination with converter operation (order codes **B43**, **B44**).
- 3) The frame sizes 280, 315, and 355 in combination with order code **B43** or **B44** are equipped with "Bearing insulation NDE" as standard (order code **L51** is included in B43/B44).
- 4) The following applies for explosion-protected motors: In the case of the types of construction with shaft extension down, the version "with protective cover" is required. For types of construction with shaft extension pointing upwards, a suitable cover must be implemented to prevent small parts from falling into the fan cover (see the standard IEC/EN 60079-0). The cover must not block the cooling air flow.
- 5) Rating plate, screws, grounding, and options with order codes **L19**, **L23**, **Q01** made of stainless steel (V4A).
- 6) Power data in converter operation according to the VSD rating lists. Wind-ing monitoring with PTC thermistor mandatory.
 - Only in combination with single voltages, e.g.: **M4A**.
 - Frame size 280 and larger with insulated bearings on the fan side (NDE).
- 7) 4 threads in the motor feet; adjustment screws not in the scope of supply.
- 8) When motors are ordered that have a longer or shorter shaft extension than normal, the required position and length of the feather keyway must be specified in a sketch. It must be ensured that only feather keys in accordance with DIN 6885, Form A are permitted to be used. The feather keyway is positioned centrally on the shaft extension. The length is defined by the manufacturer in accordance with the appropriate standard. Not valid for: Conical shafts, non-standard threaded journals, non-standard shaft tolerances, friction welded journals, extremely "thin" shafts, special geometry dimensions (e.g. square journals), hollow shafts. Valid for non-standard shaft extensions DE or NDE. The feather keys are supplied in every case.
 - For order codes **Y58**, **Y59** and **L05** the following applies:
 - Dimensions D and DA ≤ ball bearing inner diameter (see dimension tables in "Dimensions")
 - Dimensions E and EA ≤ 2 × length E (standard) of the shaft extension
 - For an explanation of the order codes, see Catalog Section 1 "Introduction".
- 9) The material of the fan is aluminum, for frame sizes 225 to 355 steel – metal fans are painted with paint finishes with film thickness 90 µm or more.
- 10) Connection in the main terminal box in the standard version.
- 11) The Operating Instructions are available on the Internet in PDF format for all official EU languages.
- 12) The delivery time for the inspection certificate may differ from the delivery time for the motor.
- 13) The delivery time is then approx. 20 working days longer.
- 14) The delivery time is then approx. 25 working days longer or the confirmed acceptance date.
- 15) Version and content of the documentation, see Chapter 1.
- 16) Not in combination with order codes **S00**, **S01**, and **S02**. Other colors, order codes **Y53** and **Y56**, on request.
- 17) Not in combination with order codes **R48** and **R49**.
- 18) For installation in a hostile and corrosive environment, paint finish with order code **S03** or better is recommended.
- 19) Only in combination with regreasing, order code **L19** or **L23**.
- 20) Cable glands in Ex e version.
- 21) Frame size 315 only in combination with order code **R50**, frame sizes 250 and 280 not in combination with order code **R50**.
- 22) Standard paint finish C2, we recommend C3 or better (e.g. order code **S02**, **S03**, **S04**).
- 23) Only possible in combination with order code **R50**.
- 24) Only possible in combination with order code **R54**.
- 25) Not possible in combination with **1MB..56** or **1MB..57**.
- 26) Not available in combination with order code **D03**.
- 27) Supplied without cable gland.
- 28) Select brake connection voltage separately, order codes **F10**, **F11**, or **F12** – note further details in Chapter 1 under "Modular technology", "Brakes".

SIMOTICS XP 1MB1, 1MB5 explosion-protected motors

Article No. supplements and special versions · Options

Cast-iron series 1MB5.4, 1MB5.3, 1MB5.3

Selection and ordering data

| Special versions | Additional identification code -Z with order code and plain text if required | Frame size | | Motor version | | |
|--|--|------------|-------|---------------|--|------------|
| | | 400 | 450 | IEC | Ex ec, Ex tc, Ex tb (Zones 2, 22 and 21) | IE4 IE3 |
| | | 1MB5.4 | | | | |
| | | 1MB5.3 | | | | |
| | | 1MB5.3 | | | | |
| 1MB5 -Z | Order code | | | | | |
| Explosion-protected version | | | | | | |
| VIK version | C02 | ✓ | ✓ | | | |
| Version additionally for dust Ex tc – Zone 22 | B30 | ✓ | ✓ | | | |
| Version IIC with stamping of IIB | B31 | ✓ | ✓ | | | |
| Version for converter operation | | | | | | |
| Version for converter operation in the basic version with SINAMICS G120 operating data with PM240-2 | B40 | O. R. | O. R. | | | |
| Version for converter operation in the basic version with SINAMICS S150 operating data | B41 | O. R. | O. R. | | | |
| Version for converter operation with power data on the PWM converter | B43 | O. R. | O. R. | | | |
| Operating data such as the B40 order code with alternative SINAMICS converter on the rating plate • G120 with PM230 • G120 with PM240 • G120C • G120P with PM230 • G120P with PM240-2 • G120P with PM240P-2 • G120P with PM330 • G130, G150, G180 • S120 (BLM/SLM) • V20 Operating data such as order code B41 with alternative SINAMICS converters on the rating plate • S120 (ALM) | Y68 • and converter type | O | O | | | |
| Motor protection | | | | | | |
| 1 or 3 PTC thermistors – for tripping (2 terminals) ¹⁾ | Q11 | ✓ | ✓ | Not for: | Combination with motor protection code letter B (15th position of the Article No.) | |
| 2 or 6 PTC thermistors – for alarm and tripping (4 terminals) ¹⁾ | Q12 | ✓ | ✓ | Not for: | Combination with motor protection code letter C (15th position of the Article No.) | |
| 3 NTC thermistors – for tripping (6 terminals) | Q21 | ✓ | ✓ | Not for: | Combination with motor protection code letter F (15th position of the Article No.) | |
| 1 KTY84-130 temperature sensor (2 terminals) ¹⁾ | Q23 | ✓ | ✓ | Not for: | Combination with motor protection code letter F (15th position of the Article No.) | |
| 2 KTY84-130 temperature sensors (4 terminals) ¹⁾ | Q25 | ✓ | ✓ | Not for: | Combination with motor protection code letter G (15th position of the Article No.) | |
| 1 Pt1000 resistance thermometer (2 terminals) | Q35 | ✓ | ✓ | | | |
| 2 Pt1000 resistance thermometers (4 terminals) | Q36 | ✓ | ✓ | | | |
| 6 Pt1000 resistance thermometers (12 terminals) | Q37 | ✓ | ✓ | | | |
| 3 Pt100 resistance thermometers – 2-wire input (6 terminals) ¹⁾ | Q60 | ✓ | ✓ | Not for: | Combination with motor protection code letter H (15th position of the Article No.) | |
| 6 Pt100 resistance thermometers – 2-wire input (12 terminals) ¹⁾ | Q61 | ✓ | ✓ | Not for: | Combination with motor protection code letter J (15th position of the Article No.) | |
| 1 Pt100 resistance thermometer – 2-wire input (2 terminals) | Q62 | ✓ | ✓ | | | |
| 3 Pt100 resistance thermometers – 3-wire input (9 terminals) | Q63 | ✓ | ✓ | | | |
| 6 Pt100 resistance thermometers – 3-wire input (18 terminals) | Q64 | ✓ | ✓ | | | |
| 2 Pt100 resistance thermometers in basic configuration for bearings (2 terminals) | Q72 | ✓ | ✓ | | | |
| 2 Pt100 resistance thermometers in 3-wire input for bearings (6 terminals) | Q78 | ✓ | ✓ | | | |
| 2 Pt100 double resistance thermometers in 3-wire input for bearings (12 terminals) | Q79 | ✓ | ✓ | | | |

For legends and footnotes, see page 5/100.

SIMOTICS XP 1MB1, 1MB5 explosion-protected motors

Article No. supplements and special versions · Options

Cast-iron series 1MB55.4, 1MB55.3, 1MB58.3

| Special versions | Additional identification code -Z with order code and plain text if required | Frame size | | Motor version | | |
|--|---|-------------------------------------|-------------------------------------|---------------|--|------------|
| | | 400 | 450 | IEC | Ex ec, Ex tc, Ex tb (Zones 2, 22 and 21) | IE4 IE3 |
| | | 1MB55 . 4 | | | | |
| | | 1MB55 . 3 | | | | |
| 1MB58 . 3 | | | | | | |
| 1MB5 -Z | Order code | | | | | |
| Motor connection and terminal box | | | | | | |
| External grounding | | <input type="checkbox"/> | <input type="checkbox"/> | | | |
| Terminal box at NDE | H08 | <input checked="" type="checkbox"/> | <input checked="" type="checkbox"/> | | | |
| Two terminal boxes at NDE ¹⁷⁾ | H09 | <input checked="" type="checkbox"/> | <input checked="" type="checkbox"/> | | | |
| Second external grounding | H70 | <input checked="" type="checkbox"/> | <input checked="" type="checkbox"/> | | | |
| Subsequently rotatable main terminal box | R09 | <input checked="" type="checkbox"/> | <input checked="" type="checkbox"/> | | | |
| Rotation of the terminal box through 90°, entry from DE ¹²⁾ | R10 | <input checked="" type="checkbox"/> | <input checked="" type="checkbox"/> | | Not for: Combination with type of construction code letters F, G, J (14th position of the Article No.) | |
| Rotation of the terminal box through 90°, entry from NDE | R11 | <input checked="" type="checkbox"/> | <input checked="" type="checkbox"/> | | | |
| Rotation of the terminal box through 180° | R12 | <input checked="" type="checkbox"/> | <input checked="" type="checkbox"/> | | | |
| Saddle terminal for connection without cable lug, accessories pack | R19 | <input checked="" type="checkbox"/> | <input checked="" type="checkbox"/> | | | |
| Larger terminal box ¹³⁾ | R50 | <input checked="" type="checkbox"/> | <input checked="" type="checkbox"/> | | | |
| Drilled removable entry plate | R52 | <input checked="" type="checkbox"/> | <input checked="" type="checkbox"/> | | | |
| Undrilled removable entry plate | | <input type="checkbox"/> | <input type="checkbox"/> | | | |
| Cast-iron auxiliary terminal box (small) | R62 | <input checked="" type="checkbox"/> | <input checked="" type="checkbox"/> | | | |
| Cast-iron auxiliary terminal box (large) | R63 | <input checked="" type="checkbox"/> | <input checked="" type="checkbox"/> | | | |
| Stainless steel auxiliary terminal box (large) | R65 | <input checked="" type="checkbox"/> | <input checked="" type="checkbox"/> | | | |
| Non-standard threaded through hole (NPT or G thread) ²⁾ | Y61 • and customer specifications | <input checked="" type="checkbox"/> | <input checked="" type="checkbox"/> | | | |
| Windings and insulation | | | | | | |
| Temperature class 155 (F), utilized acc. to 155 (F), with service factor ⁹⁾ | | <input type="checkbox"/> | <input type="checkbox"/> | | | |
| Temperature class 155 (F), utilized acc. to 130 (B), coolant temperature 45 °C, derating approx. 4 % ¹⁵⁾ | N05 | <input checked="" type="checkbox"/> | <input checked="" type="checkbox"/> | | | |
| Temperature class 155 (F), utilized acc. to 130 (B), coolant temperature 50 °C, derating approx. 8 % ¹⁵⁾ | N06 | <input checked="" type="checkbox"/> | <input checked="" type="checkbox"/> | | | |
| Temperature class 155 (F), utilized acc. to 130 (B), coolant temperature 55 °C, derating approx. 13 % ¹⁵⁾ | N07 | <input checked="" type="checkbox"/> | <input checked="" type="checkbox"/> | | | |
| Temperature class 155 (F), utilized acc. to 130 (B), coolant temperature 60 °C, derating approx. 18 % ¹⁵⁾ | N08 | <input checked="" type="checkbox"/> | <input checked="" type="checkbox"/> | | | |
| Increased air humidity/temperature with 30 to 60 g water per m ³ of air | N30 | <input checked="" type="checkbox"/> | <input checked="" type="checkbox"/> | | | |
| Increased air humidity/temperature with 60 to 100 g water per m ³ of air | N31 | <input checked="" type="checkbox"/> | <input checked="" type="checkbox"/> | | | |
| Temperature class 155 (F), utilized acc. to 130 (B), with higher coolant temperature and/or installation altitude ⁹⁾ | Y50 • and spec. power, CT .. °C or IA m above sea level | <input checked="" type="checkbox"/> | <input checked="" type="checkbox"/> | | | |
| Colors and paint finish | | | | | | |
| Standard paint finish C2 in RAL 7030 stone gray | | <input type="checkbox"/> | <input type="checkbox"/> | | | |
| Unpainted (only cast-iron parts primed) | S00 | <input type="radio"/> | <input type="radio"/> | | | |
| Unpainted, only primed | S01 | <input checked="" type="checkbox"/> | <input checked="" type="checkbox"/> | | | |
| Special paint finish C3 | S02 | <input checked="" type="checkbox"/> | <input checked="" type="checkbox"/> | | | |
| Special paint finish sea air resistant C4 ¹⁴⁾ | S03 | <input checked="" type="checkbox"/> | <input checked="" type="checkbox"/> | | | |
| Special paint finish for use offshore C5 ¹⁴⁾ | S04 | <input checked="" type="checkbox"/> | <input checked="" type="checkbox"/> | | | |
| Internal coating | S05 | <input checked="" type="checkbox"/> | <input checked="" type="checkbox"/> | | | |
| Top coat polyurethane ⁶⁾ | | <input type="checkbox"/> | <input type="checkbox"/> | | | |
| Paint finish in other standard RAL colors: RAL 1002, 1013, 1015, 1019, 2003, 2004, 3000, 3007, 5002, 5007, 5009, 5010, 5012, 5015, 5017, 5018, 5019, 6011, 6019, 6021, 7000, 7001, 7004, 7011, 7016, 7022, 7031, 7032, 7033, 7035, 9001, 9002, 9005 (see Catalog Section 1 "Introduction") | Y53 • and paint finish RAL.... | <input checked="" type="checkbox"/> | <input checked="" type="checkbox"/> | | | |

For legends and footnotes, see page 5/100.

SIMOTICS XP 1MB1, 1MB5 explosion-protected motors

Article No. supplements and special versions · Options

Cast-iron series 1MB5.4, 1MB5.3, 1MB5.3

| Special versions | Additional identification code -Z with order code and plain text if required | Frame size | | Motor version | | |
|---|---|------------|------------|---------------|---|------------|
| | | 400 | 450 | IEC | Ex ec, Ex tc, Ex tb (Zones 2, 22 and 21) | IE4 IE3 |
| | | 1MB5 . 4 | | | | |
| | | 1MB5 . 3 | | | | |
| | | 1MB5 . 3 | | | | |
| 1MB5 -Z | Order code | | | | | |
| Colors and paint finish (continued) | | | | | | |
| Paint finish in special RAL colors: For RAL colors, see "Special paint finish in special RAL colors" (see Catalog Section 1 "Introduction") | Y56 • and paint finish RAL.... | ✓ | ✓ | | | |
| Modular technology – Basic versions | | | | | | |
| Mounting of separately driven fan ¹⁰⁾ | F70 | ✓ | ✓ | | | |
| Special technology | | | | | | |
| Mounting of LL 841 (HTL); 1024 l explosion-protected rotary pulse encoder | G30 | ✓ | ✓ | | | |
| Mounting of a special type of rotary pulse encoder | Y70 • and customer specifications | O. R. | O. R. | | | |
| Mechanical version and degrees of protection | | | | | | |
| Low-noise version for 2-pole motors with clockwise direction of rotation | | □ | □ | | | |
| Low-noise version for 2-pole motors with counterclockwise direction of rotation | F78 | ○ | ○ | | | |
| Prepared for mounted components, centering hole only | | □ | □ | | | |
| Prepared for mountings with D16 shaft | G42 | ✓ | ✓ | | | |
| Mechanical protection for encoder | G43 | ✓ | ✓ | | | |
| Protective cover | H00 | ✓ | ✓ | | | |
| Condensation drainage holes | | □ | □ | | | |
| Rust-resistant screws (externally) | H07 | ✓ | ✓ | | | |
| IP65 degree of protection ¹⁹⁾ | H20 | ✓ | ✓ | | | |
| IP56 degree of protection | H22 | ✓ | ✓ | | | |
| Sealing ring made of fluoroelastomer (FKM) | H25 | ✓ | ✓ | | | |
| Increased corrosion protection for external components | H90 | ✓ | ✓ | | | |
| Coolant temperature and installation altitude | | | | | | |
| Coolant temperature –40 to +40 °C | D03 | ✓ | ✓ | | | |
| Versions in accordance with standards and specifications | | | | | | |
| Electrical according to NEMA MG1-12 | | □ | □ | | | |
| IECEX certificate | D37 | ✓ | ✓ | | | |
| Bearings and lubrication | | | | | | |
| Regreasing device with M10 × 1 grease nipple according to DIN 71412-A | L19 | ○ | ○ | | | |
| Located bearing DE | | □ | □ | | | |
| Located bearing NDE ¹¹⁾ | L21 | ✓ | ✓ | | | |
| Bearing design for increased cantilever forces ^{7), 8)} | L22 | O. R. | O. R. | | | |
| Regreasing device | | □ | □ | | | |
| Drainage for used grease | L30 | O. R. | O. R. | | | |
| Measuring nipple for SPM shock pulse measurement for bearing inspection | Q01 | ✓ | ✓ | | | |
| Balance and vibration severity | | | | | | |
| Vibration severity grade A | | □ | □ | | | |
| Vibration severity grade B | L00 | ✓ | ✓ | | | |
| Half-key balancing (standard) | | □ | □ | | | |
| Balancing without feather key ¹⁶⁾ | L01 | ✓ | ✓ | | | |
| Full-key balancing ¹⁶⁾ | L02 | ✓ | ✓ | | | |
| Shaft and rotor | | | | | | |
| Shaft extension with standard dimensions, without feather keyway | L04 | ✓ | ✓ | | | |
| Standard, cylindrical shaft extension (second shaft extension) NDE acc. to EN 50347 | L05 | ✓ | ✓ | | | |
| Shaft extension run-out in accordance with IEC 60072-1 precision class | L07 | ✓ | ✓ | | | |
| Shaft extension run-out, concentricity and perpendicularity in accordance with IEC 60072-1 precision class for flange-mounted motors | L08 | ✓ | ✓ | | | |
| Non-standard cylindrical shaft extension, DE ³⁾ | Y58 • and customer specifications | ✓ | ✓ | | | |

For legends and footnotes, see page 5/100.

SIMOTICS XP 1MB1, 1MB5 explosion-protected motors

Article No. supplements and special versions · Options

Cast-iron series 1MB55.4, 1MB55.3, 1MB58.3

| Special versions | Additional identification code -Z with order code and plain text if required | Frame size | | Motor version | | |
|---|---|------------|------------|---------------|---|------------|
| | | 400 | 450 | IEC | Ex ec, Ex tc, Ex tb (Zones 2, 22 and 21) | IE4 IE3 |
| | | 1MB55 . 4 | | | | |
| | | 1MB55 . 3 | | | | |
| | | 1MB58 . 3 | | | | |
| 1MB5 -Z | Order code | | | | | |
| Shaft and rotor (continued) | | | | | | |
| Non-standard cylindrical shaft extension, NDE ³⁾ | Y59 • and customer specifications | ✓ | ✓ | | | |
| Special shaft steel | Y60 • and customer specifications | O. R. | O. R. | | | |
| Heating and ventilation | | | | | | |
| Sheet metal fan cover | | ☐ | ☐ | | | |
| Metal external fan | | ☐ | ☐ | | | |
| Without external fan and without fan cover | F90 | ✓ | ✓ | | | |
| Anti-condensation heating for 230 V (2 terminals) | Q02 | ✓ | ✓ | | | |
| Anti-condensation heating for 115 V (2 terminals) | Q03 | ✓ | ✓ | | | |
| Anti-condensation heating for 400 V (2 terminals) | Q06 | ✓ | ✓ | | | |
| Separately driven fan with non-standard voltage and/or frequency | Y81 • and customer specifications | O. R. | O. R. | | | |
| Rating plate and additional rating plates | | | | | | |
| Second rating plate, loose | M10 | ✓ | ✓ | | | |
| Rating plate, stainless steel | | ☐ | ☐ | | | |
| Additional rating plate with deviating rating plate data ¹⁸⁾ | Y80 • and customer specifications | ✓ | ✓ | | | |
| Additional rating plate with customer specifications | Y82 • and customer specifications | ✓ | ✓ | | | |
| Additional information on rating plate and on package label (max. 20 characters) | Y84 • and customer specifications | ✓ | ✓ | | | |
| Extension of the liability for defects | | | | | | |
| Extension of the liability for defects by 12 months to a total of 24 months (2 years) from delivery ⁴⁾ | Q80 | ✓ | ✓ | | | |
| Extension of the liability for defects by 18 months to a total of 30 months (2.5 years) from delivery ⁴⁾ | Q81 | ✓ | ✓ | | | |
| Extension of the liability for defects by 24 months to a total of 36 months (3 years) from delivery ⁴⁾ | Q82 | ✓ | ✓ | | | |
| Extension of the liability for defects by 30 months to a total of 42 months (3.5 years) from delivery ⁴⁾ | Q83 | ✓ | ✓ | | | |
| Extension of the liability for defects by 36 months to a total of 48 months (4 years) from delivery ⁴⁾ | Q84 | ✓ | ✓ | | | |
| Extension of the liability for defects by 48 months to a total of 60 months (5 years) from delivery ⁴⁾ | Q85 | ✓ | ✓ | | | |
| Packaging, safety notes, documentation and test certificates | | | | | | |
| Inspection certificate 3.1 according to EN 10204 ⁴⁾ | B02 | ✓ | ✓ | | | |
| Printed German/English operating instructions enclosed ⁵⁾ | | ☐ | ☐ | | | |
| Equivalent circuit diagram | B51 | ✓ | ✓ | | | |
| Starting diagram (torque vs. speed and current vs. speed) | B52 | ✓ | ✓ | | | |
| Document – Electrical datasheet | B60 | ✓ | ✓ | | | |
| Document – Order dimensional drawing | B61 | ✓ | ✓ | | | |
| Standard test (routine test) with acceptance | B65 | ✓ | ✓ | | | |
| Temperature test without acceptance | B67 | ✓ | ✓ | | | |
| Temperature test with acceptance | B68 | ✓ | ✓ | | | |
| Type test with heat run for vertical motors, without acceptance | B80 | ✓ | ✓ | | | |
| Type test with heat run for vertical motors, with acceptance | B81 | ✓ | ✓ | | | |
| Type test with heat run for horizontal motors, without acceptance | B82 | ✓ | ✓ | | | |

For legends and footnotes, see page 5/100.

SIMOTICS XP 1MB1, 1MB5 explosion-protected motors

Article No. supplements and special versions · Options

Cast-iron series 1MB55.4, 1MB55.3, 1MB58.3

| Special versions | Additional identification code -Z with order code and plain text if required | Frame size | | Motor version | | |
|--|---|------------|-----|---------------|--|------------|
| | | 400 | 450 | IEC | Ex ec, Ex tc, Ex tb (Zones 2, 22 and 21) | IE4 IE3 |
| | | 1MB55 . 4 | | | | |
| | | 1MB55 . 3 | | | | |
| | | 1MB58 . 3 | | | | |
| 1MB5 -Z | Order code | | | | | |
| Packaging, safety notes, documentation and test certificates (continued) | | | | | | |
| Type test with heat run for horizontal motors, with acceptance | B83 | ✓ | ✓ | | | |
| "Basic" documentation package | B90 | ✓ | ✓ | | | |
| "Advanced" documentation package | B91 | ✓ | ✓ | | | |
| "Projects" documentation package | B92 | ✓ | ✓ | | | |
| Connected in star for dispatch | M01 | ✓ | ✓ | | | |
| Connected in delta for dispatch | M02 | ✓ | ✓ | | | |

- Standard version
- Without additional charge
- This order code only determines the price of the version – Additional plain text is required.
- ✓ With additional charge
- O. R. Possible on request

5

- 1) Evaluation with associated tripping unit (see Catalog IC 10) is recommended.
- 2) Parallel Whitworth threaded pipe DIN ISO 228 (DIN 259) BSPP (British Standard Pipe Parallel), threaded pipe for connections not sealed in the thread (cylindrical), external = G.
- 3) When motors are ordered that have a longer or shorter shaft extension than normal, the required position and length of the feather keyway must be specified in a sketch. It must be ensured that only feather keys in accordance with EN 50347 are used. The feather keyway is positioned centrally on the shaft extension. The length is defined by the manufacturer in accordance with the appropriate standard. Not valid for: Conical shafts, non-standard threaded journals, non-standard shaft tolerances, friction welded journals, extremely "thin" shafts, special geometry dimensions (e.g. square journals), hollow shafts. Valid for non-standard shaft extensions DE or NDE. The feather keys are supplied in every case. For order codes **Y58**, **Y59** and **L05** the following applies:
 - Dimensions D and DA ≤ ball bearing inner diameter (see dimension tables for "Dimensions")
 - Dimensions E and EA ≤ 2 × length E (standard) of the shaft extension.
- 4) The delivery time for the manufacturer's test certificate may differ from the delivery time for the motor.
- 5) The Operating Instructions (Compact) are available in PDF format for all official EU languages at <http://support.automation.siemens.com/WW/view/en/10803948/133300>
- 6) Order code **S06** cannot be combined with order codes **S00** and **S01**. Possible without restriction in combination with **Y53** for frame sizes 315 to 355 and for frame sizes 400 and 450.
- 7) A minimum cantilever force F_{\min} of $0.5 \cdot F_{\max}$ is required for NU bearings (cylindrical roller bearings) in contrast to ball bearings. Cylindrical roller bearings are not suitable for coupling output or for brief periods of no-load operation without cantilever force.
- 8) For frame sizes 400 and 450, permissible cantilever forces for motors with reinforced bearings are available on request. Please specify cantilever force and lever arm.
- 9) Only possible for line operation.
- 10) The separately driven fan motor is implemented with voltage code **34** (400 V/50 Hz; 460 V/60 Hz).
- 11) For frame sizes 400 and 450, not possible for a vertical type of construction.
- 12) For motors with flange (IM B5, IM B35, IM V1), only possible in conjunction with order code **H08**.
- 13) Restrictions can apply when mounting the terminal box.
- 14) Only available for 1MB552 (Ex tc for Zone 22). Not available for 1MB553 (Ex ec for Zone 2).
- 15) Not available for 8-pole motors, frame size 450.
- 16) Not possible in combination with order code **C02**.
- 17) Not possible in combination with order code **R50**.
- 18) Customer specifications: Voltage between 380 and 690 V (voltages outside this range are available on request), frequency, circuit, required rated power in kW.
- 19) Standard version for 1MB5.1 (Ex tb for Zone 21).

SIMOTICS XP 1MB1, 1MB5 explosion-protected motors

Article No. supplements and special versions · Accessories

Overview

Couplings for use in hazardous areas

The motor from Siemens is connected to the machine or gear unit through a coupling. Flender is an important coupling manufacturer with a wide range of products.

For standard applications, Siemens recommends that flexible couplings, types N-EUPEX and RUPEX or torsionally rigid couplings, types ARPEX and ZAPEX are used. For special applications, FLUDEX and ELPEX-S couplings are recommended. These coupling types are suitable for use in areas subject to explosion hazards and are offered with declaration of conformity and EU type-examination certificate according to Directive 2014/34/EU.

Available from:

Siemens contact partner - ordering from catalog
Siemens MD 10.1 "FLENDER Standard Couplings"

or

Flender GmbH
Kupplungswerk Mussum
Industriepark Bocholt
Schlavenhorst 100
46395 Bocholt, Germany
Phone +49 (2871) 922185
Fax +49 (2871) 922579

www.flender.com

Email: flender-kupplungen-2.pd.de@siemens.com

Taper pins according to DIN 258 with threaded ends and constant taper lengths

Taper pins are used for components that are repeatedly removed. The drilled hole is conically ground using a conical reamer until the pin can be pushed in by hand until the cone shoulder lies approx. 3 to 4 mm above the rim of the hole.

It can then be driven in using a hammer until it is correctly seated. The pin is removed from the drilled hole by screwing on the nut and tightening it.

Standardized taper pins are commercially available.

For instance, available from:

Otto Roth GmbH & Co. KG
Rutesheimer Strasse 22
70499 Stuttgart, Germany
Phone +49 711 1388-0
Fax +49 711 1388-233

www.ottoroth.de

Email: info@ottoroth.de

Foundation blocks according to DIN 799

The foundation blocks are inserted into the stone foundation and embedded in concrete. They are used for fixing machines of medium size, slide rails, pedestal bearings, base frames, etc. After the fixing bolts have been unscrewed, the machines can be shifted without them having to be lifted.

When the machine is initially installed, the foundation blocks that are bolted to the machine (without washers) and fitted with taper pins are not embedded with concrete until the machine has been fully aligned. In this case, the machine is positioned 2 to 3 mm lower. The difference in shaft height is compensated by inserting shims on final installation. The taper pins safeguard the exact position of the machine when it is repeatedly removed and replaced without the need for realignment.

Available from:

Lütgert & Co. GmbH
Postfach 42 51
33276 Gütersloh, Germany
Phone +49 5241 7407-0
Fax +49 5241 7407-90

www.luetgert-antriebe.de

Email: info@luetgert-antriebe.de

Slide rails with fixing bolts and tensioning screws according to DIN 42923

Slide rails are used to tension the belt of a machine easily and conveniently when there is no belt-tensioning pulley. They are fixed to the base using stone bolts or foundation blocks.

The assignment of slide rails to motor size can be found in DIN 42923. For motors of frame sizes 355 to 450, there are no standardized slide rails (please inquire).

Available from:

Lütgert & Co. GmbH
Postfach 42 51
33276 Gütersloh, Germany
Phone +49 5241 7407-0
Fax +49 5241 7407-90

www.luetgert-antriebe.de

Email: info@luetgert-antriebe.de

More information

Replacement motors and repair parts

- Commitment to provide replacement motors and repair parts following delivery of the motor:
 - For up to 3 years after the delivery of the original motor, in the event of total motor failure – with regard to the mounting dimensions and functions – Siemens will supply a comparable replacement motor (the type series may vary).
 - If a spare motor is supplied within the 3-year period, this does not mean that the warranty restarts.
 - Replacement motors delivered after the active production of the motor series are also identified as spare motors on the rating plate.
 - Spare parts are available only on request for these spare motors. Repair or replacement is not possible.
 - After a period of 3 years (after the delivery of the original motor), it is only possible to repair these motors (depending on the availability of the spare parts required).
 - For up to 5 years after the delivery of the original motor, spare parts will be available and for a further 5 years, Siemens will provide information about spare parts and will supply documents when required.

- When repair parts are ordered, the following details must be provided:
 - Designation and part number
 - Article No. and factory number of the motor.
- For bearing types, see Catalog Section 1 "Introduction".
- Repair parts are available for 1MB1 motors on request.
- For standard components, a commitment to supply repaired parts does not apply.
- Support hotline
 - In Germany
 - Phone +49 911 895 7 222

You will find telephone numbers for other countries on our Internet site:

www.siemens.com/automation/service&support

SIMOTICS XP 1MB1, 1MB5 explosion-protected motors

Dimensions

Notes on the dimensions

Overview

- Dimension designations according to EN 50347 and IEC 60072.

- Fits

The shaft extensions specified in the dimension tables (DIN 748) and centering spigot diameters (EN 50347) are machined with the following fits:

| Dimension designation | ISO fit DIN ISO 286-2 | |
|-----------------------|-----------------------|-----|
| D, DA | to 30 | j6 |
| | over 30 to 50 | k6 |
| | over 50 | m6 |
| N | to 250 | j6 |
| | over 250 | h6 |
| F, FA | | h9 |
| K | | H17 |
| S | flange (FF) | H17 |

The drilled holes of couplings and belt pulleys should have an ISO fit of at least H7.

- Dimensional tolerances

For the following dimension designations, the admissible deviations are given below:

| Dimension designation | Dimension | Admissible deviation |
|-----------------------|-----------|----------------------|
| H | to 250 | - 0.5 |
| | over 250 | - 1.0 |
| E, EA | | - 0.5 |

Feather keyways and feather keys (dimensions GA, GC, F and FA) are made in compliance with DIN 6885 Part 1.

- All dimensions are specified in mm.

SIMOTICS XP 1MB1, 1MB5 explosion-protected motors

Dimensions

Dimension sheet generator (within the DT Configurator)

Overview

A dimensional drawing can be created in the "Drive Technology Configurator" (DT Configurator) for every configurable motor. A dimensional drawing can be requested for every other motor.

When a complete Article No. is entered with or without order codes, a dimensional drawing can be called up under the "Documentation" tab.

These dimensional drawings can be presented in different views and sections and printed.

The corresponding dimension sheets can be exported, saved and processed further in DXF format (interchange/import format for CAD systems) or as bitmap graphics.

Online access in the Siemens Industry Mall

The "DT Configurator" is integrated into the Siemens Industry Mall and can be used on the Internet without installation.

German: www.siemens.de/dt-konfigurator
English: www.siemens.com/dt-configurator

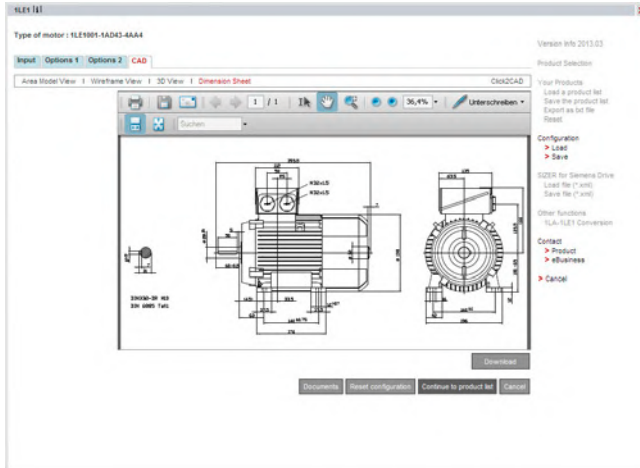

SIMOTICS XP 1MB1, 1MB5 explosion-protected motors

Dimensions · Aluminum series SIMOTICS XP

IE3 – 1MB1 with types of protection Ex tb, Ex tc, Ex ec – self-ventilated · Frame sizes 80 M to 160 L

Dimensional drawings

Type of construction IM B3

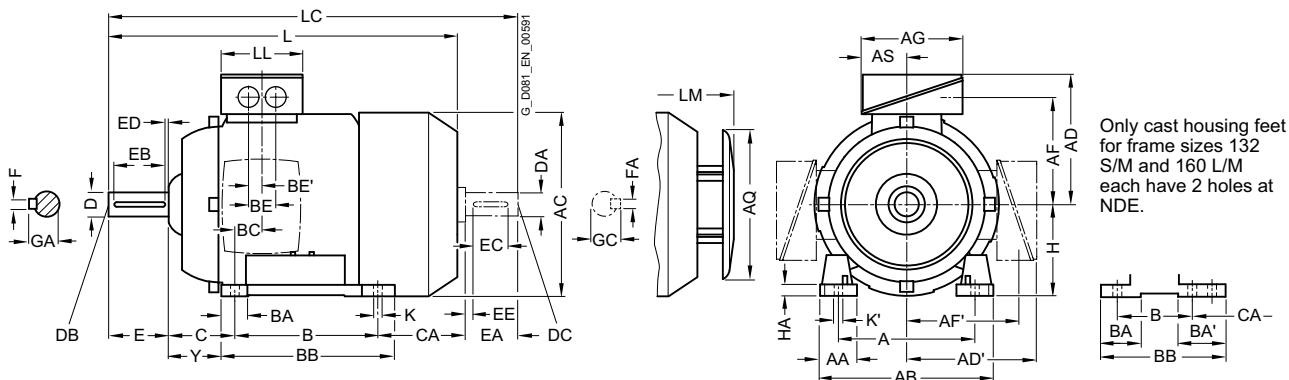

Types of construction IM B5 and IM V1

For flange dimensions, see page 1/47 (Z = the number of retaining holes)

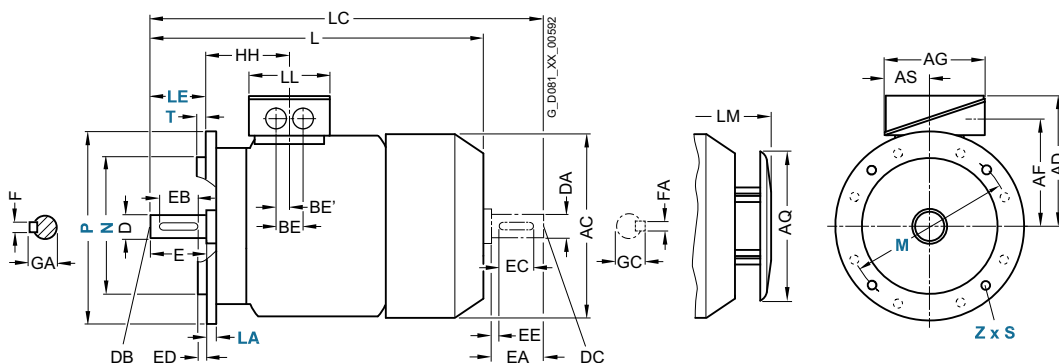

5

| For motor | | | Dimension designation acc. to IEC | | | | | | | | | | | | | | | | | | | | | | | |
|------------|--------------------------------------|---------|-----------------------------------|------|------------|-----|--------------|-------|-------|-------|-----|-----|------|-----|------|-----|-----|------|------|------|------|-------|------------|------------|----|----|
| Frame size | Motor type No. of poles | | A | AA | AB | AC | AD | AD' | AF | AF' | AG | AQ | AS | B | BA | BA' | BB | BC | BE | BE' | C | CA | H | HA | Y | |
| 80 M | 0DA2, 0DB2, 0DC3 0DA3, 0DB3, 0DC3 | 2, 4, 6 | 125 | 30.5 | 150 | 159 | 121 | 121 | 96.5 | 96.5 | 93 | 155 | 43 | 100 | 32 | 32 | 118 | 23 | 36 | 18 | 50 | 113 | 80 | 8 | 41 | |
| 90 S | All | 2, 4, 6 | 140 | 30.5 | 165 | 178 | 126 | 126 | 101.5 | 101.5 | 93 | 155 | 43 | 100 | 33 | 33 | 143 | 22.5 | 36 | 18 | 56 | 159 | 90 | 10 | 47 | |
| 90 L | All | 2, 4, 6 | 140 | 30.5 | 165 | 178 | 126 | 126 | 101.5 | 101.5 | 93 | 155 | 43 | 125 | 33 | 33 | 143 | 22.5 | 36 | 18 | 56 | 199 | 90 | 10 | 47 | |
| 100 L | All | 2, 4 | 160 | 42 | 196 | 198 | 166 | 166 | 125.5 | 125.5 | 135 | 195 | 63.5 | 140 | 37.5 | - | 176 | 33.5 | 50 | 25 | 63 | 176 | 100 | 12 | 45 | |
| 112 M | All | 2, 4 | 190 | 46 | 226 | 222 | 177 | 177 | 136.5 | 136.5 | 135 | 195 | 63.5 | 140 | 35.4 | - | 176 | 26 | 50 | 25 | 70 | 155 | 112 | 12 | 52 | |
| 132 S | 1CA0, 1CC0 | 2, 6 | 216 | 53 | 256 | 262 | 202 | 202 | 159.5 | 159.5 | 155 | 260 | 70.5 | 140 | 38 | - | 76 | 218 | 26.5 | 48 | 24 | 89 | 128.5 | 132 | 15 | 69 |
| | 1CA1, 1CB0 | 2, 4 | | | | | | | | | | | | | | | 38 | 180 | | | | 178.5 | | | | |
| 132 M | 1CC2 | 6 | 216 | 53 | 256 | 262 | 202 | 202 | 159.5 | 159.5 | 155 | 260 | 70.5 | 178 | 38 | - | 76 | 218 | 26.5 | 48 | 24 | 89 | 128.5 | 132 | 15 | 69 |
| | 1CB2, 1CC3 | 4, 6 | | | | | | | | | | | | | | | 38 | | | | | 178.5 | | | | |
| 160 M | All | 2, 4, 6 | 254 | 60 | 300 | 314 | 236.5 | 236.5 | 190 | 190 | 175 | 260 | 77.5 | 210 | 44 | - | 89 | 300 | 47 | 57 | 28.5 | 108 | 148 | 160 | 18 | 85 |
| 160 L | All | 2, 4, 6 | 254 | 60 | 300 | 314 | 236.5 | 236.5 | 190 | 190 | 175 | 260 | 77.5 | 254 | 44 | - | 300 | 47 | 57 | 28.5 | 108 | 208 | 160 | 18 | 85 | |

1) With screwed-on feet, dimension BA' is 43 mm.
 2) With screwed-on feet, dimension BB is 180 mm.
 3) With screwed-on feet, dimension BA' is 51 mm.

4) With screwed-on feet, dimension BB is 256 mm.

SIMOTICS XP 1MB1, 1MB5 explosion-protected motors

Dimensions · Aluminum series SIMOTICS XP

IE2, IE1 – 1MB1 with types of protection Ex tb, Ex tc, Ex ec – self-ventilated · Frame sizes 80 M to 160 L

Dimensional drawings

Type of construction IM B3

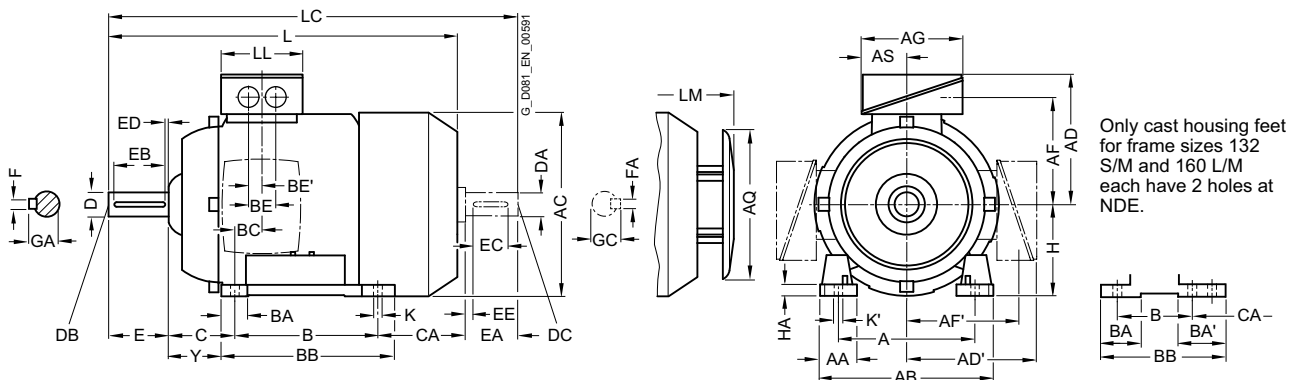

Types of construction IM B5 and IM V1

For flange dimensions, see page 1/47 (Z = the number of retaining holes)

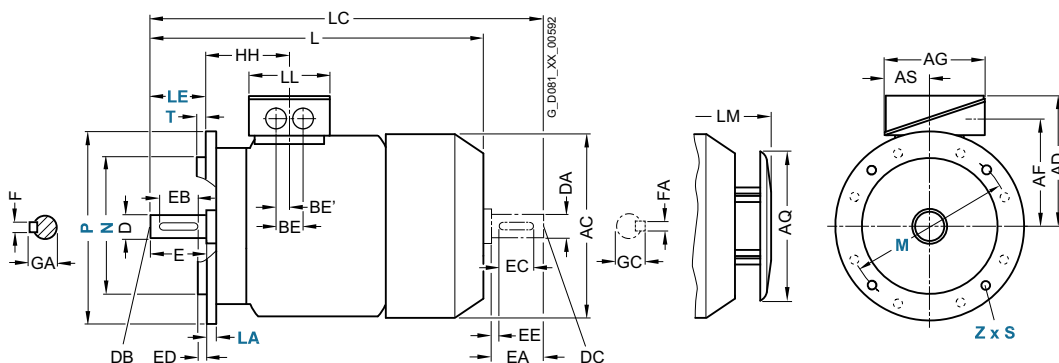

5

| For motor | | | Dimension designation acc. to IEC | | | | | | | | | | | | | | | | | | | | | | |
|------------|------------|--------------|-----------------------------------|------|------------|-----|--------------|-------|-------|-------|-------|-----|------|-----|------|------------------|-------------------|------|----|------|-----|---------------------|------------|----|----|
| Frame size | Motor type | No. of poles | A | AA | AB | AC | AD | AD' | AF | AF' | AG | AQ | AS | B | BA | BA' | BB | BC | BE | BE' | C | CA | H | HA | Y |
| 80 M | 1MB10.1 | 2, 4, 6 | 125 | 30.5 | 150 | 159 | 149 | 149 | 96.5 | 112.5 | 119.5 | 155 | 61.5 | 100 | 32 | 32 | 118 | 23 | 36 | 18 | 50 | 112.5 | 80 | 8 | 41 |
| 90 S | 1MB10.1 | 2, 4, 6 | 140 | 30.5 | 165 | 178 | 154 | 154 | 101.5 | 117.5 | 119.5 | 155 | 62.5 | 100 | 33 | 54 | 143 | 22.5 | 36 | 18 | 56 | 159 | 90 | 10 | 47 |
| 90 L | 1MB10.1 | 2, 4, 6 | 140 | 30.5 | 165 | 178 | 154 | 154 | 101.5 | 117.7 | 119.5 | 155 | 62.5 | 125 | 33 | 54 | 143 | 22.5 | 36 | 18 | 56 | 134 | 90 | 10 | 47 |
| 100 L | All | 2, 4, 6, 8 | 160 | 42 | 196 | 198 | 166 | 166 | 125.5 | 125.5 | 135 | 195 | 63.5 | 140 | 37.5 | 37.5 | 176 | 33.5 | 50 | 25 | 63 | 141 | 100 | 12 | 45 |
| 112 M | All | 2, 4, 6, 8 | 190 | 46 | 226 | 222 | 177 | 177 | 136.5 | 136.5 | 135 | 195 | 63.5 | 140 | 35.4 | 37.5 | 176 | 26 | 50 | 25 | 70 | 129.7 | 112 | 12 | 52 |
| 132 S | All | 2, 4, 6, 8 | 216 | 53 | 256 | 262 | 202 | 202 | 159.5 | 159.5 | 155 | 260 | 70.5 | 140 | 38 | 76 ¹⁾ | 218 ²⁾ | 26.5 | 48 | 24 | 89 | 128.5 ³⁾ | 132 | 15 | 69 |
| 132 M | All | 2, 4, 6, 8 | 216 | 53 | 256 | 262 | 202 | 202 | 159.5 | 159.5 | 155 | 260 | 70.5 | 178 | 38 | 76 | 218 | 26.5 | 48 | 24 | 89 | 128.5 ³⁾ | 132 | 15 | 69 |
| 160 M | All | 2, 4, 6, 8 | 254 | 60 | 300 | 314 | 236.5 | 236.5 | 190 | 190 | 175 | 260 | 77.5 | 210 | 44 | 89 ⁴⁾ | 300 ⁵⁾ | 47 | 57 | 28.5 | 108 | 148 ⁶⁾ | 160 | 18 | 85 |
| 160 L | All | 2, 4, 6, 8 | 254 | 60 | 300 | 314 | 236.5 | 236.5 | 190 | 190 | 175 | 260 | 77.5 | 254 | 44 | 89 | 300 | 47 | 57 | 28.5 | 108 | 148 ⁶⁾ | 160 | 18 | 85 |

1) With screwed-on feet, dimension BA' is 38 mm.
 2) With screwed-on feet, dimension BB is 180 mm.
 3) With screwed-on feet, dimension CA is 166.5 mm.
 4) With screwed-on feet, dimension BA' is 44 mm.

5) With screwed-on feet, dimension BB is 256 mm.
 6) With screwed-on feet, dimension CA is 192 mm.

SIMOTICS XP 1MB1, 1MB5 explosion-protected motors

Dimensions · Aluminum series SIMOTICS XP

IE2, IE1 – 1MB1 with types of protection Ex tb, Ex tc, Ex ec – self-ventilated · Frame sizes 80 M to 160 L

Dimensional drawings

Type of construction IM B35

For flange dimensions, see page 1/47 (Z = the number of retaining holes)

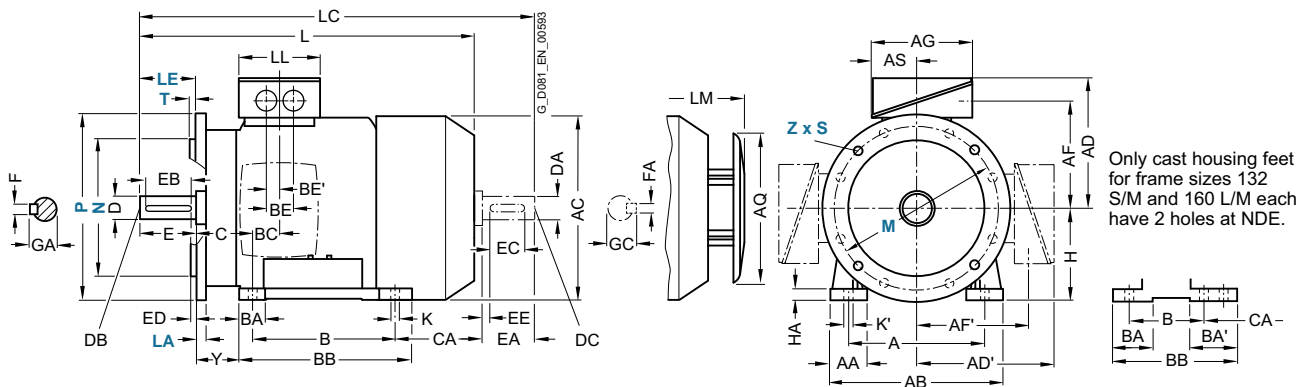

Type of construction IM B14

For flange dimensions, see page 1/47 (Z = the number of retaining holes)

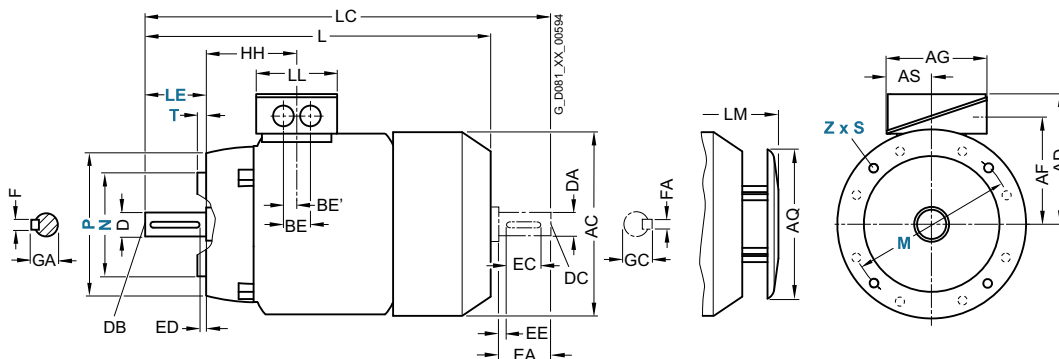

| For motor Frame size | Motor type 1MB10.1, 1MB10.2 | No. of poles | Dimension designation acc. to IEC | | | | | | DE shaft extension | | | | | | NDE shaft extension | | | | | | | | |
|-------------------------|-----------------------------------|-----------------|-----------------------------------|-----|------|--------------|-------|-----|--------------------|----|-----|-----|----|----|---------------------|------|----|-----|-----|----|----|----|------|
| | | | HH | K | K' | L | LC | LL | LM | D | DB | E | EB | ED | F | GA | DA | DC | EA | EC | EE | FA | GC |
| 80 M | 1MB10.1 | 2, 4, 6 | 73 | 9.5 | 13.5 | 253 | 342.5 | 123 | 328 | 19 | M6 | 40 | 32 | 4 | 6 | 21.5 | 19 | M6 | 40 | 32 | 4 | 6 | 21.5 |
| 90 S/L | 1MB10.1 | 2, 4, 6 | 78.5 | 10 | 14 | 294.5 | 405 | 123 | 383 | 24 | M8 | 50 | 40 | 5 | 8 | 27 | 19 | M6 | 40 | 32 | 4 | 6 | 21.5 |
| 90 L | 1MB10.1 | 2, 4, 6 | 78.5 | 10 | 14 | 294.5 | 405 | 123 | 383 | 24 | M8 | 50 | 40 | 5 | 8 | 27 | 19 | M6 | 40 | 32 | 4 | 6 | 21.5 |
| 100 L | All | 2, 4, 6, 8 | 96.5 | 12 | 16 | 388.5 | 454 | 112 | 428.5 | 28 | M10 | 60 | 50 | 5 | 8 | 31 | 24 | M8 | 50 | 40 | 5 | 8 | 27 |
| 112 M | All | 2, 4, 6, 8 | 96 | 12 | 16 | 382 | 450 | 112 | 422 | 28 | M10 | 60 | 50 | 5 | 8 | 31 | 24 | M8 | 50 | 40 | 5 | 8 | 27 |
| 132 S | All | 2, 4, 6, 8 | 115.5 | 12 | 16 | 456.5 | 535.5 | 130 | 516.5 | 38 | M12 | 80 | 70 | 5 | 10 | 41 | 28 | M10 | 60 | 50 | 5 | 8 | 31 |
| 132 M | All | 2, 4, 6, 8 | 115.5 | 12 | 16 | 456.5 | 535.5 | 130 | 516.5 | 38 | M12 | 80 | 70 | 5 | 10 | 41 | 28 | M10 | 60 | 50 | 5 | 8 | 31 |
| 160 M | All | 2, 4, 6, 8 | 155 | 15 | 19 | 594 | 730 | 145 | 654 | 42 | M16 | 110 | 90 | 10 | 12 | 45 | 42 | M16 | 110 | 90 | 10 | 12 | 45 |
| 160 L | All | 2, 4, 6, 8 | 155 | 15 | 19 | 594 | 730 | 145 | 654 | 42 | M16 | 110 | 90 | 10 | 12 | 45 | 42 | M16 | 110 | 90 | 10 | 12 | 45 |

SIMOTICS XP 1MB1, 1MB5 explosion-protected motors

Dimensions · Cast-iron series SIMOTICS XP

IE4, IE3 – 1MB5 with types of protection Ex tb, Ex tc, Ex ec – self-ventilated · Frame sizes 400 and 450

Dimensional drawings

Type of construction IM B3

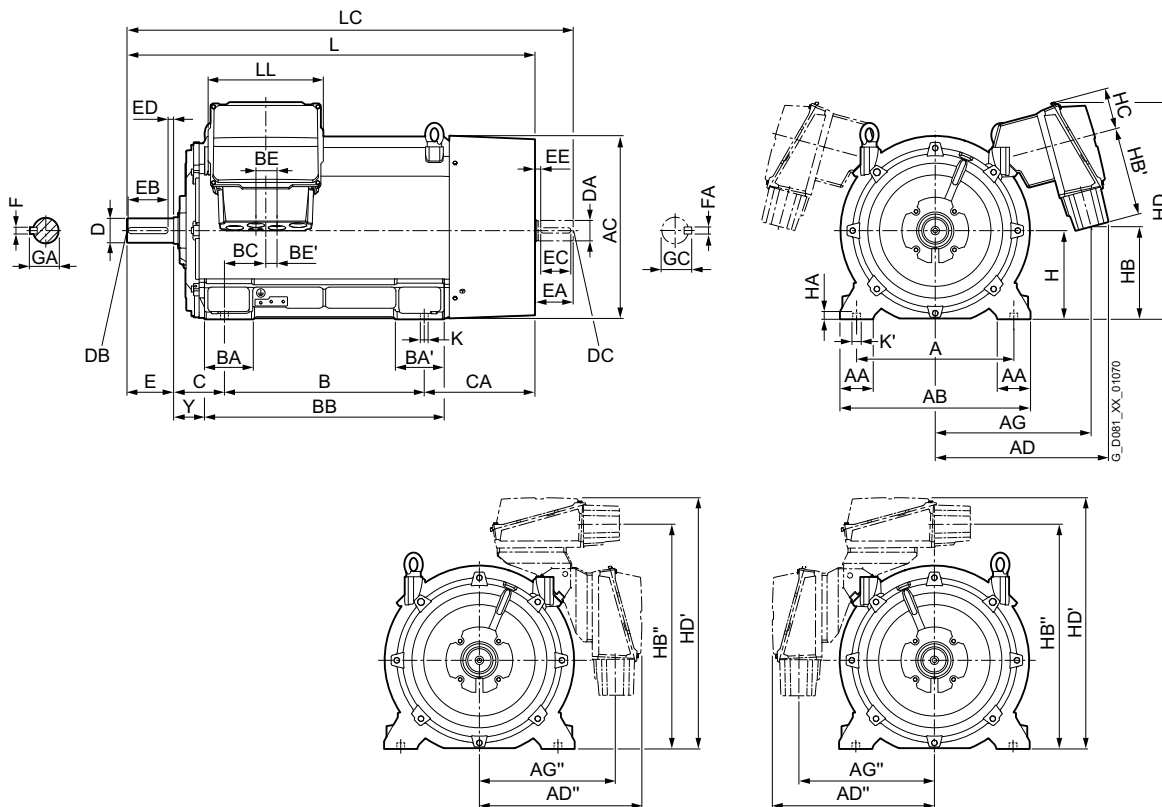

5

Types of construction IM B5 and IM V1

For flange dimensions, see page 1/47 (Z = the number of retaining holes)

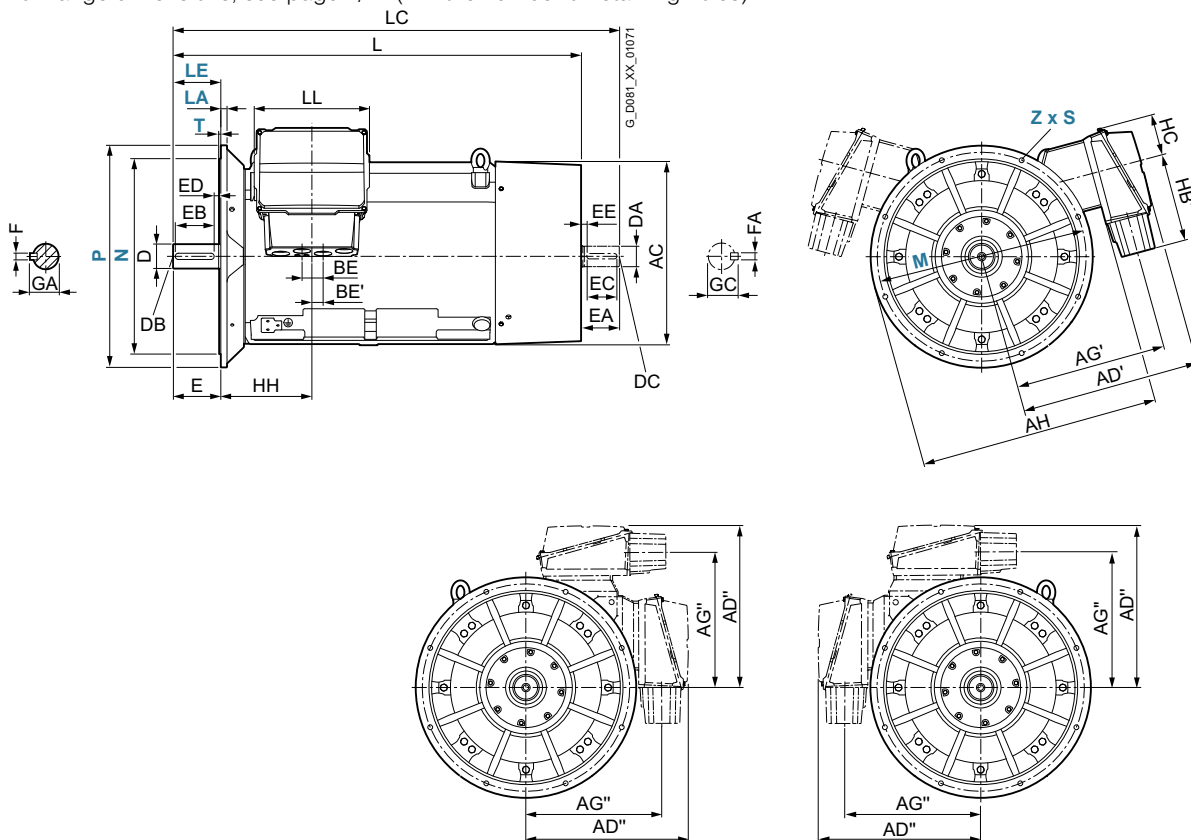

SIMOTICS XP 1MB1, 1MB5 explosion-protected motors

Dimensions · Cast-iron series SIMOTICS XP

IE4, IE3 – 1MB5 with types of protection Ex tb, Ex tc, Ex ec – self-ventilated · Frame sizes 400 and 450

Dimensional drawings

Type of construction IM B35

For flange dimensions, see page 1/47 (Z = the number of retaining holes)

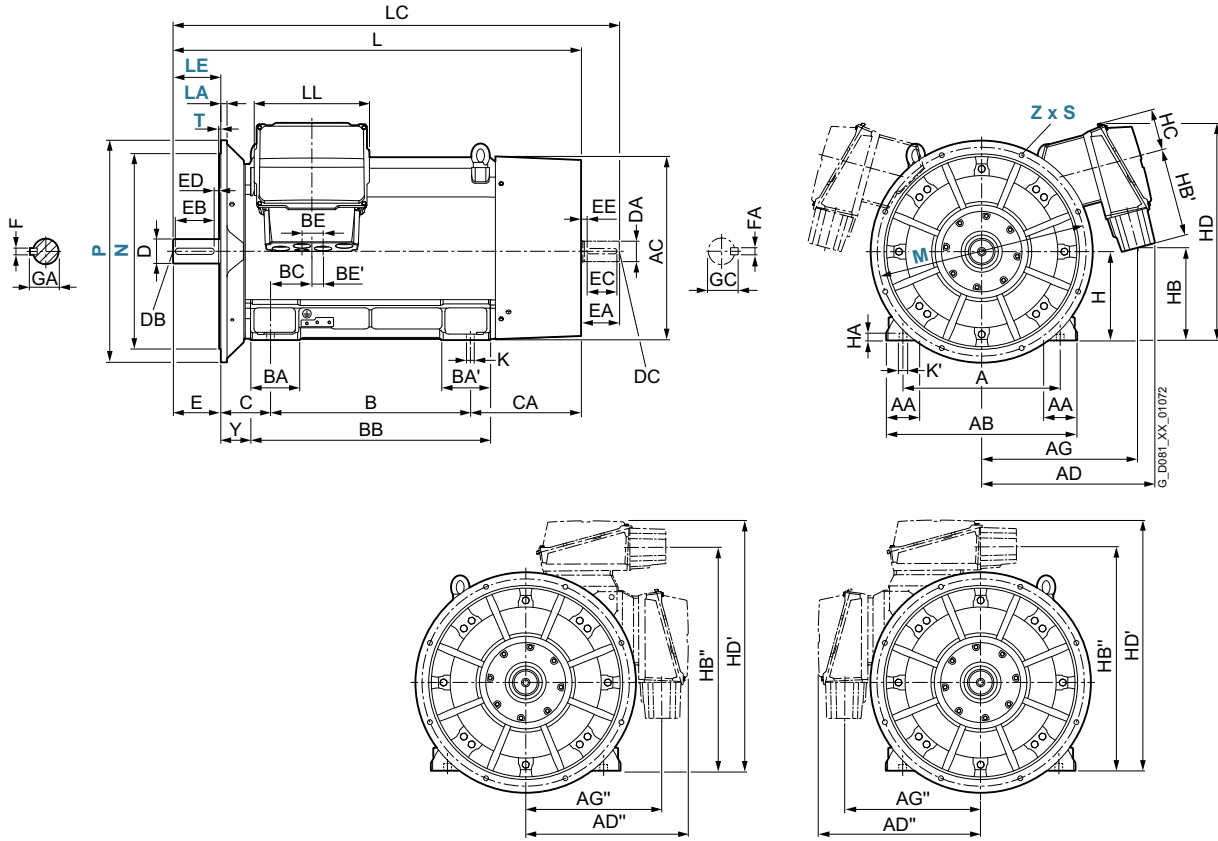

| For motor | | Dimension designation acc. to IEC | | | | | | | | | | | | | | | | | | | | | | | | | | | |
|------------|----------------------------------|-----------------------------------|-----|-----|-----|-----|-----|-----|------|-----|-----|------|------|------|----|-----|-----|-----|------|-----|------|------|-----|-----|---|---|-----|----|-----|
| Frame size | Motor type 1MB5.2- 1MB5.3- | No. of poles | A | AA | AB | AC | AD | AD' | AD'' | AG | AG' | AG'' | AH | B | B' | B'' | BA | BA' | BB | BC | BE | BE' | C | CA | C | C | H | H | HB |
| | | | | | | | | | | | | | | | | | | | | | | | | | | | | | |
| 400 | 4AA | 2 | 710 | 150 | 860 | 880 | 785 | 845 | 740 | 705 | 720 | 620 | 1110 | 900 | - | - | 220 | 220 | 1080 | 186 | 87.5 | 43.5 | 224 | 501 | - | - | 400 | 35 | 420 |
| | 4AB | 4 | | | | | | | | | | | | | | | | | | | | | | | | | | | |
| | 4AC | 6 | | | | | | | | | | | | | | | | | | | | | | | | | | | |
| | 4AD | 8 | | | | | | | | | | | | | | | | | | | | | | | | | | | |
| 450 | 4BA | 2 | 800 | 180 | 980 | 970 | 820 | 895 | 775 | 740 | 770 | 655 | 1235 | 1000 | - | - | 260 | 260 | 1220 | 170 | 87.5 | 43.5 | 250 | 535 | - | - | 450 | 42 | 505 |
| | 4BB | 4 | | | | | | | | | | | | | | | | | | | | | | | | | | | |
| | 4BC | 6 | | | | | | | | | | | | | | | | | | | | | | | | | | | |
| | 4BD | 8 | | | | | | | | | | | | | | | | | | | | | | | | | | | |

| For motor | | Dimension designation acc. to IEC | | | | | | | | | | | | | DE shaft extension | | | | NDE shaft extension | | | | | | | | | |
|------------|----------------------------------|-----------------------------------|-----|------|-----|------|------|-----|-----|----|----|------|------------------|-----|--------------------|-----|-----|-----|---------------------|-----|-----|-----|-----|-----|-----|----|-----|------|
| Frame size | Motor type 1MB5.2- 1MB5.3- | No. of poles | HB' | HB'' | HC | HD | HD' | HH | Y | K | K' | L | LC ¹⁾ | LL | D | DB | E | EB | ED | F | GA | DA | DC | EA | EC | EE | FA | GC |
| 400 | 4AA | 2 | 400 | 1020 | 190 | 980 | 1140 | 410 | 134 | 35 | 42 | 1795 | 1940 | 519 | 80 | M20 | 170 | 140 | 25 | 22 | 85 | 70 | M20 | 140 | 125 | 10 | 20 | 74.5 |
| | 4AB | 4 | | | | | | | | | | 1835 | 2010 | | 110 | M24 | 210 | 180 | 28 | 116 | 90 | M24 | 170 | 140 | 25 | 25 | 95 | |
| | 4AC | 6 | | | | | | | | | | | | | | | | | | | | | | | | | | |
| | 4AD | 8 | | | | | | | | | | | | | | | | | | | | | | | | | | |
| 450 | 4BA | 2 | 400 | 1105 | 190 | 1065 | 1225 | 420 | 140 | 42 | 50 | 1955 | 2100 | 519 | 90 | M24 | 170 | 140 | 25 | 25 | 95 | 75 | M20 | 140 | 125 | 10 | 20 | 79.5 |
| | 4BB | 4 | | | | | | | | | | 1995 | 2210 | | 120 | | 210 | 180 | 32 | 127 | 100 | M24 | 210 | 180 | 25 | 28 | 106 | |
| | 4BC | 6 | | | | | | | | | | | | | | | | | | | | | | | | | | |
| | 4BD | 8 | | | | | | | | | | | | | | | | | | | | | | | | | | |

¹⁾ In the low-noise version, a second shaft extension and/or mounted encoder is not possible.

SIMOTICS XP 1MB1, 1MB5 explosion-protected motors

Dimensions · Cast-iron series SIMOTICS XP

IE3 – 1MB1 with types of protection Ex tb, Ex tc, Ex ec – self-ventilated · Frame sizes 71 M to 160 L

Dimensional drawings

Type of construction IM B35

For flange dimensions, see page 1/47 (**Z** = the number of retaining holes)

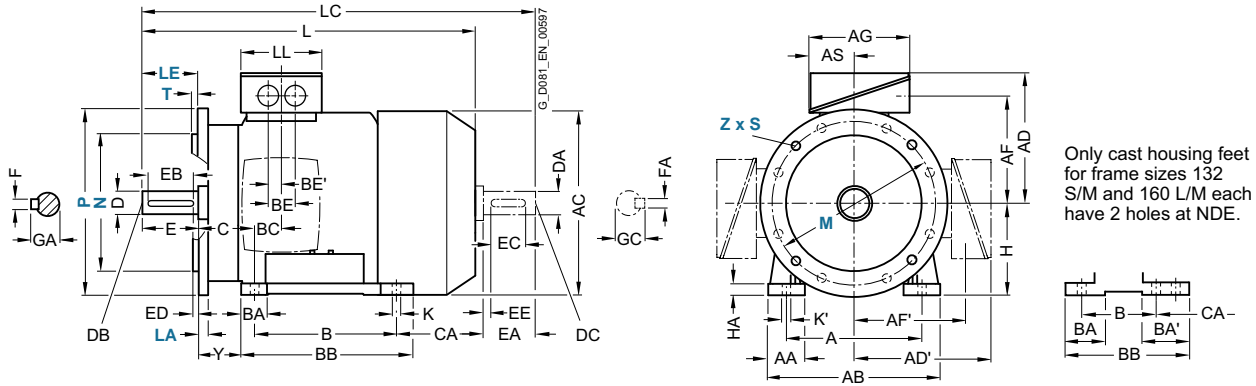

Only cast housing feet for frame sizes 132 S/M and 160 L/M each have 2 holes at NDE.

Type of construction IM B14

For flange dimensions, see page 1/47 (**Z** = the number of retaining holes)

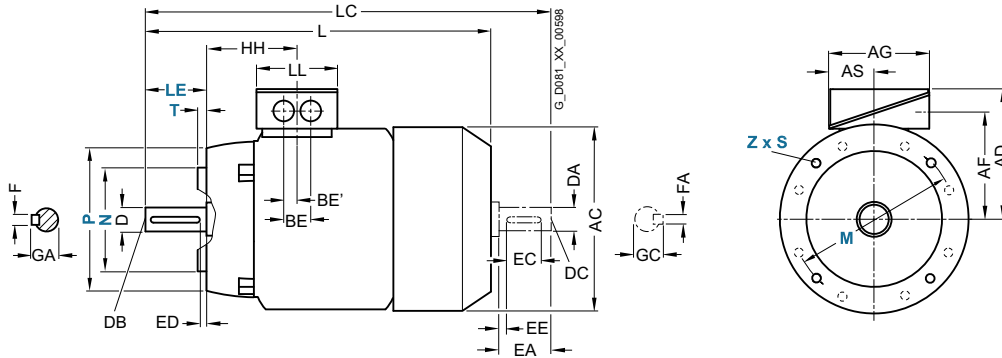

| Frame size | Motor type | No. of poles | Dimension designation acc. to IEC | | | | | | DE shaft extension | | | NDE shaft extension | | | | | | | | | | |
|------------|------------------|--------------|-----------------------------------|-----|------|--------------|-------|-----|--------------------|-----|-----|---------------------|----|----|------|----|-----|-----|----|----|----|------|
| | | | HH | K | K' | L | LC | LL | D | DB | E | EB | ED | F | GA | DA | DC | EA | EC | EE | FA | GC |
| 71 M | 0CA2, 0CB2, 0CC2 | 2, 4, 6 | 63 | 7.5 | 7.5 | 240 | 278 | 102 | 14 | M5 | 30 | 22 | 4 | 5 | 16 | 14 | M5 | 30 | 22 | 4 | 5 | 16 |
| | 0CA3, 0CB3, 0CC3 | | 70 | | | 280 | 318 | | | | | | | | | | | | | | | |
| 80 M | 0DA2, 0DB2, 0DC2 | 2, 4, 6 | 72.5 | 10 | 13.5 | 292 | 342.5 | 102 | 19 | M6 | 40 | 32 | 4 | 6 | 21.5 | 19 | M6 | 40 | 32 | 4 | 6 | 21.5 |
| | 0DA3, 0DB3, 0DC3 | | | | | 327 | 377.5 | | | | | | | | | | | | | | | |
| 90 S | All | 2, 4, 6 | 80.5 | 10 | 10 | 347 | 405 | 102 | 24 | M8 | 50 | 40 | 5 | 8 | 27 | 24 | M8 | 50 | 40 | 5 | 8 | 27 |
| 90 L | All | 2, 4, 6 | 80.5 | 10 | 10 | 387 | 445 | 102 | 24 | M8 | 50 | 40 | 5 | 8 | 27 | 24 | M8 | 50 | 40 | 5 | 8 | 27 |
| 100 L | All | 2, 4, 6 | 100.5 | 12 | 16 | 418 | 489 | 134 | 28 | M10 | 60 | 50 | 5 | 8 | 31 | 24 | M8 | 50 | 40 | 5 | 8 | 27 |
| 112 M | All | 2, 4, 6 | 100.5 | 12 | 16 | 402 | 475 | 134 | 28 | M10 | 60 | 50 | 5 | 8 | 31 | 24 | M8 | 50 | 40 | 5 | 8 | 27 |
| | 1CA0, 1CC0 | 2, 6 | 115.5 | 12 | 16 | 449.5 | 536 | 134 | 38 | M12 | 80 | 70 | 5 | 10 | 41 | 28 | M10 | 60 | 50 | 5 | 8 | 31 |
| 132 S | 1CA1, 1CB0 | 2, 4 | | | | 499.5 | 586 | | | | | | | | | | | | | | | |
| | 1CC2 | 6 | 115.5 | 12 | 16 | 449.5 | 536 | 134 | 38 | M12 | 80 | 70 | 5 | 10 | 41 | 28 | M10 | 60 | 50 | 5 | 8 | 31 |
| 132 M | 1CB2, 1CC3 | 4, 6 | | | | 499.5 | 586 | | | | | | | | | | | | | | | |
| | All | 2, 4, 6 | 145 | 15 | 19 | 586 | 730 | 165 | 42 | M16 | 110 | 90 | 10 | 12 | 45 | 42 | M16 | 110 | 90 | 10 | 12 | 45 |
| 160 L | All | 2, 4, 6 | 145 | 15 | 19 | 646 | 790 | 165 | 42 | M16 | 110 | 90 | 10 | 12 | 45 | 42 | M16 | 110 | 90 | 10 | 12 | 45 |

SIMOTICS XP 1MB1, 1MB5 explosion-protected motors

Dimensions · Cast-iron series SIMOTICS XP

IE3 – 1MB1 with types of protection Ex tb, Ex tc, Ex ec – self-ventilated · Frame sizes 180 M to 315 L

Dimensional drawings

Type of construction IM B3

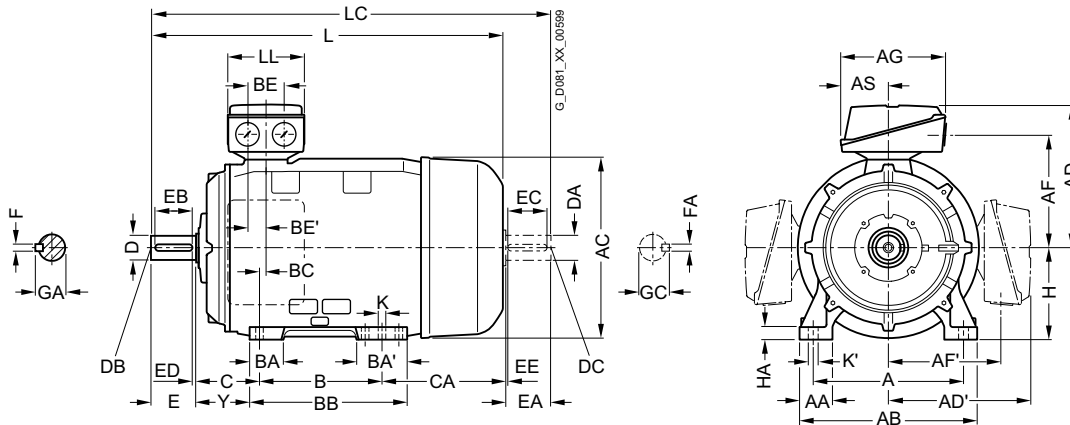

Types of construction IM B5 and IM V1

For flange dimensions, see page 1/47 (Z = the number of retaining holes)

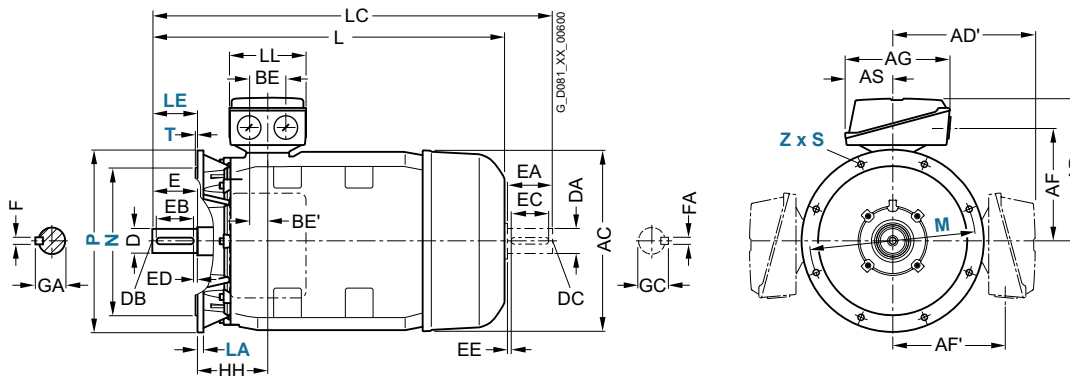

5

| For motor | | | Dimension designation acc. to IEC | | | | | | | | | | | | | | | | | | | |
|------------|------------------|--------------|-----------------------------------|-----|------------|-----|------------|-----|-----|-----|-----|-----|-----|-----|-----|-----|-----|----|-----|------|-----|-----|
| Frame size | Motor type | No. of poles | A | AA | AB | AC | AD | AD' | AF | AF' | AG | AH | AS | B | BA | BA' | BB | BC | BE | BE' | C | CA |
| 180 M | 1EA2 | 2 | 279 | 65 | 339 | 356 | 286 | 286 | 234 | 234 | 190 | 468 | 92 | 241 | 85 | 120 | 328 | 34 | 60 | 30 | 121 | 202 |
| | 1EB2 | 4 | | | | | | | | | | | | | | | | | | | | |
| 180 L | 1EB4 | 4 | 279 | 65 | 339 | 356 | 286 | 286 | 234 | 234 | 190 | 468 | 92 | 279 | 85 | 120 | 328 | 34 | 60 | 30 | 121 | 202 |
| | 1EC4 | 6 | | | | | | | | | | | | | | | | | | | | |
| 200 L | 2AA4, 2AC4 | 2, 6 | 318 | 60 | 378 | 396 | 315 | 315 | 259 | 259 | 266 | 533 | 112 | 305 | 104 | 104 | 355 | 31 | 85 | 42.5 | 133 | 177 |
| | 2AA5, 2AB5, 2AC5 | 2, 4, 6 | | | | | | | | | | | | | | | | | | | | |
| 225 S | 2BB0 | 4 | 356 | 80 | 436 | 449 | 338 | 338 | 282 | 282 | 266 | 556 | 112 | 286 | 92 | 117 | 361 | 15 | 85 | 42.5 | 149 | 218 |
| 225 M | 2BA2 | 2 | 356 | 80 | 436 | 449 | 338 | 338 | 282 | 282 | 266 | 556 | 112 | 311 | 92 | 117 | 361 | 15 | 85 | 42.5 | 149 | 253 |
| | 2BB2, 2BC2 | 4, 6 | | | | | | | | | | | | | | | | | | | | |
| 250 M | 2CA2 | 2 | 406 | 100 | 490 | 497 | 410 | 410 | 322 | 322 | 319 | 620 | 145 | 349 | 102 | 102 | 409 | 24 | 110 | 55 | 168 | 230 |
| | 2CB2, 2CC2 | 4, 6 | | | | | | | | | | | | | | | | | | | | |
| 280 S | 2DA0 | 2 | 457 | 100 | 540 | 551 | 433 | 433 | 345 | 345 | 319 | 672 | 145 | 368 | 101 | 152 | 479 | 20 | 110 | 55 | 190 | 267 |
| | 2DB0, 2DC0 | 4, 6 | | | | | | | | | | | | | | | | | | | | |
| 280 M | 2DA2 | 2 | 457 | 100 | 540 | 551 | 433 | 433 | 345 | 345 | 319 | 672 | 145 | 419 | 101 | 152 | 479 | 20 | 110 | 55 | 190 | 326 |
| | 2DB2 | 4 | | | | | | | | | | | | | | | | | | | | |
| | 2DC2 | 6 | | | | | | | | | | | | | | | | | | | | 216 |
| 315 S | 3AA0 | 2 | 508 | 120 | 610 | 616 | 515 | 515 | 404 | 404 | 374 | 780 | 164 | 406 | 113 | 170 | 527 | 22 | 110 | 55 | 216 | 295 |
| | 3AB0, 3AC0 | 4, 6 | | | | | | | | | | | | | | | | | | | | |
| 315 M | 3AA2 | 2 | 508 | 120 | 610 | 616 | 515 | 515 | 404 | 404 | 374 | 780 | 164 | 457 | 113 | 170 | 578 | 22 | 110 | 55 | 216 | 409 |
| | 3AB2, 3AC2 | 4, 6 | | | | | | | | | | | | | | | | | | | | |
| 315 L | 3AA4 | 2 | 508 | 120 | 610 | 616 | 515 | 515 | 404 | 404 | 374 | 780 | 164 | 508 | 113 | 170 | 578 | 22 | 110 | 55 | 216 | 358 |
| | 3AB4, 3AC4 | 4, 6 | | | | | | | | | | | | | | | | | | | | |
| | 3AA5 | 2 | | | | | | | | | | | | 176 | 227 | 648 | | | | | | 513 |
| | 3AB5, 3AC5, 3AC6 | 4, 6 | | | | | | | | | | | | | | | | | | | | |

SIMOTICS XP 1MB1, 1MB5 explosion-protected motors

Dimensions · Cast-iron series SIMOTICS XP

IE3 – 1MB1 with types of protection Ex tb, Ex tc, Ex ec – self-ventilated · Frame sizes 180 M to 315 L

Dimensional drawings

Type of construction IM B35

For flange dimensions, see page 1/47 (Z = the number of retaining holes)

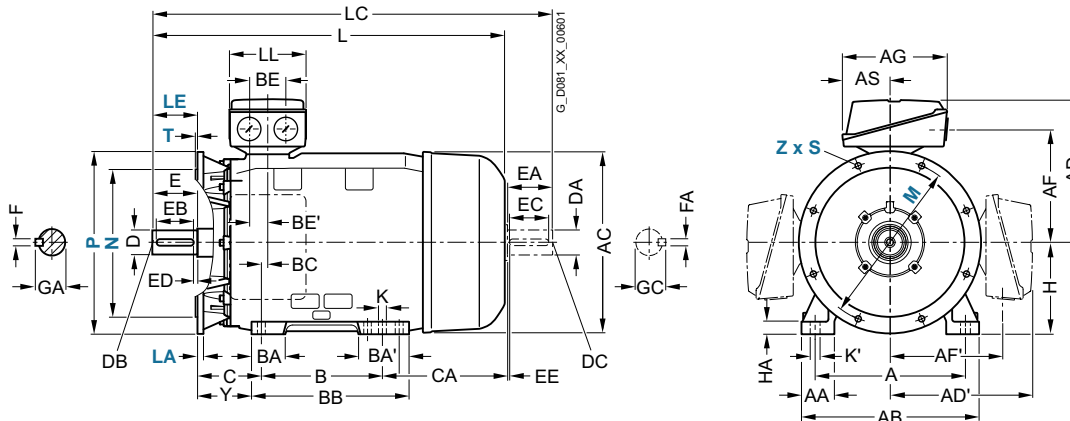

| For motor | | | Dimension designation acc. to IEC | | | | | | | DE shaft extension | | | | | NDE shaft extension | | | | | | | | | | | |
|------------|------------------|--------------|-----------------------------------|----|-----|-----|----|----|-------------|--------------------|------------------|-----|----|-----|---------------------|-----|----|----|------|----|-----|-----|-----|----|----|------|
| Frame size | Motor type | No. of poles | H | HA | Y | HH | K | K' | L | L' ¹⁾ | LC ²⁾ | LL | D | DB | E | EB | ED | F | GA | DA | DC | EA | EC | EE | FA | GC |
| 180 M | 1EA2 | 2 | 180 | 20 | 95 | 155 | 15 | 19 | 698 | 698 | 814 | 165 | 48 | M16 | 110 | 100 | 5 | 14 | 52 | 48 | M16 | 110 | 100 | 5 | 14 | 51.5 |
| | 1EB2 | 4 | | | | | | | 668 | 668 | 784 | | | | | | | | | | | | | | | |
| 180 L | 1EB4 | 4 | 180 | 20 | 95 | 155 | 15 | 19 | 698 | 698 | 814 | 165 | 48 | M16 | 110 | 100 | 5 | 14 | 52 | 48 | M16 | 110 | 100 | 5 | 14 | 51.5 |
| | 1EC4 | 6 | | | | | | | 668 | 668 | 784 | | | | | | | | | | | | | | | |
| 200 L | 2AA4, 2AC4 | 2, 6 | 200 | 25 | 108 | 164 | 19 | 25 | 721 | 755 | 835 | 197 | 55 | M20 | 110 | 100 | 5 | 16 | 59 | 55 | M20 | 110 | 100 | 5 | 16 | 59 |
| | 2AA5, 2AB5, 2AC5 | 2, 4, 6 | | | | | | | 746 | 780 | 860 | | | | | | | | | | | | | | | |
| 225 S | 2BB0 | 4 | 225 | 34 | 124 | 164 | 19 | 25 | 788 | – | 903 | 197 | 60 | M20 | 140 | 125 | 10 | 18 | 64 | 55 | M20 | 110 | 100 | 5 | 16 | 59 |
| 225 M | 2BA2 | 2 | 225 | 34 | 124 | 164 | 19 | 25 | 818 | 852 | 933 | 197 | 55 | M20 | 110 | 100 | 5 | 16 | 59 | 48 | M16 | 110 | 100 | 5 | 14 | 51.5 |
| | 2BB2, 2BC2 | 4, 6 | | | | | | | 848 | – | 963 | 60 | | | 140 | 125 | 10 | 18 | 64 | 55 | M20 | | | | 16 | 59 |
| 250 M | 2CA2 | 2 | 250 | 40 | 138 | 192 | 24 | 30 | 887 | 924 | 1002 | 233 | 60 | M20 | 140 | 125 | 10 | 18 | 64 | 55 | M20 | 110 | 100 | 5 | 16 | 59 |
| | 2CB2, 2CC2 | 4, 6 | | | | | | | – | 1032 | 65 | | | | | | | | 69 | 60 | | 140 | 125 | 10 | 18 | 64 |
| 280 S | 2DA0 | 2 | 280 | 40 | 160 | 210 | 24 | 30 | 960 | 998 | 1105 | 233 | 65 | M20 | 140 | 125 | 10 | 18 | 69 | 60 | M20 | 140 | 125 | 10 | 18 | 64 |
| | 2DB0, 2DC0 | 4, 6 | | | | | | | – | – | 75 | | | | | | | 20 | 79.5 | 65 | | | | | 69 | |
| 280 M | 2DA2 | 2 | 280 | 40 | 160 | 210 | 24 | 30 | 1070 | 1108 | 1105 | 233 | 65 | M20 | 140 | 125 | 10 | 18 | 69 | 60 | M20 | 140 | 125 | 10 | 18 | 64 |
| | 2DB2 | 4 | | | | | | | – | – | 1215 | 75 | | | | | | 20 | 79.5 | 65 | | | | | 69 | |
| | 2DC2 | 6 | | | | | | | 960 | | | | | | | | | | | | | | | | | |
| 315 S | 3AA0 | 2 | 315 | 50 | 181 | 238 | 28 | 35 | 1052 | 1122 | 1197 | 299 | 65 | M20 | 140 | 125 | 10 | 18 | 69 | 60 | M20 | 140 | 125 | 10 | 18 | 64 |
| | 3AB0, 3AC0 | 4, 6 | | | | | | | 1082 | – | 1227 | 80 | | | 170 | 140 | 25 | 22 | 85 | 70 | | | | | 20 | 74.5 |
| 315 M | 3AA2 | 2 | 315 | 50 | 181 | 238 | 28 | 35 | 1217 | 1287 | 1362 | 299 | 65 | M20 | 140 | 125 | 10 | 18 | 69 | 60 | M20 | 140 | 125 | 10 | 18 | 64 |
| | 3AB2, 3AC2 | 4, 6 | | | | | | | 1247 | – | 1392 | 80 | | | 170 | 140 | 25 | 22 | 85 | 70 | | | | | 20 | 74.5 |
| 315 L | 3AA4 | 2 | 315 | 50 | 181 | 238 | 28 | 35 | 1217 | 1287 | 1362 | 299 | 65 | M20 | 140 | 125 | 10 | 18 | 69 | 60 | M20 | 140 | 125 | 10 | 18 | 64 |
| | 3AB4, 3AC4 | 4, 6 | | | | | | | 1247 | – | 1392 | 80 | | | 170 | 140 | 25 | 22 | 85 | 70 | | | | | 20 | 74.5 |
| | 3AA5 | 2 | | | 146 | | | | 1372 | 1442 | 1517 | 65 | | | 140 | 125 | 10 | 18 | 69 | 60 | | | | | 18 | 64 |
| | 3AB5, 3AC5, 3AC6 | 4, 6 | | | | | | | 1402 | – | 1547 | 80 | | | 170 | 140 | 25 | 22 | 85 | 70 | | | | | 20 | 74.5 |

SIMOTICS XP 1MB1, 1MB5 explosion-protected motors

Dimensions · Cast-iron series SIMOTICS XP

IE3 – 1MB1 with type of protection Ex eb – self-ventilated · Frame sizes 71 M to 160 L

Dimensional drawings

Type of construction IM B3

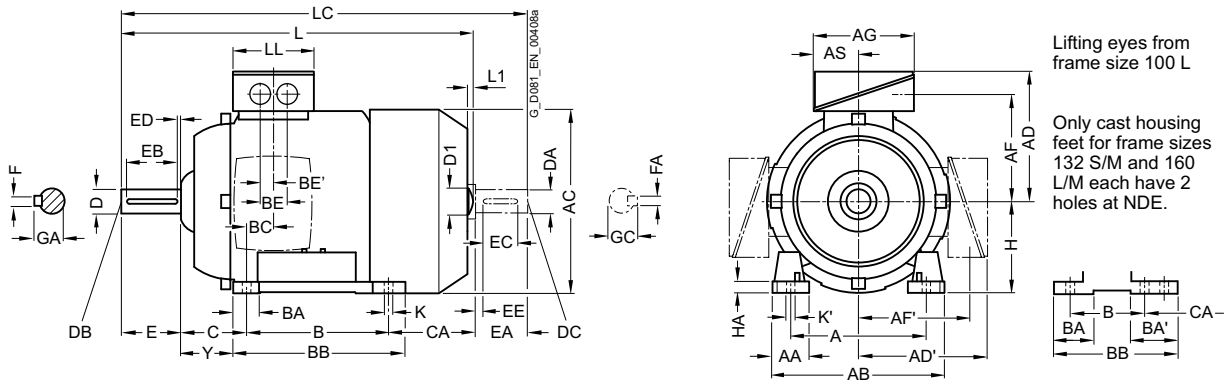

Types of construction IM B5 and IM V1

For flange dimensions, see page 1/47 (Z = the number of retaining holes)

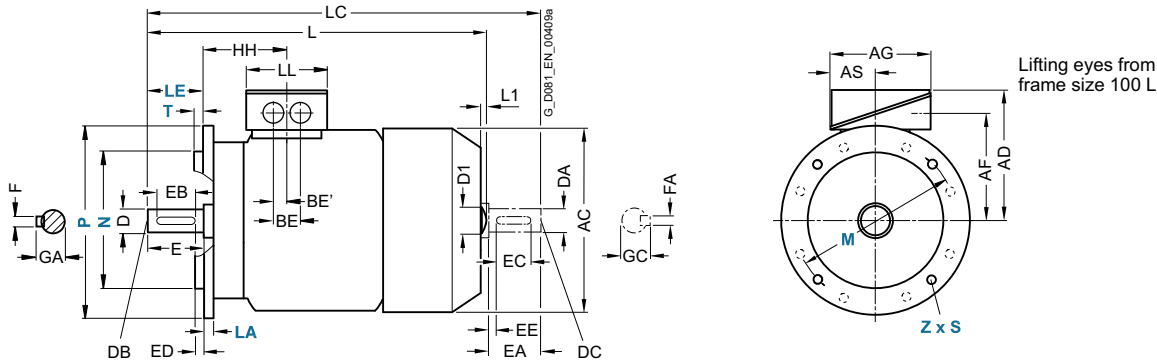

5

| For motor | | | Dimension designation acc. to IEC | | | | | | | | | | | | | | | | | | | | | |
|------------|--------------------------|--------------|-----------------------------------|------|------------|-------|--------------|-------|-----|-----|-----|------|-----|----|-------------------|-------------------|------|----|-----|-----|----------------|------------|----|----|
| Frame size | Motor type | No. of poles | A | AA | AB | AC | AD | AD' | AF | AF' | AG | AS | B | BA | BA' | BB | BC | BE | BE' | C | CA | H | HA | Y |
| 71 M | OC.2 OC.3 | 2, 4, 6 | 112 | 30.5 | 132 | 145 | 173 | 173 | 129 | 129 | 163 | 80.5 | 90 | 32 | 32 | 106 | 21 | 48 | 24 | 45 | 83 | 71 | 7 | 37 |
| 80 M | OD.2 OD.3 | 2, 4, 6 | 125 | 30.5 | 150 | 162 | 183 | 183 | 139 | 139 | 163 | 80.5 | 100 | 32 | 32 | 118 | 22.5 | 48 | 24 | 50 | 112.5 | 80 | 8 | 41 |
| 90 S | OE.0 | 2, 4, 6 | 140 | 30.5 | 165 | 180 | 188 | 188 | 144 | 144 | 163 | 80.5 | 100 | 33 | 54 | 143 | 24.5 | 48 | 24 | 56 | 159 | 90 | 11 | 47 |
| 90 L | OE.4 | 2, 4, 6 | 140 | 30.5 | 165 | 180 | 188 | 188 | 144 | 144 | 163 | 80.5 | 125 | 33 | 54 | 143 | 24.5 | 48 | 24 | 56 | 134 | 90 | 11 | 47 |
| 100 L | All | 2, 4, 6 | 160 | 42 | 196 | 217 | 193 | 193 | 147 | 147 | 163 | 80.5 | 140 | 48 | 48 | 176 | 37.5 | 48 | 24 | 63 | 141 | 100 | 12 | 45 |
| 112 M | All | 2, 4, 6 | 190 | 46 | 226 | 239 | 195 | 195 | 150 | 150 | 163 | 80.5 | 140 | 48 | 48 | 176 | 30 | 48 | 24 | 70 | 130 | 112 | 12 | 52 |
| 132 S | 1CA0, 1CC0 1CA1, 1CB0 | 2, 6 2, 4 | 216 | 53 | 256 | 281 | 214.5 | 214.5 | 169 | 169 | 163 | 80.5 | 140 | 52 | 89 ¹⁾ | 218 ²⁾ | 26.5 | 48 | 24 | 89 | 128.5 178.5 | 132 | 15 | 69 |
| 132 M | 1CC2 1CB2, 1CC3 | 6 4, 6 | 216 | 53 | 256 | 281 | 214.5 | 214.5 | 169 | 169 | 163 | 80.5 | 178 | 52 | 89 ¹⁾ | 218 | 26.5 | 48 | 24 | 89 | 128.5 178.5 | 132 | 15 | 69 |
| 160 M | All | 2, 4, 6 | 254 | 60 | 300 | 333.5 | 261 | 261 | 213 | 213 | 190 | 92 | 210 | 73 | 117 ³⁾ | 300 ⁴⁾ | 37 | 60 | 30 | 108 | 192 | 160 | 18 | 85 |
| 160 L | All | 2, 4, 6 | 254 | 60 | 300 | 333.5 | 261 | 261 | 213 | 213 | 190 | 92 | 254 | 73 | 117 ³⁾ | 300 | 37 | 60 | 30 | 108 | 208 | 160 | 18 | 85 |

1) With screwed-on feet, dimension BA' is 43 mm.
 2) With screwed-on feet, dimension BB is 180 mm.
 3) With screwed-on feet, dimension BA' is 51 mm.
 4) With screwed-on feet, dimension BB is 256 mm.

SIMOTICS XP 1MB1, 1MB5 explosion-protected motors

Dimensions · Cast-iron series SIMOTICS XP

IE3 – 1MB1 with type of protection Ex eb – self-ventilated · Frame sizes 71 M to 160 L

Dimensional drawings

Type of construction IM B35

For flange dimensions, see page 1/47 (Z = the number of retaining holes)

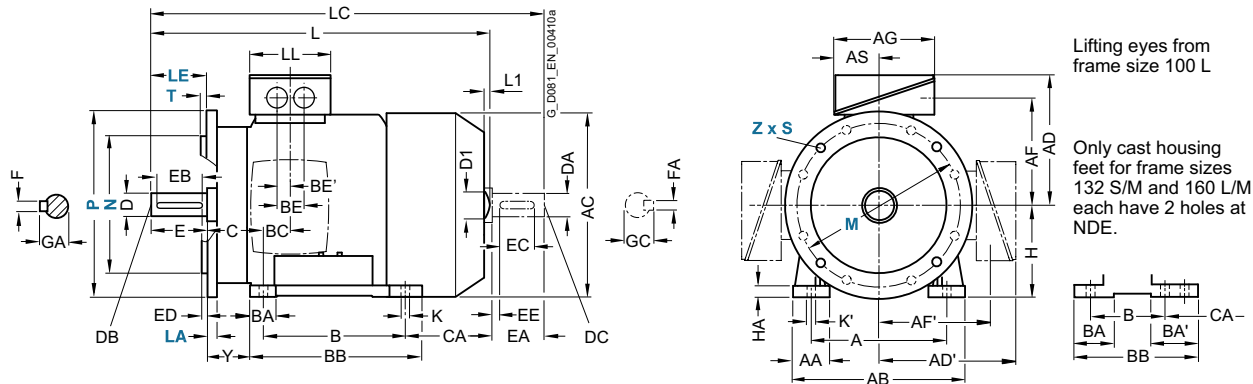

Type of construction IM B14

For flange dimensions, see page 1/47 (Z = the number of retaining holes)

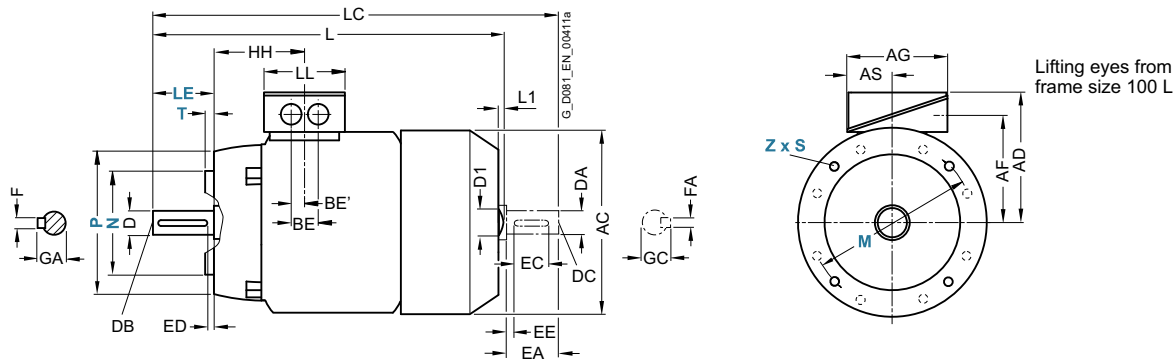

| For motor | | | Dimension designation acc. to IEC | | | | | | | DE shaft extension | | | | | NDE shaft extension | | | | | | | | | |
|------------|--------------------------|--------------|-----------------------------------|------|-----|--------------------------|----|----|-------|--------------------|----|-----|-----|----|---------------------|----|------|----|-----|-----|----|----|----|------|
| Frame size | Motor type | No. of poles | HH | K | K' | L ¹⁾ | L1 | D1 | LC | LL | D | DB | E | EB | ED | F | GA | DA | DC | EA | EC | EE | FA | GC |
| 71 M | 0C.2 0C.3 | 2, 4, 6 | 64.5 | 7.5 | 7.5 | 240 280 | - | - | 278 | 134 | 14 | M5 | 30 | 22 | 4 | 5 | 16 | 14 | M5 | 30 | 22 | 4 | 5 | 16 |
| 80 M | 0D.2 0D.3 | 2, 4, 6 | 71.5 | 10 | 10 | 292 327 | - | - | 318 | 134 | 19 | M6 | 40 | 32 | 4 | 6 | 21.5 | 19 | M6 | 40 | 32 | 4 | 6 | 21.5 |
| 90 S | 0E.0 | 2, 4, 6 | 79.5 | 10 | 10 | 347 | - | - | 343 | 134 | 24 | M8 | 50 | 40 | 5 | 8 | 27 | 19 | M6 | 50 | 40 | 5 | 8 | 21.5 |
| 90 L | 0E.4 | 2, 4, 6 | 79.5 | 10 | 10 | 387 | - | - | 378 | 134 | 24 | M8 | 50 | 40 | 5 | 8 | 27 | 19 | M6 | 50 | 40 | 5 | 8 | 21.5 |
| 100 L | All | 2, 4, 6 | 100.5 | 12 | 16 | 425.5 | - | 32 | 405 | 134 | 28 | M10 | M10 | 50 | 5 | 8 | 31 | 24 | M8 | M10 | 50 | 5 | 8 | 27 |
| 112 M | All | 2, 4, 6 | 100.5 | 12 | 16 | 408.5 | - | 32 | 445 | 134 | 28 | M10 | 60 | 50 | 5 | 8 | 31 | 24 | M8 | 60 | 50 | 5 | 8 | 27 |
| 132 S | 1CA0, 1CC0 1CA1, 1CB0 | 2, 6 2, 4 | 115.5 | 12 | 16 | 458 | - | 39 | 489 | 134 | 38 | M12 | 80 | 70 | 5 | 10 | 41 | 28 | M10 | 80 | 70 | 5 | 10 | 31 |
| 132 M | 1CC2 1CB2, 1CC3 | 6 4, 6 | 115.5 | 12 | 16 | 508 | - | 39 | 342.5 | 134 | 38 | M12 | 80 | 70 | 5 | 10 | 41 | 28 | M10 | 80 | 70 | 5 | 10 | 31 |
| 160 M | All | 2, 4, 6 | 145 | 14.5 | 18 | 596 | - | 45 | 475 | 165 | 42 | M16 | 110 | 90 | 10 | 12 | 45 | 42 | M16 | 110 | 90 | 10 | 12 | 45 |
| 160 L | All | 2, 4, 6 | 145 | 14.5 | 18 | 656 | - | 45 | 535.5 | 165 | 42 | M16 | 110 | 90 | 10 | 12 | 45 | 42 | M16 | 110 | 90 | 10 | 12 | 45 |

1) For 1MB1643 motors less dimension L1.

2) Only for 1MB1543 motors.

SIMOTICS XP 1MB1, 1MB5 explosion-protected motors

Dimensions · Cast-iron series SIMOTICS XP

IE3 – 1MB1 with type of protection Ex eb – self-ventilated · Frame sizes 180 M to 280 M

Dimensional drawings

Type of construction IM B3

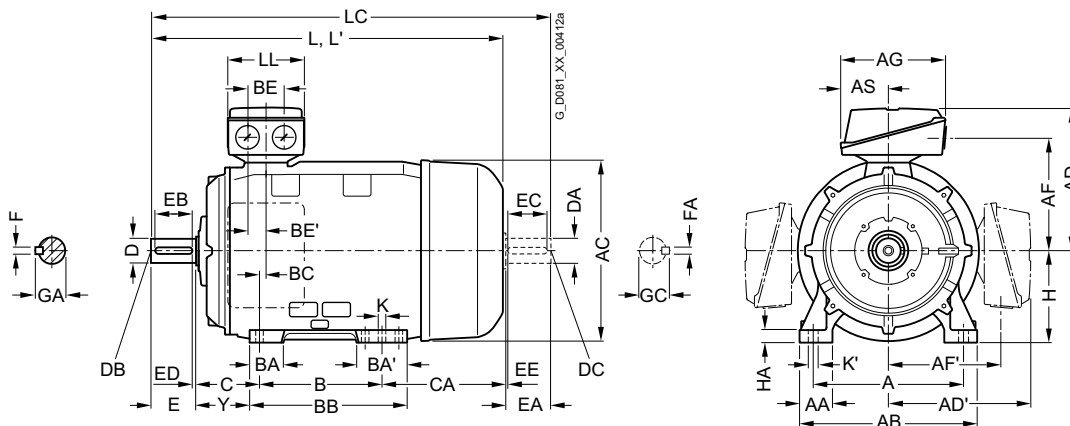

Types of construction IM B5 and IM V1

For flange dimensions, see page 1/47 (Z = the number of retaining holes)

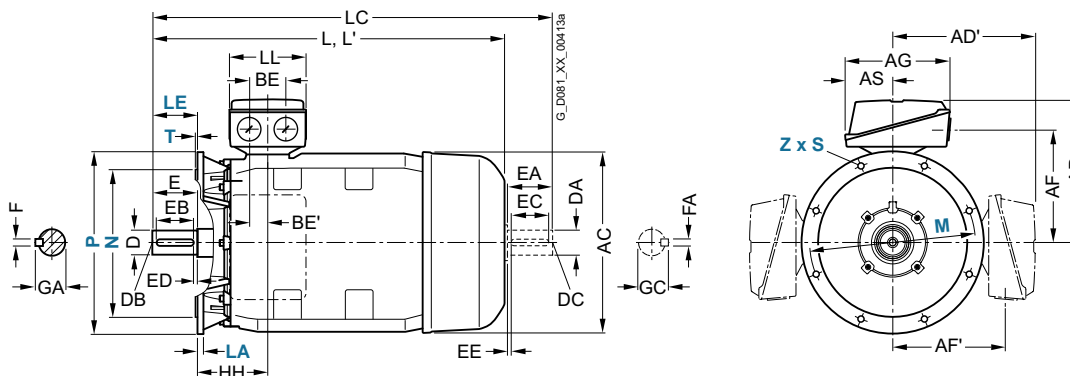

5

| For motor | Frame size | Motor type | No. of poles | Dimension designation acc. to IEC | | | | | | | | | | | | | | | | | |
|-------------|--------------------------------|-----------------|--------------|-----------------------------------|-----|------------|-----|------------|-----|-----|-----|-----|-----|-----|-----|-----|-----|----|----|-----|---|
| | | | | A | AA | AB | AC | AD | AD' | AF | AF' | AG | AS | B | BA | BA' | BB | BC | BE | BE' | C |
| 180 M/180 L | 1EA2, 1EB4 1EB2, 1EC4 | 2, 4 4, 6 | | 279 | 65 | 339 | 356 | 286 | 286 | 234 | 234 | 190 | 92 | 241 | 85 | 120 | 328 | 34 | | | |
| 200 L | 2AA4, 2AC4 2AA5, 2AB5, 2AC5 | 2, 6 2, 4, 6 | | 318 | 70 | 378 | 396 | 315 | 315 | 259 | 259 | 266 | 112 | 305 | 104 | 104 | 355 | 31 | | | |
| 225 S | 2BB0 | 4 | | 356 | 80 | 436 | 449 | 338 | 338 | 282 | 282 | 265 | 112 | 286 | 93 | 118 | 361 | 15 | | | |
| 225 M | 2BA2 2BB2, 2BC2 | 2 4, 6 | | | | | | | | | | | | 311 | | | | | | | |
| 250 M | 2CA2 2CB2, 2CC2 | 2 4, 6 | | 406 | 100 | 490 | 497 | 410 | 410 | 322 | 322 | 319 | 145 | 349 | 102 | 102 | 409 | 24 | | | |
| 280 S | 2DA0 2DB0, 2DC0 | 2 4, 6 | | 457 | 100 | 540 | 551 | 433 | 433 | 345 | 345 | 319 | 145 | 368 | 101 | 152 | 479 | 20 | | | |
| 280 M | 2DA2 2DB2 2DC2 | 2 4 6 | | | | | | | | | | | | 419 | | | | | | | |

SIMOTICS XP 1MB1, 1MB5 explosion-protected motors

Dimensions · Cast-iron series SIMOTICS XP

IE3 – 1MB1 with type of protection Ex eb – self-ventilated · Frame sizes 180 M to 280 M

Dimensional drawings

Type of construction IM B35

For flange dimensions, see page 1/47 (Z = the number of retaining holes)

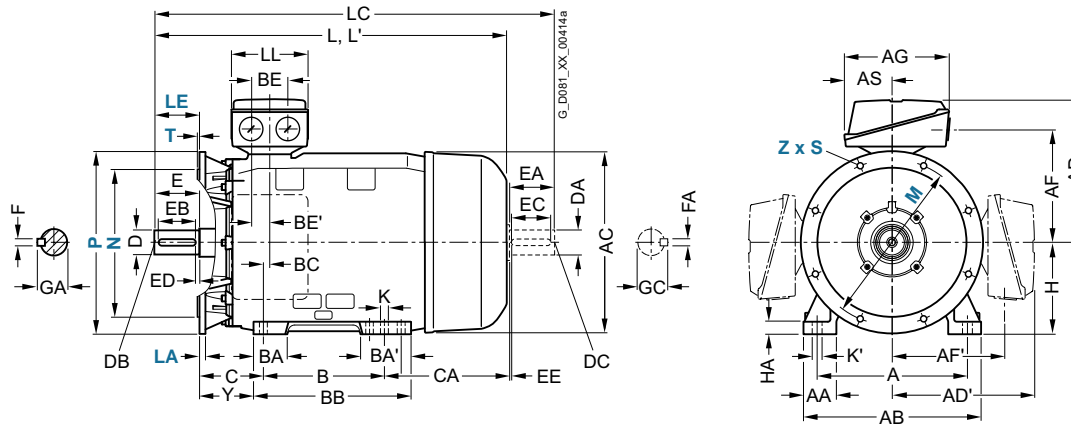

| For motor Frame size | Motor type | No. of poles | Dimension designation acc. to IEC | | | | | | | | DE shaft extension | | | | | | NDE shaft extension | | | | | | | | |
|-------------------------|---|--------------|-----------------------------------|----|-----|-----|----|----|---------------------------|------------------|--------------------|----------|-----|------------|------------|---------|---------------------|------------|------------|------------|------------|------------|----------|----------|------------|
| | | | H | HA | Y | HH | K | K' | L | LC ¹⁾ | LL | D | DB | E | EB | ED | F | GA | DA | DC | EA | EC | EE | FA | GC |
| 180 M/ 180 L | 1EA2, 1EB4 1EB2, 1EC4 | 2, 4 | 180 | 20 | 95 | 155 | 15 | 19 | 698 668 | 814 784 | 164 | 48 | M16 | 110 | 100 | 5 | 14 | 51.5 | 48 | M16 | 110 | 100 | 5 | 14 | 51.5 |
| 200 L | 2AA4, 2AC4 2AA5, 2AB5, 2, 4, 6 2AC5 | 2, 6 | 200 | 25 | 108 | 164 | 19 | 25 | 721 746 | 835 860 | 197 | 55 | M20 | 110 | 100 | 5 | 16 | 59 | 55 | M20 | 110 | 100 | 5 | 16 | 59 |
| 225 S | 2BB0 | 4 | 225 | 34 | 124 | 164 | 19 | 25 | 788 | 963 | 197 | 60 | M20 | 140 | 125 | 10 | 18 | 64 | 55 | M20 | 175 | 100 | 70 | 16 | 59 |
| 225 M | 2BA2 2BB2, 2BC2 | 2 4, 6 | | | | | | | 818 928 | 993 1103 | | 55 60 | | 110 140 | 100 125 | 5 10 | 16 18 | 59 64 | 48 55 | M16 M20 | | | | 14 16 | 51.5 59 |
| 250 M | 2CA2 2CB2, 2CC2 | 2 4, 6 | 250 | 40 | 138 | 192 | 24 | 30 | 887 957 | 1062 1162 | 233 | 60 65 | M20 | 140 | 125 | 10 | 18 | 64 69 | 55 60 | M20 | 175 205 | 100 125 | 70 75 | 16 18 | 59 64 |
| 280 S | 2DA0 2DB0, 2DC0 | 2 4, 6 | 280 | 40 | 160 | 210 | 24 | 30 | 960 | 1170 | 233 | 65 75 | M20 | 140 | 125 | 10 | 18 20 | 69 79.5 | 60 65 | M20 | 210 | 125 | 80 | 18 | 64 69 |
| 280 M | 2DA2 2DB2 2DC2 | 6 2 4 | | | | | | | 1070 960 | 1280 1170 | | 65 75 | | | | | | 18 20 | 69 79.5 | 60 65 | | | | 64 69 | 69 |

¹⁾ In the low-noise version, a second shaft extension and/or mounted encoder is not possible.

SIMOTICS XP 1MB1, 1MB5 explosion-protected motors

Dimensions · Cast-iron series SIMOTICS XP

IE3 – 1MB5 with type of protection Ex eb – self-ventilated · Frame sizes 315 S to 315 L

Dimensional drawings

Type of construction IM B3

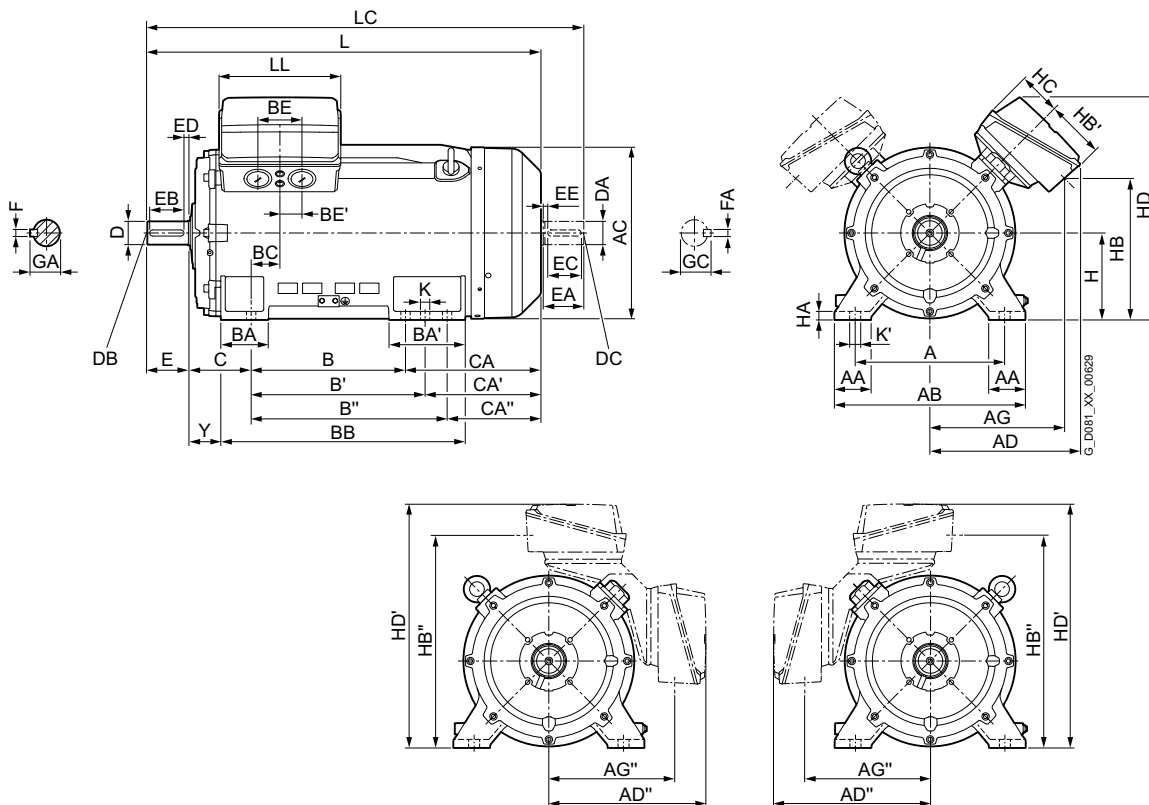

5

Types of construction IM B5 and IM V1

For flange dimensions, see page 1/47 (Z = the number of retaining holes)

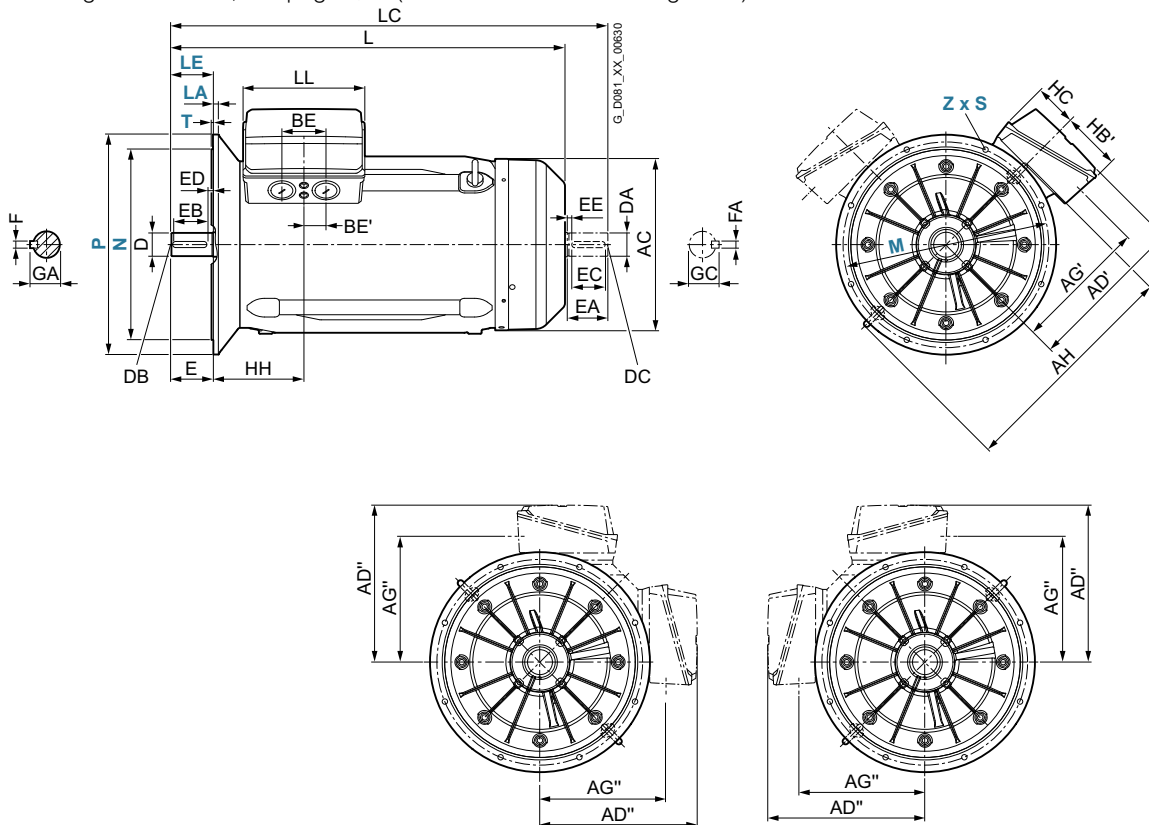

SIMOTICS XP 1MB1, 1MB5 explosion-protected motors

Dimensions · Cast-iron series SIMOTICS XP

IE3 – 1MB5 with type of protection Ex eb – self-ventilated · Frame sizes 315 S to 315 L

Dimensional drawings

Type of construction IM B35

For flange dimensions, see page 1/47 (Z = the number of retaining holes)

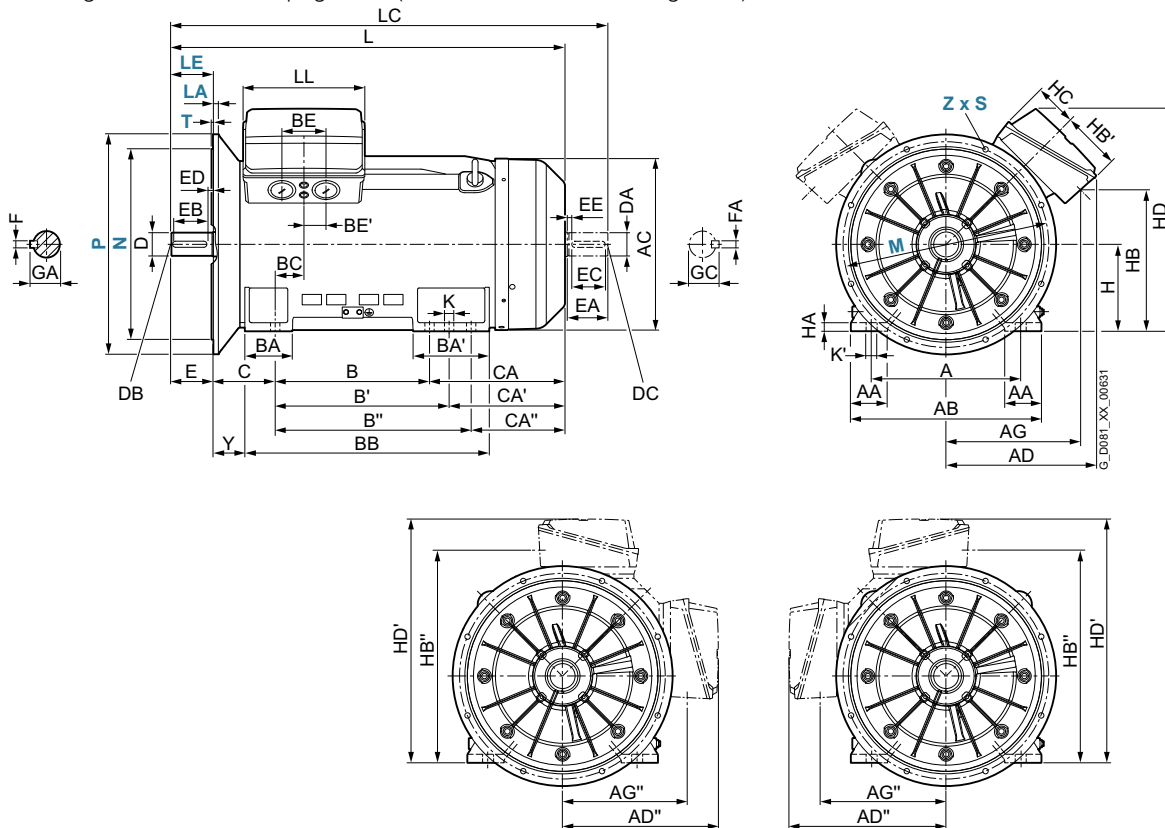

| For motor | | Dimension designation acc. to IEC | | | | | | | | | | | | | | | | | | | | | | | | | |
|------------|--|-----------------------------------|-----|-----|------------|-----|------------|-----|------|-----|-----|------|-----|-----|-----|-----|-----|-----|-----|-----|------|-----|-----|-----|------------|----|-----|
| Frame size | Motor type | No. of poles | A | AA | AB | AC | AD | AD' | AD'' | AG | AG' | AG'' | AH | B | B' | BA | BA' | BB | BC | BE | BE' | C | CA | CA' | H | HA | HB |
| 315 S/M | 3AA0, 3AA2 | 2 | 508 | 120 | 610 | 641 | 543 | 565 | 540 | 491 | 480 | 481 | 660 | 406 | 457 | 176 | 227 | 570 | 139 | 135 | 67.5 | 216 | 370 | 319 | 315 | 50 | 491 |
| | 3AB0, 3AB2, 3AC0, 3AC2 | 4, 6 | | | | | | | | | | | | | | 177 | 226 | | | | | | | | | | |
| | 3AA4, 3AA5, 3AB4, 3AB5, 3AC4, 3AC5, 3AC6 | 2, 4, 6 | 508 | 120 | 610 | 641 | 543 | 565 | 540 | 491 | 480 | 481 | 660 | 457 | 508 | 176 | 227 | 648 | 139 | 135 | 67.5 | 216 | 469 | 418 | 315 | 50 | 491 |

| For motor | | Dimension designation acc. to IEC | | | | | | | | | | | DE shaft extension | | | | NDE shaft extension | | | | | | | | | | | |
|------------|--|-----------------------------------|-----|------|-----|-----|-----|-----|-----|----|----|-------------|--------------------|-----|----|-----|---------------------|-----|----|----|----|----|-----|-----|-----|----|----|----|
| Frame size | Motor type | No. of poles | HB' | HB'' | HC | HD | HD' | HH | Y | K | K' | L | LC ¹⁾ | LL | D | DB | E | EB | ED | F | GA | DA | DC | EA | EC | EE | FA | GC |
| 315 S/M | 3AA0, 3AA2 | 2 | 225 | 796 | 167 | 800 | 880 | 355 | 146 | 28 | 35 | 1132 | 1277 | 327 | 65 | M20 | 140 | 125 | 10 | 18 | 69 | 60 | M20 | 140 | 125 | 80 | 18 | 64 |
| | 3AB0, 3AB2, 3AC0, 3AC2 | 4, 6 | | | | | | | | | | 1162 | 1307 | | 80 | M20 | 170 | 140 | 25 | 22 | 85 | 70 | | | | | 20 | 74 |
| | 3AA0, 3AA2, 3AB4, 3AB5, 3AC4, 3AC5, 3AC6 | 2, 4, 6 | 225 | 796 | 167 | 800 | 880 | 355 | 146 | 28 | 35 | 1282 | 1427 | 327 | 65 | M20 | 140 | 125 | 10 | 18 | 69 | 60 | M20 | 140 | 125 | 80 | 18 | 64 |
| | | | | | | | | | | | | 1312 | 1457 | | 80 | | | | | | | | | | | | | |

¹⁾ In the low-noise version, a second shaft extension and/or mounted encoder is not possible.

SIMOTICS XP 1MB1, 1MB5 explosion-protected motors

Dimensions · Cast-iron series SIMOTICS XP

IE3 – 1MB1 with types of protection Ex db, Ex db eb – self-ventilated · Frame sizes 71 M to 160 L

Dimensional drawings

Type of construction IM B3

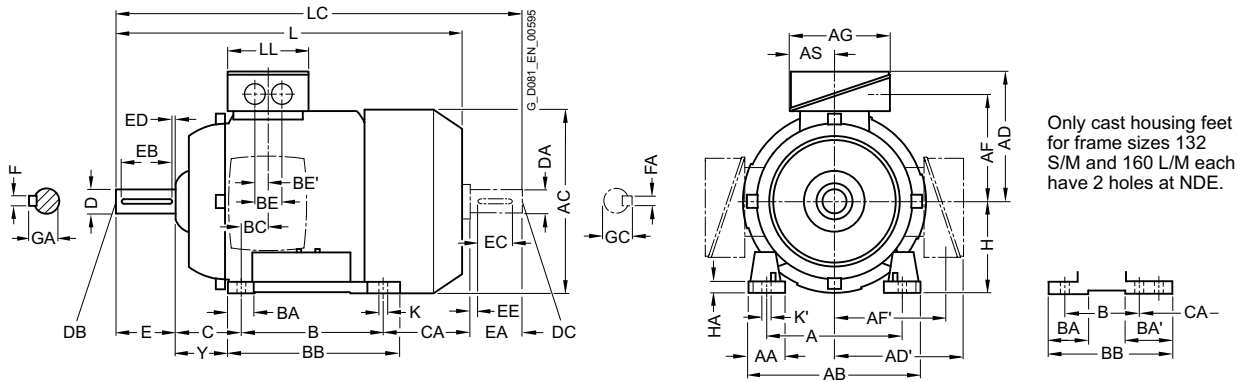

Types of construction IM B5 and IM V1

For flange dimensions, see page 1/47 (Z = the number of retaining holes)

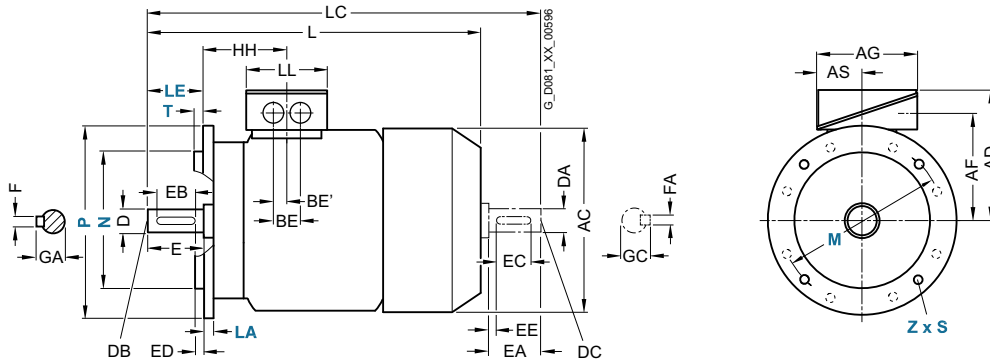

5

| For motor | | Dimension designation acc. to IEC | | | | | | | | | | | | | | | | | | | | | | |
|------------|------------|-----------------------------------|-----|----|-----|-----|-----|-----|-----|-----|-----|----|-----|----|-----|-----|-------|----|-----|-----|-------|-----|----|------|
| Frame size | Motor type | No. of poles | A | AA | AB | AC | AD | AD' | AF | AF' | AG | AS | B | BA | BA' | BB | BC | BE | BE' | C | CA | H | HA | Y |
| 71 M | All | 2, 4, 6, 8 | 112 | 25 | 140 | 169 | 240 | - | 195 | - | 163 | 81 | 90 | 30 | 45 | 125 | 76 | 36 | 18 | 45 | 199.5 | 71 | 10 | 35 |
| 80 M | All | 2, 4, 6, 8 | 125 | 35 | 160 | 169 | 249 | - | 204 | - | 163 | 81 | 100 | 33 | 38 | 130 | 75.5 | 36 | 18 | 50 | 204 | 80 | 13 | 37.5 |
| 90 S/L | All | 2, 4, 6, 8 | 140 | 40 | 180 | 182 | 261 | - | 216 | - | 163 | 81 | 125 | 41 | 40 | 155 | 80 | 36 | 18 | 56 | 239 | 90 | 13 | 41 |
| 100 L | All | 2, 4, 6, 8 | 160 | 40 | 205 | 218 | 259 | - | 213 | - | 163 | 81 | 140 | 50 | 50 | 170 | 92 | 48 | 24 | 63 | 306 | 100 | 18 | 48 |
| 112 M | All | 2, 4, 6, 8 | 190 | 45 | 240 | 230 | 279 | - | 233 | - | 163 | 81 | 140 | 50 | 50 | 170 | 92 | 48 | 24 | 70 | 280.5 | 112 | 18 | 55 |
| 132 S | All | 2, 4, 6, 8 | 216 | 50 | 260 | 262 | 295 | 295 | 250 | 250 | 163 | 81 | 140 | 58 | 104 | 235 | 101 | 48 | 24 | 89 | 292 | 132 | 18 | 64 |
| 132 M | 1CB2, 1CC3 | 4, 6 | 216 | 50 | 260 | 262 | 295 | 295 | 250 | 250 | 163 | 81 | 178 | 58 | 104 | 235 | 101 | 48 | 24 | 89 | 309 | 132 | 18 | 64 |
| | 1CC2, 1CD2 | 6, 8 | | | | | | | | | | | | | | | | | | | 254 | | | |
| 160 M | All | 2, 4, 6, 8 | 254 | 60 | 310 | 314 | 351 | 351 | 299 | 299 | 190 | 92 | 210 | 61 | 114 | 307 | 162.5 | 60 | 3 | 108 | 393 | 160 | 20 | 87.5 |
| 160 L | All | 2, 4, 6, 8 | 254 | 60 | 310 | 314 | 351 | 351 | 299 | 299 | 190 | 92 | 254 | 61 | 114 | 307 | 162.5 | 60 | 3 | 108 | 349 | 160 | 20 | 87.5 |

SIMOTICS XP 1MB1, 1MB5 explosion-protected motors

Dimensions · Cast-iron series SIMOTICS XP

IE3 – 1MB1 with types of protection Ex db, Ex db eb – self-ventilated · Frame sizes 71 M to 160 L

Dimensional drawings

Type of construction IM B14

For flange dimensions, see page 1/47 (Z = the number of retaining holes)

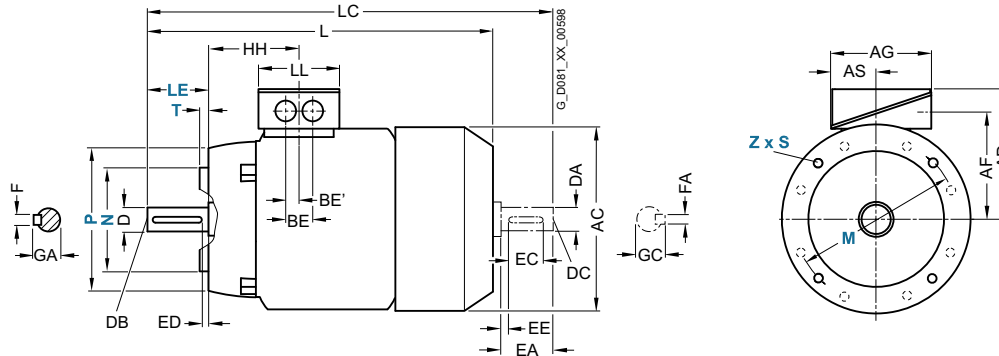

| For motor | | Dimension designation acc. to IEC | | | | | | | | | | | | | | DE shaft extension | | | | NDE shaft extension | | | | |
|------------|------------|-----------------------------------|-------|------|----|------------|-------|-----|----|-----|-----|----|----|----|------|--------------------|-----|-----|----|---------------------|----|------|--|--|
| Frame size | Motor type | No. of poles | HH | K | K' | L | LC | LL | D | DB | E | EB | ED | F | GA | DA | DC | EA | EC | EE | FA | GC | | |
| 71 M | All | 2, 4, 6, 8 | 121 | 7 | 10 | 350 | 394.5 | 134 | 14 | M5 | 30 | 22 | 4 | 5 | 16 | 14 | M5 | 30 | 22 | 4 | 5 | 16 | | |
| 80 M | All | 2, 4, 6, 8 | 125.5 | 10 | 15 | 374 | 434 | 134 | 19 | M6 | 40 | 32 | 4 | 6 | 21.5 | 19 | M6 | 40 | 32 | 4 | 6 | 21.5 | | |
| 90 S/L | All | 2, 4, 6, 8 | 136 | 10 | 15 | 450 | 510 | 134 | 24 | M8 | 50 | 40 | 5 | 8 | 27 | 19 | M6 | 40 | 32 | 4 | 6 | 21.5 | | |
| 100 L | All | 2, 4, 6, 8 | 155 | 12 | 19 | 544 | 619 | 134 | 28 | M10 | 60 | 50 | 5 | 8 | 31 | 24 | M8 | 50 | 40 | 5 | 8 | 27 | | |
| 112 M | All | 2, 4, 6, 8 | 162 | 12 | 19 | 520 | 600.5 | 134 | 28 | M10 | 60 | 50 | 5 | 8 | 31 | 24 | M8 | 50 | 40 | 5 | 8 | 27 | | |
| 132 S | All | 2, 4, 6, 8 | 190 | 12 | 19 | 571 | 661 | 134 | 38 | M12 | 80 | 70 | 5 | 10 | 41 | 28 | M10 | 60 | 50 | 5 | 8 | 31 | | |
| 132 M | 1CB2, 1CC3 | 4, 6 | 190 | 12 | 19 | 626 | 716 | 134 | 38 | M12 | 80 | 70 | 5 | 10 | 41 | 28 | M10 | 60 | 50 | 5 | 8 | 31 | | |
| | 1CC2, 1CD2 | 6, 8 | | | | 571 | 661 | | | | | | | | | | | | | | | | | |
| 160 M | All | 2, 4, 6, 8 | 270.5 | 14.5 | 23 | 786 | 931 | 165 | 42 | M16 | 110 | 90 | 10 | 12 | 45 | 42 | M16 | 110 | 90 | 10 | 12 | 45 | | |
| 160 L | All | 2, 4, 6, 8 | 270.5 | 14.5 | 23 | 786 | 931 | 165 | 42 | M16 | 110 | 90 | 10 | 12 | 45 | 42 | M16 | 110 | 90 | 10 | 12 | 45 | | |

SIMOTICS XP 1MB1, 1MB5 explosion-protected motors

Dimensions · Cast-iron series SIMOTICS XP

IE3 – 1MB1 with types of protection Ex db, Ex db eb – self-ventilated · Frame sizes 180 M to 280 M

Dimensional drawings

Type of construction IM B35

For flange dimensions, see page 1/47 (Z = the number of retaining holes)

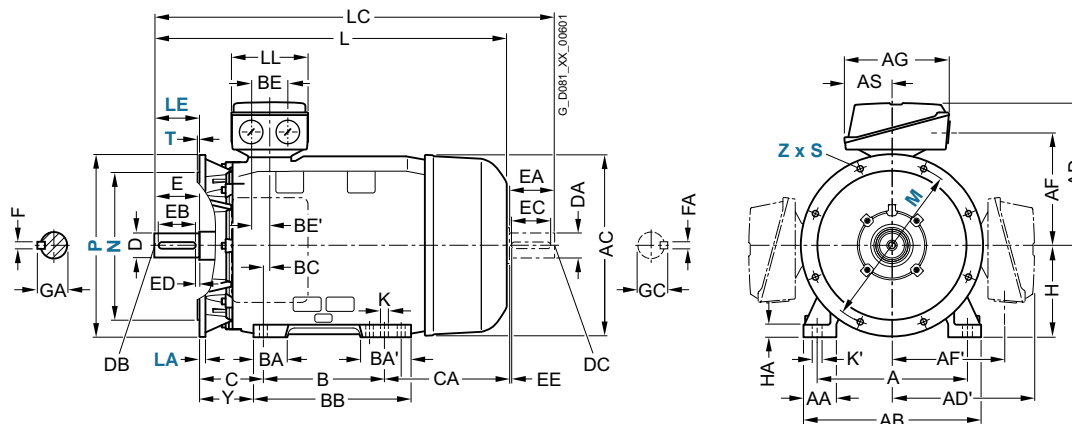

| For motor Frame size | Motor type 1MB1553- | No. of poles | Dimension designation acc. to IEC | | | | | | | DE shaft extension | | | | | | | NDE shaft extension | | | | | | | | | | | | | |
|-------------------------|------------------------|--------------|-----------------------------------|------|-----|-----|------|----|------|--------------------|-----|-----|-----|-----|-----|------|---------------------|------|----|-----|-----|-----|----|----|------|--|--|----|----|----|
| | | | H | HA | Y | HH | K | K' | L | LC | LL | D | DB | E | EB | ED | F | GA | DA | DC | EA | EC | EE | FA | GC | | | | | |
| 180 M | 1EA2, 1EB2 | 2, 4 | 180 | 19 | 97 | 305 | 14.5 | 22 | 838 | 993 | 165 | 48 | M16 | 110 | 100 | 5 | 14 | 51.5 | 48 | M16 | 110 | 100 | 5 | 14 | 51.5 | | | | | |
| 180 L | 4EB4, 1EC4, 1ED4 | 4, 6, 8 | 180 | 19 | 97 | 305 | 14.5 | 22 | 838 | 993 | 165 | 48 | M16 | 110 | 100 | 5 | 14 | 51.5 | 48 | M16 | 110 | 100 | 5 | 14 | 51.5 | | | | | |
| 200 L | All | 2, 4, 6, 8 | 200 | 25 | 101 | 350 | 18.5 | 25 | 899 | 1069 | 197 | 55 | M20 | 110 | 100 | 5 | 16 | 59 | 55 | M20 | 110 | 100 | 5 | 16 | 59 | | | | | |
| 225 S | 2BB0, 2BD0 | 4, 8 | 225 | 25.5 | 117 | 370 | 18.5 | 25 | 1004 | 1179 | 197 | 60 | M20 | 140 | 125 | 10 | 18 | 64 | 55 | M20 | 110 | 100 | 5 | 16 | 59 | | | | | |
| 225 M | 2BA2 | 2 | 225 | 25.5 | 117 | 370 | 18.5 | 25 | 974 | 1149 | 197 | 55 | M20 | 110 | 100 | 5 | 16 | 59 | 48 | M16 | 110 | 100 | 5 | 14 | 51.5 | | | | | |
| | 2BB2, 2BC2, 2BD2 | 4, 6, 8 | | | | | | | 1004 | 1179 | 60 | 140 | 125 | 10 | 18 | 64 | 55 | M20 | | | | | | | | | | 16 | 59 | |
| 250 M | 2CA2 | 2 | 250 | 35 | 133 | 356 | 24 | 40 | 1014 | 1189 | 233 | 60 | M20 | 140 | 125 | 10 | 18 | 64 | 55 | M20 | 110 | 100 | 5 | 16 | 59 | | | | | |
| | 2CB2, 2CC2, 2CD2 | 4, 6, 8 | | | | | | | | 1219 | 65 | | | | 69 | 60 | | | | 140 | 125 | 10 | 18 | 64 | | | | | | |
| | | | | | | | | | | | | | | | | | | | | | | | | | | | | | | |
| 280 S | 2CA0 | 2 | 280 | 40 | 140 | 442 | 24 | 40 | 1124 | 1334 | 233 | 65 | M20 | 140 | 125 | 10 | 18 | 69 | 60 | M20 | 140 | 125 | 10 | 18 | 64 | | | | | |
| | 2DB0, 2DC0, 2DC0 | 4, 6, 8 | | | | | | | | | 75 | | | | 20 | 79.5 | 65 | | | | | | | | | | | | | 69 |
| | | | | | | | | | | | | | | | | | | | | | | | | | | | | | | |
| 280 M | 2DA2 | 2 | 280 | 40 | 140 | 442 | 24 | 40 | 1124 | 1334 | 233 | 65 | M20 | 140 | 125 | 10 | 18 | 69 | 60 | M20 | 140 | 125 | 10 | 18 | 64 | | | | | |
| | 2CB2, 2DC2, 2DD2 | 4, 6, 8 | | | | | | | | | 75 | | | | 20 | 79.5 | 65 | | | | | | | | | | | | | 69 |
| | | | | | | | | | | | | | | | | | | | | | | | | | | | | | | |

SIMOTICS XP 1MB1, 1MB5 explosion-protected motors

Dimensions · Cast-iron series SIMOTICS XP

IE3 – 1MB5 with types of protection Ex db, Ex db eb – self-ventilated · Frame sizes 315 S to 355 L

Dimensional drawings

Type of construction IM B3

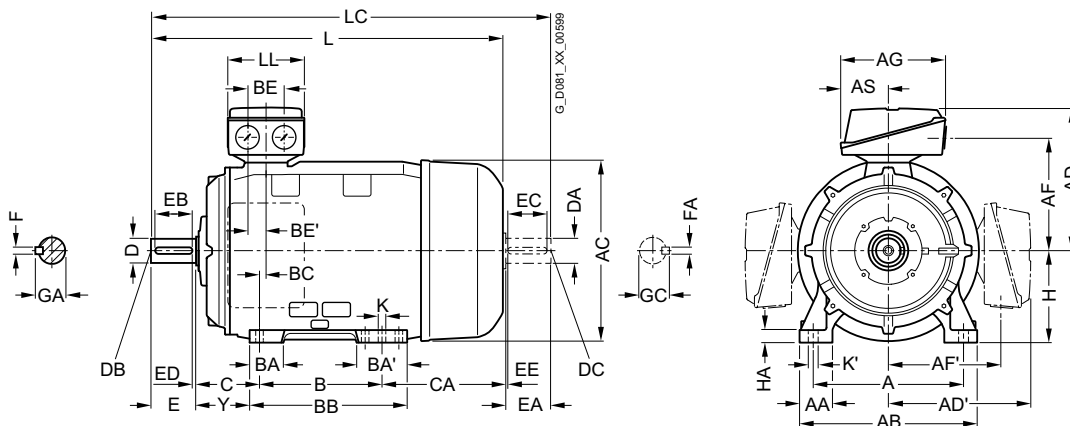

Types of construction IM B5 and IM V1

For flange dimensions, see page 1/47 (Z = the number of retaining holes)

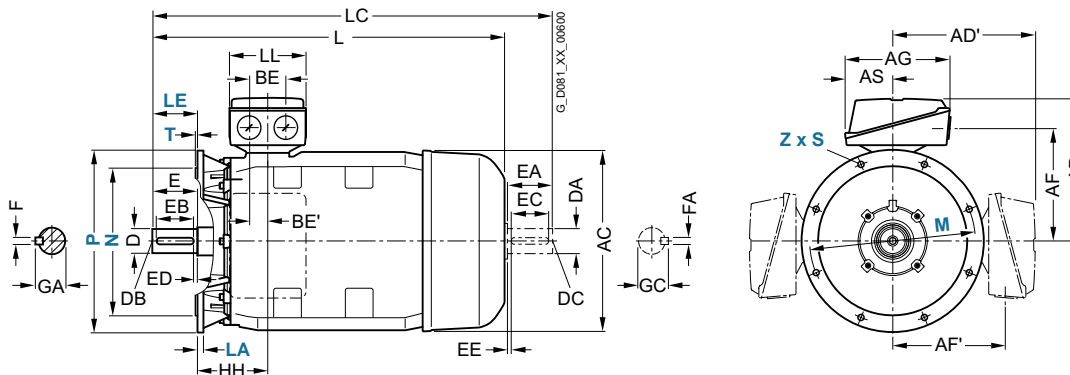

5

| For motor | | | Dimension designation acc. to IEC | | | | | | | | | | | | | | | | | | |
|------------|------------------------|--------------|-----------------------------------|-----|-----|-----|-----|-----|-----|-----|-----|-----|-----|-----|-----|-----|------|-----|-----|-----|-----|
| Frame size | Motor type | No. of poles | A | AA | AB | AC | AD | AD' | AF | AF' | AG | AS | B | BA | BA' | BB | BC | BE | BE' | C | CA |
| 315 S | 1MB553-3AA0 | 2 | 508 | 120 | 610 | 668 | 603 | 603 | 509 | 509 | 509 | 167 | 406 | 140 | 196 | 602 | 169 | 120 | 60 | 216 | 497 |
| | 3AB0, 3AC0, 3AD0 | 4, 6, 8 | | | | | | | | | | | | | | | | | | | |
| 315 M | 3AA2 | 2 | 508 | 120 | 610 | 668 | 603 | 603 | 509 | 509 | 509 | 167 | 457 | 140 | 286 | 692 | 169 | 120 | 60 | 216 | 536 |
| | 3AB2 | 4 | | | | | | | | | | | | | 286 | 692 | | | | | 536 |
| | 3AC2, 3AD2 | 6, 8 | | | | | | | | | | | | | 196 | 602 | | | | | 446 |
| 315 L | 3AA4 | 2 | 508 | 120 | 610 | 668 | 603 | 603 | 509 | 509 | 509 | 167 | 508 | 140 | 286 | 692 | 169 | 120 | 60 | 216 | 485 |
| | 3AA5 | | | | | | | | | | | | | | 305 | 762 | | | | | 555 |
| | 3AA6 | | | | | | | | | | | | | | 334 | 842 | 254 | | | | 635 |
| | 3AB4, 3AC4, 3AD5, 3AD6 | 4, 6, 8 | | | | | | | | | | | | | 286 | 692 | 169 | | | | 485 |
| | 3AB5, 3AC5, 3AC6 | 4, 6 | | | | | | | | | | | | | 305 | 762 | 169 | | | | 555 |
| | 3AB6, 3AC7, 3AD7 | 4, 6, 8 | | | | | | | | | | | | | 334 | 842 | 254 | | | | 635 |
| | 3AD4 | 8 | | | | | | | | | | | | 457 | 196 | 602 | 169 | | | | 446 |
| 355 S | 3BD0 | 8 | 508 | 120 | 610 | 668 | 603 | 603 | 509 | 509 | 509 | 167 | 457 | 140 | 196 | 602 | 169 | 120 | 60 | 216 | 446 |
| | 3BD1 | | | | | | | | | | | | | | | | | | | | |
| 355 M | 3BD2 | 8 | 508 | 120 | 610 | 668 | 603 | 603 | 509 | 509 | 509 | 167 | 457 | 140 | 196 | 602 | 169 | 120 | 60 | 216 | 446 |
| 355 L | 3BA2 | 2 | 610 | 150 | 780 | 736 | 710 | 710 | 590 | 590 | 570 | 175 | 630 | 187 | 350 | 893 | 230 | 120 | 60 | 254 | 535 |
| | 3BA3 | | | | | | | | | | | | | | 365 | 968 | | | | | 610 |
| | 3BA4, 3BA5 | | | | | | | | | | | | | | 191 | 401 | 1078 | | | | 720 |
| | 3BB2, 3BB3 | 4 | | | | | | | | | | | | | 187 | 350 | 893 | | | | 535 |
| | 3BB4, 3BC1 | 4, 6 | | | | | | | | | | | | | 365 | 968 | | | | | |
| | 3BB5, 3BC2, 3BC3, 3BC4 | 4, 6, 8 | | | | | | | | | | | | | 191 | 401 | 1078 | | | | |
| | | | | | | | | | | | | | | | | | | | | | |

SIMOTICS XP 1MB1, 1MB5 explosion-protected motors

Dimensions · Cast-iron series SIMOTICS XP

IE3 – 1MB5 with types of protection Ex db, Ex db eb – self-ventilated · Frame sizes 315 S to 355 L

Dimensional drawings

Type of construction IM B35

For flange dimensions, see page 1/47 (Z = the number of retaining holes)

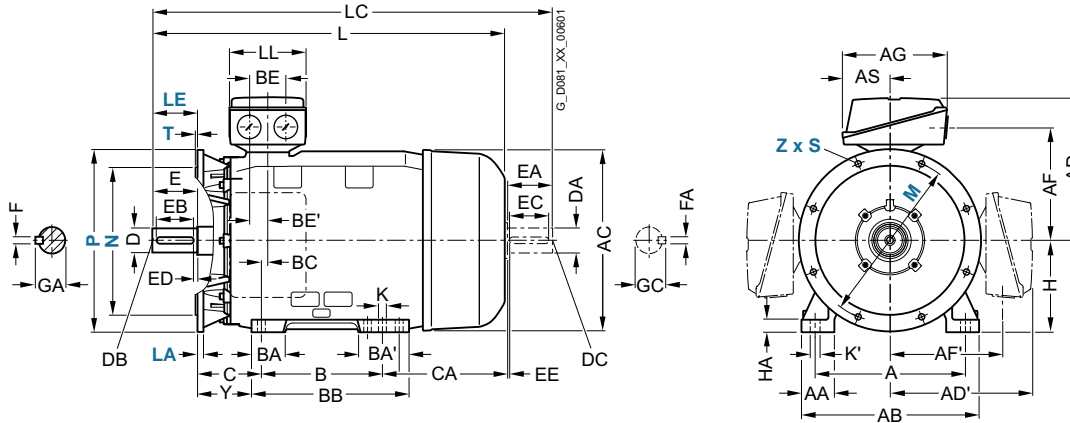

| For motor | | No. of poles | Dimension designation acc. to IEC | | | | | | | DE shaft extension | | | | | NDE shaft extension | | | | | | | | | | |
|------------|------------------------|--------------|-----------------------------------|----|-----|-----|----|----|------|--------------------|-----|----|-----|-----|---------------------|----|----|------|----|-----|-----|-----|----|----|------|
| Frame size | Motor type | | H | HA | Y | HH | K | K' | L | LC | LL | D | DB | E | EB | ED | F | GA | DA | DC | EA | EC | EE | FA | GC |
| 315 S | 3AA0 | 2 | 315 | 50 | 146 | 385 | 28 | 28 | 1189 | 1399 | 327 | 65 | M20 | 140 | 125 | 10 | 18 | 69 | 60 | M20 | 140 | 125 | 10 | 18 | 64 |
| | 3AB0, 3AC0, 3AD0 | 4, 6, 8 | | | | | | | 1219 | 1429 | | 80 | M20 | 170 | 140 | 25 | 22 | 85 | 70 | | | | | 20 | 74.5 |
| 315 M | 3AA2 | 2 | 315 | 50 | 146 | 385 | 28 | 28 | 1279 | 1489 | 327 | 65 | M20 | 140 | 125 | 10 | 18 | 69 | 60 | M20 | 140 | 125 | 10 | 18 | 64 |
| | 3AB2 | 4 | | | | | | | 1309 | 1519 | | 80 | | 170 | 140 | 25 | 22 | 85 | 70 | | | | | 20 | 74.5 |
| | 3AC2, 3AD2 | 6, 8 | | | | | | | 1219 | 1429 | | | | | | | | | | | | | | | |
| 315 L | 3AA4 | 2 | 315 | 50 | 146 | 385 | 28 | 28 | 1279 | 1489 | 327 | 65 | M20 | 140 | 125 | 10 | 18 | 69 | 60 | M20 | 140 | 125 | 10 | 18 | 64 |
| | 3AA5 | | | | | | | | 1349 | 1559 | | | | | | | | | | | | | | | |
| | 3AA6 | | | | | 470 | | | 1429 | 1639 | | | | | | | | | | | | | | | |
| | 3AB4, 3AC4, 3AD5, 3AD6 | 4, 6, 8 | | | | 385 | | | 1309 | 1519 | | 80 | | 170 | 140 | 25 | 22 | 85 | 70 | | | | | 20 | 74.5 |
| | 3AB5, 3AC5, 3AC6 | 4, 6 | | | | 385 | | | 1379 | 1589 | | | | | | | | | | | | | | | |
| | 3AB6, 3AC7, 3AD7 | 4, 6, 8 | | | | 470 | | | 1459 | 1669 | | | | | | | | | | | | | | | |
| | 3AD4 | 8 | | | | 385 | | | 1219 | 1429 | | | | | | | | | | | | | | | |
| 355 S | 3BD0 | 8 | 315 | 50 | 146 | 385 | 28 | 28 | 1584 | 1834 | 497 | 95 | M24 | 170 | 140 | 25 | 25 | 100 | 80 | M20 | 170 | 140 | 25 | 22 | 85 |
| | 3BD1 | | | | | | | | 1694 | 1944 | | | | | | | | | | | | | | | |
| 355 M | 3BD2 | 8 | 315 | 50 | 146 | 385 | 28 | 28 | 1694 | 1944 | 497 | 95 | M24 | 170 | 140 | 25 | 25 | 100 | 80 | M20 | 170 | 140 | 25 | 22 | 85 |
| 355 L | 3BA2 | 2 | 355 | 50 | 139 | 385 | 35 | 35 | 1479 | 1699 | 497 | 75 | M20 | 140 | 125 | 10 | 20 | 79.5 | 60 | M20 | 140 | 125 | 10 | 18 | 64 |
| | 3BA3 | | | | | | | | 1554 | 1774 | | | | | | | | | | | | | | | |
| | 3BA4, 3BA5 | | | | | | | | 1664 | 1884 | | | | | | | | | | | | | | | |
| | 3BB2, 3BB3 | 4 | | | | | | | 1509 | 1759 | | 95 | M24 | 170 | 140 | 25 | 25 | 100 | 80 | M20 | 170 | 125 | 25 | 22 | 85 |
| | 3BB4, 3BC1 | 4, 6 | | | | | | | 1584 | 1834 | | | | | | | | | | | | | | | |
| | 3BB5, 3BC2, 3BC3, 3BC4 | 4, 6, 8 | | | | | | | 1694 | 1944 | | | | | | | | | | | | | | | |

SIMOTICS XP 1MB1, 1MB5 explosion-protected motors

Dimensions · Cast-iron series SIMOTICS XP

IE2 – 1MB1 with types of protection Ex tb, Ex tc, Ex ec – self-ventilated · Frame sizes 71 M to 160 L

Dimensional drawings

Type of construction IM B3

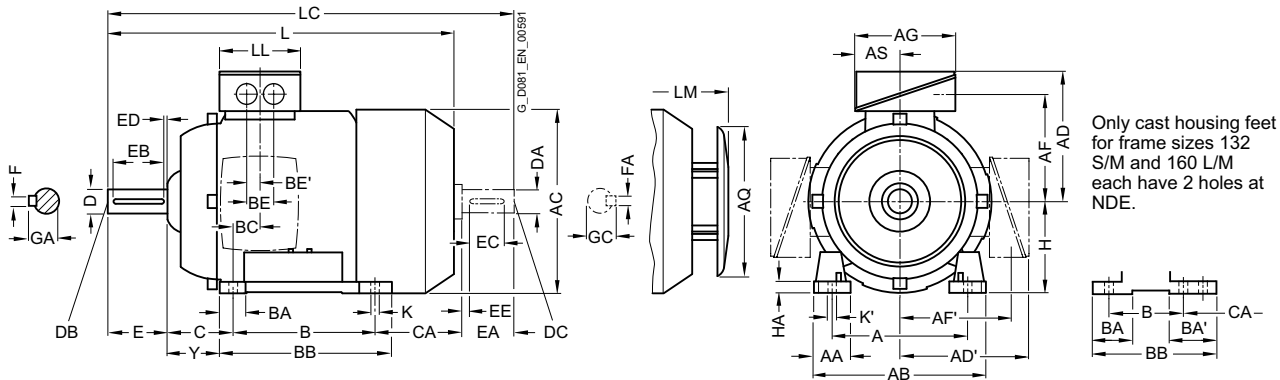

Types of construction IM B5 and IM V1

For flange dimensions, see page 1/47 (Z = the number of retaining holes)

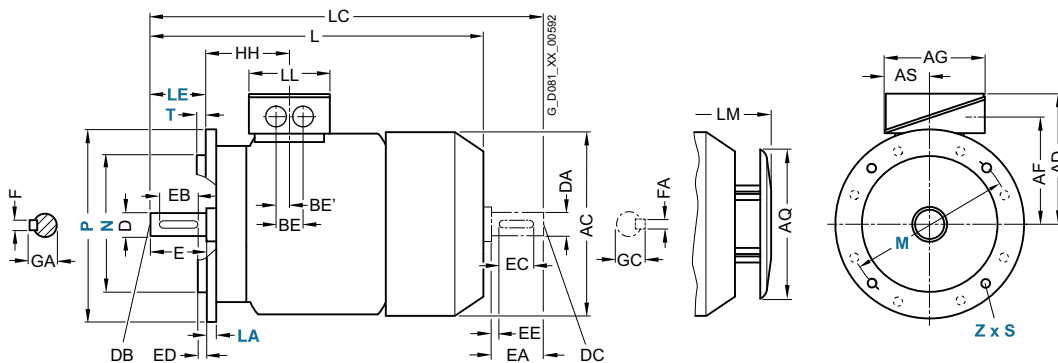

5

| Frame size | Motor type | No. of poles | Dimension designation acc. to IEC | | | | | | | | | | | | | | | | | | | | | |
|------------|------------------------|--------------|-----------------------------------|------|-----|-----|-------|-------|-----|-----|-----|------|-----|----|------------------|-------------------|------|----|-----|-----|-------|-----|----|----|
| | | | A | AA | AB | AC | AD | AD' | AF | AF' | AG | AS | B | BA | BA' | BB | BC | BE | BE' | C | CA | H | HA | Y |
| 71 M | OCA2, OCB2, OCC2, OCD2 | 2, 4, 6, 8 | 112 | 30.5 | 132 | 145 | 149 | 149 | 112 | 112 | 126 | 62 | 90 | 32 | 32 | 106 | 21 | 36 | 18 | 45 | 83 | 71 | 7 | 37 |
| | 28 | | | | | | | | | | | | | | | | | | | | | | | |
| 80 M | ODA2, ODB2, ODC2, ODD2 | 2, 4, 6, 8 | 125 | 30.5 | 150 | 162 | 159 | 159 | 122 | 122 | 126 | 62 | 100 | 32 | 32 | 118 | 22.5 | 36 | 18 | 50 | 112.5 | 80 | 8 | 41 |
| | ODA3, ODB3, ODC3, ODD3 | | | | | | | | | | | | | | | | | | | | | | | |
| 90 S | All | 2, 4, 6, 8 | 140 | 30.5 | 165 | 180 | 164 | 164 | 127 | 127 | 126 | 62 | 100 | 33 | 54 | 143 | 24.5 | 36 | 18 | 56 | 149 | 90 | 10 | 47 |
| 90 L | All | 2, 4, 6, 8 | 140 | 30.5 | 165 | 180 | 164 | 164 | 127 | 127 | 126 | 62 | 125 | 33 | 54 | 143 | 24.5 | 36 | 18 | 56 | 124 | 90 | 10 | 47 |
| 100 L | All | 2, 4, 6, 8 | 160 | 42 | 196 | 198 | 193 | 193 | 147 | 147 | 163 | 80.5 | 140 | 40 | 40 | 176 | 37.5 | 48 | 24 | 63 | 141 | 100 | 12 | 45 |
| 112 M | 1BA2, 1BB2, 1BC2 | 2, 4, 6 | 190 | 46 | 226 | 222 | 195 | 195 | 150 | 150 | 163 | 80.5 | 140 | 40 | 40 | 176 | 30 | 48 | 24 | 70 | 129.7 | 112 | 12 | 52 |
| | 1BD2 | | | | | | | | | | | | | | | | | | | | | | | |
| 132 S | All | 2, 4, 6, 8 | 216 | 53 | 256 | 262 | 214.5 | 214.5 | 169 | 169 | 163 | 80.5 | 140 | 44 | 81 ¹⁾ | 218 ³⁾ | 26.5 | 48 | 24 | 89 | 167 | 132 | 15 | 69 |
| 132 M | All | 2, 4, 6, 8 | 216 | 53 | 256 | 262 | 214.5 | 214.5 | 169 | 169 | 163 | 80.5 | 178 | 44 | 81 ¹⁾ | 218 | 26.5 | 48 | 24 | 89 | 129 | 132 | 15 | 69 |
| 160 M | All | 2, 4, 6, 8 | 254 | 60 | 300 | 314 | 265 | 265 | 213 | 213 | 190 | 92 | 210 | 51 | 95 ²⁾ | 300 ⁴⁾ | 37 | 60 | 30 | 108 | 192 | 160 | 18 | 85 |
| 160 L | All | 2, 4, 6, 8 | 254 | 60 | 300 | 314 | 265 | 265 | 213 | 213 | 190 | 92 | 254 | 51 | 95 ²⁾ | 300 | 37 | 60 | 30 | 108 | 148 | 160 | 18 | 85 |

1) With screwed-on feet, dimension BA' is 43 mm.
 2) With screwed-on feet, dimension BA' is 51 mm.
 3) With screwed-on feet, dimension BB is 180 mm.

4) With screwed-on feet, dimension BB is 256 mm.

SIMOTICS XP 1MB1, 1MB5 explosion-protected motors

Dimensions · Cast-iron series SIMOTICS XP

IE2 – 1MB1 with types of protection Ex tb, Ex tc, Ex ec – self-ventilated · Frame sizes 71 M to 160 L

Dimensional drawings

Type of construction IM B35

For flange dimensions, see page 1/47 (**Z** = the number of retaining holes)

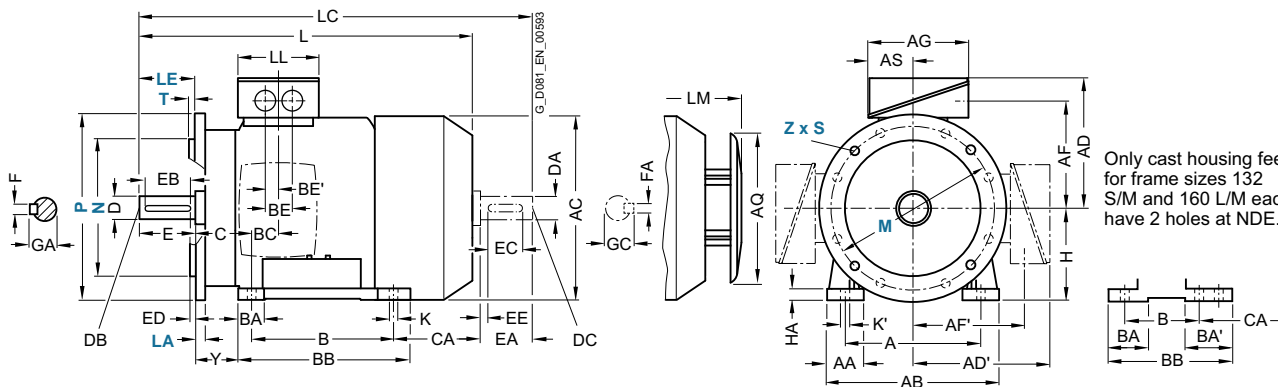

Type of construction IM B14

For flange dimensions, see page 1/47 (**Z** = the number of retaining holes)

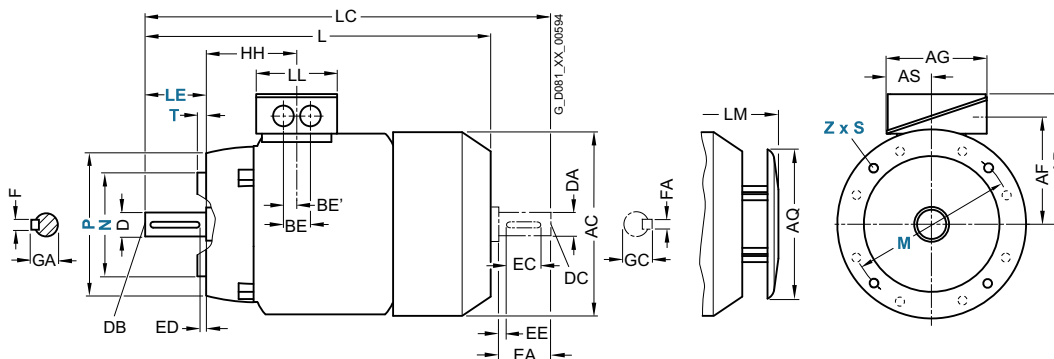

| Frame size | Motor type 1MB15.1- 1MB16.1- | No. of poles | Dimension designation acc. to IEC | | | | | DE shaft extension | | | | | NDE shaft extension | | | | | | | | | |
|------------|------------------------------------|--------------|-----------------------------------|----|------|--------------|--------------|--------------------|----|-----|-----|----|---------------------|----|------|----|-----|-----|----|----|----|------|
| | | | HH | K | K' | L | LC | LL | D | DB | E | EB | ED | F | GA | DA | DC | EA | EC | EE | FA | GC |
| 71 M | OCA2, OCB2, OCC2, OCD2 | 2, 4, 6, 8 | 63 | 7 | 7 | 240 | 278 | 102 | 14 | M5 | 30 | 22 | 4 | 5 | 16 | 14 | M5 | 30 | 22 | 4 | 5 | 16 |
| | OCA3, OCB3, OCC3, OCD3 | | 70 | | | 280 | 318 | | | | | | | | | | | | | | | |
| 80 M | ODA2, ODB2, ODC2, ODD2 | 2, 4, 6, 8 | 72.5 | 10 | 13.5 | 292 | 342.5 | 102 | 19 | M6 | 40 | 32 | 4 | 6 | 21.5 | 19 | M6 | 40 | 32 | 4 | 6 | 21.5 |
| | ODA3, ODB3, ODC3, ODD3 | | | | | 327 | 377.5 | | | | | | | | | | | | | | | |
| 90 S | All | 2, 4, 6, 8 | 80.5 | 10 | 10 | 347 | 405 | 102 | 24 | M8 | 50 | 40 | 5 | 8 | 27 | 24 | M8 | 50 | 40 | 5 | 8 | 27 |
| 90 L | All | 2, 4, 6, 8 | 80.5 | 10 | 10 | 387 | 445 | 102 | 24 | M8 | 50 | 40 | 5 | 8 | 27 | 24 | M8 | 50 | 40 | 5 | 8 | 27 |
| 100 L | All | 2, 4, 6, 8 | 100.5 | 12 | 16 | 390.5 | 454 | 134 | 28 | M10 | 60 | 50 | 5 | 8 | 31 | 24 | M8 | 50 | 40 | 5 | 8 | 27 |
| 112 M | 1BA2, 1BB2, 1BC2 | 2, 4, 6 | 100.5 | 12 | 16 | 390.5 | 450 | 134 | 28 | M10 | 60 | 50 | 5 | 8 | 31 | 24 | M8 | 50 | 40 | 5 | 8 | 27 |
| | 1BD2 | | | | | 8 | 408.5 | 475 | | | | | | | | | | | | | | |
| 132 S | All | 2, 4, 6, 8 | 115.5 | 12 | 16 | 458 | 536 | 134 | 38 | M12 | 80 | 70 | 5 | 10 | 41 | 28 | M10 | 60 | 50 | 5 | 8 | 31 |
| 132 M | All | 2, 4, 6, 8 | 115.5 | 12 | 16 | 458 | 536 | 134 | 38 | M12 | 80 | 70 | 5 | 10 | 41 | 28 | M10 | 60 | 50 | 5 | 8 | 31 |
| 160 M | All | 2, 4, 6, 8 | 145 | 15 | 19 | 596 | 730 | 165 | 42 | M16 | 110 | 90 | 10 | 12 | 45 | 42 | M16 | 110 | 90 | 10 | 12 | 45 |
| 160 L | All | 2, 4, 6, 8 | 145 | 15 | 19 | 596 | 730 | 165 | 42 | M16 | 110 | 90 | 10 | 12 | 45 | 42 | M16 | 110 | 90 | 10 | 12 | 45 |

SIMOTICS XP 1MB1, 1MB5 explosion-protected motors

Dimensions · Cast-iron series SIMOTICS XP

IE2 – 1MB1 with types of protection Ex tb, Ex tc, Ex ec – self-ventilated · Frame sizes 180 M to 250 M

Dimensional drawings

Type of construction IM B3

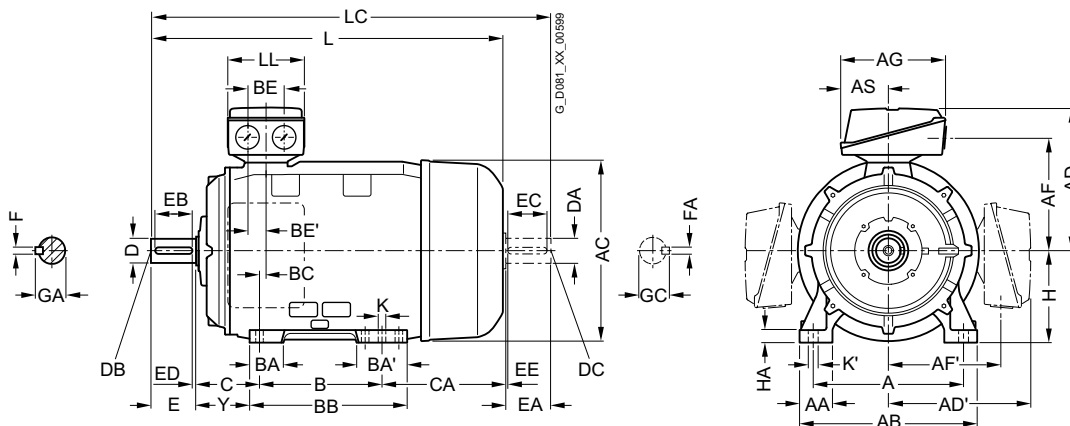

Types of construction IM B5 and IM V1

For flange dimensions, see page 1/47 (Z = the number of retaining holes)

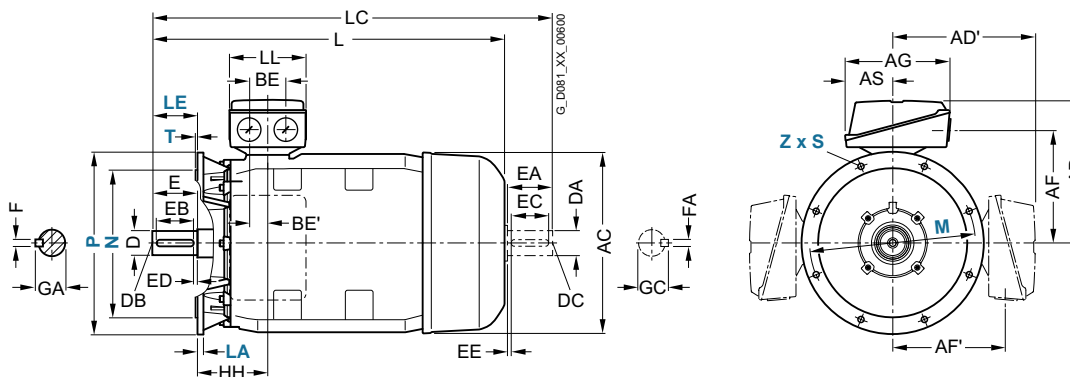

5

| For motor | | | Dimension designation acc. to IEC | | | | | | | | | | | | | | | | | | | |
|-----------------|--------------------|--------------|-----------------------------------|-----|------------|-----|------------|-----|-----|-----|-----|-----|-----|-----|-----|-----|-----|----|-----|------|-----|-----|
| Frame size | Motor type | No. of poles | A | AA | AB | AC | AD | AD' | AF | AF' | AG | AH | AS | B | BA | BA' | BB | BC | BE | BE' | C | CA |
| 180 M/ 180 L | 1MB15.1-, 1MB16.1- | 2, 4 | 279 | 65 | 339 | 356 | 286 | 286 | 234 | 234 | 190 | 468 | 92 | 241 | 85 | 120 | 328 | 34 | 60 | 30 | 121 | 202 |
| | 1EC4, 1ED4 | 6, 8 | | | | | | | | | | | | 279 | | | | | | | | |
| | 1EB4 | 4 | | | | | | | | | | | | | | | | | | | | |
| 200 L | All | 2, 4, 6, 8 | 318 | 60 | 378 | 396 | 315 | 315 | 259 | 259 | 266 | 533 | 112 | 305 | 104 | 104 | 355 | 31 | 85 | 42.5 | 133 | 177 |
| 225 S/ 225 M | 2BB0, 2BD0, | 4, 8 | 356 | 80 | 436 | 449 | 338 | 338 | 282 | 282 | 266 | 556 | 112 | 311 | 92 | 117 | 361 | 15 | 85 | 42.5 | 149 | 253 |
| | 2BB2, 2BC2, 2BD2 | 4, 6, 8 | | | | | | | | | | | | | | | | | | | | |
| | 2BA2 | 2 | | | | | | | | | | | | | | | | | | | | |
| 250 M | 2CA2 | 2 | 406 | 100 | 490 | 497 | 410 | 410 | 322 | 322 | 319 | 620 | 145 | 349 | 102 | 102 | 409 | 24 | 110 | 55 | 168 | 230 |
| | 2CB2, 2CC2, 2CD2 | 4, 6, 8 | | | | | | | | | | | | | | | | | | | | |

SIMOTICS XP 1MB1, 1MB5 explosion-protected motors

Dimensions · Cast-iron series SIMOTICS XP

IE2 – 1MB1 with types of protection Ex tb, Ex tc, Ex ec – self-ventilated · Frame sizes 180 M to 250 M

Dimensional drawings

Type of construction IM B35

For flange dimensions, see page 1/47 (Z = the number of retaining holes)

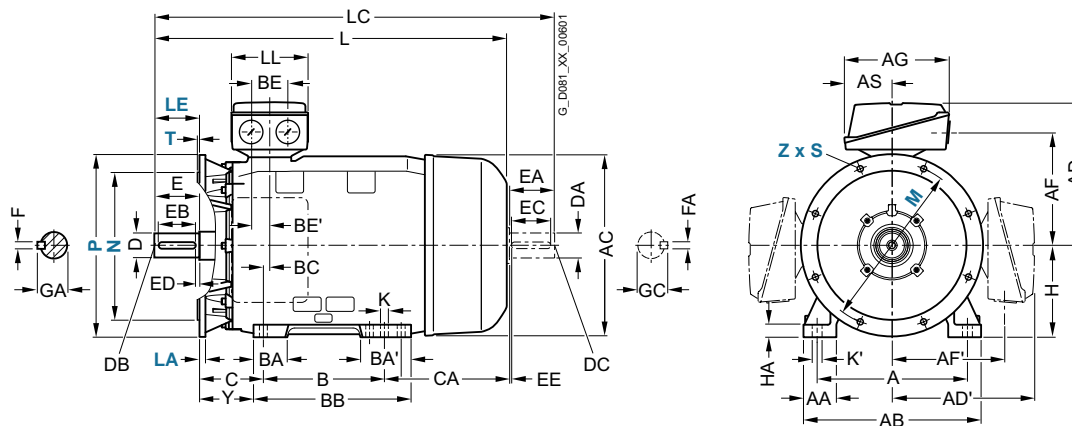

| For motor | | No. of poles | Dimension designation acc. to IEC | | | | | | | | | | DE shaft extension | | | | | NDE shaft extension | | | | | | | |
|-----------------|----------------------------------|--------------|-----------------------------------|----|-----|-----|----|----|------------|------|-----|----|--------------------|-----|-----|----|----|---------------------|-----|-----|-----|-----|----|------|------|
| Frame size | Motor type 1MB15.1-, 1MB16.1- | | H | HA | Y | HH | K | K' | L | LC | LL | D | DB | E | EB | ED | F | GA | DA | DC | EA | EC | EE | FA | GC |
| 180 M/ 180 L | 1EA2, 1EB2 | 2, 4 | 180 | 20 | 95 | 155 | 15 | 19 | 668 | 784 | 165 | 48 | M16 | 110 | 100 | 5 | 14 | 52 | 48 | M16 | 110 | 100 | 5 | 14 | 51.5 |
| | 1EC4, 1ED4 | 6, 8 | | | | | | | | | | | | | | | | | | | | | | | |
| | 1EB4 | 4 | | | | | | | 698 | 814 | | | | | | | | | | | | | | | |
| 200 L | All | 2, 4, 6, 8 | 200 | 25 | 108 | 164 | 19 | 25 | 721 | 835 | 197 | 55 | M20 | 110 | 100 | 5 | 16 | 59 | 55 | M20 | 110 | 100 | 5 | 16 | 59 |
| 225 S/ 225 M | 2BB0, 2BD0, | 4, 8 | 225 | 34 | 124 | 164 | 19 | 25 | 788 | 903 | 197 | 60 | M20 | 140 | 125 | 10 | 18 | 64 | 55 | M20 | 110 | 100 | 5 | 16 | 59 |
| | 2BB2, 2BC2, 2BD2 | 4, 6, 8 | | | | | | | 848 | 963 | | | | | | | | | | | | | | | |
| | 2BA2 | 2 | | | | | | | 818 | 933 | 55 | | 110 | 100 | 5 | 16 | 59 | 48 | M16 | | | | 14 | 51.5 | |
| 250 M | 2CA2 | 2 | 250 | 40 | 138 | 192 | 24 | 30 | 887 | 1002 | 233 | 60 | M20 | 140 | 125 | 10 | 18 | 64 | 55 | M20 | 110 | 100 | 5 | 16 | 59 |
| | 2CB2, 2CC2, 2CD2 | 4, 6, 8 | | | | | | | 1032 | | 65 | | | | | | 69 | 60 | | 140 | 125 | 10 | 18 | 64 | |

SIMOTICS XP 1MB1, 1MB5 explosion-protected motors

Dimensions · Cast-iron series SIMOTICS XP

IE2 – 1MB1 with types of protection Ex tb, Ex tc, Ex ec – self-ventilated · Frame sizes 280 S to 315 L

Dimensional drawings

Type of construction IM B3

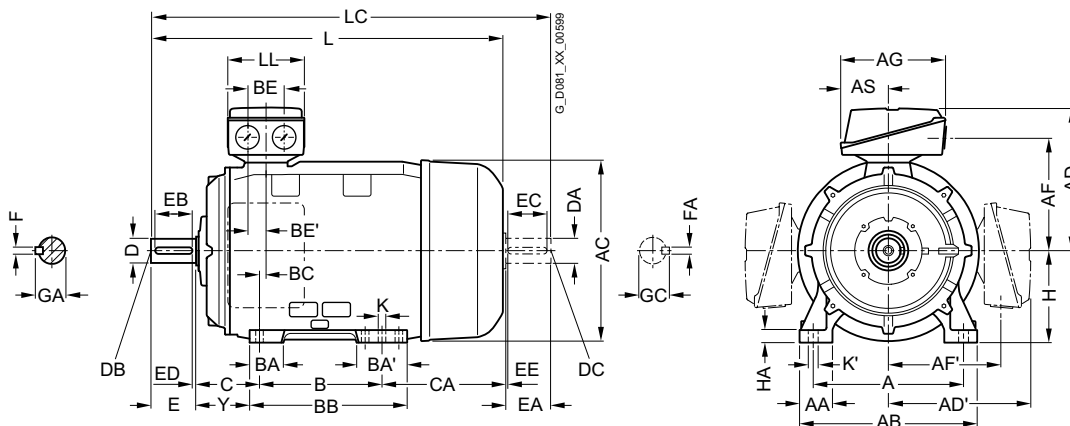

Types of construction IM B5 and IM V1

For flange dimensions, see page 1/47 (Z = the number of retaining holes)

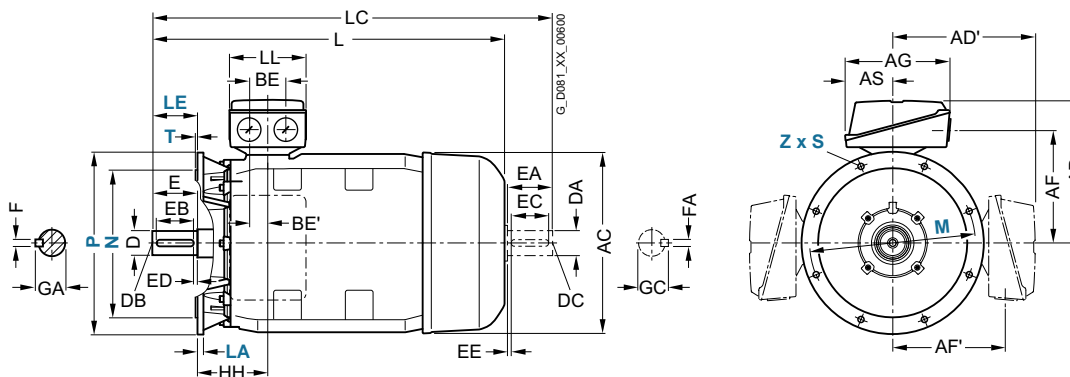

5

| For motor | | | Dimension designation acc. to IEC | | | | | | | | | | | | | | | | | | | | |
|------------|---|--------------|-----------------------------------|-----|-----|-----|-----|-----|-----|-----|-----|-----|-----|-----|-----|-----|-----|-----|-----|-----|-----|-----|-----|
| Frame size | Motor type | No. of poles | A | AA | AB | AC | AD | AD' | AF | AF' | AG | AH | AS | B | BA | BA' | BB | BC | BE | BE' | C | CA | |
| 280 S | 1MB15.1-, 1MB16.1- | 2 | 457 | 100 | 540 | 551 | 433 | 433 | 345 | 345 | 319 | 672 | 145 | 368 | 101 | 152 | 479 | 20 | 110 | 55 | 190 | 267 | |
| | 2DB0, 2DC0, 2DD0 | 4, 6, 8 | | | | | | | | | | | | | | | | | | | | | |
| 280 M | 2DA2 | 2 | 457 | 100 | 540 | 551 | 433 | 433 | 345 | 345 | 319 | 672 | 145 | 419 | 101 | 152 | 479 | 20 | 110 | 55 | 190 | 216 | |
| | 2DB2, 2DC2, 2DD2 | 4, 6, 8 | | | | | | | | | | | | | | | | | | | | | |
| 315 S | 3AA0 | 2 | 508 | 120 | 610 | 616 | 515 | 515 | 404 | 404 | 374 | 780 | 164 | 406 | 113 | 170 | 527 | 22 | 110 | 55 | 216 | 295 | |
| | 3AB0, 3AC0, 3AD0 | 4, 6, 8 | | | | | | | | | | | | | | | | | | | | | |
| 315 M | 3AA2 | 2 | 508 | 120 | 610 | 616 | 515 | 515 | 404 | 404 | 374 | 780 | 164 | 457 | 113 | 170 | 578 | 22 | 110 | 55 | 216 | 409 | |
| | 3AB2 | 4 | | | | | | | | | | | | | | | | | | | | | |
| | 3AC2, 3AD2 | 6, 8 | | | | | | | | | | | | | | | 327 | | | | | 244 | |
| 315 L | 3AA4 | 2 | 508 | 120 | 610 | 616 | 515 | 515 | 404 | 404 | 374 | 780 | 164 | 508 | 113 | 170 | 578 | 22 | 110 | 55 | 216 | 358 | |
| | 3AB4, 3AC4, 3AD4, 3AC5, 3AD5, 3AD6 | 4, 6, 8 | | | | | | | | | | | | | | | | | | | | | |
| | 3AA5 | 2 | | | | | | | | | | | | | | | 176 | 227 | 648 | | | | 513 |
| | 3AB5 ¹⁾ , 3AC6 ¹⁾ | 4, 6 | | | | | | | | | | | | | | | | | | | | | |
| | | | | | | | | | | | | | | | | | | | | | | | |

¹⁾ When ordering a terminal box positioned on the left-hand side or right-hand side, the feet are screwed on as standard. These screwed-on feet have 3 drill holes on the NDE with the respective dimension B 406, 457 and 508 mm; the dimension BB is 666 mm.

SIMOTICS XP 1MB1, 1MB5 explosion-protected motors

Dimensions · Cast-iron series SIMOTICS XP

IE2 – 1MB1 with types of protection Ex tb, Ex tc, Ex ec – self-ventilated · Frame sizes 280 S to 315 L

Dimensional drawings

Type of construction IM B35

For flange dimensions, see page 1/47 (Z = the number of retaining holes)

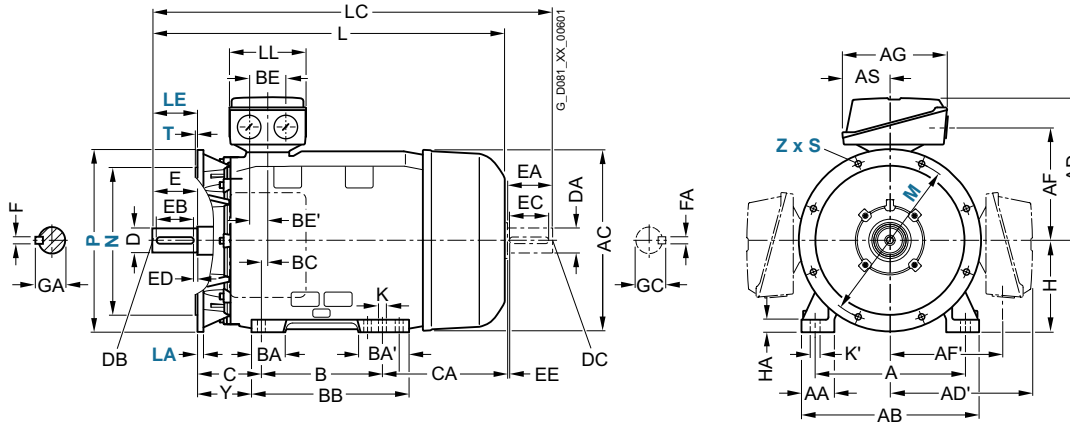

| For motor | | No. of poles | Dimension designation acc. to IEC | | | | | | | | | | DE shaft extension | | | | | NDE shaft extension | | | | | | | |
|------------|------------------------------------|--------------|-----------------------------------|----|-----|-----|----|----|-------------|------|-----|----|--------------------|-----|-----|----|----|---------------------|----|-----|-----|-----|----|----|---------|
| Frame size | Motor type | | H | HA | Y | HH | K | K' | L | LC | LL | D | DB | E | EB | ED | F | GA | DA | DC | EA | EC | EE | FA | GC |
| 280 S | 2DA0 | 2 | 280 | 40 | 160 | 210 | 24 | 30 | 960 | 1105 | 233 | 65 | M20 | 140 | 125 | 10 | 18 | 69 | 60 | M20 | 140 | 125 | 10 | 18 | 64 |
| | 2DB0, 2DC0, 2DD0 | 4, 6, 8 | | | | | | | | | | 75 | | | | | 20 | 79.5 | 65 | | | | | | 69 |
| 280 M | 2DA2 | 2 | 280 | 40 | 160 | 210 | 24 | 30 | 960 | 1105 | 233 | 65 | M20 | 140 | 125 | 10 | 18 | 69 | 60 | M20 | 140 | 125 | 10 | 18 | 64 |
| | 2DB2, 2DC2, 2DD2 | 4, 6, 8 | | | | | | | | | | 75 | | | | | 20 | 79.5 | 65 | | | | | | 69 |
| 315 S | 3AA0 | 2 | 315 | 50 | 181 | 238 | 28 | 35 | 1052 | 1197 | 299 | 65 | M20 | 140 | 125 | 10 | 18 | 69 | 60 | M20 | 140 | 125 | 10 | 18 | 64 |
| | 3AB0, 3AC0, 3AD0 | 4, 6, 8 | | | | | | | 1082 | 1227 | | 80 | | 170 | 140 | 25 | 22 | 85 | 70 | | | | | | 20 74.5 |
| 315 M | 3AA2 | 2 | 315 | 50 | 181 | 238 | 28 | 35 | 1217 | 1362 | 299 | 65 | M20 | 140 | 125 | 10 | 18 | 69 | 60 | M20 | 140 | 125 | 10 | 18 | 64 |
| | 3AB2 | 4 | | | | | | | 1247 | 1392 | | 80 | | 170 | 140 | 25 | 22 | 85 | 70 | | | | | | 20 74.5 |
| | 3AC2, 3AD2 | 6, 8 | | | | | | | 1082 | 1227 | | | | | | | | | | | | | | | |
| 315 L | 3AA4 | 2 | 315 | 50 | 181 | 238 | 28 | 35 | 1217 | 1362 | 299 | 65 | M20 | 140 | 125 | 10 | 18 | 69 | 60 | M20 | 140 | 125 | 10 | 18 | 64 |
| | 3AB4, 3AC4, 3AD4, 3AC5, 3AD5, 3AD6 | 4, 6, 8 | | | | | | | 1247 | 1392 | | 80 | | 170 | 140 | 25 | 22 | 85 | 70 | | | | | | 20 74.5 |
| | 3AA5 | 2 | | | 146 | | | | 1372 | 1517 | | 65 | | 140 | 125 | 10 | 18 | 69 | 60 | | | | | | 18 64 |
| | 3AB5, 3AC6 | 4, 6 | | | | | | | 1402 | 1547 | | 80 | | 170 | 140 | 25 | 22 | 85 | 70 | | | | | | 20 74.5 |

SIMOTICS XP 1MB1, 1MB5 explosion-protected motors

Notes

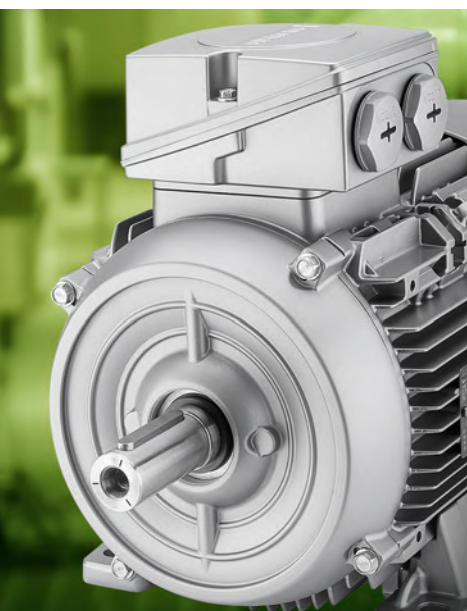
SIMOTICS DP application-specific motors

| | |
|------|--|
| 6/2 | Introduction |
| 6/3 | Marine motors |
| 6/3 | Orientation |
| 6/9 | Special versions |
| 6/9 | <u>Options</u> |
| 6/9 | • Aluminum series 1LE10 |
| 6/10 | • Cast-iron series 1LE15/1LE16 Basic/Performance Line |
| 6/11 | • Cast-iron series 1LE55/1LE56 Basic/Performance Line |
| 6/12 | • Aluminum series 1MB10, Cast-iron series 1MB15/1MB16/1MB55 |

SIMOTICS DP application-specific motors

Introduction

Overview

With the designation SIMOTICS DP, Siemens offers a number of industry and application specific (**D**efinite **P**urpose) motors that differ from standard motors in that they have special industry/application-specific features:

SIMOTICS DP marine motors

Marine motors are exposed to air humidity and other hostile conditions on the high seas and must always perform their function reliably. Our marine motors meet the standards of the leading classification companies (DNV GL, BV, LR, RS, KR, ABS, RINA) and have type test certifications up to frame size 315 L. They are basically suitable for the higher ambient temperatures in engine rooms below deck. If requested, a representative of the marine classification society can be present in our factories to formally accept equipment.

You will find more information on marine motors on the following pages.

SIMOTICS DP steel plant motors

The steel plant motors are specially designed for applications in the steel industry with stringent requirements for vibrations and shocks according to class 3M4 (EN 60721-3-3). They provide an optimized technical and economic solution for numerous transportation tasks in the steel manufacturing process or in steel manufacturing facilities, in which no scale dust occurs. Steel plant motors can be operated at a constant speed directly on the line or are used together with the SINAMICS S120 converter for dynamic processes.

The ordering data for SIMOTICS DP steel plant motors can be found in the Catalog Add On D 81.1 AO – Motors for the steel industry.

SIMOTICS DP roller table and steel plant motors

SIMOTICS DP roller table and steel plant motors are designed for directly driving the rollers of working roller tables in reversing rolling mills. They are designed as completely enclosed three-phase induction motors, with a housing made of spheroidal graphite cast iron, ring ribs, and reinforced bearing shields. This makes the motors ideal for use with typical shocks and vibrations and severe dirt due to scale dust. On account of their special mechanical design, they meet the most stringent requirements demanded by this application. Of course, the motors are also designed for variable-speed reversing operation on frequency converters of the SINAMICS S and G series.

The ordering data for SIMOTICS DP roller table and steel plant motors can be found in the Catalog Add On D 81.1 AO – Motors for the steel industry.

SIMOTICS DP crane motors

Like marine motors, crane motors are exposed to extreme climatic conditions and must meet tough operating requirements. Our crane motors stand up to high humidity levels, salt-laden air, and high wind speeds. They are characterized by high overload capability and a large speed setting range, for example, to operate hoist mechanisms efficiently in converter operation. SIMOTICS DP crane motors are reliably protected against corrosion with especially elaborate paint finishes and sealing. The rugged cast-iron motors are especially suitable for tough operation under hostile conditions, for indoor and outdoor use, e.g. in harbor facilities for rubber-tired gantry, rail-mounted gantry, and automatic stacking cranes. Special pulse encoders and brakes round off the product to form a perfectly adapted solution.

You can obtain further information on the SIMOTICS DP crane motors from your Siemens contact.

SIMOTICS DP application-specific motors – Marine motors

Orientation

Overview



Low-voltage motors in the marine version can be used below deck on ships and in the offshore industry. The thermal utilization of the motors is adapted to the generally higher ambient temperatures onboard ships. If the application demands compliance with additional regulations, such as explosion protection (Directive 2014/34/EU (ATEX 95)), the appropriate motor series must be chosen.

The motors on board ships are generally subdivided into three classes of importance by the marine classification societies in cooperation with customers, depending on the field of application:

- **Essential Service for Propulsion** or also referred to as Primary Essential Service
- **Essential Service** or also referred to as Secondary Essential Service or Important Service
- **Non-Essential Service** or also referred to as Non-Important Service

The class of importance must be specified by the customer (ordering party). Retrospective certification by means of individual acceptance test or construction supervision cannot be issued.

The categories include the following requirements of the classification societies:

| | Class of importance | | |
|---|---|---|--|
| | Essential Service for Propulsion | Essential Service | Non-Essential Service |
| Typical applications | Propeller drive, thruster | Thrusters, lateral thrust units, anchor winches, bilge and ballast pumps, fire-fighting pumps | Pumps for service water |
| Version | In accordance with the regulations set up by the classification society | | In accordance with ambient conditions set up by the classification society |
| Inspection certificate | Inspection certificate 3.2 in accordance with EN 10204 | Inspection certificate 3.1 in accordance with EN 10204 | None |
| Individual acceptance by classification society | Necessary if no type test certificate exists or the classification society has defined it based on the application | | Not required |
| Type test | Not a requirement of the classification societies For standard motors up to frame size 355, a type test certificate is supplied. These motors can only be ordered with options E11 to E54 in accordance with the classification society. | | |
| Ordering several identical motors | Differentiation between the first motor and additional ones must be realized when ordering using an order code | | No distinction |
| Rating plate data | Information about ambient conditions of the classification society | | |
| Stamp of the classification society | Stamp on shaft and housing | | No stamp |

Classification societies

| Society | Abbreviation | Location |
|---------------------------------------|---------------|----------|
| American Bureau of Shipping | ABS | USA |
| Bureau Veritas | BV | France |
| DNV GL Maritime | DNV GL | Germany |
| Korean Register | KR | Korea |
| Lloyds Register | LR | UK |
| Registro Italiano Navale | RINA | Italy |
| Russian Maritime Register of Shipping | RS | Russia |

SIMOTICS DP application-specific motors – Marine motors

Orientation

Overview

Type test (type approval)

All 1LE1, 1LE5, 1MB1, 1PC1, 1PC3, 1PC4 motors are manufactured and type tested in accordance with the regulations set up by the following international classification societies:

- ABS (American Bureau of Shipping)



- BV (Bureau Veritas, France)



- DNV GL Maritime



- KR (Korean Register of Shipping)



- LR (Lloyds Register of Shipping)



- Registro Italiano Navale (RINA)



- Russian Maritime Register of Shipping (RS)



Special versions that differ from the range defined in the catalog are possible on request.

Benefits

The marine motors offer the user a number of advantages and benefits:

- Cast-iron versions can be supplied for corrosive atmospheres especially for high humidity levels and salty air
- Increased corrosion protection using specially designed paint finishes is available
- Certified marine motors can be supplied for use in areas to be protected against explosion (hazardous zones)
- Due to the existing type test, individual acceptance test in power ranges below the power limits defined by the classification societies is not required which means short delivery times
- In depth know-how regarding customer requirements
- Worldwide service network with 24 hour service hotline for motors and converters

SIMOTICS DP application-specific motors – Marine motors

Orientation

Application

Our type tested marine motors are specially designed for use on board ship below deck and for the offshore industry:

- Applications on ships as main and auxiliary drives below deck, e.g.:
 - Fans (air conditioning systems, refrigeration systems)
 - Pumps (for fire-extinguishing water, fuels, oils)

- Winches (anchor winches, warping winches, lifting gear)
- Compressors
- Bow thruster drives
- Ex motors for hazardous zones
- Application in the offshore industry
 - Coastal areas, e.g. oil rigs, drilling ships

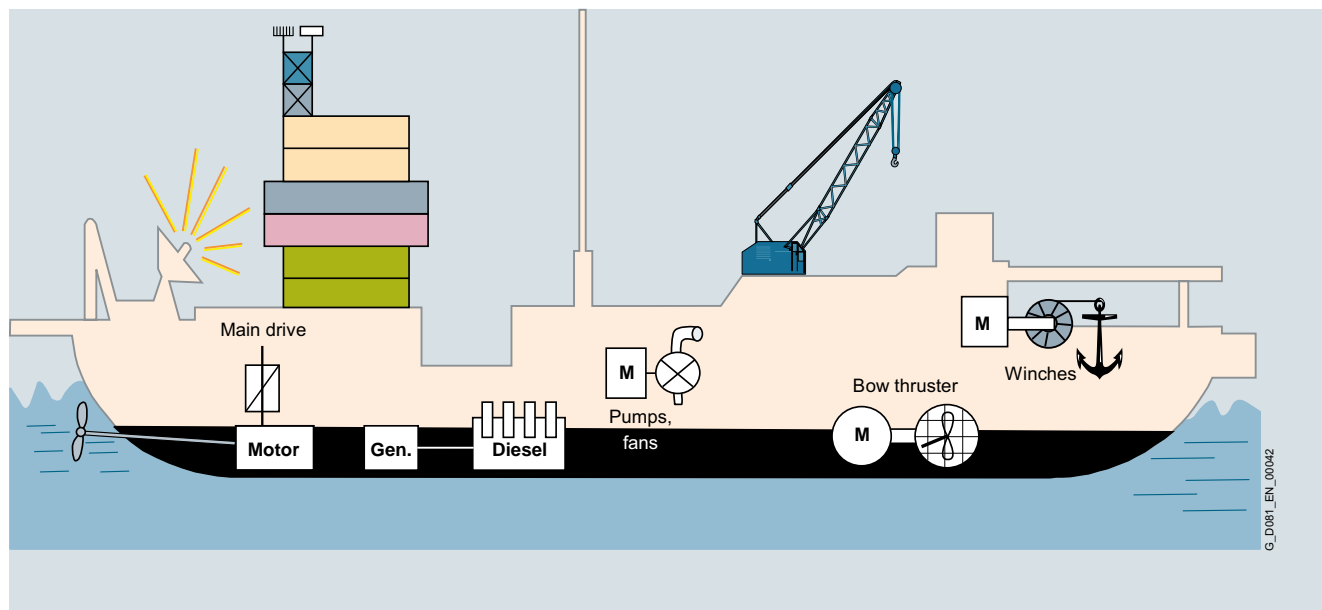

Typical below-deck applications

Technical specifications

Housing design

Motors can be supplied depending on the motor series in a corrosion-resistant aluminum housing or in a rugged low-vibration cast-iron version.

Motor connection

Cable glands are not included in the standard scope of supply with the exception of explosion-protected motors (see "Special versions").

All marine motors generally have an external grounding terminal.

Mountings (rotary pulse encoder, separately driven fan, brake)

Brakes, encoders and separately driven fans from our basic series (1LE, 1MB) are accepted as mountings without a separate certificate from the marine classification societies by the following: LR, RINA, RS, DNV GL, ABS and KR.

However, BV always demands separate certification for encoders. For this reason, 1LE1, 1MB1, 1PC1 and 1PC3 motors for BV can only be supplied in the "prepared for encoder mounting" condition. In this instance, the customer must bear responsibility for purchasing and installing a suitable encoder. With respect to brakes and separately driven fans, BV will also accept Siemens standard components.

Fan / fan cover

Fans and fan covers are made from the same materials as components from the basic series. BV stipulates that these components must be made of metal, and they are automatically supplied in this material when order code **E31** is specified.

SIMOTICS DP application-specific motors – Marine motors

Orientation

Technical specifications

Specifications of the individual classification societies with order codes (options) for motors in frame sizes 71M - 315 L

| Classification society | Coolant temperature CT | Admissible temperature rise limit according to the classification society | Rated power limit for individual acceptance test for essential service drive | Rated power limit for construction supervision for essential service drive | Order codes for surface-cooled motors up to frame size 315 L with type test certificate |
|------------------------|------------------------|---|--|--|---|
| | | Temperature class | | | |
| | °C | 130 (B) | 155 (F) | | |
| LR | 45 | 70 | 95 | ≥ 100 | E21 |
| BV | 45 | 75 | 100 | ≥ 100 | E31 |
| DNV GL | 45 | 75 | 100 | ≥ 300 | E51 |
| ABS | 50 | 70 | 95 | ≥ 100 ¹⁾ | E52 |
| RINA | 45 | 75 | 100 | ≥ 100 | E41 |
| RS | 45 | 75 | 95 | ≥ 20 | E46 |
| KR | 45 | 75 | 95 | ≥ 7.5 | E54 |

Type test certificates

The image displays several overlapping type approval certificates for Siemens asynchronous low-voltage motors. Key certificates include:

- ABS Certificate of Design Assess:** Certifies a representative of the Bureau of Verification for Siemens AG - D-97616 Bad Neustadt. It covers motor design plans and data for the below listed product.
- Bureau Veritas Type Approval Certificate:** Issued for Siemens AG, covering asynchronous machines with power below 100 kW. It specifies temperature class 130 (B) and 155 (F).
- Lloyd's Register Type Approval Certificate:** Issued for Siemens AG, Industry Sector Drive Technologies Division, Large Drive, I DT LD. It covers asynchronous low-voltage motors with asynchronous or cast iron enclosure.
- KR Type Approval Certificate:** Issued for Siemens AG, I DT LD, covering asynchronous low-voltage motors. It includes technical details like rated voltage (200 V up to 690 V) and speed (50 to 3000 rpm).
- RINA Type Approval Certificate:** Issued for Siemens AG, I DT LD, covering asynchronous low-voltage motors. It includes technical details like rated power (250 kW up to 3000 kW) and ambient temperature (40°C or 50°C).
- Other certificates:** From Bureau Veritas, Lloyd's Register, and KR, all covering various Siemens motor models and their compliance with international standards.

6

¹⁾ Required for all power ranges for ATEX compliance.

Technical specifications

Temperature class and coolant temperature

SIMOTICS GP/SD standard motors and SIMOTICS XP explosion-protected motors up to frame size 355

In general, marine motors are designed for a coolant temperature CT 45 °C in temperature class 155 (F) – used according to 155 (F) – with thermal reserve. When motors are used according to temperature class 130 (B) (order code **N05**), derating is required. For standard motors up to frame size 315 L, the derating is approx. 4 % (for order codes **E52** and **E21** approx. 8 %).

1MB1 motors in Zones 2, 21 and 22 are designed for temperature class 155 (F) – used according to temperature class 130 (B) – with derating of approx. 4 % (with order code **E52** approx. 8 %). Motors with increased power in temperature class 155 (F) – used according to temperature class 155 (F) – are also derated by approx. 4 % (with order code **E52** and **E21** approx. 8 %). If temperature class 155 (F) is to be used according to 130 (B), further derating of approximately 10 % is required.

Coolant temperatures that exceed CT 45 °C require derating in accordance with the following table:

| | Coolant temperature CT | | | |
|--|------------------------|-------|-------|-------|
| | 45 °C | 50 °C | 55 °C | 60 °C |
| Temperature class 155 (F) used according to 155 (F) | | | | |
| Derating factor for line operation | 1.00 | 0.96 | 0.92 | 0.87 |
| Temperature class 155 (F) used according to 130 (B) | | | | |
| Derating factor for line operation | 0.90 | 0.86 | 0.83 | 0.78 |

More detailed information is available on request.

Rating plate and inspection certificate

The rating plate indicates the relevant classification society and the associated coolant temperature

| V | Hz | A | kW | cosφ | NOM.EFF | 1/min | IE-CL |
|-------|----|-----|-----|------|---------|-------|-------|
| 400 Δ | 50 | 275 | 160 | 0.87 | 95.8 | 1490 | IE3 |
| 690 Y | 50 | 161 | 160 | 0.87 | 95.8 | 1490 | IE3 |
| 460 Δ | 60 | 275 | 184 | 0.88 | 96.2 | 1788 | IE3 |
| 460 Δ | 60 | 240 | 160 | 0.87 | 96.2 | 1791 | IE3 |

Rating plate for a marine motor according to DNV GL

Degree of protection

The protection classes applicable here are specified in the catalog sections for basic series 1LE1/1MB1/1PC1. With IP56, icing must be avoided.

Winding and motor protection

For monitoring the winding and bearings, the motors can be equipped with PTC thermistors, temperature sensors and resistance thermometers. Anti-condensation heaters can also be fitted to the marine motors to prevent condensation building up on the winding.

Paint finish

The standard paint finish is suitable for indoor installations or outdoor installations which are roof-protected against weathering.

When installing the standard motors in sea air or in rooms with permanent moisture, the special paint finish climate group "worldwide" according to IEC 60721-2-1 is appropriate, because this ensures a higher degree of corrosion protection. Most marine motors are finished in this special paint finish as standard (see "Special versions").

With particularly corrosive atmospheres, the sea-air-resistant special paint finish C4 (order code **S03**) or the offshore special paint finish C5 (order code **S04**) is recommended.

Special paint colors with the order codes **Y53** and **Y56** and increased film thicknesses are available on request.

Converter operation

The standard insulation of the motors is designed such that converter operation is permissible at line voltages up to $U_{\text{rated}} \leq 500$ V. The following limit values (voltage values are peak values) must be maintained: $U_{\text{phase-to-phase}} \leq 1500$ V, $U_{\text{phase-to-ground}} \leq 1100$ V, voltage rise times of $t_s > 0.1$ μs. Operation of motors at higher voltage peaks (e.g. on converters with controlled input, e.g. AFE, ALM) requires motors with higher insulation resistance.

Please inquire in this case.

During installation, the EMC guidelines must be complied with. This does not apply to motors in type of protection Ex eb according to IEC/EN 60079-2 that are certified only for line operation.

It is important to note the extent to which the converter used must also be acceptance tested by the marine classification authority.

SIMOTICS DP application-specific motors – Marine motors

Orientation

Technical specifications

Recommended special versions

- Motor protection with 1 or 3 PTC thermistors – for tripping (2 terminals) – 15th position of the Article No. **B**
- Installation of Pt100 resistance thermometers for winding temperature monitoring – 16th position of the Article No. **"H"**
- Especially for the motor series 1LE5:
Installation of 2 Pt100 resistance thermometers in basic circuit for rolling-contact bearings – order code **Q72**
- Anti-condensation heating for 230 V – order code **Q02**
- Anti-condensation heating for 115 V – order code **Q03**
- IP56 degree of protection for protection against harmful dust deposits, protection against water jets from any direction – order code **H22**
- IP65 degree of protection for complete protection against dust deposits, protection against water jets from any direction – order code **H20**
- Special bearing for drive-end (DE) and non-drive-end (NDE), bearing size 63 – order code **L25**, for non-standard motors on request
- Metal external fan for self-ventilated motors – order codes **F74** and **F76** (standard with order code **E31**)

Additional notes

Order information

The fees levied by the classification societies for individual acceptance testing are included in order code **B10** for motor types 1LE1, 1LE5, 1PC5, 1MB1, 1PC1 and 1PC3.

When ordering, add the supplement **-Z** to the Article No. and state details in plain text if required.

For information about other special versions, refer to the appropriate sections under "SIMOTICS GP/SD 1LE1/1PC1 standard motors" and "SIMOTICS XP 1MB1 explosion-protected motors".

In addition to this, for marine motors, the following special versions are the "Standard version" and therefore included in the order codes for the basic marine version.

Standard version:

| Designation | Order code |
|---|------------|
| Inspection certificate 3.1 in accordance with EN 10204 Note: The delivery time for the manufacturer's test certificate may differ from the delivery time for the motor. | B02 |
| External grounding terminal | H04 |

Ordering example

| Selection criteria | Requirement | Structure of the Article No. |
|----------------------------------|---|---|
| Motor type | SIMOTICS SD Basic Line, efficiency class IE3 Premium Efficiency, IP55 degree of protection, IM B3 type of construction, without winding protection, terminal box at top | 1LE1503 |
| No. of poles, speed, rated power | 4-pole, 1500 rpm, 55 kW | 1LE1503-2CB2 |
| Voltage, frequency | 400 VΔ/690 VY, 50 Hz | 1LE1503-2CB23-4 |
| Type of construction | IM B3 | 1LE1503-2CB23-4A |
| Motor protection | 1 or 3 PTC thermistors – for tripping (2 terminals) | 1LE1503-2CB23-4AB |
| Terminal box position | Terminal box right | 1LE1503-2CB23-4AB5 |
| Paint finish | Paint finish in "Brilliant blue" RAL 5007 | 1LE1503-2CB23-4AB5-Z Y53 Plain text: RAL5007 |
| Marine version | Drive for "Essential Services" with type test certificate according to DNV GL Maritime with coolant temperature CT 45 °C | 1LE1503-2CB23-4AB5-Z Y53+E51 Plain text: RAL5007 |
| | Individual acceptance (by marine classification society) | 1LE1503-2CB23-4AB5-Z Y53+E51+B10 Plain text: RAL5007 |
| Motor order | Type test with temperature-rise run for horizontal motors, with acceptance | 1LE1503-2CB23-4AB5-Z Y53+E51+B10+B83 Plain text: RAL5007 |

The ordering example is valid for an order quantity of 1 item. For larger order quantities, a type test with heat run (order code **B83**) has only to be ordered for one motor. It is not necessary to specify order code **B83** for any further identical motors (included in the same order). The order must be divided into two order items; see "Example for 5 identical motors".

Example for 5 identical motors

| Order item | Quantity in units | Article No. |
|------------|-------------------|--|
| 1 | 1 | 1LE1503-2CB23-4AB5-Z Z=Y53+E51+B10+B83 Plain text: RAL 5007 |
| 2 | 4 | 1LE1503-2CB23-4AB5-Z Z=Y53+E51+B10 Plain text: RAL 5007 |

SIMOTICS DP application-specific motors – Marine motors

Special versions · Options

Aluminum series 1LE10

Selection and ordering data

| Special versions | Additional identification code -Z with order code and plain text if required | Frame size | | | | | | | | | | Motor version | | |
|---------------------------|---|------------|----|---------|----|---------|-----|---------|-----|-----|-----|---------------|---------------|------------|
| | | 63 | 71 | 80 | 90 | 100 | 112 | 132 | 160 | 180 | 200 | | | |
| | | | | | | 1LE1004 | | | | | | | IEC | IE4 |
| | | | | 1LE1003 | | | | | | | | | | IE3 |
| | | 1LE1001 | | | | | | | | | | | | IE2 |
| | | 1LE1002 | | | | | | | | | | | | IE1 |
| | | | | 1LE1023 | | | | | | | | | Eagle Line | NPE (NEMA) |
| | | | | 1LE1021 | | | | | | | | | | NEE (NEMA) |
| | | | | | | | | 1LE1011 | | | | | Pole-changing | |
| | | | | | | | | 1LE1012 | | | | | | |
| 1LE10 -Z | | Order code | | | | | | | | | | | | |

Marine version – Basic version

| | | 63 | 71 | 80 | 90 | 100 | 112 | 132 | 160 | 180 | 200 | | |
|---|------------|----|----|----|----|-----|-----|-----|-----|-----|-----|--|--|
| With type test certificate according to Lloyds Register (LR), CT 45 °C, temperature class 155 (F), utilized according to 155 (F) | E21 | ✓ | ✓ | ✓ | ✓ | ✓ | ✓ | ✓ | ✓ | ✓ | ✓ | | |
| With type test certificate according to Bureau Veritas (BV), CT 45 °C, temperature class 155 (F), utilized according to 155 (F) | E31 | ✓ | ✓ | ✓ | ✓ | ✓ | ✓ | ✓ | ✓ | ✓ | ✓ | | |
| With type test certificate according to Registro Italiano Navale (RINA), CT 45 °C, temperature class 155 (F), utilized according to 155 (F) | E41 | ✓ | ✓ | ✓ | ✓ | ✓ | ✓ | ✓ | ✓ | ✓ | ✓ | | |
| With type test certificate according to Russian Maritime Register (RS), CT 45 °C, temperature class 155 (F), utilized according to 155 (F) | E46 | ✓ | ✓ | ✓ | ✓ | ✓ | ✓ | ✓ | ✓ | ✓ | ✓ | | |
| With type test certificate according to DNV GL Maritime, CT 45 °C, temperature class 155 (F), utilized according to 155 (F) | E51 | ✓ | ✓ | ✓ | ✓ | ✓ | ✓ | ✓ | ✓ | ✓ | ✓ | | |
| With type test certificate according to American Bureau of Shipping (ABS), CT 50 °C, temperature class 155 (F), utilized according to 155 (F) | E52 | ✓ | ✓ | ✓ | ✓ | ✓ | ✓ | ✓ | ✓ | ✓ | ✓ | | |
| With type test certificate according to Korean Register of Shipping (KR), CT 45 °C, temperature class 155 (F), utilized according to 155 (F) | E54 | ✓ | ✓ | ✓ | ✓ | ✓ | ✓ | ✓ | ✓ | ✓ | ✓ | | |

Marine version – Acceptance/certification

| | | 63 | 71 | 80 | 90 | 100 | 112 | 132 | 160 | 180 | 200 | | |
|--|------------|----|----|----|----|-----|-----|-----|-----|-----|-----|--|--|
| Individual acceptance by marine classification society | B10 | ✓ | ✓ | ✓ | ✓ | ✓ | ✓ | ✓ | ✓ | ✓ | ✓ | | |
| Type test with heat run for horizontal motors, with acceptance | B83 | ✓ | ✓ | ✓ | ✓ | ✓ | ✓ | ✓ | ✓ | ✓ | ✓ | | |

- ✓ With additional charge
- Not possible

SIMOTICS DP application-specific motors – Marine motors

Special versions · Options

Cast-iron series 1LE15/1LE16 Basic/Performance Line

Selection and ordering data

| Special versions | Additional identification code -Z with order code and plain text if required | Frame size | | | | | | | | | | | | Motor version | |
|----------------------------------|--|------------|--------------------|--------------------------|--------------------|-----|-----|-----|-----|-----|------------|------------|------------|---------------|--|
| | | 71 | 80 | 90 | 100 | 112 | 132 | 160 | 180 | 200 | 225 | 250 | 280 | 315 | |
| 1LE1...-.....-.....-Z Order code | | | | | 1LE1504 Basic Line | | | | | | | | IEC | IE4 | |
| | | | | 1LE1604 Performance Line | | | | | | | | | | | |
| | | | | 1LE1503 Basic Line | | | | | | | | IE3 | | | |
| | | | | 1LE1603 Performance Line | | | | | | | | | | | |
| | | | | 1LE1501 Basic Line | | | | | | | | IE2 | | | |
| | | | | 1LE1601 Performance Line | | | | | | | | | | | |
| | | | | 1LE1523 Basic Line | | | | | | | | Eagle Line | NPE (NEMA) | | |
| | | | | 1LE1623 Performance Line | | | | | | | | | | | |
| | | | 1LE1521 Basic Line | | | | | | | | NEE (NEMA) | | | | |

Marine version – Basic version

| Description | Code | 71 | 80 | 90 | 100 | 112 | 132 | 160 | 180 | 200 | 225 | 250 | 280 | 315 |
|---|------|----|----|----|-----|-----|-----|-----|-----|-----|-----|-----|-----|-----|
| With type test certificate according to Lloyds Register (LR), CT 45 °C, temperature class 155 (F), utilized according to 155 (F) | E21 | ✓ | ✓ | ✓ | ✓ | ✓ | ✓ | ✓ | ✓ | ✓ | ✓ | ✓ | ✓ | ✓ |
| With type test certificate according to Bureau Veritas (BV), CT 45 °C, temperature class 155 (F), utilized according to 155 (F) | E31 | ✓ | ✓ | ✓ | ✓ | ✓ | ✓ | ✓ | ✓ | ✓ | ✓ | ✓ | ✓ | ✓ |
| With type test certificate according to Registro Italiano Navale (RINA), CT 45 °C, temperature class 155 (F), utilized according to 155 (F) | E41 | ✓ | ✓ | ✓ | ✓ | ✓ | ✓ | ✓ | ✓ | ✓ | ✓ | ✓ | ✓ | ✓ |
| With type test certificate according to Russian Maritime Register (RS), CT 45 °C, temperature class 155 (F), utilized according to 155 (F) | E46 | ✓ | ✓ | ✓ | ✓ | ✓ | ✓ | ✓ | ✓ | ✓ | ✓ | ✓ | ✓ | ✓ |
| With type test certificate according to DNV GL Maritime, CT 45 °C, temperature class 155 (F), utilized according to 155 (F) | E51 | ✓ | ✓ | ✓ | ✓ | ✓ | ✓ | ✓ | ✓ | ✓ | ✓ | ✓ | ✓ | ✓ |
| With type test certificate according to American Bureau of Shipping (ABS), CT 50 °C, temperature class 155 (F), utilized according to 155 (F) | E52 | ✓ | ✓ | ✓ | ✓ | ✓ | ✓ | ✓ | ✓ | ✓ | ✓ | ✓ | ✓ | ✓ |
| With type test certificate according to Korean Register of Shipping (KR), CT 45 °C, temperature class 155 (F), utilized according to 155 (F) | E54 | ✓ | ✓ | ✓ | ✓ | ✓ | ✓ | ✓ | ✓ | ✓ | ✓ | ✓ | ✓ | ✓ |

Marine version – Acceptance/certification

| Description | Code | 71 | 80 | 90 | 100 | 112 | 132 | 160 | 180 | 200 | 225 | 250 | 280 | 315 |
|--|------|----|----|----|-----|-----|-----|-----|-----|-----|-----|-----|-----|-----|
| Individual acceptance by marine classification society | B10 | ✓ | ✓ | ✓ | ✓ | ✓ | ✓ | ✓ | ✓ | ✓ | ✓ | ✓ | ✓ | ✓ |
| Type test with heat run for horizontal motors, with acceptance | B83 | ✓ | ✓ | ✓ | ✓ | ✓ | ✓ | ✓ | ✓ | ✓ | ✓ | ✓ | ✓ | ✓ |

- ✓ With additional charge
- Not possible

SIMOTICS DP application-specific motors – Marine motors

Special versions · Options

Cast-iron series 1LE55/1LE56 Basic/Performance Line

Selection and ordering data

| Special versions | Additional identification code -Z with order code and plain text if required | Frame size | | Motor version | |
|------------------|--|--------------------------|-----|---------------|-----|
| | | 315 | 355 | IEC | IE4 |
| 1LE5 -Z | Order code | 1LE55.4 Basic Line | | | |
| | | 1LE56.4 Performance Line | | | |
| | | 1LE55.3 Basic Line | | | IE3 |
| | | 1LE56.3 Performance Line | | | |

Marine version – Basic version

| | | | | |
|---|------------|---|---|--|
| With type test certificate according to Lloyds Register (LR), CT 45 °C, temperature class 155 (F), utilized according to 155 (F) | E21 | ✓ | ✓ | |
| With type test certificate according to Registro Italiano Navale (RINA), CT 45 °C, temperature class 155 (F), utilized according to 155 (F) | E41 | ✓ | ✓ | |
| With type test certificate according to Russian Maritime Register (RS), CT 45 °C, temperature class 155 (F), utilized according to 155 (F) | E46 | ✓ | ✓ | |
| With type test certificate according to DNV GL Maritime, CT 45 °C, temperature class 155 (F), utilized according to 155 (F) | E51 | ✓ | ✓ | |
| With type test certificate according to American Bureau of Shipping (ABS), CT 50 °C, temperature class 155 (F), utilized according to 155 (F) | E52 | ✓ | ✓ | |

Marine version – Acceptance/certification

| | | | | |
|--|------------|---|---|--|
| Individual acceptance by marine classification society | B10 | ✓ | ✓ | |
| Type test with heat run for vertical motors, with acceptance | B81 | ✓ | ✓ | |
| Type test with heat run for horizontal motors, with acceptance | B83 | ✓ | ✓ | |

✓ With additional charge

SIMOTICS DP application-specific motors – Marine motors

Special versions · Options

Aluminum series 1MB10, cast-iron series 1MB15/1MB16/1MB55

Selection and ordering data

| Special versions | Additional identification code -Z with order code and plain text if required | Frame size | | | | | | | | | | | | | Motor version | | | |
|---|--|------------|--------------------------|---------|-----|-----|-----|-----|-----|-----|-----|-----|-----|-----|---------------|---|-----|-----|
| | | 71 | 80 | 90 | 100 | 112 | 132 | 160 | 180 | 200 | 225 | 250 | 280 | 315 | 355 | | | |
| Aluminum series | | | 1MB10.3 | | | | | | | | | | | | | | IEC | IE3 |
| | | | 1MB10.1 | | | | | | | | | | | | | | | IE2 |
| | | | | 1MB10.2 | | | | | | | | | | | | | | |
| Cast-iron series | | | 1MB15.3 Basic Line | | | | | | | | | | | | | | IE3 | |
| | | | 1MB16.3 Performance Line | | | | | | | | | | | | | | | |
| | | | 1MB1553 | | | | | | | | | | | | | | | |
| | | | 1MB5553 | | | | | | | | | | | | | | | |
| 1MB.....-.....-.....-Z | Order code | | 1MB15.1 Basic Line | | | | | | | | | | | | | | IE2 | |
| | | | 1MB16.1 Performance Line | | | | | | | | | | | | | | | |
| Marine version – Basic version | | | | | | | | | | | | | | | | | | |
| With type test certificate according to Lloyds Register (LR), CT 45 °C, temperature class 155 (F), utilized according to 155 (F) | E21 | ✓ | ✓ | ✓ | ✓ | ✓ | ✓ | ✓ | ✓ | ✓ | ✓ | ✓ | ✓ | ✓ | ✓ | ✓ | | |
| With type test certificate according to Bureau Veritas (BV), CT 45 °C, temperature class 155 (F), utilized according to 155 (F) | E31 | ✓ | ✓ | ✓ | ✓ | ✓ | ✓ | ✓ | ✓ | ✓ | ✓ | ✓ | ✓ | ✓ | ✓ | ✓ | | |
| With type test certificate according to Registro Italiano Navale (RINA), CT 45 °C, temperature class 155 (F), utilized according to 155 (F) | E41 | ✓ | ✓ | ✓ | ✓ | ✓ | ✓ | ✓ | ✓ | ✓ | ✓ | ✓ | ✓ | ✓ | ✓ | ✓ | | |
| With type test certificate according to Russian Maritime Register (RS), CT 45 °C, temperature class 155 (F), utilized according to 155 (F) | E46 | ✓ | ✓ | ✓ | ✓ | ✓ | ✓ | ✓ | ✓ | ✓ | ✓ | ✓ | ✓ | ✓ | ✓ | ✓ | | |
| With type test certificate according to DNV GL Maritime, CT 45 °C, temperature class 155 (F), utilized according to 155 (F) | E51 | ✓ | ✓ | ✓ | ✓ | ✓ | ✓ | ✓ | ✓ | ✓ | ✓ | ✓ | ✓ | ✓ | ✓ | ✓ | | |
| With type test certificate according to American Bureau of Shipping (ABS), CT 50 °C, temperature class 155 (F), utilized according to 155 (F) | E52 | ✓ | ✓ | ✓ | ✓ | ✓ | ✓ | ✓ | ✓ | ✓ | ✓ | ✓ | ✓ | ✓ | ✓ | ✓ | | |
| With type test certificate according to Korean Register of Shipping (KR), CT 45 °C, temperature class 155 (F), utilized according to 155 (F) | E54 | ✓ | ✓ | ✓ | ✓ | ✓ | ✓ | ✓ | ✓ | ✓ | ✓ | ✓ | ✓ | ✓ | ✓ | ✓ | | |
| Marine version – Acceptance/certification | | | | | | | | | | | | | | | | | | |
| Individual acceptance by marine classification society | B10 | ✓ | ✓ | ✓ | ✓ | ✓ | ✓ | ✓ | ✓ | ✓ | ✓ | ✓ | ✓ | ✓ | ✓ | ✓ | | |
| Type test with heat run for horizontal motors, with acceptance | B83 | ✓ | ✓ | ✓ | ✓ | ✓ | ✓ | ✓ | ✓ | ✓ | ✓ | ✓ | ✓ | ✓ | ✓ | ✓ | | |

✓ With additional charge

Appendix



| | |
|---|--|
| 7/2 7/2 | NEMA motors Motors according to NEMA standard |
| 7/5 7/6 7/8 | Industry Services Industry Services – Portfolio overview Online Support |
| 7/9 7/9 | Partner Partner at Siemens |
| 7/10 7/10 7/11 7/12 7/13 | Tools and engineering Drive Technology Configurator selection tool SinaSave energy efficiency tool SIZER for Siemens Drives engineering tool SIPLUS CMS Condition Monitoring Systems for the continuous condition monitoring of motors |
| 7/14 | Index of order codes |
| 7/22 | Conversion tables |
| 7/24 7/24 7/25 7/26 | Metal surcharges <ul style="list-style-type: none"> • Explanation of the raw material/ metal surcharges • Explanation of the raw material/ metal surcharges for dysprosium and neodym (rare earths) • Values of the metal factor |
| 7/27 7/27 7/27 7/28 | Conditions of sale and delivery <ul style="list-style-type: none"> • 1. General Provisions • 2. Prices • 3. Additional Terms and Conditions • 4. Export Regulations |

Appendix

NEMA motors

Motors according to NEMA standard



NEMA motors (National Electrical Manufacturers Association) for the North American market distinguish themselves as a result of their new design – and especially as a result of their efficiency. Siemens offers a complete line of General Purpose motors (aluminum and cast-iron design), Severe Duty motors, IEEE 841 and XP motors with NEMA Premium or higher efficiencies. Energy-saving motors with NEMA Premium efficiency class comply with the US EISA legislation (Energy Independence and Security Act) for minimum efficiencies. Our NEMA Premium + efficiency class exceeds the efficiencies specified in the EISA standards.

The motors are mechanically and electrically compliant with NEMA MG1. In addition to the minimum efficiencies specified in the US, these motors also fulfill the minimum efficiency requirements for Canada (CSA) and Mexico (NOM).

General technical specifications

| | |
|-----------------------------|---|
| Voltage and power range | 208 ... 230/460 V, 575 V, 60 Hz 1 ... 400 hp (0.75 ... 300 kW) |
| Frame sizes and types | NEMA frame sizes 140 ... 440 |
| Pole number and frequencies | 2, 4, 6 and 8-pole, 60 Hz |
| Environmental conditions | Surface-cooled with IP54/IP55 degree of protection |

Customer benefits

Copper die-cast rotors optimize the efficiency

Copper die-cast rotors reduce the power loss and slightly reduce the motor length. This version reduces the motor life cycle costs as a result of the lower energy consumption.

Can be easily modified for high versatility

Unmounted feet (aluminum housing) or 8-hole foot mounting (cast-iron housing) make it easier to modify the motors, ensure a high degree of versatility and reduce inventory costs – for the OEM as well as for servicing and maintenance.

A design that fulfills each and every requirement

We offer motors suitable for any application in a lightweight aluminum design or with a rugged cast-iron housing. Both variants are available with NEMA Premium or NEMA Premium + efficiency. The perfect fit for any operating period.

Typical applications

NEMA motors are suitable throughout the industrial and commercial field, in the automotive, textile, printing and chemical industries as well as in cross-industry applications – for example in conveyor technology. The HVAC sector (Heating, Ventilating & Air Conditioning), for instance, which requires extremely light motors, provides typical applications for our so-called General Purpose motors – either with cast-iron or aluminum housings. Severe Duty motors in a fully cast-iron design are suitable for use under harsh environmental conditions – for instance in the pulp and paper industry. The Severe Duty SD100 IEEE 841 motor version even exceeds the stringent IEEE 841 standards applicable in the crude oil and chemical industries.

More information

The full range of products with all ordering data and technical information can be found in Catalog
D 81.2, US/Canada www.sea.siemens.com/motors.



General Purpose



GP100A

| | | |
|----------------------------------|--|---|
| Power range | 1 ... 20 hp (0.75 ... 15 kW) | FS 140 ... 250 |
| Frame size (FS) | 140 ... 250 | |
| Degree of protection NEMA MG1 | TEFC (totally enclosed fan cooled) | |
| Housing material | Die-cast aluminum | 8-hole foot mounting |
| Efficiency | NEMA Premium NEMA Premium + | FS 140 ... 250 FS 140 ... 250 |
| Power supply | 3-phase, 60 Hz | |
| Voltage | 208 ... 230/460 V 575 V | FS 140 ... 250 FS 140 ... 250 |
| Service factor | 1.15 | Sinusoidal |
| Electrical design | NEMA design B | |
| Hazard classification | Not specified | |
| Insulation | Class F | NEMA MG1 Part 31 |
| Utilization | Class B at 1.0 SF, Class F at 1.15 SF | Sinusoidal |
| Terminal box (oversized) | Die-cast aluminum | FS 140 ... 250 |
| Fan cover | Plastic | FS 140 ... 250 |
| Fan | Bi-directional - Polypropylene | |
| Seal | O-ring | FS 140 ... 250 |
| Rotor material | Die-cast aluminum Die-cast copper | FS 140 ... 250 FS 140 ... 250 |
| Stator winding | Copper – random wound | |
| Shaft material | High-strength carbon steel | C1045 |
| Shaft seal/ slinger | V-ring slinger meets IP54 | (DE only) |
| Bearing housing | Cast aluminum | FS 140 ... 250 |
| Bearing type | Double-shielded | FS 140 ... 250 |
| Bearing inner cap | No | |
| Lubrication | Polyurea | Base grease |
| Oil filling nozzle | Not specified | |
| Oil drain valve | Not specified | |
| Vibrations | 0.15 IPS | |
| Rating plate | Aluminum | Engraved |
| Condensation drainage hole | Condensation drainage holes – lowest point (2) | |
| Mountings | Rust-resistant | |
| Lifting eye | Cast | |
| Paint finish | ALKYED modified | RAL7030 |
| Warranty | 18 months | |
| Converter operation | VT 20:1 CT 4:1 CT 10:1 | FS 140 ... 250 FS 140 ... 250 FS 140 ... 250 (Cu) |
| Catalog | D 81.2, US/Canada | |



Motors according to NEMA standard

| | | Severe Duty | | | |
|---|--|---|---|---|---|
|  | |  | |  | |
| GP100 | | SD100 | | SD100 IEE841 | |
| 1 ... 200 hp (0.75 ... 132 kW) | FS 140 ... 440 | 1 ... 400 hp (0.75 ... 300 kW) | FS 140 ... S440 | 1 ... 400 hp (0.75 ... 300 kW) | FS 140 ... S440 |
| 140 ... 440 | | 140 ... S449 | | 140 ... S449 | |
| TEFC (totally enclosed fan cooled) | | TEFC (totally enclosed fan cooled) | | TEFC (totally enclosed fan cooled) | |
| Cast iron | 8-hole foot | Cast iron | 8-hole foot | Cast iron | 8-hole foot |
| NEMA Premium NEMA Premium + | FS 140 ... 440 FS 140 ... 250 | NEMA Premium NEMA Premium + | FS 140 ... S440 FS 140 ... 250 | NEMA Premium NEMA Premium + | FS 140 ... S440 FS 140 ... 250 |
| 3-phase, 60 Hz | | 3-phase, 60 Hz | | 3-phase, 60 Hz | |
| 208 ... 230/460 V 230/460 V 460 V 575 V | FS 140 ... 250 FS 280 ... 360 100 ... 200 hp 1 ... 200 hp | 208 ... 230/460 V 460 V 575 V | 1 ... 20 hp 25 ... 400 hp 1 ... 400 hp | 460 V 575 V | FS 140 ... S440 FS 140 ... S440 |
| 1.15 | Sinusoidal | 1.15 | Sinusoidal | 1.15 | Sinusoidal |
| NEMA design B | | NEMA design B | | NEMA design B | |
| Not specified | | CL I Gr, C&D Div. 2 | Optional | CL I Gr, C&D Div. 2 | Optional |
| Class F | NEMA MG1 Part 31 | Class F | NEMA MG1 Part 31 | Class F | NEMA MG1 Part 31 |
| Class B at 1.0 SF, Class F at 1.15 SF | Sinusoidal | Class B at 1.0 SF, Class F at 1.15 SF | Sinusoidal | Class B at 1.0 SF, Class F at 1.15 SF | Sinusoidal |
| Die-cast aluminum Steel Cast iron | FS 140 ... 250 FS 280 ... 400 FS 440 | Cast iron | | Cast iron | |
| Plastic Cast iron | FS 140 ... 250 FS 280 ... 440 | Cast iron | FS 140 ... S440 | Cast iron | FS 140 ... S440 |
| Bi-directional - Polypropylene | | Bi-directional - Polypropylene - Bronze Counterclockwise | FS 140 ... 440 FS S440 300 ... 400 hp 2P/4P | Bi-directional - Polypropylene - Bronze Counterclockwise | FS 140 ... 440 FS S440 300 ... 400 hp 2P/4P |
| O-ring Neoprene | FS 140 ... 250 FS 280 ... 440 | Neoprene | | Neoprene | |
| Die-cast aluminum Die-cast copper | FS 140 ... 440 FS 140 ... 250 | Die-cast aluminum Die-cast copper | FS 140 ... S440 FS 140 ... 250 | Die-cast aluminum Die-cast copper | FS 140 ... S440 FS 140 ... 250 |
| Copper – random wound | | Copper – random wound | | Copper – random wound | |
| High-strength carbon steel | C1045 | High-strength carbon steel | C1045 | High-strength carbon steel | C1045 |
| V-ring slinger meets IP54 | (DE only) | V-ring slinger meets IP54 | (DE, NDE) | Inpro/seal bearing insulation meets IP55 | (DE, NDE) |
| Cast iron | FS 140 ... 440 | Cast iron | FS 140 ... S440 | Cast iron | FS 140 ... S440 |
| Double-shielded Regreasable inlet and outlet | (FS 440 only) | Double-shielded Single-shielded Regreasable inlet and outlet | FS 140 ... 250 FS 280 ... S440 | Double-shielded Single-shielded Regreasable inlet and outlet | FS 140 ... 250 FS 280 ... S440 |
| No | | Cast iron | | Cast iron | |
| Polyurea | Base grease | Polyurea | Base grease | Polyurea | Base grease |
| Alemite | FS 440 only | Alemite | | Alemite | |
| Plug | FS 440 only | Plug | | Pressure relief (automatic) | |
| 0.15 IPS | | 0.08 IPS | | 0.06 IPS | |
| Aluminum | Engraved | Stainless steel | Engraved | Stainless steel | Embossed |
| Condensation drainage holes – lowest point (2) | | T discharges – lowest point (2) | | T discharges – lowest point (2) | |
| Rust-resistant | | Rust-resistant | | Rust-resistant | |
| Included | > 75 lb (> 34.0 kg) | Included | > 75 lb (> 34.0 kg) | Included | |
| ALKYED modified | RAL7030 | ALKYED modified | RAL7030 | ALKYED modified | RAL7030 |
| 18 months | | 36 months | | 60 months | |
| VT 20:1 CT 4:1 CT 10:1 | FS 140 ... 440 FS 140 ... 440 FS 140 ... 250 (Cu) | CT 20:1 CT 4:1 CT 10:1 | FS 143 ... 365 FS 140 ... 440 FS 140 ... 250 (Cu) | CT 20:1 CT 4:1 CT 10:1 | FS 143 ... 365 FS 140 ... 440 FS 140 ... 250 (Cu) |
| D 81.2, US/Canada | | D 81.2, US/Canada | | D 81.2, US/Canada | |

Appendix

NEMA motors

Motors according to NEMA standard

| | Explosion Protected | | | | Definite Purpose | |
|----------------------------------|---|--|---|--|---|---|
| |  | |  | |  | |
| | XP100 | | XP100 ID1 | | SD10 MS | |
| Power range | 1 ... 300 hp (0.75 ... 200 kW) | FS 140 ... 440 | 1 ... 300 hp (0.75 ... 200 kW) | FS 140 ... 440 | 1 ... 200 hp (0.75 ... 160 kW) | 4/8-pole – 1W VT |
| Frame size (FS) | 140 ... 440 | | 140 ... 440 | | 140 ... 440 | |
| Degree of protection NEMA MG1 | TEFC (totally enclosed fan cooled) | | TEFC (totally enclosed fan cooled) | | TEFC (totally enclosed fan cooled) | |
| Housing material | Cast iron | 8-hole foot | Cast iron | 8-hole foot | Cast iron | 8-hole foot |
| Efficiency | NEMA Premium | FS 140 ... 440 | NEMA Premium | FS 140 ... 440 | Standard | FS 140 ... 440 |
| Power supply | 3-phase, 60 Hz | | 3-phase, 60 Hz | | 3-phase, 60 Hz | |
| Voltage | 208 ... 230/460 V 230/460 V 460 V 575 V | 1 ... 20 hp 25 ... 100 hp 125 ... 300 hp 1 ... 300 hp | 208 ... 230/460 V 230/460 V 460 V 575 V | 1 ... 20 hp FS 280 ... 100 hp 125 ... 300 hp 1 ... 300 hp | 460 V 575 V | FS 140 ... 440 FS 140 ... 440 |
| Service factor | 1.0 | Sinusoidal | 1.0 | Sinusoidal | 1.0 | Sinusoidal |
| Electrical design | NEMA design B | | NEMA design B | | Not specified | |
| Hazard classification | CL I Gr. C&D, CL II F&G Div 1 | Max. code T3C | CL I Gr. D, Div 1 | Max. code T2A | Not specified | |
| Insulation | Class F | NEMA MG1 Part 31 | Class F | NEMA MG1 Part 31 | Class F | NEMA MG1 Part 31 |
| Utilization | Class B at 1.0 SF, Class F at 1.15 SF | Sinusoidal | Class B at 1.0 SF, Class F at 1.15 SF | Sinusoidal not with 300, 250 hp, 4-pole | Class B at 1.0 SF, Class F at 1.15 SF | Sinusoidal not with 300, 250 hp, 4-pole |
| Terminal box (oversized) | Cast iron | | Cast iron | | Cast iron | |
| Fan cover | Cast iron | | Cast iron | | Cast iron | |
| Fan | Bi-directional - Polypropylene | FS 140 ... 440 | Bi-directional - Polypropylene | FS 140 ... 440 | Bi-directional - Polypropylene | FS 140 ... 440 |
| Seal | Neoprene | | Not specified (lead seal) | | Neoprene | |
| Rotor material | Die-cast aluminum | | Die-cast aluminum | | Die-cast aluminum | |
| Stator winding | Copper – random wound NC protective device | FS 140 – 440 Included | Copper – random wound NC protective device | FS 140 – 440 Not specified | Copper – random wound | FS 140 ... 440 |
| Shaft material | High-strength carbon steel | | High-strength carbon steel | | High-strength carbon steel | |
| Shaft seal/ slinger | V-ring slinger meets IP54 | (DE, NDE) | V-ring slinger meets IP54 | (DE, NDE) | V-ring slinger meets IP54 | (DE, NDE) |
| Bearing housing | Cast iron | | Cast iron | | Cast iron | |
| Bearing type | Double-shielded Regreasable inlet and outlet | FS 140 ... 440 | Double-shielded Regreasable inlet and outlet | FS 140 ... 440 | Double-shielded Single-shielded Regreasable inlet and outlet | FS 140 ... 250 FS 280 ... S440 |
| Bearing inner cap | Cast iron | | Cast iron | | Cast iron | |
| Lubrication | Polyurea | Base grease | Polyurea | Base grease | Polyurea | Base grease |
| Oil filling nozzle | Alemite | | Alemite | | Alemite | |
| Oil drain valve | Plug | | Plug | | Plug | |
| Vibrations | 0.08 IPS | | 0.08 IPS | | 0.08 IPS | |
| Rating plate | Stainless steel | Engraved | Stainless steel | Engraved | Stainless steel | Engraved |
| Condensation drainage hole | UL certification | FS 280 ... 440 | UL certification | FS 280 ... 440 | T discharges – lowest point (2) | |
| Mountings | Rust-resistant | | Rust-resistant | | Rust-resistant | |
| Lifting eye | Included | > 75 lb (> 34.0 kg) | Included | > 75 lb (> 34.0 kg) | Included | > 75 lb (> 34.0 kg) |
| Paint finish | ALKYED modified | RAL7030 | ALKYED modified | RAL7030 | ALKYED modified | RAL7030 |
| Warranty | 36 months | | 36 months | | 36 months | |
| Converter operation | VT 20:1 CT 4:1 | FS 140 ... 440 FS 140 ... 320 | VT 20:1 CT 4:1 | FS 140 ... 440 FS 140 ... 440 | Not specified | |
| Catalog | D 81.2, US/Canada | | D 81.2, US/Canada | | D 81.2, US/Canada | |

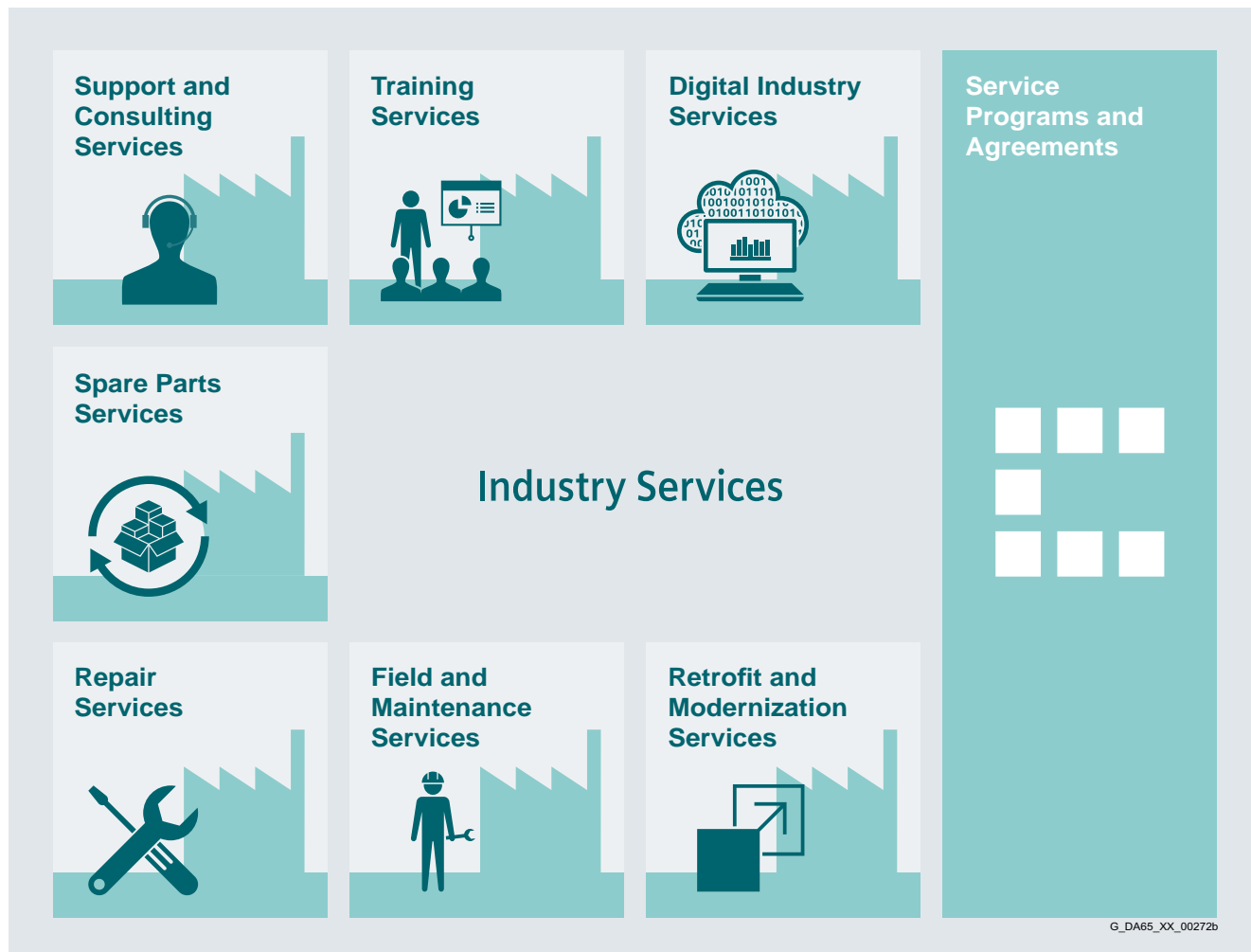
Overview

Keep your business running and shaping your digital future – with Industry Services

Optimizing the productivity of your equipment and operations can be a challenge, especially with constantly changing market conditions. Working with our service experts makes it easier. We understand your industry's unique processes and provide the services needed so that you can better achieve your business goals.

You can count on us to maximize your uptime and minimize your downtime, increasing your operations' productivity and reliability. When your operations have to be changed quickly to meet a new demand or business opportunity, our services give you the flexibility to adapt. Of course, we take care that your production is protected against cyber threats. We assist in keeping your operations as energy and resource efficient as possible and reducing your total cost of ownership. As a trendsetter, we ensure that you can capitalize on the opportunities of digitalization and by applying data analytics to enhance decision making: You can be sure that your plant reaches its full potential and retains this over the longer lifespan.

You can rely on our highly dedicated team of engineers, technicians and specialists to deliver the services you need – safely, professionally and in compliance with all regulations. We are there for you, where you need us, when you need us.

www.siemens.com/industriyservices

Appendix

Industry Services

Industry Services – Portfolio overview

Overview

Digital Industry Services



Digital Industry Services make your industrial processes transparent to gain improvements in productivity, asset availability, and energy efficiency.

Production data is generated, filtered and translated with intelligent analytics to enhance decision-making.

This is done whilst taking data security into consideration and with continuous protection against cyber-attack threats.

<https://www.siemens.com/global/en/home/products/services/industry/digital-services.html>

Support and Consulting Services



Industry Online Support site for comprehensive information, application examples, FAQs and support requests.

Technical and Engineering Support for advice and answers for all inquiries about functionality, handling, and fault clearance. The Service Card as prepaid support for value added services such as Priority Call Back or Extended Support offers the clear advantage of quick and easy purchasing.

Information & Consulting Services, e.g. SIMATIC System Audit; clarity about the state and service capability of your automation system or Lifecycle Information Services; transparency on the lifecycle of the products in your plants.

<https://support.industry.siemens.com/cs/ww/en/sc/2235>

Training Services



From the basics and advanced to specialist skills, SITRAIN courses provide expertise right from the manufacturer – and encompass the entire spectrum of Siemens products and systems for the industry.

Worldwide, SITRAIN courses are available wherever you need a training course in more than 170 locations in over 60 countries.

<https://support.industry.siemens.com/cs/ww/en/sc/2226>

Spare Parts Services



Spare Parts Services are available worldwide for smooth and fast supply of spare parts – and thus optimal plant availability. Genuine spare parts are available for up to ten years. Logistic experts take care of procurement, transport, custom clearance, storage and order management. Reliable logistics processes ensure that components reach their destination as needed.

Since not all spare parts can be kept in stock at all times, Siemens offers a preventive measure for spare parts provisioning on the customer's premises with optimized **Spare Parts Packages** for individual products, custom-assembled drive components and entire integrated drive trains – including risk consulting.

Asset Optimization Services help you design a strategy for parts supply where your investment and carrying costs are reduced and the risk of obsolescence is avoided.

<https://support.industry.siemens.com/cs/ww/en/sc/2110>

Overview
Repair Services

Repair Services are offered on-site and in regional repair centers for fast restoration of faulty devices' functionality.

Also available are extended repair services, which include additional diagnostic and repair measures, as well as emergency services.

<https://support.industry.siemens.com/cs/ww/en/sc/2154>

Retrofit and Modernization Services

Retrofit and Modernization Services provide a cost-effective solution for the expansion of entire plants, optimization of systems or upgrading existing products to the latest technology and software, e.g. migration services for automation systems.

Service experts support projects from planning through commissioning and, if desired over the entire extended lifespan, e.g. Retrofit for Integrated Drive Systems for an extended lifetime of your machines and plants.

<https://support.industry.siemens.com/cs/ww/en/sc/2286>

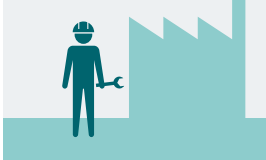
Field and Maintenance Services

Siemens specialists are available globally to provide expert field and maintenance services, including commissioning, functional testing, preventive maintenance and fault clearance.

All services can be included in customized service agreements with defined reaction times or fixed maintenance intervals.

<https://support.industry.siemens.com/cs/ww/en/sc/2265>

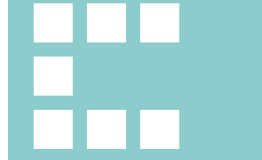
Service Programs and Agreements

A technical Service Program or Agreement enables you to easily bundle a wide range of services into a single annual or multi-year agreement.

You pick the services you need to match your unique requirements or fill gaps in your organization's maintenance capabilities.

Programs and agreements can be customized as KPI-based and/or performance-based contracts.

<https://support.industry.siemens.com/cs/ww/en/sc/2275>

Appendix Industry Services

Online Support

Overview

Online Support – fast, intuitive, whenever you want, wherever you need

Web
support.industry.siemens.com

App
SIEMENS

Google Play App Store Microsoft

Scan the QR code for information on our Online Support app.

FAQ / Application examples
Information about industrial products, programming and configuration as well as application examples

Technical information
Videos, documentation, manuals, updates, product notes, compatibility tool, certificates, planning data such as dimensional drawings, product data, 3D models

Forum
Exchange information and experience with other users and experts

Online Support for Siemens Industry Products

Siemens Industry and Online Support with some 1.7 million visitors per month is one of the most popular web services provided by Siemens. It is the central access point for comprehensive technical know-how about products, systems and services for automation and drives applications as well as for process industries.

In connection with the challenges and opportunities related to digitalization you can look forward to continued support with innovative offerings.

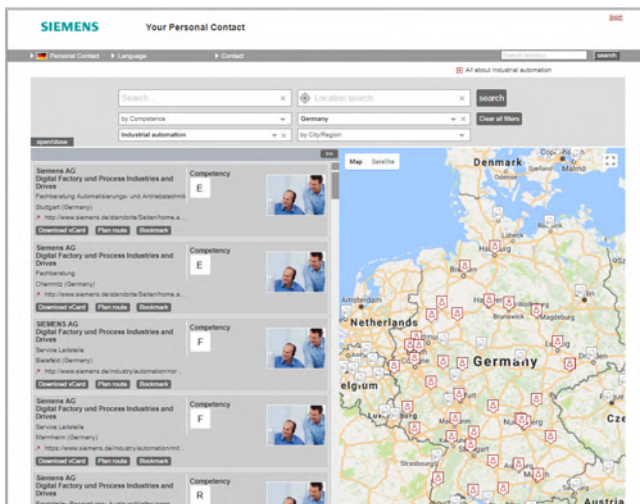

At your service locally, around the globe for consulting, sales, training, service, support, spare parts on the entire portfolio of Digital Industries.

Your partner can be found in our Personal Contacts Database at:
www.siemens.com/automation-contact

You start by selecting

- the required competence,
- products and branches,
- a country and a city

or by a

- location search or free text search.

Appendix

Tools and engineering

Drive Technology Configurator selection tool

Overview

The Drive Technology (DT) Configurator supports you when you are configuring the optimum drive technology products for your application – from gearboxes, motors, converters as well as the associated options and components through to controllers, software licenses and connection systems. With or without detailed knowledge of products: Preselected product groups, targeted navigation through selection menus and direct product selection through entry of the article number support quick, efficient and convenient configuration.

In addition, comprehensive documentation comprising technical data sheets, 2D dimensional drawings/3D CAD models, operating instructions, certificates, etc. can be selected in the DT Configurator. Immediate ordering is possible by simply transferring a parts list to the shopping cart of the Industry Mall.

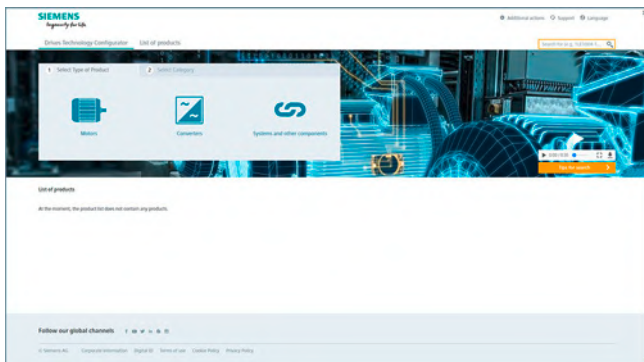

Drive Technology Configurator for efficient drive configuration with the following functions

- Quick and easy configuration of drive products and associated components – gear units, motors, converters, controllers, connection systems
- Configuration of drive systems for pump, fan and compressor applications from 1 kW to 2.6 MW
- Displayable documentation for configured products and components, such as
 - Data sheets in up to 9 languages in PDF or RTF format
 - 2D dimensional drawings/3D CAD models in various formats
 - Terminal box drawing and terminal connection diagram
 - Operating instructions
 - Certificates
 - Start-up calculation for SIMOTICS motors
 - EPLAN macros
- Support with retrofitting in conjunction with Spares On Web www.siemens.com/sow
- Ability to order products directly in the Siemens Industry Mall

Access to the Drive Technology Configurator

The Drive Technology Configurator can be called up without registration and without a login:

www.siemens.com/dt-configurator

More information

[Online access to Drive Technology Configurator](#)

More information about the Drive Technology Configurator is available on the Internet at:

www.siemens.com/dtconfigurator

Overview

The SinaSave energy efficiency tool determines energy saving potential and amortization times based on your individual conditions of use and therefore offers practical assistance in making decisions about investments in energy-efficient technologies.

In SinaSave Version 6.0 and higher, the drive systems to be compared and the relevant drive component parameters are displayed graphically. An additional expansion includes numerous comparison possibilities for different control types and comprehensive product combinations for drive solutions for pump and fan applications. In addition to SIMOTICS motors and SINAMICS converters, the product portfolio comprises SIRIUS controls, offering a comprehensive range of comparison possibilities – according to your individual requirements.



SinaSave offers numerous comparison scenarios:

- Comparison of drive systems for pump and fan applications in the power range from 0.55 kW (low voltage) to 5.5 MW (medium voltage) for
 - Reactor control (fixed speed; motor and switchgear)
 - Bypass control (fixed speed; motor and switchgear)
 - Speed control (variable speed; motor and converter)
- Comparison and evaluation of standard motors (incl. ignition protection motors) in different energy efficiency classes

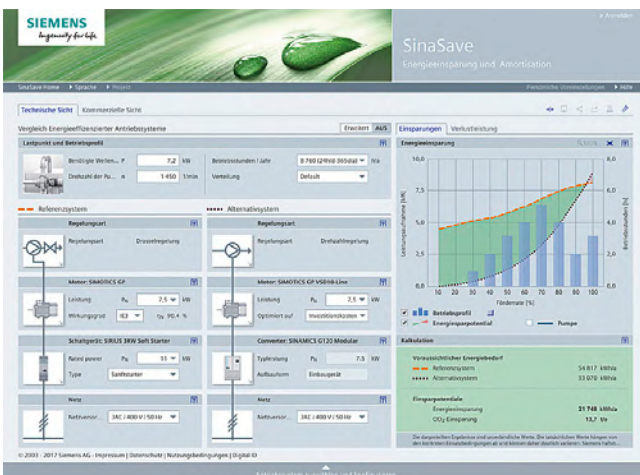

SinaSave supports the evaluation of different product and system comparisons by:

- Displaying the potential savings for energy and energy costs as well as CO₂ emissions
- Estimation of the amortization time
- Estimation of the individual total lifecycle costs
- Representation of the system power losses according to EN 50598-2 for full load and partial load
- Direct comparison of Siemens drives with the reference Power Drive System (PDS) described in EN 50598-2

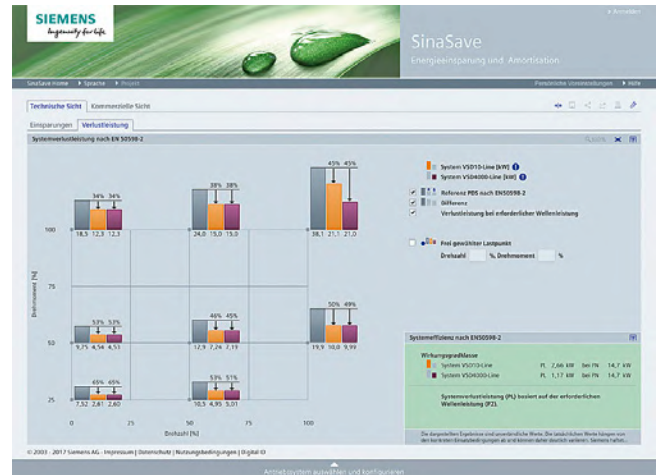

Access to the SinaSave energy efficiency tool

SinaSave can be accessed without the need for registration or logging in:

www.sinasave.siemens.com

More information

For more information about the amortization calculator for energy-efficient drive systems, visit

www.sinasave.siemens.com

More information about services for energy saving is available on the Internet at

www.siemens.com/energy-saving

Appendix

Tools and engineering

SIZER for Siemens Drives engineering tool

Overview

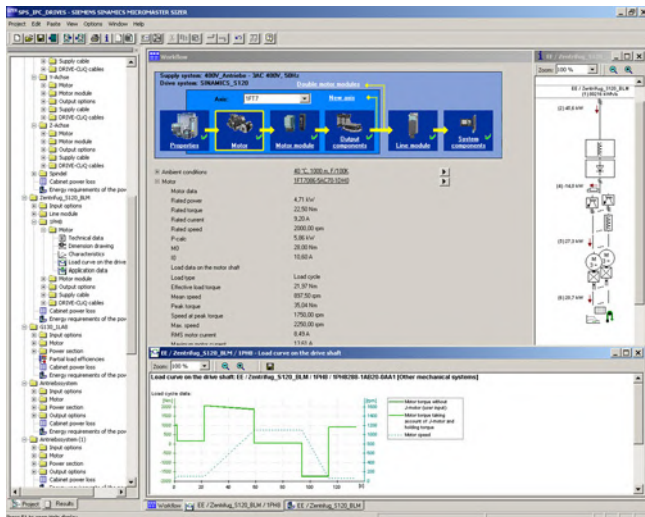

The following drives and controls can be engineered in a user-friendly way using the SIZER for Siemens Drives engineering tool:

- SIMOTICS low-voltage motors, including servo geared motors
- SIMOGEAR geared motors
- SINAMICS low-voltage drive systems
- Motor starters
- SINUMERIK CNC
- SIMOTION Motion Control controller
- SIMATIC controller

It provides support when selecting the technologies involved in the hardware and firmware components required for a drive task. SIZER for Siemens Drives covers the full range of operations required to configure a complete drive system, from basic single drives to demanding multi-axis applications.

SIZER for Siemens Drives supports all of the engineering steps in one workflow:

- Configuring the power supply
- Designing the motor and gearbox, including calculation of mechanical transmission elements
- Configuring the drive components
- Compiling the required accessories
- Selecting the line-side and motor-side power options, e.g. cables, filters, and reactors

When SIZER for Siemens Drives was being designed, particular importance was placed on a high degree of usability and a universal, function-based approach to the drive application. The extensive user guidance makes it easy to use the tool. Status information keeps you continually informed about the progress of the configuration process.

The drive configuration is saved in a project. In the project, the components and functions used are displayed in a hierarchical tree structure.

The project view permits the configuration of drive systems and the copying/inserting/modifying of drives already configured.

The configuration process produces the following results:

- A parts list of the required components (export to Excel, use of the Excel data sheet for import to SAP)
- Technical specifications of the system
- Characteristic curves
- Comments on system reactions
- Mounting arrangement of drive and control components and dimensional drawings of motors
- Energy requirements of the configured application

These results are displayed in a results tree and can be reused for documentation purposes.

Support is provided by the technological online help menu:

- Detailed technical specifications
- Information about the drive systems and their components
- Decision-making criteria for the selection of components
- Online help in English, French, German, Italian, Chinese and Japanese

System requirements

- PG or PC, Pentium™ III min. 800 MHz (recommended > 1 GHz)
- 512 MB RAM (1 GB recommended)
- At least 2 GB of free hard disk space
- An additional 100 MB of free hard disk space on Windows system drive
- Screen resolution 1024 × 768 pixels
- Operating system:
 - Windows 7 (32/64-bit) Professional, Enterprise, Ultimate, Home
 - Windows 8.1 (32/64-bit) Professional, Enterprise, Ultimate, Home
 - Microsoft Office 2003/2007/2010/2013/2016
 - Windows 365
 - Microsoft Internet Explorer V8.0
 - Microsoft .NET Framework 2.0
 - OpenGL 2.1
 - Windows 10 (64-bit) Professional, Enterprise
- Microsoft Internet Explorer from V5.5 SP2

More information

The SIZER for Siemens Drives engineering tool is available free on the Internet at www.siemens.com/sizer

SIPLUS CMS Condition Monitoring Systems for the continuous condition monitoring of motors

Overview

The SIPLUS CMS Condition Monitoring Systems continuously monitor the condition of wear-prone drive components, such as motors. Depending on the system, individual motors can be monitored as well as complete drive trains, or even the entire plant. IEPE sensors are used for acquisition of the motor vibrations for analysis, visualization and archiving by SIPLUS CMS. Information is supplied regularly and event-driven – even in remote operation. SIPLUS CMS can also be retrofitted.

More information on SIPLUS CMS is available on the Internet at www.siemens.com/siplus-cms

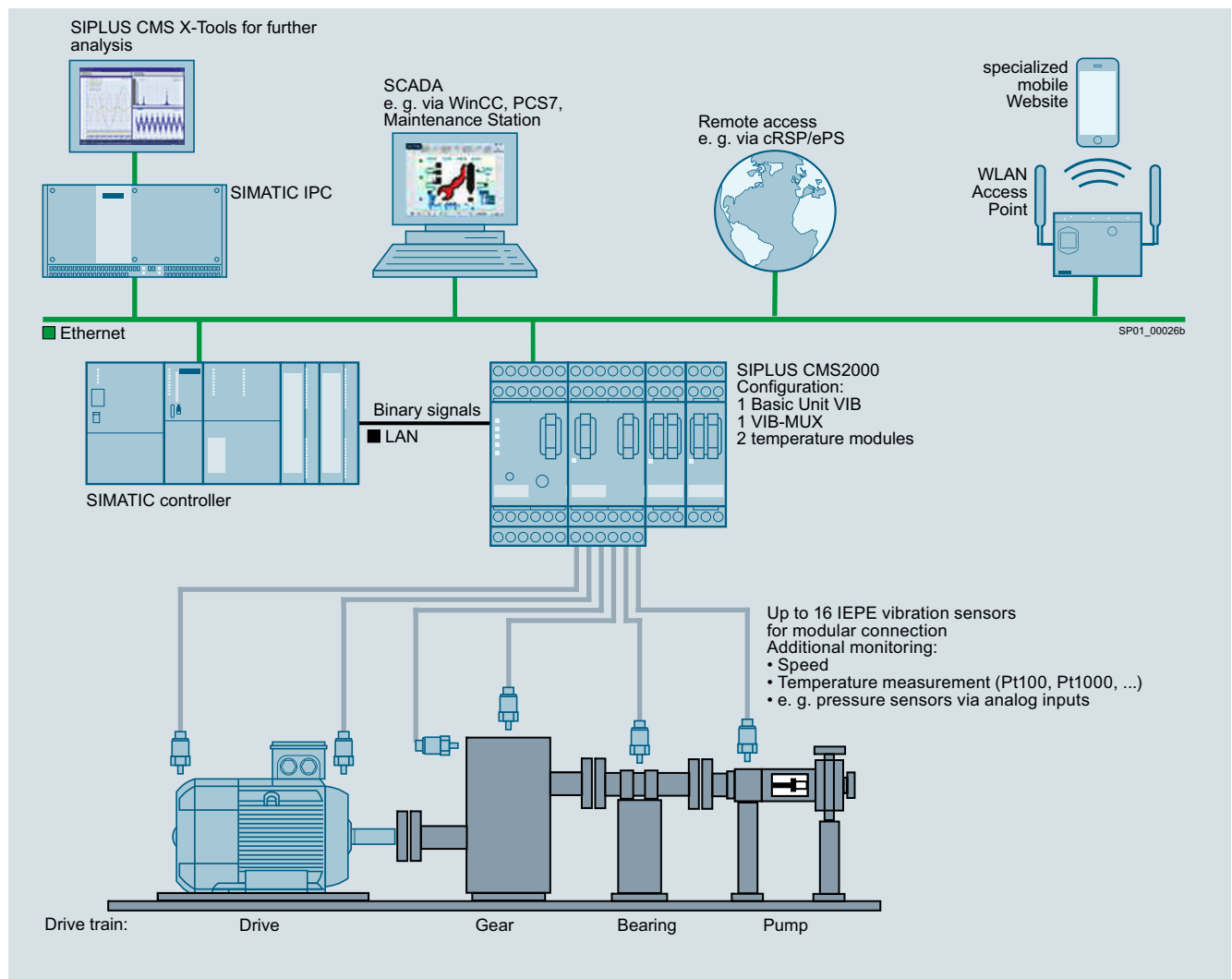
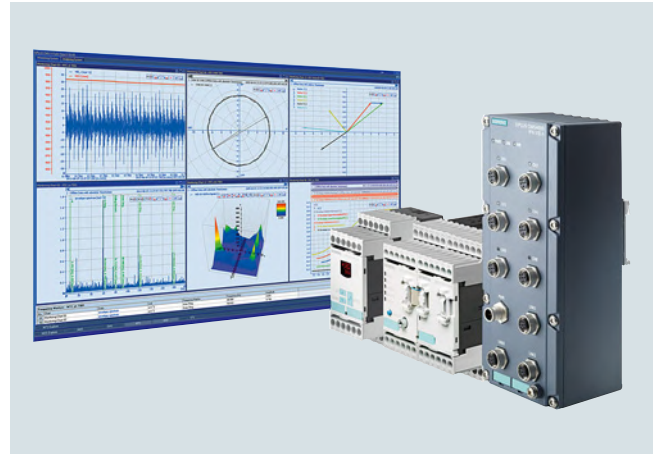

Appendix

Indexes

Index of order codes

Order codes for motors 1FP, 1LE, 1MB, 1PC

All options are listed alphanumerically according to order codes in the following table.

| Order code | Special versions | Category | For further information, see page |
|------------|--|--|--|
| B01 | A printed version of the safety notes in German/English and safety notes in the language of the country of use is supplied in each wire-lattice pallet | Packaging, safety notes, documentation and test certificates | 2/123, 4/67, 4/125 |
| B02 | Inspection certificate 3.1 in accordance with EN 10204 | | 2/123, 2/131, 2/137, 3/32, 4/67, 4/71, 4/125, 4/129, 5/81, 5/85, 5/90, 5/94, 5/99 |
| B04 | Printed German/English Operating Instructions enclosed | | 3/32 |
| B07 | Additional rating plate for voltage tolerance | Rating plate and additional rating plates | 2/123, 2/131, 3/32 |
| B10 | Individual acceptance by marine classification society | Marine version – Acceptance/certification | 6/9, 6/10, 6/11, 6/12 |
| B13 | Without "Made in manufacturing country" marking | Packaging, safety notes, documentation and test certificates | 3/32 |
| B30 | Version additionally for dust Ex tc – Zone 22 | Explosion-protected version | 5/78, 5/82, 5/96 |
| B31 | Version IIC with stamping of IIB | | 5/78, 5/82, 5/87, 5/91, 5/96 |
| B32 | Version additionally for dust Ex tb - Zone 21; IP65 | | 5/87, 5/91 |
| B33 | T1/T2 on rating plate | | 5/87 |
| B40 | Version for converter operation in basic version with operating data SINAMICS G120 with PM240-2 | Version for converter operation | 5/78, 5/82, 5/96 |
| B41 | Version for converter operation in basic version with operating data SINAMICS S150 | | 5/78, 5/82, 5/96 |
| B43 | Version for converter operation with power data on the PWM converter | | 5/91, 5/96 |
| B44 | Version for converter operation with power data on the PWM converter when used in accordance with temperature class 155 (F) | | 5/91 |
| B51 | Equivalent circuit diagram | Packaging, safety notes, documentation and test certificates | 3/32, 5/99 |
| B52 | Starting diagram (torque vs. speed and current vs. speed) | | 3/32, 5/99 |
| B60 | Document - Electrical datasheet | | 2/123, 2/131, 2/137, 3/32, 4/67, 4/71, 4/125, 4/129, 5/81, 5/85, 5/90, 5/94, 5/99 |
| B61 | Document - Order dimensional drawing | | 2/123, 2/131, 2/137, 3/32, 4/67, 4/71, 4/125, 4/129, 5/81, 5/85, 5/90, 5/94, 5/99 |
| B65 | Standard test (routine test) with acceptance | | 2/131, 2/137, 3/32, 4/71, 4/129, 5/90, 5/94, 5/99 |
| B67 | Temperature test without acceptance | | 3/32, 5/99 |
| B68 | Temperature test with acceptance | | 3/32, 5/99 |
| B71 | Noise measurement without load with octave band analysis, without acceptance | | 5/94 |
| B72 | Noise measurement without load with octave band analysis, with acceptance | | 5/94 |
| B80 | Type test with heat run for vertical motors, without acceptance | | 3/32, 5/94, 5/99 |
| B81 | Type test with heat run for vertical motors, with acceptance | | 3/32, 5/94, 5/99 |
| B81 | Type test with heat run for vertical motors, with acceptance | | 6/11 |
| B82 | Type test with heat run for horizontal motors, without acceptance | | 2/131, 2/137, 3/32, 5/90, 5/94, 5/99 |
| B83 | Type test with heat run for horizontal motors, with acceptance | | 2/123, 2/131, 2/137, 3/32, 4/67, 4/71, 4/125, 4/129, 5/81, 5/85, 5/90, 5/94, 5/100 |
| B83 | Type test with heat run for horizontal motors, with acceptance | Marine version – Acceptance/certification | 6/9, 6/10, 6/11, 6/12 |
| B90 | "Basic" documentation package | Packaging, safety notes, documentation and test certificates | 2/123, 2/131, 3/32, 4/67, 4/71, 4/125, 4/129, 5/81, 5/85, 5/90, 5/94, 5/100 |
| B91 | "Advanced" documentation package | | 2/123, 2/131, 3/32, 4/67, 4/71, 4/125, 4/129, 5/81, 5/85, 5/90, 5/94, 5/100 |
| B92 | "Projects" documentation package | | 2/123, 2/131, 3/32, 4/67, 4/71, 4/125, 4/129, 5/81, 5/85, 5/90, 5/94, 5/100 |
| B99 | Wire-lattice pallet packaging | Packaging, safety notes, documentation and test certificates | 2/123, 4/67, 4/125, 5/81, 5/85, 5/94 |
| C02 | VIK version | Versions in accordance with standards and specifications | 2/121, 2/129, 3/30 |
| C02 | VIK version | Explosion-protected version | 5/78, 5/82, 5/87, 5/91, 5/96 |

Index of order codes

| Order code | Special versions | Category | For further information, see page |
|------------|---|--|---|
| D01 | CCC China Compulsory Certification | Versions in accordance with standards and specifications | 2/121, 2/129 |
| D02 | Coolant temperature –50 to +40 °C | Coolant temperature and installation altitude | 2/129, 2/136, 3/30, 4/70, 4/128 |
| D03 | Coolant temperature -40 to +40 °C | | 2/121, 2/129, 2/136, 3/30, 4/66, 4/70, 4/124, 4/128, 5/79, 5/84, 5/88, 5/92, 5/98 |
| D04 | Coolant temperature –30 to +40 °C | | 2/121, 2/129, 2/136, 3/30, 4/66, 4/70, 4/124, 4/128 |
| D22 | Motor without CE marking for export outside EEA (see EU Regulation 640/2009) | Versions in accordance with standards and specifications | 2/121, 2/129, 2/136, 3/30 |
| D23 | Motor exclusively for use in transportation equipment for passenger and freight transportation corresponding to EVPG §1 dated February 27, 2008 | | 3/30 |
| D30 | Electrical according to NEMA MG1-12 | | 2/121, 2/129, 3/30 |
| D31 | Design according to UL with "Recognition Mark" | | 2/121, 2/129, 3/30 |
| D32 | Ex certification for China | | 5/79, 5/84, 5/93 |
| D33 | KEMCO Korea Energy Efficiency Label | | 2/121, 2/129 |
| D34 | China Energy Efficiency Label | | 2/121, 2/129, 3/30, 5/79, 5/84, 5/93 |
| D35 | Ex certificate EAC for the Eurasian Customs Union | | 5/79, 5/84, 5/93 |
| D37 | IECEX certification | | 5/79, 5/84, 5/88, 5/93, 5/98 |
| D39 | Version according to UL and CSA (Canadian regulation) | | 4/66, 4/70, 4/124, 4/128 |
| D40 | Canadian regulations (CSA) | | 2/121, 2/129, 3/30 |
| D41 | NEMA Premium Efficient, North America version acc. to NEMA MG1, Table 12-11, incl. UL and CSA | | 2/121, 2/130 |
| D47 | TR CU product safety certificate EAC for Eurasian Customs Union | | 2/121, 2/130, 3/30, 4/66, 4/70, 4/124, 4/128 |
| D70 | MEPS Australia | | 2/121, 2/130, 5/93 |
| E21 | With type test certificate according to Lloyds Register (LR), CT 45 °C, temperature class 155 (F), utilized according to 155 (F) | Marine version – Basic version | 6/9, 6/10, 6/11, 6/12 |
| E31 | With type test certificate according to Bureau Veritas (BV), CT 45 °C, temperature class 155 (F), utilized according to 155 (F) | | 6/9, 6/10, 6/12 |
| E41 | With type test certificate according to Registro Italiano Navale (RINA), CT 45 °C, temperature class 155 (F), utilized according to 155 (F) | | 6/9, 6/10, 6/11, 6/12 |
| E46 | With type test certificate according to Russian Maritime Register (RS), CT 45 °C, temperature class 155 (F), utilized according to 155 (F) | | 6/9, 6/10, 6/11, 6/12 |
| E51 | With type test certificate according to DNV GL Maritime, CT 45 °C, temperature class 155 (F), utilized according to 155 (F) | | 6/9, 6/10, 6/11, 6/12 |
| E52 | With type test certificate according to American Bureau of Shipping (ABS), CT 50 °C, temperature class 155 (F), utilized according to 155 (F) | | 6/9, 6/10, 6/11, 6/12 |
| E54 | With type test certificate according to Korean Register of Shipping (KR), CT 45 °C, temperature class 155 (F), utilized according to 155 (F) | | 6/9, 6/10, 6/12 |
| F01 | Mounting of holding brake (standard assignment) | Modular technology – Basic versions | 2/120, 2/127, 2/135, 3/28, 4/65, 4/69, 4/123, 4/127 |
| F02 | Mounting of brake for higher switching frequency (operating brake) | | 2/120, 4/65, 4/123 |
| F04 | Mounting of PRECIMA brake | | 2/127, 2/135 |
| F10 | Brake supply voltage 24 V DC | Modular technology – Additional versions | 2/120, 2/128, 2/135, 3/28, 4/65, 4/69, 4/123, 4/127, 5/92 |
| F11 | Brake supply voltage 230 V AC, 50/60 Hz | | 2/120, 2/128, 2/135, 3/28, 4/65, 4/69, 4/123, 4/127, 5/92 |
| F12 | Brake supply voltage 400 V AC, 50/60 Hz | | 2/120, 2/128, 2/135, 3/29, 4/65, 4/69, 4/123, 4/127, 5/92 |
| F17 | Brake supply voltage 180 V DC | | 2/120, 2/128, 2/135, 4/65, 4/69, 4/123, 4/127 |
| F18 | Brake supply voltage 205 V DC | | 2/120, 2/128, 2/135, 4/65, 4/69, 4/123, 4/127 |
| F20 | Mounting of brake in Ex db version | Special technology | 5/92 |
| F40 | Backstop, counterclockwise motion blocked, clockwise direction of rotation | Modular technology – Additional versions | 2/128, 2/135, 3/29, 4/69 |
| F41 | Backstop, clockwise motion blocked, counterclockwise direction of rotation | | 2/128, 2/135, 3/29, 4/69 |
| F50 | Mechanical manual brake release with lever (no locking) | | 2/120, 2/128, 2/135, 4/65, 4/69, 4/123, 4/127, 5/92 |
| F68 | Metal fan made of brass | Heating and ventilation | 5/93 |
| F70 | Mounted separately driven fan | Modular technology – Basic versions | 2/120, 2/127, 2/135, 3/28, 4/65, 4/69, 4/123, 4/127, 5/79, 5/83, 5/92, 5/98 |

Appendix

Indexes

Index of order codes

| Order code | Special versions | Category | For further information, see page |
|------------|--|---|---|
| F74 | Sheet metal fan cover | Heating and ventilation | 2/122, 2/131, 2/137, 3/31, 4/66, 4/71, 4/124, 4/129 |
| F75 | Fan cover for textile industry | | 2/122, 4/66, 4/124 |
| F76 | Metal external fan | | 2/122, 2/131, 2/137, 3/31, 4/66, 4/71, 4/124, 4/129, 5/80, 5/85, 5/89, 5/93 |
| F77 | Low-noise version for 2-pole motors with clockwise direction of rotation | Mechanical design and degrees of protection | 2/121, 2/129, 2/136, 3/29, 5/79, 5/84, 5/88, 5/92 |
| F78 | Low-noise version for 2-pole motors with counterclockwise direction of rotation | | 2/121, 2/129, 2/136, 3/29, 5/79, 5/84, 5/88, 5/92, 5/98 |
| F90 | Without external fan and without fan cover | Heating and ventilation | 2/122, 2/131, 2/137, 3/31, 4/66, 4/124, 5/99 |
| G04 | Mounting of LL 861 900 220 rotary pulse encoder | Special technology | 2/120, 2/128, 2/135, 3/29, 4/65, 4/69, 4/123, 4/127 |
| G05 | Mounting of HOG 9 DN 1024 I rotary pulse encoder | | 2/120, 2/128, 2/135, 3/29, 4/65, 4/69, 4/123, 4/127 |
| G06 | Mounting of HOG 10 D 1024 I rotary pulse encoder | | 2/120, 2/128, 2/135, 3/29, 4/65, 4/69, 4/123, 4/127 |
| G07 | Mounting of POG 10 DN rotary pulse encoder (only in combination with separately driven fan or brake) | | 2/128, 2/135, 3/29, 4/69, 4/127 |
| G08 | Mounting of POG 9 rotary pulse encoder (only in combination with separately driven fan or brake) | | 2/128, 2/135, 3/29, 4/69, 4/127 |
| G11 | Mounting of Kübler Sendix 5020 HTL, 1024 I rotary pulse encoder | Modular technology – Basic versions | 2/120, 2/127, 2/135, 3/28, 4/65, 4/69, 4/123, 4/127 |
| G12 | Mounting of Kübler Sendix 5020 TTL, 1024 I rotary pulse encoder | | 2/120, 2/127, 2/135, 3/28, 4/65, 4/69, 4/123, 4/127 |
| G15 | Mounting of HOG 10 DN 1024 I rotary pulse encoder, terminal box moisture protection | Special technology | 2/128, 2/135, 3/29 |
| G16 | Mounting of HOG 10 DN 1024 I rotary pulse encoder, terminal box dust protection | | 2/128, 2/135, 3/29 |
| G21 | Mounting of Kübler Sendix 5834FS2 1024, SIL-2 rotary pulse encoder | | 2/120, 2/128, 4/65, 4/69, 4/123, 4/127 |
| G22 | Mounting of Kübler Sendix 5834FS3 1024, SIL-3 rotary pulse encoder | | 2/120, 2/128, 4/65, 4/69, 4/123, 4/127 |
| G25 | Mounting of HOGS100S-B76.626.01024.1 rotary pulse encoder | | 2/120, 2/128, 4/65, 4/69, 4/127 |
| G27 | Mounting of LL FSI 862-184560-1024, SIL-2 rotary pulse encoder | | 2/120, 2/128, 4/65, 4/69, 4/127 |
| G30 | Mounting of LL 841 (HTL); 1024 I explosion-protected rotary pulse encoder | | 5/79, 5/83, 5/92, 5/98 |
| G40 | Prepared for mounted components, centering hole only | Mechanical design and degrees of protection | 2/121, 2/129, 2/136, 3/29, 4/65, 4/70, 4/123, 4/128 |
| G41 | Prepared for mountings with D12 shaft | | 2/121, 2/129, 2/136, 3/29, 4/65, 4/70, 4/123, 4/128 |
| G42 | Prepared for mountings with D16 shaft | | 2/121, 2/129, 2/136, 3/29, 4/65, 4/70, 4/123, 4/128, 5/98 |
| G43 | Mechanical protection for encoder | | 2/121, 2/129, 2/136, 3/29, 4/65, 4/70, 4/123, 4/128, 5/79, 5/84, 5/98 |
| G50 | Preparation for SPM measuring nipple – thread M8 | Bearings and lubrication | 5/93 |
| H00 | Protective cover | Mechanical design and degrees of protection | 2/121, 2/129, 2/136, 3/29, 4/65, 4/70, 4/123, 4/128, 5/79, 5/84, 5/88, 5/92, 5/98 |
| H01 | Screwed-on (instead of cast) feet | | 2/121, 2/129, 2/136, 4/66, 4/70, 4/123, 4/128, 5/79, 5/84, 5/88 |
| H02 | Vibration-proof version; vibration resistance to Class 3M4 according to IEC 60721-3-3:1994 | | 2/121, 2/129, 2/136, 3/30, 4/66, 4/70, 4/123, 4/128, 5/79, 5/84, 5/88, 5/92 |
| H03 | Condensation drainage holes | | 2/121, 2/129, 2/136, 4/66, 4/123, 5/79, 5/84, 5/88 |
| H04 | External grounding | Motor connection and terminal boxes | 2/118, 2/125, 2/133, 4/64, 4/68, 4/122, 4/126 |
| H06 | External screws, bolts and unpainted materials made of stainless steel (V4A) | Mechanical design and degrees of protection | 5/92 |
| H07 | Rust-resistant screws (externally) | | 2/121, 2/129, 2/136, 3/30, 4/66, 4/70, 4/123, 4/128, 5/79, 5/84, 5/88, 5/92, 5/98 |

Index of order codes

| Order code | Special versions | Category | For further information, see page |
|------------|--|---|---|
| H08 | Terminal box on NDE | Motor connection and terminal boxes | 2/118, 2/125, 2/133, 3/26, 4/64, 4/68, 4/122, 4/126, 5/97 |
| H09 | Two terminal boxes on NDE | | 3/26, 5/97 |
| H10 | Housing with screw mounting | Mechanical design and degrees of protection | 2/121, 4/66, 4/70 |
| H20 | IP65 degree of protection | | 2/121, 2/129, 3/30, 4/66, 4/70, 4/123, 4/128, 5/79, 5/84, 5/88, 5/92, 5/98 |
| H21 | IP54 degree of protection | | 2/129, 2/136, 3/30, 4/70, 4/128 |
| H22 | IP56 degree of protection | | 2/121, 2/129, 2/136, 3/30, 4/66, 4/70, 4/123, 4/128, 5/79, 5/84, 5/88, 5/92, 5/98 |
| H23 | Drive-end seal for flange-mounted motors, oil-tight to 0.1 bar | | 2/121, 2/129, 2/136, 3/30, 4/66, 4/70, 4/123, 4/128, 5/79, 5/84, 5/88, 5/92 |
| H25 | Sealing ring made of fluoroelastomer (FKM) | | 3/30, 5/98 |
| H30 | Adjustment screws for feet in horizontal installation | | 5/92 |
| H70 | Second external grounding | Motor connection and terminal boxes | 2/125, 2/133, 3/26, 4/68, 4/126, 5/87, 5/91, 5/97 |
| H90 | Increased corrosion protection for external components | Mechanical design and degrees of protection | 3/30, 5/98 |
| L00 | Vibration severity grade B | Balance and vibration severity | 2/122, 2/130, 2/136, 3/31, 5/80, 5/84, 5/89, 5/93, 5/98 |
| L01 | Balancing without feather key | | 2/122, 2/130, 2/136, 3/31, 4/66, 4/70, 4/124, 4/128, 5/80, 5/84, 5/89, 5/93, 5/98 |
| L02 | Full-key balancing | | 2/122, 2/130, 2/136, 3/31, 4/66, 4/70, 4/124, 4/128, 5/80, 5/84, 5/89, 5/93, 5/98 |
| L04 | Shaft extension with standard dimensions, without feather keyway | Shaft and rotor | 2/122, 2/130, 2/137, 3/31, 4/66, 4/70, 4/124, 4/128, 5/80, 5/85, 5/89, 5/93, 5/98 |
| L05 | Standard, cylindrical shaft extension (second shaft extension) NDE acc. to EN 50347 | | 2/122, 2/130, 2/137, 3/31, 4/66, 4/70, 4/124, 4/128, 5/80, 5/85, 5/89, 5/93, 5/98 |
| L06 | Standard shaft made of stainless steel (e.g. 1.4021) | | 2/122, 2/130, 2/137, 3/31, 4/66, 4/70, 4/124, 4/128, 5/80, 5/85, 5/89, 5/93 |
| L07 | Shaft extension run-out in accordance with IEC 60072-1 precision class | | 2/122, 2/130, 2/137, 3/31, 4/66, 4/70, 4/124, 4/128, 5/80, 5/85, 5/89, 5/93, 5/98 |
| L08 | Shaft extension run-out, concentricity and perpendicularity in accordance with IEC 60072-1 precision class for flange-mounted motors | | 2/122, 2/130, 2/137, 3/31, 4/66, 4/70, 4/124, 4/128, 5/80, 5/85, 5/89, 5/93, 5/98 |
| L19 | Regreasing device with M10 x 1 grease nipple according to DIN 71412-A | Bearings and lubrication | 2/130, 2/136, 3/30, 4/70, 4/128, 5/84, 5/88, 5/93, 5/98 |
| L20 | Located bearing DE | | 2/122, 2/130, 2/136, 3/30, 4/66, 4/70, 4/124, 4/128, 5/80, 5/84, 5/88, 5/93 |
| L21 | Located bearing NDE | | 2/122, 2/130, 2/136, 3/30, 4/66, 4/70, 4/124, 4/128, 5/80, 5/84, 5/88, 5/93, 5/98 |
| L22 | Bearing design for increased cantilever forces | | 2/122, 2/130, 2/136, 3/30, 4/66, 4/70, 4/124, 4/128, 5/80, 5/84, 5/88, 5/93, 5/98 |
| L23 | Regreasing device | | 2/122, 2/130, 2/136, 4/66, 4/70, 4/124, 4/128, 5/80, 5/84, 5/88, 5/93 |
| L24 | Hot bearing grease | | 3/30 |
| L25 | Bearings reinforced at both ends for DE and NDE, bearing size 63 | | 2/122, 2/130, 2/136, 4/66, 4/70, 4/124, 4/128, 5/80, 5/84, 5/88 |
| L28 | Reinforced bearings at both DE and NDE, DE bearing for increased cantilever forces | | 2/130, 2/136, 4/70, 4/128, 5/88 |
| L30 | Drainage for used grease | | 3/30, 5/98 |
| L37 | Special version with higher speeds | | 3/31 |
| L50 | Bearing insulation DE | | 2/130, 2/136, 3/31, 4/128, 5/88 |
| L51 | Bearing insulation NDE | | 2/122, 2/130, 2/136, 3/31, 4/66, 4/70, 4/124, 4/128, 5/80, 5/84, 5/88, 5/93 |

Appendix

Indexes

Index of order codes

| Order code | Special versions | Category | For further information, see page |
|------------|---|--|---|
| L52 | Grounding brush for converter operation | Mechanical design and degrees of protection | 2/129, 2/136, 3/30, 4/128 |
| L90 | Version suitable for railways IC411, EN IEC 60349, without EN 45545, with external fan and fan cover in plastic | Versions in accordance with standards and specifications | 2/121 |
| L91 | Version suitable for railways IC411, EN IEC 60349, with EN 45545, with external fan and fan cover in metal | | 2/121 |
| L92 | Version suitable for railways IC418, EN IEC 60349, without EN 45545, without external fan and fan cover | | 2/121 |
| M01 | Connected in star for dispatch | Packaging, safety notes, documentation and test certificates | 2/123, 2/131, 2/137, 3/32, 4/67, 4/71, 4/125, 4/129, 5/81, 5/85, 5/90, 5/94, 5/100 |
| M02 | Connected in delta for dispatch | | 2/123, 2/131, 2/137, 3/32, 4/67, 4/71, 4/125, 4/129, 5/81, 5/85, 5/90, 5/94, 5/100 |
| M10 | Second rating plate, loose | Rating plate and additional rating plates | 2/123, 2/131, 2/137, 3/32, 4/66, 4/71, 4/124, 4/129, 5/80, 5/85, 5/89, 5/94, 5/99, 6/22, 6/24 |
| M11 | Rating plate, stainless steel | | 2/123, 2/131, 2/137, 3/32, 4/66, 4/71, 4/124, 4/129, 5/80, 5/85, 5/89, 5/94 |
| N01 | Temperature class 155 (F), utilized according to 155 (F), with service factor | Windings and insulation | 2/119, 2/126, 2/134, 3/27 |
| N02 | Temperature class 155 (F), utilized acc. to 155 (F), with increased power | | 2/119, 2/126, 2/134, 3/27 |
| N03 | Temperature class 155 (F), utilized acc. to 155 (F), with increased coolant temperature | | 2/119, 2/126, 2/134, 3/27 |
| N05 | Temperature class 155 (F), utilized acc. to 130 (B), coolant temperature 45 °C, derating approx. 4 % | | 2/119, 2/126, 2/134, 3/27, 5/78, 5/83, 5/87, 5/91, 5/97 |
| N06 | Temperature class 155 (F), utilized acc. to 130 (B), coolant temperature 50 °C, derating approx. 8 % | | 2/119, 2/126, 2/134, 3/27, 5/78, 5/83, 5/87, 5/91, 5/97 |
| N07 | Temperature class 155 (F), utilized acc. to 130 (B), coolant temperature 55 °C, derating approx. 13 % | | 2/119, 2/126, 2/134, 3/27, 5/78, 5/83, 5/87, 5/91, 5/97 |
| N08 | Temperature class 155 (F), utilized acc. to 130 (B), coolant temperature 60 °C, derating approx. 18 % | | 2/119, 2/126, 2/134, 3/27, 5/78, 5/83, 5/87, 5/91, 5/97 |
| N10 | Temperature class 180 (H) | | 2/119, 2/126, 2/134, 3/27 |
| N11 | Temperature class 180 (H) at rated power and max. CT 60 °C | | 2/119, 2/126, 2/134, 3/27, 4/65, 4/69 |
| N30 | Increased air humidity/temperature with 30 to 60 g water per m ³ of air | | 2/119, 2/126, 2/134, 3/27, 4/65, 4/69, 4/122, 4/127, 5/78, 5/83, 5/87, 5/91, 5/97 |
| N31 | Increased air humidity/temperature with 60 to 100 g water per m ³ of air | | 2/119, 2/126, 2/134, 3/28, 4/65, 4/69, 4/127, 5/78, 5/83, 5/87, 5/91, 5/97 |
| Q01 | Measuring nipple for SPM shock pulse measurement for bearing inspection | Bearings and lubrication | 2/122, 2/130, 2/136, 3/31, 4/66, 4/70, 4/124, 4/128, 5/80, 5/84, 5/88, 5/93, 5/98 |
| Q02 | Anti-condensation heating for 230 V (2 terminals) | Heating and ventilation | 2/122, 2/131, 2/137, 3/31, 4/66, 4/71, 4/124, 4/129, 5/80, 5/85, 5/89, 5/93, 5/99 |
| Q03 | Anti-condensation heating for 115 V (2 terminals) | | 2/122, 2/131, 2/137, 3/31, 4/66, 4/71, 4/124, 4/129, 5/80, 5/85, 5/89, 5/93, 5/99 |
| Q04 | Anti-condensation heating for 220 V (2 terminals) | | 5/93 |
| Q06 | Anti-condensation heating for 400 V (2 terminals) | | 3/31, 5/99 |
| Q11 | 1 or 3 PTC thermistors – for tripping (2 terminals) | Motor protection | 2/118, 2/125, 2/133, 3/26, 4/64, 4/68, 4/122, 4/126, 5/96 |
| Q12 | 2 or 6 PTC thermistors – for alarm and tripping (4 terminals) | | 2/118, 2/125, 2/133, 3/26, 4/64, 4/68, 4/122, 4/126, 5/96 |
| Q21 | 3 NTC thermistors – for tripping (6 terminals) | | 5/96 |
| Q23 | 1 KTY84-130 temperature sensor (2 terminals) | | 2/118, 2/125, 2/133, 3/26, 4/64, 4/68, 4/122, 4/126, 5/96 |
| Q25 | 2 KTY84-130 temperature sensors (4 terminals) | | 2/118, 2/125, 2/133, 3/26, 4/64, 4/68, 4/122, 4/126, 5/96 |
| Q31 | 3 bimetal sensors (NC contacts) for tripping (2 terminals) | | 2/118, 2/125, 2/133, 3/26, 4/64, 4/68, 4/122, 4/126 |
| Q32 | 6 bimetal sensors (NC contacts) for alarm and tripping (4 terminals) | | 2/118, 2/125, 2/133, 3/26, 4/64, 4/68, 4/122, 4/126 |

Index of order codes

| Order code | Special versions | Category | For further information, see page |
|------------|--|--|---|
| Q33 | 3 bimetal sensors (NC contacts) for tripping (6 terminals) | Motor protection | 2/118, 2/125, 2/133, 3/26, 4/64, 4/68, 4/122, 4/126 |
| Q34 | 6 bimetal sensors (NC contacts) for alarm and tripping (12 terminals) | | 2/118, 2/125, 2/133, 3/26, 4/64, 4/68, 4/126 |
| Q35 | 1 Pt1000 resistance thermometer (2 terminals) | | 2/118, 2/125, 2/133, 3/26, 4/64, 4/68, 4/122, 4/126, 5/78, 5/82, 5/96 |
| Q36 | 2 Pt1000 resistance thermometers (4 terminals) | | 2/118, 2/125, 2/133, 3/26, 4/64, 4/68, 4/122, 4/126, 5/78, 5/82, 5/96 |
| Q37 | 6 Pt1000 resistance thermometer (12 terminals) | | 5/96 |
| Q60 | 3 Pt100 resistance thermometers – 2-wire input (6 terminals) | | 2/118, 2/125, 2/133, 3/26, 4/64, 4/68, 4/122, 4/126, 5/96 |
| Q61 | 6 Pt100 resistance thermometers – 2-wire input (12 terminals) | | 2/118, 2/125, 2/133, 3/26, 4/64, 4/122, 5/96 |
| Q62 | 1 Pt100 resistance thermometer – 2-wire input (2 terminals) | | 2/118, 2/125, 2/133, 3/26, 4/64, 4/68, 4/122, 4/126, 5/96 |
| Q63 | 3 Pt100 resistance thermometers – 3-wire input (9 terminals) | | 2/118, 2/125, 2/133, 3/26, 4/64, 4/68, 4/122, 4/126, 5/96 |
| Q64 | 6 Pt100 resistance thermometers – 3-wire input (18 terminals) | | 2/118, 2/125, 2/133, 3/26, 4/64, 4/68, 4/122, 4/126, 5/96 |
| Q72 | 2 Pt100 resistance thermometers in basic configuration for bearings (2 terminals) | | 2/118, 2/125, 2/133, 3/26, 4/64, 4/68, 4/122, 4/126, 5/82, 5/87, 5/91, 5/96 |
| Q78 | 2 Pt100 resistance thermometers in 3-wire input for bearings (6 terminals) | | 2/118, 2/125, 2/133, 3/26, 4/64, 4/68, 4/122, 4/126, 5/82, 5/87, 5/91, 5/96 |
| Q79 | 2 Pt100 double resistance thermometers in 3-wire input for bearings (12 terminals) | | 2/118, 2/125, 2/133, 3/26, 4/64, 4/68, 4/122, 4/126, 5/82, 5/87, 5/91, 5/96 |
| Q80 | Extension of the liability for defects period by 12 months to a total of 24 months (2 years) from delivery | Extension of the liability for defects | 2/131, 3/32, 4/129, 5/89, 5/94, 5/99 |
| Q81 | Extension of the liability for defects period by 18 months to a total of 30 months (2.5 years) from delivery | | 3/32, 5/99 |
| Q82 | Extension of the liability for defects period by 24 months to a total of 36 months (3 years) from delivery | | 2/131, 3/32, 4/129, 5/89, 5/94, 5/99 |
| Q83 | Extension of the liability for defects period by 30 months to a total of 42 months (3.5 years) from delivery | | 3/32, 5/99 |
| Q84 | Extension of the liability for defects period by 36 months to a total of 48 months (4 years) from delivery | | 3/32, 5/99 |
| Q85 | Extension of the liability for defects period by 48 months to a total of 60 months (5 years) from delivery | | 3/32, 5/99 |
| R09 | Subsequently rotatable main terminal box | Motor connection and terminal boxes | 3/26, 5/97 |
| R10 | Rotation of the terminal box through 90°, entry from DE | | 2/118, 2/125, 2/133, 3/26, 4/64, 4/68, 4/122, 4/126, 5/78, 5/82, 5/87, 5/91, 5/97 |
| R11 | Rotation of the terminal box through 90°, entry from NDE | | 2/118, 2/125, 2/133, 3/26, 4/64, 4/68, 4/122, 4/126, 5/78, 5/82, 5/87, 5/91, 5/97 |
| R12 | Rotation of the terminal box through 180° | | 2/118, 2/125, 2/133, 3/26, 4/64, 4/68, 4/122, 4/126, 5/78, 5/82, 5/87, 5/91, 5/97 |
| R13 | Terminal box in position 0°; connection from right | | 2/118, 4/64, 4/122 |
| R14 | One EMC cable gland | | 2/125, 2/133, 3/27, 4/68, 4/126 |
| R15 | One metal cable gland | | 2/118, 2/125, 2/133, 3/27, 4/64, 4/68, 4/122, 4/126 |
| R16 | EMC cable gland, maximum configuration | | 2/125, 2/133, 3/27, 4/68, 4/126 |
| R17 | Stud terminal for cable connection, accessories pack (3 items) | | 2/125, 2/133, 3/27, 4/126, 5/82 |
| R18 | Metal cable gland, maximum configuration | | 2/118, 2/125, 2/133, 3/27, 4/64, 4/122, 5/78, 5/82, 5/87, 5/91 |
| R19 | Saddle terminal for connection without cable lug, accessories pack | | 2/126, 2/133, 3/27, 4/126, 5/82, 5/87, 5/97 |
| R20 | 3 cables protruding, 0.5 m long | | 2/118, 2/126, 2/133, 4/64, 4/122 |

Appendix

Indexes

Index of order codes

| Order code | Special versions | Category | For further information, see page |
|--|---|-------------------------------------|---|
| R21 | 3 cables protruding, 1.5 m long | Motor connection and terminal boxes | 2/118, 2/126, 2/133, 3/27, 4/64 |
| R22 | 6 cables protruding, 0.5 m long | | 2/118, 2/126, 2/133, 4/64, 4/122 |
| R23 | 6 cables protruding, 1.5 m long | | 2/118, 2/126, 2/133, 3/27, 4/64 |
| R24 | 6 cables protruding, 3 m long | | 2/119, 2/126, 2/133, 3/27, 4/64 |
| R30 | Reduction piece for M cable gland in accordance with British Standard, mounted on both cable entries | | 2/119, 2/126 |
| R31 | 12 cables protruding with cable lugs | | 2/134 |
| R45 | 1 cable gland, Ex eb, for armored cable, line feeder cable | | 5/91 |
| R46 | 2 cable glands, Ex eb, for armored cable, line feeder cable | | 5/91 |
| R48 | Main terminal box in Ex db IIC | | 5/91 |
| R49 | Auxiliary terminal box in Ex db IIC | | 5/91 |
| R50 | Larger terminal box | | 2/119, 2/126, 2/134, 3/27, 4/64, 4/68, 4/122, 4/126, 5/78, 5/82, 5/87, 5/91, 5/97 |
| R51 | Terminal box without cable entry opening | | 2/126, 2/134, 3/27, 4/68, 4/126 |
| R52 | Drilled removable entry plate | | 2/126, 2/134, 3/27, 4/68, 4/126, 5/87, 5/97 |
| R53 | Undrilled removable entry plate | | 2/126, 2/134, 3/27, 4/68, 4/126, 5/87 |
| R54 | Enlarged connection system for main terminal box | | 5/91 |
| R60 | Auxiliary terminal box, aluminum | | 2/119 |
| R62 | Cast-iron auxiliary terminal box (small) | | 2/126, 2/134, 3/27, 4/68, 4/126, 5/82, 5/87, 5/91, 5/97 |
| R63 | Cast-iron auxiliary terminal box (large) | | 2/134, 3/27, 5/87, 5/91, 5/97 |
| R65 | Stainless steel auxiliary terminal box (large) | | 3/27, 5/97 |
| R67 | 2 small cast-iron auxiliary terminal boxes | | 5/87, 5/91 |
| R70 | Motor connector Han-Drive 10e for 230 V Δ /400 VY | 2/119, 4/64, 4/122 | |
| R71 | Motor connector EMC Han-Drive 10e for 230 V Δ /400 VY | 2/119, 4/64, 4/122 | |
| R72 | Small motor connector CQ12 with EMC | 2/119 | |
| R73 | Small motor connector CQ12 without EMC | 2/119 | |
| R74 | Silicone-free version | 2/126, 2/134, 3/27, 4/126 | |
| S00 | Unpainted (only cast-iron parts primed) | Colors and paint finish | 2/120, 2/127, 2/134, 3/28, 4/65, 4/69, 4/123, 4/127, 5/79, 5/83, 5/88, 5/92, 5/97 |
| S01 | Unpainted, only primed | | 2/120, 2/127, 2/134, 3/28, 4/65, 4/69, 4/123, 4/127, 5/79, 5/83, 5/88, 5/92, 5/97 |
| S02 | Special paint finish C3 | | 2/120, 2/127, 2/134, 3/28, 4/65, 4/69, 4/123, 4/127, 5/79, 5/83, 5/88, 5/92, 5/97 |
| S03 | Special paint finish sea air resistant C4 | | 2/120, 2/127, 2/134, 3/28, 4/65, 4/69, 4/123, 4/127, 5/79, 5/83, 5/88, 5/92, 5/97 |
| S04 | Special paint finish for use offshore C5 | | 2/127, 2/134, 3/28, 4/69, 4/127, 5/83, 5/88, 5/92, 5/97 |
| S05 | Internal coating | | 2/120, 2/127, 2/135, 3/28, 4/65, 4/69, 4/123, 4/127, 5/88, 5/92, 5/97 |
| S06 | Top coat polyurethane | | 2/120, 2/127, 2/135, 3/28, 5/79, 5/83, 5/88, 5/92 |
| Y50 • and spec. power, CT ... °C or IA m above sea level | Temperature class 155 (F), utilized acc. to 130 (B), with higher coolant temperature and/or installation altitude | Windings and insulation | 2/119, 2/127, 2/134, 3/28, 5/78, 5/83, 5/92, 5/97 |
| Y52 • and spec. power, CT ... °C or IA m above sea level | Temperature class 155 (F), utilized according to 155 (F), other requirements | | 2/119, 2/127, 2/134, 3/28 |

Index of order codes

| Order code | Special versions | Category | For further information, see page |
|---|--|---|---|
| Y53 • and paint finish RAL | Paint finish in other standard RAL colors: RAL 1002, 1013, 1015, 1019, 2003, 2004, 3000, 3007, 5002, 5007, 5009, 5010, 5012, 5015, 5017, 5018, 5019, 6011, 6019, 6021, 7000, 7001, 7004, 7011, 7016, 7022, 7031, 7032, 7033, 7035, 9001, 9002, 9005 (see Catalog Section 1 "Introduction") | Colors and paint finish | 2/120, 2/127, 2/135, 3/28, 4/65, 4/69, 4/123, 4/127, 5/79, 5/83, 5/88, 5/92, 5/97 |
| Y56 • and paint finish RAL | Paint finish in special RAL colors: For RAL colors, see "Special paint finish in special RAL colors" (see Catalog Section 1 "Introduction") | | 2/120, 2/127, 2/135, 3/28, 4/65, 4/69, 4/123, 4/127, 5/79, 5/83, 5/88, 5/92, 5/98 |
| Y58 • and customer specifications | Non-standard cylindrical shaft extension, DE | Shaft and rotor | 2/122, 2/130, 2/137, 3/31, 4/66, 4/71, 4/124, 4/129, 5/80, 5/85, 5/89, 5/93, 5/98 |
| Y59 • and customer specifications | Non-standard cylindrical shaft extension, NDE | | 2/122, 2/130, 2/137, 3/31, 4/66, 4/71, 4/124, 4/129, 5/80, 5/85, 5/89, 5/93, 5/99 |
| Y60 • and customer specifications | Special shaft steel | | 2/130, 2/137, 3/31, 4/71, 4/129, 5/99 |
| Y61 • and customer specifications | Non-standard threaded through hole (NPT or G thread) | Motor connection and terminal boxes | 2/126, 2/134, 3/27, 4/68, 4/126, 5/91, 5/97 |
| Y68 • and converter type | Operating data such as the B40 order code with alternative SINAMICS converter on the rating plate <ul style="list-style-type: none"> • G120 with PM230 • G120 with PM240 • G120C • G120P with PM230 • G120P with PM240P-2 • G120P with PM330 • G130, G150, G180 • S120 (BLM/SLM) • V20 Operating data such as the B41 order code with alternative SINAMICS converter on the rating plate <ul style="list-style-type: none"> • S120 (ALM) | Version for converter operation | 5/78, 5/82, 5/96 |
| Y70 • and customer specifications | Mounting of a special type of rotary pulse encoder | Special technology | 2/128, 3/29, 4/70, 4/127, 5/98 |
| Y74 • and spec. speed rpm | Mounting of rotary pulse encoder HOG 10 DN 1024 I + FSL, (integrated centrifugal switch, speed ... rpm), terminal box moisture protection | | 2/128, 2/135, 3/29 |
| Y75 • and spec. power, CT .. °C or IA m above sea level | Temperature class 180 (H), utilized according to 155 (F) | Windings and insulation | 2/119, 2/127, 2/134, 3/28 |
| Y76 • and spec. speed rpm | Mounting of rotary pulse encoder HOG 10 DN 1024 I + FSL, (integrated centrifugal switch, speed ... rpm), terminal box dust protection | Special technology | 2/128, 2/135, 3/29 |
| Y79 • and spec. speed (max. 3) rpm | Mounting of rotary pulse encoder HOG 10 DN 1024 I + ESL 93, (integrated electronic speed switch, speed ... rpm), terminal box dust protection | | 2/128, 2/135, 3/29 |
| Y80 • and customer specifications | Additional rating plate with deviating rating plate data | Rating plate and additional rating plates | 2/123, 2/131, 2/137, 3/32, 5/80, 5/85, 5/89, 5/94, 5/99 |
| Y81 • and customer specifications | Separately driven fan with non-standard voltage and/or frequency | Heating and ventilation | 2/131, 2/137, 3/31, 4/129, 5/93, 5/99 |
| Y82 • and customer specifications | Additional rating plate with customer specifications | Rating plate and additional rating plates | 2/123, 2/131, 2/137, 3/32, 4/67, 4/71, 4/124, 4/129, 5/80, 5/85, 5/89, 5/94, 5/99 |
| Y84 • and customer specifications | Additional information on rating plate and on package label (max. 20 characters) | | 2/123, 2/131, 2/137, 3/32, 4/67, 4/71, 4/124, 4/129, 5/80, 5/85, 5/89, 5/94, 5/99 |
| Y85 • and customer specifications | Adhesive label, supplied loose (printed with: Article No., Serial No.; 2 lines of text) | | 2/123, 2/131, 2/137, 3/32, 4/67, 4/71, 4/124, 4/129 |

Appendix

Conversion tables

Rotary inertia (to convert from A to B, multiply by entry in table)

| A \ B | lb-in ² | lb-ft ² | lb-in-s ² | lb-ft-s ² slug-ft ² | kg-cm ² | kg-cm-s ² | gm-cm ² | gm-cm-s ² | oz-in ² | oz-in-s ² |
|--|------------------------|-----------------------|-----------------------|--|---------------------|------------------------|---------------------|-----------------------|-----------------------|-----------------------|
| lb-in ² | 1 | 6.94×10^{-3} | 2.59×10^{-3} | 2.15×10^{-4} | 2.926 | 2.98×10^{-3} | 2.92×10^3 | 2.984 | 16 | 4.14×10^{-2} |
| lb-ft ² | 144 | 1 | 0.3729 | 3.10×10^{-2} | 421.40 | 0.4297 | 4.21×10^5 | 429.71 | 2304 | 5.967 |
| lb-in-s ² | 386.08 | 2.681 | 1 | 8.33×10^{-2} | 1.129×10^3 | 1.152 | 1.129×10^6 | 1.152×10^3 | 6.177×10^3 | 16 |
| lb-ft-s ² slug-ft ² | 4.63×10^3 | 32.17 | 12 | 1 | 1.35×10^4 | 13.825 | 1.355×10^7 | 1.38×10^4 | 7.41×10^4 | 192 |
| kg-cm ² | 0.3417 | 2.37×10^{-3} | 8.85×10^{-4} | 7.37×10^{-5} | 1 | 1.019×10^{-3} | 1000 | 1.019 | 5.46 | 1.41×10^{-2} |
| kg-cm-s ² | 335.1 | 2.327 | 0.8679 | 7.23×10^{-2} | 980.66 | 1 | 9.8×10^5 | 1000 | 5.36×10^3 | 13.887 |
| gm-cm ² | 3.417×10^{-4} | 2.37×10^{-6} | 8.85×10^{-7} | 7.37×10^{-8} | 1×10^{-3} | 1.01×10^{-6} | 1 | 1.01×10^{-3} | 5.46×10^{-3} | 1.41×10^{-5} |
| gm-cm-s ² | 0.335 | 2.32×10^{-3} | 8.67×10^{-4} | 7.23×10^{-5} | 0.9806 | 1×10^{-3} | 980.6 | 1 | 5.36 | 1.38×10^{-2} |
| oz-in ² | 0.0625 | 4.34×10^{-4} | 1.61×10^{-4} | 1.34×10^{-5} | 0.182 | 1.86×10^{-4} | 182.9 | 0.186 | 1 | 2.59×10^{-3} |
| oz-in-s ² | 24.13 | 0.1675 | 6.25×10^{-2} | 5.20×10^{-3} | 70.615 | 7.20×10^{-2} | 7.09×10^4 | 72.0 | 386.08 | 1 |

Torque (to convert from A to B, multiply by entry in table)

| A \ B | lb-in | lb-ft | oz-in | N-m | kg-cm | kg-m | gm-cm | dyne-cm |
|---------|------------------------|------------------------|------------------------|------------------------|-------------------------|------------------------|------------------------|---------------------|
| lb-in | 1 | 8.333×10^{-2} | 16 | 0.113 | 1.152 | 1.152×10^{-2} | 1.152×10^3 | 1.129×10^6 |
| lb-ft | 12 | 1 | 192 | 1.355 | 13.825 | 0.138 | 1.382×10^4 | 1.355×10^7 |
| oz-in | 6.25×10^{-2} | 5.208×10^{-3} | 1 | 7.061×10^{-3} | 7.200×10^{-2} | 7.200×10^{-4} | 72.007 | 7.061×10^4 |
| N-m | 8.850 | 0.737 | 141.612 | 1 | 10.197 | 0.102 | 1.019×10^4 | 1×10^7 |
| kg-cm | 0.8679 | 7.233×10^{-2} | 13.877 | 9.806×10^{-2} | 1 | 10^{-2} | 1000 | 9.806×10^5 |
| kg-m | 86.796 | 7.233 | 1.388×10^3 | 9.806 | 100 | 1 | 1×10^5 | 9.806×10^7 |
| gm-cm | 8.679×10^{-4} | 7.233×10^{-5} | 1.388×10^{-2} | 9.806×10^{-5} | 1×10^{-3} | 1×10^{-5} | 1 | 980.665 |
| dyne-cm | 8.850×10^{-7} | 7.375×10^{-8} | 1.416×10^{-5} | 10^{-7} | 1.0197×10^{-6} | 1.019×10^{-8} | 1.019×10^{-3} | 1 |

Length (to convert from A to B, multiply by entry in table)

| A \ B | inches | feet | cm | yd | mm | m |
|--------|---------|---------|-------|-----------------------|-------|--------|
| inches | 1 | 0.0833 | 2.54 | 0.028 | 25.4 | 0.0254 |
| feet | 12 | 1 | 30.48 | 0.333 | 304.8 | 0.3048 |
| cm | 0.3937 | 0.03281 | 1 | 1.09×10^{-2} | 10 | 0.01 |
| yd | 36 | 3 | 91.44 | 1 | 914.4 | 0.914 |
| mm | 0.03937 | 0.00328 | 0.1 | 1.09×10^{-3} | 1 | 0.001 |
| m | 39.37 | 3.281 | 100 | 1.09 | 1000 | 1 |

Force (to convert from A to B, multiply by entry in table)

| A \ B | lb | oz | gm | dyne | N |
|-------|------------------------|-----------------------|-------|-----------------------|---------|
| lb | 1 | 16 | 453.6 | 4.448×10^5 | 4.4482 |
| oz | 0.0625 | 1 | 28.35 | 2.780×10^4 | 0.27801 |
| gm | 2.205×10^{-3} | 0.03527 | 1 | 1.02×10^{-3} | N.A. |
| dyne | 2.248×10^{-6} | 3.59×10^{-5} | 980.7 | 1 | 0.00001 |
| N | 0.22481 | 3.5967 | N.A. | 100000 | 1 |

Mass (to convert from A to B, multiply by entry in table)

| A \ B | lb | oz | gm | kg | slug |
|-------|------------------------|------------------------|---------------------|-----------|------------------------|
| lb | 1 | 16 | 453.6 | 0.4536 | 0.0311 |
| oz | 6.25×10^{-2} | 1 | 28.35 | 0.02835 | 1.93×10^{-3} |
| gm | 2.205×10^{-3} | 3.527×10^{-2} | 1 | 10^{-3} | 6.852×10^{-5} |
| kg | 2.205 | 35.27 | 10^3 | 1 | 6.852×10^{-2} |
| slug | 32.17 | 514.8 | 1.459×10^4 | 14.59 | 1 |

Rotation (to convert from A to B, multiply by entry in table)

| A \ B | rpm | rad/s | degrees/s |
|-----------|-------|------------------------|-----------|
| rpm | 1 | 0.105 | 6.0 |
| rad/s | 9.55 | 1 | 57.30 |
| degrees/s | 0.167 | 1.745×10^{-2} | 1 |

Power (to convert from A to B, multiply by entry in table)

| A \ B | hp | Watts |
|------------------|------------------------|------------------------|
| hp (English) | 1 | 745.7 |
| (lb-in) (deg./s) | 2.645×10^{-6} | 1.972×10^{-3} |
| (lb-in) (rpm) | 1.587×10^{-5} | 1.183×10^{-2} |
| (lb-ft) (deg./s) | 3.173×10^{-5} | 2.366×10^{-2} |
| (lb-ft) (rpm) | 1.904×10^{-4} | 0.1420 |
| Watts | 1.341×10^{-3} | 1 |

Temperature Conversion

| °F | °C | °C | °F |
|---|-------|--------------------------------------|------|
| 0 | -17.8 | -10 | 14 |
| 32 | 0 | 0 | 32 |
| 50 | 10 | 10 | 50 |
| 70 | 21.1 | 20 | 68 |
| 90 | 32.2 | 30 | 86 |
| 98.4 | 37 | 37 | 98.4 |
| 212 | 100 | 100 | 212 |
| subtract 32 and multiply by $\frac{5}{9}$ | | multiply by $\frac{9}{5}$ and add 32 | |

Mechanism Efficiencies

| | |
|-----------------------------|------------|
| Acme-screw with brass nut | ~0.35–0.65 |
| Acme-screw with plastic nut | ~0.50–0.85 |
| Ball-screw | ~0.85–0.95 |
| Chain and sprocket | ~0.95–0.98 |
| Preloaded ball-screw | ~0.75–0.85 |
| Spur or bevel-gears | ~0.90 |
| Timing belts | ~0.96–0.98 |
| Worm gears | ~0.45–0.85 |
| Helical gear (1 reduction) | ~0.92 |

Friction Coefficients

| Materials | μ |
|--------------------------|------------|
| Steel on steel (greased) | ~0.15 |
| Plastic on steel | ~0.15–0.25 |
| Copper on steel | ~0.30 |
| Brass on steel | ~0.35 |
| Aluminum on steel | ~0.45 |
| Steel on steel | ~0.58 |
| Mechanism | μ |
| Ball bushings | <0.001 |
| Linear bearings | <0.001 |
| Dove-tail slides | ~0.2++ |
| Gibb ways | ~0.5++ |

Material Densities

| Material | lb-in ³ | gm-cm ³ |
|---------------------------------|--------------------|--------------------|
| Aluminum | 0.096 | 2.66 |
| Brass | 0.299 | 8.30 |
| Bronze | 0.295 | 8.17 |
| Copper | 0.322 | 8.91 |
| Hard wood | 0.029 | 0.80 |
| Soft wood | 0.018 | 0.48 |
| Plastic | 0.040 | 1.11 |
| Glass | 0.079–0.090 | 2.2–2.5 |
| Titanium | 0.163 | 4.51 |
| Paper | 0.025–0.043 | 0.7–1.2 |
| Polyvinyl chloride | 0.047–0.050 | 1.3–1.4 |
| Rubber | 0.033–0.036 | 0.92–0.99 |
| Silicone rubber, without filler | 0.043 | 1.2 |
| Cast iron, gray | 0.274 | 7.6 |
| Steel | 0.280 | 7.75 |

Wire Gauges¹⁾

| Cross-section mm ² | Standard Wire Gauge (SWG) | American Wire Gauge (AWG) |
|-------------------------------|---------------------------|---------------------------|
| 0.2 | 25 | 24 |
| 0.3 | 23 | 22 |
| 0.5 | 21 | 20 |
| 0.75 | 20 | 19 |
| 1.0 | 19 | 18 |
| 1.5 | 17 | 16 |
| 2.5 | 15 | 13 |
| 4 | 13 | 11 |
| 6 | 12 | 9 |
| 10 | 9 | 7 |
| 16 | 7 | 6 |
| 25 | 5 | 3 |
| 35 | 3 | 2 |
| 50 | 0 | 1/0 |
| 70 | 000 | 2/0 |
| 95 | 00000 | 3/0 |
| 120 | 0000000 | 4/0 |
| 150 | – | 6/0 |
| 185 | – | 7/0 |

¹⁾ The table shows approximate SWG/AWG sizes nearest to standard metric sizes; the cross-sections do not match exactly.

Appendix

Metal surcharges

Explanation of the raw material/metal surcharges¹⁾

Surcharge calculation

To compensate for variations in the price of the raw materials silver, copper, aluminum, lead, gold, dysprosium²⁾ and/or neodym²⁾, surcharges are calculated on a daily basis using the so-called metal factor for products containing these raw materials. A surcharge for the respective raw material is calculated as a supplement to the price of a product if the basic official price of the raw material in question is exceeded.

The surcharges are calculated in accordance with the following criteria:

- Basic official price of the raw material
Basic official price from the day prior to receipt of the order or prior to release order (daily price) for³⁾
 - Silver (sales price, processed)
 - Gold (sales price, processed)
- and for⁴⁾
 - Copper (lower DEL notation + 1 %)
 - Aluminum (aluminum in cables)
 - Lead (lead in cables)
- Metal factor of the products
Certain products are displayed with a metal factor. The metal factor determines the official price (for those raw materials concerned) as of which the metal surcharges are applied and the calculation method used (weight or percentage method). An exact explanation is given below.

Structure of the metal factor

The metal factor consists of several digits; the first digit indicates whether the percentage method of calculation refers to the list price or a possible discounted price (customer net price) (L = list price / N = customer net price).

The remaining digits indicate the method of calculation used for the respective raw material. If no surcharge is added for a raw material, a "-" is used.

| | |
|-----------|--|
| 1st digit | List or customer net price using the percentage method |
| 2nd digit | for silver (AG) |
| 3rd digit | for copper (CU) |
| 4th digit | for aluminum (AL) |
| 5th digit | for lead (PB) |
| 6th digit | for gold (AU) |
| 7th digit | for dysprosium (Dy) ²⁾ |
| 8th digit | for neodym (Nd) ²⁾ |

Weight method

The weight method uses the basic official price, the daily price and the raw material weight. In order to calculate the surcharge, the basic official price must be subtracted from the daily price. The difference is then multiplied by the raw material weight.

The basic official price can be found in the table below using the number (1 to 9) of the respective digit of the metal factor. The raw material weight can be found in the respective product descriptions.

Percentage method

Use of the percentage method is indicated by the letters A-Z at the respective digit of the metal factor.

The surcharge is increased - dependent on the deviation of the daily price compared with the basic official price - using the percentage method in "steps" and consequently offers surcharges that remain constant within the framework of this "step range". A higher percentage rate is charged for each new step. The respective percentage level can be found in the table below.

Metal factor examples

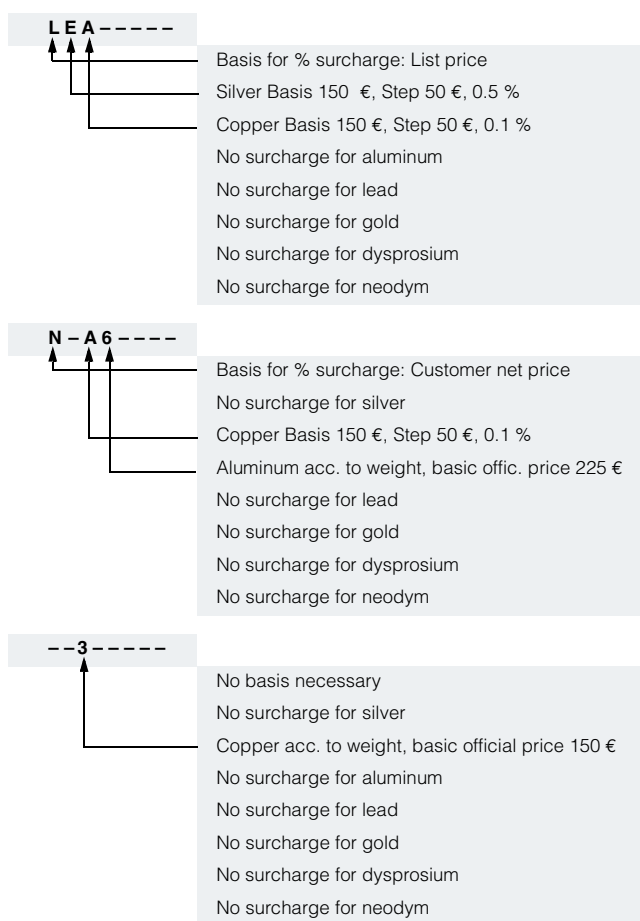

1) Refer to the separate explanation on the next page regarding the raw materials dysprosium and neodym (= rare earths).

2) For a different method of calculation, refer to the separate explanation for these raw materials on the next page.

3) Source: Umicore, Hanau (www.metalsmanagement.umicore.com).

4) Source: Schutzvereinigung DEL-Notiz e.V. (www.del-notiz.org).

Explanation of the raw material/metal surcharges for dysprosium and neodym (rare earths)

Surcharge calculation

To compensate for variations in the price of the raw materials silver¹⁾, copper¹⁾, aluminum¹⁾, lead¹⁾, gold¹⁾, dysprosium and/or neodym, surcharges are calculated on a daily basis using the so-called metal factor for products containing these raw materials. The surcharge for dysprosium and neodym is calculated as a supplement to the price of a product if the basic official price of the raw material in question is exceeded.

The surcharge is calculated in accordance with the following criteria:

- Basic official price of the raw material²⁾
Three-month basic average price (see below) in the period before the quarter in which the order was received or the release order took place (= average official price) for
- dysprosium (Dy metal, 99 % min. FOB China; USD/kg)
- neodym (Nd metal, 99 % min. FOB China; USD/kg)
- Metal factor of the products
Certain products are displayed with a metal factor. The metal factor indicates (for those raw materials concerned) the basic official price as of which the surcharges for dysprosium and neodym are calculated using the weight method. An exact explanation of the metal factor is given below.

Three-month average price

The prices of rare earths vary according to the foreign currency, and there is no freely accessible stock exchange listing. This makes it more difficult for all parties involved to monitor changes in price. In order to avoid continuous adjustment of the surcharges, but to still ensure fair, transparent pricing, an average price is calculated over a three-month period using the average monthly foreign exchange rate from USD to EUR (source: European Central Bank). Since not all facts are immediately available at the start of each month, a one-month buffer is allowed before the new average price applies.

Examples of calculation of the average official price:

| Period for calculation of the average price: | Period during which the order/release order is effected and the average price applies: |
|--|--|
| Sep 2012 - Nov 2012 | Q1 in 2013 (Jan - Mar) |
| Dec 2012 - Feb 2013 | Q2 in 2013 (Apr - Jun) |
| Mar 2013 - May 2013 | Q3 in 2013 (Jul - Sep) |
| Jun 2013 - Aug 2013 | Q4 in 2013 (Oct - Dec) |

Structure of the metal factor

The metal factor consists of several digits; the first digit is not relevant to the calculation of dysprosium and neodym.

The remaining digits indicate the method of calculation used for the respective raw material. If no surcharge is added for a raw material, a "-" is used.

| | |
|-----------|--|
| 1st digit | List or customer net price using the percentage method |
| 2nd digit | for silver (AG) ¹⁾ |
| 3rd digit | for copper (CU) ¹⁾ |
| 4th digit | for aluminum (AL) ¹⁾ |
| 5th digit | for lead (PB) ¹⁾ |
| 6th digit | for gold (AU) ¹⁾ |
| 7th digit | for dysprosium (Dy) |
| 8th digit | for neodym (Nd) |

Weight method

The weight method uses the basic official price, the average price and the raw material weight. In order to calculate the surcharge, the basic official price must be subtracted from the average price. The difference is then multiplied by the raw material weight.

The basic official price can be found in the table below using the number (1 to 9) of the respective digit of the metal factor. Your Sales contact can inform you of the raw material weight.

Metal factor examples

| | |
|---------|---|
| -----71 | No basis necessary |
| | No surcharge for silver |
| | No surcharge for copper |
| | No surcharge for aluminum |
| | No surcharge for lead |
| | No surcharge for gold |
| | Dysprosium acc. to weight, basic official price 300 € |
| | Neodym acc. to weight, basic official price 50 € |

1) For a different method of calculation, refer to the separate explanation for these raw materials on the previous page.

2) Source: Asian Metal Ltd (www.asianmetal.com)

Appendix

Metal surcharges

Values of the metal factor

| Percentage method | Basic official price in € | Step range in € | % surcharge 1st step | % surcharge 2nd step | % surcharge 3rd step | % surcharge 4th step | % surcharge per additional step | |
|--------------------------------|---|--|----------------------|----------------------|----------------------|----------------------|---------------------------------|--|
| | | | Price in € | Price in € | Price in € | Price in € | | |
| | | | 150.01 - 200.00 | 200.01 - 250.00 | 250.01 - 300.00 | 300.01 - 350.00 | | |
| A | 150 | 50 | 0.1 | 0.2 | 0.3 | 0.4 | 0.1 | |
| B | 150 | 50 | 0.2 | 0.4 | 0.6 | 0.8 | 0.2 | |
| C | 150 | 50 | 0.3 | 0.6 | 0.9 | 1.2 | 0.3 | |
| D | 150 | 50 | 0.4 | 0.8 | 1.2 | 1.6 | 0.4 | |
| E | 150 | 50 | 0.5 | 1.0 | 1.5 | 2.0 | 0.5 | |
| F | 150 | 50 | 0.6 | 1.2 | 1.8 | 2.4 | 0.6 | |
| G | 150 | 50 | 1.0 | 2.0 | 3.0 | 4.0 | 1.0 | |
| H | 150 | 50 | 1.2 | 2.4 | 3.6 | 4.8 | 1.2 | |
| I | 150 | 50 | 1.6 | 3.2 | 4.8 | 6.4 | 1.6 | |
| J | 150 | 50 | 1.8 | 3.6 | 5.4 | 7.2 | 1.8 | |
| | | | 175.01 - 225.00 | 225.01 - 275.00 | 275.01 - 325.00 | 325.01 - 375.00 | | |
| O | 175 | 50 | 0.1 | 0.2 | 0.3 | 0.4 | 0.1 | |
| P | 175 | 50 | 0.2 | 0.4 | 0.6 | 0.8 | 0.2 | |
| R | 175 | 50 | 0.5 | 1.0 | 1.5 | 2.0 | 0.5 | |
| | | | 225.01 - 275.00 | 275.01 - 325.00 | 325.01 - 375.00 | 375.01 - 425.00 | | |
| S | 225 | 50 | 0.2 | 0.4 | 0.6 | 0.8 | 0.2 | |
| U | 225 | 50 | 1.0 | 2.0 | 3.0 | 4.0 | 1.0 | |
| V | 225 | 50 | 1.0 | 1.5 | 2.0 | 3.0 | 1.0 | |
| W | 225 | 50 | 1.2 | 2.5 | 3.5 | 4.5 | 1.0 | |
| | | | 150.01 - 175.00 | 175.01 - 200.00 | 200.01 - 225.00 | 225.01 - 250.00 | | |
| Y | 150 | 25 | 0.3 | 0.6 | 0.9 | 1.2 | 0.3 | |
| | | | 400.01 - 425.00 | 425.01 - 450.00 | 450.01 - 475.00 | 475.01 - 500.00 | | |
| Z | 400 | 25 | 0.1 | 0.2 | 0.3 | 0.4 | 0.1 | |
| Price basis (1st digit) | | | | | | | | |
| L | Calculation based on the list price | | | | | | | |
| N | Calculation based on the customer net price (discounted list price) | | | | | | | |
| Weight method | Basic official price in € | | | | | | | |
| 1 | 50 | Calculation based on raw material weight | | | | | | |
| 2 | 100 | | | | | | | |
| 3 | 150 | | | | | | | |
| 4 | 175 | | | | | | | |
| 5 | 200 | | | | | | | |
| 6 | 225 | | | | | | | |
| 7 | 300 | | | | | | | |
| 8 | 400 | | | | | | | |
| 9 | 555 | | | | | | | |
| Miscellaneous | | | | | | | | |
| - | No metal surcharge | | | | | | | |

1. General Provisions

By using this catalog you can purchase products (hardware, software and services) described therein from Siemens Aktiengesellschaft subject to the following Terms and Conditions of Sale and Delivery (hereinafter referred to as "T&C"). Please note that the scope, the quality and the conditions for supplies and services, including software products, by any Siemens entity having a registered office outside Germany, shall be subject exclusively to the General Terms and Conditions of the respective Siemens entity. The following T&C apply exclusively for orders placed with Siemens Aktiengesellschaft, Germany.

1.1 For customers with a seat or registered office in Germany

For customers with a seat or registered office in Germany, the following terms and conditions apply subordinate to T&C:

- for products, which include specific terms and conditions in the description text, these specific terms and conditions shall apply and subordinate thereto,
- for installation work the "General Conditions for Erection Works – Germany"¹⁾ ("Allgemeine Montagebedingungen – Deutschland" (currently only available in German)) and/or
- for stand-alone software products and software products forming a part of a product or project, the "General License Conditions for Software Products for Automation and Drives for Customers with a Seat or registered Office in Germany"¹⁾ and/or
- for consulting services the "General Terms and Conditions for Consulting Services of the Division DF – Germany"¹⁾ and/or
- for other supplies and/or services the "General Conditions for the Supply of Products and Services of the Electrical and Electronics Industry"¹⁾.

In case such supplies and/or services should contain Open Source Software, the conditions of which shall prevail over the "General Conditions for the Supply of Products and Services of the Electrical and Electronics Industry"¹⁾, a notice will be contained in the scope of delivery in which the applicable conditions for Open Source Software are specified. This shall apply mutatis mutandis for notices referring to other third party software components.

1.2 For customers with a seat or registered office outside Germany

For customers with a seat or registered office outside Germany, the following terms and conditions apply subordinate to T&C:

- for products, which include specific terms and conditions in the description text, these specific terms and conditions shall apply and subordinate thereto,
- for services the "International Terms & Conditions for Services"¹⁾ supplemented by "Software Licensing Conditions"¹⁾ and/or
- for consulting services the "General Terms and Conditions for Consulting Services of the Division DF – Germany"¹⁾ and/or
- for other supplies of hard- and software the "International Terms & Conditions for Products"¹⁾ supplemented by "Software Licensing Conditions"¹⁾

1.3 For customers with master or framework agreement

To the extent our supplies and/or services offered are covered by an existing master or framework agreement, the terms and conditions of that agreement shall apply instead of T&C.

2. Prices

The prices are in € (Euro) ex point of delivery, exclusive of packaging.

The sales tax (value added tax) is not included in the prices. It shall be charged separately at the respective rate according to the applicable statutory legal regulations.

Prices are subject to change without prior notice. We will charge the prices valid at the time of delivery.

To compensate for variations in the price of raw materials (e.g. silver, copper, aluminum, lead, gold, dysprosium and neodym), surcharges are calculated on a daily basis using the so-called metal factor for products containing these raw materials. A surcharge for the respective raw material is calculated as a supplement to the price of a product if the basic official price of the raw material in question is exceeded.

The metal factor of a product indicates the basic official price (for those raw materials concerned) as of which the surcharges on the price of the product are applied, and with what method of calculation.

You will find a detailed explanation of the metal factor on the page headed "Metal surcharges".

To calculate the surcharge (except in the cases of dysprosium and neodym), the official price from the day prior to that on which the order was received or the release order was effected is used.

To calculate the surcharge applicable to dysprosium and neodym ("rare earths"), the corresponding three-month basic average price in the quarter prior to that in which the order was received or the release order was effected is used with a one-month buffer (details on the calculation can be found in the explanation of the metal factor).

3. Additional Terms and Conditions

The dimensions are in mm. In Germany, according to the German law on units in measuring technology, data in inches apply only to devices for export.

Illustrations are not binding.

Insofar as there are no remarks on the individual pages of this catalog – especially with regard to data, dimensions and weights given – these are subject to change without prior notice.

¹⁾ The text of the Terms and Conditions of Siemens AG can be downloaded at https://mall.industry.siemens.com/legal/ww/en/terms_of_trade_en.pdf

Appendix

Conditions of sale and delivery

4. Export Regulations

We shall not be obligated to fulfill any agreement if such fulfillment is prevented by any impediments arising out of national or international foreign trade or customs requirements or any embargoes and/or other sanctions.

Export may be subject to license. We shall indicate in the delivery details whether licenses are required under German, European and US export lists.

Our products are controlled by the U.S. Government (when labeled with "ECCN" unequal "N") and authorized for export only to the country of ultimate destination for use by the ultimate consignee or end-user(s) herein identified. They may not be resold, transferred, or otherwise disposed of, to any other country or to any person other than the authorized ultimate consignee or end-user(s), either in their original form or after being incorporated into other items, without first obtaining approval from the U.S. Government or as otherwise authorized by U.S. law and regulations.

The export indications can be viewed in advance in the description of the respective goods on the Industry Mall, our online catalog system. Only the export labels "AL" and "ECCN" indicated on order confirmations, delivery notes and invoices are authoritative.

Products labeled with "AL" unequal "N" are subject to European / national export authorization. Products without label, with label "AL:N" / "ECCN:N", or label "AL:9X9999" / "ECCN: 9X9999" may require authorization from responsible authorities depending on the final end-use, or the destination.

If you transfer goods (hardware and/or software and/or technology as well as corresponding documentation, regardless of the mode of provision) delivered by us or works and services (including all kinds of technical support) performed by us to a third party worldwide, you must comply with all applicable national and international (re-)export control regulations.

If required for the purpose of conducting export control checks, you (upon request by us) shall promptly provide us with all information pertaining to the particular end customer, final disposition and intended use of goods delivered by us respectively works and services provided by us, as well as to any export control restrictions existing in this relation.

The products listed in this catalog may be subject to European/German and/or US export regulations. Any export requiring approval is therefore subject to authorization by the relevant authorities.

Errors excepted and subject to change without prior notice.

Selection and ordering at Siemens Industry Mall, downloading and ordering catalogs

Easy product selection and ordering: Industry Mall

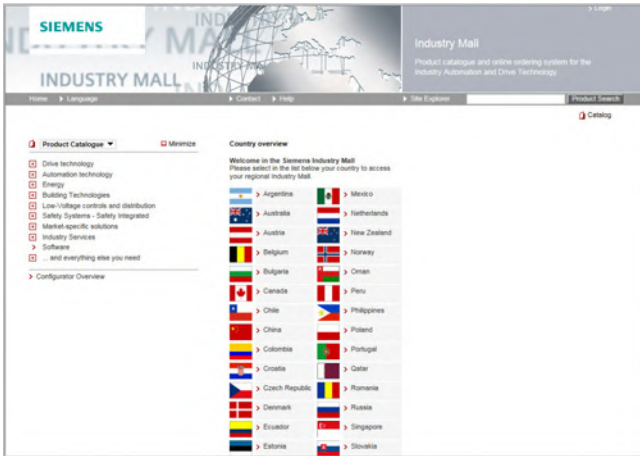

Industry Mall

The Industry Mall is a Siemens AG Internet ordering platform. It provides you with online access to a comprehensive product spectrum that is presented in an informative, well-organized way.

Powerful search functions help you select the required products, while configurators enable you to configure complex product and system components quickly and easily. CAx data are also available for you to use.

Data transfer allows the entire procedure, from selection through ordering to tracking and tracing, to be carried out online. Availability checks, individual customer discounting, and quotation preparation are also possible.

www.siemens.com/industrymall

Downloading catalogs

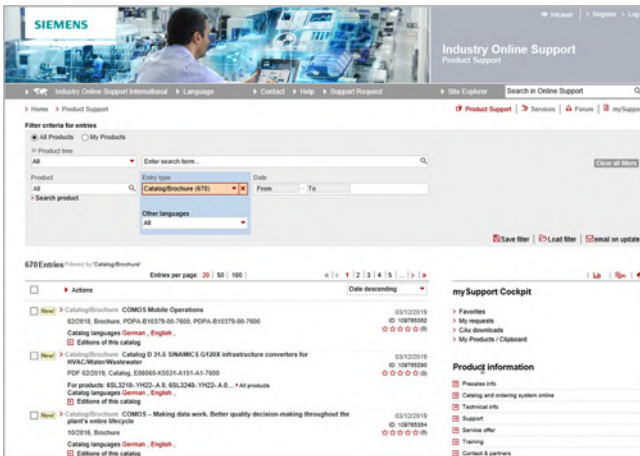

Siemens Industry Online Support

You can download catalogs and brochures in PDF format from Siemens Industry Online Support without having to register.

The filter box makes it possible to perform targeted searches.

www.siemens.com/industry-catalogs

Ordering printed catalogs



Please contact your local Siemens branch if you are interested in ordering printed catalogs.

Addresses can be found at

www.siemens.com/automation-contact

Get more information

Siemens Motors:
www.siemens.com/motors

Local partners worldwide:
www.siemens.com/automation-contact

Published by
Siemens AG

For the U.S. published by
Siemens Industry Inc.

Digital Industries
Motion Control
P.O. Box 31 80
91050 Erlangen, Germany

100 Technology Drive
Alpharetta, GA 30005
United States

PDF (Article No. E86060-K5581-A111-B4-7600)
V6.MKKATA.LDT.140
KG 0720 662 En
Produced in Germany
© Siemens 2020

Subject to changes and errors. The information given in this catalog only contains general descriptions and/or performance features which may not always specifically reflect those described, or which may undergo modification in the course of further development of the products. The requested performance features are binding only when they are expressly agreed upon in the concluded contract.

All product designations may be trademarks or product names of Siemens AG or other companies whose use by third parties for their own purposes could violate the rights of the owners.

Security information

Siemens provides products and solutions with industrial security functions that support the secure operation of plants, systems, machines and networks.

In order to protect plants, systems, machines and networks against cyber threats, it is necessary to implement – and continuously maintain – a holistic, state-of-the-art industrial security concept. Siemens' products and solutions constitute one element of such a concept.

Customers are responsible for preventing unauthorized access to their plants, systems, machines and networks. Such systems, machines and components should only be connected to an enterprise network or the internet if and to the extent such a connection is necessary and only when appropriate security measures (e.g. firewalls and/or network segmentation) are in place.

For additional information on industrial security measures that may be implemented, please visit
<https://www.siemens.com/industrialsecurity>

Siemens' products and solutions undergo continuous development to make them more secure. Siemens strongly recommends that product updates are applied as soon as they are available and that the latest product versions are used. Use of product versions that are no longer supported, and failure to apply the latest updates may increase customer's exposure to cyber threats.

To stay informed about product updates, subscribe to the Siemens Industrial Security RSS Feed under
<https://www.siemens.com/industrialsecurity>

Please scan the
QR code for more
information on
Siemens Motors.

