



501 SERIES

PNEUMATIC VALVES



NUMATICS

501 SERIES

PRODUCT LEAFLET

501 Series – Directional Control Valve Platform Featuring Higher Flow in a Compact Valve Package

Commissioning Capabilities

- Solenoid air pilot actuated
- Low wattage .8 wall for DC application
- DC solenoids Polarity insensitive with surge suppression
- Plug together circuit boards eliminate internal wiring
- Integral recessed gaskets
- IN Fittings to accommodate various tube sizes
- Simple conversion from internal to external pilot
- IP65 Certified

Sandwich and Manifold Accessories

- Pressure Regulators for supply pressure control at individual valve
- Speed control to control exhaust flow allows for control of actuator extend or retract speed
- Shut off block for individual valve to be isolated from pressure supply during operation and repair
- Mid Station Supply Manifold block allows for multiple pressure zones (with blocking discs) or additional air supply to a manifold

Fieldbus Electronics Compatible

- G3 Fieldbus Electronics
 - Graphic Display for easy commissioning, visual status & diagnostics
 - 32 valve solenoids per manifold
 - Easy distribution of additional manifolds through Sub-Bus communication
 - One Node supports up to 16 I/O modules
 - Available with Auto Recovery Module (ARM) which allows configuration information to be saved and reloaded to replacement module automatically
- 580 Fieldbus Electronics
 - Graphic Display for easy commissioning, visual status & diagnostics
 - 32 valve solenoids per manifold





NUMATICS

501 SERIES

PRODUCT LEAFLET

Performance Data

Valve Data	Min.	Max.
Pilot Pressure Range	29 PSI (2 Bar)	115 PSI (8 Bar)
Valve Operating Pressure Range	28" HG Vacuum	115 PSI (8 Bar)
Ambient Temperature Range	- 10°C (- 14°F)	50 °C (122 °F)

Proprietary		
Valve Flow Data	Cv	NL/m (6 - 5 Bar)
5/2, Double Solenoid & Single Solenoid, Spring Return	0.46	460
2X 3/2 NC-NC	0.45	450
2X 3/2 NO-NO	0.45	450
Double Solenoid, 3 pos. 4 way, Spring Centered- Open to 4 and 2 in center	0.46	460
Double Solenoid, 3 pos. 4 way, Spring Centered - Open Center	0.46	460
Double Solenoid, 3 pos. 4 way, Spring Centered - Closed Center	0.46	460



Operating Data

All Solenoids Are Continuous Duty Rated	24 VDC
Power (Watts)	0.8

Response Time (ms)	Rubber Seal	
	Energize	Deenergize
5/2, Single Solenoid, Spring Return	14	29
5/2, Double Solenoid	11	N/A
5/3 Spring Centered	15	20
2x3/2 NC	18	18
2 X3/2 NO	18	18

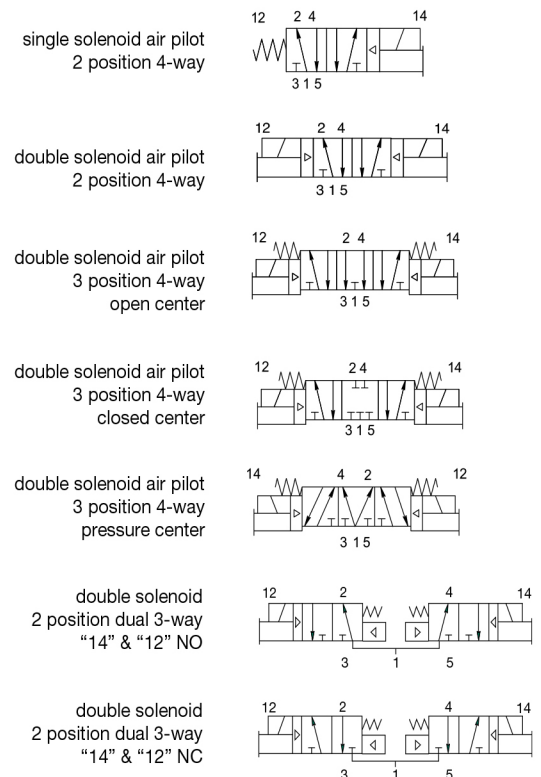



NUMATICS

501 SERIES

PRODUCT LEAFLET

How to Order

Valves

R 501 A 2 B 4 0 M A00 F1

Product Series

501 = 11 mm Valve

Revision

A = Initial Release

Actuation

2 = Rubber Packed

Valve Type

B = Solenoid Pilot with Flush Non-Locking Override

Function

- 1 = 2 Position 4-Way (5/2), Spring Return
- 4 = 2 Position 4-Way (5/2), Dual Solenoid
- 5 = 3 Position 4-Way (5/3), Open Center, Dual Pressure
- 6 = 3 Position 4-Way (5/3), Blocked Center
- 7 = 3 Position 4-Way (5/3), Open to A & B in Center
- A = Dual 3-way, A normally open - B normally open
- D = Dual 3-way, A normally closed - B normally closed
- N = Differential Air Return w/o Spring

Voltage

F1 = 24 DC

Options

- A00 = Standard (No Options)
- 11B = Flush Locking Manual Override
- 11M = Without Manual Override

Electrical

M = Plug-in, w/ Light, VDC

Port Size

0 = No Port Size

Regulators

R 501 A R S 5 1 J A00 1 0

Product Series

501 = 11 mm Valve

Revision

A = Initial Release

Product Type

R = Regulator

Regulator Type

S = Single Reg. - Pressure to Port 1

Interface

1 = Proprietary

Options

- A00 = Standard (No Options)
- 12H = Regulator Less Gauge
- 18V = Regulator with Gauge in Offset Port

Wiring Option

J = Plug-In, Receptacle Assembly

Gauge Type

1 = PSI

Pressure Range

5 = 10 - 115 PSIG

Sandwich Pressure Regulators

Type: RS



Type RS

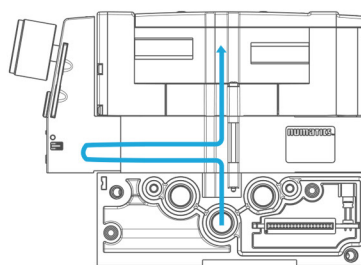

Single pressure from a single supply

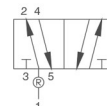



NUMATICS

501 SERIES

PRODUCT LEAFLET

Valve Regulator / Plug-in Assembly

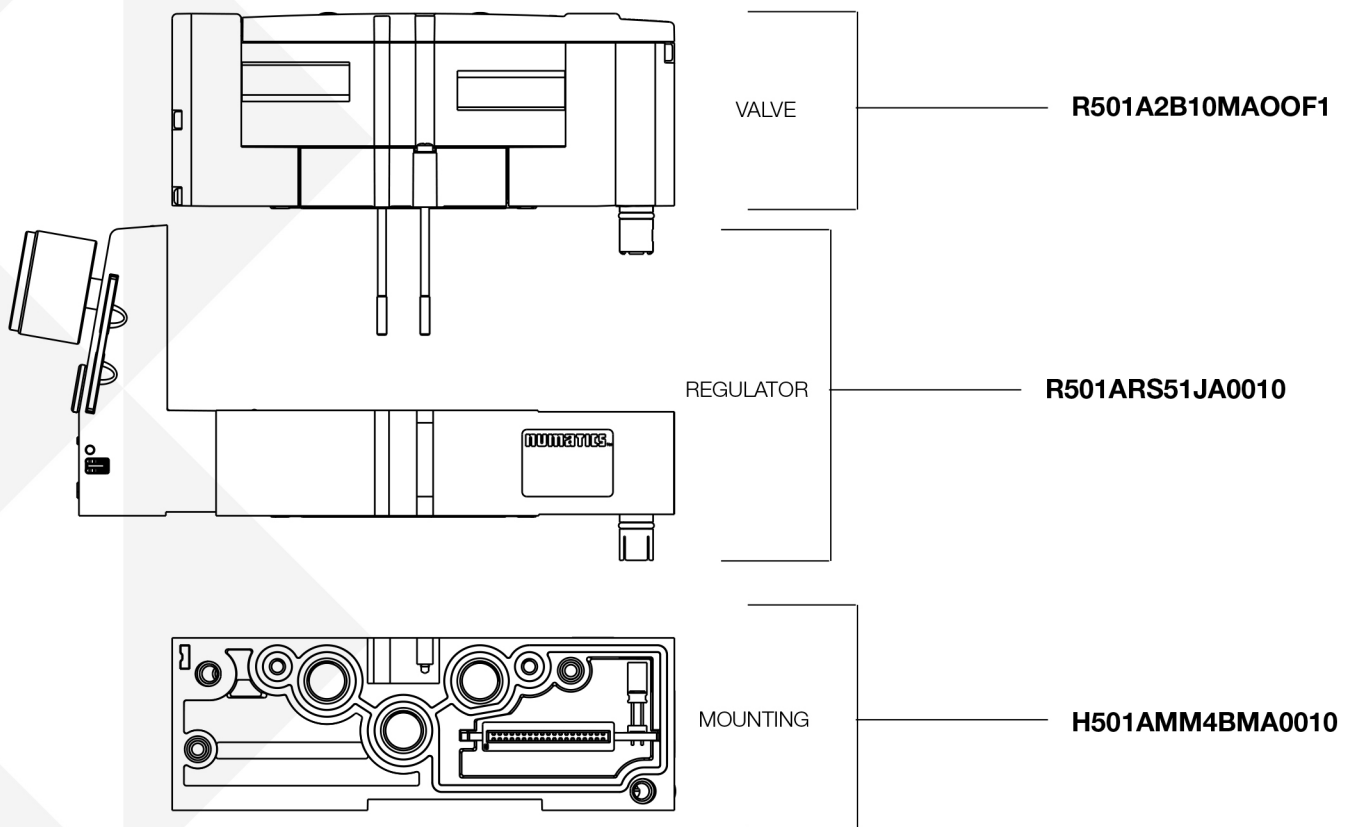



NUMATICS

501 SERIES

PRODUCT LEAFLET

Sandwich Pressure Regulator

Dimensions: mm (Inches)

Single Regulator

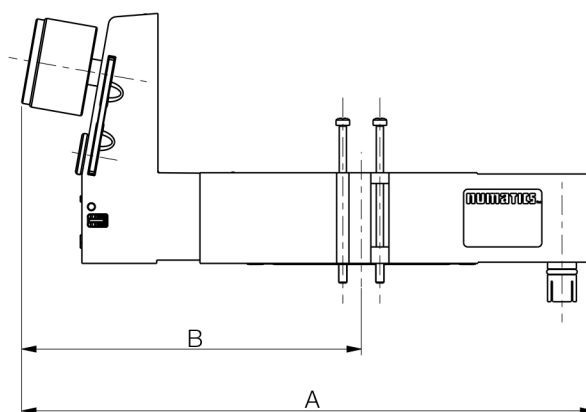
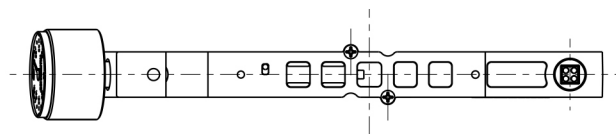
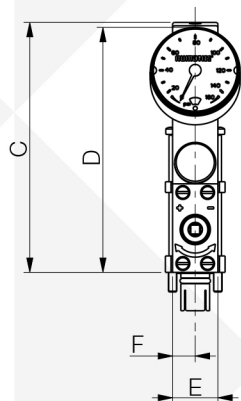

A	B	C	D	E	F
139.1 (5.476)	82.5 (3.248)	60.7 (2.390)	59.5 (2.342)	11 (0.433)	5.5 (0.216)



NUMATICS

501 SERIES

PRODUCT LEAFLET

How to Order

Manifold Assemblies

K 501 A M S4 2 M A00 1 0

Port Type

- H = Metric Thread
- K = Push-In Fittings

Product Series

- 501 = 11 mm Valve

Revision

- A = Initial Release

Product Type

- M = Manifold Sub Base
- Z = Mid Station Supply*

Mounting

- S4 = Manifold Sub Base, 4 Stations, Side Ports, Single Z-Board
- M4 = Manifold Sub Base, 4 Stations, Side Ports, Double Z-Board

*Available with M4 mounting only

Interface

- 1 = Proprietary

Options

- A00 = Standard (No Options)

Wiring Option

- M = Plug-In, Receptacle Assembly

Port Size

- B = M7 (Threaded only)
- D = 4 mm (5/32) (Push-In Fittings only)
- F = 6 mm (Push-In Fittings only)
- 2 = 1/4 (Push-In Fittings only)

Dimensions: mm (Inches)

Plug In Valve Mounted

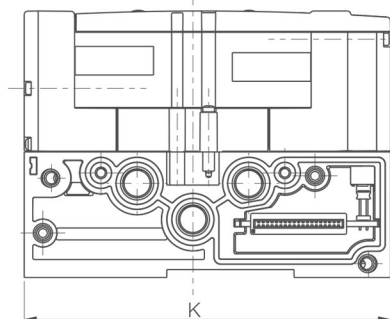
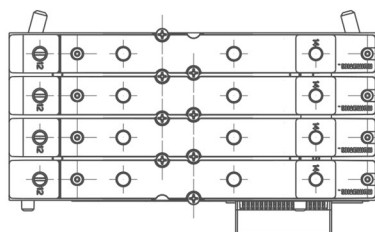
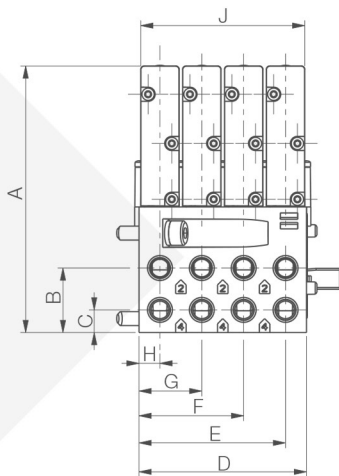

A	B	C	D	E	F	G	H	J	K
76.4	18.5	6.5	48	42	30	18	6	47	105
(3.008)	(0.728)	(0.256)	(1.890)	(1.653)	(1.181)	(0.709)	(0.236)	(1.850)	(4.134)

Sandwich Shut Off Block

- Used to shut off pressure when mounted below valve.
- Allows easy maintenance without the need to shut off pressure to the entire manifold.

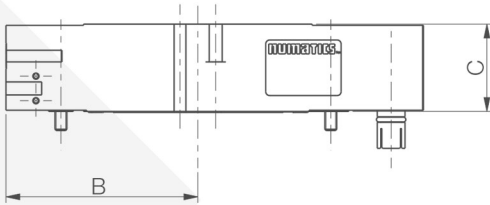
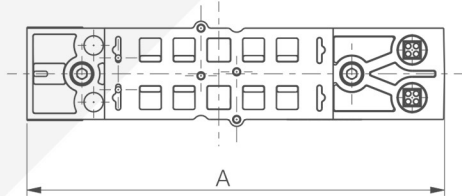
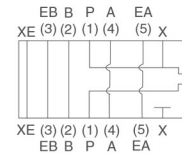

Part Number	Description
R501AY428501001	Proprietary Sandwich Shut Off Kit

Dimensions: mm (Inches)			
A	B	C	D
105.2 (4.142)	48.4 (1.905)	22 (0.866)	23 (0.905)

Blank Station Plate Kit

P501AB429685001

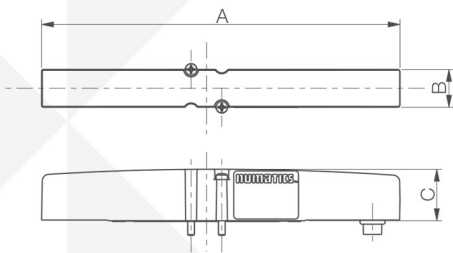

- Used to block off a manifold station for future use.

Dimensions: mm (Inches)		
A	B	C
105.1 (4.138)	11 (0.433)	15 (0.591)

Speed Control Kit

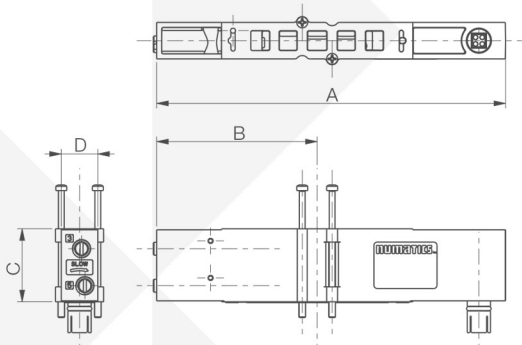

Part Number	Description
R501AS428500001	Sandwich Speed Control

Dimensions: mm (Inches)			
A	B	C	D
105.1 (4.137)	48.4 (1.905)	22 (0.866)	11 (0.433)



NUMATICS

501 SERIES

PRODUCT LEAFLET

DIN Rail Clamp Kit

239-980

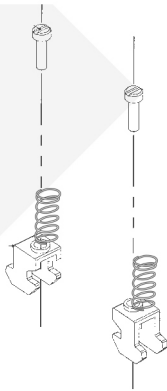

End Plate Kit - Threaded



Blocking Disc Kits

(Includes tag to label ports blocked)

Ports	Part
1	P501AD431915001
3	P501AD431915002
5	P501AD431915003
1 + 3	P501AD431915004
1 + 5	P501AD431915005
3 + 5	P501AD431915006
1, 3, 5	P501AD431915007

Port Type	NPTF			G			Push In			Push In		
Port	1	3/5	X,XE	1	3/5	X,XE	1	3/5	X,XE	1	3/5	X,XE
Port Size	1/8	1/8	M7	1/8	1/8	M7	5/16	5/16	1/4	8 mm	8 mm	6 mm
w/o Muffler, w/o DIN	8501AK429465001			G501AK429465009			K501AK429465003			K501AK429465011		
w/o Muffler, w/DIN	8501AK429465002			G501AK429465010			K501AK429465004			K501AK429465012		
w/Muffler, w/o DIN	8501AK429465005			G501AK429465013			K501AK429465007			K501AK429465015		
w/Muffler, w/DIN	8501AK429465006			G501AK429465014			K501AK429465008			K501AK429465016		



NUMATICS

501 SERIES

PRODUCT LEAFLET

Manifold Assembly

Dimensions: mm (Inches)

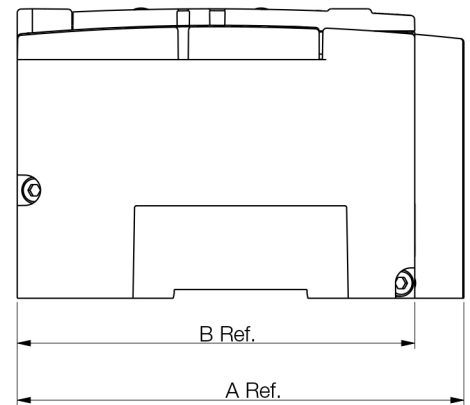
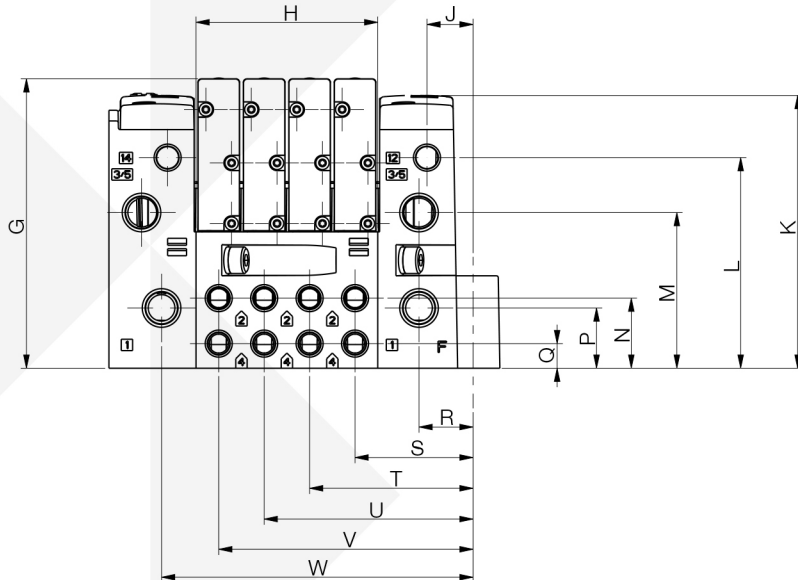
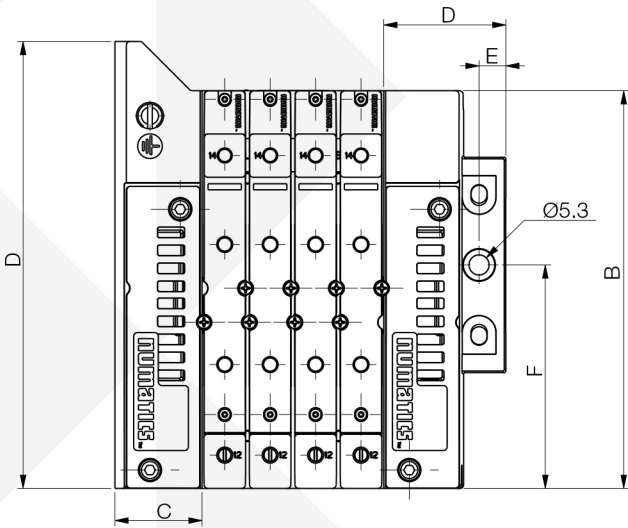

A	B	C	D	E	F	G	H	J	K	L	M	N	P	Q	R	S	T	U	V	W
118	105	23	32.3	7.1	59	76.4	48	12.2	72	55.6	41.1	18.5	15.9	6.5	14.3	31.2	43.2	55.2	67.2	82.3
(4.65)	(4.13)	(0.90)	(1.27)	(0.28)	(2.32)	(3.01)	(1.89)	(0.48)	(2.83)	(2.19)	(1.62)	(0.73)	(0.63)	(0.26)	(0.56)	(1.23)	(1.70)	(2.17)	(2.65)	(3.24)



NUMATICS

501 SERIES

PRODUCT LEAFLET

Internal Pilot

Internal Pilot
Supply Plug Location



External Pilot

For External Pilot
Supply Plug Location





NUMATICS

501 SERIES

PRODUCT LEAFLET

Manifold Assembly How to Order

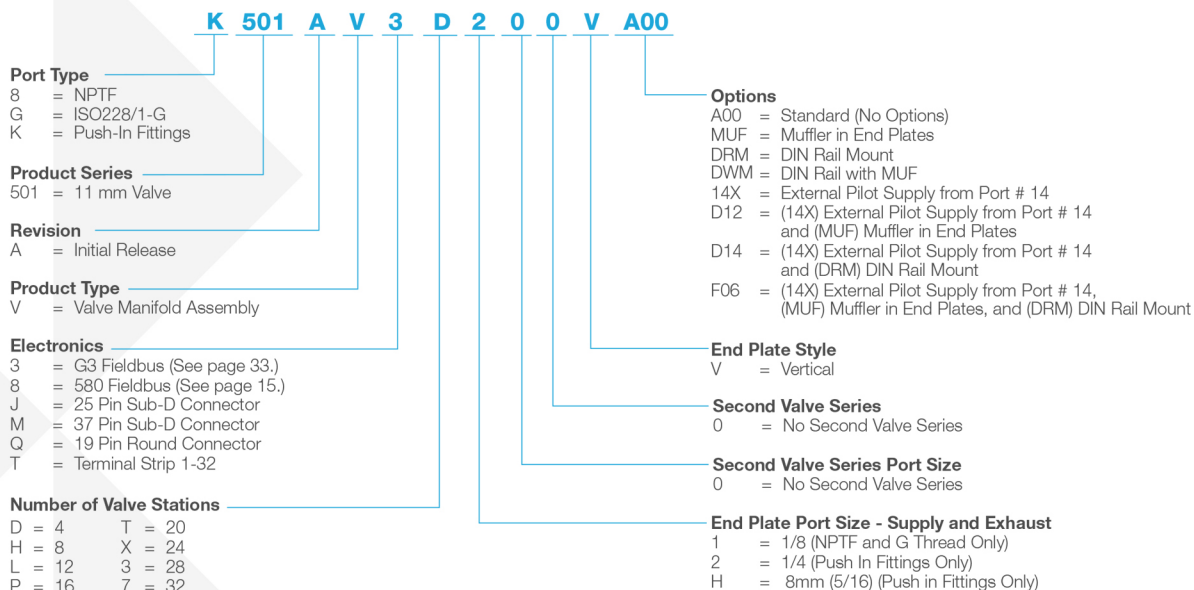

¹Port Type '8' + 'G' only available in Port Size 1/8

Maximum Solenoid Outputs

Terminal Strip	25 Pin Sub-D	37 Pin Sub-D	19 Pin Round	G3 Fieldbus	580 Fieldbus
32	22	32	16	32	32

*NOTE: Maximum number of valve stations is determined by:

- The electrical connection type.
- The valve type - single solenoid valves up to the maximum solenoid outputs allowed by the electrical connection type (see chart above) or a combination of single and/or double solenoid valves not to exceed the maximum number of solenoid outputs allowed.
- Combination of all stations cannot exceed 32 solenoids.

25 or 37 Pin Sub-D, Terminal Strip and 19 Pin Round Connector

- Shaded components described by Assembly Kit model number designation.
- Each valve manifold station is listed in sequential order from left to right when facing the port side of the manifold as indicated.

Example Order - 501 Shown

25 Pin Sub-D	K501AVJHG00VA00
Valve Station #1	R501A2B10MA00F1
Valve Station #2	R501A2B10MA00F1
Valve Station #3	R501A2B10MA00F1
Valve Station #4	R501A2B10MA00F1
Mounting #1	K501AMS42MA0010
Valve Station #5	R501A2B40MA00F1
Valve Station #6	R501A2B40MA00F1
Valve Station #7	R501A2B40MA00F1
Valve Station #8	R501A2B40MA00F1
Mounting #2	K501AMM42MA0010
Assembled	

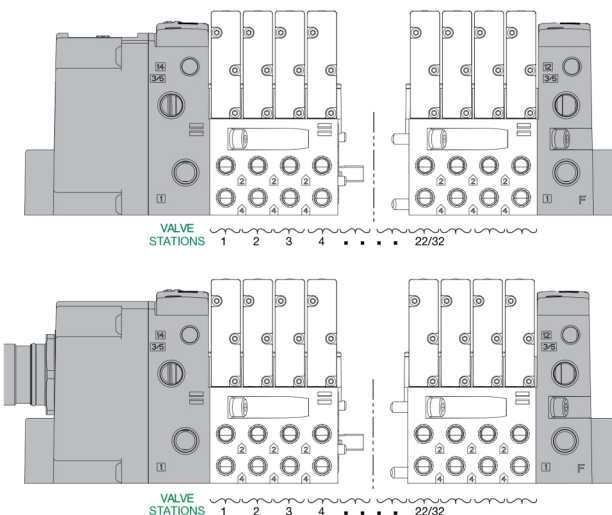

25 Pin Sub-D Connector Kit

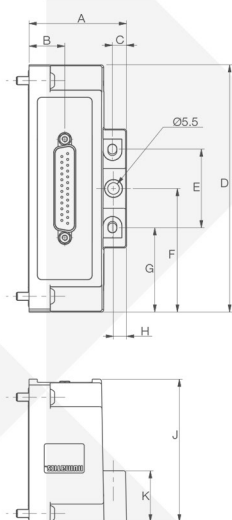

Dimensions: mm (Inches)										
A	B	C	D	E	F	G	H	J	K	
46.4	17	6.7	118	37.5	59	40.2	40.2	68.1	24.4	
(1.827)	(0.669)	(0.26)	(4.65)	(1.48)	(2.32)	(1.58)	(1.58)	(2.68)	(0.96)	

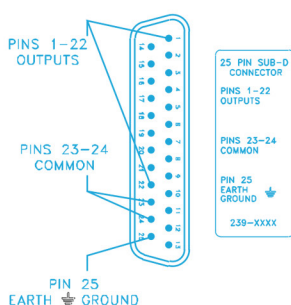

25 Pin Sub-D Connector Housing Kits	
P599AE428441001	25 PIN SUB-D ASSEMBLY WITHOUT DIN RAIL
P599AE428441002	25 PIN SUB-D ASSEMBLY WITH DIN RAIL

NOTE: External fusing or output protection recommended.

25 Pin Sub-D Female Cable 22 AWG – Unshielded, Standard	
Part Number	Length
SC2502MCX00000000	2 Meters
SC2505MCX00000000	5 Meters
SC2510MCX00000000	10 Meters
NDB25F22U02MSB4	2 Meters
NDB25F22U05MSB4	5 Meters
NDB25F22U10MSB4	10 Meters

37 Pin Sub-D Connector Kit

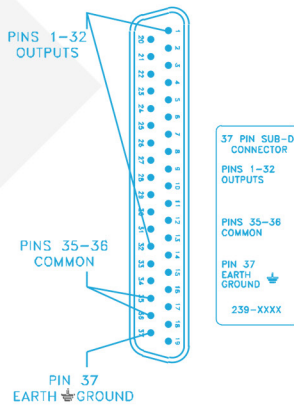
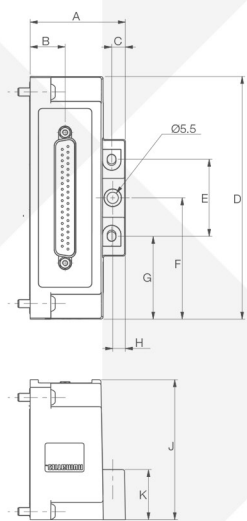

Dimensions: mm (Inches)										
A	B	C	D	E	F	G	H	J	K	
46.4	17	6.7	118	37.5	59	40.2	40.2	68.1	24.4	
(1.827)	(0.669)	(0.26)	(4.65)	(1.48)	(2.32)	(1.58)	(1.58)	(2.68)	(0.96)	

37 Pin Sub-D Connector Housing Kits	
P599AE428442001	37 PIN SUB-D ASSEMBLY WITHOUT DIN RAIL
P599AE428442002	37 PIN SUB-D ASSEMBLY WITH DIN RAIL

NOTE: External fusing or output protection recommended.

37 Pin Sub-D Female Cable 22 AWG – Unshielded, Standard	
Part Number	Length
SC3702MCX00000000	2 Meters
SC3705MCX00000000	5 Meters
SC3710MCX00000000	10 Meters

37 Pin Sub-D Female Cable 22 AWG – Unshielded IP65	
Part Number	Length
NDB37F22U02MSB4	2 Meters
NDB37F22U05MSB4	5 Meters
NDB37F22U10MSB4	10 Meters

1-32 Terminal Strip Kit

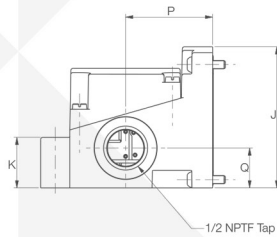
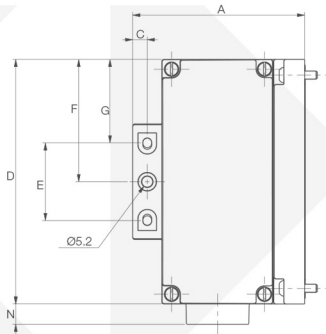

Dimensions: mm (Inches)

A	C	D	E	F	G	J	K	N	P	Q
82.7	7	118	37.5	59	40.2	68.1	24.4	9.8	41.9	19.3
(3.256)	(0.28)	(4.65)	(1.48)	(2.32)	(1.583)	(2.68)	(0.96)	(0.39)	(1.65)	(0.76)

TERMINAL STRIP
TERMINALS 1-32 OUTPUTS
TERMINAL COM COMMON
TERMINAL GND EARTH GROUND
18 AWG WIRE MAXIMUM

1 - 32 Terminal Strip Housing Kits

P599AE428444001	TERMINAL STRIP ASSEMBLY WITHOUT DIN RAIL
P599AE428444002	TERMINAL STRIP ASSEMBLY WITH DIN RAIL

NOTE: External fusing or output protection recommended.
NOTE: Min. Wire AWG 26
Max. Wire AWG 18

19 Pin Round Connector Kit

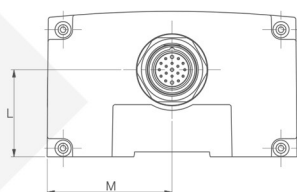
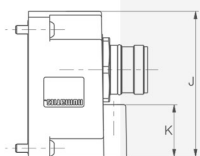
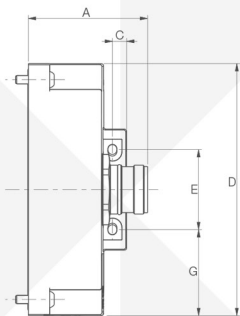

Dimensions: mm (Inches)

A	C	D	E	G	J	K	L	M
56.3	6.7	118	37.5	40.2	68.1	24.4	40.8	59
(2.217)	(0.26)	(4.65)	(1.48)	(1.583)	(2.68)	(0.96)	(1.61)	(2.323)

19 Pin Round Connector Housing Kits

P599AE428436001	19 PIN ASSEMBLY WITHOUT DIN RAIL
P599AE428436002	19 PIN ASSEMBLY WITH DIN RAIL

NOTE: External fusing or output protection recommended.

19 PIN CONNECTOR

PIN 1= COIL 15	PIN 11= COIL 13
PIN 2= COIL 11	PIN 12= P.E.
PIN 3= COIL 7	PIN 13= COIL 12
PIN 4= COIL 4	PIN 14= COIL 8
PIN 5= COIL 3	PIN 15= COIL 1
PIN 6= COMMON	PIN 16= COIL 5
PIN 7= COIL 2	PIN 17= COIL 9
PIN 8= COIL 6	PIN 18= COIL 16
PIN 9= COIL 10	PIN 19= N.C.
PIN 10= COIL 14	

19 Pin M23 Female Cable

Part Number	Length
CC1905MI00000000	5 Meters
CC1910MI00000000	10 Meters



A.P.S. CONTROL CO., LTD., THAILAND

7 SOI ON-NUCH 62 SUKHUMVIT 77 RD. ON-NUCH SUANLUANG BANGKOK 10250 WWW.APSCONTROL.CO.TH
Tel: 0 2721 1800 (Auto) Fax: 0 2721 1791 E-mail: sales@apscontrol.co.th Line ID: aps.sales Tax.ID: 010-55430-20618

Note: We are engineering partner as a total system solution provider, Numatics global operations were unified brand, setting the stage for the company's next period of growth. As a comprehensive solution provider, We have great quality control procedures. The calculate various system designs and can work together perfectly. Finally we are fully committed to maintaining environment quality together.

NUMATICS INC., THE UNITED STATES

Note: NUMATICS leads in quality management via initiatives such as ISO 9001:2008, 6 Sigma continuous improvement, and lean manufacturing. Our products are tested up to 500 million cycles, far beyond the operating requirements of their intended applications. In fact, NUMATICS is certified as a test data facility for UL and CSA-these agencies accept our test data for many parameters to grant their approval of our products.

THE NUMATICS PNEUMATIC VALVE © 2019 Numatics. All Rights Reserved.