

Forged Steel Valves



Valve Specialists™



Gate, Globe & Check



30 YEARS OF INNOVATIONS

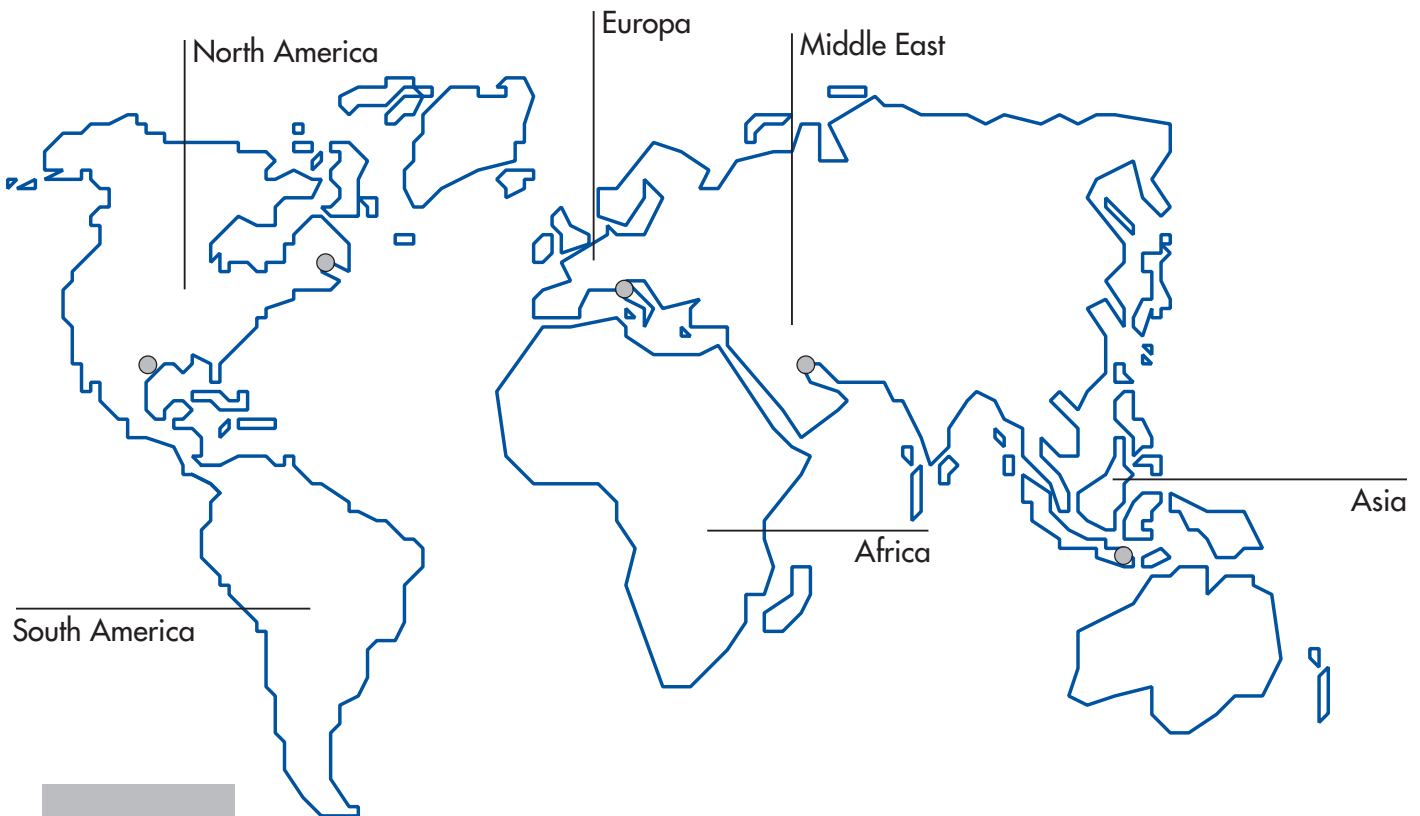

OMB Group is a family owned and managed business founded by Mr Roberto Brevi in 1973. The group is specialized in forged steel valves from small size gate valves to large diameter Trunnion mounted ball valves. The company now operates 5 plants in 3 countries and is present worldwide directly and with a well established network of agents and distributors.



NEW on this version

This is the 17th version of the general API602/ISO 15761 Forged steel valves catalog. In this version we revise the bore dimension of few globe valves to exactly meet the metric conversions set by the ISO standards.

C16 the previous version

The content of this catalog is copyrighted by OMB Valves s.p.a. (C) 2006 Nothing included in this catalog can be reproduced in any form without obtaining prior written consent by OMB Valves s.p.a. All photos and images published are copyrighted: the use of images, even if digitally modified to take away the OMB logo will be prosecuted to the maximum extend of the law.



THE GROUP



The **Brevi** family is active in the management of the operations. Roberto Brevi, Founder and Chairman, with Simone and Fabio, Managing Directors.



All OMB valves are identified by the OMB Logo embossed on the body forging in the traditional diamond shape.

At OMB we have developed a comprehensive range of engineered valves products installed globally across a wide range of industries:

- Oil & Gas Production
- Refining
- Petrochemical
- Chemical
- Pulp & Paper
- Power Generation
- Steam and Heat Transfer Fluid applications
- Desalination

In these past 30 years millions of valves have been supplied to major oil and gas companies worldwide and the OMB name became synonymous of absolute reliability, superior quality and competitive pricing.

In the early '80 we were the first to introduce robotics in the manufacturing process along with specialized equipment designed to reduce machining time and increase quality of the components.

Today we are more than ever committed to innovation and continuous improvement: we remain focused in expanding our capacity at home, opening new plants near the users and extending our distribution network.

We invite you to visit our plants where you will see an young and at the same time experienced team working with state of the art equipment to provide the best value money can buy in valves.

This is our promise !

Roberto, Simone and Fabio Brevi



OMB is based in **Bergamo**, a town 45 Km from Milan with easy access to airports, highways and seaports. Bergamo is the world center for the forged steel valves production with a large valve parts subcontracting base.



OMB manufacture a wide range of forged steel valves. In the following catalogs we present most of the products we make and which are usually available from our distribution network.

All catalogs are downloadable from our web site www.ombvalves.com



ISO15761 - API602 FORGED STEEL VALVES

Catalog C-17 present the Forged steel Gate, Globe and Check valves for general oil, gas and petrochemical use.

Includes valves with flanges according to ASME, DIN and JIS standards



ISO15761 - API602 CRYOGENIC SERVICE FORGED STEEL VALVES

Catalog C-CR2 present the Forged steel Gate, Globe and Check valves for cryogenic and low temperature service

Includes valves with Extended bonnet and cryogenic and low temperature ball valves.



ISO15761 - API602 BELLOWS SEAL FORGED & CAST STEEL VALVES

Catalog C-BS present the Forged & Cast steel range of Bellows Sealed Gate, Straight pattern Globe and "Y" pattern Globe valves.

Valves are offered in pressure class from 150 to 2500, with bellows in 321, Alloy 625, Hastelloy® C276.

Includes Cast steel valves in accordance to API600 from 2" to 16".

The range of forged steel valves we make is not limited to the oil and gas industries. We have special product lines for the steam, thermal transfer fluids, power and upstream fields.

Special products announcements are published regularly at www.ombvalves.com

ECO-L-VALVES®

Catalog C-EV3 present the Forged steel Eco-L-Valves® an exclusive product developed by OMB for steam and thermal transfer fluids designed around a revolutionary bellows seal concept.

The catalog includes bolted and welded bonnet versions, flanged and butt-welds designs and the new Y Pattern designed in classes 150, 300 and 600.



HIGH TEMPERATURE - HIGH PRESSURE VALVES

Catalog C-YV2 introduce OMB range of valves for the power and energy industries.

Y pattern globe valves up to 4500 class.

Welded bonnet and Pressure Seal construction gate, globe and check valves.

Parallel Slide Gate valves for steam service.

The catalog include information on temperature-pressure rating of all alloyed materials used for high temperature services.



API6A AND API6D VALVES FOR UPSTREAM APPLICATIONS

Catalog C-UPV1 introduces the latest developments in the API6A and API6D gate, globe and check valves for the upstream oil and gas applications.

The catalog includes the complete range of Thru Conduit gate valves, with expanding and solid (slab) gates, Globe valves and Piston and Swing check valves from class 5000 upward.

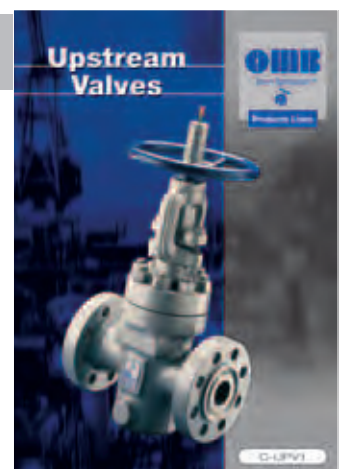

What makes you choose a valve for your plant? Quality, price, delivery, availability of product at distributors, approvals by end-users, aftermarket service?

At OMB we try hard to give you the best in every area.

QUALITY & HSE



OMB quality system is certified in accordance to ISO9000-vision 2000. Our comprehensive quality programmes cover the full scope of our activities and have been certified since 1990.

OMB products are certified to meet the European Union Pressure Equipment Directive (PED, CE mark) since its introduction in 1994.

All our products are as well certified to meet ATEX requirements.

OMB has been accepted as an approved supplier by the major energy companies in the world: a complete list of references, inclusive of projects supplied and product details is available on our web site.



MATERIAL SOURCES AND TRACEABILITY

OMB use forgings made in Italy only for all its products: we have an extensive investment in dyes covering all size and pressure classes in every material from common carbon steels to the most exotic alloys. All our suppliers are ISO9000 certified.



Our valves are always supplied with the forging plant issued 3.1 certificate. We keep on our online database, searchable via our web site, all the certificates issued in the past 15 years.

MATERIAL & VALVE TESTING FACILITIES

Non-destructive examination by ultrasonics, magnetic particles and liquid penetrant can be held at our site. Chemical analysis by computer controlled direct reading emission spectrometer and ferrite content analyzer equipment are available.

All valves are hydraulically tested, seat leakage tested and functionally tested. In addition packing emission in accordance to the latest ISO requirement, helium gas, cryogenic, vacuum and other functional testing can be arrange in our laboratories.

ISO 15761 has been recently published as part of an international effort to standardize the products for the Petroleum and Natural Gas industries. At printing time the list of ISO standards in our industry can be summarized in the following table.

We list as well the major API and ASME standards covering our industry to which we refer in some of our following pages.

On OMB web site we maintain for the registered users a updated list of the main international standards covering valves and related field, with the date of publication and link to the relevant organizations.

DESIGN AND MANUFACTURING STANDARDS		
ISO	API/ASME	DESCRIPTION
ISO 5208:1993		Industrial valves – Pressure testing of valves
ISO 5209:1977		General purpose industrial valves – Marking
ISO 5752:1982		Metal valves for use in flanged pipe systems – Face-to-face and centre-to-face dimensions
ISO 5996:1984		Cast iron gate valves
ISO 6002:1992		Bolted bonnet steel gate valves
ISO 7121:1986		Flanged steel ball valves
ISO 7259:1988		Predominantly key-operated cast iron gate valves for underground use
ISO 10423:2003	API 6A	Specification for Wellhead and Christmas Tree Equipment
ISO 10434:2004	API600	Bolted bonnet steel gate valves for the petroleum, petrochemical and allied industries
ISO 10497:2004	API607	Testing of valves - Fire type-testing requirements (Fire Test for Soft-Seated Quarter-Turn Valves)
ISO 10631:1994		Metallic butterfly valves for general purposes
ISO 12149:1999		Bolted bonnet steel globe valves for general-purpose applications
ISO 14313	API 6D	Specification for Pipeline Valves
ISO 15156	NACE MR0175	NACE MR0175, Petroleum and natural gas industries—Materials for use in H ₂ S-containing environments in oil and gas production
ISO 15761:2002	API602 - (including former BS5352)	Steel gate, globe and check valves for sizes DN 100 and smaller, for the petroleum and natural gas industries
ISO 15848-1:2006		Industrial valves – Measurement, test and qualification procedures for fugitive emission Part 1: Classification system and qualification procedures for type testing of valves
ISO 17292:2004		Metal ball valves for petroleum, petrochemical and allied industries
	API 591	User Acceptance of Refinery Valves
	API 598	Valve Inspection and Testing
	API 600	Steel Gate Valves
	API 602	Compact Carbon Steel Gate Valves
	API 603	Cast, Corrosion Resistant Gate Valves
	API608	Metal Ball Valves—Flanged, Threaded and Butt-Welding Ends (150&300)
	API 17D	Specification for Subsea Wellhead and Christmas Tree Equipment
	API 6FA	Specification for Fire Test for Valves
	API622	Type Testing of Process Valve Packing for Fugitive Emissions
	ASME B16.34	Valves 2 Flanged, Threaded, and Buttwelded End
	ASME B16.10	Face-to-Face and End-to-End Dimensions of Valves
	ASME B16.5	Pipe Flanges and Flanged Fittings
	ASME B16.25	Buttwelded Ends
	ASME B16.11	Forged Fittings, Socket Welding and Threaded

SPECIAL DESIGN

On top of the complete range of valves covered by ISO15761/API602, we manufacture as well special gate, globe and check valves to meet specific requirements in various service and process conditions:

- Bellows Seal Valves
- Cryogenic and Low Temperature Valves
- High Temperature /High Pressure service valves
- Pressure Seal valves form 1/2" upwards
- Y pattern globe and check valves
- Alkylation Service
- Extended Bonnet/ Lantern Ring Vacuum service valves
- Chlorine Service valves
- Urea service valves
- Instrumentation – Needle valves
- Valves with Soft seat inserts
- Self Closing (Spring operated) Globe valves
- Angle Valves

SPECIAL SERVICE

ISO15761/API602 valves are designed for general use in Petroleum and Natural gas industries. In the event of special application valves design, material selection, manufacturing and inspection procedure may vary to address specific requirement of the process.

OMB publish a set of guidelines for Special service which are based on its experience and industry standard identifying the particular requirements for each activity.

SPECIAL SERVICE APPLICATIONS		
Service	Note	OMB procedures
Bellows Seal	Bellows seal valves have been developed and tested according the EPA-API ANSI and BS specifications.	SV - 001
Hydrogen	Special heat treatment and gas testing procedures.	SV - 002
Oxygen	Special procedures guarantee a perfect cleanliness of the valve and protection during shipping.	SV - 003
Vacuum	Close manufacturing tollerances and special extended packingbox and lantern ring assure tight sealing. Test performed at 10 (-4) bar.	SV - 004
Actuator	Pneumatic, Hydraulic and Electric actuators are available upon customer request.	SV - 005
Chlorine	Special degreasing procedure, dry-air testing, packing in moisture absorbing materials, as suggested by the Chlorine Institute.	SV - 006
Steam	Special procedures cover all the applications for steam service	SV - 007
Cryogenic	Complete range of special designs and testing procedures for service down to -521F/-196C.	SV - 008
Sour Oil and Gas	Valves are manufactured strictly in accordance with NACE specifications MR-01-75.	SV - 009
High Temperature	Special grade of steel for use up to 1500F/800C.	SV - 010
Alkylation	Special procedures to select materials and assure a perfect cleanliness of valves.	SV - 011

Without prior notice OMB reserves the right to make modifications or changes to its production.

CLASS 150-300-600-800

BS 5352 - API 602 ^{9th} / ISO 15761					
	DN	NPS	BS 5352 (OBSOLETE)		API 602 ^{9th} /ISO 15761
			STANDARD BORE	REDUCED BORE	MINIMUM DIAMETER
GATE	8	1/4	6	-	6
	10	3/8	9	6	6
	15	1/2	12	9	9
	20	3/4	18	12	12
	25	1	23	18	17
	32	1 1/4	30	23	23
	40	1 1/2	36	30	28
	50	2	46,5	36	36
GLOBE	8	1/4	6	-	6
	10	3/8	9	6	6
	15	1/2	12	9	9
	20	3/4	17,5	12	12
	25	1	22,5	17,5	17
	32	1 1/4	29,5	22,5	23
	40	1 1/2	35	29,5	28
	50	2	45,5	35	36
CHECK	8	1/4	6	-	6
	10	3/8	9	6	6
	15	1/2	12	9	9
	20	3/4	17,5	12	12
	25	1	22,5	17,5	17
	32	1 1/4	29,5	22,5	23
	40	1 1/2	35	29,5	28
	50	2	45,5	35	36

OMB MINIMUM PASSAGE WAY				
	DN	NPS	STANDARD PORT	FULL PORT
			API 602 ^{9th} / ISO 15761	BS 5352
SW, NPT, FLANGED END, BUTT WELD END				
GATE	8	1/4	6	6
	10	3/8	6	9
	15	1/2	9	12
	20	3/4	12	18
	25	1	17	23
	32	1 1/4	23	30
	40	1 1/2	28	36
	50	2	36	46,5
GLOBE	8	1/4	6	N/A
	10	3/8	6	N/A
	15	1/2	9	N/A
	20	3/4	12	N/A
	25	1	17	N/A
	32	1 1/4	23	N/A
	40	1 1/2	28	N/A
	50	2	36	N/A
CHECK	8	1/4	6	N/A
	10	3/8	6	N/A
	15	1/2	9	N/A
	20	3/4	12	N/A
	25	1	17	N/A
	32	1 1/4	23	N/A
	40	1 1/2	28	N/A
	50	2	36	N/A

CLASS 900/1500

BS 5352 - API 602 ^{9th} / ISO 15761					
	DN	NPS	BS 5352 (OBSOLETE)		API 602 ^{9th} /ISO 15761
			STANDARD BORE	REDUCED BORE	MINIMUM DIAMETER
GATE	8	1/4	-	N/A	6
	10	3/8	-	N/A	6
	15	1/2	11,5	N/A	9
	20	3/4	15	N/A	12
	25	1	19,5	N/A	15
	32	1 1/4	28	N/A	22
	40	1 1/2	32	N/A	27
	50	2	40	N/A	34
GLOBE	8	1/4	-	N/A	5
	10	3/8	-	N/A	5
	15	1/2	11	N/A	8
	20	3/4	14,5	N/A	9
	25	1	19	N/A	14
	32	1 1/4	27	N/A	20
	40	1 1/2	31	N/A	25
	50	2	37,5	N/A	27
CHECK	8	1/4	-	N/A	5
	10	3/8	-	N/A	5
	15	1/2	11	N/A	8
	20	3/4	14,5	N/A	9
	25	1	19	N/A	14
	32	1 1/4	27	N/A	20
	40	1 1/2	31	N/A	25
	50	2	37,5	N/A	27

OMB MINIMUM PASSAGE WAY				
	DN	NPS	STANDARD PORT	FULL PORT
			API 602 ^{9th} / ISO 15761	BS 5352
			SW, NPT, BUTT WELD END (End to end OMB dimension)	FLANGED END, BUTT WELD END (End to end dimension as per ASME B16.10)
GATE	8	1/4	6	-
	10	3/8	6	-
	15	1/2	9	11,5
	20	3/4	12	15
	25	1	15	19,5
	32	1 1/4	22	28
	40	1 1/2	27	32
	50	2	34	40
GLOBE	8	1/4	5	-
	10	3/8	5	-
	15	1/2	8	11
	20	3/4	9	14,5
	25	1	14	19
	32	1 1/4	20	27
	40	1 1/2	25	31
	50	2	27	37,5
CHECK	8	1/4	5	-
	10	3/8	5	-
	15	1/2	8	11
	20	3/4	9	14,5
	25	1	14	19
	32	1 1/4	20	27
	40	1 1/2	25	31
	50	2	27	37,5

BODY AND BONNET MATERIALS

OMB valves are manufactured in a wide range of materials, supplied by the best available steel mills, forged by well known forgery with outstanding equipment and experience. All the material can be certified in the chemical composition and the mechanical characteristic.

Material Group	Common Name	Nominal Type	UNS	Forging Spec.	Casting Spec. Equivalent	DIN	DIN W. No	Application Notes
Carbon Steel	CS	C-Mn-Fe	K03504	A105N	A216-WCB	C22.8 DIN 17243	1.0460	General non-corrosive service from -20F(-29C) to 800F(427C)
Low Temperature Carbon Steel	LTCS	C-Mn-Fe	K03011	A350-LF2	A352-LCA A352-LCB A352-LCC	TSTE 355 DIN 18103	1.0566	General non-corrosive service from -50F (-46C) to 650F(340C), LF2 to 800F(427C).
Low Temperature Alloy Steel	Nickel Steel	3.1/2Ni	K32025	A350-LF3	A352-LC3	10Ni14	1.5637	-150F(-101C) to 650F(340C)
Low Alloy Steel	Moly Steel	C-1/2Mo	K12822	A182-F1	A217-WC1	15M03	1.5415	Up to 875F (468C)
	Alloy Steel Chrome Moly	1.1/4Cr-1/2Mo	K11572	A182-F11 d2	A217-WC6	13CRMO44	1.7335	Up to 1100F (593C)
		2.1/4Cr-1Mo	K21590	A182-F22 d3	A217-WC9	10CRM0910	1.7380	Up to 1100F(593C), HP steam
		5Cr-1/2Mo	K41545	A182-F5	A217-C5	12CRM0195	1.7362	High temp refinery service
		9Cr-1Mo	K90941	A182-F9	A217-C12	X 12 CrMo 9 1	1.7386	High temp erosive refinery service
	9Cr-1Mo-V		A182-F91	A217-C12A	X 10 CrMoVNb 9 1	1.4903	High pressure steam	
Stainless Steel	Austenitic S.Steel 300 series S.Steel	304 : 18Cr-8Ni	S30400	A182-F304	A351-CF8	DIN X5CrNi 18 9	1.4301	0.04% min. carbon for temp.>1000F(538C)
		304L : 18Cr-8Ni	S30403	A182-F304L	A351-CF3	X 2 CrNi 19 11	1.4306	Up to 800F(427C)
		304H :	S30409	A182-F304H		n/a	n/a	
		316 : 16Cr-12Ni-2Mo	S31600	A182-F316	A351-CF8M	DIN X5CrNiMo 18 10	1.4401	0.04% min. carbon for temp.>1000F(538C)
		316L : 16Cr-12Ni-2Mo	S31603	A182-F316L	A351-CF3M	X 5 CrNiMo 17 12 2	1.4404	Up to 800F(427C)
		316H :	S31609	A182-F316H		n/a	n/a	
		316Ti:	S31635	A182-F316Ti		X 6 CrNiMoTi 17 12 2	1.4571	
		321 : 18Cr-10Ni-Ti	S32100	A182-F321		X 6 CrNiTi 18 10	1.4541	0.04% min. carbon (grade F321H) and heat treat at 2000F(1100C) for service temps.>1000F(538C)
		321H	S32109	A182-F321H		n/a	n/a	
		347: 18Cr-10Ni-Cb(Nb)	S34700	A182-F347	A351-CF8C	DIN 8556	1.4550	0.04% min. carbon (grade F347H) and heat treat at 2000F(1100C) for service temps.>1000F(538C)
		347H	S34709	A182-F347H		n/a	n/a	
	317L	S31703	A182-F317L	A351-CG3M	X2CrNiMo18-16-4	1.4438		
	Alloy 20	28Ni-19Cr-Cu-Mo	N08020	A182-F20	A351-CN7M	DIN 1.4500	2.4660	service to 600F(316C)
	Duplex 2205	22Cr-5Ni-3Mo-N	S31803 S32205	A182-F51	A890-J92205	X2CrNiMoN22-5-3 DIN 10088-1 (95)	1.4462	service to 600F(316C) -The original S31803 UNS designation has been supplemented by S32205 which has higher minimum N, Cr, and Mo.
	Super Duplex 2507	25Cr-7Ni-4Mo-N	S32750	A182-F53	A351-CD4MCu A890 5A	X2CrNiMoN25-7-4 DIN 10088-1 (95)	1.4501	service to 600F(316C)
Super Duplex F55	25Cr-7Ni-3.5Mo-N-Cu-W	S32760	A182 F55	CD3MWCuN			Service to 600F	
Super Austenitic 6Mo	20Cr-18Ni-6Mo	S31254	A182-F44	A351-CK3MCuN	X1CrNiMoCuN20-18-7 DIN 10088-1 (95)	1.4547	service to 600F(316C)	
Nickel-Iron Alloy	Incoloy 800	33Ni-42Fe-21Cr	N08800	B564-N08800		X10NiCrAlTi32-20	1.4876	service to 1000F(538C)
	Incoloy 825	42Ni-21.5Cr-3Mo-2.3Cu	N08825	B564-N08825	A494-CU5MCuC	DIN 17744	2.4858	service to 600F(316C) for N02200, 1200F(648C) for N02201
Nickel	Nickel	99/95Ni	N02200	B160-N02200 (bar)	A494-CZ-100	NW2200	1.7740	
Nickel-Copper	Monel 400	67Ni-30Cu	N04400	B564-N04400	A494-M35-1	DIN 17730	2.4360	
	Monel 500		N05500	B564-N05500			2.4375	
Nickel-Alloy	904L		N08904	904L	n/a	Z2 NCDU 25-20	1.4539	
Nickel Superalloys	Inconel 600	72Ni-15Cr-8Fe	N06600	B564-N06600	A494-CY40	DIN 17742	2.4816	
	Inconel 625	60Ni-22Cr-9Mo-3.5Cb	N06625	B564-N06625*	A494-CW-6MC		2.4856	*Difficult to forge in close dye
	Hastelloy C-276	54Ni-15Cr-16Mo	N10276	B564-N10276*	A494-CW-2M	NiMo 16 Cr 15 W	2.4819	*Difficult to forge in close dye
Titanium	Titanium	98Ti	R50400	B381-Gr2	B367-C2	Ti 2	3.7035	

Note: these charts are for reference only. OMB recommends customer engineers to analyze service requirements and specify the materials they consider optimum. OMB cannot be held liable for any damage occurred due to the use of the tables.



BOLTS MATERIALS

The following tables suggest standard combination of body and bonnet materials and trim (stem, disc or wedge, seat) composition. Different combinations are available upon request.

OMB STANDARD TRIM DEFINITIONS

API Trim No	Nonimal Trim	OMB descr.	Stem	Disc/Wedge	Seat	Min Hardness (Brinell)
1	F6	F6	410 (13Cr)	F6 (13Cr)	410 (13Cr)	250
2	304	304	304 (18Cr-8Ni)	304 (18Cr-8Ni)	304 (18Cr-8Ni)	not specified
3	-	-	(25Cr-20Ni)	310 (25Cr-20Ni)	310 (25Cr-20Ni)	not specified
4	-	-	410 (13Cr)	F6 (13Cr)	F6 (13Cr)	750
5	Hardfaced	F6HF	410 (13Cr)	F6 + St Gr6 (CoCr Alloy)	410 + St Gr6 (CoCr Alloy)	350
5A	-	-	410 (13Cr)	F6+Hardf. NiCr Alloy	410+Hardf. NiCr Alloy	350
6	-	-	410 (13Cr)	F6 (13CR)	Monel® (NiCu Alloy)	250/175
7	-	-	410 (13Cr)	F6 (13Cr)	F6 (13Cr)	250/750
8	F6 and Hardfaced	F6HFS	410 (13Cr)	F6 (13Cr)	410 + St Gr6 (CoCr Alloy)	250/350
8A	-	-	410 (13Cr)	F6 (13Cr)	410 Hardf. Nicr Alloy	250/350
9	Monel	Monel	Monel® (NiCu Alloy)	Monel® (NiCu Alloy)	Monel® (NiCu Alloy)	not specified
10	316	316	316 (18Cr-8Ni-Mo)	316 (18Cr-8Ni-Mo)	316 (18Cr-8Ni-Mo)	not specified
11	Monel and Hardfaced	MonelHFS	Monel® (NiCu Alloy)	Monel® (NiCu Alloy)	Monel® St Gr6	350
11A	-	-	Monel® (NiCu Alloy)	Monel® (NiCu Alloy)	Monel® Hardif. NiCrA	350
12	316 and Hardfaced	316HFS	316 (18Cr-8Ni-Mo)	316 (18Cr-8Ni-Mo)	316 + St. Gr6	350
12A	-	-	316 (18Cr-8Ni-Mo)	316 (18Cr-8Ni-Mo)	316 Hardf. NiCr Alloy	350
13	Alloy 20	Alloy 20	Alloy 20 (19Cr-29Ni)	Alloy 20 (19Cr-29Ni)	Alloy 20 (19Cr-29Ni)	not specified
14	Alloy 20 and Hardfaced	Alloy 20HFS	Alloy 20 (19Cr-29Ni)	Alloy 20 (19Cr-29Ni)	Alloy 20 St Gr6	350
14A	-	-	Alloy 20 (19Cr-29Ni)	Alloy 20 (19Cr-29Ni)	Alloy 20 Hardf. NiCr Alloy	350
15	Hardfaced (304)	304-HF	304 (18Cr-8Ni)	304 + St Gr6	304 + St Gr6	350
16	Hardfaced (316)	316-HF	316 HF (18Cr-8Ni-Mo)	316 + St Gr6	316 + St Gr6	350
17	Hardfaced (347)	347-HF	347 HF (18Cr-10Ni-Cb)	347 + St Gr6	347 + St Gr6	350
18	Hardfaced Alloy 20 HF	Alloy 20 HF	Alloy 20 (19Cr-29Ni)	Alloy 20 + St Gr6	Alloy 20 + St Gr6	350
n/a	Alloy 625	Alloy 625	Alloy 625	Alloy 625	Alloy 625	

OMB TRIM MATERIAL

OMB	UNS	TYPE	Grade (forged)	ASTM wrought	DIN	DIN W NO.
F6	UNS S41000	13Cr	ASTM A182 F6a	A276-410	DIN X12Cr13	1,4006
304	UNS S30400	18-8 Cr-Ni	ASTM A182 F304	A276-304	DIN X5CrNi 18 10	1,4301
316	UNS S31600	18-8 Cr-Ni (18-10-2)	ASTM A182 F316	A276-316	DIN X5CrNiMo 18 10	1,4401
321	UNS S32100	18 Cr-10 Ni-Ti	ASTM A182 F321	A276-321	DIN X6CrNiTi 18 10	1.4541
347	UNS S34700	18 Cr-10 Ni-Cb	ASTM A182 F347	A276-347	DIN X6CrNiNb18 10	1.4550
MONEL(R)	UNS N04400	67Ni-30Cu	ASTM B564-N04400	B164-N04400	DIN 17743	2.4360
ALLOY 20	UNS N08020	28Ni-19Cr-Cu-Mo	ASTM A182-F20	ASTM B473	DIN 14500	2.4660
ALLOY 625	UNS N06625	60Ni-22Cr-9Mo-3.5Cb	ASTM B564-N06625	ASTM B564-N06625	DIN 17361	2.4865
C276	UNS N10276	54Ni-15Cr-16Mo	ASTM B564-N10276	ASTM B574-N10276	DIN NiMo 16 Cr 15 W	2,4819
17/4PH	UNS S17400	0Cr17Ni4Cu4Nb	ASTM A705 UNS S17400	ASTM A564 UNS S17400	X5CrNiCuNb17-4-4	1.4548
St. Gr6	UNS R30006	Co Cr-A	AMS 5894		Stellite(R) Gr6	



Asbestos-free packing is composed by a series of rings of pure graphite. The sets is closed with two rings, top and bottom, anti-extrusion, manufactured in braided graphite. Both internal and external rings are treaded with corrosion inhibitor.

Asbestos-free gaskets used on bolted bonnet valves are of the spiral-wound type in Stainless Steel 316 and pure graphite. On class 1500 valves, ring-joint gaskets in accordance with ANSI B16.20 - API 6A can be used.

Spare Parts: OMB maintains an extensive inventory of packing and gaskets spares. To individuate the require one please refer to the information shown on OMB's data sheets (assembly drawings), indicating code and composition of the sets.

A comprehensive updated list of packing and gaskte for each design/figure is available online at www.ombvalves.com

EMISSION CONTROL OPTIONS

OMB offers a wide range of solutions to control fugitive emissions in **packed valves**.

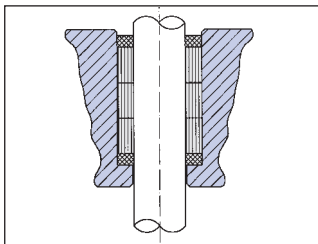

GRAFITE PACKING

Tight control on stem and packing chamber walls finishing and material purity and density in the packing guarantee a leak-proof sealing to EPA requisitions.

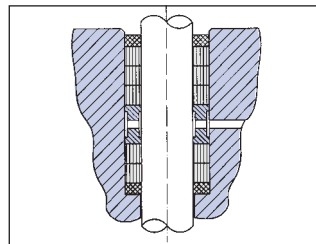

LANTERN PACKING

(on request)

The lantern ring solution provide a way to verify the packing operation and a grease injector option to increase packing seal.

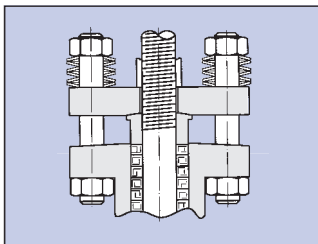

LIVE LOADING BOLTS LOADED TYPE

(on request)

Two sets of Belleville springs keep gland flange pressure on packing for long periods of time without maintenance.

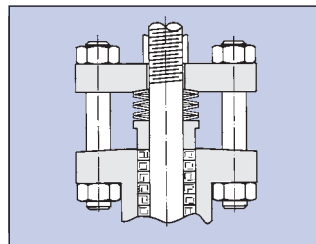

LIVE LOADING GLAND LOADED TYPE

(on request)

Sets of belleville springs keep gland pressure on packing for long periods of time without maintenance.

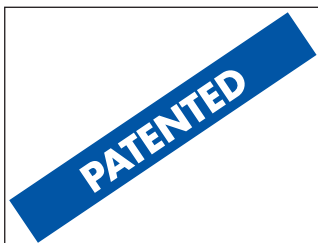

GARLOCK® EVSP 9000 FVP

(on request)

OMB offers this superior designed chevron-style graphite packing.

ISA testing qualification for BP.

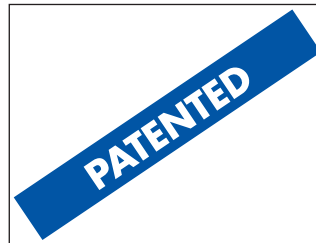

ARMA-SEAL 312™

(on request)

OMB valves qualified to ISO15848 testing using this special designed packing.

Shell 77/312 qualification.

EMISSION CONTROL TESTING & QUALIFICATION

OMB has been involved in extensive testing of various packing solutions which lead to major improvements in the standard design and qualification by the main relevant specifications.



ISO TESTING

Valve cycle tester using a mass spectrometer in sniffer mode to measure helium leakage from the valve gland.



API 622 TESTING

Valve temperature and pressure cycle with methane.



ISO 15848 TESTING

Emission test with Temperature and Pressure cycles combined. Detection by mass spectrometer in open ambient.

SUBSTITUTE BODY-TO-BONNET BOLTING MATERIALS

ASTM Bolting Material	EN 10269 Bolting Material Grade	ASTM Bolting Material	EN 10269 Bolting Material Grade
A 193 B7 A 193 B16	42CrMo4 (1.7225) QT 40CrMoV4-6 (1.7711) - QT	A 193 B8M2, CL 2B A 193 B8M3, CL 2C	X5CrNiMo 17-12-2 (1.4401) - C700 X5CrNiMo 17-12-2 (1.4401) - C700
A 193 B8M, CL 2 A 194 2H	X5CrNiMo 17-12-2 (1.4401) C45E (1.1191) - QT	A 193 B8M, CL 1 A 193 B8MA, CL 1A	X5CrNiMo 17-12-2 (1.4401) - AT X5CrNiMo 17-12-2 (1.4401) - AT
A194 8M	X5CrNiMo 17-12-2 (1.4401) - AT	A 193 B8, CL 1 A193 B8A, CL 1A	X5CrNiMo 18-10 (1.4301) - AT X5CrNiMo 18-10 (1.4301) - AT
		A 193, B8 CL 2 A 320, L7	X5CrNi 18-10 (1.4301) - C700 42CrMo4 (1.7225) - QT
		A 194 GR 8 A194 GR 4	X5CrNi 18-10 (1.4301) - AT 42CrMo4 (1.7225) - QT
		A 194 GR 7	42CrMo4 (1.7225) - QT

THERMAL EXPANSION OF BOLTS ON FORGED STEEL VALVES

In this table we will analyze the Thermal Expansion of bolting in B7 and B8 material used in Forged steel valves made according to ISO 15761/API 602.

The following table gives the mechanical properties of the most common bolt materials used in the Forged Steel valves

Identification Grade Mark 	Specification	Material	Nominal Size Range (in.)	Linear Thermal Expansion Coefficient (°C ⁻¹)	Mechanical Properties		
					Proof Load (pdi)	Yield Strength Min (psi)	Tensile Strength Min (psi)
B7	ASTM A193 Grade B7	4140, 4142, OR 4105	1/4 thru 2-1/2 Over 2-1/2 thru 4 Over 4 thru	12* 10 ⁻⁶	-- -- --	105,000 95,000 75,000	125,000 115,000 100,000
B16	ASTM A193 Grade B16	CrMoVa Alloy Steel	1/4 and larger	11* 10 ⁻⁶	--	105,000 95,000 85,000	125,000 115,000 100,000
B8	ASTM A193 Grade B8	AISI 304	1/4 thru 3/4 Over 3/4 to 1-1/2	11* 10 ⁻⁶	55,000 33,000	30,000	75,000
B8M	ASTM A193 Grade B8M	AISI 316	1/4 thru 2-1/2 Over 2-1/2 thru 4 Over 4 thru 7	11* 10 ⁻⁶	-- -- --	105,000 95,000 75,000	125,000 115,000 100,000

CORROSIVE MEDIA	CORROSION DATA				
	Carbon Steel	Stainless Steel 304	Stainless Steel 316	Inconel	Monel
Acetate Solvents, Crude	D	A	A	A	B
Acetate Solvents, Pure	C	A	A	A	A
Acetic Acid, 95%	D	B	A	A	A
Acetic Anhydride, Boiling	D	B	A	A	A
Acetone	B	A	A	A	A
Alcohols	B	A	A	A	A
Amines	B	A	A	A	A
Ammonia, Anhydrous	B	A	A	A	A
Ammonium Hydroxide, Hot	B	A	A	A	D
Ammonium Nitrate	B	A	A	A	C
Aniline Hydrochloride	D	D	C	B	B
Antimony Trichloride	D	D	C	B	B
Asphalt	B	A	A	A	A
Barium Chloride, 5%	C	A	A	A	A
Barium Hydroxide	C	A	A	A	A
Barium Nitrate	C	A	A	B	C
Benzene, Hot	B	A	A	A	A
Benzoic Acid	B	A	A	A	A
Blood	D	A	A	A	A
Bromine, Dry Gas	D	A	A	B	A
Bromine, Moist Gas	D	D	D	D	C
Buttermilk	D	A	A	A	A
Calcium Bisulfite, Hot	D	C	B	D	D
Calcium Chloride, Dilute	C	B	A	A	A
Calcium Hydroxide, 20%, Boiling	D	A	A	A	A
Calcium Hydrochloride, < 2%	C	C	B	B	C
Carbolic Acid, 90%	C	A	A	A	B
Carbon Dioxide, Dry	C	A	A	A	A
Carbon Disulphide	B	A	A	A	B
Chloroacetic Acid	D	D	C	B	B
Chloric Acid	D	D	C	C	C
Chlorinated Water, Sat.	D	D	C	C	C
Chlorine, Dry Gas	B	B	B	A	A
Chlorine, Moist Gas	D	D	C	D	C
Citric Acid, Dilute	D	A	A	A	A
Citric Acid, Hot, Conc.	D	C	B	B	B
Creosote, Hot	B	A	A	A	A
Cupric Chloride, 5%	D	D	C	D	D
Ethyl Chloride	A	A	A	A	A
Ethylene Glycol	A	A	A	A	A
Ferric Chloride < 1%	D	C	B	B	C
Ferric Nitrate, 5%	D	B	A	C	D
Ferric Sulfate, 5%	D	B	A	B	C
Ferrous Sulfate, 10%	C	A	A	B	A
Flourine, Dry Gas	C	C	B	A	A
Flourine, Moist Gas	D	D	D	B	A
Freon, Wet	C	C	C	B	A
Fuel Oil, 140°F	A	A	A	A	B

CORROSIVE MEDIA	CORROSION DATA				
	Carbon Steel	Stainless Steel 304	Stainless Steel 316	Inconel	Monel
Furfural	B	B	B	B	B
Gasoline Sour	B	A	A	C	C
Gasoline Refined	A	A	A	B	A
Gelatine	D	B	A	A	A
Glucose	B	A	A	A	A
Glycerine	B	A	A	A	A
Hydrofluoric Acid, Boiling	D	D	D	D	B
Hydrofluosilicic Acid	D	D	C	B	A
Hydrogen Chloride, Dry	B	D	C	A	A
Hydrogen Chloride, Moist	D	D	D	D	C
Hydrogen Fluoride, Dry	C	D	C	A	A
Hydrogen Peroxide, Boiling	D	C	B	B	B
Hydrogen Sulfide, Dry	B	A	A	A	A
Hydrogen Sulfide, Moist	C	B	A	A	B
Iodine, Dry	D	D	B	A	A
Kerosene	A	A	A	A	A
Lactic Acid, 5%	D	B	A	A	B
Lactic Acid, 10%	D	B	A	A	B
Lactic Acid, Boiling, 5%	D	C	B	B	C
Lactic Acid, Boiling, 10%	D	D	B	B	C
Lead Acetate, Hot	D	A	A	B	B
Magnesium Chloride, Hot, 5%	D	C	B	A	A
Magnesium Hydroxide	B	A	A	A	A
Magnesium Sulfate	B	A	A	B	A
Magnesium Sulfate, Boiling	C	A	A	C	A
Mercury	B	A	A	A	B
Mercuric Chloride, < 2%	D	D	D	D	D
Mercuric Cyanide	D	B	B	B	D
Methyl Chloride, Dry	D	B	B	A	A
Milk	D	A	A	A	B
Molasses	B	A	A	A	A
Naptha	B	A	A	A	A
Nickel Chloride	D	C	B	B	B
Nickel Sulfate, Boiling	D	C	C	B	A
Nitric Acid, 20%	D	A	A	B	D
Nitric Acid, Boiling, Conc.	D	D	D	D	D
Nitrous Acid	D	B	B	B	C
Nitrobenzene	D	B	A	B	B
Oils - Miner.	B	A	A	C	B
Oxalic Acid, Boiling, 10%	C	A	A	A	A
Oxalic Acid, Boiling, 50%	D	D	C	B	B
Oxygen	B	A	A	A	A
Picric Acid	C	A	A	D	D
Potassium Bromide	D	C	B	A	A
Potassium Carbonate	B	A	A	A	A
Potassium Chlorate	B	A	A	A	B
Potassium Chloride	D	A	A	A	A
Potassium Chloride, Hot	D	C	B	B	A

CORROSIVE MEDIA	CORROSION DATA				
	Carbon Steel	Stainless Steel 304	Stainless Steel 316	Inconel	Monel
Potassium Cyanide	B	B	B	B	B
Potassium Sulfate, Dil.	B	A	A	A	A
Propane, Liquid & Gas	B	A	A	A	A
Pyrogallic Acid	B	A	A	B	A
Rosin, Molten	D	A	A	A	A
Salicylic Acid	D	B	B	B	B
Silver Bromide	D	B	A	C	B
Silver Chloride	D	D	D	C	B
Silver Nitrate	D	A	A	A	C
Sodium Acetate	C	A	A	A	A
Sodium Bisulfate	D	B	B	B	A
Sodium Bromide, Dil.	D	B	B	B	A
Sodium Cyanide	B	B	B	B	A
Sodium Fluoride, 5%	D	B	A	B	A
Sodium Hydroxide, 50%	B	A	A	A	A
Sodium Hyposulfite	D	B	A	B	A
Sodium Nitrate	B	B	A	A	B
Sodium Perborate	C	A	A	A	B
Sodium Peroxide	C	A	A	A	B
Sodium Phosphate, Tribasic	C	A	A	A	A
Sodium Silicate	B	A	A	A	B
Sodium Thiosulfate	D	B	A	B	B
Stannous Chloride, Sat.	D	D	B	B	B
Steam, 212°F	A	A	A	A	A
Steam, 600°F	C	A	A	A	A
Sulfite Liquors	D	C	B	D	D
Sulfur Chloride	D	C	D	B	B
Sulfur Dioxide, Moist	D	B	A	D	D
Sulfuric Acid, Conc.	B	B	B	B	D
Sulfurous Acid, Sat.	D	B	B	D	D
Tannic Acid, 10%	D	A	A	B	A
Tar, Hot	B	A	A	A	B
Tartaric Acid, 120°F	D	B	A	A	A
Toluene	A	A	A	A	A
Trichlorethylene	B	A	A	A	A
Turpentine	B	A	A	A	A
Varnish, Hot	C	A	A	A	A
Vegetable Oils	B	A	A	A	B
Vinegar	D	A	A	A	A
Water, Acid Mine	D	A	A	A	C
Water, Boiler Feed	B	A	A	A	A
Water, Distilled	D	A	A	A	A
Water, Salt Sea	D	C	B	B	A
Whiskey, Boiling	D	A	A	A	C
Wine	D	A	A	A	C
Xylene, Boiling	D	A	A	A	A
Zinc Chloride, 5%	D	C	B	B	B
Zinc Sulfate, Boiling	D	A	A	B	A

A = Substantial resistance - Preferred material of construction.
B = Moderate resistance - Satisfactory for use under most conditions.
C = Questionable resistance - Use with caution.
D = Inadequate resistance - Not recommended.

OMB doesn't assume any responsibility from the use of a.m. data which are purely theoretical.
The user must verify the best conditions of use.



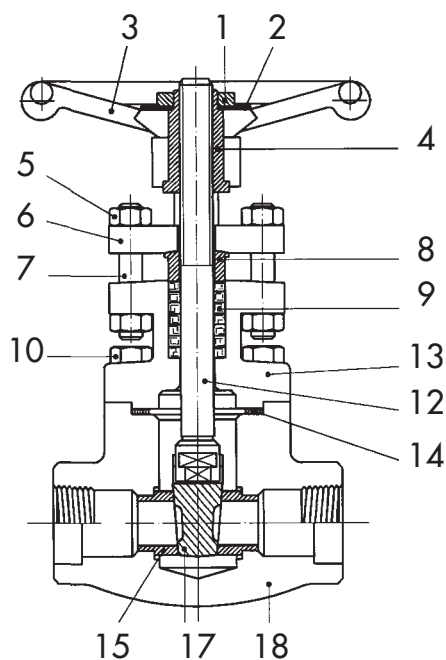

1	WHEELNUT	Austenitic ductile iron, 13Cr steel, or copper alloy having a melting point above 955°
2	NAMEPLATE	A corrosion resistant metal
3	HANDWHEEL	Malleable iron, carbon steel, or ductile iron
4	YOKE NUT	Carbon steel or similar material composition as the bonnet
5	GLAND NUT	Bolting materials of a type 300 or type 400 series stainless steel. Also, material at least equal to either ASTM A307-Grade B or EN 10269-C35E (1.1181) may be used for yoke bolting
6	GLAND FLANGE	Steel
7	GLAND STUD	-
8	GLAND	Material with a melting point above 955° C
9	PACKING	Non-asbestos material suitable for steam and petroleum fluids over a temperature range of - 29°C to 540°C and containing a corrosion inhibitor
10	BOLTS	Unless other materials are agreed between the purchaser and manufacturer the bolting material shall be according with annex F
12	STEM	-
13	BONNET	A forging or casting material as selected from ASME B 16.34, group 1 and Group 2
14	GASKET	See 5.5.3
15	SEAT	As in Table 11, except that when weld deposited facings are used, the base material shall have a corrosion resistance equal to or greater than that of the body material
17	WEDGE	Steel or base material compatible with the pressure/temperature rating and least equal in corrosion resistance as the body material
18	BODY	A forging or casting material as selected from ASME B 16.34, group 1 and Group 2

	A105/F6	A105/F6HFS	LF2/304	F11/F6HFS	F304/304	F316/316
Wheelnut	Carbon Steel	Carbon Steel	Carbon Steel	Carbon Steel	Carbon Steel	Carbon Steel
Nameplate	Aluminium	Aluminium	Aluminium	Aluminium	Aluminium	Aluminium
Handwheel	Carbon Steel	Carbon Steel	Carbon Steel	Carbon Steel	Carbon Steel	Carbon Steel
Yoke Nut	416	416	416	416	303	303
Gland Nut	2H	2H	GR8	GR8	GR8	GR8
Gland Flange	A105	A105	F6	F6	F304	F304
Gland Stud	410	410	B8	B8	B8	B8
Gland	316L	316L	316L	316L	316L	316L
Packing (*)	Graphite	Graphite	Graphite	Graphite	Graphite	Graphite
Bolts	B7	B7	L7	B16	B8	B8
Stem	410	410	304	410	304	316
Bonnet	A105	A105	LF2	F11	F304	F316
Gasket	Sp. Wound	Sp. Wound	Sp. Wound	Sp. Wound	Sp. Wound	Sp. Wound
Seat	410	410HF	304	410HF	304	316
Wedge	F6	F6	F304	F6	F304	F316
Body	A105	A105	LF2	F11	F304	F316



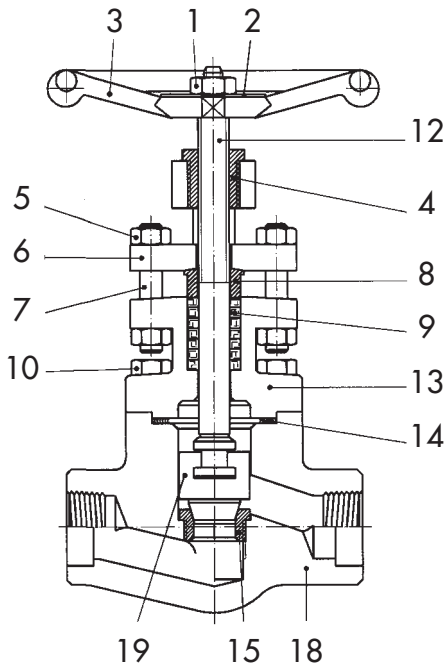

1	WHEELNUT	Austenitic ductile iron, 13Cr steel, or copper alloy having a melting point above 955°
2	NAMEPLATE	A corrosion resistant metal
3	HANDWHEEL	Malleable iron, carbon steel, or ductile iron
4	YOKE NUT	Carbon steel or similar material composition as the bonnet
5	GLAND NUT	Bolting materials of a type 300 or type 400 series stainless steel. Also, material at least equal to either ASTM A307-Grade B or EN 10269-C35E (1.1181) may be used for yoke bolting
6	GLAND FLANGE	Steel
7	GLAND STUD	-
8	GLAND	Material with a melting point above 955° C
9	PACKING	Non-asbestos material suitable for steam and petroleum fluids over a temperature range of - 29°C to 540°C and containing a corrosion inhibitor
10	BOLTS	Unless other materials are agreed between the purchaser and manufacturer the bolting material shall be according with annex F
12	STEM	-
13	BONNET	A forging or casting material as selected from ASME B 16.34, group 1 and Group 2
14	GASKET	See 5.5.3
15	SEAT	As in Table 11, except that when weld deposited facings are used, the base material shall have a corrosion resistance equal to or greater than that of the body material
18	BODY	A forging or casting material as selected from ASME B 16.34, group 1 and Group 2
19	DISC	Steel or base material compatible with the pressure/temperature rating and least equal in corrosion resistance as the body material

	A105/F6	A105/F6HFS	LF2/304	F11/F6HFS	F304/304	F316/316
Wheelnut	Carbon Steel	Carbon Steel	Carbon Steel	Carbon Steel	Carbon Steel	Carbon Steel
Nameplate	Aluminium	Aluminium	Aluminium	Aluminium	Aluminium	Aluminium
Handwheel	Carbon Steel	Carbon Steel	Carbon Steel	Carbon Steel	Carbon Steel	Carbon Steel
Yoke Nut	416	416	416	416	303	303
Gland Nut	2H	2H	GR8	GR8	GR8	GR8
Gland Flange	A105	A105	F6	F6	F304	F304
Gland Stud	410	410	B8	B8	B8	B8
Gland	316L	316L	316L	316L	316L	316L
Packing (*)	Graphite	Graphite	Graphite	Graphite	Graphite	Graphite
Bolts	B7	B7	L7	B16	B8	B8
Stem	410	410	304	410	304	316
Bonnet	A105	A105	LF2	F11	F304	F316
Gasket	Sp. Wound	Sp. Wound	Sp. Wound	Sp. Wound	Sp. Wound	Sp. Wound
Seat	410	410HF	304	410HF	304	316
Disc	410	410	304	410	304	316
Body	A105	A105	LF2	F11	F304	F316



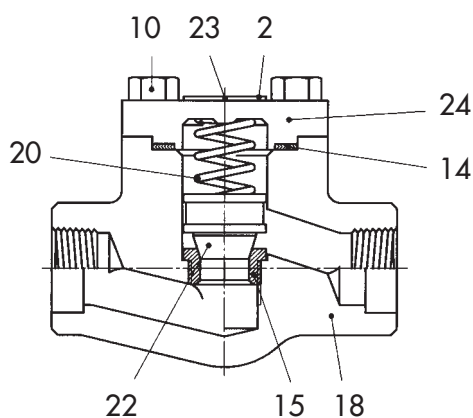

2	NAMEPLATE	A corrosion resistant metal
10	BOLTS	Unless other materials are agreed between the purchaser and manufacturer the bolting material shall be according with annex F
14	GASKET	See 5.5.3
15	SEAT	As in Table 11, except that when weld deposited facings are used, the base material shall have a corrosion resistance equal to or greater than that of the body material
18	BODY	A forging or casting material as selected from ASME B 16.34, group 1 and Group 2
20	SPRING	-
22	PISTON	Steel or base material compatible with the pressure/temperature rating and least equal in corrosion resistance as the body material
23	RIVET	-
24	CAP	A forging or casting material as selected from ASME B 16.34, group 1 and Group 2

	A105/F6	A105/F6HFS	LF2/304	F11/F6HFS	F304/304	F316/316
Wheelnut	Carbon Steel	Carbon Steel	Carbon Steel	Carbon Steel	Carbon Steel	Carbon Steel
Nameplate	Aluminium	Aluminium	Aluminium	Aluminium	Aluminium	Aluminium
Handwheel	Carbon Steel	Carbon Steel	Carbon Steel	Carbon Steel	Carbon Steel	Carbon Steel
Yoke Nut	416	416	416	416	303	303
Gland Nut	2H	2H	GR8	GR8	GR8	GR8
Gland Flange	A105	A105	F6	F6	F304	F304
Gland Stud	410	410	B8	B8	B8	B8
Gland	316L	316L	316L	316L	316L	316L
Packing (*)	Graphite	Graphite	Graphite	Graphite	Graphite	Graphite
Bolts	B7	B7	L7	B16	B8	B8
Stem	410	410	304	410	304	316
Bonnet	A105	A105	LF2	F11	F304	F316
Gasket	Sp. Wound	Sp. Wound	Sp. Wound	Sp. Wound	Sp. Wound	Sp. Wound
Seat	410	410HF	304	410HF	304	316
Wedge	F6	F6	F304	F6	F304	F316
Body	A105	A105	LF2	F11	F304	F316



According to API 602 8th / ISO 15761

CLASS 800

SERVICE TEMPER.	A105 ⁽¹⁾ A350-LF2 ⁽²⁾	A182 ⁽³⁾ F11	A182 ⁽³⁾ F22	A182 F5	A182 F9	A182 F304	A182 F316	A182 F304L	A182 F347H	SERVICE TEMPER.	A105 ⁽¹⁾ A350-LF2 ⁽²⁾	A182 ⁽³⁾ F11	A182 ⁽³⁾ F22	A182 F5	A182 F9	A182 F304	A182 F316
°F	psi	psi	psi	psi	psi	psi	psi	psi	psi	°C	bar	bar	bar	bar	bar	bar	bar
-20 to 100	1975	2000	2000	2000	2000	1920	1920	1600	1920	-29 to 38	136.2	137.9	137.9	137.9	137.9	132.4	132.4
200	1800	1900	1910	2000	2000	1600	1655	1350	1695	93.5	124.1	131.0	131.7	137.9	137.9	110.3	114.1
300	1750	1795	1805	1940	1940	1410	1495	1210	1570	149	120.7	123.8	124.5	133.8	133.8	97.2	103.1
400	1690	1755	1730	1880	1880	1255	1370	1100	1480	204.5	116.6	121.0	119.3	129.7	129.7	86.5	94.5
500	1595	1710	1705	1775	1775	1165	1275	1020	1380	260	110.0	117.9	117.6	122.4	122.4	80.3	87.9
600	1460	1615	1615	1615	1615	1105	1205	960	1310	315.5	100.7	113.4	113.4	113.4	113.4	76.2	83.1
650	1430	1570	1570	1570	1570	1090	1185	935	1280	343.5	98.6	108.3	108.3	108.3	108.3	75.2	81.7
700	1420	1515	1515	1515	1515	1075	1150	915	1250	371	97.9	104.5	104.5	104.5	104.5	74.1	79.3
750	1345	1420	1420	1420	1420	1060	1130	895	1230	399	92.7	97.9	97.9	97.9	97.9	73.1	77.9
800	1100	1355	1355	1325	1355	1050	1105	875	1215	426.5	75.9	93.4	93.4	91.4	93.4	72.4	76.2
850	715	1300	1300	1170	1300	1035	1080	860	1185	454.5	49.3	89.7	89.7	80.7	89.7	71.4	74.5
900	460	1200	1200	940	1200	1025	1050		1150	482	31.7	82.8	82.8	64.8	82.8	70.7	72.4
950	275	1005	1005	695	985	1000	1030		1030	510	19	69.3	69.3	47.9	67.9	69.0	71.0
1000	140	595	715	510	780	860	970		970	538	9.7	41.0	49.3	35.2	53.8	59.3	66.9
1050		365	530	375	505	825	960		960	565.5		25.2	36.6	25.9	34.8	56.9	66.2
1100		255	300	275	300	685	860		860	593.5		17.6	20.7	19.0	20.7	47.2	59.3
1150		140	275	185	200	520	735		735	621		9.7	19.0	12.8	13.8	35.9	50.7
1200		95	145	120	140	415	550		460	649		6.6	10.0	8.3	9.6	28.6	37.9
1250						295	485		330	676.5						20.3	33.4
1300						218	365		250	704.5						15.0	25.2
1350						165	275		180	732.5						11.4	19.0
1400						130	200		140	760.5						9.0	13.8
1450						95	155		110	788.5						6.6	10.7
1500						65	110		95	815.5						4.5	7.6

Notes: (1) Permissible, but not recommended for prolonged use above 800°F.
 (2) Not to be used over 650°F.
 (3) Permissible, but not recommended for prolonged use above 1050°F.

According to ASME B16.34

CARBON STEEL A105⁽¹⁾ & A350 LF2⁽²⁾

SERVICE TEMPERATURE	150	300	600	1500	2500	SERVICE TEMPERATURE	PN 20	PN 50	PN 100	PN 250
°F	psi	psi	psi	psi	psi	°C	bar	bar	bar	bar
-20 to 100	285	740	1480	3705	6170	38	19.6	51.1	102.1	255.3
200	260	675	1350	3375	5625	50	19.2	50.1	100.2	250.4
300	230	655	1315	3280	5470	100	17.7	46.4	92.8	231.9
400	200	635	1270	3170	5280	150	15.8	45.2	90.5	226.1
500	170	600	1200	2995	4990	200	14.0	43.8	87.6	219.1
600	140	550	1095	2735	4560	250	12.1	41.7	83.4	208.6
650	125	535	1075	2685	4475	300	10.2	38.7	77.5	193.7
700	110	535	1065	2665	4440	350	8.4	37.0	73.9	184.8
750	95	505	1010	2520	4200	375	7.4	36.5	72.9	182.3
800	80	410	825	2060	3430	400	6.5	34.5	69.0	172.5
850	65	270	535	1340	2230	425	5.6	28.8	57.5	143.8
900	50	170	345	860	1430	450	4.7	20.0	40.1	100.2
950	35	105	205	515	860	475	3.7	13.5	27.1	67.7
1000	20	50	105	260	430	500	2.8	8.8	17.6	44.0
1050						525	1.9	5.2	10.4	25.9
1100						540	1.3	3.3	6.5	16.3

Notes: (1) Permissible, but not recommended for prolonged use above 800°F.
 (2) Not to be used over 650°F.

ISO 15848 PART I - FUGITIVE EMISSION TEST MATRIX

OMB valves completed the following test to qualify the complete product range with a major end user

	Design	Temp. Range	TEST PROTOCOL NUMBER		
			150-600	1500	2500
Gate Valves ISO 15761/ API602, Wedge Type, Metal Seated, Rising Stem valves, Cryogenic	ext bonnet	-196 to 300c	1	2	3
Gate Valves ISO 15761/ API602, Wedge Type, Metal Seated, Rising Stem valves	std	-50 to 400C	4	5	6
Gate Valves ISO 15761/ API602, Wedge Type, Metal Seated, Rising Stem valves, High Temp	std	0 -650C	7	8	9
Globe Valves ISO 15761/ API602 (BS5352), Flanged, Plug/ball type, Cryogenic	straight ext bonnet	-196 to 300c	10	11	12
Globe Valves ISO 15761/ API602 (BS5352), Flanged, Plug/ball type	straight	-50 to 400C	13	14	15
Globe Valves ISO 15761/ API602 (BS5352), Flanged, Plug/ball type, High Temp	straight	0 -650C	16	17	18
Globe Valves ISO 15761/ API602 (BS5352), Flanged, Plug/ball type	Y pattern	-50 to 400C	19	20	21
Globe Valves ISO 15761/ API602 (BS5352), Flanged, Plug/ball type, High Temp	Y pattern	0 -650C	22	23	24
Check Valves ISO 15761/ API602 (BS5352), Piston Type, Bolted cover, cryogenic	straight	-196 to 300c	25	26	27
Check Valves ISO 15761/ API602 (BS5352), Piston Type, Bolted cover	straight	-50 to 400C	28	29	30
Check Valves ISO 15761/ API602 (BS5352), Piston Type, Welded cover, high temperature	straight	0 -650C	31	30	33

BODY- BONNET CONNECTIONS: BOLTED BONNET

OMB standard construction of body-bonnet connection is bolted, with a spiral wound gasket to seal the connection.

On request we offer as well Ring Joint connection. Ring Joint is standard feature on class 2500 bolted bonnet, on request on all other pressure class.

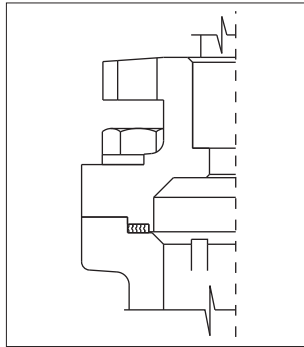

Gasket Joint

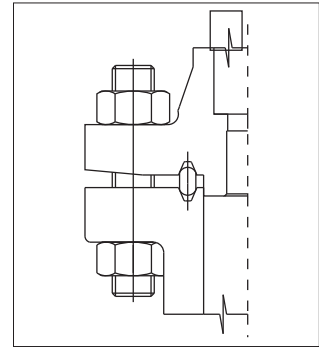

Ring Joint

BODY- BONNET CONNECTIONS: WELDED BONNET

All OMB welding procedures are performed by operators qualified according to ASME IX.

OMB Welded Bonnet Valves are supplied in the standard type threaded in and fillet welded bonnet as per "L" version. On request Full Penetration Welding as per "WP" version can be supplied.

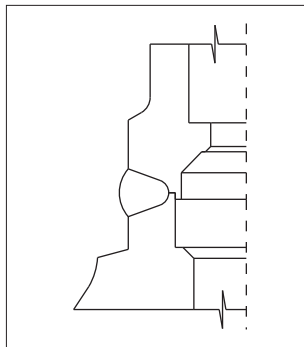

Full Penetration Weld "WP"

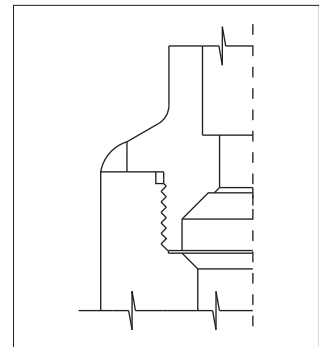

Screwed and Seal Weld "L"

INTEGRAL FLANGED ENDS

All OMB valves with flanges are provided with flanged integral with the body forgings. We do not weld on flanges in any class or materials so you can have a complete guarantee of integrity, mechanical strength and material compatibility.

All our flanged (and butt weld) valves have dimension in accordance to ASME B16.5 (ends) and ASME B16.10 (end to end).

Valves to DIN and JIS standards as well are made with integral flanged forgings.



FLOW COEFFICIENT C_v

The C_v's a valve property and is defined as follows: "The Flow Coefficient C_v states the flow capacity of a valve in U.S. gallons per minute of water at a standard temperature of 60°F (15,6° C) that will flow through the valve with a pressure loss of one pound per square inch at a specific opening position". For the metric system the analog value is K_v where measure unit are Bar, Kg and meters. The C_v show the quality and accuracy of a valve in terms of pressure loss, the highest values of C_v indicate the highest quality of a valve.

The values shown

VALVE SIZE	GATE		GLOBE			PISTON		
	Regular Port	Full Port	Regular Port	Full Port	Y-Pattern	Regular Port	Full Port	Y-Pattern
1/4	-	2.5	-	1.1	2.9	-	0.9	2.3
3/8	-	4.3	-	1.4	3.8	-	1.1	3.5
1/2	5.5	11.6	1.5	3.6	4.5	1	2.1	4.8
3/4	12	26.6	3.8	6.6	10.1	2.8	5.8	7.8
1	27	54.6	6.8	10.9	16.0	6	7	11.2
1 1/4	55	79.8	11	14	23.1	9.5	9.2	18.0
1 1/2	80	87	14.3	24.3	47.1	11	15.4	37.8
2	105.0	108	25	39.7	80.2	18	32	69.2

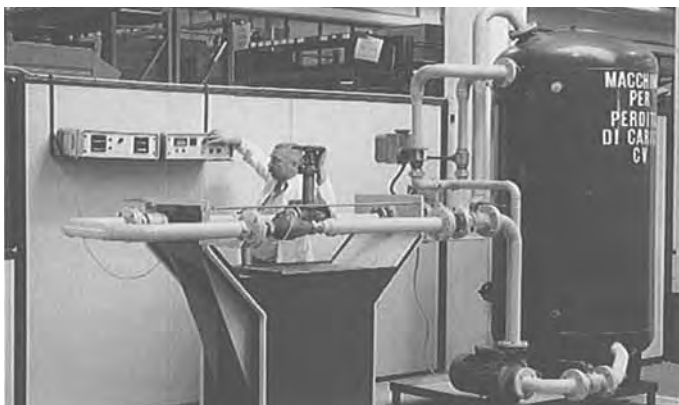

To measure the properly value of C_v there is not a standard method. OMB R & D team has used two different methods: 1-Using C_v definition, through the means of a specifically built test rig, it has been obtained 1Bar of pressure loss and the flow has been verified with specific equipment. Calculation is possible to convert the measure to C_v. 2-In the same machine the flow has been changed and different measure of pressure loss has been obtained: a table has been defined and an average value per each valve has been calculated.

FLOW-RATE

$$Q = C_v \sqrt{\frac{\Delta p}{S}}$$

PRESSURE DROP

$$\Delta p = S \left(\frac{Q}{C_v} \right)^2$$

For liquids other than water

Δp = Pressure drop (p.s.i.).

Q = Liquid flow in gallons per minute (GPM).

S = Specific gravity of liquid relative to water (60°F).

C_v = Valves flow coefficient.

CONVERSION TABLE TO METRIC STD

Flow Coefficient	C _v	K _v
C _v	1	0,865
K _v	1.156	1

CHECK VALVES CRACKING PRESSURE

Valve/ Figure Number	Piston Type		Y Pattern piston Type		Ball Type		Swing	Vertical Ball
	Non Spring Loaded	Spring Loaded	Non Spring Loaded	Spring Loaded	Non Spring Loaded	Spring Loaded	Non Spring Loaded	Spring Loaded
NPS	840	840 Spring	Y640	Y640 Spring	850	850 Spring	860	UV850
1/2" - 15	0.4 Bar	0.5 Bar	0.4 Bar	0.5 Bar	0.3 Bar	0.4 Bar	0.03 Bar	0.4 Bar
3/4" - 20	0.4 Bar	0.5 Bar	0.4 Bar	0.5 Bar	0.3 Bar	0.4 Bar	0.03 Bar	0.4 Bar
1" - 25	0.4 Bar	0.5 Bar	0.4 Bar	0.5 Bar	0.3 Bar	0.4 Bar	0.03 Bar	0.4 Bar
1.1/2" - 40	0.4 Bar	0.5 Bar	0.4 Bar	0.5 Bar	0.3 Bar	0.4 Bar	0.04 Bar	0.4 Bar
2" - 50	0.5 Bar	0.6 Bar	0.5 Bar	0.5 Bar	0.4 Bar	0.5 Bar	0.05 Bar	0.5 Bar
Type Scheme								

Disclaimer. All above data have been calculated experimentally on production lost based on a standard combination of materials tested with air. Data may vary with fluid of higher or with spring/parts in special steel grades. In case of specific need we suggest you contact OMB center at the Bergamo plants.

NAMEPLATE

Each valve is identified by proper marking on the name plate according to MSS SP25 and ISO15761 specifications.

Nameplate contains information regarding valve type, body-bonnet material, seat-wedge and stem composition, class and diameter. On the nameplate the relevant mark is incorporated.

Each valve when tested is stamped on the nameplate with the QC operator code for reference.



BODY MARKING

Material designation and heat codes are forged on both body and bonnet.

Bodies are marked with the OMB logo, pressure class designation, nominal size (using NPS number) and an arrow on check and globe valves (unidirectional).

Upon customer request further marking can be applied.



ADDITIONAL TAGS

On request valve can be supplied with tags made on customer specification to provide easier identification of products.

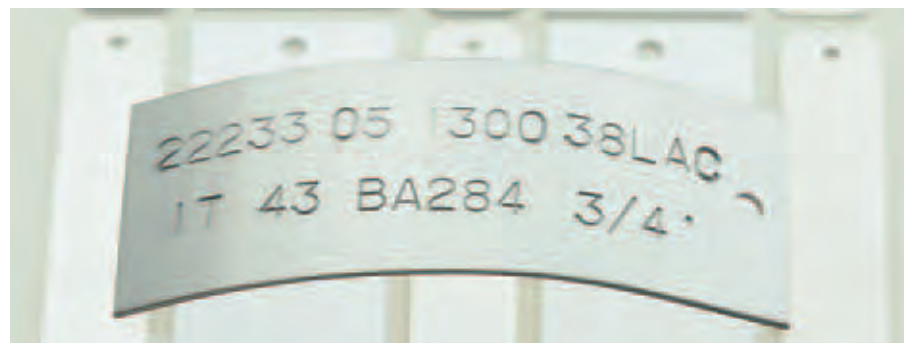

FLANGES DIN 2544-45-46

DN	PN	Size	A	B	C	D	E	Bolt holes	
								N	Ø
15	25/40	1/2	95	65	16	45	2	4	14
20		3/4	105	75	18	58	2	4	14
25		1	115	85	18	68	2	4	14
32		1.1/4	140	100	18	78	2	4	18
40		1.1/2	150	110	18	88	3	4	18
50		2	165	125	20	102	3	4	18
15	64	1/2	105	75	20	45	2	4	14
20		3/4	130	90	22	58	2	4	18
25		1	140	100	24	65	2	4	18
32		1.1/4	155	110	24	75	2	4	22
40		1.1/2	170	125	26	88	3	4	22
50		2	180	135	26	95	3	4	22

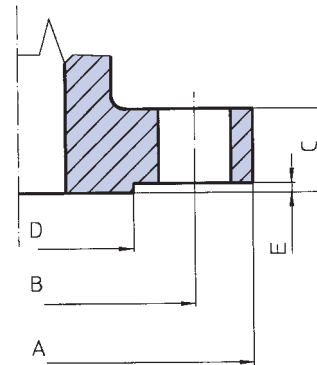

FLANGES ASME - B16.5

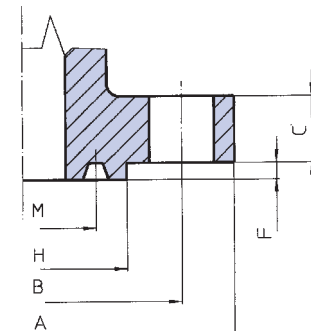
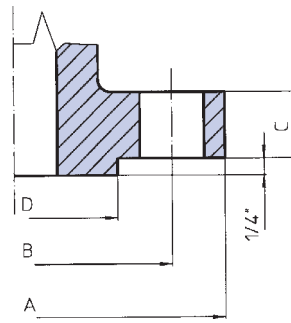
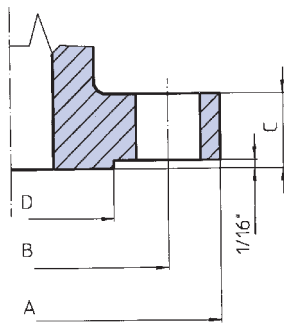

FLANGES ANSI - B16.5

RAISED FACE 600 & 1500 lb

RING JOINT FACE

CLASS	Size	A		C		D		B		Bolt holes			Ring Joint Facing				Ring N.		
		N	Size	H	M	F	N	Size	H	M	F								
150	1/2	3.50	89.0	0.44	11.5	1.38	34.9	2.38	60.5	4	0.62	16.0	-	-	-	-	-	-	
	3/4	3.88	98.5	0.50	13.0	1.69	42.9	2.75	70.0	4	0.62	16.0	-	-	-	-	-	-	
	1	4.25	108.0	0.56	14.5	2.00	50.8	3.12	79.5	4	0.62	16.0	2.50	63.5	1.875	47.62	0.250	6.4	R 15
	1.1/4	4.62	117.5	0.62	16.0	2.50	63.5	3.50	89.0	4	0.62	16.0	2.88	73.0	2.250	57.15	0.250	6.4	R 17
	1.1/2	5.00	127.0	0.69	18.0	2.88	73.0	3.88	98.5	4	0.62	16.0	3.25	82.5	2.562	65.07	0.250	6.4	R 19
	2	6.00	152.5	0.75	19.5	3.62	92.1	4.75	120.5	4	0.75	19.0	4.00	101.5	3.250	82.55	0.250	6.4	R 22
300	1/2	3.75	95.5	0.56	14.5	1.38	34.9	2.62	66.5	4	0.62	16.0	2.00	50.8	1.344	34.14	0.219	5.6	R 11
	3/4	4.62	117.5	0.62	16.0	1.69	42.9	3.25	82.5	4	0.75	19.0	2.50	63.5	1.688	42.88	0.250	6.4	R 13
	1	4.88	124.0	0.69	18.0	2.00	50.8	3.50	89.0	4	0.75	19.0	2.75	69.9	2.000	50.80	0.250	6.4	R 16
	1.1/4	5.25	133.5	0.75	19.5	2.50	63.5	3.88	98.5	4	0.75	19.0	3.12	79.2	2.375	60.32	0.250	6.4	R 18
	1.1/2	6.12	156.0	0.81	21.0	2.88	73.0	4.50	114.5	4	0.88	22.0	3.56	90.4	2.688	68.28	0.250	6.4	R 20
	2	6.50	165.5	0.88	22.5	3.62	92.1	5.00	127.0	8	0.75	19.0	4.25	108.0	3.250	82.55	0.312	7.9	R 23
600	1/2	3.75	95.5	0.56	14.5	1.38	34.9	2.62	66.5	4	0.62	16.0	2.00	50.5	1.344	34.14	0.219	5.6	R 11
	3/4	4.62	117.5	0.62	16.0	1.69	42.9	3.25	82.5	4	0.75	19.0	2.50	63.5	1.688	42.88	0.250	6.4	R 13
	1	4.88	124.0	0.69	18.0	2.00	50.8	3.50	89.0	4	0.75	19.0	2.75	69.9	2.000	50.80	0.250	6.4	R 16
	1.1/4	5.25	133.5	0.81	21.0	2.50	63.5	3.88	98.5	4	0.75	19.0	3.12	79.4	2.375	60.32	0.250	6.4	R 18
	1.1/2	6.12	156.0	0.88	22.5	2.88	73.0	4.50	114.5	4	0.88	22.0	3.56	90.5	2.688	68.28	0.250	6.4	R 20
	2	6.50	165.5	1.00	25.5	3.62	92.1	5.00	127.0	8	0.75	19.0	4.25	108.0	3.250	82.55	0.312	7.9	R 23
1500	1/2	4.75	121.0	0.88	22.5	1.38	34.9	3.25	82.5	4	0.88	22.0	2.38	60.3	1.562	39.67	0.250	6.4	R 12
	3/4	5.12	130.5	1.00	25.5	1.69	42.9	3.50	89.0	4	0.88	22.0	2.62	66.7	1.750	44.45	0.250	6.4	R 14
	1	5.88	149.5	1.12	29.0	2.00	50.8	4.00	101.5	4	1.00	25.5	2.81	71.4	2.000	50.80	0.250	6.4	R 16
	1.1/4	6.25	159.0	1.12	29.0	2.50	63.5	4.38	111.0	4	1.00	25.5	3.19	81.0	2.375	60.32	0.250	6.4	R 18
	1.1/2	7.00	178.0	1.25	32.0	2.88	73.0	4.88	124.0	4	1.12	28.5	3.62	92.1	2.688	68.28	0.250	6.4	R 20
	2	8.50	216.0	1.50	38.5	3.62	92.1	6.50	165.0	8	1.00	25.5	4.88	123.8	3.750	95.25	0.312	7.9	R 24
2500	1/2	5.23	133.5	1.20	30.5	1.38	34.9	3.50	89.0	4	0.88	22.0	2.55	65.1	1.688	42.88	0.250	6.4	R 13
	3/4	5.51	140.0	1.25	32.0	1.69	42.9	3.74	95.0	4	0.88	22.0	2.87	73.0	2.000	50.80	0.250	6.4	R 16
	1	6.25	159.0	1.37	35.0	2.00	50.8	4.24	108.0	4	1.00	25.5	3.24	82.5	2.374	60.32	0.250	6.4	R 18
	1.1/4	7.24	184.5	1.51	38.5	2.50	63.5	5.12	130.0	4	1.12	28.5	3.99	101.5	2.844	72.24	0.312	7.9	R 21
	1.1/2	7.99	203.5	1.75	44.5	2.88	73.0	5.74	146.0	4	1.25	31.5	4.50	114.3	3.250	82.55	0.312	7.9	R 23
	2	9.25	235.0	2.00	51.0	3.62	92.1	6.74	171.5	8	1.12	28.5	5.25	133.3	4.000	101.60	0.312	7.9	R 26

BUTT WELD - ASME B16.25

SIZE	SCHEDULE 40		SCHEDULE 80		SCHEDULE 160		SCHEDULE XXS	
	ØA	T	ØA	T	ØA	T	ØA	T
	mm (In)	mm (In)	mm (In)	mm (In)	mm (In)	mm (In)	mm (In)	mm (In)
1/2"	21.3	2.77	21.3	3.73	21.3	4.78	21.3	7.47
	(0.840)	(0.190)	(0.840)	(0.147)	(0.840)	(0.188)	(0.840)	(0.294)
3/4"	26.7	2.87	26.7	3.91	26.7	5.56	26.7	7.82
	(1.050)	(0.113)	(1.050)	(0.154)	(1.050)	(0.219)	(1.050)	(0.308)
1"	33.4	3.38	33.4	4.55	33.4	6.35	33.4	9.09
	(1.315)	(0.133)	(1.315)	(0.179)	(1.315)	(0.250)	(1.315)	(0.358)
1.1/4"	42.2	3.55	42.2	4.85	42.2	6.35	42.2	9.70
	(1.660)	(0.140)	(1.660)	(0.191)	(1.660)	(0.250)	(1.660)	(0.382)
1.1/2"	48.3	3.68	48.3	5.08	48.3	7.14	48.3	10.15
	(1.900)	(0.145)	(1.900)	(0.200)	(1.900)	(0.281)	(1.900)	(0.400)
2"	60.3	3.91	60.3	5.54	60.3	8.74	60.3	11.07
	(2.375)	(0.154)	(2.375)	(0.218)	(2.375)	(0.344)	(2.375)	(0.436)
2.1/2"	73.0	5.15	73.0	7.01	73.0	9.53	73.0	14.02
	(2.875)	(0.203)	(2.875)	(0.276)	(2.875)	(0.375)	(2.875)	(0.552)
3"	88.9	5.48	88.9	7.62	88.9	11.13	88.9	15.24
	(3.500)	(0.216)	(3.500)	(0.300)	(3.500)	(0.438)	(3.500)	(0.600)
4"	114.3	6.02	114.3	8.56	114.3	13.49	114.3	17.12
	(4.500)	(0.237)	(4.500)	(0.337)	(4.500)	(0.531)	(4.500)	(0.674)

-Fig. a

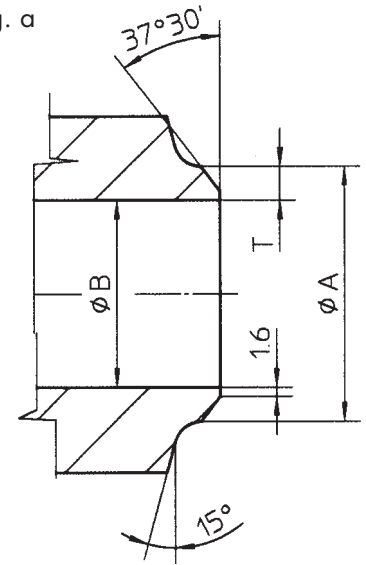

-Fig. b

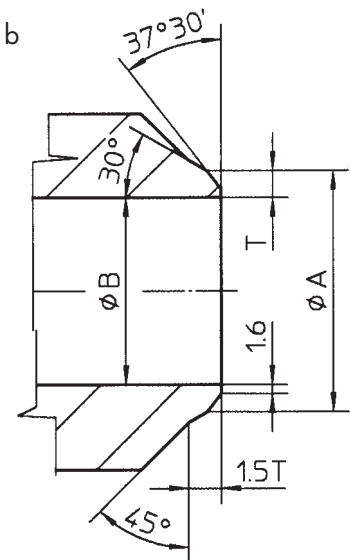

-Fig. a ≤ 2"

-Fig. b > 2"

$$B = A - 2T$$

SOCKET WELD - API 602/ISO 15761

SIZE	ØD		L (min)		L (OMB)	
	mm	Inch	mm	Inch	mm	Inch
1/4"	14.20	0.557	9.53	0.38	11,1	0.44
3/8"	17.60	0.690	9.53	0.38	11,1	0.44
1/2"	21.80	0.855	9.53	0.38	12,7	0.5
3/4"	27.20	1.065	12.70	0.5	14,5	0.57
1"	33.90	1.330	12.70	0.5	16,0	0.63
1.1/4"	42.70	1.675	12.70	0.5	17,5	0.69
1.1/2"	48.80	1.915	12.70	0.5	19,0	0.75
2"	61.20	2.406	15.88	0.62	22,0	0.86

Socket wall thickness conform to ASME B16.34
 "API table only for metric measure"

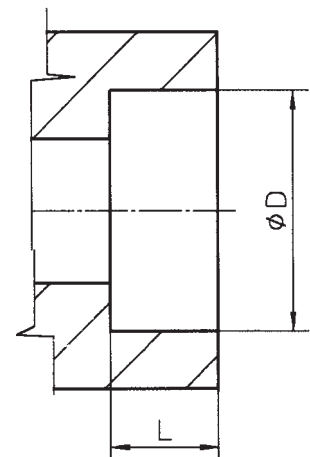

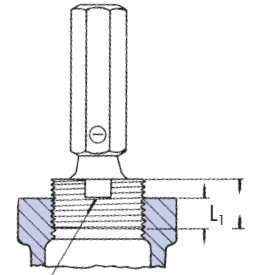
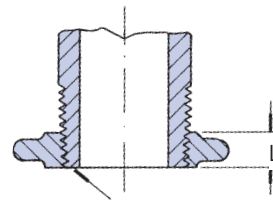
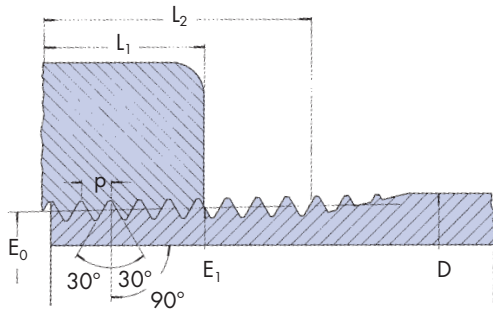

Flush by Hand

Tolerance on Product

One turn large or small from notch on plug gauge or face of ring gauge.

Notch flush with face of fitting. If chamfered, notch flush with bottom of chamfer.

$E_0 = D - (0.050D + 1.1)p$ $p = \text{Pitch}$
 $*E_1 = E_0 + 0.0625 L_1$ $\text{Depth of thread} = 0.80p$
 $L_2 = (0.80D = 6.8)p$ $\text{Total Taper } \frac{3}{4}\text{-inch per Foot}$

THREADS - ASME B1.20.1

Nominal pipe size	D Outside diameter of pipe	Number of threads per inch	p Pitch of thread	E ₀ Pitch diameter at end of external thread	E ₁ ■ Pitch diameter at end of external	L ₁ ● Normal engagement by and between external and internal threads	L ₂ ◆ Length of effective external thread	Height of thread
1/16	0.3125	27	0.03704	0.27118	0.28118	0.160	0.2611	0.02963
1/8	0.405	27	0.03704	0.36351	0.37360	0.1615	0.2639	0.02963
1/4	0.540	18	0.05556	0.47739	0.49163	0.2278	0.4018	0.04444
3/8	0.675	18	0.05556	0.61201	0.62701	0.240	0.4078	0.04444
1/2	0.840	14	0.07143	0.75843	0.77843	0.320	0.5337	0.05714
3/4	1.050	14	0.07143	0.96768	0.98887	0.339	0.5457	0.05714
1	1.315	11.5	0.08696	1.23863	1.23863	0.400	0.6828	0.06957
1 1/4	1.660	11.5	0.08696	1.55713	1.58338	0.420	0.7068	0.06957
1 1/2	1.900	11.5	0.08696	1.79609	1.82234	0.420	0.7235	0.06957
2	2.375	11.5	0.08696	2.26902	2.29627	0.436	0.7565	0.06957

- Also pitch diameter at gauging notch.
- ◆ Also length of plug gauge.
- Also length of ring gauge, and length from gauging notch to small end of plug gauge.
- * For the 1/8-27 and 1/4-18 sizes... E₁ approx. = D - (0.05D + 0.827) p.

Type "L"

Type "S"

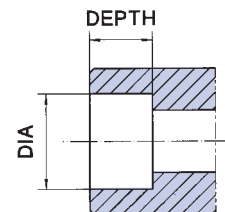
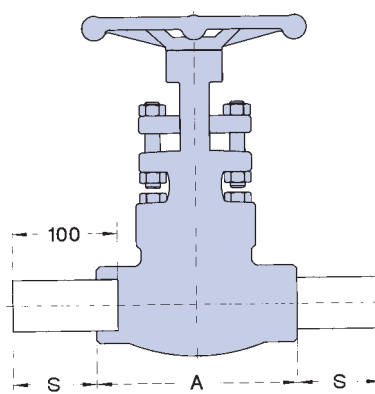
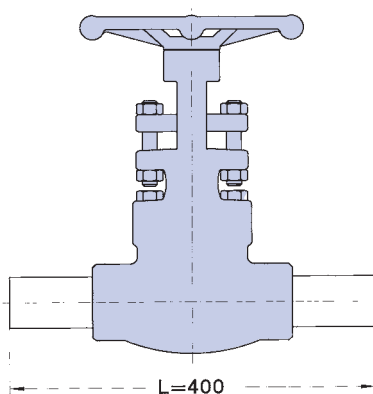

VALVES WITH NIPPLES LENGTHS

NOMINAL PIPE SIZE		SOCKET BORE DIA.		SOCKET DEPTH		S	
NPT	DN	mm	in.	mm	in.	mm	in.
1/4	8	14.2	0.557	11.1	0.437	89	3.503
3/8	10	17.6	0.690	11.1	0.437	89	3.503
1/2	15	21.8	0.855	12.7	0.500	88	3.464
3/4	20	27.2	1.065	14.5	0.570	86	3.385
1	25	33.9	1.330	16	0.629	85	3.346
1 1/4	32	42.57	1.675	17.5	0.688	83	3.267
1 1/2	40	48.8	1.915	19	0.748	82	3.228
2	50	61.2	2.406	22	0.866	79	3.110

Lont Pattern Total length 400 mm.

A = See relevant Product/Size/Class table within this catalogue
S = See table Socket Weld

PHOSPHATIZING OF CS VALVES

PHOSPHATIZING SPECIFICATION (zinc base) FOR CARBON STEEL PROTECTION			
Bath	Type of operation Product used	Min. time	Temp. °C
1	Alkaline degreasing - Italbonder 011	8'	95°
2	Cold washing - Water air (current)	1'-3'	20°
3	Bonderizing - Bonder A2 - PS	8'-10'	80°
4	Cold washing - Water air (current)	1'-3'	20°
5	Oiling - Emulsifiable protoil RE	3'	50°
6	Drying	5'	20°
Phosphatization is carried out on all forged bodies and bonnets in carbon and alloy steel.			

All OMB carbon and alloy steel bodies and bonnets undergo a photosphatization process according to the table.



PICKLING OF SS VALVES

All OMB stainless steel valves undergo a pickling process in a concentrated acid solution which cleans perfectly the surface of the components and allows a visual inspection of each piece.

RUST PREVENTION AND SHIPPING

All valves are shipped in wooden crates seaworthy with end protection cups in plastic and a rust prevention fluid applied in the valves internal parts.

In case of special applications valves can be prepared for transportation in accordance to customer specifications

SPARE PARTS

OMB supply on request spare parts in the form of kits inclusive of packing and gaskets. Valves need to be identified with the data provided on the Nameplate (model type, material and size as a minimum).

OMB policy is to maintain for at least 10 years parts in stock for every design even discontinued.

INSTALLATION, OPERATION AND MAINTENANCE MANUALS

MANUAL REQUEST

(send a copy of this page with your request to +39.035.942638)

OMB GGC

Install and Maintenance

OMB Bellows Seal Valve

Install and Maintenance

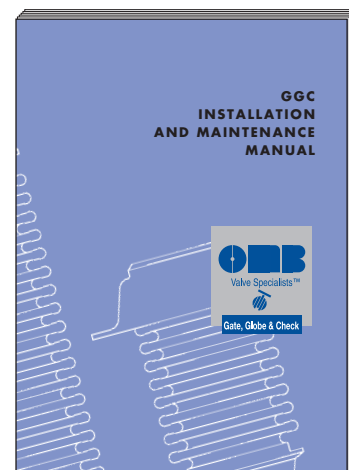
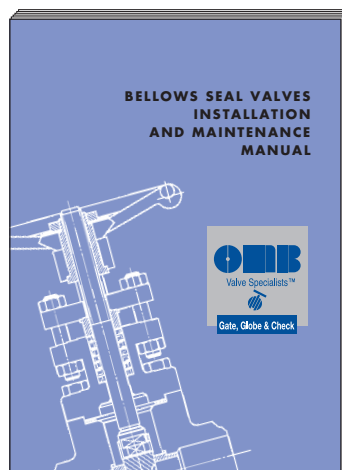



Gate valves are bi-directional valves ideally suited for on-off duties. OMB produces various types both with parallel face gates or with wedge gates. These valves have a very low resistance to flow, which in the case of parallel gate valves approaches that of a straight pipe. They are used for duties with high pressure fluids due to the fact that upstream pressure helps the sealing between gate and seat.

OMB takes great care to study finish of seating surfaces to guarantee their minimum wear under high pressures. Gate valves are supplied in various models to cover the most different and delicate services. The main characteristics of each type are described on pages 16 to 23.

Figure # is identified in each table as:

STANDARD PORT	810	-
FULL PORT	610	1/4
		mm

CLASS	CONNECTION	PORT	STANDARD	SCREW & YOKE	ENDS	SERVICE	PAGE	OMB FIG.
800	Bolted bonnet	Regular	ISO15761	Outside	Threaded and Socket Weld Ends	-	17	810
800	Bolted bonnet	Full	ISO15761	Outside	Threaded and Socket Weld Ends	-	17	610
800	Welded Bonnet	Regular	ISO15761	Outside	Threaded and Socket Weld Ends	-	17	L810
800	Welded Bonnet	Full	ISO15761	Outside	Threaded and Socket Weld Ends	-	17	L610
800	Bolted bonnet	Regular	ISO15761	Inside	Threaded and Socket Weld Ends	-	17	800
800	Bolted bonnet	Full	ISO15761	Inside	Threaded and Socket Weld Ends	-	17	600
800	Welded Bonnet	Regular	ISO15761	Inside	Threaded and Socket Weld Ends	-	17	L800
800	Welded Bonnet	Full	ISO15761	Inside	Threaded and Socket Weld Ends	-	17	L600
1500	Bolted bonnet	Regular	ISO15761	Outside	Threaded and Socket Weld Ends	-	18	R910
1500	Bolted bonnet	Full	ISO15761	Outside	Threaded and Socket Weld Ends	-	18	910
1500	Welded Bonnet	Regular	ISO15761	Outside	Threaded and Socket Weld Ends	-	18	LR910
1500	Welded Bonnet	Full	ISO15761	Outside	Threaded and Socket Weld Ends	-	18	L910
1500	Ring Joint BB	Full	ISO15761	Outside	Threaded and Socket Weld Ends	-	18	R910
1500	Ring Joint BB	Full	ISO15761	Outside	Butt Weld B16.10	-	18	BW9-RJ910
2500	Ring Joint BB	Full	ANSI B16.34	Outside	Threaded and Socket Weld Ends	-	19	RJ2510
2500	Ring Joint BB	Full	ANSI B16.34	Outside	Butt Weld and Clamp Ends	-	19	BW25-RJ2510
2500	Welded Bonnet	Full	ANSI B16.34	Outside	Threaded and Socket Weld Ends	-	19	L2510
2500	Welded Bonnet	Full	ANSI B16.34	Outside	Butt Weld and Clamp Ends	-	19	BW25-L2510
800	Welded Bonnet	Regular	ISO15761	Outside	Extended Body - Male Threaded	-	20	MLA-810
800	Welded Bonnet	Regular	ISO15761	Outside	Extended Body - Male Socket	-	20	MLB-810
800	Welded Bonnet	Regular	ISO15761	Outside	Extended Body - BW	-	20	MLC-810
800	Bolted bonnet	Regular	ISO15761	Outside	Extended Body - Male Threaded	-	20	MA-810
800	Bolted bonnet	Regular	ISO15761	Outside	Extended Body - Male Socket	-	20	MB-810
800	Bolted bonnet	Regular	ISO15761	Outside	Extended Body - BW	-	20	MC-810
800	Welded Bonnet	Regular	ISO15761	Outside	Extended Body - Reinforced - BW	-	20	MLW-810
800	Welded Bonnet	Regular	ISO15761	Outside	Extended Body - Reinforced - Male SW	-	20	MLD-810
800	Bolted bonnet	Regular	ISO15761	Outside	Extended Body - Reinforced - BW	-	20	MW-810
800	Bolted bonnet	Regular	ISO15761	Outside	Extended Body - Reinforced - Male SW	-	20	MD-810
1500	Welded Bonnet	Regular	ISO15761	Outside	Extended Body - Male Threaded	-	20	MLA-R910
1500	Welded Bonnet	Regular	ISO15761	Outside	Extended Body - Male Socket	-	20	MLB-R910
1500	Welded Bonnet	Regular	ISO15761	Outside	Extended Body - BW	-	20	MLC-R910
1500	Bolted bonnet	Regular	ISO15761	Outside	Extended Body - Male Threaded	-	20	MA-R910
1500	Bolted bonnet	Regular	ISO15761	Outside	Extended Body - Male Socket	-	20	MB-R910
1500	Bolted bonnet	Regular	ISO15761	Outside	Extended Body - BW	-	20	MC-R910
1500	Welded Bonnet	Regular	ISO15761	Outside	Extended Body - Reinforced - BW	-	20	MLW-R910
1500	Welded Bonnet	Regular	ISO15761	Outside	Extended Body - Reinforced - Male SW	-	20	MLD-R910
1500	Bolted bonnet	Regular	ISO15761	Outside	Extended Body - Reinforced - BW	-	20	MW-R910
1500	Bolted bonnet	Regular	ISO15761	Outside	Extended Body - Reinforced - Male SW	-	20	MD-R910
150	Bolted bonnet	Regular	ISO15761	Outside	Integral Flanged to ASME B16.5	-	21	F1-810
300	Bolted bonnet	Regular	ISO15761	Outside	Integral Flanged to ASME B16.5	-	21	F3-810
600	Bolted bonnet	Regular	ISO15761	Outside	Integral Flanged to ASME B16.5	-	21	F6-810
150	Bolted bonnet	Full	ISO15761	Outside	Integral Flanged to ASME B16.5	-	21	F1-610
300	Bolted bonnet	Full	ISO15761	Outside	Integral Flanged to ASME B16.5	-	21	F3-610
600	Bolted bonnet	Full	ISO15761	Outside	Integral Flanged to ASME B16.5	-	21	F6-610
1500	Ring Joint BB	Full	ISO15761	Outside	Integral Flanged to ASME B16.5	-	21	F9-RJ910
2500	Ring Joint BB	Full	ISO15761	Outside	Integral Flanged to ASME B16.5	-	21	F25-RJ2510
800	Bolted bonnet	Regular	ISO15761	Outside	Threaded and Socket Weld Ends	Sour Service	22	SS810
800	Welded Bonnet	Regular	ISO15761	Outside	Threaded and Socket Weld Ends	Alkilation	22	AS-L810
800	Welded Bonnet	Regular	ISO15761	Outside	Threaded and Socket Weld Ends	Vacuum	22	VS-L810
800	Bolted bonnet	Regular	ISO15761	Outside	Threaded and Socket Weld Ends	Chlorine	22	CS-810

Note Bellows Seal Valves please see C-B5 Bellows Seal Valve Catalog
 Cryogenic Service please see C-CR2 Cryogenic Service Valve Catalog
 Pressure Seal Valves please see C-PS Pressure Seal Valve Catalog
 Upstream Valves please see C-UPV1 Pressure Upstream Valves Catalog

JIS Valve Standards please see JIS Section on this catalog
 DIN Valve Standards please see DIN Section on this catalog



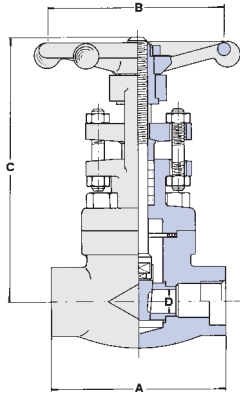

RATINGS: Carbon Steel - 1975 p.s.i. @ 100°F

CLASS 800

BOLTED BONNET - STANDART PORT TO API602/ISO 15761 - FULL PORT TO BS 5352
Outside Screw & Yoke - Threaded and Socket Weld Ends

STANDARD PORT	810	-	1/2	3/4	1	1.1/4	1.1/2	2	-								
FULL PORT	610	1/4	3/8	1/2	3/4	1	1.1/4	1.1/2	2								
		mm	in.	mm	in.	mm	in.	mm	in.	mm	in.	mm	in.				
End to End	A	80	3.14	80	3.14	90	3.54	110	4.33	127	5.00	127	5.00	150	5.90		
Handwheel	B	80	3.14	80	3.14	80	3.14	110	4.33	110	4.33	130	5.11	130	5.11	180	7.08
Center to Top Open	C	148	5.86	148	5.86	163	6.41	178	7.00	210	8.26	243	9.56	262	10.3	365	14.3
Dia. of Port	D	8	0.31	9.6	0.38	14	0.55	18	0.70	24	0.94	30	1.18	37	1.45	48	1.89
Approx. Weight	Kg / Lb	1.6	3.5	1.6	3.5	2.2	4.8	3.5	7.7	5	11	6.5	14.3	9	19.8	21.5	47.3

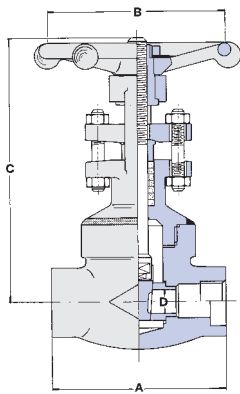

RATINGS: Carbon Steel - 1975 p.s.i. @ 100°F

CLASS 800

BOLTED BONNET - STANDART PORT TO API602/ISO 15761 - FULL PORT TO BS 5352
Outside Screw & Yoke - Threaded and Socket Weld Ends

STANDARD PORT	L810	-	1/2	3/4	1	1.1/4	1.1/2	2	-								
FULL PORT	L610	1/4	3/8	1/2	3/4	1	1.1/4	1.1/2	2								
		mm	in.	mm	in.	mm	in.	mm	in.	mm	in.	mm	in.				
End to End	A	80	3.14	80	3.14	90	3.54	110	4.33	127	5.00	127	5.00	150	5.90		
Handwheel	B	80	3.14	80	3.14	80	3.14	110	4.33	110	4.33	130	5.11	130	5.11	180	7.08
Center to Top Open	C	148	5.86	148	5.86	163	6.41	178	7.00	210	8.26	243	9.56	262	10.3	365	14.3
Dia. of Port	D	8	0.31	9.6	0.38	14	0.55	18	0.70	24	0.94	30	1.18	37	1.45	48	1.89
Approx. Weight	Kg / Lb	1.6	3.5	1.6	3.5	2.2	4.8	3.5	7.7	5	11	6.3	13.8	8	17.6	17	37.4

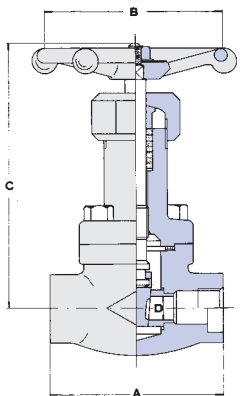

RATINGS: Carbon Steel - 1975 p.s.i. @ 100°F

CLASS 800

BOLTED BONNET - STANDART PORT TO API602/ISO 15761 - FULL PORT TO BS 5352
Inside Screw & Yoke - Threaded and Socket Weld Ends

STANDARD PORT	800	-	1/2	3/4	1	1.1/4	1.1/2	2	-								
FULL PORT	600	1/4	3/8	1/2	3/4	1	1.1/4	1.1/2	2								
		mm	in.	mm	in.	mm	in.	mm	in.	mm	in.	mm	in.				
End to End	A	80	3.14	80	3.14	90	3.54	110	4.33	127	5.00	127	5.00	150	5.90		
Handwheel	B	80	3.14	80	3.14	80	3.14	110	4.33	110	4.33	130	5.11	130	5.11	180	7.08
Center to Top Open	C	148	5.86	148	5.86	175	6.88	212	8.34	235	9.25	287	11.3	327	12.9	380	15.0
Dia. of Port	D	8	0.31	9.6	0.38	14	0.55	18	0.70	24	0.94	30	1.18	37	1.45	48	1.90
Approx. Weight	Kg / Lb	1.5	3.3	1.5	3.3	2	4.4	3	6.6	5.1	11.2	6.7	14.7	9.5	20.9	21.5	47.3

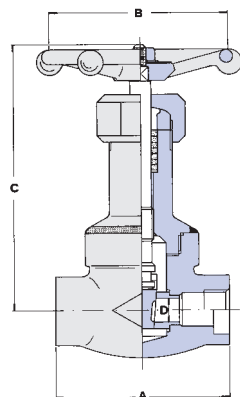

RATINGS: Carbon Steel - 1975 p.s.i. @ 100°F

CLASS 800

BOLTED BONNET - STANDART PORT TO API602/ISO 15761 - FULL PORT TO BS 5352
Inside Screw & Yoke - Threaded and Socket Weld Ends

STANDARD PORT	L800	-	1/2	3/4	1	1.1/4	1.1/2	2	-								
FULL PORT	L600	1/4	3/8	1/2	3/4	1	1.1/4	1.1/2	2								
		mm	in.	mm	in.	mm	in.	mm	in.	mm	in.	mm	in.				
End to End	A	80	3.14	80	3.14	90	3.54	110	4.33	127	5.00	127	5.00	150	5.90		
Handwheel	B	80	3.14	80	3.14	80	3.14	110	4.33	110	4.33	130	5.11	130	5.11	180	7.08
Center to Top Open	C	148	5.86	148	5.86	175	6.88	212	8.34	235	9.25	287	11.3	327	12.9	380	15.0
Dia. of Port	D	8	0.31	9.6	0.38	14	0.55	18	0.70	24	0.94	30	1.18	37	1.45	48	1.90
Approx. Weight	Kg / Lb	1.5	3.3	1.5	3.3	2	4.4	3	6.6	5.1	11.2	6.5	14.3	9	19.8	17	37.4



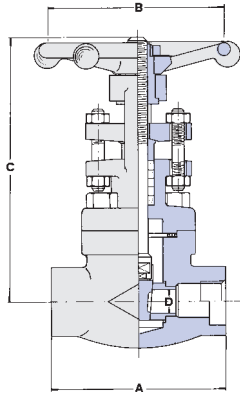

RATINGS: Carbon Steel - 3705 p.s.i. @ 100°F

CLASS 1500

BOLTED BONNET - STANDART PORT TO API602/ISO 15761 - FULL PORT TO BS 5352

Outside Screw & Yoke - Threaded and Socket Weld Ends

STANDARD PORT	R910	-		1/2		3/4		1		1.1/4		1.1/2		2		-	
	910	1/4		3/8		1/2		3/4		1		1.1/4		1.1/2		2	
FULL PORT		mm	in.	mm	in.	mm	in.	mm	in.	mm	in.	mm	in.	mm	in.	mm	in.
End to End	A	90	3.54	90	3.54	110	4.33	127	5.00	127	5.00	127	5.00	150	5.90	150	5.90
Handwheel	B	80	3.14	80	3.14	110	4.33	110	4.33	130	5.11	130	5.11	180	7.08	180	7.08
Center to Top Open	C	145	5.70	160	6.29	175	6.89	210	8.26	240	9.45	260	10.2	355	13.9	360	14.1
Dia. of Port	D	8	0.31	9.6	0.38	14	0.55	18	0.70	24	0.94	30	1.18	37	1.45	40	1.57
Approx. Weight	Kg / Lb	2.2	4.8	2.2	4.8	3.8	8.3	5.5	12.1	6.8	14.9	9.5	20.9	22.5	49.5	22	48.4

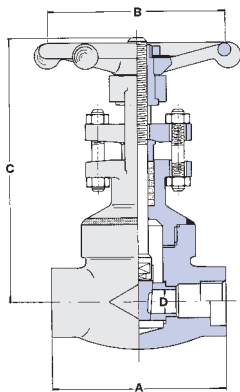

RATINGS: Carbon Steel - 3705 p.s.i. @ 100°F

CLASS 1500

BOLTED BONNET - STANDART PORT TO API602/ISO 15761 - FULL PORT TO BS 5352

Outside Screw & Yoke - Threaded and Socket Weld Ends

STANDARD PORT	LR910	-		1/2		3/4		1		1.1/4		1.1/2		2		-	
	L910	1/4		3/8		1/2		3/4		1		1.1/4		1.1/2		2	
FULL PORT		mm	in.	mm	in.	mm	in.	mm	in.	mm	in.	mm	in.	mm	in.	mm	in.
End to End	A	90	3.54	90	3.54	110	4.33	127	5.00	127	5.00	127	5.00	150	5.90	150	5.90
Handwheel	B	80	3.14	80	3.14	110	4.33	110	4.33	130	5.11	130	5.11	180	7.08	180	7.08
Center to Top Open	C	145	5.70	160	6.29	175	6.89	210	8.26	240	9.45	260	10.2	355	13.9	360	14.1
Dia. of Port	D	8	0.31	9.6	0.38	14	0.55	18	0.70	24	0.94	30	1.18	37	1.45	40	1.57
Approx. Weight	Kg / Lb	2.2	4.8	2.2	4.8	3.8	8.3	5.5	12.1	6.8	15	9	19.8	18.0	39.6	17.5	38.5

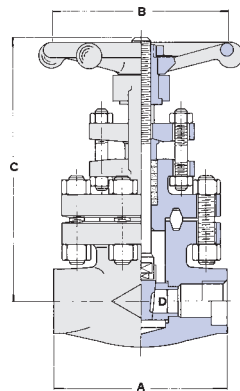

RATINGS: Carbon Steel - 3705 p.s.i. @ 100°F

CLASS 1500

ROUND BOLTED BONNET RJ - FULL PORT TO BS 5352

Outside Screw & Yoke - Threaded and Socket Weld Ends

FULL PORT	RJ910	1/4		3/8		1/2		3/4		1		1.1/4		1.1/2		2	
		mm	in.	mm	in.	mm	in.	mm	in.	mm	in.	mm	in.	mm	in.	mm	in.
End to End	A	-	-	-	-	110	4.33	150	5.90	150	5.90	-	-	210	8.26	235	9.25
Handwheel	B	-	-	-	-	110	4.33	130	5.11	130	5.11	-	-	180	7.08	250	9.84
Center to Top Open	C	-	-	-	-	227	8.93	300	11.8	307	12	-	-	400	15.7	448	17.6
Dia. of Port	D	-	-	-	-	14	0.55	18	0.70	24	0.94	-	-	37	1.45	48	1.89
Approx. Weight	Kg / Lb	-	-	-	-	5	11.0	10	22.0	11.5	25.3	-	-	22	48.4	37	81.5

Ring-Joint gasket according to ASME B16.20 - API 6A. - Spiral wound gasket joint available on request.

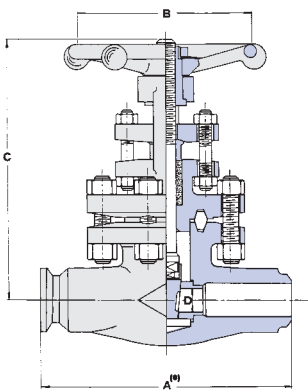

RATINGS: Carbon Steel - 3705 p.s.i. @ 100°F

CLASS 1500

ROUND BOLTED BONNET RJ - FULL PORT TO BS 5352

Outside Screw & Yoke - Butt Weld and Clamp Ends

FULL PORT	BW9-RJ910	1/4		3/8		1/2		3/4		1		1.1/4		1.1/2		2	
		mm	in.	mm	in.	mm	in.	mm	in.	mm	in.	mm	in.	mm	in.	mm	in.
End to End	A	-	-	-	-	216	8.50	229	9.01	254	10.0	-	-	305	12.0	368	14.5
Handwheel	B	-	-	-	-	110	4.33	130	5.11	130	5.11	-	-	180	7.08	300	11.8
Center to Top Open	C	-	-	-	-	260	10.2	300	11.8	300	11.8	-	-	390	15.3	420	16.5
Dia. of Port	D	-	-	-	-	14	0.55	18	0.70	24	0.94	-	-	37	1.45	48	1.89
Approx. Weight	Kg / Lb	-	-	-	-	9	19.8	12	26.4	13	28.6	-	-	26	57.2	44	96.9

Port dimensions can change depending on schedule.

Ring-Joint gasket according to ASME B16.20 - API 6A.

(* End to end dimension according to ANSI B16.10.

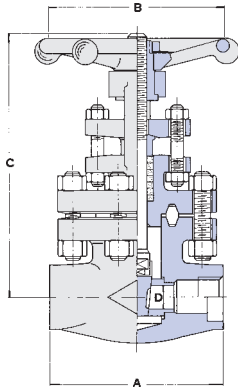

RATINGS: Carbon Steel - 6170 p.s.i. @ 100°F

CLASS 2500 ROUND BOLTED BONNET RJ - FULL PORT - ASME B16.34

Outside Screw & Yoke - Threaded and Socket Weld Ends

FULL PORT	RJ2510	1/4		3/8		1/2		3/4		1		1.1/4		1.1/2		2	
		mm	in.	mm	in.	mm	in.	mm	in.	mm	in.	mm	in.	mm	in.	mm	in.
End to End	A	-	-	-	-	150	5.90	150	5.90	210	8.26	-	-	235	9.25	235	9.25
Handwheel	B	-	-	-	-	130	5.11	130	5.11	250	9.84	-	-	300	11.8	300	11.8
Center to Top Open	C	-	-	-	-	293	11.5	300	11.8	390	15.3	-	-	435	17.1	435	17.1
Dia. of Port	D	-	-	-	-	14	0.55	18	0.70	24	0.94	-	-	37	1.45	37	1.45
Approx. Weight	Kg / Lb	-	-	-	-	10	22.0	10.3	22.7	22.4	49.3	-	-	38	83.7	38	83.7

Ring-Joint gasket according to ASME B16.20 - API 6A.

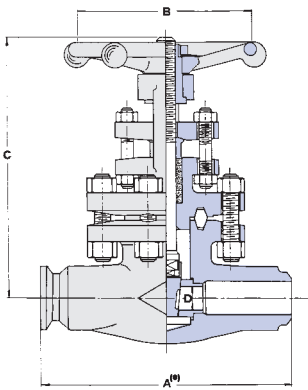

RATINGS: Carbon Steel - 6170 p.s.i. @ 100°F

CLASS 2500 ROUND BOLTED BONNET RJ - FULL PORT - ASME B16.34

Outside Screw & Yoke - Butt Weld and Clamp Ends

FULL PORT	BW25-RJ2510	1/4		3/8		1/2		3/4		1		1.1/4		1.1/2		2	
		mm	in.	mm	in.	mm	in.	mm	in.	mm	in.	mm	in.	mm	in.	mm	in.
End to End	A	-	-	-	-	264	10.4	273	10.7	308	12.1	-	-	384	15.1	451	17.7
Handwheel	B	-	-	-	-	130	5.11	130	5.11	250	9.84	-	-	300	11.8	300	11.8
Center to Top Open	C	-	-	-	-	304	11.9	315	12.4	368	14.5	-	-	445	17.5	538	21.2
Dia. of Port	D	-	-	-	-	14	0.55	18	0.70	24	0.94	-	-	37	1.45	37	1.45
Approx. Weight	Kg / Lb	-	-	-	-	15	33.0	17	37.4	33	72.6	-	-	51	112.3	75	165.1

Port dimensions can change depending on schedule.

Ring-Joint gasket according to ASME B16.20 - API 6A.

(* End to end dimension according to ANSI B16.10.

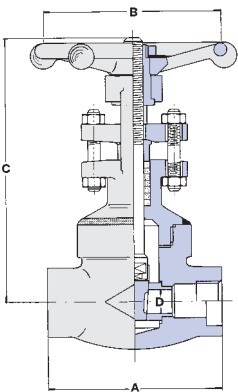

RATINGS: Carbon Steel - 6170 p.s.i. @ 100°F

CLASS 2500 WELDED BONNET - FULL PORT - ASME B16.34

Outside Screw & Yoke - Threaded and Socket Weld Ends

FULL PORT	L2510	1/4		3/8		1/2		3/4		1		1.1/4		1.1/2		2	
		mm	in.	mm	in.	mm	in.	mm	in.	mm	in.	mm	in.	mm	in.	mm	in.
End to End	A	-	-	-	-	127	5.00	127	5.00	127	5.00	-	-	235	9.25	235	9.25
Handwheel	B	-	-	-	-	130	5.11	130	5.11	130	5.11	-	-	300	11.8	300	11.8
Center to Top Open	C	-	-	-	-	214	8.42	239	9.40	253	9.96	-	-	425	16.7	430	16.9
Dia. of Port	D	-	-	-	-	14	0.55	18	0.70	24	0.94	-	-	37	1.45	37	1.45
Approx. Weight	Kg / Lb	-	-	-	-	5.8	12.7	7	15.4	10	22.0	-	-	26	57.3	25.5	56.2

CLASS 2500 WELDED BONNET - FULL PORT - ASME B16.34

Outside Screw & Yoke - Butt Weld and Clamp Ends

FULL PORT	BW25-L2510	1/4		3/8		1/2		3/4		1		1.1/4		1.1/2		2	
		mm	in.	mm	in.	mm	in.	mm	in.	mm	in.	mm	in.	mm	in.	mm	in.
End to End	A	-	-	-	-	264	10.4	273	10.7	308	12.1	-	-	384	15.1	451	17.7
Handwheel	B	-	-	-	-	130	5.11	130	5.11	250	9.84	-	-	300	11.8	300	11.8
Center to Top Open	C	-	-	-	-	304	11.9	315	12.4	368	14.5	-	-	445	17.5	538	21.2
Dia. of Port	D	-	-	-	-	14	0.55	18	0.70	24	0.94	-	-	37	1.45	37	1.45
Approx. Weight	Kg / Lb	-	-	-	-	13	28.6	14	30.8	27	59.4	-	-	41	90.3	62	136.5

Port dimensions can change depending on schedule.

(* End to end dimension according to ANSI B16.10.

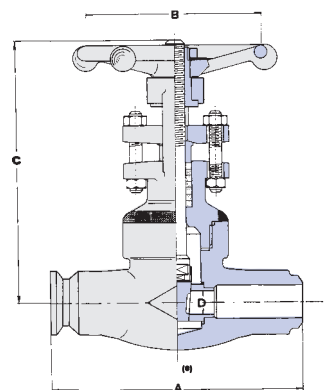

RATINGS: Carbon Steel - 6170 p.s.i. @ 100°F



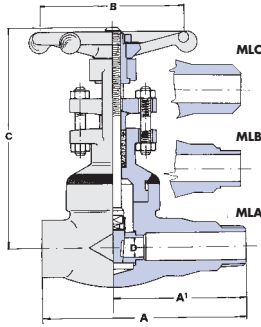

RATINGS: Carbon Steel
Class 800 - 1975 p.s.i. @ 100°F
Class 1500 - 3705 p.s.i. @ 100°F

CLASS 800-1500

TAKE-OFF VALVE - WELDED BONNET - STANDART PORT TO API602/ISO 15761
Outside Screw & Yoke - Threaded, Socket Weld and BW Ends

STANDARD PORT	Class 800	MLA-810	-		1/2		3/4		1		-		1.1/2		2		-	
	Class 1500	MLA-R910	-		-		1/2		3/4		1		-		1.1/2		2	
			mm	in.	mm	in.	mm	in.	mm	in.	mm	in.	mm	in.	mm	in.	mm	in.
End to End	A	-	-	148	5.82	153	6.02	182	7.16	216	8.50	216	8.50	264	10.4	264	10.4	
Center to Male End	A1	-	-	108	4.25	108	4.25	127	5.00	152	6.00	152	6.00	200	7.87	189	7.44	
Handwheel	B	-	-	80	3.14	80	3.14	110	4.33	110	4.33	130	5.11	130	5.11	180	7.08	
Center to Top Open	C	-	-	148	5.82	163	6.41	178	7.00	210	8.26	243	9.56	262	10.3	355	13.9	
Dia. of Port	Class 800	D	-	-	9.6	0.38	14	0.55	18	0.70	-	-	30	1.18	37	1.45	-	-
	Class 1500	D	-	-	-	-	9.6	0.38	14	0.55	18	0.70	-	-	30	1.18	37	1.45
Approx. Weight	Class 800	Kg / Lb	-	-	2.1	4.6	2.8	6.2	4.4	9.7	-	-	8.1	17.8	10.5	23.2	-	-
	Class 1500	Kg / Lb	-	-	-	-	3.1	6.8	4.8	10.6	7.5	16.5	-	-	11.5	25.3	21.1	46.5

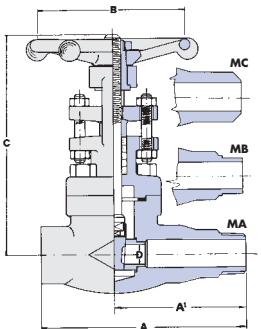

RATINGS: Carbon Steel
Class 800 - 1975 p.s.i. @ 100°F
Class 1500 - 3705 p.s.i. @ 100°F

CLASS 800-1500

TAKE-OFF VALVE - BOLTED BONNET - STANDART PORT TO API602/ISO 15761
Outside Screw & Yoke - Threaded, Socket Weld and BW Ends

STANDARD PORT	Class 800	MA-810	-		1/2		3/4		1		-		1.1/2		2		-	
	Class 1500	MA-R910	-		-		1/2		3/4		1		-		1.1/2		2	
			mm	in.	mm	in.	mm	in.	mm	in.	mm	in.	mm	in.	mm	in.	mm	in.
End to End	A	-	-	148	5.82	153	6.02	182	7.16	216	8.50	216	8.50	264	10.4	264	10.4	
Center to Male End	A1	-	-	108	4.25	108	4.25	127	5.00	152	6.00	152	6.00	200	7.87	189	7.44	
Handwheel	B	-	-	80	3.14	80	3.14	110	4.33	110	4.33	130	5.11	130	5.11	180	7.08	
Center to Top Open	C	-	-	148	5.82	163	6.41	178	7.00	210	8.26	243	9.56	262	10.3	355	13.9	
Dia. of Port	Class 800	D	-	-	9.6	0.38	14	0.55	18	0.70	-	-	30	1.18	37	1.45	-	-
	Class 1500	D	-	-	-	-	9.6	0.38	14	0.55	18	0.70	-	-	30	1.18	37	1.45
Approx. Weight	Class 800	Kg / Lb	-	-	2.1	4.6	2.8	6.2	4.4	9.7	-	-	8.3	18.3	12	26.4	-	-
	Class 1500	Kg / Lb	-	-	-	-	3.1	6.8	4.8	10.6	7.5	16.5	-	-	12	26.4	22.1	48.7

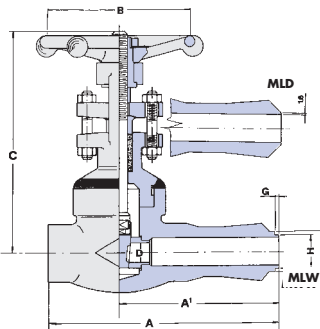

RATINGS: Carbon Steel
Class 800 - 1975 p.s.i. @ 100°F
Class 1500 - 3705 p.s.i. @ 100°F

CLASS 800-1500

REINFORCED EXTENDED BODY - WELDED BONNET - STANDART PORT TO API602/ISO 5761
Outside Screw & Yoke - Threaded and Socket Weld Female End

STANDARD PORT	Class 800	MLW-810	-		1/2		3/4		1		-		1.1/2		2		-	
	Class 1500	MLW-R910	-		-		1/2		3/4		1		-		1.1/2		2	
			mm	in.	mm	in.	mm	in.	mm	in.	mm	in.	mm	in.	mm	in.	mm	in.
End to End	A	-	-	196	7.71	220	8.66	244	9.60	265	10.4	265	10.4	270	10.6	270	10.6	
Center to Male End	A1	-	-	156	6.14	175	6.88	189	7.44	201	7.91	201	7.91	206	8.11	165	6.50	
Handwheel	B	-	-	80	3.14	80	3.14	110	4.33	110	4.33	130	5.11	130	5.11	180	7.08	
Center to Top Open	C	-	-	148	5.82	163	6.41	178	7.00	210	8.26	243	9.56	262	10.3	355	13.9	
Dia. of Port	Class 800	D	-	-	9.6	0.38	14	0.55	18	0.70	-	-	30	1.18	37	1.45	-	-
	Class 1500	D	-	-	-	-	9.6	0.38	14	0.55	18	0.70	-	-	30	1.18	37	1.45
Approx. Weight	Class 800	Kg / Lb	-	-	3	6.6	3.2	7.0	5	11.0	-	-	9.3	20.5	12.5	27.5	-	-
	Class 1500	Kg / Lb	-	-	-	-	3.5	7.7	5.4	11.9	8.1	17.8	-	-	13	28.6	23.1	50.9

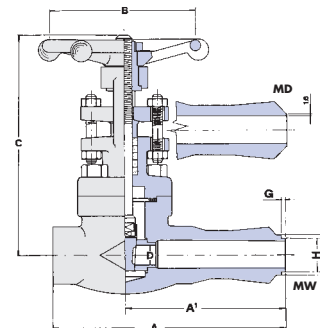

RATINGS: Carbon Steel
Class 800 - 1975 p.s.i. @ 100°F
Class 1500 - 3705 p.s.i. @ 100°F

CLASS 800-1500

REINFORCED EXTENDED BODY - BOLTED BONNET - STANDART PORT TO API602/ISO 15761
Outside Screw & Yoke - Threaded and Socket Weld Female End

STANDARD PORT	Class 800	MW-810	-		1/2		3/4		1		-		1.1/2		2		-	
	Class 1500	MW-R910	-		-		1/2		3/4		1		-		1.1/2		2	
			mm	in.	mm	in.	mm	in.	mm	in.	mm	in.	mm	in.	mm	in.	mm	in.
End to End	A	-	-	196	7.71	220	8.66	244	9.60	265	10.4	265	10.4	270	10.6	270	10.6	
Center to Male End	A1	-	-	156	6.14	175	6.88	189	7.44	201	7.91	201	7.91	206	8.11	165	6.50	
Handwheel	B	-	-	80	3.14	80	3.14	110	4.33	110	4.33	130	5.11	130	5.11	180	7.08	
Center to Top Open	C	-	-	148	5.82	163	6.41	178	7.00	210	8.26	243	9.56	262	10.3	355	13.9	
Dia. of Port	Class 800	D	-	-	9.6	0.38	14	0.55	18	0.70	-	-	30	1.18	37	1.45	-	-
	Class 1500	D	-	-	-	-	9.6	0.38	14	0.55	18	0.70	-	-	30	1.18	37	1.45
Approx. Weight	Class 800	Kg / Lb	-	-	3	6.6	3.2	7.0	5	11.0	-	-	9.5	20.9	12.5	27.5	-	-
	Class 1500	Kg / Lb	-	-	-	-	3.5	7.7	5.4	11.9	8.1	17.8	-	-	13.5	29.7	24.1	53.0

Reinforced - Lip - Class 800 & 1500	SIZE	-		1/2		3/4		1		-		1.1/2		2		-	
	H	-	-	18	0.70	23	0.91	28	1.10	-	-	44	1.73	50	1.97	-	-
	I	-	-	20.5	0.80	25.5	1.00	30.5	1.20	-	-	47	1.85	53	2.08	-	-
	G	-	-	4	0.15	4.5	0.17	5	0.19	-	-	7	0.25	8	0.31	-	-
Run size	Min.	-		1		1.1/2		2		-		3		4		-	

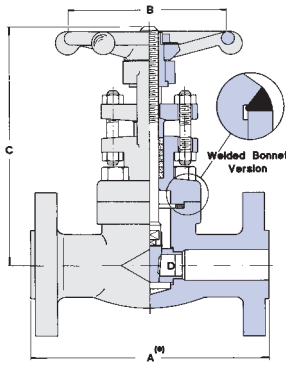

RATINGS: Carbon Steel
 Class 150 - 285 p.s.i. @ 100°F
 Class 300 - 740 p.s.i. @ 100°F
 Class 600 - 1480 p.s.i. @ 100°F

CLASS 150-300-600

BOLTED BONNET - STANDART PORT TO API602/ISO 15761
 Outside Screw & Yoke - Integral Flanged Ends according to ASME B16.5

STANDARD PORT		1/4		3/8		1/2		3/4		1		1.1/4		1.1/2		2	
		mm	in.	mm	in.	mm	in.	mm	in.	mm	in.	mm	in.	mm	in.	mm	in.
Class 150 F1-810	A	-	-	-	-	108	4.25	117	4.64	127	5.00	-	-	165	6.49	178	7.00
Class 300 F3-810	A	-	-	-	-	140	5.51	152	6.02	165	6.49	-	-	190	7.51	216	8.50
Class 600 F6-810	A	-	-	-	-	165	6.49	190	7.51	216	8.50	-	-	241	9.48	292	11.5
Handwheel	B	-	-	-	-	80	3.14	80	3.14	110	4.33	-	-	130	5.11	130	5.11
Center to Top Open	Class 150/300	C	-	-	-	170	6.69	195	7.67	203	7.99	-	-	243	9.56	262	10.3
	Class 600	C	-	-	-	148	5.82	163	6.41	178	7.00	-	-	243	9.56	262	10.3
Dia. of Port	D	-	-	-	-	9.6	0.38	14	0.55	18	0.70	-	-	30	1.18	37	1.45
Approx. Weight	Class 150	Kg / Lb	-	-	-	3.4	7.5	3.8	8.3	5.7	12.5	-	-	9.7	21.4	13.2	29.1
	Class 300	Kg / Lb	-	-	-	3.9	8.6	5	11.0	6.2	13.6	-	-	12	26.4	16.5	36.3
	Class 600	Kg / Lb	-	-	-	4	8.8	5.2	11.4	7.5	16.5	-	-	15	33.0	20.5	45.1

End to End dimensions according to ASME B16.10

(*) End to end dimension according to ANSI B16.10.

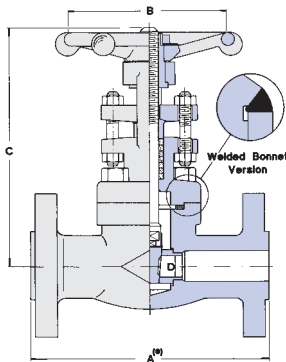

RATINGS: Carbon Steel
 Class 150 - 285 p.s.i. @ 100°F
 Class 300 - 740 p.s.i. @ 100°F
 Class 600 - 1480 p.s.i. @ 100°F

CLASS 150-300-600

ROUND BONNET - STANDART PORT TO API602/ISO 15761
 Outside Screw & Yoke - Integral Flanged Ends according to ASME B16.5

STANDARD PORT		1/4		3/8		1/2		3/4		1		1.1/4		1.1/2		2	
		mm	in.	mm	in.	mm	in.	mm	in.	mm	in.	mm	in.	mm	in.	mm	in.
Class 150 F1-610	A	-	-	-	-	108	4.25	117	4.64	127	5.00	-	-	165	6.49	178	7.00
Class 300 F3-610	A	-	-	-	-	140	5.51	152	6.02	165	6.49	-	-	190	7.51	216	8.50
Class 600 F6-RJ610	A	-	-	-	-	165	6.49	190	7.51	216	8.50	-	-	241	9.48	292	11.5
Handwheel	B	-	-	-	-	110	4.33	110	4.33	130	5.11	-	-	250	9.84	250	9.84
Center to Top Open	Class 150/300	C	-	-	-	170	6.69	195	7.67	210	8.26	-	-	262	10.3	327	12.8
	Class 600	C	-	-	-	244	9.60	268	10.5	310	12.2	-	-	391	15.4	430	16.9
Dia. of Port	D	-	-	-	-	14	0.55	18	0.70	24	0.94	-	-	37	1.45	48	1.89
Approx. Weight	Class 150	Kg / Lb	-	-	-	3.6	7.9	4.8	10.5	6.5	14.3	-	-	12	26.4	18	39.6
	Class 300	Kg / Lb	-	-	-	4.1	9.0	5.5	12.1	7.0	15.4	-	-	13	28.6	19	41.8
	Class 600	Kg / Lb	-	-	-	6	13.2	11	24.2	13	28.6	-	-	27	59.4	30	66.0

End to End dimensions according to ASME B16.10

Spiral wound gasket joint for #150 - #300

Ring-Joint gasket according to ASME B 16.20 - API 6A

(*) End to end dimension according to ANSI B16.10.

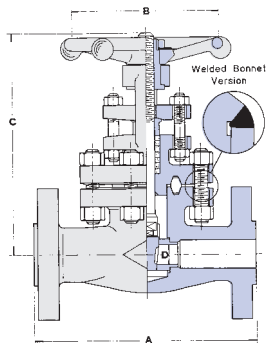

RATINGS: Carbon Steel
 Class 1500 - 3705 p.s.i. @ 100°F

CLASS 1500

ROUND BOLTED BONNET RJ - FULL PORT BS 5352
 Outside Screw & Yoke - Integral Flanged Ends according to ASME B 16.5

FULL PORT	F9-RJ910	1/4		3/8		1/2		3/4		1		1.1/4		1.1/2		2	
		mm	in.	mm	in.	mm	in.	mm	in.	mm	in.	mm	in.	mm	in.	mm	in.
End to End	A	-	-	-	-	216	8.50	229	9.01	254	10.0	-	-	305	12.0	368	14.5
Handwheel	B	-	-	-	-	110	4.33	130	5.11	130	5.11	-	-	250	9.84	300	11.8
Center to Top Open	C	-	-	-	-	260	10.2	300	11.8	300	11.8	-	-	390	15.3	420	16.5
Dia. of Port	D	-	-	-	-	14	0.55	18	0.70	24	0.94	-	-	37	1.45	48	1.89
Approx. Weight	Kg / Lb	-	-	-	-	11	24.2	16	35.2	19	41.8	-	-	35	77.1	59	130.0

End to End dimensions according to ASME B16.10

Spiral wound gasket joint available on request

Ring-Joint gasket according to ASME B 16.20 - API 6A

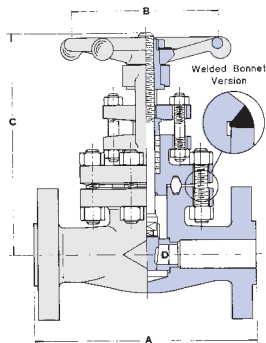

RATINGS: Carbon Steel
 Class 2500 - 6170 p.s.i. @ 100°F

CLASS 2500

ROUND BOLTED BONNET RJ - FULL PORT - ASME B16.34
 Outside Screw & Yoke - Integral Flanged Ends according to ASME B 16.5

FULL PORT	F25-RJ2510	1/4		3/8		1/2		3/4		1		1.1/4		1.1/2		2	
		mm	in.	mm	in.	mm	in.	mm	in.	mm	in.	mm	in.	mm	in.	mm	in.
End to End	A	-	-	-	-	264	10.4	273	10.7	308	12.1	-	-	384	15.1	451	17.7
Handwheel	B	-	-	-	-	130	5.11	130	5.11	250	9.84	-	-	300	11.8	300	11.8
Center to Top Open	C	-	-	-	-	304	11.9	315	12.4	368	14.5	-	-	445	17.5	538	22.2
Dia. of Port	D	-	-	-	-	14	0.55	18	0.70	24	0.94	-	-	37	1.45	37	1.45
Approx. Weight	Kg / Lb	-	-	-	-	19	41.8	21	46.2	40	88.1	-	-	62	136.5	92	202.6

End to End dimensions according to ASME B16.10

Ring-Joint gasket according to ASME B 16.20 - API 6A





Globe valves are closing-down valves in which the closure member is moved squarely on and off the seat. In this way the opening of the port is directly proportional to the travel of the disc. This proportional relationship is ideally suited for duties requiring regulation of flow rate. To have a further precision in regulation the disc element can be available in the parabolic, needle, vee-port types. Furthermore the short travel of the disc between the open and closed position makes these valves ideally suited for on-off duties when they must be opened and closed frequently. Globe valves are unidirectional valves and are installed so that fluid pressure is under the disc. They are supplied in various models to cover the different services. Among these valves the Eco-L-Valve® combines the characteristics of total safety against leakages to the easy substitution of the most delicate components such as the bellows. The main characteristics of each type are described on pages 24 to 31.

Figure # is identified in each table as:

STANDARD PORT	830	-
FULL PORT	630	1/4
		mm

CLASS	CONNECTION	PORT	STANDARD	SCREW & YOKE	ENDS	SERVICE	PAGE	OMB FIG.
800	Bolted bonnet	Regular	ISO15761	Outside	Threaded and Socket Weld Ends	-	25	830
800	Bolted bonnet	Full	ISO15761	Outside	Threaded and Socket Weld Ends	-	25	630
800	Welded Bonnet	Regular	ISO15761	Outside	Threaded and Socket Weld Ends	-	25	L830
800	Welded Bonnet	Full	ISO15761	Outside	Threaded and Socket Weld Ends	-	25	L630
800	Welded Bonnet	Regular	ISO15761	inside	Threaded and Socket Weld Ends	-	25	L820
800	Welded Bonnet	Full	ISO15761	inside	Threaded and Socket Weld Ends	-	25	L620
1500	Bolted bonnet	Regular	ISO15761	Outside	Threaded and Socket Weld Ends	-	25	R930
1500	Bolted bonnet	Full	ISO15761	Outside	Threaded and Socket Weld Ends	-	25	930
1500	Welded Bonnet	Regular	ISO15761	Outside	Threaded and Socket Weld Ends	-	26	LR930
1500	Welded Bonnet	Full	ISO15761	Outside	Threaded and Socket Weld Ends	-	26	L930
1500	Ring Joint BB	Full	ISO15761	Outside	Threaded and Socket Weld Ends	-	26	RJ930
2500	Ring Joint BB	Full	ANSI B16.34	Outside	Threaded and Socket Weld Ends	-	26	RJ2530
2500	Welded Bonnet	Full	ANSI B16.34	Outside	Threaded and Socket Weld Ends	-	26	L2530
4500	Welded Bonnet	Full	ANSI B16.34	Outside	Threaded and Socket Weld Ends	-	27	RJ4530
4500	Welded Bonnet	Full	ANSI B16.34	Outside	Threaded and Socket Weld Ends	-	27	L4530
4500	Welded Bonnet	Full	ANSI B16.34	Outside	Threaded and Socket Weld Ends	-	27	RJ-4530-BW
4500	Welded Bonnet	Full	ANSI B16.34	Outside	Threaded and Socket Weld Ends	-	27	L4530-BW
800	Welded Bonnet	Full	ISO15761	Outside	Threaded and Socket Weld Ends	-	28	Y630
1500	Welded Bonnet	Full	ISO15761	Outside	Threaded and Socket Weld Ends	-	28	Y930
2500	Welded Bonnet	Full	ANSI B16.34	Outside	Threaded and Socket Weld Ends	-	28	Y2530
4500	Welded Bonnet	Full	ANSI B16.34	Outside	Threaded and Socket Weld Ends	-	28	Y4530
150	Welded Bonnet	Full	ISO15761	Outside	Flanged	-	29	1-Y630
300	Welded Bonnet	Full	ISO15761	Outside	Flanged	-	29	3-Y630
600	Welded Bonnet	Full	ISO15761	Outside	Flanged	-	29	6-Y630
150	Bolted bonnet	Regular	ISO15761	Outside	Flanged	-	29	F1-830
300	Bolted bonnet	Regular	ISO15761	Outside	Flanged	-	29	F3-830
600	Bolted bonnet	Regular	ISO15761	Outside	Flanged	-	29	F6-830
150	Bolted bonnet	Full	ISO15761	Outside	Flanged	-	29	F1-630
300	Bolted bonnet	Full	ISO15761	Outside	Flanged	-	29	F3-RJ-630
600	Bolted bonnet	Full	ISO15761	Outside	Flanged	-	29	F6-RJ-630
1500	Ring Joint BB	Full	ISO15761	Outside	Flanged	-	29	F9-RJ930
2500	Ring Joint BB	Full	ISO15761	Outside	Flanged	-	29	F25-RJ2530
800	Bolted bonnet	Regular	ISO15761	Outside	Threaded and Socket Weld Ends	Sour Service	30	SS830
800	Welded Bonnet	Regular	ISO15761	Outside	Threaded and Socket Weld Ends	Alkilation	30	AS-L830
800	Welded Bonnet	Regular	ISO15761	Outside	Threaded and Socket Weld Ends	Vacuum	30	VS-L830
800	Bolted bonnet	Regular	ISO15761	Outside	Threaded and Socket Weld Ends	Chlorine	30	CS-830

Note Bellows Seal Valves please see C-BS Bellows Seal Valve Catalog
 Cryogenic Service please see C-CR2 Cryogenic Service Valve Catalog
 Pressure Seal Valves please see C-PS Pressure Seal Valve Catalog
 Thru Conduit Valves please see C-TC Pressure Thru Conduit Valves Catalog
 Y Pattern Valves please see C-HTHP High Pressure - High Temperature Valves

Eco-L-Valves
 OMB introduced an innovative solution to the Fugitive Emission issue: Eco-L-Valves. Special patented Short Pattern Bellows Seal valves, with dimension equal to standard non-bellows valves and able to meet the severe service conditions of standard bellows seal with a lower dimensional height and reduced cost impact.

JIS Valve Standards please see JIS Section on this catalog
 DIN Valve Standards please see DIN Section on this catalog

ECO-L-VALVES please see C-BS Bellows Seal Valve Catalog



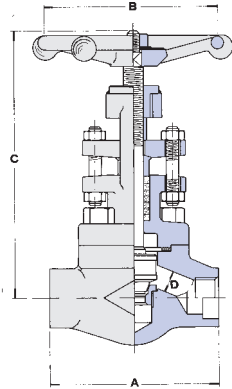

RATINGS: Carbon Steel - 1975 p.s.i. @ 100°F

CLASS 800

BOLTED BONNET - STANDART PORT TO API602/ISO 15761 - FULL PORT TO BS 5352
Outside Screw & Yoke - Threaded and Socket Weld Ends

STANDARD PORT	830	-	1/2	3/4	1	1.1/4	1.1/2	2	-
FULL PORT	630	1/4	3/8	1/2	3/4	1	1.1/4	1.1/2	2
		mm in.	mm in.	mm in.	mm in.	mm in.	mm in.	mm in.	mm in.
End to End	A	80 3.14	80 3.14	90 3.54	110 4.33	127 5.00	155 6.10	170 6.69	210 8.26
Handwheel	B	80 3.14	80 3.14	80 3.14	110 4.33	130 5.11	130 5.11	180 7.08	180 7.08
Center to Top Open	C	148 5.82	148 5.82	165 6.49	180 7.08	213 8.38	248 9.76	257 10.1	370 14.5
Dia. of Port	D	7 0.28	9 0.35	13 0.51	17.5 0.69	23 0.89	29.5 1.16	35 1.37	45.5 1.79
Approx. Weight	Kg / Lb	1.7 3.7	1.7 3.7	2.3 5.0	3.6 7.9	5.5 12.1	7.5 16.5	11.6 25.5	22.0 48.5

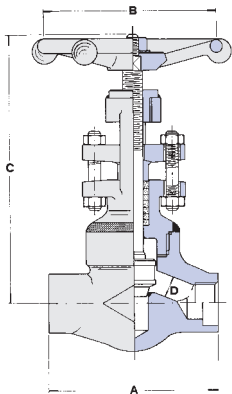

RATINGS: Carbon Steel - 1975 p.s.i. @ 100°F

CLASS 800

WELDED BONNET - STANDART PORT TO API602/ISO 15761 - FULL PORT TO BS 5352
Outside Screw & Yoke - Threaded and Socket Weld Ends

STANDARD PORT	L830	-	1/2	3/4	1	1.1/4	1.1/2	2	-
FULL PORT	L630	1/4	3/8	1/2	3/4	1	1.1/4	1.1/2	2
		mm in.	mm in.	mm in.	mm in.	mm in.	mm in.	mm in.	mm in.
End to End	A	80 3.14	80 3.14	90 3.54	110 4.33	127 5.00	155 6.10	170 6.69	210 8.26
Handwheel	B	80 3.14	80 3.14	80 3.14	110 4.33	130 5.11	130 5.11	180 7.08	180 7.08
Center to Top Open	C	148 5.82	148 5.82	165 6.49	180 7.08	213 8.38	248 9.76	257 10.1	370 14.5
Dia. of Port	D	7 0.28	9 0.35	13 0.51	17.5 0.69	23 0.89	29.5 1.16	35 1.37	45.5 1.79
Approx. Weight	Kg / Lb	1.7 3.7	1.7 3.7	2.3 5.0	3.6 7.9	5.5 12.1	7.3 16	10.5 23.1	17.5 38.5

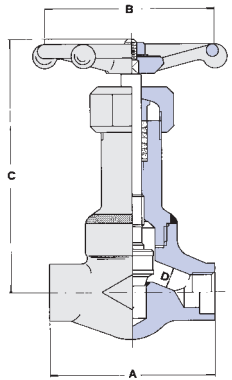

RATINGS: Carbon Steel - 1975 p.s.i. @ 100°F

CLASS 800

WELDED BONNET - STANDART PORT TO API602/ISO 15761 - FULL PORT TO BS 5352
Inside Screw - Threaded and Socket Weld Ends

STANDARD PORT	L820	-	1/2	3/4	1	1.1/4	1.1/2	2	-
FULL PORT	L620	1/4	3/8	1/2	3/4	1	1.1/4	1.1/2	2
		mm in.	mm in.	mm in.	mm in.	mm in.	mm in.	mm in.	mm in.
End to End	A	80 3.14	80 3.14	90 3.54	110 4.33	127 5.00	155 6.10	170 6.69	210 8.26
Handwheel	B	80 3.14	80 3.14	80 3.14	110 4.33	130 5.11	130 5.11	130 5.11	180 7.08
Center to Top Open	C	148 5.82	148 5.82	175 6.88	212 8.34	235 9.25	287 11.3	327 12.9	380 15.0
Dia. of Port	D	7 0.28	9 0.35	13 0.51	17.5 0.69	23 0.89	29.5 1.16	35 1.37	45.5 1.79
Approx. Weight	Kg / Lb	1.5 3.3	1.5 3.3	2.0 4.4	3.7 8.1	5.5 12.1	7.3 16	10.5 23.1	17.5 38.5

Bolted Bonnet Type on request

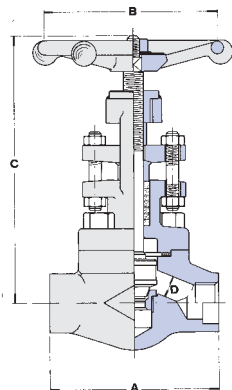

RATINGS: Carbon Steel - 3705 p.s.i. @ 100°F

CLASS 1500

BOLTED BONNET - STANDART PORT TO API602/ISO 15761 - FULL PORT TO BS 5352
Outside Screw & Yoke - Threaded and Socket Weld Ends

STANDARD PORT	R930	-	1/2	3/4	1	1.1/4	1.1/2	2	-
FULL PORT	930	1/4	3/8	1/2	3/4	1	1.1/4	1.1/2	2
		mm in.	mm in.	mm in.	mm in.	mm in.	mm in.	mm in.	mm in.
End to End	A	90 3.54	90 3.54	110 4.33	127 5.00	155 6.10	170 6.69	210 8.26	210 8.26
Handwheel	B	80 3.14	80 3.14	110 4.33	130 5.11	130 5.11	180 7.08	180 7.08	180 7.08
Center to Top Open	C	160 6.29	160 6.29	175 6.88	210 8.26	244 9.60	250 9.84	370 14.5	375 14.7
Dia. of Port	D	7 0.28	9 0.35	13 0.51	17 0.67	21 0.83	28 1.10	33 1.30	37.5 1.48
Approx. Weight	Kg / Lb	2.2 4.8	2.2 4.8	3.9 8.5	6 13.2	8 17.6	12 26.4	23.5 51.7	23 50.6



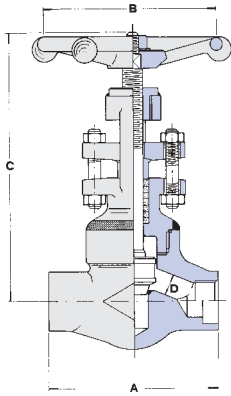

RATINGS: Carbon Steel - 3705 p.s.i. @ 100°F

CLASS 1500 WELDED BONNET - STANDART PORT TO API602/ISO 15761 - FULL PORT TO BS 5352

Outside Screw & Yoke - Threaded and Socket Weld Ends

STANDARD PORT	LR930	-	1/2	3/4	1	1.1/4	1.1/2	2	-
FULL PORT	L930	1/4	3/8	1/2	3/4	1	1.1/4	1.1/2	2
		mm in.	mm in.	mm in.	mm in.	mm in.	mm in.	mm in.	mm in.
End to End	A	90 3.54	90 3.54	110 4.33	127 5.00	155 6.10	170 6.69	210 8.26	210 8.26
Handwheel	B	80 3.14	80 3.14	110 4.33	130 5.11	130 5.11	180 7.08	180 7.08	180 7.08
Center to Top Open	C	160 6.29	160 6.29	175 6.88	210 8.26	244 9.60	250 9.84	370 14.5	375 14.7
Dia. of Port	D	7 0.28	9 0.35	13 0.51	17 0.67	21 0.83	28 1.10	33 1.30	37.5 1.48
Approx. Weight	Kg / Lb	2.2 4.8	2.2 4.8	3.9 8.5	6 13.2	8 17.6	12 26.4	19 41.8	18.5 40.7

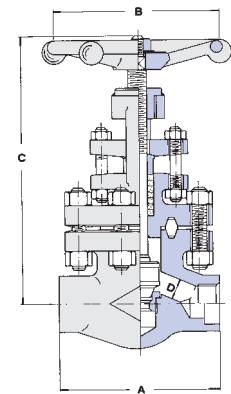

RATINGS: Carbon Steel - 3705 p.s.i. @ 100°F

CLASS 1500 ROUND BOLTED BONNET - FULL PORT BS 5352

Outside Screw & Yoke - Threaded and Socket Weld Ends

FULL PORT	RJ930	1/4	3/8	1/2	3/4	1	1.1/4	1.1/2	2
		mm in.	mm in.	mm in.	mm in.	mm in.	mm in.	mm in.	mm in.
End to End	A	- -	- -	110 4.33	150 5.90	150 5.90	- -	210 8.26	235 9.25
Handwheel	B	- -	- -	110 4.33	130 5.11	130 5.11	- -	180 7.08	250 9.84
Center to Top Open	C	- -	- -	235 9.25	265 10.4	310 12.2	- -	370 14.5	435 17.1
Dia. of Port	D	- -	- -	13 0.51	17 0.67	21 0.83	- -	33 1.30	37.5 1.48
Approx. Weight	Kg / Lb	- -	- -	5.1 11.2	11 24.2	12.1 26.6	- -	22 48.4	37 81.5

Ring-Joint gasket according to ASME B16.20 - API 6A. - Spiral wound gasket joint available on request.

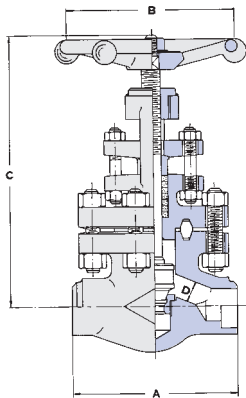

RATINGS: Carbon Steel - 6170 p.s.i. @ 100°F

CLASS 2500 ROUND BOLTED BONNET RJ - FULL PORT - ASME B16.34

Outside Screw & Yoke - Socket and Butt Weld Ends

FULL PORT	RJ2530	1/4	3/8	1/2	3/4	1	1.1/4	1.1/2	2
		mm in.	mm in.	mm in.	mm in.	mm in.	mm in.	mm in.	mm in.
End to End	A	- -	- -	150 5.90	150 5.90	210 8.26	- -	235 9.25	235 9.25
Handwheel	B	- -	- -	130 5.11	130 5.11	250 9.84	- -	300 11.8	300 11.8
Center to Top Open	C	- -	- -	265 10.4	265 10.4	360 14.1	- -	430 16.9	435 17.1
Dia. of Port	D	- -	- -	13 0.51	17 0.67	21 0.83	- -	33 1.30	35 1.37
Approx. Weight	Kg / Lb	- -	- -	11 24.2	11.3 24.8	22.4 49.3	- -	38 83.7	38 83.7

Ring-Joint gasket according to ASME B16.20 - API 6A.

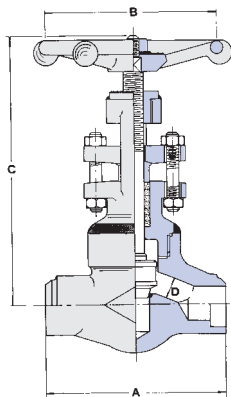

RATINGS: Carbon Steel - 6170 p.s.i. @ 100°F

CLASS 2500 WELDED BONNET - FULL PORT - ASME B16.34

Outside Screw & Yoke - Socket and Butt Weld Ends

FULL PORT	L2530	1/4	3/8	1/2	3/4	1	1.1/4	1.1/2	2
		mm in.	mm in.	mm in.	mm in.	mm in.	mm in.	mm in.	mm in.
End to End	A	- -	- -	127 5.00	155 6.10	170 6.69	- -	235 9.25	235 9.25
Handwheel	B	- -	- -	130 5.11	130 5.11	130 5.11	- -	300 11.8	300 11.8
Center to Top Open	C	- -	- -	237 9.33	242 9.52	256 10.1	- -	430 16.9	435 17.1
Dia. of Port	D	- -	- -	13 0.51	17 0.67	21 0.83	- -	33 1.30	35 1.37
Approx. Weight	Kg / Lb	- -	- -	6.5 14.3	8.5 18.7	12.5 27.5	- -	26 57.2	25.5 56.1

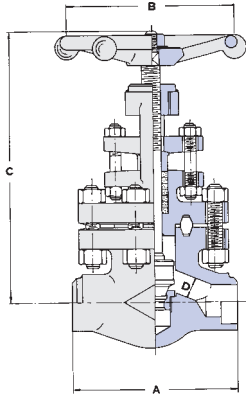

RATINGS: Carbon Steel - 11110 p.s.i. @ 100°F

CLASS 4500 ROUND BOLTED BONNET RJ - FULL PORT - ASME B16.34

Outside Screw & Yoke - Socket and Butt Weld Ends

FULL PORT	RJ4530	1/4		3/8		1/2		3/4		1		1.1/4		1.1/2		2	
		mm	in.	mm	in.	mm	in.	mm	in.	mm	in.	mm	in.	mm	in.	mm	in.
End to End	A	-	-	-	-	210	8.26	210	8.26	235	9.25	-	-	235	9.25	-	-
Handwheel	B	-	-	-	-	250	9.84	250	9.84	300	11.8	-	-	300	11.8	-	-
Center to Top Open	C	-	-	-	-	345	13.5	350	13.7	420	16.5	-	-	430	16.9	-	-
Dia. of Port	D	-	-	-	-	9	0.35	11	0.43	14	0.55	-	-	28	1.10	-	-
Approx. Weight	Kg / Lb	-	-	-	-	23	50.6	23	50.6	38.5	84.8	-	-	38.5	84.8	-	-

2" on request

Ring-Joint gasket according to ASME B16.20 - API 6A.

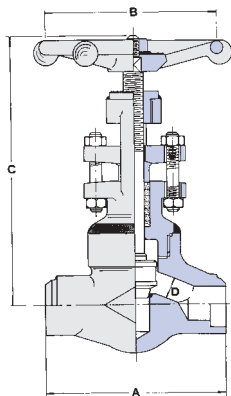

RATINGS: Carbon Steel - 11110 p.s.i. @ 100°F

CLASS 4500 WELDED BONNET - FULL PORT - ASME B16.34

Outside Screw & Yoke - Socket and Butt Weld Ends

FULL PORT	L4530	1/4		3/8		1/2		3/4		1		1.1/4		1.1/2		2	
		mm	in.	mm	in.	mm	in.	mm	in.	mm	in.	mm	in.	mm	in.	mm	in.
End to End	A	-	-	-	-	155	6.10	170	6.69	210	8.26	-	-	235	9.25	-	-
Handwheel	B	-	-	-	-	180	7.08	250	9.84	250	9.84	-	-	300	11.8	-	-
Center to Top Open	C	-	-	-	-	240	9.44	250	11.2	350	13.7	-	-	410	16.1	-	-
Dia. of Port	D	-	-	-	-	11	0.43	11	0.43	14	0.55	-	-	28	1.10	-	-
Approx. Weight	Kg / Lb	-	-	-	-	9	19.8	13	28.6	24.5	53.9	-	-	28	61.7	-	-

2" on request

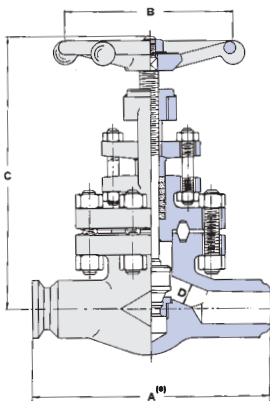

RATINGS: Carbon Steel - 11110 p.s.i. @ 100°F

CLASS 4500 ROUND BOLTED BONNET RJ - FULL PORT - ASME B16.34

Outside Screw & Yoke - Clamp and Butt Weld Ends

FULL PORT	RJ4530-BW	1/4		3/8		1/2		3/4		1		1.1/4		1.1/2		2	
		mm	in.	mm	in.	mm	in.	mm	in.	mm	in.	mm	in.	mm	in.	mm	in.
End to End	A	-	-	-	-	260	10.2	300	11.8	370	14.5	-	-	370	14.5	-	-
Handwheel	B	-	-	-	-	180	7.08	250	9.84	300	11.8	-	-	300	11.8	-	-
Center to Top Open	C	-	-	-	-	280	11.0	360	14.1	456	17.9	-	-	466	18.3	-	-
Dia. of Port	D	-	-	-	-	11	0.43	11	0.43	14	0.55	-	-	28	1.10	-	-
Approx. Weight	Kg / Lb	-	-	-	-	18	39.6	34	74.9	50	110.1	-	-	50	110.1	-	-

2" on request

(* End to end dimension according to ANSI B16.10.

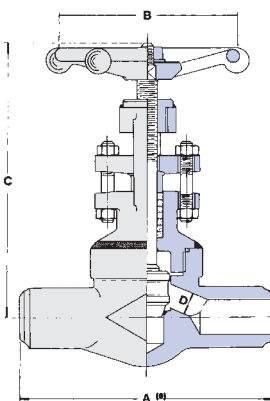

RATINGS: Carbon Steel - 11110 p.s.i. @ 100°F

CLASS 4500 WELDED BONNET - FULL PORT - ASME B16.34

Outside Screw & Yoke - Clamp and Butt Weld Ends

FULL PORT	L4530-BW	1/4		3/8		1/2		3/4		1		1.1/4		1.1/2		2	
		mm	in.	mm	in.	mm	in.	mm	in.	mm	in.	mm	in.	mm	in.	mm	in.
End to End	A	-	-	-	-	260	10.2	300	11.8	370	14.5	-	-	370	14.5	-	-
Handwheel	B	-	-	-	-	180	7.08	250	9.84	300	11.8	-	-	300	11.8	-	-
Center to Top Open	C	-	-	-	-	280	11.0	360	14.1	456	17.9	-	-	466	18.3	-	-
Dia. of Port	D	-	-	-	-	11	0.43	11	0.43	14	0.55	-	-	28	1.10	-	-
Approx. Weight	Kg / Lb	-	-	-	-	17	37.4	32	70.5	46	101.3	-	-	46	101.3	-	-

2" on request

(* End to end dimension according to ANSI B16.10.

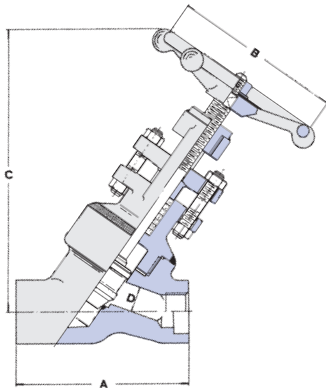

RATINGS: Carbon Steel - 1975 p.s.i. @ 100°F

CLASS 800

WELDED BONNET - FULL PORT BS 5352

Outside Screw & Yoke - Threaded and Socket Weld Ends

FULL PORT	Y630	1/4		3/8		1/2		3/4		1		1.1/4		1.1/2		2	
		mm	in.	mm	in.	mm	in.	mm	in.	mm	in.	mm	in.	mm	in.	mm	in.
End to End	A	110	4.33	100	4.33	110	4.33	110	4.33	142	5.59	142	5.59	170	6.69	180	7.08
Handwheel	B	80	3.14	80	3.14	80	3.14	110	4.33	130	5.11	130	5.11	180	7.08	180	7.08
Center to Top Open	C	155	6.10	155	6.10	155	6.10	175	6.88	220	8.66	240	9.44	280	11.02	350	13.78
Dia. of Port	D	7	0.27	9	0.35	13	0.51	17.5	0.68	23	0.88	29.5	1.16	35	1.37	45.5	1.79
Approx. Weight	Kg / Lb	1.5	3.3	1.5	3.3	1.5	3.3	2	4.4	4.2	9.2	5	11	9	19.8	13	28.6

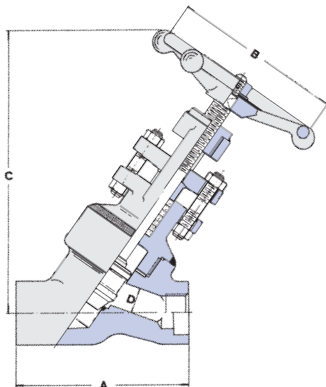

RATINGS: Carbon Steel
Class 1500 - 3705 p.s.i. @ 100°F
*Class 1700 - 4198 p.s.i. @ 100°F

CLASS 1500-1700

WELDED BONNET - FULL PORT BS 5352

Outside Screw & Yoke - Threaded and Socket Weld Ends

FULL PORT	Y930	1/4		3/8		1/2		3/4		1		1.1/4		1.1/2		2	
		mm	in.	mm	in.	mm	in.	mm	in.	mm	in.	mm	in.	mm	in.	mm	in.
End to End	A	110	4.33	110	4.33	110	4.33	142	5.59	142	5.59	170	6.69	170	6.69	180	7.08
Handwheel	B	110	4.33	110	4.33	110	4.33	130	5.11	130	5.11	180	7.08	180	7.08	180	7.08
Center to Top Open	C	180	7.08	180	7.08	170	7.08	240	9.44	250	9.84	280	11.02	380	14.96	420	16.53
Dia. of Port	D	7	0.27	9	0.35	11	0.43	15	0.59	19.5	0.76	27.5	1.08	31.5	1.24	39	1.53
Approx. Weight	Kg / Lb	2	4.4	2	4.4	2	4.4	4.2	9.2	5.2	11.4	9	20.9	10.5	23.1	13.5	29.8

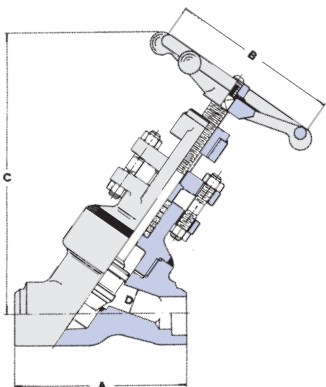

RATINGS: Carbon Steel
Class 2500 - 6170 p.s.i. @ 100°F
*Class 2700 - 6664 p.s.i. @ 100°F

CLASS 2500-2700

WELDED BONNET - FULL PORT - ASME B16.34

Outside Screw & Yoke - Socket and Butt Weld Ends

FULL PORT	Y2530	1/4		3/8		1/2		3/4		1		1.1/4		1.1/2		2	
		mm	in.	mm	in.	mm	in.	mm	in.	mm	in.	mm	in.	mm	in.	mm	in.
End to End	A	142	5.59	142	5.59	142	5.59	142	5.59	170	6.69	170	6.69	180	7.08	225	8.86
Handwheel	B	130	5.11	130	5.11	130	5.11	130	5.11	180	7.08	180	7.08	180	7.08	300	11.8
Center to Top Open	C	280	11.02	280	11.02	280	11.02	280	11.02	360	14.1	370	14.56	420	16.53	540	21.2
Dia. of Port	D	7	0.27	9	0.35	11	0.43	15	0.59	19.5	0.76	27.5	1.08	31.5	1.24	39	1.53
Approx. Weight	Kg / Lb	4.5	9.9	4.5	9.9	4.5	9.9	7.1	15.6	7.6	16.7	9.8	21.5	17.1	37.8	36	79.5

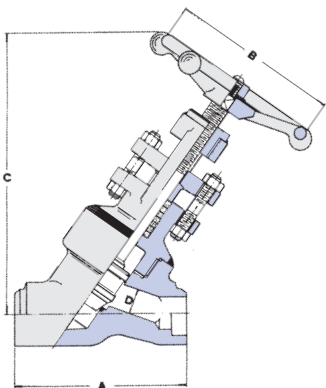

RATINGS: Carbon Steel - 11110 p.s.i. @ 100°F

CLASS 4500

WELDED BONNET - FULL PORT - ASME B16.34

Outside Screw & Yoke - Socket and Butt Weld Ends

FULL PORT	Y4530	1/4		3/8		1/2		3/4		1		1.1/4		1.1/2		2	
		mm	in.	mm	in.	mm	in.	mm	in.	mm	in.	mm	in.	mm	in.	mm	in.
End to End	A	170	6.69	170	6.69	170	6.69	170	6.69	170	6.69	-	-	225	8.86	225	8.86
Handwheel	B	180	7.08	180	7.08	180	7.08	180	7.08	180	7.08	-	-	400	15.75	400	15.75
Center to Top Open	C	350	13.77	350	13.77	350	13.77	350	13.77	380	14.96	-	-	453	17.83	453	17.83
Dia. of Port	D	7	0.27	9	0.35	11	0.43	11	0.43	15	0.59	-	-	26	1.02	28	1.10
Approx. Weight	Kg / Lb	9.6	21.1	9.6	21.1	9.6	21.1	9.4	20.7	10.5	23.1	-	-	34	75.0	36	79.5

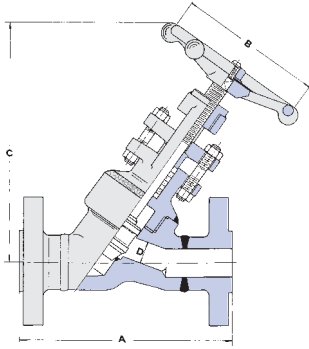

RATINGS: Carbon Steel
 Class 150 - 285 p.s.i. @ 100°F
 Class 300 - 740 p.s.i. @ 100°F
 Class 600 - 1480 p.s.i. @ 100°F

CLASS 150-300-600 WELDED BONNET - FULL PORT - ISO 15761 BS 5352

Outside Screw & Yoke - Flanged Ends according to ASME B16.5

FULL PORT		1/4		3/8		1/2		3/4		1		1.1/4		1.1/2		2			
		mm	in.	mm	in.	mm	in.	mm	in.	mm	in.	mm	in.	mm	in.	mm	in.		
Class 150 1-Y630	A	-	-	-	-	108	4.25	117	4.64	127	5.00	-	-	165	6.49	203	7.99		
Class 300 3-Y630	A	-	-	-	-	152	6.02	178	7.00	203	7.99	-	-	229	9.01	267	10.5		
Class 600 6-Y630	A	-	-	-	-	165	6.49	190	7.51	216	8.50	-	-	241	9.48	292	11.5		
Handwheel	B	-	-	-	-	80	3.14	80	3.14	130	5.11	-	-	180	7.08	180	7.08		
Center to Top Open	C	-	-	-	-	155	6.10	175	6.88	220	8.66	-	-	280	11.0	350	13.78		
Dia. of Port	D	-	-	-	-	13	0.51	17.5	0.68	22.5	0.88	-	-	35	1.37	45.5	1.79		
Approx. Weight	Class 150	Kg / Lb		-	-	-	-	3.2	7.04	4	8.8	7.2	15.8	-	-	14.9	32.8	19	41.8
	Class 300	Kg / Lb		-	-	-	-	4.2	9.25	5.7	12.5	10.7	23.5	-	-	16.4	36.1	21	46.2
	Class 600	Kg / Lb		-	-	-	-	4.7	10.3	6	13.2	11.7	25.7	-	-	17.4	38.3	23	50.6

End to End dimensions according to ASME B16.10

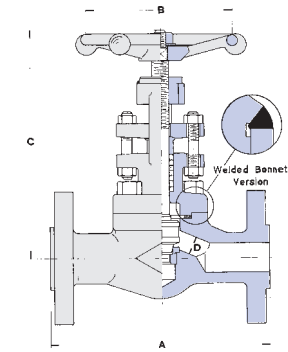

RATINGS: Carbon Steel
 Class 150 - 285 p.s.i. @ 100°F
 Class 300 - 740 p.s.i. @ 100°F
 Class 600 - 1480 p.s.i. @ 100°F

CLASS 150-300-600 BOLTED BONNET - STANDARD PORT TO API602/ISO 15761

Outside Screw & Yoke - Integral Flanged Ends according to ASME B16.5

STANDARD PORT		1/4		3/8		1/2		3/4		1		1.1/4		1.1/2		2			
		mm	in.	mm	in.	mm	in.	mm	in.	mm	in.	mm	in.	mm	in.	mm	in.		
Class 150 F1-830	A	-	-	-	-	108	4.25	117	4.64	127	5.00	-	-	165	6.49	203	7.99		
Class 300 F3-830	A	-	-	-	-	152	6.02	178	7.00	203	7.99	-	-	229	9.01	267	10.5		
Class 600 F6-830	A	-	-	-	-	165	6.49	190	7.51	216	8.50	-	-	241	9.48	292	11.5		
Handwheel	B	-	-	-	-	80	3.14	80	3.14	110	4.33	-	-	130	5.11	180	7.08		
Center to Top Open	Class 300-600	C		-	-	-	-	148	5.82	165	6.49	180	7.08	-	-	248	9.76	257	10.1
	Class 150	C		-	-	-	-	170	6.69	197	7.75	205	8.07	-	-	248	9.76	257	10.1
Dia. of Port	D	-	-	-	-	9	0.35	13	0.51	17.5	0.69	-	-	29.5	1.16	35	1.37		
Approx. Weight	Class 150	Kg / Lb		-	-	-	-	3.4	7.5	4	8.8	5.7	12.5	-	-	10	22.0	17.0	37.4
	Class 300	Kg / Lb		-	-	-	-	4	8.8	5	11.0	7.3	16.1	-	-	14	30.8	20.5	45.1
	Class 600	Kg / Lb		-	-	-	-	4.5	9.9	5.5	12.1	7.6	16.7	-	-	15	33.0	21	46.2

End to End dimensions according to ASME B16.10

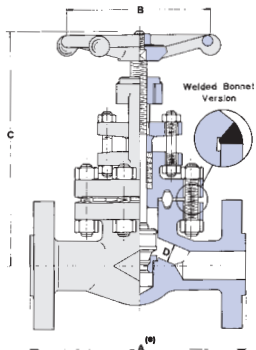

RATINGS: Carbon Steel
 Class 150 - 285 p.s.i. @ 100°F
 Class 300 - 740 p.s.i. @ 100°F
 Class 600 - 1480 p.s.i. @ 100°F

CLASS 150-300-600 BOLTED BONNET - FULL PORT - BS 5352

Outside Screw & Yoke - Integral Flanged Ends according to ASME B16.5

FULL PORT		1/4		3/8		1/2		3/4		1		1.1/4		1.1/2		2			
		mm	in.	mm	in.	mm	in.	mm	in.	mm	in.	mm	in.	mm	in.	mm	in.		
Class 150 F1-630	A	-	-	-	-	108	4.25	117	4.64	127	5.00	-	-	165	6.49	203	7.99		
Class 300 F3-RJ630	A	-	-	-	-	152	6.02	178	7.00	203	7.99	-	-	229	9.01	267	10.5		
Class 600 F6-RJ630	A	-	-	-	-	165	6.49	190	7.51	216	8.50	-	-	241	9.48	292	11.5		
Handwheel	B	-	-	-	-	110	4.33	110	4.33	130	5.11	-	-	250	9.84	250	9.84		
Center to Top Open	Class 300-600	C		-	-	-	-	245	9.64	273	10.7	295	11.6	-	-	410	16.1	440	17.3
	Class 150	C		-	-	-	-	170	6.69	200	7.87	250	9.84	-	-	285	11.2	320	12.6
Dia. of Port	D	-	-	-	-	13	0.51	17.5	0.69	22.5	0.89	-	-	35	1.37	45.5	1.79		
Approx. Weight	Class 150	Kg / Lb		-	-	-	-	4.2	9.2	5.5	12.1	7.5	16.5	-	-	13.5	29.7	21	46.2
	Class 300	Kg / Lb		-	-	-	-	5.8	12.8	10.8	23.8	12.8	28.2	-	-	26.5	58.4	29	63.9
	Class 600	Kg / Lb		-	-	-	-	6	13.2	10	22.0	14.5	32.0	-	-	27	59.4	30	66.0

End to End dimensions according to ASME B16.10

Ring-Joint gasket according to ANSI B16.10 - API 6A

Spiral wound gasket joint for #150

(*) End to end dimension BW on request Fig. N. BW 1-630 / BW 3-630 / BW 6-630

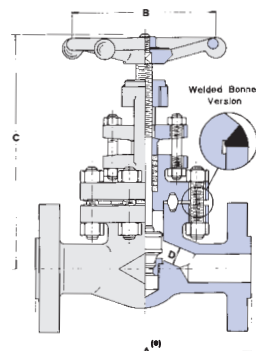

RATINGS: Carbon Steel
 Class 1500 - 3705 p.s.i. @ 100°F
 Class 2500 - 6170 p.s.i. @ 100°F

CLASS 1500-2500 ROUND BOLTED BONNET RJ - FULL PORT - BS 5352 - ASME B16.34

Outside Screw & Yoke - Integral Flanged Ends according to ANSI B16.5

FULL PORT		1/4		3/8		1/2		3/4		1		1.1/4		1.1/2		2			
		mm	in.	mm	in.	mm	in.	mm	in.	mm	in.	mm	in.	mm	in.	mm	in.		
Class 1500 F9-RJ930	A	-	-	-	-	216	8.50	229	9.01	254	10.0	-	-	305	12.0	368	14.5		
Class 2500 F25-RJ2530	A	-	-	-	-	264	10.4	273	10.7	308	12.1	-	-	384	15.1	451	17.7		
Handwheel	Class 1500	B		-	-	-	-	110	4.33	130	5.11	-	-	250	9.84	300	11.8		
	Class 2500	B		-	-	-	-	130	5.11	130	5.11	250	9.84	-	-	300	11.8	300	11.8
Center to Top Open	Class 1500	C		-	-	-	-	260	10.2	300	11.8	300	11.8	-	-	390	15.3	420	16.5
	Class 2500	C		-	-	-	-	332	13.0	332	13.0	370	14.5	-	-	435	17.1	570	22.4
Dia. of Port	Class 1500	D		-	-	-	-	13	0.51	17	0.67	21	0.83	-	-	33	1.30	37.5	1.48
	Class 2500	D		-	-	-	-	11	0.43	17	0.67	21	0.83	-	-	33	1.30	37.5	1.48
Approx. Weight	Class 1500	Kg / Lb		-	-	-	-	11	24.2	16	35.2	19.5	42.9	-	-	34	74.8	61	134.3
	Class 2500	Kg / Lb		-	-	-	-	19.5	42.9	21.5	47.3	42	92.5	-	-	65	143.2	95	209.2

End to End dimensions according to ASME B16.10

Ring-Joint gasket according to ASME B16.20 - API 6A

For class 1500 spiral wound gasket joint available on request

(*) End to end dimension BW on request Fig. N. BW 9-RJ930 / BW 25-RJ2530





Check valves are uni-directional valves which automatically open with forward flow and close against reverse flow. They are supplied to meet a wide variety of applications with the closing element in the piston, ball or swing type. Piston check valves are normally supplied by OMB with the addition of a spring which allows both the vertical and horizontal installation.

Great care is given by OMB employees in the design and in manufacturing to prevent noisy operation and unsatisfactory wear of closure components.

The full range of OMB production is reported on pages 32 to 37.

Figure # is identified in each table as:

STANDARD PORT	PISTON	840	-
	BALL	850	
	SWING	860	
FULL PORT	PISTON	640	1/A
	BALL	650	
	SWING	660	

CLASS	DESIGN	CONNECTION	PORT	STANDARD	SCREW & YOKE	ENDS	PAGE	OMB FIG.
800	Piston	Bolted bonnet	Regular	ISO15761	Outside	Threaded and Socket Weld Ends	33	840
800	Piston	Bolted bonnet	Full	ISO15761	Outside	Threaded and Socket Weld Ends	33	640
800	Ball	Bolted bonnet	Regular	ISO15761	Outside	Threaded and Socket Weld Ends	33	850
800	Ball	Bolted bonnet	Full	ISO15761	Outside	Threaded and Socket Weld Ends	33	650
800	Swing	Bolted bonnet	Regular	ISO15761	Outside	Threaded and Socket Weld Ends	33	860
800	Swing	Bolted bonnet	Full	ISO15761	Outside	Threaded and Socket Weld Ends	33	660
800	Piston	Welded Bonnet	Regular	ISO15761	Outside	Threaded and Socket Weld Ends	33	L840
800	Piston	Welded Bonnet	Full	ISO15761	Outside	Threaded and Socket Weld Ends	33	L640
800	Ball	Welded Bonnet	Regular	ISO15761	Outside	Threaded and Socket Weld Ends	33	L850
800	Ball	Welded Bonnet	Full	ISO15761	Outside	Threaded and Socket Weld Ends	33	L650
1500	Piston	Bolted bonnet	Regular	ISO15761	Outside	Threaded and Socket Weld Ends	33	R940
1500	Piston	Bolted bonnet	Full	ISO15761	Outside	Threaded and Socket Weld Ends	33	940
1500	Ball	Bolted bonnet	Regular	ISO15761	Outside	Threaded and Socket Weld Ends	33	R950
1500	Ball	Bolted bonnet	Full	ISO15761	Outside	Threaded and Socket Weld Ends	33	950
1500	Swing	Bolted bonnet	Regular	ISO15761	Outside	Threaded and Socket Weld Ends	33	R960
1500	Piston	Welded Bonnet	Regular	ISO15761	Outside	Threaded and Socket Weld Ends	33	LR940
1500	Piston	Welded Bonnet	Full	ISO15761	Outside	Threaded and Socket Weld Ends	33	LR940
1500	Ball	Welded Bonnet	Regular	ISO15761	Outside	Threaded and Socket Weld Ends	33	LR950
1500	Ball	Welded Bonnet	Full	ISO15761	Outside	Threaded and Socket Weld Ends	33	LR950
1500	Swing	Bolted bonnet	Full	ISO15761	Outside	Threaded and Socket Weld Ends	33	960
1500	Piston	Ring Joint BB	Full	ANSI B16.34	Outside	Threaded and Socket Weld Ends	34	RJ940
1500	Ball	Ring Joint BB	Full	ANSI B16.34	Outside	Threaded and Socket Weld Ends	34	RJ950
1500	Swing	Ring Joint BB	Full	ANSI B16.34	Outside	Threaded and Socket Weld Ends	34	RJ960
2500	Piston	Ring Joint BB	Full	ANSI B16.34	Outside	Threaded and Socket Weld Ends	34	RJ2540
2500	Ball	Ring Joint BB	Full	ANSI B16.34	Outside	Threaded and Socket Weld Ends	34	RJ2550
2500	Piston	Welded Bonnet	Full	ANSI B16.34	Outside	Threaded and Socket Weld Ends	34	L2540
2500	Ball	Welded Bonnet	Full	ANSI B16.34	Outside	Threaded and Socket Weld Ends	34	L2550
4500	Piston	Ring Joint BB	Full	ANSI B16.34	Outside	Threaded and Socket Weld Ends	34	RJ4540
4500	Ball	Ring Joint BB	Full	ANSI B16.34	Outside	Threaded and Socket Weld Ends	34	RJ4550
800	Piston Y Pattern	Welded Bonnet	Full	ISO15761	Outside	Threaded and Socket Weld Ends	35	Y640
1500	Piston Y Pattern	Welded Bonnet	Full	ANSI B16.34	Outside	Threaded and Socket Weld Ends	35	Y940
2500	Piston Y Pattern	Welded Bonnet	Full	ANSI B16.34	Outside	Threaded and Socket Weld Ends	35	Y2540
4500	Piston	Welded Bonnet	Full	ANSI B16.34	Outside	Threaded and Socket Weld Ends	35	Y4540
150	Piston	Bolted bonnet	Regular	ISO15761	Outside	Flanged	36	F1-840
150	Ball	Bolted bonnet	Regular	ISO15761	Outside	Flanged	36	F1-850
300	Piston	Bolted bonnet	Regular	ISO15761	Outside	Flanged	36	F3-840
300	Ball	Bolted bonnet	Regular	ISO15761	Outside	Flanged	36	F3-850
600	Piston	Bolted bonnet	Regular	ISO15761	Outside	Flanged	36	F6-840
150	Swing	Bolted bonnet	Regular	ISO15761	Outside	Flanged	36	F1-860
300	Swing	Bolted bonnet	Regular	ISO15761	Outside	Flanged	36	F3-860
600	Swing	Bolted bonnet	Regular	ISO15761	Outside	Flanged	36	F6-860
600	Ball	Bolted bonnet	Regular	ISO15761	Outside	Flanged	36	F6-850
150	Piston	Bolted bonnet	Full	ISO15761	Outside	Flanged	36	F1-640
150	Ball	Bolted bonnet	Full	ISO15761	Outside	Flanged	36	F1-650
300	Piston	Bolted bonnet	Full	ISO15761	Outside	Flanged	36	F3-640
300	Ball	Bolted bonnet	Full	ISO15761	Outside	Flanged	36	F3-650
600	Piston	Bolted bonnet	Full	ISO15761	Outside	Flanged	36	F6-640
600	Ball	Bolted bonnet	Full	ISO15761	Outside	Flanged	36	F6-650
150	Swing	Bolted bonnet	Full	ISO15761	Outside	Flanged	36	F1-660
300	Swing	Ring Joint BB	Full	ISO15761	Outside	Flanged	36	F3-RJ-660
600	Swing	Ring Joint BB	Full	ISO15761	Outside	Flanged	36	F6-RJ-660
1500	Piston	Ring Joint BB	Full	ISO15761	Outside	Flanged	37	F9-RJ-940
1500	Ball	Ring Joint BB	Full	ISO15761	Outside	Flanged	37	F9-RJ-950
1500	Swing	Ring Joint BB	Full	ISO15761	Outside	Flanged	37	F9-RJ-960
2500	Piston	Ring Joint BB	Full	ANSI B16.34	Outside	Flanged	37	F25-RJ-2540
2500	Ball	Ring Joint BB	Full	ANSI B16.34	Outside	Flanged	37	F25-RJ-2550
2500	Swing	Ring Joint BB	Full	ANSI B16.34	Outside	Flanged	37	F25-RJ-2560
1500	Piston Y Pattern	Welded Bonnet	Full	ISO15761	Outside	Flanged	37	9-Y940
2500	Piston Y Pattern	Welded Bonnet	Full	ANSI B16.34	Outside	Flanged	37	25-Y2540

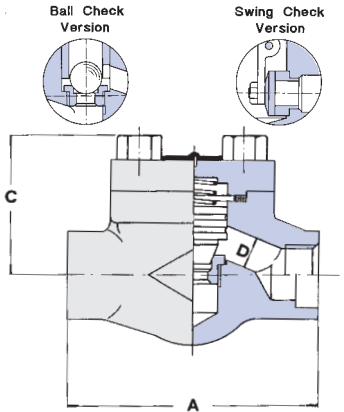

RATINGS: Carbon Steel - 1975 p.s.i. @ 100°F

CLASS 800

PISTON, BALL AND SWING TYPE - STANDART PORT TO API602/ISO 15761 - FULL PORT TO BS 5352
Bolted Cover - Threaded and Socket Weld Ends

STANDARD PORT		PISTON 840	-		1/2		3/4		1		1.1/4		1.1/2		2		-	
FULL PORT		PISTON BALL 640	1/4		3/8		1/2		3/4		1		1.1/4		1.1/2		2	
		SWING 860																
End to End	PISTON - BALL	A	mm	in.	mm	in.	mm	in.	mm	in.	mm	in.	mm	in.	mm	in.	mm	in.
	SWING	A	80	3.14	80	3.14	90	3.54	110	4.33	127	5.00	155	6.10	170	6.69	210	8.26
Center to Top		C	53	2.08	53	2.08	60	2.36	73	2.87	80	3.14	98	3.85	118	4.64	150	5.90
Dia. of Port	PISTON - BALL	D	7	0.28	9	0.35	13	0.51	17.5	0.69	23	0.88	29.5	1.16	35	1.38	45.5	1.79
	SWING	D	8	0.31	9.6	0.38	14	0.55	18	0.70	24	0.94	30	1.18	37	1.45	48	1.89
Approx. Weight	PISTON - BALL	Kg / Lb	1.3	2.8	1.3	2.8	1.4	3.0	2.4	5.2	4.0	8.8	7.4	16.2	8	17.6	18	39.6
	SWING	Kg / Lb	1.3	2.8	1.3	2.8	1.4	3.0	2.4	5.2	4.0	8.8	5.5	12.1	6.5	14.3	17.5	38.5

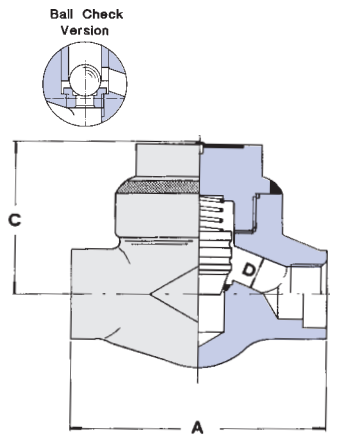

RATINGS: Carbon Steel - 1975 p.s.i. @ 100°F

CLASS 800

PISTON AND BALL TYPE - STANDART PORT TO API602/ISO 15761 - FULL PORT TO BS 5352
Welded Cover - Threaded and Socket Weld Ends

STANDARD PORT		PISTON L840	-		1/2		3/4		1		1.1/4		1.1/2		2		-	
FULL PORT		BALL L850	1/4		3/8		1/2		3/4		1		1.1/4		1.1/2		2	
		PISTON L640																
End to End		A	mm	in.	mm	in.	mm	in.	mm	in.	mm	in.	mm	in.	mm	in.	mm	in.
		A	80	3.14	80	3.14	90	3.54	110	4.33	127	5.00	155	6.10	170	6.69	210	8.26
Center to Top		C	53	2.08	53	2.08	60	2.36	73	2.87	80	3.14	98	3.85	110	4.33	150	5.90
Dia. of Port		D	7	0.28	9	0.35	13	0.51	17.5	0.69	23	0.88	29.5	1.16	35	1.37	45.5	1.79
Approx. Weight		Kg / Lb	1.3	2.8	1.3	2.8	1.4	3.0	2.4	5.2	4.0	8.8	7.4	16.3	8	17.6	17	37.4

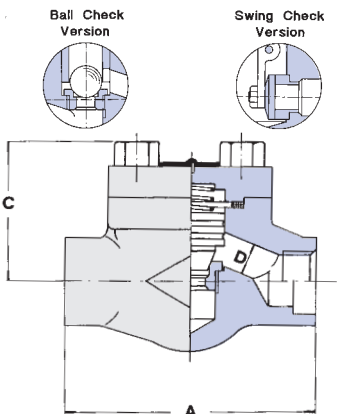

RATINGS: Carbon Steel - 3705 p.s.i. @ 100°F

CLASS 1500

PISTON, BALL AND SWING TYPE - STANDART PORT TO API602/ISO 15761 - FULL PORT TO BS 5352
Bolted Cover - Threaded and Socket Weld Ends

STANDARD PORT		PISTON R940	-		1/2		3/4		1		1.1/4		1.1/2		2		-	
FULL PORT		BALL R950	1/4		3/8		1/2		3/4		1		1.1/4		1.1/2		2	
		SWING R960																
End to End	PISTON - BALL	A	mm	in.	mm	in.	mm	in.	mm	in.	mm	in.	mm	in.	mm	in.	mm	in.
	SWING	A	90	3.54	90	3.54	110	4.33	127	5.00	155	6.10	170	6.69	210	8.26	210	8.26
Center to Top		C	60	2.36	60	2.36	73	2.87	80	3.14	98	3.85	118	4.64	150	5.90	150	5.90
Dia. of Port	PISTON - BALL	D	7	0.28	9	0.35	13	0.51	17.5	0.69	21	0.83	28	1.10	33	1.30	37.5	1.48
	SWING	D	8	0.31	9.6	0.38	14	0.55	18	0.70	24	0.94	30	1.18	37	1.45	40	1.57
Approx. Weight	PISTON - BALL	Kg / Lb	1.5	3.3	1.5	3.3	2.8	6.1	4.6	10.1	7.4	16.2	9	19.8	19.5	49.9	19	41.8
	SWING	Kg / Lb	1.6	3.5	1.5	3.3	2.4	5.2	4	8.8	6	13.2	9.5	20.9	19	41.8	18.5	40.7

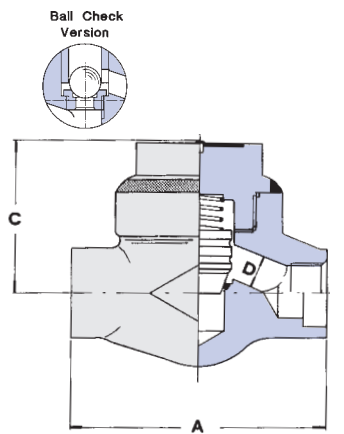

RATINGS: Carbon Steel - 3705 p.s.i. @ 100°F

CLASS 1500

PISTON AND BALL TYPE - STANDART PORT TO API602/ISO 15761 - FULL PORT TO BS 5352
Welded Cover - Threaded and Socket Weld Ends

STANDARD PORT		PISTON LR940	-		1/2		3/4		1		1.1/4		1.1/2		2		-	
FULL PORT		BALL LR950	1/4		3/8		1/2		3/4		1		1.1/4		1.1/2		2	
		PISTON L940																
End to End		A	mm	in.	mm	in.	mm	in.	mm	in.	mm	in.	mm	in.	mm	in.	mm	in.
		A	90	3.54	90	3.54	110	4.33	127	5.00	155	6.10	170	6.69	210	8.26	210	8.26
Center to Top		C	60	2.36	60	2.36	73	2.87	80	3.14	98	3.85	110	4.33	150	5.90	150	5.90
Dia. of Port		D	7	0.28	9	0.35	13	0.51	17	0.67	21	0.83	28	1.10	33	1.30	37.5	1.47
Approx. Weight		Kg / Lb	1.5	3.3	1.5	3.3	2.8	6.1	4.6	10.1	7.4	16.3	9	19.8	15	33.0	14.5	31.9



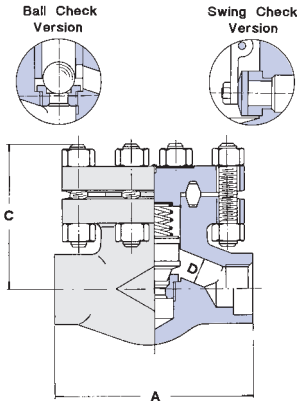

RATINGS: Carbon Steel - 3705 p.s.i. @ 100°F

CLASS 1500 PISTON, BALL AND SWING TYPE - FULL PORT BS 5352

Round Bolted Cover - Threaded and Socket Weld Ends

FULL PORT	PISTON BALL SWING RJ940 RJ950 RJ960	1/4		3/8		1/2		3/4		1		1.1/4		1.1/2		2	
		mm	in.	mm	in.	mm	in.	mm	in.	mm	in.	mm	in.	mm	in.	mm	in.
End to End	A	-	-	-	-	110	4.33	150	5.90	150	5.90	-	-	210	8.26	235	9.25
Center to Top	C	-	-	-	-	100	3.93	130	5.11	145	5.70	-	-	160	6.29	195	7.67
Dia. of Port	PISTON - BALL	D	-	-	-	13	0.51	17	0.67	21	0.83	-	-	33	1.30	37.5	1.48
	SWING	D	-	-	-	14	0.55	18	0.70	24	0.94	-	-	37	1.45	48	1.89
Approx. Weight	PISTON - BALL	Kg / Lb	-	-	-	4	8.8	7.5	16.5	9	19.8	-	-	18.5	40.7	30	66
	SWING	Kg / Lb	-	-	-	3.8	8.37	7	15.4	8.5	18.7	-	-	17.5	38.5	29	63.8

Spiral wound gasket joint available on request

Ring-Joint gasket according to ASME B16.20 - API 6A

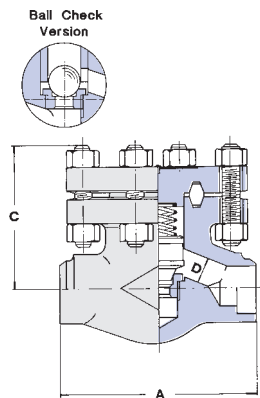

RATINGS: Carbon Steel - 6170 p.s.i. @ 100°F

CLASS 2500 PISTON AND BALL TYPE - FULL PORT - ASME B16.34

Round Bolted Cover - Socket and Butt Weld Ends

FULL PORT	PISTON BALL RJ2540 RJ2550	1/4		3/8		1/2		3/4		1		1.1/4		1.1/2		2	
		mm	in.	mm	in.	mm	in.	mm	in.	mm	in.	mm	in.	mm	in.	mm	in.
End to End	A	-	-	-	-	150	5.90	150	5.90	210	8.26	-	-	235	9.25	235	9.25
Center to Top	C	-	-	-	-	130	5.11	130	5.11	160	6.29	-	-	195	7.67	195	7.67
Dia. of Port	D	-	-	-	-	13	0.51	17	0.67	21	0.83	-	-	33	1.30	35	1.37
Approx. Weight	Kg / Lb	-	-	-	-	7	15.4	6.8	14.9	17.5	38.5	-	-	29	63.8	29	63.8

Ring-Joint gasket according to ASME B16.20 - API 6A

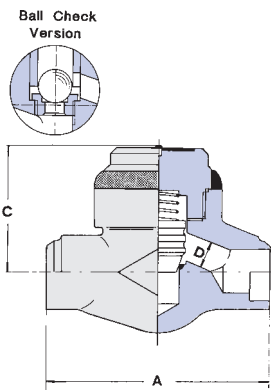

RATINGS: Carbon Steel - 6170 p.s.i. @ 100°F

CLASS 2500 PISTON AND BALL TYPE - FULL PORT - ASME B16.34

Welded Cover - Socket and Butt Weld Ends

FULL PORT	PISTON BALL L2540 L2550	1/4		3/8		1/2		3/4		1		1.1/4		1.1/2		2	
		mm	in.	mm	in.	mm	in.	mm	in.	mm	in.	mm	in.	mm	in.	mm	in.
End to End	A	-	-	-	-	127	5.00	155	6.10	170	6.69	-	-	235	9.25	235	9.25
Center to Top	C	-	-	-	-	80	3.14	98	3.85	110	4.33	-	-	170	6.69	170	6.69
Dia. of Port	D	-	-	-	-	13	0.51	17	0.67	21	0.83	-	-	33	1.30	35	1.37
Approx. Weight	Kg / Lb	-	-	-	-	5	11.0	8	17.6	10	22.0	-	-	21.5	47.3	21.3	46.9

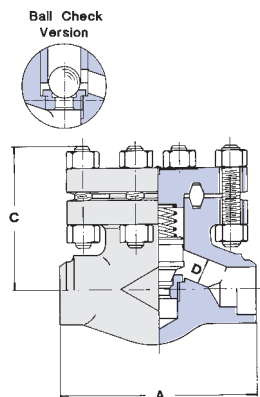

RATINGS: Carbon Steel - 11110 p.s.i. @ 100°F

CLASS 4500 PISTON AND BALL TYPE - FULL PORT - ASME B16.34

Round Bolted Cover - Socket and Butt Weld Ends

FULL PORT	PISTON BALL RJ4540 RJ4550	1/4		3/8		1/2		3/4		1		1.1/4		1.1/2		2	
		mm	in.	mm	in.	mm	in.	mm	in.	mm	in.	mm	in.	mm	in.	mm	in.
End to End	A	-	-	-	-	210	8.26	210	8.26	235	9.25	-	-	235	9.25	-	-
Center to Top	C	-	-	-	-	160	6.29	160	6.29	195	7.67	-	-	195	7.67	-	-
Dia. of Port	D	-	-	-	-	9	0.35	11	0.43	14	0.55	-	-	28	1.10	-	-
Approx. Weight	Kg / Lb	-	-	-	-	18	39.6	18	39.6	29.5	65.0	-	-	29.5	65.0	-	-

Ring-Joint gasket according to ASME B16.20 - API 6A



CLASS 800

PISTON TYPE - FULL PORT BS 5352

Welded Cover - Threaded and Socket Weld Ends

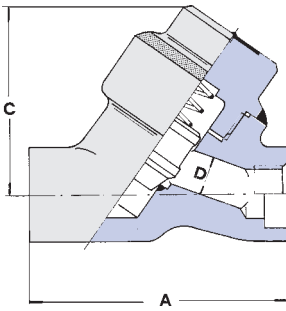

FULL PORT	Y640	1/4		3/8		1/2		3/4		1		1.1/4		1.1/2		2	
		mm	in.	mm	in.	mm	in.	mm	in.	mm	in.	mm	in.	mm	in.	mm	in.
End to End	A	110	4.33	110	4.33	110	4.33	110	4.33	142	5.59	142	5.59	170	6.69	180	7.08
Center to Top	C	65	2.55	65	2.55	65	2.55	65	2.55	80	3.14	95	3.74	115	4.52	135	5.31
Dia. of Port	D	7	0.27	9	0.35	13	0.51	17.5	0.68	22.5	0.88	29.5	1.16	35	1.37	45.5	1.79
Approx. Weight	Kg / Lb	1.2	2.6	1.2	2.6	1.2	2.6	1.2	3.9	3	6.6	3.3	7.2	5.8	12.7	7	15.4

RATINGS: Carbon Steel - 1975 p.s.i. @ 100°F

CLASS 1500-1700

WELDED BONNET - FULL PORT BS 5352

Welded Cover - Threaded and Socket Weld Ends

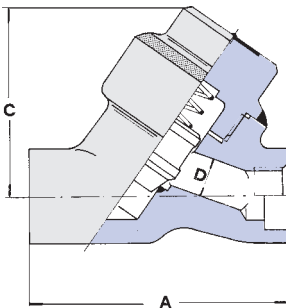

FULL PORT	Y940 Y940*	1/4		3/8		1/2		3/4		1		1.1/4		1.1/2		2	
		mm	in.	mm	in.	mm	in.	mm	in.	mm	in.	mm	in.	mm	in.	mm	in.
End to End	A	110	4.33	110	4.33	110	4.33	142	5.59	142	5.59	170	6.69	170	6.69	180	7.08
Center to Top	C	70	2.75	70	2.75	70	2.75	100	3.93	100	3.93	120	4.72	120	4.72	140	5.51
Dia. of Port	D	7	0.27	9	0.35	11	0.43	15	0.59	19.5	0.76	27.5	1.08	31.5	1.24	39	1.53
Approx. Weight	Kg / Lb	1.5	3.3	1.5	3.3	1.5	3.3	3.2	7.0	3.2	7.0	6	13.2	6.2	13.6	9.5	20.9

RATINGS: Carbon Steel
Class 1500 - 3705 p.s.i. @ 100°F
*Class 1700 - 4198 p.s.i. @ 100°F

CLASS 2500-2700

WELDED BONNET - FULL PORT - ASME B16.34

Welded Cover - Socket and Butt Weld Ends

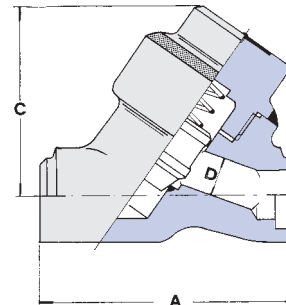

FULL PORT	Y2540 Y2540*	1/4		3/8		1/2		3/4		1		1.1/4		1.1/2		2	
		mm	in.	mm	in.	mm	in.	mm	in.	mm	in.	mm	in.	mm	in.	mm	in.
End to End	A	142	5.59	142	5.59	142	5.59	170	6.69	170	6.69	180	7.08	180	7.08	225	8.86
Center to Top	C	115	4.52	115	4.52	115	4.52	120	4.72	150	5.90	150	5.90	160	6.30	170	6.70
Dia. of Port	D	7	0.27	9	0.35	11	0.43	15	0.59	19.5	0.76	27.5	1.08	31.5	1.24	39	1.53
Approx. Weight	Kg / Lb	3.2	7.0	3.2	7.0	3.5	7.7	3.5	7.7	6.2	13.7	5.6	12.3	10.4	22.9	14	30.8

RATINGS: Carbon Steel
Class 2500 - 6170 p.s.i. @ 100°F
*Class 2700 - 6664 p.s.i. @ 100°F

CLASS 4500

PISTON TYPE - FULL PORT - ASME B16.34

Welded Cover - Socket and Butt Weld Ends

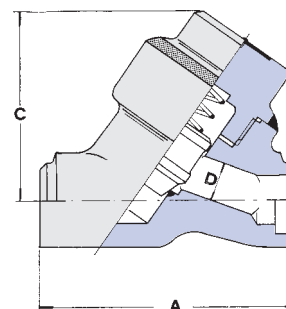

FULL PORT	Y4540	1/4		3/8		1/2		3/4		1		1.1/4		1.1/2		2	
		mm	in.	mm	in.	mm	in.	mm	in.	mm	in.	mm	in.	mm	in.	mm	in.
End to End	A	170	6.69	170	6.69	170	6.69	170	6.69	170	6.69	-	-	225	8.86	225	8.86
Center to Top	C	120	4.72	120	4.72	120	4.72	120	4.72	145	5.70	-	-	160	6.30	160	6.30
Dia. of Port	D	7	0.27	9	0.35	11	0.43	11	0.43	15	0.59	-	-	26	1.02	28	1.10
Approx. Weight	Kg / Lb	8.7	19.1	8.7	19.1	8.7	19.1	8.0	17.6	7.6	16.7	-	-	16.5	36.3	16	35.2

RATINGS: Carbon Steel - 11110 p.s.i. @ 100°F

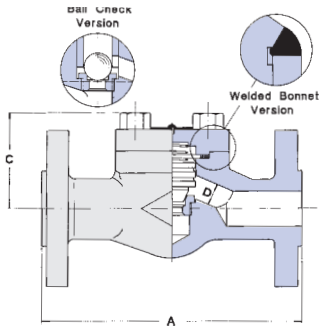

RATINGS: Carbon Steel
 Class 150 - 285 p.s.i. @ 100°F
 Class 300 - 740 p.s.i. @ 100°F
 Class 600 - 1480 p.s.i. @ 100°F

CLASS 150-300-600

PISTON AND BALL TYPE - STANDART PORT TO API602/ISO 15761
 Bolted Cover - Integral Flanged Ends according to ASME B16.5

STANDARD PORT		1/4		3/8		1/2		3/4		1		1.1/4		1.1/2		2	
		mm	in.	mm	in.	mm	in.	mm	in.	mm	in.	mm	in.	mm	in.	mm	in.
Class 150	PISTON BALL F1-840 F1-850	A	-	-	-	108	4.25	117	4.64	127	5.00	-	-	165	6.49	203	7.99
Class 300	PISTON BALL F3-840 F3-850	A	-	-	-	152	6.02	178	7.00	203	7.99	-	-	229	9.01	267	10.5
Class 600	PISTON BALL F6-840 F6-850	A	-	-	-	165	6.49	190	7.51	216	8.50	-	-	241	9.48	292	11.5
Center to Top Open	Class 150	C	-	-	-	75	2.95	92	3.62	98	3.85	-	-	98	3.85	110	4.33
	Class 300-600	C	-	-	-	53	2.08	60	2.36	73	2.87	-	-	98	3.85	110	4.33
Dia. of Port		D	-	-	-	9	0.35	13	0.51	17.5	0.69	-	-	29.5	1.16	35	1.37
Approx. Weight	Class 150	Kg/Lb	-	-	-	2.9	6.4	3.2	7.0	4.3	9.5	-	-	6.5	14.3	14.5	31.9
	Class 300	Kg/Lb	-	-	-	3.6	7.9	4.2	9.2	6	13.2	-	-	12	26.4	16	35.2
	Class 600	Kg/Lb	-	-	-	4.1	9.0	4.7	10.4	6.3	13.8	-	-	13	28.6	17	37.4

End to End dimensions according to ASME B16.10

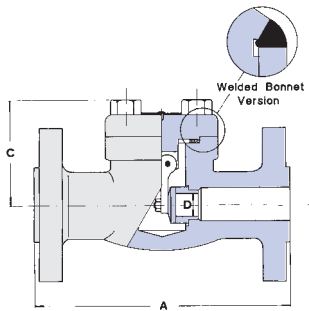

RATINGS: Carbon Steel
 Class 150 - 285 p.s.i. @ 100°F
 Class 300 - 740 p.s.i. @ 100°F
 Class 600 - 1480 p.s.i. @ 100°F

CLASS 150-300-600

SWING TYPE - STANDART PORT TO API602/ISO 15761
 Round Bolted Cover - Integral Flanged Ends according to ASME B16.5

STANDARD PORT		1/4		3/8		1/2		3/4		1		1.1/4		1.1/2		2	
		mm	in.	mm	in.	mm	in.	mm	in.	mm	in.	mm	in.	mm	in.	mm	in.
Class 150	F1-860	A	-	-	-	108	4.25	117	4.64	127	5.00	-	-	165	6.49	203	7.99
Class 300	F3-860	A	-	-	-	152	6.02	178	7.00	216	8.50	-	-	241	9.48	267	10.5
Class 600	F6-860	A	-	-	-	165	6.49	190	7.51	216	8.50	-	-	241	9.48	292	11.5
Center to Top Open	Class 150	C	-	-	-	75	2.95	92	3.62	98	3.85	-	-	98	3.85	110	4.33
	Class 300-600	C	-	-	-	53	2.08	60	2.36	73	2.87	-	-	98	3.85	110	4.33
Dia. of Port		D	-	-	-	9.6	0.38	14	0.55	18	0.70	-	-	30	1.18	37	1.45
Approx. Weight	Class 150	Kg/Lb	-	-	-	2.9	6.4	3.2	7.0	4.3	9.5	-	-	6.5	14.3	14.5	31.9
	Class 300	Kg/Lb	-	-	-	3.6	7.9	4.2	9.2	6.1	13.4	-	-	13	28.6	16	35.2
	Class 600	Kg/Lb	-	-	-	4.1	9.0	4.7	10.4	6.3	13.8	-	-	13	28.6	17	37.4

End to End dimensions according to ASME B16.10

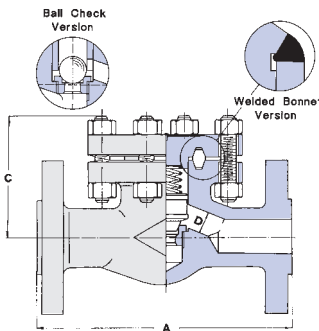

RATINGS: Carbon Steel
 Class 150 - 285 p.s.i. @ 100°F
 Class 300 - 740 p.s.i. @ 100°F
 Class 600 - 1480 p.s.i. @ 100°F

CLASS 150-300-600

PISTON AND BALL TYPE - FULL PORT BS 5352
 Bolted Cover - Integral Flanged Ends according to ASME B16.5

FULL PORT		1/4		3/8		1/2		3/4		1		1.1/4		1.1/2		2	
		mm	in.	mm	in.	mm	in.	mm	in.	mm	in.	mm	in.	mm	in.	mm	in.
Class 150	PISTON BALL F1-640 F1-650	A	-	-	-	108	4.25	117	4.64	127	5.00	-	-	165	6.49	203	7.99
Class 300	PISTON BALL F3-RJ640 F3-RJ650	A	-	-	-	152	6.02	178	7.00	203	7.99	-	-	229	9.01	267	10.5
Class 600	PISTON BALL F6-RJ640 F6-RJ650	A	-	-	-	165	6.49	190	7.51	216	8.50	-	-	241	9.48	292	11.5
Center to Top Open	Class 150	C	-	-	-	75	2.95	100	3.93	110	4.33	-	-	120	4.72	147	5.78
	Class 300-600	C	-	-	-	115	4.52	130	5.11	140	5.51	-	-	170	6.69	195	7.67
Dia. of Port		D	-	-	-	13	0.51	17.5	0.69	22.5	0.89	-	-	35	1.37	45.5	1.79
Approx. Weight	Class 150	Kg/Lb	-	-	-	3.2	7.0	3.5	7.7	4.6	10.1	-	-	7.0	15.4	16	35.2
	Class 300	Kg/Lb	-	-	-	4.6	10.1	6.1	13.4	9.1	20.0	-	-	16	35.2	21	46.2
	Class 600	Kg/Lb	-	-	-	4.8	10.5	6.3	13.8	9.3	20.5	-	-	16.5	36.3	22	48.4

End to End dimensions according to ASME B16.10
 Spiral wound gasket joint and for #150

Ring-Joint gasket according to ASME B16.20 - API 6A

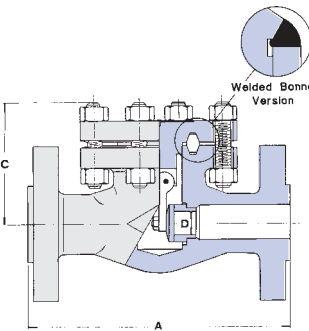

RATINGS: Carbon Steel
 Class 150 - 285 p.s.i. @ 100°F
 Class 300 - 740 p.s.i. @ 100°F
 Class 600 - 1480 p.s.i. @ 100°F

CLASS 150-300-600

SWING TYPE - FULL PORT BS 5352
 Bolted Cover - Integral Flanged Ends according to ASME B16.5

FULL PORT		1/4		3/8		1/2		3/4		1		1.1/4		1.1/2		2	
		mm	in.	mm	in.	mm	in.	mm	in.	mm	in.	mm	in.	mm	in.	mm	in.
Class 150	F1-660	A	-	-	-	108	4.25	117	4.64	127	5.00	-	-	165	6.49	203	7.99
Class 300	F3-RJ660	A	-	-	-	152	6.02	178	7.00	216	8.50	-	-	241	9.48	267	10.5
Class 600	F6-RJ660	A	-	-	-	165	6.49	190	7.51	216	8.50	-	-	241	9.48	292	11.5
Center to Top Open	Class 150	C	-	-	-	75	2.95	100	3.93	110	4.33	-	-	120	4.72	147	5.78
	Class 300-600	C	-	-	-	115	4.52	130	5.11	140	5.51	-	-	170	6.69	195	7.67
Dia. of Port		D	-	-	-	14	0.55	18	0.70	24	0.94	-	-	37	1.45	48	1.89
Approx. Weight	Class 150	Kg/Lb	-	-	-	3.1	6.8	3.4	7.5	4.5	9.9	-	-	6.8	14.9	15.7	34.5
	Class 300	Kg/Lb	-	-	-	4.6	10.1	6.1	13.4	9.3	20.5	-	-	16.5	36.3	21	46.2
	Class 600	Kg/Lb	-	-	-	4.8	10.5	6.3	13.8	9.3	20.5	-	-	16.5	36.3	22	48.4

End to End dimensions according to ASME B16.10
 Spiral wound gasket joint for #150

Ring-Joint gasket according to ASME B16.20 - API 6A



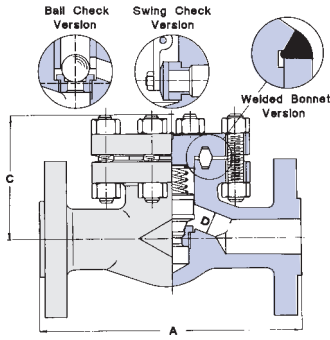

RATINGS: Carbon Steel - 3075 p.s.i. @ 100°F

CLASS 1500 PISTON, BALL AND SWING TYPE - FULL PORT BS 5352

Round Bolted Cover - Integral Flanged Ends according to ASME B16.5

FULL PORT	PISTON BALL SWING	1/4		3/8		1/2		3/4		1		1.1/4		1.1/2		2	
		mm	in.	mm	in.	mm	in.	mm	in.	mm	in.	mm	in.	mm	in.	mm	in.
End to End	A	-	-	-	-	216	8.50	229	9.01	254	10.0	-	-	305	12.0	368	14.5
Center to Top	C	-	-	-	-	130	5.11	140	5.51	155	6.10	-	-	170	6.69	195	7.67
Dia. of Port	PISTON - BALL	D	-	-	-	13	0.51	17	0.67	21	0.83	-	-	33	1.30	37.5	1.48
	SWING	D	-	-	-	14	0.55	18	0.70	24	0.94	-	-	37	1.45	48	1.89
Approx. Weight	PISTON - BALL	Kg / Lb	-	-	-	8	17.6	14	30.8	17	37.5	-	-	28	61.6	37	81.4
	SWING	Kg / Lb	-	-	-	7.8	17.1	13.8	30.4	16.5	36.3	-	-	27	59.5	35	77.1

End to End dimensions according to ASME B16.10
Spiral wound gasket joint available on request

Ring-Joint gasket according to ASME B16.20 - API 6A

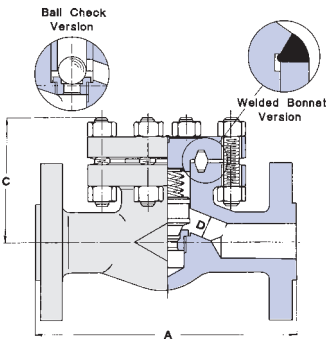

RATINGS: Carbon Steel - 6170 p.s.i. @ 100°F

CLASS 2500 PISTON AND BALL TYPE - FULL PORT - ASME B16.34

Round Bolted Cover - Integral Flanged Ends according to ASME B16.5

FULL PORT	PISTON BALL	1/4		3/8		1/2		3/4		1		1.1/4		1.1/2		2	
		mm	in.	mm	in.	mm	in.	mm	in.	mm	in.	mm	in.	mm	in.	mm	in.
End to End	A	-	-	-	-	264	10.4	273	10.7	308	12.1	-	-	384	15.1	451	17.7
Center to Top	C	-	-	-	-	155	6.10	155	6.10	170	6.69	-	-	245	9.64	260	10.23
Dia. of Port	D	-	-	-	-	11	0.43	17	0.67	21	0.83	-	-	33	1.30	37.5	1.48
Approx. Weight	Kg / Lb	-	-	-	-	17	37.5	21	46.2	28	61.6	-	-	58	127.7	85	187.2

End to End dimensions according to ASME B16.10

Ring-Joint gasket according to ASME B16.20 - API 6A

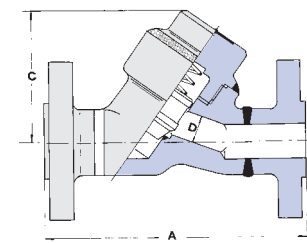

RATINGS: Carbon Steel - 3705 p.s.i. @ 100°F

CLASS 1500 PISTON TYPE - STANDART PORT TO API602/ISO 15761

Welded Cover - Flanged Ends according to ASME B16.5

FULL PORT	9-Y940	1/4		3/8		1/2		3/4		1		1.1/4		1.1/2		2	
		mm	in.	mm	in.	mm	in.	mm	in.	mm	in.	mm	in.	mm	in.	mm	in.
End to End	A	-	-	-	-	216	8.50	229	9.01	254	10.0	-	-	305	12.0	368	14.5
Center to Top	C	-	-	-	-	70	2.75	100	3.93	100	3.93	-	-	120	4.72	140	5.51
Dia. of Port	D	-	-	-	-	11	0.43	15	0.59	19.5	0.76	-	-	31.5	1.24	39	1.53
Approx. Weight	Kg / Lb	-	-	-	-	7.4	16.3	9.5	21.0	10.6	23.3	-	-	18.2	40.0	33.5	73.8

End to End dimensions according to ASME B16.10

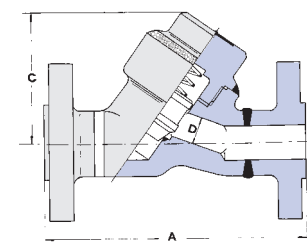

RATINGS: Carbon Steel - 6170 p.s.i. @ 100°F

CLASS 2500 PISTON TYPE - FULL PORT - ASME B16.34

Welded Cover - Flanged Ends according to ASME B16.5

FULL PORT	25-Y2540	1/4		3/8		1/2		3/4		1		1.1/4		1.1/2		2	
		mm	in.	mm	in.	mm	in.	mm	in.	mm	in.	mm	in.	mm	in.	mm	in.
End to End	A	-	-	-	-	264	10.4	273	10.7	308	12.1	-	-	384	15.1	451	17.7
Center to Top	C	-	-	-	-	115	4.52	120	4.72	150	5.90	-	-	165	6.49	180	7.08
Dia. of Port	D	-	-	-	-	11	0.43	15	0.59	19.5	0.76	-	-	31.5	1.24	39	1.53
Approx. Weight	Kg / Lb	-	-	-	-	12	26.4	14.2	31.3	20.2	44.5	-	-	37.4	82.3	65.6	144.5

End to End dimensions according to ASME B16.10

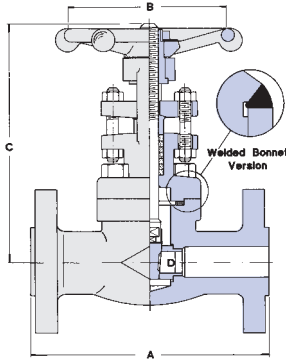

RATINGS: Carbon Steel
 Class 10K - 14 bar @ 29°F
 Class 20K - 34 bar @ 29°F
 Class 40K - 68 bar @ 29°F

CLASS 10K-20K-40K

GATE VALVES - BOLTED BONNET- JIS 2071:2000

Outside Screw & Yoke - Integral Flanged Ends according to JIS B2238

REGULAR PORT		1/4		3/8		1/2		3/4		1		1.1/4		1.1/2		2	
		mm	in.	mm	in.	mm	in.	mm	in.	mm	in.	mm	in.	mm	in.	mm	in.
Class 10K	F10K-810	A	-	-	-	108	4.25	117	4.64	127	5.00	-	-	165	6.49	178	7.00
Class 20K	F20K-810	A	-	-	-	140	5.51	152	5.98	165	6.49	-	-	190	7.48	216	8.50
Class 40K	F40K-810	A	-	-	-	165	6.49	190	7.48	216	8.50	-	-	241	9.48	292	11.5
Handwheel		B	-	-	-	80	3.14	80	3.14	110	4.33	-	-	130	5.11	130	5.11
Center to Top Open	Class 10K-20K	C	-	-	-	170	6.69	195	7.67	203	7.99	-	-	243	9.56	262	10.3
		Class 40K	C	-	-	148	5.82	163	6.41	178	7.00	-	-	243	9.56	262	10.3
Dia. of Port		D	-	-	-	9.6	0.38	14	0.55	18	0.70	-	-	30	1.18	37	1.45
Approx. Weight	Class 10K	Kg/Lb	-	-	-	3.4	7.5	3.8	8.3	5.7	12.5	-	-	9.7	21.4	13.2	29.1
	Class 20K	Kg/Lb	-	-	-	3.9	8.6	5	11.0	6.2	13.6	-	-	12	26.4	16.5	36.3
	Class 40K	Kg/Lb	-	-	-	4	8.8	5.2	11.4	7.5	16.5	-	-	15	33.0	20.5	45.1

End to End dimensions according to JIS B2002

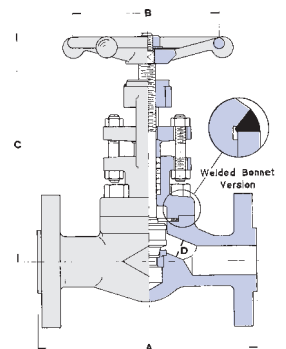

RATINGS: Carbon Steel
 Class 10K - 14 bar @ 29°F
 Class 20K - 34 bar @ 29°F
 Class 40K - 68 bar @ 29°F

CLASS 10K-20K-40K

GATE VALVES - BOLTED BONNET- JIS 2071:2000

Outside Screw & Yoke - Integral Flanged Ends according to JIS B2238

REGULAR PORT		1/4		3/8		1/2		3/4		1		1.1/4		1.1/2		2	
		mm	in.	mm	in.	mm	in.	mm	in.	mm	in.	mm	in.	mm	in.	mm	in.
Class 10K	F10K-830	A	-	-	-	108	4.25	117	4.60	127	5.00	-	-	165	6.49	203	7.99
Class 20K	F20K-830	A	-	-	-	152	5.98	178	7.00	203	7.99	-	-	229	9.01	267	10.5
Class 40K	F40K-830	A	-	-	-	165	6.49	190	7.48	216	8.50	-	-	241	9.48	292	11.5
Handwheel		B	-	-	-	80	3.14	80	3.14	110	4.33	-	-	130	5.11	180	7.08
Center to Top Open	Class 20K-40K	C	-	-	-	148	5.82	165	6.49	180	7.08	-	-	248	9.76	257	10.1
		Class 10K	C	-	-	170	6.69	197	7.75	205	8.07	-	-	248	9.76	257	10.1
Dia. of Port		D	-	-	-	9	0.35	13	0.51	17.5	0.69	-	-	29.5	1.16	35	1.37
Approx. Weight	Class 10K	Kg/Lb	-	-	-	3.4	7.5	4	8.8	5.7	12.5	-	-	10	22.0	17.0	37.4
	Class 20K	Kg/Lb	-	-	-	4	8.8	5	11.0	7.3	16.1	-	-	14	30.8	20.5	45.1
	Class 40K	Kg/Lb	-	-	-	4.5	9.9	5.5	12.1	7.6	16.7	-	-	15	33.0	21	46.2

End to End dimensions according to JIS B2002

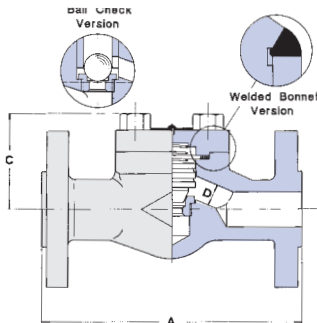

RATINGS: Carbon Steel
 Class 10K - 14 bar @ 29°F
 Class 20K - 34 bar @ 29°F
 Class 40K - 68 bar @ 29°F

CLASS 10K-20K-40K

PISTON AND BALL VALVES - BOLTED COVER - JIS 2071:2000

Integral Flanged Ends according to JIS B2238

REGULAR PORT		1/4		3/8		1/2		3/4		1		1.1/4		1.1/2		2	
		mm	in.	mm	in.	mm	in.	mm	in.	mm	in.	mm	in.	mm	in.	mm	in.
Class 10K	PISTON F10K-840 BALL F10K-850	A	-	-	-	108	4.25	117	4.60	127	5.00	-	-	165	6.49	203	7.99
Class 20K	PISTON F20K-840 BALL F20K-850	A	-	-	-	152	5.98	178	7.00	203	7.99	-	-	229	9.01	267	10.5
Class 40K	PISTON F40K-840 BALL F40K-850	A	-	-	-	165	6.49	190	7.48	216	8.50	-	-	241	9.48	292	11.5
Center to Top Open	Class 10K	C	-	-	-	75	2.95	92	3.62	98	3.85	-	-	98	3.85	110	4.33
		Class 20K-40K	C	-	-	53	2.08	60	2.36	73	2.87	-	-	98	3.85	110	4.33
Dia. of Port		D	-	-	-	9	0.35	13	0.51	17.5	0.69	-	-	29.5	1.16	35	1.37
Approx. Weight	Class 10K	Kg/Lb	-	-	-	2.9	6.4	3.2	7.0	4.3	9.5	-	-	6.5	14.3	14.5	31.9
	Class 20K	Kg/Lb	-	-	-	3.6	7.9	4.2	9.2	6	13.2	-	-	12	26.4	16	35.2
	Class 40K	Kg/Lb	-	-	-	4.1	9.0	4.7	10.4	6.3	13.8	-	-	13	28.6	17	37.4

End to End dimensions according to JIS B2002

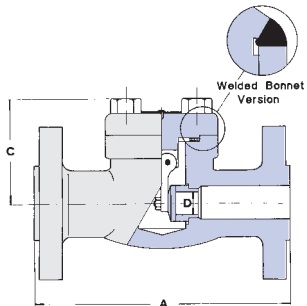

RATINGS: Carbon Steel
 Class 10K - 14 bar @ 29°F
 Class 20K - 34 bar @ 29°F
 Class 40K - 68 bar @ 29°F

CLASS 10K-20K-40K

SWING VALVES - BOLTED COVER - JIS 2071:2000

Integral Flanged Ends according to JIS B2238

REGULAR PORT		1/4		3/8		1/2		3/4		1		1.1/4		1.1/2		2	
		mm	in.	mm	in.	mm	in.	mm	in.	mm	in.	mm	in.	mm	in.	mm	in.
Class 10K	F10K-860	A	-	-	-	108	4.25	117	4.60	127	5.00	-	-	165	6.49	203	7.99
Class 20K	F20K-860	A	-	-	-	153	6.02	178	7.00	203	7.99	-	-	229	9.01	267	10.5
Class 40K	F40K-860	A	-	-	-	165	6.49	190	7.48	216	8.50	-	-	241	9.48	292	11.5
Center to Top Open	Class 10K	C	-	-	-	75	2.95	92	3.62	98	3.85	-	-	98	3.85	110	4.33
		Class 20K-40K	C	-	-	53	2.08	60	2.36	73	2.87	-	-	98	3.85	110	4.33
Dia. of Port		D	-	-	-	9.6	0.38	14	0.55	18	0.70	-	-	30	1.18	37	1.45
Approx. Weight	Class 10K	Kg/Lb	-	-	-	2.9	6.4	3.2	7.0	4.3	9.5	-	-	6.5	14.3	14.5	31.9
	Class 20K	Kg/Lb	-	-	-	3.6	7.9	4.2	9.2	6.1	13.4	-	-	13	28.6	16	35.2
	Class 40K	Kg/Lb	-	-	-	4.1	9.0	4.7	10.4	6.3	13.8	-	-	13	28.6	17	37.4

End to End dimensions according to JIS B2002

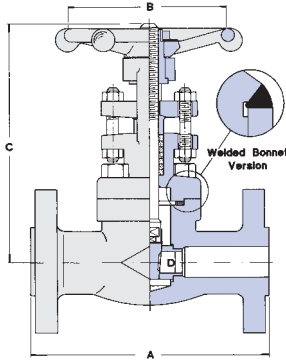

RATINGS: Carbon Steel
DIN PIN - 25-40 - 40 bar @ 29°C
DIN PIN - 63-100 - 100 bar @ 29°C

DIN PN25/40/63/100 GATE VALVES - BOLTED BONNET - IN ACCORDANCE TO DIN STANDARD

Outside Screw & Yoke - Integral Flanged Ends according to DIN 2634/2635/2636/2637

FULL PORT	PN25 PN100	F4U-610 F10U-610	-		DIN 15		DIN 20		DIN 25		DIN 32		DIN 40		DIN 50	
			mm	in.	mm	in.	mm	in.	mm	in.	mm	in.	mm	in.	mm	in.
End to End	PN 25-40	A	-	-	130	5.11	150	5.90	160	6.30	-	-	240	9.44	250	9.84
	PN 63-100	A	-	-	140	5.51	150	5.90	160	6.30	-	-	240	9.44	250	9.84
Handwheel		B	-	-	80	3.14	110	4.33	110	4.33	-	-	130	5.11	180	7.08
Center to Top Open		C	-	-	152	5.98	182	7.16	214	8.42	-	-	270	10.6	333	13.1
Dia of Port		D	-	-	14	0.55	18	0.70	24	0.94	-	-	37	1.45	47	1.85
Approx.	PN 25-40	Kg / Lb	-	-	4.4	9.7	6.5	14.3	7.9	17.4	-	-	13	28.6	24.5	53.9
Weight	PN 63-100	Kg / Lb	-	-	5	11.0	7.4	16.3	9.4	20.7	-	-	15	33.0	27	59.4

End to End dimensions according to DIN 3202

PN 63 and PN 100 Welded Flanged

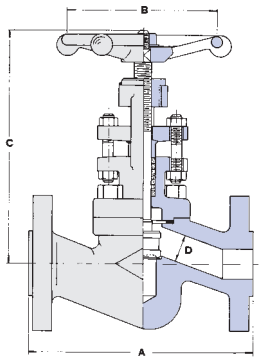

RATINGS: Carbon Steel
DIN PIN - 25-40 - 40 bar @ 29°C
DIN PIN - 63-100 - 100 bar @ 29°C

DIN PN25/40/63/100 GLOBE VALVES - BOLTED BONNET - IN ACCORDANCE TO DIN STANDARD

Outside Screw & Yoke - Integral Flanged Ends according to DIN 2634/2635/2636/2637

FULL PORT	PN25 PN100	F4U-630 F10U-630	-		DIN 15		DIN 20		DIN 25		DIN 32		DIN 40		DIN 50	
			mm	in.	mm	in.	mm	in.	mm	in.	mm	in.	mm	in.	mm	in.
End to End	PN 25-40	A	-	-	130	5.11	150	5.90	160	6.30	-	-	200	7.87	230	9.05
	PN 63-100	A	-	-	210	8.26	230	9.05	230	9.05	-	-	260	10.2	300	11.8
Handwheel		B	-	-	80	3.14	110	4.33	110	4.33	-	-	130	5.11	180	7.08
Center to Top Open		C	-	-	180	7.08	185	7.28	215	8.46	-	-	260	10.2	230	9.0
Dia of Port		D	-	-	15	0.59	19	0.75	24	0.95	-	-	38	1.49	50	1.96
Approx.	PN 25-40	Kg / Lb	-	-	5	11.0	6.5	14.3	8.5	18.7	-	-	14	30.8	24.5	53.9
Weight	PN 63-100	Kg / Lb	-	-	6.5	14.3	8.0	17.6	10	22.0	-	-	16.5	36.3	30	66.0

End to End dimensions according to DIN 3202

PN 63 and PN 100 Welded Flanged

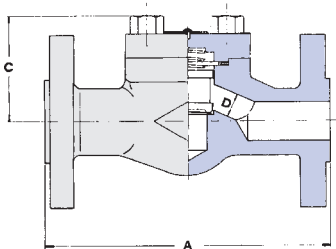

RATINGS: Carbon Steel
DIN PIN - 25-40 - 40 bar @ 29°C
DIN PIN - 63-100 - 100 bar @ 29°C

DIN PN25/40/63/100 PISTON CHECK - BOLTED COVER - IN ACCORDANCE TO DIN STANDARD

Integral Flanged Ends according to DIN 2634/2635/2636/2637

FULL PORT	PN25 PN100	F4U-640 F10U-640	-		DIN 15		DIN 20		DIN 25		DIN 32		DIN 40		DIN 50	
			mm	in.	mm	in.	mm	in.	mm	in.	mm	in.	mm	in.	mm	in.
End to End	PN 25-40	A	-	-	130	5.11	150	5.90	160	6.30	-	-	200	7.87	230	9.05
	PN 63-100	A	-	-	210	8.26	230	9.05	230	9.05	-	-	260	10.2	300	11.8
Center to Top Open		C	-	-	85	3.34	90	3.54	95	3.74	-	-	135	5.31	120	4.72
Dia of Port		D	-	-	15	0.59	19	0.75	24	0.95	-	-	38	1.49	50	1.96
Approx.	PN 25-40	Kg / Lb	-	-	3.5	7.7	4.0	8.8	6.0	13.2	-	-	11	24.2	16	35.2
Weight	PN 63-100	Kg / Lb	-	-	5	11.0	5.5	12.1	7.5	16.5	-	-	13.5	29.7	21.5	47.3

End to End dimensions according to DIN 3202

PN 63 and PN 100 Welded Flanged

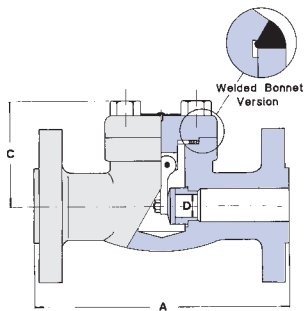

RATINGS: Carbon Steel
DIN PIN - 25-40 - 40 bar @ 29°C
DIN PIN - 63-100 - 100 bar @ 29°C

DIN PN25/40/63/100 PISTON CHECK - BOLTED COVER - IN ACCORDANCE TO DIN STANDARD

Integral Flanged Ends according to DIN 2634/2635/2636/2637

FULL PORT	PN25 PN100	F4U-640 F10U-640	-		DIN 15		DIN 20		DIN 25		DIN 32		DIN 40		DIN 50	
			mm	in.	mm	in.	mm	in.	mm	in.	mm	in.	mm	in.	mm	in.
End to End	PN 25-40	A	-	-	130	5.11	150	5.90	160	6.30	-	-	200	7.87	230	9.05
	PN 63-100	A	-	-	210	8.26	230	9.05	230	9.05	-	-	260	10.2	300	11.8
Center to Top Open		C	-	-	85	3.34	90	3.54	95	3.74	-	-	135	5.31	120	4.72
Dia of Port		D	-	-	14	0.55	18	0.70	24	0.94	-	-	37	1.45	47	1.85
Approx.	PN 25-40	Kg / Lb	-	-	3.2	7.0	3.5	7.7	5.5	12.1	-	-	10.5	23.1	15	33.0
Weight	PN 63-100	Kg / Lb	-	-	4.7	10.3	5	11.0	7	15.4	-	-	13	28.6	20.5	45.1

End to End dimensions according to DIN 3202

PN 63 and PN 100 Welded Flanged

CONVERSION CHART



PRESSURE

$$1 \text{ Kg/cm}^2 = 142233 \text{ lb/inch}^2$$

$$1 \text{ lb/inch}^2 = 0,07037 \text{ Kg/cm}^2$$

TEMPERATURE

$$^{\circ}\text{F} = 9/5 \text{ }^{\circ}\text{C} + 32$$

$$^{\circ}\text{C} = 5/9 (^{\circ}\text{F} - 32)$$

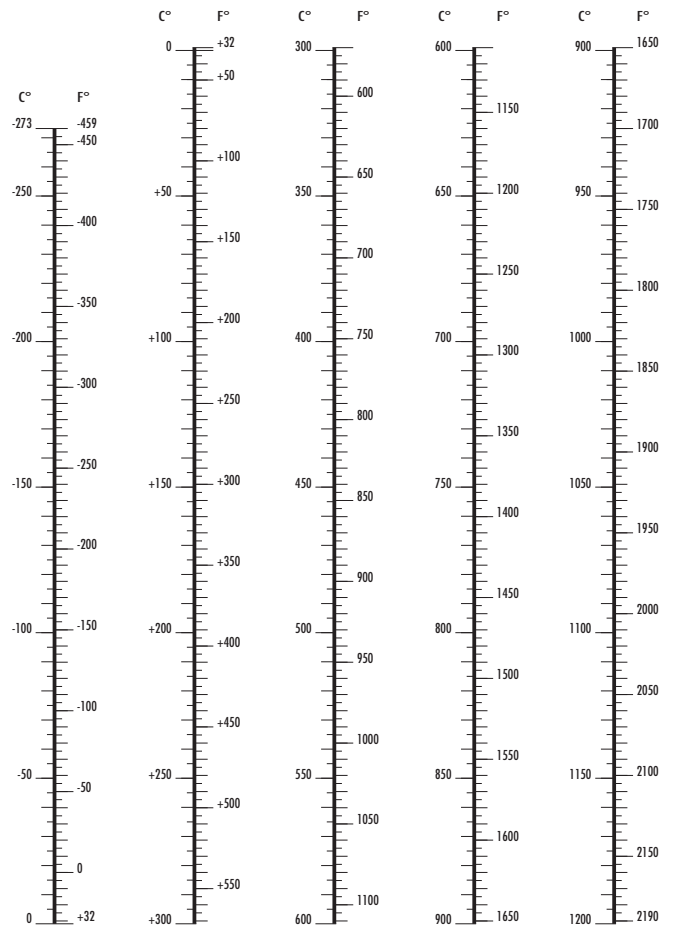
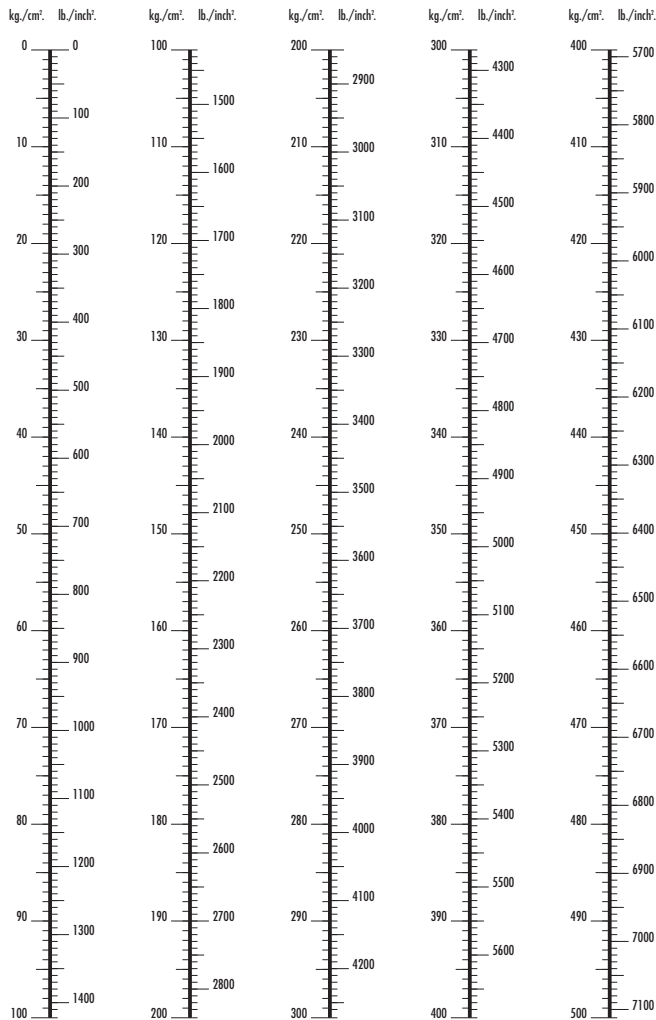

FRACTION OF 1 INCH INTO DECIMALS AND MILLIMETERS

Fract.	Inch.	Millim.	Fract.	Inch.	Millim.	Fract.	Inch.	Millim.	Fract.	Inch.	Millim.
1/64	0.016	0.397	17/64	0.266	6.747	33/64	0.516	13.097	49/64	0.766	19.447
1/32	0.031	0.794	9/32	0.281	7.141	17/32	0.531	13.494	25/32	0.781	19.844
3/64	0.047	1.191	19/64	0.297	7.541	35/64	0.547	13.891	51/64	0.797	20.241
1/16	0.062	1.587	5/16	0.312	7.937	5/8	0.562	14.287	13/16	0.812	20.637
5/64	0.078	1.984	21/64	0.328	8.334	37/64	0.578	14.684	53/64	0.828	21.034
3/32	0.094	2.381	11/32	0.344	8.731	19/32	0.594	15.081	27/32	0.844	21.431
7/64	0.109	2.778	23/64	0.359	9.128	39/64	0.609	15.478	55/64	0.859	21.828
1/8	0.125	3.175	3/8	0.375	9.525	5/8	0.625	15.875	7/8	0.875	22.225
9/64	0.141	3.572	25/64	0.391	9.922	41/64	0.641	16.272	57/64	0.891	22.622
5/32	0.156	3.969	13/32	0.406	10.319	21/32	0.656	16.669	29/32	0.906	23.019
11/64	0.172	4.365	27/64	0.422	10.716	43/64	0.672	17.066	59/64	0.922	23.406
3/16	0.187	4.762	7/16	0.437	11.112	11/16	0.687	17.462	15/16	0.937	23.812
13/64	0.203	5.159	29/64	0.453	11.509	45/64	0.703	17.859	61/64	0.953	24.209
7/32	0.219	5.556	15/32	0.469	11.906	23/32	0.719	18.256	31/32	0.969	24.606
15/64	0.234	5.953	31/64	0.484	12.303	47/64	0.734	18.653	63/64	0.984	25.003
1/4	0.250	6.350	1/2	0.500	12.700	3/4	0.750	19.050	1	1.000	25.400



Suggested spares for OMB valves are packing and gaskets: We provide here below a list, inclusive of the bonnet capscrew specification, which can be used to source spare parts for the most common valves.

All other valves' spares can be requested directly at OMB or at any of the OMB approved distributors worldwide.

Desc	Class	Base Figure No	NPS	Packing Code	Gasket Code	Bonnet Capscrew	Gland Stud
RB Gate	150-800#	810	0.50"	T2	40x30	M10x25	M8x42
RB Gate	150-800#	810	0.75"	T2	40x30	M10x25	M8x42
RB Gate	150-800#	810	1"	T4	48x38	M12x30	M8x48
RB Gate	150-800#	810	1.25"	T5	54x44	M12x35	M10x58
RB Gate	150-800#	810	1.50"	T6	66x54	M14x35	M10x60
RB Gate	150-800#	810	2"	T6	74x50	M16x40	M10x60

Desc	Class	Base Figure No	NPS	Packing Code	Gasket Code	Bonnet Capscrew	Gland Stud
RB Globe	150-800#	830	0.50"	T2	40x30	M10x25	M8x42
RB Globe	150-800#	830	0.75"	T3	40x30	M10x25	M8x42
RB Globe	150-800#	830	1"	T5	48x38	M12x30	M8x48
RB Globe	150-800#	830	1.25"	T25	54x44	M12x35	M10x58
RB Globe	150-800#	830	1.50"	T6	66x54	M14x35	M10x60
RB Globe	150-800#	830	2"	T27	74x50	M16x40	M10x60

Desc	Class	Base Figure No	NPS	Packing Code	Gasket Code	Bonnet Capscrew	Gland Stud
RB Check	150-800#	840, 850, 860	0.50"	-	40x30	M10x25	-
RB Check	150-800#	840, 850, 860	0.75"	-	40x30	M10x25	-
RB Check	150-800#	840, 850, 860	1"	-	48x38	M12x30	-
RB Check	150-800#	840, 850, 860	1.25"	-	54x44	M12x35	-
RB Check	150-800#	840, 850, 860	1.50"	-	66x54	M14x35	-
RB Gate	150-800#	840, 850, 860	2"	-	74x50	M16x40	-

PRODUCT INFORMATION REQUEST Request to send the following printed catalogs incopies:

FromCompany

AddressCity

Zip CodeCountry

To: **OMB Valves s.p.a.**
 Fax: **+39 035 942 638**



Catalogs can be downloaded at www.ombvalves.com



OMB Valves s.p.a.
Valves Specialist

HEADQUARTERS

Via Europa, 7
24069 Cenate Sotto (Bg) - Italy
Phone +39 035 425 6711
Fax +39 035 942 638

www.ombvalves.com

Worldwide Network
of Agents and Distributors

WORLDWIDE SUBSIDIARIES

OMB Valves s.p.a.
Rep. office **SOUTH EAST ASIA & PACIFIC (MALAYSIA)**
Phone +60 3 772 880 77 - Fax +60 3 772 860 66

OMB Americas inc.
HOUSTON, TX - U.S.A.
Phone (Loc/Int) +1 713 675 0367
(Toll free) +1 800 456 5625 - Fax +1 713 675 2733

OMB Americas inc.
MONTREAL - CANADA
Phone +1 514 457 0813 - Fax +1 514 457 0814

OMB Valves Asia Pte. Ltd
WOODLAND - SINGAPORE
Phone +65 685 221 10 - Fax +65 685 214 10

OMB Offshore Application Ltd
DUNDEE - UNITED KINGDOM
Phone +44 (0) 759 894 8073

IVM OMB Saudi
Al-Khobar - SAUDI ARABIA
Phone +966 3 889 3334 - Fax +966 3 889 3332



B.com.it

C-17/11.08

Local Agent: >>