

SUPER LINE P SERIES
THREE PHASE
INDUCTION MOTOR
PREMIUM EFFICIENCY IE3

**For the sake of the planet,
motors have their own part to play**



GLOBAL IMPACT OF MITSUBISHI ELECTRIC



Changes for the Better

We bring together the best minds to create the best technologies. At Mitsubishi Electric, we understand that technology is the driving force of change in our lives. By bringing greater comfort to daily life, maximizing the efficiency of businesses and keeping things running across society, we integrate technology and innovation to bring changes for the better.

Mitsubishi Electric is involved in many areas including the following

Energy and Electric Systems

A wide range of power and electrical products from generators to large-scale displays.

Electronic Devices

A wide portfolio of cutting-edge semiconductor devices for systems and products.

Home Appliances

Dependable consumer products like air conditioners and home entertainment systems.

Information and Communication Systems

Commercial and consumer-centric equipment, products and systems.

Industrial Automation Systems

Maximizing productivity and efficiency with cutting-edge automation technology.

OVERVIEW

High Efficiency Regulatory Trends for Three-Phase Motors	4
Lineup	5
Premium Efficiency Motors	
1 SF-PR 80M~225S FOOT TYPE TOTALLY ENCLOSED FAN-COOLED TYPE, IP44 DEGREES OF PROTECTION (Indoor Motor)	6
2 SF-PRO 80M~225S FOOT TYPE TOTALLY ENCLOSED FAN-COOLED TYPE, IP44 DEGREES OF PROTECTION (Outdoor Waterproof Motor)	9
3 SF-PRP 80M~225S FOOT TYPE TOTALLY ENCLOSED FAN-COOLED TYPE, IP55 DEGREES OF PROTECTION (Outdoor Dust & Water jet proof Motor)	11
4 SF-PRV / SF-PRF 80M~225S VERTICAL / HORIZONTAL FLANGE TYPE TOTALLY ENCLOSED FAN-COOLED TYPE, IP44 DEGREES OF PROTECTION (Vertical / Horizontal Flange Motor)	13
5 SF-PRB 80M~225S FOOT TYPE BRAKE MOTOR TOTALLY ENCLOSED FAN-COOLED TYPE, IP44 DEGREES OF PROTECTION (Motor with Brake)	15

Contributing to energy conservation with advanced high efficiency technology

"Super Line Premium Series SF-PR" demonstrates the full potential of Mitsubishi high-efficiency technology, while maintaining the ease of use of general-purpose motors.

With proprietary steel frame technology, Mitsubishi Electric will continue to develop and sell products that comply with global high efficiency regulations.

The logo for the SF-PR motor series, featuring a stylized green 'S' with a blue swoosh and the letters 'F-PR' in black.

High performance energy-saving motor
Super Line Premium Series
SF-PR Type

ROTOR

Rotor slot shape is adopted in order to address startup characteristics while suppressing operating resistance. Furthermore, the number of slots is also optimized.

FAN

The shape of the cooling fan is developed for enhanced balance between cooling performance and mechanical loss.

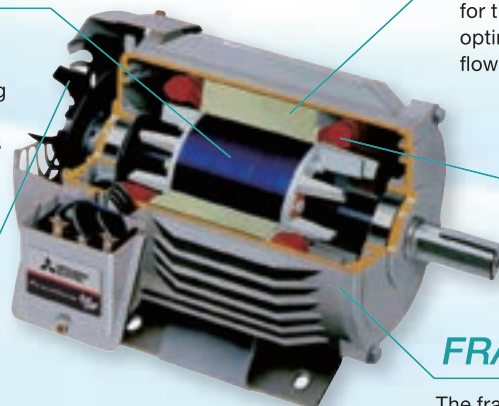

CORE

Low generation loss materials are used for the iron core, while the shape is optimized for revised magnetic flux flow.

COIL

Electric wire resistance is suppressed with increased cross-sectional area due to improved wire space factor, and by reducing the crossover area.

FRAME

The frame is made of a steel plate that easily transfers magnetic flux and is ideal for high efficiency design.

High Efficiency Regulatory Trends for Three-Phase Motors

Background of energy efficiency laws and regulations for three-phase motors

Global warming prevention countermeasures are gaining impetus around the world (demand for CO₂ reduction)

Global Electricity Consumption in 2010

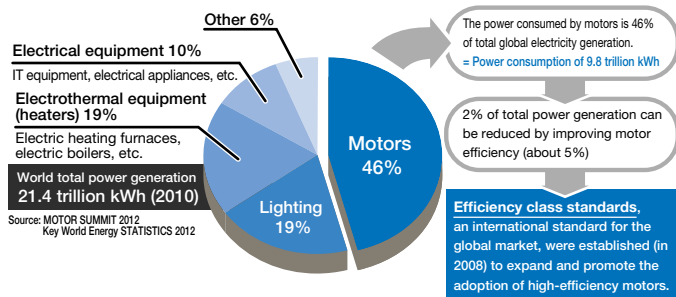

IE Code

IEC 60034-30 (efficiency classes of single-speed, three-phase, squirrel-cage induction motors) was enacted in October 2008 as an international standard for motor efficiency. The efficiency defined therein is classified into levels from IE1 to IE4, and the larger this number is, the higher the efficiency will be.

IEC standard efficiency class (IE Code)	Major regulatory countries	Mitsubishi product series
IE4 Super Premium Efficiency		Premium high-efficiency IPM motor MM-EFS
IE3 Premium Efficiency	United States, Japan, China, Europe, Korea	Super Line Premium Series SF-PR
IE2 High Efficiency		Super Line Eco Series SF-HR
IE1 Standard Efficiency		Super Line Series SF-JR
(Non-standard)		

Introduction of Energy Efficiency Standards in Major Countries

Country (region)	Energy efficiency standards introduction schedule									
	2009	2010	2011	2012	2013	2014	2015	2016	2017	2018
Japan							Enforced 2013/11/1 Designated specified devices for Top Runner system	Target start date 2015/4/1 Top Runner (IE3)		
United States	IE2		2010/12/19 IE3 (Foot-mounted type, etc. conventional IE2 compliant products) 2010/12/19 IE2 (Flange type, etc.)							
China			2011/7/1 (GB2) IE2	2012/9/1 (New GB3) IE2				2016/9/1 (7.5 kW up) (New GB2) IE3 2017/9/1 (0.75 kW up) (New GB2) IE3		
Europe			2011/6/16 IE2				2015/1/1 (7.5 kW up) IE3		2017/1/1 (0.75 kW up) IE3	
Korea	IE2							2015/10/1 (37 kW or more - less than 200 kW) IE3 2016/10/1 (200 kW or more - 375 kW or less) IE3 2018/10/1 (0.75 kW or more - less than 37 kW) IE3		
Mexico			2011/1/1 IE3							
Vietnam					2013/1/1 on: Mandatory energy labeling				2016/1/1 Efficiency regulations start, according to IE1 original criteria	

Energy Efficiency Regulations Overview by Country

Country and region	United States	China	Europe	Korea	Mexico	Vietnam		
Safety standards	UL Standards	CCC Mark	CE Mark	—	—	—		
Energy efficiency standards	EISA NEMA MG1-12-12	Energy efficiency labeling implementation regulations GB18613-2012	COMMISSION REGULATION(CEC) No.640/2009 IEC60034-30-1(2014)	Energy Consumption Efficiency grade indication system KS C 4202	NOM-016-ENER-2010	No.51/2011/QD-TTg TCVN 7540-1:2013		
Certification mark Certification label			—			 Use for high level IE3 only		
Efficiency level	NEMA Premium(IE3)	Grade GB2 (IE3)	IE3 or IE2 + Variable speed drive	IE3	IE3	IE1		
Start time	2010/12/19 on 2016/6/1 on	2016/9/1 on 2017/9/1 on	2015/1/1 on 2017/1/1 on	2015/10/1 on 2016/10/1 on 2018/10/1 on	2011/1/1 on	2016/1/1 on		
Target motors	Output	0.75 to 150 kW (1 to 200 HP) 0.75 to 373 kW (1 to 500 HP)	7.5 kW or more - 375 kW or less 0.75 kW or more - 375 kW or less	7.5 kW or more - 375 kW or less 0.75 kW or more - 375 kW or less	37 kW or more - less than 200 kW 200 kW or more - 375 kW or less 0.75 kW or more - less than 37 kW	0.746 to 373 kW	0.75 to 150 kW	
	Number of poles	2-pole, 4-pole, 6-pole	2-pole, 4-pole, 6-pole	2-pole, 4-pole, 6-pole	2-pole, 4-pole, 6-pole, 8-pole	2-pole, 4-pole, 6-pole	2-pole, 4-pole, 6-pole	
	Voltage	230 V, 460 V 230/460 V	600 V or less	1000 V or less	1000 V or less	600 V or less	600 V or less	1000 V or less
	Frequency	60 Hz	50 Hz	50 Hz, 50/60 Hz	60 Hz	60 Hz	60 Hz	50 Hz, 60 Hz
Rating	S1	S1, S3 80% ED	S1, S3 80% ED	S1, S3 to S10	S1	S1		
Exceptions	Inverter drive dedicated Built-in submersible motor High slip motor	Inverter drive dedicated Built-in Motor for special environments	Brake motor Built-in submersible motor Motor for special environments	Inverter drive dedicated Built-in	—	Gearred motor Inverter drive dedicated Built-in Motor for special environments		

Lineup

SF-PR (Indoor Motor) P6

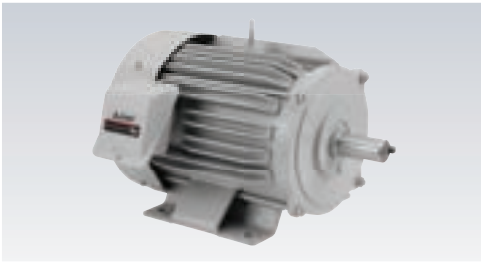

Contributing to energy conservation with advanced high efficiency technology

Features

(1) Compatible mounting dimensions

With the exception of some models, the total length and shaft dimensions are the same as for Mitsubishi SF-JR standard efficiency motors.

(2) Combination with power distribution control equipment

Specially designed for use with power distribution control equipment equivalent to that of SF-JR.

SF-PRO (Outdoor Waterproof Motor) P9



Can be used safely outdoors, even under weather conditions such as rain, wind, snow, etc.

Features

(1) Waterproof performance (IP44 Degrees of protection)

Passed the water spray test for compliance with JIS C 4034-5, and can be securely used outdoors.

SF-PRP (Outdoor Dust & Water jet proof Motor) P11



Operates normally under severe outdoor conditions

Features

(1) Dust & Water jet proof performance (IP55 Degrees of protection)

Passed the dust and the water spray test for compliance with JIS C 4034-5, so it can be used with confidence in locations exposed to large quantities of water.

SF-PRV (Vertical Flange Motor) P13 SF-PRF (Horizontal Flange Motor)



Premium efficiency motor for flange mounting

Features

(1) Compatible mounting dimensions

With the exception of some models, the total length and shaft dimensions are the same as for Mitsubishi SF-JRV / SF-JRF standard efficiency motors.

(2) Combination with power distribution control equipment

Specially designed for use with power distribution control equipment equivalent to that of SF-JRV / SF-JRF.

SF-PRB (Motor with Brake) P15



Low noise, compact/lightweight motor with brake

Features

(1) Energy saving / CO₂ reduction

Premium efficiency motor with brake.

(2) Guaranteed compatibility

- Mounting dimensions: Same mounting dimensions as SF-JRB.
(Can fit into the existing space, except for some models)
- Same motor frame number and mounting dimensions as SF-PR.
- Brake specification: For SF-PRB, the same brake is used as for SF-JRB.

(3) Low noise

Due to the sound absorbing material used for the TB-A brake part, it features low noise with less impact sound during brake release. (Operating noise 75 dB or below)

● Production Model List

Model	Totally-enclosed Fancooled Type		Model	Totally-enclosed Fancooled Type	
Model Name	SF-PR(O,P,V,F)	SF-PRB	Model Name	SF-PR(O,P,V,F)	SF-PRB
Frame Number	4 Poles	4 Poles	Frame Number	4 Poles	4 Poles
80M	0.75	0.75	160M	11	11
90L	1.5	1.5	160L	15	15
100L	2.2	2.2	180M	18.5,22	18.5,22
112M	3.7	3.7	180LD	30	30
132S	5.5	5.5	200LD	37,45	37,45
132M	7.5	7.5	225S	55	55

●The output listing in the above table is the production range. ●SF-PRF (Horizontal flange type) frame number 225S is not available.

Premium Efficiency Motors

SF-PR 80M~225S FOOT TYPE

TOTALLY ENCLOSED FAN-COOLED TYPE, IP44 DEGREES OF PROTECTION (Indoor Motor)

Features

As the SF-PR type is compatible with conventional products (SF-JR, SF-HR), it is available not only for use as a new product, but also for conventional product replacement. Furthermore, inverter surge protection and reinforced insulation are implemented in all motor models.

Compatibility

- Can be easily mounted on existing equipment as well as on new equipment.
- (1) Mounting dimensions
Same mounting dimensions as the standard efficiency motor.
(Can fit into the existing space)
- (2) Power distribution control equipment
Uses the same power distribution control equipment as standard efficiency motors.

Note 1. When using Mitsubishi Electric Circuit Breaker NF400-SW at 55 kW, replace the breaker.
(Be sure to change the rated current of the NF400-SW breaker from 300A to 350A)
2. The existing thermal may be tripped if the unit is used for replacement in applications with a high load inertia moment. Contact the nearest sales office to handle this.

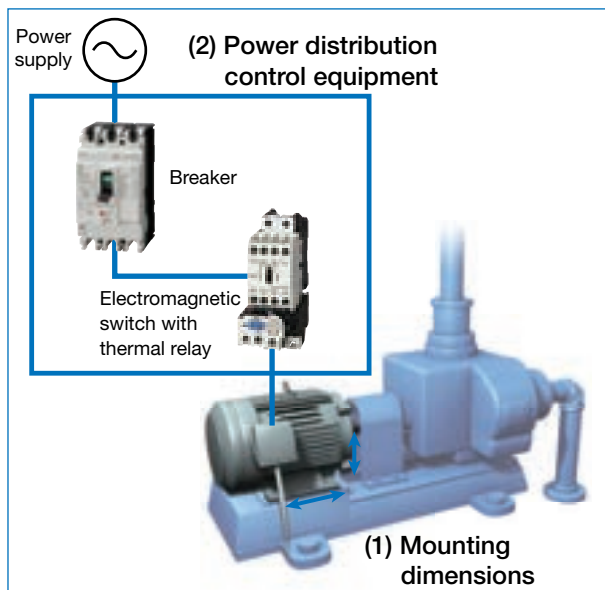

Characteristics after Replacement

The slip and starting current remain at the same level as SF-HR, while achieving even higher efficiency.

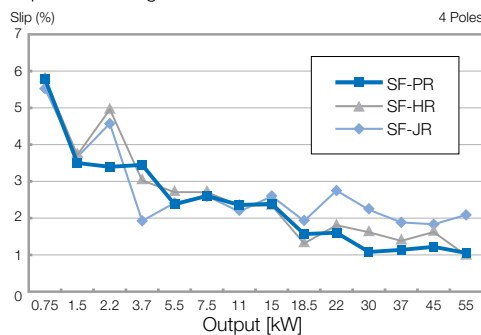

* The smaller the slip, the faster the rotation speed.

● All above graph data are based on Mitsubishi Electric Japan motors.



Energy-saving Effects

Efficiency

Power generation loss is reduced by 40-50% compared to Mitsubishi standard efficiency motors (SF-JR standard efficiency). Compared to Mitsubishi high efficiency motors (SF-HR), power generation loss is reduced by 20 to 30%, supporting higher-efficiency IE3 premium efficiency. Enables further energy saving operation.

* Some models are excluded.

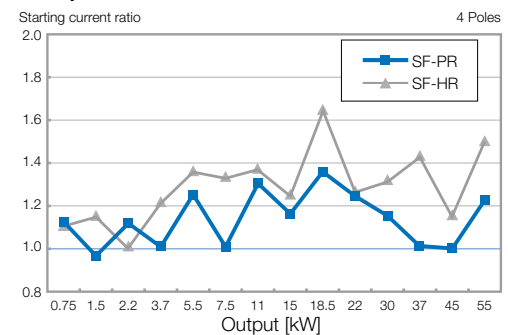
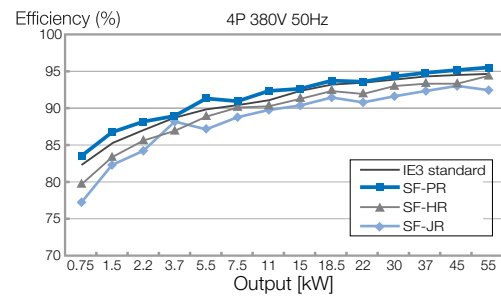

* The starting current ratio of SF-HR and SF-PR is shown when the starting current of the conventional model SF-JR is set to 1.0.

Model Name

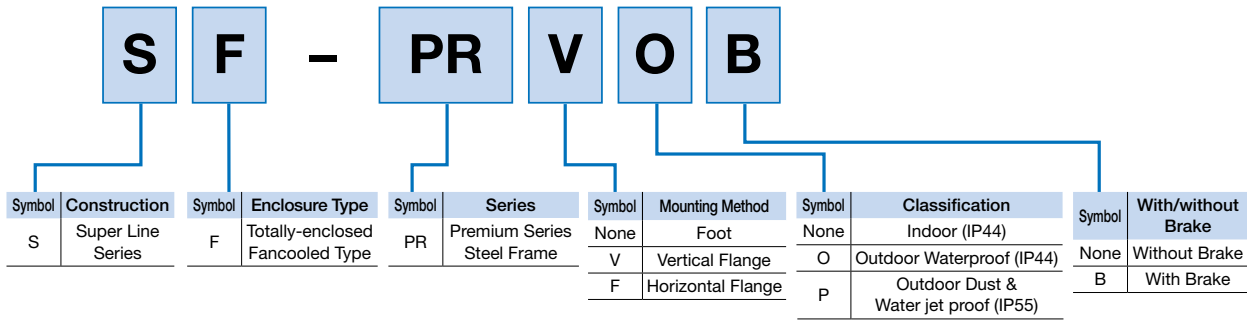

Standard Specifications

Enclosure Structure / Model Name	Totally-enclosed Fancooled Type SF-PR	
Voltage/Frequency	380 V 50 Hz	
Operation Rating	S1 (continuous)	
Power Transmission Method	Direct Coupling / Belt Driven	
Rotation Direction	Counterclockwise (CCW), viewed from shaft-end side	
Thermal Class	120 (E): Frame Numbers 80M - 112M 130 (B): Frame Numbers 132S - 180M 155 (F): Frame Numbers 180LD - 225S	
Ambient Conditions	Temperature	-30°C to 40°C
	Humidity	100% RH (no condensation)
	Altitude	1000 m above sea level or below
	Atmosphere	No corrosive/explosive gas, no steam or condensation, minimal dust.
Coating Color	Munsell N7	
Applicable Standards	JIS C 4213, JEC-2137-2000	

- Note 1 Standard specifications use a varnish capable of handling tropical atmospheres. However, coating changes and so on are required for tropicalization: designate separately.
- 2 This table does not include models with brakes.
- 3 Horizontal flange model with frame number 225S is not available.
- 4 Vertical flange models (excluding frame number 225S) can be used as is as Horizontal flange models. However, note that the outdoor type cannot be used. Refer to the Instruction Manual for motor handling.

Characteristics Table

380V 50Hz

Number of Poles [P]	Output [kW]	Frame Number	Load Characteristics									Rated Current [A]	Rated Rotation Speed [min ⁻¹]	Rated Torque (N·m)	Maximum Torque [%]	Starting Torque [%]	Starting Current [A]
			50% load			75% load			100% load								
			Current [A]	Efficiency [%]	Power Factor [%]	Current [A]	Efficiency [%]	Power Factor [%]	Current [A]	Energy Consumption Efficiency [%]	Power Factor [%]						
4 Poles	0.75	80M	1.26	83.6	54.3	1.49	84.5	68.1	1.78	83.5	76.8	1.8	1410	5.1	275	349	11.6
	1.5	90L	2.08	87.6	62.7	2.62	87.9	74.4	3.29	86.7	80.1	3.7	1445	9.9	220	253	23
	2.2	100L	3.04	88.4	62.2	3.82	88.9	73.9	4.75	88.1	79.9	4.8	1445	14.5	226	291	35.5
	3.7	112M	4.77	89.9	65.7	6.1	89.8	77.3	7.65	88.6	83.1	7.8	1445	24.4	261	330	61
	5.5	132S	7.3	91.1	62.6	9.1	91.7	75.1	11.2	91.2	81.7	11.3	1460	36.0	284	255	89
	7.5	132M	9.2	92	67.5	11.8	91.8	78.9	14.9	90.9	84.3	15.1	1460	49.0	267	234	110
	11	160M	12.8	92.4	70.9	16.8	92.8	80.6	21.3	92.3	85.2	21.5	1460	71.9	275	258	178
	15	160L	17.7	92.7	69.5	23	93.1	79.9	29	92.6	84.9	29.5	1460	98.1	287	266	254
	18.5	180M	20.6	93.8	72.8	27.4	94.1	82	34.8	93.8	86.1	35.5	1475	120	282	197	294
	22	180M	24.5	93.5	73	32.5	94	82.2	41.4	93.7	86.2	42	1475	142	285	201	350
	30	180LD	32.7	94.5	73.9	43.8	94.8	82.4	56.1	94.4	86	57	1480	193	271	195	491
	37	200LD	41.4	94.9	71.6	54.9	95.2	80.6	70.1	94.9	84.5	71	1480	239	249	158	513
	45	200LD	51	95	70.6	67.2	95.4	80.1	85.3	95.1	86.2	86.5	1480	290	265	166	667
55	225S	62.2	95.4	70.4	81.6	95.8	80.3	103	95.5	84.6	105	1480	355	282	168	875	

- Characteristic calculation method is based on dynamometer method (actual measurement method).
- Characteristic values indicate representative values, not guaranteed values.

[Precautions for Using Premium Efficiency Motors]

- Starting current tends to be larger than with SF-JR. Pay attention to the design of the distribution side.
- Rotation speed tends to be faster than with SF-JR. The motor output may increase, especially when using with a fan, pump, etc.

Dimensional Drawings

SF-PR Indoor Motor

Figure - 1

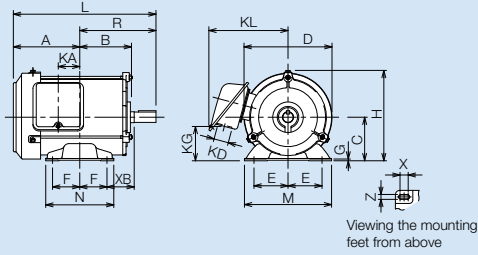
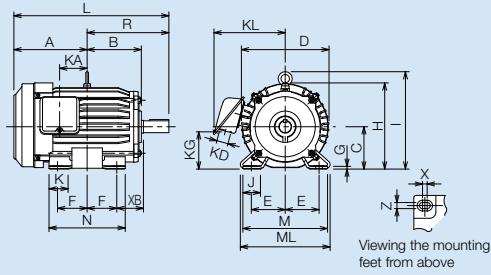

Figure - 3



Shaft End Dimensions

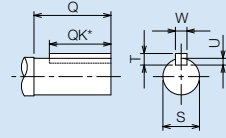

Figure - 2

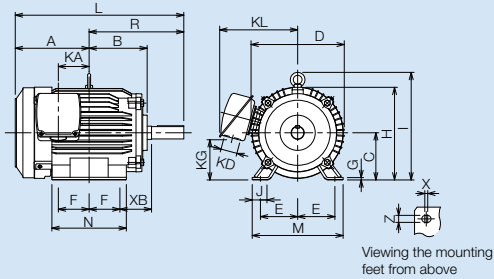
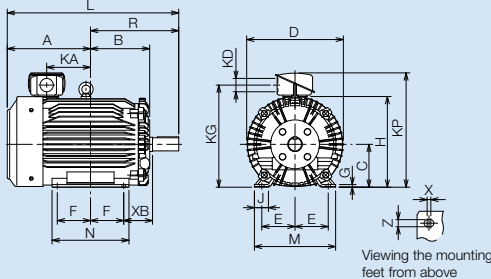

Figure - 4



* Since the key groove is machined with end mill, there is no roundness at the groove bottom.

Dimension Table

Frame Number	Thermal Class	Output (kW)	Figure Number	Dimensions (mm)														
				Motors														
				A	B	C*	D	E	F	G	H	I	J	K	KA	KD	KG	KL(KP)
80M	120 (E)	0.75	1	122	93	80	162	62.5	50	3.2	166	—	—	—	39.5	27	63	145
90L		1.5		143	111.5	90	184	70	62.5	4	191	—	—	—	53	27	76	158
100L		2.2		173	128	100	207	80	70	6.5	203.5	230	40	45	65	27	88	169
112M		3.7		181	135	112	228	95	70	6.5	226	253	40	45	69	27	103	180
132S		5.5		211.5	152	132	266	108	70	6.5	265	288	40	45	75	27	120	197
132M	130 (B)	7.5	2	230.5	171	132	266	108	89	6.5	265	288	40	45	94	27	120	197
160M		11		252	198	160	318	127	105	8	316	367	50	—	105	56	142	266
160L		15		274	220	160	318	127	127	8	316	367	50	—	127	56	142	266
180M		18.5, 22		292.5	225.5	180	363	139.5	120.5	8	359	410	50	—	127	56	168	289
180LD		30		349.5	248.5	180	406	139.5	139.5	11	381	—	58	—	184	56	429	(480)
200LD	155 (F)	37, 45	4	355	271	200	446	159	152.5	11	421	—	64	—	145	90	498	(568)
225S		55		425	271	225	446	178	143	11	446	—	70	—	205	90	523	(593)

Frame Number	Dimensions (mm)														Bearing Number		Approximate Unloaded Mass (kg)
	Motors							Shaft End							Load Side	Anti-Load Side	
	L	M	ML	N	X	XB	Z	Q	QK	R	S	T	U	W			4 Poles
80M	262	160	—	125	15	50	9	40	32	140	19j6	6	3.5	6	6204ZZ	6204ZZ	13
90L	311.5	175	—	150	15	56	9	50	40	168.5	24j6	7	4	8	6205ZZ	6205ZZ	20
100L	366	200	212	180	4	63	12	60	45	193	28j6	7	4	8	6206ZZ	6205ZZ	29
112M	381	230	242	180	4	70	12	60	45	200	28j6	7	4	8	6207ZZ	6206ZZ	39
132S	450.5	256	268	180	4	89	12	80	63	239	38k6	8	5	10	6308ZZ	6207ZZ	56
132M	488.5	256	268	218	4	89	12	80	63	258	38k6	8	5	10	6308ZZ	6207ZZ	65
160M	575	310	—	254	4	108	14.5	110	90	323	42k6	8	5	12	6309ZZ	6308ZZ	100
160L	619	310	—	298	4	108	14.5	110	90	345	42k6	8	5	12	6309ZZ	6308ZZ	120
180M	644	335	—	285	4	121	14.5	110	90	351.5	48k6	9	5.5	14	6311ZZ	6310ZZ	150, 155
180LD	720	341	—	323	4	121	14.5	110	90	370.5	55m6	10	6	16	6312ZZ	6311ZZ	245
200LD	780.5	390	—	361	4	133	18.5	140	110	425.5	60m6	11	7	18	6315ZZ	6312ZZ	290, 315
225S	857	428	—	342	4	149	18.5	140	110	432	65m6	11	7	18	6315ZZ	6312ZZ	370

- * The vertical tolerance for the shaft center is ± 0.5 .
- Since outline drawings are shown by representative models, some appearances may slightly differ depending on the frame number.
- Make sure to inquire when requiring exact external dimensions, since the external dimensions may be partially modified due to the refinement process, etc.
- For frame number 180 LD, the terminal box is on top of the motor, not side-mounted. (Differ from 180M.)

SF-PRO 80M~225S FOOT TYPE

TOTALLY ENCLOSED FAN-COOLED TYPE, IP44 DEGREES OF PROTECTION (Outdoor Waterproof Motor)

Features

Waterproof performance (IP44 Degrees of protection)

Complies with the water spray test prescribed by JIS C 4034-5.



Construction

The main parts of the motor are the same as of SF-PR type, but in order to provide stable operation even under severe outdoor conditions, such as wind, rain and snow, etc. special consideration is given to the following.

1. Shaft through part

Both the load side and the anti-load side are provided with a fringer that rotates together with the shaft so as to prevent water leaking inside the motor. In addition, an end cover is mounted to the load side to further improve the waterproofing.

* On the vertical flange and horizontal flange type motors, fringer is provided only on the anti-load side. Note that the shaft through part does not have a waterproof structure since the load side is incorporated into the mating machine.

2. Terminal box

Terminal boxes with frame numbers from 80 to 180 are made of steel plate, and those with number 200 or higher are made of cast iron. To ensure waterproof structure, a gasket is provided between the base and the cover. Terminal block connection method is used for frame numbers 80 to 132, and lead wire connection method is used for frame numbers 160 and higher. Also, since the external cable entry port is parallel pipe threaded, conduits and watertight cable glands can be installed.

* When changing the direction of the cable entry port, be sure to firmly seal the piping so as to prevent the ingress of water, dust, etc.

3. Mating part

Liquid gasket is applied to the frame and bracket mating section to improve the waterproof performance. Reapply the liquid gasket when disassembling and reassembling the motor.

4. Installation method

Waterproof performance is provided in the installation direction shown in the dimensional drawings; inquire in the case of non-standard installation.

5. Coating

Coated with paint that is excellent in weather resistance, saltwater resistance, and chemical resistance.

Example of shaft through structure on outdoor waterproof motor (foot-mounted type)

Frame Number	Anti-Load Side	Load Side
80 - 225		

Terminal box detailed view

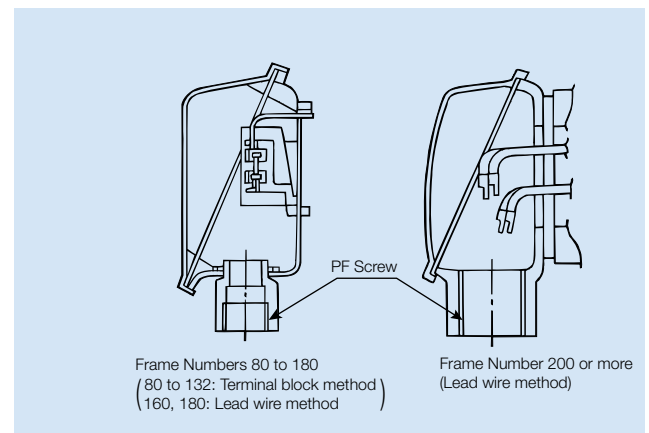

Dimensional Drawings

SF-PRO Outdoor Waterproof Motor

Figure - 1

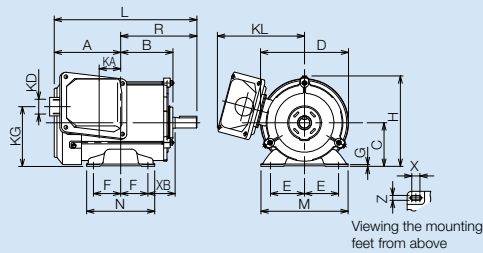
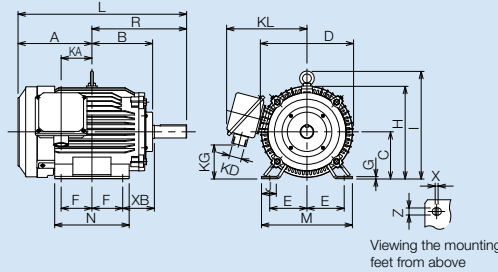

Figure - 3



Shaft End Dimensions

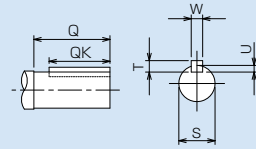

Figure - 2

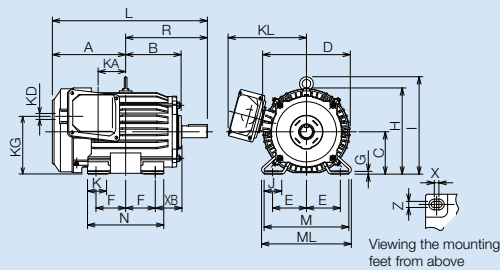
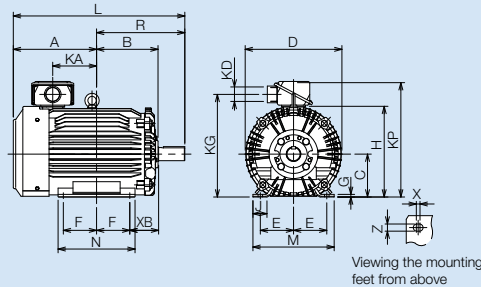

Figure - 4



* Since the key groove is machined with end mill, there is no roundness at the groove bottom.

Dimension Table

Frame Number	Thermal Class	Output (kW)	Figure Number	Dimensions (mm)															
				Motors															
				A	B	C*	D	E	F	G	H	I	J	K	KA	KD	KG	KL(KP)	
80M	120 (E)	0.75	1	122	96	80	162	62.5	50	3.2	166	—	—	—	39.5	PF 3/4	109	168	
90L		1.5		143	114.5	90	184	70	62.5	4	191	—	—	53	PF 3/4	123	173		
100L		2.2		173	131	100	207	80	70	6.5	203.5	230	40	45	65	PF 3/4	136	185	
112M		3.7		181	138	112	228	95	70	6.5	226	253	40	45	69	PF 3/4	151	196	
132S	130 (B)	5.5	2	211.5	155	132	266	108	70	6.5	265	288	40	45	75	PF 1	177	223	
132M		7.5		230.5	174	132	266	108	89	6.5	265	288	40	45	94	PF 1	177	223	
160M		11		252	207	160	318	127	105	8	316	367	50	—	105	PF 1 1/4	116	274	
160L		15		274	229	160	318	127	127	8	316	367	50	—	127	PF 1 1/4	116	274	
180M	155 (F)	18.5,22	3	292.5	235.5	180	363	139.5	120.5	8	359	410	50	—	127	PF 1 1/2	140	296	
180LD		30		349.5	258	180	406	139.5	139.5	11	381	—	58	—	184	PF 2	432	(487)	
200LD		37,45		355	282	200	446	159	152.5	11	421	—	64	—	145	PF 2	487	(567)	
225S		55		425	282	225	446	178	143	11	446	—	70	—	205	PF 2 1/2	512	(592)	

Frame Number	Dimensions (mm)														Bearing Number		Approximate Unloaded Mass (kg)
	Motors							Shaft End							Load Side	Anti-Load Side	
	L	M	ML	N	X	XB	Z	Q	QK	R	S	T	U	W			4 Poles
80M	262	160	—	125	15	50	9	40	32	140	19j6	6	3.5	6	6204ZZ	6204ZZ	13
90L	311.5	175	—	150	15	56	9	50	40	168.5	24j6	7	4	8	6205ZZ	6205ZZ	20
100L	366	200	212	180	4	63	12	60	45	193	28j6	7	4	8	6206ZZ	6205ZZ	29
112M	381	230	242	180	4	70	12	60	45	200	28j6	7	4	8	6207ZZ	6206ZZ	39
132S	450.5	256	268	180	4	89	12	80	63	239	38k6	8	5	10	6308ZZ	6207ZZ	56
132M	488.5	256	268	218	4	89	12	80	63	258	38k6	8	5	10	6308ZZ	6207ZZ	65
160M	575	310	—	254	4	108	14.5	110	90	323	42k6	8	5	12	6309ZZ	6308ZZ	100
160L	619	310	—	298	4	108	14.5	110	90	345	42k6	8	5	12	6309ZZ	6308ZZ	120
180M	644	335	—	285	4	121	14.5	110	90	351.5	48k6	9	5.5	14	6311ZZ	6310ZZ	150,155
180LD	720	341	—	323	4	121	14.5	110	90	370.5	55m6	10	6	16	6312ZZ	6311ZZ	245
200LD	780.5	390	—	361	4	133	18.5	140	110	425.5	60m6	11	7	18	6315ZZ	6312ZZ	300,325
225S	857	428	—	342	4	149	18.5	140	110	432	65m6	11	7	18	6315ZZ	6312ZZ	380

* The vertical tolerance for the shaft center is ± 0.05 .

● Since outline drawings are shown by representative models, some appearances may slightly differ depending on the frame number.

● Make sure to inquire when requiring exact external dimensions, since the external dimensions may be partially modified due to the refinement process, etc.

● For frame number 180 LD, the terminal box is on top of the motor, not side-mounted. (Differ from 180M.)

SF-PRP 80M~225S FOOT TYPE

TOTALLY ENCLOSED FAN-COOLED TYPE, IP55 DEGREES OF PROTECTION (Outdoor Dust & Water jet proof Motor)

Features

Dust & Water jet proof performance (IP55 Degrees of protection)

Passed the dust and the water spray test for compliance with JIS C 4034-5, so it can be used with confidence in locations exposed to large quantities of water.

Construction

The main parts of the motor are the same as SF-PR, but in order to provide stable operation under even more severe conditions than those of the outdoor type, special consideration is given to the following.

1. Shaft through part

Both the load side and the anti-load side are provided with a fringer or V-ring that rotate together with the shaft so as to prevent water leaking into the motor. In addition, end covers are mounted on the load side and anti-load side to further improve the dust & water jet proofing.

* The vertical flange type motor has a fringer or V-ring mounted on the anti-load side, while the horizontal flange type motor has a fringer or V-ring and end cover mounted on the anti-load side.

Note that the shaft through part does not have a waterproof structure since the load side of the vertical flange and horizontal flange type motors is incorporated into the mating machine.

2. Terminal box

Terminal boxes with frame numbers from 80 to 180 are made of steel plate, and those with number 200 or higher are made of cast iron. To ensure complete dust & water jet proof structure, a gasket is provided between the base and the cover. Terminal block connection method is used for frame numbers 80 to 132, and lead wire connection method is used for frame numbers 160 and higher. Also, since the external cable entry port is parallel pipe threaded, conduits and watertight cable glands can be installed.

* When changing the direction of the cable entry port, be sure to firmly seal the piping so as to prevent the ingress of water, dust, etc.

Load side shaft through structure on outdoor dust & water jet proof motor

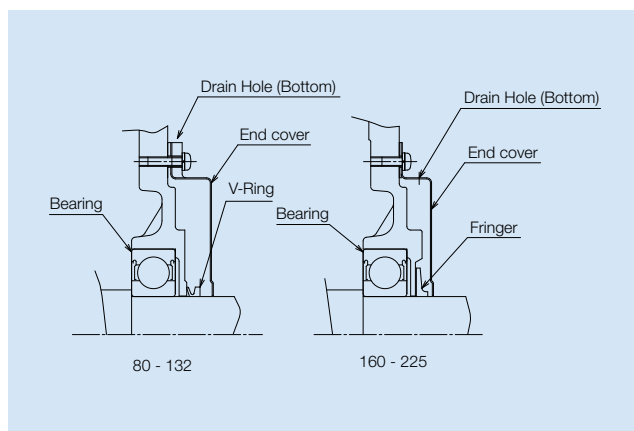

3. Mating part

Liquid gasket is applied to the frame and bracket mating section to improve the dust & water jet proof performance.

Reapply the liquid gasket when disassembling and reassembling the motor.

4. Installation method

Dust & water jet proof performance is provided in the standard installation direction shown in the dimensional drawings; inquire in the case of non-standard installation.

5. Coating

Coated with paint that is excellent in weather resistance, saltwater resistance, and chemical resistance.

Terminal box detailed view

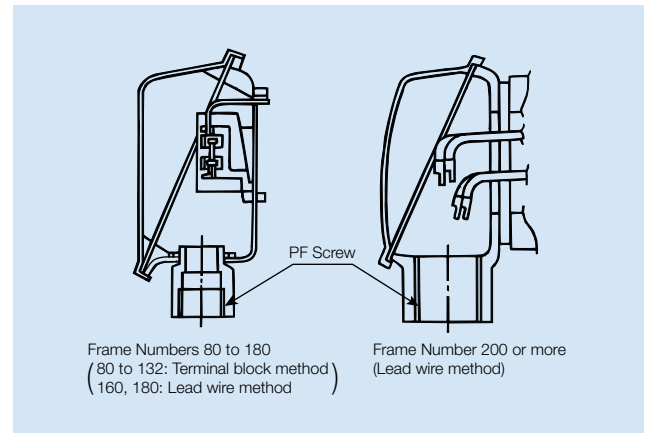

Dimensional Drawings

SF-PRP Outdoor Dust & Water jet proof Motor

Figure - 1

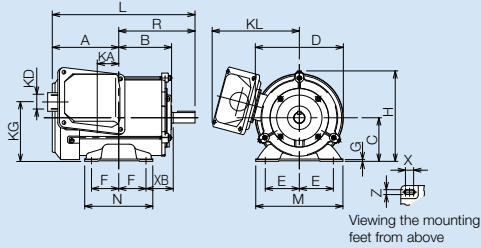
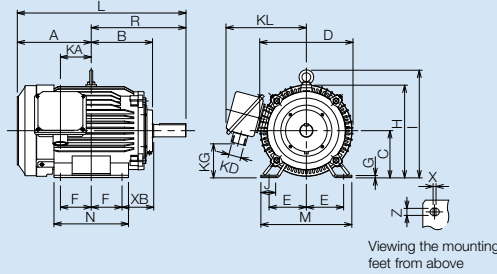

Figure - 3



Shaft End Dimensions

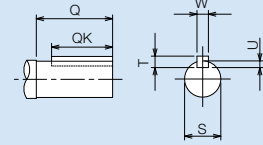

Figure - 2

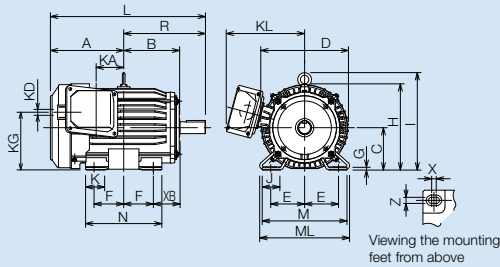
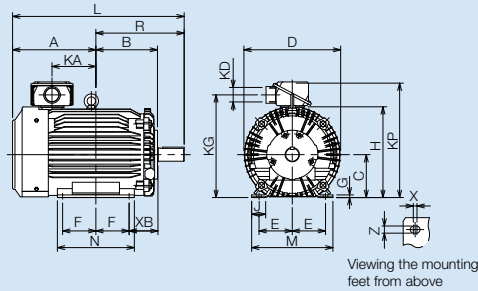

Figure - 4



* Since the key groove is machined with end mill, there is no roundness at the groove bottom.

Dimension Table

Frame Number	Thermal Class	Output (kW) 4 Poles	Figure Number	Dimensions (mm)														
				Motors														
				A	B	C*	D	E	F	G	H	I	J	K	KA	KD	KG	KL(KP)
80M	120 (E)	0.75	1	122	97	80	162	62.5	50	3.2	166	—	—	—	39.5	PF 3/4	109	168
90L		1.5		143	116.5	90	184	70	62.5	4	191	—	—	—	53	PF 3/4	123	173
100L		2.2		173	132	100	207	80	70	6.5	203.5	230	40	45	65	PF 3/4	136	185
112M		3.7		181	139	112	228	95	70	6.5	226	253	40	45	69	PF 3/4	151	196
132S	130 (B)	5.5	2	211.5	158	132	266	108	70	6.5	265	288	40	45	75	PF 1	177	223
132M		7.5		230.5	177	132	266	108	89	6.5	265	288	40	45	94	PF 1	177	223
160M		11		252	209	160	318	127	105	8	316	367	50	—	105	PF 1 1/4	116	274
160L		15		274	231	160	318	127	127	8	316	367	50	—	127	PF 1 1/4	116	274
180M	155 (F)	18.5,22	3	292.5	237.5	180	363	139.5	120.5	8	359	410	50	—	127	PF 1 1/2	140	296
180LD		30		349.5	258.5	180	406	139.5	139.5	11	381	—	58	—	184	PF 2	432	(487)
200LD		37,45		355	282	200	446	159	152.5	11	421	—	64	—	145	PF 2	487	(567)
225S		55		425	282	225	446	178	143	11	446	—	70	—	205	PF 2 1/2	512	(592)

Frame Number	Dimensions (mm)														Bearing Number		Approximate Unloaded Mass (kg)	
	Motors							Shaft End							Load Side	Anti-Load Side		
	L	M	ML	N	X	XB	Z	Q	QK	R	S	T	U	W			4 Poles	
80M	262	160	—	125	15	50	9	40	32	140	19j6	6	3.5	6	6204ZZ	6204ZZ	14	
90L	311.5	175	—	150	15	56	9	50	40	168.5	24j6	7	4	8	6205ZZ	6205ZZ	21	
100L	366	200	212	180	4	63	12	60	45	193	28j6	7	4	8	6206ZZ	6205ZZ	31	
112M	381	230	242	180	4	70	12	60	45	200	28j6	7	4	8	6206ZZ	6206ZZ	42	
132S	450.5	256	268	180	4	89	12	80	63	239	38k6	8	5	10	6308ZZ	6207ZZ	60	
132M	488.5	256	268		4	89	12	80	63	258	38k6	8	5	10	6308ZZ	6207ZZ	69	
160M	575	310	—		254	4	108	14.5	110	90	323	42k6	8	5	12	6309ZZ	6308ZZ	100
160L	619	310	—		298	4	108	14.5	110	90	345	42k6	8	5	12	6309ZZ	6308ZZ	120
180M	644	335	—	285	4	121	14.5	110	90	351.5	48k6	9	5.5	14	6311ZZ	6310ZZ	150,155	
180LD	720	341	—	323	4	121	14.5	110	90	370.5	55m6	10	6	16	6312ZZ	6311ZZ	245	
200LD	780.5	390	—	361	4	133	18.5	140	110	425.5	60m6	11	7	18	6315ZZ	6312ZZ	300,325	
225S	857	428	—	342	4	149	18.5	140	110	432	65m6	11	7	18	6315ZZ	6312ZZ	380	

* The vertical tolerance for the shaft center is -0.5 .

- Since outline drawings are shown by representative models, some appearances may slightly differ depending on the frame number.
- Make sure to inquire when requiring exact external dimensions, since the external dimensions may be partially modified due to the refinement process, etc.
- For frame number 180 LD, the terminal box is on top of the motor, not side-mounted. (Differ from 180M.)

SF-PRV / SF-PRF 80M~225S VERTICAL / HORIZONTAL FLANGE TYPE

TOTALLY ENCLOSED FAN-COOLED TYPE, IP44 DEGREES OF PROTECTION (Vertical / Horizontal Flange Motor)

Dimensional Drawings

SF-PRV Vertical Flange Motor

Figure - 1

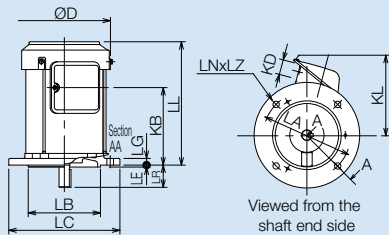

Figure - 3

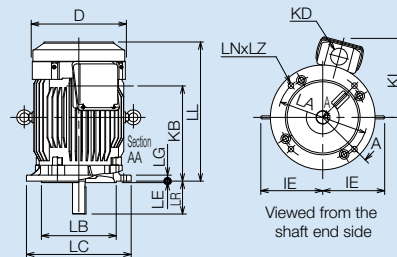

Figure - 2

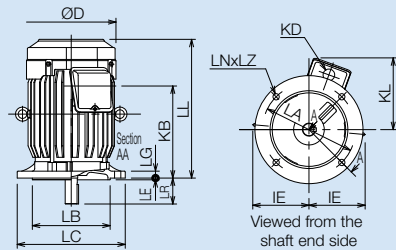
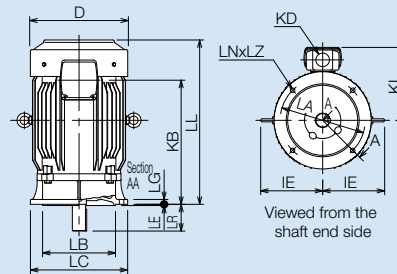
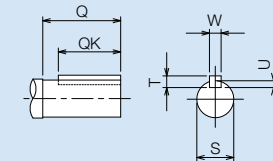

Figure - 4



Shaft End Dimensions



* Since the key groove is machined with end mill, there is no roundness at the groove bottom.

Dimension Table

Flange Number	Frame Number	Thermal Class	Output (kW) 4 Poles	Figure Number	Dimensions (mm)												
					Motors												
					D	IE	KB	KD	KL	LA	LB	LC	LE	LG	LL	LN	LZ
FF165	80M	120 (E)	0.75	1	166	—	139.5	27	145	165	130j6	200	3.5	12	222	4	12
FF165	90L		1.5		202	—	198.5	27	158	165	130j6	200	3.5	12	288.5	4	12
FF215	100L		2.2	207	130	213	27	166	215	180j6	250	4	16	321	4	14.5	
FF215	112M		3.7	228	141	239	27	177	215	180j6	250	4	16	351	4	14.5	
FF265	132S	130 (B)	5.5	2	266	156	256	27	194	265	230j6	300	4	20	392.5	4	14.5
FF265	132M		7.5		266	156	294	27	194	265	230j6	300	4	20	430.5	4	14.5
FF300	160M		11	318	207	318	56	264	300	250j6	350	5	20	465	4	18.5	
FF300	160L		15	318	207	362	56	264	300	250j6	350	5	20	509	4	18.5	
FF350	180M	155 (F)	18.5,22	3	363	230	378.5	56	285	350	300j6	400	5	20	544	4	18.5
FF350	180LD		30		406	255	510.5	56	300	350	300j6	400	5	20	676	4	18.5
FF400	200LD		37,45	446	275	485	90	368	400	350j6	450	5	22	695	8	18.5	
FF500	225S		55	446	—	560	90	368	500	450j6	550	5	22	780	8	18.5	

Flange Number	Frame Number	Dimensions (mm)							Bearing Number		Approximate Unloaded Mass (kg)
		Shaft End							Load Side	Anti-Load Side	
		LR	Q	QK	S	T	U	W			4 Poles
FF165	80M	40	40	32	19j6	6	3.5	6	6204ZZ	6204ZZ	16
FF165	90L	50	50	40	24j6	7	4	8	6205ZZ	6205ZZ	23
FF215	100L	60	60	45	28j6	7	4	8	6206ZZ	6205ZZ	33
FF215	112M	60	60	45	28j6	7	4	8	6207ZZ	6206ZZ	44
FF265	132S	80	80	63	38k6	8	5	10	6308ZZ	6207ZZ	63
FF265	132M	80	80	63	38k6	8	5	10	6308ZZ	6207ZZ	72
FF300	160M	110	110	90	42k6	8	5	12	6309ZZ	6308ZZ	110
FF300	160L	110	110	90	42k6	8	5	12	6309ZZ	6308ZZ	130
FF350	180M	110	110	90	48k6	9	5.5	14	6311ZZ	6310ZZ	170,175
FF350	180LD	110	110	90	55m6	10	6	16	6312ZZ	6311ZZ	265
FF400	200LD	140	140	110	60m6	11	7	18	6315ZZ	6312ZZ	320,345
FF500	225S	140	140	110	65m6	11	7	18	6315ZZ	6312ZZ	415

● Since outline drawings are shown by representative models, some appearances may slightly differ depending on the frame number.

● Make sure to inquire when requiring exact external dimensions, since the external dimensions may be partially modified due to the refinement process, etc.

SF-PRF Horizontal Flange Motor

For SF-PRF Horizontal Flange Motor, please refer to above dimensions detail of SF-PRV Vertical Flange Motor. But there are some differences as follow.

- Standard installation direction is Horizontal.
- Terminal box lead hole direction is downward, perpendicular to shaft direction. (For SF-PRV 80M-90L, their direction is same style as SF-PRF already.)
- Have only 1 eye bolt on top.
- Frame number 225S is not available.



Motor terminal pullout structure and power connections

When connecting lead wires or terminal block terminals to the power supply, use the following table. For motors other than the standard, connect in accordance with the connection nameplate inside the terminal box.

Standard motor terminal pullout structure and power connections

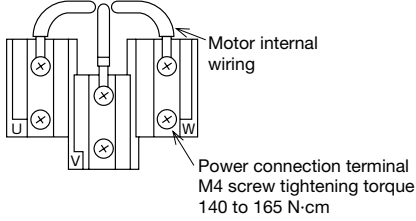
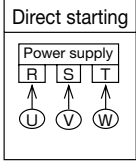
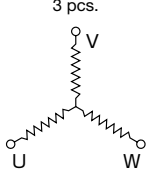
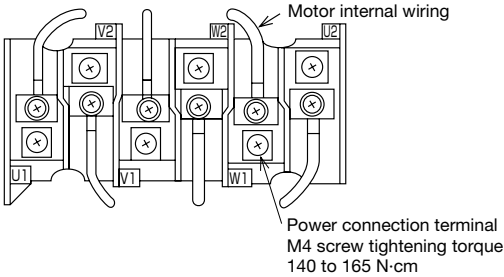
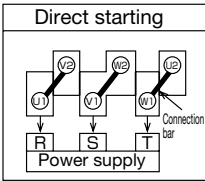
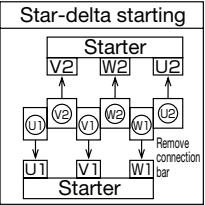
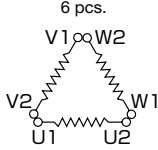
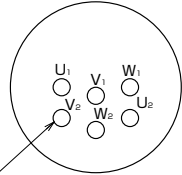
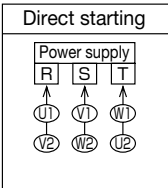
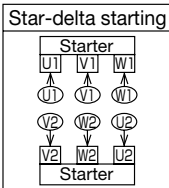
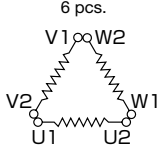
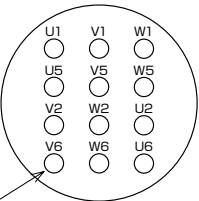
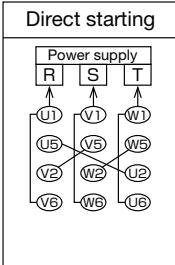
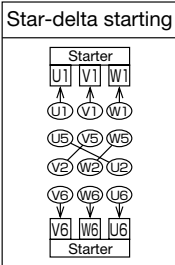
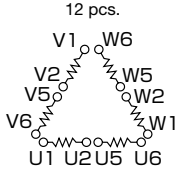
Frame Number	Output (kW)	Terminal pullout structure	Connection method	Lead wire terminal count
	4 Poles			
80 to 112	0.75 to 3.7	<p>Terminal block method</p>  <p>Motor internal wiring</p> <p>Power connection terminal M4 screw tightening torque 140 to 165 N-cm</p>	<p>Direct starting</p> 	<p>3 pcs.</p> 
132	5.5 to 7.5	<p>Terminal block method</p>  <p>Motor internal wiring</p> <p>Power connection terminal M4 screw tightening torque 140 to 165 N-cm</p>	<p>Direct starting</p>  <p>Star-delta starting</p> 	<p>6 pcs.</p> 
160 to 180	11 to 30	<p>Lead wire method</p> <p>Lead wire arrangement</p>  <p>With round crimp terminal (see Note 2) Standard product terminal screws: for M6</p>	<p>Direct starting</p>  <p>Star-delta starting</p> 	
200 to 225	37 to 55	<p>Lead wire method</p> <p>Lead wire arrangement</p>  <p>With round crimp terminal (see Note 2) Standard product terminal screws: for M6</p>	<p>Direct starting</p>  <p>Star-delta starting</p> 	<p>12 pcs.</p> 

Notes (1) Precautions for the star-delta start method
When normal voltage is applied to a motor at rest or only with the neutral point unconnected, depending on the operating environment, the insulation may degrade and cause burning. Therefore, use a star-delta starter with primary side electromagnetic switch (3-contactor type).
If not using a primary side electromagnetic switch, be sure to open the circuit of the power-side switch when the motor is stopped.

(2) Screw size for Lead wire method
6-M6x12 terminal screws are provided with the 6 lead wires type motor, and 9-M6x16 terminal screws are provided with the 12 lead wires type motor.

SF-PRB 80M~225S FOOT TYPE BRAKE MOTOR

TOTALLY ENCLOSED FAN-COOLED TYPE, IP44 DEGREES OF PROTECTION (Motor with Brake)

Features

● Energy saving / CO₂ reduction

- A premium efficiency motor with brake.

● Guaranteed compatibility

- Same mounting dimensions as SF-JRB.
(Can fit into the existing space, except for some models)
- Same motor frame number and mounting dimensions as SF-PR.
- For SF-PRB, the same brake is used as for SF-JRB.

● Low noise

- Due to the sound absorbing material used for the TB-A brake part, it features low noise with less impact sound during brake release. (Operating noise 75 dB or below)



Production Range

Model Name		SF-PRB	SF-PRVB	SF-PRFB	SF-PROB
Number of Poles		4 Poles	4 Poles	4 Poles	4 Poles
Output [kW]	0.75	●	●	●	●
	1.5	●	●	●	●
	2.2	●	●	●	●
	3.7	●	●	●	●
	5.5	●	●	●	●
	7.5	●	●	●	●
	11	●	●	●	●
	15	●	●	●	●
	18.5	★	—	—	—
	22	★	—	—	—
	30	★	—	—	—
	37	★	—	—	—
45	★	—	—	—	
55	★	—	—	—	

●: TB-A brake type
★: ESB brake type

Motor with TB-A Brake

Structure and Operation

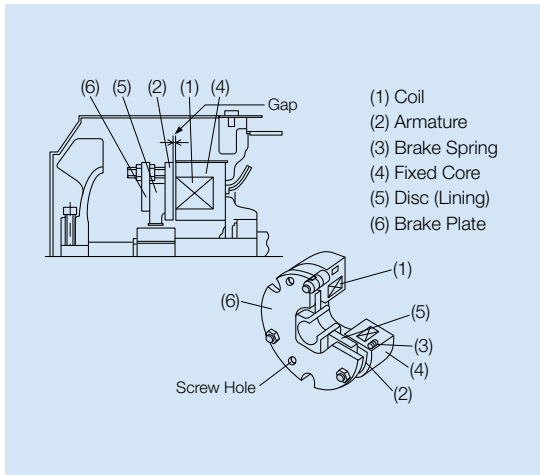

● Operation

When electric current is supplied to the coil, the electromagnetic force causes the armature to overcome the compressive force of the braking spring and be attracted to the fixed core, creating a gap between the armature and the disc and releasing the brake.

When turning off the brake power, the armature is pressed back by the force of the braking spring, pressing the disc against the brake plate, and applying braking due to friction torque. The brakes are always applied when non-conductive.

● Gap adjustment

When the disc (lining) wears out and the gap (electromagnet stroke) increases, the operating sound becomes louder and suction is disabled, which may lead to motor burnout or mechanical damage of the brake.

Be sure to adjust the gap to the initial value before reaching the limit value of the electromagnet stroke.

For details, refer to the instruction manual.

Standard Specifications

Item	Contents			
Enclosure Structure / Model Name	Totally Enclosed Fan-cooled Type SF-PRB			
Voltage / Frequency	380 V 50 Hz			
Degrees of Protection	Motor: IP44 Brake: IP20			
Thermal Class	120 (E): Frame Numbers 80M - 112M 130 (B): Frame Numbers 132S - 160L			
Motor Operating Environment	Ambient Temperature	-20 to 40°C		
	Humidity	95% RH or less		
	Altitude	1000 m above sea level or below		
	Atmosphere	No corrosive/explosive gas, no steam or condensation, minimal dust		
Lead Wire	Number of Leads 3.7 kW or less: 3 5.5 kW or more: 6 Frame number 132 or less uses terminal block method Frame number 160 uses lead wire method Brake leads are connected to the power supply in the terminal box			
Coating Color	Munsell N7			
Applicable Standards	JIS C 4213, JEC-2137-2000			
Braking Method	Non-excited Braking Type (spring braking type)			
Braking Torque	7.5 to 150 N·m			
Brake Power Supply Unit	Power Supply Method	Frame Number	Mounting Location	Input Voltage (VAC)
	Half wave rectifier	80 - 112	Terminal box interior (Figure 1)	380
	Over-excitation ¹⁾	132 160	Terminal box side (Figure 2) Terminal box interior (Figure 3)	380
Insulation Class	Class F			
Mechanical Life	2 million operations			
Applicable Standards	TES 1111			

¹⁾ Power supply units of frame numbers 132 and 160 are dedicated current control type over-excitation power supplies.

Figure 1: Frame numbers 80 to 112 (indoor type)
A varistor is built into the power supply unit.

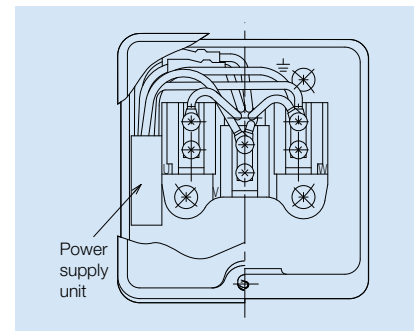

Figure 2: Frame number 132 (indoor type)

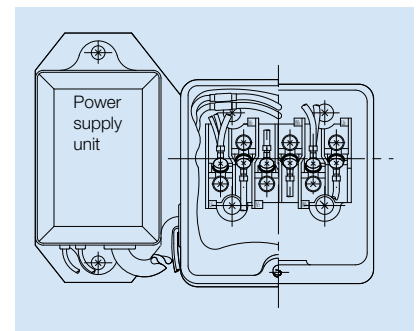
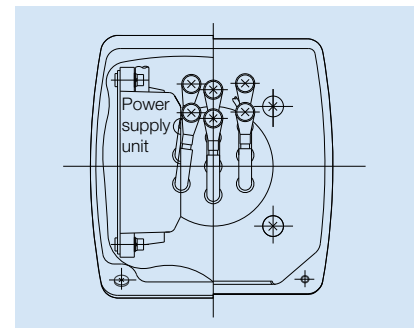

Figure 3: Frame number 160 (indoor type)



Connection with Power Supply

Brake coil and motor coil are connected in parallel, but operating characteristics change according to the connection method. AC simultaneous turn-off connection is generally used, but AC separate turn-off connection is more convenient for shortening operation time. (The factory default setting is AC simultaneous turn-off connection.)
DC turn-off connection is possible to further shorten the operation time.

Item	Frame Number	AC simultaneous turn-off	AC separate turn-off	DC turn-off (using power supply terminal)
Connection Circuit	80			
	112			
	132			
	160			
Coast down time		0.2 to 0.6 sec	0.1 to 0.4 sec	0.01 to 0.05 sec

- Coast down time is extended in AC simultaneous turn-off circuit as circulating current flows through the motor coil and the brake. For fall prevention in lifting applications, or to increase stop positioning accuracy, use DC turn-off connection.
- With DC turn-off, turn off the motor switch simultaneously. The current controlled type over-excitation power supplies with frame numbers 132 to 160 may cause the internal transformer to generate heat, resulting in a breakdown.
- In case of switching surge overvoltage due to AC turn-off or DC turn-off, taking the brake power from the primary side of the motor switch has a reduction effect.
- With DC turn-off, main contacts are recommended for the contacts of the electromagnetic contactor. For auxiliary contacts, there is a risk of contacts welding together.
- Coast down time (armature release time) indicates when the electromagnetic gap is at the initial value.

Connection with Power Supply when Using Inverter Drive

Item	Frame Number	AC separate turn-off	DC turn-off
Connection Circuit	80		
	112		
	132		
	160		

● Wiring of brake power supply

With inverter drive, connect the brake power supply from the primary side (commercial power supply) of the inverter. (The brake cannot operate properly because the voltage of inverter output changes.) Note that frequent turning ON/OFF of the inverter input side switch during inverter operation causes failure of the inverter.

● Brake operation

When continuous operation is performed in the low speed range of inverter drive 900 min⁻¹ or less, brake lining rattle noise may occur, but there is no functional problem. Braking should be done at 1800 min⁻¹ or less.

Brake Manual Release

It is possible to turn on only the brake power supply without turning on the motor, in order to release only the brake without running the motor. This method is effective when the brake is frequently released, and "separate turn-off" is recommended for switching. Even in the non-energized state, the brake can be released manually by the following method.

- (1) Remove external fan cover and external fan.
- (2) Screw the bolts into the 3 screw holes provided on the brake plate and evenly tighten them, pushing the armature toward the fixed core side to release the lining and the motor shaft.
Use 3 bolts with threaded parts the L length shown in the table.
- (3) Be sure to return to the original state after manual release operation.
- (4) In case there is not enough space to remove the external fan cover, just turn on the brake and release it.
- (5) For manual brake release, ensure sufficient space on the opposite shaft-end side of the motor. For details, refer to the instruction manual.

■ Manual release screw

Brake Model Name	Screw Hole Dimensions	Dimensions (mm)
TB-A0.75H	3-M4 screw	12 or more
TB-A1.5H	3-M6 screw	16 or more
TB-A2.2H	3-M6 screw	18 or more
TB-A3.7H	3-M6 screw	18 or more
TB-A7.5H	3-M6 screw	22 or more
TB-A15H	3-M8 screw	35 or more

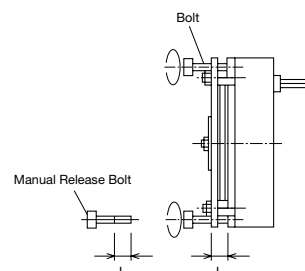

Dimensional Drawings

SF-PRB Motor with TB-A Brake

Figure - 1

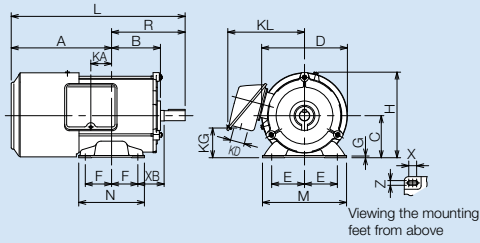
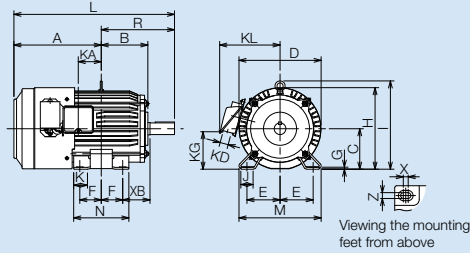

Figure - 3



Shaft End Dimensions

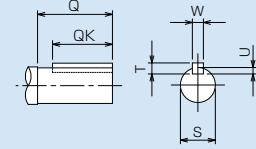

Figure - 2

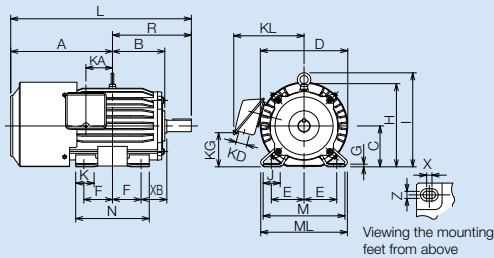
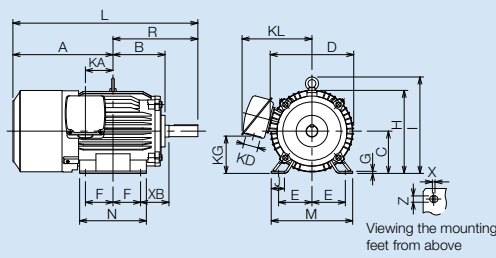

Figure - 4



* Since the key groove is machined with end mill, there is no roundness at the groove bottom.

Dimension Table

Frame Number	Thermal Class	Output (kW)	Brake		Figure Number	Dimensions (mm)														
			4 Poles	Model Name		Torque (N·m)	Motors													
							A	B	C*	D	E	F	G	H	I	J	K	KA	KD	KG
80M	120(E)	0.75	TB-A0.75H	7.5	1	191	93	80	163	62.5	50	3.2	163	—	—	—	39.5	27	55	146
90L		1.5	TB-A1.5H	15		219.5	111.5	90	185	70	62.5	4	191	—	—	—	53	27	68	158
100L		2.2	TB-A2.2H	22	2	249	128	100	214	80	70	6.5	207	230	40	45	65	27	82	172
112M		3.7	TB-A3.7H	37		262	135	112	228	95	70	6.5	226	253	40	45	69	27	97	182
132S	130(B)	5.5	TB-A7.5H	75	3	285	152	132	268	108	70	6.5	266	288	40	45	75	27	120	197
132M		7.5	TB-A7.5H	75		304	171	132	268	108	89	6.5	266	288	40	45	94	27	120	197
160M		11	TB-A15H	150	4	381	198	160	318	127	105	8	316	367	50	—	105	56	142	266
160L		15	TB-A15H	150		403	220	160	318	127	127	8	316	367	50	—	127	56	142	266

Frame Number	Dimensions (mm)															Bearing Number		Approximate Unloaded Mass (kg)
	Motors							Shaft End								Load Side	Anti-Load Side	
	L	M	ML	N	X	XB	Z	Q	QK	R	S	T	U	W			4 Poles	
80M	331	160	—	125	15	50	9	40	32	140	19j6	6	3.5	6	6204ZZ	6204ZZ	17	
90L	388	175	—	150	15	56	9	50	40	168.5	24j6	7	4	8	6205ZZ	6205ZZ	26	
100L	442	200	212	180	4	63	12	60	45	193	28j6	7	4	8	6206ZZ	6206ZZ	37	
112M	462	230	242	180	4	70	12	60	45	200	28j6	7	4	8	6207ZZ	6206ZZ	48	
132S	524	256	268	180	4	89	12	80	63	239	38k6	8	5	10	6308ZZ	6208ZZ	69	
132M	562	256	268	218	4	89	12	80	63	258	38k6	8	5	10	6308ZZ	6208ZZ	78	
160M	704	310	—	254	4	108	14.5	110	90	323	42k6	8	5	12	6309ZZ	6309ZZ	126	
160L	748	310	—	298	4	108	14.5	110	90	345	42k6	8	5	12	6309ZZ	6309ZZ	146	

* The vertical tolerance for the shaft center is ± 0.05 .

● Brake power supply units of frame numbers 80 to 112 and 160 are built into the terminal box. For frame number 132, the unit is mounted on the side of the terminal box.

● Brake supply power wiring is factory installed AC simultaneous turn-off connection.

For lifting applications, or to increase stop positioning accuracy, use a DC turn-off connection (using power supply terminal).

● Since outline drawings are shown by representative models, some appearances may slightly differ depending on the frame number.

● Make sure to inquire when requiring exact external dimensions, since the external dimensions may be partially modified due to the refinement process, etc.

Motor with ESB Brake

Structure and Operation

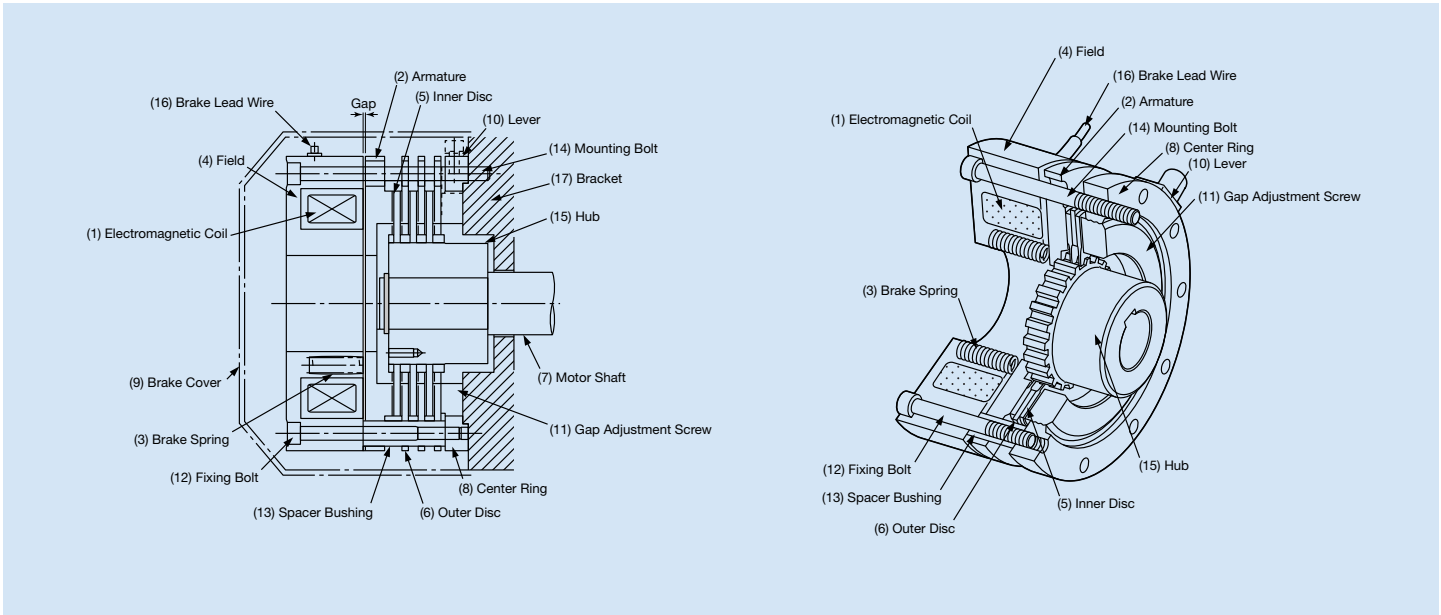

● Operation

When electric current is supplied to the electromagnetic coil, the electromagnetic force causes the armature to overcome the compressive force of the braking spring and be attracted to the field, creating a gap between the inner and outer discs and releasing the brake. When turning off the brake power, the armature is pressed back by the force of the braking spring, pressing the inner and outer disc against the gap adjustment screw, and applying braking due to friction torque. The brakes are always applied when non-conductive.

● Gap adjustment

When the inner disc lining wears out and the gap (electromagnet stroke) increases, the suction becomes defective, which may lead to motor burnout or mechanical damage of the brake. Be sure to adjust the gap to the initial value before reaching the limit value of the electromagnet stroke. For details, refer to the instruction manual.

Standard Specifications

Item		Standard Specifications	
Motor	Enclosure Structure / Model Name	Totally-enclosed Fancooled Type SF-PRB	
	Voltage / Frequency	380 V 50 Hz	
	Degrees of Protection	Motor: IP44 Brake: IP44	
	Thermal Class	130 (B): Frame number 180M 155 (F): Frame number 180LD or higher	
	Operating Environment	Ambient Temperature	-20°C to 40°C
		Humidity	85% RH or less (no condensation)
		Altitude	1000 m above sea level or below
		Atmosphere	No corrosive/explosive gas, no steam or condensation, minimal dust
	Lead Wire	Motor: 6 Brake: 2	
	Coating Color	Munsell N7	
Applicable Standards	JIS C 4213, JEC-2137-2000		
Brake	Braking Method	Non-excited Braking Type (spring braking type)	
	Braking Torque	300 to 600 N·m	
	Voltage	Brake operating voltage 90 VDC (Power supply unit is not provided, so provide separately)	
	Insulation Class	Class E	
	Mechanical Life	1 million operations	
	Applicable Standards	TES 1111	

Wiring

Since the ESB type electromagnetic brake is powered by direct current, a power supply unit is required to obtain DC from an AC power supply. The power supply unit that converts energy from AC to DC is not built into the motor and must be provided separately.

Single-phase 200 VAC is required for brake power supply.

(Note that the power supply unit HD-110M3 cannot be used for SF-PRB.)

Note 1) When the motor requires 380 V 50 Hz power supply, the input to the power supply unit via the transformer should be 200 V.

Note 2) With inverter drive, connect to the primary side of the inverter.

Power supply unit

(HD-120M, manufactured by Osaki Electric Clutch and Brake Ltd.)

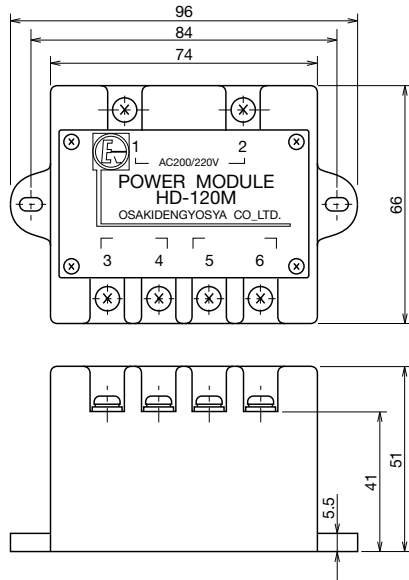

Brake lead wire connection guidelines

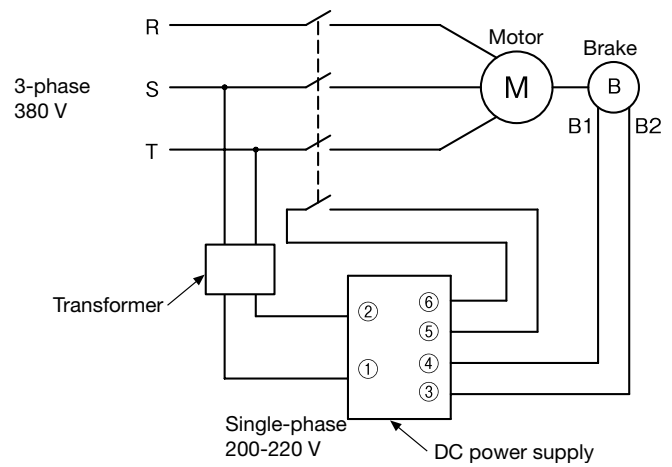

Brake Manual Release

It is possible to turn on only the brake power supply without turning on the motor, in order to release only the brake without running the motor. Even in the non-energized state, the brake can be released manually by the following method.

- (1) Remove the brake cover.
- (2) Pass the loosening bolts through the 2 holes provided in the field and screw them into the screw holes on the armature plate. Tighten until the gap between the armature and the field is closed and release the brake.
Use 2 bolts as specified in the table.
- (3) For manual brake release, ensure sufficient space on the opposite shaft-end side of the motor. For details, refer to the instruction manual.

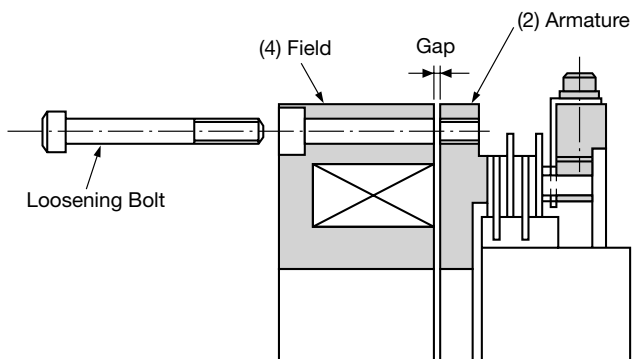

Loosening bolts (hexagon socket head bolts) dimension table

Brake Model Name	Bolt Dimensions
ESB-220	M10 x length 60
ESB-250(S)	M12 x length 65

Dimensional Drawings

SF-PRB Motor with ESB Brake

Figure - 1

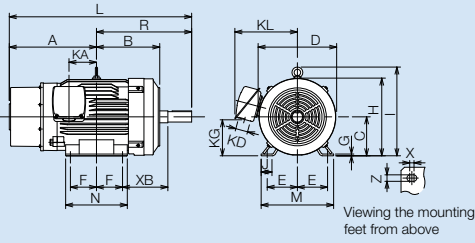
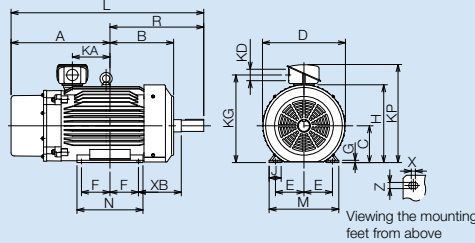
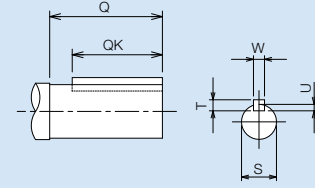

Figure - 2



Shaft End Dimensions



* Since the key groove is machined with end mill, there is no roundness at the groove bottom.

Dimension Table

Frame Number	Thermal Class	Output (kW)	Brake		Figure Number	Dimensions (mm)														
			4 Poles	Model Name		Torque (N-m)	Motors													
							A	B	C*	D	E	F	G	H	I	J	KA	KD	KG	KL(KP)
180M	130(B)	18.5,22	ESB-220	300	1	403	292.5	180	363	139.5	120.5	8	359	410	50	127	56	168	289	
180LD	155(F)	30	ESB-250S	450	2	484	311.5	180	406	139.5	139.5	11	381	—	58	184	56	429	(480)	
200LD		37,45	ESB-250S	450		474	355	200	446	159	152.5	11	421	—	64	145	90	492	(568)	
225S		55	ESB-250	600		546	370	225	446	178	143	11	446	—	70	205	90	517	(593)	

Frame Number	Dimensions (mm)													Bearing Number		Approximate Unloaded Mass (kg)
	Motors						Shaft End							Load Side	Anti-Load Side	
	L	M	N	X	XB	Z	Q	QK	R	S	T	U	W			4 Poles
180M	843	335	285	4	209.5	14.5	110	90	440	48k6	9	5.5	14	6213ZZ	6310ZZ	195,200
180LD	943	341	323	4	209.5	14.5	110	90	459	55m6	10	6	16	6213ZZ	6311ZZ	290
200LD	1017	390	361	4	250.5	18.5	140	110	543	60m6	11	7	18	6313ZZ	6312ZZ	345,370
225S	1103	428	342	4	274	18.5	140	110	557	65m6	11	7	18	6315ZZ	6313ZZ	445

* The vertical tolerance for the shaft center is ± 0.05 .

- Since outline drawings are shown by representative models, some appearances may slightly differ depending on the frame number.
- Make sure to inquire when requiring exact external dimensions, since the external dimensions may be partially modified due to the refinement process, etc.
- Note that for frame number 180 LD, the terminal box is on top of the motor, not side-mounted. (Differ from 180M.)

Brake Capacity Selection

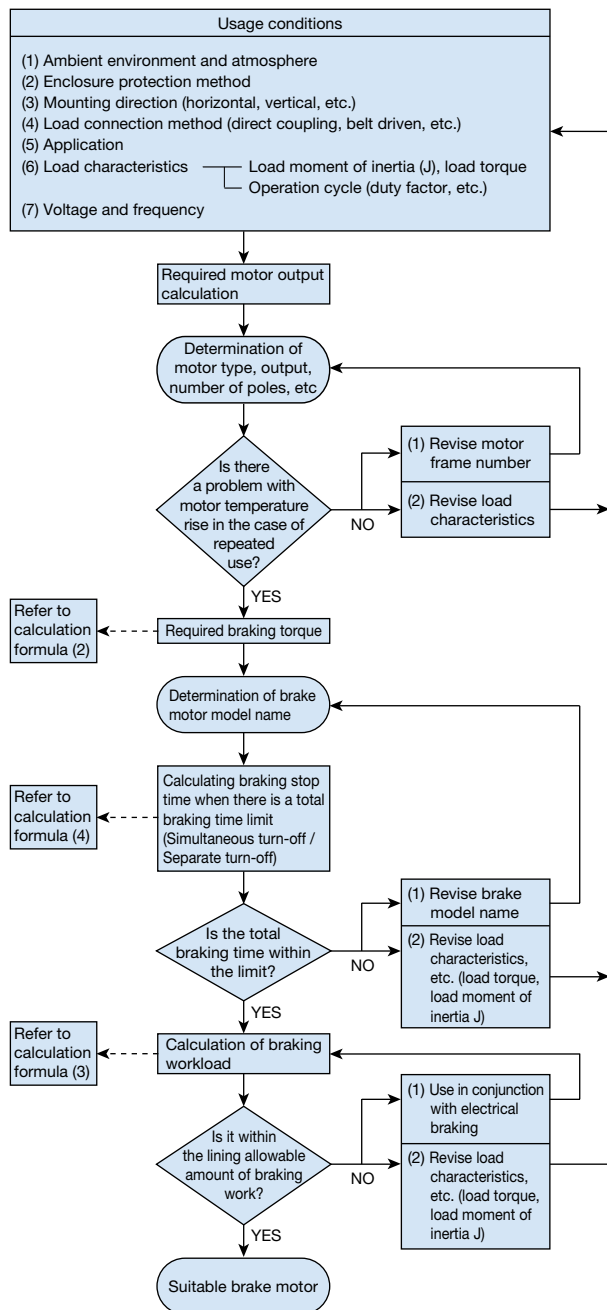

When selecting a brake motor, consider the following issues in addition to the standard ratings of the motor (output, rotation speed, voltage, frequency, time rating).

Braking torque

$$T_M = \frac{9550 \times P}{N} \quad (\text{N} \cdot \text{m}) \quad \dots \quad (1)$$

T_M : Motor rated torque (N·m)
 P : Motor rated output (kW)
 N : Motor rated rotation speed (min⁻¹)

$$T_B = k \times T_M \quad (\text{N} \cdot \text{m}) \quad \dots \quad (2)$$

T_B : Braking torque
 k : Safety factor

Braking frequency

With a large load moment of inertia or frequent starting and stopping, it is necessary to consider motor heat build-up at start-up, and brake heat build-up during braking.

Allowable braking frequency

Braking workload per minute can be obtained by the following formula.

$$E = \frac{(J_M + J_L) \times N^2}{182} \times \frac{T_B}{T_B \pm T_L} \times n \quad \dots \quad (3)$$

E : Braking workload per minute (J)
 J_M : Motor moment of inertia (kg·m²)
 J_L : Load moment of inertia (kg·m²)
 T_B : Braking torque (N·m)
 T_L : Load torque (N·m)
 n : Frequency per minute (times/min)

The value obtained by the above equation and the braking workload per brake operation must be within the allowable braking workload. In case the load torque T_L makes the motor output shaft increase, calculate it as (-).

Braking time

Braking stop characteristics are as follows.

The brake operates for a certain time (coast down time) after the power is turned off; the braking continues virtually linearly (braking time) and then stops.

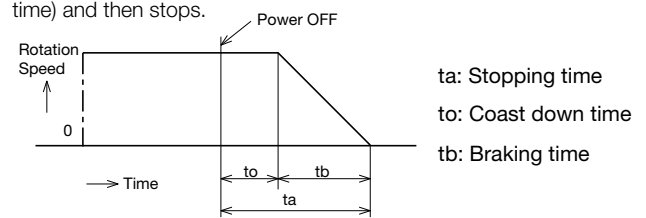

(1) Stopping time calculation formula

$$t_a = t_o + t_b = t_o + \frac{\Sigma J \cdot N}{9.55 (T_B + T_L)} \quad \dots \quad (4)$$

t_a : Full braking time (s)
 ΣJ : Motor shaft converted total moment of inertia (kg·m²)
 N : Motor rated rotation speed (min⁻¹)
 T_B : Brake static friction torque (N·m)
 T_L : Load resistance torque (N·m)
 t_o : Coast down time (s)
 t_b : Braking time (s)

Here it is calculated with static friction torque as braking torque, but actually the numerical value of the average dynamic friction torque is used. The coast-down time "to" from power off to braking operation start varies depending on the power supply connection method of the brake electromagnet (internal connection simultaneous turn-off, external connection separate connection turn-off). Since the load falls during the coast-down time "to" in hoists, etc. make sure to use a quick break circuit such as a DC cutoff to quickly cut the motor shaft rotation speed in its falling speed at the start of braking, so as not to exceed the rated rotation speed of the motor.

Precautions for inverter drive

- (1) Connect the brake power supply from the primary side (commercial power supply) of the inverter.
- (2) When continuous operation is performed in the low speed range of inverter drive 900 min⁻¹ or less, brake lining rattle noise may occur, but there is no functional problem.
- (3) Braking with inverter drive should be done at 1800 min⁻¹ or less.

Precautions for replacement from other brakes

- (1) Note that gap adjustment frequency and lining replacement intervals vary, because the lining wear rate and the allowable wear amount differ depending on the model name and type of brake.
- (2) There is also a difference in the operating time depending on the model name and type of the brake, so caution is necessary especially when fast operation is required.

SUPER LINE P SERIES

THREE PHASE

INDUCTION MOTOR

PREMIUM EFFICIENCY **IE3**

Global Partner. Local Friend.

The History of High Efficiency

1921	Mitsubishi Electric Corporation established	2012	Super Line Premium Series / SF-PR (United States energy efficiency standards compliant type) released
1924	Nagoya Works established / Electric motor production begins	2013	SF-PR (Japanese regulations compliant type) released
1974	Shinshiro Factory established / Super Line Series SF-E released	2014	SF-PR-KR Korea energy efficiency standards compliant (dedicated series) / SF-PR-EU European energy efficiency standards compliant (dedicated series)
1983	80/90 frames switched to steel plate / Power-saving type (later SF-JRM) released		SF-PR-SC Vector controlled with PLG (dedicated series)
1984	Super Line Series SF-J(R) released	2015	SF-PR-UL United States EISA / UL standards compliant (dedicated series)
1985	100-132 frames switched to steel plate		SF-PR-MX Mexico energy efficiency standards compliant (dedicated series)
1990	160-225 frames switched to steel plate		SF-PR-VS Marine standards (MK, JG) compliant (dedicated series)
1999	Super Line Eco Series SF-HR released	2016	SF-PR-RU Russia energy efficiency standards compliant (dedicated series)
2001	SF-HR EPAAct compliant		SF-PR-VN Vietnam energy efficiency standards compliant (dedicated series)
2002	SF-HR JS C 4212 compliant		
2011	SF-HR China energy efficiency standards compliant (dedicated series) / SF-HR European energy efficiency standards compliant (dedicated series)		

 : Equivalent to IE3
 : Equivalent to IE2
 : Equivalent to IE1

MITSUBISHI ELECTRIC AUTOMATION (THAILAND) CO., LTD.
 No.111 Soi Serithai 54 T.kannayao, A.Kannayao Bangkok 10230 Thailand
www.meath-co.com