

**HOBART**701 S Ridge Avenue, Troy, OH 45374  
1-888-4HOBART • www.hobartcorp.com**FP300  
FOOD PROCESSOR****HOBART****STANDARD FEATURES**

- Red OFF, Green ON Button
- Compact Design
- Angled Front
- Planetary Drive
- Large Half Size Feed Hopper
- All Aluminum Hopper and Housing
- Double Interlock Switch
- Plate Speed of 430 RPMs

**OPTIONS**

- Maximum Security Correctional Package

**ACCESSORIES**

- 3-Pack Plates:  $\frac{1}{16}$ ,  $\frac{5}{32}$  slicer plates,  $\frac{3}{16}$  shredder plate, 1 wall rack
- 6-Pack Plates:  $\frac{1}{16}$ ,  $\frac{5}{32}$ ,  $\frac{3}{8}$ ,  $\frac{7}{32}$  slicer plates,  $\frac{3}{16}$  shredder plate and  $\frac{3}{8}$  dicer plate, 2 wall racks
- 3-Peg Wall Rack: designed to hold three plates for additional plate storage
- Slicer Plates:  $\frac{1}{16}$ ,  $\frac{1}{8}$ ,  $\frac{5}{32}$ ,  $\frac{3}{8}$ ,  $\frac{3}{8}$  HD,  $\frac{7}{32}$  and  $\frac{9}{16}$ ;  $\frac{3}{16}$  crimping plate
- Julienne Plates:  $\frac{3}{32}$ ,  $\frac{3}{16}$ ,  $\frac{7}{32}$ ,  $\frac{3}{8}$
- Dicer Grids:  $\frac{9}{32}$ ,  $\frac{3}{8}$ ,  $\frac{1}{2}$ ,  $\frac{5}{8}$ ,  $\frac{3}{4}$ , and 1; soft dice  $\frac{5}{16}$ ,  $\frac{3}{8}$ ,  $\frac{1}{2}$ ,  $\frac{5}{8}$

\*NOTE: The  $\frac{3}{4}$  dicer grid or the 1" dicer grid should be used with the  $\frac{9}{16}$  slicer plate only.

- Shredder Plates:  $\frac{1}{16}$ ,  $\frac{3}{32}$ ,  $\frac{1}{8}$ ,  $\frac{3}{16}$ ,  $\frac{5}{16}$ ,  $\frac{7}{32}$
- Grater Plate: Fine
- French Fry:  $\frac{3}{8}$
- Machine Table: Adjustable height table to hold Food Processor
- Adjustable height stainless steel lug cart
- Stainless steel receiving pan
- Plastic receiving pan

**MODELS**

- FP300 Continuous Feed Half Size Hopper Food Processor

Specifications, Details and Dimensions on Inside and Back.

**FP300 FOOD PROCESSOR**

# FP300 FOOD PROCESSOR



701 S Ridge Avenue, Troy, OH 45374  
1-888-4HOBART • www.hobartcorp.com

## SOLUTIONS/BENEFITS

### Red OFF, Green ON Button

Ease of use

- Operator can readily recognize

### Compact Design

Ease of use, small footprint, reduced labor, increased sanitation and productivity

- Occupies minimal counter space
- Unit and receiving pan fit on 27" deep counter
- Plates remove in seconds
- Feed hopper removes without tools for ease of cleaning
- Produces consistent quality product results in seconds
- Production capability for 16 lbs. per minute

### Angled Front

Operator convenience, ease of use

- 45° angle for ease of product loading
- Helps to reduce operator fatigue

### Planetary Drive

Performance, reliability

- Helps to prevent stalling under heavy loads
- No rest times required between loads

### Large Half Size Feed Hopper

Flexibility, convenience, reduced labor

- Supports processing capabilities for large variety of products
- Design permits continuous cutting of long products
- Eliminates precutting

### All Aluminum Hopper and Housing

Durability, sanitation

- Anodized finish resists harsh cleaners
- Easy clean up

### Double Interlock Switch

Protection

- Prevents machine from running when pusher plate swings away or is open

### Plate Speed of 430 RPM

Product quality and consistency

- Precise cutting and dicing action without bruising or mashing of products

## 3 PAK



1/16" Slicing Plate



5/32" Slicing Plate



3/16" Shredder Plate



Wall Rack

## 6 PAK 3 Pack Plus



7/32" Slicing Plate



3/8" HD Slicing Plate

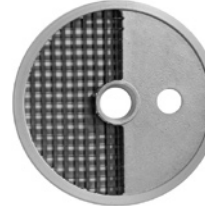

3/8" Dicing Plate

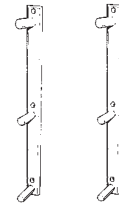

(2) Wall Racks



701 S Ridge Avenue, Troy, OH 45374  
1-888-4HOBART • www.hobartcorp.com

# FP300 FOOD PROCESSOR

## SPECIFICATIONS

**DESIGN:** Compact, conveniently designed at 45° angle for operator convenience. Base occupies minimal counter space. Housing constructed of anodized aluminum with rubber feet on base to prevent movement or skidding. Removable hopper front is burnished aluminum.

**ELECTRICAL:** 120/60/1, 3 Conductor power cord (14 AWG) is 6 feet in length.

**MOTOR:** 10 amps. Gear driven operating at 430 RPM output. 1 H.P. with overload protection.

**SWITCHES:** Easy to operate (red) OFF and (green) ON switch. Pusher plate and hopper front are interlocked.

**STANDARD EQUIPMENT:** Basic unit comes with deflector plate and cleaning brush.

**WARRANTY:** Unit has full one-year warranty on parts, labor and mileage against manufacturer's defects. Service contracts are available.

**CUTTING TOOLS:** Plates feature aluminum or acetal thermoplastic supports combined with cutlery grade stainless steel cutting surfaces.

**WEIGHT:** Net - 66 lbs. Approximate Shipping - 72 lbs.

## ASSEMBLY PARTS

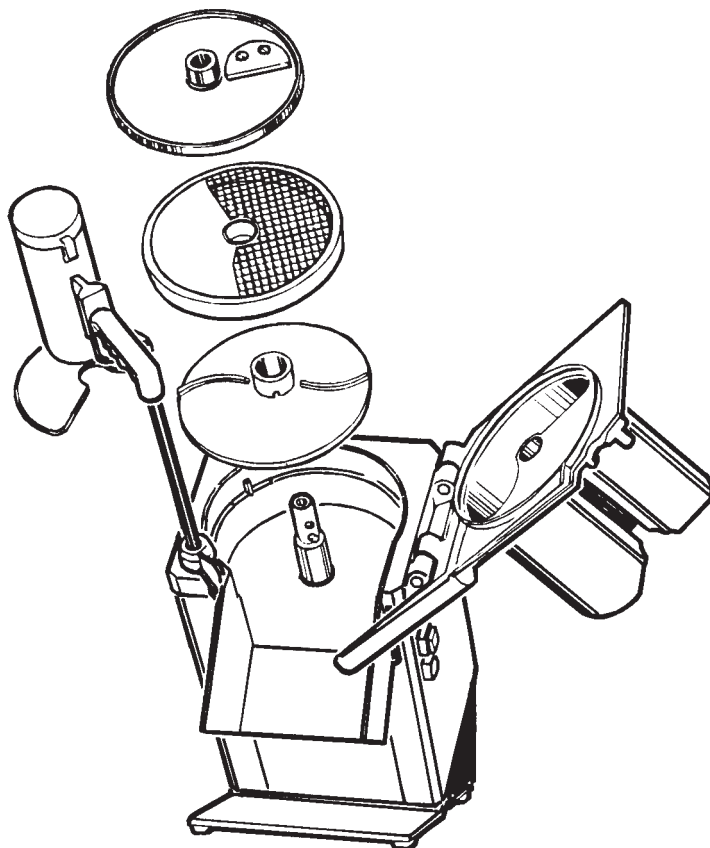

## PRODUCT LOADING

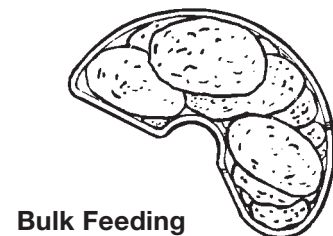

Bulk Feeding

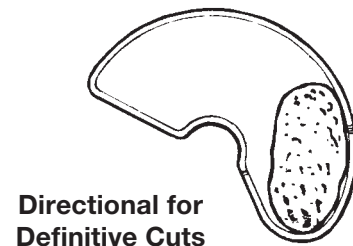

Directional for  
Definitive Cuts



Tube Feeding for  
Long Products

# FP300 FOOD PROCESSOR



701 S Ridge Avenue, Troy, OH 45374  
1-888-4HOBART • www.hobartcorp.com

## DETAILS AND DIMENSIONS

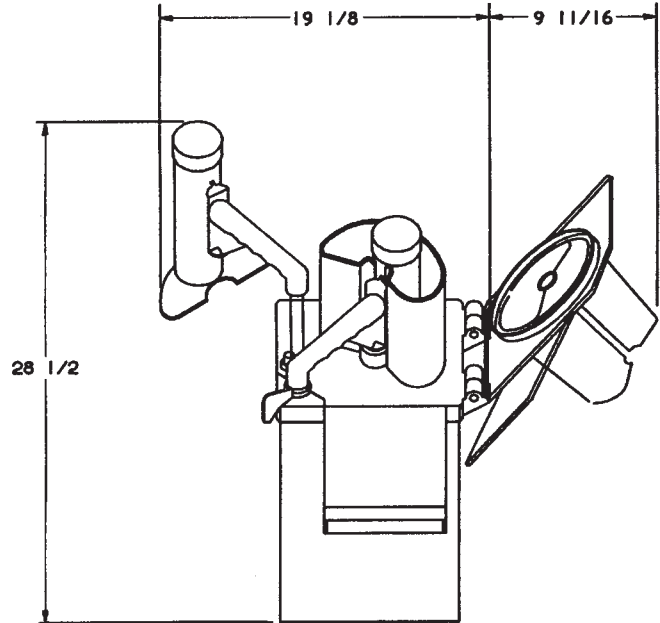
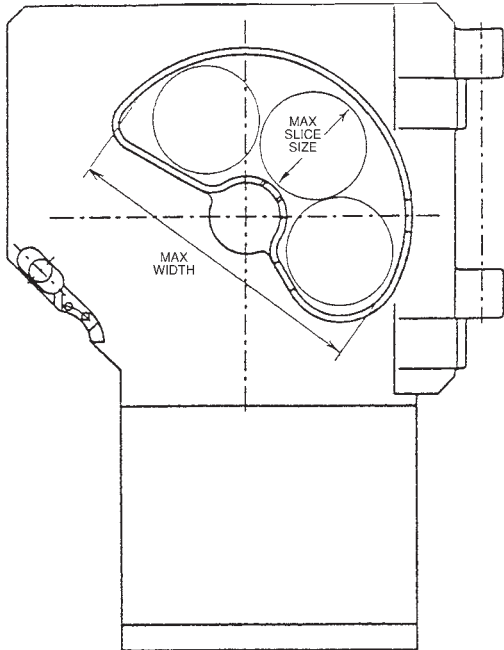

### FP300

Hopper Diameter	7 <sup>3</sup> / <sub>8</sub> "
Maximum Slice Size	3"
Usable Depth	7"
Feed Tube Diameter	2 <sup>5</sup> / <sub>16</sub> "

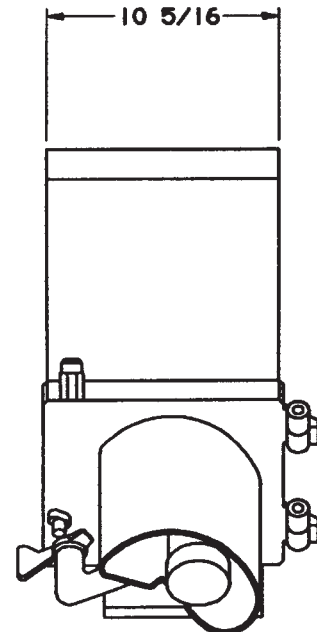
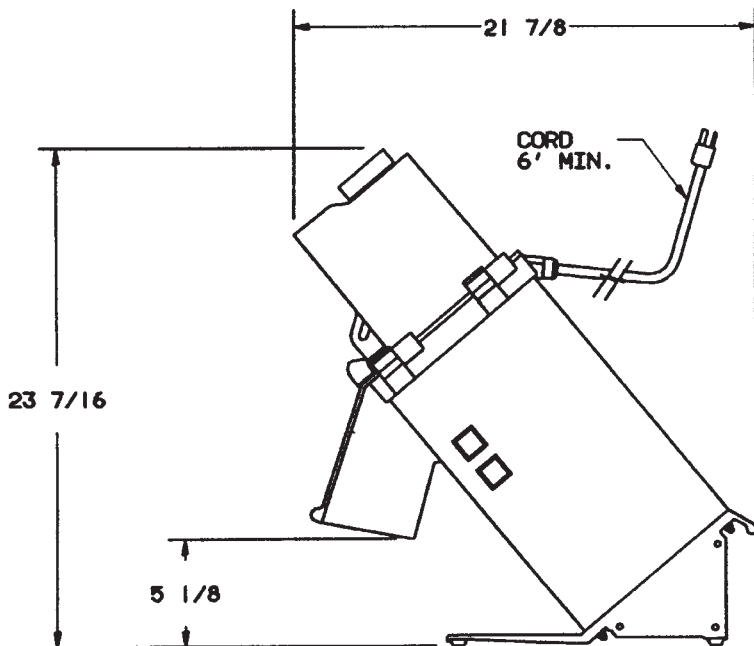

As continued product improvement is a policy of Hobart, specifications are subject to change without notice.