



B140-S100



PROFESSIONAL MACHINERY TOOLS



PROFESSIONAL MACHINERY TOOLS



- SSK PLUS CHUCK SSK10 - 高速精密刀桿 ————— 1
- SSK PLUS CHUCK SSK - 高速精密刀桿 ————— 2
- SDC SLIM CHUCK SDC - 後拉高速刀桿 ————— 3
- ER COLLET CHUCK WITH BT SHANK ER - 筒夾式 BT 刀桿 ————— 4
- COLLET - SDC 高速後拉筒夾、WRENCH - ER 板手 ————— 5
- M / UM STRAIGHT SHANK M / UM 直柄延長桿 ————— 6
- PRECISION POWERFUL MILLING CHUCK 強力型精密銑床夾頭 ————— 7
- FACE MILL ARBOR WITH BT SHANK FMA / FMB 面銑刀用 BT 刀桿 ————— 8
- SIDE LOCK HOLDER WITH BT SHANK SLA 側固式 BT 刀桿 ————— 9
- KEYLESS CHUCK WITH BT SHANK 鑽夾頭用 BT 刀桿 ————— 10
- MORSE TAPER ARBOR 莫式錐度刀桿 ————— 11
- TEST BAR WITH BT SHANK 測試棒、SDC GOLD CHUCK - SC - 後拉延長桿 — 12

## SSK PLUS CHUCK

### SSK10 - 高速精密刀桿

材質：JIS SNCM220

硬度：HRC 56°C~58°C 滲碳硬度>0.8mm

所有刀把外徑全研磨

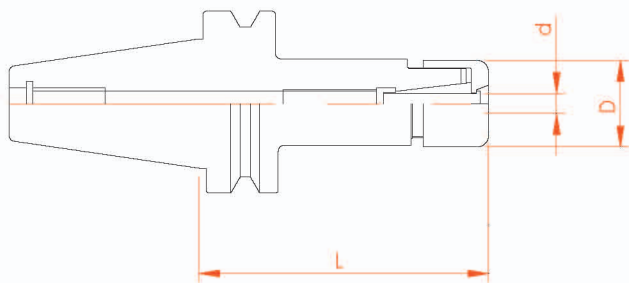

Type No 型號	Range(d)	L
BT30-SSK10-60	2-10	60
BT30-SSK10-90	2-10	90
BT30-SSK16-60	3-16	60
BT30-SSK16-90	3-16	90
BT40-SSK10-60	2-10	60
BT40-SSK10-90	2-10	90
BT40-SSK10-120	2-10	120
BT40-SSK10-135	2-10	135
BT40-SSK10-150	2-10	150
BT40-SSK10-165	2-10	165
BT40-SSK10-200	2-10	200
BT50-SSK10-105	2-10	105
BT50-SSK10-135	2-10	135
BT50-SSK10-150	2-10	150
BT50-SSK10-165	2-10	165
BT50-SSK10-200	2-10	200

## BEARING WRENCH

### SSK10 軸承板手

(專利止滑把手)



# SSK PLUS CHUCK

## SSK - 高速精密刀桿

材質：JIS SNCM220

硬度：HRC 56°C~58°C 滲碳硬度 > 0.8mm

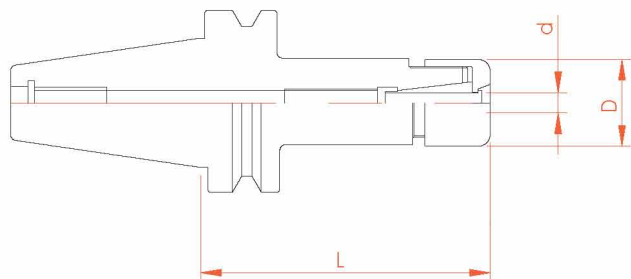

Type No 型號	Range(d)	L
BT30-SSK16-60	3-16	60
BT30-SSK16-90	3-16	90
BT30-SSK20-60	4-20	60
BT30-SSK20-80	4-25	80
BT40-SSK16-60	3-16	60
BT40-SSK16-90	3-16	90
BT40-SSK16-120	3-16	120
BT40-SSK16-135	3-16	135
BT40-SSK16-150	3-16	150
BT40-SSK16-165	3-16	165
BT40-SSK16-200	3-16	200
BT40-SSK20-60	4-20	60
BT40-SSK20-90	4-20	90
BT40-SSK20-120	4-20	120
BT40-SSK20-150	4-20	150
BT40-SSK20-200	4-20	200
BT40-SSK25-80	4-25	80
BT40-SSK25-120	4-25	120
BT50-SSK16-105	3-16	105
BT50-SSK16-135	3-16	135
BT50-SSK16-150	3-16	150
BT50-SSK16-165	3-16	165
BT50-SSK16-200	3-16	200
BT50-SSK20-105	4-20	105
BT50-SSK20-135	4-20	135
BT50-SSK20-150	4-20	150
BT50-SSK20-165	4-20	165
BT50-SSK20-200	4-20	200
BT50-SSK25-105	4-25	105
BT50-SSK25-135	4-25	135
BT50-SSK25-165	4-25	165

# SDC SLIM CHUCK

## SDC - 後拉高速刀桿 - 全研磨型

材質：JIS SNCM220

硬度：HRC 56°C~58°C 滲碳硬度 > 0.8mm

精密動平衡：G2.5 30000rpm

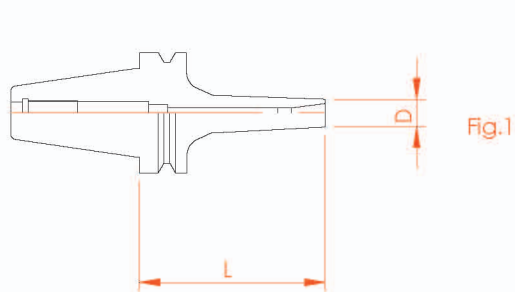

Fig.1

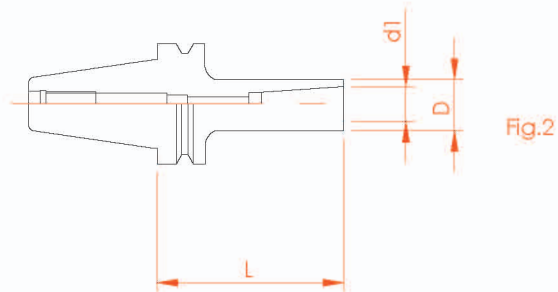

Fig.2

Type No 型號	Gripping Range	L	D	Fig	Collet
BT-30-SDC6-60	2-6	60	13	1	SDC6
BT-30-SDC6-90	2-6	90	13	1	SDC6
BT-40-SDC6-60	2-6	60	13	1	SDC6
BT-40-SDC6-90	2-6	90	13	1	SDC6
BT-40-SDC6-120	2-6	120	13	1	SDC6
BT-40-SDC6-150	2-6	150	13	1	SDC6
BT-40-SDC8-90	3-8	90	22	1	SDC6
BT-40-SDC8-120	3-8	120	22	1	SDC6
BT-40-SDC8-150	3-8	150	22	1	SDC6
BT-40-SDC12-70	3-12	70	34	2	SDC12
BT-40-SDC12-90	3-12	90	34	2	SDC12
BT-40-SDC12-120	3-12	120	34	2	SDC12

# ER COLLET CHUCK WITH BT SHANK

## ER - 筒夾式 BT 刀桿

材質：JIS SNCM220

硬度：HRC 56°C~58°C 滲碳硬度 > 0.8mm

適用於：

- 一般加工
- 剛性攻牙

Application：

- General hole making.
- Rigid tapping.

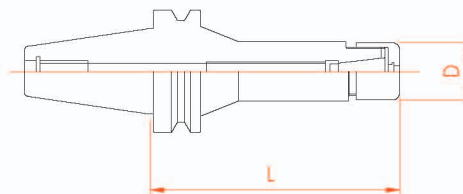

Model No 規格	夾持範圍 Range Ød	ØD	L	Collet
BT30-ER11-060	0.5~7.0	19	060	ER11
BT30-ER11-100	0.5~7.0	19	100	ER11
BT30-ER16-060	0.5~10.0	28	060	ER16
BT30-ER16-100	0.5~10.0	28	100	ER16
BT30-ER20-060	1.0~13.0	34	060	ER20
BT30-ER20-100	1.0~13.0	34	100	ER20
BT30-ER25-060	1.0~16.0	42	060	ER25
BT30-ER32-060	2.0~20.0	50	060	ER32
BT40-ER11-070	0.5~7.0	19	070	ER11
BT40-ER11-100	0.5~7.0	19	100	ER11
BT40-ER16-070	0.5~10.0	28	070	ER16
BT40-ER16-100	0.5~10.0	28	100	ER16
BT40-ER16-125	0.5~10.0	28	150	ER16
BT40-ER16-150	0.5~10.0	28	150	ER16
BT40-ER16-200	0.5~10.0	28	200	ER16
BT40-ER20-070	1.0~13.0	34	070	ER20
BT40-ER20-100	1.0~13.0	34	100	ER20
BT40-ER20-125	1.0~13.0	34	125	ER20
BT40-ER20-150	1.0~13.0	34	150	ER20
BT40-ER20-200	1.0~13.0	34	200	ER20
BT40-ER25-070	1.0~16.0	42	070	ER25
BT40-ER25-100	1.0~16.0	42	100	ER25
BT40-ER25-125	1.0~16.0	42	125	ER25

Model No 規格	夾持範圍 Range Ød	ØD	L	Collet
BT40-ER25-150	1.0~16.0	42	150	ER25
BT40-ER25-200	1.0~16.0	42	200	ER25
BT40-ER32-070	2.0~20.0	50	070	ER32
BT40-ER32-100	2.0~20.0	50	100	ER32
BT40-ER40-080	3.0~26.0	63	080	ER40
BT40-ER40-100	3.0~26.0	63	100	ER40
BT40-ER40-120	3.0~26.0	63	120	ER40
BT40-ER40-135	3.0~26.0	63	135	ER40
BT50-ER16-100	0.5~10.0	28	100	ER16
BT50-ER16-150	0.5~10.0	28	150	ER16
BT50-ER16-200	0.5~10.0	28	200	ER16
BT50-ER20-100	1.0~13.0	34	100	ER20
BT50-ER20-150	1.0~13.0	34	150	ER20
BT50-ER20-200	1.0~13.0	34	200	ER20
BT50-ER25-100	1.0~16.0	42	100	ER25
BT50-ER25-150	1.0~16.0	42	150	ER25
BT50-ER25-200	1.0~16.0	42	200	ER25
BT50-ER32-100	2.0~20.0	50	100	ER32
BT50-ER32-150	2.0~20.0	50	150	ER32
BT50-ER32-200	2.0~20.0	50	200	ER32
BT50-ER40-100	2.0~20.0	63	100	ER40
BT50-ER40-150	2.0~20.0	63	150	ER40
BT50-ER40-200	2.0~20.0	63	200	ER40

## COLLET TYPE

### SDC - 高速後拉筒夾



Collet Series	Ød	D	L
SSK10	3, 3.175, 3.5, 4, 4.5, 5, 5.5, 6, 6.5, 7, 7.5, 8, 8.5, 9, 9.5, 10	15.2	30
SSK16	4, 6, 8, 10, 12, 16	24.1	40
SSK20	4, 6, 8, 10, 12, 16, 20	29.1	50
SSK25	4, 6, 8, 10, 12, 16, 20, 25	35.3	57

Collet Series	Ød
SDC6	3,4,5,6
SDC8	3,4,6,8,10
SDC12	3,4,5,6,8,10,12

Collet Series	Ød	D1	L
ER11	Ø0.5 - Ø7.0	11.5	18.5
ER16	Ø0.5 - Ø10.0	17.0	27.0
ER20	Ø1.0 - Ø13.0	21.0	31.0
ER25	Ø2.0 - Ø16.0	26.0	35.0
ER32	Ø3.0 - Ø20.0	33.0	40.0
ER40	Ø3.0 - Ø26.0	41.0	46.0

## WRENCH

### ER 板手

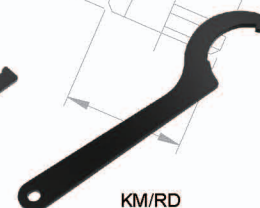

TYPE	Model No
A	ER11
	ER16
	ER20

TYPE	Model No
UM	ER11
	ER16
	ER20

TYPE	Model No
KM/RD	ER16
	ER20
	ER25

TYPE	Model No
KM/RD	ER32
	ER40
	ER50

# M / UM STRAIGHT SHANK M / UM

## 直柄延長桿

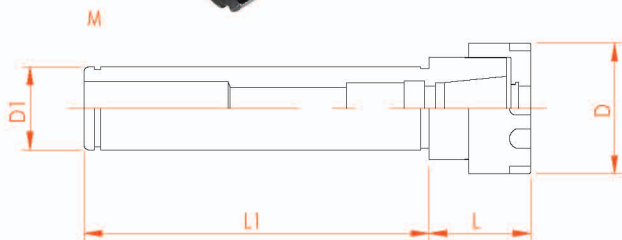
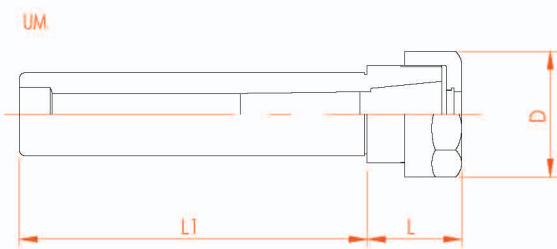

### 直柄延長桿 Collet Holders with Straight Shank (UM TYPE)

Model No	L1	L	D
C20-ER16-100	100	30	28
C20-ER16-150	150	30	28
C20-ER20-100	100	36	34
C20-ER25-100	100	46	42
C20-ER25-150	150	46	42
C25-ER16-100	100	30	28
C25-ER16-150	150	30	28
C25-ER20-150	150	36	34
C25-ER25-100	100	46	42
C25-ER25-150	150	46	42

### 直柄延長桿 (M型) Collet Holders with Straight Shank (M TYPE)

Model No	L1	L	D	D1
C16-ER11-100(M)	100	12	16	16
C16-ER16-100(M)	100	18	22	20
C16-ER16-150(M)	150	18	22	20
C20-ER20-100(M)	100	19	28	20
C20-ER20-150(M)	150	19	28	20
C25-ER20-100(M)	100	19	28	25
C25-ER20-150(M)	150	19	28	25



# PRECISION POWERFUL MILLING CHUCK

## 強力型精密銑床夾頭

材質：JIS SNCM220

硬度：HRC 56°C~58°C 滲碳硬度 > 0.8mm

- 精度：內孔同心度0.005mm/夾持刀具於100mm處，偏擺0.01mm。
- 特殊的防塵設計。  
請注意：若螺帽旋緊扭力超過限度，將導致刀桿、螺帽或筒夾永久損壞。
- Accuracy：Concentricity 0.005mm at holder nose and 0.01mm(TIR). At 100mm from nose.
- Special design of dust-proof prevents the milling chucks from locking and extends 50% or more lifetime of tool holders.
- Caution：Excessive tightening force will damage the chuck, nut and collet.



Type	L	ØD	ØD1
BT30-DCM20-80	80	20	55
BT30-DCM25-85	85	25	69
BT40-DCM20-85	85	20	55
BT40-DCM20-105	105	20	55
BT40-DCM25-85	85	25	69
BT40-DCM25-105	105	25	69
BT40-DCM25-135	135	25	69
BT40-DCM25-150	150	25	69
BT40-DCM32-90	90	32	69
BT40-DCM32-105	105	32	69
BT40-DCM32-135	135	32	69
BT50-DCM32-105	105	20	55
BT50-DCM32-135	135	32	69
BT50-DCM32-165	165	32	69
BT50-DCM42-110	110	42	86
BT50-DCM42-125	125	42	86
BT50-DCM42-165	165	42	86

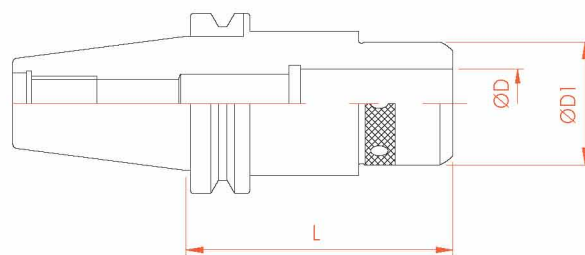

# FACE MILL ARBOR WITH BT SHANK

## FMA / FMB 面銑刀用 BT 刀桿

適用於：平面銑削加工  
Application : Face milling.

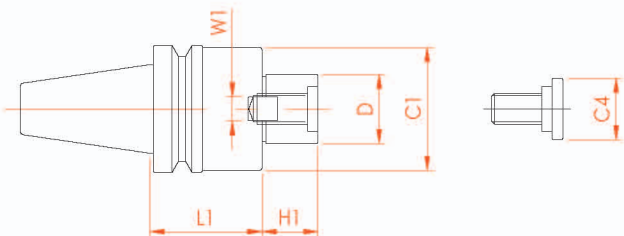

BT-FMA 平面銑刀桿 FaceMill Arbor / FMA

Model No	D1	L1	H1	C1	W1	C4
BT30-FMA25.4-45	25.4	45	20	45	9.5	33
BT30-FMA25.4-60	25.4	60	20	45	9.5	33
BT40-FMA25.4-45	25.4	45	20	60	9.5	33
BT40-FMA25.4-60	25.4	60	20	60	9.5	33
BT40-FMA31.75-45	31.75	45	22	70	12.7	40
BT40-FMA31.75-60	31.75	60	22	70	12.7	40
BT40-FMA31.75-90	31.75	90	22	70	12.7	40
BT40-FMA38.1-60	38.1	60	23	85	15.9	50
BT40-FMA38.1-90	38.1	90	23	85	15.9	50
BT50-FMA25.4-45	25.4	45	20	60	9.5	33
BT50-FMA25.4-75	25.4	75	20	60	9.5	33
BT50-FMA25.4-150	25.4	150	20	60	9.5	33
BT50-FMA31.75-45	31.75	45	22	70	12.7	40
BT50-FMA31.75-75	31.75	75	22	70	12.7	40
BT50-FMA31.75-105	31.75	150	22	70	12.7	40
BT50-FMA38.1-45	38.1	45	23	85	15.9	50
BT50-FMA38.1-75	38.1	75	23	85	15.9	50
BT50-FMA50.8-45	50.8	45	24	95	19.05	65
BT50-FMA50.8-75	50.8	75	24	95	19.05	65

BT-FMB 平面銑刀桿 FaceMill Arbor / FMB

Model No	D	L	C1	H1	H2	W	G
BT30-FMB22-45	22	45	50	18	4	10	M10
BT30-FMB27-45	27	45	60	20	4	12	M12
BT40-FMB22-45	22	45	48	18	4	10	M10
BT40-FMB22-90	22	90	48	18	4	10	M10
BT40-FMB27-60	27	60	60	20	4	12	M12
BT40-FMB27-90	27	90	60	20	4	12	M12
BT40-FMB32-45	32	45	78	22	4	14	M16
BT40-FMB40-60	40	60	80	25	4	16	M16
BT50-FMB22-45	22	45	48	18	4	10	M10
BT50-FMB22-75	22	75	48	18	4	10	M10
BT50-FMB27-45	27	45	60	20	4	12	M12
BT50-FMB27-75	27	75	60	20	4	12	M12
BT50-FMB27-100	27	90	60	20	4	12	M12
BT50-FMB32-75	32	75	78	22	4	14	M16
BT50-FMB32-105	32	45	78	22	4	16	M16
BT50-FMB32-150	32	75	78	22	4	16	M16
BT50-FMB40-45	40	75	89	25	4	16	M16
BT50-FMB40-75	40	75	89	25	4	16	M16

# SIDE LOCK HOLDER WITH BT SHANK

## SLA 側固式 BT 刀桿

適用於：

- 重切削
- 一般銑削加工
- 直柄刀桿連結用

Application :

- Heavy cutting.
- General milling.
- Locking with straight tool shank.

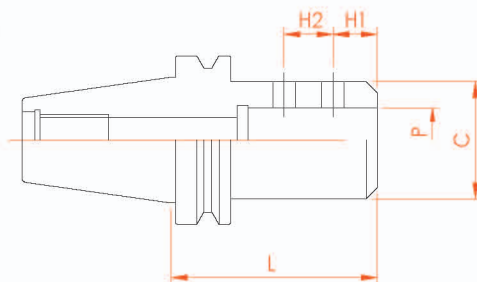

Model No	P	L	C	G(2T)	H1	H2
BT30-SLA6-60	6	60	25	M6xP1.0	18	
BT30-SLA8-60	8	60	28	M8xP1.25	18	
BT30-SLA10-60	10	60	35	M10xP1.5	20	
BT30-SLA12-75	12	60	42	M12xP1.75	22.5	
BT30-SLA16-60	16	60	48	M14xP2.0	24	
BT30-SLA16-75	16	75	48	M14xP2.0	24	
BT30-SLA20-75	20	75	52	M16xP2.0	25	
BT40-SLA6-75	6	75	25	M5xP0.8	12	10
BT40-SLA8-75	8	75	28	M6xP1.0	14	12
BT40-SLA10-75	10	75	35	M6xP1.0	15	14
BT40-SLA12-75	12	75	40	M8xP1.25	20	16
BT40-SLA16-75	16	75	45	M10xP1.5	20	18
BT40-SLA20-90	20	90	50	M12xP1.75	25	20
BT40-SLA25-90	25	90	55	M12xP1.75	25	22
BT40-SLA32-105	32	105	60	M16xP2.0	24	28
BT50-SLA6-105	6	105	25	M6xP1.0	12	10
BT50-SLA8-105	8	105	28	M8xP1.25	14	12
BT50-SLA10-105	10	105	35	M8xP1.25	15	14
BT50-SLA12-105	12	105	40	M12xP1.75	20	16
BT50-SLA16-105	16	105	45	M10xP1.5	22	18
BT50-SLA20-105	20	105	50	M12xP1.75	25	20
BT50-SLA25-105	25	105	55	M12xP1.75	25	22
BT50-SLA32-105	32	105	60	M16xP2.0	24	28
BT50-SLA42-105	42	105	80	M16xP2.0	24	28

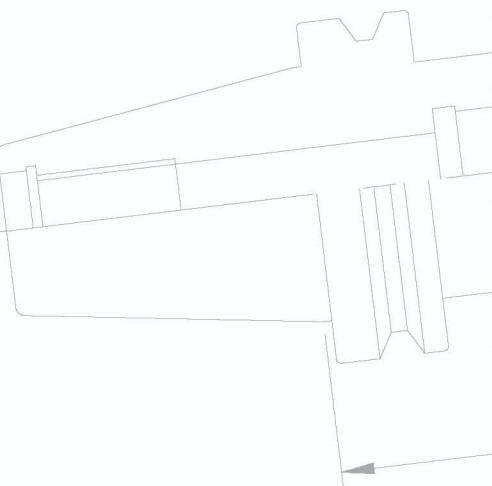

## KEYLESS CHUCK WITH BT SHANK

### 鑽夾頭用 BT 刀桿

材質：JIS SNCM220

硬度：HRC 56°C~58°C 滲碳硬度 > 0.8mm

適用於：

- 一般鉗孔加工
- 小徑牙之剛性攻牙
- 本產品可依指定尺寸製作

Application：

- General drilling.
- Small hole rigid tapping.
- Can be made upon requested dim.

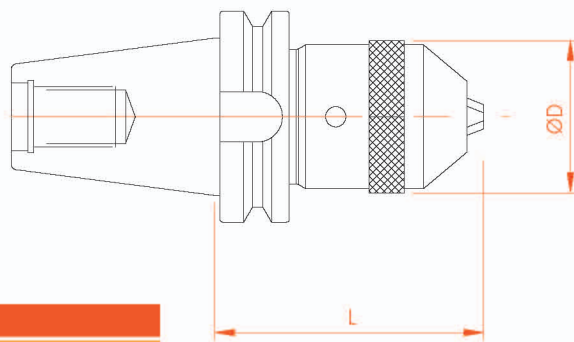

### BT-SLA 側固式刀桿 Sidelock End Mill Arbor

Model No 規格	夾持範圍 Clamping range ( $\varnothing$ mm)	D	L	
			最小 Minimum	最大 Maximum
BT30-APU08-80	1-8	36.3	75	82
BT30-APU13-100	1-13	51.5	100	110
BT40-APU08-85	1-8	36.3	79	86.5
BT40-APU13-100	1-13	51.5	100	110
BT40-APU16-130	3-16	58	116	130
BT50-APU13-100	1-13	51.5	100	110
BT50-APU16-130	3-16	58	116	130

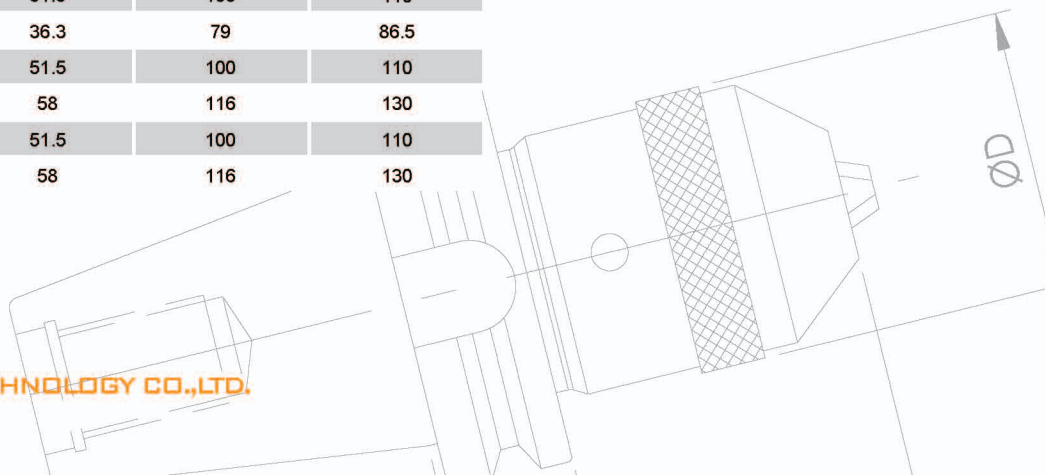

## MORSE TAPER ARBOR

### 莫式錐度刀桿

適用於：

- 一般孔加工
- MT柄鉸刀

Application：

- General hole making.
- Reaming with shank reamer.

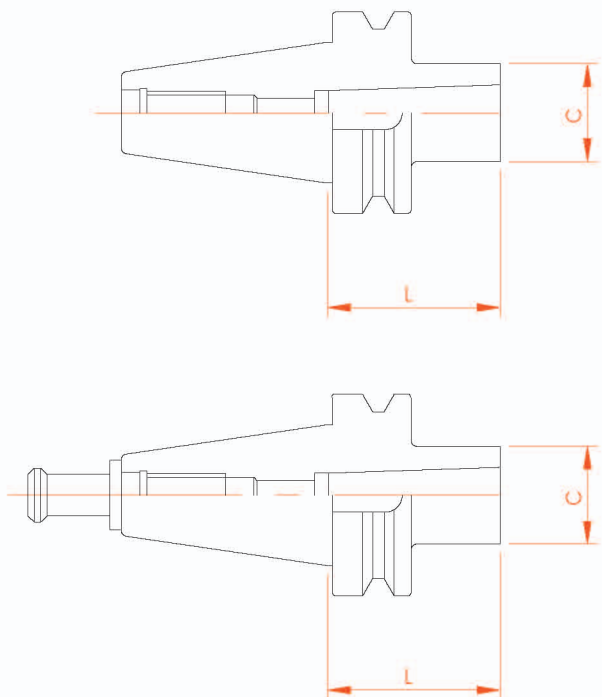

BT-MTA 莫式錐度刀桿 Morse Taper Arbor

Model No	L	C
BT40-MTA1-45	45	25
BT40-MTA2-45	45	32
BT40-MTA3-75	75	40
BT40-MTA4-90	90	50
BT50-MTA1-45	45	25
BT50-MTA2-45	45	32
BT50-MTA3-75	75	40
BT50-MTA4-75	75	50

## TEST BAR WITH BT SHANK

### 測試棒

材質：機台精度測試用

每組含木盒、測試棒、出廠檢驗報告，如需公證另需付費

Application：for machine precision test

Each model provide wood box and inspection report.

Additional charge should be paid if the official approval is requested.



Model No 規格	D	L	偏擺精度 RUN-OUT	真圓度 CIRCULARITY
BT30-L250	30	250	0.003	0.001
BT40-L300	40	300	0.003	0.001
BT50-L300	40	300	0.003	0.001

## SDC GOLD CHUCK

### SC - 後拉延長桿

材質：JIS SNCM220

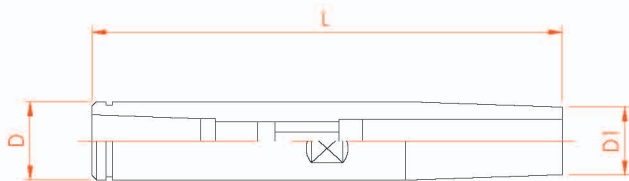

Order Code	L	D	D1
SC16-SDC6-150L	150	25	22
SC16-SDC6-200L	200	25	22



**SPEED TIGER**



震虎精密科技股份有限公司

SPEED TIGER PRECISION TECHNOLOGY CO.,LTD.

[www.speedtiger.com.tw](http://www.speedtiger.com.tw)

No.22, 22th Rd, Industrial Park, Taichung, Taiwan 408

TEL:+886-4-2350-3022 FAX:+886-4-2350-3083 [carbide@seed.net.tw](mailto:carbide@seed.net.tw)