

NS-1275-A (12 V, 7.5 Ah / 20hrs.)

VRLA Rechargeable Sealed Lead Acid Battery

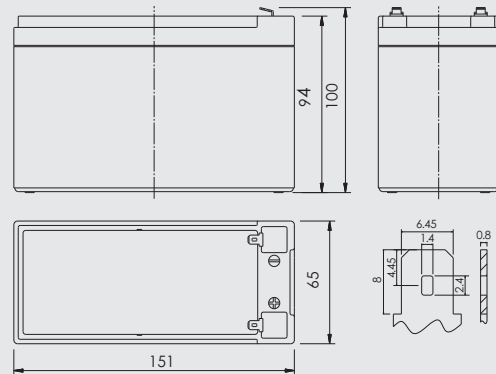

Specifications

Nominal Voltage	12V	
Rated Capacity (20 hour rate)	7.5Ah	
Dimensions	Total Height (with terminals)	3.86
	Height	3.70 inches (94mm)
	Length	5.94 inches (151mm)
	Width	2.56 inches (65mm)
Weight	Approx. 4.84 Pound (2.2kg)	

Characteristics

Capacity 77°F (25°C)	20 hour rate (0.35A)	7.5Ah
	10 hour rate (0.65A)	6.9Ah
	5 hour rate (1.12A)	6.0Ah
	1 hour rate (4.20A)	4.5Ah
	15 minute rate (12.3A)	3.3Ah
Internal Resistance	Full charged battery 77°F (25°C)	21mΩ
Capacity affected by Temperature (20hour rate)	104°F (40°C)	102%
	77°F (25°C)	100%
	32°F (0°C)	85%
	5°F (-15°C)	65%
Self-Discharge 77°F (25°C)	Capacity after 3 month storage	91%
	Capacity after 6 month storage	81%
	Capacity after 12 month storage	60%
Max. Discharge Current 77°F (25°C)	112.5A (5S)	
Terminal	F1/F2	
Charge (Constant Voltage)	Cycle	Initial charging current less than 2.25A Voltage 14.4 V / 77°F (25°C) Equalization temperature compensation coefficient: -24mV/°C
	Float	Voltage 13.8 V / 77°F (25°C) Compensation coefficient of floating charging temperature: -18mV/°C

Discharge Curves 77°F (25°C)

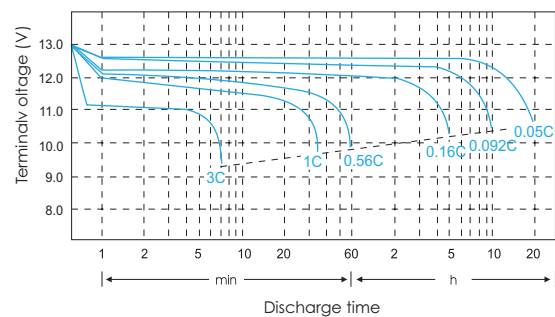

Relationship between charge voltage and temperature

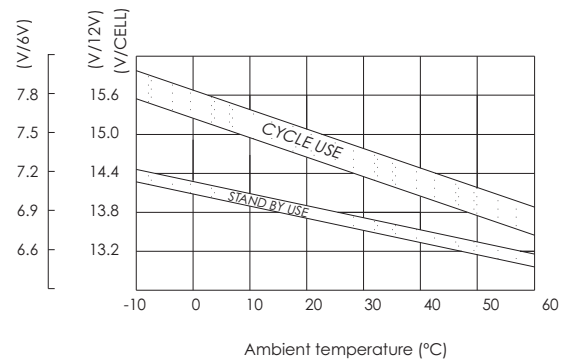

Constant Current Discharge (AMPERES@25°C)

F.V/Time	5Min	10Min	15Min	30Min	60Min	2H	3H	4H	5H	10H	20H
1.60	28.6	18.2	13.2	8.10	4.77	2.80	1.93	1.50	1.23	0.706	0.385
1.65	27.9	17.6	12.7	7.88	4.68	2.70	1.90	1.47	1.22	0.690	0.382
1.70	26.6	16.9	12.2	7.73	4.59	2.67	1.88	1.46	1.22	0.690	0.378
1.75	25.5	16.2	12.0	7.65	4.50	2.63	1.88	1.44	1.20	0.690	0.375
1.80	24.0	16.1	11.7	7.43	4.42	2.55	1.85	1.43	1.18	0.673	0.367

Constant Power Discharge (WATTS PER CELL@25°C)

F.V/Time	5Min	10Min	15Min	30Min	60Min	2H	3H	4H	5H	10H	20H
1.60	53.1	33.9	25.1	15.4	8.64	5.44	3.83	2.99	2.45	1.42	0.761
1.65	51.9	33.1	24.2	15.0	8.52	5.28	3.78	2.93	2.42	1.41	0.758
1.70	49.7	31.7	23.2	14.8	8.36	5.19	3.75	2.91	2.43	1.40	0.756
1.75	47.5	30.6	22.8	14.6	8.17	5.14	3.75	2.88	2.40	1.40	0.753
1.80	44.7	30.3	22.3	14.2	8.04	5.00	3.69	2.85	2.37	1.37	0.739

NS-1275-A (12 V, 7.5 Ah / 20hrs.)

VRLA Rechargeable Sealed Lead Acid Battery



The operating environment temperature above 40°C should be avoided. After long term storage, The battery actual capacity would be less than the rated capacity. Full capacity will be obtained through several charge/discharge cycles. To get the longest life, battery should be fully charged before storage.

Cycle service life in relation to depth of discharge

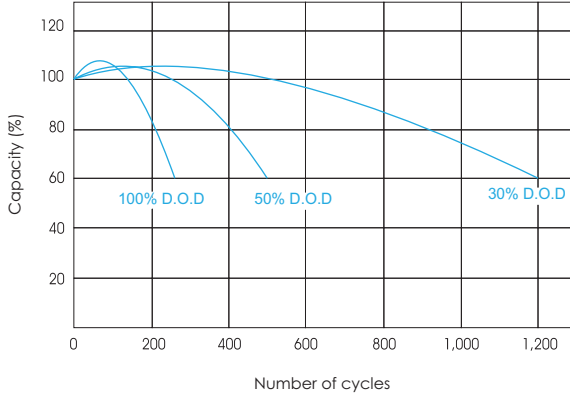

Constant voltage charge characteristic

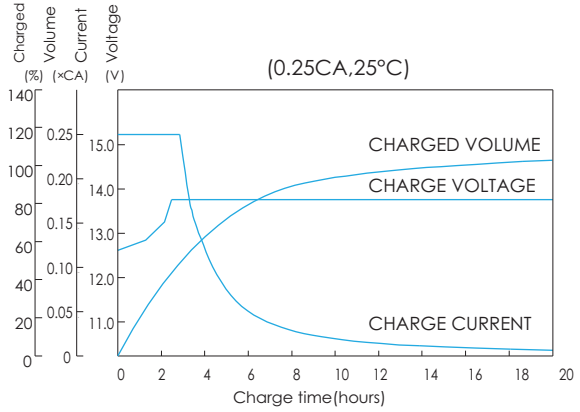

Self-Discharge Characteristics

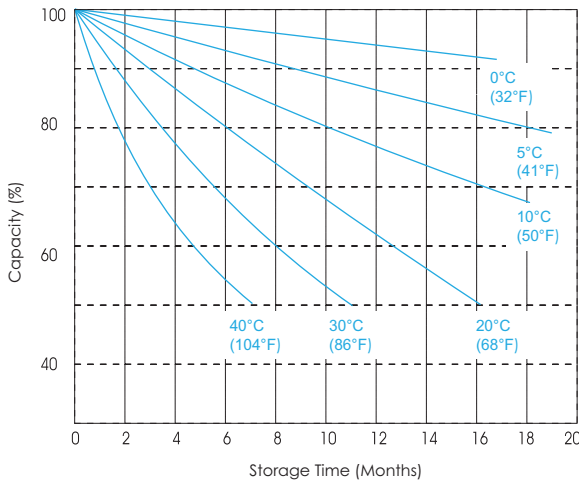

Relationship of OCV and Residual Capacity % (25°C)

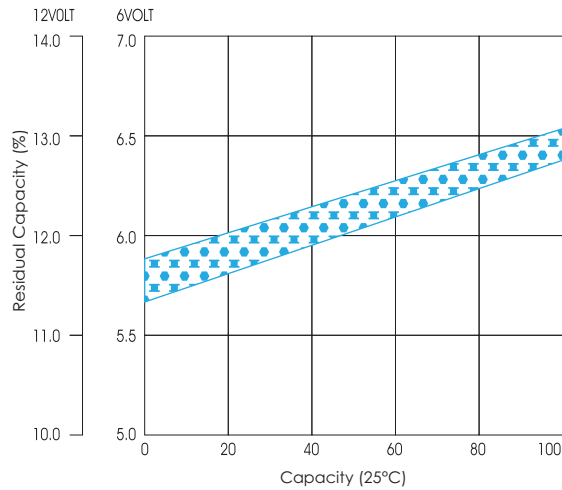

Temperature effects on capacity

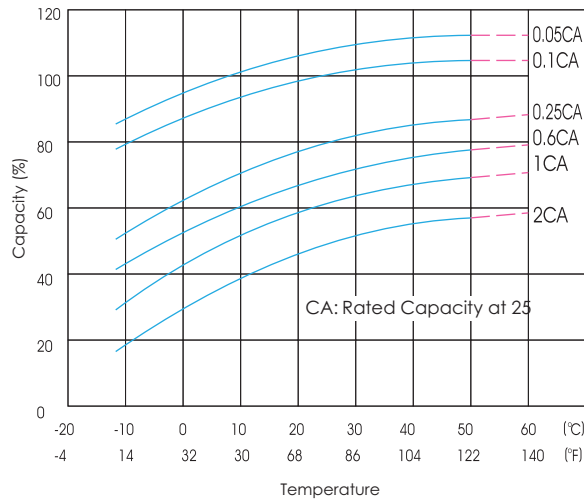

Temperature effects float life

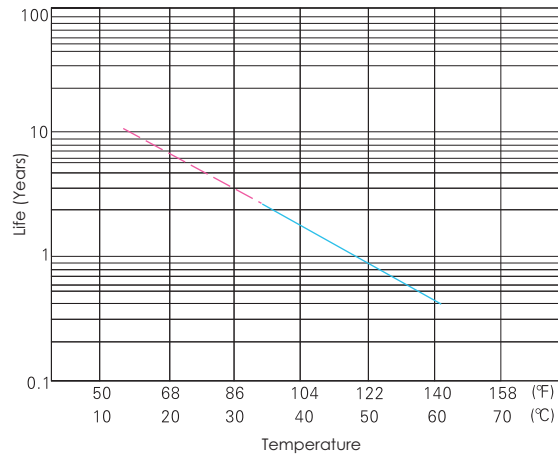

Continuous product development is our commitment. In that manner, the above specifications may be changed without prior notice.
Version number : AO 2023-10

Authorized Distributor

LEO POWER SUPPLY CO.,LTD.

27, 4th Floor, Soi Bangna-Trad Rd 34, Bangna Tai, Bangna, Bangkok 10260 THAILAND

Tel. 0-2746-9500 Fax. 0-2746-8712 e-mail : marketing@lpsups.com