



The power behind competitiveness

Delta Micro-Datacenter Catalogue



www.onesmartfactory.com



About Delta

Corporate Mission

To provide innovative, clean, and energy-efficient solutions for a better tomorrow.

Delta was founded in 1971. Delta offers energy efficient power products, switching power supplies with efficiency over 90%, telecom power with up to 98%, and PV inverters with up to 98.8% efficiency. We have also developed the world's first server power supply certified as 80 Plus Titanium. We regularly invest over 8% of our annual sales revenues in R&D and have worldwide R&D facilities in China, Europe, India, Japan, Singapore, and the U.S.

Delta is a frequent recipient of international awards and related recognition for innovation, design, energy management and corporate social responsibility. Since 2011, Delta has been selected each year for the prestigious Dow Jones Sustainability™ World Index (DJSI World Index). In 2020, Delta was also recognized by CDP with two "A" leadership level ratings for its substantial contribution to climate change and water security issues.

Delta continues to deliver strong and stable financial performance, achieving a compound annual growth rate of around 30.0% since 1971.



Bruce Cheng
Founder and
Honorary Chairman



Yancey Hai
Chairman

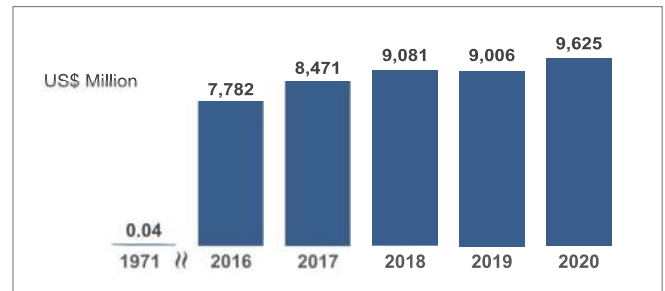

Delta Thailand Overview

- Founded in 1988
- Thailand's largest listed electronics manufacturer
- Business management center for Southeast Asia, India and Australia/ New Zealand markets
- Product development management center for Bangkok (Thailand), Soest/ Teningen (Germany), UK, USA, India, Singapore and Bucharest (Romania).
- Manufacturing management center to synergize advanced technologies and highly efficient production across manufacturing plants in Thailand, India, Slovakia and Myanmar.



Chang Tsai-hsing (Jackie)
President

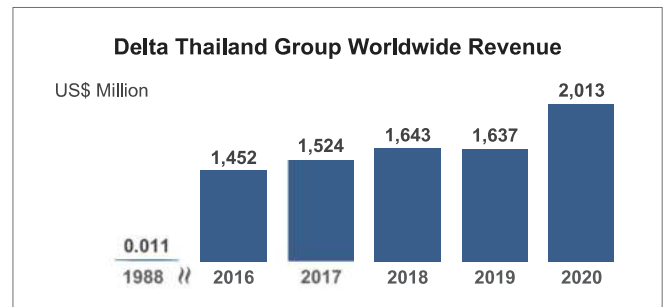

Global Operations

Delta Group has 176 sales offices, 38 plant sites, and 75 R&D centers with over 9,000 R&D engineers throughout the world.

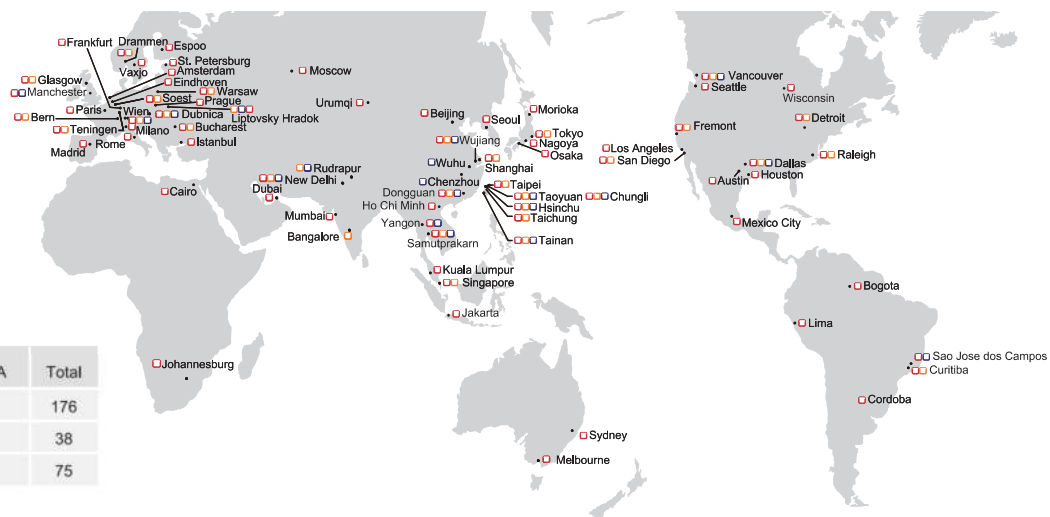

	Asia-Pacific	Americas	EMEA	Total
Sales Offices	107	24	45	176
Plant Sites	31	4	3	38
R&D Centers	52	9	14	75

Business Categories



Power Electronics

- Components
- Embedded Power
- Fans & Thermal Management
- Automotive Electronics

- Merchant & Mobile Power
Innergie



Automation

- Industrial Automation
- Building Automation



Infrastructure

- ICT Infrastructure
- Energy Infrastructure & Industrial Solutions
vivitek

Green Solutions



Industrial Automation and Smart Manufacturing



Building Automation



Data Center

Delta provides integrated energy-saving solutions to build a better world for future generations.



Telecom Energy



Display and Monitoring



Renewable Energy



EV Charging

Industrial Automation and Smart Manufacturing

Industrial Automation Solution

Data Analytics & Optimization	IIoT Cloud-based Platform		Big Data Analysis		Artificial Intelligence (Edge/Cloud)		Modeling & Simulation		
	DIAMMP Manufacturing Management Platform DIAMES Manufacturing Execution System DIASPC Statistical Process Control DIAPMS Preventative Maintenance System DIAWMS Warehouse Management System DIAAMS Alarm Manage System		DIAView Supervisory Control and Data Acquisition System (SCADA) DIALink Equipment IoT Platform DIABCS Block Control System DIAMCS Material Control System DIACPC CIM PC System DIAEnergie Industrial Energy Management System (IEMS)		DIAMPP Manufacturing Management Platform DIAMES Manufacturing Execution System DIASPC Statistical Process Control DIAPMS Preventative Maintenance System DIAWMS Warehouse Management System DIAAMS Alarm Manage System		DIAMMP Manufacturing Management Platform DIAMES Manufacturing Execution System DIASPC Statistical Process Control DIAPMS Preventative Maintenance System DIAWMS Warehouse Management System DIAAMS Alarm Manage System		
Management	Industrial PC DIAMMP Manufacturing Management Platform DIAMES Manufacturing Execution System DIASPC Statistical Process Control DIAPMS Preventative Maintenance System DIAWMS Warehouse Management System DIAAMS Alarm Manage System		DIAMMP Manufacturing Management Platform DIAMES Manufacturing Execution System DIASPC Statistical Process Control DIAPMS Preventative Maintenance System DIAWMS Warehouse Management System DIAAMS Alarm Manage System		DIAMMP Manufacturing Management Platform DIAMES Manufacturing Execution System DIASPC Statistical Process Control DIAPMS Preventative Maintenance System DIAWMS Warehouse Management System DIAAMS Alarm Manage System		DIAMMP Manufacturing Management Platform DIAMES Manufacturing Execution System DIASPC Statistical Process Control DIAPMS Preventative Maintenance System DIAWMS Warehouse Management System DIAAMS Alarm Manage System		
Networking	IIoT Industrial Cloud Router Ethernet Solution Industrial Fieldbus Solution		IIoT Industrial Cloud Router Ethernet Solution Industrial Fieldbus Solution		IIoT Industrial Cloud Router Ethernet Solution Industrial Fieldbus Solution		IIoT Industrial Cloud Router Ethernet Solution Industrial Fieldbus Solution		
Control & Sensing	Integration Software - DIAStudio								
	PLC	Motion Control			HMI	Robot Controller	Machine Vision System	Sensor	Meter & Measurement
		PLC-Based Motion Controller CNC Controller PC-Based Motion Controller Motion Control Card 	CAD/CAM Computer-Aided Design/Manufacturing HMI Robot Controller Machine Vision System Sensor Pressure Sensor Smart Sensor Encoder 	Meter & Measurement Gas Flow Meter Power Meter Temperature Controller 					
AC Motor Drive Servo System (AC Servo Drive & Motor) Planetary Gearbox Servo Press 	Linear Stage Industrial Power Supply 	Industrial Robot Robot Workstation Pick & Place Soldering Inspection Screw Driving 							

Building Automation

IoT-based Smart Building Solution

Delta's building solutions provide the best energy efficiency for a smart and sustainable building.

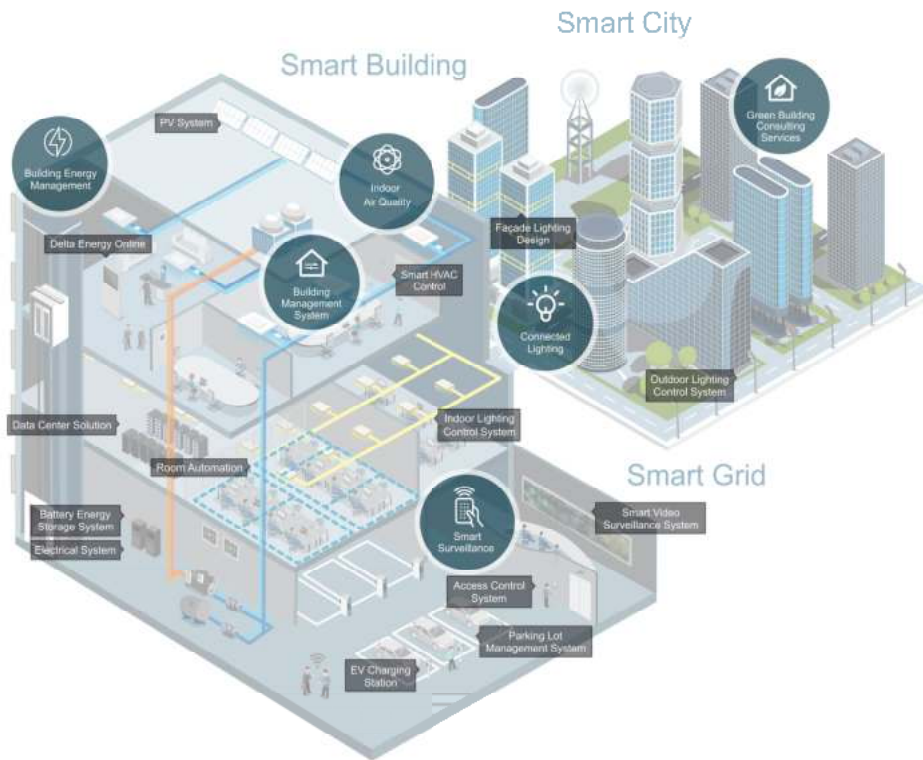

Our Products



Our Offerings



Our Practices

System Integration Services

HVAC

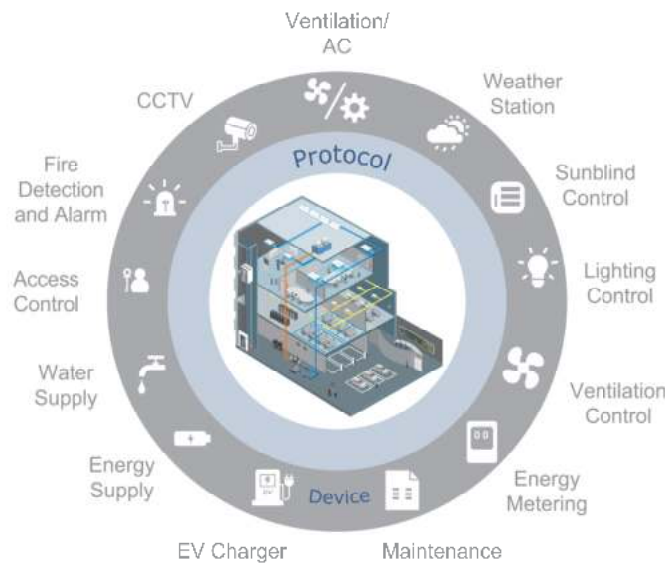

Surveillance

Lighting Control

Infrastructure



Room Control

Data Center



Display and Monitoring

Delta's visual display applications include projection and video wall solutions. Our projection solutions fulfill a wide range of professional applications, such as multimedia interaction, large-scale auto blending projection and 3D projection mapping. For control rooms and public information display systems, Delta offers innovative laser-light source DLP slim cubes video wall and LED display solutions integrated with DVCS (Distributive Vision Control Systems) for large area video walls.

High Performance Projector	Multimedia Projector	DLP, LED and LCD Video Wall
<p>Delta's high performance projectors include the world's first 8K projector. Our projectors can customize brightness with optimal lamp/ ballast selection. The projectors come with multiple optional lenses to meet versatile installation flexibility and featured with edge blending and warping capability. Delta also offers tailored colorimetry/contrast to meet home cinema or E-cinema requirement, and specialty design to meet simulator partners' requirements.</p> 	<p>As a leading professional design and manufacturing team, we offer total system solution service in commercial and multimedia projection display world.</p> <ul style="list-style-type: none"> • Offer total system solution service in commercial and multimedia projection display world • Projector designs to fulfill different kind of needs 	<ul style="list-style-type: none"> • DLP; an extensive product portfolio with over 40 "off-the-shelf" products • LCD; designed to deliver even the largest images with stunning clarity with its super-slim bezel • LED; latest indoor LED products are high resolution LED display 

Renewable Energy

Energy Infrastructure Solution

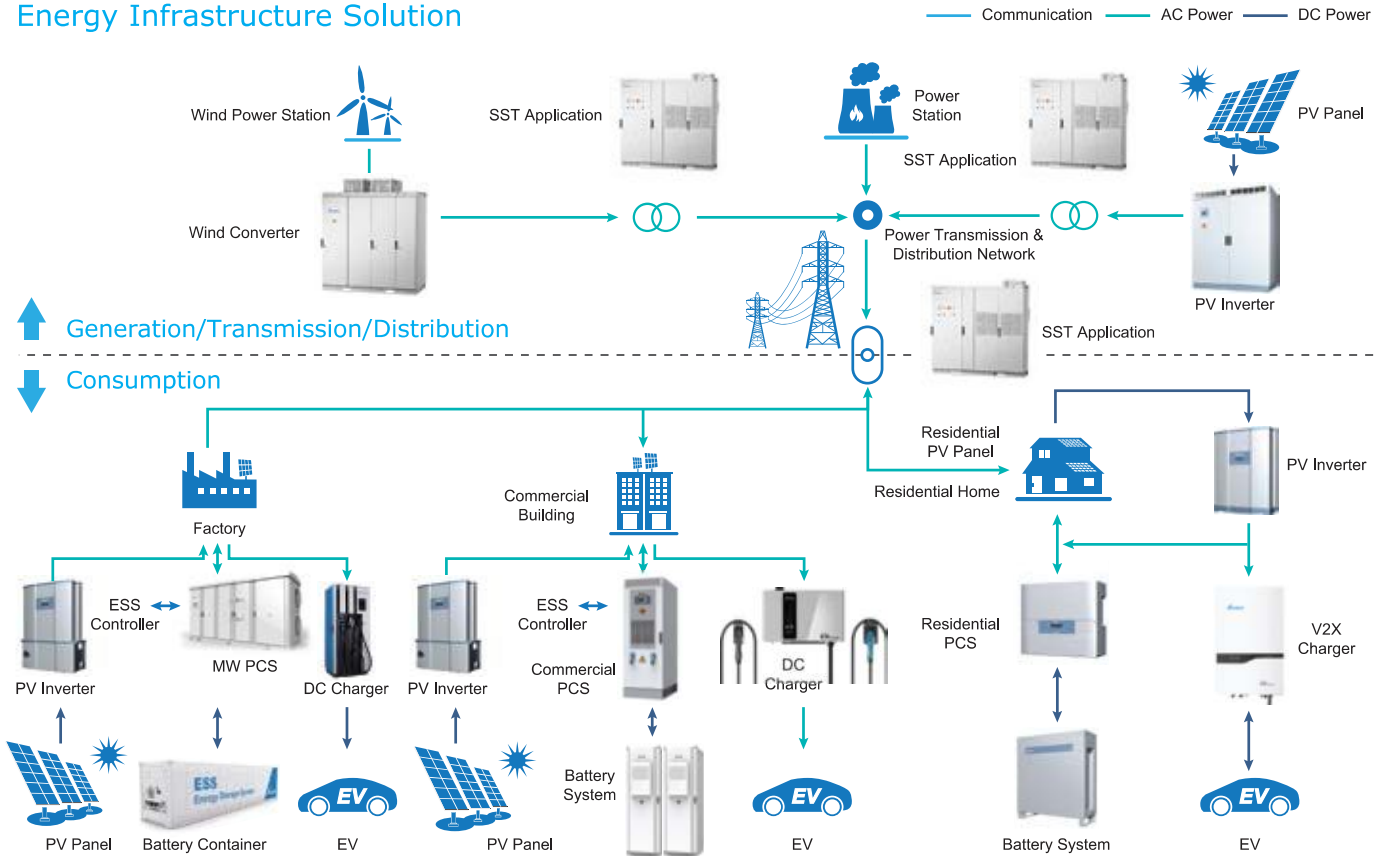





EV Charging

EV Charging Infrastructure Solution



- Scalable and customizable solution
- Optimize CapEX and OPEX to maximize charging efficiency and profitability
- Optimize energy efficiency with smart charging and energy allocation
- Reducing peak load impact on grid

Management System	Energy Storage	Solar Inverter	EV Charger
<ul style="list-style-type: none"> • Manage multiple energy sources • Optimize energy consumption • Avoid overloading 	<ul style="list-style-type: none"> • Peak shaving & load shift • Backup power • Bi-directional; demand-response enabled 	<ul style="list-style-type: none"> • Provide clean energy • Integrate with energy storage & management system 	<ul style="list-style-type: none"> • Supply electricity to EVs • Backup power for buildings  <p>Specification</p> <ul style="list-style-type: none"> • AC Charger (7.4/ 11/ 22kW) • DC Charger (25/ 50/ 150kW)

Delta Group

A Leading expert in power management and thermal management solutions

Delta Group is the world's leading provider of power and thermal management solutions, as well as a major source for components, visual displays, industrial automation, networking products, and renewable energy solutions. Delta Group is focused on three main businesses: Power Electronics, Automation, and Infrastructure. Delta Group has sales offices worldwide and manufacturing plants in Taiwan, China, Thailand, Japan, Mexico, India, Brazil and Europe.

As a global leader in power electronics, Delta's mission is, "To provide innovative, clean and energy-efficient solutions for a better tomorrow." Delta is committed to environmental protection and has implemented green, lead-free production and recycling and waste management programs for many years.

World no. 1 in Switching Power Supplies, DC Brushless Fans and Telecom Power Systems

163 sales offices and **39** manufacturing facilities worldwide

5-6% of annual sales revenues invested in R&D with over **7,000** engineers in **64** R&D centers worldwide

Awarded **7,100+** patents and received **47** internationally recognized design awards including iF, Reddot, and the Taiwan Excellence awards.

Awards

Delta Electronics outperformed 37 leading global companies in the Electronic Equipment, Instrument, and Component sector of the 2017 Dow Jones Sustainability Indexes (DJSI), and was selected for the DJSI World Index for the seventh consecutive year.

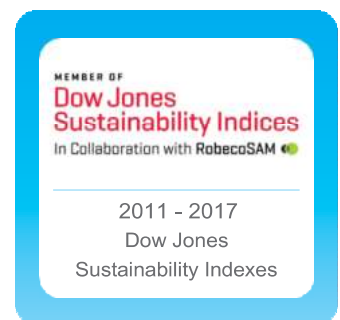

More information about Delta Group can be found at <https://www.deltathailand.com/>

Quality and Service



Quality

- Delta's large-scale production follows comprehensive quality management to do things right the first time and deliver the best quality
- All manufacturing sites are certified with ISO 9001 and ISO 14001 and conform to the highest quality control in terms of product development and production to achieve customer satisfaction.
- With six laboratories accredited by the China National Accreditation Service for Conformity Assessment (CNAS) all of our products go through the tightest checks.



Performance

- Wide input voltage range reduces the chance of battery use and extends battery life
- High input power factor increases utilization of utilities and reduces total cost
- High output power factor provides more real power to critical loads
- Higher efficiency lowers operating costs
- Lower harmonic distortion saves on upstream investment
- Compact design saves more space for critical equipment



Service

- Up to 2-year warranty
- Service line is available on work days to answer your questions
- Customer-needs-oriented, available with comprehensive and professional service and technical support

The power behind competitiveness

Delta Micro-datacenter DSE series

Highly versatile all-in-one rack for mission critical IT equipment

Key features

Easy Deployment

Pre-manufactured and fully tested solution ensures minimal on-site engineering and installation is required to deploy your data center significantly reducing your CAPEX

Easy Management

Design once and deploy anywhere this standardized architecture and remote monitoring platform you have total visibility of critical assets, reducing risk, operational costs and improving service levels.

Easy Expansion

A stand-alone fully functional solution. You can plan and deploy your IT assets step by step as business grows. Buy small and scale to big. Invest only when necessary.



Application

- Converged or Hyper-converged IT infrastructure
- Edge computing datacenter
- Office server room



PREDICTABLE
PERFORMANCE



FASTER
DEPLOYMENT



FLEXIBILITY AND
SCALABILITY



Datacenter



Telecom



Industrial



Network



Banking



Security



Lab



Medical



Metro

Delta Micro-datacenter DSE series

Ready for the era of converged infrastructure

Ending the traditional ways of implementing IT infrastructure by dedicated server which consumes lot of space, power consumption and hardly maintain. Converged infrastructure has rapidly growth due to merit virtualization technology. Further moving forward to hyper-converge eventually obtains super flexibility from all software defined elements, shrink down system size, cost and maintenance complexity. Virtualized and clustering, furthermore, improves system reliability.

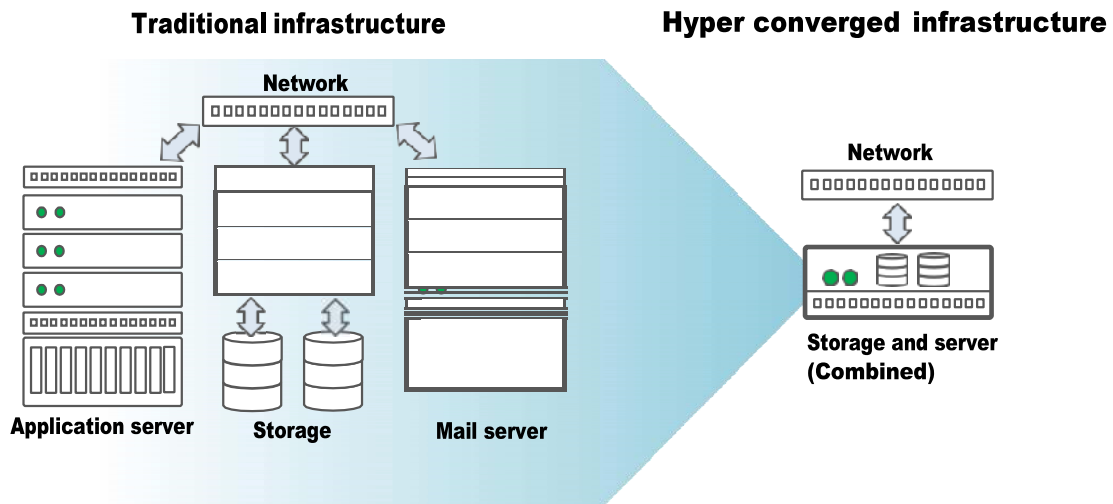

Pre-fabricated all-in-one datacenter and ready to move in

Delta's micro datacenter provides all necessities components in one package so that eases to implement converged or hyper-converged IT infrastructure. All pre-fabricated ensures high quality and rapid deploy of IT infrastructure to be right on time.

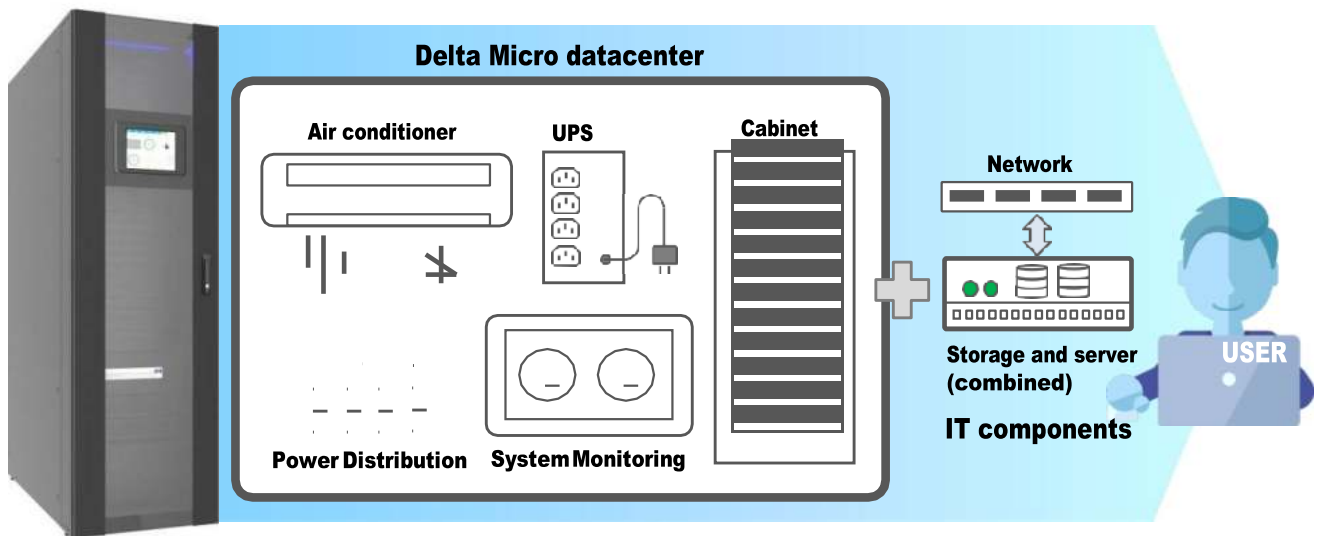

The power behind competitiveness

Multiple choices of model, flexible configuration to exactly fit your requirement.

Delta's offers range of micro-datacenter product, various configuration from fan ventilation cooling type, all-in-one packed cooling up to row cooling providing most flexibility and choices to exactly match IT infrastructure requirement.

Available U-space

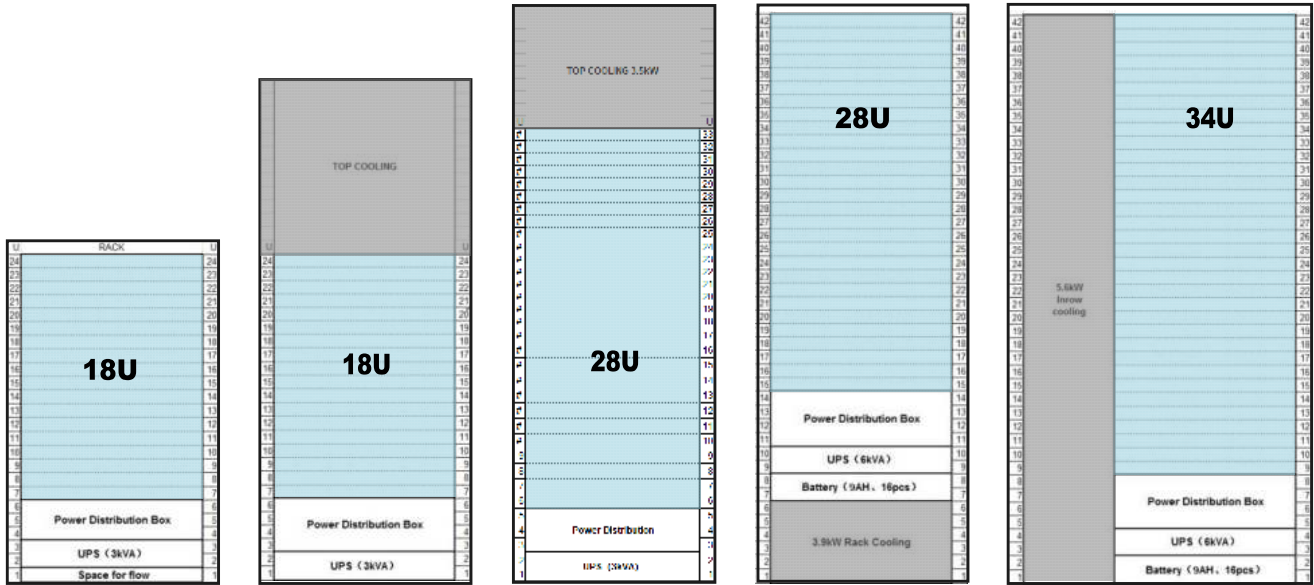

DSE-E1



DSE-E2.2



DSE-E2.3



DSE-E3



DSE-E4/5



Technical Specification

Model	DSE-E1	DSE-E2.2	DSE-E2.3	DSE-E3	DSE-E4	DSE-E5
Mechanical Specification						
Available U space	18	18	28	28	34	34
Width-mm	600	600	600	600	600	600
Depth-mm	1000	1100	1400	1400	1400	1400
Height-mm	1200	1590	2000	2000	2000	2000
Weight-kg	152	190	240	374	521	525
Electrical Specification						
Input Voltage	230V/50Hz					
UPS-kVA/kW	3/2.7		6/5.4		6/5.4	10/9
Cooling Specification						
Type	Ventilation	Packaged DX		Split DX	Split DX Inrow	
Refrigerant		R410A		R410A	R410A	
Mount Type	Top	Top		Rack	Row	
Capacity-kw		2.5	3.5	3.9	5.6	7.6
SHR-%		100		95	100	100
Air Volume-m ³ /hr		800		700	2000	2250
Monitoring						
Control	10" Touch Screen					
Sensors	Temp. & Hum./Smoke/Leakage/Door status					
Management	UPS/Cooling/Environment Sensor					
Price (Bath)	Ask for price	257,000.00	275,000.00	355,000.00	Ask for price	Ask for price

Note: The price is exclude delivery fee and Vat.

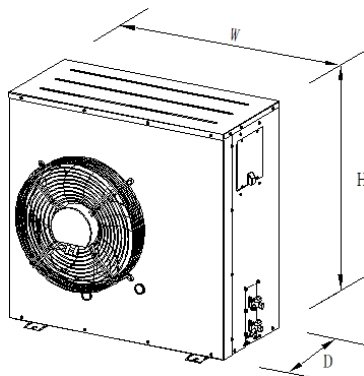

DSE E3/E4/E5 Outdoor unit specification

Model	E3	E4	E5
D-mm	395	480	480
W-mm	800	800	800
H1-mm	632	790	790
Input Power	220V/50-60Hz/1Ph		
Weight (kg)	35	25	4

Delta Micro-datacenter DSE series

No more condensation

Hot moisture air cooled by cold object whose temperature lower than dew point then form condensate on the surface.

Delta's MDC is specially designed to prevent by using transparent thermal insulation material in addition to glass front door. This helps to keep front glass door temperature above dew point so that condensation is avoided.

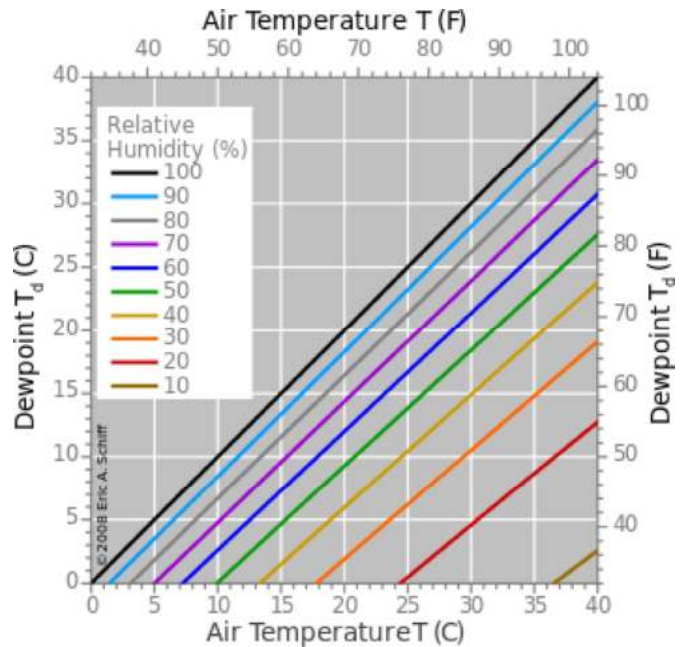
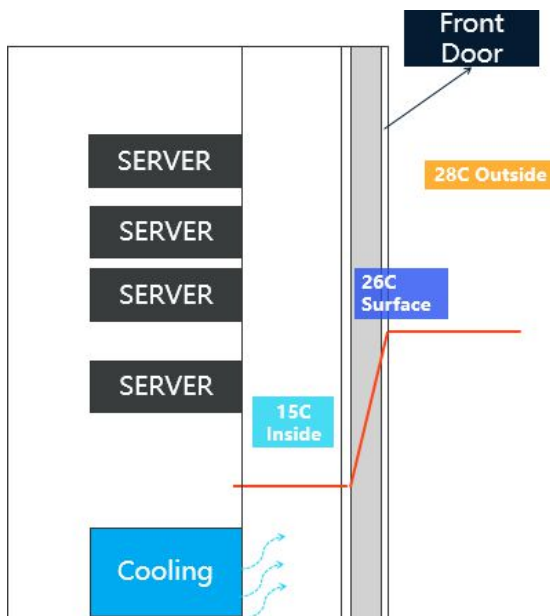

Heat Transfer Basic

Adopt double layer front door and thermal insulation improving external door temperature to prevent condensate.

Cooling System Design

- Control supply air temperature no less than dewpoint temperature.
- Capacity modulating means flexibility with supply temperature adjusting and same time cooling effect reached.

Delta Micro-datacenter DSE series

Highly Flexible for Future Expansion

Additional 42U rack add-on is applicable to increase available U-space* of Delta's micro datacenter obtaining extremely flexibility for future IT infrastructure expansion. 600mm and 800mm additional rack is available option to serve IT requirements.



* However remain cooling capacity of cooling unit must be considered.

Excellence Cooling Performance

- Closed Cold/Hot Aisle and highly efficient
- Fully closed system is dust proof and noise canceling
- Double door and supply temperature control to prevent condensate



Delta Micro-datacenter DSE series

Optional Component to Enhance your Micro-datacenter

Rack Access Control

Biometric type rack access control, provides completely security control of micro- datacenter as security control become more crucial for IT infrastructure security standard.



Rack Mount Fire Suppression System

Delta provides an optional 3U in-rack fire suppression system strengthens fire protection capability into the rack level. This is to enhance safety and reliability without relying on springer of building protection nor additional dedicated fire protection system just for a rack, yet lower cost of ownership.



Delta Micro-datacenter DSE series

Vari°Row® Configurable Micro-datacenter

Delta micro-datacenter is designed and engineered with expansion in mind. It allows IT professionals to smoothly plan, grow and manage critical assets as they expand their infrastructure.

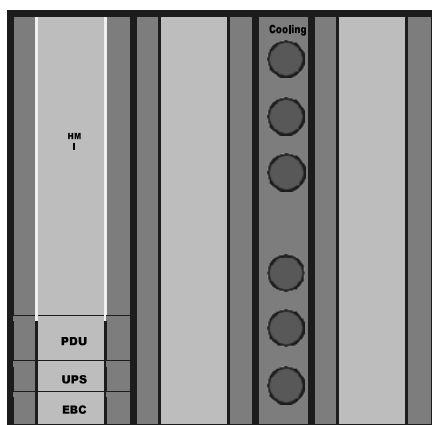
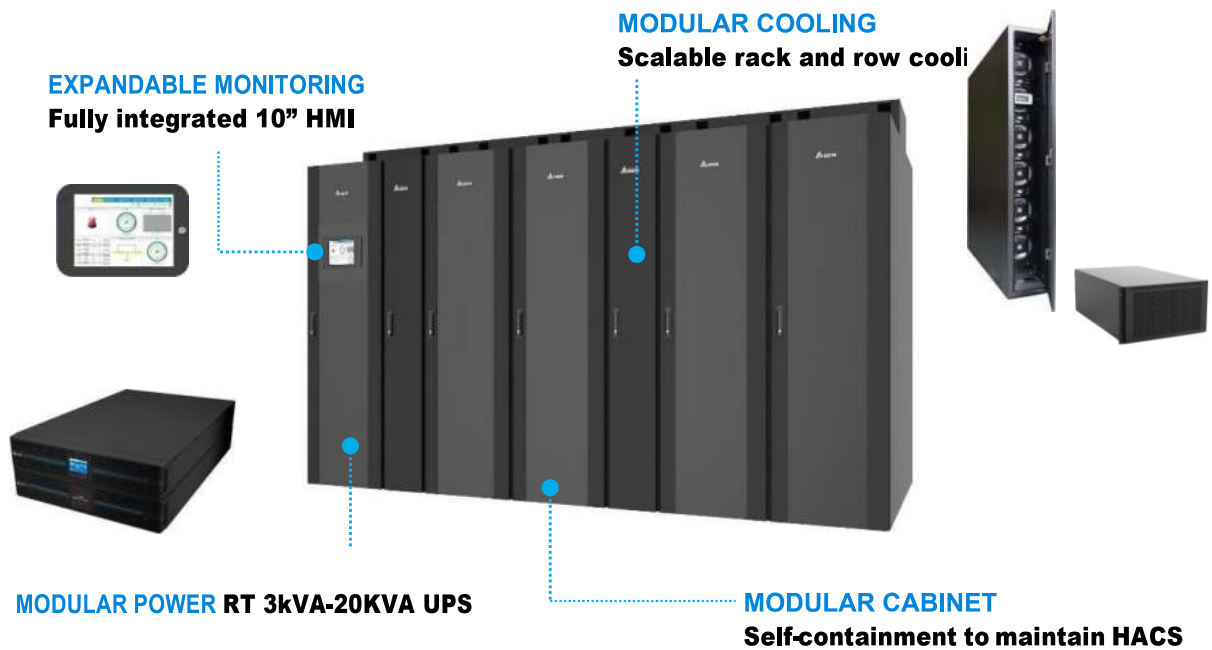

BASIC N-CONFIGURATION

- Single UPS from 3kVA up to 30kVA.
- Single Row Cooling 5.6kW up to 30kW.
- Single PDU with bypass function.

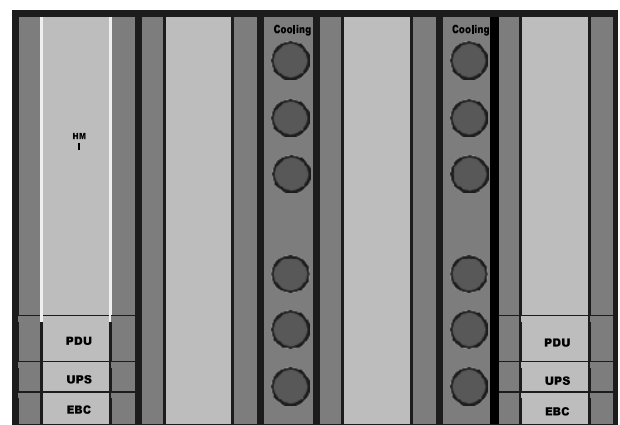

N+1 OR 2N -CONFIGURATION

- Dual UPS from 3kVA up to 30kVA.
- Dual Row Cooling 5.6kW up to 30kW with N+1 or 2N configuration.
- Single PDU with N+1 or Dual PDU to support dual feeder configuration.

The power behind competitiveness

Delta Micro-datacenter DSE series

Vari°POD® Configurable Micro-datacenter

Delta micro-datacenter is designed and engineered with expansion in mind. It allows IT professionals to smoothly plan, grow and manage critical assets as they expand their infrastructure.

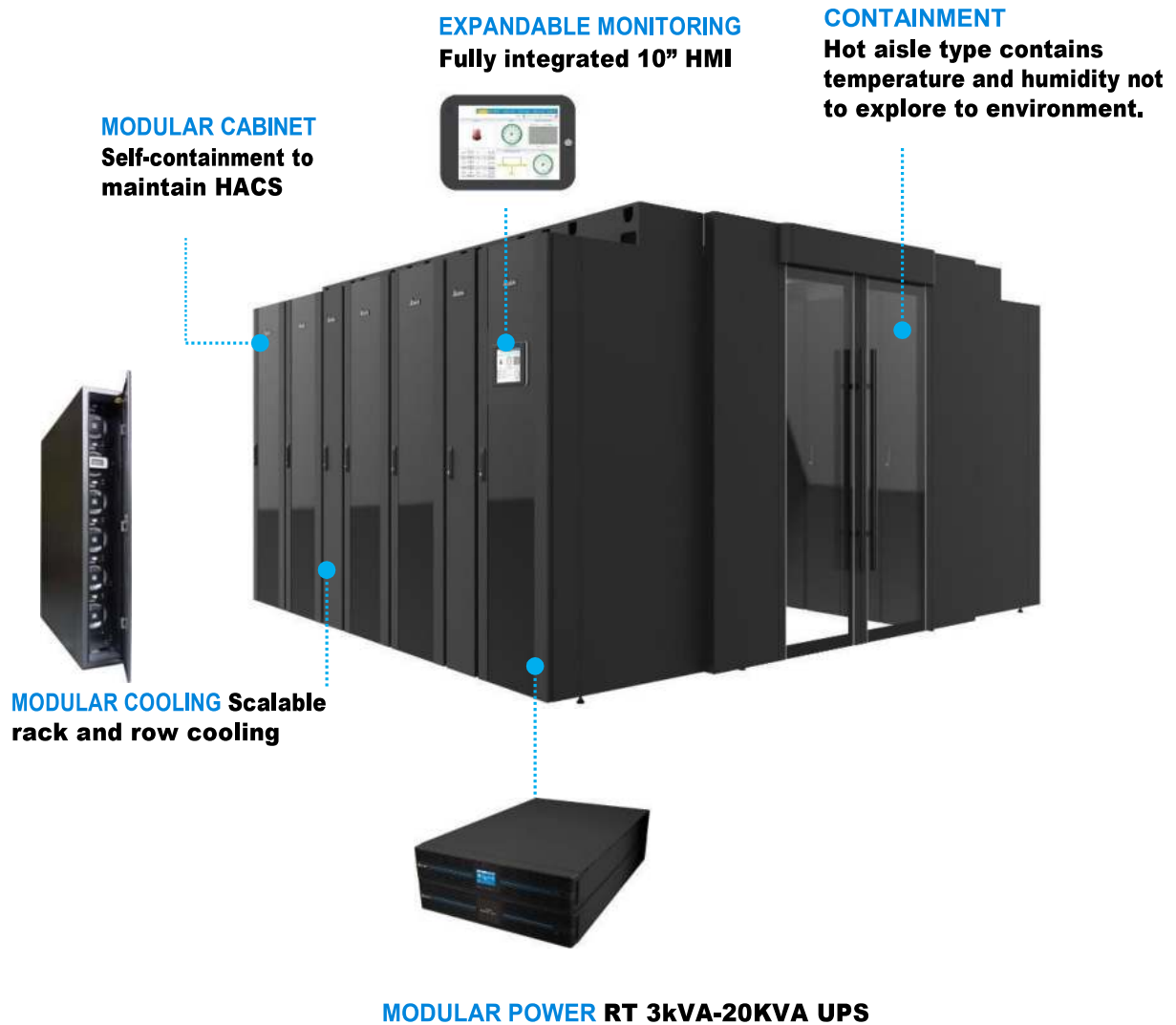

Delta Micro-datacenter DSE series

X°Edge Micro-datacenter, Readiness for Hash Environment



Edge is too close to user access. Delta understands an application of Edge computing well. An optional outdoor enclosure is offered for Micro-datacenter thus it can be deployed anywhere without limitation of environmental impact. This also helps to reduce CAPEX of implementation due to eliminating of shelter or concrete housing investment.



DSE-XE3



DSE-XE4/5

Technical Specification

Model	DSE-XE3	DSE-XE6
Mechanical Specification		
IP rate	IP55	
Weight-kg	630	850
Available U space	28	56
Internal rack width-mm	600	1200
Internal rack depth-mm	1100	1100
Internal rack height-mm	2000	2000
Electrical Specification		
Input Voltage	230V/50Hz	
UPS-kVA/kW	5/5	6/6
Cooling Specification		
Type	Split DX	Split DX Inrow
Refrigerant	R410A	R410A
Mount Type	Rack	Rack
Capacity-kw	3.9	7.8
SHR-%	95	95
Air Volume-m ³ /hr	700	1400
Monitoring		
Sensors	Temp. & Hum./Smoke/Leakage/Door status	
Management	UPS/Cooling/Environment Sensor	

DSE-XE3 External Dimension

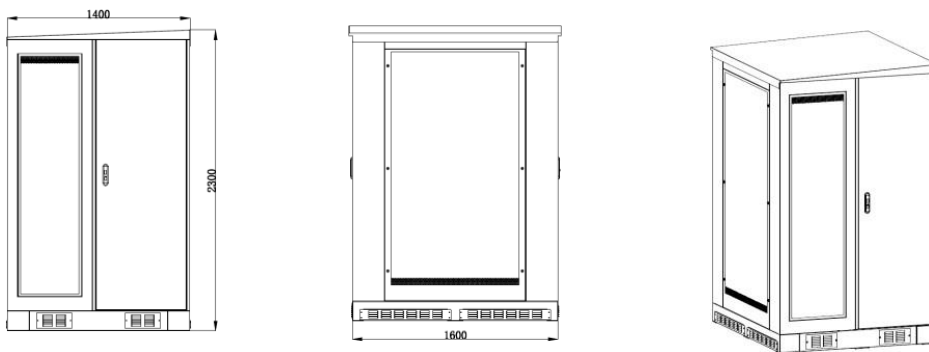

DSE-XE6 External Dimension

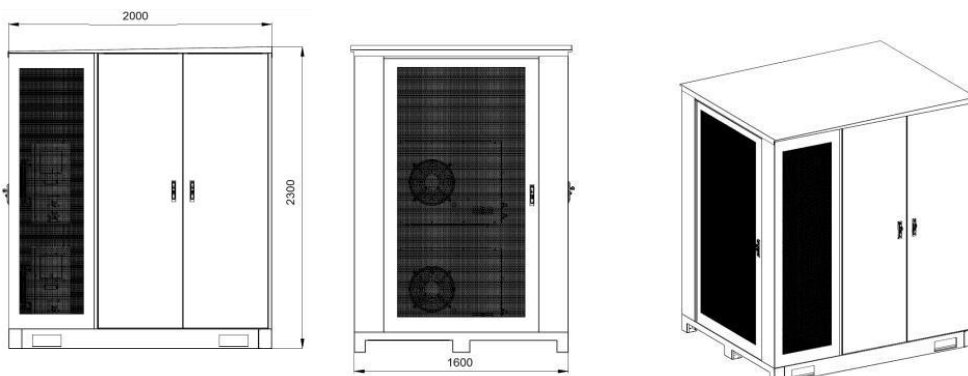



www.onesmartfactory.com



@onesmartfactory



Facebook

Bigphaisan Project Co.,Ltd

25/34-38 47-51, Sukhumvit Soi 27, Pak Nam, Mueang Samut Prakan District, Samut Prakan 10270

Tel : 02-755-2688 | Line : @onesmartfactory