

Z-PC LINE REMOTE I/O MODULES



Z-PC LINE

DATA ACQUISITION, DISTRIBUTED AUTOMATION AND TELECONTROL SYSTEMS

Z-PC Line is a modular automation system for managing from a single signal to thousands of I/Os. Z-PC series includes the maximum variety of I/O modules: digital inputs, fast counters, digital relay and mosfet outputs, analog channels (mA, V, Ohm, mV), strain gauge, resistance thermometers, thermocouples, electrical signals, galvanically isolated and with ModBUS, CANopen, Ethernet, M-BUS communication protocols. The I/O modules support RS485 serial communication with ModBUS RTU protocol, up to 64 nodes without repeater and speeds up to 115 kbps. The wiring of the power supply and the serial connection is facilitated by means of a bus housed in the IEC EN 60715 DIN rail. Maximum data concentration is also guaranteed.

For example, up to 24 digital and 8 analog signals can be acquired with just one module. The DIN rail modular bus support is available in 1, 2, 4, 8 slots. The modules are hot-swappable, i.e. they are hot-swappable without power and communication interruption. The system is completed by a wide range of interfaces and network interconnections to expand the configuration. Thanks to its flexibility and modularity, the Z-PC Line is a distributed system for multi-sector applications: data acquisition, building automation, telecontrol, energy monitoring, manufacturing control, ship automation, laboratory tests, environmental analysis, water treatment etc.

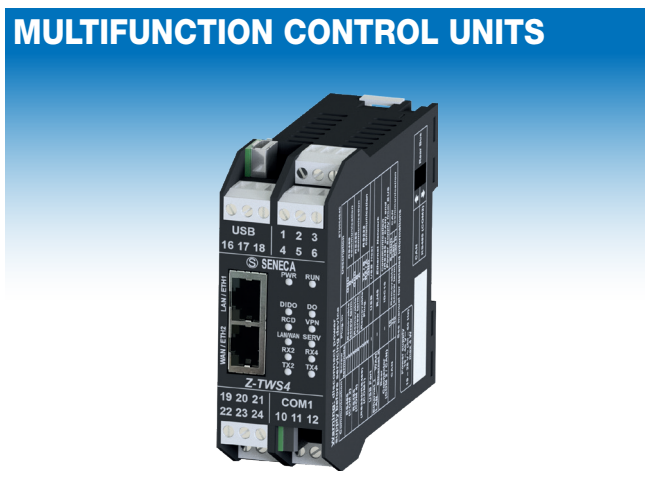

SoftPLC
IEC 61131

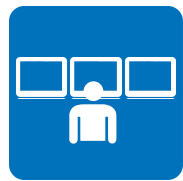

OPEN TO SCADA / OPC / WEB CLIENT

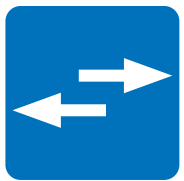

I/O MANAGEMENT
Built-in on board
External up to 1.000 I/O



DIGITAL INPUTS
Read, PNP, NPN, Proximity, Contact

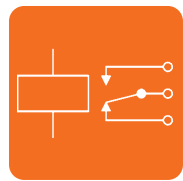

BUILT-IN CONTROL FUNCTIONS

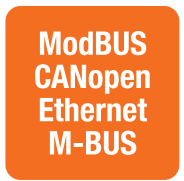

SUPPORTED PROTOCOLS
ModBUS
CANopen
Ethernet
M-BUS



IEC 81850
IEC 60870-5-101/104
ENERGY PROTOCOLS



DATA STORAGE



ADVANCED ALARM MANAGEMENT



DIGITAL OUTPUTS
SPST Relay or Mosfet



MULTIWAYS ISOLATION @1,5 kVac



32 BIT COUNTERS @10kHz



INTEGRATION WITH THIRD-PARTY DEVICES

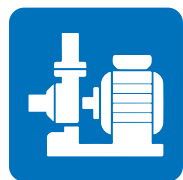

SPECIAL APPLICATIONS AND LIBRARIES



DATA EXCHANGE WITH OPC UA STANDARD



WIDE OPERATING TEMPERATURE RANGE
-20..+70°C









2,5 mm² REMOVABLE TERMINALS



FRONT COMMUNICATION PORT
Micro USB jack 3,5mm RS232

GENERAL FEATURES

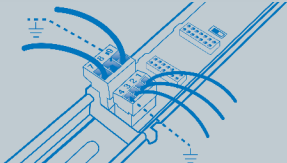
<p>WIDE RANGE</p> 	<p>UNIVERSAL APPLICATIONS</p> 	<p>FLEXIBLE CONFIGURATION (EASY SETUP, Z-NET4, DIP switch)</p> 	<p>TOOLS AND SERVICES FOR SYSTEM INTEGRATORS</p> 
<p>DATA ACQUISITION TOOLS (Data Recorder, OPC UA, NI LabVIEW Drivers, ModBUS Visual Studio Libraries)</p> 	<p>AC/DC SWITCHING POWER SUPPLY</p> 	<p>POWER TRANSDUCERS</p> 	<p>BUS SYSTEM (power supply/communication) on DIN rail</p> 



COMMUNICATION INTERFACES



HOT SWAPPING MODULES



DATA RECORDER DAQ SOFTWARE



ANALOG INPUT



3G+/4G/GPS/GLONASS GATEWAYS / ROUTERS



SERIAL / USB CONVERTERS



INDUSTRIAL MODEMS

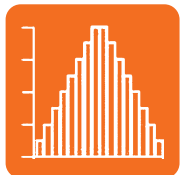

RESOLUTION UP TO 16 BITS



CE / UL APPROVALS



LOAD CELL INPUT



FIBER OPTICS CONVERTERS



MULTI-CHANNEL RADIO MODEMS

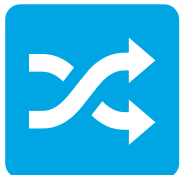

IT PROTOCOLS

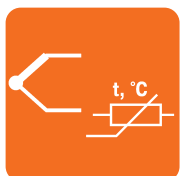

TEMPERATURE SENSORS INPUT



ELECTRICAL MEASUREMENT

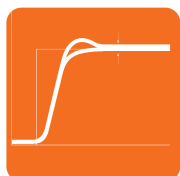

PID REGULATION



TELECONTROL / REMOTE ASSISTANCE SOLUTIONS







VPN SUPPORT





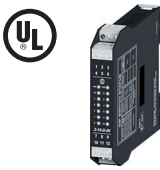



IoT / Cloud SOLUTIONS





MODBUS RTU DIGITAL I/O MODULES

	Z-D-IN	Z-D-OUT	Z-10-D-IN	Z-10-D-OUT
				
	5-CH digital input module / RS485 ModBUS RTU	5-CH digital output module / RS485 ModBUS RTU	10-CH digital input module / RS485 ModBUS RTU	10-CH digital output module / RS485 ModBUS RTU
GENERAL DATA				
Power Supply	10..40 Vdc / 19..28 Vac	10..40 Vdc / 19..28 Vac	10..40 Vdc / 19..28 Vac	10..40 Vdc / 19..28 Vac / 50-60 Hz
Max Power Consumption	2,5 W	2,5 W	3,5 W	2,5 W
Isolation	1.500 Vac (3-ways)	1.500 Vac (3-ways)	1.500 Vac (3-ways)	1.500 Vac (3-ways)
Power Transducers	Yes, 17Vdc/20mA, max 5 sensors	-	Yes, 17Vdc/40mA, max 10 sensors	-
LED status indicators	Power Supply Error Data transmission Data receiving Input status	Power Supply Error Data transmission Data receiving Output status	Power Supply Error Data transmission Data receiving Input status	Power Supply Error Data transmission Data receiving Output status Diagnostic
Protection degree	IP20	IP20	IP20	IP20
Operating temperature	-10..+65°C	-10..+65°C	-10..+65°C	-10..+65°C
Dimension	17.5 x 100 x 112 mm	17.5 x 100 x 112 mm	17.5 x 100 x 112 mm	17.5 x 100 x 112 mm
Weight	140 g approx	140 g approx	140 g approx	140 g approx
Case	Nylon 6, 30% fiberglass filled, self extinguishing class V0	Nylon 6, 30% fiberglass filled, self extinguishing class V0	Nylon 6, 30% fiberglass filled, self extinguishing class V0	Nylon 6, 30% fiberglass filled, self extinguishing class V0
Connections	Removable terminals with section of 2,5 mm ²	Removable terminals with section of 2,5 mm ²	Removable terminals with section of 2,5 mm ²	Removable terminals with section of 2,5 mm ²
Mounting	DIN 46277 35 mm rail	DIN 46277 35 mm rail	DIN 46277 35 mm rail	DIN 46277 35 mm rail
Programming	Z-NET4 (system software) EASY SETUP (plug&play software) DIP switch	Z-NET4 (system software) EASY SETUP (plug&play software) DIP switch	Z-NET4 (system software) EASY SETUP (plug&play software) DIP switch	Z-NET4 (system software) EASY SETUP (plug&play software) DIP switch
Memory (data)	EEPROM for setting parameters, retention time 10 years, Nr.5 registers @16 bits, Nr.5 overflow bits, FeRAM for counters saving	EEPROM for setting parameters, retention time 10 years	EEPROM for setting parameters, retention time 10 years, FeRAM for counters saving	EEPROM for setting parameters, retention time 10 years
Approvals	CE	CE	UL-UR CSA, CE	UL-UR CSA, CE
COMMUNICATION				
Interfaces	RS485 2 wires	RS485 2 wires	RS485 2 wires	RS485 2 wires
Speed	Up to 115.200 bps	Up to 115.200 bps	Up to 115.200 bps	Up to 115.200 bps
Protocols	ModBUS RTU slave	ModBUS RTU slave	ModBUS RTU slave	ModBUS RTU slave
Communication time	< 10 ms (@ 38400 bps)	< 10 ms (@ 38400 bps)	< 10 ms (@ 38400 bps)	< 10 ms (@ 38400 bps)
Max distance	Up to 1.200 m	Up to 1.200 m	Up to 1.200 m	Up to 1.200 m
Connectivity	Max 32 nodes	Max 32 nodes	Max 32 nodes	Max 32 nodes
INPUT / OUTPUT DATA				
Nr. Channels	5 inputs	5 outputs	10 inputs	10 outputs
Tipo	Nr.5 optoisolated input Reed, Proximity, PNP, NPN, contact etc. Nr.5 counters @16 bit, max freq. 100 Hz; Nr.1 counter @32 bit, max freq. 10 kHz Anti-rebound filter 5..250 ms Overflow indication of each totalizer	Nr.5 SPST relay output (NO in common) max relay capacity 5A 250 Vac with resistive load; 2A with inductive load Max current 12 A on common terminal Relay safety status in case of communication failure Adjustable safety time from 0,5 to 25 ms	Nr.10 optoisolated channels (reed, proximity, npn, npn, contact) with common negative self-powered 24 Vdc, protected from transients up to 600 W/ms Nr.8 inputs @16 bits max freq. 100 Hz; nr.2 inputs@32 bits max freq. 10 KHz Inputs protected by fast transient suppressors TVS 600 W/ms Frequency measurement for 10 kHz inputs Measurement of period, frequency, Ton, Toff for 100 Hz inputs Total count forward or backward Overflow indication of each totalizer	Nr.10 MOSFET outputs protected from short circuit with negative in common, supplied from 6 to 40 Vdc, flow rate 0,5 A, resistive or inductive load Adjustable safety time 33 ms..2184 s Load supply voltage measurement Diagnostic signal on the front panel for each channel: ON / OFF / Overload / Open circuit Programmable fail-safe function (output status)





MODBUS RTU ANALOG I/O MODULES

	Z-DAQ-PID	Z-4AI	Z-8AI	Z-3AO	Z-SG
					
	I/O universal module with PID regulation / RS485 ModBUS RRTU	4-CH current/voltage input module / RS485 ModBUS RTU	8-CH current/voltage input module / RS485 ModBUS RTU	3-CH current/voltage output module / RS485 ModBUS RTU	Strain gauge input module / RS485 ModBUS RTU
GENERAL DATA					
Power Supply	10..40 Vdc / 19..28 Vac	10..40 Vdc / 19..28 Vac	10..40 Vdc / 19..28 Vac	10..40 Vdc / 19..28 Vac	10..40 Vdc / 19..28 Vac
Max power consumption	2 W	3,5 W	3,5 W	3,2 W	2 W
Isolation	1,5 kVac (3-way)	1,5 kVac (3-way)	1,5 kVac (3-way)	1,5 kVac (3-way)	1,5 kVac (3-way)
Power transducers	Yes, 17Vdc/25mA, max 1 channel	Yes, 20Vdc/40mA, max 4 channels	Yes, 13Vdc/90+90mA, max 8 channels		Yes, 5Vdc/60mA, max 1 sensor
Protection degree	IP20	IP20	IP20	IP20	IP20
Operating temperature	-10..+65°C	-10..+65°C	-10..+65°C	-10..+65°C	-10..+65°C
Dimension	17.5x100x112 mm	17.5x100x112 mm	17.5x100x112 mm	17.5x100x112 mm	17.5x100x112 mm
Weight	Approx 140 g	Approx 140 g	Approx 140 g	Approx 140 g	Approx 140 g
Case	Nylon 6, 30% fiberglass filled, self extinguishing class V0	Nylon 6, 30% fiberglass filled, self extinguishing class V0	Nylon 6, 30% fiberglass filled, self extinguishing class V0	Nylon 6, 30% fiberglass filled, self extinguishing class V0	Nylon 6, 30% fiberglass filled, self extinguishing class V0
Connections	Removable screw terminals for conductors up to 2.5 mm ² IDC10 rear connector for DIN rail RS232 communication front jack (COM)	Removable screw terminals for conductors up to 2.5 mm ² DC10 rear connector for DIN rail RS232 communication front jack (COM)	Removable screw terminals for conductors up to 2.5 mm ² Nr.1 Micro USB 2.0	Removable screw terminals for conductors up to 2.5 mm ² IDC10 rear connector for DIN rail RS232 communication front jack (COM)	Removable screw terminals for conductors up to 2.5 mm ² IDC10 rear connector for DIN rail Nr.1 Micro USB 2.0
Mounting	DIN 46277 35 mm rail	DIN 46277 35 mm rail	DIN 46277 35 mm rail	DIN 46277 35 mm rail	DIN 46277 35 mm rail
Programming	Z-NET4 (system software) EASY SETUP (plug&play software) DIP switch	Z-NET4 (system software) EASY SETUP (plug&play software) DIP switch	Z-NET4 (system software) EASY SETUP (plug&play software) DIP switch	Z-NET4 (system software) EASY SETUP (plug&play software) DIP switch	Z-NET4 (system software) EASY SETUP (plug&play software) DIP switch
Memory (data)	EEPROM for configuration parameters, retention time 10 years	EEPROM for configuration parameters, retention time 10 years	EEPROM for configuration parameters, retention time 10 years	EEPROM for configuration parameters, retention time 10 years	EEPROM for configuration parameters, retention time 40 years
Approvals	CE	CE	CE, UL-UR	CE, UL-UR	CE
COMMUNICATION					
Interfaces	RS485 2 wires RS232 (jack stereo 3.5 mm)	RS485 2 wires RS232 (jack stereo 3.5 mm)	RS485 2 wires RS232 (jack stereo 3.5 mm)	RS485 2 wires RS232 (jack stereo 3.5 mm)	RS485 2 wires
Speed	Up to 115.200 bps	Up to 115.200 bps	Up to 115.200 bps	Up to 115.200 bps	Up to 115.200 bps
Protocols	MosBUS RTU slave	MosBUS RTU slave	MosBUS RTU slave	MosBUS RTU slave	MosBUS RTU slave
Communication time	< 10 ms (@38.400 bps)	< 10 ms (@38.400 bps)	< 10 ms (@38.400 bps)	< 10 ms (@38.400 bps)	< 10 ms (@38.400 bps)
Max distance	Up to 1.200 m	Up to 1.200 m	Up to 1.200 m	Up to 1.200 m	Up to 1.200 m
Connectivity	Max 32 nodes	Max 32 nodes	Max 32 nodes	Max 32 nodes	Max 32 nodes
INPUT / OUTPUT DATA					
Nr.channels	1 input, 1 output	4 inputs	8 inputs	3 outputs (active)	1 input, 1 output
Type	INPUT Millivolt: configurable from -10 to +80 mV Voltage: configurable from 0 to 10 V Current: configurable from 0 to 20 mA Potentiometer: 1 kΩ... 100 kΩ Thermocouple J,K,E,T,N,B,R,S RTD: Pt100, Pt500, Pt1000, Ni100 OUTPUT Configurable voltage between 0-10 V Active / passive current configurable between 0-20 mA	Bipolar voltage ±10 Vdc or ±2 Vdc, impedance 100 KΩ Bipolar direct current ±20 mA, impedance 100 Ω	Bipolar programmable voltage (±2.5 Vdc, ±10 Vdc, impedance >100 kΩ) or current (±20 mA)	Voltage (±10 V, 0/2...10 V, controllable impedance > 600 Ω) or current (0/4..20 mA, controllable impedance < 600 Ω)	INPUT 1 analog channel for reading (and power supply) up to 4 (350 Ω) or 8 (1,000 Ω) strain gauge load cells, 4-wire or 6-wire connection, equivalent impedance 87 Ω 1 DI/1DO tare calibration or weight threshold Sensitivity from 1 to 64 mV/V OUTPUT 1 analog retransmission channel of the net weight in current (0..20, 4..20 mA) or voltage (0..5/10 V)
Resolution	14 bit + sign	16 bit	16 bit	13 bit	24 bit (ADC)
Accuracy class	0,1%	0,1%	0,1%	0,1%	0,01%
Stability	0,01%/°C	0,01%/°C	0,01%/°C	0,01%/°C	25 ppm/K





MODBUS RTU TEMPERATURE MODULES

	Z-4RTD2	Z-4RTD2-SI	Z-4TC
	 		
	4-CH RTD input module / RS485 ModBUS RTU	4-CH RTD input module / RS485 ModBUS RTU @24bits	4-CH Thermocouple input module / RS485 ModBUS RTU
GENERAL DATA			
Power Supply	10..40 Vdc, 19..28 Vac 50..60 Hz	10..40 Vdc, 19..28 Vac 50..60 Hz	10..40 Vdc, 19..28 Vac 50..60 Hz
Max Power Consumption	0,7 W	0,7 W	1 W
Isolation	1.500 Vac	1.500 Vac	1.500 Vac
Status indicators	Power supply Error Data transmission Data reception	Power supply Error Data transmission Data reception	Power supply Error Data transmission Data reception
Protection degree	IP20	IP20	IP20
Operating temperature	-10..+65°C	-20..+70°C	-10..+65°C
Dimension	17,5x100x112 mm	17,5x100x112 mm	17,5x100x112 mm
Weight	Approx 140 g	Approx 140 g	Approx 140 g
Case	Nylon 6 preloaded 30% glass fibre, self-extinguishing class V0	Nylon 6 preloaded 30% glass fibre, self-extinguishing class V0	Nylon 6 preloaded 30% glass fibre, self-extinguishing class V0
Connections	Removable screw terminals for conductors up to 2.5 mm ² IDC10 rear connector for DIN rail Nr.1 Micro USB 2.0	Removable screw terminals for conductors up to 2.5 mm ² IDC10 rear connector for DIN rail Nr.1 Micro USB 2.0	Removable screw terminals for conductors up to 2.5 mm ² IDC10 rear connector for DIN rail RS232 communication front jack (COM)
Mounting	For 35 mm rail DIN 46277	For 35 mm rail DIN 46277	For 35 mm rail DIN 46277
Programming	System software (Z-NET4) Plug & Play Configurator (EASY SETUP) DIP switch	System software (Z-NET4) Plug & Play Configurator (EASY SETUP) DIP switch	System software (Z-NET4) Plug & Play Configurator (EASY SETUP) DIP switch
Memory (data)	EEPROM for configuration parameters, retention time 10 years	EEPROM for configuration parameters, retention time 10 years	EEPROM for configuration parameters, retention time 10 years
Approvals	CE, UL-UR	CE, UL-UR	CE
COMMUNICATION			
Interfaces	Nr.1 RS485 2 wires Nr.1 Micro USB 2.0	Nr.1 RS485 2 wires Nr.1 Micro USB 2.0	Nr.1 RS485 2 wires
Speed	Up to 115.200 bps	Up to 115.200 bps	Up to 115.200 bps
Protocols	ModBUS RTU slave	ModBUS RTU slave	ModBUS RTU slave
Communication time	45..179 ms	45..179 ms	< 20 ms (@38.400 bps)
Max distance	Up to 1.200 m	Up to 1.200 m	Up to 1.200 m
Connectivity	Max 32 nodes	Max 32 nodes	Max 32 nodes
INPUT / OUTPUT DATA			
Nr.channels	4 inputs	4 inputs	4 inputs
Type	4 terminals (ohmeter at 2,3,4 wires) Pt100: -200..+650°C (f.s. 330 Ω) Pt500: -200..+750°C (f.s. 1.800 Ω) Pt1000: -200..+210°C (f.s. 1.800 Ω) Ni100: -60..+250°C (f.s. 330 Ω)	RTD 2,3,4-wire PT100, EN 60751/A2 (ITS-90), - 200..+650°C PT500, EN 60751/A2 (ITS-90), - 200..+750°C PT1000, EN 60751/A2 (ITS-90), - 200..+210°C NI100, EN 60751/A2 (ITS-90), -60..+250°C CU50 GOST 6651-2009, -180..+200°C CU100 GOST 6651-2009, -180..+200°C Ni120 DIN 43760, -60..+250°C	Bipolar voltage ± 80 mVdc, impedance 10 MΩ Thermocouple J, K, R, S, T, B, E, N
Resolution	14 bits	24 bits	13 bits + sign
Accuracy class	0,05	0,05	0,1%
Thermal drift	< 50 ppm/K	< 50 ppm/K	0,01%/°C c.d.m.





MODBUS RTU TEMPERATURE MODULES

	Z-8TC-1	Z-8TC-LAB	Z-8NTC
	 		
	8-CH Thermocouple and mV input module / RS485 ModBUS RTU	8-CH Thermocouple and mV input module / RS485 ModBUS RTU, interchangeable clamps	8-CH NTC thermistors input module / RS485 ModBUS RTU
GENERAL DATA			
Power Supply	10..40 Vdc, 19..28 Vac 50..60 Hz, bus powered	10..40 Vdc, 19..28 Vac 50..60 Hz, bus powered	10..40 Vdc, 19..28 Vac 50..60 Hz
Max Power Consumption	0,6 W	0,6 W	TBD
Isolation	1.500 Vac	1.500 Vac	1.500 Vac
Status indicators	Power supply Error RS485	Power supply Error RS485	Power supply Error Data transmission Data reception
Protection degree	IP20	IP20	IP20
Operating temperature	-10..+65°C	-10..+65°C	-20..+70°C
Dimension	17,5x100x112 mm	17,5x100x112 mm	17,5x100x112 mm
Weight	Approx 140 g	Approx 140 g	Approx 140 g
Case	Nylon 6 preloaded 30% glass fibre, self-extinguishing class V0	Nylon 6 preloaded 30% glass fibre, self-extinguishing class V0	Nylon 6 preloaded 30% glass fibre, self-extinguishing class V0
Connections	Removable screw terminals for conductors up to 2.5 mm ² IDC10 rear connector for DIN rail RS232 communication front jack (COM)	Removable screw terminals for conductors up to 2.5 mm ² IDC10 rear connector for DIN rail Nr.1 micro USB 2.0	Removable screw terminals for conductors up to 2.5 mm ² IDC10 rear connector for DIN rail Nr.1 micro USB 2.0
Mounting	For 35 mm rail DIN 46277	For 35 mm rail DIN 46277	For 35 mm rail DIN 46277
Programming	System software (Z-NET4) Plug & Play Configurator (EASY SETUP) DIP switch	System software (Z-NET4) Plug & Play Configurator (EASY SETUP) DIP switch	System software (Z-NET4) Plug & Play Configurator (EASY SETUP) DIP switch
Memory (data)	EEPROM for configuration parameters, retention time 10 years	EEPROM for configuration parameters, retention time 10 years	EEPROM for configuration parameters, retention time 10 years
Approvals	CE	CE	CE
COMMUNICATION			
Interfaces	Nr.1 RS485 2 wires	Nr.1 RS485 2 wires Nr.1 Micro USB 2.0	Nr.1 RS485 2 wires; Nr.1 Micro USB 2.0
Speed	Up to 115.200 bps	Up to 115.200 bps	Up to 115.200 bps
Protocols	ModBUS RTU slave	ModBUS RTU slave	ModBUS RTU slave
Communication time	45..179 ms	45..179 ms	< 10 ms (@38.400 ms)
Max distance	Up to 1.200 m	Up to 1.200 m	Up to 1.200 m
Connectivity	Max 32 nodes	Max 32 nodes	Max 32 nodes
INPUT / OUTPUT DATA			
Nr.channels	8 inputs	8 inputs	8 inputs
Type	Thermocouple type J, K, R, S, T, B, E, N (EN 60584-1, ITS-90) Range: -210.. +1820 °C Span mV: -10,1..81,4 mV Shunt up to 70 mΩ	Thermocouple type J, K, R, S, T, B, E, N (EN 60584-1, ITS-90) Range: -210.. +1820 °C Span mV: -10,1..81,4 mV Shunt up to 70 mΩ	Generic NTC, user defined curve. Rated values 1K, 10K, 50K @25°C; Resistance from 100 Ohm to 10 kOhm; 1 kOhm to 100 kOhm; 5 kOhm to 500 kOhm
Resolution	16 bits	16 bits	16 bits
Accuracy class	0,1%	0,1%	0,5%
Thermal drift	< 100 ppm/K	< 100 ppm/K	< 100 ppm/K

MODBUS RTU / TCP-IP MIXED I/O MODULES

	Z-D-10	Z-5DI-2DO	Z-4DI-2AI-2DO	ZE-4DI-2AI-2DO	ZE-2AI
	 Modbus	 Modbus	 Modbus	 Modbus ETHERNET	 Modbus ETHERNET
	8-CH ModBUS RTU, 6 digital inputs, 2 digital outputs module	7-CH ModBUS RTU 5 digital inputs, 2 digital outputs module	8-CH ModBUS RTU, 4 digital inputs, 2 analog inputs, 2 digital outputs module	8-CH ModBUS RTU/TCP-IP, 4 digital inputs, 2 analog inputs, 2 digital outputs module	2-CH 2 ModBUS RTU/TCP-IP 2 analog inputs module
GENERAL DATA					
Power supply	10..40 Vdc / 19..28 Vac	10..40 Vdc / 19..28 Vac	11.40 Vdc; 19..28 Vac	11.40 Vdc; 19..28 Vac	10..40 Vdc / 19..28 Vac
Power consumption	2,5 W	3,5 W	1,5W @ 24Vdc, Max: 4W	1,5W @ 24Vdc, Max: 4W	1,5W @ 24Vdc, Max: 2W
Isolation	1.5 kVac vs inputs; 3.75 kVac vs outputs	1.5 kVac vs inputs; 3.75 kVac vs outputs	1.5 kVac 3-way	1.5 kVac 3-way	1.5 kVac 2-way
Protection degree	IP20	IP20	IP20	IP20	IP20
LED status indicators	Power supply Error Data Transmission Data Reception Input Status Status Outputs	Power supply Error Data Transmission Data Reception Input Status Output Status	Power supply Rx/Tx ModBUS Status Inputs/Outputs Fail	Power supply/IP address Rx/Tx ModBUS Tx Ethernet Ethernet Link Status Inputs / Outputs Fail	Power Supply / IP Address Rx/Tx ModBUS Tx Ethernet Ethernet Link Status Inputs / Outputs Fail
Operating temperature	-10..+65°C	-20..+65°C	-25..+70°C	-25..+70°C	-25..+70°C
Storage temperature	-20..+85°C	-20..+85°C	-25..+85°C	-25..+85°C	-25..+85°C
Humidity	30..90% non-condensing	30..90% non-condensing	30..90% noncondensing	30..90% noncondensing	30..90% noncondensing
Dimensions	35x102.5x111 mm	35x102.5x111 mm	35x102.5x111 mm	35x102.5x111 mm	17.5x102.5x111 mm
Weight	110 g approx.	110 g approx.	110 g approx.	110 g approx.	110 g approx.
Housing	PA6, color black	PA6, color black	PA6, color black	PA6, color black	PA6, color black
Connections	Removable screw terminals for conductors up to 2.5 mm ² IDC10 rear connector for DIN rail 46277	Removable screw terminals for conductors up to 2.5 mm ² Rear IDC10 connector for DIN rail 46277 Micro USB front RJ45	Removable screw terminals for conductors up to 2.5 mm ² IDC10 rear connector for DIN rail 46277 Micro USB lateral RJ45	Removable screw terminals for conductors up to 2.5 mm ² IDC10 rear connector for DIN rail 46277 - RJ45	Removable screw terminals for conductors up to 2.5 mm ² IDC10 rear connector for DIN rail 46277 - RJ45
Mounting	For 35 mm DIN rail 46277	For 35 mm DIN rail 46277	For 35 mm DIN rail 46277	For 35 mm DIN rail 46277	For 35 mm DIN rail 46277
Programming	DIP Switch Z-NET EASY SETUP	DIP Switch (factory configuration) Web Server EASY SETUP / EASY SETUP 2	DIP Switch (factory configuration) Web Server EASY SETUP / EASY SETUP 2	DIP Switch (factory configuration) Web Server EASY SETUP 2	DIP Switch (factory configuration) Web Server EASY SETUP 2
Special Functions	Timed Control Logics		-	LAN ModBUS TCP Server	LAN ModBUS TCP Server
Approvals	CE	CE	CE	CE	CE
COMMUNICATION					
Interfaces	Nr.1 RS485	Nr.1 RS485, Nr.1 Micro USB	Nr.1 RS232/RS485 Nr1 RS485 Nr.1 micro USB laterale	Nr.1 Ethernet 10/100 Mbps Nr.1 RS232/RS485 Nr1 RS485	Nr.1 Ethernet 10/100 Mbps Nr.1 RS232/RS485 Nr1 RS485
Velocità	Fino a 115.200 bps	Fino a 115.200 bps	Fino a 115.200 bps	Fino a 115.200 bps / 100 Mbps (TCP-IP)	Fino a 115.200 bps / 100 Mbps (TCP-IP)
Protocols	ModBUS RTU	ModBUS RTU	ModBUS RTU	ModBUS RTU, ModBUS TCP-IP, http	ModBUS RTU, ModBUS TCP-IP, http
DIGITAL INPUTS					
Number	N°6 Digital Inputs	Nr. 5 Digital Inputs	Nr. 4 Digital Inputs	Nr. 4 Digital Inputs	-
Type	Reed, Contact, Proximity PNP, NPN	Reed, Contact, Proximity PNP, NPN	PNP / NPN; Voltage input OFF < 4V, ON > 8V (max. 24 Vdc). Current input 20mA	PNP / NPN; Voltage input OFF < 4V, ON > 8V (max. 24 Vdc). Current input 20mA	-
Max frequency		5 kHz	5 kHz	5 kHz	-
Power consumption		3.5mA @ 12Vdc, 10mA @ 24Vdc	3mA @ 12Vdc, 10mA @ 24Vdc	3mA @ 12Vdc, 10mA @ 24Vdc	-
Counters			Nr.4 resettable counters @32 bit max 5 kHz	Nr.4 resettable counters @32 bit max 5 kHz	-
ANALOG INPUTS					
Number	-	-	Nr. 2 Analog Inputs	Nr. 2 Analog Inputs	Nr. 2 Analog Inputs
Type	-	-	0-20 mA / 0-30 V	0-20 mA / 0-30 V	0-20 mA / 0-30 V
Resolution	-	-	Max 16 bits	Max 16 bits	Max 16 bits
Protection	-	-	40V / 25mA	40V / 25mA	40V / 25mA
DIGITAL OUTPUTS					
Number	Nr. 2 Digital Outputs	No. 2 Digital Outputs	Nr. 2 Digital Outputs	Nr. 2 Digital Outputs	-
Type	SPST relay with common, capacity 2A - 250 Vac	SPST relay with common, capacity 2A - 250 Vac	NO / NC SPDT relay, max 250Vac - 5A	NO / NC SPDT relays, max 250Vac - 5A	-

MODBUS RTU / CANOPEN DIGITAL I/O MODULES







	ZC-24DI	ZC-24DO	ZC-16DI-8DO
 	 24-CH digital input module ModBUS/ CANopen	 24-CH digital output module ModBUS/ CANopen	 16 CH digital input - 8 CH digital output module ModBUS/CANpen
GENERAL DATA			
Power supply	10..40 Vdc / 19..28 Vac	10..40 Vdc / 19..28 Vac	10..40 Vdc / 19..28 Vac
Power consumption	1,5 W (typical), 2,5 W (max)	2,5 W	2,5 W
Isolation	1,5 kVac (@ 3 ways)	1,5 kVac (@ 3 ways)	1,5 kVac (@ 3 ways)
Power transducers	Yes, 16V/70mA, max 24 sensors	-	Yes, 16V/70mA, max 16+8 sensors
LED status indicators	Power supply Input status Communication	Power supply Output status Communication	Power supply Input / Output status Communication
Protection degree	IP20	IP20	IP20
Operating temperature	-10..-65°C	-10..-65°C	-10..-65°C
Dimension	35 x 100 x 112 mm	35 x 100 x 112 mm	35 x 100 x 112 mm
Weight	Approx 200 g	Approx 200 g	Approx 200 g
Case	Nylon 6 reinforced 30% glass fibre, self-extinguishing class V0	Nylon 6 reinforced 30% glass fibre, self-extinguishing class V0	Nylon 6 reinforced 30% glass fibre, self-extinguishing class V0
Connections	Removable 4-way screw terminals pitch 3.5 mm, section 2.5 mm ² Nr.1 Micro USB 2.0 (front panel) Nr.1 IDC10 rear connector for DIN rail	Removable 4-way screw terminals pitch 3.5 mm, section 2.5 mm ² Nr.1 Micro USB 2.0 (front panel) Nr.1 IDC10 rear connector for DIN rail Nr.1 IDC10 side connector Nr.1 IDC20 side connector	Removable 4-way screw terminals pitch 3.5 mm, section 2.5 mm ² Nr.1 Micro USB 2.0 (front panel) Nr.1 IDC10 rear connector for DIN rail Nr.1 IDC10 side connector
Mounting	35 mm DIN rail IEC EN 60715	35 mm DIN rail IEC EN 60715	35 mm DIN rail IEC EN 60715
Programming	DIP switch, Z-NET4, EASY SETUP, EDS, Codesys (IEC 61131)	DIP switch, Z-NET4, EASY SETUP, EDS, Codesys (IEC 61131)	DIP switch, Z-NET4, EASY SETUP, EDS, Codesys (IEC 61131)
Approvals / Norms	CE, EN 61000-6-4, EN 64000-6-2, EN 61010-1, CAN 2.0A, 2.0B CiA 401 v.2.01 IEC EN 61131-2	CE, EN 61000-6-4, EN 64000-6-2, EN 61010-1, CAN 2.0A, 2.0B CiA 401 v.2.01 IEC EN 61131-2	CE, EN 61000-6-4, EN 64000-6-2, EN 61010-1, CAN 2.0A, 2.0B CiA 401 v.2.01 IEC EN 61131-2
COMMUNICATION			
Interfaces	RS485, RS232	RS485, RS232	RS485, RS232
Data rate	1 Mbps (CANopen); 115.200 bps (ModBUS)	1 Mbps (CANopen); 115.200 bps (ModBUS)	1 Mbps (CANopen); 115.200 bps (ModBUS)
Protocols	CAN bus standard (2.0A, 2.0B); CANopen (profile CiA 401 v.2.01); ModBUS RTU (via RS485)	CAN bus standard (2.0A, 2.0B); CANopen (profile CiA 401 v.2.01); ModBUS RTU (via RS485)	CAN bus standard (2.0A, 2.0B); CANopen (profile CiA 401 v.2.01); ModBUS RTU (via RS485)
Communication time	2,5 ms	1,2 ms	1,2..2,5 ms
Special function	CANopen/ModBUS protocol switching	CANopen/ModBUS protocol switching	CANopen/ModBUS protocol switching
INPUT / OUTPUT DATA			
Nr. Channels	24 inputs (with common negative self-powered at 16 Vdc)	24 outputs	16 inputs, 8 outputs
Type	Nr. 24 digital inputs with polarity EN 61131-2 type 2, synq (pnp); Nr 8 @ 32 bit, freq. max 10 kHz; configuration increment, reset, preset; Overflow indication; Vmax=30V; pulse width 250µs; on/off delay < 3ms; TPDO < 1msa	Nr.24 Mosfet outputs (open source with common negative); supply voltage 5..30 Vc; Imax=0,5A (from terminals) / 25 mA (from connectors); on/off delay < 1ms; RPDO < 1,25 ms	Nr.16 digital inputs with polarity EN 61131-2 type 2, synq (pnp); Nr 8 @ 32 bit, freq. max 10 kHz; configuration increment, reset, preset; Overflow indication; Vmax=30V; pulse width 250µs; on/off delay < 3ms; TPDO < 1ms Nr.8 Mosfet outputs (open source with common negative); supply voltage 5..30 Vc; Imax=0,5A (from terminals) / 25 mA (from connectors); on/off delay < 1ms; RPDO < 1,25 ms

CANopen
I/O

CANopen Z-PC Line is a truly distributed I/O system based on IEC 61131 programming that does not require the use of couplers, controllers or repeaters for each communication line. All modules have an interface CAN communication with speeds up to 1 Mbps and are therefore ideal for acquiring and controlling system signals on plants and machines where the distance between the signals plays a fundamental role.

CANopen Z-PC Line modules can be integrated with configurators and master controllers / network managers of third parties, even on existing machines and installations. The advantage of not needing an end-of-line coupler significantly reduces the cost factor for small to medium installations CANopen.

CANOPEN ANALOG I/O MODULES

	ZC-8AI	ZC-3AO	ZC-4RTD	ZC-8TC	ZC-SG
					
	8-CH analog (mA, V) input module CANopen	3-CH analog (mA, V) output CANopen module	4-CH thermoresistance CANopen module	8-CH thermocouple CANopen module	1-CH load cello CANopen module
GENERAL DATA					
Power supply	10..40 Vdc / 19..28 Vac	10..40 Vdc / 19..28 Vac	10..40 Vdc / 19..28 Vac	10..40 Vdc / 19..28 Vac	10..40 Vdc / 19..28 Vac (strain gauge powered by the instrument)
Power consumption	5 W	2,5 W	1 W	1 W	2 W
Isolation	1.5 kVac	1.5 kVac	1.5 kVac	1.5 kVac	1.5 kVac
Input protection	Against ESD up to 4 kV	Against ESD up to 4 kV	Against ESD up to 4 kV	Against ESD up to 4 kV	Against ESD up to 4 kV
Power transducers	Yes, 16V/22mA, max 8 sensors	-	-	-	Yes, 5Vdc, max 8 sensors
LED status indicators	Power supply Communication Input error	Power supply Communication Input error	Power supply Communication Input error	Power supply Communication Input error	Power supply Communication Input error
Protection degree	IP20	IP20	IP20	IP20	IP20
Operating temperature	-10..-65°C	-10..-65°C	-10..-65°C	-10..-65°C	-10..-65°C
Dimension	17,5 x 100 x 112 mm	17,5 x 100 x 112 mm	17,5 x 100 x 112 mm	17,5 x 100 x 112 mm	17,5 x 100 x 112 mm
Weight	170 g	170 g	170 g	170 g	170 g
Case	Nylon 6 reinforced 30% glass fibre, self-extinguishing class V0	Nylon 6 reinforced 30% glass fibre, self-extinguishing class V0	Nylon 6 reinforced 30% glass fibre, self-extinguishing class V0	Nylon 6 reinforced 30% glass fibre, self-extinguishing class V0	Nylon 6 reinforced 30% glass fibre, self-extinguishing class V0
Connections	4-way removable screw terminals, pitch 3,5 mm IDC10 rear connector for DIN rail 3.5 mm stereo front jack for RS232 (COM)	4-way removable screw terminals, pitch 3,5 mm IDC10 rear connector for DIN rail 3.5 mm stereo front jack for RS232 (COM)	4-way removable screw terminals, pitch 3,5 mm IDC10 rear connector for DIN rail 3.5 mm stereo front jack for RS232 (COM)	4-way removable screw terminals, pitch 3,5 mm IDC10 rear connector for DIN rail 3.5 mm stereo front jack for RS232 (COM)	4-way removable screw terminals, pitch 3,5 mm IDC10 rear connector for DIN rail 3.5 mm stereo front jack for RS232 (COM)
Mounting	For 35 mm rail DIN 46277	For 35 mm rail DIN 46277	For 35 mm rail DIN 46277	For 35 mm rail DIN 46277	For 35 mm rail DIN 46277
Programming	DIP switch, Z-NET4, EASY SETUP, EDS, Codesys (IEC 61131)	DIP switch, Z-NET4, EASY SETUP, EDS, Codesys (IEC 61131)	DIP switch, Z-NET4, EASY SETUP, EDS, Codesys (IEC 61131)	DIP switch, Z-NET4, EASY SETUP, EDS, Codesys (IEC 61131)	DIP switch, Z-NET4, EASY SETUP, EDS, Codesys (IEC 61131)
Approvals / Norms	CE, EN 61000-6-4, EN 64000-6-2, EN 61010-1 CAN 2.0A, 2.0B CIA 401 v.2.01 IEC EN 61131-2	CE, EN 61000-6-4, EN 64000-6-2, EN 61010-1 CAN 2.0A, 2.0B CIA 401 v.2.01 IEC EN 61131-2	CE, EN 61000-6-4, EN 64000-6-2, EN 61010-1 CAN 2.0A, 2.0B CIA 401 v.2.01 IEC EN 61131-2	CE, EN 61000-6-4, EN 64000-6-2, EN 61010-1 CAN 2.0A, 2.0B CIA 401 v.2.01 IEC EN 61131-2	CE, EN 61000-6-4, EN 64000-6-2, EN 61010-1 CAN 2.0A, 2.0B CIA 401 v.2.01 IEC EN 61131-2
COMMUNICATION					
Interfaces	RS485, RS232	RS485, RS232	RS485, RS232	RS485, RS232	RS485, RS232
Data rate	1Mbps (CANopen)	1Mbps (CANopen)	1Mbps (CANopen)	1Mbps (CANopen)	1Mbps (CANopen)
Protocols	CAN bus standard (2.0A, 2.0B) CANopen (CIA 401 v.2.01 profile) ModBUS RTU (RS485)	CAN bus standard (2.0A, 2.0B) CANopen (CIA 401 v.2.01 profile) ModBUS RTU (RS485)	CAN bus standard (2.0A, 2.0B) CANopen (CIA 401 v.2.01 profile) ModBUS RTU (RS485)	CAN bus standard (2.0A, 2.0B) CANopen (CIA 401 v.2.01 profile) ModBUS RTU (RS485)	CAN bus standard (2.0A, 2.0B) CANopen (CIA 401 v.2.01 profile) ModBUS RTU (RS485)
Sampling time	< 28 ms	< 7 ms	< 28 ms	< 28 ms	< 7 ms
INPUT / OUTPUT DATA					
Nr.channels	8 inputs (isolated in pairs)	3 outputs	4 RTD-isolated inputs, 2,3,4-wire measurement	8 inputs (thermocouple or mV measurement)	1 analog input, 1 digital input/output
Type	Voltage (0-10 V); Current (0-20 mA)	Voltage (± 10 V); Current (0-20, 4-20 mA)	PT100 (EN 60751/A2-ITS90), -200..+650°C PT500 (EN 60751/A2-ITS90), -200..+750°C PT1000 (EN 60751/A2-ITS90), -200..+210°C Ni100 (EN 60751/A2-ITS90), -60..+250°C	Thermocouple: J,K,E,N,S,R,B,T; EN - 60584-1 (ITS-90) Span mV: -10,1 mV..+81,4 mV Input impedance: 10 M Ω	"ANALOG INPUT load cells (strain gauge); 4 / 6-wire differential measurement (± 5 mV.. ± 320 mV); power supply voltage 5 Vdc; impedance min 87 equivalent; sensitivity from ± 1 mV/V to ± 64 mV/V DIGITAL INPUT Tare and span calibration (max 30 V)" 1 optoisolated digital output for stable or threshold weighing (max current 50 mA, max voltage 30 V)
Resolution	15 bit	14 bit	14 bit	15 bit	24 bit
Accuracy class	0,05%	0,01%	0,05%	0,1%	0,01%
Thermal drift	<100 ppm/°C	<100 ppm/°C	<50 ppm/°C	<100 ppm/°C	<25 ppm/°C

I/O MODULES - APPLICATION DIAGRAMS

Process measurement and data retransmission via ModBUS RTU

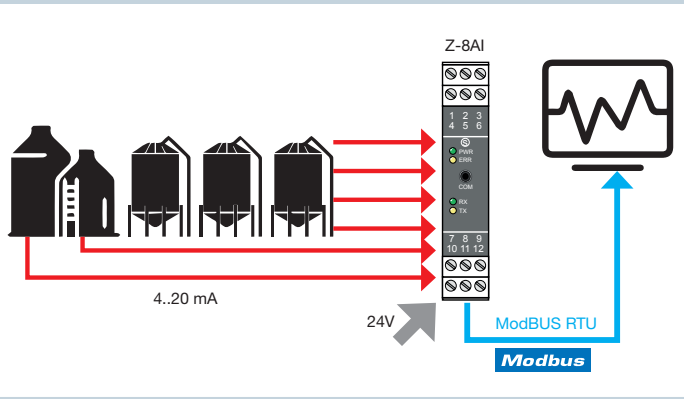

ModBUS acquisition and display for weighing systems

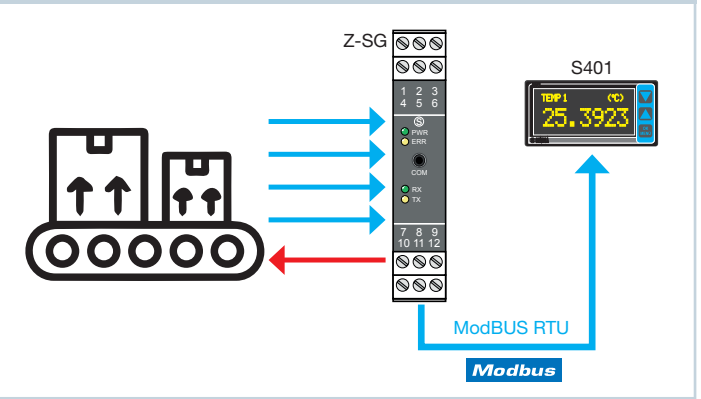

Local control via PLC and remote I/O

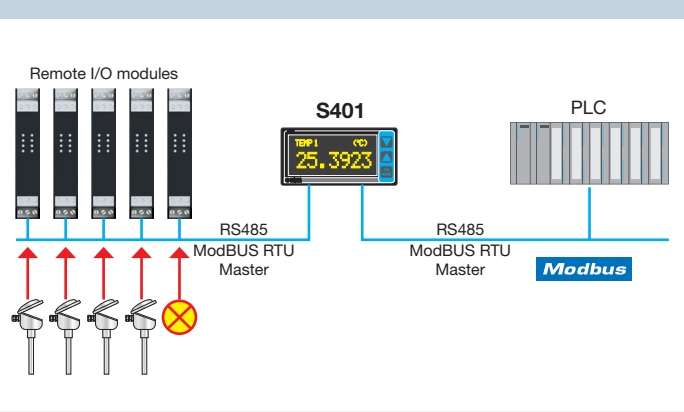

Acquisition and transmission of temperatures to a closed loop control system

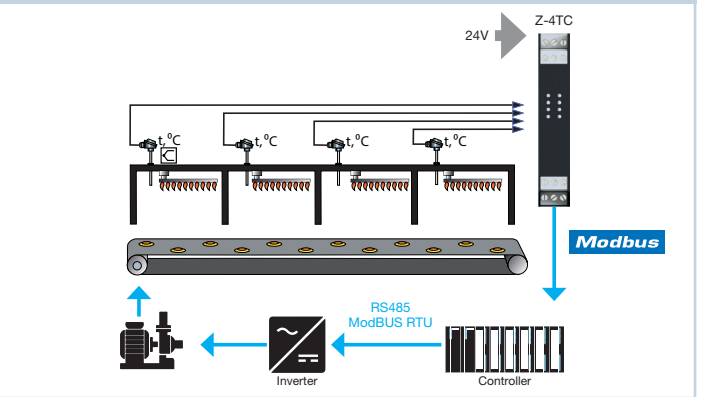

Data acquisition over Ethernet

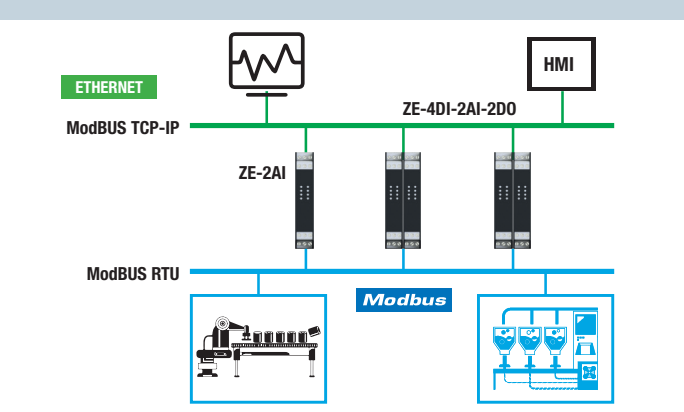

Ethernet Daisy Chain and ModBUS Pass-Through connection

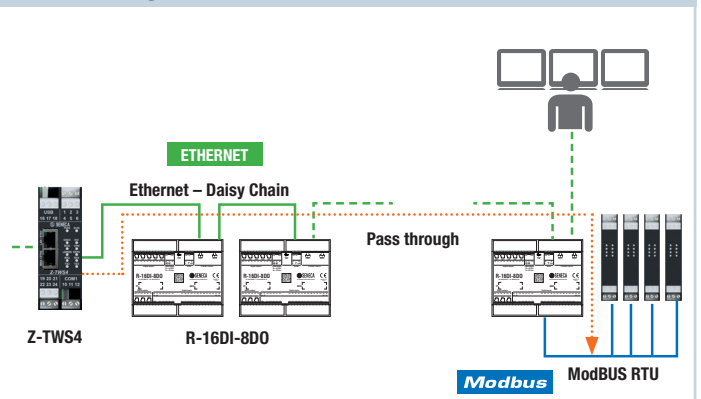

Programmable handling system

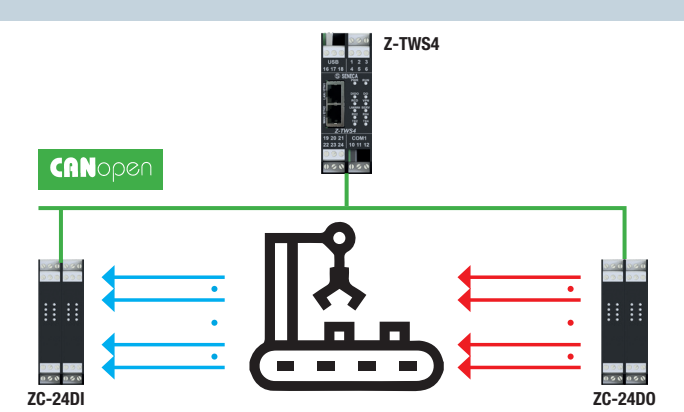

Automatic bottling system

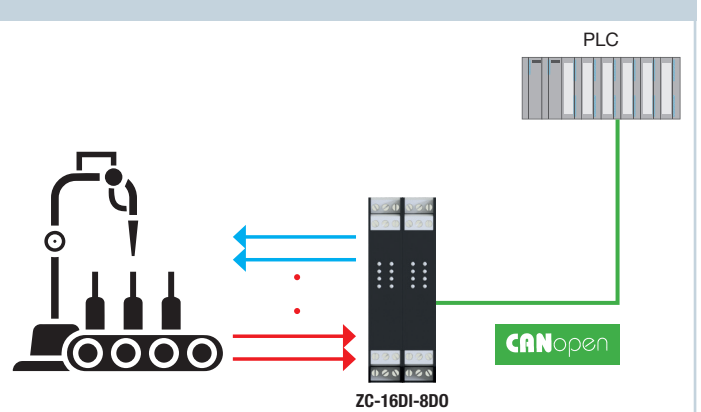

MULTIFUNCTION CONTROLLERS - OVERVIEW

SENECA high connectivity multifunction controllers and RTUs (Z-TWS11, Z-TWS4, Z-PASS2-S, S6001-RTU) combine PLC tasks based on Straton IEC 61131-1 softLPLC platform with web server, datalogger, remote control, remote assistance and energy management features (in compliance with IEC 60870-101/104, IEC 61850 protocols).

The controllers can be used with different architectures and configurations depending on the complexity of the system and the required hardware requirements. SENECA also provides process controllers and flow computers for predefined scenarios such as pump control and pressure boosting units (S6001-PC) and fluid control (Z-FLOWCOMPUTER).



MAIN FEATURES						
Built-in I/O	2AI	1DI, 2DO, 1DI/DO	2DI, 2DO, 2DI/DO	15DI+2DI, 8DO, 4AI, 2AO	4DI, 4DO, 2AI	2DI/DO
Programming	Straton, Z-NET4	Straton, Z-NET4	Straton, Z-NET4	Straton, Z-NET4	Straton, Z-Net4	Straton, Web Server, Widget
Flash	8 MB	1 GB	1 GB	1 GB	>= 4GB	>= 4GB
RAM	256 kB	64 MB	64 MB	64 MB	64 MB	512 MB
Programming dimension	246 kB	4 MB	4 MB	4 MB	4 MB	4 MB
PLC var. memory	38 kB	4 MB	4 MB	4 MB	4 MB	4 MB
CONNECTIVITY						
Modem/Router	-	-	3G+ / 4G	3G+	With optional module	With optional module
Protocols	ModBUS RTU/TCP, http, ftp, smtp	ModBUS RTU/TCP, CANopen, M-BUS, http, ftp, smtp	ModBUS RTU/TCP, CANopen, M-BUS, http, ftp, smtp, ppp	ModBUS RTU/TCP, CANopen, M-BUS, http, ftp, smtp, ppp	ModBUS RTU/TCP-IP, FTP/SFTP, HTTP/HTTPS, SSL, MQTT, OPC UA, http post	ModBUS RTU/TCP-IP, FTP/SFTP, HTTP/HTTPS, SSL, MQTT, OPC UA, http pos
Energy protocols (opt.)	-	Iec 60870-101/104, IEC 61850	Iec 60870-101/104, IEC 61850	Iec 60870-101/104, IEC 61850	-	-
VPN	-	VPN Box, OpenVPN	VPN Box, OpenVPN	VPN Box, OpenVPN	VPN Box, OpenVPN	VPN Box, OpenVPN
APN	-	x	x	x	x	-
Ethernet ports	1	2	2	2	2	2
Serial ports	2	3	3	3	2	2
USB ports	1 (Micro)	1 (Host)	1 (Host)	1 (Host)	2	2
APPLICATIONS						
Up to 200 I/O	x	-	-	-	x	x
Up to 1.000 I/O	-	x	x	x	x	x
Advanced Automation	-	-	x	x	x	x
Telecontrol / Remote Assistance	-	x	x	x	-	-
Microautomation	x	-	-	-	-	-
Energy Management	-	x	x	x	-	x

MULTIFUNCTION CONTROL UNITS - APPLICATION SCHEMES

Electrical stations control

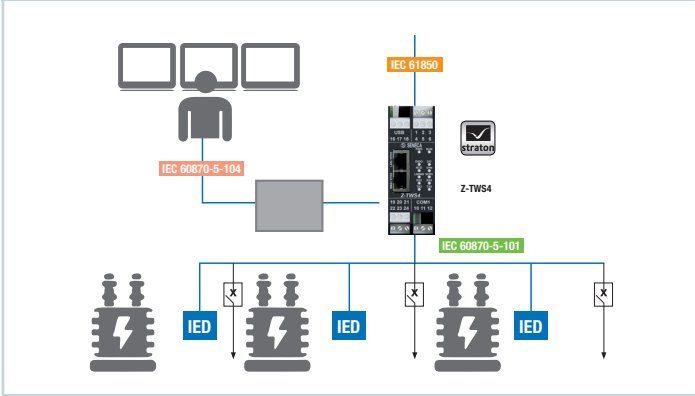

Temperature regulation system

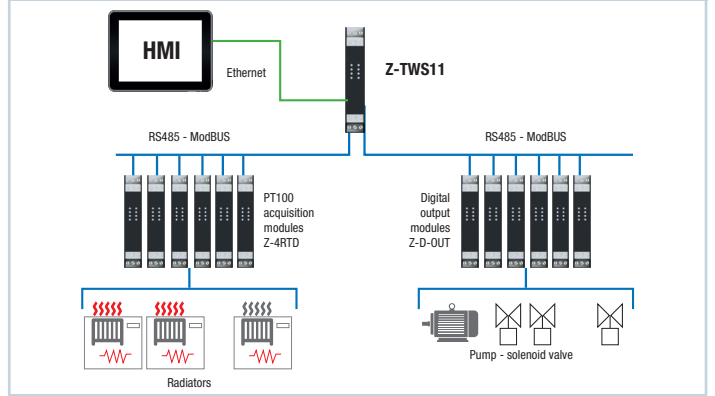

Plant control and remote maintenance

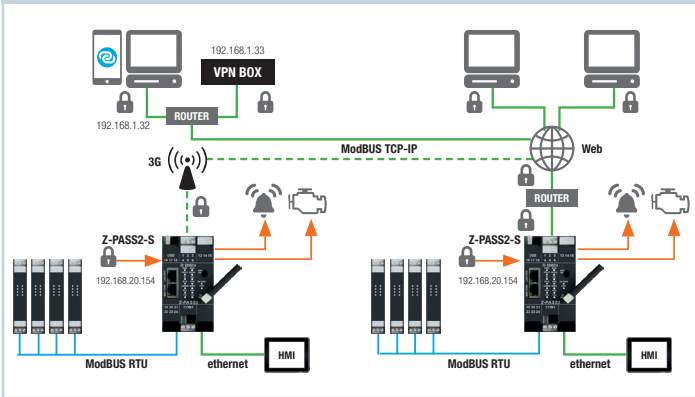

Metering and energy consumption telecontrol

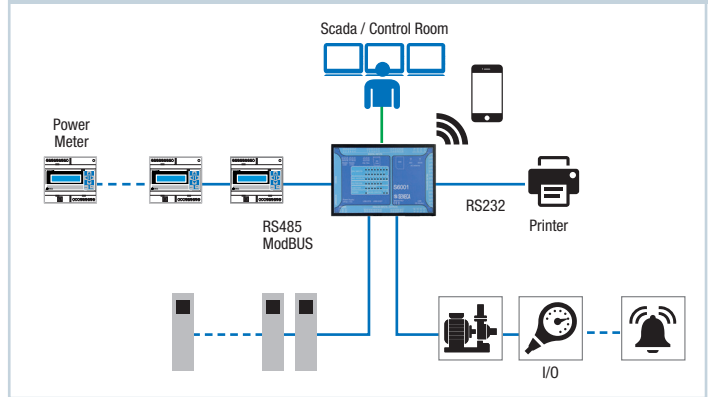

Seneca CPU – M-BUS sensors and meters connection

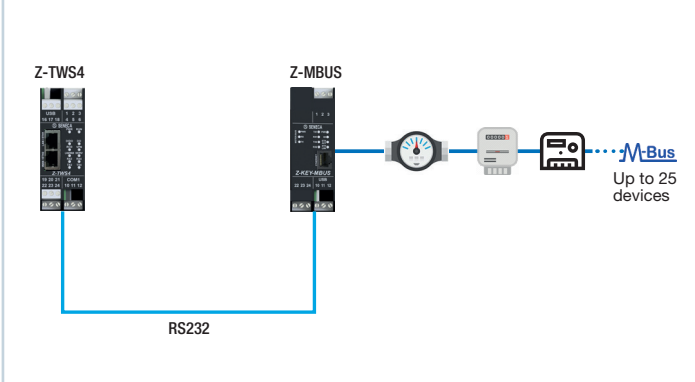

Distributed and multiuser connection with M-BUS sensors and meters

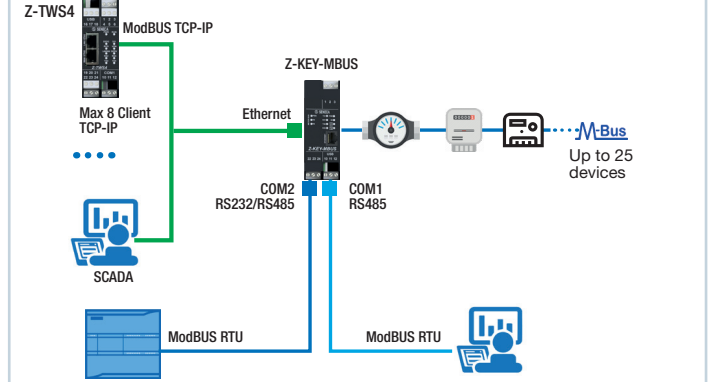

Pumps control

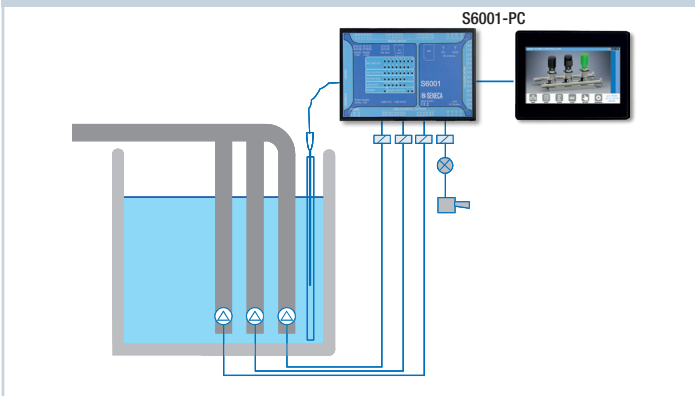

OPC UA / MQTT Control

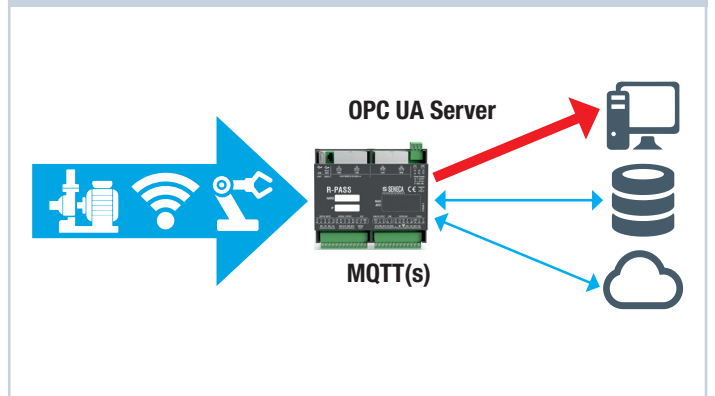

SOFTWARE PLATFORM

SENECA software suite includes powerful system configurators, programming environments including libraries, acquisition tools, data, events and alarms access and management. Z-NET-4, designed for the configuration of CPUs/controllers, I/O modules and ModBUS devices also enables the management and creation of databases of machine / plant variables (IEC 61131, OPC, trend, log). Alternatively, for quick configuration of the I/O modules is available the EASY SETUP plug&play software, also in Android app version.

The programming strategy of the SENECA controllers is based on the industry standard for IEC 61131 PLCs, in particular the Straton softPLC development environment which includes energy management libraries and protocols. Integrated in the Z-NET4 platform, Web Factory allows to develop html/web supervision pages loaded in the CPUs, to start with the overall project. Data Recorder and Trend Viewer are flexible tools for data acquisition, trend visualization, events, variables, alarms and more. than managing logs and archives. With the OPC Server technology it is possible to exchange real-time data with Scada and other Client applications.



EASY SETUP

Plug&Play suite for SENECA programmable instruments



Z-NET4

Complete configuration environment for Z-PC Series systems



WEB FACTORY

HMI/Web editor integrato in Z-NET4



DATA RECORDER

HMI/Web Editor (Z-NET4 built-in)



TREND VIEWER

Trend visualization software (Z-NET4 built-in)



STRATON

IEC 61131 programming environment



OPC SERVER

Data exchange and real-time variables management software



	EASY SETUP	Z-NET4	WEB FACTORY	DATA RECORDER	TREND VIEWER	STRATON	OPC Server
License	free	free	free	USB key	free	USB key	USB key
Hardware and I/O configuration	✓	✓					
Full system configuration	✓	✓					
Communication settings	✓	✓		✓		✓	✓
Variables advanced settings		✓				✓	✓
Alarms management		✓		✓		✓	
Control logic		✓				✓	
Remote control functions		✓				✓	
Math functions				✓		✓	
Logs / events archive						✓	
Diagnostic		✓		✓		✓	✓
Data Acquisition	✓	✓	✓	✓		✓	✓
Real-time variables simulation / acquisition	✓	✓	✓	✓		✓	✓
Data visualization (graphics / trends)			✓	✓	✓		
Data import / export					✓		✓
Variables configuration import / export		✓			✓	✓	✓

DATA RECORDER



Data Recorder is an open, scalable and economical software recorder based on Windows PC, ideal for testing sessions, laboratories, rehearsal rooms, monitoring of process measurements. Physical data acquisitions is made through Z-PC Line distributed I/O modules (with or without CPU), and in general from any ModBUS RTU slave standard device.

Communication between hardware and PC can be serial (RS232/RS485/ModBUS RTU) or Ethernet / ModBUS TCP, on wired or wireless physical medium. The licensing is managed with USB key and covers a visualization range from 2 to unlimited channels. The normalized graphic representation can be set with nibs or display (digit). The real-time display offers multiple selection options: groups of channels, visualization range, screen scrolling direction.

TOOLS / OPTIONS

Minimum hardware requirements

O.S. Windows 8 or later
RAM 128 MB
HD 3G
SVGA 800x600

Physical data acquisition via SENECA Z-PC Line remote I/O system



Windows & OPC tested & supported



Hand-held DAQ system ready-to-use

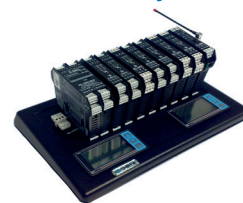

HIGHLIGHTS

Software license from 2 to unlimited channels



Real-time data recording with pen or display (digit)



Logging files (SQLite) displayed with Trend Viewer software tool



Data and project integration with Z-NET configuration suite



PLUS package with math, report, alarm, multiclient functions



Scheduling recording



Serial, Ethernet, Wireless connection support



Advanced calibration for temperature sensors



APPLICATION SCHEMES

MONITORING OF WATER QUALITY PARAMETERS

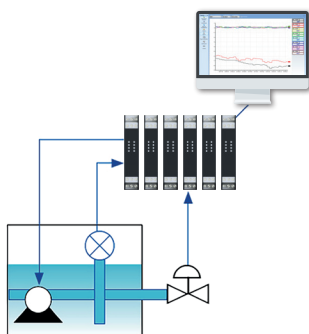

TEST AND DATA ACQUISITION FOR ELECTRIC MOTORS

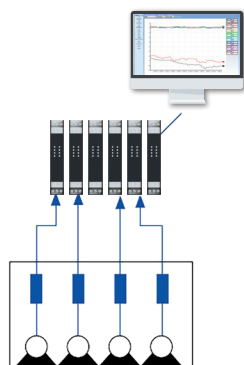

TEMPERATURE AND HUMIDITY MONITORING

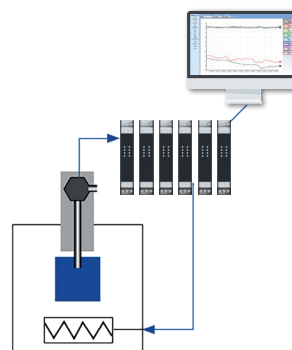

MONITORING OF CLIMATIC CHAMBERS

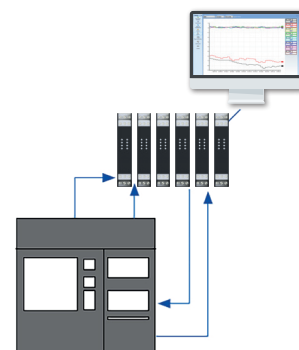

CONTACTS AND INFORMATIONS

Address

Headquarter: Via Austria 26 - 35127 Padova (I)
Tel. +39 049 8705 359 (408)
Fax +39 049 8706287

Web

General website: www.seneca.it
Documentation: www.seneca.it/en/cataloghi-flyers/
Tech support: www.seneca.it/en/supporto-e-assistenza
eCommerce: www.seneca.it/en/vetrina

E-mail

General information: info@seneca.it
Sales Office: sales@seneca.it
Quality Management: qualita@seneca.it
Product technical support: support@seneca.it

Follow us on Social Media

