

PLANT REMODELING

FIND IT FAST

Strip Doors and Accessories	540-542
Mesh Curtain Strips	543
Air Doors	544
Curtains and Roll-Up Doors	545
Flexible Doors	546
Traffic Doors	547-549
Personnel and Interior Doors	550
Cold Storage Doors and Parts	552-553
LED Fixture	554
Shatterproof Light Bulbs	554
Fluorescent Low Bay Fixtures	555
Washdown Light Fixtures	556-557
LED Lighting Fixtures	557
LED Emergency Lighting	558
Ceiling Panels and Systems	559-560
Stainless Steel Corners	560
Wall Coverings and Accessories	560-561
Floor Coatings	562
Lockers, Bollard Covers and Benches	563
Sanitary Barriers	564



Template Kit

Simplifies the process of cutting bulk roll material into individual door strips.

- Fabricated of non-slip 1/4-inch acrylic.
- Dimensions are permanently etched directly on the template.
- Special drill bit bores a perfectly round hole into material to prevent tearing.
- Kit includes template, drill bit and marker.



F.O.B. FACTORY EACH

ITEM NO.	PRODUCT	F.O.B. FACTORY EACH
G368 2700	Quickmount™ Template Kit	\$51.95

How to figure the AMOUNT OF STRIP NEEDED

We recommend mounting these doors 1 foot above door opening to eliminate tearing strips with tall loads.

- 1. Measure** the opening width and height in feet.
- 2. Add** 1 foot to the door height and width, depending on space available.
- 3. Calculate** using the following formula in feet:
 - 6" Strips — (width x height) x (1-1/2) x (2)
 - 8" Strips — (width x height) x (1-1/2) x (1-7/10)
 - 12" Strips — (width x height) x (1-1/2)

All strip doors are designed to mount on either the inside or outside wall above the door opening with a minimum of 5" overlap on each side.



8-inch PVC Strips 50% overlap.



8-inch PVC Strips 100% overlap.

Clear Antibacterial Door Strips

Antibacterial properties are blended into the compound to inhibit the growth of bacteria — will not wash out!

- Proven to kill 99.9% of bacteria like e-coli, staph and pneumonia on the surface of the PVC strip.
- Made of clear, high-quality durable vinyl, resists scratching and remains pliable in cold.
- Effective airflow, dirt and moisture block. • Can be used in walk-ins and food storage areas.



ITEM NO.	COLOR	WIDTH	LENGTH	THICKNESS	ROLL
G368 10381	Clear	.6"	300 ft.	0.080"	\$289.95
G368 20471	Clear	.8"	150 ft.	0.080"	264.95
G368 20481	Clear	12"	100 ft.	0.120"	397.95

Bulk PVC Colored Door Strips, For Applications Above 32 °F Only

ITEM NO.	COLOR	WIDTH	LENGTH	THICKNESS	F.O.B. FACTORY ROLL
G368 2800	Anti-Insect Yellow Durarib™	.8"	150 ft.	0.080"	\$251.95
G368 2801	Anti-Insect Yellow Durarib™	12"	150 ft.	0.110"	526.95
G368 2802	Opaque Black	.8"	300 ft.	0.080"	424.95
G368 2803	Safety Orange	.8"	300 ft.	0.080"	475.95
G368 2804	Safety Orange	12"	300 ft.	0.120"	701.95
G368 2805	ScreenFlex™ Bronze	.8"	300 ft.	0.080"	449.95
G368 2806	ScreenFlex™ Red	.8"	300 ft.	0.080"	449.95
G368 2807	ScreenFlex™ Green	.8"	300 ft.	0.080"	449.95

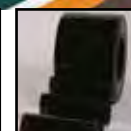
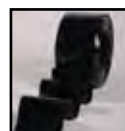

Quickstrip Perforated Pre-Punched PVC Strip Door Material

Fastest, most convenient way to replace worn strips.

- Perforated edge allows you to neatly remove individual strips for quick and easy installation.
- Each strip is pre-punched on 2-inch centers to fit most studded mounting hardware – no tools needed.



ITEM NO.	COLOR	WIDTH	LENGTH	STRIPS/ROLL	THICKNESS	F.O.B. FACTORY ROLL
G368 2902	Standard Smooth	.8"	84"	7	0.080"	\$106.95
G368 2901	Standard Durarib™	.8"	96"	9	0.072"	166.95
G368 2900	Standard Smooth	.8"	96"	9	0.080"	146.95
G368 2903	Low Temp Reinforced	.8"	84"	7	0.080"	119.95
G368 2904	Standard Smooth	.8"	120"	7	0.080"	146.95
G368 2905	Standard Durarib™	.8"	120"	7	0.072"	186.95
G368 2906	Standard Smooth	12"	120"	7	0.120"	304.95
G368 2907	Standard Smooth	12"	144"	6	0.120"	318.95
G368 2908	Standard Durarib™	12"	144"	6	0.110"	359.95

Perforated edge for quick and easy installation.



Aluminum HD Strip Door Mounting Hardware

- 70% faster installation time – 90% faster strip replacement time.
- One-piece, heavy-duty 1/4-inch thick aluminum construction won't rust or corrode.
- Use 3/8-inch bit to drill holes in strip material or template kit shown on facing page.
- 2-inch sections snap together. • Includes installation instructions.



Scan this QR code with your mobile device to watch a video showing the difference between the door mounting hardware options.

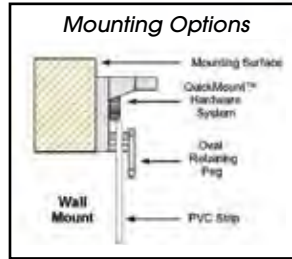
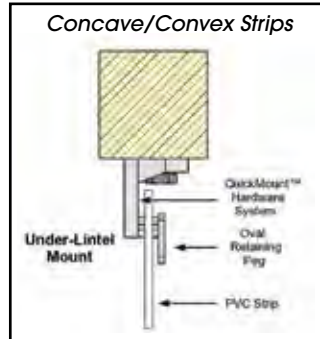

NOTE: Purchase Quickmount™ Hardware and Strips and get Quickmount™ Template for FREE! CALL FOR DETAILS.



MADE IN USA

SPECIAL ORDER ITEM

ITEM NO.	PRODUCT	F.O.B. FACTORY EACH
G368 27021	2" Section Mounting Hardware	\$32.95

Bolt-On Universal Galvanized Hardware

A heavy-duty mounting system used when maximum strength and durability are required.

- Each section comes complete with retaining plates and lock-nuts to secure the strips.
- Made from heavy-duty galvanized steel for ultra-heavy traffic applications.
- Strips held in place by galvanized steel retaining plates and lock nuts.
- Can be mounted on the face of the wall or under the lintel.

For Door Strips ▶ SEE PAGES 540-542

CALL 800-456-5624
for pricing and information.



ITEM NO.	PRODUCT
G368 00031	3 ft. Section
G368 00071	4 ft. Section



SPECIAL ORDER ITEM

E-Z Hang™ Clear Vinyl Door Strips

The BEST door strip program available!

- Able to withstand heavy traffic including forklifts. • Made from a non-phthalate formulation.

Standard Applications

Smooth — Clear

ITEM NO.	WIDTH	LENGTH	THICKNESS	ROLL
G368 5092	6"	300 ft.	0.060"	\$251.95
G368 2102	8"	150 ft.	0.060"	226.95
G368 2104	12"	100 ft.	0.120"	334.95
G368 2106	16"	100 ft.	0.160"	565.95

Ribbed — Clear

ITEM NO.	WIDTH	LENGTH	THICKNESS	ROLL
G368 2107	8"	150 ft.	0.072"	\$238.95
G368 2108	12"	150 ft.	0.110"	526.95
G368 2109	16"	100 ft.	0.144"	616.95

Below 32° Applications — Low-temp strip for freezer applications.

Smooth — Clear

ITEM NO.	WIDTH	LENGTH	THICKNESS	ROLL
G368 0092	8"	150 ft.	0.080"	\$238.95
G368 2112	12"	100 ft.	0.120"	372.95
G368 10311	16"	100 ft.	0.160"	623.95

Reinforced — Clear

ITEM NO.	WIDTH	LENGTH	THICKNESS	ROLL
G368 10321	6"	300 ft.	0.060"	\$264.95
G368 10331	8"	300 ft.	0.080"	462.95
G368 10341	12"	200 ft.	0.120"	623.95

Ribbed — Clear

ITEM NO.	WIDTH	LENGTH	THICKNESS	ROLL
G368 10351	6"	150 ft.	0.072"	\$264.95
G368 10361	8"	150 ft.	0.110"	565.95
G368 10371	12"	100 ft.	0.144"	687.95

NOTE: Other sizes available. Call for more information.

WHY REPLACE DOOR STRIPS?

- Old strips harbor bacteria in the cuts and cracks that form as a result of impact.
- Worn and scratched strips cut down on visibility and safety.
- Maintain Temperature Integrity — Worn out strips have holes and cracks which allows cold air to escape and warm air to infiltrate.
- To reduce the transfer of contaminants between work areas.

PRICES ARE SUBJECT TO CHANGE • MINIMUMS MAY APPLY • VISIT OUR WEBSITE FOR CURRENT PRICING.

STRIP DOORS AND MOUNTING HARDWARE

Standard Smooth Clear PVC Strip Curtain

- Versatile, economical material for cooler temperatures or ambient applications.
- Temperature range: +150 °F to -10 °F.
- Install strips faster, easier and without tools with the exclusive QuickMount HD aluminum mounting hardware.

► SEE PAGE 541
For QuickMount™ HD Mounting Hardware

ITEM NO.	DOOR SIZE WIDTH X HEIGHT	STRIP SIZE		OVERLAP%	F.O.B. FACTORY
		WIDTH	GAUGE		ROLL
G368 0027	3' x 7'	6"	0.060"	67%	\$141.95
G368 0026	4' x 7'	6"	0.060"	67%	192.95
G368 0025	4' x 8'	6"	0.060"	67%	192.95
G368 0024	3' x 7'	8"	0.080"	50%	128.95
G368 0023	4' x 7'	8"	0.080"	50%	179.95
G368 0022	4' x 8'	8"	0.080"	50%	192.95
G368 0021	5' x 7'	8"	0.080"	50%	205.95
G368 0020	5' x 8'	8"	0.080"	50%	231.95
G368 0019	6' x 7'	8"	0.080"	50%	256.95
G368 0018	6' x 8'	8"	0.080"	50%	295.95
G368 0017	8' x 8'	8"	0.080"	50%	347.95
G368 0016	8' x 8'	12"	0.120"	67%	424.95
G368 0015	8' x 10'	12"	0.120"	67%	513.95
G368 0014	10' x 8'	12"	0.120"	67%	526.95
G368 0013	10' x 10'	12"	0.120"	67%	642.95
G368 0012	10' x 12'	12"	0.120"	67%	758.95
G368 0011	12' x 12'	12"	0.120"	67%	899.95
G368 0010	12' x 14'	12"	0.120"	67%	1,028.95
G368 0009	14' x 12'	12"	0.120"	67%	1,053.95
G368 0008	14' x 14'	12"	0.120"	67%	1,182.95



Flexible PVC Impact Doors

As all doors are custom made, price varies by size.

700 Series Door

- Clear, flexible 0.275-inch or 0.254-inch PVC material.
- Smooth, easy swing action.
- Adjustable torsion.
- Maximum visibility and safety.
- Easy installation and panel replacement.
- Low maintenance.
- Designed for medium to heavy-duty applications.
- Available in three panel types: standard clear, low-temp clear and standard reinforced.

1000 Series Door

- Heavy-duty, clear 0.354-inch PVC material.
- Tough, durable construction.
- Adjustable torsion spring hinge.
- Replaceable top and jamb wipers.
- Available in two panel types: standard and low-temp clear.



F.O.B. FACTORY **SPECIAL ORDER ITEM** Clearway



Impact plates available in both Series



ORDER A DOOR

Please have the following information available.

Exact finished opening size (inches): Width _____ Height _____

Type of traffic: People Carts Temperature: Inside _____ Outside _____

CALL 800-456-5624
FOR PRICING AND INFORMATION

AirFlex® Mesh Barrier Strip Curtain Door System

Allows cool, fresh air in while keeping bugs and flying insects out.

- 8-inch wide mesh strips are made of 12-ounce PVC coated polyester for long life and durability. Strips come in 7 feet and 8 feet lengths.
- 12-inch clear PVC footer acts as a weight for straight hanging and can be field modified for a perfect fit.
- Replacement strips available.



NOTE: Cut to Size.
Call with opening size for pricing.



MESH STRIP DOORS

ORDER MESH OR PERFORATED STRIPS

Please have the following information available.

Exact finished opening size (inches): Width _____ Height _____

Width of strips: 8" 12" Mounting: Undermount Wall Mount

Color (Mesh): Yellow Color (Perforated): Amber Clear



F.O.B. FACTORY
EACH
CALL FOR PRICING

ITEM NO.	PRODUCT	F.O.B. FACTORY EACH
1036 4050	AirFlex® Strip Door System	CALL FOR PRICING

SHOP bunzlpd.com 24/7



Where you can find out what's on sale, find updated product information, reviews and pricing.

Need Help?
Chat With Us
Online!



STAY CONNECTED WITH US:



PRICES ARE SUBJECT TO CHANGE • MINIMUMS MAY APPLY • VISIT OUR WEBSITE FOR CURRENT PRICING.

Berner™ International Air Doors

FDA, USDA, NSF and UL listed.

- Galvanized steel fan wheels and housings.
- Aluminum airfoil shaped directional vanes.
- Aluminum base frame.
- White aluminum or stainless steel housing.
- Keyhole slots in backplate for quick wall mounting.
- Licensed to bear AMCA Air Performance Seal.
- Five year parts warranty.
- Perfect for customer entry doors, receiving doors, patio doors, dock doors, walk-in coolers, drive-up windows and concession windows.



F.O.B. FACTORY

Air door.



Ask about FREE SHIPPING.

NOTE: Also available in ambient, electric heat, steam heat and hot water heat.

CALL 800-456-5624
FOR PRICING AND INFORMATION

ORDER AIR DOORS

Please have the following information available.

Exact finished opening size (inches): Width _____ Height _____ **Controlling:** Temperature Dust Insects Fumes

Voltage Requirements: 110 220 440 **Door Usage:** Run for short periods On constantly Start and run when door opens

Phasing: Single Three (requires starter panel) **Mounting Location:** Interior Exterior **Opening Type:** Cooler/Freezer Dock Service Retail Other_____

▶ SEE PAGES 570-571

FOR TAPES, COATINGS, COMPOUNDS & MORE PRODUCTS FOR PLANT MAINTENANCE



PRICES ARE SUBJECT TO CHANGE • MINIMUMS MAY APPLY • VISIT OUR WEBSITE FOR CURRENT PRICING.

Washdown Curtain Walls and Clean Curtains

Reduce process line down time during washdown cycles.

- Custom sized to meet any cleaning or sanitation requirement.
- Constructed with non-porous PVC material.
- Prevent cross contamination between processing lines.
- Wash spray can hit all surfaces.
- Improves plant sanitation.



Open trolley design to prevent bacteria from forming.



CALL 800-456-5624
FOR PRICING AND INFORMATION

ITEM NO.	PRODUCT	F.O.B. FACTORY
B399 2100	Washdown Curtains	CUT TO
B399 1059	Clean Curtains.	SIZE

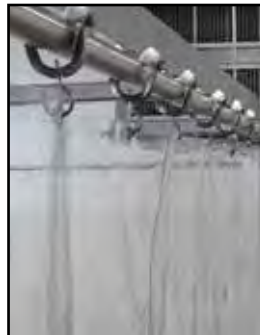

Climate Curtains

- Double-paneled 18-ounce coated vinyl curtain walls lined with Thinsulate™ Ultra insulation from 3M™.
- Flexible, climate control isolation for a variety of applications including freezer and cooler areas, loading docks, food processing lines and warehouse separation.
- Thermal valance and floor sweep.



CALL 800-456-5624
FOR PRICING AND INFORMATION

ITEM NO.	PRODUCT
B399 1001	Climate Curtains

F.O.B. FACTORY
CUT TO
SIZE



Overlapping panel design.



Vinyl and Mesh Roll-Up Doors

Complete kit ready to install!

Benefits:

- Significantly reduces heat loss while allowing light into work areas.
- Keeps out unwanted pests, birds and intruders.
- Controls airborne contaminants and improves building appearance.
- Mesh allows fresh air to flow through for comfort and productivity and helps meet FDA and AIB requirements.
- Three year warranty — one year warranty on motor drive mechanism.

Features:

- High speed: up to 36 inches per second.
- Low maintenance: no cables, wheels, springs or sewn construction.
- Wind load rated: 45 mph wind load*.
- Durable: fiberglass windbars won't bend or break. Automatically resets after impact.
- Quick and easy installation: upper box completely assembled in factory.
- Multi-season: exchangeable panels available in mesh, clear and solid vinyl.
- Fire resistant: meets NFPA-701 and CSFM standards for flame retardancy.
- Resistant to all ultraviolet rays and is rot, tear and mildew resistant.

* Wind load tested on a 10-inch x 12-inch solid vinyl roll-up door per ANSI/DASMA 108-2002.

Available Options:

- Vinyl Door color options: gray, black, blue, beige, green, red, yellow, orange and white.
- Mesh Door color options: gray, black, almond, royal blue, spruce green, yellow and red.
- Operations include: manual chain hoist, 18 inches per second (in tube motor), 28 inches per second and 36 inches per second (external mounted motor).
- Various Control Options: hardwired and RF available to meet your specific application.
- Outside face mount or inside projection mount available.



Bug and bird mesh door.



High-speed vinyl roll-up door.

Also available:
vinyl roll-up doors for extreme conditions.



Spring assist.



Side seal.

CALL 800-456-5624 FOR PRICING AND INFORMATION

ITEM NO.	PRODUCT	F.O.B. FACTORY
B399 0037	Bug and Bird Mesh Door.	CUT TO
B399 1325	High-Speed Vinyl Roll-Up Door.	SIZE

Flexible Airguard® Doors



Series 100 Doors

Models Numbers 100E and 100CE

- Meets USDA requirements.
- 45-ounce, heavy-duty, abrasion-resistant vinyl coated nylon.
- Large 30 x 14-inch vision panel made from shatterproof polycarbonate.
- Top mounted gravity actuated hinge provides completely automatic operation. Opens instantly upon contact and closes automatically by gravity.
- 48-inch heavy-duty, 1/8-inch thick Kydex® impact plates mounted front and back of each door.
- Available in green only.

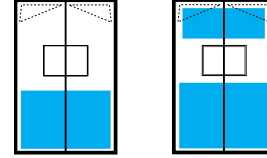
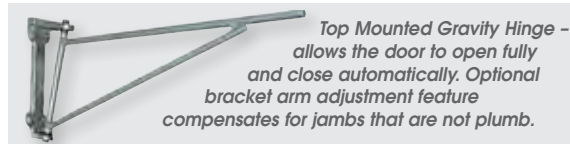

Model 100E (photo) Model 100CE



UNIFLEX 240 PVC Door

Models Number 240PVC

- Constructed of two layers of 0.12-inch PVC heat welded together to a thickness of 0.24 inches and textured embossed finish.
- 15 x 14-inch clear vinyl window centered in each panel.
- Meets USDA requirements.
- Top mounted gravity actuated hinge provides completely automatic operation. Opens instantly upon contact, then closes automatically by gravity.
- Colors: navy, royal blue, chocolate brown, medium brown, forest green, red, metallic gray and black.

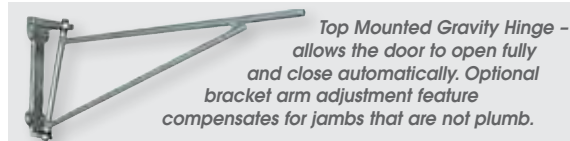

300 Belted Door

Models Number 300 Belted

- For heavy use forklift and/or freezer applications down to -30 °F.
- Wiper seals are provided at bottom and top.
- Balloon seals provided at jamb edge of each door.
- Window centered in each panel 15 inches x 14 inches.
- Constructed of two layers of abrasion-resistant, two-ply "belting" material bonded together.
- Top mounted gravity actuated hinge provides completely automatic operation. Opens instantly upon contact, then closes automatically by gravity.
- Available in green only.

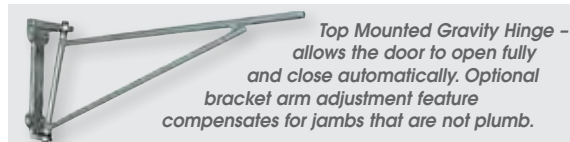

973 Standard Forklift Doors

Models Number 973

- NOT for freezer applications.
- Constructed of 0.16-inch thick, PVC door body with a two-ply, vinyl coated nylon bracket pocket.
- Top mounted gravity actuated hinge provides completely automatic operation. Opens instantly upon contact, then closes automatically by gravity.
- Extra-large viewing area allows clear visibility and maximum safety.
- Balloon seals provided at jamb edge of each door, top and bottom wipers.
- Textured vinyl impact plates on both sides increases strength and durability of door.
- Colors: navy, royal blue, chocolate brown, medium brown, forest green, red, metallic gray and black.

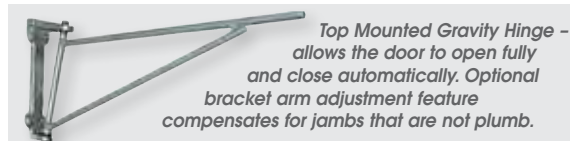

ORDER FLEXIBLE AIRGUARD® DOORS

Please have the following information available.

REMEMBER: Check your local building codes and/or with your local USDA inspector when buying products for your remodeling job.

Exact finished opening size (inches): Width _____ Height _____ Color: _____ Model: 100E 100CE 240 300 973

Traffic: People Carts Other _____

Temperature: Inside _____ Outside _____

CALL 800-456-5624 FOR PRICING AND INFORMATION

Insulated Traffic Doors

- Fully gasketed doors can be mounted on either wood or metal frames (not included).
- Large polycarbonate windows are virtually scratch-resistant.
- Optional bumpers and impact plates 6 inches to 42 inches high, available.
- V-cam hinge; 1-inch diameter steel hinge post and steel leading edge post is molded in the door and runs the full length of panel.
- No gap seams; impervious to moisture, acids, petroleum products, or animal fats.
- XHD Retail Door (all stainless steel hardware) also available.
- Available in 14 colors: navy, royal blue, cadet blue, beige, chocolate brown, medium brown, jade, forest green, red, burgundy, white, cloud gray, metallic gray and black.



NOTE: Frames sold separately.

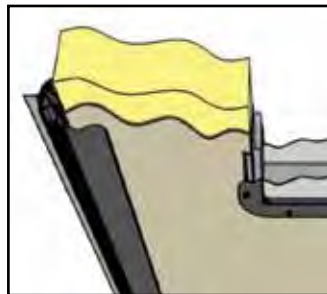

Ultra-high density, non-CFC urethane foam core.



Durulife double-action V-Cam hinge system.

ORDER INSULATED TRAFFIC DOORS

Please have the following information available.

Exact finished opening size (inches):

Width _____ Height _____

Bumpers:

Standard 24" High Other _____

Kickplates: 24" Other _____

Model: Medium-Duty Heavy-Duty
 Ultra Heavy-Duty

Color: Red Royal Blue Beige Navy
 Cadet Blue Jade Medium Brown
 Chocolate Brown Metallic Gray
 Cloud Gray Forest Green
 Burgundy White Black

CALL 800-456-5624 FOR PRICING AND INFORMATION

Medium-Duty Retailer Door

For use with people and cart traffic.

- One-piece molded 1/8-inch thick cross linked polyethylene outer skin over 1/4-inch urethane foam.
- Overall panel thickness: 1-1/2 inches.
- 8-1/2-inch lower hinge guards.
- Sizes up to 96 inches x 96 inches. Larger openings can be accompanied with swinging transom panel.



R-FACTOR: 9.86

Heavy-Duty Standard Door

For use with people, carts and motorized cart traffic.

- One-piece molded 1/8-inch thick cross linked polyethylene outer skin over 1-3/8-inch urethane foam.
- Overall panel thickness: 1-7/8 inches.
- 11-inch lower hinge guards.
- Sizes up to 96 inches x 96 inches.



R-FACTOR: 10.83

Ultra Heavy-Duty Industrial Door

For use with people, carts, motorized carts and forklift traffic.

- One-piece molded 1/4-inch thick cross linked polyethylene outer skin over 1-3/8-inch urethane foam.
- Panel thickness: 1-7/8 inches. • 11-inch lower hinge guards.
- Sizes up to 120 inches x 120 inches. Larger openings can be accompanied with swinging transoms or double dutch panels.



R-FACTOR: 10.83

PRICES ARE SUBJECT TO CHANGE • MINIMUMS MAY APPLY • VISIT OUR WEBSITE FOR CURRENT PRICING.

ABS 5000 Light-Duty Traffic Door

Aluminum Sheet Door Alternative – Constructed of 1/4-inch thick stress relieved high-density polyethylene, textured to hide normal dents and scratches. For use with cart, pallet jacks and people traffic.

- Includes 14 x 16-inch scratch resistant polycarbonate window set in vacuum formed frames for a clean, low profile and centered 60 inches from the floor.
- Constructed of light-weight durable 1/4-inch ABS plastic and resists dents, gouges and abrasions.
- Hinge system mounts to the jamb with offset cam system and hardened rollers.
- The entire length of the panel is reinforced at the back with 3 layers of 6-inch wide x 3/4-inch thick ABS material, allowing for superior impact resistance and virtually eliminating broken spines.
- Can be custom designed to fit any plant, store or restaurant application.
- Not recommended for forklifts. • Not gasketed.
- Doors can be mounted on either wood or metal jambs, frames not included.
- Optional kickplates, jamb guards and locking devices.
- Colors: beige, cloud grey, white, medium brown, red and black.



SRP 5000 Medium-Duty Traffic Door

Constructed of 1/2-inch thick stress relieved high-density polyethylene, textured to hide normal dents and scratches. For use with carts, pallet jacks and people.

- Includes 9 x 14-inch acrylic windows set in rubber molding.
- Can be custom designed to fit any plant, store or restaurant application.
- Doors can be mounted on either wood or metal jambs, frames not included.
- Back edge spine is a one-piece, continuous extruded 1/4 inch x 2-inch diameter anodized aluminum tube with flanges that radius the door panel for added strength and durability.
- Not gasketed.
- Colors: chocolate brown, red, metallic gray, black, beige, white and cloud gray.



Structural Steel Door Frames Available

Manufactured of tubular steel to fit your particular door opening. They are shipped knocked-down in three easy to assemble pieces.

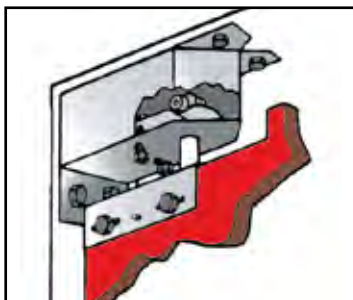

Classic "C" Hinge — can easily be adjusted after removing the cover and screws.

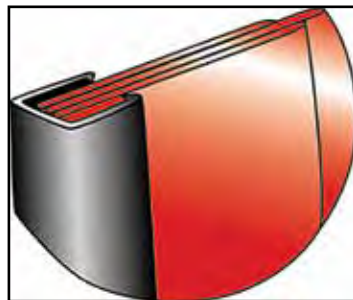

Back Spine — Heavy-duty "U" shaped fiberglass pultrusion further stiffens the spine for added strength and stability.

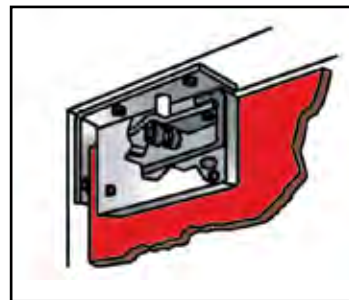

Classic "E" Hinge — gravity close hinge system mounts to the jamb with offset hardened steel cam and rollers.

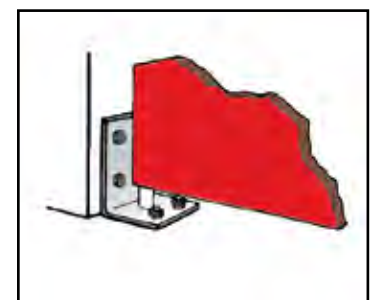

Heavy-duty bottom hinge pin stabilizes the panel in the frame.

CALL 800-456-5624 FOR PRICING AND INFORMATION

Traffic Doors



TRAFFIC DOORS

SD2000 Light-Weight Aluminum Traffic Doors

For use with cart and people traffic only, no motorized traffic.

- Includes 9 x 14-inch acrylic windows wet in black rubber molding.
- Constructed with 0.063-inch anodized aluminum.
- Hinge system mounts to the jamb with offset cam system and hardened rollers.
- Can be custom designed to fit any plant, store or restaurant application.
- NOT for washdown. • Optional kickplates available.
- Doors can be mounted on either wood or metal jambs, frames not included.

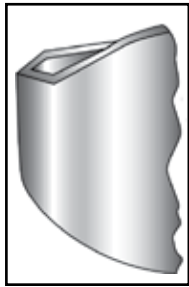

Leading Edge — is formed in a diamond for vertical panel stiffness and edge protection.



Back Edge Spine — 1 inch thick by 5 inches wide back edge spine is reinforced with 3/8-inch plywood and capped with aluminum.

SST2000 Stainless Steel Traffic Doors

Custom made for any size opening! For use with cart and people traffic only, no motorized traffic.

- Available in single or double door styles.
- Constructed of 16 gauge, #4 brushed finish stainless steel.
- Includes 9 x 14-inch acrylic window set in rubber molding.
- Ultra Soft Touch™ assisted gravity hinge is hidden in the back spine.
- Low-maintenance, no unattractive upper panel cutouts or large corner hinge components visible.
- For added strength and durability, the entire length of the back panel is reinforced with one continuous piece of extruded aluminum that has flanges which wrap the door panel.
- Optional impact plates available.



CALL 800-456-5624
FOR PRICING AND INFORMATION

PRICES ARE SUBJECT TO CHANGE • MINIMUMS MAY APPLY • VISIT OUR WEBSITE FOR CURRENT PRICING.

ORDER SERVICE DOORS

Please have the following information available.

Exact finished opening size (inches): Width _____ Height _____ Kick plate height: _____ Traffic: People Carts Other _____

FREE SHIPPING*
FREE GROUND SHIPPING
when you place an order for \$400 or more from THIS BUYERS GUIDE!

*FREE SHIPPING does NOT include UPS Next Day Air, UPS 2nd Day or UPS 3rd Day Select. Certain items may not qualify. This offer is good only on orders shipped UPS Ground in the 48 contiguous states. Based on dimensional weight, we will determine the most efficient means of shipment, either UPS or LTL. Products may ship by truckline.



Chem-Pruf Fiberglass Doors

Manufactured to withstand the most corrosive environments from saltwater, chemicals, detergents, chlorine, acid, to humidity and more.

- Superior 25 mil molded gel coat door finish is equal to 50 – 60 coats of paint.
- 0.125 inch thick and weighing 1.0 pound/square foot, Chem-Pruf door plates are by far the strongest in the industry.
- The interior cavity of the FRP door is completely filled with a corrosion-resistant material.
- Proprietary bonding resin system to fuse the plates to the collar and core. There will be no separation or delamination.
- Available options: polyurethane foam or mineral cores, various window options, fiber reinforced accessories and high quality stainless steel hardware.

Every Chem-Pruf Fiberglass Door is
CUSTOM MANUFACTURED
to Your Exact Requirements.



STANDARD COLORS



OPTIONAL COLORS



CALL 800-456-5624
FOR PRICING AND INFORMATION

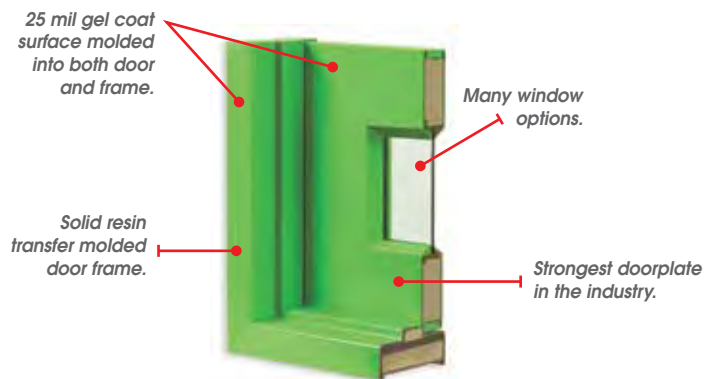

Single Door Sizes:
Rough Opening Fit
34" x 82"
38" x 82"
34" x 86"
38" x 86"



Double Door Sizes: Rough Opening Fit
67" x 82"
75" x 82"
57" x 86"
75" x 86"
75" x 98"

NOTE: Size includes framing, actual door will be 2 inches (height and width) smaller.

PVC Interior Doors

- Choose from insulated or non-insulated.
- Available in white only.
- For interior use only — light-weight, corrosion and mildew resistant.
- Internal steel reinforced sides.
- Double track felt sweeps on top, rubber sweeps on bottom.
- Available options: windows, kickplates, door closer, locking devices and insulation.



F.O.B. FACTORY



ORDER PVC INTERIOR DOORS

Please have the following information available.

Single Door Double Door **Door size:** Width _____ Height _____

Insulated Non-Insulated **Swing:** LH RH In/Out

Wall Type: _____ **Wall Thickness:** _____

Options: Windows Kickplates Door Closer Locking Devices

Required Hardware: _____

Bunzl Processor Division

Where Washdown Lighting and 150 psi Meet

▶ **See pages 146-150**
for our full selection
of water nozzles.

▶ **See pages 556-557**
for washdown
lighting fixtures.

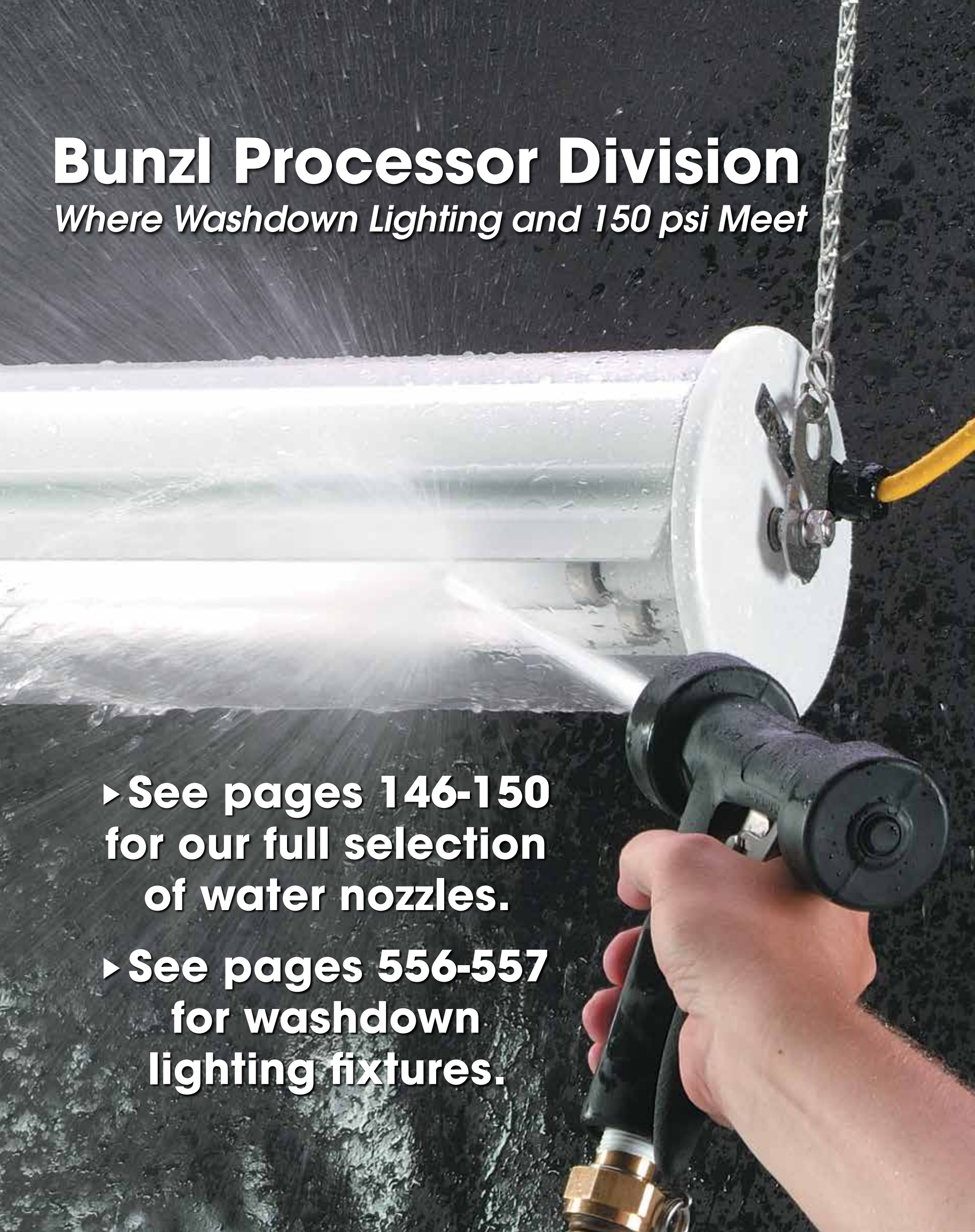

Cooler and Freezer Cold Storage Doors

Custom designed doors to meet your individual needs.



- Features:
- No wood in door.
 - FRP frame.
 - Chrome cam lift hinges.
 - Heavy-duty chrome handle.
 - Heated gasket prevents door from freezing closed.

- Options:
- Inside casing and return jambs.
 - Locking devices.
 - Meat rail provision.
 - Panic bar latching hardware.
 - Door closer (manual or electric).
 - Optional window.
 - Kick plates (stainless or aluminum).



CALL
800-456-5624
FOR PRICING
AND INFORMATION



ORDER COOLER AND FREEZER STORAGE DOORS

Please have the following information available.

Exact finished opening size (inches): Width _____ Height _____ Single Door Double Door **Swing:** LH RH

Finish: White USDA Embossed Galvanized Steel Stainless Steel **Door Closer:** _____ **Window:** _____

Frame: Standard (front face casing only) L-Shaped (front face casing, jamb) L-Shaped (front face casing, jamb, inside casing)

Wall type: _____ **Wall thickness:** _____ **Temperature:** Inside _____ Outside _____

Meat rail cut-out: Yes No **Sill:** Flush High **Diamond tread kickplate size (inches):** Length _____ Height _____

Polished Chrome Reversible Cam-Rise Door Hinge

- Reversible, constructed of die-cast zinc with chrome finish.



Lift strap from flange and remove pin assembly.



Pop out cap. Turn strap 180°, reinsert pin in strap.

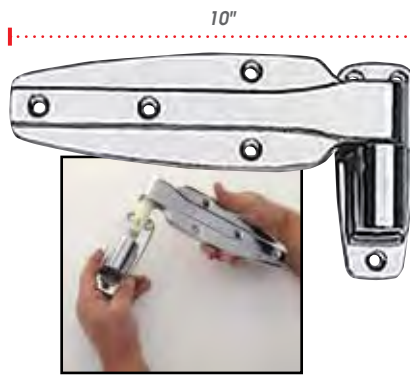

Reposition strap into flange and replace cap.

ITEM NO.	PRODUCT	EACH
3687 29281	1-3/8" Offset	\$71.95
3687 0029	Flush Mount (Pair)	138.95

Bolt-Action Walk-In Cooler Door Latch

- Cast iron body and strike, malleable iron handle and zinc-plated.
- Inside safety release handle included.



ITEM NO.	PRODUCT	EACH
3687 2165	3/4" x 1-3/8" Offset	\$243.95
3687 9404	Flush Mount	252.95

Heavy-Duty Door Closer

- Malleable iron with steel rod and tube with adjustable spring.
- Use with doors greater than 200 pounds.
- Zinc plated.

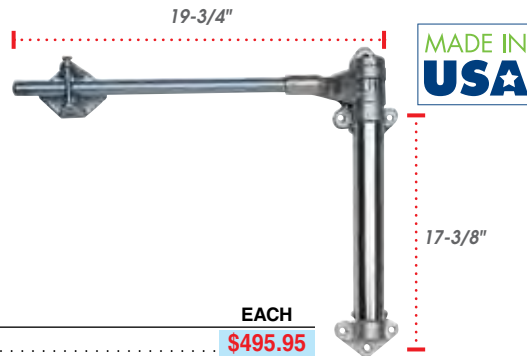

ITEM NO.	PRODUCT	EACH
3687 2949	Heavy-Duty Door Closer	\$495.95

SureClose™ Hydraulic Door Closer

Gas-loaded hydraulic cylinder guarantees controlled closure.

- Patented solid steel enclosed housing assures long wear.
- Extra-wide, bend-resistant hook ensures roller pick-up and overcomes alignment problems.
- Reliable operation even after half-million closures.
- Hook sold separately (order below).

NOTE: Hook sold separately. ORDER BELOW.

ITEM NO.	PRODUCT	EACH
3687 0005	Closer w/o Hook	\$128.95
3687 1002	Offset Hook	18.60
3687 1003	Flush Hook	14.45

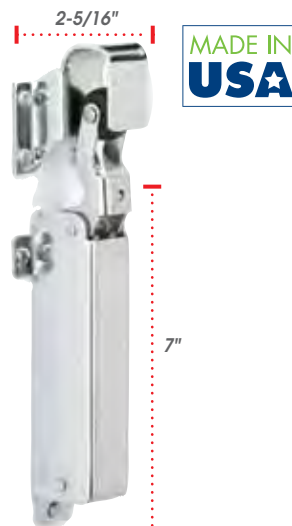

Cold Storage Door Latch

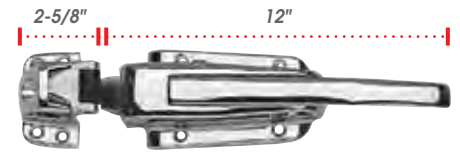

ITEM NO.	PRODUCT	EACH
3687 36961	1-1/2" Chrome Finish	\$253.95
3687 17431	1-5/8" Stainless Steel	340.95
3687 0500	Chrome Finish Flush-Mount	266.95
3687 5022	SS Flush Mount	353.95

(Includes inside release handle.)

Push Inside Release



ITEM NO.	PRODUCT	EACH
3687 29431	Chrome Push Inside Release	\$18.60

Heavy-Duty Cold Storage Door Latch



- Die-cast zinc body and strike housing.
- Inside push-release paddle included.



ITEM NO.	PRODUCT	EACH
3687 2951	3/4" x 1-1/8" Offset	\$319.95

Heavy-Duty Reversible Cam-Rise Door Hinge



- Choose from high-pressure die-cast zinc, zinc-plated or stainless steel.

NOTE: Sold by the pair.



ITEM NO.	PRODUCT	PAIR
3687 29591	23-1/8" Zinc Plated, 1-1/4" Offset	\$168.95
3687 20101	13-11/16" Stainless, 1-1/4" Offset	597.95
3687 10141	23-1/8" Zinc Plated, 1-1/2" Offset	247.95
3687 00041	23" Flush Mounted Zinc Plated	154.95

ORDER REPLACEMENT HARDWARE Please have the following information available.

Offset of door: _____
Many Offsets Available from Flush to 1-1/2".

Size of Replacement Part Needed: _____

Thickness of door: _____



Shat-R-Shield® Incoplas™ LED Hybrid

Functional as an area light, flood light or wall pack. Tailored to your custom specification.

- Available in three mounting options, adjustable, surface or wall.
- One person installation with built-in self-leveling kit.
- Choose from 45 or 90 Watts.
- Lumen Output: Up to 5,000 (45 W); Up to 10,000 (90 W)
- Voltage: 120-277 V
- Operating Temperature: -22 °F to 113 °F (-30°C to 45°C)
- Up to 122 °F (50 °C) in 5,000 lumen package.
- Dimming: 0-10 V
- Weight: 7-1/2 pounds.
- Dimensions: 13 inches L x 10-1/4 inches W x 5-3/5 inches H.



Choose From 3 Mounting Options:



Adjustable Mount



Surface Mount



Wall Mount*



At 7-1/2 pounds, this fixture is extremely light-weight.

Thumb screw makes junction box easily accessible and can be loosened or tightened without using any tools; allows for a simple one-person installation.

Stainless steel screws are corrosion-resistant and can withstand the harshest environments.

Tapered fins allow for water runoff so the fixture can be washed down with high-pressure as often as needed.

Frosted polycarbonate lens (shown) is 1 of 5 lens options. This particular lens is optically engineered to eliminate hotspots and create uniform, glare-free illumination.

▶ 10 PER CASE.

ITEM NO.	PRODUCT	EACH
3208 00091	45 Watt Fixture with Mount	\$499.95
3208 00101	90 Watt Fixture with Mount	619.95

*NSF rating does not apply to this mount.



Shat-R-Shield® Fluorescent Lights

- If accidentally broken, virtually all glass, mercury and phosphors are safely contained within the skin tight coating.
- Shat-R-Shield® lamps are UL & NSF Certified, USDA approved and meet FDA and OSHA standards.
- Base: Miniature bi-pin (G5)
- Length: 46 inches.

▶ 24 BULBS PER CASE.

ITEM NO.	PRODUCT	WATTAGE	CASE
3208 0008	T5, 46"	4100 K (82 Watt)	\$459.95
3208 0007	T5, 46"	5000 K (100 Watt)	459.95

NEED ASSISTANCE?

Our experienced customer service representatives are available to answer your questions, find the products you are looking for, check product availability, as well as take your order.

800-456-5624



Coated Shatterproof Insect Lamp Bulbs

- 2x contact.

▶ SEE PAGE 583 For Insect Light Traps



F.O.B. FACTORY

ITEM NO.	PRODUCT	WATTAGE	EACH
E756 00135	T8, 18"	15 Watt	\$16.95
E756 00081	T8, 18"	15 Watt	13.95
E756 00281	T8, 24"	20 Watt	19.95
E756 00091	T12, 24"	20 Watt	17.95
E756 00031	T12, 48"	40 Watt	22.95

Shat-R-Shield® Waterproof LED Lamps

IP68 Waterproof, Safety-Coated LED lamps have a thin layer of silicone coating that completely seals the lamp to protect fragile electronic components against moisture, corrosion and premature failure. Ideal for any application exposed to harsh environments.

- Shatter-resistant, safety-coated lamps will contain all particles if the lamp is accidentally broken. The coating does not affect light output. <1% lumen loss.



▶ 10 PER CASE.

ITEM NO.	PRODUCT	EACH
3208 00051	A. 75 Watt Equivalent	\$20.95

▶ 12 PER CASE.

ITEM NO.	PRODUCT	EACH
3208 00041	B. 65 Watt Equivalent	\$26.45

FLB Standard Service Light Fixtures

- Rugged UV stabilized non-metallic housing and one piece molded, impact resistant acrylic lens.
- Universal voltage electronic ballast. Energy saving lamp and ballast configuration.
- State-of-the-Art universal voltage electronic ballast.
- High-pressure tested to 1500 psi.
- Toolless entry for easy installation and maintenance.
- 12 stainless steel captive latches for positive lens fit against a poured-in-place closed cell polyurethane gasket.
- NSF Certified for splash zone, NEMA 4x certified and IP 67 certified.
- Completely assembled — ready to install out-of-the-box.

SPECIAL ORDER ITEM



► SEE PAGE 554
For Bulbs, Sold Separately



Stainless steel hook mount.



Stainless steel mounting bracket.

ITEM NO.	PRODUCT	BULB TYPE	WATTAGE	F.O.B. FACTORY EACH
3436 0434	4' FLB	4-Lamp, T5	54 Watt	\$289.95
3436 0435	4' FLB	6-Lamp, T5	54 Watt	299.95

FLB-RS (Rough Service) Light Fixtures

- Rugged UV stabilized non-metallic housing and one-piece molded, impact resistant acrylic lens.
- Proven lampholder bridge system with plunger and stationary lampholder set.
- State-of-the-Art universal voltage electronic ballast.
- Toolless entry for easy installation and maintenance.
- 12 stainless steel captive latches for positive lens fit against a poured-in-place closed cell polyurethane gasket.
- Reinforced stainless steel mounts for numerous mounting options.
- Completely assembled — ready to install out-of-the-box.
- High-pressure tested to 1500 psi.
- NSF Certified for splash zone, NEMA 4x certified and IP 67 certified.
- 6-foot factory installed lead. • Instant restrike.

► SEE PAGE 554
For Bulbs, Sold Separately



Lampholder bridge.

S.S. chain mount bracket.



Available in LED version



ITEM NO.	PRODUCT	BULB TYPE	WATTAGE	F.O.B. FACTORY EACH
3436 0438	4' FLB-RS	4-Lamp, T5	54 Watt	\$379.95
3436 0439	4' FLB-RS	6-Lamp, T5	54 Watt	456.95

Vapor Guard Wet Light Fixtures

- One-piece closed cell polyurethane gasket is molded into the edge of the housing.
- Conduit entries have a sealed plastic closure plug.
- For use in environments down to -20 °F.
- Fiberglass housing allows light to be mounted in corrosive and wet locations.
- Toolless entry for easy bulb replacement.
- UV stabilized lens.
- NSF certified and ETL listed.

Unit comes with plastic latches.

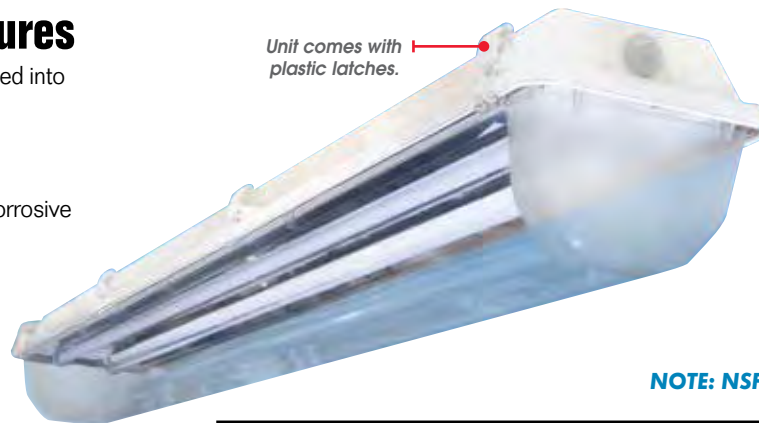

Optional Stainless Steel Latches and Standard Mounting Bracket.

NOTE: NSF and UL listed.

► SEE PAGE 554
For Bulbs, Sold Separately

T5 Vapor Guard Lights

Universal Voltage

ITEM NO.	PRODUCT	F.O.B. FACTORY EACH
3436 2545	4', 2-Lamp, 54 Watt, High Output	\$187.95
3436 8634	4', 3-Lamp, 54 Watt, High Output	179.95
3436 8635	8', 2-Lamp, 54 Watt, High Output	311.95
3436 8636	8', 6-Lamp, 54 Watt, High Output	359.95

Vapor Guard Replacement Parts

For use with Vapor Guard fixtures only. Will NOT work with other brands.

ITEM NO.	PRODUCT	EACH
3436 20041	4' Replacement Cover, Ribbed Lens	\$29.95
3436 10081	8' Replacement Cover, Ribbed Lens	53.95
3436 22011	Replacement SS Mounting Brackets	12.95
3436 10041	Optional SS Latch Kit for 4' Fixture	35.95
3436 10071	Optional SS Latch Kit for 8' Fixture	60.95
3436 04601	4' Clear Lens	35.95
3436 04611	8' Clear Lens	53.95



Recessed O-ring for water tight seal.



Waterproof power pig tail. (Shown with optional watertight mini-connector.)



Totally sealed design for high-pressure washdown areas.

Seal Lite High-Pressure Washdown Lighting Fixtures

Totally sealed design for high-pressure washdown areas.

- All exposed areas are made from non-corrosive materials.
- Chemical- and crack-resistant acrylic lens.
- Universal voltage.
- UL listed.
- Aluminum interior materials for safety and long life.
- 6-foot pigtail cable is included as well as two 1-foot stainless steel hanging chains.



T5 High Output

Mini Bi-pin, Universal Voltage

ITEM NO.	LENGTH	BULBS REQUIRED	WATTAGE	EACH
3436 4254	4'	2x, T5 - 48" Bulbs	.54 Watt	\$348.95
3436 4354	4'	3x, T5 - 48" Bulbs	.54 Watt	329.95
3436 8455	8'	4x, T5 - 48" Bulbs	.54 Watt	472.95
3436 8654	8'	6x, T5 - 48" Bulbs	.54 Watt	562.95



Standard unit with white end caps. Unit shown with T5 bulbs.

Optional stainless steel end caps. Unit shown with T8 bulbs.

Optional Emergency Battery Backup Light available. Call for more details.

Replacement Parts

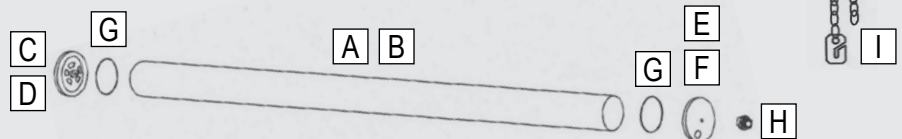

ITEM NO.	PRODUCT	ITEM NO.	PRODUCT
3436 30081	A. Standard 6" Lens, Clear	3436 00021	G. O-Ring Rubber Gasket Seal
3436 30041	B. Standard 4" Lens, Clear	3436 0005	H. Washer w/Gasket, Stainless Steel
3436 0010	C. End Cap, Plastic Non-Electrical	3436 0013	I. Stainless Steel Chain, 1' Mounting Kit
3436 0008	D. End Cap, Stainless Steel, Non-Electrical		
3436 0011	E. End Cap, Plastic, Electrical		
3436 0009	F. End Cap, Stainless Steel, Electrical		

Call 800-456-5624 For Current Pricing

Washdown LED Lighting

- Dust tight and waterproof rated.
- Polycarbonate, shatterproof lens.
- Up to 70% energy savings compared to standard fixtures.
- Ceiling mounted fixtures.

MOUNTING OPTION:

Hook Mount

MOUNTING ACCESSORIES:
Both included with every unit.

Metal Bracket Suspending Cable

70% Energy Savings 2 Year ROI Shatterproof Waterproof

Nautilus High Bay LED Lighting

Poseidon Linear LED Lighting

FintronX LED

NSF CERTIFIED SPECIAL ORDER ITEM

FC UL LISTED

IP67

ITEM NO.	PRODUCT	AMBIENT TEMP RANGE	WATTAGE	EACH
J680 00081	Nautilus High Bay Light	-40° to 149 °F	150 Watt	\$995.00
J680 00091	Poseidon 24" Linear Light	-40° to 122 °F	66 Watt	524.95
J680 00101	Poseidon 48" Linear Light	-40° to 122 °F	136 Watt	899.00

Call 800-456-5624 For More Information

LED WDL, Washdown Light

- WDL is an energy efficient linear LED fixture designed specifically for heavy wash-down applications.
- IP69K rated enclosure utilizes a 0.125-inch thick chemical and impact resistant frosted lens which provides a glare-free wide distribution light pattern similar to fluorescent products.
- UL 1598 for wet locations and battery back-up.
- ANSI/NSF 2 certified for splash zones.
- CSA Std C22.2 No.250.0

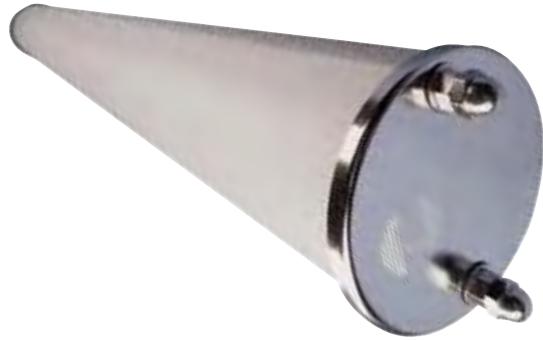

ITEM NO.	PRODUCT	SIZE	F.O.B. FACTORY EACH
3436 2122	LED WDL	4 ft.	\$649.00
3436 2123	LED WDL	8 ft.	1,073.95

LED PIPE LITE Series

- PIPE LITE provides a cost effective, precise, uniform, glare-free, LED task lighting solution for the food processing industry.
- IP69K rated housing allows for easy clean-up while withstanding the rigors of daily sanitation.
- UL 1598 for wet locations and battery back-up.
- Tube-less design reduces costs by eliminating replacement tubes.
- ANSI/NSF 2 certified for splash zones.
- CSA Std C22.2 No.250.0



ITEM NO.	PRODUCT	SIZE	F.O.B. FACTORY EACH
3436 01701	LED Pipe Task Light	2 ft.	\$499.00
3436 42001	LED Pipe Task Light	4 ft.	599.00
3436 82501	LED Pipe Task Light	8 ft.	999.00

LED NML-RS

- Non-Metallic LED Rough Service is a low-bay solution to reduce energy usage without sacrificing lumen output.
- Frosted lens to provide a glare-free work environment.
- Completely assembled and ready to install.
- UL 1598 for wet locations.
- IP65, IP66, IP67 rated.
- Gray with clear lens.



ITEM NO.	PRODUCT	F.O.B. FACTORY EACH
3436 0015	LED NML-RS	\$1,205.05

LED Light Fixture

- Designed for damp/wet/cooler/freezer environments.
- Low profile high-impact Lexan anti-glare globe.
- Operational for -40 °F (-40 °C) to 104 °F (40 °C).
- Designed to reduce electrical usage by 85%.
- Rated for 50,000+ hours of life.
- Minimal heat generation.
- Surface mount design.
- LM-79 tested.



ITEM NO.	PRODUCT	DIMENSIONS	F.O.B. FACTORY EACH
3687 80801	1808 LED Fixture	5-1/2" x 3-1/5"	\$162.95

NEED ASSISTANCE? 800-456-5624

Our experienced customer service representatives are available to answer your questions, find the products you are looking for, check product availability, as well as take your order.



PRICES ARE SUBJECT TO CHANGE • MINIMUMS MAY APPLY • VISIT OUR WEBSITE FOR CURRENT PRICING.

LED Emergency Exit Signs For Wet Locations

- 90 minute emergency exit lighting. • Long life nickel cadmium batteries.
- Test switch and test light. • Exit signs have extended life LED lamps.
- State-of-the-art water tight ventilation system for wet locations.
- Meets or surpasses safety codes for emergency lighting.
- Exit sign illuminates continuously in AC and power failure modes (egress model downlight illuminates in power failure mode).
- Non-corrosive enclosures and external hardware.
- Completely assembled — ready to install out-of-the-box.



Shown with egress downlight.



F.O.B. FACTORY

Emergency Exit Light with Egress Downlight

ITEM NO.	PRODUCT	EACH
3436 04401	120V	\$549.95
3436 04411	277V	549.95

Emergency Exit Light No Downlight

ITEM NO.	PRODUCT	EACH
3436 04421	120V	\$449.95
3436 04431	277V	449.95

AC Only Powered Exit Signs

- Energy efficient LED lamps.
- Non-corrosive enclosures and external hardware.
- Meets or surpasses safety codes for emergency lighting.
- Completely assembled — ready to install out-of-the-box.



ITEM NO.	PRODUCT	EACH
3436 04441	120V	\$489.95
3436 04451	277V	489.95

EWP-LED Emergency Hose-Down Wall Pack Light Fixture

Compact emergency fixture specifically engineered for applications requiring protection in severe corrosion, heavy hose-down and wet environments.

- Long-life PL lamp with maximum illumination reflector.
- UL listed 924 Emergency.
- NEMA 4x polycarbonate enclosure.
- Stainless steel hardware on exposed areas.
- 3-foot cord conduit lead. • Push button test switch.
- Sealed maintenance free battery.
- Two mounting options: Surface mount or aluminum angle mount.



ITEM NO.	PRODUCT	F.O.B. FACTORY EACH
3436 1012	120V Surface Mount Fixture	\$519.95
3436 1013	277V Surface Mount Fixture	499.95
3436 12121	Aluminum Angle Bracket Mount	39.95

▶ SEE PAGES 566-568

FOR FLASHLIGHTS AND BATTERIES



Keelgrid Suspended Ceiling System

- Fiberglass reinforced plastic grid doesn't conduct heat like metal grids.
- FRP Rating: Class A.
- Unaffected by moisture and humidity.
- Rust and corrosion proof.
- Light-weight yet rigid.

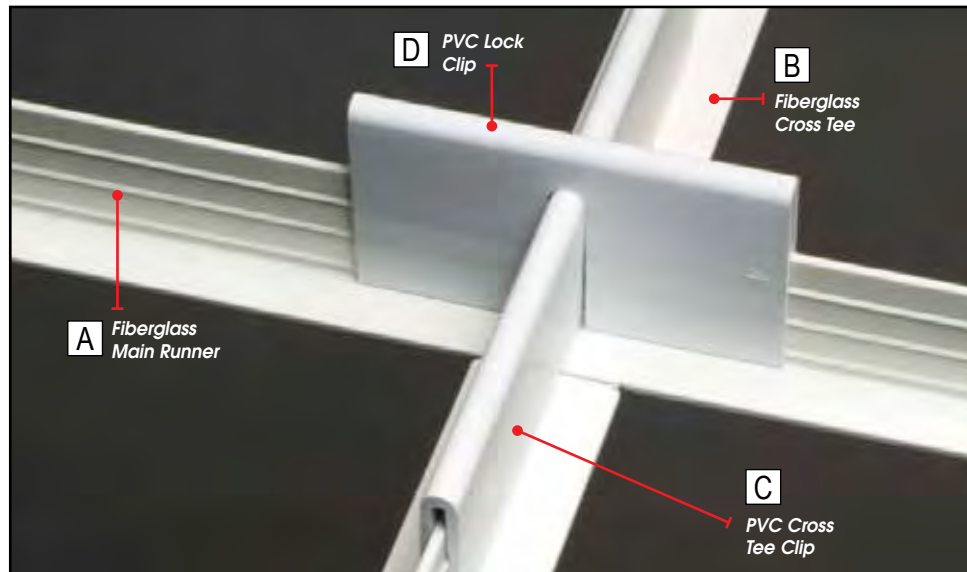

ITEM NO.	PRODUCT	F.O.B. FACTORY EACH
3110 80351	A. 12' Fiberglass Main Runner	\$45.25
3110 0478	B. 2' Fiberglass Cross Tee	8.75
3110 8036	4' Fiberglass Cross Tee	16.45
3110 8038	C. 8" PVC Cross Tee Clip	3.25
3110 8039	D. 4" PVC Lock Clip	2.15
3110 8037	6" PVC Splice Clip	2.15
3110 8040	Hold Down Clip for 0.090" and 0.004" Panels	0.65
3110 0479	Hold Down Clip for 1" Foam Panel	1.05
3110 3939	Hold Down Clip for 2" Foam Panel	4.45
3110 8041	8" x 1-1/2" x 1-2/5" Fiberglass Angle	31.05
3110 8043	12" x 12-Gauge Galvanized Wire	2.95
3110 7220	12" x 12-Gauge Stainless Wire	12.95
3110 8044	0.12" x 1-1/2" Aluminum Pop Rivets (500)	70.95
3110 5273	Wall Clips	3.25

CEILING PANELS AND SYSTEM

EASY TO INSTALL



1. Easy to install with positive "cross tee" grid lock brackets.



2. No special tools required. Use simple hand tools.



3. Ceiling panels resist moisture, match wall coverings and are easily removed for repair of service utilities.

Suspended Ceiling Panels

FRP Panels (Fiberglass Reinforced Plastic)



A. 0.09-inch FiberLite Liner Ceiling, 2-feet x 4-feet Textured FRP panel with no substrate backer.



B. 0.12-inch FiberLite Liner Ceiling, 2-feet x 4-feet Textured FRP panel with no substrate backer. Use in high heat areas.



C. 1-inch EPS Foam is laminated to 1/2-inch fire and moisture-resistant gypsum and FiberLite FRP one side only. 2 feet x 4 feet.



D. 1 1/2-inch EPS Foam is laminated to 1/2-inch fire and moisture-resistant gypsum and FiberLite FRP one side only. 2 feet x 4 feet.



E. 2-inch EPS Foam is laminated to 1/2-inch fire and moisture-resistant gypsum and FiberLite FRP one side only. 2 feet x 4 feet.

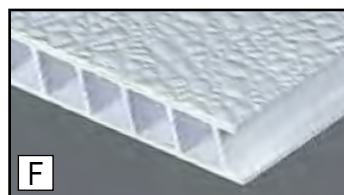

F. 0.4-inch FiberCorr Liner Ceiling, 2-feet x 4-feet textured FRP panel with no substrate backer.

► PURCHASE IN MULTIPLES OF 4.

ITEM NO.	PRODUCT	F.O.B. FACTORY EACH
3149 0912	A. FiberLite Liner Ceiling Panel 0.090", 2' x 4' Texture FRP Panel - No Substrate Backer	\$18.95
3149 1204	B. FiberLite Liner Ceiling Panel 0.120", 2' x 4' Texture FRP Panel - No Substrate Backer	30.75
3149 5100	C. FiberLite Insulated Ceiling Panel, 1" EPS Foam, 2' x 4' FRP	44.95
3149 0151	D. FiberLite Insulated Ceiling Panel, 1-1/2" EPS Foam, 2' x 4' FRP	49.95
3149 5200	E. FiberLite Insulated Ceiling Panel, 2" EPS Foam, 2' x 4' FRP	54.95
3149 4004	F. FiberCorr Ceiling Panel 0.400", 2' x 4' FRP Panel	59.95

Stainless Steel Hanger for Ceiling Grid System

Perfect for suspension lighting systems.

- Supports 25 pounds.



ITEM NO.	PRODUCT
3110 0001	25 lb Hanger

EACH \$14.95



PVC Panels

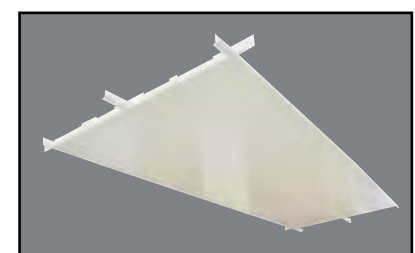

► PURCHASE IN MULTIPLES OF 4.

ITEM NO.	PRODUCT
E090 40041	PVC Ceiling Panel, 2' x 4' x 1/2"

F.O.B. FACTORY EACH \$34.95

PRICES ARE SUBJECT TO CHANGE • MINIMUMS MAY APPLY • VISIT OUR WEBSITE FOR CURRENT PRICING.

Tongue and Groove 1/2-Inch PVC Ceiling and Wall Covering

NOTE: Not for use in freezer applications.

Stain-resistant, low-maintenance, waterproof panels are also easy to clean and ideal for high moisture areas. Materials are totally recyclable. Never needs painting and will not rot or rust.



- Panels are 100% recyclable and do not support mold or mildew per ASTM D3273 and D3274.
- Panels meet ASTM E-84-05 and CAN/ULC S102.2-3 Class A fire rating.
- Can easily be cut using fine tooth blade, table saw or utility knife.
- Custom cut lengths up to 20 feet long.
- No exposed fasteners.
- Panels are extruded from exterior-grade PVC.
- Easy to install using the tongue and groove system.
- Cleans with pressure washers or soap and water.
- Can be attached directly to walls and ceilings.
- Limited 10 year warranty.

Panels slide together with tongue and groove design leaving no exposed fasteners to rust or promote mold or bacteria growth. Use stainless steel screws to connect nailing fin to wall or stud.



Call 800-456-5624
for Custom Room and Ceiling quotes.

FINISHING TRIP OPTIONS:

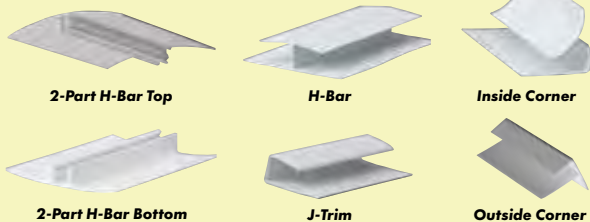

ORDER PVC CEILING AND WALL COVERING

Please have the following information available.

SPECIAL ORDER ITEM

F.O.B. FACTORY

Covering: Full Room (walls and ceiling) Walls Only Ceiling Only

Room dimensions: Length _____ Width _____ Height _____

Panel directions (ceilings only): Perpendicular to trusses Parallel to trusses

Rubberized Silicone Sealant



- Meets FDA and USDA requirements for use in federally inspected meat and poultry plants
- Will not crack, crumble or dry out.
- Temperature range: -60 °F to +450 °F.



► 12 PER CASE.

ITEM NO.	PRODUCT	EACH	
		1-11	12+
3149 12881	White, 11 oz.	\$9.75	\$8.75
3149 12891	Clear, 11 oz.	9.75	8.75

Multi-Purpose Adhesives



- Specially formulated for bonding fiberglass reinforced plastic to various substrates.
- Fast setting and resistant to temperature changes.



ITEM NO.	PRODUCT	EACH
3149 1359	11 oz. Tube	\$7.25
3149 0006	4 Gallon Pail, Latex-Based	83.95

Stainless Steel Corners

Protect interior corners from damage.

- Custom widths and lengths available.
- Six pre-drilled holes.

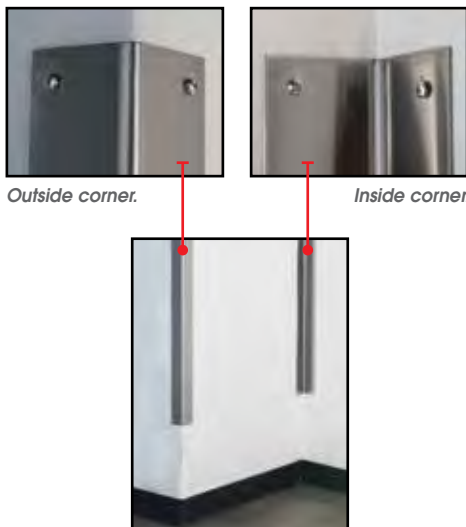

ITEM NO.	PRODUCT	DIMENSIONS	F.O.B. FACTORY
			EACH
2510 22361	Outside	2" x 2" x 36"	\$51.15
2510 22481	Outside	2" x 2" x 48"	54.45
2510 22601	Outside	2" x 2" x 60"	63.15
2510 22721	Outside	2" x 2" x 72"	68.25
2510 22371	Inside	2" x 2" x 72"	51.15
2510 22491	Inside	2" x 2" x 48"	54.45
2510 22611	Inside	2" x 2" x 60"	63.15
2510 22731	Inside	2" x 2" x 36"	98.55

Fiberglass Wall Coverings

• Meets USDA requirements. • Meets Class C/3 Fire Rating per ASTM E 84.



0.09-Inch Textured Wall Liner Panels
Orders Under 20 Panels Require a Crate Fee

ITEM NO.	PRODUCT	F.O.B. FACTORY EACH
3149 1313	4' x 8' x 0.090" Liner Panel	CALL FOR PRICING
3149 1314	4' x 10' x 0.090" Liner Panel	CALL FOR PRICING
3149 4451	4' x 12' x 0.090" Liner Panel	CALL FOR PRICING
3149 1429	4' x 50' x 0.090" Liner Panel	CALL FOR PRICING

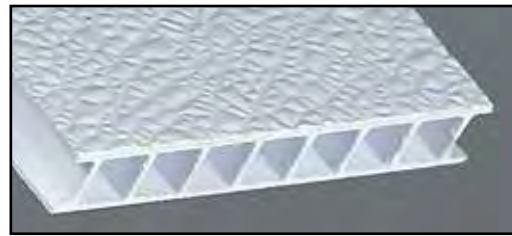

0.4-Inch FiberCorr Wall Panel
Orders Under 12 Panels Require a Crate Fee

ITEM NO.	PRODUCT	F.O.B. FACTORY EACH
3149 4463	4' x 8' FiberCorr Panel	CALL FOR PRICING
3149 4464	4' x 10' FiberCorr Panel	CALL FOR PRICING
3149 4012	4' x 12' FiberCorr Panel	CALL FOR PRICING



0.375-Inch Laminated Wall Panel
Orders Under 16 Panels Require a Crate Fee

ITEM NO.	PRODUCT	F.O.B. FACTORY EACH
3149 4469	4' x 8' Exterior Plywood	CALL FOR PRICING
3149 4470	4' x 10' Exterior Plywood	CALL FOR PRICING
3149 7512	4' x 12' Exterior Plywood	CALL FOR PRICING

White Nylon Rivets

• Non-corroding, white nylon rivets will fasten panels to wood, metal, drywall and concrete.
• Rivets will expand into either solid substrates behind sheet material or metal studs.



NOTE: Recommended 1 per square foot.

▶ 100 PER BAG.

ITEM NO.	SIZE	BAG
3149 12801	3/4"	\$15.95
3149 12811	1"	17.95
3149 12821	1-1/2"	42.95
3149 1283	2"	64.95

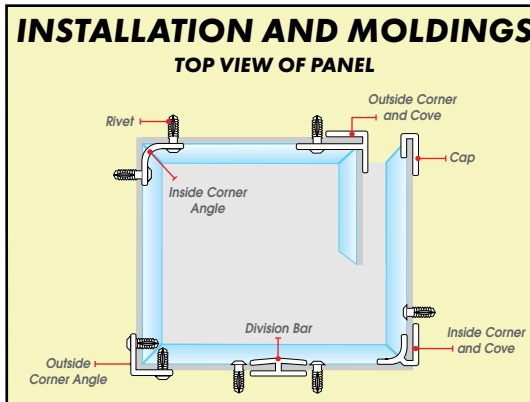

Stainless Steel Fastener

• Provides an expansion relief allowing thermal expansion of paneling products after fastening.
• One-step fastening for FRP panels eliminates pre-drilling larger expansion holes.
• Rustproof, reusable fasteners use Phillips or square drive bits.



NOTE: Recommended 1 per square foot.

▶ 100 PER BAG.

ITEM NO.	SIZE	BAG
3149 12001	1-1/4" Stainless Fastener	\$64.95

Vinyl Moldings For Wall Panel Installation



Molding for 0.09-Inch Panels

ITEM NO.	PRODUCT	F.O.B. FACTORY EACH
3149 1290	8' Cap	\$3.75
3149 1291	10' Cap	4.95
3149 0038	12' Cap	4.95
3149 1292	8' Division Bar	3.75
3149 1293	10' Division Bar	4.95
3149 3106	12' Division Bar	6.25
3149 1294	8' Inside Corner and Cove	3.75
3149 1295	10' Inside Corner and Cove	4.95
3149 0552	12' Inside Corner and Cove	6.25
3149 1296	8' Outside Corner and Cove	2.95
3149 1297	10' Outside Corner and Cove	4.95
3149 0099	12' Outside Corner and Cove	6.25
3149 1459	8' Inside Corner Angle	8.75
3149 1460	10' Inside Corner Angle	11.25
3149 0014	12' Inside Corner Angle	11.25
3149 1308	8' Outside Corner Angle	10.05
3149 1309	10' Outside Corner Angle	11.25
3149 9001	12' Outside Corner Angle	11.25
3149 1279	8' Base Cove 3"	12.55
3149 1277	10' Base Cove 3"	21.35
3149 1306	12' Base Cove 3"	21.35

Molding for 0.4-Inch FiberCorr Panels

ITEM NO.	PRODUCT	F.O.B. FACTORY EACH
3149 0042	8' Cap	\$6.25
3149 0029	10' Cap	7.55
3149 9000	12' Cap	7.55
3149 1108	8' Division Bar	3.65
3149 1104	10' Division Bar	3.75
3149 0063	12' Division Bar	9.95
3149 1302	8' Inside Corner and Cove	7.55
3149 1303	10' Inside Corner and Cove	8.75
3149 0122	12' Inside Corner and Cove	11.25
3149 1304	8' Outside Corner and Cove	7.55
3149 1305	10' Outside Corner and Cove	8.75
3149 0124	12' Outside Corner and Cove	11.25
3149 0016	8' Inside Corner Angle	16.35
3149 0017	10' Inside Corner Angle	20.15
3149 0024	12' Inside Corner Angle	23.75
3149 0018	8' Outside Corner Angle	16.35
3149 0019	10' Outside Corner Angle	18.85
3149 0028	12' Outside Corner Angle	22.65
3149 1279	8' Base Cove 3"	12.55
3149 1277	10' Base Cove 3"	21.35
3149 1306	12' Base Cove 3"	21.35

Molding for 0.375-Inch Panels

ITEM NO.	PRODUCT	F.O.B. FACTORY EACH
3149 1298	8' Cap	\$6.25
3149 1299	10' Cap	6.25
3149 1020	12' Cap	7.55
3149 1300	8' Division Bar	7.55
3149 1301	10' Division Bar	8.75
3149 0098	12' Division Bar	11.25
3149 1302	8' Inside Corner and Cove	7.55
3149 1303	10' Inside Corner and Cove	8.75
3149 0122	12' Inside Corner and Cove	11.25
3149 1304	8' Outside Corner and Cove	7.55
3149 1305	10' Outside Corner and Cove	8.75
3149 0124	12' Outside Corner and Cove	11.25
3149 0016	8' Inside Corner Angle	16.35
3149 0017	10' Inside Corner Angle	20.15
3149 0024	12' Inside Corner Angle	23.75
3149 0018	8' Outside Corner Angle	16.35
3149 0019	10' Outside Corner Angle	18.85
3149 0028	12' Outside Corner Angle	22.65
3149 1279	8' Base Cove 3"	12.55
3149 1277	10' Base Cove 3"	21.35
3149 1306	12' Base Cove 3"	21.35

Dura-Seal 400 Industrial Light-Duty Concrete Floor Coatings

Very hard, very chemically resistant. Good in a water environment once hardened. Has odor during applications, but not after curing (6 hours).

- One, 2-gallon container applies two coats over 325-350 sq. ft.
- By mixing 50/50, coating penetrates pores and forms a solid surface plate recognized by the USDA as a contaminant barrier.
- Apply by roller, brush or spray — leaves an easy-to-clean, hard, glossy surface suitable for incidental food contact.
- Mix with optional Satin Texture for non-skid durability.
- Meets all USDA and EPA standards.
- Quick-drying coating hardens to a 6-8 mil thickness.

DURA-SEAL 400 COLORS

FLAT BLACK	CHARCOAL	GRAY	LIGHT GRAY	FLAT GRAY	ALUMINUM	FAUN
WHITE	BLUE WHITE	OSHA YELLOW	CREAM	BUFF	TAUPE	BLUE
TILE RED	DEEP RED	BROWN	COCO BROWN	TERRA-COTTA	TURQUOISE	LIGHT BLUE
DARK GREEN	BLUE GREEN	MEDIUM GREEN	LIGHT GREEN	CLEAR		

ITEM NO.	COLOR
A468 00151	80 Dura-Seal Aluminum
A468 00131	99 Dura-Seal Clear
A468 00091	100 Dura-Seal White
A468 00121	108 Dura-Seal Flat Gray
A468 00171	109 Dura-Seal House Gray
A468 00111	110 Dura-Seal Light Gray
A468 00071	112 Dura-Seal Gray Floor
A468 00101	114 Dura-Seal Charcoal
A468 00301	118 Dura-Seal Faun
A468 00081	160 Dura-Seal OSHA Yellow
A468 00291	168 Dura-Seal Cream
A468 00141	190 Dura-Seal Terra Cotta
A468 00161	192 Dura-Seal Tan
A468 00271	195 Dura-Seal Taupe
A468 00231	198 Dura-Seal Coco Brown
A468 00241	200 Dura-Seal Brown
A468 00251	204 Dura-Seal Deep Red
A468 00281	225 Dura-Seal Buff
A468 00051	270 Dura-Seal Tile Red
A468 00211	308 Dura-Seal Light Blue
A468 00221	309 Dura-Seal Turquoise
A468 00261	310 Dura-Seal Blue
A468 00181	350 Dura-Seal Light Green
A468 00191	355 Dura-Seal Medium Green
A468 00201	358 Dura-Seal Blue Green
A468 00061	60 Dura-Seal Dark Green



Both Dura-Seal and Dura-Poxy coatings produce a high polish surface.



Optional Satin Texture Surface.

NOTE: Must purchase floor prep/cleaning products shown below to validate manufacturer warranty.

ITEM NO.	PRODUCT	F.O.B. FACTORY EACH
SEE ABOVE	Dura-Seal 400 (above), 2 Gallons (Specify color and surface)	\$258.95
A468 1000	Satin Skid-Resistant Texture	17.95

Dura-Poxy Industrial Heavy-Duty Concrete Floor Coatings

A heavier-bodied "100% solids" catalyzed epoxy laminate. Very hard and highly chemically resistant. No odor. Hardens even in a water environment. Accepted by the USDA for incidental food contact use. For use on floors with major irregularities.

- 8-hour curing time.
- 1 gallon covers 125 square feet. at 8-10 mil.
- For use on floors with major irregularities in the surface and floors that require maximum resistance to damage from falling tools, forklifts and similar causes of harm.
- Quick drying coating hardens to a 20 mil thickness with 2 coats.
- Mix with quartz chips for high skid areas (such as wet or frosty environments) and to form a coating that is resistant to the passing of steel wheels or other heavy machinery.

NOTE: Require temperatures of at least 55 °F during application.

DURA-POXY COLORS

FLAT BLACK	WHITE	FAUN	GRAY	LIGHT GRAY	TILE RED	OSHA YELLOW	CLEAR
------------	-------	------	------	------------	----------	-------------	-------

ITEM NO.	COLOR
A468 00371	000 Dura-Poxy Clear
A468 00351	100 Dura-Poxy White
A468 00381	110 Dura-Poxy Light Gray
A468 00331	112 Dura-Poxy Gray
A468 00341	118 Dura-Poxy Faun
A468 00361	160 Dura-Poxy OSHA Yellow
A468 00321	270 Dura-Poxy Tile Red
A468 00311	900 Dura-Poxy Black



Optional Quartz Granular Surface

NOTE: Must purchase floor prep/cleaning products shown below to validate manufacturer warranty.

ITEM NO.	PRODUCT	F.O.B. FACTORY EACH
SEE ABOVE	Dura-Poxy (above), 1 Gallon (Specify color and surface)	\$186.95
A468 0003	Quartz, 50 lb Bag	69.95

Help Line Available. Call 952-888-1488

Degrease Rite Floor Prep/Cleaning

High-alkaline water-based industrial liquid cleaner, 11.5 pH. USDA approved. Cleans oils, grease, fats, wax, dirt and stains.

- 1 gallon covers up to 500 sq. ft.



ITEM NO.	PRODUCT	F.O.B. FACTORY EACH
A468 1002	Degrease Rite, 1 Gallon	\$29.95

Dura-Kleen Floor Prep/Cleaning

Heavy-duty acid-based industrial liquid cleaner, 5 pH w/detergents and water softener. Cleans scale and mineral stains.

- 1 gallon covers up to 300 sq. ft.



ITEM NO.	PRODUCT	F.O.B. FACTORY EACH
A468 1001	Dura-Kleen, 1 Gallon	\$31.95

Plastic Lockers

Perfect for use in food processing plants or any wet environment.

- Maintenance-free washdown lockers are rust proof and non-corrosive.
- Engraveable aluminum ID plate on all lockers.
- Sanitary holes for easy drainage.
- One-piece, double-wall construction makes these lockers durable and easy to install.
- Available with sloped hoods for extra storage space.
- 36-inch lockers come with double-coat hook (1 each).
- 60-inch lockers come with double-coat hook (1 each) and shelf.



SPECIAL ORDER ITEM

MADE IN USA

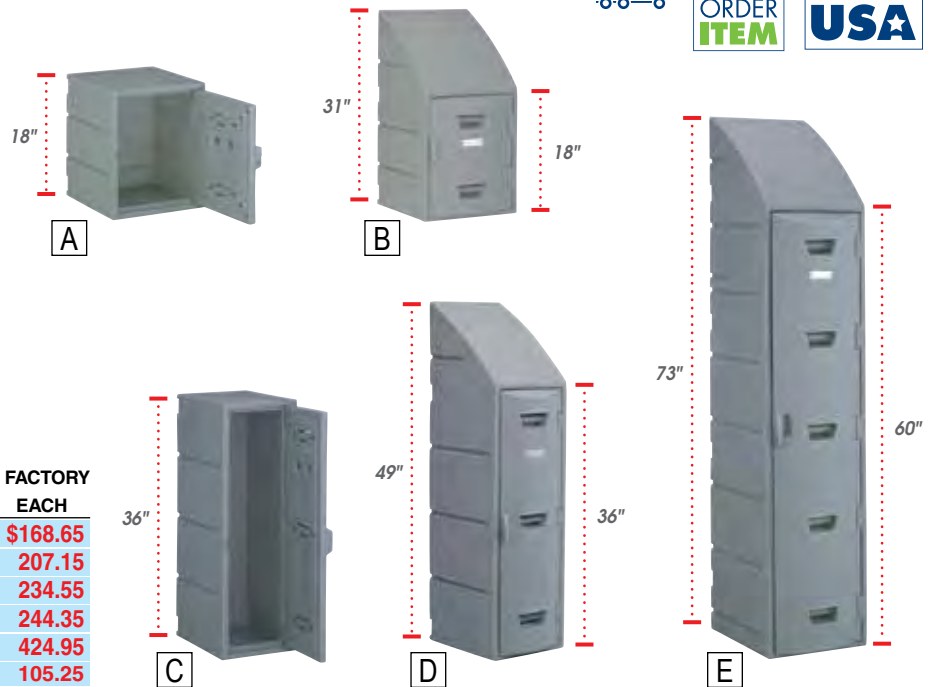

ITEM NO.	PRODUCT	BASE DIMENSIONS	F.O.B. FACTORY	
			SHIP WT.	EACH
3177 7202	A. 18" w/Drain Holes	15" x 15"	10 lb.	\$168.65
3177 7203	B. 18" w/Drain Holes and Hood	15" x 15"	12 lb.	207.15
3177 7204	C. 36" w/Drain Holes	12" x 15"	19 lb.	234.55
3177 7205	D. 36" w/Drain Holes and Hood	15" x 15"	21 lb.	244.35
3177 7206	E. 60" w/Drain Holes and Hood	15" x 18"	42 lb.	424.95
3177 5109	Wall Mount Installation Kit			105.25

Bollard Covers

Constructed from 1/8-inch thick polyethylene and 3M™ reflective tape for durability and long service life.

- Patented GripperTabs™ for fast and easy installation — self-adhesive fingers stick to the bollard itself and the cover just slides over.
- UV rated against fading for 5 years.
- Cover colors: yellow, red, gray, white, blue and black.
- Reflective tape colors: red, black, white, yellow, orange and blue.
- Dome shape: flat or dome.

SPECIAL ORDER ITEM

MADE IN USA

NOTE: Please specify cover and tape color, dome or flat top and length when ordering.



ITEM NO.	PRODUCT	MAX PIPE O.D.	EACH
B753 10041	4" Bollard Cover	4-1/2"	CALL
B753 10071	6" Bollard Cover	6-3/5"	FOR
B753 0006	8" Bollard Cover	8-3/5"	PRICING

Indoor/Outdoor Stainless Steel Benches

- Constructed from heavy duty corrosion resistant T-304 stainless steel.
- Formed 12-gauge legs are provided with mounting holes allowing unit to be bolted to floor.
- Ships knocked down for additional freight savings.
- Standard bench surface is 12 inches deep. Standard bench height is 18 inches tall.
- Easy to assemble, no special tools required.

KNOCKS DOWN FOR SHIPPING

SPECIAL ORDER ITEM

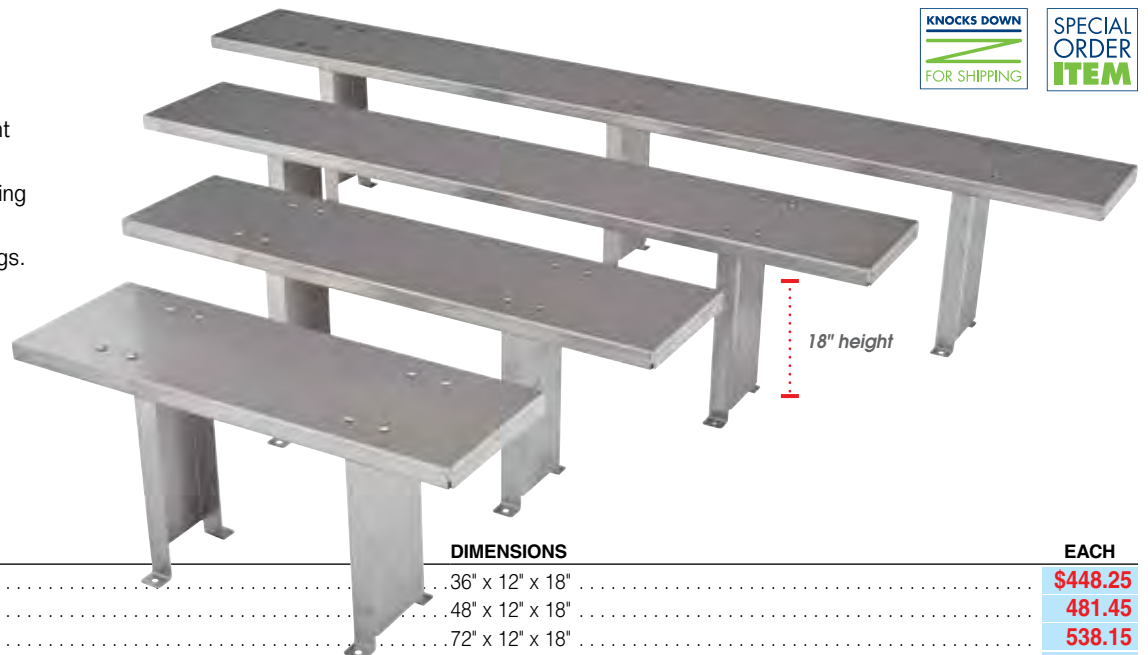

ITEM NO.	PRODUCT	DIMENSIONS	EACH
2990 0053	3 ft. Stainless Steel Bench	36" x 12" x 18"	\$448.25
2990 0054	4 ft. Stainless Steel Bench	48" x 12" x 18"	481.45
2990 0055	6 ft. Stainless Steel Bench	72" x 12" x 18"	538.15
2990 0056	8 ft. Stainless Steel Bench	96" x 12" x 18"	650.55
2990 0057	4 ft. Stainless Steel Bench, ADA Compliant	48" x 20" x 18"	840.95

LOCKERS, BOLLARD COVERS AND BENCHES

PRICES ARE SUBJECT TO CHANGE • MINIMUMS MAY APPLY • VISIT OUR WEBSITE FOR CURRENT PRICING.

Iso-Guard™ Sanitary Barriers

Idea for production line operations to provide a sanitary barrier between workers.



Fixed-Mount Stainless Steel Model

Stainless steel frames can be moved around production line to wherever mounts are located.

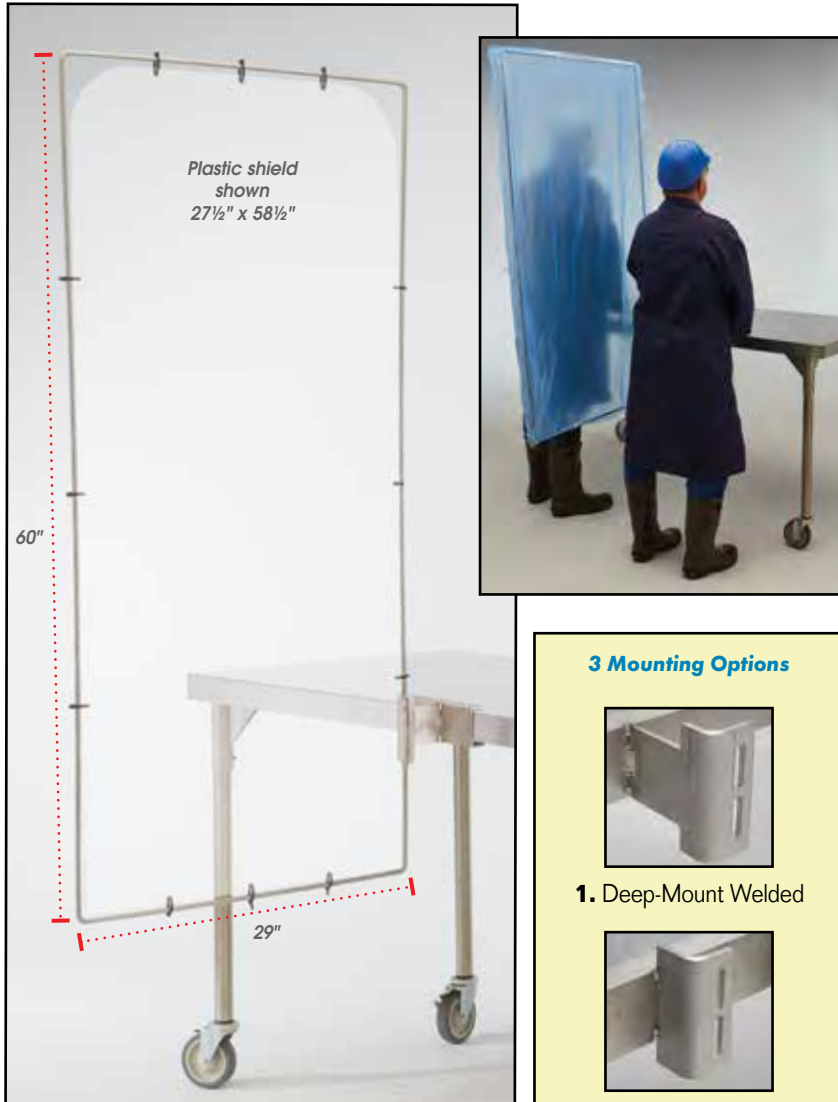

3 Mounting Options



1. Deep-Mount Welded



2. Snug-Mount Welded



3. Bolt-Mount



Scan this QR Code with your mobile device to see how easy it is to attach frame to mount.



Tool-free removal from mount.

Portable Aluminum Model

Mobile aluminum frames are light-weight and easy to move.

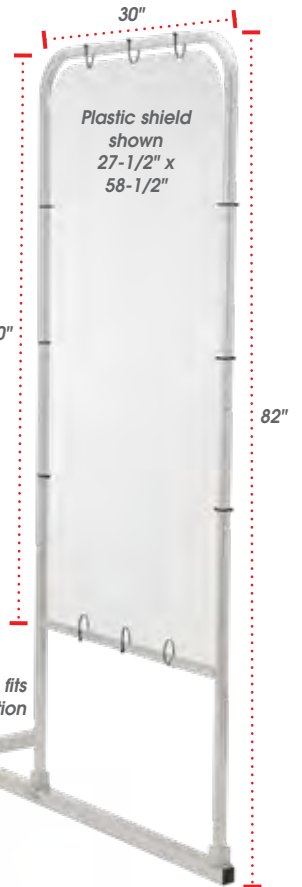

No-trip design fits under workstation



Scan this QR Code with your mobile device to see how light the Iso-Guard™ frame is.

F.O.B. FACTORY Ships from factory 7 days from order date.

ITEM NO.	PRODUCT	EACH
2990 01561	Stainless Steel Iso-Guard™ Frame	\$159.95
2990 01571	Deep-Mount Welded Bracket for SS Frame	34.95
2990 01581	Snug-Mount Welded Bracket for SS Frame	34.95
2990 01591	Bolt-Mount Bracket for SS Frame	34.95
3538 0155	Light-Duty Solid Clear Plastic Shield* (24-1/2" x 58-1/2", 5/Pack)	419.95
J722 02291	Shield Bags, 32" x 60", Blue, 400/Roll	169.95
J722 02301	Shield Bags, 32" x 60", Clear, 400/Roll	169.95

*Material in high demand – lead times will vary and can be up to 6 weeks. **This is a special order item.

F.O.B. FACTORY Ships from factory 7 days from order date.

ITEM NO.	PRODUCT	EACH
3775 00801	Aluminum Iso-Guard™ Frame	\$145.95
J722 02291	Shield Bags, 32" x 60", Blue, 400/Roll	169.95
J722 02301	Shield Bags, 32" x 60", Clear, 400/Roll	169.95
3538 0155	Light-Duty Solid Clear Plastic Shield* (5/Pack)	419.95

*Material in high demand – lead times will vary and can be up to 6 weeks. **This is a special order item.

PLANT MAINTENANCE

FIND IT FAST

Flashlights	566-567
Batteries	568
Utility Brushes and Scrubbing Wipes	569
Spray Bottles and Caddy	569
Tapes, Coatings and Compounds	570
Rust-Oleum® Products	571
Ladders	572
Mobile Work Centers	573
Blowers and Fans	574-575
Lubricants and Oils	576-578
Drum Pumps and Faucets	579
Absorbents and Soaker Pads	580-581
Sprayers	582
Insect Control	583
Door Gaskets, Sealants and Adhesives	584
Concrete Floor Patch Kit	584
Floor Grating and Stands	585



Multi-Use LED Water-Resistant Headlight



- Multi-use: headlight, magnet, hat clip, helmet.
- Includes 2 headstraps for wearing on head and rubber grip for helmet use.
- Adjustable spot to flood beam. • High performance LED.
- Uses 3 AAA batteries, (included).



Includes rubber grip headstrap for attaching easily over hard hat.



80 LUMENS

ITEM NO.	PRODUCT	LUMENS	EACH
7784 20031	Multi-Use LED Headlight80	\$21.95

RoughNeck LED Flashlight



Aluminum body withstands 7 foot drop test and is IPX4 water resistant.

- 105-260 lumens adjustable spot to flood beam.
- Compact design with 3 modes: low, high and strobe.
- Beam distance up to 110 meters (360 feet).
- Uses 3 AAA batteries, (included).



Holster included.



UP TO 260 LUMENS

ITEM NO.	PRODUCT	LENGTH	LUMENS	EACH
7784 10231	RoughNeck LED Flashlight	6"	105-260	\$29.95

Sportsman Essentials®



3C LED Glow Ring Flashlight

Features a glow in the dark locator ring, which charges when the flashlight is in use and is IPX4 Water resistant.

- High performance LEDs and 2 modes: High (310 lumens) and energy saver (95 lumens)
- Beam distance: 141 meters (98 energy saver mode).
- 7-foot drop test performance (2 meters).
- Aluminum housing with non-slip grip.
- Uses 3 C batteries, (included).

UP TO 310 LUMENS



ITEM NO.	PRODUCT	EACH
7784 00961	Sportsman LED Flashlight	\$29.95

Industrial™ Flashlight



- Constructed of high-impact polypropylene that is drop tested from 7 feet.
- Resists chemicals, grease, oil, water and corrosion.
- Comfort-grip design with protected slide on/off switch.
- Length: 5-1/2 inches. • With ring hanger.
- Uses 2 AA batteries, (included).



10 LUMENS

ITEM NO.	PRODUCT	EACH
7784 20121	Industrial™ 2AA Flashlight	\$6.95

Brite Essentials™ Laser Pointer Flashlight



Laser Pointer Flashlight

- 9 LED flashlight with built-in laser pointer.
- Push button on/off.
- Aluminum construction with durable rubber grip.
- Uses 3 AAA batteries, (included).



22 LUMENS

ITEM NO.	PRODUCT	EACH
7784 01061	Brite Essentials™ Flashlight	\$9.95

Rechargeable PolyStinger® Flashlight



- Up to 11,000 candela, peak beam intensity, for seventy five minutes between charges.
- Xenon bulb adjustable spot-to-floor beam, ultra-tough nylon polymer casing and non-slip grip.
- Rechargeable up to 1,000 times, saving on replacement batteries.
- AC/DC charger included, as well as a cigarette lighter recharger.

NOTE: Spare bulb included.



90 LUMENS



WARNING: The products on this page can expose you to chemicals including DEHP, which is known to the State of California to cause cancer and birth defects or other reproductive harm. For more information go to www.P65Warnings.ca.gov.

ITEM NO.	PRODUCT	LENGTH	WEIGHT	EACH
3423 60011	Rechargeable PolyStinger®	7.34"	8.7 oz.	\$141.95

PRICES ARE SUBJECT TO CHANGE • MINIMUMS MAY APPLY • VISIT OUR WEBSITE FOR CURRENT PRICING.

Virtually Indestructible LED Spotlight



- High performance LEDs: 670 lumens, (80 energy saver mode).
- ANSI IP67 waterproof up to 1 meter, complete dust protection.
- 3 light modes: high, medium and low.
- 15-foot drop test performance.
- Battery run time: 8 hours, (40 energy saver mode).
- Beam distance: 440 meters, (164 energy saver mode).
- Shatterproof lens and reflector. • Over-mold rubber head.
- Impact resisting internal engineering and compact design.
- Includes handy wrist strap.
- Uses 6 AA batteries (included).



UP TO
750
LUMENS



ITEM NO.	PRODUCT	WEIGHT	LUMENS	EACH
7784 00731	LED 6AA Spotlight	4 lb.	80-750	\$39.95

Workhorse® Pro LED Virtually Indestructible Flashlight



- Aluminum-titanium body, rubber head and tail cap shock absorbers, shatterproof lens and reflector, impact resisting internal engineering.
- 2 modes: high (350 lumens) and energy saver (70 lumens).
- Beam distance: 161 meters.
- IP67 waterproof up to 1 meter.
- 30 foot drop tested. • Length: 9-1/2 inches.
- Uses 2 AA batteries, (included).



UP TO
350
LUMENS

ITEM NO.	PRODUCT	EACH
7784 01051	Workhorse® LED Flashlight	\$24.95

6-Inch LED Penlight

- General purpose penlight clips conveniently in shirt pocket. • Super bright white LED with beam distance up to 36 feet.
- Color will vary: blue, orange or silver.
- Uses 1 AAA battery, (included).

NOTE: Color can NOT be specified.

3
LUMENS



ITEM NO.	PRODUCT	LENGTH	EACH
7784 01021	LED Penlight	6"	\$4.95

Virtually Indestructible LED Flashlight



Drop tested from 30 feet — the aluminum titanium body is so tough it will last a lifetime.

- Shatterproof lens and reflector.
- Rubber shock absorbers help protect impact-resistant internal parts.
- High performance LED has two modes: 300 lumens and 20 lumens (energy saver).
- Beam distance: 168 meters in regular mode; 45 meters in energy saver mode.
- Battery run time: 3 hours in regular mode; 39 hours in energy saver mode.
- ANSI IP67 waterproof up to 1 meter, complete dust protection.
- Uses 3 AAA batteries, (included).



UP TO
300
LUMENS

ITEM NO.	PRODUCT	LENGTH	EACH
7784 10031	Virtually Indestructible Flashlight	5-3/8"	\$19.95

Dorcy LED Cyber Light



- True Spot Reflector technology provides 275-meter high beam distance for visibility.
- Heavy-duty lens, durable rubber and plastic housing withstand a 10-foot drop test.
- Rubber grip, push button switch and nylon lanyard.
- Uses 4 AA batteries, (included).



UP TO
190
LUMENS

ITEM NO.	PRODUCT	LENGTH	EACH
3353 47501	Dorcy LED Cyber Flashlight	7-1/2"	\$29.95



WARNING: The products on this page can expose you to chemicals including DEHP, which is known to the State of California to cause cancer and birth defects or other reproductive harm. For more information go to www.P65Warnings.ca.gov.

Ultra PRO Alkaline Batteries

- Engineered for professional use.
- 10 year power guarantee (AAA/AA/C/D sizes only).



ITEM NO.	PRODUCT	QTY./PACK	PACK	ITEM NO.	PRODUCT	QTY./PACK	PACK
7784 00045	AAA Size	8/Pack	\$3.95	7784 00075	9 Volt	6/Pack	\$10.95
7784 00035	AA Size	8/Pack	3.95	A692 10131	LR44 1.5 Volt	2/Pack	5.95
7784 00015	C Size	6/Pack	5.95	3508 0800	LR44 1.5 Volt	1/Pack	1.25
7784 00025	D Size	6/Pack	7.95	3508 1131	LR1130 1.5 Volt	1/Pack	0.95



BATTERY REFERENCE CHART



Need a replacement battery for one of our products? Use this chart to help identify the correct batteries needed.

FLASHLIGHTS

ITEM NO.	PRODUCT	BATTERY	QTY. REQ.	BATTERY NO.
7784 01061	Brite Essentials Flashlight/Laser Pointer	AAA	3	7784 00045
3353 00011	Dorcy Aluminum LED Flashlight	AA	2	7784 00035
3353 47501	Dorcy LED Cyber Light	AA	4	7784 00035
7784 20121	Industrial AA-Cell Flashlight	AA	2	7784 00035
7784 01021	LED Penlight	AAA	1	7784 00045
7784 20031	Multi-Use LED Headlight	AAA	3	7784 00045
7784 10231	RoughNeck LED	AAA	3	7784 00045
7784 00961	Sportsman LED Glow Ring Flashlight	C	3	7784 00015
7784 10031	Virtually Indestructible LED Flashlight	AAA	3	7784 00045
7784 00731	Virtually Indestructible LED Spotlight	AA	6	7784 00035
7784 01051	Workhorse Pro LED Flashlight	AA	2	7784 00035

THERMOMETERS

3098 51321	Atkins 351 Digital	AAA	2	7784 00045
3098 32301	Atkins EconoTemp w/HD Probe	AAA	3	7784 00045
3098 01131	Atkins EconoTemp w/Std. Probe	AAA	3	7784 00045
E542 70011	Big Red In-Line Thermometer	LR1130	1	3508 1131
E542 70021	Big Red Pocket Thermometer	LR44	1	3508 0800
E542 59091	Big Red T-Handle Thermometer	LR44	1	3508 0800
A692 00181	C48 Thermocouple	AA	2	7784 00035
3368 0377	Compact Chart Recorder	AA	1	7784 00035
3542 41211	Digital Thermometer	1.5 V	1	3508 0800
3443 1051	Heavy-Duty Digital Thermometer	1.5 V	4	A692 10131
A692 00011	Infrared Non-Contact Thermometer	9 V	1	7784 00075
3098 22091	Infrared Thermometer	AAA	2	7784 00045
4599 10401	Lollipop Thermometers	LR44	1	3508 0800
4599 10501				
4599 00071				
3098 0450	Pocket Thermometer	1.5 V	1	3508 0800
3368 00041	Temperature Chart Recorder	AA	1	7784 00035
3368 10081	Temperature Chart Recorder	AA	4	7784 00035
3542 98671	Thermocouple Therm, folding probe	AAA	2	7784 00045
4599 00081	ThermoTrace Infrared/Probe	AAA	2	7784 00045
3611 00441	Waterproof Digital Probe	1.5 V	1	3508 0800

SCALES

ITEM NO.	PRODUCT	BATTERY	QTY. REQ.	BATTERY NO.
3416 20121	Checkweigh Scale	D	6	7784 00025
3416 00261	Low Profile Bench Scale	C	4	7784 00015
3416 00271	Low Profile Bench Scale	C	4	7784 00015
3416 00281	Low Profile Bench Scale	C	4	7784 00015
3416 3000	SS Washdown Safe Scale	AA	6	7784 00035
3416 0011	SS Washdown Scale	D	6	7784 00025
3416 0021	SS Washdown Scale	D	6	7784 00025
3416 1001	SS Washdown Scale	D	6	7784 00025
3416 2002	SS Washdown Scale	D	6	7784 00025
3416 5002	SS Washdown Scale	D	6	7784 00025
3416 00151	Washdown Compact Scales	D	6	7784 00025
3416 00161	Washdown Compact Scales	D	6	7784 00025
3416 00171	Washdown Compact Scales	D	6	7784 00025
3416 00181	Washdown Compact Scales	D	6	7784 00025
4893 00111	Washdown Portion Control Scales	D	4	7784 00025
4893 00211	Washdown Portion Control Scales	D	4	7784 00025
4893 00441	Washdown Portion Control Scales	D	4	7784 00025
4893 03211	Washdown Portion Control Scales	D	4	7784 00025
4893 30111	Washdown Portion Control Scales	D	4	7784 00025
4893 00391	Washdown Scale	D	6	7784 00025
4893 00401	Washdown Scale	D	6	7784 00025
4893 00411	Washdown Scale	D	6	7784 00025
4893 65551	Washdown Scale	D	6	7784 00025

METERS

3024 0015	pH Meter	9 V	1	7784 00075
-----------	----------	-----	---	------------

TIMERS AND STOPWATCHES

A692 02641	Countdown Timer	AAA	1	7784 00045
4804 20001	Dual Function Stopwatch	LR44	1	3508 0800
3098 04081	Multi-Station Timer	C	4	7784 00015
3098 00151	TFS4 Timer	C	4	7784 00015
3244 46011	Water Resistant Stopwatches	LR44	1	3508 0800

NEED HELP? Our experienced customer service representatives are available **CALL 800-456-5624**



Available in 72- or 170-count bucket.

GOJO® Scrubbing Towels

Formulated to lift heavy dirt and grime from skin pores without dryness or irritation.

- Dual textured with a scrubbing side for removing tough soils and a smooth side for quick dirt absorption.
- Pre-moistened with a GOJO® heavy-duty cleaning solution.
- Contains skin conditioners to help prevent dryness and irritation.
- For use anywhere heavy-duty cleaning is required; no water needed.
- 72-count bucket features SimPul™ Nozzle Technology, which virtually eliminates roping, providing one towel every time.

For More Hand Wipes ▶ SEE PAGE 161



ITEM NO.	PRODUCT	EACH
3540 63965	72-Count Bucket	\$14.95
3540 63985	170-Count Bucket (2 Pack)	59.95

24-Ounce Spray Bottles

- 9¾-inch dip tube.
- Bottles can easily be marked to identify contents.
- Adjustable spray pattern with full off position.
- Replacement pump available (sold separately, listed below).
- Chemical resistant.



Bottles are labeled with safety information and bilingual check off grid (printed in English/Spanish)

ITEM NO.	PRODUCT	EACH
6710 01205	24 oz. Spray Bottles, Each with Spray Pumps (3-Pack)	\$9.95
6710 02461	Replacement Trigger Spray Pump, Red	1.95
E542 10881	White Repl. Trigger Sprayer	1.95

Stainless Steel Utility Brushes

Ideal for removing grease and deposits from small and tight areas.

- Stainless steel bristles allow for aggressive removal of grease.
- Blue plastic handle.

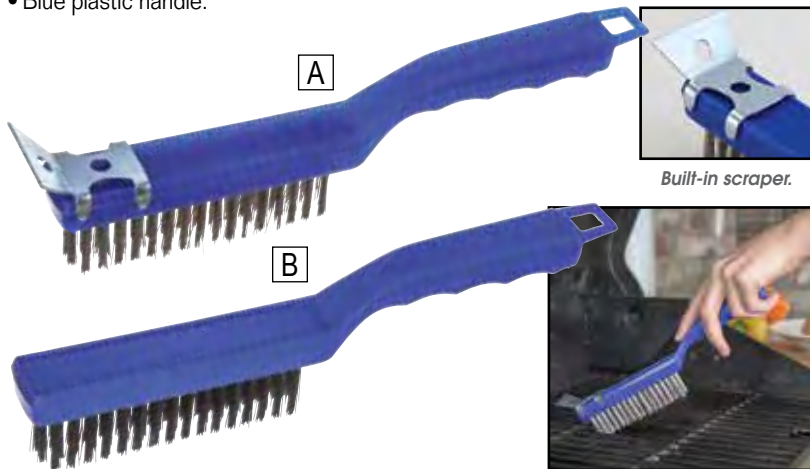

ITEM NO.	PRODUCT	EACH
6387 00501	A. 11-1/2" Utility Brush w/Scraper	\$13.05
6387 67111	B. 11-1/2" Utility Brush w/o Scraper	8.95

Deluxe Carry Caddy

- Holds up to eight 32-ounce spray bottles.
- Ergonomic handle design.



Ideal for carrying cleaning supplies.

ITEM NO.	PRODUCT	DIMENSIONS	EACH
1770 54001	Deluxe Carry Caddy	15" x 11" x 7-1/2"	\$19.95

7-Inch Toothbrush-Style Utility Brushes

Ideal for cleaning tight, small areas.

- Great for small jobs, tight areas and detail work, small parts, seams, threads and soldered joints.
- 7-inch plastic handle.

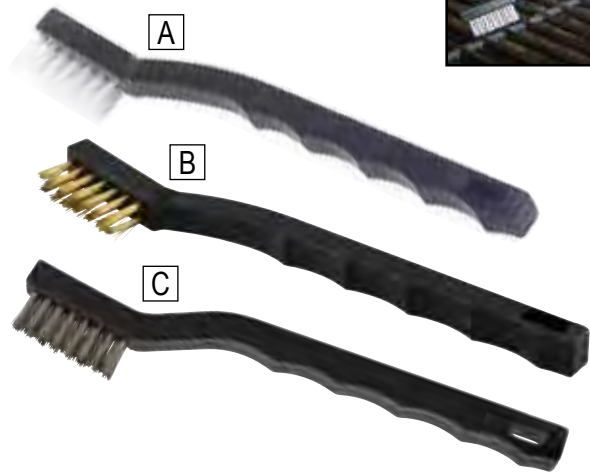

ITEM NO.	PRODUCT	EACH	
		1-11	12+
6387 74011	A. 7" Utility Brush, Nylon Bristles	\$3.95	\$2.95
6387 12701	B. 7" Utility Brush, Brass Bristles	3.95	2.95
6387 06331	C. 7" Utility Brush, Stainless Steel Bristles	3.95	2.95

▶ 12 PER CASE.

WIPES, UTILITY BRUSHES, SPRAY BOTTLE AND CARRY CADDY

PRICES ARE SUBJECT TO CHANGE • MINIMUMS MAY APPLY • VISIT OUR WEBSITE FOR CURRENT PRICING.

All Purpose Duct Tape

Tears easily by hand and provides ease of application and handling.

- Tightly woven scrim provides high tensile strength.
- Aggressive, synthetic rubber adhesive provides instant adhesion to a wide variety of surfaces.
- Withstands a temperature range of +32 °F to +160 °F.
- 1.88 inches W x 180 feet (48 mm x 54.8 m) per roll.
- Core: 3 inches. • 9 mil • Color: silver. • Each roll is individually wrapped.



▶ 24 ROLLS PER CASE.

ITEM NO.	PRODUCT	ROLL	
		1-23	24+
3957 49771	All Purpose Duct Tape.....	\$7.85	\$6.85

Scotch® Super 33+™ Vinyl Electrical Tape

Stands up to the elements: from UV rays and moisture to alkalis, acids and corrosion.

- The tape's pressure-sensitive, rubber-resin adhesive and a durable PVC backing provide great protection.
- Measures 3/4 inch x 76 feet x 7 mil • Color: black.
- Compatible with rubber and synthetic splicing compounds.
- UL Listed, ASTM Approved, CSA Certified and RoHS 2011/65/EU Compliant.
- Withstands a temperature range of 0 °F to 221 °F (-18 °C to 105 °C).



▶ 10 ROLLS PER CASE.

ITEM NO.	PRODUCT	ROLL	
		1-9	10+
6655 15681	Super 33+ Vinyl Electrical Tape	\$11.45	\$10.45

Plasti-Dip Liquid-Rubber Coating

- Synthetic rubber coating insulates and protects against moisture, acids, abrasions and reduces skidding/slipping.
- Resists rust and corrosion.
- Remains flexible and stretchy over time and will not crack in extreme weather conditions.
- Withstands temperatures from -30 °F to 200 °F.



NOTE:
This product can NOT be sold in California.

▶ 4 GALLONS PER CASE.

ITEM NO.	COLOR	GALLON	
		1-3	4+
3176 44751	White	\$89.95	\$87.95
3176 44761	Red	89.95	87.95
3176 44771	Black	89.95	87.95

Freezer Kote

- Withstands temperatures from -40 °F up to +190 °F.
- Coating designed for cold storage application.
- One gallon covers 400 to 500 sq. ft.
- High-gloss finish dries in one hour.
- Suitable for USDA-inspected facilities.
- 1 gallon, 10 pounds.
- Color: white.



▶ 4 GALLONS PER CASE.

ITEM NO.	PRODUCT	GALLON	
		1-3	4+
3027 13101	Freezer Kote	\$144.85	\$141.85

Evapo-Rust™ Rust Remover

- Non-toxic, non-corrosive and non-flammable formula removes rust in as little as 5 minutes.
- Easy to use – just immerse rusted part in room temperature biodegradable, water soluble solution, then rinse with water.
- Safe for use in spray cabinets, ultrasonic cleaners, pressure washers, pumps and vats.
- One gallon de-rusts up to 300 pounds of heavily rusted steel.



Removes even the deepest of rust in minutes.

▶ 4 GALLONS PER CASE.

ITEM NO.	PRODUCT	GALLON	
		1-3	4+
1210 00011	Evapo-Rust	\$25.95	\$24.95

STEEL-IT Stainless Steel Coating

The STEEL-IT Polyurethane Coating System features a unique stainless steel leafing pigment and provides optimum weather-, abrasion- and corrosion-resistance in general maintenance applications. The easy to apply system yields a hard, non-toxic, metallic finish that protects a multitude of surfaces from ultraviolet rays, chemicals, oils, alkalis, food acids, water immersion, abrasion and high-pressure washdowns.

- Industrial strength, non-dielectric stainless steel coating. • 250-300 sq. ft. coverage per gallon. • Prevents rust and corrosion.

▶ 12 CANS PER CASE.

ITEM NO.	PRODUCT	CAN	
		1-11	12+
3194 93741	Aerosol Can, 14 oz.	\$32.95	\$31.95

▶ 4 GALLONS PER CASE.

ITEM NO.	PRODUCT	GALLON	
		1-3	4+
3194 02481	1-Gallon Can	\$220.95	\$215.95

STEEL-IT Alkyd Primer

- 1 coat Alkyd Primer prior to Stainless Coating recommended for optimum corrosion resistance.

▶ 4 GALLONS PER CASE.

ITEM NO.	PRODUCT	GALLON	
		1-3	4+
3194 21031	Primer, 1-Gallon Can	\$192.95	\$187.95

▶ 6 QUARTS PER CASE.

ITEM NO.	PRODUCT	CASE
		3194 2003





LeakSeal® Self Fusing Silicone Tape

Rust-Oleum® LeakSeal® Self Fusing Silicone Tape conforms to any surface while providing a water-tight seal.

- Creates a chemical- and moisture-resistant barrier that fixes leaky pipes and hoses, and covers frayed electrical wires.
- Easy to remove, leaves no sticky residue and protects from corrosion.
- Withstands temperatures -85 °F to 500 °F.
- Superior strength 700 psi.
- Corrosion and chemical resistant.

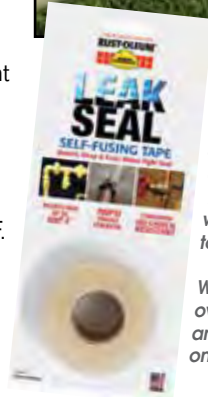

Using tension, stretch tape around the object, overlapping each layer by 1/2 inch and wrap over itself to fuse.
Wrap completely over problem area and cut the tape once finished.

ITEM NO.	PRODUCT	QTY.	CASE
A321 0004	10 ft. Roll, Opaque	6/Case	\$52.95

Cold Galvanizing Compound

Instantly galvanize metal surfaces, or repair worn or damaged galvanized steel with Rust-Oleum® High Performance 7000 System Cold Galvanizing Compound.

- Contains 95% pure zinc in the dry film — for maximum corrosion resistance.
- Protects and repairs bare sheet metal, galvanized ducts, storage tanks, etc.
- Self-priming; excellent adhesion to galvanized metal.
- Ideal for use in mild industrial environments.
- Meets USDA requirements for incidental food contact; meets Federal Specifications.*



*DOD-P-21035A; MIL-P-26915C

ITEM NO.	PRODUCT	QTY.	F.O.B. FACTORY CASE
A321 0005	1 Quart	2/Case	\$83.95
A321 0002	1 Gallon	2/Case	368.50

LeakSeal® Flexible Rubber Coating

Repair and prevent leaks on a wide range of demanding surfaces with Rust-Oleum® LeakSeal® Spray.

- This rubberized coating provides a water-tight seal to fill small holes and provide firm-but-flexible protection against moisture and rust.
- Great for gutters, roofs, flashing, duct work, PVC, masonry, concrete and more.
- Paintable finish.



ITEM NO.	PRODUCT	QTY.	CASE
A321 0006	15 oz., Black Spray	6/Case	\$82.95
A321 0010	15 oz., ANSI Gray Spray	6/Case	82.95

InstaPatch® Concrete Repair

Quickly patch and repair damaged concrete floors with InstaPatch® Ultra-Rapid Curing Concrete Repair.

- InstaPatch® is a two component, 100% solid polyurethane concrete repair compound that cures in 15 minutes or less.
- Versatile formula can be poured or trowel applied. • Virtually no odor.
- Gray InstaPatch® changes from black upon application to gray so you know when it's fully cured.
- Can be applied in temperatures as low as -5 °F.



Before grinding.

After grinding.



ITEM NO.	PRODUCT	EACH
A321 0012	1 Gallon Gray	\$156.95



STEEL-TECH™ Stainless Steel Rich Coating

Rust-Oleum's High Performance Steel-Tech™ Polyurethane Stainless Steel Rich Coating is infused with stainless-steel flakes to provide armor-like protection in harsh environments.

- Uses 1/3 less product and requires 1/3 less dry time than other brands.
- Aerosol Spray matches Steel-Tech polyurethane coating for easy touch up and dries in only 20 minutes.
- Applies direct-to-metal (DTM) — no primer or additional coat needed.
- Low-odor, one-component system — no mixing required.
- Not for use on concrete, masonry or galvanized steel.
- Can be used on surfaces that reach up to 200 °F.
- Meets USDA requirements.



ITEM NO.	PRODUCT	QTY.	F.O.B. FACTORY CASE
A321 0009	Aerosol Spray, 15 oz.	6/Case	\$75.95

Little Giant Safety Step Ladders

With a super-slim 5-inch folded depth the Little Giant Safety Step is the go-anywhere, do-anything stepladder. It's perfect for around the home or office.

- Features wide, slip-resistant treads for maximum stability and a fold-up safety bar with integrated tool tray.
- Constructed of rugged, corrosion-resistant aluminum alloy for added durability while remaining portable and lightweight.
- Tip & Glide™ wheels make moving and positioning your ladder easier than ever.
- Choose from 2, 3 or 4-step models.
- 300 pound weight rating.



5-inch storage width.



Tip & Glide™ Wheels.

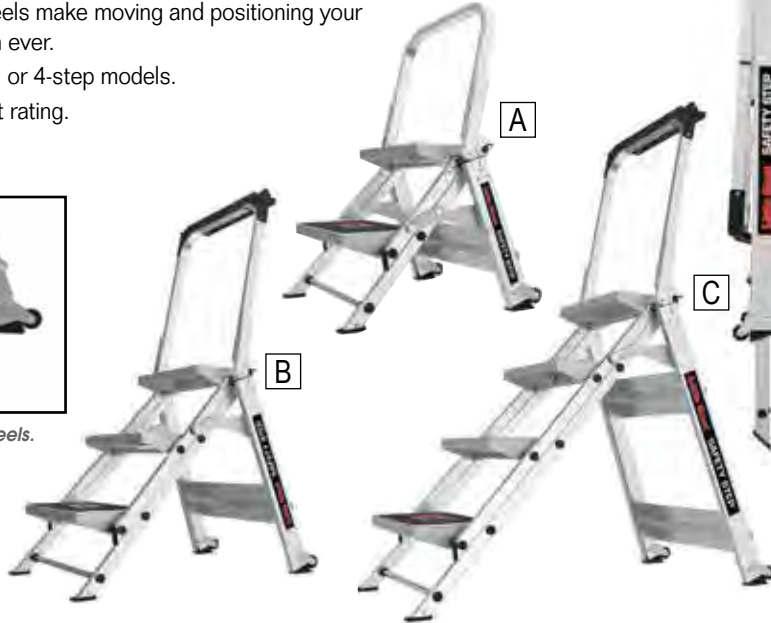

ITEM NO.	PRODUCT	HEIGHT	SHIPPING WT.	F.O.B. FACTORY EACH
E373 02101	A. 2-Step Ladder w/Bar	17" to Top Step	18 lb.	\$149.95
E373 0310	B. 3-Step Ladder w/Bar and Tray	26" to Top Step	24-1/2 lb.	204.95
E373 0410	C. 4-Step Ladder w/Bar and Tray	34" to Top Step	31-1/2 lb.	296.95

Fiberglass Step Ladder



- Molded top with handyman's tool slots.
- Pinch-resistant spreader braces.
- Heavy gusset bracing.
- Duty rated at 300 pounds.
- Slip-resistant rubber feet.



ITEM NO.	SIZE	SHIPPING WT.	EACH
3333 3016	4 ft.	14 lb.	\$102.95
3333 3017	6 ft.	20 lb.	135.95
3333 3018	8 ft.	26 lb.	179.95
3333 3019	10 ft.	37 lb.	271.95
3333 3020	12 ft.	46 lb.	336.95

Multi-Purpose Aluminum Ladder

Four different ladder types in one — can be used as a twin step ladder, stairway ladder, scaffold and an extension ladder.

- Light-weight aluminum design.
- Quick activating flip and snap-lock hinges.
- Provides wider footprint for stability and versatility for the most demanding projects.
- One man set-up.
- Slip resistant rubber feet.
- Available in: 13-, 17- or 22-foot heights
- Load capacity: 300 pounds.



Extend ladder fully for use in high location needs.



Ladder adjusts easily to be used in a variety of environments.



ITEM NO.	SIZE	STRAIGHT EXTENSION	TWIN STEPLADDER	STAIRWAY LADDER	PLANK SUPPORT	SHIPPING WT.	F.O.B. FACTORY EACH
3333 00161	13 ft.	7' - 11'	3' - 5'	3' - 5'	1' - 2'	.35 lb.	\$273.95
3333 00171	17 ft.	9' - 15'	4' - 7'	4' - 7'	1' - 4'	.42 lb.	317.95
3333 00181	22 ft.	11' - 19'	5' - 9'	5' - 9'	1' - 5'	.50 lb.	350.95

► WWW.BUNZLPD.COM
For More Ladders



PRICES ARE SUBJECT TO CHANGE • MINIMUMS MAY APPLY • VISIT OUR WEBSITE FOR CURRENT PRICING.

5-Drawer Mobile Work Center

A place for everything at a reasonable price.

- Cart weighs only 77 pounds.
- Work top supports up to 250 pounds.
- 5 metal drawers conveniently hold all your tools and supplies.
- Work top has built-in tool and parts holder, cord wrap and conversion table.



Locking bar provides security and holds drawers securely in place when moving.

For Locks ► SEE PAGE 278



Built-in peg board.

2-inch thick wheels with casters provide easy rolling portability; two of the casters have locks for safety.

ITEM NO.	PRODUCT	DIMENSIONS	EACH
1770 3488	5-Drawer Work Center	32-3/5" x 19-4/5" x 33-1/2"	\$679.00

TradeMaster® Mobile Work Centers



- All-plastic design provides easy maintenance and quiet operation without rusting, denting, chipping or peeling.
- Molded in storage compartments and cup holder to keep tools accessible and organized.
- Raised ergonomic handle reduces wrist and back strain.
- Rounded corners help protect walls, doorways and furniture.
- 3-outlet, surge-protected power strip with 10 foot cord and wrap.
- 4 inch deep drawers with ball bearing slides allows for easy opening and closing.
- (A) Capacity: 750 pounds. • (B) Capacity: 500 pounds.
- Locking 5-inch non-marking casters.
- Top shelf can hold refuse bin (optional). • Ships knocked down.



A

Cabinet doors swing 270° for easy access and a heavy-duty cam locking system.



Optional refuse bin.



B

ITEM NO.	PRODUCT	DIMENSIONS	F.O.B. FACTORY EACH
1770 4533	A. 4 Drawers w/Cabinet	49" L x 26-1/4" W x 38" H	\$1,483.00
1770 1388	B. 4 Drawers	40-3/5" L x 18-2/5" W x 33-2/5" H	1,483.00
1770 53881	Optional Refuse Bin		119.95

WORK CARTS

PRICES ARE SUBJECT TO CHANGE • MINIMUMS MAY APPLY • VISIT OUR WEBSITE FOR CURRENT PRICING.

SHOP bunzlpd.com 24/7

STAY CONNECTED WITH US:



Need Help?
Chat With Us
Online!



Sahara Pro X3 TurboDryer

Incredibly powerful static pressure and huge CFM volumes!

- Daisy-chain capability with built-in power outlet and circuit breaker.
- Low amp draw – 4 amps max!
- Excellent versatility with 3 speeds and 3 operating positions – 0°, 45° and 90°.
- Underside drying vent for drying under the airmover.
- Quick disassembly for cleaning.
- Rated airflow: 2700 CFM (4587 CMH).
- CFM/amp: 235.
- Static pressure: 1.28 inches (3.25 cm).
- CFM per 15 amp circuit: 2817 CFM, tested.
- Airflow velocity: 2,071 feet/minute (631 m/minute), tested.



CFM stands for "cubic feet per minute" and is a measure of air flow capability.

Example: a 1000 CFM blower or fan can move air from an area 10 feet x 10 feet x 10 feet in one minute.



3-Position air flow allows air to be directed where you need it.

ITEM NO.	PRODUCT	DIMENSIONS	EACH
F169 0351	Sahara Pro X3 TurboDryer	18.3" x 17" x 18-4/5"	\$403.95

Stainless Steel Food Service Fans

Designed to withstand moist/wet environments, high-pressure cleaning with concentrated caustic solutions without affecting performance or function.

- Constructed with electropolished 304 stainless steel.
- Meets USDA and NSF requirements for food zones.
- All stainless steel motor. • Non-oscillating.
- Motor washdown specification is IEC-IP55.
- 1 phase, TENC, ball bearing, BISSC Approved motor.
- 20-inch fan: 115 V, 1/15 hp, 2 speed.
- 24-inch fan: 115/230 V, 1/4 hp, 1 speed.
- 30-inch fan: 115/230 V, 1/3 hp, 1 speed.
- Available in non-adjustable pedestal or wall mount.
- UL/CUL listed.

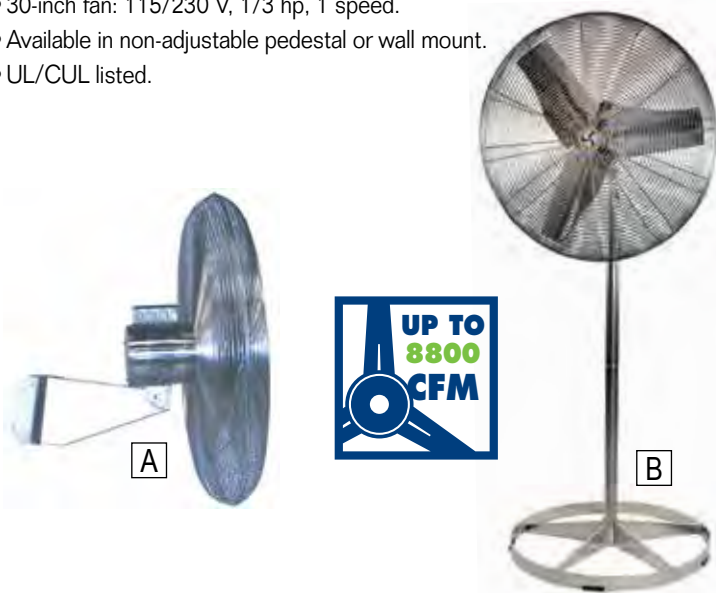

ITEM NO.	PRODUCT	CFM		HP	SHIPPING WT.	F.O.B. FACTORY
		HIGH	LOW			EACH
F011 0833	A. 20" Wall Model	.2670	.1670	.1/15	.52 lb.	\$1,971.95
F011 0835	24" Wall Model	.5220		.1/4	.62 lb.	2,218.95
F011 0767	30" Wall Model	.8800		.1/3	.64 lb.	2,559.95
F011 0834	B. 20" Floor Model	.2670	.1670	.1/15	.69 lb.	2,094.95
F011 0836	24" Floor Model	.5220		.1/4	.79 lb.	2,342.95

Industrial Air Pivot Fans

- Four position easy reach switch with 10-foot three conductor cord and plug.
- 115 V, 1 phase, 3 speed, open drip proof, ball bearing motor.
- Nickel chrome guards meet OSHA requirements.
- Choose from yoke mount, low or high stand.
- Aluminum propellers.
- Adjusts 360°. • UL/CUL listed.

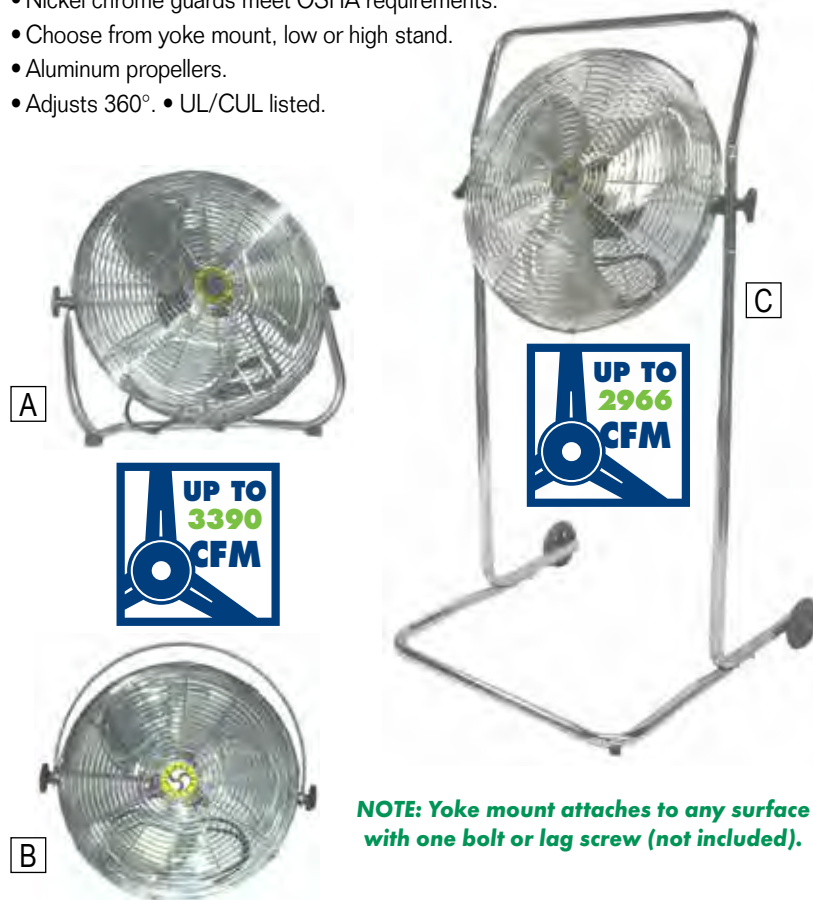

NOTE: Yoke mount attaches to any surface with one bolt or lag screw (not included).

ITEM NO.	PRODUCT	CFM			HP	F.O.B. FACTORY
		HIGH	MED	LOW		EACH
F011 89741	A. 18" Low Stand	2,966	2,437	2,013	1/8	\$179.95
F011 89751	20" Low Stand	3,390	2,755	2,295	1/5	198.95
F011 89721	B. 18" Yoke Mount	2,966	2,437	2,013	1/8	190.95
F011 89701	20" Yoke Mount	3,390	2,755	2,295	1/5	210.95
F011 89691	C. 18" High Stand	2,966	2,437	2,013	1/8	238.95



Ceiling Mount

Hanging Mount



Portable Barrel

Wall Mount

4-in-1 Direct Drive Fan

One fan with four mounting options (mounts included)!

- 30-inch fan: 1/4 hp, 115 V, 1 phase, ball bearing motor, 3 speeds.
- 36-inch fan: 1/2 hp, 115 V, 1 phase, ball bearing motor, 2 speeds.
- Epoxy coated guards, barrel and mountings.
- Shipping weights: 30-inch fan = 97 pounds; 36-inch fan = 119 pounds.
- Tilttable. • Pull chain switch. • UL/CUL listed.

30-inch Fan

36-inch Fan



ITEM NO.	PRODUCT	CFM			HP	EACH
		HIGH	MED	LOW		
F011 0470	30" 4-in-1 Fan	5,670	4,590	3,410	1/4	\$617.95
F011 00051	36" 4-in-1 Fan	11,200		8,090	1/4	\$518.95



42-Inch Belt Drive Drum Fan

Powerful fans for use when moving a large amount of air.

- 115 V, 1 phase, 2 speed, ODP, 1/2 hp motor.
- Guards, barrel and propellers epoxy coated.
- Three bladed aluminum propeller.
- Two speed rocker switch.
- 8-inch steel wheels with rubber tires.
- Handle with cord wrap.
- 10-foot, three conductor SJT type cord.
- Dimensions: 46-inch cabinet size.
- Shipping weight: 130 pounds.
- UL/CUL listed.



ITEM NO.	PRODUCT	CFM			HP	EACH
		HIGH	LOW			
F011 6002	42" Belt Drive Fan	14,000	8,000		1/2 (2SP)	\$921.95



Industrial Grade Fan Components

Customize your fan according to the needs of your plant.

- A. Non-oscillating fan head available in 20 inch, 24 inch or 30 inch. 20-inch fan head is 1/15 hp, 2 speed. 24-inch and 30-inch fan heads are 1/4 hp, 3 speed.
- 15-foot cord with 3-prong plug included.
- B. Solid pedestal base available in 26 inches or 32 inches.
- C. Wall/ceiling mount bracket includes safety cable kit.
- D. Snap-on wheel kit with set screw lock fits 20-inch to 30-inch pedestal fans.
- E. Adjustable pole allows fan to be used from 5 to 8 feet.



ITEM NO.	PRODUCT	CFM			WEIGHT	F.O.B. FACTORY EACH
		HIGH	MED	LOW		
F011 71141	A. 20" Non-Oscil. Fan Head	2,670		2,035	.27 lb.	\$329.95
F011 15901	24" Non-Oscil. Fan Head	4,400	3,460	2,460	.39 lb.	\$357.95
F011 15911	30" Non-Oscil. Fan Head	6,100	4,400	2,700	.48 lb.	\$368.95
F011 11651	B. 26" Dia. Solid Pedestal Base				17 lb.	\$422.05
F011 11661	32" Dia. Solid Pedestal Base				34 lb.	\$152.05
F011 50021	C. Wall/Ceiling Mount Bracket				.5 lb.	\$82.15
F011 06011	D. Pedestal Wheel Kit				.5 lb.	\$191.25
F011 31011	E. Adjustable Pole, 5' to 8'				12 lb.	\$129.95

PRICES ARE SUBJECT TO CHANGE • MINIMUMS MAY APPLY • VISIT OUR WEBSITE FOR CURRENT PRICING.

Magna-Plate Food Grade Grease

For use on machinery where grease may come into contact with edible product.

- White grease has excellent water-resistance and lubrication qualities.
- Good oil bleed characteristics at low ambient temperatures make it ideal for small, high-speed bearings.
- Choose from standard or high-temp grease. Standard grease is for temperatures under 250 °F (121 °C). High-Temp grease is for temperatures 500 °F (260 °C).
- Fits standard hand-operated grease gun.



▶ 10 PER PACK. EACH

ITEM NO.	PRODUCT	1-9	10+
5484 10501	14.5 oz., Standard	\$13.15	\$11.75
5484 20521	14.5 oz., High-Temp	13.20	11.80

Clear-Guard Food Grade Grease

For use on machinery where grease may come into contact with edible product.

- Clear grease compounded with a high-temperature polymer will cling to metal surfaces under the most severe conditions.
- Water, salts, heat and chemicals will not affect performance.
- Resists sling and channeling under high-speed or high-temperature conditions.
- Fits standard hand-operated grease gun.



▶ 10 PER PACK. EACH

ITEM NO.	PRODUCT	1-9	10+
5484 20011	14.5 oz. Tube	\$15.40	\$14.00

BDF Cling-Lube

For use on overhead chains, conveyors trolleys and way guides in meat and poultry processing plants.

- Contains MICRONOX® Technology*.
- High-cling, thick foaming, non-drip, overhead lubricant.



▶ 12 PER CASE. EACH

ITEM NO.	PRODUCT	1-11	12+
5484 02141	11 oz. Aerosol	\$15.35	\$13.35

Food Grade Anti-Seize Compound

Prevents galling seizure, corrosion, wear and friction on fasteners, threads and joints.

- Apply with built-in cap brush to clean surface.
- Non-toxic, clean white color.
- Taste- and stain-free and kosher.



▶ 12 BOTTLES PER CASE. EACH

ITEM NO.	PRODUCT	1-11	12+
5484 01341	Food Grade Anti-Seize, 8 oz. Jar	\$17.55	\$15.55

Heavy-Duty Industrial Grease Gun

Heavy-duty cast iron head with cadmium plated toggle and lever.

- Exclusive "Flip-Over" follower allows a superior seal for either cartridge or bulk loading applications.
- Extra-heavy follower spring ensures positive priming and uninterrupted pumping action.
- Jam-proof toggle mechanism prevents binding or bending of plunger.
- Precision-fit plunger prevents lubricant bypass and resists scoring.
- Lube Capacity:
 - 16 ounce bulk;
 - 14-1/2-ounce cartridge.



ITEM NO.	PRODUCT	LENGTH	EACH
3538 1142	Grease Gun	21-1/4"	\$69.45

USDA-NSF AUTHORIZATION CODES

FOOD GRADE CATEGORY	APPLICATION
A1	General cleaning products
A7	Metal cleaners and polishes for non-food contact surfaces.
H1	Lubricants with incidental food contact.
H2	Lubricants with no food contact.
3H	Lubricants with direct food contact.
P1	Compounds requiring a letter for authorized use.

Zerk Replacement Kit

- 100 assorted grease gun fittings in all popular sizes.



F.O.B. FACTORY EACH

ITEM NO.	PRODUCT	EACH
3538 6643	Zerk Replacement Kit	\$115.75

*Micronox® food grade antimicrobial technology for product protection. JAX USDA/NSF authorized H1 lubricants containing Micronox incorporate proprietary food additive antimicrobial agents that provide antimicrobial protection to the lubricant from contamination as a result of indirect contact with processed foods or beverages. Use of this product is not a substitute for proper sanitation processes and protocols. Micronox® products contain an odor.

Dry-Glide All Purpose Silicone

For use on food packaging machinery, friction areas for films, wraps, cartons and large flat areas where a no-stick surface is needed.

- Food grade quick dry silicone lubricant can be used in all sanitary food plant applications.
- High silicone content, so there is little need to reapply as often – saving time and money.
- Available in a trigger spray bottle or as an aerosol.



▶ 12 SPRAY BOTTLES W/ONE TRIGGER SPRAYER PER CASE.
▶ 12 AEROSOL CANS PER CASE.

ITEM NO.	PRODUCT	EACH	
		1-11	12+
5484 00021	16 oz. Trigger Spray ..	\$14.00	\$12.00
5484 01081	10 oz. Aerosol	13.20	11.20
5484 04001	Trigger Sprayer Only ..	5.30	---

Magna-Plate 74 Air Tool/Air Line Oil

Food grade oil for use on industrial air lines.

- Rust inhibitors help provide trouble-free operation of any air line system.
- Emulsifies exhaust system moisture.
- Premium additives protect internal components.
- Contains MICRONOX® Technology.*



▶ 12 BOTTLES PER CASE.

ITEM NO.	PRODUCT	EACH	
		1-11	12+
5484 00091	16 oz. Bottle ..	\$13.15	\$11.15

Magna-Plate 78 Anti-Wear Food Grade Lubricant

For use on chains, slides, ways, bearings conveyors and food processing and packaging equipment.

- Food grade machinery oil should be used where there is a chance of incidental food contact.
- Contains MICRONOX® Technology.*
- Available in a trigger spray bottle or as an aerosol.



▶ 12 SPRAY BOTTLES W/ONE TRIGGER SPRAYER PER CASE.
▶ 12 AEROSOL CANS PER CASE.

ITEM NO.	PRODUCT	EACH	
		1-11	12+
5484 00041	16 oz. Trigger Spray ...	\$14.25	\$13.25
5484 00031	11 oz. Aerosol	14.25	12.25
5484 04001	Trigger Sprayer Only ...	5.30	---

Halo-Guard FG-2

- “Extreme Pressure” high-performance, high-temperature food machinery grease has oxidation stability and performance.
- Excellent rust and corrosion control.
- Water washout and chemical resistance.
- Contains MICRONOX® Technology.*



▶ 12 PER CASE.

ITEM NO.	PRODUCT	EACH	
		1-11	12+
5484 00071	11 oz. Aerosol	\$15.35	\$13.35

PürGel Klear

For applications where direct food contact is certain or likely.

- Resists and retains moisture and creates a seal.
- For use on valves, rings, seals and gaskets.
- Great assembly paste of pumps.
- Pure, clean petrolatum. • NSF registered.



▶ 12 PER CASE.

ITEM NO.	PRODUCT	EACH	
		1-11	12+
5484 40021	8 oz. PürGel Squeeze Tube.	\$14.30	\$12.90

Food Grade Penetrating Oil

Used by canners, dairies, meat packers, bottlers and bakers.

- Blend of the finest oils, solvents, wetting agents and molybdenum disulfide formulated to penetrate and loosen more effectively than a torch.
- Excellent spray-down oil to help eliminate rust after pressure washing or steam cleaning.
- Loosens corroded fasteners and speeds and protects during disassembly or retooling.
- Available in a trigger spray bottle or as an aerosol.

▶ 12 SPRAY BOTTLES W/ONE TRIGGER SPRAYER PER CASE.
▶ 12 AEROSOL CANS PER CASE.

ITEM NO.	PRODUCT	EACH	
		1-11	12+
5484 00051	16 oz. Trigger Spray	\$15.35	\$13.35
5484 00061	11 oz. Aerosol	13.20	11.20
5484 04001	Trigger Sprayer Only	5.30	---



Food Grade White Mineral Oil

Fast and easy way to clean, lubricate and protect electric and manual food processing equipment.

- Authorized by USDA for use in federally inspected meat and poultry plants.
- Contains no GMO's. Kosher and VEGAN certified, gluten and allergen free, free of any VOC's and carries BSE/TSE statement.
- Suitable for use on food machinery and equipment.
- Can also be used for the lubrication of abrasive stones used for sharpening knives.
- Non-toxic and tasteless.



► 12 PER CASE.

ITEM NO.	PRODUCT	EACH	
		1-11	12+
J134 00011	A. 32 oz. Bottle w/Sprayer	\$10.95	\$9.95

► 4 PER CASE.

ITEM NO.	PRODUCT	EACH	
		1-3	4+
J134 00021	B. 1 Gallon Bottle/Jug	\$26.95	\$25.95

ITEM NO.	PRODUCT	EACH
J134 0003	C. 5 Gallon Bucket	\$113.95
J134 0004	D. 55 Gallon Drum	940.95
J134 0005	275 Gallon Tote (Not Shown)	4,335.00



Pump Dispensers for Gallon Bottles

- Pumps from 1/4 ounce to 1 ounce increments.
- Pump fits any 1-gallon bottle.



ITEM NO.	PRODUCT	EACH
6710 61001	Pump Dispenser, 1 oz.	\$2.95
6710 11091	Pump Dispenser, 1/4 oz.	2.95

Orange Oil

- Semi-fluid, high-performance lubricant, provides excellent rust protection.
- USDA authorized H1.



ITEM NO.	PRODUCT	EACH
3057 0010	10 lb Pail	\$118.95
3057 0035	35 lb Pail	358.65











Sure Shot Sprayer

Excellent for use with mineral oils shown above.



- Black anodized aluminum canister is refillable and rechargeable.
- Filler cap stem fits standard compressed air chuck.
- Spring loaded trigger for easy volume control.
- Includes adjustable spray nozzle rated for use up to 200 psi.





Adjustable spray nozzle.

ITEM NO.	PRODUCT	LENGTH	EACH
3573 24011	Sure Shot Sprayer	24 oz.	\$122.95

Heavy-Duty Stainless Steel Faucet



- Adjustable shank designed to easily adjust to proper drain position after installing in drum.
- 3/4-inch NPT connection.
- PTFE gasket.
- Internal flame arrestor.
- FM approved for use with oils (under 30 SAE) and non-flammables, compatible with stainless steel.



ITEM NO.	PRODUCT	EACH
7447 20381	Heavy-Duty Stainless Steel Faucet	\$262.95

Zinc Die-Cast Drum Faucet



- Easy to use self closing faucet.
- Can be padlocked in closed position.
- Nylon gasket, 3/4 inch NPT connection.
- No flame arrestor.
- FM approved for viscous liquids only.



ITEM NO.	PRODUCT	EACH
7447 2080	Die-Cast Faucet.	\$28.95

Rotary Drum Pump



- Rugged cast iron construction.
- Durable phenolic veins.
- Self-priming.
- Three piece plated suction tube — 47 inch assembled.
- 48-inch PVC discharge tube.



ITEM NO.	PRODUCT	WEIGHT	EACH
7447 0021	Rotary Drum Pump	15 lb.	\$143.95

Hand-Operated Stainless Steel Piston Drum Pump

- Use with nitric acids, alkaloids and phosphoric acid.
- Made of type 304 stainless steel with polyethylene components.
- Fits standard 2-inch bung.
- Food approved.

Threaded adapter for 55-gallon drum.



ITEM NO.	PRODUCT	EACH
3323 01201	Stainless Steel Drum Pump	\$107.95
3323 9493	2" Threaded Adapter	36.95

Stainless Steel Drum Dolly



- Greater stability from strategically placed casters.
- 304 stainless steel construction with reinforced outriggers.
- Suitable for washdown applications.
- Four swivel white polypropylene and stainless steel casters.

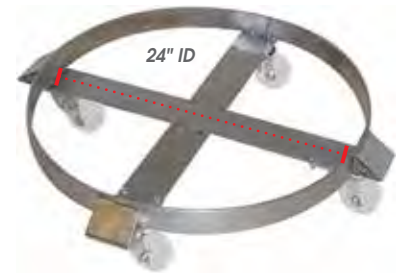

ITEM NO.	PRODUCT	SIZE	WEIGHT	CAPACITY	EACH
7447 0197	SS Drum Dolly	55 Gallon	22 lb.	1,000 lb	\$438.95

Drum Wrench



- Constructed of spark-proof bronze.
- Offset handle reduces knuckle injury.



ITEM NO.	PRODUCT	SIZE	EACH
7447 2018	Drum Wrench	12" Length	\$59.95

Chrome-Plated Drum Pump

- Self-priming pump dispenses 22-ounce per stroke.
- Chrome plating protects metal from the corrosive effects of water-based solutions.
- Teflon® coated packing seal increases chemical resistance.
- Fits standard 15-, 30- and 55-gallon drums with 2-inch standard FIP fittings.



ITEM NO.	PRODUCT	SIZE	EACH
6710 00261	Drum Pump	41-3/8" x 1-7/16"	\$46.95

Plastic Drum Pump

- Adjusts to dispense 2, 4, 6 or 8 ounces per stroke.
- Chemical and acid-resistant in design.
- Fits both 5-gallon pail with Rieke Senior Flexspout and 15, 30 or 55-gallon drums with 3/4-inch or 2-inch standard FIP fittings.
- All necessary adaptor fittings included.



ITEM NO.	PRODUCT	SIZE	EACH
6710 01501	Plastic Drum Pump	48" x 3/5" Dia.	\$20.95

PRICES ARE SUBJECT TO CHANGE • MINIMUMS MAY APPLY • VISIT OUR WEBSITE FOR CURRENT PRICING.

Universal Poly Spill Kit



Absorption and disposal in one kit.

- Kits absorbs up to 5 gallons of spilled liquid and is designed to meet OSHA 29 CFR 1910.120 in a U.N. approved 6-1/2 gallon disposal container.
- Absorbs up to 5-1/2 gallons.



Spill Kit includes:

- (10) Fiberlink Heavy-Weight Pads, 15 inches x 18 inches
- (3) Fiberlink Absorbent Socks, 3 inches x 4 inches
- Two, Disposal Bags and Ties
- Two, Hazmat Waste Labels
- Pair of Nitrile Gloves
- Pair of Splash Goggles
- Dust Mask

ITEM NO.	PRODUCT	EACH
6017 06001	Spill Kit, 6-1/2 Gallons	\$70.95

Universal Absorbent Socks



- Environmentally friendly and safe to use.
- Made of 100% absorbent fiber filling in a durable polypropylene sleeve.
- Universal socks can be reused or incinerated.



ITEM NO.	PRODUCT	SIZE	CASE
6017 0004	Case of 4, Absorbent Socks	3" Dia. x 4'	\$14.95
6017 0001	Case of 10, Absorbent Socks	3" Dia. x 4'	34.95
6017 0035	Case of 20, Absorbent Socks	3" Dia. x 4'	69.95
6017 3440	Case of 40, Absorbent Socks	3" Dia. x 4'	129.95

Hazmat Absorbent Socks



- Absorbent FiberLink fiber encased in a yellow polyfill fabric for the absorption of both oil and water based liquids.
- Color helps to mark and warn of hazardous conditions.

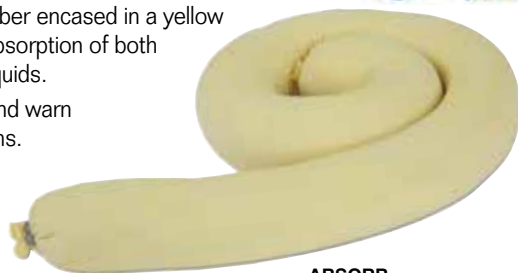

ITEM NO.	PRODUCT	SIZE	ABSORB CAPACITY	CASE
6017 0344	Case of 4, HazMat Socks	3" Dia. x 4'	5 Gallon	\$18.95
6017 3410	Case of 10, HazMat Socks	3" Dia. x 4'	12-1/2 Gallon	44.95
6017 3420	Case of 20, HazMat Socks	3" Dia. x 4'	25 Gallon	90.95
6017 3441	Case of 40, HazMat Socks	3" Dia. x 4'	50 Gallon	164.95

▶ SEE PAGE 280

**FOR BIOHAZARD
ABSORBENT KITS**



ColdForm™ Drum Cover Pads



- Offers outstanding absorbency and durability, while being constructed of natural fibers.
- Manufactured with almost no dependency on either foreign or domestic oil.
- Out-performs polypropylene by up to 30%.
- Manufactured utilizing largely American-grown renewable resources.
- Constructed from a single layer of extremely fine natural fibers. Enhanced by chemistry and minimal use of synthetic fibers.



A

B

▶ 25 PER CASE.

ITEM NO.	PRODUCT	COLOR	SIZE	CASE
6017 00475	A. Universal Heavy-Weight	Gray	22" Dia.	\$99.95
6017 00465	B. Oil Only Heavy-Weight	White	22" Dia.	104.95

Oil-Only Poly Spill Pads



- Absorbs petroleum products while repelling water and water-based liquids.
- Absorbs 15 gallons.
- Perforated for easy tear.
- Bonded for durability.
- Heavy-weight.



▶ 100 PADS PER BALE.

ITEM NO.	PRODUCT	COLOR	SIZE	BALE
6017 0012	Poly Spill Pads	White	15" x 18"	\$58.95

Universal Heavy-Weight Spill Pads



- Designed to pick up spills on contact, stop liquids from running, and prevent tracking in the workplace.
- Absorbs up to 15 gallons per bale.
- Perforated for easy tear.
- Dark gray color helps hide grease and grime.



▶ 100 PADS PER BALE.

ITEM NO.	PRODUCT	COLOR	SIZE	BALE
6017 1012	Poly Spill Pads	Gray	15" x 18"	\$75.95

Universal Super Absorbent

The safe, easy and economical spill clean up.

- Absorbs 7-1/2 times more than clay — up to 14 gallons per box.
- More economical than paper towels.
- Accepted by landfills — non-leaching.
- Absorbs oil and water based liquids.
- Quick absorption for fast clean up.
- Light-weight and easy to handle.
- Leaves surface dry and slip free.
- Non-toxic and environmentally friendly.
- Meets USDA, FDA and EPA requirements.



ABSORBENTS AND SPILL CLEAN-UP

XSORB Spill Station



Disposable bags and instructions.



Scan this QR Code with your mobile device to watch a video about XSORB Spill Kit.

Spill Kit includes:

- 6-Quart Bottle of XSORB Universal Absorbent
- Long-Handled Broom
- Dustpan and Brush Set
- Wire Rack
- (50) Disposal Bags
- Instruction Label

ITEM NO.	PRODUCT	EACH
6017 00071	Spill Station	\$69.95

XSORB Spill Clean-Up

- Plastic bottles with screw-on caps designed to fit in the Spill Station (shown left).
- Refilling the bottles with the 25-pound box is simple and easy, saves time, money and the environment.



ITEM NO.	PRODUCT	WT.	CASE
6017 0036	6 qt. Bottles	10 lb.	\$49.95

ITEM NO.	PRODUCT	BOX DIMENSIONS
6017 0025	25 lb Box	16-1/2" x 14" x 22-1/4"

BOX
\$34.95

▶ 4 BOTTLES PER CASE.

ShurFoot Non-Slip Floor Compound

- Absorbs grease, oil and blood.
- 50-pound box.



ITEM NO.	PRODUCT	EACH
3988 0051	50 lb Box	\$37.95

Absorb-A-Trac

- Sprinkle over floors, walkways and work areas for sure footing in slippery areas.
- Doesn't contain sawdust, won't hold odors.
- Sweep or hose down at end of day.
- 50-pound box.



ITEM NO.	PRODUCT	EACH
4418 3057	50 lb Box	\$44.95

Biofresh™ Disinfecting Absorbent

- Easily cleans up biohazard accidents such as vomit, blood and other body fluids while treating the spill with a powerful disinfecting agent.
- Turns contaminated liquids to solid waste for fast, easy disposal.
- Each canister can absorb and disinfect up to 1/2 gallon of liquid.



ITEM NO.	PRODUCT	EACH
6017 10091	Shaker Canister	\$5.95

Safety Sorbent Non-Slip Floor Compound

Instant traction on slippery floors.

- Sprinkle over floors, walkways and work areas where water, grease or oil accumulate.
- Contains no sawdust, won't hold odors.
- Sweep or hose down at the end of each day.



ITEM NO.	PRODUCT	EACH
7070 0010	2-1/2 lb Carton	\$37.95

PRICES ARE SUBJECT TO CHANGE • MINIMUMS MAY APPLY • VISIT OUR WEBSITE FOR CURRENT PRICING.

Stainless Steel Sprayers



Heavy-duty stainless steel tanks are built for durability at an economical price.

- Large funnel top for ease of filling with a reinforced chemical-resistant hose.
- Adjustable and fan nozzle.
- Features Viton® gaskets and seals.
- Plastic valve with brass extension.
- Plastic pin-to-cone and fan spray tips.
- Available in 2 gallon with 12-inch brass extension or 3 gallon with 18-inch brass extension.
- 40-inch hose.



ITEM NO.	PRODUCT	EACH
4828 25001	2-Gallon SS Sprayer	\$180.45
4828 26001	3-Gallon SS Sprayer	213.75

1, 2 or 3-Gallon Poly Molded Sprayers



- An economical heavy-duty, poly molded design.
- Features Viton® gaskets and seals.
- Funnel top design for ease of filling.
- Braided reinforced hose with durable plastic valve and extension with pin-to-cone spray tip.
- Available in 1 or 2 gallon with 12-inch brass extension or 3 gallon with 18-inch brass extension.
- Adjustable nozzle.
- 30-inch hose.



ITEM NO.	PRODUCT	EACH
4828 00061	1-Gallon Plastic Sprayer	\$35.95
4828 23381	2-Gallon Plastic Sprayer	52.95
4828 24381	3-Gallon Plastic Sprayer	61.95

3-Gallon Economy Poly Molded Sprayer



- An economical heavy-duty, poly molded design.
- Funnel top design for ease of filling.
- Braided reinforced hose with durable plastic valve and extension with pin-to-cone spray tip.
- Color: white.



ITEM NO.	PRODUCT	EACH
4828 00051	3-Gallon Sprayer	\$40.95

Foaming Nozzle

Easily converts sprayers to foamers!

- Attaches to all sprayer nozzles.



ITEM NO.	PRODUCT	EACH
4828 19001	Foaming Nozzle	\$16.65

Commercial Bak-Pak® Sprayer

4 gallon/16 liter usable capacity.

- Viton® seals provide maximum chemical resistance.
- Extra-long 20-inch poly spray wand.
- Shipping weight: 11 pounds.
- Extra-large fill opening prevents spills when adding chemicals.
- Locking shut-off valve is thumb-operated and comfortable to use.
- Bonus nozzle system includes four nozzles with different spray settings to allow for the precise droplet size.
- Comfortable carrying straps.
- Pressurizing this sprayer is easy with the powerful piston pump.
- Dimensions: 21 inches H x 14-1/2 inches W x 8-3/4 inches D.

ITEM NO.	PRODUCT	EACH
6829 31941	Bak-Pak® Sprayer (Includes Four Nozzles)	\$105.95



Ergo comfort shut-off valve.



Wide mouth opening.



Pump handle can be used with left- or right-handed pumping.



Braided power sprayer-style hose stands up to harsh chemicals and resists kinking or clogging.

INCLUDES FOUR, Easy-To-Use Nozzles



Long reach nozzle.



Flat fan nozzle.



Dual cone nozzle.



Standard nozzle.

GT-180S Adhesive Trap

Attractive, durable and industrial white, painted steel design.

- Hinged, easy access door allows quick replacement of UV insect lights and glue board adhesive panels.
- Easy-to-clean. Just replace adhesive trapping boards.
- 24-hour, non-chemical trapping.
- Energy-efficient UV Insect Lamps.
- Attraction range: 1,500 square feet (40 lineal feet).
- UV Light output: 30 Watts — two 15-Watt bulbs.
- FDA and USDA accepted under current code.
- Glueboards: (1) 9 inch x 16 inch; (1) 3 inch x 19 inch.
- UL approved/listed.



Patented glueboard roller guides for easy replacement.



ITEM NO.	PRODUCT	EACH
E756 0006	GT-180S Light Trap, 19-1/2" x 3-1/2" x 11-1/2"	\$192.95
E756 00155	EL-63 Replacement Glue Boards, 3" x 19" Black (10 Pack)	16.95
E756 00165	EL-61 Replacement Glue Boards, 9" x 16" White (10 Pack)	33.95
E756 00055	EL-62 Replacement Glue Boards, 9" x 16" Black (10 Pack)	33.95
E756 00135	18" Replacement Shatter-Coated Bulb, 15 Watt	16.95

GT-220SS Stainless Steel Adhesive Trap

Open grid emits the maximum amount of light on all sides.

- 24-hour, non-chemical trapping.
- Energy-efficient UV insect lamps.
- Attraction Range: 1,800 square feet (50 lineal feet).
- UV Light output: 40 Watts — two 20-Watt lamps.
- FDA and USDA accepted under current code.
- UL approved/listed, 115 V/60 Hz, with 6-foot cord.



Flip-open front fits 5-inch x 22-inch glueboard.



ITEM NO.	PRODUCT	EACH
E756 0010	GT-220S Stainless Steel Light Trap, 24-3/4" x 3-3/4" x 9"	\$231.05
E756 00045	EL-58 Replacement Glue Boards, 5" x 22" White (24 Pack)	37.85
E756 00175	EL-59 Replacement Glue Boards, 5" x 22" Black (24 Pack)	40.95
E756 00311	24" Replacement Shatter-Coated Bulb, 20 Watt	19.95

Wasp and Hornet Killer



- Jet sprays up to 20 feet, killing pests from a comfortable distance.
- Can be used indoors or outdoors.

ITEM NO.	PRODUCT	CASE
7507 5839	16 oz. Aerosol Can	\$70.95

► 12 PER CASE.

GT-215SS Slimline Adhesive Trap

Thin design with stainless steel front that conceals insects while maintaining effectiveness.

- Position 5-6 feet above the floor for best results.
- 24-hour, non-chemical trapping.
- Energy-efficient UV Insect Lamps.
- Attraction range: 1,500 square feet (40 lineal feet).
- Stainless steel finish.
- UV Light output: 30 Watts.
- 115 V/60 Hz, with 6-foot cord.



Choose from black or white glueboards



ITEM NO.	PRODUCT	EACH
E756 0012	GT-215SS, Stainless Steel, 18-3/4" x 2.3" x 12"	\$202.35
E756 00165	EL-61 Replacement Glue Boards, 9" x 16" White (10 Pack)	33.95
E756 00055	EL-62 Replacement Glue Boards, 9" x 16" Black (10 Pack)	33.95
E756 00081	T8, 18"	13.95

GT-480S Industrial Adhesive Trap

For use in shipping/receiving areas and food production facilities where flying insect activity is high.

- Utilizes 3 large adhesive insect trapping boards for maximum capacity.
- Patented roller guides for easy replacement.
- 24-hour, non-chemical trapping.
- UV Light output: 80 Watts.
- Attraction range: 3,500 square feet.
- Easy open front door.
- 432 square inches of trapping surface.
- White, painted steel design.

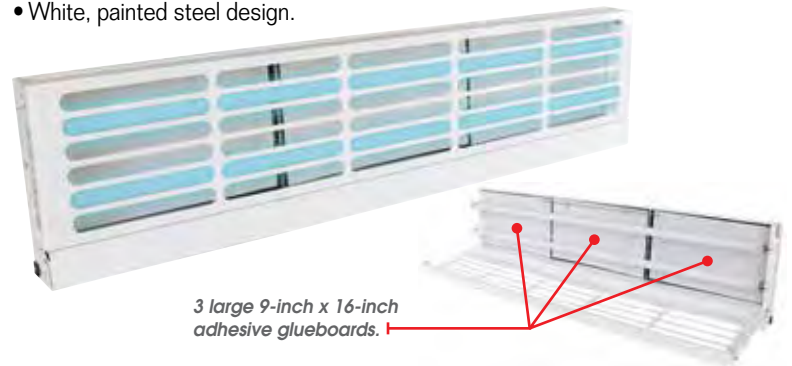

3 large 9-inch x 16-inch adhesive glueboards.

ITEM NO.	PRODUCT	EACH
E756 0001	GT-480S Industrial Light Trap, 48-3/4" x 3" x 11-1/2"	\$305.95
E756 00165	EL-61 Replacement Glue Boards, 9" x 16" White (10 Pack)	33.95
E756 00055	EL-62 Replacement Glue Boards, 9" x 16" Black (10 Pack)	33.95
E756 00031	T12, 48"	22.95

SHATTERPROOF BULBS

Labeled shatterproof coating on bulbs forms a protective envelope to minimize the dangers of broken glass and meets auditing standards.

Door Gaskets and Sealants



Sewn Fabric Over 3/4-Inch PVC

- Replacement gasket for sliding doors and frames.
- Size: 3/4 inch dia. x 1-1/4 inch x 25 feet.

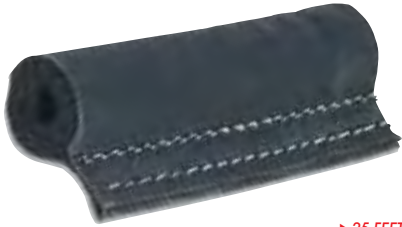

▶ 25 FEET PER ROLL

ITEM NO.	PRODUCT	ROLL
3538 1542	PVC/Fabric	\$197.85

Sewn Fabric Over 1/2-Inch PVC

- Cooler and freezer door use.
- Size: 1/2 inch dia. x 1-3/8 inch x 25 feet.



▶ 25 FEET PER ROLL

ITEM NO.	PRODUCT	ROLL
3538 0013	PVC/Fabric	\$108.35

Silicone Smokehouse Gasket

- Replacement smokehouse gasket.
- Maximum temperature: 450 °F.
- Size: 1 inch x 2 inch.
- Available in 25-, 50- or 100-foot rolls.



Cross section closeup



ITEM NO.	PRODUCT	LENGTH	ROLL
3538 01211	Silicone Gasket	25 ft.	\$347.35
3538 01221	Silicone Gasket	50 ft.	692.55
3538 8469	Silicone Gasket	100 ft.	1,295.35

Neoprene Refrigeration Gasket, Black

- Easy to fit, cut and shape for custom gasketing and sealing applications.
- Size: 13/16 inch x 2-3/4 inch x 25 feet.

P-shaped cross section closeup.



▶ 25 FEET PER ROLL

ITEM NO.	PRODUCT	ROLL
3538 2452	Neoprene, Black	\$104.15

Neoprene Refrigeration Gasket, White

- Size: 7/8 inch x 2-3/4 inch x 25 feet.

P-shaped cross section closeup



▶ 25 FEET PER ROLL

ITEM NO.	PRODUCT	ROLL
3538 0962	Neoprene, White	\$80.95

Neoprene Gasket

- Temperature range: -40° to 130 °F. • Closed-cell.
- Size: 1/2 inch x 1-1/4 inch x 25 feet.

NOTE: More sizes available.



Cross section with adhesive backing

▶ 25 FEET PER ROLL

ITEM NO.	PRODUCT	ROLL
3538 1543	Non-Adhesive	\$26.25
3538 1544	Adhesive	29.45

Silicone Caulk/Sealant



- Meets FDA and USDA requirements for use in federally inspected meat and poultry plants.
- Effective operating range: -60 °F to 400 °F.



▶ 24 PER CASE.

ITEM NO.	PRODUCT	1-23	24+
3470 03701	Clear Caulk, 13.3 fl. oz.	\$10.95	\$9.95

Rubberized Silicone Sealant



- Will not crack, crumble or dry out.
- Temperature range: -60 °F to +450 °F.
- Meets FDA and USDA requirements for use in federally inspected meat and poultry plants.



▶ 12 PER CASE.

ITEM NO.	PRODUCT	1-11	12+
3149 12881	White, 11 oz.	\$9.75	\$8.75
3149 12891	Clear, 11 oz.	9.75	8.75

Multi-Purpose Adhesives



- Specially formulated for bonding fiberglass reinforced plastic to various substrates.
- Fast setting and resistant to temperature changes.



ITEM NO.	PRODUCT	EACH
3149 1359	11 oz. Tube	\$7.25
3149 0006	4-Gallon Pail, Latex-Based	83.95

Overnight Concrete Floor Patch Kit

- Gray sand/epoxy patch.
- May be used in temperatures as low as 50 °F.
- Kit covers 15 sq. ft. x 1/4 inch thick.
- Instruction and mixing kit included.



ITEM NO.	PRODUCT	EACH
3117 3509	Overnight Concrete Floor Patch Kit	\$125.95



▶ SEE PAGE 141 and 562

FOR FLOOR CLEANERS AND COATINGS

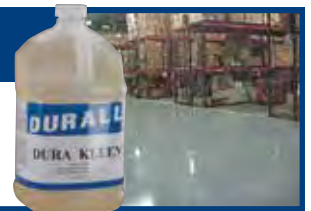

Order \$400 or more and receive **FREE SHIPPING**

*Does not include UPS Next Day Air, 2nd Day or 3rd Day Select. This offer good only on orders shipped UPS Ground in the 48 contiguous states. Certain items may not qualify. Based on dimensional weight we will determine the most efficient means of shipping, either UPS or LTL. Products may ship by truckline.

Anti-Slip Dunnage Rack Cover Stand

- Ideal for converting dunnage racks to personnel stands.
- Keeps workers elevated off the floor.
- Anti-slip cover made entirely of aluminum with drainage holes.
- Corrosion resistant, all welded and easy to keep clean.

NOTE: Cover only.
Dunnage rack sold separately.



▶ SEE PAGE 237
For Dunnage Racks



ITEM NO.	DIMENSIONS	CAPACITY	SHIPPING WT.	EACH
3775 21361	20" x 36"	3,000 lb	11 lb.	\$143.75
3775 21351	20" x 48"	2,500 lb	14 lb.	216.25
3775 21341	20" x 60"	2,000 lb	18-1/2 lb	236.15



Anti-slip raised drainage holes



Ergo2000 Stand with KorDek-II Grating

- Fiberglass grate is gritted on both sides and can be used with or without the stainless steel stand for a comfortable anti-slip surface.
- Stand is easily adjustable from 4-1/4 to 17-1/4 inches.
- Stainless steel frame with a load capacity of 900 pounds.
- Shipping Weight: 125 pounds.

▶ SEE PAGES 269 - 271
For More Ergonomic Stands and Mats.



4-1/4" to 17-1/4" adjustable height.



ITEM NO.	PRODUCT	EACH
3523 6543	Ergo2000 2' x 4' Stand (includes grating)	\$898.95



Fiberglass, Square Grid Floor Grating

- Weighs about one-quarter as much as steel grating.
- Available with a grit top or a concave, plain meniscus top.
- Integral grit top surface provides outstanding anti-slip protection for workers.
- Unlike metal grating, GatorGrate does not rust, never needs painting and is corrosion-resistant.
- Easy-to-clean. Smooth, tapered bars allows debris that enters the top to come out of the bottom.
- Can be easily cut with ordinary hand tools, using a masonry, carbide tip blade or diamond edge.



F.O.B. FACTORY

NOTE: More sizes available. Call for more information.

1-Inch Grating

Slip-Resistant Grit Top

ITEM NO.	SIZE	COLOR	EACH	
			1-2	3+
0760 0022	1" x 4' x 12'	Gray	\$699.00	\$689.00
0760 0023	1" x 4' x 12'	Green	699.00	689.00
0760 0024	1" x 4' x 12'	Yellow	699.00	689.00
0760 0025	1" x 3' x 10'	Gray	529.00	519.00
0760 0026	1" x 3' x 10'	Green	529.00	519.00
0760 0027	1" x 3' x 10'	Yellow	529.00	519.00

1" x 5" x 10" available. Call for details.

1-Inch Grating

Slip-Resistant, Plain Concave Meniscus Top

ITEM NO.	SIZE	COLOR	EACH	
			1-2	3+
0760 0004	1" x 4' x 12'	Gray	\$569.00	\$559.00
0760 0005	1" x 4' x 12'	Green	569.00	559.00
0760 0006	1" x 4' x 12'	Yellow	569.00	559.00
0760 0007	1" x 3' x 10'	Gray	419.00	409.00
0760 0009	1" x 3' x 10'	Yellow	419.00	409.00

1" x 5" x 10" available. Call for details.

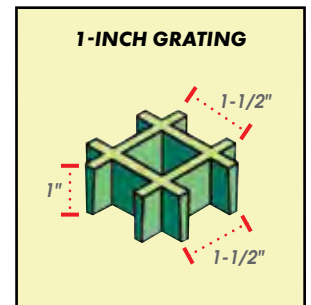

1-1/2-Inch Grating

Slip-Resistant Grit Top

ITEM NO.	SIZE	COLOR	EACH	
			1-2	3+
0760 0031	1-1/2" x 4' x 12'	Gray	\$899.00	\$889.00
0760 0032	1-1/2" x 4' x 12'	Green	899.00	889.00
0760 0033	1-1/2" x 4' x 12'	Yellow	899.00	889.00
0760 0034	1-1/2" x 3' x 10'	Gray	669.00	659.00
0760 0035	1-1/2" x 3' x 10'	Green	669.00	659.00
0760 0036	1-1/2" x 3' x 10'	Yellow	669.00	659.00

1-1/2" x 5" x 10" available. Call for details.

1-1/2-Inch Grating

Slip-Resistant, Plain Concave Meniscus Top

ITEM NO.	SIZE	COLOR	EACH	
			1-2	3+
0760 0013	1-1/2" x 4' x 12'	Gray	\$729.00	\$719.00
0760 0014	1-1/2" x 4' x 12'	Green	729.00	719.00
0760 0015	1-1/2" x 4' x 12'	Yellow	729.00	719.00
0760 0016	1-1/2" x 3' x 10'	Gray	549.00	539.00
0760 0017	1-1/2" x 3' x 10'	Green	549.00	539.00
0760 0018	1-1/2" x 3' x 10'	Yellow	549.00	539.00

1-1/2" x 5" x 10" available. Call for details.

