

BLADES

FIND IT FAST

Bone Collector System	398
Grinder Plates and Knives	398-399
Bandsaw Blades	400-402
Hyde Processing Blades	402
Tray Pack Blades	403
Circular Blades	404-405
Specialty Blades	406-409
Scalpel Knives	410
Replacement Specialty Blades	410-411





FOUR STEPS TO THE RIGHT SPECO™ GRINDER PLATE

1. Determine the plate size of your grinder.

Measure the diameter of the grinder plate and match it up to the corresponding plate size below:

DIAMETER	2-3/4"	3-1/4"	3-15/16"	5-1/8"	6"	8-5/8"
PLATE SIZE	#12	#22	#32	#52	#56	#66

2. Identify grinder plate mounting style.

Look at your grinder plate and match up the face shape to one of the styles listed below:

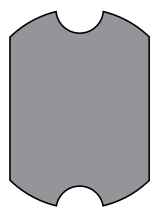

Universal Style
(Works for Cleveland Style also.)



Cleveland Style

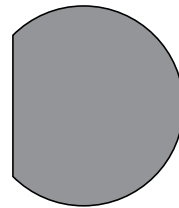

Toledo Style

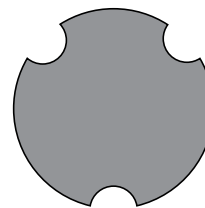

Enterprise Style

3. Determine hole size.

The hole sizes we are referring to are the holes that are cut into the top side of the grinder plate. Choose from the following sizes:

HOLE SIZE	1/8"	3/16"	1/4"	3/8"	1/2"	3/4"	1"
-----------	------	-------	------	------	------	------	----

4. Hub or hubless plate?

Plates with a center hub are stronger and easier to remove from grinder. Hubless plates are reversible for extended wear.

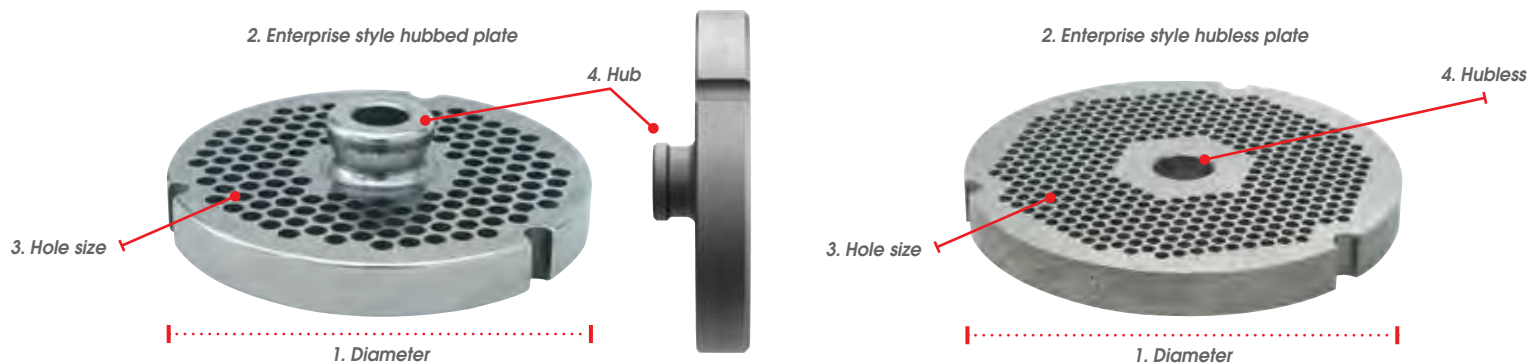

Call 800-456-5624 For Pricing and To Order.

Bone Collector System

Solid hub bone collector plates in the following sizes:

- Hole sizes: 3/32 inch, 1/8 inch, 5/32 inch and 3/16 inch.
- Grinder sizes: 52, 56, 66 or 11.
- Plate diameters: 5-1/8 inch, 6 inch, 8-5/8 inch and 11 inch.

NOTE: When ordering please specify the following: machine make and model, plate hole and size and plate mounting style.



Scan to watch a video about the Speco Bone Collector System

SPECIAL ORDER ITEM



Speco™ Knives

Solid Drop Forged Knives

Constructed out of one solid piece of heavy-duty forged steel.

- Excellent for low-volume rugged meat processing jobs.
- Not recommended for resharpening.
- Most economical knife available.



ITEM NO.	PLATE SIZE	EACH
1044 00121	#12	\$21.95

“XL” Knives

Constructed out of one solid piece of INOX stainless steel.

- Raised edge allows blades to be resharpened and last longer than solid-forged knives.

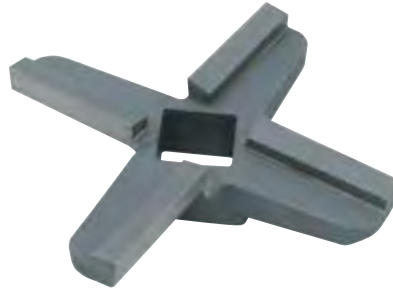

ITEM NO.	PLATE SIZE	EACH
3046 35481	#22	\$15.95
3046 16011	#32	16.95

Everlasting Knives

- Outwears regular drop-forged or snap-in knives.
- High wear-resistant cutting edge fused solidly to a drop-forged frame.

NOTE: These knives CAN be re-sharpened.



ITEM NO.	PLATE SIZE	EACH
3046 7159	#12	\$34.95
3046 7320	#22	30.95
3046 0900	#32	39.95
3046 6506	#52	63.95
3046 4660	#56	64.95
3046 6940	#66	139.95

Reversible Grinder Plate with FREE Knife

- Computer-drilled holes for precision alignment and total coverage across the plate.
- Maximum number of holes per plate permits higher production volume and cooler cutting.
- Reversible plates are super sharp and can be re-sharpened.
- One FREE drop-forged knife comes with each plate.

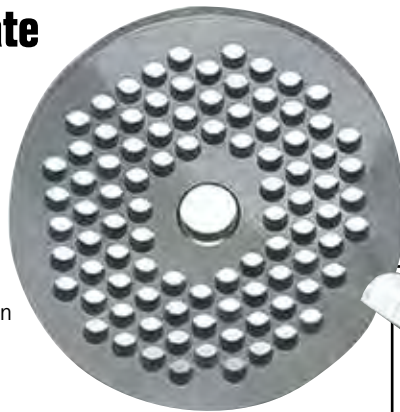

NOTE: Hub style plates available. CALL FOR DETAILS.



Order grinder plate, get knife FREE!

ITEM NO.	PLATE SIZE	HOLE SIZE	EACH
1044 1012	#12	3/16"	\$59.95
1044 0861	#12	1/8"	58.95
1044 1022	#22	3/16"	65.95
1044 0863	#22	1/8"	75.95
1044 1032	#32	3/16"	103.95
1044 0865	#32	1/8"	92.95

Double Life- Stainless Steel Grinder Plate with a Reversible Hub

Stainless steel plate won't rust!

- Grinder plate comes in Enterprise style with Everlasting knives.
- #32 plate with 1/8 inch hole size (only).



Reversible hub allows both sides of grinder plate to be used, doubling the plate's life.



Two hard edge grinder knives FREE with each plate set!

ITEM NO.	PRODUCT	EACH
3363 4675	Grinder Plate and Knives	\$124.95

Triumph Knives with Holder

The handiest, most sanitary meat grinder mincer cutting edge ever developed.

- A twist releases the blade insert from the holder and another twist locks the blade insert securely in place.
- Easy to clean and keep clean.
- Blades are set at an angle which allows only the cutting edge to touch the plate, reducing friction and temperature rise.

NOTE: Replacement blades available. SEE BELOW.

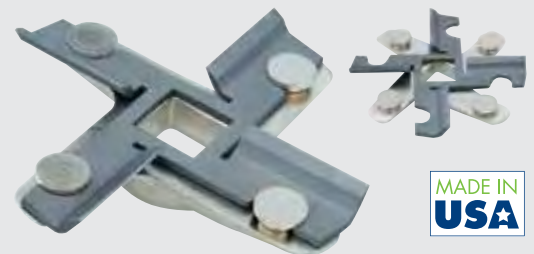

ITEM NO.	PLATE SIZE	EACH
3046 3184	#52	\$49.95
3046 3426	#56	49.95
3046 3187	#66	79.95

Triumph Blade Insert Replacement Knives

NOTE: Blade only. Holder NOT INCLUDED.

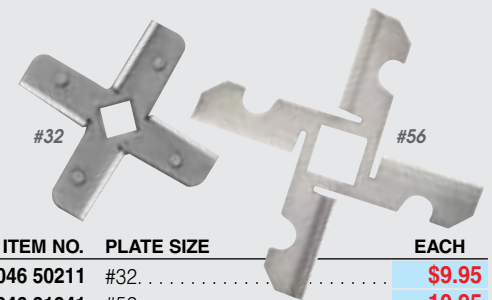

ITEM NO.	PLATE SIZE	EACH
3046 50211	#32	\$9.95
3046 31941	#52	10.95
3046 31951	#56	10.95
3046 70371	#66	12.95

EdgeMaster™ Performer America's Finest Quality Bandsaw Blades

High yield, 3- or 4-tooth design gives smooth cuts, less waste.

- Made of super-hard steel with precision-stamped, specially tempered tooth set for smooth sharp cutting and long-lasting performance.
- Accurate, narrow blade tooth set permits faster, cleaner cuts.
- Meat waste, bone dust and vibration are reduced and scoring is eliminated.
- All welds are guaranteed for the life of the band.

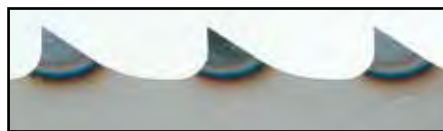

Accurate, narrow blade set permits faster, cleaner cuts. Impulse hardened tooth edge extends band life.

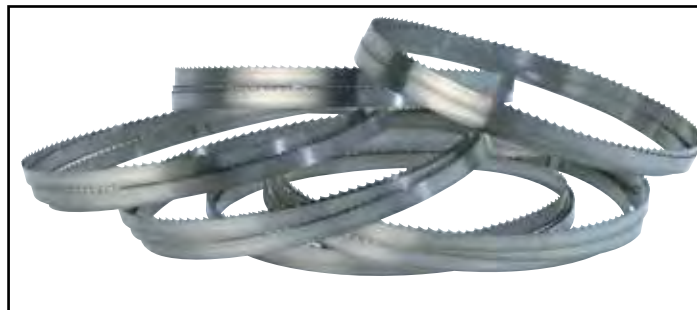

▶ 6 PER BAG - 4 BAGS PER CASE.

ITEM NO.	MACHINE	LENGTH	BLADE SPEC.	BAG	
				1-3	4+
3363 06005	Biro 22	91"	5/8" x 0.022" x 4T	\$53.50	\$52.50
3363 07115	Biro 1433	108"	5/8" x 0.025" x 3T	61.90	60.90
3363 06015	Biro 33	116"	5/8" x 0.025" x 3T	64.00	63.00
3363 06025	Biro 34	118"	5/8" x 0.025" x 3T	66.10	65.10
3363 06035	Biro 3334	124"	5/8" x 0.025" x 3T	67.15	66.15
3363 92705	Biro 3334	124"	5/8" x 0.025" x 4T	67.15	66.15
3363 06045	Biro 44	135"	5/8" x 0.025" x 3T	68.20	67.20

▶ 6 PER BAG - 4 BAGS PER CASE.

ITEM NO.	MACHINE	LENGTH	BLADE SPEC.	BAG	
				1-3	4+
3363 06055	Butcher Boy B-12	98"	5/8" x 0.022" x 4T	\$54.55	\$53.55
3363 06065	Butcher Boy B-14	112"	5/8" x 0.025" x 3T	64.00	63.00
3363 06075	Butcher Boy B-16	126"	5/8" x 0.025" x 3T	67.15	66.15
3363 01265	Butcher Boy B-16	126"	5/8" x 0.025" x 4T	67.15	66.15
3363 06085	Butcher Boy SA-20	154"	5/8" x 0.025" x 3T	67.15	66.15

▶ 6 PER BAG - 4 BAGS PER CASE.

ITEM NO.	MACHINE	LENGTH	BLADE SPEC.	BAG	
				1-3	4+
3363 06055	Hobart 5212	98"	5/8" x 0.022" x 4T	\$54.55	\$53.55
3363 06105	Hobart 5213	106"	5/8" x 0.022" x 4T	56.65	55.65
3363 06065	Hobart 5214, 5614	112"	5/8" x 0.025" x 3T	64.00	63.00
3363 06125	Hobart 5216	128"	5/8" x 0.025" x 3T	66.10	65.10
3363 06135	Hobart 5700, 5801	142"	5/8" x 0.025" x 4T	69.25	68.25

NOTE: All EdgeMaster™ PERFORMER Band Saw blades are packaged 6 blades per bag, 4-bags per box. Minimum order: 1 bag.



Ziploc® poly bags keeps blades dry.

EdgeMaster™ 2000 Bandsaw Blades

▶ 6 PER BAG - 4 BAGS PER CASE.

ITEM NO.	MACHINE	LENGTH	BLADE SPEC.	BAG	
				1-3	4+
3363 44235	Biro 22	91"	5/8" x 0.022"	\$53.50	\$52.50
3363 44285	Biro 33	116"	5/8" x 0.025"	64.00	63.00
3363 44305	Biro 3334	124"	5/8" x 0.025"	67.15	66.15
3363 44335	Biro 44	135"	5/8" x 0.025"	68.20	67.20

▶ 6 PER BAG - 4 BAGS PER CASE.

ITEM NO.	MACHINE	LENGTH	BLADE SPEC.	BAG	
				1-3	4+
3363 44245	Butcher Boy B-12	98"	5/8" x 0.022"	\$54.55	\$53.55
3363 44275	Butcher Boy B-14	112"	5/8" x 0.025"	62.95	61.95
3363 44315	Butcher Boy B-16	126"	5/8" x 0.025"	67.15	66.15
3363 44345	Butcher Boy SA-20	154"	5/8" x 0.025"	71.35	70.35

▶ 6 PER BAG - 4 BAGS PER CASE.

ITEM NO.	MACHINE	LENGTH	BLADE SPEC.	BAG	
				1-3	4+
3363 44245	Hobart 5212	98"	5/8" x 0.022"	\$54.55	\$53.55
3363 44255	Hobart 5213	106"	5/8" x 0.022"	60.85	59.85
3363 44275	Hobart 5214, 5614	112"	5/8" x 0.025"	62.95	61.95
3363 44325	Hobart 5216	128"	5/8" x 0.025"	67.15	66.15
3363 44265	Hobart 5700, 5801	142"	5/8" x 0.025"	69.25	68.25



Top view.

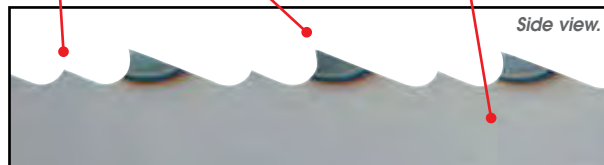

Side view.

1. Special design and construction permits a unique gullet tooth that removes waste and dust during cutting.
2. Enables the following tooth to cut uninterrupted and to ultimate capacity.
3. Steel composition offers wear resistance properties not available in competitive blades providing a longer life.

EdgeMaster™ Munkfors Premium Quality Bandsaw Blades

Quality:

- Committed personnel with long experience in inspecting and evaluating blade design, materials, construction and function.
- Only the best strip steel – meets or exceeds requirements for high strength, exceptional flatness and straightness, excellent weldability and tight tolerance levels.
- Stringent standards of production and quality control guided by ISO 14001. MUNKFORS leads the development of bandsaw blades in the meat, poultry and fish processing industries.
- Unique manufacturing technology guarantees blades of the highest quality and longevity of performance.
- Quality EDGEMASTER™ MUNKFORS blades enable our customers to improve productivity and sharpen their competitive edge.
- Small part for big value – Bandsaw blades account for a small part of production costs, but are critical in maximizing the operating performance and product yield.
- Blades exceed standard running time — maximizing profit.
- Identical ultra-sharp teeth of uniform geometry.
- Allows use of harder steel than in conventional manufacturing methods, which increase blade reliability and stability.

Advantages:

- Swedish steel. • Longer blade lifetime. • Sharper blades.
- Less waste. • Cleaner cutting. • Minimum downtime.



All blades are individually wrapped and coiled.

▶ SOLD IN 5-PACK BUNDLES ONLY.

ITEM NO.	SIZE	TOOTH TYPE	5-PACK
C785 29195	72" x 5/8" x 0.022" x 3TPI	6° Hook Angle	\$49.45
C785 29345	72" x 5/8" x 0.022" x 4TPI	3° Hook Angle	49.45
C785 29355	80" x 5/8" x 0.022" x 4TPI	3° Hook Angle	51.65
C785 29435	82-3/4" x 5/8" x 0.024" x 4TPI	6° Hook Angle	52.75
C785 29365	91" x 5/8" x 0.022" x 4TPI	3° Hook Angle	54.95
C785 29555	95" x 5/8" x 0.024" x 4TPI	3° Hook Angle	56.05
C785 32265	97" x 5/8" x 0.022" x 4TPI	3° Hook Angle	54.95
C785 28495	105-3/4" x 5/8" x 0.022" x 3TPI	1° Hook Angle	56.05
C785 29165	108" x 5/8" x 0.022" x 3TPI	6° Hook Angle	59.35
C785 30365	108" x 5/8" x 0.024" x 3TPI	6° Hook Angle	62.65
C785 29295	112" x 5/8" x 0.022" x 4TPI	3° Hook Angle	60.45
C785 29065	124" x 5/8" x 0.016" x 3TPI	1° Hook Angle	61.55
C785 29055	124" x 5/8" x 0.016" x 4TPI	3° Hook Angle	61.55
C785 29135	124" x 5/8" x 0.020" x 4TPI	Scalloped	96.75
C785 29095	124" x 5/8" x 0.020" x 4TPI	3° Hook Angle	61.55
C785 29255	124" x 5/8" x 0.022" x 3-4TPI	6° Hook Angle	61.55
C785 29175	124" x 5/8" x 0.022" x 3TPI	6° Hook Angle	61.55
C785 31145	124" x 5/8" x 0.022" x 3TPI	1° Hook Angle	59.35
C785 29305	124" x 5/8" x 0.022" x 4TPI	3° Hook Angle	61.55
C785 29525	124" x 5/8" x 0.024" x 3TPI	6° Hook Angle	61.55
C785 29565	124" x 5/8" x 0.024" x 4TPI	3° Hook Angle	61.55
C785 29145	126" x 5/8" x 0.020" x 4TPI	Scalloped	103.35
C785 29315	126" x 5/8" x 0.022" x 4TPI	3° Hook Angle	62.65
C785 29485	126" x 5/8" x 0.024" x 3TPI	6° Hook Angle	62.65
C785 34035	127" x 5/8" x 0.024" x 3TPI	6° Hook Angle	63.75
C785 29125	128" x 5/8" x 0.020" x 4TPI	3° Hook Angle	65.95
C785 29595	131" x 3/4" x 0.022" x 3TPI	6° Hook Angle	67.05

▶ SOLD IN 5-PACK BUNDLES ONLY.

ITEM NO.	SIZE	TOOTH TYPE	5-PACK
C785 29495	135" x 5/8" x 0.024" x 3TPI	6° Hook Angle	\$67.05
C785 31935	142" x 1" x 0.024" x 3TPI	1° Hook Angle	90.15
C785 29155	142" x 5/8" x 0.020" x 4TPI	Scalloped	107.75
C785 29325	142" x 5/8" x 0.022" x 4TPI	3° Hook Angle	65.95
C785 30355	142" x 5/8" x 0.024" x 3TPI	6° Hook Angle	67.05
C785 29545	142" x 5/8" x 0.024" x 4TPI	3° Hook Angle	67.05
C785 29185	154" x 5/8" x 0.022" x 3TPI	6° Hook Angle	69.25
C785 29335	154" x 5/8" x 0.022" x 4TPI	3° Hook Angle	69.25
C785 29505	154" x 5/8" x 0.024" x 3TPI	6° Hook Angle	69.25
C785 30765	164-1/2" x 3/4" x 0.022" x 3TPI	6° Hook Angle	72.55
C785 29515	164-1/2" x 5/8" x 0.024" x 3TPI	6° Hook Angle	72.55
C785 29605	173" x 3/4" x 0.022" x 3TPI	6° Hook Angle	74.75
C785 29615	173" x 3/4" x 0.024" x 4TPI	3° Hook Angle	74.75
C785 13855	175-5/8" x 3/4" x 0.022" x 3TPI	6° Hook Angle	78.05
C785 32935	175-5/8" x 3/4" x 0.024" x 3TPI	1° Hook Angle	74.75
C785 29445	194-3/4" x 5/8" x 0.024" x 6TPI	6° Hook Angle	87.95

▶ SOLD IN 3-PACK BUNDLES ONLY.

ITEM NO.	SIZE	TOOTH TYPE	5-PACK
C785 30745	199" x 1" x 0.032" x 3TPI	1° Hook Angle	\$85.75
C785 29685	216" x 1" x 0.032" x 3TPI	1° Hook Angle	91.25
C785 29625	228" x 1" x 0.032" x 3TPI	1° Hook Angle	94.55
C785 31945	228" x 3/4" x 0.024" x 4TPI	3° Hook Angle	69.25
C785 29695	248" x 1" x 0.032" x 3TPI	1° Hook Angle	101.15
C785 29715	248" x 1" x 0.032" x 4TPI	3° Hook Angle	101.15



THREE GENERATIONS OF EXPERIENCE...



PRICES ARE SUBJECT TO CHANGE • MINIMUMS MAY APPLY • VISIT OUR WEBSITE FOR CURRENT PRICING.

Scalloped Bandsaw Blades

- Ideal for cutting fresh food products, as well as foam and rubber.
NOT made for use with hard materials such as bone or frozen food products.
- Blades feature a fully sharpened scallop that is 1/2 inch long or two scallops per inch.
- Constructed from 1075 series bright polished spring steel.

NOTE: Also available in stainless steel. Call for details.

► 6 BLADES PER BAG - 4 BAGS PER CASE.

ITEM NO.	PRODUCT	EACH	
		1-3	4+
3363 00985	98" x 5/8" x 0.025"	\$85.00	\$81.00
3363 12545	108" x 5/8" x 0.025"	89.20	85.20
3363 21125	112" x 5/8" x 0.025"	89.20	85.20
3363 21165	116" x 5/8" x 0.022"	89.20	85.20
3363 21245	124" x 5/8" x 0.022"	89.20	85.20
3363 01245	124" x 5/8" x 0.025"	89.20	85.20
3363 01105	126" x 5/8" x 0.022"	89.20	85.20
3363 61265	126" x 5/8" x 0.025"	89.20	85.20
3363 11285	128" x 5/8" x 0.022"	89.20	85.20
3363 2135	135" x 5/8" x 0.025"	89.20	85.20
3363 58205	142" x 5/8" x 0.020"	96.55	92.55
3363 01085	142" x 5/8" x 0.022"	90.25	86.25

► 4 BLADES PER BUNDLE.

ITEM NO.	PRODUCT	EACH	
		1-3	4+
3363 80231	135" x 5/8" x 0.022"	\$15.70	\$11.70

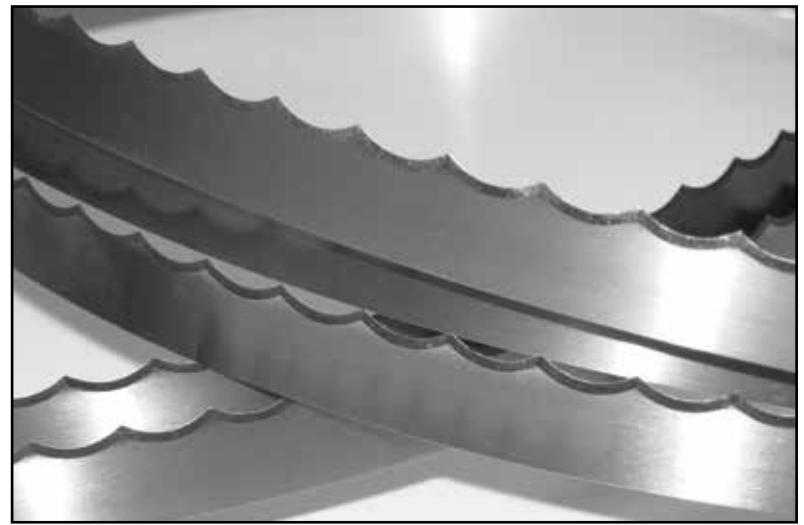

Processing Blades

S = Single bevel
D = Double bevel



Circular Blades

ITEM NO.	DIAMETER	BORE	THICKNESS	BEVEL	SCALLOPS	AFTERMARKET NAME AND NO.
B466 10581	8"		0.040"	D	0	Carruthers #235902/71058
B466 03221	10"	1.125"	0.094"	D	44	Hill# 4010-414
B466 03761	9"	1.25"	0.066"	D	0	Hill# 4010-110M
B466 04041	10"	1.26"	0.125"	MISER	0	Hill# 4010-429
B466 04101	12"	1.27"	0.118"	MISER	0	Hill# 4010-467
B466 19511	9.055"	1.26"	0.078"	D	0	Hill# 4010-149



Specialty Blades

ITEM NO.	DESCRIPTION	LENGTH	WIDTH	THICKNESS	CUTTING EDGE	REPLACEMENT FOR OEM	AFTERMARKET NAME AND NO.	
B466 82101	Cut-Up Knife	5"	1.574"	0.118"	SB	STORK®	Hill# 4010-468	
B466 80851	Leg Cutter Blade	5.48"	1.81"	0.060"	DB	DAPEC	Hill# 4010-306	
B466 80871	Scraper Blade	10.45"	1.67"	0.090"	SB	Contherm	Hill# 401093	
F186 00071	Butterfly Knife SS	6.5"	0.5"	0.0625"	DB	Grasselli/B14802	---	---
F186 00111	Skate Knife, Right Hand	120 mm	40 mm	3 mm	SB	Marel/616305	---	---
F186 00121	Skate Knife, Left Hand	120 mm	40 mm	3 mm	SB	Marel/616305	---	---

*All parts are manufactured for Bunzl Processor Division and are not made, licensed, sponsored or approved by the original equipment manufacturer. All products listed are replacement parts only; they are not an original equipment part of the manufacturers listed and Bunzl Processor Division is not affiliated with the manufacturers listed. All references to original manufacturer's equipment are for identification purposes only. All Bunzl parts are manufactured to exacting specifications using the highest quality materials.

Call 800-456-5624 For More Information

Tray Pack Blades for All Tray Pack Machines

SPECIAL ORDER ITEM

Short lead times and high quality products at affordable prices.

- Single- and multi-lane tray pack blades are manufactured to the highest industry standards.
- Customize to suit unique shape and form requirements.
- Razor sharp tooth profile ensures quality cuts in even the most demanding of food packaging applications.

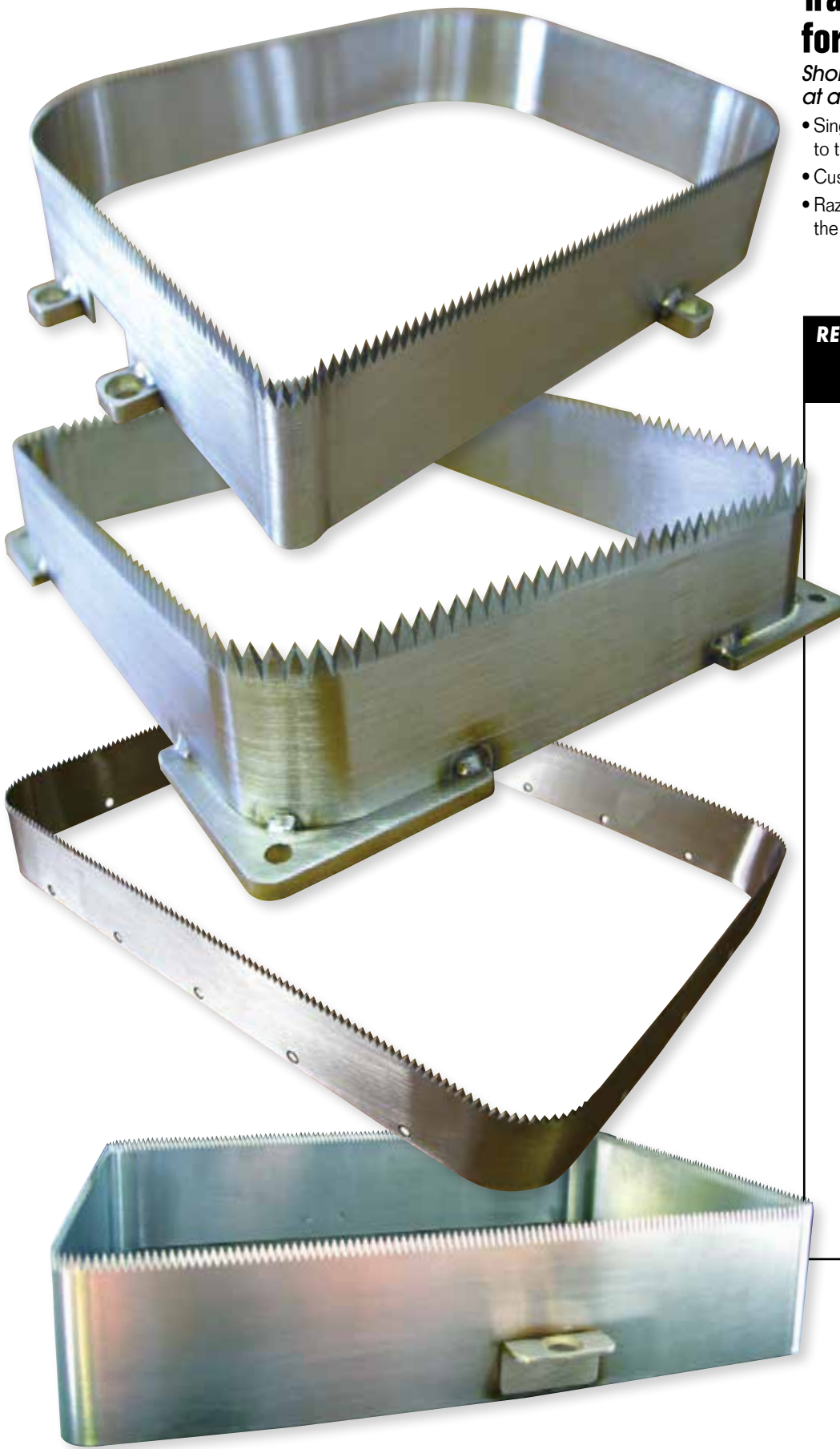

REPLACEMENT* FOR ALL OF THE MAJOR OEM'S IN THE MODIFIED ATMOSPHERE PACKAGING MACHINE SECTOR, SUCH AS:



MULTIVAC
BETTER PACKAGING



UltraSource

REISER

HARPAK  **ULMA**



ROSS Industries, Inc.
http://www.rossindustrial.com



G. MONDINI
DOSSATRICI - CONFEZIONATRICI AUTOMATICI

SEALPAC



VE999
PACKAGING SYSTEMS

AND MANY MORE!

**Call 800-456-5624
For More Information
and Pricing**

*All parts are manufactured for BUNZL Processor Division and are not made, licensed, sponsored or approved by the original equipment manufacturer. All products listed are replacement parts only; they are not an original equipment part of the manufacturers listed and BUNZL Processor Division is not affiliated with the manufacturers listed. All references to original manufacturer's equipment are for identification purposes only. All BUNZL parts are manufactured to exacting specifications using the highest quality materials.

Circular Blades

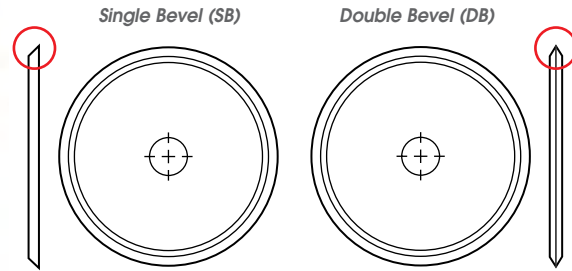

ITEM NO.	DIAMETER	BORE	THICKNESS	SLOTS	BEVEL	SCALLOPS	REPLACEMENT FOR OEM*	OEM*	AFTERMARKET NAME AND NO.
F176 01681	350 mm	22 mm	4 mm		DB		BAADER®	94.01.0168	
F176 12381	5", Slitter Blade w/Keyway	1½"	0.06"	Y	DB		BRIDGE MACHINE	33996	HILL# 401072
F187 21721	3 -7/8" Slitter w/2 Keyway 12 and 2 o'clock	1½"	0.032"		DB		BRIDGE MACHINE	33806	
F187 25121	95 mm, Slitter w/2 Keyway 12 and 6 o'clock	38.25 mm	1.2 mm		DB		BRIDGE MACHINE	32541	
F176 21051	11"	1-1/8"	0.093"	8	DB		CANTRELL		HILL# 401074S
F176 21491	11"	1-1/8"	0.093"		DB		CANTRELL		HILL# 401074/M&M# 2108
F176 21501	11" Serrated	1-1/8"	0.093"		S, SB	50	CANTRELL	SPECIAL MAKE	
F176 21621	11"	1-1/8"	0.071"		DB		CANTRELL	210396	HILL# 401036/M&M# 2109
F176 21481	175 mm	32 mm	2 mm	6	SB		CANTRELL/MEYN	9924904/0990.IDCO.007.00	HILL# 4010-117
F176 21291	7-1/4"	7/8"	0.08"	16	DB		CANTRELL/SIMMONS	911239/02007-01B	HILL# 4010115/M&M# 2117
F176 21261	9"	1/2"	0.066"		DB		CANTRELL/SIMMONS	N027006	HILL# 401032/M&M# 2120
B466 00151	12"	2.109"	0.041"		DB		CARRUTHERS	002359-00	
B466 00141	14"	2.109"	0.041"		DB		CARRUTHERS	002358-00	
F176 21021	100 mm	22.2 mm	2 mm		SB		DAPEC/MEYN	02.04.000.000	HILL# 4010-474
F176 21451	100 mm, Serrated	22.2 mm	2 mm		S, SB	18	DAPEC/MEYN	SPECIAL MAKE	
F176 21441	125 mm	22.2 mm	1.5 mm	8	SB		DAPEC/MEYN	08.24.000.001	HILL# 4010113
F176 21461	5"	7/8"	0.059"		SB		DAPEC/MEYN	08.24.000.000	HILL# 401079
F176 21201	5"	7/8"	0.059"	6	SB		DAPEC/MEYN	02.04.000.030	HILL# 401079S
F176 21091	150 mm	22.2 mm	1.5 mm		DB		DAPEC/MEYN	02.04.000.004/FB80012	HILL# 4010-154
B466 04021	178 mm, Scalloped	22.2 mm	1.5 mm		S	44	DAPEC/MEYN	02.04.000.025	
F176 21231	7"	7/8"	0.062"	6	DB		DAPEC/MEYN	XB30050/02.04.000.027	HILL# 401015
F176 21241	7"	7/8"	0.062"		DB		DAPEC/MEYN	08.02.000.001	HILL# 401098
F176 21651	200 mm	32 mm	2 mm		DB		DAPEC/MEYN	08.24.000.002	MEYN# 0990.IDCO.001.00
F176 21001	270 mm, +Tip	40 mm	3 mm		DB		DAPEC/MEYN	08.24.000.003	401081
F176 21431	110 mm	32 mm	2 mm		SB		DAPEC/MEYN	0990.IDCO.053.00	
F176 21121	170 mm	32 mm	2 mm		DB		DAPEC/MEYN	0990.IDCO.003.00	
F176 21661	6-15/16"	7/8"	0.080"		DB		DAPEC/MEYN	0990.IDCO.050.00	
F176 21561	175 mm	32 mm	2 mm		SB		DAPEC/MEYN	0990.IDCO.002.00	HILL# 4010-140
F176 21571	175 mm, Scalloped	32 mm	2 mm		S	32	DAPEC/MEYN	SPECIAL MAKE	
F176 21161	250 mm	32 mm	2.5 mm		SB		DAPEC/MEYN	0990.IDCO.006.00	HILL# 4010-142
F176 21541	250 mm, 1 Pin Hole	32 mm	3 mm		DB		DAPEC/MEYN	0990.IDCO.047.00	
F176 21301	250 mm	32 mm	3 mm	6	DB		DAPEC/MEYN	SPECIAL MAKE	

Call 800-456-5624 For More Information and Pricing

*All parts are manufactured for BUNZL Processor Division and are not made, licensed, sponsored or approved by the original equipment manufacturer. All products listed are replacement parts only; they are not an original equipment part of the manufacturers listed and BUNZL Processor Division is not affiliated with the manufacturers listed. All references to original manufacturer's equipment are for identification purposes only. All BUNZL parts are manufactured to exacting specifications using the highest quality materials.

Circular Blades



Serrated Blade

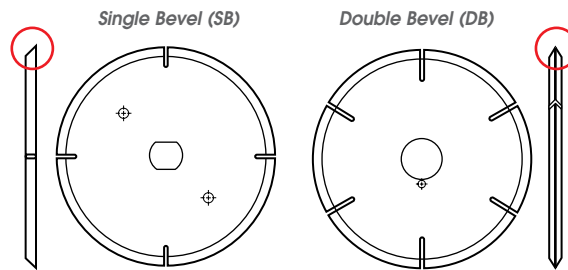

25/30 Bore with Slots

ITEM NO.	DIAMETER	BORE	THICKNESS	SLOTS	BEVEL	SCALLOPS	REPLACEMENT FOR OEM*	OEM*	AFTERMARKET NAME AND NO.
F176 21611	270 mm, Serrated	40 mm	3 mm		DB	44	DAPEC/MEYN	02.04.000.0014	4010198
F176 00351	310 mm, Halver Blade	40 mm	3 mm		DB		DAPEC/MEYN	02.04.000.035	
E075 10641	2-1/2" Squared-Edged Pinch Blade	1-3/8"	1/8"		Flat Edge	2 Notches	DOUGHBOY		
F176 21551	4-1/2"	1"	0.093"		SB		FOODCRAFT	66020198	HILL# 401078
F176 21081	14-1/2", Keel	1-1/8"	0.095"		DB		FOODCRAFT	66015795	HILL# 401022
F176 21211	6-1/4"	1"	0.090"	4	DB		FOODCRAFT		HILL# 401021S/M&M# 2113S
F176 21061	12" Scalloped Serrated	1-1/8"	0.093"		S, DB	50	JOHNSON	41822400	HILL# 4010-249
F176 80571	10"	1-1/8"	0.057"		DB		JOHNSON		HILL# 401097/M&M# 2125
F176 21071	12"	1-1/8"	0.093"		DB		JOHNSON	41822500	HILL# 401043
F176 21251	9"	1-1/8"	0.071"		DB		JOHNSON		HILL# 401053/M&M#2124
F176 21031	10"	1-1/8"	1/8"	8	DB		LEWIS	LH8410/LE90-010	HILL# 401062S/M&M# 2102S
F176 21591	10"	1-1/8"	1/8"		DB		LEWIS	LH8412/LE90-012	HILL# 401062/LH8412
F176 21281	60 mm	11 mm	1 mm		DB		MAREL®	009-0021-2587	
F187 46001	250 mm, Micro Serrated	32 mm	3 mm		S, SB	Micro Serr	MEYN MAESTRO	0990.ICCO.056.00	HILL# 4010-462
F187 12391	100 mm, Packaging Blade Tin Coded	30 mm	2 mm		DB		OSSID®		CP015
F187 59111	100 mm, Packaging Blade	30 mm	2 mm		DB		OSSID®	42-2591-1	
F176 21421	2-3/8" Square-edged Packaging Blade	1"	0.104"		Flat Edge		PACKRITE	82048500A	
F264 29981	80 mm, Slotted w/Hub	30 mm	1 mm	Y	SB		SIMMONS/TIROMAT	700A146K	
F176 21711	7-1/4"	7/8"	0.080"		DB		SIMMONS	02007-02B	
F176 21271	9"	5/8"	0.080"		DB		SIMMONS/CANTRELL	02009-05/N027005	HILL# 401017 & 401034/SUB# CBC52122
F176 21581	9"	5/8"	0.063"	8	DB		SIMMONS		HILL# 401017S
F176 00051	110 mm	25/30	2 mm		SB		STORK®	555710	
F176 21101	165 mm	25/30 ob	2 mm	4	DB		STORK®		
F176 21111	165 mm	25/30 ob	2 mm	4	SB		STORK®	518391G	HILL# 401016
F176 21131	175 mm	25/30 ob	2 mm	4	DB		STORK®	507971	
B466 00251	175 mm, Micro Serrated	25/30 ob	2 mm		S	Micro Serr	STORK®	3943357	HILL# 401073
F176 21151	200 mm	25/30 ob	2 mm	4	SB		STORK®	683074	HILL# 4010-217
F176 21631	200 mm	25/30 ob	3 mm	4	SB		STORK®	SPECIAL MAKE	
F176 21701	250 mm	25/30 ob	2 mm	4w	SB		STORK®	518180	HILL# 4010-224
F176 21011	250 mm	25/30 ob	2 mm		SB		STORK®	504237	HILL# 4010-179
F176 21171	250 mm	25/30 ob	2 mm	4n	SB		STORK®	596746	HILL# 4010-179S
F187 03251	250 mm, Micro Serrated	25/30 ob	2 mm		S	Micro Serr	STORK®	3930325	
F176 21181	250 mm	25/30 ob	2 mm	12	DB		STORK®	255502	
F176 21191	300 mm, Serrated	25/30 ob	3 mm		S	Yes	STORK®	673314/671371	
F176 21371	350 mm	25/30 ob	3 mm		DB		STORK®	669290	
F176 00101	175 mm	25/30	2 mm		SB	Yes	STORK®/MAREL®	3930331	
F186 00151	300 mm	25/30	3 mm		DB		STORK®/MAREL®	671371	
F191 18221	16.53" (Dished) Slicer	1-1/4"	3/4"		DB	0	TOBY	SK-T950182D2	

Call 800-456-5624 For More Information and Pricing

Specialty Blades

• Single bevel (SB) • Double bevel (DB)



ITEM #	PRODUCT	DESCRIPTION	REPLACEMENT FOR OEM*	OEM NO.*	LENGTH	WIDTH	THICKNESS	CUTTING EDGE	MOUNT HOLES	AFTERMARKET NAME AND NO.
F187 24011		Tape Blade	3M™	78-8017-9173-8	2.56"	1.1"	1.5 mm	Serrated	3 Slots	
F187 25071		Specialty Blade	BAADER®	940.31.45.011	4"	2-5/8"	5 mm	SB	2 Slots	
F176 23461		Vent Drill Eviscerator	BAADER® LINCO®	292346 19285661	61 mm	29½ OD	25 ID	SB	Slot Locks	
F176 21321		Hock Cutter Blade	BARKER		29"	1/2"	1/8"	DB	4	HILL# 401002NS M&M# 2101
F176 21641		Hock Cutter Blade w/Notches	BARKER		29"	1/2"	1/8"	Notched	4	HILL# 401002
F176 21361		Star Wing Blade	CANTRELL	NO-46210	12"	1½"	1/8"	DB	0	CP-057
F176 78101		Spiral Slicer	CARRUTHERS	000178-10	21-5/8"		0.062"	SB	Yes	
F176 01051		Spiral Slicer w/ 4 Mounting Holes	CARRUTHERS		21-5/8"		0.100/0.110"	SB	Yes	
F187 22091		Piercing Blade	CRYOVAC®	FUR-58463	45.6 mm	10.3 mm	0.80 mm	45° w/pt	1	
F186 00011		Narrow Cut Blade	CRYOVAC®	PE20S074	345 mm	15 mm	1.2 mm	SB	0	PE20S04SB
F187 22111		Packaging Cutoff Blade	CRYOVAC®	2070A-8550	385 mm	19 mm	1.3 mm	Serrated	Yes	
F187 22131		0.080" Standard Packaging Cutoff Blade	CRYOVAC®	PV01S004 FUR82607	414 mm	46.25 mm	0.080" STD	Serrated	2	
F187 22121		0.125" Heavy Duty Packaging Cutoff Blade	CRYOVAC®	PV01S004 THICK VERSION	414 mm	46.25 mm	1.25 HD	Serrated	Yes	
F187 22151		Packaging Cutoff Blade	CRYOVAC®	PV01S005 FUR82606	514 mm	35 mm	0.50 mm	Serrated	Yes	
F187 15351		Packaging Cutoff Blade	CRYOVAC®	PV23S001	570.2 mm	50.5 mm	0.80 mm	Serrated	2	
F264 05261		Packaging Shear Blade	CRYOVAC®	PV2S002	526 mm	50 mm	1 mm	Serrated	Yes	
F187 51661		2-Tooth Piercing Blade	CRYOVAC®	4-35166	41 mm	45 mm	1 mm	2 Tooth SB	2	
F187 17681		4-Tooth Piercing Blade	CRYOVAC®	4-35165	75 mm	47 mm	0.80 mm	DB	2	TGW #AS1768
F187 76711		4-Tooth Piercing Blade	CRYOVAC®		80 mm	45 mm	0.80 mm	4 Tooth DB	4	TGW #AS1767-1
F186 21351		Leg Processor Blade	DAPEC		138.8 mm	35 mm	1.6 mm	DB	1 Hole 2 Slots	
F187 44401		Leg Processor Blade, Large HD Thick Version	DAPEC		193.8 mm		1.6 mm	DB	2 Slots	HILL #4010-338
F176 21311		Wing Blade	DAPEC	FB038055	12-3/4"	1-1/2"	1/16"	DB	0	HILL #401046
F187 21881		Tape Blade	DEKKA	06-015	60 mm	24.5 mm	1.6 mm	Serrated	2 Slots	
F187 08881		Breast Splitter	EQUIMEX		214 mm	0.19 mm	2 mm	DB	2 Holes	

Call 800-456-5624 For More Information and Pricing

*All parts are manufactured for BUNZL Processor Division and are not made, licensed, sponsored or approved by the original equipment manufacturer. All products listed are replacement parts only; they are not an original equipment part of the manufacturers listed and BUNZL Processor Division is not affiliated with the manufacturers listed. All references to original manufacturer's equipment are for identification purposes only. All BUNZL parts are manufactured to exacting specifications using the highest quality materials.

Specialty Blades

• Single bevel (SB) • Double bevel (DB)



SPECIALTY BLADES

ITEM #	PRODUCT	DESCRIPTION	REPLACEMENT FOR OEM*	OEM NO.*	LENGTH	WIDTH	THICKNESS	CUTTING EDGE	MOUNT HOLES	AFTERMARKET NAME AND NO.
3192 10091		Tender Cutter Blade	FOODCRAFT	6015278	3-3/8"	3/4"	1/8"	DB	1 Hole	FC-401008
F186 23031		Leg Processor Knife	FOODCRAFT	6015277	3-1/2"	5/8"	1/8"	DB	No	HILL# 401009
F186 22761		Processor Blade Resharpenable	FOODCRAFT		3-3/4"	1/2"	0.06"	DB	No	HILL# 401010
F186 30201		Leg Tendon Blade	FOODMATE	IF.05.002.015	191 mm	30 mm	2 mm	Straight	2 Slots	
F187 21921		Leg Processor	FOODMATE	IF.05.002.005	192 mm	25.25 mm	3.1 mm	DB	4 Slots	
F187 00021		Leg Processing Blade RH	FOODMATE	IF.05.002.029	43.39 mm	24.3 mm	2 mm	Single Bevel		
F187 00031		Leg Processing Blade LH	FOODMATE	IF.05.002.030	43.39 mm	24.3 mm	2 mm	Single Bevel		
0098 00061		Arched 1/2 Moon Blade	FOODMATE	DF.000.606.00	212 mm	80 mm	3 mm	Double Bevel	4 Slot	
F187 19451		Packaging Blade	HART		17"	1"	0.040"	Serrated		
F176 21381		Evisceration Vent Drill	JOHNSON	2421530321CCW	2.52"	1.237"	0.97"	Bore	Slot Locks	
F176 21391		Evisceration Vent Drill RH Blade CW	JOHNSON	2421530320CW	2.52"	1.237"	0.97"	Bore	Slot Locks	
0098 62525		Celanese Vent Opener SS	JOHNSON	R-016252S	1.625"	0.740"	0.036"	DB	2 Slots	HILL# 401045
F187 94401		Chub Cutoff Knife	K-PAK	007-52671-000						
7949 00011		Opener Blade	MAREL®	91400497	2.458"	0.750"	0.036"	DB	2 Slots	IDSL# TE03-018
F187 21861		Processing Blade	LINCO®		190 mm	25 mm	1.2 mm	DB	4 Slots	
F264 26401		Tape Blade	LITTLE DAVID	PCS11B4	62 mm	25 mm	0.50 mm	Serrated	3 Holes	
B466 87121		L-Shaped, I-Cut Blade	MAREL®	0200-999-80118201	341.91 mm	90.09 mm	1.5 mm	L-shp DB	2 Holes	NOR-80118201
F187 96701		LH Leg Processor Blade	MAREL® STORK®	249670	115 mm	36.5 mm	2 mm		2 Slots	
F187 96711		RH Leg Processor Blade	MAREL® STORK®	649671	115 mm	36.5 mm	2 mm		2 Slots	
F187 38671		Groin Cut Blade	MEYN	0990.IDC1.015.00	43.9 mm	36.2 mm	2.5 mm	SB	2 Holes	
F186 00281		Rapid Cut 1/2 Moon	MEYN	0700-0010-W01-93	84.56 mm	42 mm	3 mm	Micro-Serrated		
F176 21341		Half Circle Blade	MEYN	LPC-1458 77.50.008.50	239 mm	80 mm	3 mm	DB	4 Slots	
F187 13931		Leg Processor Blade	MEYN	LEP-2015 77.50.006.100	139 mm	33 mm	1 mm	DB	2 Slots	
3028 38651		Left Hand Vent Blade	MEYN	0338.0001.331.0	73 mm	32 mm ID	3 mm	SB		
3028 38641		Right Hand Vent Blade	MEYN	0338.0000.316.0	73 mm	32 mm ID	3 mm	SB		

PRICES ARE SUBJECT TO CHANGE • MINIMUMS MAY APPLY • VISIT OUR WEBSITE FOR CURRENT PRICING.

Call 800-456-5624 For More Information and Pricing

Specialty Blades

• Single bevel (SB) • Double bevel (DB)



ITEM #	PRODUCT	DESCRIPTION	REPLACEMENT FOR OEM*	OEM NO.*	LENGTH	WIDTH	THICKNESS	CUTTING EDGE	MOUNT HOLES	AFTERMARKET NAME AND NO.
E516 20001		V-Anvil Lower	K-PAK	007-52702-000						
E516 30001		V-Anvil Upper	K-PAK	007-52703-000						
E516 00401		V-Insert Cutoff	K-PAK	007-60650-040						
E516 10201		V-Punch	K-PAK	007-52701-020						
E516 01501		V-Assembly Lower Punch	K-PAK	007-53810-150						
E516 00501		V-Assembly Upper Punch	K-PAK	007-53810-050						
F187 22161		Vent Opener Blade	MEYN	0774.000.000.315 200050154	104 mm	45 mm	0.05 mm	Serrated	Yes	4010-311
F187 22141		Packaging Blade	M-TEK	113021C1	16-5/8"	1.062"	0.079"	Serrated	Yes	TARHEEL #CP-301
F187 09411		2pc SS Slitter Blade DB	MULTIVAC	79.915.2009.41	90 mm	42 mm	2 mm	DB	3/Blade	
F187 09421		2pc SS Slitter Blade SB	MULTIVAC	79.915.2009.42	90 mm	42 mm	2 mm	Single	3/Blade	
F264 04051		Cutoff Blade	MULTIVAC		405 mm	40 mm	1 mm	DB Scalloped	2, No Notches	
F264 04761		260 mm Cutoff Blade	OMORI	HFM147001	260 mm	32 mm	2 mm	SB	3	
F187 22101		Packaging Blade	OSSID®	025-000-17	10-1/2"	0.393"	0.04"	Serrated	2	
F187 25961		Packaging Cutoff Blade	OSSID®	2-475-3	280 mm	45 mm	1.2 mm	Serrated	4 Slots	
F187 22061		Packaging Cutoff Blade	PACMAC	9202-0009	20-1/4"	1.05"	0.064"	Serrated	2	HILL #4010-207
F187 00641		Serrated Packaging Blade Tin Coated	PACMAC	9200-064	20-1/4"	1.05"	0.064"	Serrated	2	
F187 95211		Cutoff Blade w/Tear Notch	PACMAC	9202-00095SDB2-1	20-1/4"	1.05"	0.064"	DB	w/Tear Notch	
F187 00951		Packaging Cutoff Blade	PACMAC	9202-00095	20-1/4"	1.05"	0.064"	Scalloped	2	
F187 22821		Perforating Blade	PACMAC	9502-0009P	20-1/4"	1.05"	0.064"		Yes	
F176 00171		Spreader Bar	PACMAC	9212-0017	29"		1/2"			

Call 800-456-5624 For More Information and Pricing

*All parts are manufactured for BUNZL Processor Division and are not made, licensed, sponsored or approved by the original equipment manufacturer. All products listed are replacement parts only; they are not an original equipment part of the manufacturers listed and BUNZL Processor Division is not affiliated with the manufacturers listed. All references to original manufacturer's equipment are for identification purposes only. All BUNZL parts are manufactured to exacting specifications using the highest quality materials.

Specialty Blades

• Single bevel (SB) • Double bevel (DB)



SPECIALTY BLADES

ITEM #	PRODUCT	DESCRIPTION	REPLACEMENT FOR OEM*	OEM NO.*	LENGTH	WIDTH	THICKNESS	CUTTING EDGE	MOUNT HOLES	AFTERMARKET NAME AND NO.
F187 19151		Net Blade	POLY CLIP®	71678	175 mm	19 mm	2 mm	SB	No	
F187 32011		Crosscut Blade	REISER	A-352-04320.1	12"	1-3/8"	1 mm	SB	2	
F187 22071		Packaging Blade	SANDIACRE	KN14464	335 mm	18.5 mm	2.5 mm	Serrated	2	
F187 22081		Packaging Blade	SANDIACRE		365 mm	18.5 mm	2.5 mm	Serrated	Yes	
F187 22011		JLR Blade LH	STORK®	608788	80.5 mm	3 mm	3 mm	Single	3	HILL #4010-177
F187 22021		JLR Blade RH	STORK®	608789	80.5 mm	3 mm	3 mm	Single	3	HILL #4010-178
F264 29981		Circular Slitter Blade Tin Coated Blade	TIROMAT	700A46K	80 mm	1 mm	1 mm	SB	0	
F187 20501		Cutoff Knife	TIPPER TIE	11-0140-05		1"	1/8"	SB		
F187 33521		Packaging Blade	TRIANGLE	A83352	465 mm	25 mm	1.5 mm	Serrated		
F187 19301		Packaging Blade	TRIANGLE	A12279	13-7/8"	1"	0.062"	SB		
F187 03451		Packaging Cutoff	TRIANGLE		345 mm	26 mm	1.2 mm	SB Scalloped	2 Mtg Holes	HILL #4010-282
F264 04741		Piercing Blade	TRIANGLE		474 mm	25.4 mm	1.5 mm	Serrated		4010-340
F264 04751		Tin Cutoff Blade	TRIANGLE	A38349	474 mm	25 mm	1 mm	Serrated		
F264 06611		Tin Slitter Blade, 2pcs	MULTIVAC		115 mm	25 mm	1 mm	DB	3 per	
F264 04951		Tapered Tin Blade	ROSS		495 mm	70/60 mm	0.8 mm		7 Slots	
F264 04771		EZ Open Blade	ULMA	6254938	425 mm	57 mm	3.5/2.5 mm	Serrated	2	

Call 800-456-5624 For More Information and Pricing

*All parts are manufactured for BUNZL Processor Division and are not made, licensed, sponsored or approved by the original equipment manufacturer. All products listed are replacement parts only; they are not an original equipment part of the manufacturers listed and BUNZL Processor Division is not affiliated with the manufacturers listed. All references to original manufacturer's equipment are for identification purposes only. All BUNZL parts are manufactured to exacting specifications using the highest quality materials.

FREE SHIPPING*
FREE GROUND SHIPPING
When you order \$400 or more!

*FREE SHIPPING does NOT include UPS Next Day Air, UPS 2nd Day or UPS 3rd Day Select. Certain items may not qualify. This offer is good only on orders shipped UPS Ground in the 48 contiguous states. Based on dimensional weight, we will determine the most efficient means of shipment, either UPS or LTL. Products may ship by truckline.

PRICES ARE SUBJECT TO CHANGE • MINIMUMS MAY APPLY • VISIT OUR WEBSITE FOR CURRENT PRICING.

Replacement V-Tooth Slicer Blade

- Compatible with GROTE® Slicers.



NOTE: Other sizes available upon request.

► 50 BLADES PER PACK.

ITEM NO.	PRODUCT	SIZE	EACH
C785 00041	Slicer Blade	172-3/8" x 1/2" x 0.020" . . .	\$19.95
C785 00051	Slicer Blade	192-3/8" x 1/2" x 0.020" . . .	22.95
C785 00061	Slicer Blade	124-15/16" x 1/2" x 0.020" . .	15.95
C785 00115	Slicer Blade (5-Pack)	137-15/16" x 1/2" x 0.020" . .	86.95

*GROTE® is a registered trademark of J.E. Grote Company, Inc. This product is a replacement part; it is not an original equipment part of and is not affiliated with J.E. Grote Company, Inc. All references to original equipment are for identification purposes only.

Replacement Slicing Blades

- Compatible with GRASSELLI® Slicers.

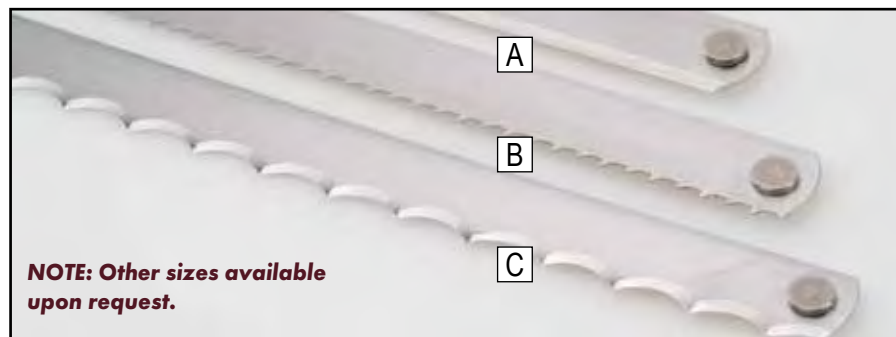

NOTE: Other sizes available upon request.

► 25 BLADES PER PACK.

ITEM NO.	PRODUCT	SIZE	PACK
6466 0435	A. Knife Edge Slicer Blade	17-5/8" x 5/8" x 0.020"	\$134.95
6466 0006	B. 6 TPI Slicer Blade	17-5/8" x 5/8" x 0.022"	134.95
6466 7116	C. Scallop Edge Slicer Blade	17-5/8" x 5/8" x 0.022"	136.95

► 50 BLADES PER PACK.

ITEM NO.	PRODUCT	SIZE	PACK
6466 6016	C. Scallop Edge Slicer Blade	17-5/8" x 7/16" x 0.016"	\$247.95

*GRASSELLI® is a registered trademark of Grasselli Company. This product is a replacement part; it is not an original equipment part of and is not affiliated with Grasselli Company. All references to original equipment are for identification purposes only.

Scalpel Knives

- Easy to replace, wrapped, stainless steel blades.
- Contoured, textured handle.
- Length: 2.876 inches.



Stainless steel blade.

ITEM NO.	PRODUCT	EACH
3363 00431	Poly Blue Scalpel Knife Handle	\$36.25
1060 80265	#60 Poultry Blades, Stainless Steel, 150/Box	137.45

Replacement Peeler Blades

- Compatible with TOWNSEND® Model 2600.



► 20 BLADES PER BOX.

ITEM NO.	OEM#	BOX
7949 30315	25155	\$52.95

*TOWNSEND® is a registered trademark of Marel Meat Processing, Inc. This product is a replacement part; it is not an original equipment part of and is not affiliated with Marel Meat Processing, Inc. All references to original equipment are for identification purposes only.

Replacement Peeler Blades

- Compatible with RANGER®.
- 0.012-inch x 0.324-inch stainless steel.



► 100 BLADES PER BOX.

ITEM NO.	OEM#	BOX
A657 00015	880242	\$59.95

*RANGER® is a registered trademark of Ranger Blade Mfg. This product is a replacement part; it is not an original equipment part of and is not affiliated with Ranger Blade Mfg. All references to original equipment are for identification purposes only.

Rib Pulling Handle and Blades

- Molded plastic handle. • Easily replaceable blades.
- 6-1/4-inch stainless steel arm.



► 5 BLADES PER PACK.

ITEM NO.	PRODUCT	PACK
A657 34101	A. Rib Pulling Handle	\$58.95
A657 14121	B. 12 mm Blade	\$20.95
A657 14145	14 mm Blade	20.95
A657 14165	16 mm Blade	20.95
A657 14185	18 mm Blade	20.95
A657 14205	20 mm Blade	20.95
A657 14225	22 mm Blade	20.95
A657 14255	25 mm Blade	20.95

Spinal Cord Remover

- Constructed of stainless steel to resist rusting.
- Pork blade: 1 inch long.
- Beef blade: 1-1/2 inches long.
- Overall length: 7-1/4 inches.
- Machine washable.
- Heavy-duty plastic handle.



NOTE: Blades and handle sold separately.

ITEM NO.	PRODUCT	EACH
6466 0600	Spinal Cord Remover	\$26.35
6466 0601	Beef Replacement Blade	3.05
6466 0602	Pork Replacement Blade	3.10

Poultry Lung Scraper

- Stainless steel with plastic handle.
- Overall length: 12-1/2 inches.
- Blade: 1 inch x 1-3/4 inches.



ITEM NO.	PRODUCT	EACH
2990 10561	Lung Scraper	\$85.95

Skinner Blades

Setting the standard for quality and precision.

- Engineered to provide maximum yields.
- Polished cutting edge eliminates product loading of cutting edge.
- Long lasting cutting edges reduce blade replacement downtime.
- Proven edge geometry for all applications.

NOTE: Blades are individually packed in a heat sealed safety package, preserving cutting edge integrity and protecting plant personnel.

ITEM NO.	PRODUCT	OEM#	QTY/PACK	F.O.B. FACTORY CASE
5880 6354	518 mm x 22 mm x 0.7 mm	16354	100 Individually Packaged	\$416.95
5880 0840	670 mm x 22 mm x 0.7 mm	9759302	100 Individually Packaged	655.95
5880 0004	517 mm x 22 mm x 0.7 (Carbon)	100 Individually Packaged	292.95

ITEM NO.	PRODUCT	OEM#	QTY/PACK	F.O.B. FACTORY EACH*
5880 82321	518 mm x 22 mm x 0.7 mm	18232	100 Individually Packaged	\$5.95
5880 6952	365 mm x 22 mm x 0.7 mm	9726952	100 Individually Packaged	3.95
5880 00031	392 mm x 22 mm x 0.7 mm	9727955	100 Individually Packaged	3.95

*100 Minimum



NOTE: Available in sizes ranging from 77 mm to 1,000 mm long in either 0.7 mm or 1.0 mm thickness. CALL FOR DETAILS.

Replacement Hand Held Skinner Blades

- Compatible with BEST & DONOVAN® S-1011.



* BEST & DONOVAN® is a registered trademark of Best & Donovan N.A. This product is a replacement part; it is not an original equipment part of and is not affiliated with Best & Donovan N.A. All references to original equipment are for identification purposes only.

► 100 BLADES PER BOX.

ITEM NO.	PRODUCT	SIZE	BOX
1060 0101	Carbon Steel	3-3/4" x 7-9/10"	41.95
5880 3062	Stainless Steel	3-3/4" x 7-9/10"	89.95

Involute Blades

Replacement Involute blades for high speed slicers manufactured by Weber®, Formax®, Thurne® and many others.

- Various edge angles are available from 22° to 32°.
- All blades are available coated and uncoated.



Call 800-456-5624 For More Details

Hog Hide Shaver

► SEE PAGE 445
For More Details and Hog Scraper Accessories

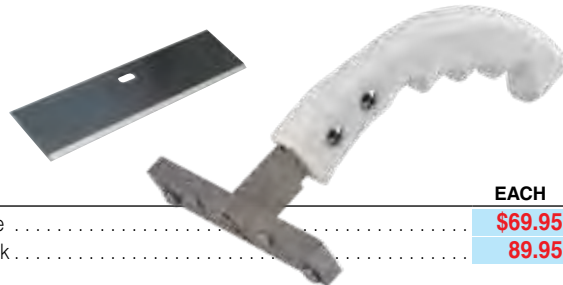

ITEM NO.	PRODUCT	EACH
0891 00021	Hog Hide Shaver Handle	\$69.95
5880 3062	Skinner Blades, 100/pack	89.95

► WWW.BUNZLPD.COM

FOR MORE PROCESSING TOOLS AND ACCESSORIES

110 mm Dehider Blades

JARVIS

- Compatible with JC-III and JC-IV model dehiders.
- For use on cattle, veal, hogs and sheep.
- Skins perfectly: no cuts, marks or holes.

MADE IN USA

NOTE: We sell Jarvis® Dehiders. CALL FOR DETAILS.



ITEM NO.	PRODUCT	OEM#	PAIR
3028 0155	110 mm Dehider Blades	3023011	\$199.95

We are a full-line stocking distributor for JARVIS REPLACEMENT PARTS AND BLADES FOR ALL JARVIS TOOLS.