



NEW FEATURES 2026
KITCHEN, BATHROOM
AND LIVING AREA



DESIGN BEYOND THE ORDINARY

More and more, a need for peace and safety is at the heart of interior design. In a world that seems to be turning faster every day, a person's home is their haven of well-being. Our new features for 2026 reflect this trend, presenting a perfect balance of tranquillity and individuality, freedom of design and clarity, function and simplicity. Join us in keeping up with the times and benefit from integrated solutions combining design, service and sophisticated concepts.

In higher demand than ever before: Nature and minimalism. With soft natural hues like Sand, Macchiato, Taupe grey, Coffee, Stone grey and Olive, our collection responds to a growing demand for a calm, warm ambiance. Our highlights in a minimalistic style are a particularly beautiful example of how to use this subtle world of colours to great effect. The Sakura design line in the Japandi style combines elegant frames and bar handles with minimalist lines and a modern cosiness. Our new LINE One features the innovative push-to-open system that permits a fully handleless design with beautifully tranquil surfaces. The glass cabinets Air represent a meeting of subtle elegance and technological sophistication – thanks to their delicate aluminium frame, hidden hinges and elegant glass front.

The new cottage style – modern and versatile. 6 new framed fronts are our response to this huge global trend. From traditional elegance to modern flair, with our products in a New Cottage design, we offer a fresh interpretation of this popular trend. Our versatile designs combine beautifully with any style and open up greater potential thanks to our new products in the entry-level price segment. Moreover, our expanded cottage style range, featuring a breakfast unit, wine racks and shelf holders is sure to maximise flexibility in any market – be it modern, Nordic or classic.

The market demands innovation. We deliver. Our new features are developed in close dialogue with you, our partners, and are tailored to meet customer requests and market requirements. One example of this is the fascination of movement. The rotating FurnSpin and the new table system with a Butterfly pull-out represent an exciting new world of momentum. We have responded to growing price sensitivity among your customers by offering familiar quality at attractive prices. The LOOK program expands the diversity of our product range at entry-level prices. The FRAME program represents new, attractively-priced options in the cottage style segment at price level 4. At the same time, we have systematically expanded our nobi smart range for particularly price-sensitive customers. 9 new décors now complement our worktop collection. The new thickness of 25 mm provides more planning freedom and, like the Slim Line, it is now available with all the modification options we previously only offered for our 38 mm worktops. New Curve elements and sliding doors for installation in front of a wall are the cherry on top of the cake that is our new collection.

Being our partner means access to strong trends and sophisticated concepts. We hope the following pages will inspire you. Enjoy!

DIVERSITY. TRENDS. IMPULSES 2026.



NEW VERSATILITY IN DESIGN

- 08 Fronts
- 44 Sakura design line
- 48 Handleless designs
- 54 Worktops
- 58 Surround colours
- 60 Handles and recessed handles
- 62 Niche designs
- 64 nBOX design options
- 66 Design with glass doors
- 68 Sliding doors



KITCHEN UPDATE

- 72 FurnSpin
- 74 Diagonal units
- 76 More options for planning width 762 mm
- 78 Type extensions and accessories
- 84 New features electric appliances
- 86 Stylish sinks and taps
- 88 nobi smart range



MORE THAN KITCHEN

- 92 New living features
- 100 Dining tables and chairs
- 104 New bathroom features
- 110 Discontinued products



GREATER DIVERSITY, GREATER OPTIONS!

You can look forward to a collection of natural colours and textures, beautifully coordinated designs and sophisticated solutions. From kitchens, through bathrooms, to living rooms:
Discover a world of inspiration and innovative concepts for creative, individual design.



01.

—
Tradition meets trend:
6 new fronts for a
modern cottage style

—
See page 08

02.

—
Pure minimalism:
LINE One – handleless
with push-to-open

—
See page 49

03.

—
New thickness options:
More selection in
the worktop segment

—
See page 54

04.

—
Update for the nBOX –
greater versatility with
new design options

—
See page 64

05.

—
Glass cabinets Air:
Innovative technology
for lovers of design

—
See page 66

OUR FRONTS FOR 2026: QUALITY MEETS TREND!

We are expanding our range with 13 new fronts that combine current trends and time-tested classics. From fashionable colours reminiscent of nature through textured surfaces to in-demand framed fronts: our new fronts set new standards in design, feel and quality.



Range no. 099

LOOK 604 PG 1
Sand textured
—
Matching surround:
Upright panels, plinth

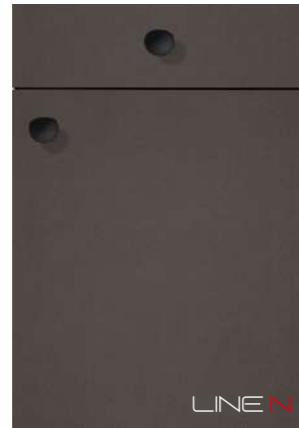

Range no. 099

LOOK 605 PG 1
Coffee textured
—
Matching surround:
Upright panels, plinth



Range no. 615

LASER 412 PG 1
Macchiato
—
Matching surround:
Carcase, upright panels,
shelf units, plinth

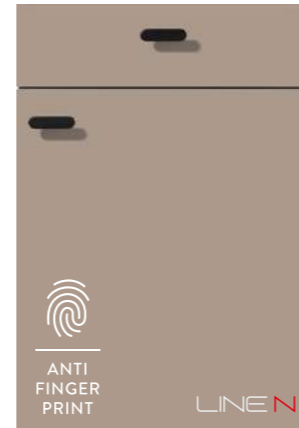

Range no. 357

SENSO 483 PG 3
Lacquer,
premium honed macchiato
—
Matching surround:
Carcase, upright panels,
shelf units, plinth



Range no. 419

FRAME 613 PG 4
Lacquered laminate,
white wood texture
—
Matching surround:
Upright panels, shelf units,
plinth



Range no. 419

FRAME 614 PG 4
Lacquered laminate,
stone blue wood texture
—
Matching surround:
Upright panels, shelf units,
plinth



Range no. 419

FRAME 617 PG 4
Lacquered laminate,
olive wood texture
—
Matching surround:
Upright panels, shelf units,
plinth



Range no. 419

FRAME 619 PG 4
Lacquered laminate,
macchiato wood texture
—
Matching surround:
Carcase, upright panels,
shelf units, plinth

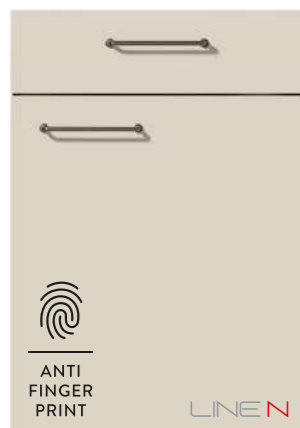

Range no. 187

SOFTLINE 504 PG 5
Lacquer,
perfect honed sand
—
Matching surround:
Upright panels

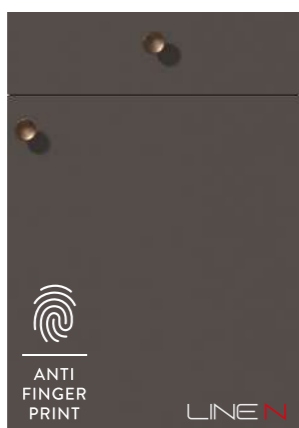

Range no. 187

SOFTLINE 505 PG 5
Lacquer,
perfect honed coffee
—
Matching surround:
Upright panels



Range no. 115

NOVALUX 513 PG 6
Lacquer,
taupe grey high gloss
—
Matching surround:
Upright panels



Range no. 497

NORDIC 791 PG 7
Lacquer,
perfect honed black
—
Matching surround:
Upright panels



Range no. 706

SYLT 848 PG 7
Lacquer,
perfect honed sand
—
Matching surround:
Upright panels



TREND 2026: EARTHY HUES

SOFT HUES
NATURAL CONTRASTS
DELICATE TEXTURES



For Macchiato-coloured beauty across the entire design:

MATCHING
FRONT DESIGNS

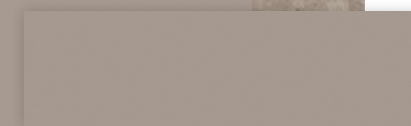

LASER 412
Macchiato

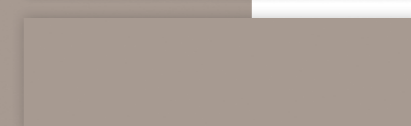

SENSO 483
Lacquer,
premium honed macchiato

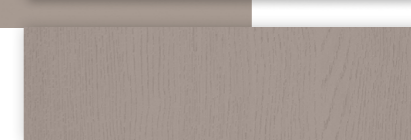

FRAME 619
Lacquered laminate,
macchiato wood texture

CARCASE COLOUR 133
Macchiato

Beige and brown colours in a variety of hues, like sand, macchiato, taupe grey and coffee, are among the top colours for 2026. Earthy hues offer a versatile range of colour that gives furniture, decoration and fabrics a charm that is unique to each colour and material. Surfaces featuring a ceramic or wood texture create a pleasant feel and emphasise the natural look.



TEXTURED SURFACES

Our quality is made to impress, even at entry-level prices – you can see it, feel it and it comes in a high-demand colour. The warm sandy hue and the delicate texture with a ceramic look give this design its natural flair and vibrancy.

LOOK 604
Sand textured

BAR HANDLE 870
Black

CARCASE 122
Sand

WORKTOP 245
Sand textured
Slim Line 16 mm



Range no. 099

LOOK 604
Sand textured

PG 1

Matching surround:
Upright panels, plinth

A perfect match:
The new Slim Line décor
in Sand textured and the
niche cladding Wood-Art,
Como oak complement
the harmony of colour
and texture.



MODERN TRANQUILITY

The colour coffee represents natural warmth and relaxed elegance. Its earthy brown hue radiates a cosy ambiance and creates harmony in modern and classic designs. The textured surface highlights the depth of the colour – a subtle, yet impactful look. Even in the entry-level price segment, this design meets even the most exacting demands for style and quality.

LOOK 605
Coffee textured

METAL KNOB 244
Black

CARCASE 071
Taupe grey

WORKTOP 237
Jura greige marble
reproduction



LINEA

Range no. 099

LOOK 605
Coffee textured

PG 1

Matching surround:
Upright panels, plinth



A look that connects:
A dark hue like coffee
creates style across
rooms – as shown by
the sideboard with its
modern frame.



ELEGANT RESTRAINT

Tone-in-tone, the trend colour macchiato displays its full effect. The matching wall panel and the recessed handle in a uniform natural hue underline the consistently minimalist design and strengthen its tranquil, restrained appearance.



Range no. 615

LASER 412 PG 1
Macchiato

—
Matching surround:
Carcase, upright panels,
shelf units, plinth



Popular design meets amazing convenience: LINE One complements the overall image with its push-to-open function, creating surface tranquillity with minimalist lines. For further information about LINE One, see page 49.



LASER 412
Macchiato

LINE ONE RECESSED HANDLE 008
Macchiato

CARCASE 133
Macchiato

WORKTOP 389
Macchiato Xtra matt
Slim Line Xtra 16 mm

NATURAL AESTHETICS

Modern cosiness meets current trends. The warm earthy hue macchiato creates a calm, stylish ambiance that will appeal particularly to design-loving customers. Combined with a light wood décor, you get a first-class look that is perfect for sophisticated kitchen and living room concepts.

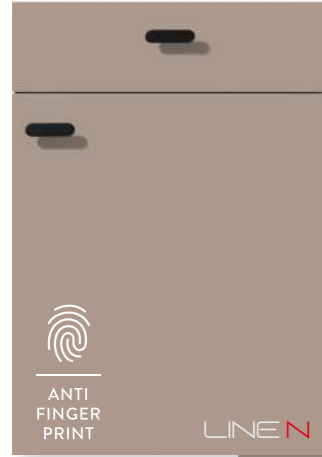

The honed lacquer surface with its anti-fingerprint coating reduces visible fingerprints and helps maintain a flawless look – a strong advantage in daily use.



Sustainable design: The melamine chipboard consists of 100 % recycled material. It is produced without the use of virgin fibres. Moreover, the surface is completely recyclable so that it can be reused at the end of its service life. For that reason, the surface has been certified with the 'Blauer Engel' (Blue Angel) eco label.



www.blauer-engel.de/uz38

Range no. 357

SENSO 483 PG 3
Lacquer,
premium honed macchiato

Matching surround:
Carcase, upright panels,
shelf units, plinth



SENSO 483
Lacquer,
premium honed macchiato

PUSH-TO-OPEN

CARCASE 133
Macchiato

WORKTOP 198
Sierra oak reproduction
25 mm

COLOUR WITH FINESSE

Discover the meeting of a successful colour and a best-selling front! This program with its perfect honed lacquer design has been a highlight for customers since its market launch last year. We are now adding another stylish colour to the available range. The soft colour sand is one of our most popular and best-selling colours and strengthens the minimalism of the front design. It gives the space a relaxed, classy ambiance – thanks to the honed surface that prevents any bothersome glare. An edge radius of 1.8 mm strengthens the impression of modern elegance.



Range no. 187

SOFTLINE 504 PG 5
Lacquer,
perfect honed sand

Matching surround:
Upright panels



Attractive all-around!

- Easy to clean thanks to anti-fingerprint coating
- Resistant to common stains
- Resistant to many cleaning agents, heat and moisture
- Resistant to micro-scratches, which can also occur during cleaning

SOFTLINE 504
Lacquer,
perfect honed sand

PUSH-TO-OPEN

CARCASE 122
Sand

WORKTOP 245
Sand textured
Slim Line 16 mm



COFFEE STATEMENT

The lacquered front in coffee is sure to win over customers with its warm, intense hue and a velvety-matt surface. Stylish, yet designed for everyday use: Thanks to a high-quality feel, resistant coating and innovative anti-fingerprint properties, this range is perfect for daily life.



Range no. 187

SOFTLINE 505 PG 5
Lacquer,
perfect honed coffee

—
Matching surround:
Upright panels

Elements to create ambiance:
The vertical lighting in the
recessed handle creates a
subtle highlight of illumination
and emphasises the handleless
design in an elegant manner.

A classy duo:
The drawer and pull-out
system nBOX with its Milano
walnut cover fits seamlessly
into darker colour concepts
and adds a high-quality,
beautifully-coordinated
material aesthetic to
designs. You can find all the
new design options for the
nBOX on page 64.



SOFTLINE 505
Lacquer,
perfect honed coffee

LINE ONE RECESSED HANDLE 027
Black

CARCASE 194
Slate grey

WORKTOP 214
Black marble reproduction
25 mm

BRILLIANT DESIGN

Genuine lacquer fronts with a high-gloss appearance remain a strong trend – so we have now added taupe grey to our available range. This warm grey hue with a slight brown tinge creates a relaxed, modern ambiance. The lacquered fronts on all sides feature an elegantly slim edge radius of 1.8 mm.

NOVALUX 513
Lacquer,
taupe grey high gloss

METAL HANDLE 225
Bronze metallic colour

CARCASE 071
Taupe grey

WORKTOP 344
Black granite décor
Slim Line 16 mm



Contemporary elements:
Niche cladding, sinks, taps
and handles in bronze
add a classy touch to the
trendy hue.



Range no. 115

NOVALUX 513 PG 6
Lacquer,
taupe grey high gloss

Matching surround:
Upright panels



The purest form of design: A surface mix of high-gloss and glass! The glass cabinets Air combine sophisticated technology with first-class design. Their innovative hinge technology remains invisible, hiding elegantly behind the delicate contours of the frame. For more information, see page 66.



COTTAGE STYLE MEETS MODERN FLAIR

MODERN HUES
DELICATE FRAMES
DISTINCTIVE DETAILS



The new cottage style: Tradition may be a trend, but that doesn't mean having to put up with frumpy designs. This time-tested style of interior design that brings tradition and craftsmanship into the home has undergone a rejuvenating treatment and is now returning with a modern look. Without the traditional embellishments, it presents itself in modern colours.

WHITE – TIMELESS AND VERSATILE

The new five-part framed front in White combines classic shapes with a delicate, modern wood texture. The result is a modern cottage style that is timeless, elegant and surprisingly versatile. Depending on the combination of matching materials, colours and other cottage-style elements, this design can exude Nordic minimalism or a cosy familiar feel.

FRAME 613
Lacquered laminate,
white wood texture

METAL HANDLE 838
Black

CARCASE 106
White

WORKTOP 243
Honey oak reproduction

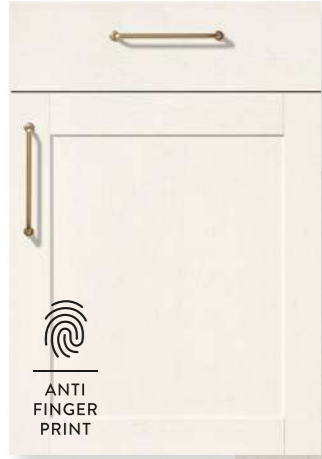

ANTI
FINGER
PRINT



Range no. 419

FRAME 613 **PG 4**
Lacquered laminate,
white wood texture

Matching surround:
Upright panels, shelf units,
plinth

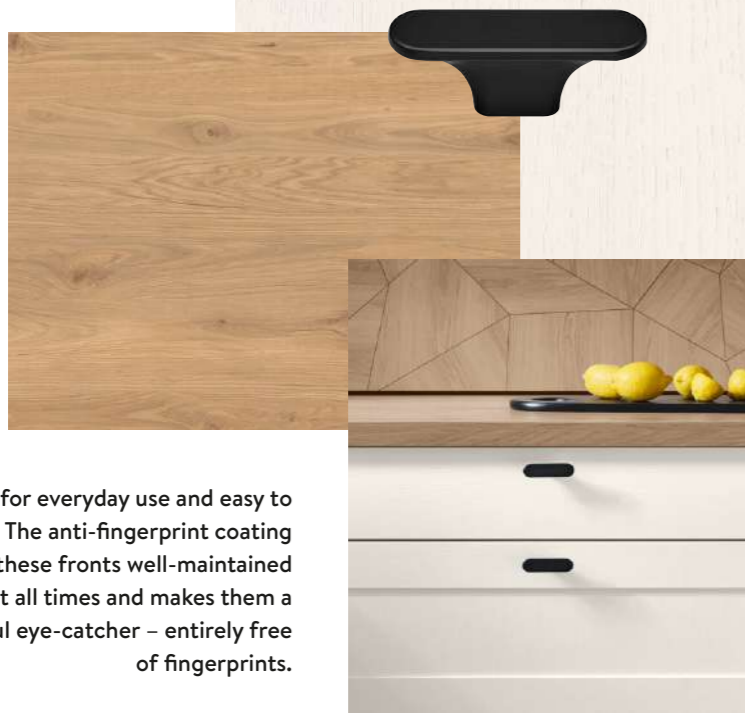

A broad portfolio at attractive entry-level prices: The new entry-level cottage style segment features impressively high-class craftsmanship and modern design. Four modern colours create a portfolio that will appeal to many different tastes and opens up opportunities for versatile design.

Perfect for everyday use and easy to clean: The anti-fingerprint coating keeps these fronts well-maintained at all times and makes them a beautiful eye-catcher – entirely free of fingerprints.



STONE BLUE – CLARITY AND INDIVIDUALITY

Cottage style can be so modern: The colour stone blue rejuvenates this popular look. The subtle wood texture makes the front look particularly classy – perfect for customers intending to rethink cottage-style design.



Range no. 419

FRAME 614 **PG 4**
 Lacquered laminate,
 stone blue wood texture

—
 Matching surround:
 Upright panels, shelf units,
 plinth

The matching wall panel with a wood texture is a stylish eye catcher, creating a beautiful combination of tradition and clean lines. Its 3D motif gives the room new depth and creates an unparalleled experience of look and feel.



FRAME 614
 Lacquered laminate,
 stone blue wood texture

METAL HANDLE 838
 Black

CARCASE 089
 Stone grey

WORKTOP 193
 Alpine white
 Slim Line 16 mm

GREEN STILL GOING STRONG

The green trend is here to stay – you can tell from the success of our fronts in jade, mineral green and olive and our most popular cottage-style front in reed green. That is why we added olive to our range of new features as a genuine alternative for a modern cottage style. The texture you can feel makes this front seem like genuine wood and adds a touch of warmth to modern design.



The versatile colour combines beautifully with both light and dark wood hues and effortlessly creates a special ambience of well-being.



FRAME 617 Lacquered laminate, olive wood texture METAL HANDLE 226 Black CARCASE 194 Slate grey WORKTOP 243 Honey oak reproduction

MACCHIATO – DESIGN THAT HARMONISES

Framed fronts in macchiato combine classic design with a modern colour. Together with marble, this look is elegant yet inviting and absolutely perfect for sophisticated cottage-style designs. The tranquil appearance adds clarity and warmth to the room.



Range no. 419

FRAME 619 PG 4
Lacquered laminate,
macchiato wood texture

Matching surround:
Carcase, upright panels,
shelf units, plinth



A love for detail: This décor is complemented by the cottage-style surround elements featuring a wine rack, plate rack, shelf holder and breakfast unit. For more information, see page 36.



FRAME 619
Lacquered laminate,
macchiato wood texture

METAL HANDLE 226
Black

CARCASE 133
Macchiato

WORKTOP 218
Pangaea grey marble
reproduction

NEW DESIGN ELEMENTS IN THE COTTAGE-STYLE SEGMENT

How much cottage would you like? Our extensive range of cottage-style details is perfect for creating precisely the atmosphere your customers are looking for – down to the smallest element. Whether in a classic or modern interpretation, our versatile elements combine flexibly and adapt to your customers' specific requests.



Available in 2 widths, the breakfast unit creates the impressive look shown in this example with plenty of storage when placed in a duo.

BREAKFAST UNIT

The elegant breakfast unit is a stylish yet convenient element with plenty of storage space, designed with a plan: Even the insides of the doors are put to clever use, offering additional space.

BKFST 50/60*

- 2 doors (1 top, 1 bottom)
- Equipment behind the top door: Insertable shelves and eye-catcher back panel in Sierra oak
- 1 door shelf set in solid oak wood
- Equipment behind the bottom door: 1 insertable shelf
- Available in all tall unit heights and all front programs

BKFST2IA 50/60*

- Equipment like top, but 2 internal drawers and 1 internal pull-out or 1 internal drawer and 2 internal pull-outs behind the bottom door depending on tall unit height

The oak door shelf set TRSET50/60E for tall units is also available separately as an accessory. The set consists of 2 shelves each and a 360 mm high frame with boxes.

WALL UNIT WGGT* WITH FRAMED GLASS DOOR

- 1 door, partially glazed
- With clear glass no. 01
- Available widths: 450, 500, 600 mm
- Available heights: 720, 792, 864 mm
- Ribbed glass no. 23 available for surcharge MP-GW
- Only available for program FRAME 419



OPEN-SHELF BASE UNIT WITH WINE RACK URWK* / -X / -M / -36 / -43

- 1 fixed shelf
- Bottom compartment with wine rack in solid oak
- Width: 450 mm
- Side depth: 582 mm, usable depth: 345 mm

Available in all base unit heights.
Available in all shelf unit colours.

Also available separately as wine rack WKR45-36 / -43

- Solid wood design in oak
- For inserting in 450 mm wide shelf compartments
- WKR45-36: for compartment height: min. 298 mm for usable depth: 345 mm
- WKR45-43 compartment height: min. 370 mm for usable depth: 345 mm



PLATE RACK THR50 / 60

- Solid wood design in oak
- For inserting in 500 mm wide shelf compartments



WALL SHELF WITH CONSOLE SUPPORT VBK16 100/258: 16 MM THICK VBK25 100/258: 25 MM THICK

- 300 mm deep, polymer edging all around
- From 200 mm to 1000 mm width with 2 console supports VBK
- From 1001 mm to 2580 mm width with 4 console supports VBK
- Available console support colour: 010 Black

Available in all carcasses, worktops, lacquered laminate, premium honed and high-gloss colours. Not available in Xtra-honed finishes 381 Alpine white, 389 Macchiato and 366 Black textured.

Also available as **console support VBK in set of 2 as accessories**



SINK UNIT SPUST(A)60* FOR BELFAST SINK

- 1 door or 1 door with pull-out rails
- 1 internal panel
- Matching Belfast sink Schöck KALLIO M 100

Available heights: 720, 792, 864 mm

TRADITION INSPIRED BY NATURE

Cottage-style fronts can be presented in a wide variety of ways. In this example, traditional design combines beautifully with nature as a trend topic. The warm hue Sand is perfect for adding natural elegance to any design – an ideal colour for exacting customers. The lacquer fronts in perfect honed sand are designed to impress with their exclusive style and exceptional convenience thanks to anti-fingerprint coating. Natural contours and craftsmanship down to the smallest detail underline the high quality of this design and make this front the ideal choice for stylish room concepts.

SYLT 848
Lacquer,
perfect honed sand

METAL HANDLE 262
Titanium-coloured

CARCASE 122
Sand

WORKTOP 238
Amber quartzite
reproduction



ANTI-FINGERPRINT



Range no. 706

SYLT 848
Lacquer,
perfect honed sand

PG 7

Matching surround:
Upright panels



Matching cottage-style elements such as cornice strips, pilasters or light pelmets in a cottage style complement the look and can be combined as desired.



The innovative anti-fingerprint coating makes the fronts particularly easy to clean and protects them against fingerprints. This feature applies to all fronts in lacquer, perfect honed and premium honed.



BLACK, A CLASSIC TREND

Black is a style-defining classic in both fashion and interior design. The classic frame structure gives this colour a modern stage that is both minimalist and expressive. This front colour combines traditional values with urban aesthetics and appeals to customers that appreciate a design-conscious interpretation of cottage style.



Range no. 497

NORDIC 791 PG 7
Lacquer,
perfect honed black
—
Matching surround:
Upright panels

The honed surfaces with anti-fingerprint coating make this kitchen perfect for everyday use and easy to clean.



Intense depth of colour: Despite the extremely honed surface, the brilliant colours are particularly intense. A special matt finish technology does away with the need for matting agents. Highly pigmented coating improves the colour depth and ensures high colour stability.



NORDIC 791
Lacquer,
perfect honed black

METAL HANDLE 358
Titanium-coloured

CARCASE 194
Slate grey

WORKTOP 366
Black textured

MINIMALISM: THE NEED FOR CLARITY

TIMELESS DESIGN
CLEAN LINES
FORM AND FUNCTION

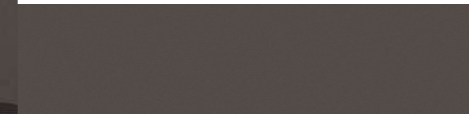

As the outside world grows ever louder, the need for tranquillity at home also grows. The current trend of minimalism creates not just clarity, but ambiance – sometimes with purist straight lines, sometimes with modern warmth. Beautifully balanced tone-in-tone colours, natural materials and a restrained design language bring calm, clarity and serenity to your customers' everyday lives. Discover our highlights of minimalist design and see how versatile restraint can be.

SAKURA DESIGN LINE: NATURAL BEAUTY IN A MINIMALIST FRAME

The Sakura design line is our response to the popularity of the Japandi style – a sought-after combination of Japanese clarity and Scandinavian cosiness. The elegant frame design in Como oak brings together minimalist lines and modern comfort. The delicate 16 mm frames are made possible by extra-deep upright panels and cover shelves, while the bar handle in Como oak complements the overall design. Minimalist shapes, soft colours and natural materials create a calm, restrained and pleasant ambiance – the ideal response to the growing demand for clarity and serenity in the home.



DELICATE FRAMES AS A DESIGN FEATURE

This example shows the distinctive details that create a modern room concept in the Japandi style: The delicate 16 mm frame is possible thanks to extra-deep upright panels and cover shelves. The wooden screw-on bar handle 315 in Como oak complements the sophisticated frame design.

VERSATILE DESIGN FOR CALM ROOM CONCEPTS

The Sakura planning concept permits consistent design for kitchens and bathrooms – functional, beautiful and tailored to each customer's needs.



SAKURA DESIGN CONCEPT: A FRAMEWORK FOR VERSATILE DESIGN

Wood-look frames are the consistent design element of the Sakura line – and can be combined with a wide selection of fronts. Whether solid colours or wood décors: The concept can be used on any smooth front and lets you create a personal interpretation of the japanese-scandinavian interior design style.

WORKTOP SLIM LINE APSLN61
16 mm thick,
recommended worktop depth: 605 mm

A matching product from our Slim Line range that combines perfectly for a consistent overall style.



**WOODEN SCREW-ON
BAR HANDLE 315**
Como oak

Visually designed to match our worktop in Como oak.

For a surcharge: 7941
Drill pattern: 01
Drill spacing: 320 / 160 mm
Height: 21 mm

Planning note: Bar handles on panels / pull-outs / drawers / flaps are supplied in front width. Fixed panel and pinned fronts are also fitted with a bar handle. The bar handle on hinged doors is offset inward by 50 mm on the stop side.

**EXTRA-DEEP UPRIGHTS
AT END OF RUN**
Como oak reproduction

Upright panel depth, base unit / tall unit:
603 mm

Upright panel depth, wall unit /
sideboard / occasional furniture:
392 mm

Upright panel depth, bathroom base unit:
503 mm

FRONT

Whether in classic white or combined with natural hues: Sakura can be combined with any smooth front.

Not available for framed doors:
CASCADA 684, FRAME 419,
INLINE 526, NORDIC 497, PURA 917
and SYLT 706



UPGRADE FOR HANDLELESS DESIGNS

The trend toward minimalist designs opens up new options for modern planning. With LINE One, handleless design focuses on clean, horizontal lines in the kitchen. LINE One drawers and pull-outs are convenient to open thanks to the Push-to-open system. To complement the lighting options for horizontal recessed handles, the 2026 collection introduces lighting for vertical recessed handles. This detail creates an even greater ambiance with indirect, pleasantly harmonising light elements. New Curve options for sink units complement the kitchen product range. The organic contours of Curve end fronts loosen up the lines of the design and are now also available with a hinged door for bathrooms and living rooms in the entry-level price segment.



LINE ONE

Minimalist lines with great convenience: LINE One combines the design versatility of LINE N with the convenient push-to-open technology of the nBOX drawer system.

LINE N HANDLE PROFILE

11 handle profile colours – the right solution for any style: tone-in-tone harmony or modern contrasts.

LINE N RECESSED HANDLE

A recessed handle is used to open doors, top pull-outs and top drawers.

PUSH-TO-OPEN PTOSA

Drawers and pull-outs are factory-equipped with PTOSA and open with a light push on the front.

RANGE OF ELEMENTS

LINE One is a pre-defined product range in the base unit heights 720 and 792 mm and in all highboard and tall unit heights.

LINE one



EXPANSIONS FOR LINE N ELEMENTS

LIGHTING FOR VERTICAL BAR HANDLES

The new aluminium profile is available in a lighted and unlighted version and is both practical and a design statement.

SURCHARGE FOR LED LIGHT DESIGN FOR VERTICAL RECESSED HANDLE MP-NGMS

- For lighting the end-of-run recessed handle NGMA* and the recessed handle between units NGMZ*
- Energy efficiency class: G / degree of protection IP44
- With Emotion technology
- A surcharge will be invoiced per recessed handle

LED starter sets LSET-SMART36/60(-FB) are not included. Take into account the following special notes when planning housings for ovens, microwaves, steam ovens and compact appliances:

- The lighting can only be installed opposite the fastening strip
- Not possible with end-of-run recessed handle NGMA*
- Not possible between two housings
- The lighting MP-NGMS cannot be retrofitted



As a variant of the LINE N range, LINE One permits restrained, end-to-end horizontal lines – but without having to forego the convenience of drawers and pull-outs.

The defined range of elements can be combined with items from the familiar LINE N range. This makes it possible for LINE N elements with just one recessed handle such as hinged door units or elements with internal drawers and pull-outs to be combined with LINE One units. The LINE N chapter of the Sales Manual lists all alternatives. These are marked with an icon and the code PTOSA in the sketches.

The product codes have a different first letter.

- N** = LINE N (e.g. NU2SA)
- L** = LINE One (e.g. LU2SA)

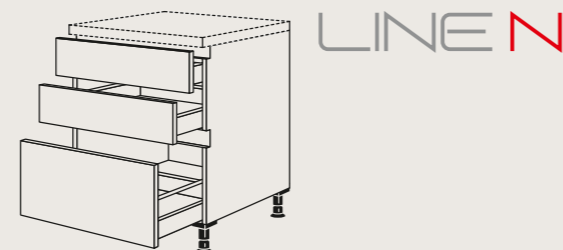

NU2SA

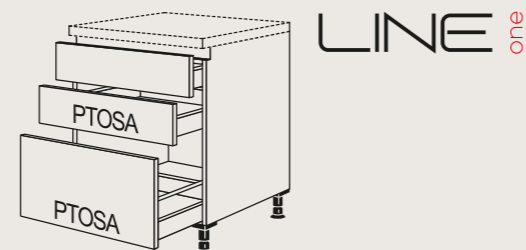

LU2SA



EXPANSION CURVE ELEMENTS

We are expanding the LINE N and LINE One range with Curve units with hinged doors for kitchen and bathroom designs.



SPACE FOR INDIVIDUAL DESIGN

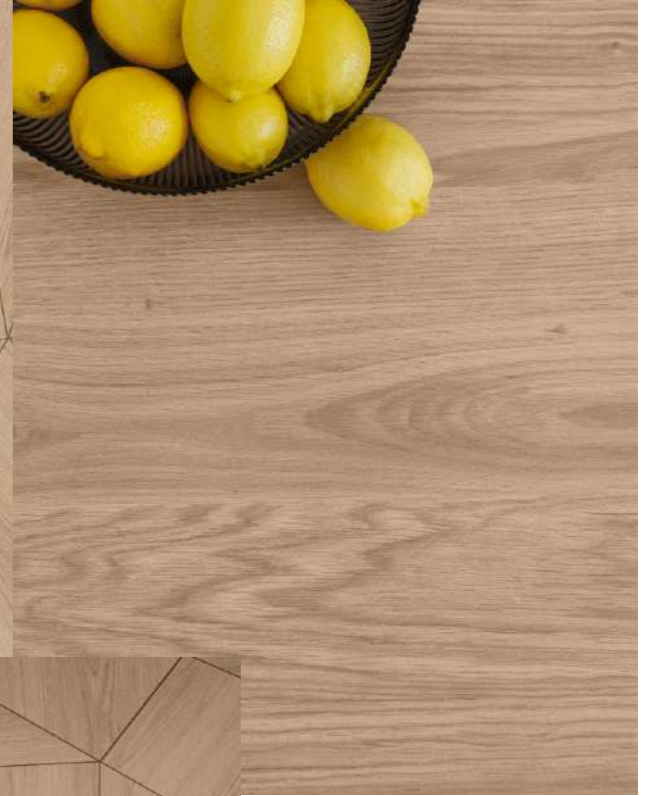

MODULAR VERSATILITY
CUSTOMISABLE SOLUTIONS
STRONG COLOUR CONCEPTS

An ever-growing number of people are using their homes to express their personality. Different lifestyles and preferences define the demand for customisable solutions that are both convenient and have aesthetic appeal. Innovative, long-lived materials and a broad selection of décors in trend colours or natural wood and stone looks create space for personal fulfilment. Versatile design elements make it possible to add deliberate eye catchers or create balanced transitions – for designs that adapt flexibly to any style and demand.

WORKTOPS WITH 25 MM THICKNESS

Modern design, created to be convenient in everyday use and give greater flexibility: Our worktop range now offers even more freedom for customised designs. The expanded diversity of décors and the new thickness of 25 mm open up a world of additional options – and permit the full range of modifications. The ideal selection, then, for planning without compromises.



MINIMALIST DESIGN, FULL FUNCTIONALITY

With its slim elegance, the new 25 mm thickness represents modern design and perfectly matches our extensive range of 25 mm thick upright panels. Benefit from even more flexibility when making current living trends a reality.



WORKTOP DÉCOR 198 DG 1
Sierra oak reproduction
—
25 mm

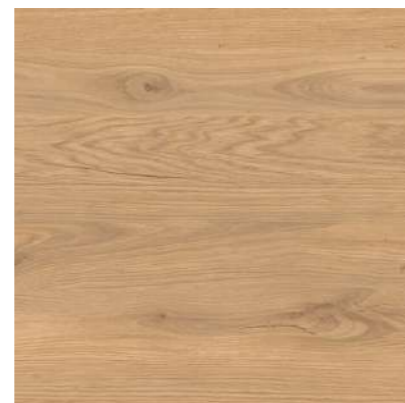

WORKTOP DÉCOR 243 DG 1
Honey oak reproduction
—
25 mm



SLIM DESIGN, GREAT OPTIONS

Be it the new 25 mm thickness or our popular, delicate 16 mm Slim Line – the slim look now comes with all modification options previously available only for our 38 mm standard worktops. Beveling and rounding is therefore available for all 3 worktop thicknesses.



WORKTOP DÉCOR 214 DG 1
Black marble reproduction
—
25 mm



WORKTOP DÉCOR 354 DG 1
Concrete slate grey reproduction
—
25 mm



WORKTOP DÉCOR 237 DG 1
Jura greige marble reproduction
—
25 mm



WORKTOP DÉCORS

We have added nine new décors to our range, and they combine beautifully with all front and carcass colours. Matching upright panels and niches create a balanced overall design down to the smallest detail.

The design versatility of Slim Line is also growing: In addition to the popular décor Como oak, we now also offer Xtra honed designs.



WORKTOP DÉCOR 214 DG 1
Black marble reproduction
 —
 38/100 mm
 • Also available in a thickness of 25 mm



WORKTOP DÉCOR 218 DG 1
Pangaea grey marble reproduction
 —
 38/100 mm



WORKTOP DÉCOR 236 DG 1
Mystic grey marble reproduction
 —
 38/100 mm

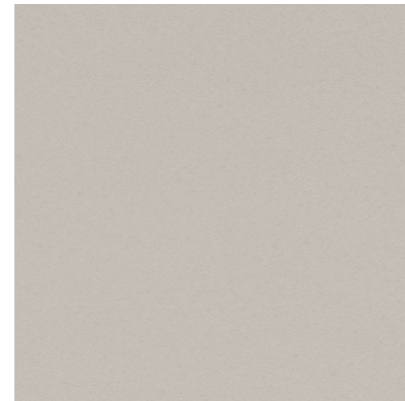

WORKTOP DÉCOR 245 DG 1
Sand textured
 —
 16 mm



WORKTOP DÉCOR 237 DG 1
Jura greige marble reproduction
 —
 38/100 mm
 • Also available in a thickness of 25 mm



WORKTOP DÉCOR 238 DG 1
Amber quartzite reproduction
 —
 38/100 mm



WORKTOP DÉCOR 243 DG 1
Honey oak reproduction
 —
 38/100 mm
 • Also available in a thickness of 25 mm

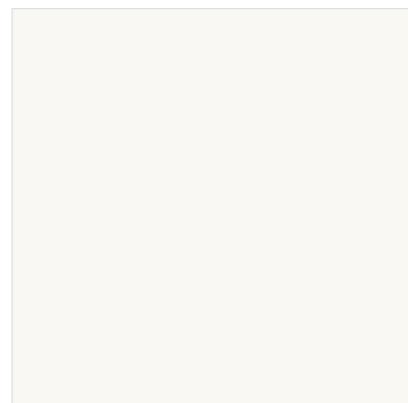

XTRA WORKTOP DÉCOR 381 DG 2
Honed alpine white Xtra
 —
 16 mm



XTRA WORKTOP DÉCOR 389 DG 2
Honed macchiato Xtra
 —
 16 mm



WORKTOP DÉCOR 362 DG 1
Como oak reproduction
 —
 16 / 38 / 100 mm
 • Now also available as Slim Line in 16 mm



WORKTOP DÉCOR 392 DG 1
Nevada oak reproduction
 —
 38/100 mm
 • New décor designation
 • Previously sold under the name 392 Master oak reproduction

AN IDEAL COMBINATION

Beauty all around! Our new surround colours let upright panels, plinths and shelf units meld seamlessly with our new fronts or the worktop décors, creating a beautifully coordinated overall design.

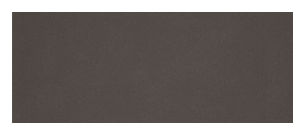

UPRIGHT PANEL
COLOUR 047

Coffee textured

· Matching plinth color
067 Coffee



UPRIGHT PANEL
COLOUR 133

Macchiato

· Also available as plinth
and shelf unit colour

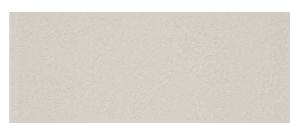

UPRIGHT PANEL
COLOUR 245

Sand textured



UPRIGHT PANEL
COLOUR 483

Lacquer,
premium honed macchiato



UPRIGHT PANEL
COLOUR 505

Lacquer,
perfect honed coffee



UPRIGHT PANEL
COLOUR 513

Lacquer,
taupe grey high gloss



UPRIGHT PANEL
COLOUR 613

Lacquered laminate,
white wood texture



UPRIGHT PANEL
COLOUR 614

Lacquered laminate,
stone blue wood texture
· Matching plinth and shelf
unit colour 040 stone blue



UPRIGHT PANEL
COLOUR 617

Lacquered laminate,
olive wood texture

· Matching plinth and shelf
unit colour 033 olive

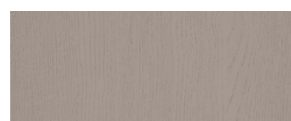

UPRIGHT PANEL
COLOUR 619

Lacquered laminate,
macchiato wood texture



UPRIGHT PANEL
COLOUR 788

Lacquer,
perfect honed sand



UPRIGHT PANEL
COLOUR 791

Lacquer,
perfect honed black

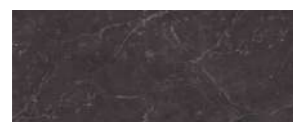

UPRIGHT PANEL
COLOUR 214

Black marble
reproduction



UPRIGHT PANEL
COLOUR 218

Pangaea grey marble
reproduction



UPRIGHT PANEL
COLOUR 236

Mystic grey marble
reproduction



UPRIGHT PANEL
COLOUR 237

Jura greige marble
reproduction



UPRIGHT PANEL
COLOUR 238

Amber quartzite
reproduction



UPRIGHT PANEL
COLOUR 243

Honey oak
reproduction



UNIQUE DESIGN: WE HAVE A HANDLE ON IT

Small details with great effect! From tone-in-tone to match the front, through wood looks, to modern materials like bronze – our ten new handles, from knobs to bar handles, open up a world of design to underline each customer's individual style.



225 METAL HANDLE
Bronze metallic colour
192 mm
SURCHARGE 7945



226 METAL HANDLE
Black
192 mm
SURCHARGE 7945



257 METAL HANDLE
Yellow gold coloured
160 mm



262 METAL HANDLE
Titanium-coloured
160 mm



265 METAL HANDLE
Bronze metallic colour
192 mm
SURCHARGE 7945



813 METAL HANDLE
Yellow gold coloured
16 mm



831 METAL KNOB
Bronze metallic colour
16 mm



838 METAL HANDLE
Black
16 mm



315 WOODEN SCREW-ON BAR HANDLE
Como oak
Recommended for the Sakura design line
320 / 160 mm
SURCHARGE 7941



008 LINE N RECESSED HANDLE
Macchiato

CREATIVE NICHE DESIGN

Our diverse range of niche cladding styles opens up a vast variety of options for creative room design. Tile, natural stone and wood looks seem almost real and give the design an exciting depth, thanks to their vivid textures. This experience of look and feel is sure to inspire.



NVM 599
Décor, natural Terrazzo
—
3D digital print



NVM 570
Décor, wall panel,
stone blue wood texture
—
3D digital print



NVM 592
Décor, wall panel,
Sierra oak
—
3D digital print

NVM 557
Décor, wall panel,
olive wood texture
—
3D digital print



NVM 556
Décor, herringbone,
Como oak
—
3D digital print



NVM 598
Décor, Wood-Art,
Como oak
—
3D digital print



NVM 555
Décor, vintage tile,
green
—
3D digital print



NVM 586
Décor, wall panel,
macchiato wood texture
—
3D digital print



nBOX WITH STYLISH EXPANSIONS

Our successful switch to the innovative drawer and pull-out system nBOX represents a major milestone in the evolution of our products. Based on this success, we are expanding our 2026 collection with new, stylish designer options that respond to current trends and offer greater freedom of design.



P199

P399

DESIGN PROFILE MP-DPRO

- Surcharge for design profile
- Can be used on all (internal) drawers and (internal) pull-outs
- A surcharge is invoiced per (internal) drawer and (internal) pull-out

Now also available in

P199 Anthracite metallic colour

P399 Milano walnut reproduction



DESIGN GLASS SIDE MP-GLAS

- Surcharge for glass side
- Usable on all (internal) pull-outs with a rectangular railing
- A surcharge is invoiced per (internal) pull-out

Now also available in

G058 Parsol glass, bronze



C199

C399

DESIGN COVER MP-DCOV

- Surcharge for design cover
- Individually selectable frame design for the sides
- Aluminium profile for clipping on
- Can be used on all (internal) drawers and (internal) pull-outs
- A surcharge is invoiced per (internal) drawer and (internal) pull-out

Now also available in

C199 Anthracite metallic colour

C399 Milano walnut reproduction



DESIGN THAT ADAPTS

A small detail for great effect:

The nBOX system offers unique design options in the furniture interior. From a subtle highlight to a completely new look, our design profiles and design covers make it possible to create a wide range of design variants. Attaching and replacing covers and profiles is simple and requires no tools. With these options, nBOX has a matching interior design for any lifestyle and any space.

Select your style!



GLASS CABINET AIR: FOR SOPHISTICATED LOVERS OF FORM AND FUNCTION

This product is an expressive statement for lovers of design that appreciate minimalism: The glass wall and tall units Air combine modern transparency with technological sophistication. The delicate black aluminium frame features an integrated handle profile and emphasises the elegant, restrained look.

PRACTICALLY INVISIBLE – YET A REAL HIGHLIGHT!

The hinges are fully hidden in the narrow aluminium profile. This creates a light, modern look and proves the first-class craftsmanship of this product – making it an ideal choice for kitchens, living rooms or bathrooms. As an option, the units can be equipped with an eye catcher back panel. For further information, see page 95.



ALUMINIUM-FRAMED GLASS DOOR AIR

Wall units WGAIR*

in heights 1, 2, 3, 130 and
widths 300, 450, 500, 600 mm

Tall units HGAIR*

in all heights and widths 300 and 600 mm
(without highboard)

- Side depth 350 mm, therefore décor texture on both sides
- Total depth: 379 mm

The interior décor of glass cabinets Air always matches the exterior carcass décor. In addition, the units can be equipped with an eye catcher back panel.



SLIDING DOORS WITH VERSATILE APPLICATIONS

Sliding doors for installation in front of walls are quick and easy to install directly in front of the wall, without requiring costly wall renovation. This installation method makes them easy to retrofit for exceptional flexibility. Be it as a room divider, for built-in closets or walk-in wardrobes – our sliding doors are true universal talents when it comes to efficient use of limited space. To expand the design freedom provided by our sliding doors, we now offer two new glass panel designs: grey glass and bronze mirror. This gives you even more options for offering your customers stylish yet practical solutions.

1-TRACK SLIDING DOOR SYSTEM FOR MOUNTING IN FRONT OF WALL

- Available in 3 sliding door sets:
 - 1 door, without stop toward wall GSWSET 001
 - 2 doors, without stop toward wall GSWSET 002
 - 1 door, stop toward wall GSWSET 003
- For door widths from 500 to 1200 mm

COLOUR RANGE EXPANSION



103 Mirror, bronze colour



104 Grey glass



KITCHEN UPDATES

Our new features are all about clever solutions, systematic expansions and surprising details to make everyday life in the kitchen simpler and richer.

We inspire your customers and help them design a kitchen that is unique and fits their needs – with designs that feature sophisticated function and appealing design and create noticeable added value.



01.

—
FurnSpin: Momentum in
the world of fittings

—
See page 72

02.

—
Diagonal units – a clever
storage space solution
for narrow rooms

—
See page 74

03.

—
GPNext by BORA:
The exclusive successor of
the successful GP4U

—
See page 84



NEW MOMENTUM: FITTING INNOVATION FURNSPIN

FurnSpin opens up a range of new creative design options for better use of storage space. It all revolves around a true innovation in the world of fittings: FurnSpin permits a unique pivot-swivel movement that allows the base unit to turn completely around its own axis. The inside becomes the outside or vice versa. All without bothersome open doors or flaps. Hidden hinges, cushioning and the push-to-open function make elegant design come together with maximum convenience.



FURNSPIN UFSP60 (-X)

This master of transformation combines two pieces of furniture in one: Just a single turn makes shelf elements and the unit interior visible and easily accessible. Another turn gently returns the contents to where they came from, hiding them behind closed fronts. This fascinating design transition creates an emotional experience and gives the space a completely new vibe, depending on which side is visible.

The FurnSpin is available in a clearly defined range of fronts. The selected front colour automatically determines the matching carcass colour.

Available fronts:

- 615 LASER:
only fronts 427 Alpine white / 416 White / 415 Sand / 461 Taupe grey / 412 Macchiato
- 371 RIVA:
only front 842 Concrete Sand reproduction
- 357 SENSO:
only fronts 490 Lacquer, premium honed alpine white / 488 Lacquer, premium honed white / 491 Lacquer, premium honed slate grey / 483 Lacquer, premium honed macchiato / 496 Lacquer, premium honed black
- 945 EASYTOUCH:
only fronts 969 Lacquered laminate, sand ultra matt / 970 Lacquered laminate, taupe grey ultra matt

Dimensions:

- Base unit 600 mm wide
- In heights 720 and 792 mm



The pivot-swivel hinge FurnSpin has already received multiple international awards for its high level of innovation:



CLEVER USE OF SPACE WITH DIAGONAL UNITS

Narrow rooms and kitchen alcoves require clever storage space solutions that open up the space visually and are practical at the same time. Diagonal units with a bevelled carcass offer just that: They make tight spaces look more open and visually create more space. This solution is a favourite among planners. Diagonal units are also an elegant option for protruding solutions.



- Suitable for end-of-run and protruding areas with 179 mm depth
- Planning cottage-style open-shelf end-of-run units or pilasters as immediately adjacent units is not permitted in the programs CASCADA 684 and NORDIC 497
- Connection to built-under appliances and handleless versions or width reductions are not possible

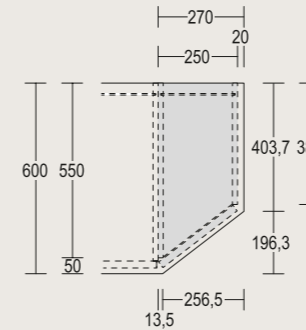

BASE UNITS UDIAD25
DIAGONAL, 250 MM WIDE

- Base unit, diagonal
- 1 door
- 1 insertable shelf

Also available as
side pull-out variant UDIAAD

Available heights: 720 mm, 792 mm



TALL UNITS HDIAD25* / HDIAF25*
DIAGONAL, 250 MM WIDE

- Tall unit, diagonal
- 1 door
- 1 fixed shelf and 4 insertable shelves
- Side depth: 550 / 382 mm
- Planning dimension: 561 / 382 mm

Available in all highboard and tall unit heights



WALL UNITS WDIA25*
DIAGONAL, 250 MM WIDE

- Wall unit height 576 mm:
- 1 insertable shelf
- Additional wall unit heights
- 2 insertable shelves
- Side depth: 338 / 170 mm
- Planning dimension: 350 / 170 mm

Available heights: 576 mm, 720 mm, 792 mm, 864 mm

NEW DIMENSIONS FOR EVEN MORE POSSIBILITIES

What started with a 750 mm fridge has now been developed even further: We have added a width of 762 mm to create a consistent planning option that represents an intelligent combination of function and design. A matching cupboard and dresser unit as an elegant storage space expansion all the way up to the ceiling complement the concept. At the same time, the 762 mm size opens up completely new opportunities – for instance as a wider door size for single-door access solutions.

CUPBOARD/PANTRY UNIT HDV76*

IN 762 MM WIDTH

- 2 doors
- 2 fixed shelves
- 4 or 5 insertable shelves depending on the height

Available in heights 1 to 3X.



DRESSER UNITS NAHS 76* / NAHSK76*

IN 762 MM WIDTH

- LINE N dresser unit for mounting on tall units
- Height 288, 360 and 432 with flap NAHSK76*
- Height 501, 576, 648 and 720 with hinged door NAHS76*



ACCESS DOOR HDWDT* WITH 110° HINGE

IN 762 MM WIDTH

- 1 lug-connected door
- 2 upright panels, 16 mm thick, in all carcass colours, in carcass height
- 1 cover panel, 16 mm thick
- 1 plinth panel incl. connecting bracket

Available in heights 1 to 3X.

TECHNICAL UPGRADE TO 110° HINGES

The 2026 collection also includes an upgrade of our current access doors to 110° hinges. This adaptation applies to all door widths.



KITCHEN SOLUTIONS EXPANDED WITH A SYSTEM

Our practical design to perfectly meet the needs of your customers: Thanks to systematic product range expansions, we can offer precisely the kind of perfect-fit product types, sophisticated table solutions, new lighting concepts and practical accessories that complement a kitchen for everyday life. This versatility does not just create convenience but also permits tailored planning solutions – for kitchens that are designed to impress on every level.

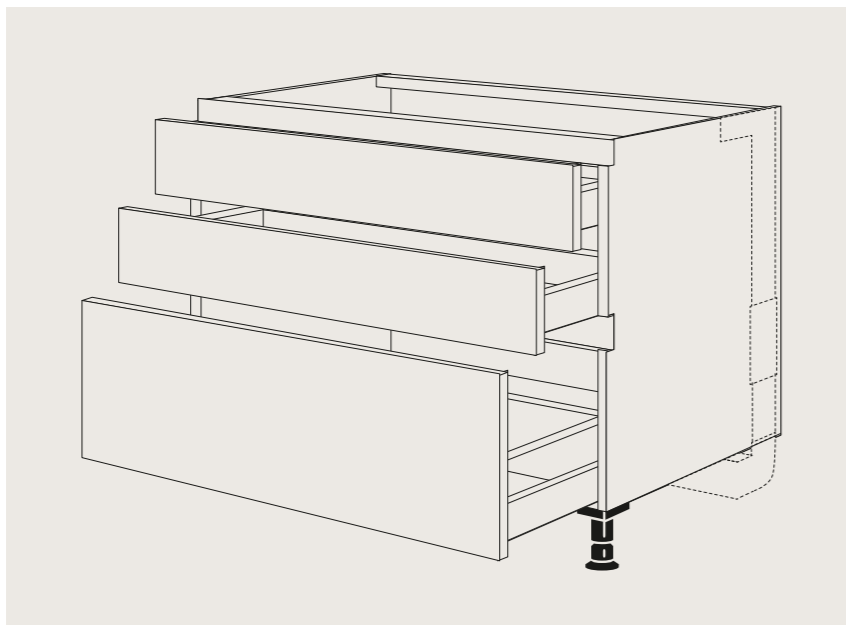

HOT PLATE UNIT FOR PANORAMA HOT PLATE EXTRACTOR FAN KMP* WITH VERTICAL MOTOR

—
It is absolutely necessary that the appliance information is included in the order, since drawer and pull-out depths are dependent upon the appliance used and the empty space planned and are configured accordingly at the factory.

Available widths:
900, 1000, 1200 mm
Available heights:
720, 792, 864 mm

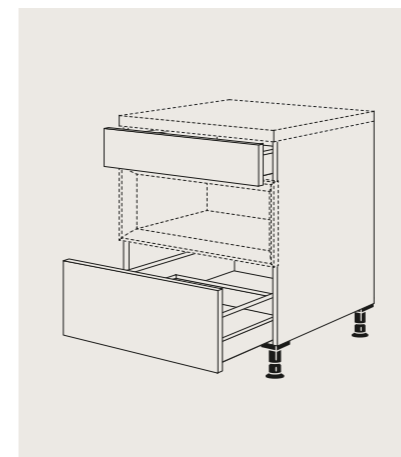

XL PULL-OUT UNIT USAC*-X FOR CASE SHELF INSERT

- Shelf insert height: 285 mm
- 1 drawer
- 1 pull-out

Available widths: 300 to 1200 mm



SURCHARGE FOR CARCASE INTERIOR DÉCOR 194 MP-KID

—
CARCASE INTERIOR COLOUR SLATE GREY

As of the 2026 collection, 90° corner units are also available with slate grey 194 as the interior colour.



SINK UNIT FOR WATER TREATMENT SYSTEMS AND CUSTOMER-SUPPLIED RECYCLABLES CONTAINER SYSTEMS SPUA(D)WA-BW*

- 2 fixed panels, 1 pull-out, 1 door
- Hinge on the right = pull-out on the right
- Hinge on the left = pull-out on the left

Available widths: 900, 1000 mm
Available heights: 720, 792, 864 mm

SINK UNIT SPUST(A)60* FOR BELFAST SINK

- 1 door or 1 door with pull-out rails
- 1 internal panel
- In special height

Available heights: 720, 792, 864 mm



EVISYS GUIDE HINGE EVIS

- For tall refrigerator doors with fixed hinge system



COVERING PROFILE VPGU FOR FIXED SHELVES IN APPLIANCE HOUSING UNITS

- The plug-in profile is intended for 19 mm shelves
- Optimum adaptation for seamless transitions between appliances

Available in 014 Stainless steel appearance and 010 Black.

ACCESSORIES

**BUILT-IN WASTE COLLECTOR
SINGLE AS10497**

- Made of plastic, dark grey
- Installation on the right or left, no strain on door hinges, 17 l volume
- Lid opens automatically when the door is opened
- Installation dimensions:
H x W x T: 386 x 331 x 294 mm
- Waste container can only be installed on the side wall with the door hinge
- Can be installed from door width of 450 mm

**BAKING TRAY HOLDER
BBHSET60**

- Set consisting of two holders, suitable for carcass width 600 mm
- For retrofitting in tall or base units

**EVOLINE SPIN
SPIN-F / -E**

- Retractable double socket with contact protection
- Housing made of plastic, black
- For mounting in worktops up to max. 50 mm thick
- Cut-out dimensions:
H x W x T: 48 x 120 x 92 mm
- 2500 mm power cable
- Sockets type F and E

ACCESSORIES

**OAK WOOD CUTLERY TRAY WITH INSERT FOR SPICE
CONTAINERS UP TO MAX. Ø 50 MM BE-GMS*E
SOLID WOOD DESIGN IN OAK**

- Height: 49 mm, side depth: 561 mm
- Fits drawer depth 500 mm
- For drawers with height of 141 mm, not possible in conjunction with construction or spacer shelves KKB* / DBKI*
- Not for use in conjunction with LED interior unit light LSID
- Not possible for drawers SKU* and SKA*
- Available widths: 600, 800, 900, 1000, 1200 mm

Also available as **slate grey ash wood cutlery tray with insert for spice containers up to max. Ø 50 mm BE-GMS*ES** in solid ash, painted slate grey.

**SLATE GREY ASH WOOD CUTLERY TRAY
WITH KNIFE BLOCK BE-M*ES
IN SOLID ASH, PAINTED SLATE GREY**

- Incl. 5 knives
- Height: 49 mm, side depth: 561 mm
- Fits drawer depth 500 mm
- For drawers with height of 141 mm, not possible in conjunction with construction or spacer shelves KKB* / DBKI*
- Not for use in conjunction with LED interior unit light LSID
- Not possible for drawers SKU* and SKA*
- Available widths: 600, 800, 900, 1000, 1200 mm

Also available as **oak wooden cutlery tray with knife block BE-M*E** in solid wood design in oak.

PLATE RACK THR

- Solid wood design in oak
- For inserting in 500 mm wide shelf compartments

WINE RACK WKR

- Solid wood design in oak
- For inserting in 450 mm wide shelf compartments
- Compartment height: min. 298 mm
- For usable depth: 345 mm

**DOOR SHELF SET OAK TRSET
FOR TALL UNITS**

- For spice containers
- Solid wood design in oak
- Set consisting of 2 shelf units
- Height 360 mm each
- 1 frame with 2 boxes 430 mm x 96 mm
- 1 frame with 1 box 430 mm x 116 mm

When installed at a later date, the insertable shelf must be shortened on site.

TABLES



**TABLE TOP IN KIDNEY SHAPE
APDTNL
FOR CENTRO**

—
The kidney-shaped table top is the perfect organic design element – available with the contours on the right or, now also, on the left.

- In fixed dimensions, with décor edge, 38 mm thick
- In the sizes:
2200 × 1050 mm and 2400 × 1050 mm



TABLE FRAME CENTRO ATKC106 / 116*
FOR ATTACHMENT TABLES

- Black, powder-coated steel
- Height adjustment: -10 / +20 mm
- Available heights: 720 mm / 870 mm
- Planning height: 710 to 760 mm / 860 to 910 mm

ATKC 106*

- Frame width: 540 mm
- Worktop depth of 600 to 900 mm
- With max. 1400 mm worktop overhang to a wall or base unit

ATKC 116*

- Frame width: 740 mm
- Worktop depth of 901 to 1200 mm
- With max. 1400 mm worktop overhang to a wall or base unit

Please note: This solution cannot be combined with quartz or Xtra Ceramic worktops and is not intended for constructing free-standing, separate tables, bar counters or similar elements.

LIGHTING



**SURCHARGE FOR GLASS
WALL UNITS WITH LED LIGHT
DESIGN LUCIA
MP-LML-O / MP-LML-U
IN UNIT TOP SHELF
OR BOTTOM SHELF**

- Unit top shelf with integrated LED built-in light LUCIA and 1700 mm connection cable to starter set
- Energy efficiency class: E
- Available for wall units with glass doors, units with sliding glass doors, glass roll-up front units, climbers, bevelled shelves, open shelf base and wall units in height 360 mm

In bottom shelf:

- Available for wall units and shelf units from 300 to 1200 mm width, with a side depth of min. 190 mm
- Not available for wall units with draining rack or climber

Width and depth reductions are not permitted. For optimum illumination, lights of varying widths are used.



**LED CORNER CONNECTOR
HUE LINEAR GRADIENT LNHLGE***

- 90° inner corner for LED niche light Hue Linear Gradient LNHLG*



**LED BUILT-IN / TOP-MOUNTED
LIGHT HUE SPOT WHITE COLOR
AMBIANCE
LHSPOT / LHSPOT-SET**

- Black
- LED – 2.5 W / 24 V DC, 2200 – 6500 K RGBTW, 2000 mm connection cable, 6 pins to starter set
- Diameter: 81 mm, height 16 mm, built-in depth: 13 mm, drill diameter: 68 mm
- For mounting in wall units with glass doors, cornice and bridging shelves
- Energy efficiency class: G

VK-LEDH*

- LED extension cable 2000 mm for extending the connection cable to the distributor of the built-in light Hue Spot White Color Ambiance



LED UNIT INTERIOR LIGHT HIDE

—
As of the 2026 collection, the LED unit interior light Hide is also available for the glass tall unit Air LSIDHGAIR*.

ELECTRIC APPLIANCES WITH STYLE FOR THE FUTURE

We are adding state-of-the-art electric appliances to our product range to offer intelligent solutions that combine function, design and efficiency. And these are available even at attractive entry-level prices. Our selection meets even the most exacting demands and adapts perfectly to the needs of modern households. This makes cooking more convenient, quieter and smarter than ever before.



ADDITION TO ELECTROLUX RANGE

Electrolux brings together Swedish values and a love for nature and develops products with clear, sustainable purpose – to benefit future generations and maintain the ecological balance. This sense of responsibility for the world is reflected in the company’s products: Electrolux creates innovative, high-quality solutions that open up a world of new flavours, make everyday life easier and put sustainability front and centre. 68 built-in appliances by this brand are complementing our 2026 range.



DOWNDRAFT EXTRACTOR FAN GPNEXT

GPnext is the technical upgrade for our exclusive BORA hot plate extractor fan GP4U. This successor model is based on the current Pure platform and features its own user interface, a new jet design and modern, clear print. GPNext is available in a width of 600 or 800 mm – the 800 mm variant comes with or without a bridging function.



GPNext E60N



GPNext E80N



GPNext E80P with bridge function



DIVERSITY FOR ANY KITCHEN PLAN

Various sink sizes, materials and designs offer maximum flexibility for tailored kitchen planning – from classic stainless steel to innovative surfaces. With their easy-care, durable properties, these products handle everyday life beautifully. They are complemented by matching taps in stainless steel, chrome or, as a modern eye-catcher, black.



GESSI HIGH-PRESSURE SINGLE-LEVER MIXING TAP MIX

- Connection for hot and cold water
- Swivel spout, swivel range 360°
- Aerator 24 mm diameter
- Flexible connection hoses
- Reinforced panels

Available colour: chrome

Only available in a bundle with the sink RODI Okio Line 80.



GESSI HIGH-PRESSURE SINGLE-LEVER MIXING TAP HAMPSHIRE

- Connection for hot and cold water
- Swivel spout, swivel range 360°
- Aerator 21 mm diameter
- Flexible connection hoses
- Reinforced panels
- Also available with pull-out swivel spout

Available colour:
Black matt



KLUDI HIGH-PRESSURE SINGLE-LEVER MIXING TAP FLAT

- Connection for hot and cold water
- Swivel spout, swivel range 360°
- Aerator 24 mm diameter
- Flexible connection hoses
- Reinforced panels

Available colours:
Stainless steel appearance
and Black matt



CARLO NOBILI HIGH-PRESSURE SINGLE-LEVER MIXING TAP MANIA

- Connection for hot and cold water
- Swivel spout, swivel range 180°
- Aerator 28 mm diameter
- Flexible connection hoses
- Reinforced panels

Available colours:
Chrome and Black matt



CARLO NOBILI LOW-PRESSURE SINGLE-LEVER MIXING TAP

- Connection for cold water and for hot water appliance
- Swivel spout, swivel range 360°
- Aerator 24 mm diameter
- Flexible connection hoses
- Reinforced panels



SCHOCK BELFAST SINK KALLIO M 100, MADE OF CRISTADUR® GREEN LINE

- 1 basin 518 × 465 × 220 mm
- Incl. 3 1/2" sieve valve
- Basin waste with drain and overflow set
- 3 tap holes, 3 of which are predetermined breaking points
- Odour stop
- Matching sink unit type SPUST60(-X/-M)
- Due to the tapered design of the sink, the worktop length must be planned 5 mm longer.

Outer dimensions (H/W/D):
234 × 598 × 630 mm

Available colours:
Day Green Line, Night Green Line
and Dusk Green Line



SCHOCK BELFAST SINK KALLIO M 175, MADE OF CRISTADUR® GREEN LINE

- 1 basin 456 × 465 × 220 mm
- 1 waste sink 326 × 465 × 220 mm
- Incl. 3 1/2" sieve valve
- Basin waste with drain and overflow set
- 3 tap holes, 3 of which are predetermined breaking points
- Odour stop
- Matching sink unit type SPUST90(-X/-M)
- Due to the tapered design of the sink, the worktop length must be planned 5 mm longer.

Outer dimensions (H/W/D):
220 × 898 × 630 mm

Available colours:
Day Green Line, Night Green Line
and Dusk Green Line



SCHOCK BUILT-IN SINK PATOS D-100 FB, MADE OF CRISTADUR®

- 1 basin 347 × 430 × 195 mm
- Drip tray
- Incl. 3 1/2" sieve valve
- Basin waste with drain and overflow set
- 2 tap holes, 2 of which are predetermined breaking points
- Odour stop
- Reversible
- Only suitable for flush mounting
- Available exclusively from us

Outer dimensions: 853 × 493 mm
Cut-out dimensions: 857 × 497 mm

Available colours:
Magma, Stone and Bronze



RODI BUILT-IN SINK BOX LUX 76, STAINLESS STEEL

- 1 basin 740 × 400 × 200 mm
- Incl. 3 1/2" sieve valve
- Basin waste with drain and overflow set
- 2 tap holes
- Odour stop
- Space-saving connector
- Incl. accessories:
Strainer 415 × 178 × 80 mm and
draining rack 415 × 157 × 57 mm
- Minimum sink unit width: 900 mm
- Combined with Slim Line worktops:
900 mm

Outer dimensions: 790 × 505 mm
Cut-out dimensions: 770 × 485 mm



RODI BUILT-IN SINK OKIO LINE 80, BASIN WASTE, STAINLESS STEEL WITH MIXING TAP

- 1 basin 340 × 400 × 160 mm
- Drip tray
- Incl. 3 1/2" sieve valve
- Basin waste with drain and overflow set
- 2 tap holes
- Odour stop
- Space-saving connector
- Minimum sink unit width: 450 mm
- Combined with Slim Line worktops:
900 mm

Outer dimensions: 800 × 500 mm
Cut-out dimensions: 780 × 480 mm



NEW IN OUR PROGRAM: NOBI SMART

Many customers are increasingly on the look-out for solutions and offers in an entry-level price segment. To support them systematically, we are strengthening the entry-level segment with our new nobi smart range. nobi smart is characterised by a narrow, easy-to-plan range of elements with attractive pricing. The new entry-level price segment is the result of our definition of a new price group 0. The prices for reference kitchens in this group are approximately 10% lower than those of price group 1.

We are proud to present nobi smart, a strong range of products at particularly attractive prices. We are confident that, together with you, we can create new impulses in the entry-level price segment.



ATTRACTIVE FRONTS IN PG 0

The SPEED program has been reactivated and is now available, together with the new FLAIR program, in 6 new front décors with matching surrounding elements.



Range no. 351

SPEED 244
Alpine white PG 0



Range no. 351

SPEED 259
Satin grey PG 0



Range no. 351

SPEED 239
White PG 0



Range no. 351

SPEED 252
Sand PG 0

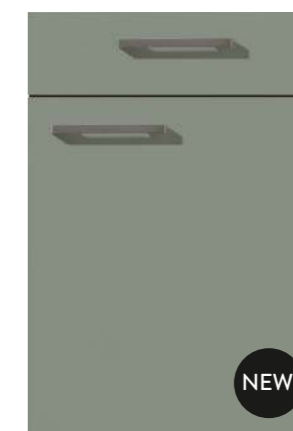

Range no. 351

SPEED 258
Reed green PG 0



Range no. 724

FLAIR 289
Sanremo oak reproduction PG 0

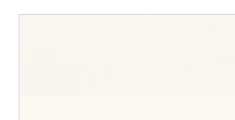

CARCASE COLOUR
193
Alpine white



CARCASE COLOUR
106
White



CARCASE COLOUR
122
Sand



CARCASE COLOUR
194
Slate grey



SHELF UNIT AND
PLINTH COLOR 038
Reed green
• Also as upright panel
colour 776



CARCASE COLOUR
070
Satin grey



CARCASE COLOUR
078
Sanremo oak
reproduction



CARCASE COLOUR
198
Sierra oak
reproduction



CARCASE COLOUR
097
Havana oak
reproduction



CARCASE COLOUR
127
Black



FOCUSED RANGE OF ELEMENTS

To permit quick and uncomplicated sales, we have made a focused, easy-to-plan range of elements available. nobi smart focuses on the essentials and permits uncomplicated, entry-level kitchen planning.



PROFI+ PULL-OUT MECHANISM

Drawers and pull-outs are equipped with the time-tested Profi+ pull-out mechanism.

EXPANSION OF UNITS & ACCESSORIES

- Base units in 30 cm width: UD30, US30, UA30
- Cooker housing HUB
- Corner sink base units: SPUE 90-45, SPUE 100-50, SPUE 100-60, SPUED 90-45, SPUED 100-50, SPUED 100-60
- Wall units: W 30-58, W 30-1
- Wall units for microwave: WM 50-1, WM 60-1
- Wall units for slimline cooker hood: WDAF 60-58, WDAF 60-1
- Cutlery tray Trend BE 30
- Fridge housings: G123 M-1, G123 L-1
- Electric appliances: Elica Slim Line cooker hood Elite 1460D stainless steel 88102



LAURUS APPLIANCES OFFERING ATTRACTIVE VALUE FOR MONEY

Quality and innovation in a broad product range, especially designed for the lower price segment! Laurus offers over fifty built-in appliances.



Available instantly, sustainable and cost-efficient: For nobi smart we are making use of digital sales documents in place of print media. You can find these in our extranet and in the media portal.

NEW DESIGNS FOR NEW LIFESTYLES

For us, modern living means customising your space and giving it personality. New, flexible design elements open up a variety of options for a new living experience. Modern mechanisms improve convenience and create versatility while high-quality materials exude natural warmth and elegance. The worlds of interior design created by these features adapt beautifully to all lifestyles – they are modern, personal and full of style.

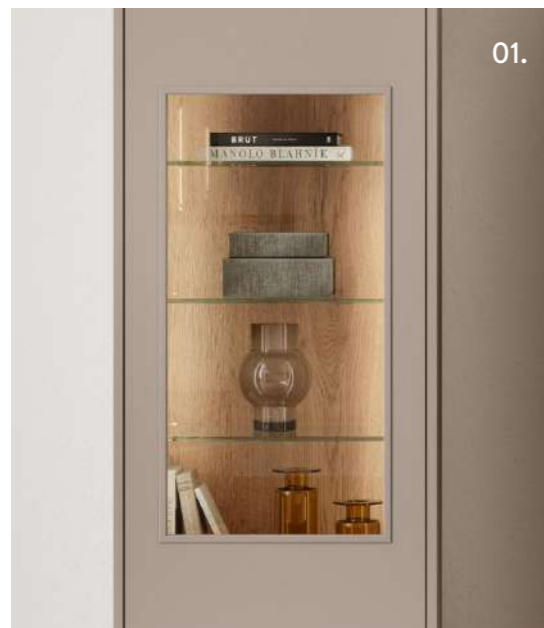

01.

—
Eye catcher back panels
open up a world of
exciting design options

—
See page 95

03.

—
Media tray –
The elegant glass solution
with integrated cable
management

—
See page 103

02.

—
Stylish new features in
the dining segment – from
tables with a Butterfly
system to elegant
upholstery

—
See page 100



WALL AND TALL UNITS WITH FRAMED GLASS DOOR AMBIA

Experience a whole new dimension of modern interior design: Our glass units Ambia combine proven functionality with an exciting approach to design. Their key features are asymmetrical glass cut-outs, which break up the classic unit image and create stylish highlights. Additional design elements, such as an eye catcher back panel in the unit or wall panels that can be freely attached to the wall behind the furniture create a cosy atmosphere with contemporary style. Optional atmospheric lighting also ensures even more ambiance and elegantly stages the glass cut-outs and contents. The result is an eye-catcher designed to impress, day and night.

WALL AND TALL UNITS WITH FRAMED GLASS DOOR AMBIA

- Design: clear glass
- Depth reductions not permitted
- Available widths: 400, 500, 600 mm
- Compartment shelves behind closed door = glass
- Wall units WGAMB* / WGMBG*
- Available heights: 720, 792, 864, 1296 mm
- Highboards and tall units HBGAMB* / HSGAMB*

Available in all carcasse colours.

Integrated interior lighting is only built into fixed shelves. You can find the matching LED unit interior light Hide LSIDHW-43 in the accessories, chapter Lighting. Optionally with eye catcher back panel MP-ARW at a surcharge, see chapter Surcharges and equipment options. Can be optionally combined with wall panel for customised planning WPANW* / WPANS*.



EYE CATCHER BACK PANELS OPEN UP SPACE FOR CREATIVE FREEDOM

The glass cut-out revealing the interior defines the character of our glass units. With their customisable features, these units add a vivid flair to a room – sometimes through beautiful contrasts, sometimes through coordinated balance – and thereby create an effect of fascinating depth.

SURCHARGE EYE CATCHER BACK PANEL MP-ARW (7916)

- Texture direction vertical for glass wall units, sideboards and tall units Ambia, Air and single-door wall units (bar) flap with framed glass door
- Available in carcasse and worktop décors, NVM décor 598 Wood-Art Como oak, 050 Mirror, bronze colour and 051 Mirror, slate grey (glass DG2)
- Not available in Xtra décors and 366 Black textured
- A surcharge per unit will be invoiced



WALL ELEMENTS

WALL PANEL FOR CUSTOMISED PLANNING
WPANW / WPANS

The new wall panel creates new freedom of design and is easy to integrate seamlessly, to create a wide variety of looks. This panel does it all, from elegant backgrounds for TVs, through eye-catchers with optional lighting to stylish staging for wall shelves and wall units. Well-placed notches make it easy to adapt this piece to adjacent furniture.

- Wall panel, 16 mm thick, incl. suspension fitting, 18 mm thick
- Available with horizontal grain WPANW or vertical grain WPANS
- WPANW: max. 2580 mm wide, 1800 mm high
- WPANS: max. 1800 mm wide, 2580 mm high
- As an option, the wall panel is available at a surcharge with a notch at the bottom left or bottom right NVAUSK (4050)
- Available in all carcass and worktop décors, except 366 Black textured and motifs in 3D texture. Not available in Xtra décors
- Invoiced per m², minimum price: 0.5 m²
- Optionally also available with LED light design MP-WPANL (6495)

NOTCH NVAUSK

- The notch is exclusively available at the bottom right or left
- Only one notch per panel is possible

BAR FLAP UNITS

Product expansion in the widths
1000 / 1200 mm



PLINTH-FREE LOOK

PLINTH HEIGHT 20 MM

Our 2026 collection adds a plinth height of 20 mm, which can be used with an installation height of 20 mm in the living room and up to 28 mm in the kitchen. This creates a practically plinth-free look for the design. The adjustment range is 20 mm to 35 mm. The plinth height 20 mm can be ordered in addition to the previous heights 70, 100, 150 and 200 mm for elements with plinth design and for designs with the sideboard surcharge MP-SB. Plinth panels and plinth side panels are not supplied with this design.

- The adjustment range is between 20 and 35 mm
- The base unit floor is factory-drilled for the 20 mm plinth height; the adapters are installed on site
- Also order plinth height 20 mm to stack base units in special heights on top of each other
- The safety bracket KIPPS20 is included as standard with plinth height 20 mm and ensures stability for positioning against the wall

Planning information for kitchens

In kitchens, as a rule the new plinth height is used with an installation height of 28 mm. This height is achieved by making use of the adjustment range. The new plinth height of 20 mm may not be used in the "active areas" of the kitchen (cooking, washing dishes, cooling) for ergonomic reasons, even in installation height 28 mm. Moreover the new plinth height is not suitable for planning access doors. Elements are marked accordingly in the Sales Manual.



Notes for free-standing island designs without wall attachment

Single-run island designs with a plinth height of 20 mm are not permitted. On two-run islands, one side must have a minimum plinth height of 70 mm so that the safety bracket KIPPS can be installed.

New element range for the Living Sales Manual

To permit more convenient planning of pure living concepts, the Living Sales Manual includes 400 new elements as floor-standing lowboards, sideboards and highboards with a plinth height of 20 mm.



NATURAL GROWTH: OUR GENUINE WOOD VENEER RANGE

Sideboard, bar flap, wall panel, wall unit or base unit: Our range of genuine wood veneer products is growing. With natural warmth and a delicate grain, genuine wood veneer furniture in Native Oak offers plenty of design options for a balanced room concept. As stand-alone furniture, these pieces draw all the eyes, and in a group they display their full, impressive effect. A combination with the single-coloured unit elements from our current collection creates stylish highlights. Matching dining and coffee tables in the same veneer complement the overall style.



EXPANSION OF VENEERED UNITS

- Base unit, wall-mounted BUEF45-86 and sideboard, floor-standing SEF45-86 with mechanical opening support mechanism, carcass height: 864 mm, width: 450 mm, depth: 461 mm
- Base unit with bar flap, wall-mounted BUKBEF*-36 and floor-standing UKBEF*-36 with mechanical opening support mechanism, carcass height: 360 mm, widths: 600, 900 and 1200 mm, depth: 461 mm
- Pull-out units, wall-mounted and floor-standing, with mechanical opening support mechanism, in the widths: 600, 900 and 1200 mm, depth: 461 mm and carcass heights: 360, 576 and 864 mm
- Design with 1 pull-out box, wall-mounted BUAEF*-36 and floor-standing UAEF*-36, carcass height: 360 mm
- Design with 2 drawers and 1 pull-out box, wall-mounted BU2SAEF*-58 and floor-standing U2SAEF*-58, carcass height: 576 mm
- Design with 1 drawer and 2 pull-out boxes, floor-standing SBS2AEF-86, carcass height: 864 mm
- Midi unit, wall-mounted, with mechanical opening support mechanism and a door or as a glass cabinet with segmented glass door in grey glass, carcass height: 1296 mm, width: 450 mm, depth: 350 mm
- Design with door MEF45-130
- Design as glass cabinet with segmented glass door using grey glass MVEF45-130
- Optionally also available with mirrored back panel MP-SPR
- Highboard, floor-standing, with mechanical opening support mechanism and a door or as a glass cabinet with segmented glass door in grey glass, carcass height: 1296 mm, width: 450 mm, depth: 350 mm
- Design with door HEF45-130
- Design as glass cabinet with segmented glass door using grey glass HVEF45-130
- Optionally also available with mirrored back panel MP-SPR

WALL PANEL WPBEF

- Back panel 500 mm wide, 1230 mm high, 16 mm thick, vertical grain
- 3 wall shelves, 1 wall shelf 800 mm wide, 150 mm deep, 16 mm thick
- With 2 mm veneered edge all around
- Spacer frame, black, 19 mm thick
- Optionally also available with LED light design MP-WPBL



WALL UNIT WKBEF

- Carcass height: 360 mm, width: 1200 mm, depth: 350 mm
- 1 flap with mechanical opening support mechanism, 1 centre panel



GLASS CABINET VKBLEF / VKBREF

- Carcass height: 360 mm, width: 1200 mm, depth: 350 mm
- Design with glass cut-out on the left in grey glass VKBLEF120-36
- Design with glass cut-out on the right in grey glass VKBREF120-36
- With mechanical opening support mechanism
- Optionally also available with mirrored back panel MP-SPR

SURCHARGE FOR MIRRORRED BACK PANEL MP-SPR (7922)

- For glass cabinets in genuine wood veneer
- Available in 051 Mirror, slate grey (glass DG 2)



NEW IMPULSES FOR THE DINING AREA

Invisible but impactful: Our new Butterfly pull-out system for four-leg frames executes an elegant movement, permitting quick and simple extension of the tabletop. In the dining table area we combine time-tested genuine wood veneer panels with the distinctive Centro base frame to create a natural and modern look. Upholstered chairs and armchairs with new bouclé fabrics complement the convenience and modern design of the dining table.



TABLE SYSTEM ETB* WITH BUTTERFLY HINGED INSERT AND FRONTSIDE PULL-OUT

- Expansion of four leg table frames: London ETB-LON, Porto ETB-POR
- Available in the existing décors: 097 Havana oak, 198 Sierra oak, 354 Slate grey concrete, 378 Black concrete, 399 Milano walnut
- The model Oslo ET-OSL in Native Oak is also available with Frontslide pull-out and Butterfly hinged insert

NEW FABRIC COVER COLOURS



750 Coffee



751 Cashmere



DINING TABLE BOSTON ET-BOS* WITH VENEERED TABLETOP AND SWISS EDGE

- Tabletop, oak veneer
- 24 mm thick
- W 1600 / 1800 / 2000 x D 950 mm
- With pre-existing Centro table frame



MOVE CHAIR MOVE-CH*

- Stackable
- Graphic back design with all-round welted seam
- Available in the existing fabrics: 746 Storm Grey and 749 Cognac, and in the new bouclé fabrics 750 Coffee, 751 Cashmere
- MOVE-CH1: 1 piece / MOVE-CH2: 2 pieces



TURN II ARMCHAIR TURNII-CHA

- 360° rotation with return function
- Back design with open cut-out
- Available in the existing fabrics: 746 Storm Grey and 749 Cognac, and in the new bouclé fabrics 750 Coffee, 751 Cashmere



MEDIA FURNITURE WITH SOPHISTICATED DESIGN

As a beautifully designed attachment, the media tray expands base units with an elegant glass shelf that looks like it is floating. The media tray is available in two heights to adapt seamlessly to various line patterns. The integrated compartment keeps cables invisible, thereby combining style and function for easy integration of technology. Slim plinth foot mounts set base units and sideboards apart from the floor with great elegance, creating a light, floating effect.



PLINTH FRAME SOGK* / SOGF*

The plinth frames with a sled-type base SOGK and with feet SOGF are the perfect addition to base units and sideboards. They set the furniture apart from the floor in a subtle manner, making it look like it is floating.

- For planning beneath base units and sideboards with a side depth of: 561 and 350 mm
- Available for the carcass widths: 400 / 600 / 800 / 1000 / 1200 / 1400 / 1600 / 1800 / 2000 / 2200 / 2400 mm
- Visible middle foot for widths of 1600 mm or more
- Height: 192 mm
- Height adjustment + 15 mm
- Available in 010 Black



Plinth foot SOGK*



Plinth foot SOGF*

MEDIA TRAY MTBAGK*

- Width: 1200 mm
- Depths: 483 mm / 583 mm
- **MTBAGK120*** Height: 88 mm, usable height: 69 mm, usable depth: 344 mm / 444 mm
- **MTBAGG120*** Height: 160 mm, usable height: 141 mm, usable depth: 344 mm / 555 mm
- Available in 10 new colours (see below)

Optionally also available with LED light version MP-MTBAGL.



INFRA-RED REPEATER PLUS FOR MEDIA FURNITURE IPPM

From receivers to DVD or Blu-ray players: Hide away your electronic devices in our furniture designed especially for this purpose. Thanks to infra-red transmission, the controls continue to work perfectly: A receiver receives the remote control signal and reliably transmits it to the devices inside the furniture.

Set consisting of

- Receiver with mount, transmitter, control unit and power supply unit with Euro flat plug
- 12 volt DC max. 8 watt
- 2000 mm supply line,
- IR frequency band 20-60kHz
- Standby < 0.5 W
- 1700 mm switching line to transmitter and receiver



NEW COLOURS FROM HONED DÉCOR GROUP FOR MEDIA FURNITURE

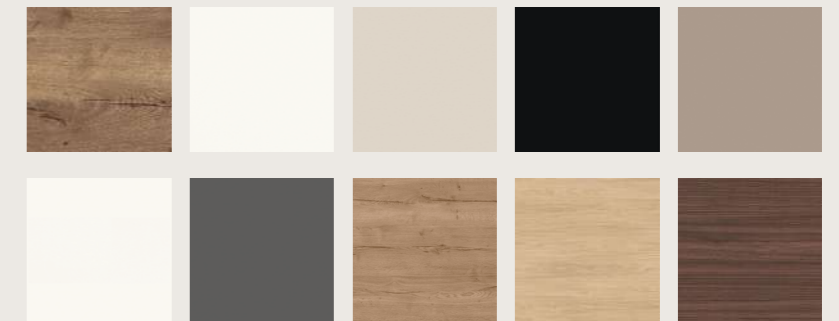

097 Havana oak reproduction
106 White
122 Sand
127 Black
133 Macchiato

193 Alpine white
194 Slate grey
198 Sierra oak reproduction
362 Como oak reproduction
399 Milano walnut reproduction

INSPIRING BATHROOMS

Our new bathroom solutions permit aesthetically sophisticated yet functional bathroom concepts that combine convenience, style and quality. Elaborate new features and expansions offer great potential, especially for small bathrooms – from space-saving storage solutions through new carcass depths to modern design highlights. Discover versatile ideas for planning bathrooms as havens of wellness that make many different customer dreams come true.

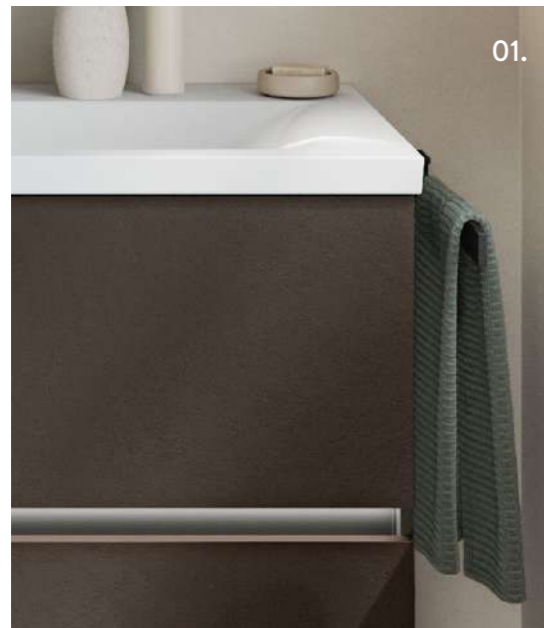

01.



02.



03.

01.

— Thanks to a centred recessed handle, the type expansion LINE N exudes even more minimalist elegance

— See page 106

02.

— Upright panels with illumination on the side emphasise the lines and create a beautiful ambience

— See page 107

03.

— Taps and hand basins combine modern aesthetics with high quality and suitability for everyday use

— See page 108



BRAND-NEW BATHROOM SOLUTIONS FOR ROOMS OF ANY SIZE

Be it storage solutions with a clever design, reduced carcass depths or modern light elements on mirrors and upright panels: Our versatile bathroom products bring brand-new ideas and sophisticated functions to rooms of any size and any style. Especially for lovers of design: LINE N with the centred recessed handle creates an aesthetically clean, handleless overall look. The larder pull-out unit is equipped with the innovative pull-out system nBOX – for a thoroughly stylish and practical bathroom design.



BASE UNITS CENTRED LINE N RECESSED HANDLE

- Carcase height: 603 mm
- As vanity unit for top-mounted hand basins with 2 pull-outs NBW2A*
- As vanity unit for built-in and top-mounted hand basins, 1 drawer, 1 pull-out NBWSA*
- As pull-out type with 2 pull-outs NBU2A*
- Available widths: 300 / 400 / 450 / 500 / 600 / 800 / 900 / 1000 / 1200 mm

EXPANSION CURVE UNITS

- The bathroom segment is being expanded with additional hinged doors with Curve



WALL UNIT FOR CONNECTION PLANNING WITH MIRRORED CABINETS WT20*-1

- Developed for planning at the same depth as the mirrored cabinets
- Widths: 200 / 250 / 300 / 400 / 450 / 500 / 600 mm
- Carcase height: 720 mm
- Carcase depth: 202 mm

MIRROR ABRIL SP-ABRIL 50 OVAL-SHAPED WITH LED LIGHTING ON ALL SIDES

- 1000 mm high, 43 mm deep
- 1 plastic frame, silver
- 1 plastic profile on all sides with LED lighting
- LED – 12 V DC, 3000 – 6500 K, degree of protection IP 44
- 1 touch dimmer
- 1 connection cable / 220 – 240 V
- Energy efficiency class: F

BASE UNIT FOR GUEST BATHROOM BW(B)* / BU*-36 NBU* / NBWA*-36

- Carcase height: 360 mm
- Carcase depth: 461 mm and 350 mm without surcharge
- Widths: 450 / 500 / 600 mm
- As hinged door and pull-out type
- Design with top-mounted hand basin

You can find an overview of our new hand basins on page 109.



MIRROR WITH BEVEL ON THE SIDE SPL-FAC*-130

- Expanded product range in height 1296 mm
- Widths: 400 / 600 / 800 mm



LED LIGHTING PROFILE LPW10* FOR 10 MM UPRIGHT PANELS

- Consisting of two LED light strips, light exit at the front and at one side
- Stainless steel appearance
- 12V DC, 2700 – 6500K
- 2000 mm connection cable to starter set, 600 mm of which is a ribbon cable
- Usable for mirrored cabinet and upright panels for bathroom base units
- For heights / lengths: 288 / 360 / 432 / 576 / 720 mm
- Please reduce the depth of the upright panels by 7 mm



LARDER PULL-OUT UNIT nBOX BUAA*-58

- Carcase height: 576 mm
- Carcase depth: 461 mm
- Widths: 300 mm / 400 mm
- 1 front with 1 nBOX drawer and 1 nBOX pull-out

TOP-MOUNTED HAND BASINS AND TAPS WITH SOPHISTICATED DESIGN

Round or rectangular, honed black, honed grey or glossy white: Our top-mounted hand basins come in many beautiful shapes, sizes and designs. Their long-lived, durable ceramic surface with a smooth glazing for greater hygiene represents aesthetic quality and exceptional durability. The taps in brushed bronze add a matching modern design highlight, complemented by a high-quality free flow basin waste in bronze metallic colour.



KLUDI HAND BASIN SINGLE-LEVER MIXER PURA 100, HIGH-PRESSURE

- Connection for hot and cold water
- Aerator 18.5mm diameter
- Flexible connection hoses
- with push-open drain fitting
- Tap hole: 35 mm
- Height of outlet above worktop: 100 mm
- Highest point above worktop: 195 mm
- Spout: 130 mm
- Available in bronze metallic colour

• We recommend a combination with free flow basin waste 17110.



KLUDI HAND BASIN SINGLE-LEVER MIXER PURA, HIGH PRESSURE

- Connection for hot and cold water
- Aerator 18.5 mm diameter
- Flexible connection hoses
- Tap hole: 35 mm
- Height of outlet above worktop: 240 mm
- Highest point above worktop: 335 mm
- Spout 170 mm
- Available in bronze metallic colour

• We recommend a combination with free flow basin waste 17110.



FREE FLOW BASIN WASTE 17110

- Stem valve stainless steel/plastic
- Cover plate bronze metallic colour
- With screen insert
- For hand basins without overflow

Dimensions: G 1 1/4" × 73 × 75 mm



DISEGNO CERAMICA TOP-MOUNTED HAND BASIN SLIM SQUARE 60 AND 80, CERAMIC MATERIAL

- 1 basin 589 / 789 × 339 × 102 mm
- 1 tap hole 35 mm diameter
- 1 overflow
- Outer dimensions: 604 / 804 × 462 mm
- Height: 123 mm

Available colours: Honed grey, white high-gloss and honed black
Available widths: 600, 800 mm

RTMR FURNITURE HAND BASIN SERIES MENTO, CERAMIC MATERIAL

- Basin in 3 widths: 440 / 580 / 600 mm × 300 × 130 mm
- 1 tap hole
- 1 overflow
- Outer dimensions: 610 / 810 / 1010 × 460 mm
- Height: 180 mm

Also available as **2-basin hand basin**

- 2 basin 440 × 300 × 130 mm
- 2 tap holes
- 2 overflows
- Outer dimensions: 1210 × 460 mm
- Height: 180 mm

Suitable for installation in bathroom vanity units BW* / NBW2A* and NBWSA* in 431 mm side depth. The depth reduction on the bathroom vanity units is confirmed and supplied without invoicing.



RTMR SURFACE-MOUNTED HAND BASIN YAZZ 36, CERAMIC MATERIAL

- 1 basin 348 × 95 mm
- Incl. free flow basin waste with ceramic cover
- Outer dimensions: Diameter 360 mm
- Height: 120 mm
- Cut-out dimensions: Diameter 60 mm

Available colours: White high gloss, honed black



RTMR SURFACE-MOUNTED HAND BASIN TAMU 33, CERAMIC MATERIAL

- 1 basin 318 × 100 mm, without overflow
- Outer dimensions: Diameter 330 mm
- Height: 120 mm
- Cut-out dimensions: Diameter 60 mm

Available colour: White high gloss



DISCONTINUED 31.12.2025

Fronts / Surrounds / Elements / Accessories



LASER 414 PG 1
—
Volcanic grey



STONEART 305 PG 4
—
Taupe grey basalt reproduction



SYLT 851 PG 7
—
Lacquer, honed black
• Incl. cottage-style surrounding elements



CASTELLO 390 PG 8
—
Washed ivory
• Incl. cottage-style surrounding elements



CHALET 883 PG 9
—
Lacquer, honed ivory
• Incl. cottage-style surrounding elements



YORK 901 PG 9
—
Genuine wood, lacquered satin grey
• Incl. cottage-style surrounding elements



ARTIS 937 PG 10
—
Glass appearance, Titanio matt
• Incl. upright panel



ARTIS 938 PG 10
—
Glass appearance, alpine white matt
• Incl. upright panel

DISCONTINUED SURROUND COLOURS

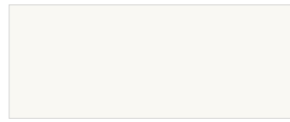

CARCASE COLOUR 060
Alpine white gloss
· Incl. upright panel, ADB, shelf unit, NVM, media furniture, bridging shelves, cornice and light pelmets. Plinth will be maintained.



UPRIGHT PANEL COLOUR 022
White gloss
· Also as NVM and shelf unit colour



UPRIGHT PANEL COLOUR 059
Titanio

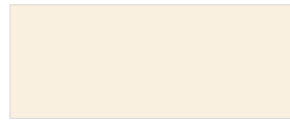

UPRIGHT PANEL COLOUR 116
Ivory gloss
· Also as NVM and shelf unit colour



UPRIGHT PANEL COLOUR 207
Volcanic grey
· Also as plinth and shelf unit colour



SHELF UNIT COLOUR 205
Vikings oak reproduction



SHELF UNIT COLOUR 254
Aqua

DISCONTINUED WORKTOP DÉCORS IN SLIM LINE, 16 MM THICK



WORKTOP DÉCOR 149
Concrete terra grey reproduction



WORKTOP DÉCOR 193
Alpine white



WORKTOP DÉCOR 369
Stone grey slate reproduction



WORKTOP DÉCOR 376
Limestone reproduction

DISCONTINUED WORKTOP DÉCORS, 38 MM THICK



WORKTOP DÉCOR 066
Slate décor reproduction
· Also as NVM



WORKTOP DÉCOR 215
Strombolian light reproduction
· Also as APP, ADB, upright panel and NVM



WORKTOP DÉCOR 225
Stem oak reproduction
· Also as APP, ADB, upright panel and NVM



WORKTOP DÉCOR 274
Teramo marble reproduction
· Also as APP, ADB, upright panel and NVM



WORKTOP DÉCOR 355
Ferro bronze reproduction
· Also as APP, ADB, upright panel and NVM



WORKTOP DÉCOR 363
Taupe grey basalt reproduction
· Also as Slim Line 16 mm, APP, ADB, upright panel, plinth and NVM

DISCONTINUED NICHE CLADDING



NVM 294
Décor Circle black



NVM 295
Décor Circle taupe grey



NVM 433
Décor quarry stone



NVM 525
Décor Patchwork Multicolor



NVM 549
Décor ornamental green



NVM 553
Décor geometry

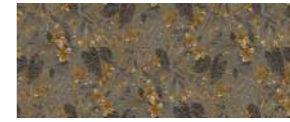

NVM 582
Décor Golden Nature



NVM 583
Décor Batik Style

DISCONTINUED HANDLES



188 LEATHER LOOP
Brown / Stainless steel finish



271 METAL HANDLE
Titanium-coloured

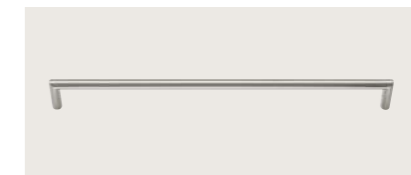

409 BOW HANDLE
Stainless steel finish



595 METAL HANDLE
Black / Stainless steel finish



612 METAL HANDLE
Chromed black



715 METAL HANDLE
Anthracite brushed



718 METAL HANDLE
Chromed black



719 BOW HANDLE
Chromed black



737 WOODEN / METAL HANDLE
Oak / Black



799 METAL HANDLE
Chromed black

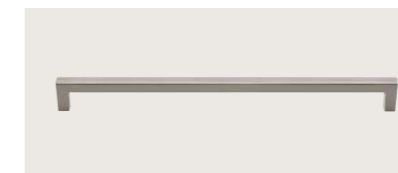

930 RAILING HANDLE
Stainless steel finish

DISCONTINUED UNITS AND ACCESSORIES

DISCONTINUED COTTAGE STYLE

- Wall unit with wooden lattice door (WGH*)
31384, 31385, 31386, 31389, 31390, 43384, 43385, 43386, 43389, 43390, 51384, 51385, 51386, 51389, 51390
- Open-shelf wall unit cottage-style with plate rack (WRTH60-*)
33732, 43732, 53732
- Open-shelf base unit cottage-style (USWK*)
22042, 22043, 37042, 37043
- Base unit wine rack cottage-style (URWF*)
21793, 21797, 37793, 37797
- Open-shelf end unit cottage-style (*R*-PIH*)
763, 24097, 24764, 25764, 30771, 30897, 31768, 33764, 34097, 34764, 34781, 37763, 41771, 41897, 42768, 42781, 44764, 45764, 50897, 51768, 51771, 51781, 54764, 55764
- Wall shelves cottage-style (WBLH*)
5774, 5776, 5779, 5784, 5786, 5789
- Canopy hood with cornice cottage-style (K*-LH*)
686, 690, 691, 693, 696
- Cornice strip / cornice side panel, cottage style (KL*)
903, 914, 915, 923, 90903, 90914
- Light pelmet, cottage style (LB*)
9314, 9316, 9603, 9606, 9317, 9607, 99314, 99603
- Niche wall cladding / end strip (NVH*)
9189, 9193, 9194, 9197, 9198, 9199

DISCONTINUED PILASTERS

- For base units (UPIH*-*)
5701, 5702, 5703 5704, 5705, 5706
- For highboards and tall units (HPIH*-*)
5709, 5710, 5729, 5730, 55761, 55762, 55765, 55766, 55731, 55732, 55734, 55735, 55711, 55712, 55718, 55720
- For dresser units (APIH*-*)
55747, 55738, 55759
- For wall unit (WPIH*-*)
55752, 55737, 55753

DISCONTINUED DIAGONAL UNITS

- Base unit diagonal (UZ*)
31750, 750, 21753, 22753, 109
- Wall unit diagonal (WZ30-*)
31032, 41032, 51032
- Insertable shelf base/tall unit diagonal (EBZ*)
7247, 7249
- Insertable shelf for wall unit, diagonal (EB-WZ*)
29042, 29041
- Surcharge for bevels, Z shape (APN-Z)
7827, 7831, 7813, 7159

DISCONTINUED SIGN EMOTION

- Glass door for Sign Emotion (SERNGT*)
33605, 33606
- Aluminium shelf unit Sign Emotion (SER*)
49404, 49405, 49406, 49424, 49425, 49426
- Holder Sign Emotion Teufel music station (SEAH)
49438
- Wardrobe rail Sign Emotion (SEKST)
49441

DISCONTINUED MORE THAN KITCHEN

- Mirror bathroom / wardrobe (SPLAR*)
15224, 15226, 15228, 15229, 15230, 15232, 15234, 15236, 15238, 15240, 15241, 15242
- Mirror with LED lighting (SPLAR*B*)
15277, 15278, 15279, 15267, 15268, 15269
- ADB mirrored cabinet 10/16 mm lacquer (ADBL*)
10774, 10775, 10776, 16771, 16772, 16773, 16774, 16775, 16776
- Towel rail for planning on 16 mm upright panels in 583 mm depth (HTHW-56)
3317
- Insertable wood/glass shelf for boulevard/glass cabinet (B*)
48868, 48869, 48870, 29126, 29127, 29128

DISCONTINUED MISCELLANEOUS

- Bench frame for worktops (ABGF*)
40215, 40218, 40221
- Plinth foot mount made of steel (SOFGB*)
48901, 48902, 48903, 48904, 48905, 48906, 48911, 48912, 48913, 48914, 48915, 48916
- Sled-type plinth mount made of steel (SOKU*)
3325, 3326, 3328, 3344, 3412
- Surcharge plinth foot (SOWR)
3505
- Wall bracket made of steel to support worktop and cover shelf in 600 mm depth (WKON-56)
3314
- Metal box with non-slip mat (MBOX-UZ30-*)
10270, 10271
- Door wooden lattice (WGH*)
60681, 60581, 60481, 60689, 60589, 60489, 60384, 60385, 60386

DISCONTINUED ACCESSORIES/LIGHTING

- LED light shelf Denver (WBLA*)
15104, 15105, 15106, 15108, 15109
- LED niche lights DHL (LN15*)
15042, 15041
- LED niche light UDL (LNUDL*)
15097
- LED ceiling light iLAND (LDILAND*)
15099
- LED plinth light (LSO)
5980, 5981
- Surcharge for cover shelf for mirrored cabinets WBSP* with LED light design Manila Plus (MP-LADB)
7910
- Triple socket Trio (TRIO-*)
38901, 38902
- Rectangular support console, double socket (STK-BS*C-*)
47071, 47072, 47081, 47082
- Built-in socket Twist (TWIST-*)
33447, 33448
- Radio switch set for lights (FUNK5200)
5200

DISCONTINUED SINKS/MIXING TAPS

- Elleci built-in sink Life 400 made of Granitek
87831, 87832, 87833
- Gessi Delia high-pressure single-lever mixing tap
17893, 17894, 17895, 17896, 17897, 17898
- Grohe high-pressure single-lever mixing tap Eurosmart
17875, 17876
- Kludi high-pressure single lever mixing tap Bingo Star
17758
- Grohe Eurosmart M
17879

DISCONTINUED ELECTRIC APPLIANCES

- Complete Grundig range
- Complete Faber range



