

# INTERLINK

คิดถึง Cabling ... คิดถึง INTERLINK Tel.02-666-1111 www.interlink.co.th



บริษัทนำเข้าและจัดจำหน่าย  
สายสัญญาณที่ใหญ่ที่สุดในอาเซียน

COMMSCOPE®





## LAN (UTP) SYSTEM

- 17-18 CAT 5E ENHANCE 350 MHZ LAN CABLING
- 19-20 CAT 6 ULTRA 600 MHZ LAN CABLING
- 21-22 CAT 6A SUPER-S & SUPER XG LAN CABLING
- 23-24 CAT 5E PATCH PANEL, CONNECTOR, PATCH CORD
- 25-26 CAT 6 PATCH PANEL, CONNECTOR, PATCH CORD
- 27-28 CAT 6A PATCH PANEL, CONNECTOR, PATCH CORD
- 29-30 FACE PLATE, WALL BOX, CHANGER
- 31-32 CAT 8 CABLING SYSTEM
- 33-34 INDUSTRIAL & RESIDENCE LAN SOLUTION
- 35-36 CABLE MANAGEMENT, UNLOAD PATCH PANEL
- 37-38 TOOL & TESTER

## FIBER OPTIC SYSTEM

- 39-40 OUTDOOR / INDOOR FIBER OPTIC CABLE
- 41-42 OUTDOOR / INDOOR, ARMORED FIBER OPTIC CABLE
- 43-44 MULTI-TUBE, ARMORED FIBER OPTIC CABLE
- 45-46 OUTDOOR / INDOOR, DROP WIRE FIBER OPTIC CABLE
- 47-48 SINGLE OR 3-TWISTED TUBE / ARMORED CABLE
- 49-50 FIG.8 / MULTI-TUBE / ARMORED CABLE
- 51-52 MINI-ARSS & ARSS FIBER OPTIC CABLE
- 53-54 MINI-ADSS & ADSS FIBER OPTIC CABLE
- 55-56 INDOOR SIMPLEX & DISTRIBUTION CABLE
- 57-58 F.O. RACK MOUNT & WALL MOUNT FDU
- 59-60 FIBER OPTIC SNAP-IN PLATE & CLOSURE
- 61-66 FIBER OPTIC CONNECTOR & ADAPTER
- 67-68 FIBER OPTIC PIGTAIL (Singlemode & Multimode)
- 69-70 FIBER OPTIC PATCH CORD (Singlemode & Multimode)
- 71-72 FIBER OPTIC TOOLS AND TESTER
- 73-74 F.O. STRIPPER, TOOL & CONSUMER MATERIAL

## FTTR / FTTX SYSTEM

- 75-76 FTTR / FTTX OVAL & FLAT CABLE
- 77-78 FTTR / FTTX ROUND CABLE
- 79-80 FTTR / FTTX DISTRIBUTION AND OUTLETS
- 81-82 FTTR / FTTX PIGTAIL & PATCH CORD, SPLITTER & TOOL

## DATA CENTER SYSTEM

- 83-84 DATA CENTER MTP®/MPO FIBER PATCH PANEL
- 85-86 DATA CENTER MTP®/MPO TRUNK CABLE ASSEMBLY
- 87-92 DATA CENTER DAC & AOC CABLE ASSEMBLY

## COAXIAL SYSTEM

- 93-94 RG 6 COAXIAL CABLE (INDOOR)
- 95-96 RG 6 COAXIAL CABLE (OUTDOOR)
- 97-98 RG 11, RG 58, RG 59 & FLEXIBLE CABLE
- 99-100 COAXIAL CONNECTOR (BNC, F-Type, TV, PANEL)
- 101-102 COAXIAL TOOLS & CABLE ASSEMBLY

## TELEPHONE SYSTEM

- 103-104 TELEPHONE CABLE, TIEV, TPEV, JUMPER WIRE
- 105-106 TELEPHONE CONNECTOR, RJ11 PLUG & OUTLET
- 107-108 TELEPHONE MUDULE & ARRESTER & TOOL
- 109-110 TELEPHONE PLASTIC BOX (Indoor & Outdoor)
- 111-112 TELEPHONE STEEL CABINET (Indoor & Outdoor)
- 113-114 TELEPHONE BACK MOUNT FRAME & 19" BMF





### SOLAR SYSTEM

- 115-116 SOLAR CABLE
- 117-118 SOLAR CABLE FOR FLOATING, GROUND WIRE
- 119-120 MC4 CONNECTOR AND CRIMP TOOL,  
MC4 SPANNER
- 121-122 SOLAR EXTENSION CABLE ASSEMBLY

### SECURITY AND CONTROL SYSTEM

- 123-124 FIRE ALARM CABLE
- 125-126 FIRE RESISTANT CABLE ( FRC )
- 127-128 BAS CONTROL CABLE
- 129-130 MULTI - CORE & MULTI - PAIR
- 131-132 LIYCY CONTROL CABLE
- 133-134 SPEAKER CONTROL CABLE

### NETWORKING SYSTEM

- 135-140 OPTICAL TRANSCEIVER for ALL  
1.25G, 2.5G SFP, 10G SFP+  
25G SFP28, 40G QSFP+  
50G SFP56, 100G QSFP28  
200G ; 400G ; 800G TRANSCEIVER
- 141-142 MEDIA CONVERTER 10/100/100, RS485
- 143-144 PoE INDUSTRIAL SWITCH 1, 2, 4, 8 Port
- 145-146 SURGE PROTECTOR, INJECTOR, EOC, BALUN

### 19" GERMAN RACK SYSTEM

- 147-148 NEW GERMAN RACK CABINET ; G3N Series
- 149-150 NEW GERMAN SERVER RACK ; G4N Series
- 151-152 NEW GERMAN DATA CENTER RACK ; G8N Series
- 153-154 NEW GERMAN WALL RACK ; G1 Series
- 155-156 NEW WALL RACK OUTDOOR & MINI STEEL BOX ; G2 & G6 Series
- 157-158 19"GERMAN OPEN RACK & TELECOM RACK ; G0 Series
- 161-162 GERMAN RACK's ACCESSORIES ; G7 Series  
AC Power Distribution, Component Shelf, Exhaust Fan,  
Cable Management, Screw M6
- 163-164 GERMAN COLD AISLE CONTAINMENT ; G10 Series

### CCTV OUTDOOR CABINETS SYSTEM

- 165-166 LINK CCTV OUTDOOR CABINET

### 19" LINK RACK SYSTEM

- 167-168 19" GLASS RACK CABINET
- 169-170 19" GLASS-WAVE RACK CABINET
- 171-172 19" CURVE-WAVE RACK CABINET
- 173-174 19" WALL RACK & FTTR MDF & 3-P RACK
- 175-176 RACK's ACCESSORIES ; PDU, SHELF, Exhaust Fan

### COMMSCOPE Cabling

- 177-178 CAT 6 CABLE, PATCH PANEL, CONNECTOR & PATCH CORD
- 179-180 CAT 6A CABLE, PATCH PANEL, CONNECTOR & PATCH CORD
- 181-182 FIBER OPTIC CABLE ; Indoor / Outdoor ; Duct ; Armored
- 183-184 FIBER OPTIC Patch Panel, Pigtail & Patch Cord



### TERMINATE & TEST

- 185-186 LAN (UTP) CABLING
- 187-188 FIBER OPTIC CABLING





# CAT 6A CABLING SOLUTIONS

## (SHIELED, SUPER-S Series)

OPTION (Indoor)

**US-9266LSZH**  
CAT 6A U/FTP SUPER-S SERIES CABLE, LSZH (Aqua Blue)



**US-9267LSZH**  
CAT 6A U/FTP SUPER-S SERIES CABLE, LSZH (Aqua Blue)



**US-9256ALSZH**  
CAT 6A U/FTP SUPER-S SERIES CABLE, LSZH (Aqua Blue)



OPTION (Outdoor)

**US-9256ADUT**  
CAT 6A U/FTP SUPER-S SERIES CABLE, Outdoor Jacket

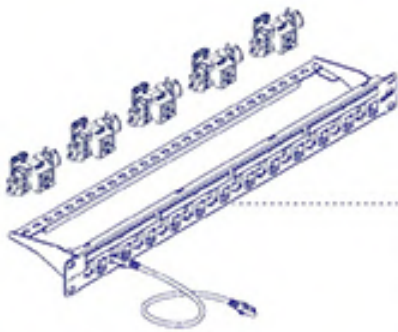

**US-30025A**  
Shielded UNLOADED STAGGERED PATCH PANEL, 24 PORT

**US-6722TFS**  
CAT 6A SHIELED, SUPER-S RJ45 JACK, SHORT BODY, Tool Free, Auto Shutter

**US-69015LZ-9**  
Shielded CAT 6A Super-S 28 AWG, 1 M., KS, LSZH, (Aqua Blue)



**US-6722TFS**  
CAT 6A SHIELED, SUPER-S RJ45 JACK, SHORT BODY, Tool Free, Auto Shutter

**US-2002AWH**  
FACE PLATE 2 PORT with Icon & Label ID (White)

**US-2001AWH**  
FACE PLATE 1 PORT with Icon & Label ID (White)



**US-69035LZ-9**  
Shielded CAT 6A Super-S 28 AWG, 3 M., KS, LSZH, (Aqua Blue)

**US-69025LZ-9**  
Shielded CAT 6A Super-S 28 AWG, 2 M., KS, LSZH, (Aqua Blue)

**US-69015LZ-9**  
Shielded CAT 6A Super-S 28 AWG, 1 M., KS, LSZH, (Aqua Blue)



**US-10705G**  
CAT 6A RJ45 SOLID PLUS (UTP/SHIELD, Hybrid w/Boot)

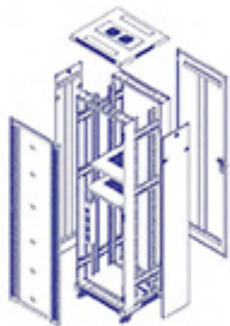

**CH-6064205**  
1U LINK Tempered Glass RACK 42U Back (450 x 600 x 1007 cm)

**CH-10312A**  
POU 12 TS OUTLET (Lighting Cat w/Guard + Protection 95%)

**CK-01204**  
LINK PIN 2 x 4", BALL BEARING HEAVY DUTY PIN

**CK-20350**  
FIX SHELF for RACK 60 cm., Deep 35 cm.

**CK-40350**  
SLIDE SHELF for RACK 60 cm., Deep 35 cm.

TOOL & TESTER



**TL-110640A**  
CRIMP TOOL for 110/100 CAT 6A RJ45 GOLD PLUS (New Back Blue)



**TX-1302A**  
UTP CABLE CRIMP WEAPON (New SUPER-S)



**TL-5070A**  
SHIELD CRIMP TOOL for Tool Free JACK in Shield Terminated RJ45



# CAT 6 CABLING SOLUTIONS

## ( UTP , ULTRA Series )

OPTION

US-9106LSZH

CAT 6 UTP ULTRA (600 MHz) w/Dross Filter, 23AWG, LSZH (Self-Healing)

LINK CAT 6 UTP ULTRA (600 MHz) 24 PAIR UNBUNDLED

US-9106LSZH

CAT 6 UTP ULTRA (600 MHz) w/Dross Filter, 23AWG, LSZH (Self-Healing)

LINK CAT 6 UTP ULTRA (600 MHz) 24 PAIR UNBUNDLED

US-9116LSZH

CAT 6 UTP ULTRA (600 MHz) w/Dross Filter, 23AWG, LSZH (Self-Healing)

LINK CAT 6 UTP ULTRA (600 MHz) CABLE

OPTION

US-9106A

CAT 6 UTP ULTRA (600 MHz) w/Dross Filter, 23AWG, LSZH (Self-Healing)

LINK CAT 6 UTP ULTRA (600 MHz) 24 PAIR UNBUNDLED

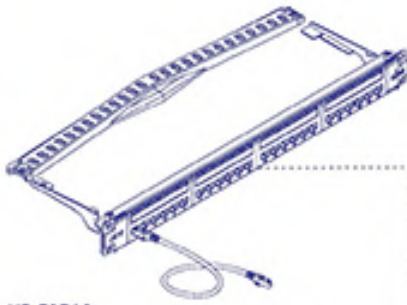

**US-3124A**  
CAT 6A PATCH PANEL 24 PORT w/Case Management

**US-5101LZ-X**  
CAT 6 RJ45-RJ45 PATCH CORD 24 AWG LSZH 1 M.

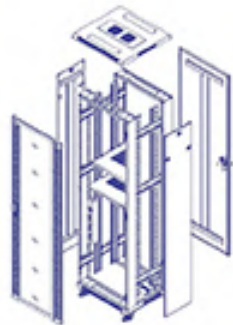

**CH-60642G5**  
29" Link Tempered Glass RACK 4U Back (W60 x D60 x H207 cm.)

**CH-10312A**  
POU 12 TS Out/LET Lighting Str w/Guard + Protection (5A)

**CK-61204**  
LINK FAN 2 X 4" BALL BEARING HEAVY DUTY FAN

**CK-20150**  
FR SH-ELF for RACK 40 cm., Deep 35 cm.

**CK-40150**  
SLOE SH-ELF for RACK 40 cm., Deep 35 cm.

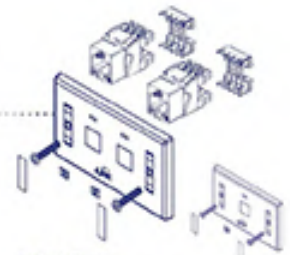
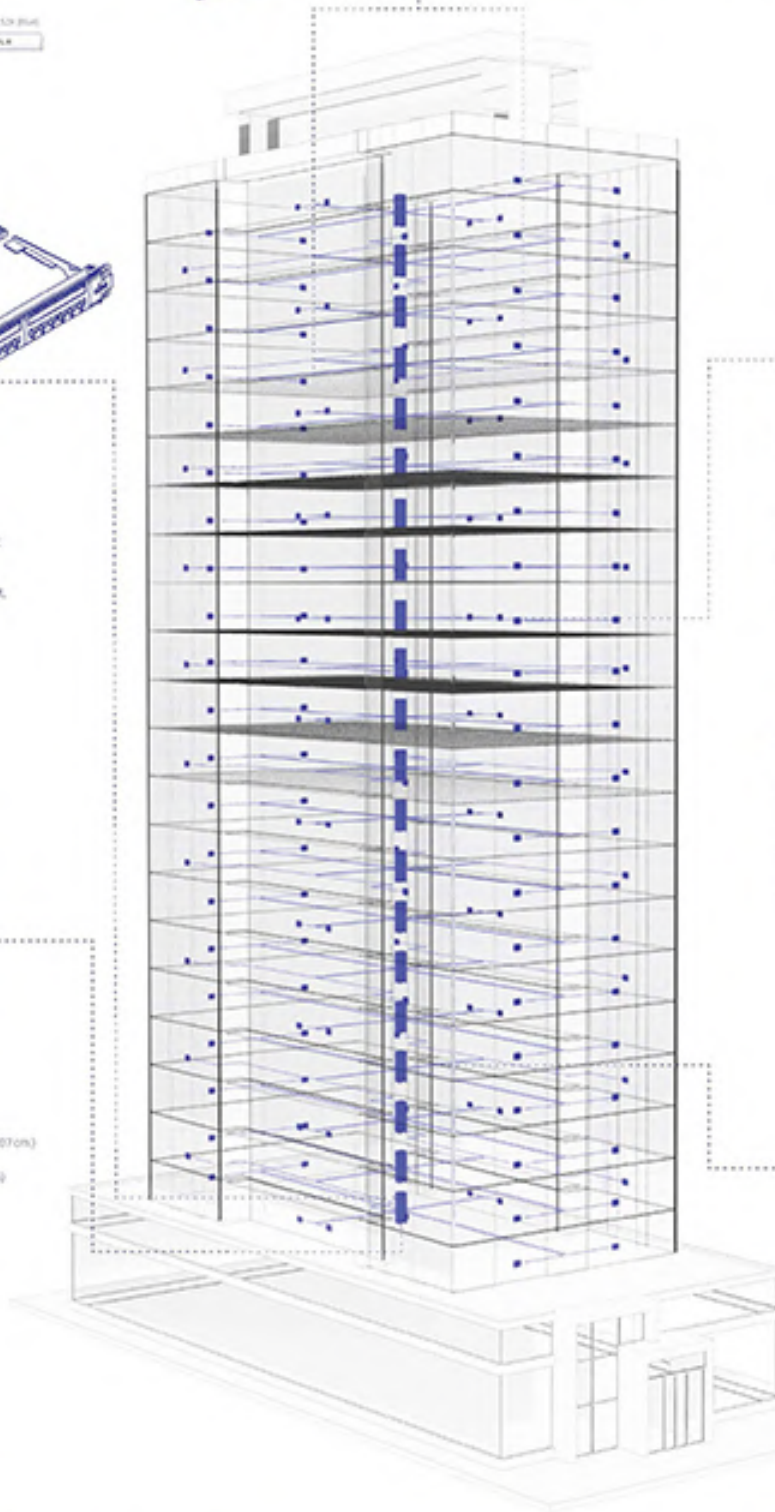

**US-1006SL**  
CAT 6 RJ45 MODULAR JACK 5119 (white)

**US-2002AWH**  
FACE PLATE 2 PORT WITH KEYS & LABEL (white)

**US-2003AWH**  
FACE PLATE 1 PORT WITH KEYS & LABEL (white)



**US-5103LZ-X**  
CAT 6 RJ45-RJ45 PATCH CORD 24 AWG LSZH 3 M.

**US-5102LZ-X**  
CAT 6 RJ45-RJ45 PATCH CORD 24 AWG LSZH 2 M.

**US-5101LZ-X**  
CAT 6 RJ45-RJ45 PATCH CORD 24 AWG LSZH 1 M.



**US-1002AA**  
CAT 6 New RJ45 PLUS 2 Layer TRANSPARENT CLEAR

**US-662XA**  
CAT 6 New CRYSTAL LOCKING PLUS BOOT



**TL-1003R**  
RJ45 ROLL OVER PLIERS



**TL-3116**  
PUNCH TOOL WITH PLATE FOR JACK PATCH PANEL



**US-8061**  
RJ45 PATCH PANEL WITH 24 PORTS



**TX-1302A**  
RJ45 PATCH PANEL WITH 24 PORTS



PRICE LIST 2569

TOOL & TESTER

# CAT 6 CABLING SOLUTIONS

## ( OUTDOOR , ULTRA Series )

# CAT 6 CABLING SOLUTIONS

## ( OUTDOOR , ULTRA Series )



**OUTDOOR**  
**US-9106OUT**  
 CAT 6 UTP, PE OUTDOOR w/Cross Filler, 23 AWG, (Double Jacket), (Black)  
**LINK CAT 6 UTP, PE OUTDOOR 23 AWG CABLE**



**INDOOR**  
**US-9106A**  
 CAT 6 UTP (250 MHz) w/Cross Filler, 24 AWG, CM, UL (Blue)  
**LINK CAT 6 UTP (250 MHz) 24 AWG CABLE**



**US-9106LSZH**  
 CAT 6 UTP (250 MHz) w/Cross Filler, 23 AWG, LSZH (Blue)  
**LINK CAT 6 UTP (250 MHz) 23 AWG CABLE**

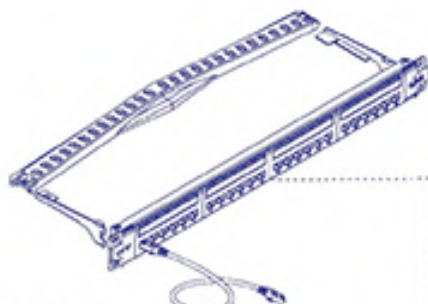

**US-3124A**  
 CAT 6+ PATCH PANEL, 24 PORT w/Case Management

**US-5101LZ-X**  
 CAT 6 RJ45 RJ45 PATCH CORD 24 AWG LSZH 1M.



**US-1006SL**  
 CAT 6+ RJ45 MODULAR JACK, Slim (white)

**US-2002AWH**  
 FACE PLATE 2 PORT With Icon & Label (White)

**US-2001AWH**  
 FACE PLATE 1 PORT With Icon & Label (White)

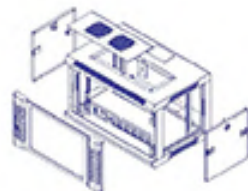
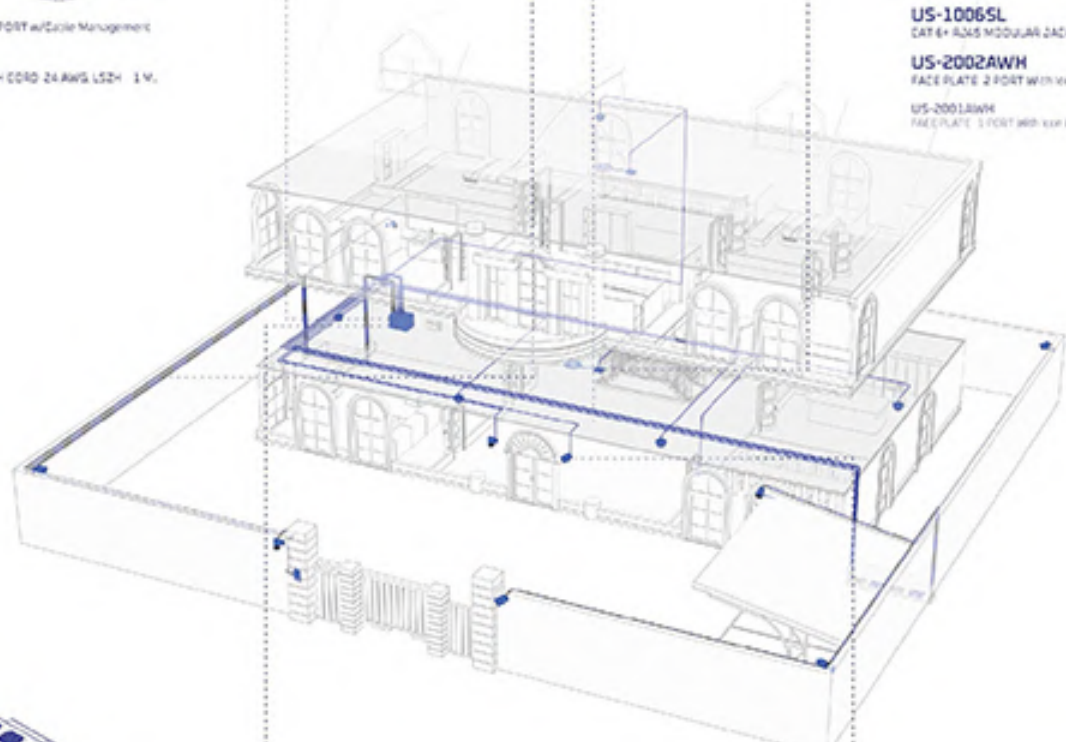

**CW1-604060**  
 30" LINK TETHERED GLASS WALL SHELF 6U, Deep 40CM, 1 Port

**CH-10306A**  
 PORT TO OUTLET Cabling SW w/Guard + Protection 360

**CK-80104**  
 LINK FAX 1 + 247, 2-Bolt Bearing HEAVY DUTY FAX w/RC Cord 3.8 M.

**CK-12250**  
 FRONT MOUNT SHELF Deep 25 CM.



**US-5103LZ-X**  
 CAT 6 RJ45 RJ45 PATCH CORD 24 AWG, LSZH 3M.

**US-5102LZ-X**  
 CAT 6 RJ45 RJ45 PATCH CORD 24 AWG, LSZH 2M.

**US-5101LZ-X**  
 CAT 6 RJ45 RJ45 PATCH CORD 24 AWG, LSZH 1M.



**US-1002AA**  
 CAT 6 New RJ45 PLUS 2 Layer TRANSPARENT CLEAR

**US-662XA**  
 CAT 6 New CRYSTAL LOCKING PLUS BOOT

PRICE LIST 2669

4

# FTTR / FTTX CABLING SOLUTIONS

( FTTR-1008 HOUSING ESTATE / FTTH @ ROOM RESIDENCE )  
 ( FTTR-1008 HOUSING ESTATE / FTTH @ ROOM RESIDENCE )

**UFC9312A**

F.O. Outdoor/Indoor, Armored 12 Core, LSZH-FR, DSI



**UFC9324MA**

F.O. Outdoor/Indoor, Armored 24 Core, LSZH-FR, DSI, Multi-Fiber

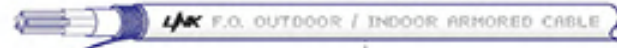

**UFH3112**

FTTR-1008 FLOOR DISTRIBUTION UNIT  
 With 32 SC/APC, Double-Q Pigtail  
 (Adapter + Pigtail + Sleeve)



**UFH3113**

FTTR-1008 FLOOR DISTRIBUTION UNIT  
 With 24 SC/APC, Double-Q Pigtail  
 (Adapter + Pigtail + Sleeve)



**UFH3111**

FTTR-1008 SMART OUTLET, 2 Port,  
 with SC/APC, Double-Q Pigtail  
 (Adapter + Pigtail + Sleeve)



**UFH3110**

FTTR-1008 SMART OUTLET, 1 Port,  
 with SC/APC, Double-Q Pigtail  
 (Adapter + Pigtail + Sleeve)

**UFH9222**

FTTR OVAL 2C, Double-Q Cable, LSZH



**UFH9221**

FTTR OVAL 1C, Double-Q Cable, LSZH

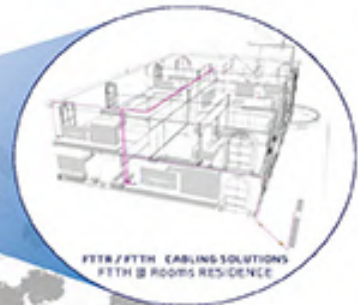
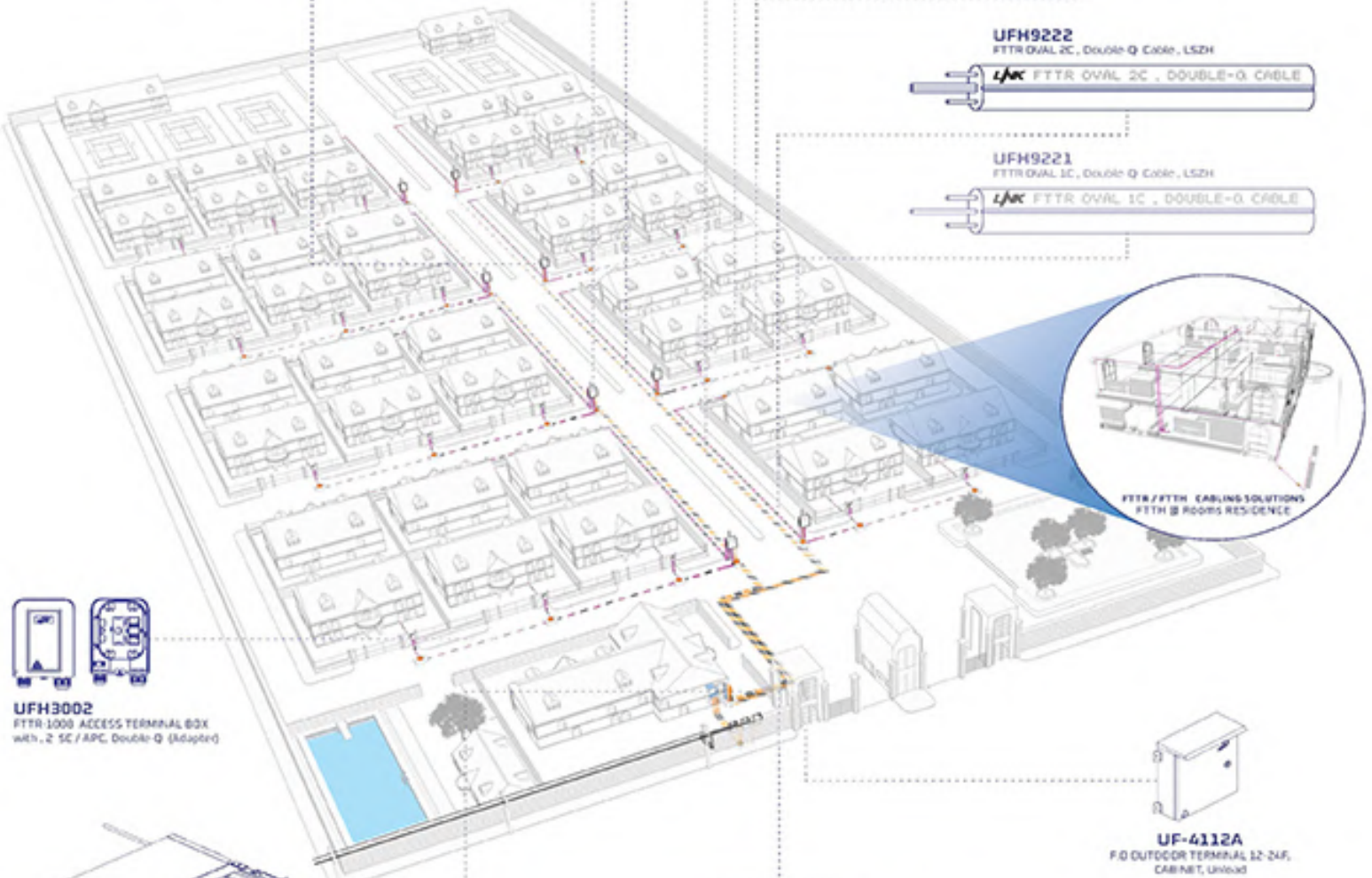

**UFH3002**

FTTR-1008 ACCESS TERMINAL BOX  
 with 2 SC/APC, Double-Q (Adapted)

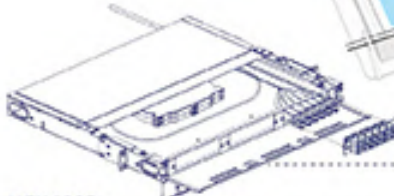

**UFH4083**

FOU DOUBLE-Q SMD 12-36A, w/Space Tray, Unload (1U)

**UF-2255SM/APC**

125C SIMPLEX, Strip-In Adapter PLATE (SC/APC, 12F)

UF-2256SM/APC

6C DUPLEX, Strip-In Adapter PLATE (SC/APC, 12F)



**UF960502-1.5**

SIMPLEX PATCH CORD, 1.5M, Simplex (20 core)



**UF960522-1.5**

SIMPLEX PATCH CORD, 1.5M, Simplex (20 core)



**UF960522-03**

SIMPLEX PATCH CORD, 0.3M, Simplex (20 core)



**UFH5108**

FTTR-1008 MDF 42U  
 w/2 Side-Cable Management  
 (ODF / MDF)



**UFH5113**

FTTR-1008 THREE OPERATOR  
 CABINET RACK 42U  
 (Operator Rack)



**UF-4112A**  
 F.O. OUTDOOR TERMINAL 12-24F,  
 CABINET, Unload



PRICE LIST 2569

# SMART BUILDING CABLING SOLUTIONS

( F.O. IN-BUILDING + UTP CAT 6A SUPER-S + FTTR-1008 BUILDING RISER & HORIZONTAL )

( F.O. IN-BUILDING + UTP CAT 6A SUPER-S + FTTR-1008 BUILDING RISER & HORIZONTAL )

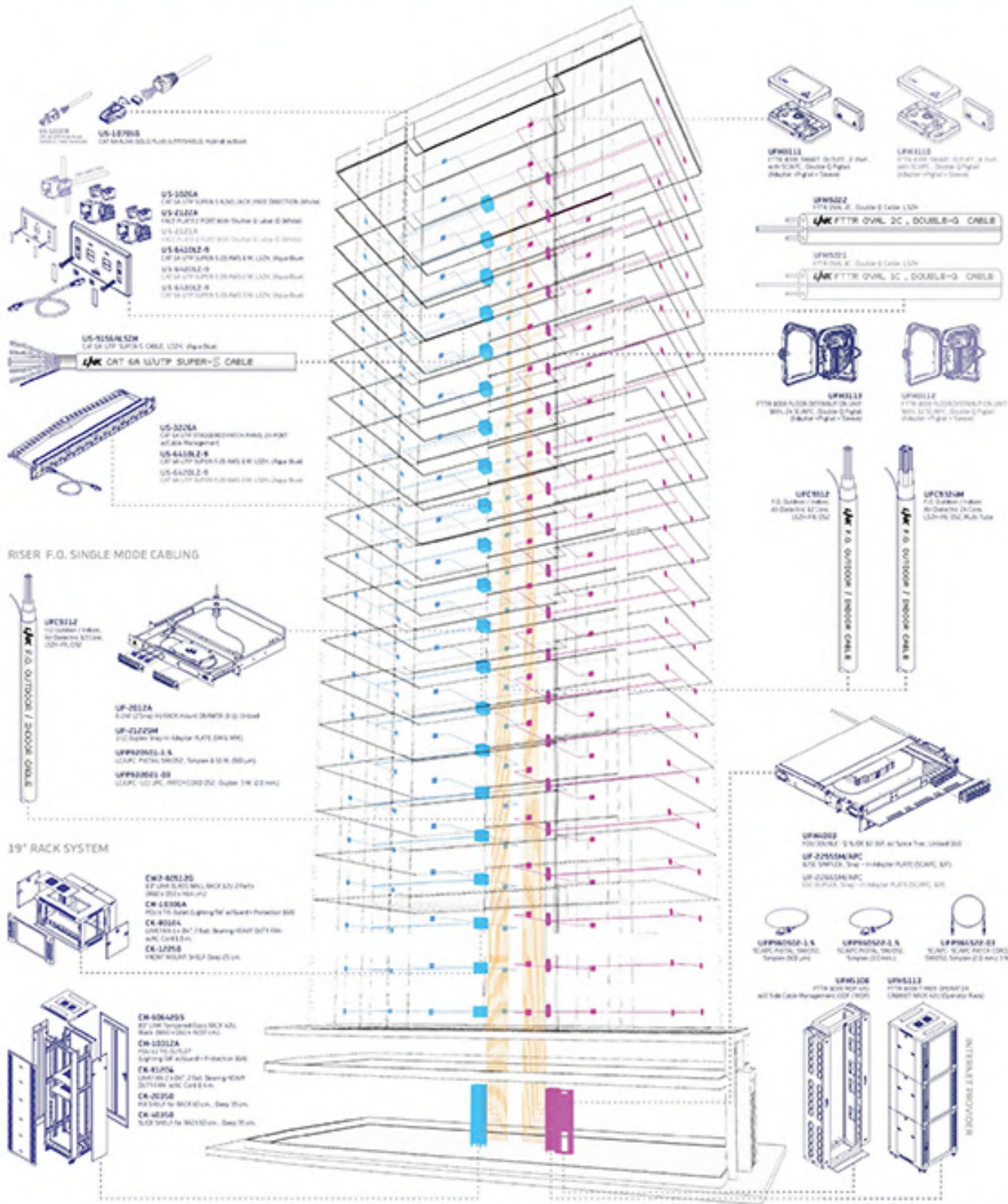

- US-12700A**  
12700 Series Patch Cord
- US-12700B**  
12700 Series Patch Cord
- US-12700C**  
12700 Series Patch Cord
- US-12700D**  
12700 Series Patch Cord
- US-12700E**  
12700 Series Patch Cord
- US-12700F**  
12700 Series Patch Cord
- US-12700G**  
12700 Series Patch Cord
- US-12700H**  
12700 Series Patch Cord
- US-12700I**  
12700 Series Patch Cord
- US-12700J**  
12700 Series Patch Cord
- US-12700K**  
12700 Series Patch Cord
- US-12700L**  
12700 Series Patch Cord
- US-12700M**  
12700 Series Patch Cord
- US-12700N**  
12700 Series Patch Cord
- US-12700O**  
12700 Series Patch Cord
- US-12700P**  
12700 Series Patch Cord
- US-12700Q**  
12700 Series Patch Cord
- US-12700R**  
12700 Series Patch Cord
- US-12700S**  
12700 Series Patch Cord
- US-12700T**  
12700 Series Patch Cord
- US-12700U**  
12700 Series Patch Cord
- US-12700V**  
12700 Series Patch Cord
- US-12700W**  
12700 Series Patch Cord
- US-12700X**  
12700 Series Patch Cord
- US-12700Y**  
12700 Series Patch Cord
- US-12700Z**  
12700 Series Patch Cord

- RISER F.O. SINGLE MODE CABLING**
- UP-2012A**  
12700 Series Patch Cord
  - UP-2012B**  
12700 Series Patch Cord
  - UP-2012C**  
12700 Series Patch Cord
  - UP-2012D**  
12700 Series Patch Cord
  - UP-2012E**  
12700 Series Patch Cord
  - UP-2012F**  
12700 Series Patch Cord
  - UP-2012G**  
12700 Series Patch Cord
  - UP-2012H**  
12700 Series Patch Cord
  - UP-2012I**  
12700 Series Patch Cord
  - UP-2012J**  
12700 Series Patch Cord
  - UP-2012K**  
12700 Series Patch Cord
  - UP-2012L**  
12700 Series Patch Cord
  - UP-2012M**  
12700 Series Patch Cord
  - UP-2012N**  
12700 Series Patch Cord
  - UP-2012O**  
12700 Series Patch Cord
  - UP-2012P**  
12700 Series Patch Cord
  - UP-2012Q**  
12700 Series Patch Cord
  - UP-2012R**  
12700 Series Patch Cord
  - UP-2012S**  
12700 Series Patch Cord
  - UP-2012T**  
12700 Series Patch Cord
  - UP-2012U**  
12700 Series Patch Cord
  - UP-2012V**  
12700 Series Patch Cord
  - UP-2012W**  
12700 Series Patch Cord
  - UP-2012X**  
12700 Series Patch Cord
  - UP-2012Y**  
12700 Series Patch Cord
  - UP-2012Z**  
12700 Series Patch Cord

- 19" RACK SYSTEM**
- CR-1001A**  
19" Rack System
  - CR-1001B**  
19" Rack System
  - CR-1001C**  
19" Rack System
  - CR-1001D**  
19" Rack System
  - CR-1001E**  
19" Rack System
  - CR-1001F**  
19" Rack System
  - CR-1001G**  
19" Rack System
  - CR-1001H**  
19" Rack System
  - CR-1001I**  
19" Rack System
  - CR-1001J**  
19" Rack System
  - CR-1001K**  
19" Rack System
  - CR-1001L**  
19" Rack System
  - CR-1001M**  
19" Rack System
  - CR-1001N**  
19" Rack System
  - CR-1001O**  
19" Rack System
  - CR-1001P**  
19" Rack System
  - CR-1001Q**  
19" Rack System
  - CR-1001R**  
19" Rack System
  - CR-1001S**  
19" Rack System
  - CR-1001T**  
19" Rack System
  - CR-1001U**  
19" Rack System
  - CR-1001V**  
19" Rack System
  - CR-1001W**  
19" Rack System
  - CR-1001X**  
19" Rack System
  - CR-1001Y**  
19" Rack System
  - CR-1001Z**  
19" Rack System

- UP-1001A**  
19" Rack System
- UP-1001B**  
19" Rack System
- UP-1001C**  
19" Rack System
- UP-1001D**  
19" Rack System
- UP-1001E**  
19" Rack System
- UP-1001F**  
19" Rack System
- UP-1001G**  
19" Rack System
- UP-1001H**  
19" Rack System
- UP-1001I**  
19" Rack System
- UP-1001J**  
19" Rack System
- UP-1001K**  
19" Rack System
- UP-1001L**  
19" Rack System
- UP-1001M**  
19" Rack System
- UP-1001N**  
19" Rack System
- UP-1001O**  
19" Rack System
- UP-1001P**  
19" Rack System
- UP-1001Q**  
19" Rack System
- UP-1001R**  
19" Rack System
- UP-1001S**  
19" Rack System
- UP-1001T**  
19" Rack System
- UP-1001U**  
19" Rack System
- UP-1001V**  
19" Rack System
- UP-1001W**  
19" Rack System
- UP-1001X**  
19" Rack System
- UP-1001Y**  
19" Rack System
- UP-1001Z**  
19" Rack System

OUTDOOR TERMINATION



PRICE LIST 2669  
10

# DATA CENTER INTERCONNECT SOLUTIONS

- Security & Control / Fire Alarm / Fire Resistant
- Building Automation System (RS485)
- Solar System
- Transformer
- Inverter Battery
- HVAC Control System



**AOC**  
Active Optical Cable



**DAC**  
Direct Attach Copper Cable



**TRANSCEIVER for ALL**  
(10G, 25G, 40G, 50G, 100G, 200G, 400G, 800G)

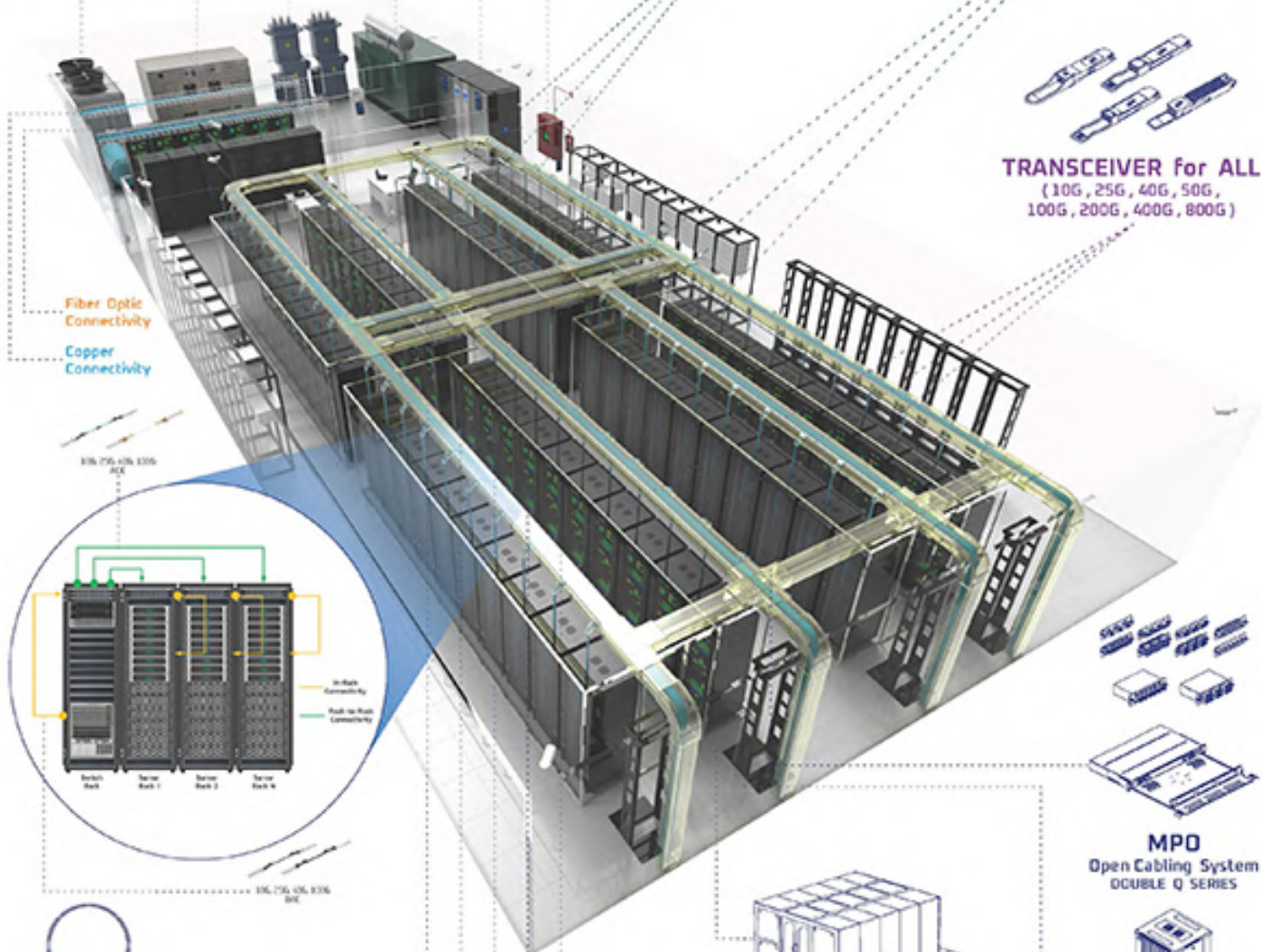

Fiber Optic Connectivity  
Copper Connectivity

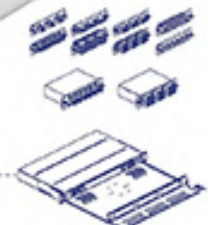
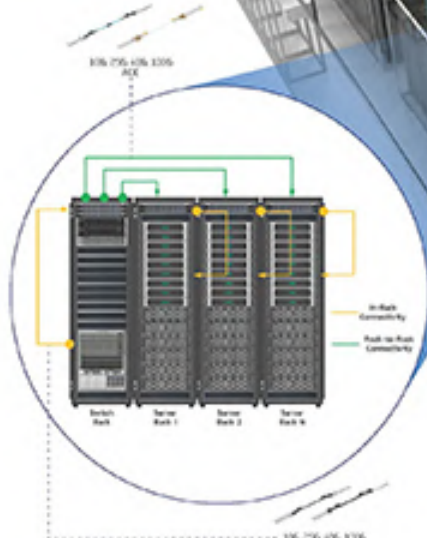

**MPD**  
Open Cabling System  
DOUBLE Q SERIES



**COLD AISLE CONTAINMENT**

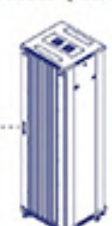

**19" DATA CENTER RACK SYSTEM**



**LC FIBER OPTIC PATCH CORD**  
DOUBLE Q SERIES



**MPD / MPD FIBER PATCH CORD**  
DOUBLE Q SERIES



**MPD / MPD FIBER TRUNK CABLE**  
DOUBLE Q SERIES



**MPD / MPD CONVERSION CABLE**  
DOUBLE Q SERIES



**MPD / LC FIBER ARRAY HARNESS CORD**  
DOUBLE Q SERIES



PRICE LIST 2569  
11

# CCTV OUTDOOR CABLING SOLUTIONS

## CCTV OUTDOOR CABLING SOLUTIONS

**UFC9312A**  
F.O. OUTDOOR / INDOOR, Armored 32 Core, LSZH + FR, 052



**LINK F.O. OUTDOOR / INDOOR CABLE**

**UFC9712A**  
F.O. MINI-RSS, Armored 32 Core, 052, 3\*Twisted Pair



**LINK F.O. MINI-RSS CABLE**

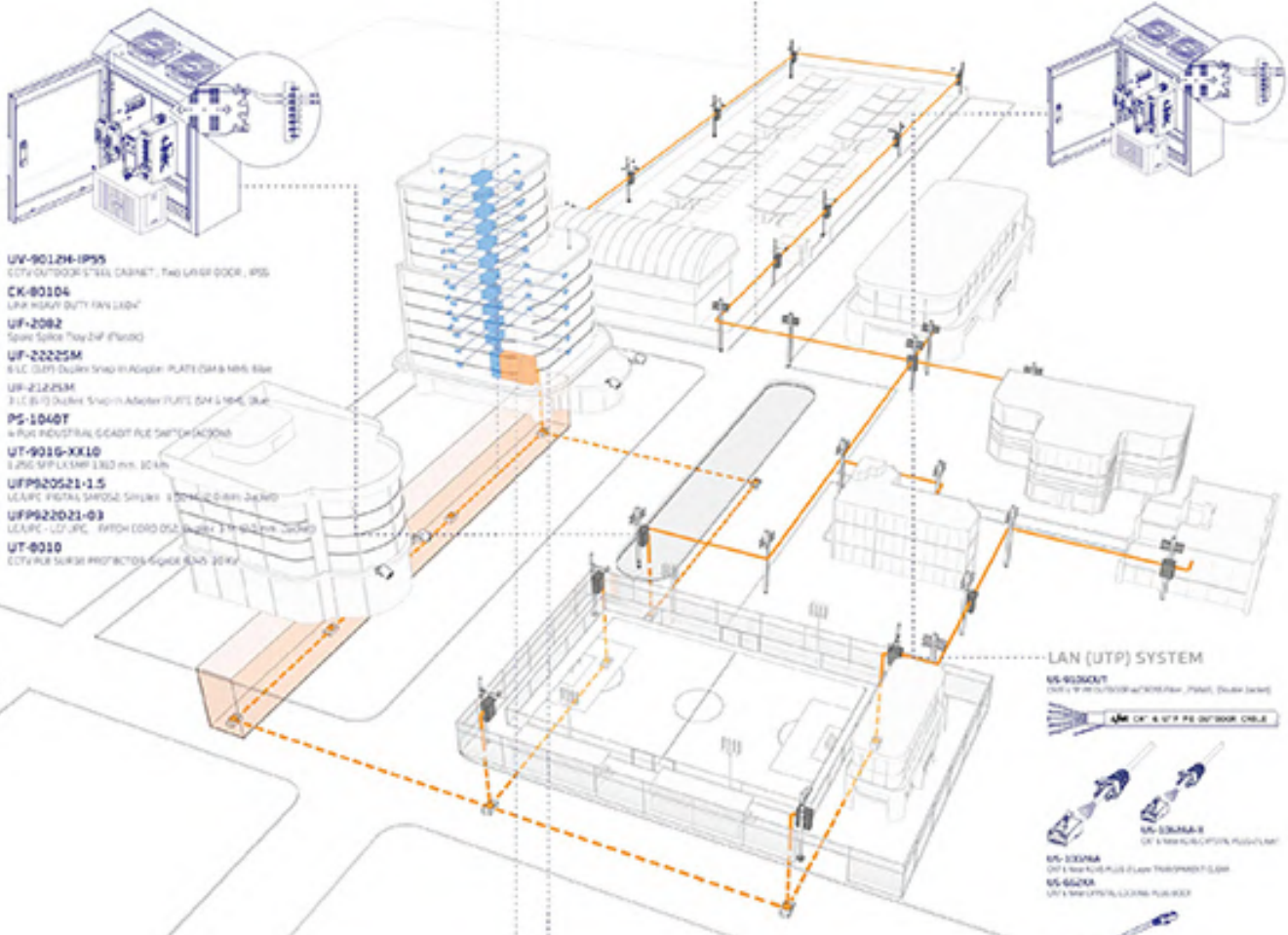

- UV-9012H-IP55**  
CCTV OUTDOOR WALL CABINET, Two UV-50 DOOR, IP55
- CK-80104**  
LINK HDV DUTY FREE LSZH
- UF-2092**  
Splice Splitter Tray 24P (FR02)
- UF-2222SM**  
6 LC DSI Ductile Snap-In Adapter PLATE DM & MM Blue
- UF-2322SM**  
3 LC B-TD Ductile Snap-In Adapter PLATE DM & MM Blue
- PS-1040T**  
4 Port INDUSTRIAL SCADY FIBRE SWITCH (SC2004)
- UT-9010-XX10**  
1.250 MP LC SMP 1.800 mm 30 km
- UFP920521-1.5**  
LC/APC FIBRA SFP050 Simplex 1.50 M (005) M Jacked
- UFP922021-03**  
LC/APC LC FIBRA CORD 030 Duplex 3 M (030) M Jacked
- UT-8010**  
CCTV FIBRE SURGE PROTECTORS (Spike Supp) 300V

### LAN (UTP) SYSTEM

- US-6520CVT**  
Cable Tray with 1200mm x 400mm (Floor, Panel, Under Deck)
- LINK OF & UTP PE OUTDOOR CABLE**
- US-1020M/2**  
OF & MM PLUG/SCREW PLUG/PLUG
- US-1020M/4**  
OF & MM PLUG/SCREW PLUG/PLUG
- US-6520K**  
OF & MM PLUG/SCREW PLUG/SCREW
- US-5120L2 X**  
OVERHEAD/UNDERGROUND CABLE PLUG, 052+ 1/4"
- US-5120L2 X**  
OVERHEAD/UNDERGROUND CABLE PLUG, 052+ 1/4"

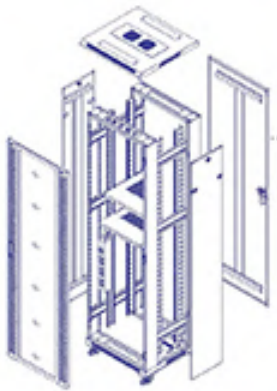

- CH-6064205**  
17" Rack Temperature Cases (Rack with Back Panel) + (052 + 052) (mm)
- CH-10312A**  
Four 12-TS OUTLET (splitting for wireless + Protection 3M)
- CK-81204**  
LINK PANEL + 052, 2 Port (locking when duty free) with 052 Core LSZH
- CK-20350**  
Two Outlet for RACK 052 (mm), Deep 35 (mm)
- CK-40350**  
SLEEVE for RACK 052 (mm), Deep 35 (mm)

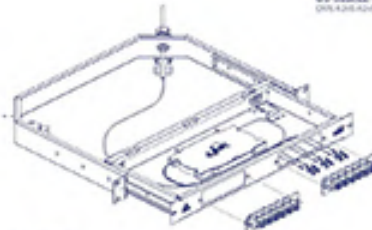

- UF-2012A**  
6-Port 12-Strip 12-Port Rack Mount DPA/RTR, D = 33.20 cm (13.06 inch)
- UF-2222SM**  
6 LC DSI Ductile Snap-In Adapter PLATE DM & MM Blue
- UF-2322SM**  
3 LC B-TD Ductile Snap-In Adapter PLATE DM & MM Blue
- UFP92051-1.5**  
LC/APC FIBRA SFP050 Simplex 1.50 M (005) M Jacked
- UFP922021-03**  
LC/APC LC FIBRA CORD 030 Duplex 3 M (030) M Jacked



PRICE LIST 2569  
12

# SMART CITY CABLING SOLUTIONS

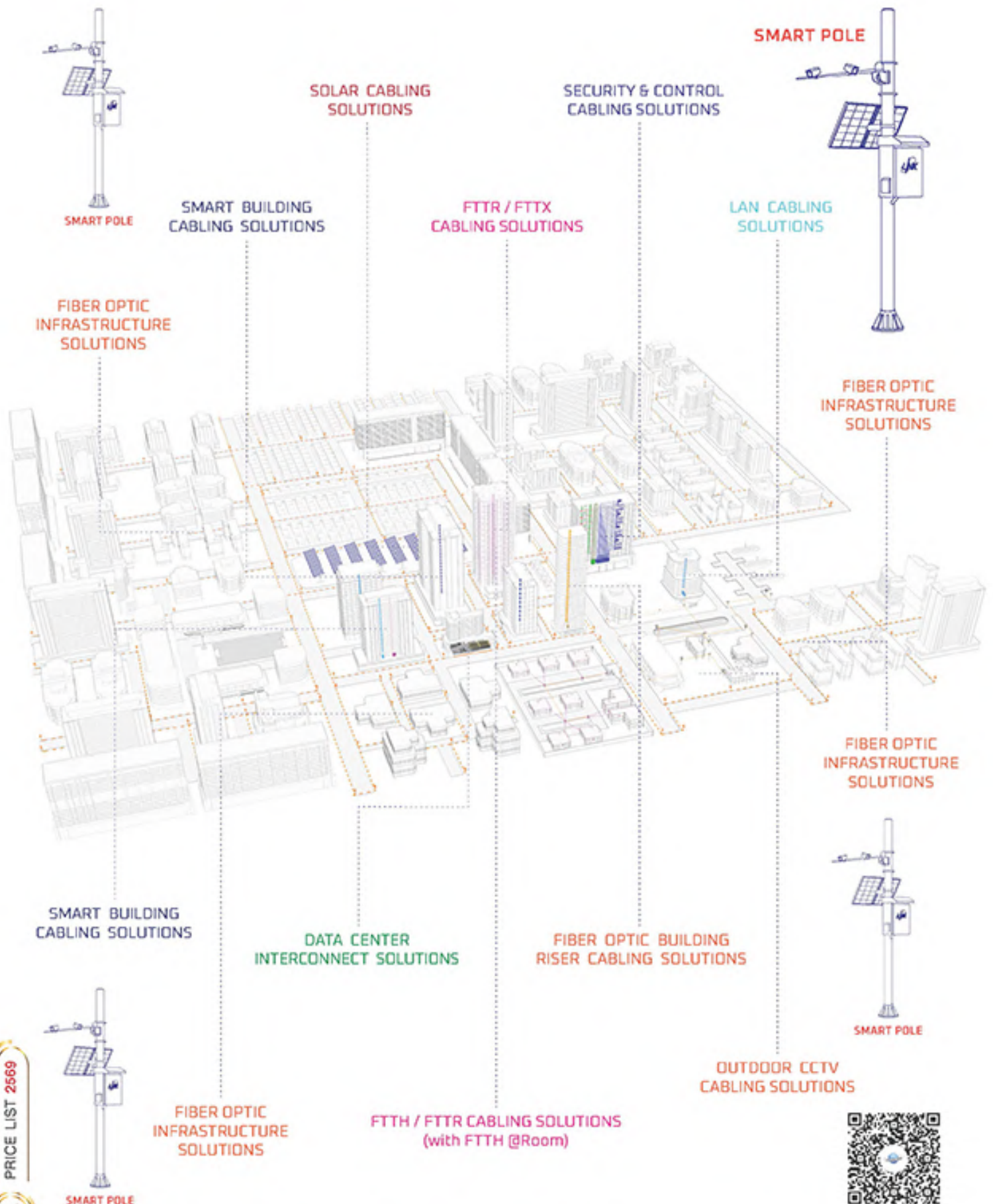

PRICE LIST 2569  
13



# SOLAR CABLING SOLUTIONS

(Solar ROOF TOP, Solar Cable AD8)

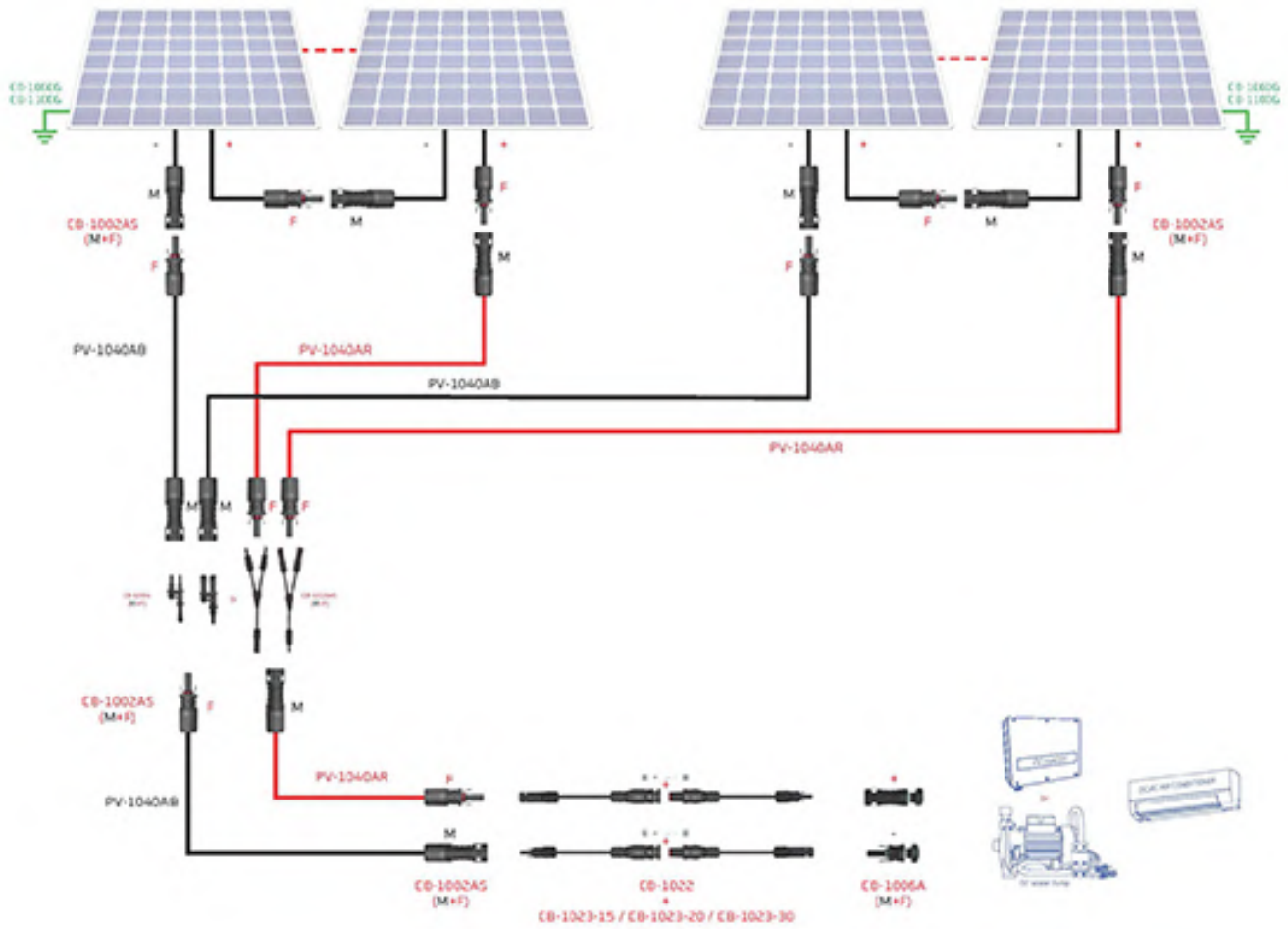

- PV-1040AB or PV-1060AB**  
PV Solar Cable 4 wire for 6 mm<sup>2</sup> Black
- PV-1040AR or PV-1060AR**  
PV Solar Cable 4 wire for 6 mm<sup>2</sup> Red
- CB-1002AS**  
MC4 CONNECTOR 2.5-6 mm<sup>2</sup>, 5-Insert Tight-Locking (Pair)
- CB-1016AS**  
MC4 V-Branch 6 mm<sup>2</sup> Cable w/CONNECTOR, 2 to 3 (Pair) 1500V
- CB-1004**  
MC4 T-Type CONNECTOR, 2 to 3 (Pair)
- CB-1022**  
MC4 FUSED IN-LINE CONNECTOR, Blank
- CB-1023-15**  
MC4 FUSED 15A CONNECTOR
- CB-1023-20**  
MC4 FUSED 20A CONNECTOR
- CB-1023-30**  
MC4 FUSED 30A CONNECTOR

CRIMP TOOL & SPANNER



**CB-1084**  
MC4 CRIMPING TOOL for MC4 2.5-6 mm<sup>2</sup> CONNECTOR



**CB-1086AS**  
MC4 Span SPANNER for MC4 CONNECTOR (Pair)



**CB-1088**  
SOLAR CABLE AUTO STRIPPER 2.5-10 mm<sup>2</sup>



PRICE LIST 2669

# SOLAR CABLING SOLUTIONS

(Solar FARM , Solar Cable AD8)

**CB-1002AS**

MCA CONNECTOR 2.5 6 mm<sup>2</sup>, 5 - Insert Tight Locking (Pair)



**CB-1003AS**

MCA CONNECTOR 30 mm<sup>2</sup>, 5 - Insert Tight Locking (Pair)



**CB-1022**

MCA FUSED IN-LINE CONNECTOR, 2x Pair



**CB-1023-15**

MCA FUSED 2EA CONNECTOR

**CB-1023-20**

MCA FUSED 2EA CONNECTOR

**CB-1023-30**

MCA FUSED 2EA CONNECTOR

**PV-1060AR / PV-1040AR / PV-1100AR**

PV Solar Cable 6 mm<sup>2</sup> / 4 mm<sup>2</sup> / 10 mm<sup>2</sup>, Red



**PV-1060AB / PV-1040AB / PV-1100AB**

PV Solar Cable 6 mm<sup>2</sup> / 4 mm<sup>2</sup> / 10 mm<sup>2</sup>, Black



**OPTION : GROUND WIRE**

**CB-1060G / CB-1100G**

Grounding Wire 6 mm<sup>2</sup> / 10 mm<sup>2</sup>, XLPE (Green - White)

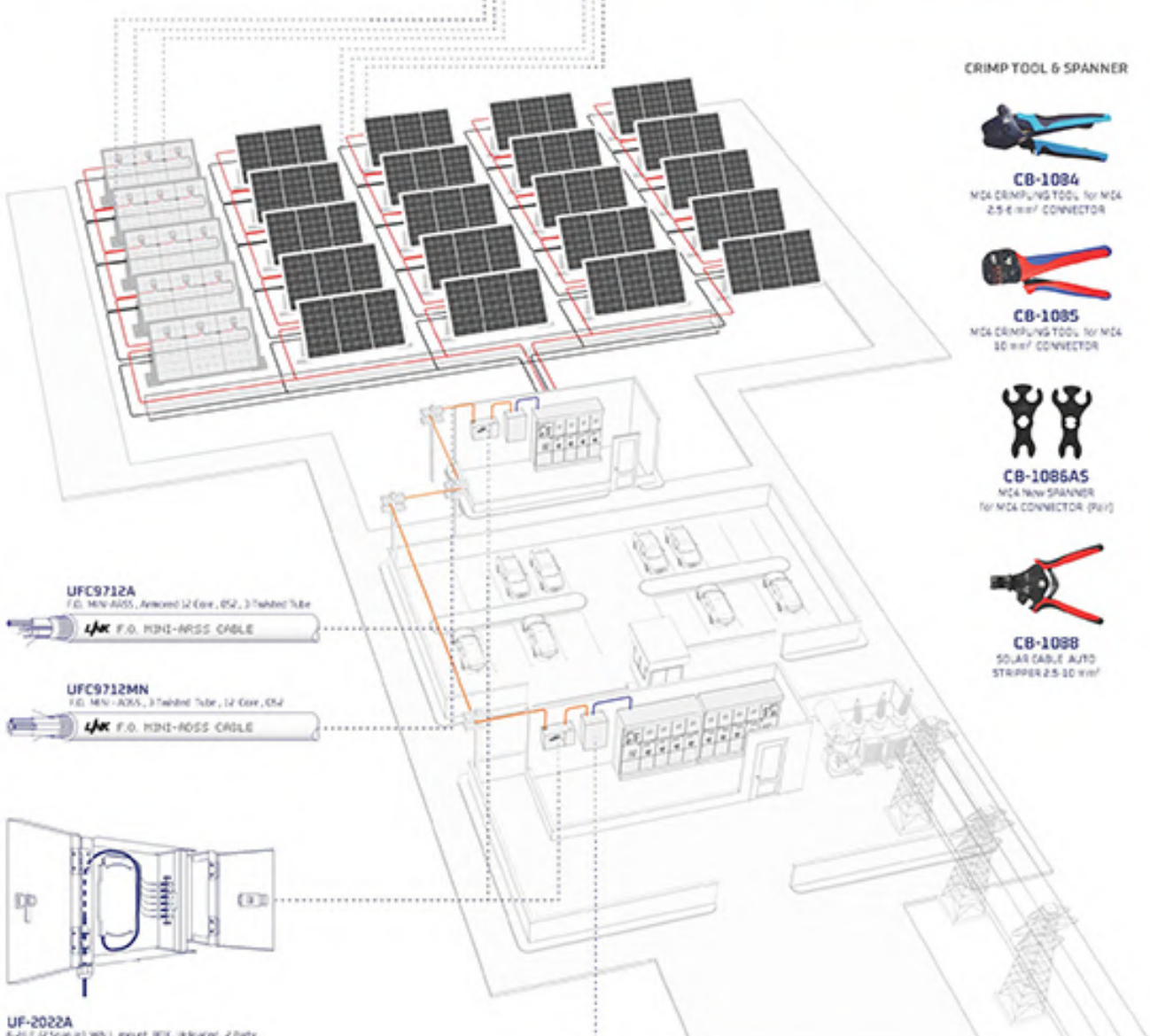

**CRIMP TOOL & SPANNER**



**CB-1084**

MCA CRIMPING TOOL for MCA 2.5 6 mm<sup>2</sup> CONNECTOR



**CB-1085**

MCA CRIMPING TOOL for MCA 30 mm<sup>2</sup> CONNECTOR



**CB-1086AS**

MCA New SPANNER for MCA CONNECTOR (Pair)



**CB-1088**

SOLAR CABLE AUTO STRIPPER 2.5-10 mm<sup>2</sup>

**UFC9712A**

F.O. MINI-ARSS, Arched 1/2 Core, 0.52, 3 Tabled Tube



**UFC9712MN**

F.O. MINI-ARSS, 3 Tabled Tube, 1/2 Core, 0.54

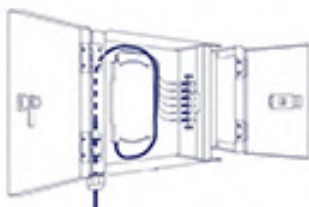

**UF-2022A**

6-Port (3 Group) WALL Mount BOX, Unlocked, 2 Ports

**UF-2222SM**

6-Port (3) Duplex Strip-in Adapter PLATE (EM & ME), Blue

**UF-2122SM**

3-Port (1.5) Duplex Strip-in Adapter PLATE (EM & ME), Blue



**UFP920501-1.5**  
LED Cable 1.5 M, 1000PCS, Single 1.5 M, 1000PCS



**UFP962021-03**  
LED Cable 1.5 M, 1000PCS, Single 1.5 M, 1000PCS

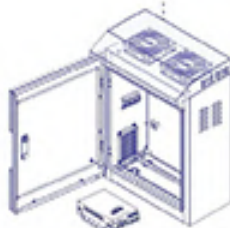

**UT-4206SM-30**

30-400x485-1E (M) F.O. MCA CONVERTER, 3E (M)

**UV-9012H-IP55**

ULTY OUTDOOR STEEL CABINET, Two LAYER DOOR, IP55

**CK-80104**

LINK HEAVY DUTY FAN (12V)

**UF-2082**

Splice Light Tool 2W (100PCS)



# SECURITY & CONTROL CABLING SOLUTIONS

( Fire Alarm Cable + Fire Resistance Cable + BAS Cable + PA / BGM Speaker Cable )

## SECURITY CABLE

### Fire Alarm Cable

**CB-0118**  
FIRE ALARM, UNSHIELDED ZN63RNG, 1 PAIR, 19/0.15 Grade



**CB-0116**  
FIRE ALARM, UNSHIELDED ZN63RNG, 1 PAIR, 19/0.15 Grade



OPTION  
**CB-0210**  
FIRE ALARM, SHIELDED ZN63RNG, 1 PAIR, 19/0.15 Grade



**CB-0216**  
FIRE ALARM, SHIELDED ZN63RNG, 1 PAIR, 19/0.15 Grade

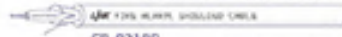

**CB-0218R**  
FIRE ALARM, SHIELDED ZN63RNG, 1 PAIR, 19/0.15 Grade



**CB-0216R**  
FIRE ALARM, SHIELDED ZN63RNG, 1 PAIR, 19/0.15 Grade

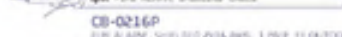

**CB-0216P**  
FIRE ALARM, SHIELDED ZN63RNG, 1 PAIR, 19/0.15 OUTDOOR



### Fire Resistant Cable (FRC)

**CB-0801**  
FIRE RESISTANT, Insulated, Non-Sheathed 3.5 mm<sup>2</sup> 3 C Cable



**CB-0802**  
FIRE RESISTANT, Insulated, Non-Sheathed 2.5 mm<sup>2</sup> 3 C Cable



OPTION  
**CB-0821A**  
FIRE RESISTANT UNSHIELDED 2x1.5mm<sup>2</sup> 1 P, 2 C Cable

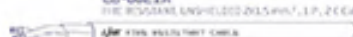

**CB-0825A**  
FIRE RESISTANT UNSHIELDED 2x2.5mm<sup>2</sup> 1 P, 2 C Cable



## CONTROL CABLE

### BAS CONTROL Cable

**CB-0318AA**  
BAS, TWISTED PAIR TC 2 C, 22 AWG, 1 PAIR Cable



**CB-0418AA**  
BAS, TWISTED PAIR TC 4 C, 22 AWG, 2 PAIR Cable



**CB-0422AA**  
BAS, TWISTED PAIR TC 4 C, 22 AWG, 2 PAIR Cable



OPTION  
**CB-0318AAP**  
BAS, TWISTED PAIR SHIELD 22AWG, 1 PAIR 1000FT Cable



**CB-0418AAP**  
BAS, TWISTED PAIR SHIELD 22AWG, 2 PAIR 1000FT Cable



## SPEAKER CABLE

**CB-0516W**  
ROUND SPEAKER 1 P., 16 AWG, CABLE

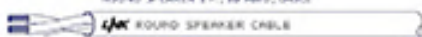

**CB-0514W**  
ROUND SPEAKER 1 P., 14 AWG, CABLE



**CB-0501**  
FLAT SPEAKER CABLE 2 X 1.5 mm<sup>2</sup>, TRANSPARENT



**CB-0502**  
FLAT SPEAKER CABLE 2 X 2.5 mm<sup>2</sup>, TRANSPARENT

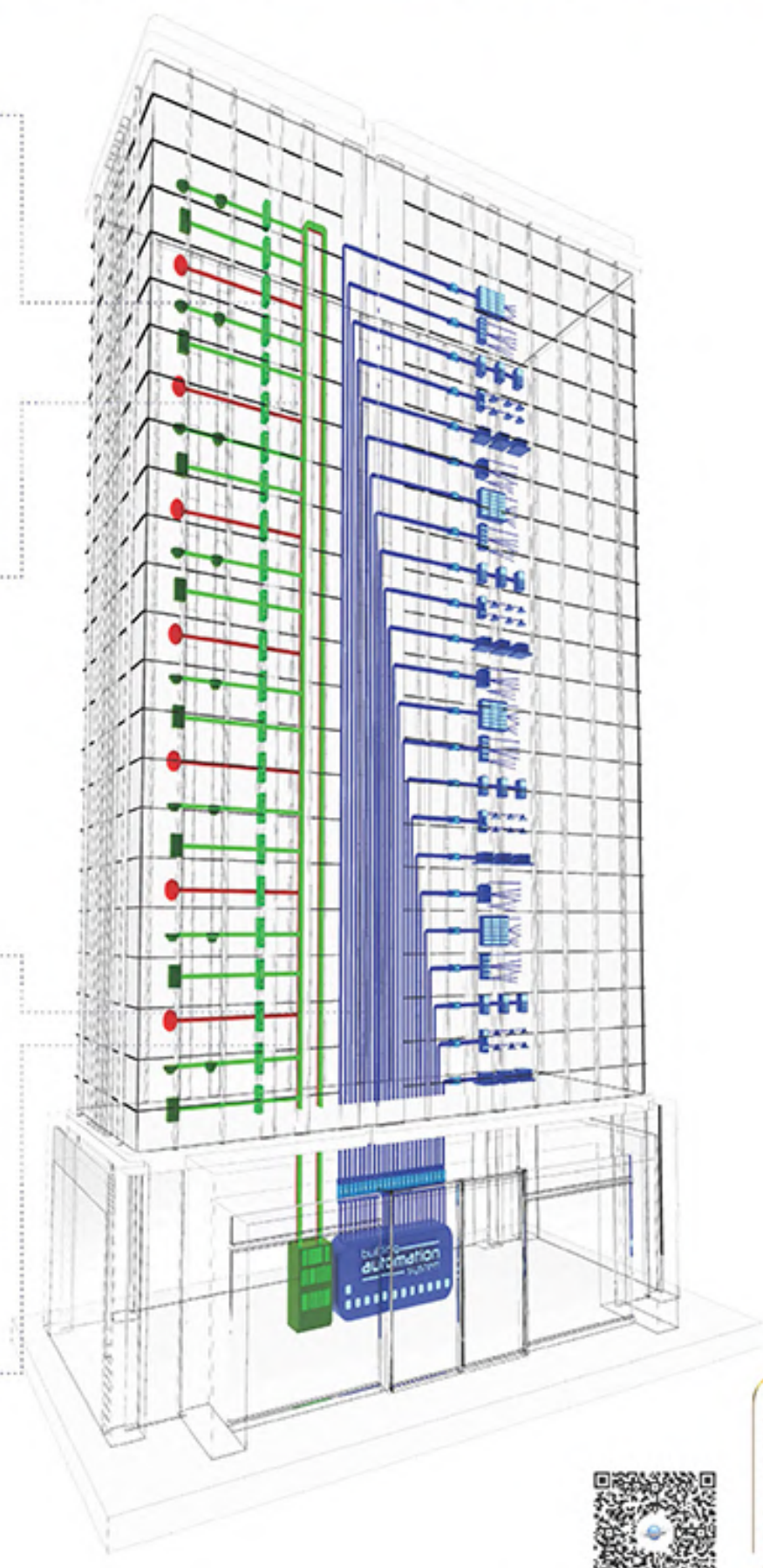

PRICE LIST 2569  
16



# CAT 5E ENHANCED 350 MHz LINK

American Cabling

## LAN (UTP) System



### STANDARD

- ANSI/TIA-568.2 - E Category 5E
- ANSI/TIA-568.2 - D Category 5E
- ISO / IEC 11801 : 2017 class D
- EN 50173-1 Category 5E
- EN 50288-3-1
- IEC 61156-5
- UL 1666 (CMR)
- UL 1685 (CM)
- UL 1581 (CMX)
- IEC 60332-1 (LSZH)
- NFPA 262 (CMP)
- UL 444
- CSA 22.2 NO.214
- UL, ETL and 3P verified to Category 5E
- RoHS Compliant

### APPLICATION

- Structure Cabling (Backbone & Horizontal)
- 1000 BASE-T (IEEE 802.3ab Gigabit Ethernet)
- 1000 BASE-TX (IEEE 802.3e)
- 100 BASE-TX (IEEE 802.3u Fast Ethernet)
- 52/155/622Mbps and 1.2Gbps ATM
- IEEE 802.3 1u/ab.
- CDDI / ATM / Token Ring / VoIP
- IEEE 802.3 at (PoE) / IEEE 802.3 at (PoE+)
- HDBase T 2.0 standard
- EtherCAT Industrial standard
- TP-PMD, TPOD, ISDN
- Digital and analog for data, video and audio application

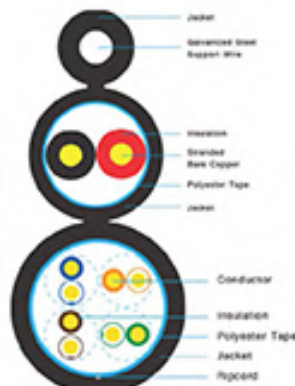
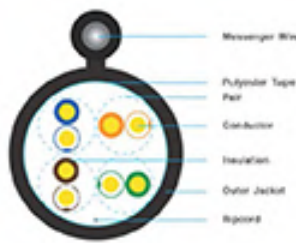
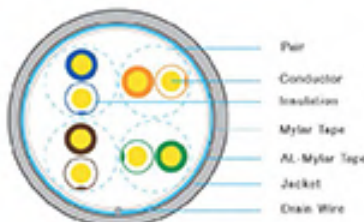



# LAN (UTP) CAT 5E 350 MHz



P/N	DESCRIPTION	COLOR	PACKING	UNIT PRICE
<b>INDOOR (UL Sticker)</b>				Effective P18 1 APRIL 2026
US-9015LSZH	CAT 5E UTP Enhanced CABLE (350 MHz), LSZH	White	305 <sup>ft</sup> M. /Reelink	4,950.-
US-9025LSZH	CAT 5E STRANDED PATCH CORD, LSZH	White	305 <sup>ft</sup> M. /Reelink	6,195.-
US-9055E	CAT 5E UTP 25 Pairs Power Sum CABLE, CMR, UL	White	305 <sup>ft</sup> M. /Roll	44,200.-
US-9035	CAT 5E F/UTP Enhanced CABLE (350 MHz), CMR, UL	White	305 <sup>ft</sup> M. /Reelink	5,995.-

<b>OUTDOOR</b>				
US-9045	CAT 5E UTP, PE OUTDOOR (Double Jacket)	Black	305 <sup>ft</sup> M. /Reelink	5,300.-
US-9015M	CAT 5E UTP, PE OUTDOOR w/Drop Wire (Single Jacket)	Black	305 <sup>ft</sup> M. /Reel in Bx.	6,305.-
US-9015PW	CAT 5E UTP, PE OUTDOOR w/Power wire	Black	305 <sup>ft</sup> M. /Reel in Bx.	11,385.-
US-9015MW	CAT 5E UTP, PE OUTDOOR w/Drop Wire & Power wire	Black	305 <sup>ft</sup> M. /Reel in Bx.	12,495.-
US-9035PE	CAT 5E F/UTP PE OUTDOOR CABLE (Single Jacket)	Black	305 <sup>ft</sup> M. /Reelink	6,755.-

<b>100 Meter (Color Bx. , Reelink or Reel in Bx.)</b>				
US-9015LSZH-1	CAT 5E UTP Enhanced CABLE (350 MHz), LSZH	White	100 <sup>ft</sup> M. /Color Box	1,710.- /Bx.
US-9045-1	CAT 5E UTP, PE OUTDOOR (Double Jacket)	Black	100 <sup>ft</sup> M. /Reelink	1,800.- /Bx.
US-9015M-1	CAT 5E UTP, PE OUTDOOR w/Drop Wire (Single Jacket)	Black	100 <sup>ft</sup> M. /Reel in Bx.	2,140.- /Bx.
US-9015PW-1	CAT 5E UTP, PE OUTDOOR w/Power wire	Black	100 <sup>ft</sup> M. /Reel in Bx.	3,765.- /Bx.
US-9015MW-1	CAT 5E UTP, PE OUTDOOR w/Drop Wire & Power wire	Black	100 <sup>ft</sup> M. /Reel in Bx.	4,150.- /Bx.



### Why? สาย LAN... สาย เรือ... ต้อง สาย LINK

- สาย LINK CAT 5E คุณภาพดีสูงกว่าสาย CAT 5E ทั่วๆ ไป เพราะออกแบบมาเพื่อรองรับ Bandwidth ที่ 350 MHz ซึ่งสายทั่วไปรองรับที่ 100-200 MHz และ LINK CAT 6 ULTRA ออกแบบเพื่อรองรับ Bandwidth ที่ 600 MHz สูงกว่ามาตรฐานที่ระบุ 250 MHz อีกทั้ง CAT 6A มีทั้ง UTP, Shield รองรับที่ Bandwidth ที่ 750 MHz สูงกว่ามาตรฐาน 500 MHz อีกด้วย
- สินค้า LINK เป็นสินค้าที่มีคุณภาพเพื่อรองรับตลาดสายสัญญาณระบบ Cabling โดยคำนึงถึงประสิทธิภาพการใช้งานเป็นหลักจึงจะเห็นได้จากหน่วยงานขนาดใหญ่ในประเทศไทยเกือบทุกแห่งได้เลือกใช้สายสัญญาณของ LINK อาทิ อาคารรัฐสภาใหม่, สนามบินสุวรรณภูมิ, ศูนย์ราชการอาคารใหม่, จุฬาลงกรณ์มหาวิทยาลัย, ทางสรรพสินค้าชั้นนำที่ทุกสาขา, ทำเนียบรัฐบาลและห้องประชุม สม. การไฟฟ้าฝ่ายผลิตแห่งประเทศไทย, การไฟฟ้าส่วนภูมิภาค, การไฟฟ้าส่วนกลาง, กองทัพเรือ, กองทัพอากาศ, ธนาคารทุกธนาคาร, บริษัทเงินทุนหลักทรัพย์, มหาวิทยาลัยเชียงใหม่, มหาวิทยาลัยธรรมศาสตร์, มหาวิทยาลัยเทคโนโลยีพระจอมเกล้าธนบุรี, พระนครเหนือ-อาคารระบิ่ง, การบินไทยและโรงแรมหรูเกือบทุกแห่งทั่วประเทศ
- เหตุผลที่ LINK เป็นสายสัญญาณที่ถูกรับเลือกใช้มากที่สุด เพราะ 1. การรับประกันสิทธิการรับประกันทั่วโลก 2. ใช้มาตรฐานอเมริกาผ่านการรับรอง UL และ INTERTEK 3. รับประกันผลิตภัณฑ์ 30 ปี โดยในปัจจุบัน LINK ยังเสนอการรับประกันให้มากกว่าสายสัญญาณ LSZH มากำหนดไว้ในสาขาที่รับสายลูกค้าทั่วไป เพื่อให้นักชื้อได้มั่นใจว่าสายสัญญาณที่ซื้อนั้นคือของแท้
- LINK สอดคล้องตามเงื่อนไขสินค้า ที่กำหนดให้รับประกันสูงสุด ครอบคลุมการรับประกัน Product Warranty 30 Years ซึ่งเป็นที่ยอมรับในตลาดของประเทศไทยในปัจจุบันขณะนี้

Reelink or Reellex ; is a cable box that utilizes innovative technology to organize cables, making them easier to pull out and use .

- Remark : 1. Packing 500 M./ Reel (ไม่มี R หรือ \* ) หมายถึง สินค้าที่มีใน STOCK สามารถสั่งซื้อ และ สั่งตัดได้ทุก 10 เมตร เท่านั้น  
 2. Packing 100<sup>ft</sup> M., 500<sup>ft</sup> M./ Reel (มี R ) หมายถึง สินค้าที่มีใน STOCK แต่ต้องสั่งซื้อแยก Box หรือ Roll  
 3. Packing 100<sup>ft</sup> M., 500<sup>ft</sup> M./ Reel (มี \* ) หมายถึง สินค้าที่ต้องสั่งผลิตและ ต้องสั่งซื้อแยก Roll เท่านั้น (Made to Order)



# CAT 6 ULTRA 600 MHz



## LAN (UTP) System

www.interlink.co.th

Tel. 02-668-1111

Think of Cabling ... Think INTERLINK

Think of Cabling ... Think INTERLINK

PRICE LIST 2569

19



### STANDARD

- ANSI/TIA-568.2 - E Category 6
- ANSI/TIA-568.2 - D Category 6
- ANSI/TIA-568-C.2 Category 6
- ISO / IEC 11801 : 2017 class E
- EN 50173-1 Category 6
- EN 50288-6-1
- IEC 61156-5
- UL 1666 (CMR)
- UL 1685 (CM)
- UL 1581 (CMX)
- IEC 60332-1 (LSZH)
- NFPA 262 (CMP)
- UL 444
- CSA 22.2 NO.214
- UL, ETL and 3P verified to Category 6
- RoHS Compliant

### APPLICATION

- Structure Cabling (Backbone & Horizontal)
- 10G BASE-T (IEEE 802.3an 10Gigabit Ethernet, Limited Distance)
- 1000 BASE-T (IEEE 802.3ab Gigabit Ethernet)
- 1000 BASE-TX (TIA/EIA-854)
- 100 BASE-TX (IEEE 802.3u Fast Ethernet)
- 52/155/622Mbps and 1.2Gbps ATM
- IEEE 802.3 Vx/vb,
- CDDI / ATM / Token Ring / VoIP
- IEEE 802.3 at (PoE) / IEEE 802.3 at (PoE+)
- HDBase T 2.0 standard
- EtherCAT Industrial standard
- TP-PMD, TPOD, ISDN
- Digital and analog for data, video and audio application



US-9106A

CAT 6 UTP, CM, 24 AWG

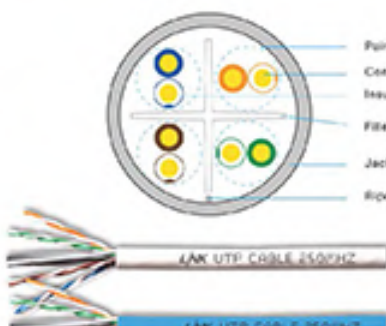

US-9106LSZH / US-9106BSZH

CAT 6 UTP, LSZH, 23 AWG

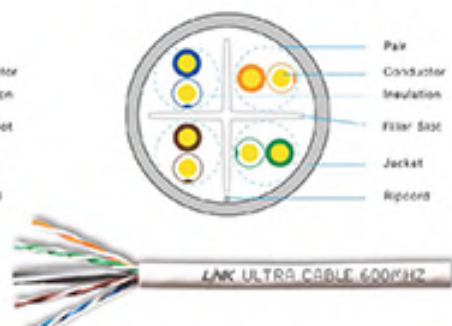

US-9116LSZH

CAT 6 UTP ULTRA, 23 AWG, LSZH



US-9106OUT

CAT 6 UTP, PE OUTDOOR w/Filler, 23 AWG (Double Jacket)

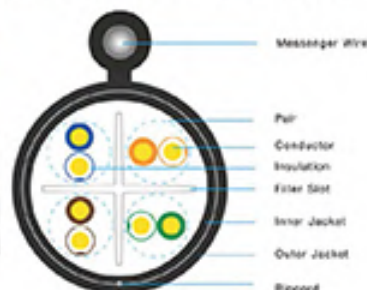

US-9106MD

CAT 6 UTP, PE OUTDOOR w/Filler, 23 AWG, w/Drop Wire (Double Jacket)

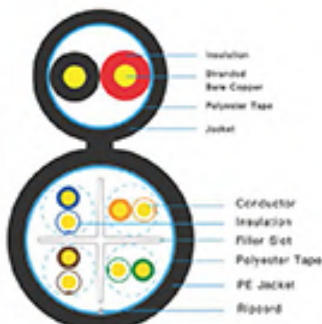

US-9106PW

CAT 6 UTP, PE OUTDOOR w/Power wire

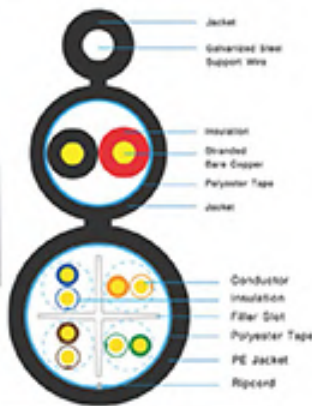







US-9106MW

CAT 6 UTP, PE OUTDOOR w/Drop wire & Power wire



# LAN (UTP) CAT 6 ULTRA 600 MHz



P/N	DESCRIPTION	COLOR	PACKING	UNIT PRICE
<b>INDOOR , (  Sticker )</b>				Effective P20 1 APRIL 2026
 US-9106A	CAT 6 UTP [ 250 MHz ] w/Cross Filler, 24 AWG, CM , UL	Blue	305 <sup>ft</sup> M. /Reelink	5,510.-
 US-9106LSZH	CAT 6 UTP [ 250 MHz ] w/Cross Filler, 23 AWG, LSZH	White	305 <sup>ft</sup> M. /Reelink	6,080.-
 US-9106BLSZH	CAT 6 UTP [ 250 MHz ] w/Cross Filler, 23 AWG, LSZH	Blue	305 <sup>ft</sup> M. /Reelink	6,080.-
 US-9116LSZH	CAT 6 UTP ULTRA [ 600 MHz ] w/Cross Filler, 23 AWG, LSZH	White	305 <sup>ft</sup> M. /Reelink	6,490.-
 US-9126LSZH	CAT 6 UTP STRANDED [ 600 MHz ] Patch Cord, 24 AWG, LSZH	Blue	305 <sup>ft</sup> M. /Reelink	6,410.-
 US-9136LSZH	CAT 6 F/UTP ULTRA SHIELDED w/Cross Filler, 23 AWG, LSZH	White	305 <sup>ft</sup> M. /Roll	7,780.-









## OUTDOOR

 US-91060UT	CAT 6 UTP ULTRA , PE OUTDOOR w/Cross Filler, 23 AWG (Double Jacket) Black	Black	305 <sup>ft</sup> M. /Reelink	7,060.-
 US-9106MD	CAT 6 UTP ULTRA , PE OUTDOOR, 23 AWG, w/Drop Wire (Double Jacket) Black	Black	305 <sup>ft</sup> M. /Reel in Bx.	8,820.-
US-9106PW	CAT 6 UTP ULTRA , PE OUTDOOR w/Power wire	Black	305 <sup>ft</sup> M. /Reel in Bx.	14,340.-
US-9106MW	CAT 6 UTP ULTRA , PE OUTDOOR w/Drop wire & Power wire	Black	305 <sup>ft</sup> M. /Reel in Bx.	15,020.-
 US-9136PE	CAT 6 F/UTP ULTRA , PE OUTDOOR w/Cross Filler, 23 AWG	Black	305 <sup>ft</sup> M. /Reel in Bx.	8,530.-



## 100 Meter ( Easy Bx. , Reelink , Reel in Bx. )

 US-9106A-1	CAT 6 UTP [ 250 MHz ] w/Cross Filler, 24 AWG, CM , UL	Blue	100 <sup>ft</sup> M. /Easy Bx.	1,810.- /Bx.
 US-9106LSZH-1	CAT 6 UTP [ 250 MHz ] w/Cross Filler, 23 AWG, LSZH	White	100 <sup>ft</sup> M. /Easy Bx.	2,050.- /Bx.
 US-9106BLSZH-1	CAT 6 UTP [ 250 MHz ] w/Cross Filler, 23 AWG, LSZH	Blue	100 <sup>ft</sup> M. /Easy Bx.	2,050.- /Bx.
 US-91060UT-1	CAT 6 UTP, PE OUTDOOR w/Cross Filler, 23 AWG (Double Jacket) Black	Black	100 <sup>ft</sup> M. /Easy Bx.	2,360.- /Bx.
 US-9106MD-1	CAT 6 UTP, PE OUTDOOR 23 AWG w/Drop wire (Double Jacket) Black	Black	100 <sup>ft</sup> M. /Reel in Bx.	2,850.- /Bx.
US-9106PW-1	CAT 6 UTP, PE OUTDOOR w/Power wire	Black	100 <sup>ft</sup> M. /Reel in Bx.	4,800.- /Bx.
US-9106MW-1	CAT 6 UTP, PE OUTDOOR w/Drop wire & Power wire	Black	100 <sup>ft</sup> M. /Reel in Bx.	5,020.- /Bx.
 US-9138EF	CAT 6 ELEVATOR EXTRA FLEX CABLE 	Black	305 <sup>ft</sup> M. /Roll	14,810.-



### LSZH CMR CM

ความแตกต่างระหว่างสาย LSZH , CMR และ สาย CM คือวัสดุ, รูปแบบการติดตั้ง และอัตราการลามไฟของสายสัญญาณที่ติดตั้งภายในอาคาร สำนักงานด้วยเหตุผลเรื่องความปลอดภัยจากอัคคีภัย (ตามมาตรฐาน UL) สาย CM (Communication Metallic) จะสามารถติดตั้งได้ภายในชั้น หรือติดตั้งวางไปกับพื้น มาตรฐานกำหนดติดตั้งเปลี่ยนในแนวอื่นแต่ลักษณะสาย CMR (Communication Metallic Riser) จะสามารถติดตั้งได้ทั้งในแนวราบ และแนวตั้งบริเวณช่องชาร์ป (จุดรวมของสายสัญญาณที่เชื่อมต่อระหว่างชั้น) โดยไม่ต้องหุ้มท่อConduit เพราะสาย CMR ถูกออกแบบด้วยวัสดุที่ทนทาน, ดับไฟได้เร็ว และความเร็วของเปลวไฟจะไม่ลามไปติดอีกชั้นหนึ่ง จึงเหมาะกับการเดินทั้งแนวตั้งและแนวราบ ติดกับโครงสร้างของสาย CMR จึงจะแพงกว่าสาย CM แต่กว่าสาย CMR จะมีความทนทานและคงทนมากกว่าสาย CM อย่างแน่นอนและคุ้มค่าในกาเข้าไปใช้งานในระยะยาว

สาย LSZH จะเพิ่มคุณสมบัติด้านความปลอดภัย กรณีที่เกิดเพลิงไหม้ สาย LSZH จะมีคุณสมบัติพิเศษที่จะไม่ลามไฟ และมีควันน้อยกว่าปกติ และควันก็ไม่ก่อให้เกิดอาการสำลักควันที่เป็นสาเหตุทำให้คนเสียชีวิต เหมาะสำหรับพื้นที่สาธารณะ และ พื้นที่อาคารสำนักงาน และ ทั่วไป

*Reelink or Reellex ; is a cable box that utilizes innovative technology to organize cables, making them easier to pull out and use .*

*Easy Bx = กล่องสาย LAN ที่ออกแบบให้สะดวกในการลากสายมาติดตั้ง ซึ่งใช้สำหรับความยาว 100 เมตร เท่านั้น*



## LAN (UTP) System

# CAT 6A , SUPER-S , 750 MHz

### UTP CAT 6A CABLE

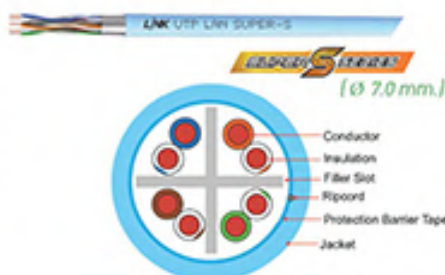

US-9156ALSZH

CAT 6A UTP Super-S Series Cable, LSZH

### Technical Standard

- ANSI/TIA-568-2-E Category 6A
- ANSI/TIA-568-2-D Category 6A
- ANSI/TIA-568-C.2 Category 6A
- ISO/IEC 11801:2017 class EA
- EN 50173-1 Category 6A
- EN 50288-11-1
- IEC 61156-5, IEC 60332-1
- IEC 60754-1, IEC 60754-2
- IEC 61034-1, IEC 61034-2
- UL 444/NEC 800
- 3P Verified to Category 6A
- RoHS Compliant

### Application

- 2.5G/5G BASE-T (IEEE 802.3bz)
- 10G BASE-T (IEEE 802.3an 10Gigabit Ethernet)
- 1000 BASE-T (IEEE 802.3ab Gigabit Ethernet)
- 1000 BASE-TX (TIA/EIA-854)
- 100 BASE-TX (IEEE 802.3u Fast Ethernet)
- 10 BASE-T (IEEE 802.3i Ethernet)
- 52/155/622Mbps and 1.2Gbps ATM
- 4/16 Mbps Token Ring
- IEEE 802.3af (PoE), IEEE 802.3at (PoE+), IEEE 802.3bt (Type4)
- TP-PMD, TPDD, ISDN, CDD, VoIP
- EtherCAT Industrial standard, HDBaseT 2.0 standard
- Baseband, Broadband
- Digital and analog for data, video and audio application



US-9157LSZH

CAT 6A UTP Super-S [750 MHz.] Cable, LSZH

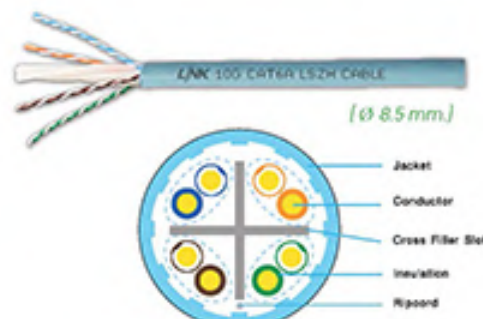

US-9146LSZH

CAT 6A UTP XG [750 MHz.], Slot Jacket Cable LSZH

### SHIELDED CAT 6A CABLE



US-9256ALSZH

CAT 6A U/FTP Super-S Series, LSZH  
[Individual Shielded Twisted Pair]

### Technical Standard

- ANSI/TIA-568-2-E Category 6A
- ANSI/TIA-568-2-D Category 6A
- ANSI/TIA-568-C.2 Category 6A
- ISO / IEC 11801 : 2017 class EA
- EN 50173-1 Category 6A
- EN 50288-10-1
- IEC 61156-5
- UL 1666 (CMR)
- UL 1685 (CM)
- UL 1581 (CMX)
- IEC 60332-1 (LSZH)
- NFPA 262 (CMP)
- UL 444
- CSA 22.2 NO.214
- UL, ETL and 3P verified to Category 6A
- RoHS Compliant

### Application

- 2.5G/5G BASE-T (IEEE 802.3bz)
- 10G BASE-T (IEEE 802.3an 10Gigabit Ethernet)
- 1000 BASE-T (IEEE 802.3ab Gigabit Ethernet)
- 1000 BASE-TX (TIA/EIA-854)
- 100 BASE-TX (IEEE 802.3u Fast Ethernet)
- 10 BASE-T (IEEE 802.3i Ethernet)
- 52/155/622Mbps and 1.2Gbps ATM
- 4/16 Mbps Token Ring
- IEEE 802.3af (PoE), IEEE 802.3at (PoE+), IEEE 802.3bt (Type4)
- TP-PMD, TPDD, ISDN, CDD, VoIP
- EtherCAT Industrial standard, HDBaseT 2.0 standard
- Baseband, Broadband
- Digital and analog for data, video and audio application

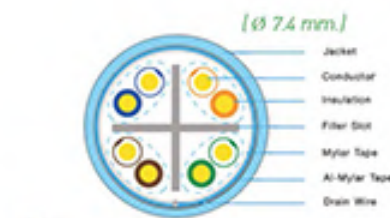

US-9266LSZH

CAT 6A F/FTP Super XG, LSZH  
[Foil Shielded Twisted Pair]



US-9267ALSZH

CAT 6A F/FTP Super-S Series, LSZH  
[Foil Cover Individual Shielded Twisted Pair]



# CAT 6A , SUPER-S<sup>®</sup> , 750 MHz



P/N	DESCRIPTION	Diameter	PACKING	UNIT PRICE
-----	-------------	----------	---------	------------

## UTP CAT 6A CABLE (INDOOR) **BLUPER S<sup>®</sup> SERIES** , Aqua Blue Jacket

Effective P22  
1 APRIL 2026

<b>US-9156ALSZH</b>	CAT 6A UTP SUPER-S SERIES CABLE, LSZH	[ $\varnothing$ 7.0 mm.]	305 <sup>0</sup> M. /Pull in Bx.	8,500.-
<b>US-9157LSZH</b>	CAT 6A UTP SUPER-S [ 750 MHz ] CABLE, LSZH	[ $\varnothing$ 7.3 mm.]	305 <sup>0</sup> M. /Pull in Bx.	8,990.-
<b>US-9146LSZH</b>	CAT 6A UTP SUPER XG [ 750 MHz ] CABLE, LSZH	[ $\varnothing$ 8.5 mm.]	305 <sup>0</sup> M. /Roll	9,100.-

## SHIELDED CAT 6A CABLE (INDOOR) **BLUPER S<sup>®</sup> SERIES** , Aqua Blue Jacket

<b>US-9256ALSZH</b>	CAT 6A U/FTP SUPER-S SERIES CABLE, LSZH	[ $\varnothing$ 6.8 mm.]	305 <sup>0</sup> M. /Pull in Bx.	9,100.-
<b>US-9256LSZH</b>	CAT 6A U/FTP SUPER XG CABLE, LSZH	[ $\varnothing$ 7.3 mm.]	305 <sup>0</sup> M. /Roll	8,320.-
<b>US-9266LSZH</b>	CAT 6A F/UTP SUPER XG [ 650 MHz ] CABLE, LSZH	[ $\varnothing$ 7.4 mm.]	305 <sup>0</sup> M. /Pull in Bx.	9,100.-
<b>US-9267ALSZH</b>	CAT 6A F/FTP SUPER-S SERIES CABLE, LSZH	[ $\varnothing$ 6.9 mm.]	305 <sup>0</sup> M. /Pull in Bx.	8,800.-
<b>US-9267LSZH</b>	CAT 6A F/FTP XG [ 500 MHz ] CABLE, LSZH	[ $\varnothing$ 7.5 mm.]	305 <sup>0</sup> M. /Roll	8,740.-

## UTP CAT 6A CABLE (OUTDOOR) **BLUPER S<sup>®</sup> SERIES** , Black Jacket

<b>US-9156AOUT</b>	CAT 6A UTP SUPER-S OUTDOOR CABLE, Double Jacket		305 <sup>0</sup> M. /Roll	9,510.-
<b>US-9256AOUT</b>	CAT 6A U/FTP SUPER-S OUTDOOR CABLE, Double Jacket		305 <sup>0</sup> M. /Roll	9,610.-

## 100 Meter CAT 6A CABLE (INDOOR) **BLUPER S<sup>®</sup> SERIES** , Aqua Blue Jacket

<b>US-9156ALSZH-1</b>	CAT 6A UTP SUPER-S SERIES CABLE, LSZH	[ $\varnothing$ 7.0 mm.]	100 <sup>0</sup> M. /Pull in Bx.	3,150.-
<b>US-9266LSZH-1</b>	CAT 6A F/UTP SUPER XG [ 650 MHz ] CABLE, LSZH	[ $\varnothing$ 7.4 mm.]	100 <sup>0</sup> M. /EASY BOX	3,200.-



### ควาขแตกต่างของสาย CAT 6A ประเภทต่าง ๆ

1. สาย UTP ได้รับความนิยมในสหรัฐอเมริกา ติดตั้งง่าย ไม่จำเป็นต้องต่อสายกราวด์เพื่อระบายสัญญาณรบกวน เนื่องจากหากรบบกราวด์ไม่สมบูรณ์ อาจทำให้เกิดสัญญาณรบกวนสะสมบนชิลด์ของสาย ส่งผลต่อประสิทธิภาพของระบบ ดังนั้น สาย UTP จึงเป็นทางเลือกที่คุ้มค่าที่สุด

2. สาย Shielded (F/UTP, U/FTP, F/FTP)

แม้ทั้งหมดจะผ่านมาตรฐาน CAT 6A แต่มีความแตกต่างกันในเชิงโครงสร้าง เช่น สาย U/FTP ซึ่งใช้พอยล์หุ้มแต่ละคู่สายแยกอิสระ จะมีประสิทธิภาพในการป้องกันสัญญาณรบกวนเฉียบพลัน (Shock Load) ได้ดีกว่าแบบ F/UTP ที่หุ้มพอยล์รวมทั้ง 4 คู่ เหมาะสำหรับการติดตั้งในสภาพแวดล้อมที่มีการรบกวนทางไฟฟ้าสูง เช่น โรงงานอุตสาหกรรมหรือพื้นที่ที่มีมอเตอร์ไฟฟ้าหนาแน่น ส่วนสาย F/FTP จะมีประสิทธิภาพการป้องกันสัญญาณการรบกวนเฉียบพลันได้ดีกว่า สาย F/UTP และ U/FTP แต่จะต้องต่อระบบ Grounding เพื่อถ่ายเทสัญญาณการรบกวนสะสมบนชิลด์ของสายด้วย



# CONNECTORS CAT 5E 350 MHz



## LAN (UTP) System



**US-1001**  
ตัวผู้ High Performance , สีใส



**US-1051-X** : ตัวผู้ Crystal High Performance



**US-651X** : CAT 5E Locking Plug Boot



**US-600X** : CAT 5E Plug Boot



**US-1005SC1**  
CAT 5E ตัวเมีย Slim สีขาว  
(ตัวผู้จะกัดรัดกว่า แบบ US-1005)



**US-1005SCX**  
CAT 5E ตัวเมีย Slim , Colorful



**US-1005STF**  
CAT 5E ตัวเมีย Slim Tool Free, สีฟ้า



**US-4005IL**  
ตัวต่อติด Panel



**US-4005**  
ตัวต่อสาย UTP



**US-3024 / US-3048**  
CAT 5E แผงกระจายสายมีเหล็กรัดสายและติดป้ายชื่อได้



**US-5003/5006/5010/5015/5020/5025/5030LZ-X**  
Patch Cord (มีหลากหลายสีให้เลือก)



**US-2021A / 2022A / 2023A**  
POP-UP Stainless 1, 2, 3 Port with box and Dampening



**US-1003**  
ตัวผู้ Shielded



**US-1013**  
CAT 5E ตัวเมีย Shielded



**US-4005S**  
ตัวต่อสาย Shielded FTP



**US-5003 / 5006 / 5010 / 5015 / 5020SLZ-6**  
Shielded Patch Cord (สีดำ)



**US-8061**  
คีมเข้าหัวตัวเมีย และ เข้าหัวตัวผู้ (Two in one)  
[ Fast Jack and Plug Termination Tool ]

www.interlink.co.th  
Tel. 02-668-1111  
Think of Cabling ... Think INTERLINK

PRICE LIST 2569  
23



# CAT 5E 350 MHz PACTH PANEL & CONNECTORS



Effective P24  
1 APRIL 2026

P/N	DESCRIPTION		
US-1001	CAT 5E RJ45 PLUG (Transparent Clear)	10 Pcs /Pkg.	9.- /Pc
US-1051-X	CAT 5E RJ45 PLUG (แก้ว), [CRYSTAL] [X=2Red/3Green/4Blue/5Yellow/6Black]	10 Pcs /Pkg.	9.- /Pc
US-651X	CAT 5E Locking Plug BOOT [X=0Clear/1 White/2Red/3Green/4 Blue/5Yellow]	10 Pcs /Pkg.	6.- /Pc
US-600X	CAT 5E Plug BOOT [X=1Ivory/2Red/3Green/4Blue/5Yellow]	10 Pcs /Pkg.	5.- /Pc
US-1005SC1	CAT 5E RJ45 Colorful JACK, Slim, White	แก้วเขียวสีขาวขุ่น มีฝาปิด	90.-
US-1005SCX	CAT 5E RJ45 Colorful JACK, Slim [X= 2Red/3Green/4 Blue/5Yellow]	แก้วเขียวหลากสี มีฝาปิด	90.-
US-1005STF	CAT 5E RJ45 JACK, Slim , Tool Free, Blue	แก้วเขียวไม่ต้องใช้เครื่องมือ	105.-
US-3024	CAT 5E PATCH PANEL 24 PORT (1U) w/Support	แผงกระจายสายมีเหล็กรัดสายและติดป้ายชื่อได้	2,500.-
US-3048	CAT 5E PATCH PANEL 48 PORT (2U) w/Support	แผงกระจายสายมีเหล็กรัดสายและติดป้ายชื่อได้	4,500.-
US-4005IL	CAT 5E RJ45 COUPLER In-Line or Patch Panel Insert	ตัวต่อสายตัวเมีย 2 ด้าน , ใส่ Patch Panel ได้	90.-
US-4005 (แทนที่ US-4005IL)	CAT 5E RJ45 COUPLER In-Line	ตัวต่อสายตัวเมีย 2 ด้าน	100.-
US-8061	<b>FAST JACK and PLUG Termination TOOL (Two in one For CAT 6 and CAT 5E Slim)</b> (ใช้เพื่อรวมเข้าหัวตัวเมีย CAT 6 รุ่นเก่า และ CAT 5E รุ่นเก่า US-1006SL , US-1005SCX)		2,120.-
US-5003LZ-X	CAT 5E RJ45 - RJ45 PATCH CORD 24 AWG , LSZH 1 M. [X=1 White/2Red/3Green/4 Blue/5Yellow]		74.-
US-5006LZ-X	CAT 5E RJ45 - RJ45 PATCH CORD 24 AWG , LSZH 2 M. [X=1 White/2Red/3Green/4 Blue/5Yellow]		107.-
US-5010LZ-X	CAT 5E RJ45 - RJ45 PATCH CORD 24 AWG , LSZH 3 M. [X=1 White/2Red/3Green/4 Blue/5Yellow]		141.-
US-5015LZ-X	CAT 5E RJ45 - RJ45 PATCH CORD 24 AWG , LSZH 5 M. [X=1 White/2Red/3Green/4 Blue/5Yellow]		209.-
US-5020LZ-X	CAT 5E RJ45 - RJ45 PATCH CORD 24 AWG , LSZH 10 M. [X=1 White/2Red/3Green/4 Blue/5Yellow]		378.-
US-5025LZ-X	CAT 5E RJ45 - RJ45 PATCH CORD 24 AWG , LSZH 15 M. [X=1 White/2Red/3Green/4 Blue/5Yellow]		547.-
US-5030LZ-X	CAT 5E RJ45 - RJ45 PATCH CORD 24 AWG , LSZH 20 M. [X=1 White/2Red/3Green/4 Blue/5Yellow]		716.-
US-2030	BLANK RJ45 POP-UP STAINLESS 1-3 PORT w/Damping	เก้าอี้รับปีพ่นแผ่นมีDamping	1,200.-
US-2021A	CAT 5E NEW POP-UP STAINLESS 1 PORT OUTLET w/Damping	เก้าอี้รับปีพ่นแผ่นมีDamping	1,300.-
US-2022A	CAT 5E NEW POP-UP STAINLESS 2 PORT OUTLET w/Damping	เก้าอี้รับปีพ่นแผ่นมีDamping	1,400.-
US-2023A	CAT 5E NEW POP-UP STAINLESS 3 PORT OUTLET w/Damping	เก้าอี้รับปีพ่นแผ่นมีDamping	1,500.-
US-2200	RJ45 Socket Protector (ตัวจุดปิดกันฝุ่นตัวเมีย)	10 Pcs /Pkg.	100.- /Pkg.
US-1003	Shielded CAT 5E RJ45 PLUG (ตัวผู้ชิด)	1 Pc /Pkg.	36.-
US-1013	Shielded CAT 5E RJ45 Modular JACK, (ตัวเมียชิด)	ตัวเมียรุ่นชิด	120.-
US-4005S	Shielded CAT 5E In-Line COUPLER	ตัวต่อสายชิดตัวเมีย 2 ด้าน	130.-
US-5003SLZ-6	Shielded CAT 5E RJ45 - RJ45 PATCH CORD 26 AWG , LSZH 1 M. , Black	สีดำ	95.-
US-5006SLZ-6	Shielded CAT 5E RJ45 - RJ45 PATCH CORD 26 AWG , LSZH 2 M. , Black	สีดำ	122.-
US-5010SLZ-6	Shielded CAT 5E RJ45 - RJ45 PATCH CORD 26 AWG , LSZH 3 M. , Black	สีดำ	155.-
US-5015SLZ-6	Shielded CAT 5E RJ45 - RJ45 PATCH CORD 26 AWG , LSZH 5 M. , Black	สีดำ	212.-
US-5020SLZ-6	Shielded CAT 5E RJ45 - RJ45 PATCH CORD 26 AWG , LSZH 10 M. , Black	สีดำ	375.-

Think of Cabling ... Think@ INTERLINK Tel: 02-666-1111 www.interlink.co.th

PRICE LIST 2569



# CONNECTORS CAT 6 ULTRA 600 MHz



## LAN (UTP) System

www.interlink.co.th  
Tel. 02-668-1111  
Think of Cabling ... Think INTERLINK

**NEW**



**NEW**

US-1062AA-X : CAT 6 NEW RJ45 CRYSTAL PLUG 2 Layer



US-1002AA  
CAT 6 NEW RJ45 PLUG 2 Layer  
(One Piece 2 Layer)



US-662XA : CAT 6 NEW CRYSTAL LOCKING PLUG BOOT



US-1006SL  
CAT 6 SLIM JACK



US-1006A  
CAT 6 RJ45 JACK, White  
( 5 Color Changeable )



US-1006STF  
CAT 6 Slim JACK [Tool Free]



US-1006TFAS  
CAT 6 Auto Shutter JACK



US-4006IL  
In-Line COUPLER JACK  
Patch Panel Insert



US-5101/5102/5103/5105/5110LZ-X  
UTP CAT 6 RJ45-RJ45 Patch Cord

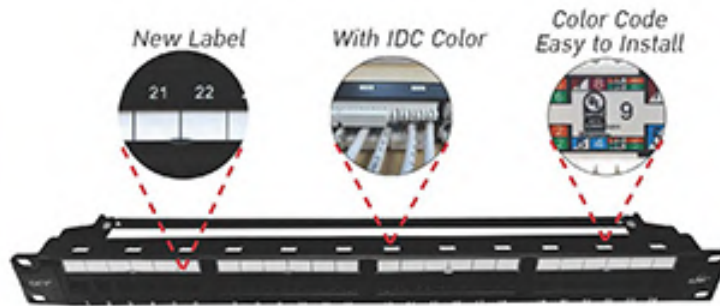

US-3124A : CAT 6+ PATCH PANEL 24 PORT (1U) w/Cable Management



US-3148A : CAT 6+ PATCH PANEL 48 PORT (2U) w/Cable Management



US-514XSS-X  
UTP CAT 6 Small O.D Patch Cord



US-1004A  
Shield CAT 6 RJ45  
w/Blue BOOT



US-1014A  
Shielded CAT 6 JACK  
ToolFree



US-4006SIL  
Shielded In-Line COUPLER  
Patch Panel Insert

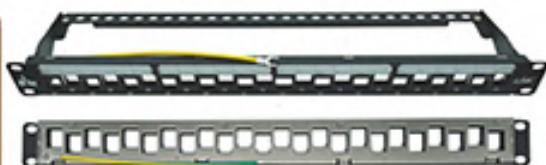

US-3002SA  
HYBRID UNLOAD SUPER-S STAGGERED PATCH  
PANEL 24 PORT (1U) w/label, management



US-5101 / 5102 / 5103 / 5105 / 5110SLZ-1  
Shielded CAT 6 RJ45-RJ45 Patch Cord (100m)



US-2031A / 2032A / 2033A  
POP-UP Stainless 1, 2, 3 Port with box and Damping  
[ US-2030 Blank Pop-up with US-1006SL 1,2,3 Port ]

PRICE LIST 2569

25



# CAT 6 ULTRA 600 MHz PACTH PANEL & CONNECTORS



Effective P26  
1 APRIL 2026

P/N	DESCRIPTION	PACKING	
US-1002AA	CAT 6 New RJ45 PLUG 2 Layer TRANSPARENT CLEAR (One Piece 2 Layer, New Technology)	10 Pcs /Pkg.	12.- /Pc
US-1002	CAT 6 Old RJ45 PLUG, 2 Layer with pre-insert bar (Two Piece, Old Technology)	10 Pcs /Pkg.	14.- /Pc
US-1062AA-X <small>(Replace US-1062A-X)</small>	CAT 6 New RJ45 CRYSTAL PLUG 2 Layer (transparent X=2Red/3Green/4Blue/5Yellow/6Black)	10 Pcs /Pkg.	12.- /Pc
US-662XA <small>(Replace US-662x)</small>	CAT 6 New CRYSTAL LOCKING PLUG BOOT (X=0Clear/2Red/3Green/4Blue/5Yellow /6Black)	10 Pcs /Pkg.	6.- /Pc
US-1006SL	CAT 6 RJ45 Modular JACK, SLIM, White (Used Fast Tool US-8061)		120.-
US-1006A	CAT 6 RJ45 Modular JACK (5 Color Changeable), White (Used Fast Tool TL-2106)		110.-
US-1006STF	CAT 6 RJ45 Modular JACK, Slim, Tool Free, White		140.-
US-1006TFAS	CAT 6 RJ45 Modular JACK, Auto Shutter, White		150.-
US-3124A	CAT 6+ PATCH PANEL 24 PORT (1U) w/Management, Dust Cover, Labeling		3,000.-
US-3148A	CAT 6+ PATCH PANEL 48 PORT (2U) w/Management, Dust Cover, Labeling		5,600.-
US-4006IL	CAT 6 RJ45 COUPLER In-Line Useable in Panel (Relace US-4006)		120.-
<small>obsolete</small> US-4006	CAT 6 RJ45 COUPLER In-Line (Recommend US-4006IL)		150.-
US-2030	BLANK RJ45 POP-UP STAINLESS 1-3 PORT w/Damping		1,200.-
US-2031A	CAT 6 NEW POP-UP STAINLESS 1 PORT OUTLET w/DAMPING	ได้รับดัมป์ Damping	1,350.-
US-2032A	CAT 6 NEW POP-UP STAINLESS 2 PORT OUTLET w/DAMPING	ได้รับดัมป์ Damping	1,450.-
US-2033A	CAT 6 NEW POP-UP STAINLESS 3 PORT OUTLET w/DAMPING	ได้รับดัมป์ Damping	1,550.-
US-5101LZ-X	CAT 6 RJ45-RJ45 PATCH CORD 24 AWG, LSZH 1 M. (X=1 White/2Red/3Green/4 Blue/5Yellow)		90.-
US-5102LZ-X	CAT 6 RJ45-RJ45 PATCH CORD 24 AWG, LSZH 2 M. (X=1 White/2Red/3Green/4 Blue/5Yellow)		120.-
US-5103LZ-X	CAT 6 RJ45-RJ45 PATCH CORD 24 AWG, LSZH 3 M. (X=1 White/2Red/3Green/4 Blue/5Yellow)		155.-
US-5105LZ-X	CAT 6 RJ45-RJ45 PATCH CORD 24 AWG, LSZH 5 M. (X=1 White/2Red/3Green/4 Blue/5Yellow)		225.-
US-5110LZ-X	CAT 6 RJ45-RJ45 PATCH CORD 24 AWG, LSZH 10 M. (X=1 White/2Red/3Green/4 Blue/5Yellow)		415.-
US-5115LZ-X	CAT 6 RJ45-RJ45 PATCH CORD 24 AWG, LSZH 15 M. (X=1 White/2Red/3Green/4 Blue/5Yellow)		600.-
US-5120LZ-X	CAT 6 RJ45-RJ45 PATCH CORD 24 AWG, LSZH 20 M. (X=1 White/2Red/3Green/4 Blue/5Yellow)		785.-
US-5125LZ-X	CAT 6 RJ45-RJ45 PATCH CORD 24 AWG, LSZH 25 M. (X=1 White/2Red/3Green/4 Blue/5Yellow)		975.-
US-5130LZ-X	CAT 6 RJ45-RJ45 PATCH CORD 24 AWG, LSZH 30 M. (X=1 White/2Red/3Green/4 Blue/5Yellow)		1,160.-
US-5139SS-X	CAT 6 Small O.D PATCH CORD 28 AWG, LSZH 0.3 M. (x = 4 Blue / 6 Black)		70.-
US-5140SS-X	CAT 6 Small O.D PATCH CORD 28 AWG, LSZH 0.5 M. (x = 4 Blue / 6 Black)		75.-
US-5141SS-X	CAT 6 Small O.D PATCH CORD 28 AWG, LSZH 1 M. (x = 4 Blue / 6 Black)		85.-
US-5142SS-X	CAT 6 Small O.D PATCH CORD 28 AWG, LSZH 2 M. (x = 4 Blue / 6 Black)		115.-
US-5143SS-X	CAT 6 Small O.D PATCH CORD 28 AWG, LSZH 3 M. (x = 4 Blue / 6 Black)		135.-
US-5145SS-X	CAT 6 Small O.D PATCH CORD 28 AWG, LSZH 5 M. (x = 4 Blue / 6 Black)		200.-
US-5150SS-X	CAT 6 Small O.D PATCH CORD 28 AWG, LSZH 10 M. (x = 4 Blue / 6 Black)		355.-
US-1004A	Shielded CAT 6 RJ45 PLUG w/Blue Boot (Used Tool TL-1106AGA)	1 Pc. / Pkg	62.-
US-1014A	Shielded CAT 6 RJ45 Modular JACK, Tool Free (Replace US-1014)		160.-
US-3002SA	HYBRID UNLOAD SUPER-S STAGGERED PATCH PANEL 24 PORT (1U) w/label, management <small>(Choose US-1014A JACK LOAD)</small>		1,350.-
US-4006SIL	Shielded CAT 6 In-Line COUPLER Useable in Panel (Relace US-4006S)		160.-
<small>obsolete</small> US-4006S	Shielded CAT 6 In-Line COUPLER (Recommend US-4006SIL)		160.-
US-5101SLZ-1	Shielded CAT 6 RJ45 - RJ45 Patch Cord 26 AWG, LSZH 1 M., White		120.-
US-5102SLZ-1	Shielded CAT 6 RJ45 - RJ45 Patch Cord 26 AWG, LSZH 2 M., White		170.-
US-5103SLZ-1	Shielded CAT 6 RJ45 - RJ45 Patch Cord 26 AWG, LSZH 3 M., White		200.-
US-5105SLZ-1	Shielded CAT 6 RJ45 - RJ45 Patch Cord 26 AWG, LSZH 5 M., White		300.-
US-5110SLZ-1	Shielded CAT 6 RJ45 - RJ45 Patch Cord 26 AWG, LSZH 10 M., White		500.-

Think of Cabling ... Think@ INTERLINK Tel: 02-666-1111 www.interlink.co.th

PRICE LIST 2569 26



# CONNECTORS CAT 6A SUPER-S



## LAN (UTP) System

### CAT 6A UNSHIELDED CONNECTORS



US-1070SG  
HYBRID CAT 6A RJ45  
GOLD PLUG (UTP/SHIELDED)



US-1070A  
CAT 6A RJ45 PLUG w/Boot,  
Fielded Terminate



US-6110TF  
CAT 6A UTP RJ PLUG  
Super-S Field Terminate



US-1026A  
CAT 6A UTP SUPER-S RJ45 JACK  
*(FREE DIRECTION)*



US-6222TFS  
CAT 6A RJ45 SUPER-S, SHORT BODY  
*(Auto Shutter JACK)*



US-64XXLZ - 1 White / US-64XXLZ - 9 Aqua Blue  
UTP CAT 6A SUPER-S PATCH CORD



US-4007IL  
CAT 6A In-Line COUPLER  
Usable for Patch Panel



US-3226A  
CAT 6A *(Super-S STAGGERED)* PATCH PANEL 24 Port  
w/Cable, management

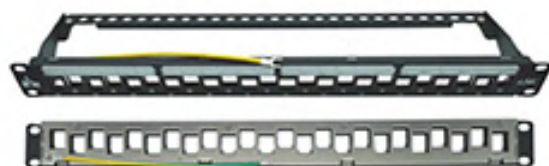

US-3002SA  
HYBRID UNLOAD SUPER-S STAGGERED PATCH PANEL 24 PORT  
(1U) w/label, management  
*[ Choose US-6222TFS LOAD ]*

### CAT 6A SHIELDED CONNECTORS



US-1070SG  
HYBRID CAT 6A RJ45  
GOLD PLUG (UTP/SHIELDED)



US-1071S  
Shielded CAT 6A PLUG  
( Field Terminated )



US-6722TFS  
Shielded CAT 6A Super-S JACK  
SHORT BODY, Tool Free Auto Shutter

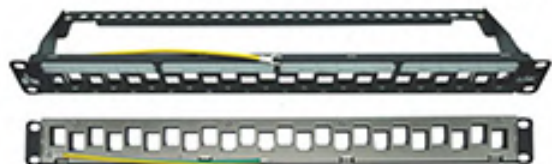

US-3002SA  
HYBRID UNLOAD SUPER-S STAGGERED PATCH PANEL 24 PORT  
(1U) w/label, management  
*[ Choose US-6722TFS LOAD ]*



US-3002AG  
HYBRID UNLOAD ANGLE PATCH PANEL 24 Port  
*[ Choose US-6722TFS LOAD ]*



US-4007SIL  
Shielded CAT 6A In-Line COUPLER (Usable for Patch Panel)



US-6901SLZ / 6902SLZ / 6903SLZ / 6905SLZ / 6910SLZ / 6915SLZ / 6920SLZ-X  
Shielded CAT 6A RJ45-RJ45 Super-S Patch Cord



# CAT 6A, SUPER-S PATCH PANEL & CONNECTORS



P/N	DESCRIPTION	PACKING	UNIT PRICE
<b>CAT 6A UNSHIELDED CONNECTORS</b>			Effective P28 1 APRIL 2026
US-1070SG	CAT 6A RJ45 GOLD PLUG HYBRID, SUPER-S, w / Boot <i>[ Used TL-1106AGA Tool ]</i>		70.-
US-6110TF	CAT 6A UTP RJ45 PLUG, SUPER-S, Field Terminate		210.-
US-1070A	CAT 6A UTP RJ45 PLUG w / Two Boots, Field Terminate		240.-
US-1026A	CAT 6A UTP SUPER-S RJ45 JACK, FREE DIRECTION <i>[ Used TL-5026A or TL-3116 Tool ]</i>		220.-
US-6222TFS	CAT 6A UTP SUPER-S RJ45 JACK, SHORT BODY, Tool Free, Auto Shutter		230.-
US-1022TFAS	CAT 6A UTP RJ45 JACK, TOOL FREE, Auto Shutter		250.-
US-3226A	CAT 6A UTP SUPER-S STAGGERED PATCH PANEL 24 PORT w / Cable Management		4,900.-
US-3224A	CAT 6A PATCH PANEL 24 Port, Auto Shutter w / Cable Management		5,900.-
US-3002SA	HYBRID UNLOAD SUPER-S STAGGERED PATCH PANEL 24 PORT (1U) w/label, Management <i>[ Choose US-6222TFS ]</i>		1,350.-
US-4007IL	CAT 6A In-Line COUPLER, Usable for Patch Panel		250.-
US-6405LZ-X	CAT 6A UTP SUPER-S 28 AWG, 0.5 M. LSZH, <i>[ X = 1 White / 9 Aqua Blue ]</i> <i>[ Replace US-5200ALZ-9 ]</i>		100.-
US-6410LZ-X	CAT 6A UTP SUPER-S 28 AWG, 1 M. LSZH, <i>[ X = 1 White / 9 Aqua Blue ]</i> <i>[ Replace US-5201ALZ-9 ]</i>		120.-
US-6420LZ-X	CAT 6A UTP SUPER-S 28 AWG, 2 M. LSZH, <i>[ X = 1 White / 9 Aqua Blue ]</i> <i>[ Replace US-5202ALZ-9 ]</i>		150.-
US-6430LZ-X	CAT 6A UTP SUPER-S 28 AWG, 3 M. LSZH, <i>[ X = 1 White / 9 Aqua Blue ]</i> <i>[ Replace US-5203ALZ-9 ]</i>		180.-
US-6440LZ-X	CAT 6A UTP SUPER-S 28 AWG, 5 M. LSZH, <i>[ X = 1 White / 9 Aqua Blue ]</i> <i>[ Replace US-5205ALZ-9 ]</i>		250.-
US-6510LZ-X	CAT 6A UTP SUPER-S 28 AWG, 10 M. LSZH, <i>[ X = 1 White / 9 Aqua Blue ]</i> <i>[ Replace US-5210ALZ-9 ]</i>		380.-
US-6515LZ-X	CAT 6A UTP SUPER-S 28 AWG, 15 M. LSZH, <i>[ X = 1 White / 9 Aqua Blue ]</i> <i>[ Replace US-5215ALZ-9 ]</i>		490.-
US-6520LZ-X	CAT 6A UTP SUPER-S 28 AWG, 20 M. LSZH, <i>[ X = 1 White / 9 Aqua Blue ]</i> <i>[ Replace US-5220ALZ-9 ]</i>		630.-
<b>CAT 6A SHIELDED CONNECTORS</b>			
US-1070SG	CAT 6A RJ45 GOLD PLUG HYBRID, SUPER-S, w / Boot	1 Pc. / Pkg	70.-
US-1071S	Shielded CAT 6A RJ45 Modular PLUG, Field Terminate, Tool free	1 Pc. / Pkg	270.-
US-6722TFS	CAT 6A SHIELDED, SUPER-S RJ45 JACK, SHORT BODY, Tool Free, Auto Shutter		280.-
US-1034TFAS	Shielded CAT 6A RJ45 JACK, Super Slim, Auto Shutter, Tool Free		280.-
US-3324S	Shielded CAT 6A PATCH PANEL 24 PORT, Auto Shutter w/Cable Management		6,800.-
US-3324TFAS	Shielded CAT 6A ANGLE PATCH PANEL 24 PORT, Auto Shutter Jack		7,800.-
US-3002SA	HYBRID UNLOAD SUPER-S STAGGERED PATCH PANEL 24 PORT (1U) w/label, Management <i>[ Choose US-6722TFS LOAD ]</i>		1,350.-
US-3002AG	HYBRID UNLOAD ANGLE PATCH PANEL 24 PORT <i>[ Choose US-6722TFS LOAD ]</i>		2,000.-
US-4007SIL	Shielded CAT 6A In-Line COUPLER, usable for Patch Panel		280.-
US-6901SLZ-X	Shielded CAT 6A Super-S 28 AWG, 1 M., XG, LSZH <i>[ X = 1 White / 9 Aqua Blue ]</i> <i>[ Replace US-5201SLZ ]</i>		120.-
US-6902SLZ-X	Shielded CAT 6A Super-S 28 AWG, 2 M., XG, LSZH <i>[ X = 1 White / 9 Aqua Blue ]</i> <i>[ Replace US-5202SLZ ]</i>		150.-
US-6903SLZ-X	Shielded CAT 6A Super-S 28 AWG, 3 M., XG, LSZH <i>[ X = 1 White / 9 Aqua Blue ]</i> <i>[ Replace US-5203SLZ ]</i>		180.-
US-6905SLZ-X	Shielded CAT 6A Super-S 28 AWG, 5 M., XG, LSZH <i>[ X = 1 White / 9 Aqua Blue ]</i> <i>[ Replace US-5205SLZ ]</i>		230.-
US-6910SLZ-X	Shielded CAT 6A Super-S 28 AWG, 10 M., XG, LSZH <i>[ X = 1 White / 9 Aqua Blue ]</i> <i>[ Replace US-5210SLZ ]</i>		380.-
US-6915SLZ-X	Shielded CAT 6A Super-S 28 AWG, 15 M., XG, LSZH <i>[ X = 1 White / 9 Aqua Blue ]</i> <i>[ Replace US-5215SLZ ]</i>		500.-
US-6920SLZ-X	Shielded CAT 6A Super-S 28 AWG, 20 M., XG, LSZH <i>[ X = 1 White / 9 Aqua Blue ]</i> <i>[ Replace US-5220SLZ ]</i>		650.-
US-6925SLZ-X	Shielded CAT 6A Super-S 28 AWG, 25 M., XG, LSZH <i>[ X = 1 White / 9 Aqua Blue ]</i> <i>[ Replace US-5225SLZ ]</i>		800.-

Think of Cabling ... Think@ INTERLINK Tel: 02-666-1111 www.interlink.co.th

PRICE LIST 2569

28



# FACE PLATE, WALL BOX, CHANGER



LAN (UTP) System



US-2311

US-2312

US-2313

US-2314

US-2316

SHINY FACE PLATE : White Face Plate without Label



US-2001AWH / US-2002AWH (White)  
FACE PLATE with Icon & Color Label  
(หน้ากาก มีป้ายชื่อ และ สัญลักษณ์สี)



US-2121A / US-2122A (White)  
SHUTTER FACE PLATE with Icon & Color Label  
(หน้ากากมีชัตเตอร์มีป้ายชื่อ และ สัญลักษณ์สี)



US-2331

US-2332

SHINY EXCLUSIVE FACE PLATE w/ Shutter  
(หน้ากากมีบานมาژุ่นสวชสุดหรูมีชัตเตอร์)



US-2342A

Angle FACE PLATE 2 Port w/Label



US-2401

US-2402

US-2406

SURFACE Mount Box : Floor Mount Box



US-2118

US-2119

SURFACE Mount Box  
Floor Mount w/ Shutter



US-2015WH (White)

US-2016 (White)

Plastic Wall Box : Wall Mount Box



US-2005 / US-2006 / US-2006B

US-2109

PANASONIC or CLIPSAL  
LINK JACK CHANGER for Other Brand



US-2331SQ

US-2332SQ

US-2015SQ

SHINY SHUTTER SQUARE FACE PLATE  
1 OR 2 PORT w/Label

LINK SQUARE  
WALL BOX, WHITE  
(86\*86\*37mm)

PRICE LIST 2569

29

www.interlink.co.th

Tel. 02-668-1111

Think of Cabling ... Think INTERLINK



# FACE PLATE, WALL BOX, CHANGER



P/N	DESCRIPTION	PACKING	UNIT PRICE
<b>FACE PLATE</b>			
Effective P30 1 APRIL 2026			
US-2311	SHINY FACE PLATE 1 PORT (White)	1 Pc. / Pkg.	27.-
US-2312	SHINY FACE PLATE 2 PORT (White)	1 Pc. / Pkg.	27.-
US-2313	SHINY FACE PLATE 3 PORT (White)	1 Pc. / Pkg.	30.-
US-2314	SHINY FACE PLATE 4 PORT (White)	1 Pc. / Pkg.	32.-
US-2316	SHINY FACE PLATE 6 PORT (White)	1 Pc. / Pkg.	35.-
US-2001AWH	FACE PLATE 1 PORT With Icon & Label ID (White)	1 Pc. / Pkg.	30.-
US-2002AWH	FACE PLATE 2 PORT With Icon & Label ID (White)	1 Pc. / Pkg.	32.-
US-2001A	FACE PLATE 1 PORT With Icon & Label ID (Ivory)	1 Pc. / Pkg.	30.-
US-2002A	FACE PLATE 2 PORT With Icon & Label ID (Ivory)	1 Pc. / Pkg.	32.-
US-2121A	FACE PLATE 1 PORT With Shutter & Label ID (White)	1 Pc. / Pkg.	42.-
US-2122A	FACE PLATE 2 PORT With Shutter & Label ID (White)	1 Pc. / Pkg.	52.-
US-2331	SHINY EXCLUSIVE FACE PLATE 1 PORT w/Shutter (White)	1 Pc. / Pkg.	110.-
US-2332	SHINY EXCLUSIVE FACE PLATE 2 PORT w/Shutter (White)	1 Pc. / Pkg.	120.-
US-2333	SHINY EXCLUSIVE FACE PLATE 3 PORT w/Shutter (White)	1 Pc. / Pkg.	130.-
US-2334	SHINY EXCLUSIVE FACE PLATE 4 PORT w/Shutter (White)	1 Pc. / Pkg.	140.-
US-2342A	ANGLE FACE PLATE 2 PORT with Label ID	1 Pc. / Pkg.	60.-
<b>WALL BOX and SURFACE BOX</b>			
US-2015WH	Plastic WALL BOX 2 X 4" [Deep 38 mm.] (White)	1 Pc. / Pkg.	30.-
US-2015	Plastic WALL BOX 2 X 4" [Deep 38 mm.] (Ivory)	1 Pc. / Pkg.	30.-
US-2016	Plastic WALL BOX 2 X 4" [Deep 47 mm.] (White)	1 Pc. / Pkg.	60.-
US-2118	SURFACE MOUNT BOX 1 PORT with Shutter [ BOX ตัวเมียติดพื้น หรือ ผนัง 1 ช่อง มี Shutter ]	1 Pc. / Pkg.	50.-
US-2119	SURFACE MOUNT BOX 2 PORT with Shutter [ BOX ตัวเมียติดพื้น หรือ ผนัง 2 ช่อง มี Shutter ]	1 Pc. / Pkg.	70.-
US-2401	SURFACE WHITE MOUNT BOX 1 PORT	1 Pc. / Pkg.	35.-
US-2402	SURFACE WHITE MOUNT BOX 2 PORT	1 Pc. / Pkg.	45.-
US-2406	SURFACE WHITE MOUNT BOX 6 PORT	1 Pc. / Pkg.	180.-
<b>JACK CHANGER ( ตัวแปลงหน้าจาก เพื่อใส่ตัวเมียคอมพิวเตอร์ )</b>			
US-2006	PANASONIC # INITIO, WIDE Series JACK CHANGER , White	10 Pcs. / Pkg.	15.- /PC
US-2006B	PANASONIC # INITIO, WIDE Series JACK CHANGER , Black	10 Pcs. / Pkg.	16.- /PC
US-2005	PANASONIC # Full Color JACK CHANGER	10 Pcs. / Pkg.	15.- /PC
US-2109	CLIPSAL # 30VA, 31VA, 32VA JACK CHANGER	1 Pc. / Pkg.	15.- /PC
<b>SHINY SHUTTER SQUARE FACE PLATE (Europe Square Style)</b>			
US-2331SQ	SHINY SHUTTER SQUARE FACE PLATE 1 PORT w/Label	1 Pc. / Pkg.	35.-
US-2332SQ	SHINY SHUTTER SQUARE FACE PLATE 2 PORT w/Label	1 Pc. / Pkg.	40.-
US-2015SQ	LINK SQUARE WALL BOX, WHITE [ 86*86*37 mm.]	1 Pc. / Pkg.	50.-

Think of Cabling ... Think@ INTERLINK Tel. 02-666-1111 www.interlink.co.th

PRICE LIST 2569

30

## SHIELDED CAT 8 CABLE



### STANDARD

- ANSI/TIA-568 2-E Category 8
- ANSI/TIA-568 2-D Category 8
- IEC 61156-9
- ISO/IEC 11801
- IEC 60332-1-2, IEC 61034-1
- IEC 60754-1, IEC 60754-2
- RoHS Compliant

### APPLICATION

- Structure cabling for horizontal and building backbone
- 25/40G BASE-T (IEEE 802.3aq/ba 25/40Gigabit Ethernet) \*30m
- 10G BASE-T (IEEE 802.3an 10Gigabit Ethernet)
- 10/100/1000 BASE-T (IEEE 802.3u/ab)
- IEEE 802.3af/at (PoE/PoE+), IEEE 802.3bt (Type 4)
- 155/622Mbps and 1.2Gbps ATM
- 4/16 Mbps Token Ring
- HD BaseT2.0 standard, Baseband, Broadband
- Digital&Analog for Data, Video and audio application

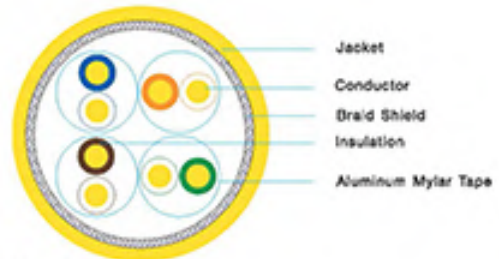

US-9488LSZH : CAT 8 S/FTP CABLE, LSZH



US-1081 : CAT 8 PLUG SHIELDED



US-1044TF : CAT 8 Jack, TOOL FREE



US-5400SLZ-5 / US-5401SLZ-5 / US-5402SLZ-5 / US-5403SLZ-5 / US-5405SLZ-5  
CAT 8 SHIELDED RJ45-RJ-45 PATCH CORD

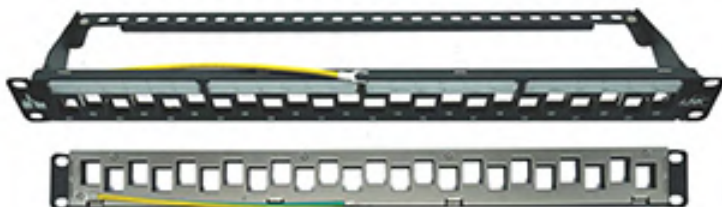

US-3002SA  
HYBRID UNLOAD SUPER-S STAGGERED PATCH PANEL 24 PORT  
(1U) w/label, management | Choose US-1044TF LOAD |



US-2342A  
Angle FACE PLATE 2 Port w/Label



# CAT 8 CABLING SYSTEM

NEW



P/N	DESCRIPTION	PACKING	UNIT PRICE
<b>SHIELDED CAT 8 CABLE &amp; CONNECTORS (2,000 MHz), GHMT Approve</b>			Effective P32 1 APRIL 2026
US-9488LSZH	CAT 8 S/FTP [ Braid & Foil Shielded ] 22 AWG CABLE, LSZH, Yellow	305* M. /Roll	22,390.- /Roll
US-1081	CAT 8 SHIELDED , PLUG , FIELDED TERMINATE	1 Pc. /Pkg.	350.- /Pkg.
US-1044TF	CAT 8 SHIELDED , JACK , TOOL FREE		350.- /Pc.
US-3002SA	HYBRID UNLOAD SUPER-S STAGGERED PATCH PANEL 24 PORT (1U) W/LABEL, MANAGEMENT [ Choose US-1044TF LOAD]		1,350.- /Pc.
US-2342A	ANGLE FACE PLATE 2 PORT, with Label ID	Angle 45°	60.- /Pc.

Think of Cabling ... Think@ INTERLINK

Tel. 02-666-1111

www.interlink.co.th

<b>SHIELDED CAT 8 PATCH CORD , GHMT Approve</b>			
US-5400SLZ-5	CAT 8 SHIELDED RJ45 - RJ45 Patch Cord 0.5 M. , LSZH , 24 AWG , Yellow		280.-
US-5401SLZ-5	CAT 8 SHIELDED RJ45 - RJ45 Patch Cord 1 M. , LSZH , 24 AWG , Yellow		350.-
US-5402SLZ-5	CAT 8 SHIELDED RJ45 - RJ45 Patch Cord 2 M. , LSZH , 24 AWG , Yellow		450.-
US-5403SLZ-5	CAT 8 SHIELDED RJ45 - RJ45 Patch Cord 3 M. , LSZH , 24 AWG , Yellow		550.-
US-5405SLZ-5	CAT 8 SHIELDED RJ45 - RJ45 Patch Cord 5 M. , LSZH , 24 AWG , Yellow		800.-

<b>CABLE MANAGEMENT</b>		
US-3053A	Cable Management PANEL 1 U with Cover	630.-
US-3051	Cable Management PANEL 1 U [ Plastic 5 Ring ]	300.-
US-3057	Vertical Cable Routing Hanger, Small	120.-
US-3058	Vertical Cable Routing Hanger, Medium	150.-



## CAT 8 CABLING SYSTEM

มาตรฐานสายสัญญาณ จะแบ่งหมวดหมู่ของสาย เป็น Category ตามความสามารถในการรองรับความถี่ในการส่งสัญญาณ หรือบางท่านอาจเรียกง่าย ๆ ว่าความเร็วในการส่งสัญญาณ โดยมีหน่วยวัดเป็น MHz ได้แก่ CAT 3 รองรับ 1-16 MHz CAT 5E รองรับ 100 MHz ; CAT 6 รองรับ 250 MHz ; CAT 6A รองรับ 500 MHz ; CAT 7 รองรับ 1,000 MHz และ CAT 8 รองรับ 2,000 MHz เป็นต้น

ปัจจุบันคอมพิวเตอร์ต้องการสื่อสารกันด้วยความเร็วที่สูงขึ้นมาก จนทำให้เกิดสนามแม่เหล็กไปรบกวนคู่สายของสายสัญญาณอื่นๆ ดังนั้นเพื่อแก้ปัญหาโดยง่ายจึงได้ออกแบบให้ใส่โลหะป้องกัน หุ้มสายสัญญาณ และเรียกสายสัญญาณว่า F/UTP (Foil Twisted Pair) และ F/FTP และ U/FTP ซึ่งอยู่กับการหุ้มสายที่ละคู่ หรือ ทั้งหมด แต่การเพิ่ม Foil หุ้มสายเป็นการเพิ่มต้นทุนของสายสัญญาณ ปัจจุบัน สาย CAT 8 ยังอยู่ในระหว่างการพัฒนา สาย UTP ( Unshielded Twisted Pair )

PRICE LIST 2569

32



## LAN (UTP) System

### CAT 6 WATERPROOF / INDUSTRIAL SOLUTION



US-7060  
Industrial Cover PLUG Kit  
(ตัวครอบตัวผู้ มีเกลียวล็อก)



US-7006  
CAT 6 Industrial JACK  
(ตัวเมียกับผู้ มีเกลียวล็อก)



US-7016  
CAT 6 Industrial COUPLER  
(ตัวต่อกันผู้ มีเกลียวล็อก)



US-7086 : 6 PORT INDUSTRIAL  
JACK INSERT PANEL  
w/ Support Box



US-7080 : Industrial Surface mount Box  
(กล่อง Industrial สำหรับตัวเมีย และ ตัวต่อ มีเกลียวล็อก)



US-706X : CAT 6 RJ45 - RJ45 Industrial PATCH CORD  
(สายพ่วงกันผู้ มีเกลียวล็อก ความยาวตามระบุ)

### MINI PANEL & RJ45 INSERT for Condominium , Residence



US-2510A  
10 PORT MINI PANEL Insert w/Support Box



US-2204  
BNC Modular Insert



US-2207A  
TV Socket Modular Insert



US-2209  
F-Type Modular Insert



US-2201  
Blank Insert



US-1006A  
CAT 6 RJ45 JACK , White  
( 5 Color Changeable )



US-2503A  
CONSOLIDATION POINT CABINET 30 Port  
w/Wire Management



www.interlink.co.th  
Tel. 02-668-1111  
Think of Cabling ... Think INTERLINK

PRICE LIST 2569  
33



P/N	DESCRIPTION	PACKING	UNIT PRICE
<b>CAT 6 WATERPROOF INDUSTRIAL Solution</b> (เหมาะสำหรับภาคสนาม หรือ ในโรงงานอุตสาหกรรม หรือ สะพานปลา หรือ ตลาดสด)			
US-7086	6 PORT INDUSTRIAL JACK INSERT PANEL w/ Support Box		Effective P31 1 APRIL 2026 900.- /Set
US-7060	WATERPROOF / INDUSTRIAL COVER PLUG KIT	Used for all modular Plug	135.- /Pc.
US-7006	WATERPROOF / INDUSTRIAL RJ45 JACK		660.- /Pc.
US-7016	WATERPROOF / INDUSTRIAL RJ45 COUPLER		680.- /Pc.
US-7080	WATERPROOF / INDUSTRIAL SURFACE MOUNT BOX		290.- /Bx.
US-706X	CAT 6 RJ45-RJ45 WATERPROOF / INDUSTRIAL PATCH CORD X = Meter		400+25.- /m.

Think of Cabling ... Think INTERLINK  
Tel: 02-666-1111  
www.interlink.co.th

<b>OPTION CABLE for Used with INDUSTRIAL &amp; BROADCAST Solution</b>			
US-9136LSZH	CAT 6 F/UTP ULTRA SHIELDED w/Cross Filler, 23 AWG, LSZH	White 305' M. /Roll	7,780.-
US-9106OUT	CAT 6 UTP, PE OUTDOOR w/Filler, 23 AWG [Double Jacket]	Black 305' M. /Pull Bx.	7,060.-

<b>MINI PANEL &amp; RJ45 INSERT &amp; CABINET [ for Residence &amp; Smart Office &amp; Modern Shop ]</b>			
US-2510A	10 Port MINI PANEL Insert w/Support Box [W 26 x D 6.0 x H 6.5 cm.]	แผง 10 ช่อง พร้อม Box	900.-
US-1006A	CAT 6 RJ45 Modular JACK [ 5 Color Changeable ], White	ตัวเมีย CAT 6 เปลี่ยนสีได้ 5 สี มีฝาครอบ	110.-
US-2204	BNC Modular Insert	ตัวเมีย BNC 2 ด้าน ใสแฉก	80.-
US-2207A	TV Socket Modular Insert	ตัวเมีย TV รุ่นสูง ใสแฉก	200.-
US-2209	F-Type Modular Insert	ตัวเมีย F type 2 ด้าน ใสแฉก	50.-
US-2201	Blank Insert	ตัวเมีย RJ45	10.-
US-2503A	CONSOLIDATION CABINET 30 Port [W 30 x D 17 x H 45 cm.]	ตู้ CP สำหรับใส่ MINI PANEL	1,800.-



### ห้าปีสุจัน

Industrial Connector แบบมีเกลียวล็อก โดยสามารถเชื่อมต่อในท่าได้นานกว่า 24 ชั่วโมง ดังนั้นจึงตัดปัญหาการเชื่อมต่อระบบ LAN ที่จะนำไปใช้ในโรงงานอุตสาหกรรมที่มีฝุ่นจำนวนมาก หรือแม้แต่ในพื้นที่ที่ค่อนข้างเปียกๆ เช่น ห้องเย็น หรือ ใช้งานสำหรับการถ่ายทอดสดกลางแจ้งได้อย่างปลอดภัยไม่มีปัญหาการเดินสะดุด และ สายหลุด ทำให้การถ่ายทอดไม่เสียหาย

PRICE LIST 2569



### 19" UNLOADED PATCH PANEL

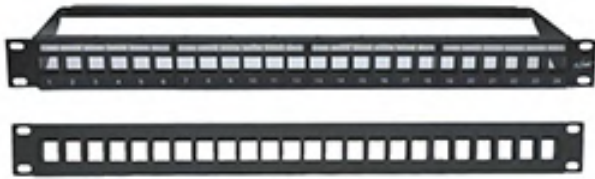

US-3001

แผงเปล่า Unshielded 24 ช่อง พร้อมแผงจัดการสายด้านหลัง 19"

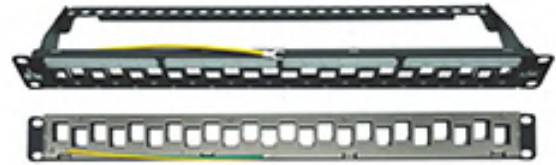

US-3002SA

HYBRID UNLOAD SUPER-S STAGGERED PATCH PANEL 24 PORT (1U) w/label, management

### 19" CABLE MANAGEMENT PANEL



US-3053A

Cable Management 1U w/Cover

US-3054

Cable Management 2U w/Cover



US-3051

Cable Management 1U (Plastic 5 Ring)



Small

Medium

Large

US-3057 , US-3058 , US-3059  
Vertical Cable Routing Hanger



US-3055

Brush Cable Management with Management bar

### 19" EXTENSIBLE SUPPORT BRACKET



US-3061



US-3062



US-3064

### VERSATILE STRAP



US-2286 Versatile Strap 10 x 150 mm.

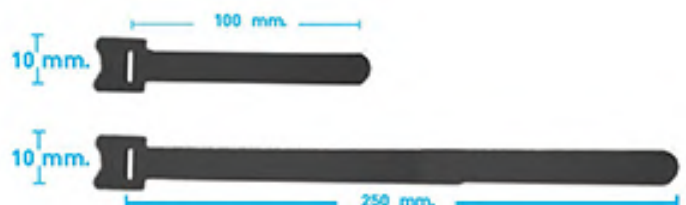

US-2276 / US-2296 Versatile Strap



# CABLE MANAGEMENT , UNLOADED PATCH PANEL



P/N	DESCRIPTION	UNIT PRICE
-----	-------------	------------

## 19" UNLOADED PATCH PANEL ( LOAD With MODULAR JACK )

Effective P36  
1 APRIL 2026

US-3001	Unloaded PATCH PANEL 24 PORT (1U) w/label, management	900.-
US-3002SA	HYBRID UNLOAD SUPER-S STAGGERED PATCH PANEL 24 PORT (1U) w/label, management	1,350.-
US-3002AG	HYBRID UNLOAD ANGLE PATCH PANEL 24 PORT	2,000.-
US-1026A	CAT 6A UTP SUPER-S RJ45 JACK , FREE DIRECTION <span style="float: right;">White</span>	220.-
US-6222TFS	CAT 6A UTP SUPER-S RJ45 JACK , SHORT BODY , Tool Free , Auto Shutter	230.-
US-6722TFS	CAT 6A SHIELDED , SUPER-S RJ45 JACK , SHORT BODY , Tool Free , Auto Shutter	280.-

## 19" CABLE MANAGEMENT PANEL

US-3053A	CABLE MANAGEMENT PANEL 1 U with Cover	แผงจัดสายด้านหน้าแบบมีฝาครอบ	630.-
US-3054	CABLE MANAGEMENT PANEL 2 U with Cover	แผงจัดสายด้านหน้าแบบมีฝาครอบ	1,400.-
US-3051	CABLE MANAGEMENT PANEL 1 U (Plastic 5 Ring)	แผงจัดสายด้านหน้า 5 ห่วง	300.-
US-3055	Brush CABLE MANAGEMENT PANEL 1 U with Management bar	แผงจัดสายขนแปรง มีตัวจัดสายหลุม	700.-
US-3057	Vertical Cable Routing Hanger, Small	ห่วงจัดสายแนวตั้ง	120.-
US-3058	Vertical Cable Routing Hanger, Medium	ห่วงจัดสายแนวตั้ง	150.-
US-3059	Vertical Cable Routing Hanger, Large	ห่วงจัดสายแนวตั้ง	180.-

## 19" EXTENSIBLE WALL MOUNTED BRACKET

US-3061	19" Extensible WALL MOUNTED BRACKET 1U	(Deep Extend $\frac{23}{37}$ cm)	800.-
US-3062	19" Extensible WALL MOUNTED BRACKET 2U	(Deep Extend $\frac{23}{37}$ cm)	1,200.-
US-3064	19" Extensible WALL MOUNTED BRACKET 4U	(Deep Extend $\frac{23}{37}$ cm)	2,000.-

## VERSATILE STRAP

US-2276	VERSATILE STRAP 10 X 100 MM., 20 pcs./bag, Black	220.-/bag
US-2286	VERSATILE STRAP 10 X 150 MM., 20 pcs./bag, Black	250.-/bag
US-2296	VERSATILE STRAP 10 X 250 MM., 20 pcs./bag, Black	300.-/bag

Think of Cabling ... Think@ INTERLINK

Tel. 02-666-1111

www.interlink.co.th

PRICE LIST 2569

36



LAN (UTP) System

# LAN TOOL & TESTER

[ Tools & Tester that empower every install ]



**TL-1101R (RJ45, RJ11, Hs)**  
PROFESSIONAL CRIMP TOOL



**TL-1103R (RJ45, RJ11, HS)**  
RJ45 PLUG CRIMP TOOL



**TL-1106AGA**  
RJ45 SHIELDED PLUG CRIMP AND CLAMP TOOL



**TL-3116 (110 IDC / KRONE)**  
IMPACT TOOL w/Blade



**US-8030**

LAN PROFESSIONAL SET BAG  
TL-1103R + TL-3116 + TX-1302 + US-8060



**US-8061**  
Fast Jack and Plug Tool  
[ Two in One Cat 5 & Cat 6 ]



**TL-2106**  
Fast Jack Termination Tool  
[ Cat 6 Color Changeable Only ]



**TL-5026A**  
Fast Jack CAT 6A Tool  
[ Free Direction ]



**UC-8145**  
UTP/STP/COAXIAL CABLE STRIPPER



**TL-5070A**  
PARALLEL CRIMP TOOL  
for Tool free JACK & Filed Terminated PLUG



**TL-2070A**  
CRIMP TOOL  
For US-1070A (Only)



**TX-1302**  
HANDED UTP CABLE TESTER (BLUE)



**TX-1302A**  
UTP CABLE QUICK SMART TESTER



**US-8015**  
LINK NET TONNER & PROBE KITT



**US-8012**  
NET FINDER included 25 remote  
(Find 25 No of Cables)

PRICE LIST 2569

37







# LAN TOOL & TESTER

[ Tools & Tester that empower every install ]



P/N	DESCRIPTION	UNIT PRICE
<b>UTP TOOL</b>		Effective P38 1 APRIL 2026
 <b>TL-1101R</b>	RJ45 , RJ11 , HS PLUG <b>PROFESSIONAL CRIMP TOOL</b> <i>[ Recommended for Contractors ]</i>	<b>3,000.-</b>
 <b>TL-1103R</b>	RJ45 , RJ11 , HS PLUG <b>CRIMP TOOL</b>	<b>850.-</b>
 <b>TL-1106AGA</b>	RJ45 <b>SHIELDED PLUG CRIMP and CLAMP TOOL</b> <i>[ for US-1070SG &amp; US-1004A ]</i>	<b>2,270.-</b>
 <b>TL-3116</b>	<b>IMPACT TOOL with BLADE for All JACK &amp; PATCH PANEL</b>	<b>750.-</b>
 <b>US-8030</b>	<b>LAN PROFESSIONAL SET OF TOOL &amp; TESTER</b>	<b>3,000.-</b>
 <b>US-8061</b>	<b>FAST JACK and PLUG TERMINATION TOOL (CAT 5E &amp; CAT 6)</b>	<b>2,120.-</b>
 <b>TL-2106</b>	<b>FAST JACK CAT 6 Color-Changeable TERMINATION TOOL</b> <i>[ for US-1006A Only ]</i>	<b>1,560.-</b>
 <b>TL-5026A</b>	<b>FAST JACK CAT 6A Free Direction TERMINATION TOOL</b> <i>[ for US-1026A Only ]</i>	<b>2,270.-</b>
 <b>TL-5070A</b>	<b>PARALLEL CRIMP TOOL For Tool free JACK &amp; Filed Terminated PLUG</b>	<b>1,270.-</b>
 <b>TL-2070A</b>	RJ45 CAT 6A PLUG (Field Termination) <b>CRIMP TOOL</b> <i>[ for US-1070A Only ]</i>	<b>550.-</b>
 <b>UC-8145</b>	<b>UTP / STP / COAXIAL CABLE STRIPPER</b>	<b>395.-</b>
<b>US-8060</b>	RJ45 JACK HOLDER	<b>35.-</b>

Think of Cabling ... Think@ INTERLINK Tel: 02-666-1111 www.interlink.co.th

<b>UTP TESTER</b>		
 <b>TX-1302</b>	<b>UTP CABLE TESTER</b>	<b>750.-</b>
 <b>TX-1302A</b>	<b>UTP CABLE QUICK SMART TESTER</b>	<b>1,200.-</b>
 <b>US-8015</b>	<b>NET TONER &amp; PROBE KIT</b>	<b>3,150.-</b>
 <b>US-8012</b>	<b>NET FINDER 25 &amp; TESTER ( Included 25 remote )</b>	<b>9,900.-</b>



### LNK **หัวใจในระบบสายสัญญาณของท่าน ป้องกัน Human Error**

1. LINK แนะนำให้ใช้เครื่องมือที่ออกแบบมาโดยเฉพาะ จะช่วยลดปัญหาในการซ่อมบำรุง และปัญหาต่างๆ ที่จะตามมาในระยะยาว
2. LINK เน้นขายเครื่องมือ (Tool) และ เครื่องทดสอบ (Tester) ในราคาทุน เพื่อให้ช่างทุกคนมีโอกาสเป็นเจ้าของได้ และสามารถสร้างคุณภาพให้ลูกค้าของท่าน
3. กระเป๋าเครื่องมือ LAN ครบชุด รุ่น US-8030 เหมาะเป็นชุดเครื่องมือประจำองค์กรอย่างหนึ่งที่ทุกองค์กรและหน่วยงานควรซื้อใช้ประจำสำนักงาน โดยเฉพาะอย่างยิ่ง ธุรกิจโทรคมนาคมเช่น TRUE, ITEL, AIS ฯลฯ ได้ซื้อไปเป็นเครื่องมือประจำชุดช่าง เพื่อสะดวกในงานติดตั้งระบบสายสัญญาณ หรือ คอมพิวเตอร์ , โทรศัพท์ และ อื่นๆ โดยมีเครื่องมือทดสอบเบื้องต้นด้วย

### Application

- 25/40/50/100/200/400/800 Gbps Ethernet
- IEEE802.3ae 10G Ethernet
- IEEE802.3z Gigabit Ethernet
- IEEE802.3u Fast Ethernet
- 52/155/622Mbps, 1.2Gbps ATM
- FDDI, Fiber Channel
- FTTx, CATV, CCTV and others

### Standards

- ANSI/TIA/EIA-568.3-D, ANSI/TIA-568-C.3
- ANSI/ICEA 696, ANSI/ICEA 596
- Telcordia(Bellcore)GR-20-CORE, GR-409-CORE
- ITU-T G.651 (Multimode)
- ITU-T G.652D (Singlemode)
- ISO/IEC 11801:2017, EN 50173-1
- IEC 60332-1-2
- IEC 61034-2, IEC60754-2
- IEC 60793, IEC60794-1-2
- TIS 2165
- RoHS Compliant

### Optical Performance

Optical Transmission Performance	Singlemode	Multimode			
	1310/1383/1550/1625 nm	850/1300 nm			850/953/1300 nm
	9/125 μm [OS2]	50/125 μm [OM2]	50/125 μm [OM3]	50/125 μm [OM4]	50/125 μm [OM5]
Max. Attenuation [dB/km]	0.35 / 0.35 / 0.21 / 0.23	2.7 / 0.8	2.7 / 0.8	2.7 / 0.8	2.7/2.3/0.8
Typ. Attenuation [dB/km]	0.33 / 0.31 / 0.19 / 0.20	2.5 / 0.7	2.3 / 0.6	2.3 / 0.6	2.3/2.0/0.6
Bandwidth [MHz/km]	N / A	500 / 500	1500 / 500	3500 / 500	3500/1850/500
850 nm Laser bandwidth [MHz/km]	N / A	N / A	2000	4700	4700
Numerical Aperture	0.13 ± 0.01	0.200 ± 0.015	0.200 ± 0.015	0.200 ± 0.015	0.200±0.015

### Mechanical Properties

- Max. Tensile Load, Installation / Operation
- Max. Crush Resistance
- Cable Diameter, approx.
- Cable Weight, approx.
- Min. Bending Radius, Installation / Operation
- Installation / Operation Temperature
- Storage / Shipping Temperature

	UFCX3XX 4 -6 Core	UFCX312 12 Core	UFCX324M 24 Core	
Max. Tensile Load, Installation / Operation	1800 / 900	1800 / 900	1800 / 1000	N
Max. Crush Resistance	1500	1500	2200	N / 10 cm
Cable Diameter, approx.	7.2 ± 0.5	7.7 ± 0.5	9.2 ± 1.0	mm
Cable Weight, approx.	53 ± 5	60 ± 5	85 ± 10	kg / km
Min. Bending Radius, Installation / Operation	15x / 10x	15x / 10x	20x / 10x	Cable Diameter
Installation / Operation Temperature	-40°C to +70°C	-40°C to +70°C	-40°C to +70°C	
Storage / Shipping Temperature	-40°C to +75°C	-40°C to +75°C	-40°C to +75°C	











### Part Number

Description	4 Core	6 Core	12 Core	24 Core
Singlemode, 9/125 μm, OS2	UFC9304	UFC9306	UFC9312	UFC9324M
Multimode, 50/125 μm, OM2	UFC5304	UFC5306	UFC5312	UFC5324M
XG Multimode, 50/125 μm, OM3	UFC4304	UFC4306	UFC4312	UFC4324M
Multimode, 50/125 μm, OM4	UFC3304	UFC3306	UFC3312	UFC3324M
Multimode, 50/125 μm, OM5	UFC2304	UFC2306	UFC2312	UFC2324M



### Features/Construction

- High performance multimode [OM2, OM3, OM4 and OM5] and singlemode [OS2 or G.652D] fiber optic cable
- Fiber colors identification comply to TIA/EIA-598-C and EIA-359-A
- PBT Loose tube design provides high strength and low shrinkage with thixotropic jelly filled loose tube for water penetration protection
- E-glass yarn with water blocking provide for strength member water blocking and Safety for outdoor environment
- Ripcord is easy to strip
- UV-resistant, Flame-retardant black PE with LSZH (Low Smoked Zero Halogen) outer jacket

P/N	DESCRIPTION	PACKING	PRICE /m.
<b>OS2 9/125 μm, SINGLEMODE, DOUBLE Q SERIES</b>			Effective P40 1 APRIL 2026
 UFC9304	F.O. Outdoor / Indoor, All-Dielectric 4 Core, LSZH-FR, OS2	4,000 M.	16.45 /m.
 UFC9306	F.O. Outdoor / Indoor, All-Dielectric 6 Core, LSZH-FR, OS2	4,000 M.	19.05 /m.
 UFC9312	F.O. Outdoor / Indoor, All-Dielectric 12 Core, LSZH-FR, OS2	4,000 M.	27.95 /m.
 UFC9324M	F.O. Outdoor / Indoor, All-Dielectric 24 Core, LSZH-FR, OS2, Multi-Tube	4,000 M.	46.15 /m.
UFC9348M	F.O. Outdoor / Indoor, All-Dielectric 48 Core, LSZH-FR, OS2, Multi-Tube	2/3/4,000* M.	Call
UFC9360M	F.O. Outdoor / Indoor, All-Dielectric 60 Core, LSZH-FR, OS2, Multi-Tube	4,000* M.	Call
UFC9372M	F.O. Outdoor / Indoor, All-Dielectric 72 Core, LSZH-FR, OS2, Multi-Tube	4,000* M.	Call
UFC9396M	F.O. Outdoor / Indoor, All-Dielectric 96 Core, LSZH-FR, OS2, Multi-Tube	4,000* M.	Call
<b>OM2 50/125 μm, MULTIMODE, DOUBLE Q SERIES</b>			
UFC5304	F.O. Outdoor / Indoor, All-Dielectric 4 Core, LSZH-FR, OM2	4,000 M.	20.-/m.
 UFC5306	F.O. Outdoor / Indoor, All-Dielectric 6 Core, LSZH-FR, OM2	4,000 M.	23.65 /m.
 UFC5312	F.O. Outdoor / Indoor, All-Dielectric 12 Core, LSZH-FR, OM2	4,000 M.	35.80 /m.
UFC5324M	F.O. Outdoor / Indoor, All-Dielectric 24 Core, LSZH-FR, OM2, Multi-Tube	4,000* M.	Call
<b>OM3 XG 50/125 μm, MULTIMODE, DOUBLE Q SERIES</b>			
UFC4304	F.O. Outdoor / Indoor, All-Dielectric 4 Core, LSZH-FR, OM3	4,000* M.	Call
 UFC4306	F.O. Outdoor / Indoor, All-Dielectric 6 Core, LSZH-FR, OM3	4,000 M.	36.05 /m.
 UFC4312	F.O. Outdoor / Indoor, All-Dielectric 12 Core, LSZH-FR, OM3	4,000 M.	60.65 /m.
UFC4324M	F.O. Outdoor / Indoor, All-Dielectric 24 Core, LSZH-FR, OM3, Multi-Tube	4,000* M.	Call
<b>OM4 50/125 μm, MULTIMODE, DOUBLE Q SERIES</b>			
UFC3304	F.O. Outdoor / Indoor, All-Dielectric 4 Core, LSZH-FR, OM4	4,000* M.	Call
 UFC3306	F.O. Outdoor / Indoor, All-Dielectric 6 Core, LSZH-FR, OM4	4,000 M.	59.40 /m.
 UFC3312	F.O. Outdoor / Indoor, All-Dielectric 12 Core, LSZH-FR, OM4	4,000 M.	107.30 /m
UFC3324M	F.O. Outdoor / Indoor, All-Dielectric 24 Core, LSZH-FR, OM4, Multi-Tube	4,000* M.	Call

**Remark** 1. Packing 2/3/4,000 M. (ไม่มี\*) หมายถึง สินค้ามีใน STOCK สามารถส่งได้ทันทีทุกระยะ: 100 เมตร ตามการสั่งซื้อ  
 2. Packing 2/3/4,000\* M. มี\* หมายถึง เป็นสินค้าที่ต้องสั่งผลิต และ ต้องสั่งซื้อยกเว้นขั้นต่ำ ตามความยาวต่อหน่วยที่ระบุ  
 3. Packing 4,000\* M. มี\* หมายถึง เป็นสินค้าที่ต้องสั่งผลิต และ ต้องสั่งซื้อยกเว้นขั้นต่ำ 4,000\* M./หน่วย เช่นนี้



### ทำไม? ถึงต้องใช้สาย OUTDOOR./INDOOR

จากความเคยชินของการติดตั้งสาย OUTDOOR ของประเทศไทย ส่วนใหญ่จะเดินสาย OUTDOOR จากภายนอก และเดินสาย OUTDOOR ต่อเข้าภายในอาคารซึ่งผิดข้อกำหนดของมาตรฐานสากล กล่าวคือ สาย OUTDOOR จะลามไฟ (Flammable) ซึ่งไม่เหมาะกับการเดินภายในอาคาร ดังนั้นเพื่อความถูกต้องจึงต้องใส่สาย OUTDOOR / INDOOR หากเดินสายแทน OUTDOOR เนื่องจากสาย OUTDOOR / INDOOR มีคุณสมบัติพิเศษคือ ฉนวนภายนอก ใช้สาร PE รมสภาวะแวดล้อม และเคมสารป้องกันการลามไฟ (FR) และสาร Low Smoke Zero Halogen (LSZH) ตามมาตรฐานการป้องกันอัคคีภัยของสากล เพื่อให้อายุการใช้งานที่ยาวนานยิ่งขึ้น ควันไม่เป็นอันตรายเมื่อเกิดไฟไหม้ และไม่ลามไฟ

### ความหมายของคำย่อ

- PE = Polyethylene เป็นชนิดของวัสดุที่นำมาทำ Jacket ซึ่งมีความทนทานต่อลมที่อากาศภายนอก
- LSZH = Low Smoke Zero Halogen เป็นชนิดของวัสดุทางวิทยาศาสตร์ที่นำมาผสมกับวัสดุอื่น ทำให้มีประสิทธิภาพ เมื่อ Jacket ถูกไฟเผาจะมีควันน้อย และไม่มีสารพิษในควันไฟ
- FR = Flame Retardant เป็นชนิดของวัสดุทางวิทยาศาสตร์ที่ช่วยให้อายุการใช้งาน Jacket ไม่ลามไฟ



FIBER OPTIC System

Application

- 25/40/50/100/200/400/800 Gbps Ethernet
- IEEE802.3ae 10G Ethernet
- IEEE802.3z Gigabit Ethernet
- IEEE802.3u Fast Ethernet
- 52/155/622Mbps, 1.2Gbps ATM
- FDDI, Fiber Channel
- FTTx, CATV, CCTV and others

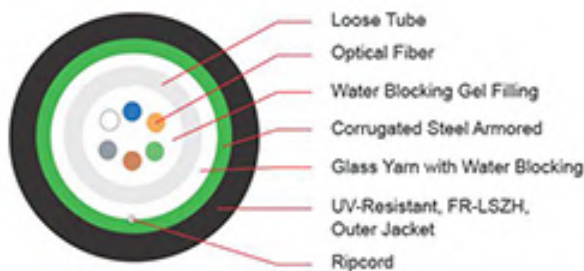

Outdoor/Indoor, Armored, Single Tube  
UFCX3XXA

Standards

- ANSI/TIA/EIA-568.3-D, ANSI/TIA-568-C.3
- ANSI/ICEA 696, ANSI/ICEA 596, ANSI/ICEA 640
- Telcordia(Bellcore)GR-20-CORE, GR-409-CORE
- ITU-T G.651 (Multimode)
- ITU-T G.652D (Singlemode)
- ISO/IEC 11801:2017, EN 50173-1
- IEC 60332-1-2
- IEC 61034-2, IEC60754-2
- IEC 60793, IEC60794-1-2
- TIS 2165
- RoHS Compliant

Features/Construction

- High performance multimode (OM2, OM3, OM4 and OM5) and singlemode (OS2 or G.652D) fiber optic cable
- Fiber colors identification comply to TIA/EIA-598-C and EIA-359-A
- PBT Loose tube design provides high strength and low shrinkage with thixotropic jelly filled loose tube for water penetration protection
- E-glass yarn with water blocking provide for strength member water blocking and Safety for outdoor environment
- Ripcord is easy to strip
- Corrugated steel tape coat with polymer provides rodent protection
- UV-resistant, Flame-retardant black PE with LSZH [Low Smoked Zero Halogen] outer jacket

Optical Performance

Optical Transmission Performance	Singlemode 1310/1383/1550/1625 nm	Multimode			
		850/1300 nm			850/953/1300 nm
	9/125 μm (OS2)	50/125 μm (OM2)	50/125 μm (OM3)	50/125 μm (OM4)	50/125 μm (OM5)
Max. Attenuation [dB/km]	0.35 / 0.35 / 0.21 / 0.23	2.7 / 0.8	2.7 / 0.8	2.7 / 0.8	2.7/2.3/0.8
Typ. Attenuation [dB/km]	0.33 / 0.31 / 0.19 / 0.20	2.5 / 0.7	2.3 / 0.6	2.3 / 0.6	2.3/2.0/0.6
Bandwidth [MHz/km]	N / A	500 / 500	1500 / 500	3500 / 500	3500/1850/500
850 nm Laser bandwidth [MHz/km]	N / A	N / A	2000	4700	4700
Numerical Aperture	0.13 ± 0.01	0.200 ± 0.015	0.200 ± 0.015	0.200 ± 0.015	0.200±0.015

Mechanical Properties

- Max. Tensile Load, Installation / Operation
- Max. Crush Resistance
- Cable Diameter, approx.
- Cable Weight, approx.
- Min. Bending Radius, Installation / Operation
- Installation / Operation Temperature
- Storage / Shipping Temperature

	UFCX3XXA	UFCX312A	UFCX324MA	
	4 - 6 Core	12 Core	24 Core	
Max. Tensile Load, Installation / Operation	1800 / 1000	1800 / 1000	1800 / 1000	N
Max. Crush Resistance	2200	2200	3400	N / 10 cm
Cable Diameter, approx.	7.9 ± 0.5	8.4 ± 0.5	10.3 ± 1.0	mm
Cable Weight, approx.	75 ± 5	82 ± 5	90 ± 10	kg / km
Min. Bending Radius, Installation / Operation	15x / 10x	15x / 10x	20x / 10x	Cable Diameter
Installation / Operation Temperature	-40°C to +70°C	-40°C to +70°C	-40°C to +70°C	
Storage / Shipping Temperature	-40°C to +75°C	-40°C to +75°C	-40°C to +75°C	

Part Number

Description	4 Core	6 Core	12 Core	24 Core
Singlemode, 9/125 μm, OS2	UFC9304A	UFC9306A	UFC9312A	UFC9324MA
Multimode, 50/125 μm, OM2	UFC5304A	UFC5306A	UFC5312A	UFC5324MA
XG Multimode, 50/125 μm, OM3	UFC4304A	UFC4306A	UFC4312A	UFC4324MA
Multimode, 50/125 μm, OM4	UFC3304A	UFC3306A	UFC3312A	UFC3324MA
Multimode, 50/125 μm, OM5	UFC2304A	UFC2306A	UFC2312A	UFC2324MA



NEW

# F.O. OUTDOOR/INDOOR, ARMORED / Direct Burial



P/N	DESCRIPTION	PACKING	PRICE /m.
<b>OS2 9/125 μm, SINGLEMODE , DOUBLE Q SERIES</b>			Effective P12 1 APRIL 2026
UFC9304A	F.O. Outdoor / Indoor, Armored 4 Core, LSZH - FR, OS2	4,000 M.	18.70 /m.
UFC9306A	F.O. Outdoor / Indoor, Armored 6 Core, LSZH - FR, OS2	4,000 M.	21.35 /m.
UFC9312A	F.O. Outdoor / Indoor, Armored 12 Core, LSZH - FR, OS2	4,000 M.	30.20 /m.
UFC9324MA	F.O. Outdoor / Indoor, Armored 24 Core, LSZH - FR, OS2, Multi-Tube	4,000 M.	50.-/m.
UFC9348MA	F.O. Outdoor / Indoor, Armored 48 Core, LSZH - FR, OS2, Multi-Tube	2/3/4,000* M.	Call
UFC9360MA	F.O. Outdoor / Indoor, Armored 60 Core, LSZH - FR, OS2, Multi-Tube	4,000* M.	Call
UFC9372MA	F.O. Outdoor / Indoor, Armored 72 Core, LSZH - FR, OS2, Multi-Tube	4,000* M.	Call
UFC9396MA	F.O. Outdoor / Indoor, Armored 96 Core, LSZH - FR, OS2, Multi-Tube	4,000* M.	Call
<b>OM2 50/125 μm, MULTIMODE , DOUBLE Q SERIES</b>			
UFC5304A	F.O. Outdoor / Indoor, Armored 4 Core, LSZH - FR, OM2	4,000 M.	24.45 /m.
UFC5306A	F.O. Outdoor / Indoor, Armored 6 Core, LSZH - FR, OM2	4,000 M.	26.20 /m.
UFC5312A	F.O. Outdoor / Indoor, Armored 12 Core, LSZH - FR, OM2	4,000 M.	38.35 /m.
UFC5324MA	F.O. Outdoor / Indoor, Armored 24 Core, LSZH - FR, OM2, Multi-Tube	4,000* M.	Call
<b>OM3 50/125 μm, MULTIMODE , DOUBLE Q SERIES</b>			
UFC4304A	F.O. Outdoor / Indoor, Armored 4 Core, LSZH-FR, OM3	4,000* M.	Call
UFC4306A	F.O. Outdoor / Indoor, Armored 6 Core, LSZH-FR, OM3	4,000 M.	38.60 /m.
UFC4312A	F.O. Outdoor / Indoor, Armored 12 Core, LSZH-FR, OM3	4,000 M.	63.20 /m.
UFC4324MA	F.O. Outdoor / Indoor, Armored 24 Core, LSZH-FR, OM3, Multi-Tube	4,000* M.	Call
<b>OM4 50/125 μm, MULTIMODE , DOUBLE Q SERIES</b>			
UFC3304A	F.O. Outdoor / Indoor, Armored 4 Core, LSZH-FR, OM4	4,000* M.	Call
UFC3306A	F.O. Outdoor / Indoor, Armored 6 Core, LSZH-FR, OM4	4,000 M.	61.95 /m.
UFC3312A	F.O. Outdoor / Indoor, Armored 12 Core, LSZH-FR, OM4	4,000 M.	109.85 /m.
UFC3324MA	F.O. Outdoor / Indoor, Armored 24 Core, LSZH-FR, OM4, Multi-Tube	4,000* M.	Call

**Remark** 1. Packing 2/3/4,000 M. (ไม่มี\*) หมายถึง สินค้ามีใน STOCK สามารถสั่งซื้อได้ทันทีทุกระยะ: 100 เมตร ตามการสั่งซื้อ  
 2. Packing 2/3/4,000\* M. มี\* หมายถึง เป็นสินค้าที่ต่อระดับผลิต และ ต่อระดับชื่อยกเว้นขั้นต่ำ ตามความยาวต่อหน่วยระบุ  
 3. Packing 4,000\* M. มี\* หมายถึง เป็นสินค้าที่ต่อระดับผลิต และ ต่อระดับชื่อยกเว้นขั้นต่ำ 4,000\* M./หน่วย เท่านั้น



### 1. ทำไม? ถึงต้องใช้สาย OUTDOOR/INDOOR, ARMORED

ปกติสายใยแก้วที่ติดตั้ง OUTDOOR จะมีฉนวนภายนอกที่ทำจากสาร PE ซึ่งสามารถทนความร้อนและสภาพแวดล้อมได้ดี แต่เมื่อเข้าไปฝังดิน (Direct Burial) อาจจะมีผลกระทบจากการกัดกร่อนของดินที่ขุดหรือเจาะลงไปทำโพรงใส่ได้ ดังนั้นสายที่มีฉนวนส่วนใหญ่มักจะมีกระเบื้องป้องกัน (Armored) และ มีชั้นป้องกันการกระแทกที่หุ้มด้วยเหล็ก Corugate Armored Steel (เหล็กเป็นรูปคลื่น)

และเพื่อตอบสนองความต้องการของช่างใช้งานในประเทศไทยในแถบเอเชีย LNK จึงผลิตสายใยแก้วที่ Outdoor และ เดินเข้าไปในอาคารได้โดยไม่ต้องไปเกิดปัญหาการลามไฟ หรือ มีควันไฟเป็นพิษ อีกทั้งเมื่อเดินภายนอกยังมีฉนวนกัน Armored ป้องกันสิ่งกัดกัดแฉะ หรือ ขอบมีดินมาสัมผัสด้วย

### 2. ความหมายของคำย่อ

Armored = กระเบื้องป้องกัน, Direct Burial = ฝังดินไปเลย

Think of Cabling ... Think@ INTERLINK Tel: 02-666-1111

www.interlink.co.th

PRICE LIST 2569

42

### Application

- 25/40/50/100/200/400/800 Gbps Ethernet
- IEEE802.3ae 10G Ethernet
- IEEE802.3z Gigabit Ethernet
- IEEE802.3u Fast Ethernet
- S2/155/622Mbps , 1.2Gbps ATM
- FDDI, Fiber Channel
- FTtx, CATV, CCTV and others

### Standards

- ANSI/TIA/EIA-568.3-D, ANSI/TIA-568-C.3
- Telcordia(Bellcore)GR-20-CORE, GR-409-CORE
- ITU T G.651 (Multimode)
- ITU-T G.652D (Singlemode)
- ISO/IEC 11801:2017, EN 50173-1
- IEC 60793, IEC60794-1-2
- IIS 2165
- RoHS Compliant



### Features/Construction

- High performance multimode (OM2, OM3, OM4 and OM5) and singlemode (OS2 or G.652D) fiber optic cable
- Fiber colors identification comply to TIA/EIA-598-C and EIA-359-A
- PBT Loose tube design provides high strength and low shrinkage with thixotropic jelly filled loose tube for water penetration protection
- E-glass yarn with water blocking provide for strength member
- High Strength Steel Wire Central Strength Member provide for tensile strength (FRP available on Request)
- Water blocking tape provide for double protection and safety for outdoor environment
- Ripcord is easy to strip
- Corrugated steel tape coat with polymer provides rodent protection
- UV-resistant, black HDPE outer jacket
- Multi-tube structure contain up to 312 core

### Optical Performance

Optical Transmission Performance	Singlemode	Multimode			
	1310/1383/1550/1625 nm	850/1300 nm			850/953/1300 nm
	9/125 μm (OS2)	50/125 μm (OM2)	50/125 μm (OM3)	50/125 μm (OM4)	50/125 μm (OM5)
Max. Attenuation (dB/km)	0.35 / 0.35 / 0.21 / 0.23	2.7 / 0.8	2.7 / 0.8	2.7 / 0.8	2.7/2.3/0.8
Typ. Attenuation (dB/km)	0.33 / 0.31 / 0.19 / 0.20	2.5 / 0.7	2.3 / 0.6	2.3 / 0.6	2.3/2.0/0.6
Bandwidth (MHz/km)	N / A	500 / 500	1500 / 500	3500 / 500	3500/1050/500
850 nm Laser bandwidth (MHz/km)	N / A	N / A	2000	4700	4700
Numerical Aperture	0.13 ± 0.01	0.200 ± 0.015	0.200 ± 0.015	0.200 ± 0.015	0.200±0.015

### Mechanical Properties

	UFCX6XXM 6 - 72 Core	UFCX6XXMD 6 - 72 Core	
Max. Tensile Load, Installation / Operation	2700 / 1500	3000 / 1800	N
Max. Crush Resistance	3400	4400	N / 10 cm
Cable Diameter, approx.	10-11 ± 1.0	11.6-12.6 ± 1.0	mm
Cable Weight, approx.	90-125 ± 10	120-150 ± 10	kg / km
Min. Bending Radius, Installation / Operation	20x / 10x	20x / 10x	Cable Diameter
Installation / Operation Temperature	-40°C to +70°C	-40°C to +70°C	
Storage / Shipping Temperature	-40°C to +75°C	-40°C to +75°C	

### Part Number

Description	12 Core	24 Core	48 Core	60 Core	72 Core	96 Core
Singlemode, 9/125 μm, OS2, Single Jacket	UFC9612M	UFC9624M	UFC9648M	UFC9660M	UFC9672M	UFC9696M
Multimode, 50/125 μm, OM2, Single Jacket	UFC5612M	UFC5624M	UFC5648M	UFC5660M	UFC5672M	UFC5696M
Description	12 Core	24 Core	48 Core	60 Core	72 Core	96 Core
Singlemode, 9/125 μm, OS2, Double Jacket	UFC9612MD	UFC9624MD	UFC9648MD	UFC9660MD	UFC9672MD	UFC9696MD
Multimode, 50/125 μm, OM2, Double Jacket	UFC5612MD	UFC5624MD	UFC5648MD	UFC5660MD	UFC5672MD	UFC5696MD



NEW

# F.O. MULTI-TUBE , ARMORED / Direct Burial (Single or Double Jacket)



P/N	DESCRIPTION	PACKING	PRICE /m.
<b>OS2 9/125 μm, SINGLEMODE, SINGLE JACKET , DOUBLE Q SERIES</b>			Effective P44 1 APRIL 2026
UFC9606M	F.O. Armored, Multi-Tube 6 Core, OS2, Single Jacket	4,000 M.	19.80 /m.
UFC9612M	F.O. Armored, Multi-Tube 12 Core, OS2, Single Jacket	4,000 M.	27.85 /m.
UFC9624M	F.O. Armored, Multi-Tube 24 Core, OS2, Single Jacket	4,000 M.	44.05 /m.
UFC9648M	F.O. Armored, Multi-Tube 48 Core, OS2, Single Jacket	4,000 M.	77.25 /m.
UFC9660M	F.O. Armored, Multi-Tube 60 Core, OS2, Single Jacket	4,000* M.	Call
UFC9672M	F.O. Armored, Multi-Tube 72 Core, OS2, Single Jacket	4,000* M.	Call
UFC9696M	F.O. Armored, Multi-Tube 96 Core, OS2, Single Jacket	4,000* M.	Call

<b>OS2 9/125 μm, SINGLEMODE, DOUBLE JACKET , DOUBLE Q SERIES</b>			
UFC9612MD	F.O. Armored, Multi-Tube 12 Core, OS2, Double Jacket	4,000* M.	Call
UFC9624MD	F.O. Armored, Multi-Tube 24 Core, OS2, Double Jacket	4,000* M.	Call
UFC9648MD	F.O. Armored, Multi-Tube 48 Core, OS2, Double Jacket	4,000* M.	Call
UFC9660MD	F.O. Armored, Multi-Tube 60 Core, OS2, Double Jacket	4,000* M.	Call
UFC9672MD	F.O. Armored, Multi-Tube 72 Core, OS2, Double Jacket	4,000* M.	Call
UFC9696MD	F.O. Armored, Multi-Tube 96 Core, OS2, Double Jacket	4,000* M.	Call

- Remark**
1. Packing 2/3/4,000 M. (ไม่มี\*) หมายถึง สินค้ามีใน STOCK สามารถสั่งซื้อได้ทันทีทุกระยะ: 100 เมตร ตามการสั่งซื้อ
  2. Packing 2/3/4,000\* M. มี\* หมายถึง เป็นสินค้าที่ต้องสั่งซื้อ และ ต้องสั่งซื้อยกเว้นขั้นต่ำ ตามความยาวต่อม้วนที่ระบุ
  3. Packing 4,000\* M. มี\* หมายถึง เป็นสินค้าที่ต้องสั่งซื้อ และ ต้องสั่งซื้อยกเว้นขั้นต่ำ 4,000\* M./ม้วน เท่านั้น



### Why use ARMORED cables?

Normally, outdoor fiber optic cables have an outer sheath made of PE (Polyethylene), which provides excellent resistance to acids, alkalis, and environmental conditions. However, when buried directly in the ground (Direct Burial), they may be damaged by sharp objects during digging or drilling. For this reason, most underground cables are designed with protective armor (Armored). The most commonly used type of armor is Corrugated Armored Steel (steel formed in a wave-like shape).

Some installers may also use Outdoor/Armored cables for aerial installation or placement on cable ladders, wireways, cable trays, etc. In such cases, the armor also provides effective protection against rodents.

### Application

- 25/40/50/100/200/400/800 Gbps Ethernet
- IEEE802.3ae 10G Ethernet
- IEEE802.3z Gigabit Ethernet
- IEEE802.3u Fast Ethernet
- 52/155/622Mbps , 1.2Gbps ATM
- FDDI, Fiber Channel
- FTTx, CATV, CCTV and others

### Standards

- ANSI/TIA/EIA-568.3-D, ANSI/TIA-568-C.3
- ANSI/ICEA 696, ANSI/ICEA 596
- Telcordia(Bellcore)GR-20-CORE, GR-409-CORE
- ITU-T G.651 (Multimode)
- ITU-T G.652D (Singlemode)
- ISO/IEC 11801:2017, EN 50173-1
- IEC 60332-1-2
- IEC 61034-2, IEC60754-2
- IEC 60793, IEC60794-1-2
- TIS 2166
- RoHS Compliant

### Optical Performance

Optical Transmission Performance	Singlemode	Multimode			
	1310/1383/1550/1625 nm	850/1300 nm			850/953/1300 nm
	9/125 μm (OS2)	50/125 μm (OM2)	50/125 μm (OM3)	50/125 μm (OM4)	50/125 μm (OM5)
Max. Attenuation (dB/km)	0.35 / 0.35 / 0.21 / 0.23	2.7 / 0.8	2.7 / 0.8	2.7 / 0.8	2.7/2.3/0.8
Typ. Attenuation (dB/km)	0.33 / 0.31 / 0.19 / 0.20	2.5 / 0.7	2.3 / 0.6	2.3 / 0.6	2.3/2.0/0.6
Bandwidth (MHz/km)	N / A	500 / 500	1500 / 500	3500 / 500	3500/1850/500
850 nm Laser bandwidth (MHz/km)	N / A	N / A	2000	4700	4700
Numerical Aperture	0.13 ± 0.01	0.200 ± 0.015	0.200 ± 0.015	0.200 ± 0.015	0.200±0.015

### Mechanical Properties

	UFCX5XX01	
Max. Tensile Load, Installation / Operation	1200 / 600	N
Max. Span Length	40 - 80	m
Max. Crush Resistance	1500	N / 10 cm
Cable Diameter, approx.	5.6 - 6.1 ± 0.5	mm
Overall Diameter, approx.	9.3 - 9.8 ± 0.5	mm
Cable Weight, approx.	52 ± 5 to 58 ± 5	kg / km
Min. Bending Radius, Installation / Operation	15x / 10x	Cable Diameter
Installation / Operation Temperature	-40°C to +70°C	
Storage / Shipping Temperature	-40°C to +75°C	

### Part Number

Description	4 Core	6 Core	12 Core
Singlemode, 9/125 μm, OS2	UFC950401	UFC950601	UFC951201
Multimode, 50/125 μm, OM2	UFC550401	UFC550601	UFC551201
XG Multimode, 50/125 μm, OM3	UFC450401	UFC450601	UFC451201
Multimode, 50/125 μm, OM4	UFC350401	UFC350601	UFC351201
Multimode, 50/125 μm, OM5	UFC250401	UFC250601	UFC251201



OUTDOOR/INDOOR, DROP WIRE  
UFCX5XX01

### Features/Construction

- High performance multimode [OM2, OM3, OM4 and OM5] and singlemode [OS2 or G.652D] fiber optic cable
- Fiber colors identification comply to TIA/EIA-598-C and EIA-359-A
- PBT Loose tube design provides high strength and low shrinkage with thixotropic jelly filled loose tube for water penetration protection
- E-glass yarn with water blocking provide for strength member water blocking and Safety for outdoor environment
- Ripcord is easy to strip
- UV-resistant, Flame-retardant black PE with LSZH (Low Smoked Zero Halogen) outer jacket
- Messenger wire provide by 1.2 mm. galvanize steel wire



# F.O. OUTDOOR / INDOOR , DROP WIRE



P/N	DESCRIPTION	PACKING	PRICE /m.
<b>OS2 9/125 μm, SINGLEMODE, Drop Wire Solid Ø1.2 mm.</b>			Effective P46 1 APRIL 2026
<b>UFC950401</b> [Recommend UFC9504DSA ; P48]	F.O. Outdoor / Indoor, Drop Wire 4 Core, LSZH-FR, OS2	2/3/4,000* M.	Call
<b>UFC950601</b> [Recommend UFC9506DSA ; P48]	F.O. Outdoor / Indoor, Drop Wire 6 Core, LSZH-FR, OS2	4,000 M.	18.55 /m.
<b>UFC951201</b> [Recommend UFC9512DSA ; P48]	F.O. Outdoor / Indoor, Drop Wire 12 Core, LSZH-FR, OS2	4,000 M.	27.15 /m.
<b>OM2 50/125 μm, MULTIMODE, Drop Wire Solid Ø1.2 mm.</b>			
<b>UFC550401</b> [Recommend UFC5504DSA ; P48]	F.O. Outdoor / Indoor, Drop Wire 4 Core, LSZH-FR, OM2	4,000* M.	Call
<b>UFC550601</b> [Recommend UFC5506DSA ; P48]	F.O. Outdoor / Indoor, Drop Wire 6 Core, LSZH-FR, OM2	4,000 M.	25.10 /m.
<b>UFC551201</b> [Recommend UFC5512DSA ; P48]	F.O. Outdoor / Indoor, Drop Wire 12 Core, LSZH-FR, OM2	4,000 M.	37.25 /m.

- Remark**
1. Packing 2/3/4,000 M. (ไม่มี\*) หมายถึง สินค้ามีใน STOCK สามารถสั่งซื้อได้ทันทีที่ระยะเวลา: 100 เมตร ตามการสั่งซื้อ
  2. Packing 2/3/4,000\* M. มี\* หมายถึง เป็นสินค้าที่ต้องสั่งผลิต และ ต้องสั่งซื้อยกเว้นขั้นต่ำ ตามความยาวต่อหน่วยที่ระบุ
  3. Packing 4,000\* M. มี\* หมายถึง เป็นสินค้าที่ต้องสั่งผลิต และ ต้องสั่งซื้อยกเว้นขั้นต่ำ 4,000\* M./หน่วย เท่านั้น



### ทำไม ? ถึงต้องใช้สาย OUTDOOR/INDOOR with Drop Wire

ปัจจุบันการใช้งานการสื่อสารมีความจำเป็นที่ต้องเดินสายสัญญาณระยะทางยาวๆ ซึ่งต้องใช้สาย Fiber Optic เป็นสายสัญญาณหลักและการติดตั้งจริงมักจะเดิน Outside Plant หรือ Outdoor โดยติดตั้งบนเสาไฟฟ้าหรือคานาแขวนสายอากาศทางด้านซ้ายไป เช่น การติดตั้งกล้อง CCTV, การเชื่อมโยงบริษัทแม่และลูก, การเชื่อมโยงแต่ละอาคาร

สาย Fiber Optic ชนิด OUTDOOR / INDOOR with Drop Wire เป็นทางเลือกที่ช่วยให้ผู้ติดตั้งประหยัดไม่ต้องเดินสายลงถึงเพื่อเป็น Messenger Wire สำหรับแขวนสาย Fiber Optic ทำให้อายุการใช้งานที่ยาวนาน และ สาย Fiber Optic ชนิดนี้ยังมีคุณสมบัติสามารถเดินสาย OUTDOOR/INDOOR จากภายนอกเข้าไปภายในอาคารได้เลย ไม่จำเป็นต้องเปลี่ยนเป็นสาย INDOOR จึงทำให้ประหยัดและมีความปลอดภัยสูง (สูงสุดแบบไม่มีสาย Outdoor/Indoor) ไม่ Tip ทำไม ? ต้องใช้สาย OUTDOOR/INDOOR

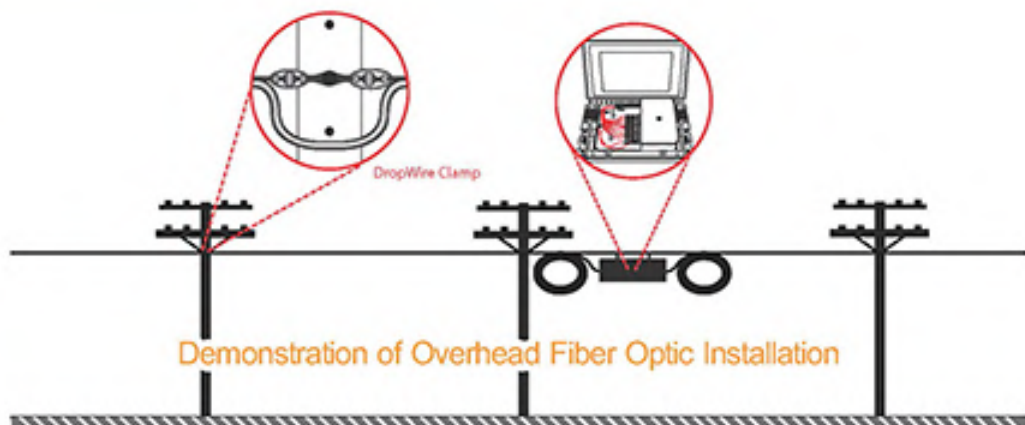

FIBER OPTIC System

Application

- 25/40/50/100/200/400/800 Gbps Ethernet
- IEEE802.3ae 100 Ethernet
- IEEE802.3z Gigabit Ethernet
- IEEE802.3u Fast Ethernet
- 52/155/622Mbps , 1.26bps ATM
- FDDI, Fiber Channel
- FTTx, CATV, CCTV and others

Standards

- ANSI/TIA/EIA-568.3-D, ANSI/TIA-568-C.3
- ANSI/ICEA 640
- Telcordia(Bellcore)GR-20-CORE
- ITU-T G.651 (Multimode)
- ITU-T G.652D (Singlemode)
- ISO/IEC 11801:2017, EN 50173-1
- IEC 60793, IEC60794-1-2
- TIS 2166
- RoHS Compliant

Optical Performance

Optical Transmission Performance	Singlemode		Multimode		
	1310/1383/1550/1625 nm		850/1300 nm		
	9/125 μm [OS2]	50/125 μm [OM2]	50/125 μm [OM3]	50/125 μm [OM4]	850/953/1300 nm
Max. Attenuation [dB/km]	0.35 / 0.35 / 0.21 / 0.23	2.7 / 0.8	2.7 / 0.8	2.7 / 0.8	2.7/2.3/0.8
Typ. Attenuation [dB/km]	0.33 / 0.31 / 0.19 / 0.20	2.5 / 0.7	2.3 / 0.6	2.3 / 0.6	2.3/2.0/0.6
Bandwidth [MHz/km]	N / A	500 / 500	1500 / 500	3500 / 500	3500/1850/500
850 nm Laser bandwidth [MHz/km]	N / A	N / A	2000	4700	4700
Numerical Aperture	0.13 ± 0.01	0.200 ± 0.015	0.200 ± 0.015	0.200 ± 0.015	0.200±0.015

Mechanical Properties

	UFC5XX0SA	UFC95XXMDA	
Max. Tensile Load, Installation / Operation	1200 / 600	1800 / 1000	N
Max. Span Length	40 - 80	40-80	m
Max. Crush Resistance	2200	3400	N / 10 cm
Conductor cross-sectional area	-	-	mm <sup>2</sup>
Cable Diameter, approx.	7.7 - 8.2 ± 0.5	8.5 - 8.8 ± 0.5	mm
Overall Diameter, approx.	11.4 -11.9 ± 1.0	12.6 -12.9 ± 1.0	mm
Cable Weight, approx.	67 -75 ± 10	65 -90 ± 5.0	kg / km
Min. Bending Radius, Installation / Operation	20x / 10x	20x / 10x	Cable Diameter
Installation / Operation Temperature	-40°C to +70°C	-40°C to +70°C	
Storage / Shipping Temperature	-40°C to +75°C	-40°C to +75°C	

Part Number

Description	4 Core	6 Core	12 Core	24 Core
Singlemode, 9/125 μm, OS2, Stranded Drop wire	UFC9504DSA	UFC9506DSA	UFC9512DSA	-
Multimode, 50/125 μm, OM2, Stranded Drop wire	UFC5504DSA	UFC5506DSA	UFC5512DSA	-
Singlemode, OS2, 3 Twisted TUBE,Solid Drop wire	UFC9504MDA	UFC9506MDA	UFC9512MDA	UFC9524MDA



Outdoor, Stranded Drop Wire, Armored  
UFC5XX0SA



OTV Drop Wire, 3 Tube, Armored  
UFC95XXMDA

Features/Construction

- High performance multimode [OM2, OM3, OM4 and OM5] and singlemode [OS2 or G.652D] fiber optic cable
- Fiber colors identification comply to TIA/EIA-598-C and EIA-359-A
- PBT Loose tube design provides high strength and low shrinkage with thixotropic jelly filled loose tube for water penetration protection
- E-glass yarn with water blocking provide for strength member water blocking and safety for outdoor environment
- Corrugated steel tape coat with polymer provides rodent protection
- Messenger wire provide by 7 x 0.4 mm.[1.2 mm.] stranded galvanize steel wire for tensile strength or φ 1.6 mm. solid galvanize steel wire for MDA Series
- UV-resistant, black HDPE outer jacket



# F.O. SINGLE or 3-TWISTED TUBE , DROP-WIRE / ARMORED



P/N	DESCRIPTION	PACKING	PRICE /m.
<b>OS2 9/125 μm, SINGLE TUBE, ARMORED, STRANDED, DROP WIRE (สลิ้งแกนเดี่ยว Ø1.2 mm.)</b>			
<b>UFC9504DSA</b> [Compatible UFC95040I]	F.O. CTV Drop Wire, Stranded, Armored 4 Core, OS2	4,000 M.	Effective P48 1 APRIL 2026 <b>15.65 /m.</b>
<b>UFC9506DSA</b> [Compatible UFC95060I]	F.O. CTV Drop Wire, Stranded, Armored 6 Core, OS2	4,000 M.	<b>18.20 /m.</b>
<b>UFC9512DSA</b> [Compatible UFC95120I]	F.O. CTV Drop Wire, Stranded, Armored 12 Core, OS2	4,000 M.	<b>26.90 /m.</b>
<b>OM2 50/125 μm, SINGLE TUBE, ARMORED, STRANDED, DROP WIRE (สลิ้งแกนเดี่ยว Ø1.2 mm.)</b>			
<b>UFC5504DSA</b> [Compatible UFC55040I]	F.O. CTV Drop Wire, Stranded, Armored 4 Core, OM2	4,000* M.	<b>Call</b>
<b>UFC5506DSA</b> [Compatible UFC55060I]	F.O. CTV Drop Wire, Stranded, Armored 6 Core, OM2	4,000 M.	<b>24.25 /m.</b>
<b>UFC5512DSA</b> [Compatible UFC55120I]	F.O. CTV Drop Wire, Stranded, Armored 12 Core, OM2	4,000 M.	<b>36.40 /m.</b>
<b>OS2 9/125 μm, 3-TWISTED TUBE, ARMORED, SOLID 3-TWISTED TUBE DROP WIRE ( สลิ้งแกนเดี่ยว Ø1.6 mm.)</b>			
<b>UFC9504MDA</b> [Recommend UFC9504DSA or UFC9706A]	F.O. CTV Drop Wire, Solid, 3-Twisted Tube, Armored 4 Core, OS2	4,000* M.	<b>Call</b>
<b>UFC9506MDA</b> [Recommend UFC9506DSA or UFC9706A]	F.O. CTV Drop Wire, Solid, 3-Twisted Tube, Armored 6 Core, OS2	4,000 M.	<b>20.45 /m.</b>
<b>UFC9512MDA</b> [Recommend UFC9512DSA or UFC9712A]	F.O. CTV Drop Wire, Solid, 3-Twisted Tube, Armored 12 Core, OS2	4,000 M.	<b>28.45 /m.</b>
<b>UFC9524MDA</b> [Recommend UFC9724A or UFC9724MA]	F.O. CTV Drop Wire, Solid, 3-Twisted Tube, Armored 24 Core, OS2	2/3/4,000* M.	<b>Call</b>

Think of Cabling ... Think@ INTERLINK Tel: 02-666-1111 www.interlink.co.th

- Remark**
1. Packing 2/3/4,000 M. (ไม่มี\*) หมายถึง สินค้าเป็น STOCK สามารถสั่งตัดได้ทันทีทุกระยะ: 100 เมตร ตามการสั่งซื้อ
  2. Packing 2/3/4,000\* M. มี\* หมายถึง เป็นสินค้าที่ต้องสั่งผลิต และ ต้องสั่งซื้อยกเว้นขั้นต่ำ ตามความยาวต่อม้วนที่ระบุ
  3. Packing 4,000\* M. มี\* หมายถึง เป็นสินค้าที่ต้องสั่งผลิต และ ต้องสั่งซื้อยกเว้นขั้นต่ำ 4,000\* M./ม้วน เท่านั้น



### Single Solid Drop Wire, 3- Twisted Tube VS Stranded Drop Wire, Single Tube with Armored

Stranded เป็นอีกทางเลือกหนึ่งของ Fiber Optic ที่ออกแบบมาเพื่อประโยชน์สูงสุดของการติดตั้งและยังคงประสิทธิภาพในเชิงวิศวกรรม กล่าวคือ โครงสร้างสายเหมือน Drop Wire แต่ไรลวดที่เคลือบใยแก้วเส้นผ่าศูนย์กลางเท่ากับ Drop Wire (เพื่อใช้งานกับอุปกรณ์ติดตั้งสายไฟเบอร์ Drop Wire โคโรส) โดยการออกแบบ Drop Wire เป็นเส้นลวดขนาดเล็กที่เคลือบใยแก้ว หรือ Standard Drop Wire เพื่อเป็นการเพิ่มแรงดึงหรือเพิ่มการรับน้ำหนักของ สายใยแก้วโพลิ Span หรือระยะขงสายใยแก้วที่มากขึ้น

3- Twisted Tube เป็นนวัตกรรมการแก้ปัญหาของสาย Drop Wire ที่ขมสายไฟทำ เส้นใยแก้วที่แสง ภายในจะไม่เกิดการขยับตัว (โหว) เมื่อเกิดการแกว่งขึ้นเนื่องมาจากกระแสลม โดยสายชนิดนี้ไม่มีการทดสอบและรับรองจาก TOT (ตัว Drop Wire จะเป็น Solid เพื่อสะดวกในการติดตั้ง)

### Application

- 25/40/50/100/200/400/800 Gbps Ethernet
- IEEE802.3ae 10G Ethernet
- IEEE802.3z Gigabit Ethernet
- IEEE802.3u Fast Ethernet
- 52/155/622Mbps , 1.2Gbps ATM
- FDDI, Fiber Channel
- FTTx, CATV, CCTV and others

### Standards

- ANSI/TIA/EIA-568.3-D, ANSI/TIA-568-C.3
- ANSI/ICEA 640
- Telcordia(Bellcore)GR-20-CORE
- ITU-T G.651 (Multimode)
- ITU-T G.652D (Singlemode)
- ISO/IEC 11801:2017, EN 50173-1
- IEC 60793, IEC60794-1-2
- TIS 2166
- RoHS Compliant

### Optical Performance

Optical Transmission Performance	Singlemode		Multimode		
	1310/1383/1550/1625 nm		850/1300 nm		
	9/125 μm (OS2)	50/125 μm (OM2)	50/125 μm (OM3)	50/125 μm (OM4)	50/125 μm (OM5)
Max. Attenuation [dB/km]	0.35 / 0.35 / 0.21 / 0.23	2.7 / 0.8	2.7 / 0.8	2.7 / 0.8	2.7/2.3/0.8
Typ. Attenuation [dB/km]	0.33 / 0.31 / 0.19 / 0.20	2.5 / 0.7	2.3 / 0.6	2.3 / 0.6	2.3/2.0/0.6
Bandwidth (MHz/km)	N / A	500 / 500	1500 / 500	3500 / 500	3500/1850/500
850 nm Laser bandwidth (MHz/km)	N / A	N / A	2000	4700	4700
Numerical Aperture	0.13 ± 0.01	0.200 ± 0.015	0.200 ± 0.015	0.200 ± 0.015	0.200±0.015

### Mechanical Properties

- Max. Tensile Load, Installation / Operation
- Max. Span Length
- Max. Crush Resistance
- Cable Diameter, approx.
- Overall Diameter, approx.
- Cable Weight, approx.
- Min. Bending Radius, Installation / Operation
- Installation / Operation Temperature
- Storage / Shipping Temperature

#### UFCX8XXMA

6 - 72 Core

6000 / 3000

40 - 80

3400

9.8-10.8 ± 1.0

16.8-17.8 ± 1.0

150-180 ± 10.0

20x / 10x

-40°C to + 70°C

-40°C to + 75°C

#### UFCX8XXMAD

24 - 72 Core

6000

100

4400

12.2-13.0 ± 1.0

19.0-20.0 ± 1.0

19.5-23.5 ± 10.0

20x / 10x

-40°C to + 70°C

-40°C to + 75°C

### Part Number

Description	24 Core	48 Core	60 Core	72 Core
Armored / Singlemode, 9/125 μm, OS2	UFC9824MA	UFC9848MA	UFC9860MA	UFC9872MA
Armored / Multimode, 50/125 μm, OM2	UFC5824MA	UFC5848MA	UFC5860MA	UFC5872MA

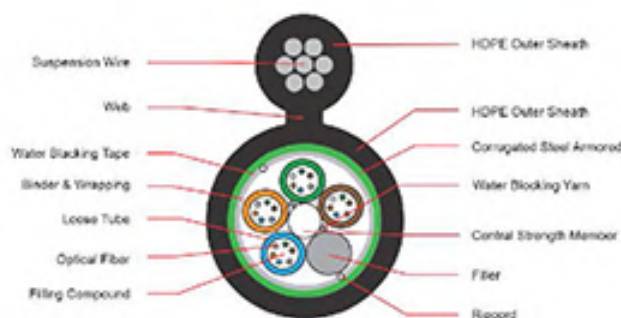

Fig.8, Multi-Tube, Armored  
UFCX8XXMA



### Features/Construction

- High performance multimode (OM2, OM3, OM4 and OM5) and singlemode (OS2 or G.652D) fiber optic cable
- Fiber colors identification comply to TIA/EIA-598-C and EIA-359-A
- PBT Loose tube design provides high strength and low shrinkage with thixotropic jelly filled loose tube for water penetration protection
- High Strength Steel Wire Central Strength Member provide for tensile strength [FRP available on Request]
- Water blocking yarns & tape provide for double protection and safety for outdoor environment
- Ripcord is easy to strip
- Suspension wire provide by 7 x 1.0 mm. stranded galvanize steel wire for tensile strength
- UV-resistant, black HDPE outer jacket, Up to 312 core

P/N	DESCRIPTION	PACKING	PRICE /m.
<b>OS2 9/125 μm, MULTI-TUBE, SINGLE JACKET / ARMORED, SINGLEMODE</b>			Effective P50 1 APRIL 2026
UFC9824MA	F.O. FIG. 8, Multi-Tube , Armored 24 Core, OS2, Single Jacket	4,000* M.	Call
UFC9848MA	F.O. FIG. 8, Multi-Tube , Armored 48 Core, OS2, Single Jacket	4,000* M.	Call
UFC9860MA	F.O. FIG. 8, Multi-Tube , Armored 60 Core, OS2, Single Jacket	4,000* M.	Call
UFC9872MA	F.O. FIG. 8, Multi-Tube , Armored 72 Core, OS2, Single Jacket	4,000* M.	Call

<b>OS2 9/125 μm, MULTI-TUBE, DOUBLE JACKET / ARMORED, SINGLEMODE</b>			
UFC9824MAD	F.O. FIG. 8, Multi-Tube , Armored 24 Core, OS2, Double Jacket	4,000* M.	Call
UFC9848MAD	F.O. FIG. 8, Multi-Tube , Armored 48 Core, OS2, Double Jacket	4,000* M.	Call
UFC9860MAD	F.O. FIG. 8, Multi-Tube , Armored 60 Core, OS2, Double Jacket	4,000* M.	Call
UFC9872MAD	F.O. FIG. 8, Multi-Tube , Armored 72 Core, OS2, Double Jacket	4,000* M.	Call

- Remark**
1. Packing 2/3/4,000 M. (ไม่มี\*) หมายถึง สินค้าเป็น STOCK สามารถรับตัดได้ทันทีทุกระยะ: 100 เมตร ตามการสั่งซื้อ
  2. Packing 2/3/4,000\* M. มี\* หมายถึง เป็นสินค้าที่ต้องสั่งผลิต และ ต้องสั่งซื้อยกเว้นขั้นต่ำ ตามความยาวต่อถ่วงที่ระบุ
  3. Packing 4,000\* M. มี\* หมายถึง เป็นสินค้าที่ต้องสั่งผลิต และ ต้องสั่งซื้อยกเว้นขั้นต่ำ 4,000\* M./ถ่วง เท่านั้น



### Tip Fig.8 OUTDOOR / MULTI-TUBE

เป็นแคบิลใยแก้วที่แสงที่ถูกออกแบบมาเป็นพิเศษเพื่อนำไปใช้ติดตั้งเป็นโครงข่ายหลัก (infrastructure) ของโครงข่ายระบบสื่อสารที่มีความแข็งแรงอย่างมาก การติดตั้งวิธีนี้มักใช้กับสายใยแก้วที่หุ้มด้วยท่อพลาสติก และนำใส่ในรางสายใยแก้วที่มีระยะ span ไปเกิน 80 เมตรได้ทันที ส่วนโครงข่ายของ Optical Fiber ที่ถูกออกแบบไว้ใช้โครงข่ายการป้องกันน้ำซึมเข้าสายแล้ว Water Blocking Tape และยังมี Water Blocking yarn เป็นตัวเพิ่มความแข็งแรงอีกด้วย

อีกทั้งยังมีโครงข่ายที่เสริมเกราะเหล็ก (Armored) ของรุ่น MA ยังสามารถทนต่อการกัดกร่อนของตัวหรืออุบัติเหตุจากภายนอกเข้าไป กระทั่งแคบิลใยแก้วภายในได้อีกด้วย

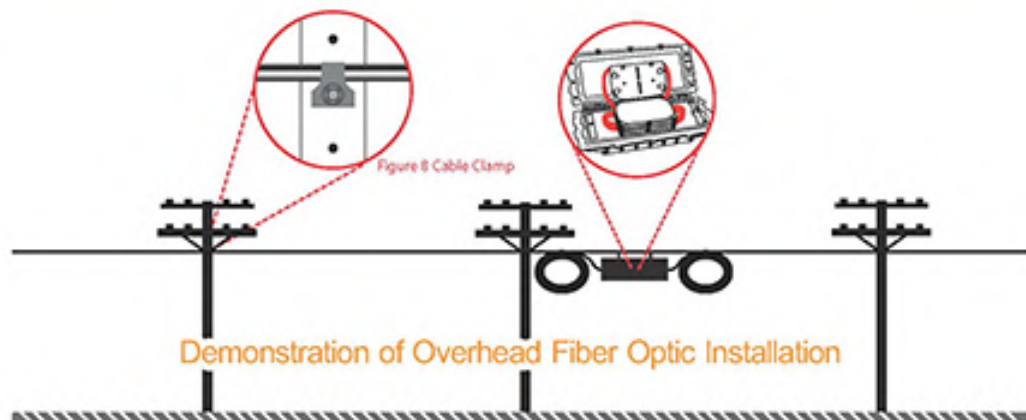

### Application

- 25/40/50/100/200/400/800 Gbps Ethernet
- IEEE802.3ae 10G Ethernet
- IEEE802.3z Gigabit Ethernet
- IEEE802.3u Fast Ethernet
- 52/155/622Mbps, 1.2Gbps ATM
- FDDI, Fiber Channel
- FTTx, CATV, CCTV and others

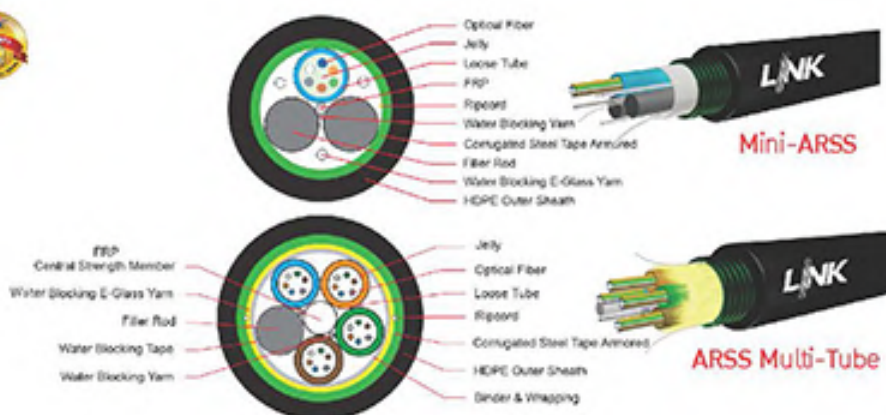

### Standards

- ANSI/TIA/EIA-568.3-D, ANSI/TIA-568-C.3
- ANSI/ICEA 640
- Telcordia(Bellcore)GR-20-CORE
- ITU-T G.651 (Multimode)
- ITU-T G.652D (Singlemode)
- ISO/IEC 11801:2017, EN 50173-1
- IEC 60793, IEC60794-1-2
- TIS 2166
- RoHS Compliant

### Features/Construction

- High performance multimode (OM2, OM3, OM4 and OM5) and singlemode (OS2 or G.652D) fiber optic cable
- Fiber colors identification comply to TIA/EIA-598-C and EIA-359-A
- PBT Loose tube design provides high strength and low shrinkage with thixotropic jelly filled loose tube for water penetration protection
- FRP central strength member provide for tensile strength
- Water blocking yarns & tape provide for double protection and safety for outdoor environment
- Water blocking E-glass yarn provide for strength member
- Ripcord is easy to strip
- UV-resistant, black HDPE outer jacket
- UP to 312 Core for ARSS

### Optical Performance

Optical Transmission Performance	Singlemode		Multimode		
	1310/1383/1550/1625 nm		850/1300 nm		850/953/1300 nm
	9/125 μm (OS2)	50/125 μm (OM2)	50/125 μm (OM3)	50/125 μm (OM4)	50/125 μm (OM5)
Max. Attenuation (dB/km)	0.35 / 0.35 / 0.21 / 0.23	2.7 / 0.8	2.7 / 0.8	2.7 / 0.8	2.7/2.3/0.8
Typ. Attenuation (dB/km)	0.33 / 0.31 / 0.19 / 0.20	2.5 / 0.7	2.3 / 0.6	2.3 / 0.6	2.3/2.0/0.6
Bandwidth (MHz/km)	N / A	500 / 500	1500 / 500	3500 / 500	3500/1850/500
850 nm Laser bandwidth (MHz/km)	N / A	N / A	2000	4700	4700
Numerical Aperture	0.13 ± 0.01	0.200 ± 0.015	0.200 ± 0.015	0.200 ± 0.015	0.200±0.015

### Mechanical Properties

	UFCX7XXA 6 - 24 Core	UFCX7XXMA 6 - 72 Core	
Max. Tensile Load, Installation / Operation	1200 / 600	1800 / 1000	N
Max. Span Length	40 - 80	40 - 80	m
Max. Crush Resistance	3400	3400	N / 10 cm
Cable Diameter, approx.	8.5-8.8 ± 0.5	10.3-12.4 ± 1.0	mm
Cable Weight, approx.	60-65 ± 5	90-135 ± 10	kg / km
Min. Bending Radius, Installation / Operation	20x / 10x	20x / 10x	Cable Diameter
Installation / Operation Temperature	-40°C to + 70°C	-40°C to + 70°C	
Storage / Shipping Temperature	-40°C to + 75°C	-40°C to + 75°C	

### Part Number

Description	6 Core	12 Core	24 Core	48 Core	60 Core	72 Core
MINI-ARSS / Singlemode, 9/125 μm, OS2	UFC9706A	UFC9712A	UFC9724A	-	-	-
ARSS / Singlemode, 9/125 μm, OS2	UFC9706MA	UFC9712MA	UFC9724MA	UFC9748MA	UFC9760MA	UFC9772MA
MINI-ARSS / Multimode, 50/125 μm, OM2	UFC5706A	UFC5712A	UFC5724A	-	-	-
ARSS / Multimode, 50/125 μm, OM2	UFC5706MA	UFC5712MA	UFC5724MA	UFC5748MA	UFC5760MA	UFC5772MA



# F.O. **MINI ARSS<sup>®</sup>** (3-Tube) & **ARSS<sup>®</sup>** (Multi-Tube) (ANTI RODENT SELF SUPPORT CABLE)



P/N	DESCRIPTION	PACKING	PRICE /m.
<b>OS2 9/125 μm, SINGLEMODE, MINI-ARSS 3-Twisted Tube, DOUBLE Q SERIES, (Tensile 1,200 N)</b>			
UFC9704A	F.O. MINI-ARSS, Armored 4 Core, OS2, 3-Twisted Tube	2/3/4,000* M.	Call
UFC9706A	F.O. MINI-ARSS, Armored 6 Core, OS2, 3-Twisted Tube	4,000 M.	17.85 /m.
UFC9712A	F.O. MINI-ARSS, Armored 12 Core, OS2, 3-Twisted Tube	4,000 M.	25.90 /m.
UFC9724A	F.O. MINI-ARSS, Armored 24 Core, OS2, 3-Twisted Tube	4,000 M.	42.35 /m.
<b>OS2 9/125 μm, SINGLEMODE, ARSS Multi-Tube, DOUBLE Q SERIES, (Tensile 1,800 N)</b>			
UFC9706MA	F.O. ARSS, Multi-Tube, Armored 6 Core, OS2, Single Jacket	2/3/4,000* M.	Call
UFC9712MA	F.O. ARSS, Multi-Tube, Armored 12 Core, OS2, Single Jacket	4,000 M.	28.70 /m.
UFC9724MA	F.O. ARSS, Multi-Tube, Armored 24 Core, OS2, Single Jacket	4,000 M.	44.80 /m.
UFC9748MA	F.O. ARSS, Multi-Tube, Armored 48 Core, OS2, Single Jacket	4,000 M.	77.30 /m.
UFC9760MA	F.O. ARSS, Multi-Tube, Armored 60 Core, OS2, Single Jacket	4,000* M.	Call
UFC9772MA	F.O. ARSS, Multi-Tube, Armored 72 Core, OS2, Single Jacket	4,000* M.	Call
UFC9796MA	F.O. ARSS, Multi-Tube, Armored 96 Core, OS2, Single Jacket	4,000* M.	Call
<b>OS2 9/125 μm, SINGLEMODE, DOUBLE JACKET, ARSS Multi-Tube, DOUBLE Q SERIES</b>			
UFC9724MAD	F.O. ARSS, Multi-Tube, Armored 24 Core, OS2, Double Jacket	2/3/4,000* M.	51.55 /m.
UFC9748MAD	F.O. ARSS, Multi-Tube, Armored 48 Core, OS2, Double Jacket	2/3/4,000* M.	Call
UFC9760MAD	F.O. ARSS, Multi-Tube, Armored 60 Core, OS2, Double Jacket	4,000* M.	Call
UFC9772MAD	F.O. ARSS, Multi-Tube, Armored 72 Core, OS2, Double Jacket	4,000* M.	Call
UFC9796MAD	F.O. ARSS, Multi-Tube, Armored 96 Core, OS2, Double Jacket	4,000* M.	Call

- Remark**
1. Packing 2/3/4,000 M. (ไม่มี\*) หมายถึง สินค้าเป็น STOCK สามารถสั่งซื้อได้ทันทีทุกระยะ: 100 เมตร ตามการสั่งซื้อ
  2. Packing 2/3/4,000\* M. มี\* หมายถึง เป็นสินค้าที่ต้องสั่งซื้อ และ ต้องสั่งซื้อยกม้วนขั้นต่ำ ตามความยาวต่อม้วนที่ระบุ
  3. Packing 4,000\* M. มี\* หมายถึง เป็นสินค้าที่ต้องสั่งซื้อ และ ต้องสั่งซื้อยกม้วนขั้นต่ำ 4,000\* M./ม้วน เท่านั้น



### Tip ARSS, ANTI RODENT SELF SUPPORT CABLE (สายชนิดนิยมน)

เป็นชนิดใยแก้วนำแสงโครงสร้างพิเศษที่ออกแบบ เพื่อตอบสนองการใช้งานในประเทศไทยที่เกิดปัญหาการกัดสาย ADSS (All Dielectric Self Support) ที่ไม่มีแรงป้องกันการกัดแฉะของสัตว์ เหมาะสำหรับการติดตั้งเป็นโครงสร้างหลัก (Infrastructure) ของโครงข่ายระบบสื่อสารที่มีปัญหาสัตว์กัดสายทุกมุมของโครงข่ายของ สาย MiniARSS<sup>™</sup> และ ARSS ได้ถูกออกแบบพิเศษให้มีวัสดุป้องกันที่มีอยู่สูงพร้อมทั้งความเค้นของสาย F.O. โดยมีชั้นของ Water Blocking Tape และชั้นส่วน Water Blocking yarn เป็นตัวรับความชื้น และมีเกาะหนามป้องกัน

LNK ยินดีออกแบบ สาย MiniARSS<sup>™</sup> นี้มา เพื่อตอบสนองการใช้งานของระบบโครงข่ายระบบในเขตเมือง โดยออกแบบให้ใช้ 3-Tube Twisted ป้องกันการเคลื่อนตัวของสาย Optical Fiber และเมื่อแรงดึง ในกรณีไม่ขมสายให้ที่ด้วย (เวลาองศาสาย ถ้าออกแบบไม่ดี เสริมใยแก้วใน Loose Tube จะเคลื่อนตัว)

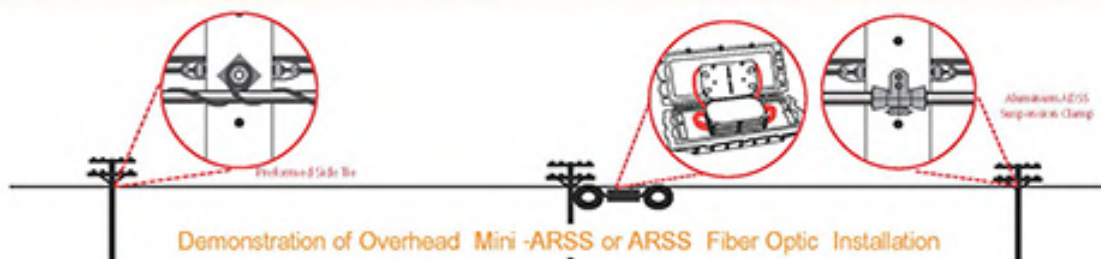

### Application

- 25/40/50/100/200/400/800 Gbps Ethernet
- IEEE802.3ae 10G Ethernet
- IEEE802.3z Gigabit Ethernet
- IEEE802.3u Fast Ethernet
- 52/155/622Mbps , 1.2Gbps ATM
- FDDI, Fiber Channel
- FTTx, CATV, CCTV and others

### Standards

- ANSI/TIA/EIA-568.3-D, ANSI/TIA-568-C.3
- ANSI/ICEA 640
- Telcordia(Bellcore)GR-20-CORE
- ITU-T G.651 (Multimode)
- ITU-T G.652D (Singlemode)
- ISO/IEC 11801:2017, EN 50173-1
- IEC 60793, IEC60794-1-2
- TIS 2166
- RoHS Compliant



Mini-ADSS

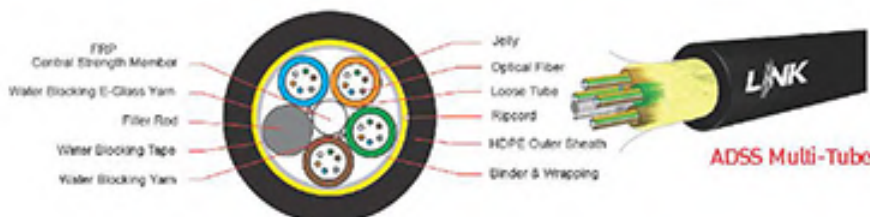

ADSS Multi-Tube

### Features/Construction

- High performance multimode (OM2, OM3, OM4 and OM5) and singlemode (OS2 or G.652D) fiber optic cable
- Fiber colors identification comply to TIA/EIA-598-C and EIA-359-A
- PBT Loose tube design provides high strength and low shrinkage with thixotropic jelly filled loose tube for water penetration protection
- FRP central strength member provide for tensile strength
- Water blocking yarns & tape provide for double protection and safety for outdoor environment
- Water blocking E-glass yarn provide for strength member
- Ripcord is easy to strip
- Outer jacket UV-resistant, black HDPE
- Up to 312 core for ADSS , up to 24 core for mini ADSS

### Optical Performance

Optical Transmission Performance	Singlemode		Multimode		
	1310/1383/1550/1625 nm		850/1300 nm		850/953/1300 nm
	9/125 μm (OS2)	50/125 μm (OM2)	50/125 μm (OM3)	50/125 μm (OM4)	50/125 μm (OM5)
Max. Attenuation [dB/km]	0.35 / 0.35 / 0.21 / 0.23	2.7 / 0.8	2.7 / 0.8	2.7 / 0.8	2.7/2.3/0.8
Typ. Attenuation [dB/km]	0.33 / 0.31 / 0.19 / 0.20	2.5 / 0.7	2.3 / 0.6	2.3 / 0.6	2.3/2.0/0.6
Bandwidth [MHz/km]	N / A	500 / 500	1500 / 500	3500 / 500	3500/1850/500
850 nm Laser bandwidth [MHz/km]	N / A	N / A	2000	4700	4700
Numerical Aperture	0.13 ± 0.01	0.200 ± 0.015	0.200 ± 0.015	0.200 ± 0.015	0.200±0.015

### Mechanical Properties

- Max. Tensile Load, Installation / Operation
- Max. Span Length
- Max. Crush Resistance
- Cable Diameter, approx.
- Cable Weight, approx.
- Min. Bending Radius, Installation / Operation
- Installation / Operation Temperature
- Storage / Shipping Temperature

#### UFCX7XXMN

- 4 - 24 Core
- 1200 / 600
- 40 - 80
- 2,200
- 6.9-7.4 ± 0.5
- 43-50 ± 5
- 20x / 10x
- 40°C to + 70°C
- 40°C to + 75°C

#### UFCX7XXCM

- 6 - 72 Core
- 1800 / 1000
- 40 - 80
- 2,200
- 9.2-9.9 ± 1.0
- 60-78 ± 10
- 20x / 10x
- 40°C to + 70°C
- 40°C to + 75°C

### Part Number

Description	6 Core	12 Core	24 Core	48 Core	60 Core	72 Core
MINI-ADSS / Singlemode, 9/125 μm, OS2	UFC9706MN	UFC9712MN	UFC9724MN	-	-	-
ADSS / Singlemode, 9/125 μm, OS2	UFC9706CM	UFC9712CM	UFC9724CM	UFC9748CM	UFC9760CM	UFC9772CM
MINI-ADSS / Multimode, 50/125 μm, OM2	UFC5706MN	UFC5712MN	UFC5724MN	-	-	-
ADSS / Multimode, 50/125 μm, OM2	UFC5706CM	UFC5712CM	UFC5724CM	UFC5748CM	UFC5760CM	UFC5772CM



F.O. **ADSS<sup>MINI</sup>™** (3-Tube) & **ADSS<sup>TR</sup>™** (Multi-Tube)  
(ALL DIELECTRIC SELF SUPPORT FIBER OPTIC CABLE)



P/N	DESCRIPTION	PACKING	PRICE /m.
<b>OS2 9/125 μm, SINGLEMODE, MINI ADSS, 3-Twisted Tube, DOUBLE Q SERIES, (Tensile 1,200 N)</b>			
UFC9704MN	F.O. MINI - ADSS, 3-Twisted Tube, 4 Core, OS2	2/3/4,000* M.	Call
UFC9706MN	F.O. MINI - ADSS, 3-Twisted Tube, 6 Core, OS2	4,000 M.	15.90 /m.
UFC9712MN	F.O. MINI - ADSS, 3-Twisted Tube, 12 Core, OS2	4,000 M.	24.15 /m.
UFC9724MN	F.O. MINI - ADSS, 3-Twisted Tube, 24 Core, OS2	4,000 M.	41.-/m.
<b>OS2 9/125 μm, SINGLEMODE, ADSS Multi - Tube, DOUBLE Q SERIES, (Tensile 1,800 N)</b>			
UFC9706CM	F.O. ADSS, Multi-Tube, Single Jacket 6 Core, OS2	4,000 M.	18.10 /m.
UFC9712CM	F.O. ADSS, Multi-Tube, Single Jacket 12 Core, OS2	4,000 M.	26.35 /m.
UFC9724CM	F.O. ADSS, Multi-Tube, Single Jacket 24 Core, OS2	4,000 M.	42.85 /m.
UFC9748CM	F.O. ADSS, Multi-Tube, Single Jacket 48 Core, OS2	2/3/4,000* M.	76.20 /m.
UFC9760CM	F.O. ADSS, Multi-Tube, Single Jacket 60 Core, OS2	4,000* M.	Call
UFC9772CM	F.O. ADSS, Multi-Tube, Single Jacket 72 Core, OS2	4,000* M.	Call
UFC9796CM	F.O. ADSS, Multi-Tube, Single Jacket 96 Core, OS2	4,000* M.	Call

Think of Cabling ... Think INTERLINK Tel: 02-666-1111 www.interlink.co.th

- Remark**
1. Packing 2/3/4,000 M. (ไม่มี\*) หมายถึง สินค้าเป็น STOCK สามารถนับตัดได้ทันทีทุกระยะ: 100 เมตร ตามการสั่งซื้อ
  2. Packing 2/3/4,000\* M. มี\* หมายถึง เป็นสินค้าที่ต้องสั่งซื้อ และ ต้องสั่งซื้อยกเว้นขั้นต่ำ ตามความยาวต่อหน่วยที่ระบุ
  3. Packing 4,000\* M. มี\* หมายถึง เป็นสินค้าที่ต้องสั่งซื้อ และ ต้องสั่งซื้อยกเว้นขั้นต่ำ 4,000\* M./หน่วย เท่านั้น



**ADSS, OUTDOOR/Multi-Tube (All Dielectric Self Support Fiber Cable)**

เป็นเคเบิลใยแก้วนำแสงโครงสร้างพิเศษที่ออกแบบให้ไม่มีตัวนำไฟฟ้าเพื่อป้องกันการเกิดประกายไฟที่เสาหม้อแปลงไฟฟ้าและเสาขั้วดินซึ่งเป็นโครงสร้างหลัก (Infrastructure) ของโครงข่ายระบบสื่อสารที่มีอยู่ทั้งการไฟฟ้านครหลวง โดยโครงสร้างของสาย F.O. นี้ ถูกออกแบบให้มีวัสดุป้องกันที่ขั้วซึ่งอยู่ต่อหุ้ม เช่นกัน โดยการใช้ของ Water Blocking Tape และใช้เส้น Water Blocking yarn เป็นตัวกันความชื้น

Option : สำหรับโครงสร้างภายนอกที่มีแบบ Single Jacket and Double Jacket ให้เลือกหาการไขว้ และ ความจำเป็นของสถานที่ติดตั้ง

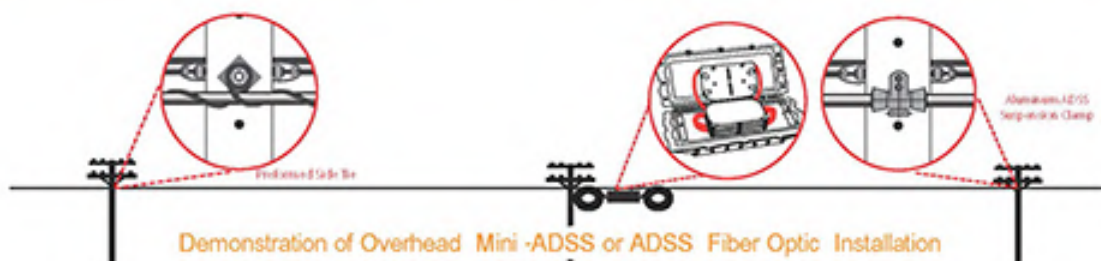

PRICE LIST 2569

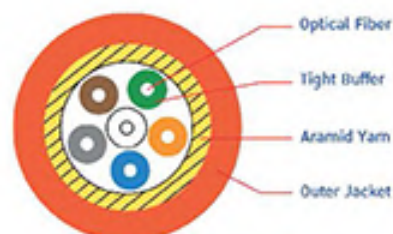
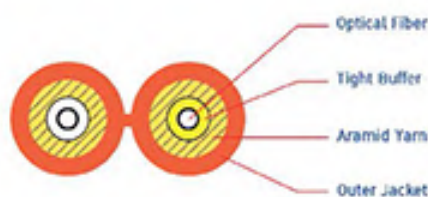
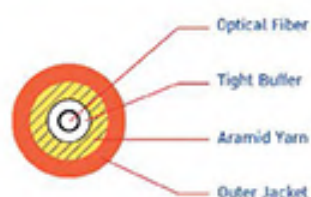

**Simplex**



**Zipcord**



**Distribution**

### APPLICATION

- 25/40/50/100/200/400/800 Gbps Ethernet
- IEEE802.3ae 10G Ethernet
- IEEE802.3z Gigabit Ethernet
- IEEE802.3u Fast Ethernet
- S2/155/622Mbps, 1.2Gbps ATM
- FDDI, Fiber channel
- FTTx, CATV, CCTV and others

### STANDARDS

- ANSI/TIA-568.3-D, ANSI/TIA-568-C.3
- ANSI/CEA 596
- Telcordia(Bellcore)GR-409-CORE
- ITU-T G.651 [Multimode]
- ITU-T G.652D [Singlemode]
- ISO/IEC 11801:2017, EN 50173-1
- IEC 60332-1-2
- IEC 61034-2, IEC60754-2
- IEC 60793, IEC60794-1-2
- UL, FR-LSZH&OFNR
- RoHS Compliant

### OPTICAL PERFORMANCES

Optical Transmission Performance	Optical Transmission Performance 9/125 μm [OS2]	Multimode 850/1300nm			
		50/125 μm [OM2]	50/125 μm [OM3]	50/125 μm [OM4]	850/953/1300 50/125 μm [OM5]
Max. Attenuation [dB/km]	0.35/0.36/0.21/0.23	2.7/0.8	2.7/0.8	2.7/0.8	2.7/2.3/0.8
Typ. Attenuation [dB/km]	0.33/0.31/0.19/0.20	2.5/0.7	2.3/0.6	2.3/0.6	2.3/2.0/0.6
Bandwidth [MHz/km]	N/A	500/500	1500/500	3500/500	3500/1850/500
850nm Laser bandwidth [MHz/km]	N/A	N/A	2000	4700	4700
Numerical Aperture	0.13 ± 0.01	0.200 ± 0.015	0.200 ± 0.015	0.200 ± 0.015	0.200 ± 0.015

### MECHANICAL PROPERTIES

	SIMPLEX 150/80	ZIPCORD 200/100	DISTRIBUTION 600/300	N
Maximum Tensile Load, Installation / Operation	150/80	200/100	600/300	N
Cable Diameter, Jacket 3 mm. / Jacket 2 mm., approx.	2.9±0.1/2.0±0.1	2.9±0.1/2.0±0.1	4.8-6.8±0.2	mm
Cable Weight, Jacket 3 mm. / Jacket 2 mm., approx.	7/6	14/12	21-42	kg / km
Minimum Bending Radius, Installation / Operation	15x/10x	15x/10x	15x/10x	Cable Diameter

### OPTICAL PERFORMANCES

Description	Simplex		Duplex [zipcord]	
	3.0 mm. Jacket	2.0 mm. Jacket	3.0 mm. Jacket	2.0 mm. Jacket
Singlemode, 9/125 μm, OS2	UFC9201LSZH	UFC9201-2LSZH	UFC9202LSZH	UFC9202-2LSZH
Multimode, 50/125 μm, OM2	UFC5201LSZH	UFC5201-2LSZH	UFC5202LSZH	UFC5202-2LSZH
XG Multimode, 50/125 μm, OM3	UFC4201	UFC4201-2	UFC4202	UFC4202-2
Multimode, 50/125 μm, OM4	UFC3201	UFC3201-2	UFC3202	UFC3202-2
Multimode, 50/125 μm, OM5	UFC3201	UFC3201-2	UFC3202	UFC3202-2
Description	Distribution			
	4 Core	6 Core	12 Core	24 Core
Singlemode, 9/125 μm, OS2	UFC9204LSZH	UFC9206LSZH	UFC9212LSZH	UFC9224LSZH
Multimode, 50/125 μm, OM2	UFC5204LSZH	UFC5206LSZH	UFC5212LSZH	UFC5224LSZH
XG Multimode, 50/125 μm, OM3	UFC4204	UFC4206	UFC4212	UFC4224
Multimode, 50/125 μm, OM4	UFC3204	UFC3206	UFC3212	UFC3224
Multimode, 50/125 μm, OM5	UFC2204	UFC2206	UFC2212	UFC2224



# F.O. INDOOR / SIMPLEX & DISTRIBUTION

( Pigtail, Patch Cord and Distribution Fiber Optic Cable )



P/N	DESCRIPTION	PACKING	PRICE /m.
<b>OS2 9/125 μm, SINGLEMODE / Yellow Jacket , DOUBLE Q SERIES</b>			Effective P56 1 APRIL 2026
UFC9201B	F.O. Simplex 0.9 mm 1 Core, SM 9/125 μm, for pigtail, OS2	1/2,000* M.	1.90 /m.
UFC9201-2LSZH	F.O. Simplex 2.0 mm. 1 Core, SM 9/125 μm, LSZH-FR, OS2	1/2,000* M.	3.00 /m.
UFC9201LSZH	F.O. Simplex 3.0 mm. 1 Core, SM 9/125 μm, LSZH-FR, OS2	1/2,000* M.	3.20 /m.
UFC9202-2LSZH	F.O. Zipcord 2.0 mm. 2 Core, SM 9/125 μm, LSZH-FR, OS2	1/2,000* M.	5.50 /m.
UFC9202LSZH	F.O. Zipcord 3.0 mm. 2 Core, SM 9/125 μm, LSZH-FR, OS2	1/2,000* M.	6.10 /m.
UFC9204LSZH	F.O. Distribution 4 Core, SM 9/125 μm, LSZH-FR, OS2	2,000 M.	11.- /m.
UFC9206LSZH	F.O. Distribution 6 Core, SM 9/125 μm, LSZH-FR, OS2	2,000 M.	15.- /m.
UFC9212LSZH	F.O. Distribution 12 Core, SM 9/125 μm, LSZH-FR, OS2	2,000 M.	26.60 /m.
UFC9224LSZH	F.O. Distribution 24 Core, SM 9/125 μm, LSZH-FR, OS2	1/2,000* M.	55.- /m.
<b>OM2 50/125 μm, MULTIMODE , DOUBLE Q SERIES</b>			
UFC5202-2LSZH	F.O. Zipcord 2.0 mm. 2 Core, MM 50/125 μm, LSZH-FR, OM2 , Grey	1/2,000* M.	8.- /m.
UFC5202LSZH	F.O. Zipcord 3.0 mm. 2 Core, MM 50/125 μm, LSZH-FR, OM2 , Grey	2,000* M.	9.- /m.
UFC5204LSZH	F.O. Distribution 4 Core, MM 50/125 μm, LSZH-FR, OM2 , Orange	2,000 M.	14.- /m.
UFC5206LSZH	F.O. Distribution 6 Core, MM 50/125 μm, LSZH-FR, OM2 , Orange	2,000 M.	16.- /m.
UFC5212LSZH	F.O. Distribution 12 Core, MM 50/125 μm, LSZH-FR, OM2 , Orange	2,000 M.	30.- /m.
<b>OM3 XG, 50/125 μm, MULTIMODE / Aqua Jacket , DOUBLE Q SERIES</b>			
UFC4202-2	F.O. Zipcord 2.0 mm. 2 Core, XG 50/125 μm, LSZH-FR, OM3	1/2,000* M.	12.- /m.
UFC4202	F.O. Zipcord 3.0 mm. 2 Core, XG 50/125 μm, LSZH-FR, OM3	1/2,000* M.	14.- /m.
UFC4204	F.O. Distribution 4 Core, XG 50/125 μm, LSZH-FR, OM3	1/2,000* M.	22.- /m.
UFC4206	F.O. Distribution 6 Core, XG 50/125 μm, LSZH-FR, OM3	2,000 M.	32.- /m.
UFC4212	F.O. Distribution 12 Core, XG 50/125 μm, LSZH-FR, OM3	2,000 M.	54.- /m.
<b>OM4 50/125 μm, MULTIMODE / AquaJacket , DOUBLE Q SERIES</b>			
UFC3202-2	F.O. Zipcord 2.0 mm. 2 Core, OM4 50/125 μm, LSZH-FR, OM4	1/2,000* M.	20.- /m.
UFC3202	F.O. Zipcord 3.0 mm. 2 Core, OM4 50/125 μm, LSZH-FR, OM4	1/2,000* M.	22.- /m.
UFC3204	F.O. Distribution 4 Core, OM4 50/125 μm, LSZH-FR, OM4	1/2,000* M.	36.- /m.
UFC3206	F.O. Distribution 6 Core, OM4 50/125 μm, LSZH-FR, OM4	1/2,000* M.	52.- /m.
UFC3212	F.O. Distribution 12 Core, OM4 50/125 μm, LSZH-FR, OM4	1/2,000* M.	98.- /m.
<b>OM5 50/125 μm, MULTIMODE / Lime Green Jacket , DOUBLE Q SERIES</b>			
UFC2204	F.O. Distribution 4 Core, OM5 50/125 μm, LSZH-FR, OM5	1/2,000* M.	62.- /m.
UFC2206	F.O. Distribution 6 Core, OM5 50/125 μm, LSZH-FR, OM5	1/2,000* M.	90.- /m.
UFC2212	F.O. Distribution 12 Core, OM5 50/125 μm, LSZH-FR, OM5	1/2,000* M.	176.- /m.

- Remark**
1. Packing 1/2,000 M. (ไม่มี\*) หมายถึง สินค้ามี STOCK สามารถสั่งซื้อได้ทันทีทุกประเภท: 100 เมตร ตามการสั่งซื้อ
  2. Packing 1/2,000\* M. มี\* หมายถึง เป็นสินค้าที่ต้องสั่งซื้อ และ ต้องสั่งซื้อยกเว้นขั้นต่ำ ตามความยาวต่อม้วนระบุ
  3. Packing 1/2,000\* M. มี\* หมายถึง เป็นสินค้าที่ต้องสั่งซื้อ และ ต้องสั่งซื้อยกเว้นขั้นต่ำ 4,000\* M./ม้วน เท่านั้น



**SIMPLEX**  
**ZPCORD**  
Jacket = Bare, 2 mm., 3 mm.  
**DISTRIBUTION**

หมายถึง เคเบิลใยแก้วชนิด 1 แกน หรือ แกนเดียว มีที่โหวกหลาย Pigtail

หมายถึง เคเบิลใยแก้วชนิด 2 แกน ที่มีแกนใยแก้วแกนเดียวภายในเคเบิลใยแก้วชนิดหลายแกนโหวกหลาย Patch Cord

หมายถึง Jacket ที่ขุมนหลาย ถ้าเป็น Bare คือ 900 μm ส่วน 2 mm., 3 mm. หมายถึง Jacket 2 mm. และ 3 mm.

หมายถึง เคเบิลใยแก้วตั้งแต่ 4 แกนขึ้นไป ใช้สำหรับเดินสายกระจายไปหลายจุดทางๆ หรือ เป็นสาย Back Bone เชื่อมใยในอาคาร

**RACK MOUNT  
F.O. DRAWER PATCH PANEL**

*(Slide สายใยแก้วไม่ขยับ และ ไม่รื้อตัว ลิขสิทธิ์การออกแบบของ LINK American Cabling)*



UF-2012A : Deep 33.20 cm

UF-2013A : Deep 40.20 cm

**F.O. SLIDE PATCH PANEL (RACK MOUNT)**



UF-2010  
Deep 19.50 cm



UF-2010A  
Deep 25 cm



UF-2011A  
Deep 25 cm

**RACK MOUNT  
FDU (Fiber Optic Distribution Unit)**  
*Deep 33.60 cm.*

**WALL MOUNT  
FIBER DISTRIBUTION BOX (Indoor)**



UF-2014A



UF-2016A



UF-2022A / UF-2024A

**FIBER OPTIC OUTDOOR TERMINAL (STEEL CABINET)**



NOT Include Snap-in Adapter Plate

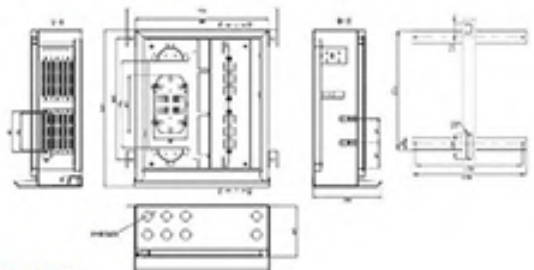

UF-4112A / UF-4114A / UF-4116A / UF-4119A / UF-4120A  
F.O TERMINAL OUTDOOR Steel Cabinet







Think of Cabling ... Think INTERLINK  
Tel. 02-666-1111  
www.interlink.co.th

PRICE LIST 2569  
57



## F.O. RACK MOUNT PATCH PANEL & WALL MOUNT BOX





P/N	DESCRIPTION	UNIT PRICE
<b>FIBER OPTIC DISTRIBUTION PANEL (FDU) , DOUBLE Q SERIES</b>		
 <b>UF-2010</b>	6-24F (2 Snap-In) RACK mount SLIDE, D = 19 cm (1U), Unloaded <span style="float: right;">Shallow Slide</span>	<b>2,110.-</b>
 <b>UF-2010A</b>	<b>6-24F (2 Snap-In) RACK mount SLIDE, D = 25 cm (1U), Unloaded</b> <span style="float: right;">Shallow Slide</span>	<b>2,200.-</b>
 <b>UF-2011A</b>	6-36F (3 Snap-In) RACK mount SLIDE, D = 25 cm (1U), Unloaded <span style="float: right;">Shallow Slide</span>	<b>2,570.-</b>
 <b>UF-2012A</b>	<b>6-24F (2 Snap-In) RACK mount DRAWER, D = 33.20 cm (1U), Unloaded</b> <span style="float: right;">Bearing Slide</span>	<b>2,690.-</b>
 <b>UF-2013A</b>	6-36F (3 Snap-In) RACK mount DRAWER, D = 40.20 cm (1U), Unloaded <span style="float: right;">Bearing Slide</span>	<b>2,950.-</b>
 <b>UF-2014A</b>	6-48F (4 Snap-In) RACK mount FIX FDU, D = 33.60 cm (2U), Unloaded <span style="float: right;">Fix</span>	<b>3,500.-</b>
<b>UF-2016A</b>	6-96F (8 Snap-In) RACK mount FIX FDU, D = 33.60 cm (3U), Unloaded <span style="float: right;">Fix</span>	<b>3,640.-</b>



Think of Cabling ... Think@ INTERLINK Tel: 02-666-1111

www.interlink.co.th

### FIBER OPTIC DISTRIBUTION BOX (WALL MOUNT) : กล่องรวมและกระจายสายใยแก้ว

 <b>UF-2022A</b>	<b>6-24 F (2 Snap-In) WALL mount BOX, Unloaded , 2 Part</b> <span style="float: right;">(H21.4 x W33 x D9.2 cm.)</span>	<b>1,930.-</b>
 <b>UF-2024A</b>	6-48 F (4 Snap-In) WALL mount BOX, Unloaded , 2 Part <span style="float: right;">(H31.6 x W33.1 x D9.2 cm.)</span>	<b>2,310.-</b>

### FIBER OPTIC OUTDOOR TERMINAL STEEL CABINET , DOUBLE Q SERIES

 <b>UF-4112A</b>	<b>F.O. OUTDOOR TERMINAL 12-24F, CABINET , Unloaded</b> <span style="float: right;">(H40.35 x W35 x D12 cm.)</span>	<b>7,250.-</b>
 <b>UF-4114A</b>	F.O. OUTDOOR TERMINAL 24-48F, CABINET , Unloaded <span style="float: right;">(H40.35 x W35 x D12 cm.)</span>	<b>8,790.-</b>
<b>UF-4116A</b>	F.O. OUTDOOR TERMINAL 48-72F, CABINET , Unloaded <span style="float: right;">(H46 x W39 x D15 cm.)</span>	<b>11,770.-</b>
<b>UF-4119A</b>	F.O. OUTDOOR TERMINAL 72-96F, CABINET , Unloaded <span style="float: right;">(H55 x W49 x D20 cm.)</span>	<b>12,880.-</b>
<b>UF-4120A</b>	F.O. OUTDOOR TERMINAL 120F, CABINET , Unloaded <span style="float: right;">(H55 x W49 x D22.50 cm.)</span>	<b>13,760.-</b>

PRICE LIST 2569

## F.O. SNAP - IN PLATE (LGX Standard)



UF-2144SM  
ST(SM)

UF-2166SM  
SC(SM)

UF-2166SM-APC  
SC(SM)

UF-2188SM  
FC(SM)

UF-2122SM  
LC(SM)

UF-2266SM  
SC(SM)

## F.O. DOME CLOSURE (Splice Closure Dome Type)

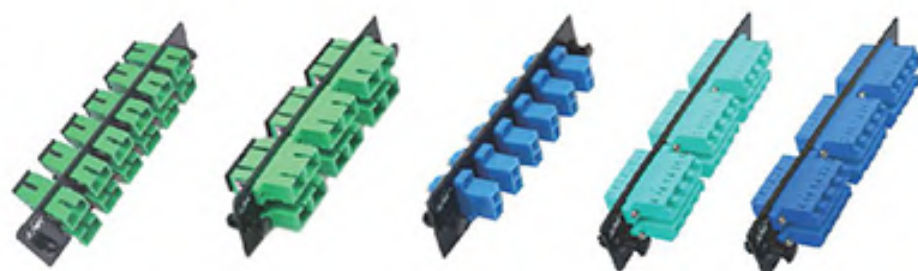

UF-2255SM-APC  
SC(SM)

UF-2266SM-APC  
SC(SM)

UF-2222SM  
LC(SM)

UF-2222Q  
6 LC QUAD (MM)

UF-2222QSM  
6 LC QUAD (SM)



UF-3022A / UF-3024A / UF-3027A / UF-3029A

## F.O. HORIZONTAL CLOSURE (Splice Horizontal Closure)



UF-3041 12 Core, Horizontal  
(L 21 X W 15 X H 3.0 cm.)



UF-3042A / UF-3044A / UF-3047A / UF-3049A  
(L 40 X W 19 X H 12.6 cm.)



## SPCICE TRAY (SPARE PART)



UF-3061A / UF-3062A  
( Spare : Plastic Splice Tray )



UF-3063A  
UF-3064A  
( Spare : Plastic Splice Tray )

## F.O. Accessories



SV-2252A-12  
Fusion splice  
Protector Sleeves (12in)













SV-2253-10  
Fusion splice  
Protector Sleeves (10in)





# F.O. SNAP-IN PLATE & CLOSURE, (DOME & HORIZONTAL TYPE)



P/N	DESCRIPTION	UNIT PRICE
<b>FIBER OPTIC SNAP-IN ADAPTER PLATE , DOUBLE Q SERIES</b>		Effective P60 1 APRIL 2026
 UF-2166	3 SC (6F) Duplex Snap-In Adapter PLATE (MM.), Biege	(SNAP PLATE MM, SC 6 F) 170.-
UF-2266	6 SC (6F) Duplex Snap-In Adapter PLATE (MM.), Biege	(SNAP PLATE MM, SC 12 F) 255.-
UF-2166SM	3 SC (6F) Duplex Snap-In Adapter PLATE (SM & MM.), Blue	(SNAP PLATE SM, SC 6 F) 190.-
 UF-2166SM-APC	3 SC (6F) Duplex Snap-In Adapter PLATE (SM /APC), Green	(SNAP PLATE SM, SC 6 F) 190.-
 UF-2266SM	6 SC (12F) Duplex Snap-In Adapter PLATE (SM & MM.)	(SNAP PLATE SM, SC 12 F) 270.-
 UF-2266SM-APC	6 SC (12F) Duplex Snap-In Adapter PLATE (SM /APC)	(SNAP PLATE SM, SC 12 F) 270.-
 UF-2255SM-APC	12 SC (12F) Simplex Snap-In Adapter PLATE (SM /APC)	(SNAP PLATE SM, SC 12 F) 360.-
 UF-2122	3 LC Duplex Snap-In Adapter PLATE (MM.)	(SNAP PLATE MM, LC 6 F) 190.-
 UF-2222	6 LC Duplex Snap-In Adapter PLATE (MM.)	(SNAP PLATE MM, LC 12 F) 290.-
 UF-2122SM	3 LC Duplex Snap-In Adapter PLATE (SM & MM.)	(SNAP PLATE SM, LC 6 F) 210.-
 UF-2222SM	6 LC Duplex Snap-In Adapter PLATE (SM & MM.)	(SNAP PLATE SM, LC 12 F) 320.-
UF-2222Q	6 LC QUAD Snap-In Adapter PLATE (MM.)	(SNAP PLATE MM, LC 24F) Call
UF-2222QSM	6 LC QUAD Snap-In Adapter PLATE (SM & MM.)	(SNAP PLATE SM, LC 24F) 500.-
UF-2144	6 ST Snap-In Adapter PLATE (MM.)	(SNAP PLATE MM, ST 6 F) 230.-
UF-2244	12 ST Snap-In Adapter PLATE (MM.)	(SNAP PLATE MM, ST 12 F) 350.-
UF-2144SM	6 ST Snap-In Adapter PLATE (SM & MM.)	(SNAP PLATE SM, ST 6 F) 230.-
UF-2244SM	12 ST Snap-In Adapter PLATE (SM & MM.)	(SNAP PLATE SM, ST 12 F) 390.-
UF-2188SM	6 FC Snap-In Adapter PLATE (SM & MM.)	(SNAP PLATE SM, FC 6 F) 300.-
UF-2288SM	12 FC Snap-In Adapter PLATE (SM & MM.)	(SNAP PLATE SM, FC 12 F) 480.-
 UF-2200	BLANK Snap-In Adapter PLATE	(BLANK PLATE) 75.-

## F.O. SPLICE HORIZONTAL CLOSURE , OUTDOOR

 UF-3041	12 Core F.O. Splice Closure, Horizontal Type / 1 Tray (12F)	L21 x W15 x H 3.0 cm. 1,100.-
 UF-3042A	24 Core F.O. Splice Closure, Horizontal Type / 2 Tray (12F)	L40 x W19 x H12.6 cm. 2,100.-
UF-3044A	48 Core F.O. Splice Closure, Horizontal Type / 4 Tray (12F)	L40 x W19 x H12.6 cm. 2,300.-
UF-3047A	72 Core F.O. Splice Closure, Horizontal Type / 6 Tray (12F)	L40 x W19 x H12.6 cm. 2,500.-
UF-3049A	96 Core F.O. Splice Closure, Horizontal Type / 4 Tray (24F)	L40 x W19 x H12.6 cm. 2,600.-

## F.O. SPLICE CLOSURE , DOME TYPE , OUTDOOR

 UF-3022A	24 Core F.O. Splice Closure, Dome Type (Vertical) / 2 Tray (12F)	∅ 19 x H41.5 cm. 2,650.-
UF-3024A	48 Core F.O. Splice Closure, Dome Type (Vertical) / 4 Tray (12F)	∅ 19 x H41.5 cm. 2,750.-
UF-3027A	72 Core F.O. Splice Closure, Dome Type (Vertical) / 6 Tray (12F)	∅ 19 x H41.5 cm. 2,800.-
UF-3029A	96 Core F.O. Splice Closure, Dome Type (Vertical) / 4 Tray (24F)	∅ 19 x H41.5 cm. 2,850.-

## SPARE PART SPLICE TRAY FOR CLOSURE

UF-3061A	Spare Splice Tray (Plastic) 12 Fiber used for Dome Closure , Spare Part	100.- /PC
UF-3062A	Spare Splice Tray (Plastic) 24 Fiber used for Dome Closure , Spare Part	130.- /PC
 UF-3063A	Spare Splice Tray (Plastic) 12 Fiber used for Horizontal Closure , Spare Part	100.- /PC
UF-3064A	Spare Splice Tray (Plastic) 24 Fiber used for Horizontal Closure , Spare Part	130.- /PC

## ST Simplex Connector



UF-0004



UF-0004SM

## SC Simplex Connector



UF-0005SM



UF-0005SM/APC

## SC Duplex Connector



UF-0006

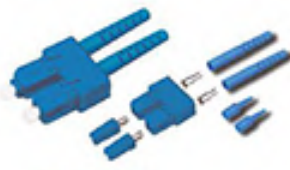

UF-0006SM



UF-0006SM/APC



UF-0008



UF-0008SM

## FC Simplex Connector

## LC Duplex Connector



UF-0002D



UF-0002DSM

## LC Simplex Connector



UF-0002



UF-0002SM



UF-0044 / UF-0044SM  
ST Adapter



UF-0044SQ  
ST Adapter Flange Type



UF-0088 / UF-0088SM /  
UF-0088SM/APC  
FC D - Type Adapter



UF-0088 / UF-0088SM /  
UF-0088SM/APC  
SC Duplex Adapter



SC Simplex Adapter



UF-0022 Series  
LC Duplex and Quad Adapter



UF-H048 : ST to FC



UF-H045 : ST to SC



UF-H058 : SC to FC



UF-H048 : ST to SC Duplex

## PROTECTOR SLEEVE



SV-2252A-12  
Fusion splice Protector Sleeve (12)



SV-2253-10  
Fusion splice Protector Sleeve (10)

## F.O. ACCESSORIES

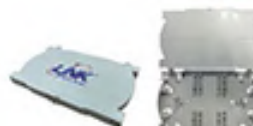

UF-2082  
Splice Tray 24F



SV-2250  
Full moon Cable Routing

www.interlink.co.th

Tel. 02-666-1111

Think of Cabling ... Think INTERLINK

PRICE LIST 2569  
61



# F.O. CONNECTOR and ADAPTER



P/N	DESCRIPTION				UNIT PRICE
<b>FIBER OPTIC CONNECTOR, DOUBLE Q SERIES</b>					
UF-0004	ST Multimode ,	Zirconia Connector	Black Boot	0.9 & 3.0 mm.	50.-
UF-0004SM	ST Singlemode ,	Zirconia Connector	Yellow Boot	0.9 & 3.0 mm.	60.-
UF-0005SM	SC Simplex SM, Blue,	Zirconia Connector	Blue Boot	0.9 & 3.0 mm.	60.-
UF-0006	SC Duplex MM, Ivory,	Zirconia Connector	Black Boot	0.9 & 3.0 mm.	100.-
UF-0006SM	SC Duplex SM, Blue,	Zirconia Connector	Blue Boot	0.9 & 3.0 mm.	120.-
UF-0008	FC Multimode ,	Zirconia Connector	Black Boot	0.9 & 3.0 mm.	72.-
UF-0008SM	FC Singlemode,	Zirconia Connector	Yellow Boot	0.9 & 3.0 mm.	82.-
UF-0002D	LC Duplex MM, Ivory,	Zirconia Connector	Beige Boot	0.9 & 3.0 mm.	84.-
UF-0002DSM	LC Duplex SM, Blue,	Zirconia Connector	Beige Boot	0.9 & 3.0 mm.	89.-

<b>FIBER OPTIC ADAPTER, DOUBLE Q SERIES</b>					
UF-0044	ST ADAPTER, Coupling	MM, Ceramic Sleeve	Metal Housing		30.-
UF-0044SM	ST ADAPTER, Coupling	SM, Ceramic Sleeve	Metal Housing		35.-
UF-0055SM	SC SIMPLEX ADAPTER,	SM, Ceramic Sleeve	Blue Housing		19.-
UF-0055SM-APC	SC /APC SIMPLEX ADAPTER	SM /APC, Ceramic Sleeve	Green Housing		19.-
UF-0066	SC DUPLEX ADAPTER,	MM, Ceramic Sleeve	Ivory Housing		38.-
UF-0066SM	SC DUPLEX ADAPTER,	SM, Ceramic Sleeve	Blue Housing		38.-
UF-0066SM-APC	SC /APC DUPLEX ADAPTER,	SM /APC, Ceramic Sleeve	Green Housing		38.-
UF-0088	FC D-type ADAPTER,	MM, PB Sleeve	Metal Housing		48.-
UF-0088SM	FC D-type ADAPTER,	SM, Ceramic Sleeve	Metal Housing		50.-
UF-0088SM-APC	FC /APC ADAPTER,	SM /APC, Ceramic Sleeve	Metal Housing		50.-
UF-0022D	LC DUPLEX ADAPTER	MM, Ceramic Sleeve	Ivory Housing		38.-
UF-0022DSM	LC DUPLEX ADAPTER	SM, Ceramic Sleeve	Blue Housing		40.-
UF-0022Q	LC QUAD ADAPTER	MM, Ceramic Sleeve	Ivory Housing		102.-
UF-0022QSM	LC QUAD ADAPTER	SM, Ceramic Sleeve	Blue Housing		102.-

<b>HYBRID ADAPTER, DOUBLE Q SERIES</b>					
UF-H048	ST to FC HYBRID ADAPTER	SM, Ceramic Sleeve	Metal Housing		115.-
UF-H045	ST to SC HYBRID ADAPTER	SM, Ceramic Sleeve	Metal Housing		121.-
UF-H058	SC to FC HYBRID ADAPTER	SM, Ceramic Sleeve	Metal Housing		122.-
UF-H046	ST to SC DUPLEX HYBRID ADAPTER	SM, Ceramic Sleeve	Metal Housing		255.-
UF-H028	LC to FC HYBRID ADAPTER	SM, Ceramic Sleeve	Metal Housing		750.-
UF-H025	LC to SC HYBRID ADAPTER	SM, Ceramic Sleeve	Metal Housing		750.-

<b>PROTECTOR SLEEVE SPARE ACCESSORIES and CLEAR 900 μm BUFFER TUBE</b>					
SV-2252A-12	Fusion Splice Protector Sleeve, [O.D.= 2.5 mm.] L= 60 mm.			12 Pcs. /Pkg.	20.- /Pkg.
SV-2253-10	Fusion Splice Protector Sleeve, [O.D.= 5.0 mm.] L= 60 mm.			10 Pcs. /Pkg.	40.- /Pkg.
UF-2082	Spare Splice Tray 24F (Plastic) (Use For FDU , UF-20XXA Series) ใ้สนุ Splice tray ที่สนุ				100.-/Ea
SV-2250	Spare Full Moon Cable Routing			Spare Part	23.- /Pair
UFC6200	CLEAR 900 μm, Buffer TUBE [ 1,000 M. /Reel ]				10.- /m.

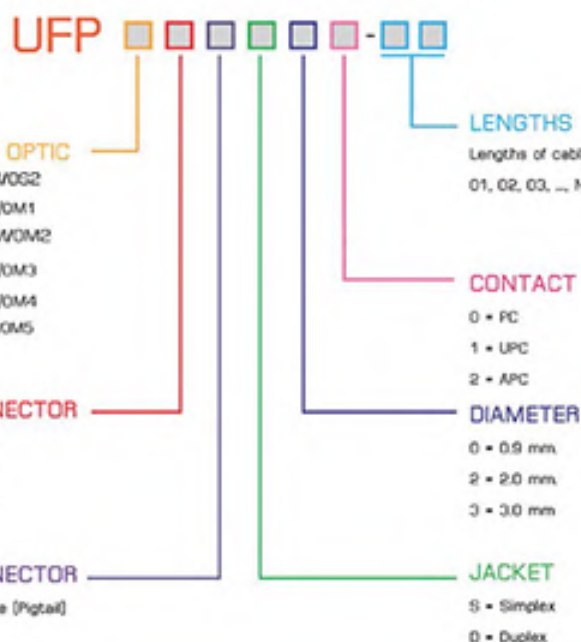

### ◆ Description

• A fiber optical pigtail is fitted with a connector at one end and bare fiber cable at the other. Fiber optical pigtail is constructed by single fiber cable. Different connectors are available, such as SC, FC, ST, LC, etc. Fiber optic cables can be divided into different types based on fiber model, structure, connector types, connector polishing types and others.

### ◆ Features

- Conform to IEC, EIA-TIA, or Telcordia performance requirements.
- Low insertion loss and High return loss
- Ferrule end surface pre-domed
- Available in pigtails with 900 micron buffer, 2 mm., 3 mm. diameter cable with LSZH jacket
- Excellent mechanical performance

### ◆ Technical Specifications

Item	Description			
Name	Single mode			
Polish	UPC		APC	
Test Wavelength	1310 / 1550 nm			
Insertion Loss (dB)	0.3 dB (Typical)			
Return Loss (dB)	≥ 50 dB (UPC) / ≥ 60 dB (APC)			
Operating Temperature	-40°C ~ +60°C			
Storage Temperature	-45°C ~ +85°C			
Fiber Type	(1)G652D	(2)G655	(3)G657A	(4)G657B3
Connector	SC/UPC, SC/APC, LC/UPC, LC/APC, FC/UPC, FC/APC, ST/UPC			
Core Type	Simplex			
Cable Diameter	0.9 mm., 2.0 mm. and 3.0 mm.			
Cable Jacket	FR-LSZH			
Length(M)	1.5 m, 3 m, 5 m... Customized			



# FIBER OPTIC PIGTAIL



P/N	DESCRIPTION	UNIT PRICE
<b>F.O. PIGTAIL SM/OS2, SIMPLEX (SINGLEMODE), DOUBLE Q SERIES</b>		
UFP940S01-1.5	ST /UPC PIGTAIL SM/OS2, Simplex, 1.50 m. (900 μm Jacket)	62.-/Pc
UFP940S21-1.5	ST /UPC PIGTAIL SM/OS2, Simplex, 1.50 m. (2.0 mm. Jacket)	63.-/Pc
UFP940S31-1.5	ST /UPC PIGTAIL SM/OS2, Simplex, 1.50 m. (3.0 mm. Jacket)	65.-/Pc
UFP960S01-1.5	SC /UPC PIGTAIL SM/OS2, Simplex, 1.50 m. (900 μm Jacket)	55.-/Pc
UFP960S21-1.5	SC /UPC PIGTAIL SM/OS2, Simplex, 1.50 m. (2.0 mm. Jacket)	60.-/Pc
UFP960S31-1.5	SC /UPC PIGTAIL SM/OS2, Simplex, 1.50 m. (3.0 mm. Jacket)	63.-/Pc
UFP960S02-1.5	SC /APC PIGTAIL SM/OS2, Simplex, 1.50 m. (900 μm Jacket)	62.-/Pc
UFP960S22-1.5	SC /APC PIGTAIL SM/OS2, Simplex, 1.50 m. (2.0 mm. Jacket)	66.-/Pc
UFP960S32-1.5	SC /APC PIGTAIL SM/OS2, Simplex, 1.50 m. (3.0 mm. Jacket)	69.-/Pc
UFP920S01-1.5	LC /UPC PIGTAIL SM/OS2, Simplex, 1.50 m. (900 μm Jacket)	57.-/Pc
UFP920S21-1.5	LC /UPC PIGTAIL SM/OS2, Simplex, 1.50 m. (2.0 mm. Jacket)	62.-/Pc
UFP920S31-1.5	LC /UPC PIGTAIL SM/OS2, Simplex, 1.50 m. (3.0 mm. Jacket)	65.-/Pc
UFP980S21-1.5	FC /UPC PIGTAIL SM/OS2, Simplex, 1.50 m. (2.0 mm. Jacket)	69.-/Pc
UFP980S31-1.5	FC /UPC PIGTAIL SM/OS2, Simplex, 1.50 m. (3.0 mm. Jacket)	72.-/Pc
UFP980S02-1.5	FC /APC PIGTAIL SM/OS2, Simplex, 1.50 m. (900 μm Jacket)	72.-/Pc
UFP980S22-1.5	FC /APC PIGTAIL SM/OS2, Simplex, 1.50 m. (2.0 mm. Jacket)	77.-/Pc
UFP980S32-1.5	FC /APC PIGTAIL SM/OS2, Simplex, 1.50 m. (3.0 mm. Jacket)	80.-/Pc
<b>F.O. PIGTAIL MM/OM2, SIMPLEX (MULTIMODE), DOUBLE Q SERIES</b>		
UFP540S01-1.5	ST /UPC PIGTAIL MM/OM2, Simplex, 1.50 m. (900 μm Jacket)	59.-/Pc
UFP540S21-1.5	ST /UPC PIGTAIL MM/OM2, Simplex, 1.50 m. (2.0 mm. Jacket) (Replace UFP540S31-1.5)	60.-/Pc
UFP560S01-1.5	SC /UPC PIGTAIL MM/OM2, Simplex, 1.50 m. (900 μm Jacket)	52.-/Pc
UFP560S21-1.5	SC /UPC PIGTAIL MM/OM2, Simplex, 1.50 m. (2.0 mm. Jacket) (Replace UFP560S31-1.5)	57.-/Pc
UFP520S01-1.5	LC /UPC PIGTAIL MM/OM2, Simplex, 1.50 m. (900 μm Jacket)	53.-/Pc
UFP520S21-1.5	LC /UPC PIGTAIL MM/OM2, Simplex, 1.50 m. (2.0 mm. Jacket) (Replace UFP520S31-1.5)	58.-/Pc
<b>F.O. PIGTAIL MM/OM3, SIMPLEX (MULTIMODE), DOUBLE Q SERIES</b>		
UFP460S01-1.5	SC /UPC PIGTAIL MM/OM3, Simplex, 1.50 m. (900 μm Jacket)	58.-/Pc
UFP460S21-1.5	SC /UPC PIGTAIL MM/OM3, Simplex, 1.50 m. (2.0 mm. Jacket)	65.-/Pc
UFP460S31-1.5	SC /UPC PIGTAIL MM/OM3, Simplex, 1.50 m. (3.0 mm. Jacket)	68.-/Pc
UFP420S01-1.5	LC /UPC PIGTAIL MM/OM3, Simplex, 1.50 m. (900 μm)	59.-/Pc
UFP420S21-1.5	LC /UPC PIGTAIL MM/OM3, Simplex, 1.50 m. (2.0 mm.)	66.-/Pc
UFP420S31-1.5	LC /UPC PIGTAIL MM/OM3, Simplex, 1.50 m. (3.0 mm. Jacket)	68.-/Pc
<b>F.O. PIGTAIL MM/OM4, SIMPLEX (MULTIMODE), DOUBLE Q SERIES</b>		
UFP360S01-1.5	SC /UPC PIGTAIL MM/OM4, Simplex, 1.50 m. (900 μm Jacket)	62.-/Pc
UFP360S21-1.5	SC /UPC PIGTAIL MM/OM4, Simplex, 1.50 m. (2.0 mm. Jacket)	68.-/Pc
UFP360S31-1.5	SC /UPC PIGTAIL MM/OM4, Simplex, 1.50 m. (3.0 mm. Jacket)	70.-/Pc
UFP320S01-1.5	LC /UPC PIGTAIL MM/OM4, Simplex, 1.50 m. (900 μm Jacket)	63.-/Pc
UFP320S21-1.5	LC /UPC PIGTAIL MM/OM4, Simplex, 1.50 m. (2.0 mm. Jacket)	69.-/Pc
UFP320S31-1.5	LC /UPC PIGTAIL MM/OM4, Simplex, 1.50 m. (3.0 mm. Jacket)	71.-/Pc



# FIBER OPTIC PATCH CORD //DOUBLE Q SERIES// ( Singlemode & Multimode )



FIBER OPTIC System

Think of Cabling ... Think INTERLINK ... Tel. 02-666-1111 www.interlink.co.th

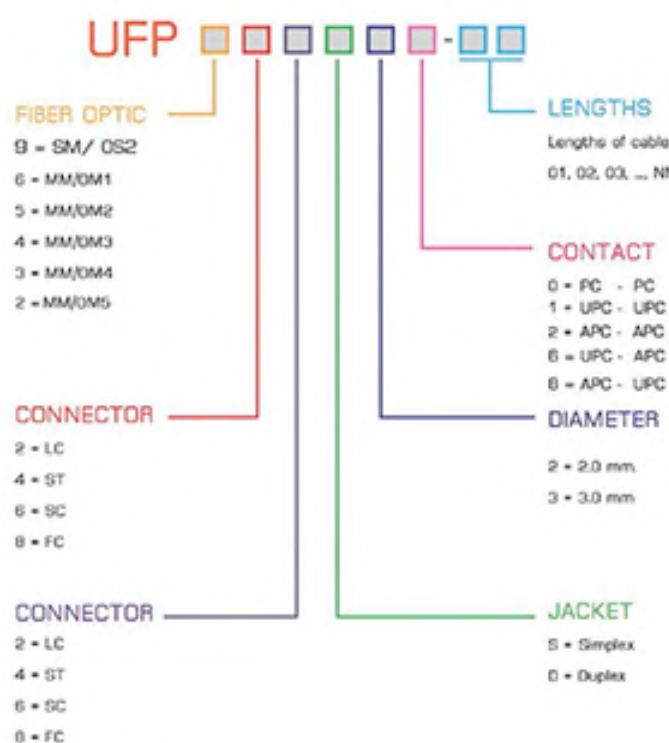

### Description

The patch cord is always fitted with connectors at both ends. Various connectors such as FC, SC, ST, LC, are available. Fiber patch cord can be divided into different types based on fiber cable mode, cable structure, connector types, connector polishing types and cable sizes. Strict manufacturing process ensure reliable quality of the pre-connected optical cable.

### Features

- Compliant with telcordia, GR-326-CORE, IIA/EIA and IEC
- Low insertion loss & High return loss
- Superior quality standard UPC/APC polishing
- Customer defined specifications
- Available for all common types of connectivity systems
- Environmental stable

### Technical Specifications

Item	Description	
	UPC	APC
Polish	UPC	APC
Wavelength	1310/1550nm	
Insertion Loss (dB)	0.3dB(Typical)	
Return Loss (dB)	≥ 50dB (UPC) / ≥ 60dB (APC)	
Standards Compliant	ROHS, IEC and GR-326	
Fiber Type Single mode:	(1) G652D (2) G655 (3) G657A (4) G657B3	
Fiber Type Multimode:	(5) OM2 (6) OM4 (7) OM3 (8) OM8	
Connector	SC/UPC, SC/APC, LC/UPC, LC/APC, FC/UPC, FC/APC, ST/UPC, MU/UPC, MTRJ/Female, MTRJ/Male, MPO/MTP	
Cord Type	Simplex and Duplex	
Cable Diameter	2.0 mm. and 3.0 mm.	
Cable Jacket	RFLSH and ORN	
Length(M)	1 m , 3 m , 5 m...Customized	



# FIBER OPTIC PATCH CORD



P/N	DESCRIPTION	UNIT PRICE
<b>F.O. PATCH CORD OS2, SIMPLEX (SINGLEMODE) , DOUBLE Q SERIES</b>		
UFP966S21-03	SC /UPC - SC /UPC PATCH CORD OS2, Simplex <b>3 M.</b> (2.0 mm. Jacket) (Better 3.0 mm.)	112.-/Pc
UFP966S31-03	SC /UPC - SC /UPC PATCH CORD OS2, Simplex <b>3 M.</b> (3.0 mm. Jacket)	116.-/Pc
UFP966S21-YY	SC /UPC - SC /UPC PATCH CORD OS2, Simplex , Length per Request (2.0 mm.)	104.-/Pc + 4.20.-/m.
UFP966S22-03	SC /APC - SC /APC PATCH CORD OS2, Simplex <b>3 M.</b> (2.0 mm. Jacket) (Better 3.0 mm.)	127.-/Pc
UFP966S32-03	SC /APC - SC /APC PATCH CORD OS2, Simplex <b>3 M.</b> (3.0 mm. Jacket)	134.-/Pc
UFP966S22-YY	SC /APC - SC /APC PATCH CORD OS2, Simplex , Length per Request (2.0 mm.)	119.-/Pc + 4.20.-/m.
UFP968S22-03	SC /APC - FC /APC PATCH CORD OS2, Simplex <b>3 M.</b> (2.0 mm. Jacket)	140.-/Pc
UFP962S21-03	SC /UPC - LC /UPC PATCH CORD OS2, Simplex <b>3 M.</b> (2.0 mm. Jacket) (Better 3.0 mm.)	116.-/Pc
UFP962S31-03	SC /UPC - LC /UPC PATCH CORD OS2, Simplex <b>3 M.</b> (3.0 mm. Jacket)	120.-/Pc
UFP962S21-YY	SC /UPC - LC /UPC PATCH CORD OS2, Simplex , Length per Request (2.0 mm.)	108.-/Pc + 4.20.-/m.
UFP962S28-03	SC /APC - LC /UPC PATCH CORD OS2, Simplex <b>3 M.</b> (2.0 mm. Jacket) (Better 3.0 mm.)	123.-/Pc
UFP962S38-03	SC /APC - LC /UPC PATCH CORD OS2, Simplex <b>3 M.</b> (3.0 mm. Jacket)	130.-/Pc
UFP962S28-YY	SC /APC - LC /UPC PATCH CORD OS2, Simplex , Length per Request (2.0 mm.)	115.-/Pc + 4.20.-/m.
UFP922S21-03	LC /UPC - LC /UPC PATCH CORD OS2, Simplex <b>3 M.</b> (2.0 mm. Jacket) (Better 3.0 mm.)	120.-/Pc
UFP922S31-03	LC /UPC - LC /UPC PATCH CORD OS2, Simplex <b>3 M.</b> (3.0 mm. Jacket)	124.-/Pc
UFP922S21-YY	LC /UPC - LC /UPC PATCH CORD OS2, Simplex , Length per Request (2.0 mm.)	111.-/Pc + 4.20.-/m.
<b>F.O. PATCH CORD OS2, DUPLEX (SINGLEMODE) , DOUBLE Q SERIES</b>		
UFP966D21-01	SC /UPC - SC /UPC PATCH CORD OS2, Duplex <b>1 M.</b> (2.0 mm. Jacket)	205.-/Pc
UFP966D21-03	SC /UPC - SC /UPC PATCH CORD OS2, Duplex <b>3 M.</b> (2.0 mm. Jacket) (Better 3.0 mm.)	216.-/Pc
UFP966D31-03	SC /UPC - SC /UPC PATCH CORD OS2, Duplex <b>3 M.</b> (3.0 mm. Jacket)	225.-/Pc
UFP966D21-YY	SC /UPC - SC /UPC PATCH CORD OS2, Duplex , Length per Request (2.0 mm.)	205.-/Pc + 5.60.-/m.
UFP962D21-01	SC /UPC - LC /UPC PATCH CORD OS2, Duplex <b>1 M.</b> (2.0 mm. Jacket)	210.-/Pc
UFP962D21-03	SC /UPC - LC /UPC PATCH CORD OS2, Duplex <b>3 M.</b> (2.0 mm. Jacket) (Better 3.0 mm.)	221.-/Pc
UFP962D31-03	SC /UPC - LC /UPC PATCH CORD OS2, Duplex <b>3 M.</b> (3.0 mm. Jacket)	230.-/Pc
UFP962D21-YY	SC /UPC - LC /UPC PATCH CORD OS2, Duplex , Length per Request (2.0 mm.)	210.-/Pc + 5.60.-/m.
UFP922D21-01	LC /UPC - LC /UPC PATCH CORD OS2, Duplex <b>1 M.</b> (2.0 mm. Jacket)	215.-/Pc
UFP922D21-03	LC /UPC - LC /UPC PATCH CORD OS2, Duplex <b>3 M.</b> (2.0 mm. Jacket) (Better 3.0 mm.)	226.-/Pc
UFP922D31-03	LC /UPC - LC /UPC PATCH CORD OS2, Duplex <b>3 M.</b> (3.0 mm. Jacket)	235.-/Pc
UFP922D21-YY	LC /UPC - LC /UPC PATCH CORD OS2, Duplex , Length per Request (2.0 mm.)	215.-/Pc + 5.60.-/m.

**3 WEEKS DELIVERY FOR PATCH CORD ASSEMBLY**

Think of Cabling ... Think@ INTERLINK Tel: 02-666-1111 www.interlink.co.th

PRICE LIST 2569



# FIBER OPTIC PATCH CORD



P/N	DESCRIPTION	UNIT PRICE
<b>F.O. PATCH CORD OS2, DUPLEX (SINGLEMODE) , DOUBLE Q SERIES</b>		
UFP944D21-03	ST /JPC - ST /JPC PATCH CORD OS2, Duplex 3 M. (2.0 mm. Jacket) (Better 3.0 mm.)	238.-/Pc
UFP944D31-03	ST /JPC - ST /JPC PATCH CORD OS2, Duplex 3 M. (3.0 mm. Jacket)	247.-/Pc
UFP944D21-YY	ST /JPC - ST /JPC PATCH CORD OS2, Duplex , Length per Request (2.0 mm.)	227.-/Pc +5.60.-/m.
UFP946D21-03	ST /JPC - SC /JPC PATCH CORD OS2, Duplex 3 M. (2.0 mm. Jacket) (Better 3.0 mm.)	227.-/Pc
UFP946D31-03	ST /JPC - SC /JPC PATCH CORD OS2, Duplex 3 M. (3.0 mm. Jacket)	236.-/Pc
UFP946D21-YY	ST /JPC - SC /JPC PATCH CORD OS2, Duplex , Length per Request (2.0 mm.)	216.-/Pc +5.60.-/m.
UFP948D21-03	ST /JPC - FC /JPC PATCH CORD OS2, Duplex 3 M. (2.0 mm. Jacket) (Better 3.0 mm.)	252.-/Pc
UFP948D31-03	ST /JPC - FC /JPC PATCH CORD OS2, Duplex 3 M. (3.0 mm. Jacket)	260.-/Pc
UFP948D21-YY	ST /JPC - FC /JPC PATCH CORD OS2, Duplex , Length per Request (2.0 mm.)	241.-/Pc +5.60.-/m.
UFP942D21-03	ST /JPC - LC /JPC PATCH CORD OS2, Duplex 3 M. (2.0 mm. Jacket) (Better 3.0 mm.)	232.-/Pc
UFP942D31-03	ST /JPC - LC /JPC PATCH CORD OS2, Duplex 3 M. (3.0 mm. Jacket)	241.-/Pc
UFP942D21-YY	ST /JPC - LC /JPC PATCH CORD OS2, Duplex , Length per Request (2.0 mm.)	221.-/Pc +5.60.-/m.
UFP966D22-03	SC /APC - SC /APC PATCH CORD OS2, Duplex 3 M. (2.0 mm. Jacket) (Better 3.0 mm.)	228.-/Pc
UFP966D32-03	SC /APC - SC /APC PATCH CORD OS2, Duplex 3 M. (3.0 mm. Jacket)	236.-/Pc
UFP966D22-YY	SC /APC - SC /APC PATCH CORD OS2, Duplex , Length per Request (2.0 mm.)	217.-/Pc + 5.60.-/m.
UFP966D26-YY	SC /JPC - SC /APC PATCH CORD OS2, Duplex , Length per Request (2.0 mm.)	211.-/Pc + 5.60.-/m.
UFP968D21-03	SC /JPC - FC /JPC PATCH CORD OS2, Duplex 3 M. (2.0 mm. Jacket) (Better 3.0 mm.)	241.-/Pc
UFP968D31-03	SC /JPC - FC /JPC PATCH CORD OS2, Duplex 3 M. (3.0 mm. Jacket)	250.-/Pc
UFP968D21-YY	SC /JPC - FC /JPC PATCH CORD OS2, Duplex , Length per Request (2.0 mm.)	230.-/Pc + 5.60.-/m.
UFP968D26-YY	SC /JPC - FC /APC PATCH CORD OS2, Duplex , Length per Request	246.-/Pc +5.60.-/m.
UFP988D21-03	FC /JPC - FC /JPC PATCH CORD OS2, Duplex 3 M. (2.0 mm. Jacket) (Better 3.0 mm.)	266.-/Pc
UFP988D31-03	FC /JPC - FC /JPC PATCH CORD OS2, Duplex 3 M. (3.0 mm. Jacket)	274.-/Pc
UFP988D21-YY	FC /JPC - FC /JPC PATCH CORD OS2, Duplex , Length per Request (2.0 mm.)	255.-/Pc +5.60.-/m.
UFP988D22-03	FC /APC - FC /APC PATCH CORD OS2, Duplex 3 M. (2.0 mm. Jacket)	297.-/Pc
UFP988D32-03	FC /APC - FC /APC PATCH CORD OS2, Duplex 3 M. (3.0 mm. Jacket)	306.-/Pc
UFP988D22-YY	FC /APC - FC /APC PATCH CORD OS2, Duplex , Length per Request (2.0 mm.)	286.-/Pc +5.60.-/m.
UFP982D21-03	FC /JPC - LC /JPC PATCH CORD OS2, Duplex 3 M. (2.0 mm. Jacket) (Better 3.0 mm.)	246.-/Pc
UFP982D31-03	FC /JPC - LC /JPC PATCH CORD OS2, Duplex 3 M. (3.0 mm. Jacket)	255.-/Pc
UFP982D21-YY	FC /JPC - LC /JPC PATCH CORD OS2, Duplex , Length per Request (2.0 mm.)	235.-/Pc +5.60.-/m.

**3 WEEKS DELIVERY FOR PATCH CORD ASSEMBLY**

www.interlink.co.th

Tel. 02-666-1111

Think of Cabling ... Think@ INTERLINK

PRICE LIST 2569

67



# FIBER OPTIC PATCH CORD



P/N	DESCRIPTION	UNIT PRICE
<b>F.O. PATCH CORD OM2, SIMPLEX (MULTIMODE) , DOUBLE Q SERIES</b>		
UFP566S21-03	SC /UPC - SC /UPC PATCH CORD OM2, Simplex 3 M. (2.0 mm. Jacket) (Better 3.0 mm.)	118.-/Pc
UFP566S31-03	SC /UPC - SC /UPC PATCH CORD OM2, Simplex 3 M. (3.0 mm. Jacket)	122.-/Pc
UFP566S21-YY	SC /UPC - SC /UPC PATCH CORD OM2, Simplex , Length per Request (2.0 mm.)	108.-/Pc + 5.20.-/m.
UFP562S21-03	SC /UPC - LC /UPC PATCH CORD OM2, Simplex 3 M. (2.0 mm. Jacket) (Better 3.0 mm.)	119.-/Pc
UFP562S31-03	SC /UPC - LC /UPC PATCH CORD OM2, Simplex 3 M. (3.0 mm. Jacket)	123.-/Pc
UFP562S21-YY	SC /UPC - LC /UPC PATCH CORD OM2, Simplex , Length per Request (2.0 mm.)	109.-/Pc + 5.20.-/m.
UFP522S21-03	LC /UPC - LC /UPC PATCH CORD OM2, Simplex 3 M. (2.0 mm. Jacket) (Better 3.0 mm.)	120.-/Pc
UFP522S31-03	LC /UPC - LC /UPC PATCH CORD OM2, Simplex 3 M. (3.0 mm. Jacket)	124.-/Pc
UFP522S21-YY	LC /UPC - LC /UPC PATCH CORD OM2, Simplex , Length per Request (2.0 mm.)	110.-/Pc + 5.20.-/m.
<b>F.O. PATCH CORD OM3, SIMPLEX (MULTIMODE) , DOUBLE Q SERIES</b>		
UFP466S21-03	SC /UPC - SC /UPC PATCH CORD OM3, Simplex 3 M. (2.0 mm. Jacket) (Better 3.0 mm.)	126.-/Pc
UFP466S31-03	SC /UPC - SC /UPC PATCH CORD OM3, Simplex 3 M. (3.0 mm. Jacket)	130.-/Pc
UFP466S21-YY	SC /UPC - SC /UPC PATCH CORD OM3, Simplex , Length per Request (2.0 mm.)	111.-/Pc + 7.90.-/m.
UFP462S21-03	SC /UPC - LC /UPC PATCH CORD OM3, Simplex 3 M. (2.0 mm. Jacket) (Better 3.0 mm.)	127.-/Pc
UFP462S31-03	SC /UPC - LC /UPC PATCH CORD OM3, Simplex 3 M. (3.0 mm. Jacket)	131.-/Pc
UFP462S21-YY	SC /UPC - LC /UPC PATCH CORD OM3, Simplex , Length per Request (2.0 mm.)	112.-/Pc + 7.90.-/m.
UFP422S21-03	LC /UPC - LC /UPC PATCH CORD OM3, Simplex 3 M. (2.0 mm. Jacket) (Better 3.0 mm.)	128.-/Pc
UFP422S31-03	LC /UPC - LC /UPC PATCH CORD OM3, Simplex 3 M. (3.0 mm. Jacket)	130.-/Pc
UFP422S21-YY	LC /UPC - LC /UPC PATCH CORD OM3, Simplex , Length per Request (2.0 mm.)	113.-/Pc + 7.90.-/m.
<b>F.O. PATCH CORD OM4, SIMPLEX (MULTIMODE) , DOUBLE Q SERIES</b>		
UFP362S21-03	SC /UPC - LC /UPC PATCH CORD OM4, Simplex 3 M. (2.0 mm. Jacket) (Better 3.0 mm.)	139.-/Pc
UFP362S31-03	SC /UPC - LC /UPC PATCH CORD OM4, Simplex 3 M. (3.0 mm. Jacket)	143.-/Pc
UFP362S21-YY	SC /UPC - LC /UPC PATCH CORD OM4, Simplex , Length per Request (2.0 mm.)	116.-/Pc + 11.90.-/m.
UFP322S21-03	LC /UPC - LC /UPC PATCH CORD OM4, Simplex 3 M. (2.0 mm. Jacket) (Better 3.0 mm.)	140.-/Pc
UFP322S31-03	LC /UPC - LC /UPC PATCH CORD OM4, Simplex 3 M. (3.0 mm. Jacket)	144.-/Pc
UFP322S21-YY	LC /UPC - LC /UPC PATCH CORD OM4, Simplex , Length per Request (2.0 mm.)	117.-/Pc + 11.90.-/m.

**3 WEEKS DELIVERY FOR PATCH CORD ASSEMBLY**

Think of Cabling ... Think@ INTERLINK Tel: 02-666-1111 www.interlink.co.th

PRICE LIST 2569

68



# FIBER OPTIC PATCH CORD



P/N	DESCRIPTION	UNIT PRICE
<b>F.O. PATCH CORD OM2, DUPLEX (MULTIMODE) , DOUBLE Q SERIES</b>		
UFP566D21-03	SC /UPC - SC /UPC PATCH CORD OM2, Duplex 3 M. (2.0 mm. Jacket) (Better 3.0 mm.)	222.-/Pc
UFP566D31-03	SC /UPC - SC /UPC PATCH CORD OM2, Duplex 3 M. (3.0 mm. Jacket)	230.-/Pc
UFP566D21-YY	SC /UPC - SC /UPC PATCH CORD OM2, Duplex , Length per Request (2.0 mm.)	206.-/Pc + 7.80.-/m.
UFP562D21-03	SC /UPC - LC /UPC PATCH CORD OM2, Duplex 3 M. (2.0 mm. Jacket) (Better 3.0 mm.)	220.-/Pc
UFP562D31-03	SC /UPC - LC /UPC PATCH CORD OM2, Duplex 3 M. (3.0 mm. Jacket)	228.-/Pc
UFP562D21-YY	SC /UPC - LC /UPC PATCH CORD OM2, Duplex , Length per Request (2.0 mm.)	204.-/Pc + 7.80.-/m.
UFP522D21-03	LC /UPC - LC /UPC PATCH CORD OM2, Duplex 3 M. (2.0 mm. Jacket) (Better 3.0 mm.)	218.-/Pc
UFP522D31-03	LC /UPC - LC /UPC PATCH CORD OM2, Duplex 3 M. (3.0 mm. Jacket)	226.-/Pc
UFP522D21-YY	LC /UPC - LC /UPC PATCH CORD OM2, Duplex , Length per Request (2.0 mm.)	202.-/Pc + 7.80.-/m.
UFP544D21-03	ST /UPC - ST /UPC PATCH CORD OM2, Duplex 3 M. (2.0 mm. Jacket) (Better 3.0 mm.)	226.-/Pc
UFP544D31-03	ST /UPC - ST /UPC PATCH CORD OM2, Duplex 3 M. (3.0 mm. Jacket)	234.-/Pc
UFP544D21-YY	ST /UPC - ST /UPC PATCH CORD OM2, Duplex , Length per Request (2.0 mm.)	210.-/Pc + 7.80.-/m.
UFP546D21-03	ST /UPC - SC /UPC PATCH CORD OM2, Duplex 3 M. (2.0 mm. Jacket) (Better 3.0 mm.)	224.-/Pc
UFP546D31-03	ST /UPC - SC /UPC PATCH CORD OM2, Duplex 3 M. (3.0 mm. Jacket)	232.-/Pc
UFP546D21-YY	ST /UPC - SC /UPC PATCH CORD OM2, Duplex , Length per Request (2.0 mm.)	208.-/Pc + 7.80.-/m.
UFP542D21-03	ST /UPC - LC /UPC PATCH CORD OM2, Duplex 3 M. (2.0 mm. Jacket) (Better 3.0 mm.)	222.-/Pc
UFP542D31-03	ST /UPC - LC /UPC PATCH CORD OM2, Duplex 3 M. (3.0 mm. Jacket)	230.-/Pc
UFP542D21-YY	ST /UPC - LC /UPC PATCH CORD OM2, Duplex , Length per Request (2.0 mm.)	206.-/Pc + 7.80.-/m.

www.interlink.co.th

Tel. 02-668-1111

Think of Cabling ... Think@ INTERLINK

PRICE LIST 2569

69

**3 WEEKS DELIVERY FOR PATCH CORD ASSEMBLY**



# FIBER OPTIC PATCH CORD



P/N	DESCRIPTION	UNIT PRICE
-----	-------------	------------

## F.O. PATCH CORD OM3, DUPLEX (MULTIMODE) , DOUBLE Q SERIES

UFP466D21-03	SC /UPC - SC /UPC PATCH CORD OM3, Duplex 3 M. (2.0 mm. Jacket) (Better 3.0 mm.)	238.-/Pc
UFP466D31-03	SC /UPC - SC /UPC PATCH CORD OM3, Duplex 3 M. (3.0 mm. Jacket)	246.-/Pc
UFP466D21-YY	SC /UPC - SC /UPC PATCH CORD OM3, Duplex , Length per Request (2.0 mm.)	212.-/Pc + 13.20.-/m.
UFP462D21-03	SC /UPC - LC /UPC PATCH CORD OM3, Duplex 3 M. (2.0 mm. Jacket) (Better 3.0 mm.)	236.-/Pc
UFP462D31-03	SC /UPC - LC /UPC PATCH CORD OM3, Duplex 3 M. (3.0 mm. Jacket)	244.-/Pc
UFP462D21-YY	SC /UPC - LC /UPC PATCH CORD OM3, Duplex , Length per Request (2.0 mm.)	210.-/Pc + 13.20.-/m.
UFP422D21-03	LC /UPC - LC /UPC PATCH CORD OM3, Duplex 3 M. (2.0 mm. Jacket) (Better 3.0 mm.)	234.-/Pc
UFP422D31-03	LC /UPC - LC /UPC PATCH CORD OM3, Duplex 3 M. (3.0 mm. Jacket)	243.-/Pc
UFP422D21-YY	LC /UPC - LC /UPC PATCH CORD OM3, Duplex , Length per Request (2.0 mm.)	208.-/Pc + 13.20.-/m.
UFP444D21-03	ST /UPC - ST /UPC PATCH CORD OM3, Duplex 3 M. (2.0 mm. Jacket) (Better 3.0 mm.)	242.-/Pc
UFP444D31-03	ST /UPC - ST /UPC PATCH CORD OM3, Duplex 3 M. (3.0 mm. Jacket)	250.-/Pc
UFP444D21-YY	ST /UPC - ST /UPC PATCH CORD OM3, Duplex , Length per Request (2.0 mm.)	216.-/Pc + 13.20.-/m.
UFP446D21-03	ST /UPC - SC /UPC PATCH CORD OM3, Duplex 3 M. (2.0 mm. Jacket) (Better 3.0 mm.)	240.-/Pc
UFP446D31-03	ST /UPC - SC /UPC PATCH CORD OM3, Duplex 3 M. (3.0 mm. Jacket)	248.-/Pc
UFP446D21-YY	ST /UPC - SC /UPC PATCH CORD OM3, Duplex , Length per Request (2.0 mm.)	214.-/Pc + 13.20.-/m.
UFP442D21-03	ST /UPC - LC /UPC PATCH CORD OM3, Duplex 3 M. (2.0 mm. Jacket) (Better 3.0 mm.)	240.-/Pc
UFP442D31-03	ST /UPC - LC /UPC PATCH CORD OM3, Duplex 3 M. (3.0 mm. Jacket)	248.-/Pc
UFP442D21-YY	ST /UPC - LC /UPC PATCH CORD OM3, Duplex , Length per Request (2.0 mm.)	214.-/Pc + 13.20.-/m.

## F.O. PATCH CORD OM4, DUPLEX (MULTIMODE) , DOUBLE Q SERIES

UFP362D21-03	SC /UPC - LC /UPC PATCH CORD OM4, Duplex 3 M. (2.0 mm. Jacket) (Better 3.0 mm.)	260.-/Pc
UFP362D31-03	SC /UPC - LC /UPC PATCH CORD OM4, Duplex 3 M. (3.0 mm. Jacket)	268.-/Pc
UFP362D21-YY	SC /UPC - LC /UPC PATCH CORD OM4, Duplex , Length per Request (2.0 mm.)	218.-/Pc + 21.20.-/m.
UFP322D21-03	LC /UPC - LC /UPC PATCH CORD OM4, Duplex 3 M. (2.0 mm. Jacket) (Better 3.0 mm.)	258.-/Pc
UFP322D31-03	LC /UPC - LC /UPC PATCH CORD OM4, Duplex 3 M. (3.0 mm. Jacket)	261.-/Pc
UFP322D21-YY	LC /UPC - LC /UPC PATCH CORD OM4, Duplex , Length per Request (2.0 mm.)	216.-/Pc + 21.20.-/m.

**3 WEEKS DELIVERY FOR PATCH CORD ASSEMBLY**

Think of Cabling ... Think@ INTERLINK Tel: 02-666-1111 www.interlink.co.th

PRICE LIST 2569

70



# FIBER OPTIC TOOL

NEW



FIBER OPTIC System ( Professional Tools & Tester , Accessible To Everyone )

Think of Cabling ... Think INTERLINK Tel. 02-666-1111 www.interlink.co.th



UF-2841B BLUE ADVANCE FUSION SPLICER SET



UF-2842AG GOLD PROFESSIONAL FUSION SPLICER SET



UF-2843B BLUE AUTO CLEAVER W/Trash



UF-2846 SPARE ELECTRODE FUSION SPLICE  
( 1 Pair / 3600 Splices Electrode Life )



UF-2844AG GOLD PRO CLEAVER W/Trash



UF-2800 3 Hole Fiber STRIPPER  
( 2-3 mm., 900 μm., 250 μm. )



UF-2851 FIELD MICROSCOPE 400X



UF-2805A Kevlar SCISSORS  
(Rust Proof)



UF-2820 FTTH STRIPPER  
(Flat & Oval FTTR / FTTH Drop Cable)



UF-2877 Small Mid Span Jacket SLITTER



UF-2878 ARMORED Cable SLITTER



UF-2824A CLEANER CASSETTE



UF-2828-1  
1.25 mm. One Click Ferrule Cleaner



UF-2828-2  
2.5 mm. One Click Ferrule Cleaner



UF-2821A WIPE PAPER 100 pcs / Bx



UF-2822 Kirkwipes 280 pcs / Bx



UF-2832 MTP/MPO™ BULKHEAD Cleaner

PRICE LIST 2569  
71



# FIBER OPTIC TOOL <sup>NEW</sup>

( Professional Tools & Tester , Accessible To Everyone )



P/N	DESCRIPTION	UNIT PRICE
<b>NEW</b> <b>UF-2841B</b> <i>obsolete</i> <b>UF-2841</b>	<b>F.O. BLUE ADVANCE FUSION SPLICER SET</b> <i>F.O. MINI ADVANCE FUSION SPLICER SET</i>	<b>33,900.-</b> เครื่อง Fusion Splicer สแตนเลส 46,000.-
<b>NEW</b> <b>UF-2842AG</b> <i>obsolete</i> <b>UF-2842A</b>	<b>F.O. GOLD PROFESIONAL FUSION SPLICER SET</b> <i>F.O. PROFESSIONAL FUSION SPLICER SET (รุ่น UF-2842)</i>	<b>44,550.-</b> เครื่อง Fusion Splicer มืออาชีพ 63,300.-
<b>NEW</b> <b>UF-2843B</b> <i>obsolete</i> <b>UF-2844A</b>	<b>F.O. BLUE AUTO CLEAVER w/Trash</b> <i>F.O. AUTO PRO CLEAVER W/Trash (รุ่น UF-2844, UF-2845)</i>	<b>3,110.-</b> เครื่องตัด CLEAVER อัตโนมัติ 6,600.-
<b>NEW</b> <b>UF-2844AG</b> <i>obsolete</i> <b>UF-2844A</b>	<b>F.O. GOLD PRO CLEAVER w/Trash</b> <i>F.O. AUTO PRO CLEAVER W/Trash (รุ่น UF-2844, UF-2845)</i>	<b>5,370.-</b> เครื่องตัด CLEAVER อัตโนมัติ 6,600.-
<b>UF-2846</b>	SPARE ELECTRODE FUSION SPLICE 1 Pair ( 3600 Splices Life )	<b>1,500.-</b>
<b>UF-2851</b>	FIELD MICROSCOPE 400X w/ST , SC , FC & LC Adapter ( Reduce from 5,330.- )	<b>3,530.-</b>
<b>UF-2800</b> <i>obsolete</i> <b>UF-2803</b>	3 Hole Fiber STRIPPER [ 2-3 mm., 900 μm., 250 μm. ] ( Discount from 760.- ) <i>Fiber STRIPPER, 250-900 mm ,Original</i>	<b>300.-</b> กิ๊บปอกไฟเบอร์ 625.-
<b>NEW</b> <b>UF-2805A</b> <i>obsolete</i> <b>UF-2804</b> <i>obsolete</i> <b>UF-2805</b>	Kevlar SCISSORS Rust Proof <i>KEVLAR SCISSORS, Original</i> <i>KEVLAR SCISSORS, New Style</i>	<b>500.-</b> นรโรกรัดคอปไฟเบอร์ 715.- นรโรกรัดคอปไฟเบอร์ 635.-
<b>NEW</b> <b>UF-2820</b>	FTTH Flat Drop Cable STRIPPER ( Reduce from 890.- )	<b>300.-</b>
<b>NEW</b> <b>UF-2877</b>	Fiber Optic Small Mid Span JACKET SLITTER ( Reduce from 1,140.- )	<b>250.-</b>
<b>NEW</b> <b>UF-2878</b>	ARMORED Cable SLITTER [ Slitting the metal corrugated ]	<b>1,130.-</b>
<b>UF-2824A</b>	Fiber Connector Cleaner CASSETTE [ 500 connectors ] ( Discount from 2,280.- )	<b>1,130.-</b>
<b>UF-2828-1</b>	One Click 1.25 mm. Ferrule Cleaner [ 800 connectors ] ( Discount from 1,265.- )	<b>540.-</b>
<b>UF-2828-2</b>	One Click 2.5 mm. Ferrule Cleaner [ 800 connectors ] ( Discount from 1,265.- )	<b>540.-</b>
<b>NEW</b> <b>UF-2821A</b>	Wipe PAPER [ Pre - Moistened Alcohol Wipes [ 100 pcs./Box ]	<b>110.-</b>
<b>UF-2822</b>	Kimwipe Cleaning Wipe PAPER [ 280 pcs./Box ] ( Discount from 275.- )	<b>160.-</b>
<b>NEW</b> <b>UF-2834</b>	F.O. CLEANING FULL SET w/Field MICROSCOPE 400X	<b>7,350.-</b>
<b>NEW</b> <b>UF-2832</b>	MTP/MPO™ BULKHEAD Cleaner	<b>950.-</b>

Think of Cabling ... Think@ INTERLINK Tel. 02-666-1111 www.interlink.co.th



### หัวใจในระบบสายสัญญาณของท่าน

1. LNK แนะนำให้ใช้เครื่องมือที่ออกแบบมาโดยเฉพาะ จะช่วยลดปัญหาในการซ่อมบำรุง และปัญหาต่างๆ ที่จะตามมาในระยะยาว ดังนั้น LNK จึงเน้นราคาสูงสำหรับเครื่องมือ เพื่อให้ช่างทุกคนมีโอกาสเป็นเจ้าของได้
2. กระเป๋าเครื่องมือ LAN ครบชุด เหมาะเป็นอย่างยิ่งที่ทุกองค์กรและหน่วยงานจะซื้อไปประจำสำนักงาน

PRICE LIST 2569

72



**UF-2872H F.O. HANDHELD OTDR 22 / 20 dB**  
(1310 / 1550 nm, SC / UPC)



**UF-2874A F.O. PRO OTDR 28 / 26 / 26 dB**  
(1310 / 1550 / 1625 nm, SC / UPC)



**UF-2874PMM (Multimode)**  
**F.O. PRO MAX OTDR 28 / 26 dB**  
(850 / 1300 nm., Full Option)



**UF-2874PMS (Singlemode)**  
**F.O. PRO MAX OTDR 37 / 35 dB**  
(1310 / 1550 nm., Full Option)



**UF-2874PMQ(QUAD)**  
**F.O. PRO MAX OTDR 37 / 35 / 28 / 26 dB**  
(850 / 1300 / 1310 / 1550 nm. Full Option)



**UF-2890A**  
**PON POWER METER**



**UF-2889**  
**XG PON POWER METER**



**UF-2883 / UF-2884**  
**VFL 10 mw for 2.5 mm. / 1.25 mm.**



**Optical Fiber IDENTIFIER**  
(Identify direction & Power of core)  
Includes the signal direction and power in fiber.  
Includes the signal presence or absence (Low or Dark fiber).  
Efficiently identifies the traffic direction and frequency tone (1310nm, 1550nm) with audible warning.  
Displays the relative core power level to replace adapters.  
Built-in VFL function.

**UF-2888**  
**OPTICAL FIBER IDENTIFIER**



**UF-2891**  
**F.O. ADVANCE POWER METER**



**UF-2893 LIGHT SOURCE MM**  
(850 / 1300 nm.)



**UF-2894 LIGHT SOURCE SM**  
(1310 / 1550 nm.)



**UF-2892Q LIGHT SOURCE QUAD**  
(850 / 1300 / 1310 / 1550 nm.)



**UF-2851**

**FIELD MICROSCOPE 400X**



**UF-2852 PROFESSIONAL VIDEO MICROSCOPE**

( Full Set w / Accessories )

**PRO. FO HANDHELD VIDEO MICROSCOPE SET ; Full Option**  
ACACATIONEWA/CALUMPO compatible  
5 inch TFT display  
Up to 2000X overall magnification  
17 card storage up to 32G  
Snapshot, video recording and playback  
167 image rollers  
Flashlight function



**OM2 OM3 with SC/APC SC/APC (cable fiber 20)**  
**OM3 OM4 with SC/APC SC/APC (cable fiber 20)**



**DUMMY Launch Cable Box, OM2, SC / SC, 500m, 500m SC/APC/SC/APC (cable fiber 20)**



**500m SC/APC/SC/APC (cable fiber 20)**



# FIBER OPTIC TESTER

[ Professional Tools & Testers , Accessible to Everyone ]



P/N	DESCRIPTION	UNIT PRICE
<b>FIBER OPTIC TESTER</b>		
<b>NEW</b> <b>UF-2872H</b> <i>obsolete</i> UF-2872	<b>F.O HANDHELD OTDR 22/20 dB [ 1310 / 1550 nm. ] ; SC/UPC [ 80 Km.]</b> <i>F.O. HANDHELD OTDR 100 Km. [1310/1550 nm.]; SC/UPC</i>	<b>15,500.-</b> 41,350.-
<b>NEW</b> <b>UF-2874A</b> <i>obsolete</i> UF-2874	<b>F.O PRO OTDR 28/26/26 dB [ 1310 / 1550 / 1625 nm. ] ; SC/UPC [ 80 Km.]</b> <i>F.O. PROFESSIONAL OTDR 100 Km. [1310/1550/1625 nm.] , Full Option</i>	<b>40,510.-</b> 185,200.-
<b>NEW</b> <b>UF-2874PMM</b>	<b>F.O PRO MAX OTDR 28/26 dB [ 850 / 1300 nm. ] ; Full Option</b>	<b>85,190.-</b>
<b>NEW</b> <b>UF-2874PMS</b>	<b>F.O PRO MAX OTDR 37/35 dB [ 1310 / 1550 nm. ] ; Full Option [ 100 Km.]</b>	<b>34,170.-</b>
<b>NEW</b> <b>UF-2874PMQ</b> <i>obsolete</i> UF-2874QUAD	<b>F.O PRO MAX OTDR 37/35/28/26 dB [ 850 / 1300 / 1310 / 1550 nm. ] ; Full Option</b> <i>F.O. PROFESSIONAL OTDR [ 850/1300/1310/1550 nm. ] , Full Option</i>	<b>112,250.-</b> 261,150.-
<b>NEW</b> <b>UF-2890A</b> <i>obsolete</i> UF-2890	<b>PON POWER METER ; Full Option</b> <i>PON POWER METER, w/Power Meter Function, Color Display</i>	<b>5,330.-</b> 17,450.-
<b>NEW</b> <b>UF-2889</b>	<b>XG PON POWER METER ; Full Option</b>	<b>27,330.-</b>
<b>UF-2891</b>	<b>F.O ADVANCE POWER METER for FC , ST , SC [ Discount from 4,850.-]</b>	<b>3,550.-</b>
<b>UF-2893</b>	<b>F.O LIGHT SOURCE MM 850 / 1300 nm. [ Discount from 11,350.-]</b>	<b>6,220.-</b>
<b>UF-2894</b>	<b>F.O LIGHT SOURCE SM 1310 / 1550 nm. [ Discount from 11,350.-]</b>	<b>5,330.-</b>
<b>NEW</b> <b>UF-2892Q</b>	<b>F.O LIGHT SOURCE QUAD 850 / 1300 / 1310 / 1550 nm.</b>	<b>9,760.-</b>
<b>NEW</b> <b>UF-2883</b>	<b>VFL [Visual-Fault locator] 10 mw for 2.5 mm. FC, ST, SC, [ 7 Km.] [ Discount from 1,650.-]</b>	<b>890.-</b>
<b>NEW</b> <b>UF-2884</b>	<b>VFL [Visual-Fault locator] 10 mw for 1.25 mm. LC [ 7 Km.] [ Discount from 2,750.-]</b>	<b>1,340.-</b>
<b>NEW</b> <b>UF-2888</b>	<b>OPTICAL FIBER IDENTIFLER [ Identify direction &amp; Power of core ] [ Discount from 6,300.-]</b>	<b>4,800.-</b>
<b>UF-2851</b>	<b>FIELD MICROSCOPE 400X w/ST, SC, FC &amp; LC Adapter [ Discount from 5,330.-]</b>	<b>3,110.-</b>
<b>NEW</b> <b>UF-2852</b>	<b>PRORESIONAL VIDEO MICROSCOPE 400X w/various Connector</b>	<b>28,400.-</b>
<b>UF-28800S2-10</b>	<b>DUMMY Launch Cable Box , OS2 ; SC / SC 1,000 m. [ Replace UF-SC-SC-9-10 ]</b>	<b>7,210.-</b>
<b>UF-28810S2-10</b>	<b>DUMMY Launch Cable Box , OS2 ; SC / FC 1,000 m. [ Replace UF-SC-FC-9-10 ]</b>	<b>7,220.-</b>
<b>UF-28820S2-10</b>	<b>DUMMY Launch Cable Box , OS2 ; SC / LC 1,000 m. [ Replace UF-SC-LC-9-10 ]</b>	<b>7,230.-</b>
<b>UF-28800M2-05</b>	<b>DUMMY Launch Cable Box , OM2 ; SC / SC 500 m. [ Replace UF-SC-SC-5-0.5 ]</b>	<b>8,220.-</b>
<b>NEW</b> <b>UF-28800M3-05</b>	<b>DUMMY Launch Cable Box , OM3 ; SC / SC 500 m. [ Replace UF-SC-SC-4-0.5 ]</b>	<b>9,150.-</b>
<b>NEW</b> <b>UF-28800M4-05</b>	<b>DUMMY Launch Cable Box , OM4 ; SC / SC 500 m.</b>	<b>10,100.-</b>
<b>NEW</b> <b>UF-28800M5-05</b>	<b>DUMMY Launch Cable Box , OM5 ; SC / SC 500 m.</b>	<b>12,000.-</b>

Think of Cabling ... Think@ INTERLINK Tel: 02-666-1111 www.interlink.co.th

PRICE LIST 2569

74



# FTTR / FTTH OVAL / FLAT CABLE



(Fiber Optic to the ROOM / Fiber Optic to The HOME)

FTTR / FTTH System

www.interlink.co.th  
Tel. 02-666-1111  
Think of Cabling ... Think INTERLINK

## FTTR OVAL DISTRIBUTION CABLE , DOUBLE Q SERIES

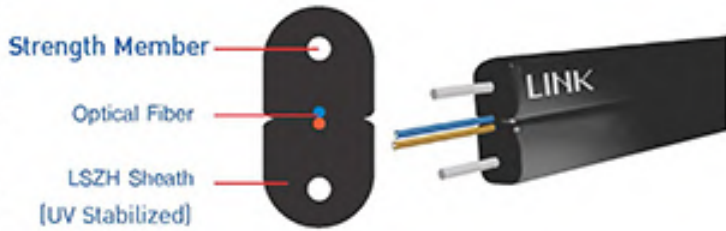

UFH922x



## FTTH FLAT ; STRANDED DROP CABLE , DOUBLE Q SERIES



UFH 952x Self - Support Drop Cable



## FTTH FLAT ; SOLID DROP CABLE



UFH 951xM Self - Support Drop Cable

## FTTR FLAT ; Non-Metallic



UFH 932x DISTRIBUTION CABLE

## FTTR / FTTH PATCH CORD & ACCESSORIES



UFH966SFS2-03-TCC or UFH966SFS2-03



FTTH FLAT CABLE ASSEMBLY

PRICE LIST 2569

75



# FTTR / FTTH OVAL / FLAT CABLE



P/N	DESCRIPTION	PACKING (Reel/In Per)	PRICE /m.
<b>FTTR / FTTH OVAL CABLE , DOUBLE Q SERIES</b>			Effective P76 1 APRIL 2024
UFH9221	FTTR OVAL 1C, CABLE, LSZH (Distribution) , Double-Q	1,000 <sup>R</sup> M. /Box	3.95 /m.
UFH9221-3	FTTR OVAL 1C, CABLE, LSZH (Distribution) , Double-Q	300 <sup>R</sup> M. /Box	4.75 /m.
UFH9221-1	FTTR OVAL 1C, CABLE, LSZH (Distribution) , Double-Q	100 <sup>R</sup> M. /Box	8.20 /m.
UFH9222	FTTR OVAL 2C, CABLE, LSZH (Distribution) , Double-Q	1,000 <sup>R</sup> M. /Box	6.30 /m.
UFH9222-3	FTTR OVAL 2C, CABLE, LSZH (Distribution) , Double-Q	300 <sup>R</sup> M. /Box	7.25 /m.
UFH9222-1	FTTR OVAL 2C, CABLE, LSZH (Distribution) , Double-Q	100 <sup>R</sup> M. /Box	10.60 /m.
UFH9224	FTTR OVAL 4C, CABLE, LSZH (Distribution) , Double-Q	1,000 <sup>R</sup> M. /Box	11.40 /m.
<b>FTTH SELF STRANDED DROP CABLE , DOUBLE Q SERIES</b>			
UFH9521	FTTH FLAT 1C, STRANDED DROP CABLE, LSZH (Self-Support)	1,000 <sup>R</sup> M. /Box	5.- /m.
UFH9522	FTTH FLAT 2C, STRANDED DROP CABLE, LSZH (Self-Support)	1,000 <sup>R</sup> M. /Box	7.40 /m.
UFH9522-3	FTTH FLAT 2C, STRANDED DROP CABLE, LSZH (Self-Support)	300 <sup>R</sup> M. /Box	8.30 /m.
UFH9522-1	FTTH FLAT 2C, STRANDED DROP CABLE, LSZH (Self-Support)	100 <sup>R</sup> M. /Box	11.65 /m.
UFH9524	FTTH FLAT 4C, STRANDED DROP CABLE, LSZH (Self-Support)	1,000 <sup>R</sup> M. /Box	12.50 /m.
<b>FTTH SELF SOLID DROP CABLE , DOUBLE Q SERIES</b>			
UFH9511M	FTTH FLAT 1C, Solid Drop Cable, LSZH (Self-Support)	1,000 <sup>R</sup> M. /Box	5.- /m.
UFH9512M	FTTH FLAT 2C, Solid Drop Cable, LSZH (Self-Support)	1,000 <sup>R</sup> M. /Box	7.35 /m.
<b>FTTR FLAT CABLE , Non-Metallic , DOUBLE Q SERIES</b>			
UFH9321	FTTR FLAT 1C, Non-Metallic Cable, LSZH (Distribution) [Recommend UFH9221]	1,000 <sup>R</sup> M. /Box	3.90 /m.
UFH9322	FTTR FLAT 2C, Non-Metallic Cable, LSZH (Distribution) [Recommend UFH9222]	1,000 <sup>R</sup> M. /Box	6.30 /m.
UFH9324	FTTR FLAT 4C, Non-Metallic Cable, LSZH (Distribution) [Recommend UFH9224]	1,000 <sup>R</sup> M. /Box	11.40 /m.
<b>FTTR POWER FIBER CABLE , DOUBLE Q SERIES</b>			
UFH9162	FTTR POWER FIBER OS2 CABLE , 2C , 2 X 16 AWG Conductors		Call
UFH9462	FTTR POWER FIBER OM3 CABLE , 2C , 2 X 16 AWG Conductors		Call
<b>FTTR / FTTH PATCH CORD &amp; ACCESSORIES , DOUBLE Q SERIES</b>			
UFH966SFS2-03	SC/APC to SC/APC PATCH CORD, SIMPLEX FLAT DROP CABLE [TRUE Compatible]		90.-
<b>FTTR / FTTH FLAT CABLE ASSEMBLY , DOUBLE Q SERIES</b>			
UFH9862-050	FTTH FLAT ASSEMBLY 50 M., SC/APC to SC/APC		340.-
UFH9862-100	FTTH FLAT ASSEMBLY 100 M., SC/APC to SC/APC		585.-
UFH9862-150	FTTH FLAT ASSEMBLY 150 M., SC/APC to SC/APC		830.-
UFH9862-200	FTTH FLAT ASSEMBLY 200 M., SC/APC to SC/APC		1,070.-
UFH9862-300	FTTH FLAT ASSEMBLY 300 M., SC/APC to SC/APC		1,570.-

Think of Cabling ... Think@ INTERLINK Tel: 02-666-1111

www.interlink.co.th

PRICE LIST 2569

76

## FTTR / FTTH ROUND ; Distribution Cable



UFH930xR



UFH930xRA

## FTTR / FTTH ROUND ; STRANDED Drop Cable (NT Specification)

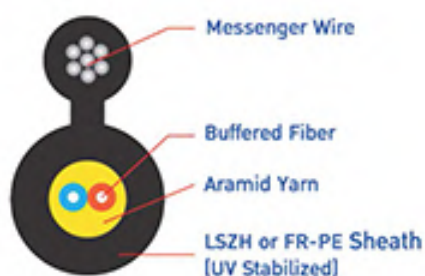

UFH950xR or UFH950xR-TOT



## FTTR / FTTH ROUND ; ARMORED, SOLID Drop Cable (NT Specification)

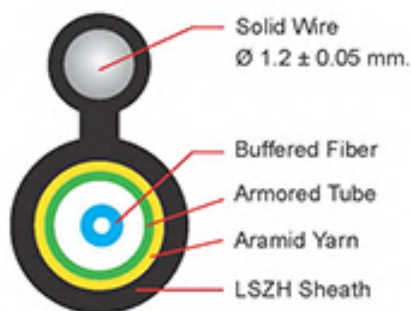

UFH9501RA



## FTTR / FTTH ROUND PATCH CORD & ACCESSORIES (NT Approved)

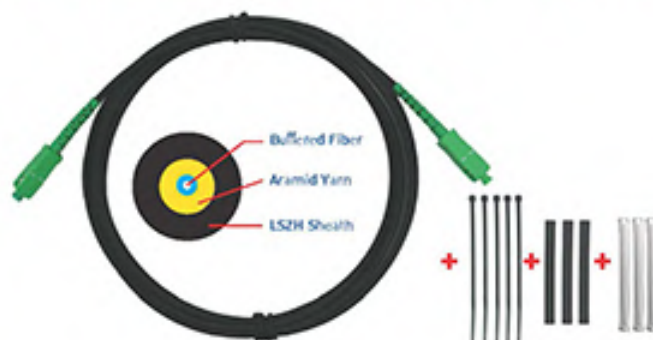

UFP966S42-03-01

+ Free OFTK, Indoor/Outdoor Patch cord



# FTTR / FTTH ROUND CABLE



P/N	DESCRIPTION	PACKING (Reel in Box)	PRICE /Box
<b>FTTR / FTTH ROUND CABLE , NT Compatible</b>			Effective P78 1 APRIL 2026
Obsolete2b UFH9301R	FTTR / FTTH ROUND 1C, LSZH (Distribution)	1,000* M. /Reel	7,170.- /Reel
Obsolete2b UFH9302R	FTTR / FTTH ROUND 2C, LSZH (Distribution)	1,000* M. /Reel	9,515.- /Reel
Obsolete2b UFH9301RA	FTTR / FTTH ROUND ARMORED 1C, LSZH (Distribution)	1,000* M. /Reel	11,610.- /Reel
Obsolete2b UFH9302RA	FTTR / FTTH ROUND ARMORED 2C, LSZH (Distribution)	1,000* M. /Reel	15,080.- /Reel
<b>FTTR / FTTH SELF-SUPPORT ROUND DROP CABLE , NT Compatible</b>			
UFH9501R	FTTx ROUND 1C, Stranded Drop Cable, LSZH (Self-Support)	1,000* M. /Reel	7,410.- /Reel
UFH9502R	FTTx ROUND 2C, Stranded Drop Cable, LSZH (Self-Support)	1,000* M. /Reel	10,195.- /Reel
Project UFH9501R-TOT	FTTx ROUND 1C, Stranded Drop Cable, FR-PE (Self-Support)	1,000* M. /Reel	8,085.- /Reel
Obsolete2b UFH9502R-TOT	FTTx ROUND 2C, Stranded Drop Cable, FR-PE (Self-Support)	1,000* M. /Reel	10,665.- /Reel
Obsolete2b UFH9501RA	FTTx ROUND 1C, Stranded Drop Cable, LSZH (Self-Support)	1,000* M. /Reel	13,205.- /Reel
Project UFH9501RA-TOT	FTTx ROUND ARMORED 1C, Solid Drop Cable, LSZH (Self-Support)	1,000* M. /Reel	14,675.- /Reel
Obsolete2b UFH9502RA-TOT	FTTx ROUND ARMORED 2C, Solid Drop Cable, LSZH (Self-Support)	1,000* M. /Reel	16,345.- /Reel

## FTTH ROUND PATCH CORD AND ACCESSORIES

UFP966S42-03-01	OFTK, SC/APC to SC/APC Indoor/Outdoor Patch cord 3.5 mm., SM G.657B3, LSZH , 3M.	220.-
-----------------	--	-------



### FTTR / FTTH = Fiber Optic to the ROOM HOME

1. FTTH เป็นชื่อเรียกกลาง ๆ โดยเดิมเป็นการนำสาย Fiber Optic ชนิด 1C มาเดินเพื่อให้บริการ Internet ความเร็วสูงแก่บ้านเรือนหรือห้องพักในคอนโดมิเนียม จึงเรียกสายประเภทนี้ว่า สาย FTTH (Fiber Optic to the HOME) และในเวลาต่อมาได้นำไปใช้งานที่หลากหลายมากขึ้น จึงเรียกชื่อตามการนำไปติดตั้ง ณ จุดใช้งาน เช่น จะเป็น H (Home) , ห้อง R (Room) , D (Desk) เป็นต้น
2. FTTR เป็นชื่อเรียก Solution ที่ใช้เดินสาย Fiber Optic ไปยังห้องใน Condominium , Apartment , โรงแรม , โรงพยาบาล , Residence เพื่อรองรับ Internet Operation ไม่ต้องมาติดตั้งสายสัญญาณ Fiber ใหม่ และสามารถเชื่อมต่อสัญญาณ Internet ไปยังจุดใช้งานได้ทันที เพื่อให้บริการระบบ INTERNET , ระบบโทรศัพท์ , สัญญาณดิจิทัล , สัญญาณ TV ระบบ Streaming ซึ่งสามารถดูหนัง ฟังเพลง , YouTube , N , Zoom ฯลฯ ผ่าน Core Fiber เพียง 1 Core โดยสาย FTTR 1 Core สามารถรองรับ Application ได้มากมาย และกำลังได้รับความนิยมใช้สาย FTTR มากกระจายติดตั้งให้ตาม โรงแรม , Condominium, Apartment, ห้องพักในโรงพยาบาล หรือแม้แต่อาคารหอพัก หรือ ติดตั้งในโครงการบ้านจัดสรร สามารถเลือกให้ Operator มา Plug-in ที่ระบบส่วนกลาง ทำให้ User สามารถเปลี่ยน Operator ได้โดยไม่มีข้อจำกัด และไม่ก่อให้เกิดปัญหา สัญญาณขาดๆหายๆ เพราะ การเดิน สาย FTTR นี้ เป็น ระบบ FTTR Open Cabling System



## FTTR / FTTH System



**UFH5113 / UFH5108**

OPERATOR RACK / FTTR - 1008 MDF 42U

## FTTR-1008 DISTRIBUTION UNIT MDF , OPERATOR RACK

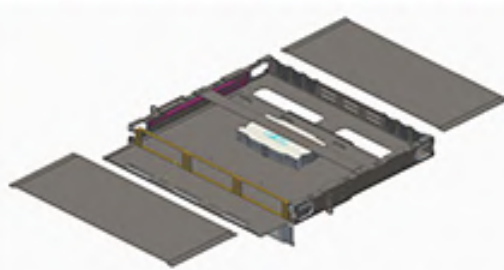

**UFH4083** : FDU DOUBLE - Q SLIDE 12- 36F, w/ Splice Tray & Acc.

## FTTR-1008 SMART OUTLET & FLOOR DISTRIBUTION



**UFH3112 / UFH3113**

12-24F , FTTR-1008 FLOOR DISTRIBUTION UNIT w/12 or 24 SC / APC Adapter & Pigtail (W 270 x H 335 x D 95 mm.)



**UFH3110 / UFH3111 / UFH3111A4**

FTTR-1008 SMART OUTLET ( 2" x 4" FACE PLATE)



**UFH3114**

24-48 FTTR DISTRIBUTION CABINET w/o Adapter & Pigtail (W 440 x H 400 x D 90 mm)



**UFH3002**

FTTR-1008 ACCESS TERMINAL BOX with 2x SC / APC (W 128 x W 190 x D 44 mm.)

## FTTH @ ROOM DISTRIBUTION & OLD OUTLET



**UF-1014** : 4 Port Fiber Termination Box w/o Adapter (W152 x H112 x D30 mm. )



**UFH3022 / UFH3026** : FTTR Shutter OUTLET Wall Mount



## SPARE PART , FUSION SPLICE PROTECTOR & SLEEVE



**SV-2252SET**

HEAT SHRINK SET AND SLEEVE O.D 5.0 MM.



**SV-2253-10**

PROTECTOR SLEEVE O.D 5.0 MM.

www.interlink.co.th  
Tel. 02-668-1111  
Think of Cabling ... Think INTERLINK

PRICE LIST 2569



# FTTR-1008 MDF / FDU DISTRIBUTION & OUTLET



P/N	DESCRIPTION	PRICE /m.
-----	-------------	-----------

## FTTR-1008 MDF DISTRIBUTION UNIT (RACK MOUNT), DOUBLE Q SERIES Effective P80 1 APRIL 2026

<b>UFH5108</b>	<b>FTTR-1008 MDF 42U w/2 Side Cable Management (ODF / MDF)</b> <i>(MDF = Main Distribution Frame ; Optical Distribution Frame)</i>	<b>24,300.-</b>
<b>UFH5113</b> <i>Obsolete26</i> CN-61142FTR	<b>FTTR-1008 THREE OPERATOR CABINET RACK 42U (Operator Rack)</b> <i>FTTR MAIN DISTRIBUTION FRAME 42U , Complete Set</i>	<b>37,750.-</b> 24,630.-
<b>UFH4083</b>	<b>FDU DOUBLE - Q SLIDE 12- 36F, w/ Splice Tray , Unload ( 1U )</b>	<b>3,860.-</b>
<b>UFH4085</b>	<b>FDU DOUBLE - Q SLIDE 12- 72F, w/ Splice Tray , Unload ( 2U )</b>	<b>4,800.-</b>
<b>UF-4082A</b>	FDU SLIDE 12- 24F, w/ Tray & Acc. , Unload	<b>3,730.-</b>
<b>UF-4084A</b> <i>Obsolete26</i>	FDU SLIDE 24- 48F, Slide , w/ Tray & Acc. , Unload	<b>4,675.-</b>
<b>UF-4086A</b>	FDU SLIDE 48- 72F, Slide , w/ Tray & Acc. , Unload	<b>5,395.-</b>
<b>UF-2155SM-APC</b> <i>Obsolete26</i> UF-2166SM-APC	<b>6 SC Simplex Snap-In DOUBLE - Q Adapter PLATE (SC /APC, 6F)</b>	<b>230.-</b>
	3 SC Duplex Snap-In DOUBLE - Q Adapter PLATE (SC /APC, 6F)	190.-
<b>UF-2255SM-APC</b> <i>Obsolete26</i> UF-2266SM-APC	<b>12 SC Simplex Snap-In DOUBLE - Q Adapter PLATE (SC /APC, 12F)</b>	<b>360.-</b>
	6 SC Duplex Snap-In DOUBLE - Q Adapter PLATE (SC /APC, 12F)	270.-

## FTTR-1008 SMART OUTLET & FLOOR DISTRIBUTION, DOUBLE Q SERIES

<b>UFH3110</b>	<b>FTTR-1008 SMART OUTLET , 1 Port , with SC /APC , Double-Q ( Complete Set )</b>	<b>300.-</b>
<b>UFH3111</b>	<b>FTTR-1008 SMART OUTLET , 2 Port , with SC /APC , Double-Q ( Complete Set )</b>	<b>380.-</b>
<b>UFH3111A4</b>	<b>FTTR-1008 SMART OUTLET , 4 Port , with SC /APC , Double-Q ( Complete Set )</b>	<b>700.-</b>
<b>UFH3112</b>	<b>FTTR-1008 FLOOR DISTRIBUTION UNIT With , 12 SC /APC , Double-Q ( Complete Set )</b>	<b>3,000.-</b>
<b>UFH3113</b>	<b>FTTR-1008 FLOOR DISTRIBUTION UNIT With , 24 SC /APC , Double-Q ( Complete Set )</b>	<b>3,650.-</b>
<b>UFH3114</b> <i>Obsolete26</i>	<b>FTTR DISTRIBUTION CABINET w/o Adapter &amp; Pigtail ( 24-48 F )</b>	<b>4,200.-</b>
<b>UFH3002</b>	<b>FTTR-1008 ACCESS TERMINAL BOX With , 2 SC /APC , Double-Q ( Complete Set )</b>	<b>400.-</b>

## FTTH @ ROOM DISTRIBUTION BOX & OLD SHUTTER & OLD SQUARE OUTLET

<b>UFH3022</b> <i>Obsolete26</i>	<b>FTTR Shutter Vertical OUTLET Wall Mount w/o Adapter (W x H = 8.5 x 12.9 cm.)</b>	<b>125.-</b>
<b>UFH3026</b> <i>Obsolete26</i>	<b>FTTR Square OUTLET Wall Mount w/o Adapter (W x H = 8.6 x 8.6 cm.)</b>	<b>100.-</b>
<b>UF-1014</b> <i>Obsolete26</i>	<b>4 Port Fiber Distribution Box w/o Adapter (W 152 x H 112 x D 30 mm.)</b>	<b>150.-</b>
<b>UF-0055SM-APC</b>	<b>SC /APC SIMPLEX Double-Q ADAPTER, Green housing , Singlemode</b>	<b>19.-</b>

## SPARE PART , FUSION SPLICE PROTECTOR & SLEEVE

<b>SV-2252A-12</b>	<b>Fusion Splice Protector Sleeve , O.D. 2.5 mm. , L = 60 mm. (12 Pcs. / Pkg.)</b>	<b>20.- /Pkg.</b>
<b>SV-2253-10</b>	<b>Fusion Splice Protector Sleeve , O.D. 5.0 mm. , L = 60 mm. (10 Pcs / Pkg.)</b>	<b>40.- /Pkg.</b>
<b>SV-2252SET</b>	<b>HEAT SHRINK with Protector Sleeve for FLAT FTTH (10 Shrink , 10x Sleeve )</b>	<b>380.- /Set</b>

## FTTR / FTTH System



**UFP960S02-1.5**    **UFP960S22-1.5**  
SC/APC Pigtail, SM/OS2, Simplex



**UFH3011**  
SC/UPC Field Install Connector  
( Flat Cable )



**UFH3012**  
SC/APC Field Install Connector  
( Flat Cable )



**UFH-31XX**  
BLOCKLESS PLC Splitter 1M.



**UFH-83XX**  
MODULE Type PLC Splitter 2 M.



**UF-3042S**  
Aerial Outdoor Straight Joint Closure UNIT, Snap in  
(ใช้ได้กับทั้งสายแบนและสายกลม)



**UF-3042SP**  
Aerial Outdoor Splitter Closure UNIT, Snap in  
(ใช้ได้กับทั้งสายแบนและสายกลม)



**UF-2841B**  
BLUE ADVANCE FUSION SPLICER SET



**UF-2851**  
FIELD MICROSCOPE 400X



**UF-2872H**  
F.O. HANDHELD OTDR 22 / 20 dB



**UF-2874A**  
F.O. PRO OTDR 28 / 26 / 26 dB  
(1310 / 1550 nm, SC / UPC)    (1310 / 1550 / 1625 nm, SC / UPC)

Think of Cabling ... Think INTERLINK ... Tel. 02-668-1111    www.interlink.co.th

PRICE LIST 2569



# FTTR / FTTH PIGTAIL & PATCH CORD, SPLITTER



P/N	DESCRIPTION	PRICE /m.
<b>PIGTAIL &amp; PATCH CORD for DOUBLE Q SERIES</b>		
UFP960S02-1.5	SC /APC Double-Q PIGTAIL, SM /os2, Simplex, [ 0.9 mm. ]	62.-
UFP960S22-1.5	SC /APC Double-Q PIGTAIL, SM /os2, Simplex, [ 2.0 mm. ]	66.-
UFP966S22-03	SC /APC - SC /APC Double-Q PATCH CORD, SM /os2, Simplex 3 M.	127.-
UFP968S22-03	SC /APC - FC /APC Double-Q PATCH CORD, SM /os2, Simplex 3 M.	140.-
<b>F.O FIELD INSTALLATION CONNECTOR</b>		
UFH3011	SC /UPC Field Install Connector, Blue for OVAL / FLAT Cable, Blue	160.-
UFH3012	SC /APC Field Install Connector, Green for OVAL / FLAT Cable, Green	165.-
<b>PLC SPLITTER BLOCKLESS (XX = RATIO ; 02 (1X2), 04 (1X4), 08 (1X8), 16 (1X16), 32 (1X32))</b>		
UFH8102	PLC Double-Q Splitter Module 1 X 2 SC /APC, 1 m. [Blockless]	330.-
UFH8104	PLC Double-Q Splitter Module 1 X 4 SC /APC, 1 m. [Blockless]	385.-
UFH8108	PLC Double-Q Splitter Module 1 X 8 SC /APC, 1 m. [Blockless]	440.-
UFH8116	PLC Double-Q Splitter Module 1 X 16 SC /APC, 1 m. [Blockless]	870.-
UFH8132	PLC Double-Q Splitter Module 1 X 32 SC /APC, 1 m. [Blockless]	1,615.-
<b>PLC SPLITTER MODULE TYPE (XX = RATIO ; 02 (1X2), 04 (1X4), 08 (1X8), 16 (1X16), 32 (1X32))</b>		
UFH8302	PLC Double-Q Splitter Module 1 X 2 SC /APC, 2 m. [Module Type]	420.-
UFH8304	PLC Double-Q Splitter Module 1 X 4 SC /APC, 2 m. [Module Type]	500.-
UFH8308	PLC Double-Q Splitter Module 1 X 8 SC /APC, 2 m. [Module Type]	660.-
UFH8316	PLC Double-Q Splitter Module 1 X 16 SC /APC, 2 m. [Module Type]	1,100.-
UFH8332	PLC Double-Q Splitter Module 1 X 32 SC /APC, 2 m. [Module Type]	2,090.-
<b>AERIAL JOINT STRAIGHT CLOSURE &amp; JOINT w/CLOSURE &amp; SPLITTER</b>		
UF-3042S	FTTH Aerial Outdoor Straight Joint Closure UNIT [ Suitable with Flat & Round Cable ]	1,700.-
UF-3042SP	FTTH Aerial Outdoor w/Splitter 1 x 8 Closure UNIT [ Suitable with Flat & Round Cable ]	2,170.-
<b>F.O. TOOL &amp; TESTETR , PROFESSIONAL INSTALLER</b>		
UF-2841B	F.O. BLUE ADVANCE FUSION SPLICER SET	33,900.-
UF-2851	F.O. MICROSCOPE 400X w/ST, SC, FC & LC adapter	3,530.-
UF-2872H	F.O. HANDHELD OTDR 22/20 dB [ 1310 / 1550 nm. ] ; SC /UPC [ 80 Km. ]	15,500.-
UF-2874A	F.O. PRO OTDR 28/26/26 dB [ 1310 / 1550 / 1625 nm. ] ; SC /UPC [ 80 Km. ]	40,510.-
UFC6200	CLEAR 900 μm, Buffer TUBE [ 1,000 M. /Roll ] <i>ท่อใส่ป้องกันสำหรับสวมที่ตอนเข้าหัวสาย</i>	10.- /m.

Think of Cabling ... Think@ INTERLINK Tel: 02-666-1111 www.interlink.co.th

PRICE LIST 2569

82



# DATA CENTER FIBER PATCH PANEL



DATA CENTER Interconnect

FIBER SLIDE PANEL FDU / LGX SLIDE PATCH PANEL, **DOUBLE Q** SERIES

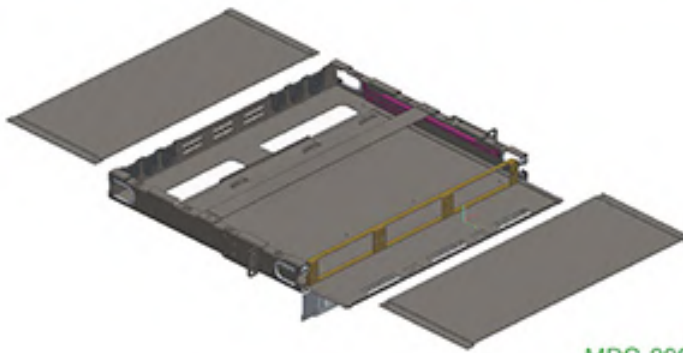

MDC-2003LGX / 2006LGX  
FDU / LGX SLIDE PANEL 1U / 2U

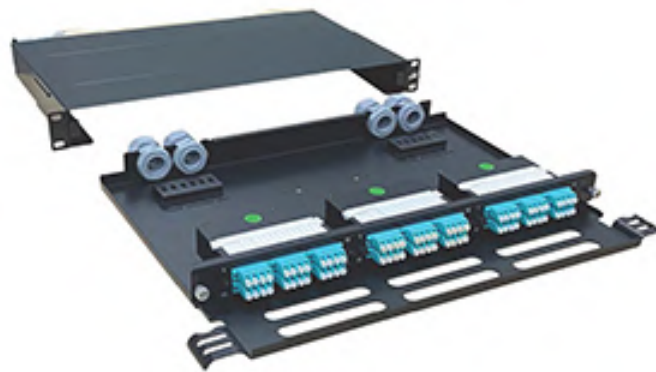

MDC-2017A



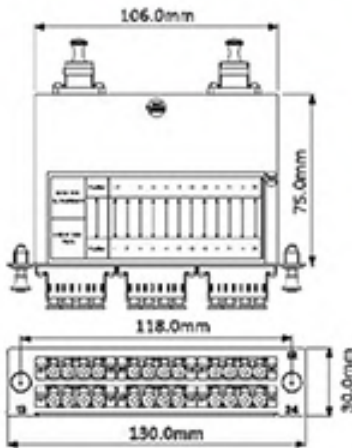



MPO / LGX CASSETTES, **DOUBLE Q** SERIES



MPO Cassette \*Use with MDC-2017A

1-6 MPO Type MDC-20	7 Fiber Type 9	8 Connector A 4	9 Connector B 3	10 Method A
MDC-20 MPO Cassette	9 OS2 4 OM3 3 OM4 2 OM5	2 MPO-8 3 MPO-12 4 MPO-2*12 5 MPO-24 6 MPO-2*24	1 4*LC Duplex 2 8*LC Duplex 3 12*LC Duplex 4 3*MPO-8 5 6*MPO-8 6 4*MPO-12	A Method A B Method B C Method C

Think of Cabling ... Think INTERLINK ... Tel. 02-668-1111 www.interlink.co.th

P/N	DESCRIPTION	UNIT PRICE
<b>MPO DATA CENTER PATCH &amp; CASSETTE , DOUBLE Q SERIES</b>		Effective P84 1 APRIL 2026
 <b>MDC -2003LGX</b>	<b>DOUBLE - Q FDU / LGX 3 Slots , SLIDE PANEL 1 U</b>	<b>3,840.-</b>
 <b>MDC -2006LGX</b>	<b>DOUBLE - Q FDU / LGX 6 Slots , SLIDE PANEL 2 U</b>	<b>4,850.-</b>
Obsolète26 <b>MDC -2017A</b>	<b>FIBER SLIDE PANEL, w/Support bar &amp; door cover</b>	<b>6,500.-</b>
<b>MDC -20331A</b>	<b>1 x 12F DOUBLE - Q MPO to 8 LC CASSETTE (LGX) , OM4</b>	<b>2,230.-</b>
 <b>MDC -20332A</b>	<b>1 x 12F DOUBLE - Q MPO to 12 LC CASSETTE (LGX) , OM4</b>	<b>2,270.-</b>
 <b>MDC -20333A</b>	<b>2 x 12F DOUBLE - Q MPO to 24 LC CASSETTE (LGX) , OM4</b>	<b>4,070.-</b>
Obsolète26 <b>MDC -20353A</b>	<b>1 x 24F DOUBLE - Q MPO to 24 LC CASSETTE (LGX) , OM4</b>	<b>3,890.-</b>
<b>MDC -20344A</b>	<b>2 x 12F DOUBLE - Q MPO to 3 x 8 MPO MIGRATION CASSETTE (LGX) , OM4</b>	<b>3,540.-</b>
 <b>MDC -20366A</b>	<b>2 x 24F DOUBLE - Q MPO to 4 x 12 MPO MIGRATION CASSETTE (LGX) , OM4</b>	<b>5,690.-</b>
<b>MDC -20365A</b>	<b>2 x 24F DOUBLE - Q MPO to 6 x 8 MPO MIGRATION CASSETTE (LGX) , OM4</b>	<b>6,270.-</b>
<b>MDC -20231A</b>	<b>1 x 12F DOUBLE - Q MPO to 8 LC CASSETTE (LGX) , OM5</b>	<b>2,380.-</b>
 <b>MDC -20232A</b>	<b>1 x 12F DOUBLE - Q MPO to 12 LC CASSETTE (LGX) , OM5</b>	<b>2,420.-</b>
<b>MDC -20243A</b>	<b>2 x 12F DOUBLE - Q MPO to 24 LC CASSETTE (LGX) , OM5</b>	<b>4,390.-</b>
Obsolète26 <b>MDC -20253A</b>	<b>1 x 24F DOUBLE - Q MPO to 24 LC CASSETTE (LGX) , OM5</b>	<b>4,200.-</b>
<b>MDC -20244A</b>	<b>2 x 12F DOUBLE - Q MPO to 3 x 8 MPO MIGRATION CASSETTE (LGX) , OM5</b>	<b>3,850.-</b>
<b>MDC -20266A</b>	<b>2 x 24F DOUBLE - Q MPO to 4 x 12 MPO MIGRATION CASSETTE (LGX) , OM5</b>	<b>6,160.-</b>
<b>MDC -20265A</b>	<b>2 x 24F DOUBLE - Q MPO to 6 x 8 MPO MIGRATION CASSETTE (LGX) , OM5</b>	<b>6,740.-</b>
<b>MDC -20931A</b>	<b>1 x 12F DOUBLE - Q MPO to 8 LC CASSETTE (LGX) , OS2</b>	<b>2,590.-</b>
 <b>MDC -20932A</b>	<b>1 x 12F DOUBLE - Q MPO to 12 LC CASSETTE (LGX) , OS2</b>	<b>2,630.-</b>
 <b>MDC -20943A</b>	<b>2 x 12F DOUBLE - Q MPO to 24 LC CASSETTE (LGX) , OS2</b>	<b>4,800.-</b>
Obsolète26 <b>MDC -20953A</b>	<b>1 x 24F DOUBLE - Q MPO to 24 LC CASSETTE (LGX) , OS2</b>	<b>5,800.-</b>
<b>MDC -20944A</b>	<b>2 x 12F DOUBLE - Q MPO to 3 x 8 MPO MIGRATION CASSETTE (LGX) , OS2</b>	<b>5,220.-</b>
 <b>MDC -20966A</b>	<b>2 x 24F DOUBLE - Q MPO to 4 x 12 MPO MIGRATION CASSETTE (LGX) , OS2</b>	<b>9,660.-</b>
<b>MDC -20965A</b>	<b>2 x 24F DOUBLE - Q MPO to 6 x 8 MPO MIGRATION CASSETTE (LGX) , OS2</b>	<b>16,110.-</b>

**ON REQUEST :** 1. Standard Stock is MPO connector. MTP® connector is available upon request with additional cost and approx 4 weeks lead time  
 2. High-Density MPO Patch Panel is available upon request



# MPO PATCH CORD & TRUNK CABLE



DATA CENTER Interconnect

## MPO / MPO FIBER PATCH CORD , DOUBLE Q SERIES

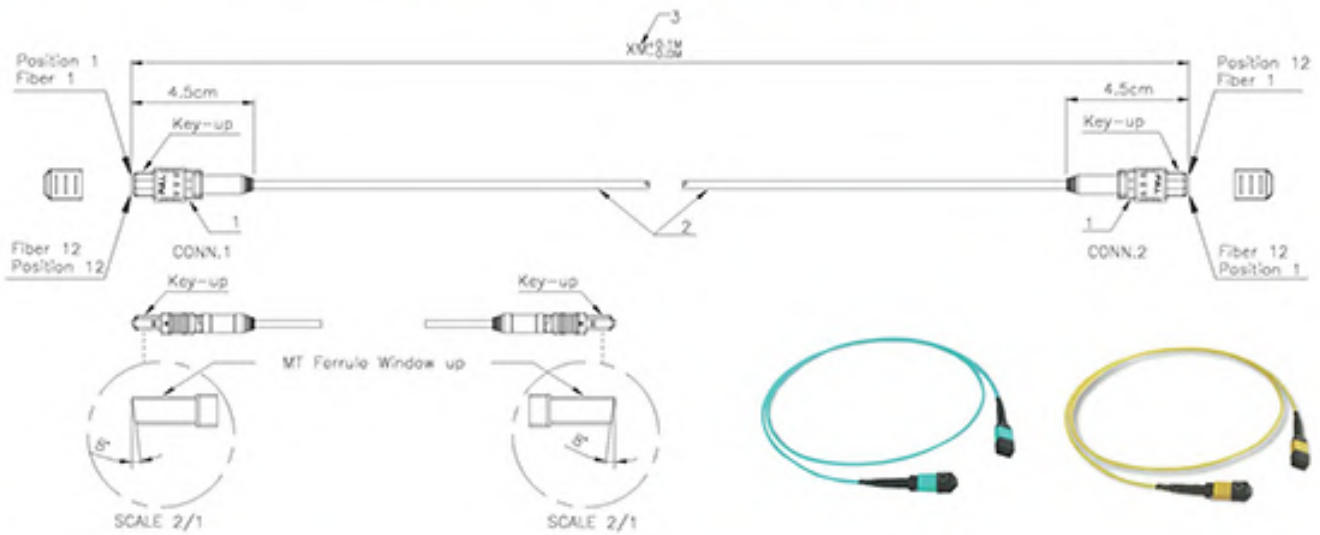

### Specification : Singlemode

1. MPO(Short boot) Connector : Key up to Key up, Female to Female.

Mode	MT Ferrule	Housing	Boot	Cap
SM APC	12 Fibers SM Black(PPS)	Green(PBT)	Black(TPV)	Black(TPV)
SM Low Loss	12 Fibers SM Low Loss Black(PPS)	Yellow(PBT)	Black(TPV)	Black(TPV)

2. Cable Type : 12C Round

Category	Jacket O.D.	Jacket Material	Color
G.652D(9/125um)	ø3.0mm	PVC DFNR/PVC DFNP/LSFRZH	Yellow
G.657A2(9/125um)	ø3.0mm	PVC DFNR/PVC DFNP/LSFRZH	Yellow

3. Length : X Meter

### Specification : Multimode

1. MPO(Short boot) Connector : Key up to Key up, Female to Female.

Mode	MT Ferrule	Housing	Boot	Cap
MM	12 Fibers MM Black(PPS)	Ivory/Aqua/Violet/Lime Green(PBT)	Black(TPV)	Black(TPV)
MM Low Loss	12 Fibers MM Low Loss Black(PPS)	Aqua/Violet/Lime Green(PBT)	Black(TPV)	Black(TPV)

2. Cable Type : 12C Round

Category	Jacket O.D.	Jacket Material	Color
OM3(62.5/125um)	ø3.0mm	PVC DFNR/PVC DFNP/LSFRZH	Orange
OM2(50/125um)	ø3.0mm	PVC DFNR/PVC DFNP/LSFRZH	Orange
OM3(50/125um)	ø3.0mm	PVC DFNR/PVC DFNP/LSFRZH	Aqua
OM4(50/125um)	ø3.0mm	PVC DFNR/PVC DFNP/LSFRZH	Aqua/Violet
OM5(50/125um)	ø3.0mm	PVC DFNR/PVC DFNP/LSFRZH	Lime Green

3. Length : X Meter

## MPO / LC FIBER ARRAY HARNESS CORD , DOUBLE Q SERIES



## MPO / MPO FIBER TRUNK CABLE , DOUBLE Q SERIES

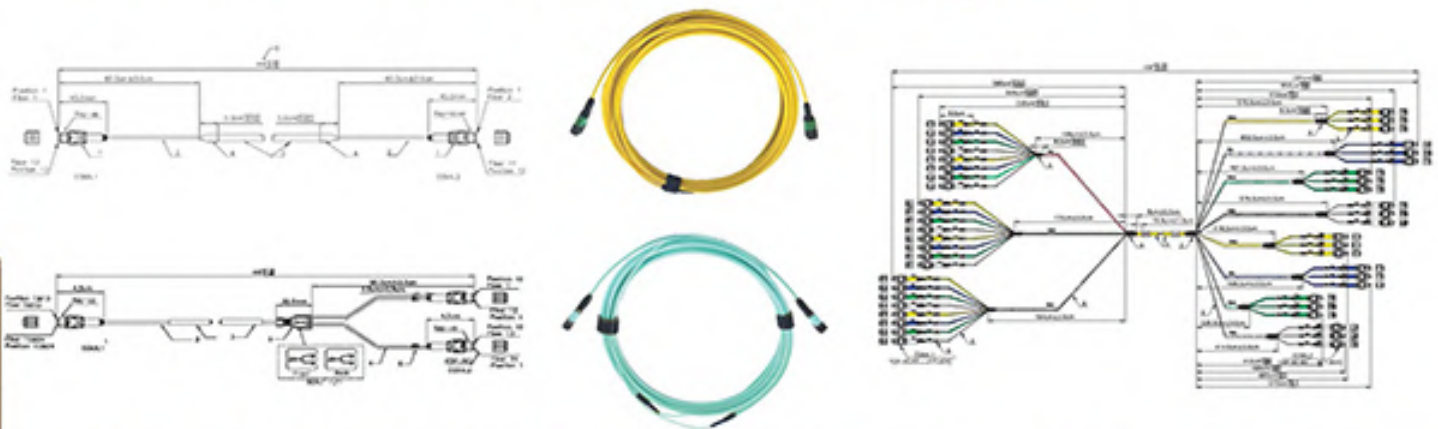

DOUBLE Q SERIES; Quality Beyond Standard & Quick & Easy Installation

MPO=Multi-fiber Push On

UPC=Ultra Physical Contact

PC=Physical

APC=Angle Physical Contact

P/N	DESCRIPTION	PRICE / SET
<b>MPO / MPO FIBER PATCH CORD , DOUBLE Q SERIES</b>		
		Effective P86 1 APRIL 2026
MUB333B1-L003M	MPO (F) - MPO (F) PATCH CORD , <b>OM4</b> , OFNP 12 F, "B"	3 M. 1,360.-
MUB333B1-L005M	MPO (F) - MPO (F) PATCH CORD , <b>OM4</b> , OFNP 12 F, "B"	5 M. 1,570.-
MUB333B1-L010M	MPO (F) - MPO (F) PATCH CORD , <b>OM4</b> , OFNP 12 F, "B"	10 M. 2,100.-
MUB333B1-L020M	MPO (F) - MPO (F) PATCH CORD , <b>OM4</b> , OFNP 12 F, "B"	20 M. 3,150.-
MUB333B1-L030M	MPO (F) - MPO (F) PATCH CORD , <b>OM4</b> , OFNP 12 F, "B"	30 M. 4,200.-
MUB333B1-L050M	MPO (F) - MPO (F) PATCH CORD , <b>OM4</b> , OFNP 12 F, "B"	50 M. 6,300.-
MUB333B1-L100M	MPO (F) - MPO (F) PATCH CORD , <b>OM4</b> , OFNP 12 F, "B"	100 M. 11,550.-
MUB933B1-L010M	MPO (F) - MPO (F) PATCH CORD , <b>SM</b> , OFNP 12 F, "B"	10 M. 1,850.-
MUB933B1-L020M	MPO (F) - MPO (F) PATCH CORD , <b>SM</b> , OFNP 12 F, "B"	20 M. 2,170.-
MUB933B1-L030M	MPO (F) - MPO (F) PATCH CORD , <b>SM</b> , OFNP 12 F, "B"	30 M. 2,490.-
MUB933B1-L040M	MPO (F) - MPO (F) PATCH CORD , <b>SM</b> , OFNP 12 F, "B"	40 M. 2,810.-
MUB933B1-L050M	MPO (F) - MPO (F) PATCH CORD , <b>SM</b> , OFNP 12 F, "B"	50 M. 3,140.-
MUB933B1-L100M	MPO (F) - MPO (F) PATCH CORD , <b>SM</b> , OFNP 12 F, "B"	100 M. 4,760.-
MUB343B2-L005M	24X MPO(F) - 2 x 12 MPO (F) PATCH CORD , <b>OM4</b> , OFNP 24 F, "B"	5 M. 2,750.-
MUB343B2-L010M	24X MPO(F) - 2 x 12 MPO (F) PATCH CORD , <b>OM4</b> , OFNP 24 F, "B"	10 M. 3,800.-

<b>MPO / LC FIBER ARRAY HARNESS CORD , DOUBLE Q SERIES</b>		
MUD325B0-L003M	1 x 8F MPO - 4XLC Duplex ARRAY CORD , <b>OM4</b> , OFNP 8F, "B"	3 M. 1,470.-
MUD325B0-L005M	1 x 8F MPO - 4XLC Duplex ARRAY CORD , <b>OM4</b> , OFNP 8F, "B"	5 M. 1,640.-
MUD325B0-L010M	1 x 8F MPO - 4XLC Duplex ARRAY CORD , <b>OM4</b> , OFNP 8F, "B"	10 M. 2,050.-
MUD336B1-L003M	1 x 12F MPO - 6XLC Duplex ARRAY CORD , <b>OM4</b> , OFNP 12F, "B"	3 M. 1,890.-
MUD925B0-L003M	1 x 8F MPO - 4XLC Duplex ARRAY CORD , <b>SM</b> , OFNP 8F, "B"	3 M. 1,580.-
MUD925B0-L005M	1 x 8F MPO - 4XLC Duplex ARRAY CORD , <b>SM</b> , OFNP 8F, "B"	5 M. 1,630.-
MUD925B0-L010M	1 x 8F MPO - 4XLC Duplex ARRAY CORD , <b>SM</b> , OFNP 8F, "B"	10 M. 1,760.-
MUD936B1-L003M	1 x 12F MPO - 6XLC Duplex ARRAY CORD , <b>SM</b> , OFNP 12F, "B"	3 M. 1,900.-

<b>MPO / MPO FIBER TRUNK CABLE , DOUBLE Q SERIES</b>			Start Base	Add Per M.
MUP333A4-LxxxM	1 x 12F MPO - 1 x 12F MPO TRUNK CABLE , <b>OM4</b> , OFNP 12F, "A"	1 M.+	1,050.-/M.	142.-/M.
MUP343A5-LxxxM	1 x 24F MPO - 2 x 12F MPO TRUNK CABLE , <b>OM4</b> , OFNP 24F, "A"	1 M.+	2,180.-/M.	262.-/M.
MUP344A5-LxxxM	1 x 24F MPO - 1 x 24F MPO TRUNK CABLE , <b>OM4</b> , OFNP 24F, "A"	1 M.+	2,280.-/M.	246.-/M.
MUP933A4-LxxxM	1 x 12F MPO - 1 x 12F MPO TRUNK CABLE , <b>SM</b> , OFNP 12F, "A"	1 M.+	1,520.-/M.	65.-/M.
MUP943A5-LxxxM	1 x 24F MPO - 2 x 12F MPO TRUNK CABLE , <b>SM</b> , OFNP 24F, "A"	1 M.+	3,130.-/M.	110.-/M.
MUP944A5-LxxxM	1 x 24F MPO - 1 x 24F MPO TRUNK CABLE , <b>SM</b> , OFNP 24F, "A"	1 M.+	4,350.-/M.	95.-/M.

MPO FIBER PATCH CORD / MPO FIBER ARRAY CORD

1-3 Cable Type MMA	4 Fiber Type B	5 Connector A B	6 Connector B B	7 Method A	8 Fiber core A	9 - -	10 Loss L	11 - 13 Length 000	14 Unit M
MJA Patch Cord U2H	3 OM3	2 MPO-B	2 MPO-B	A Method A	3 8P	-	B Standard Loss	000 - 999 Feet	F : Feet
MJB Patch Cord Plenum	4 OM3	3 MPO-SE	3 MPO-SE	B Method B	4 12P	-	L Low Loss	001 - 300 Meter	M : Meter
MJC Array U2H	3 OM4	4 MPO-B4	4 MPO-B4	C Method C	5 8P	-			
MJD Array Plenum	4 OM4	5 MPO/WPO-B MM	5 4PLC Duplex		6 40P	-			
			6 8PLC Duplex		7 75P	-			
			7 12PLC Duplex		8 8P	-			
			8 16PLC Duplex		9 12P	-			
			9 MPO/WPO-B MM		10 16P	-			

MPO FIBER TRUNK CABLE

1-3 Cable Type MMM	4 Fiber Type B	5 Connector A B	6 Connector B B	7 Method A	8 Fiber core A	9 - -	10 Loss L	11 - 13 Length 000	14 Unit M
MMM Trunk U2H	3 OM3	2 MPO-B	2 MPO-B	A Method A	3 8P	-	B Standard Loss	000 - 999 Feet	F : Feet
MMP Trunk Plenum	4 OM3	3 MPO-SE	3 MPO-SE	B Method B	4 12P	-	L Low Loss	001 - 300 Meter	M : Meter
	3 OM4	4 MPO-B4	4 MPO-B4	C Method C	5 8P	-			
	4 OM4	5 MPO/WPO-B MM	5 4PLC Duplex		6 40P	-			
			6 8PLC Duplex		7 75P	-			
			7 12PLC Duplex		8 8P	-			
			8 16PLC Duplex		9 12P	-			
			9 MPO/WPO-B MM		10 16P	-			

Think of Cabling ... Think@ INTERLINK Tel: 02-888-1111 www.interlink.co.th

www.interlink.co.th  
Tel. 02-668-1111  
Think of Cabling ... Think INTERLINK



10G SFP+ DAC  
25G SFP28 DAC



40G QSFP+ DAC



100G QSFP28 DAC



200G QSFP56 DAC



400G QSFP-DD DAC

### How to Select P/N for 10-56G DAC

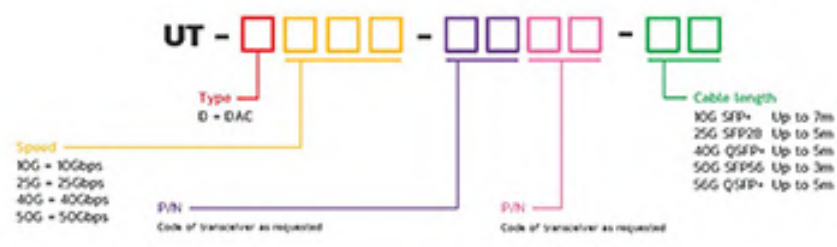

### How to Select P/N for 100-800G DAC



ALL COMPATIBLE / 3 WEEKS DELIVERY / 3 YEAR WARRANTY  
" Seamless Connectivity Across All Brands "































PRICE LIST 2569  
87



#### DAC (Direct Attach Copper Cable)

เป็นสายสัญญาณที่ผลิตมาจากสายเคเบิลทองแดงมีหัวต่อ Transceiver Module มาพร้อมกับสายทั้งสองด้าน โดย Transceiver Module มีความเร็วให้เลือกหลากหลายตามความต้องการเชื่อมต่อ เช่น 10G (SFP+), 40G (QSFP+) และ 100G (QSFP28)

DAC เป็นสายที่ออกแบบมาให้เชื่อมต่อเข้ากับพอร์ต Networking ในระบบ Data Center เช่น Switch, Server หรือ Network Storage เป็นต้น เหมาะสำหรับการนำมาเชื่อมต่ออุปกรณ์ในระยะสั้นภายในตู้ Rack (ToR or EoR) เดียวกัน ทำให้สามารถลดเวลาในการติดตั้งและประหยัดต้นทุนของ Data Center ได้ มีให้เลือกทั้งแบบ Passive และ Active เนื่องจากข้อจำกัดในเรื่องของระยะสาย หากกรณีที่ต้องการความยาวที่มากขึ้น แนะนำให้เลือกใช้สาย AOC แทน

P/N	DESCRIPTION	UNIT PRICE
 UT-D10G-XXYY01	10G SFP+ / 10G SFP+ DAC Cable 1 M.	590.-
 UT-D10G-XXYY03	10G SFP+ / 10G SFP+ DAC Cable 3 M.	820.-
 UT-D10G-XXYY05	10G SFP+ / 10G SFP+ DAC Cable 5 M.	1,290.-
 UT-D10G-XXYY07	10G SFP+ / 10G SFP+ DAC Cable 7 M.	1,730.-
 UT-D25G-XXYY01	25G SFP28 / 25G SFP28 DAC Cable 1 M.	1,190.-
 UT-D25G-XXYY03	25G SFP28 / 25G SFP28 DAC Cable 3 M.	1,520.-
 UT-D25G-XXYY05	25G SFP28 / 25G SFP28 DAC Cable 5 M.	2,170.-
 UT-D40G-XXYY01	40G QSFP+ / 40G QSFP+ DAC Cable 1 M.	1,620.-
 UT-D40G-XXYY03	40G QSFP+ / 40G QSFP+ DAC Cable 3 M.	2,270.-
 UT-D40G-XXYY05	40G QSFP+ / 40G QSFP+ DAC Cable 5 M.	3,330.-
 UT-D50G-XXYY01	50G SFP56 / 50G SFP56 DAC Cable 1 M.	1,550.-
 UT-D50G-XXYY02	50G SFP56 / 50G SFP56 DAC Cable 2 M.	1,730.-
 UT-D50G-XXYY03	50G SFP56 / 50G SFP56 DAC Cable 3 M.	2,230.-
 UT-D56G-XXYY01	56G QSFP+ / 56G QSFP+ DAC Cable 1 M.	1,910.-
 UT-D56G-XXYY03	56G QSFP+ / 56G QSFP+ DAC Cable 3 M.	4,130.-
 UT-D56G-XXYY05	56G QSFP+ / 56G QSFP+ DAC Cable 5 M.	4,870.-
 UT-D01CQS-XXYY01	100G QSFP28 / 100G QSFP28 DAC Cable 1 M.	2,420.-
 UT-D01CQS-XXYY03	100G QSFP28 / 100G QSFP28 DAC Cable 3 M.	3,130.-
 UT-D01CQS-XXYY05	100G QSFP28 / 100G QSFP28 DAC Cable 5 M.	6,310.-
 UT-D02CQD-XXYY01	200G QSFP-DD / 200G QSFP-DD DAC Cable 1 M.	8,800.-
 UT-D02CQS-XXYY01	200G QSFP56 / 200G QSFP56 DAC Cable 1 M.	2,880.-
 UT-D02CQS-XXYY02	200G QSFP56 / 200G QSFP56 DAC Cable 2 M.	3,480.-
 UT-D02CQS-XXYY03	200G QSFP56 / 200G QSFP56 DAC Cable 3 M.	5,150.-
 UT-D04CQD-XXYY01	400G QSFP-DD / 400G QSFP-DD DAC Cable 1 M.	14,520.-
 UT-D04CQD-XXYY02	400G QSFP-DD / 400G QSFP-DD DAC Cable 2 M.	15,890.-
 UT-D04CQD-XXYY03	400G QSFP-DD / 400G QSFP-DD DAC Cable 3 M.	19,210.-
 UT-D04CQS-XXYY01	400G QSFP112 / 400G QSFP112 DAC Cable 1 M.	N / A
 UT-D04CQS-XXYY02	400G QSFP112 / 400G QSFP112 DAC Cable 2 M.	N / A
 UT-D08CQD-XXYY01	800G QSFP-DD / 800G QSFP-DD DAC Cable 1 M.	33,275.-
 UT-D08CQD-XXYY02	800G QSFP-DD / 800G QSFP-DD DAC Cable 2 M.	38,025.-
 UT-D08CQS-XXYY01	800G QSFP / 800G QSFP DAC Cable 1 M.	N / A



# DAC Breakout by Transceiver Clinic ( Direct Attach Copper Cable )



DATA CENTER Interconnect



40G QSFP+ / 4 x 10G SFP+  
DAC Breakout Cable



100G QSFP28 / 4 x 25G SFP28  
DAC Breakout Cable



200G QSFP56 / 2 x 100G QSFP56  
DAC Breakout Cable



400G QSFP-DD / 2 x 200G QSFP56  
DAC Breakout Cable



400G QSFP-DD / 4 x 100G QSFP56  
DAC Breakout Cable



800G QSFP-DD / 2 x 400G QSFP112  
DAC Breakout Cable



800G QSFP / 2 x 400G QSFP112  
DAC Breakout Cable

## How to select P/N for DAC Breakout

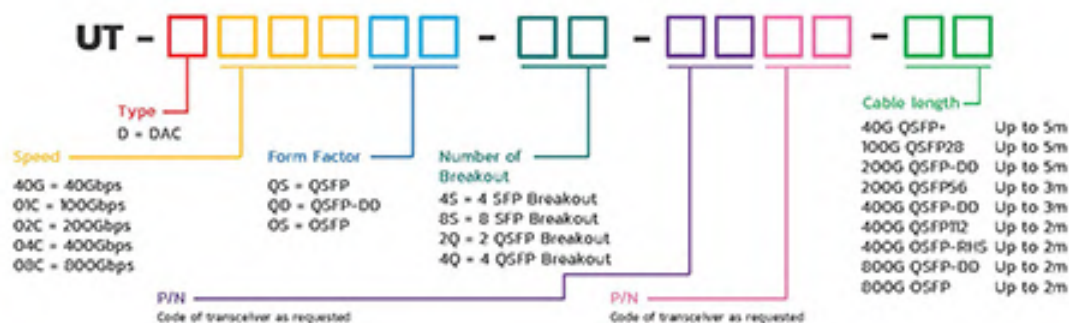

ALL COMPATIBLE / 3 WEEKS DELIVERY / 3 YEAR WARRANTY

" Seamless Connectivity Across All Brands "

**XXYY = CODE OF TRANSCEIVER AS REQUESTED FOR BRANDS**

LC = LINK, CISCO, Allied-Telesis Avago, Cisco Meraki, Check Point, Chelsio, Dahua, D-Link, Delta, EnGenius, Edgecore, FS, Fiberhome, Hikvision, Hillstone, Ruckus, Ruijie, Linksys, Mikrotik, MRV, Moxa, Netgear, Palo Alto, Planet, QNAP, Oscilloquartz, Sophos, Synology, TP-Link, Ubiquity, Zyxel, etc.

HP = Hewlett Packard	AA = Adva / Adtran	AB = Aruba	AL = Alcatel-Lucent	AT = Arista	AY = Avaya
BC = Brocade	CN = Ciena	DL = Dell	ES = Ericsson	ET = Extreme	FN = Fortinet
HC = H3C	HM = Hirschmann	HW = Huawei	IB = IBM	IT = Intel	JP = Juniper
MN = Mellanox, NMDIA	NK = Nokia	SM = Siemens	ZT = ZTE		





PRICE LIST 2569

89

www.interlink.co.th

Tel. 02-668-1111

Think of Cabling ... Think INTERLINK

P/N	DESCRIPTION	UNIT PRICE
UT-D40G0S-4S-XXYY01	40G QSFP+ / 10G 4x SFP+ DAC Breakout Cable 1 M.	2,440.-
 UT-D40G0S-4S-XXYY03	40G QSFP+ / 10G 4x SFP+ DAC Breakout Cable 3 M.	3,180.-
UT-D40G0S-4S-XXYY05	40G QSFP+ / 10G 4x SFP+ DAC Breakout Cable 5 M.	4,270.-
UT-D01C0S-4S-XXYY03	100G QSFP28 / 25G 4x SFP28 DAC Breakout Cable 3 M.	6,050.-
UT-D01C0S-4S-XXYY05	100G QSFP28 / 25G 4x SFP28 DAC Breakout Cable 5 M.	9,270.-
UT-D02C0S-2Q-XXYY01	200G QSFP56 / 100G 2x QSFP56 DAC Breakout Cable 1 M.	4,690.-
UT-D02C0S-2Q-XXYY02	200G QSFP56 / 100G 2x QSFP56 DAC Breakout Cable 2 M.	6,510.-
 UT-D02C0S-2Q-XXYY03	200G QSFP56 / 100G 2x QSFP56 DAC Breakout Cable 3 M.	7,870.-
UT-D04C0D-2Q-XXYY01	400G QSFP-DD / 200G 2x QSFP56 DAC Breakout Cable 1 M.	8,630.-
UT-D04C0D-2Q-XXYY02	400G QSFP-DD / 200G 2x QSFP56 DAC Breakout Cable 2 M.	13,470.-
 UT-D04C0D-2Q-XXYY03	400G QSFP-DD / 200G 2x QSFP56 DAC Breakout Cable 3 M.	18,910.-
UT-D04C0D-4Q-XXYY01	400G QSFP-DD / 100G 4x QSFP56 DAC Breakout Cable 1 M.	9,680.-
UT-D04C0D-4Q-XXYY02	400G QSFP-DD / 100G 4x QSFP56 DAC Breakout Cable 2 M.	14,650.-
 UT-D04C0D-4Q-XXYY03	400G QSFP-DD / 100G 4x QSFP56 DAC Breakout Cable 3 M.	20,650.-
UT-D04C0D-8S-XXYY01	400G QSFP-DD / 50G 8x SFP56 DAC Breakout Cable 1 M.	10,460.-
UT-D04C0D-8S-XXYY02	400G QSFP-DD / 50G 8x SFP56 DAC Breakout Cable 2 M.	15,430.-
UT-D04C0D-8S-XXYY03	400G QSFP-DD / 50G 8x SFP56 DAC Breakout Cable 3 M.	21,440.-
 UT-D08C0D-2Q-XXYY01	800G QSFP-DD / 400G 2x QSFP112 DAC Breakout Cable 1 M.	33,280.-
UT-D08C0S-2Q-XXYY01	800G QSFP / 400G 2x QSFP112 DAC Breakout Cable 1 M.	N / A

Think of Cabling ... Think@ NTERLINK Tel: 02-866-1111 www.terlink.co.th



# AOC by Transceiver Clinic For ALL ( Active Optical Cable )



DATA CENTER Interconnect



10G SFP+ AOC  
25G SFP28 AOC



40G QSFP+ AOC



100G QSFP28 AOC



200G QSFP56 AOC



400G QSFP-DD AOC

## How to select P/N for 100G-800G AOC

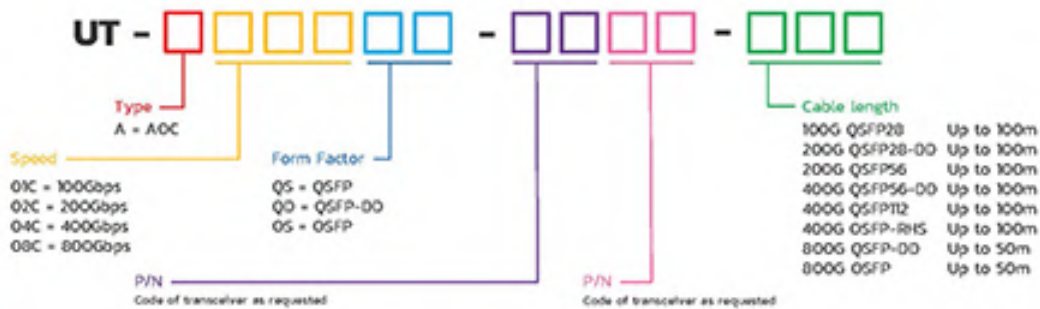

ALL COMPATIBLE / 3 WEEKS DELIVERY / 3 YEAR WARRANTY  
" Seamless Connectivity Across All Brands "

### AOC (Active Optical Cable)

เป็นสายสัญญาณที่ผลิตจากสายใยแก้วนำแสงมีหัวต่อ Transceiver Module มาตรฐานมาพร้อมสายทั้งสองด้าน โดย Transceiver Module มีความเร็วให้เลือกหลากหลายตามความต้องการเชื่อมต่อ เช่น 10G (SFP+), 25G (SFP28), 40G (QSFP+) และ 100G (QSFP28) รองรับความยาวของสายตั้งแต่ 1 - 100 เมตร

AOC เป็นสายที่ออกแบบมาเพื่อใช้งานร่วมกับอุปกรณ์ Networking ในระบบ Data Center เช่น Switch, Server หรือ Network Storage เป็นต้น เหมาะสำหรับการเชื่อมต่ออุปกรณ์ระหว่างตู้ ToR Rack ไปยัง EoR Rack หรือ ข้ามตู้ Rack ทำให้สามารถลดเวลาในการติดตั้งและประหยัดต้นทุนของ Data Center ได้

Think of Cabling ... Think@ INTERLINK Tel. 02-668-1111 www.interlink.co.th

PRICE LIST 2569

P/N	DESCRIPTION	UNIT PRICE	
		BASE	ZZZ M. Effective P92 1 APRIL 2026
 UT-A10G-XXYYZZZ	10G SFP+ / 10G SFP+ AOC Cable ZZZ M.	1,970 +	16.-/m.
 UT-A25G-XXYYZZZ	25G SFP28 / 25G SFP28 AOC Cable ZZZ M.	3,940 +	20.-/m.
 UT-A40G-XXYYZZZ	40G QSFP+ / 40G QSFP+ AOC Cable ZZZ M.	4,840 +	80.-/m.
 UT-A40GQS-4S-XXYYZZZ	40G QSFP+ / 10G 4x SFP+ AOC Breakout Cable ZZZ M.	5,750 +	125.-/m.
UT-A50G-XXYYZZZ	50G SFP56 / 50G SFP56 AOC Cable ZZZ M.	37,150 +	40.-/m.
UT-A56G-XXYYZZZ	56G QSFP+ / 56G QSFP+ AOC Cable ZZZ M.	6,830 +	110.-/m.
 UT-A01CQS-XXYYZZZ	100G QSFP28 / 100G QSFP28 AOC Cable ZZZ M.	5,600 +	300.-/m.
UT-A01CQS-2Q-XXYYZZZ	100G QSFP28 / 50G 2x QSFP28 AOC Breakout Cable ZZZ M.	11,620 +	300.-/m.
 UT-A01CQS-4S-XXYYZZZ	100G QSFP28 / 25G 4x SFP28 AOC Breakout Cable ZZZ M.	8,020 +	300.-/m.
 UT-A02CQD-XXYYZZZ	200G QSFP-DD / 200G QSFP-DD AOC Cable ZZZ M.	37,820 +	150.-/m.
UT-A02CQS-XXYYZZZ	200G QSFP56 / 200G QSFP56 AOC Cable ZZZ M.	21,180 +	300.-/m.
 UT-A02CQS-2Q-XXYYZZZ	200G QSFP56 / 100G 2x QSFP56 AOC Breakout Cable ZZZ M.	30,250 +	300.-/m. (>5 m.)
UT-A02CQS-4S-XXYYZZZ	200G QSFP56 / 50G 4x SFP56 AOC Breakout Cable ZZZ M.	27,700 +	300.-/m. (>5 m.)
 UT-A04CQD-XXYYZZZ	400G QSFP-DD / 400G QSFP-DD AOC Cable ZZZ M.	36,300 +	150.-/m.
UT-A04CQD-2Q-XXYYZZZ	400G QSFP-DD / 200G 2x QSFP56 AOC Breakout Cable ZZZ M.	38,600 +	150.-/m. (>5 m.)
 UT-A04CQD-4Q-XXYYZZZ	400G QSFP-DD / 100G 4x QSFP56 AOC Breakout Cable ZZZ M.	74,620 +	150.-/m. (>5 m.)
UT-A04CQD-8S-XXYYZZZ	400G QSFP-DD / 50G 8x SFP56 AOC Breakout Cable ZZZ M.	N / A	Call
UT-A04CQS-XXYYZZZ	400G QSFP112 / 400G QSFP112 AOC Cable ZZZ M.	N / A	Call
UT-A08CQD-XXYYZZZ	800G QSFP-DD / 800G QSFP-DD AOC Cable ZZZ M.	N / A	Call

Think of Cabling ... Think INTERLINK Tel: 02-866-1111 www.interlink.co.th

PRICE LIST 2569  
92

## COAXIAL (RG) System

SPECIFICATION	STANDARD	ADVANCE	STANDARD+
	LINK	LINK	LINK
PART NUMBER	<b>CB-0109</b>	<b>CB-0106A</b>	<b>CB-0109S+</b>
CONDUCTOR $\varnothing$ mm	Copper Covered Steel 1.02 mm	Copper Covered Steel 1.02 mm	Copper Covered Steel 1.02 mm
DIELECTRIC $\varnothing$ mm	Foamed Polyethylene 4.57 mm	Foamed Polyethylene 4.57 mm	Foamed Polyethylene 4.57 mm
SHIELDED TAPE	AL/P-Foil (Bonded)	AL/P-Foil (Bonded)	AL/P-Foil (Bonded)
BRAID SHIELDED $\varnothing$ mm	Aluminum 0.16 mm x 64 wire	Aluminum 0.12 mm x 144 wire	Aluminum 0.16 mm x 144 wire
COVERAGE %	60%	95%	96%
JACKET $\varnothing$ mm	White PVC 6.86 mm	Black PVC 6.86 mm	Black PVC 6.86 mm

SPECIFICATION			
	LINK	LINK	LINK
PART NUMBER	<b>CB-0108</b>	<b>CB-0106AWB</b>	<b>CB-0109SW+</b>
CONDUCTOR $\varnothing$ mm	Bare Copper 1.02 mm	Copper Covered Steel 1.02 mm	Copper Covered Steel 1.02 mm
DIELECTRIC $\varnothing$ mm	Foamed Polyethylene 4.80 mm	Foamed Polyethylene 4.57 mm	Foamed Polyethylene 4.57 mm
SHIELDED TAPE	AL/P-Foil (Bonded)	AL/P-Foil (Bonded)	AL/P-Foil (Bonded)
BRAID SHIELDED $\varnothing$ mm	Bare Copper 0.12 mm x 168 wire	Aluminum 0.12 mm x 144 wire	Aluminum 0.16 mm x 144 wire
COVERAGE %	95%	95%	96%
JACKET $\varnothing$ mm	Black PVC 6.80 mm	Black PVC 6.86 ± 0.1 mm	Black PVC 6.86 ± 0.1 mm
Over All w/ POWER WIRE $\varnothing$ mm	-	Stranded BC 13.00 mm	Stranded BC 11.56 mm



### LINK Coaxial Cable "คมชัด.....ไม่สะดุด"

เป็นสายที่ออกแบบและผลิตจากสหรัฐอเมริกา โดยเป็นสายที่มีคุณภาพสูง (High Quality Cable)

และมีหลายรุ่นหลายแบบให้เลือก เพื่อความเหมาะสมกับสภาพการติดตั้งดังนี้

- 1.INDOOR เป็นสายที่ออกแบบเพื่อใช้ในอาคาร หรือเดินร้อยท่อ Conduit Jacket ภายนอกทั่วไป มักเป็น PVC สีขาว (บางรุ่นอาจเป็นสีดำได้ ซึ่งไม่มีมาตรฐานบังคับ)
- 2.OUTDOOR เป็นสายที่เดินทั้งภายนอกและภายในอาคาร ฉนวนภายนอกจะเป็น PE (Polyethylene) ที่มีความคงทนต่อสภาพแวดล้อมเป็นพิเศษ และยังมีคุณสมบัติป้องกันน้ำผ่านได้ระดับหนึ่ง(ไม่ควรติดตั้งแช่น้ำ)
- 3.w/Power Wire เป็นสาย Cable ออกแบบ โดยมีสายไฟทั้ง 2 เส้น อยู่ในโครงสร้างด้วย เพื่อนำไฟฟ้าทั้ง DC หรือ AC ไปจ่ายให้อุปกรณ์ปลายทาง
- 4.w/Messenger เป็นสาย Outdoor ที่เพิ่มเส้นลวดเพื่อความสะดวกในการแขวนไปตามชายคา หรือตามเสาไฟฟ้า และเมื่อจะเดินเข้าอาคารก็สามารถตัดลวดทิ้งแล้วเดินเฉพาะสายเข้าอาคารได้เพิ่มความสะดวกในการติดตั้งอย่างมาก
- 5.FLEXIBLE เป็นสายพอยท์ทำให้มีความยืดหยุ่นสูง เหมาะกับงานที่ต้องเคลื่อนไหวตลอด เช่น ลิฟท์ หรือ ยื่นๆ



# RG 6 INDOOR COAXIAL CABLE



P/N	DESCRIPTION	GRADE	PACKING	PRICE /m.
<b>RG 6 INDOOR CCTV CABLE</b>				Effective P94 1 APRIL 2026
<b>CB-0109</b>	RG 6/U Cable , 60% Shield, White Jacket	STANDARD	300 <sup>0</sup> M. /Pull Bx.	<b>7.70 /m.</b>
<b>CB-0106A</b>	<b>RG 6/U Cable, 95% Shield, Black Jacket</b>	ADVANCED	500 M. /Reel in Bx.	<b>8.20 /m.</b>
<b>CB-0106A-WH</b>	RG 6/U Cable, 95% Shield, White Jacket	ADVANCED	500 M. /Reel in Bx.	<b>8.20 /m.</b>
<b>CB-0109S+</b> [Recommend CB-0106A]	<b>RG 6/U Cable, 96% Shield, Black Jacket</b>	STANDARD+	500 M. /Reel in Bx.	<b>9.50 /m.</b>
<b>CB-0109S+WH</b> [Recommend CB-0106A-WH]	RG 6/U Cable, 96% Shield, White Jacket	STANDARD+	500 M. /Reel in Bx.	<b>9.50 /m.</b>
<b>CB-0108</b>	RG 6/U Cable, 95% Shield, Black Jacket	MILITARY	500 M. /Reel in Bx.	<b>36.50 /m.</b>

## RG 6 INDOOR w/POWER WIRE CCTV CABLE







<b>CB-0106AWB</b>	<b>RG 6/U, 95% Shield, Black w/Copper Power Wire</b>	ADVANCED	500 M. /Roll	<b>25.- /m.</b>
<b>CB-0109SW+</b> [Recommend CB-0106AWB]	RG 6/U, 96% Shield, Black w/Copper Power wire	STANDARD+	500 M. /Roll	<b>31.50 /m.</b>





## RG 6 INDOOR CCTV CABLE (100 m. /BOX)









<b>CB-0109-1</b>	RG 6/U Cable, 60% Shield, White Jacket	STANDARD	100 <sup>0</sup> M. /Easy Bx.	<b>7.70 /m.</b>
<b>CB-0106A-1</b>	RG 6/U Cable, 95% Shield, Black Jacket	ADVANCED	100 <sup>0</sup> M. /Easy Bx.	<b>8.20 /m.</b>
<b>CB-0106A-1WH</b>	<b>RG 6/U Cable, 95% Shield, White Jacket</b>	ADVANCED	100 <sup>0</sup> M. /Easy Bx.	<b>8.20 /m.</b>
<b>CB-0109S+1</b> [Recommend CB-0106A-1]	RG 6/U Cable, 96% Shield, Black Jacket	STANDARD+	100 <sup>0</sup> M. /Easy Bx.	<b>9.50 /m.</b>
<b>CB-0109S+1WH</b> [Recommend CB-0106A-1WH]	<b>RG 6/U Cable, 96% Shield, White Jacket</b>	STANDARD+	100 <sup>0</sup> M. /Easy Bx.	<b>9.50 /m.</b>
<b>CB-0106AWB-1</b>	<b>RG6/U, 95% Shield, Black w/Copper Power wire</b>	ADVANCED	100 <sup>0</sup> M. /Easy Bx.	<b>25.- /m.</b>

Remark : 1. Packing 500 M./ Reel (ไม่มี R หรือ \*) หมายถึง สินค้าที่มีใน STOCK สามารถสั่งซื้อ และ ตัดได้ทุก 10 เมตร เท่านั้น  
 2. Packing 100<sup>0</sup> M. , 500<sup>0</sup> M./ Reel (มี R) หมายถึง สินค้าที่มีใน Stock แต่ต้องสั่งซื้อแยก Box หรือ Roll  
 3. Packing 100<sup>0</sup> M. , 500<sup>0</sup> M./ Reel (มี \*) หมายถึง สินค้าที่ต้องสั่งผลิตและต้องสั่งซื้อแยก Roll เท่านั้น (Made to Order)

## COAXIAL (RG) System

SPECIFICATION	ADVANCE 	STANDARD+ 	MILITARY 
			
PART NUMBER	<b>CB-0106AP</b>	<b>CB-0109SP+</b>	<b>CB-0108P</b>
CONDUCTOR $\varnothing$ mm	Copper Covered Steel 1.02 mm	Copper Covered Steel 1.02 mm	Bare Copper 1.02 mm
DIELECTRIC $\varnothing$ mm	Foamed Polyethylene 4.57 mm	Foamed Polyethylene 4.57 mm	Foamed Polyethylene 4.80 mm
SHIELDED TAPE	AL/P-Foil (Bonded)	AL/P-Foil (Bonded)	AL/P-Foil (Bonded)
BRAID SHIELDED $\varnothing$ mm	Aluminum (Second Shielded) 0.12 mm x 144 wire	Aluminum 0.16 mm x 144 wire	Bare Copper 0.12 mm x 168 wire
COVERAGE %	95%	96%	95%
JACKET $\varnothing$ mm	Black PE 6.86 mm	Black PE 6.86 mm	Black PE 6.80 mm

SPECIFICATION	ADVANCE w/Messenger 	STANDARD+ w/Messenger 
		
PART NUMBER	<b>CB-0106AM</b>	<b>CB-0109SM+</b>
CONDUCTOR $\varnothing$ mm	Copper Covered Steel 1.02 mm	Copper Covered Steel 1.02 mm
DIELECTRIC $\varnothing$ mm	Foamed Polyethylene 4.57 mm	Foamed Polyethylene 4.57 mm
SHIELDED TAPE	AL/P-Foil (Bonded)	AL/P-Foil (Bonded)
BRAID SHIELDED $\varnothing$ mm	Aluminum (Second Shielded) 0.12 mm x 144 wire	Aluminum 0.16 mm x 144 wire
COVERAGE %	95%	96%
JACKET $\varnothing$ mm	Black PE 6.86 mm	Black PE 6.86 mm
MESSANGER $\varnothing$ mm	Galvanize Steel 1.3 mm	Galvanize Steel 1.3 mm

SPECIFICATION	ADVANCE w/Power CU 	STANDARD+ w/Power CU 	ADVANCE w/Mes & CU 	STANDARD+ w/Mes & CU 
				
PART NUMBER	<b>CB-0106APWB</b>	<b>CB-0109SPW+</b>	<b>CB-0106AMWB</b>	<b>CB-0109SMW+</b>
CONDUCTOR $\varnothing$ mm	Copper Covered Steel 1.02 mm	Copper Covered Steel 1.02 mm	Copper Covered Steel 1.02 mm	Copper Covered Steel 1.02 mm
DIELECTRIC $\varnothing$ mm	Foamed Polyethylene 4.57 mm	Foamed Polyethylene 4.57 mm	Foamed Polyethylene 4.57 mm	Foamed Polyethylene 4.57 mm
SHIELDED TAPE	AL/P-Foil (Bonded)	AL/P-Foil (Bonded)	AL/P-Foil (Bonded)	AL/P-Foil (Bonded)
BRAID SHIELDED $\varnothing$ mm	Aluminum 0.12 mm x 144 wire	Aluminum 0.16 mm x 144 wire	Aluminum 0.12 mm x 144 wire	Aluminum 0.16 mm x 144 wire
COVERAGE %	95%	96%	95%	96%
JACKET $\varnothing$ mm	Black PE 6.86 mm	Black PE 6.86 mm	Black PE 6.86 mm	Black PE 6.86 mm
MESSANGER $\varnothing$ mm			Galvanize Steel 1.3 mm	Galvanize Steel 1.3 mm
Over All w/ POWER WIRE $\varnothing$ mm	Stranded BC 13.00 mm	Stranded BC 11.56 mm	Stranded BC 15.8 mm	Stranded BC 13.86 mm



# RG 6 OUTDOOR COAXIAL CABLE



P/N	DESCRIPTION	GRADE	PACKING	PRICE /m.
<b>RG 6 OUTDOOR CCTV CABLE</b>				Effective P96 1 APRIL 2026
<b>CB-0106AP</b>	RG 6/U Outdoor, 95% Shield, Black PE Jacket	ADVANCE	500 M. /Reel in Bx.	8.30 /m.
<b>CB-0106AP-1</b>	RG 6/U Outdoor, 95% Shield, Black PE Jacket	ADVANCE	100 <sup>0</sup> M. /Reel in Bx.	8.30 /m.
<b>CB-0109SP+</b> [Recommend CB-0106AP]	RG 6/U Outdoor, 96% Shield, Black PE Jacket	STANDARD+	500 M. /Reel in Bx.	9.50 /m.
<b>CB-0108P</b>	RG 6/U Outdoor, 95% Shield, Black PE Jacket	MILITARY	500 M. /Reel in Bx.	36.50 /m.
<b>RG 6 OUTDOOR w/Messenger CCTV CABLE</b>				
<b>CB-0106AM</b>	RG 6/U Outdoor, 95% Shield, Black PE w/Messenger	ADVANCE	500 M. /Roll	10.10 /m.
<b>CB-0109SM+</b> [Recommend CB-0106AM]	RG 6/U Outdoor, 96% Shield, Black PE w/Messenger	STANDARD+	500 M. /Roll	11.50 /m.
<b>RG 6 OUTDOOR w/Power wire CCTV CABLE</b>				
<b>CB-0106APWB</b>	RG 6/U Outdoor, 95% Shield, Black w/Copper Power Wire	ADVANCE	500 M. /Roll	25.- /m.
<b>CB-0106APWB-1</b>	RG 6/U Outdoor, 95% Shield, Black w/Copper Power Wire	ADVANCE	100 <sup>0</sup> M. /Easy Bx.	25.- /m.
<b>CB-0109SPW+</b> [Recommend CB-0106APWB]	RG 6/U Outdoor, 96% Shield, Black w/Copper Power Wire	STANDARD+	500 M. /Roll	31.50 /m.
<b>CB-0109SPW+1</b> [Recommend CB-0106APWB-1]	RG 6/U Outdoor, 96% Shield, Black w/Copper Power Wire	STANDARD+	100 <sup>0</sup> M. /Easy Bx.	32.50 /m.
<b>RG 6 OUTDOOR w/Messenger and Power Wire CCTV CABLE</b>				
<b>CB-0106AMWB</b>	RG 6/U Outdoor, 95% Shield, Black w/Messenger & Copper Power Wire	ADVANCE	500 M. /Roll	28.20 /m.
<b>CB-0109SMW+</b> [Recommend CB-0106AMWB]	RG 6/U Outdoor, 96% Shield, Black w/Messenger & Copper Power Wire	STANDARD+	500 M. /Roll	34.80 /m.

Remark : 1. Packing 500 M./ Reel (ไม่มี R หรือ \*) หมายถึง สินค้าที่มีใน STOCK สามารถสั่งซื้อ และ คัดได้ทุก 10 เมตร เท่านั้น  
 2. Packing 100<sup>0</sup> M. , 500<sup>0</sup> M./ Reel (มี R) หมายถึง สินค้าที่มีใน Stock แต่ต้องสั่งซื้อยก Box หรือ Roll  
 3. Packing 100<sup>0</sup> M. , 500<sup>0</sup> M./ Reel (มี \*) หมายถึง สินค้าที่ต้องสั่งผลิตและต้องสั่งซื้อยก Roll เท่านั้น (Made to Order)







### LINK Coaxial Cable "คมชัด.....ไม่สะดุด"

LINK Cable เป็นสายสัญญาณที่ออกแบบและผลิตตามมาตรฐานของสหรัฐอเมริกา โดยโรงงานผู้ผลิตที่ผ่านการคัดเลือกของ LINK แล้ว  
 โดยมีคุณภาพหลายอย่างมากกว่าดังนี้





1. STANDARD เป็นสายสัญญาณที่ออกแบบ, ผลิตและผ่านการทดสอบมาตรฐานสากล (World Class)
2. STANDARD+ เป็นสายสัญญาณ STANDARD GRADE ที่เพิ่มการป้องกัน (Shield) ให้ทรงประสิทธิภาพเพิ่มขึ้น โดยป้องกันการรบกวนได้เกือบ 100%
3. ADVANCE เป็นสายสัญญาณที่พัฒนาตัวนำสัญญาณด้วยเทคโนโลยีให้ตัวนำสัญญาณสามารถนำสัญญาณได้สูงขึ้น และมีการป้องกันที่ทรงประสิทธิภาพ 90-95%
4. MILITARY เป็นสายสัญญาณที่ออกแบบมาเพื่อการใช้งานในภาคทหาร จึงมีมาตรฐานการนำสัญญาณและมีการป้องกันสูงสุดสามารถใช้งานในทุกสถานการณ์และทุกสภาวะแวดล้อมที่อาจมีอันตราย











COAXIAL (RG) System

SPECIFICATION	ADVANCE 	MILITARY 
	 LINK	 LINK
PART NUMBER	<b>CB-0111A</b> 	<b>CB-0110</b>
CONDUCTOR $\varnothing_{mm}$	Copper Covered Steel 1.63 mm	Bare Copper 1.63 mm
DIELECTRIC $\varnothing_{mm}$	Foamed Polyethylene 7.10 mm	Foamed Polyethylene 7.11 mm
SHIELD TAPE	AL/P-Foil (Bonded)	AL/P-Foil (Bonded)
BRAID SHIELD $\varnothing_{mm}$	Aluminum 0.16 mm x 168 wire	Bare Copper 0.16 mm x 152 wire
COVERAGE %	90%	95%
JACKET $\varnothing_{mm}$	White PVC 10.03 mm	Black PVC 10.03 mm

SPECIFICATION	ADVANCE 	MILITARY 	ADVANCE w/MeS <sup>T</sup> 	MILITARY w/MeS <sup>T</sup> 
	 LINK	 LINK	 LINK	 LINK
PART NUMBER	<b>CB-0111AP</b>	<b>CB-0110P</b>	<b>CB-0111AM</b>	<b>CB-0110M</b>
CONDUCTOR $\varnothing_{mm}$	Copper Covered Steel 1.63 mm	Bare Copper 1.63 mm	Copper Covered Steel 1.63 mm	Bare Copper 1.63 mm
DIELECTRIC $\varnothing_{mm}$	Foamed Polyethylene 7.11 mm	Foamed Polyethylene 7.11 mm	Foamed Polyethylene 7.11 mm	Foamed Polyethylene 7.11 mm
SHIELD TAPE	AL/P-Foil (Bonded)	AL/P-Foil (Bonded)	AL/P-Foil (Bonded)	AL/P-Foil (Bonded)
BRAID SHIELD $\varnothing_{mm}$	Aluminum 0.16 mm x 168 wire	Bare Copper 0.16 mm x 168 wire	Aluminum 0.16 mm x 168 wire	Bare Copper 0.16 mm x 168 wire
COVERAGE %	90%	95%	90%	95%
JACKET $\varnothing_{mm}$	Black PE 10.03 mm	Black PE 10.03 mm	Black PE 10.03 mm	Black PE 10.03 mm
MESSENGER $\varnothing_{mm}$	-	-	Galvanize Steel 1.83 mm	Galvanize Steel 1.83 mm

SPECIFICATION	RG 58 	RG 59 MILITARY 
	 LINK	 LINK
PART NUMBER	<b>CB-0102</b>	<b>CB-0104</b>
CONDUCTOR $\varnothing_{mm}$	Stranded Tinned Copper 0.18 mm x 19 wire	Bare Copper 0.81 mm
DIELECTRIC $\varnothing_{mm}$	Solid Polyethylene 2.95 mm	Foamed Polyethylene 3.80 mm
SHIELD TAPE	-	-
BRAID SHIELD $\varnothing_{mm}$	Tinned Copper 0.11 mm x 144 wire	Bare Copper 0.11 mm x 144 wire
COVERAGE %	95%	95%
JACKET $\varnothing_{mm}$	Black PVC 4.95 mm	Black PVC 6.00 mm

SPECIFICATION	ADVANCE 	STANDARD 	MILITARY 
	 LINK	 LINK	 LINK
PART NUMBER	<b>CB-0106F</b> 	<b>CB-0105HF-1</b>	<b>CB-0104F</b> 
CONDUCTOR $\varnothing_{mm}$	Stranded Copper Cover Steel 0.27 mm x 7 wire	Copper Covered Steel 0.81 mm	Stranded Bare Copper 0.20 mm x 16 wire
DIELECTRIC $\varnothing_{mm}$	Foamed Polyethylene 3.66 mm	Foamed Polyethylene 3.66 mm	Foamed Polyethylene 3.66 mm
SHIELD TAPE	AL/P-Foil (Bonded)	AL/P-Foil (Bonded)	AL/P-Foil (Bonded)
BRAID SHIELD $\varnothing_{mm}$	Aluminum 0.16 mm x 64 wire	Aluminum 0.12 mm x 128 wire	Bare Copper 0.12 mm x 112 wire
COVERAGE %	60%	90%	95%
JACKET $\varnothing_{mm}$	White PVC 6.10 mm	White PVC 6.10 mm	Black PVC 6.10 mm