

POCKET DOOR SYSTEM (INSET)



TSSL-2V

Door Width	Max. 800 mm
Door Height	1760 - 2300 mm
Door Weight	Max. 20 kg/Door

Features

- Opening door is stored inside the cabinet.
- One touch door installation & removal.

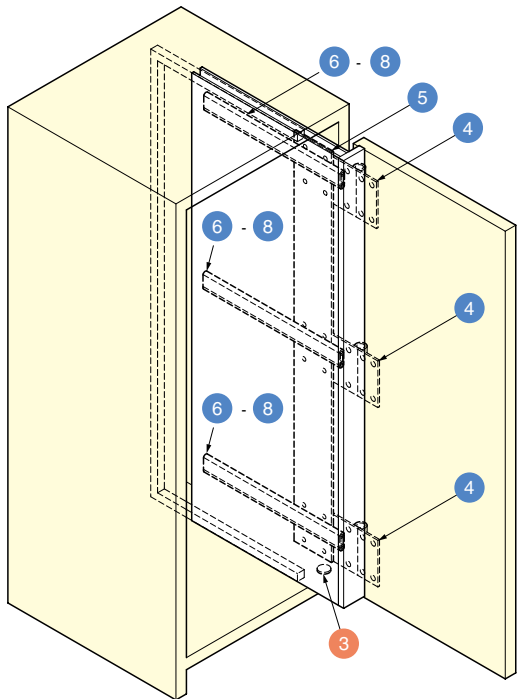
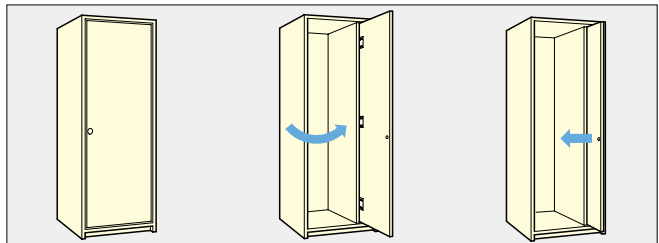

WARDROBE & CABINET DOOR HARDWARE

POCKET DOOR SYSTEM (INSET)

Installation

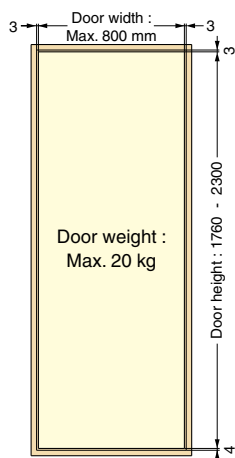
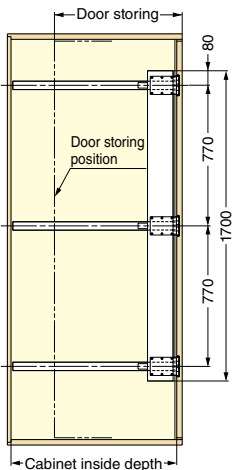

Door weight :
Max. 20 kg

Side view (Wooden door)

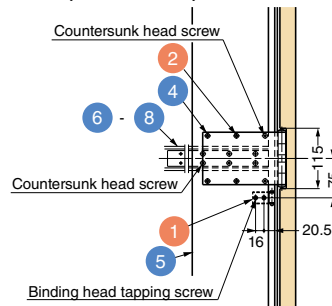

Top view (Wooden door)

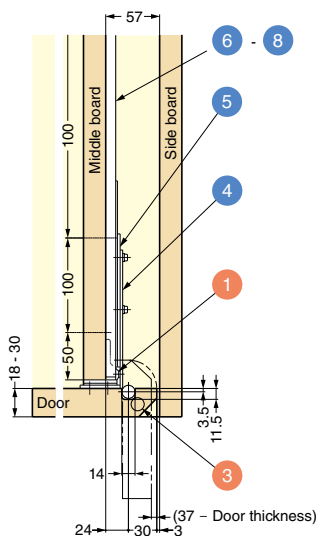

Top view (Steel door)

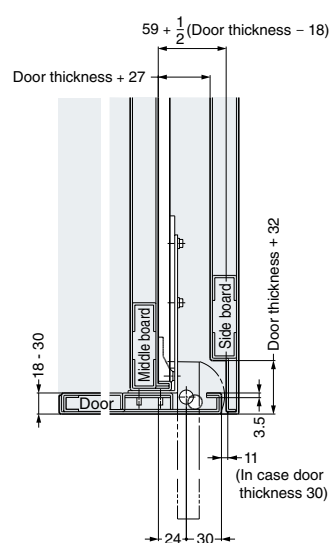



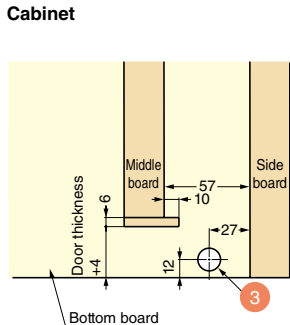
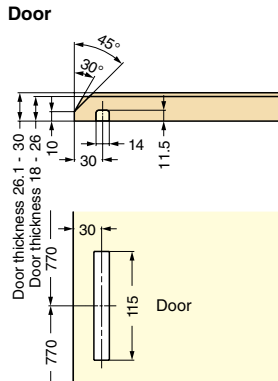

Cut Out Dimensions

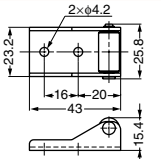

• Necessary Parts **Parts Set** + **Hinge** + **Connecting Plate** + **Rails**

Parts Set (Per Door)		Necessary Parts	
Type	Item Code	Item Name	
a) 600 mm Rails	180-110-575	TSSL-2VD600	
b) 800 mm Rails	180-110-576	TSSL-2VD800	
c) 900 mm Rails	180-110-577	TSSL-2VD900	

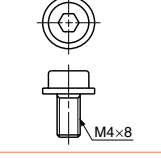
Rail		Necessary Parts			
		3 pcs are necessary for 1 door.			
No.	Type	Qty	Item Code	Part Name	Description
6	Slide Length 600 mm	1 pc	190-110-570	Rail	 <ul style="list-style-type: none"> Material SUS304
			TSSL-600SV		
7	Slide Length 800 mm	1 pc	190-110-571	Rail	
			TSSL-800SV		
8	Slide Length 900 mm	1 pc	190-110-572	Rail	
			TSSL-900SV		

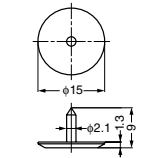
No.	Qty			Part Name	Dimensions	Description
	a	b	c			
1	3 pcs	3 pcs	3 pcs	 Door Stopper	 <ul style="list-style-type: none"> Material Steel Finish Clear Zinc Chromate 	
2	12 pcs	12 pcs	12 pcs	 Bolt	 <ul style="list-style-type: none"> Material Steel Finish Yellow Zinc Chromate 	
3	1 pc	1 pc	1 pc	 Slider	 Item Code : 210-030-122 Item Name : F-15 <ul style="list-style-type: none"> Material POM Finish Natural 	

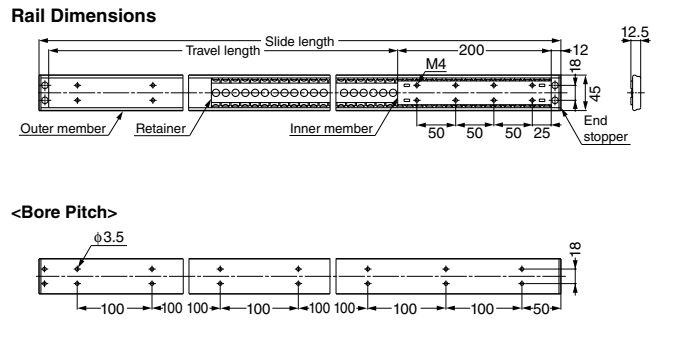

Parts Included
 Binding head tapping screw 3.5x15..... a) 36 pcs, b) 48 pcs, c) 54 pcs
 Countersunk head screw..... 24 pcs

Item Name	Slide Length	Travel Length	Bore Qty N	Door Storage	Depth Inside Cabinet
TSSL-600SV	600	376	12	402.5+Door thickness	Min. 620
TSSL-800SV	800	576	16	602.5+Door thickness	Min. 820
TSSL-900SV	900	676	18	702.5+Door thickness	Min. 920

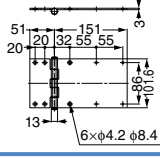
Hinge		Necessary Parts			
		3 pcs are necessary for 1 door.			
No.	Qty	Item Code	Part Name	Dimensions	Description
4	1 pc	180-110-562	Hinge		<ul style="list-style-type: none"> Material Steel Finish White
		TSSL-2VH			

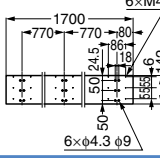
Connecting Plate		Necessary Parts			
		1 pc is necessary for 1 door.			
No.	Qty	Item Code	Part Name	Dimensions	Description
5	1 pc	180-110-563	Connecting Plate		<ul style="list-style-type: none"> Material Steel Finish Yellow Zinc Chromate
		TSSL-2VP			

WARDROBE & CABINET DOOR HARDWARE

POCKET DOOR SYSTEM (INSET)