

# LAMP® FOLDING POCKET DOOR SYSTEM ALT-F Installation Manual

Thank you for selecting our product. Before starting installation, please read this manual thoroughly to ensure correct installation. Please keep this manual at hand for future reference.

## ABOUT THE PRODUCT

- Pocket door hardware for folding door system.
- The folding door can be stored inside the shallow cabinet.

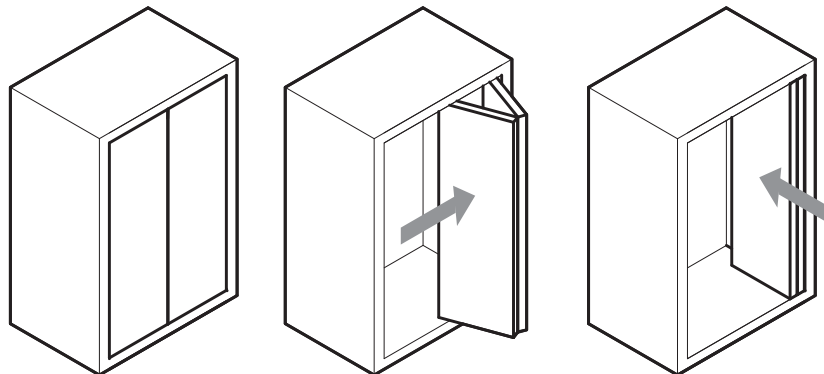

## SPECIFICATIONS

	2 Rails Type	3 Rails Type
Max. door width	450 mm / door	
Max. door height	1830 mm	1831 - 2400 mm
Door thickness	23 - 30 mm	
Max. door weight	10 kg / door	

## FOR YOUR SAFE WORK AND CORRECT INSTALLATION

### Meaning of symbols



**! WARNING:** If these warnings are not followed, it may result in death or serious injury.

- ! It is necessary to manufacture the frame with sufficient strength so it endures the weight of the door and impact shocks upon opening/closing the door. Also make sure to only use the designated screws and to fasten them firmly. A frame with poor strength or loose screws might result in improper and slower movement of the door. In the worst case, the door might drop down and cause injury.
- ⊘ Do not try to use this product for any other purposes other than originally intended for. Do not use the parts for applications that are out of specification.
- ⊘ Do not disassemble nor modify any parts than those described in this document.

**! CAUTION:** If these cautions are not followed, it may result in injury or damage.

- ! This (folding door system) should be installed by an experienced person who has correct knowledge. If the system is not installed correctly, the door will not operate smoothly, and or may cause injury.
- ! This (folding door system) is a part for furniture fittings. After installation, make sure to test the finished product thoroughly to ensure that it is well-functioning and safe.
- ! Make sure to follow the designated measurements, specifications, and horizontal/vertical angles. Make sure that the cabinet is not warped, since it may affect the movement of the door.
- ! If cutting any parts, make sure to remove any burr before installation. Also check the upper rail for any left-over burr or scrap and remove these.
- ! Make sure to check the screws for slack at regular intervals (one month from first usage, half year and then one time every year is recommended).





# PARTS SET (Single folding door)

## [1] 2 Rails Type: Max. door height: 1830 mm (Max. cabinet inside height: 1840 mm)

### A

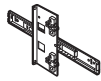

Parts set Item Name: ALT-F18LV2, ALT-F18RV2, ALT-F20LV2, ALT-F20RV2

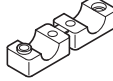
2 Rails Type Screws supplied ⑱Pan head screw (self-tapping) 4x20: 8 pcs (⑥)  
⑲Truss head tapping screw 4x20: 18 pcs (①)

Pats Name	①Rail	②Rack	③Cap	④Gear	⑤Bush	⑥Stationary Block
						
Q'ty	2	2	1	4	4	4

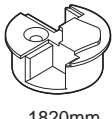
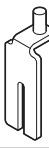
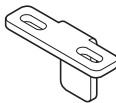
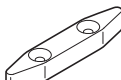
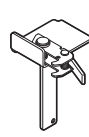
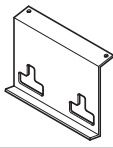
Pocket Door Parts Set Screws supplied ⑳Countersunk head tapping screw 4x20: 8 pcs . . . . . for ⑦⑩⑭  
㉑Pan head screw M6x8: 4 pcs . . . . . for ⑪⑫  
㉒Bind head tapping screw 4.5x20: 2 pcs . . . . . for ⑨  
㉓Hexagon flange head tapping screw 4x16: 2 pcs . . . . . for ⑧  
㉔Spring washer 4 mm: 2 pcs . . . . . for ⑧  
㉕Countersunk head tapping screw 3.5x16 (ϕ6 head): 10 pcs . . for ⑬

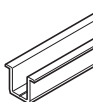
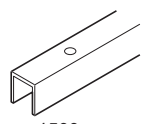
Pats Name	⑦Upper Rail Joint	⑧End Guide	⑨Door holder	⑩Angle Stopper	⑪Interlock	⑫Hinge Cover Bracket
						
	1820mm					
Q'ty	1	1	1	1	1	1

Pats Name	⑬Upper Rail	⑭Guide Rail	⑮Center hinge
			
	1820mm	1500mm	
Q'ty	1	1	3

Pitch end:  
Approx. 30 mm  
Hole pitch:  
Approx. 300 mm  
Do not use the screws attached.

Pitch end:  
Approx. 30 mm  
Hole pitch:  
Approx. 300 mm

Screws supplied  
㉖Countersunk head tapping screw 3.5x16: 24 pcs . . . for ⑮

### B

Connecting bar (1 pc)

Pats Name	⑰Connecting bar
	
	Length: 902±13 mm 1207±13 mm 1816±13 mm
Q'ty	1

⑰Hinge Set

Screws supplied ㉗Countersunk head tapping screw 3.5x20: 8 pcs . . for ⑰
4

## [2] 3 Rails Type : Door height: 1831 - 2400 mm (Cabinet inside height: 1841 -2440 mm)

Item Name: ALT-F18LV3, ALT-F18RV3, ALT-F20LV3, ALT-F20RV3

This includes above **A**, **B** and below parts.

Screws Supplied ⑱Pan head screw (self-tapping) 4x20: 8 pcs (⑥)  
⑲Truss head tapping screw 4x20: 9 pcs . . . for ①

Name	①Rail	②Rack	④Gear	⑤Bush	⑥Stationary Block
Q'ty	1	1	2	2	2

Name	⑮Center Hinge	Screws supplied ㉖Countersunk head tapping screw 3.5x16: 8 pcs . . . for ⑮	⑰Hinge set	Screws supplied ㉗Countersunk tapping screw 3.5x20: 8 pcs . . . for ⑰	⑫Hinge Cover Bracket	Screws supplied ㉑Pan head screw M6x8: 2 pcs . . . for ⑫
Q'ty	1		2 pcs		1	

# INSTALLATION DRAWINGS

The procedure describes the right handed opening type.  
The left-handed opening is installed in the opposite position.

Item Name	Opening direction	Rail Length (A)	Door Storing	Cabinet Depth (B)
ALT-F18LV2	Left	460.4	355.6	Min. 466.7 + Door thickness
ALT-F18RV2	Right			
ALT-F20LV2	Left	511.2	406.4	Min. 517.5 + Door thickness
ALT-F20RV2	Right			
ALT-F18LV3	Left	460.4	355.6	Min. 466.7 + Door thickness
ALT-F18RV3	Right			
ALT-F20LV3	Left	511.2	406.4	Min. 517.5 + Door thickness
ALT-F20RV3	Right			

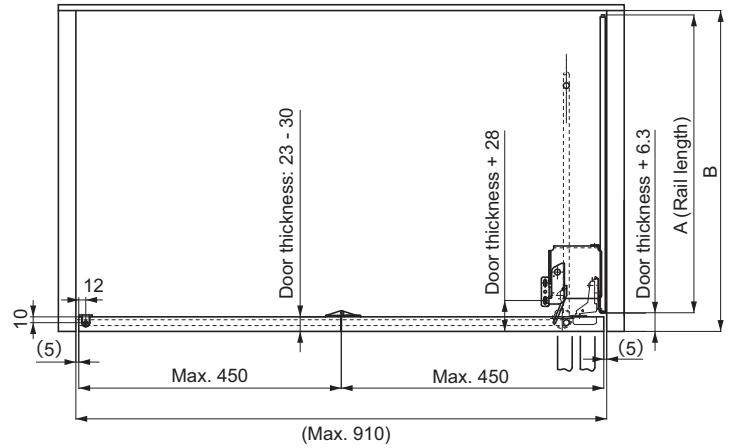

Installation Drawing (3 Rails Type)

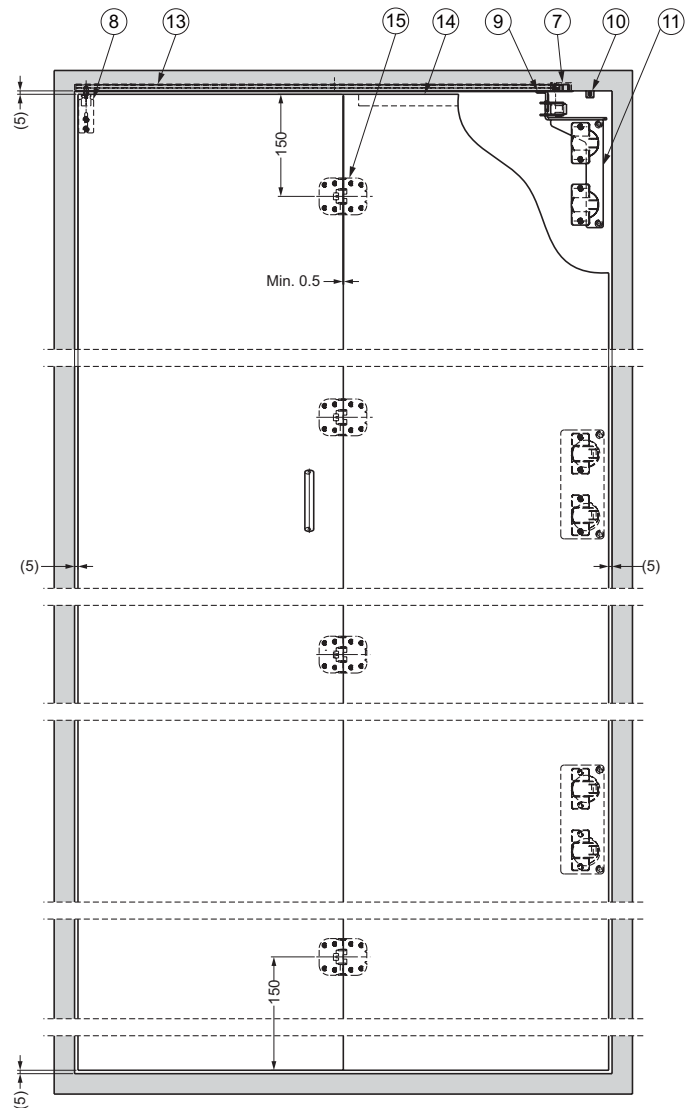
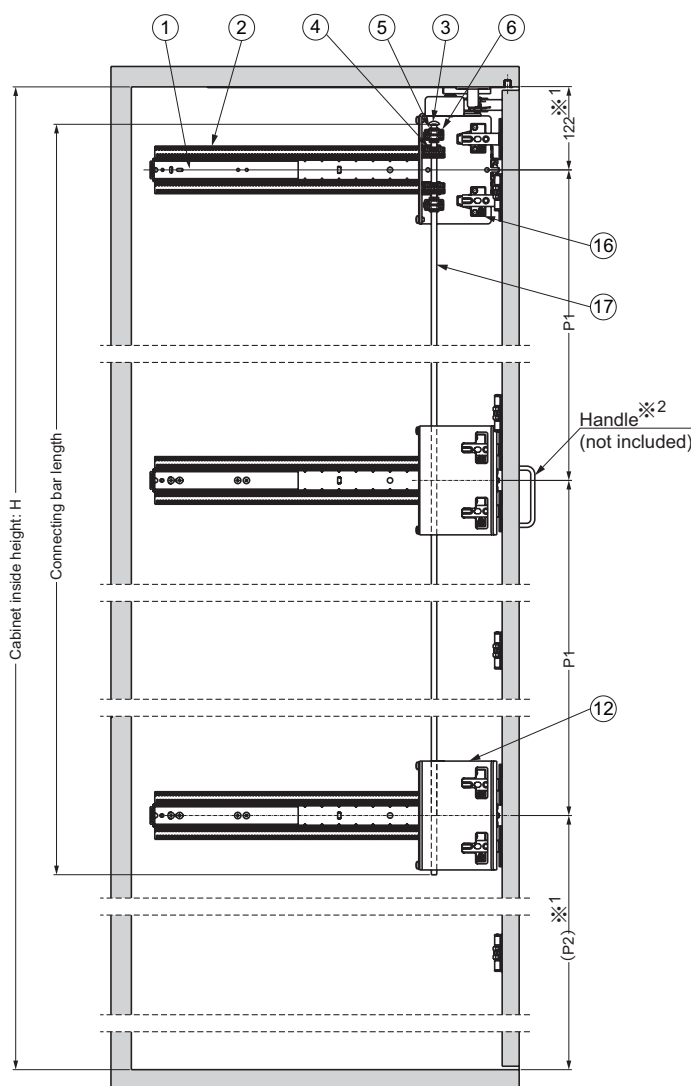

※<sup>1</sup> Position of rails

The dimension of the design is 125, but take into consideration that the door may sag when installing the door.

※<sup>2</sup> Position of handle

See page 4 when placing a middle board.

	2 Rails Type	3 Rails Type	
Door Height	Max. 1830	1831 - 1903	1904 - 2400
Cabinet Inside Height: H	Max. 1840	1841 - 1913	1914 - 2410
Connecting Bar Length	H-110		1803
P1	H-250	(H-250)/2	831
(P2)	128		H-1784

# CABINET DIMENSION

Use hardwood for core material for parts fitting area.

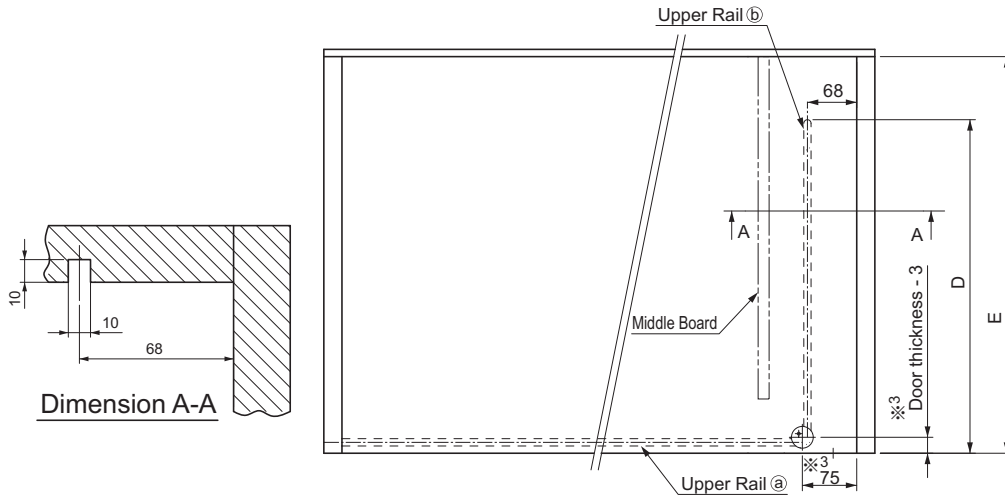

※<sup>3</sup>: Position (center) of  $\phi 30$  hole

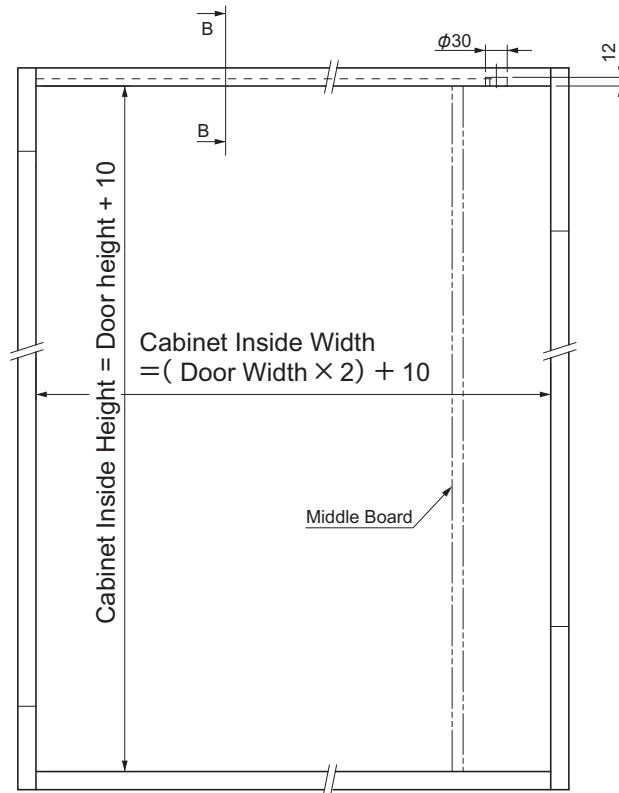
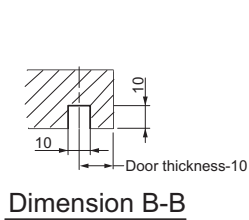

When installing middle board  
Position middle board to avoid  
interference with handle and angle  
stopper.

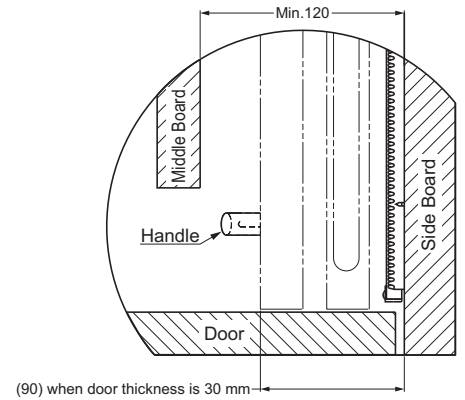

Length of Upper Rail ⑬

	Rail ①	Rail ②	D	E
ALF-F18(L/R)	Door Width x 2 - 69	375	410	Min. 466.7 + Door thickness
ALF-F20(L/R)		425	460	Min. 517.5 + Door thickness

Please drill a new hole within 50 mm from the end of upper rail after cutting the rail.  
Do not deform when the rail is cut.  
Deburr the cut surfaces.

# DOOR DIMENSION

Use hardwood for core material for parts fixing area.

## [1] 2 Rails Type

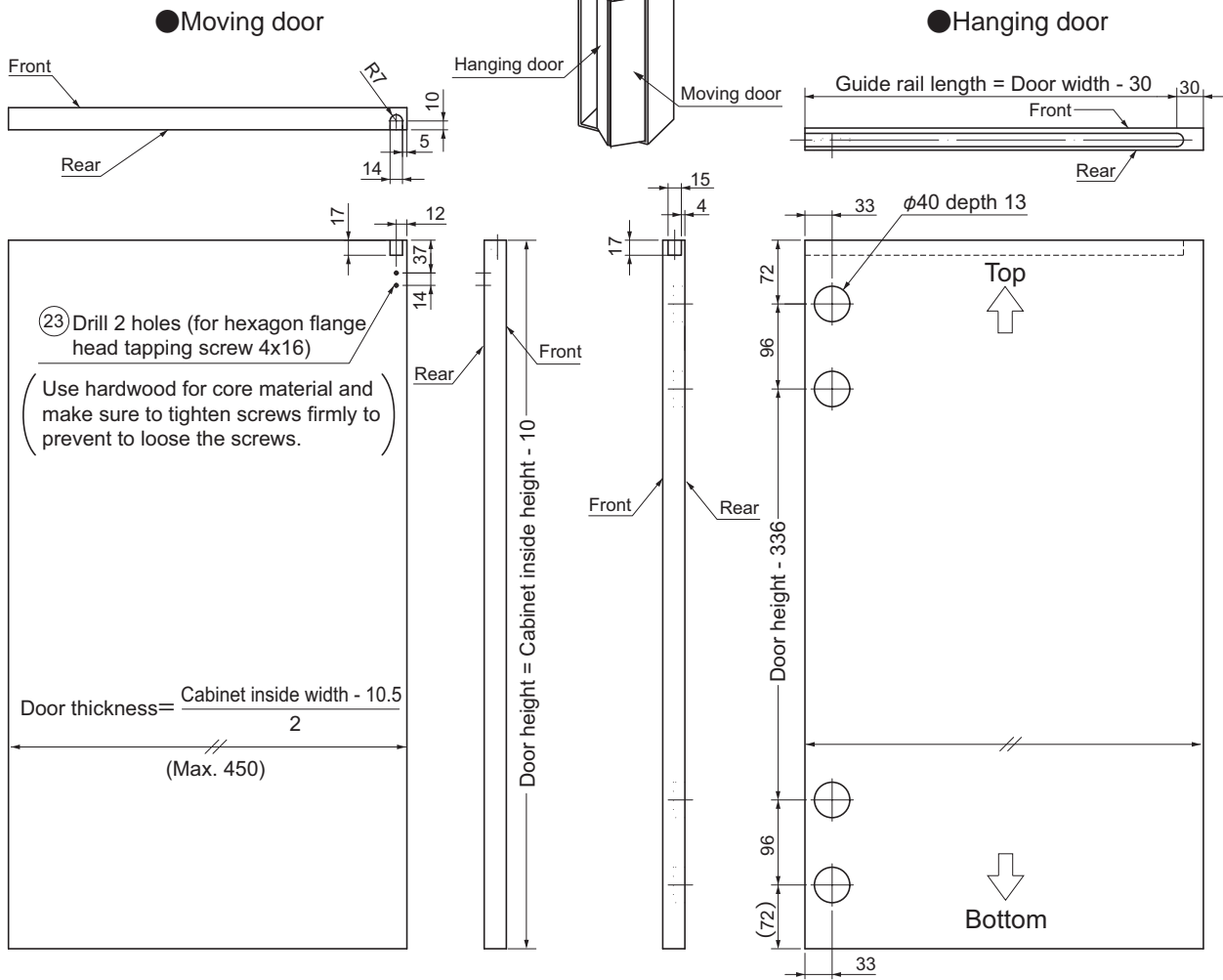

## [2] 3 Rails Type

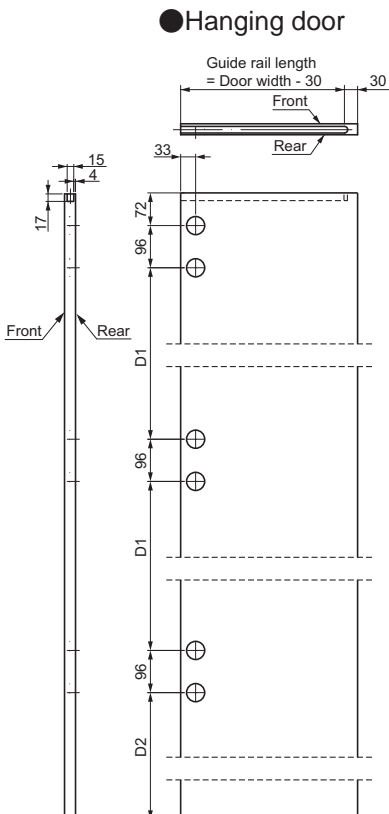

● Moving door is the same as 2 rails type

※<sup>4</sup> Please drill a new hole within 50 mm from the end of rail after cutting the rail.

Do not deform when the rail is cut.

Deburr the cut surfaces.

Door height	1831 - 1903	1904 - 2400
Cabinet inside height: H	1841 - 1913	1914 - 2410
D1	(Door height - 432)/2	735
(D2)	(72)	Door height - 1830

# INSTALLATION PROCEDURES

## 1 Installing Parts on the Top Board

Install parts in order of ① to ⑥.

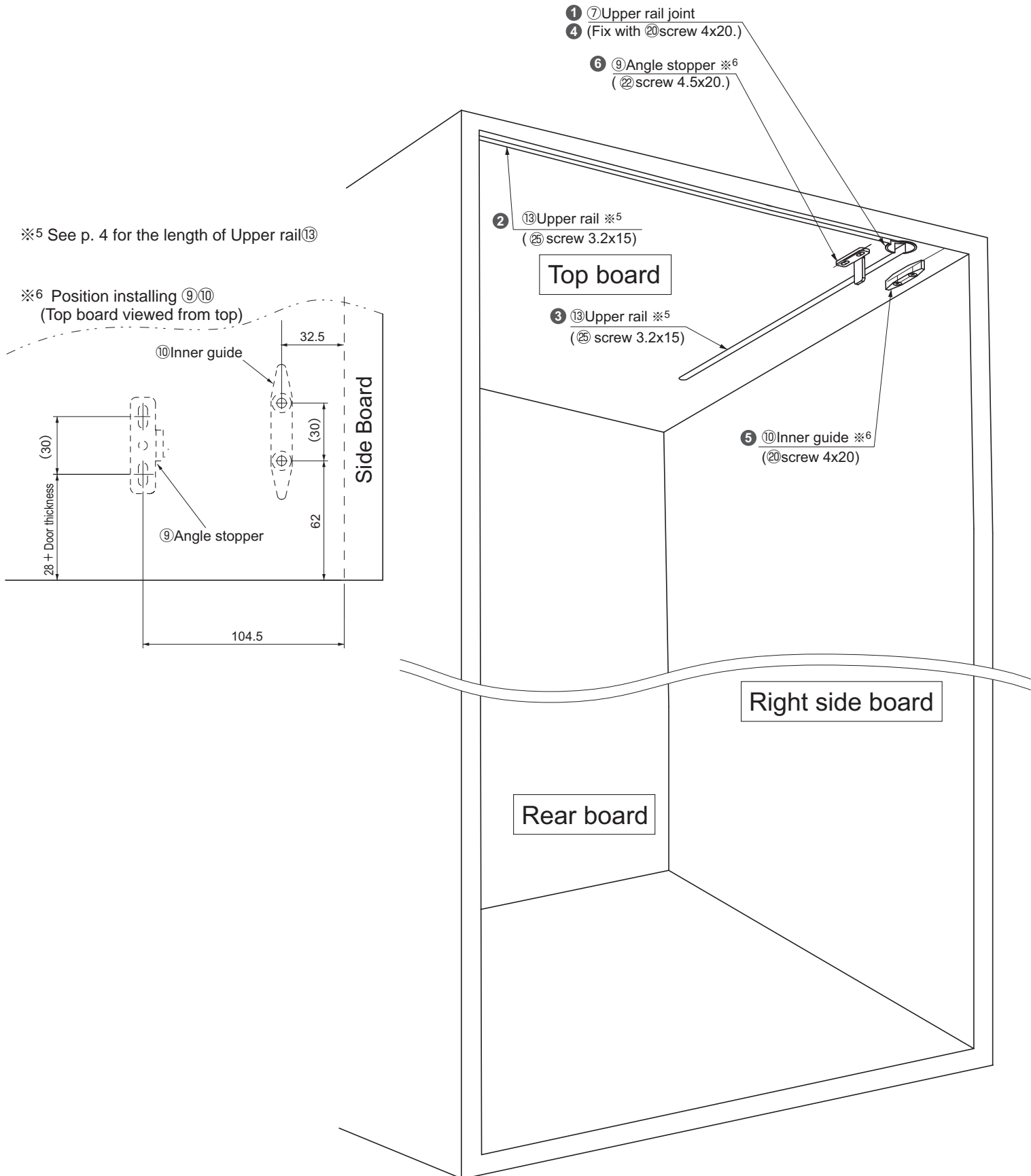

## 2 Installing Parts

- (1) Fix hinge set ⑯ into the hanging door.
- (2) Fix guide rail ⑭ into grooves in the upper blocks in hanging door.
- (3) Fix center hinge ⑮.

2 rails type : Fix as show in the below drawing.

3 rails type : Fix 2 center hinges within 150 mm from the end.

※7 Another 2 hinges should be mounted in even distance each other.

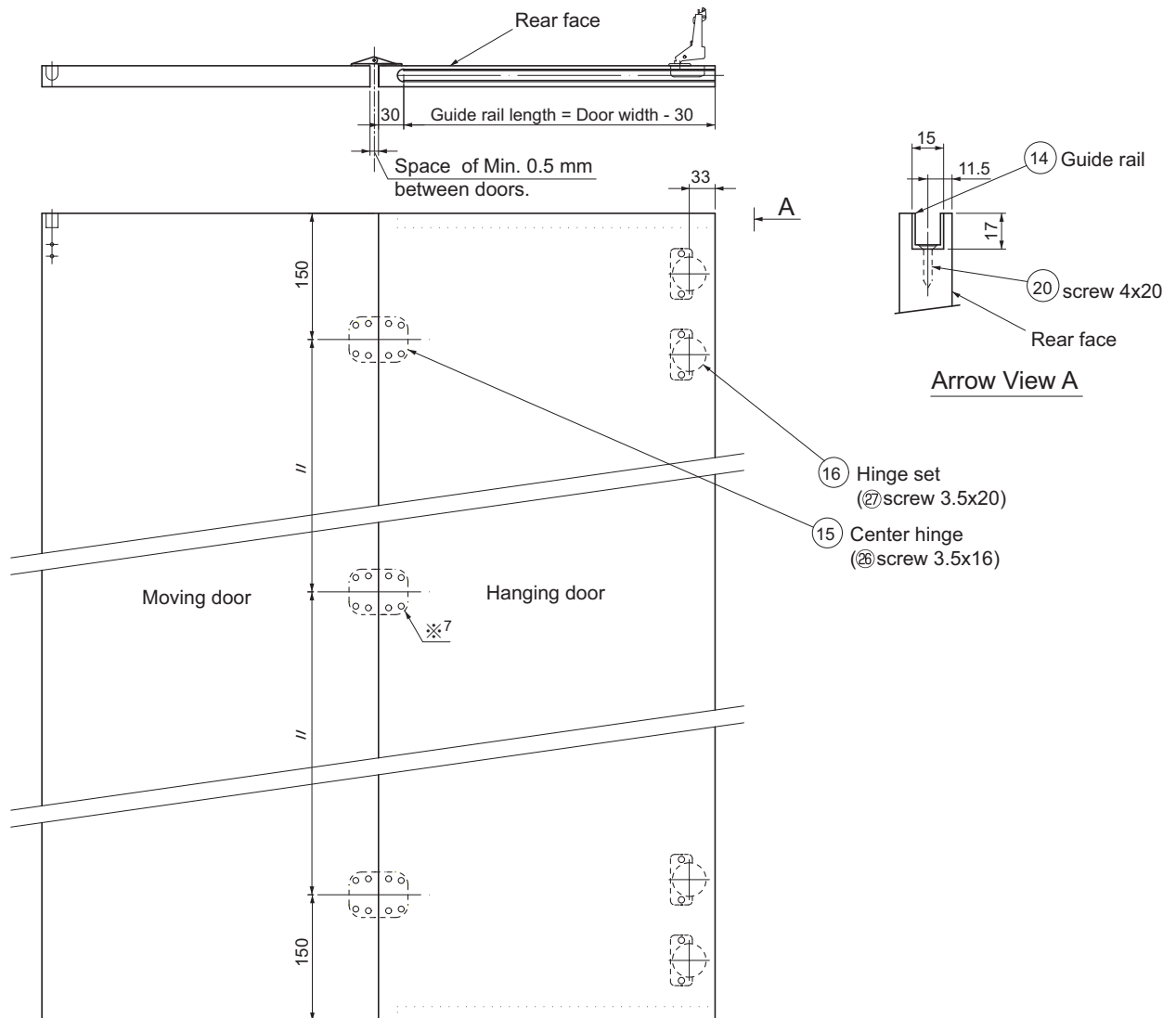

### 3 Assembling Interlock to Rail

Assemble interlock (11) to rail (1) with screw (21).

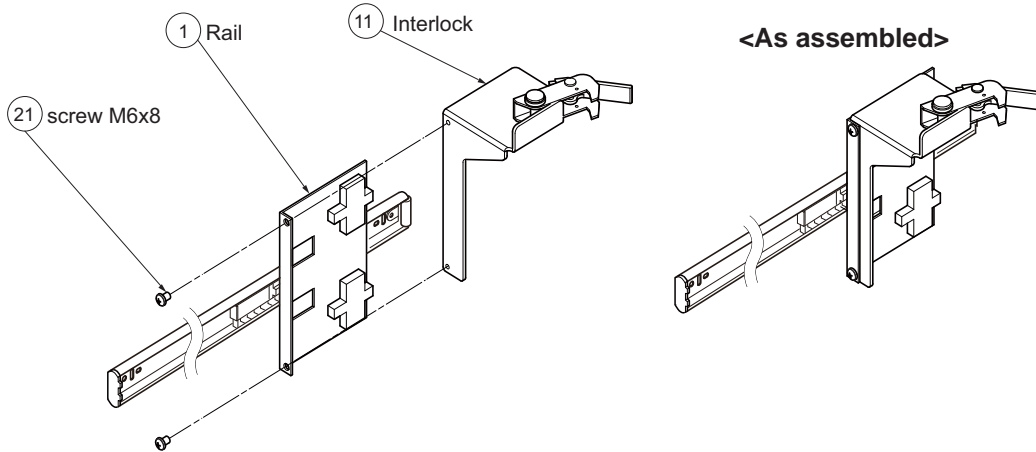

### 4 Installing Rails and Racks

#### 1 Positions for rails

##### [1] 2 Rails Type

##### [2] 3 Rails Model

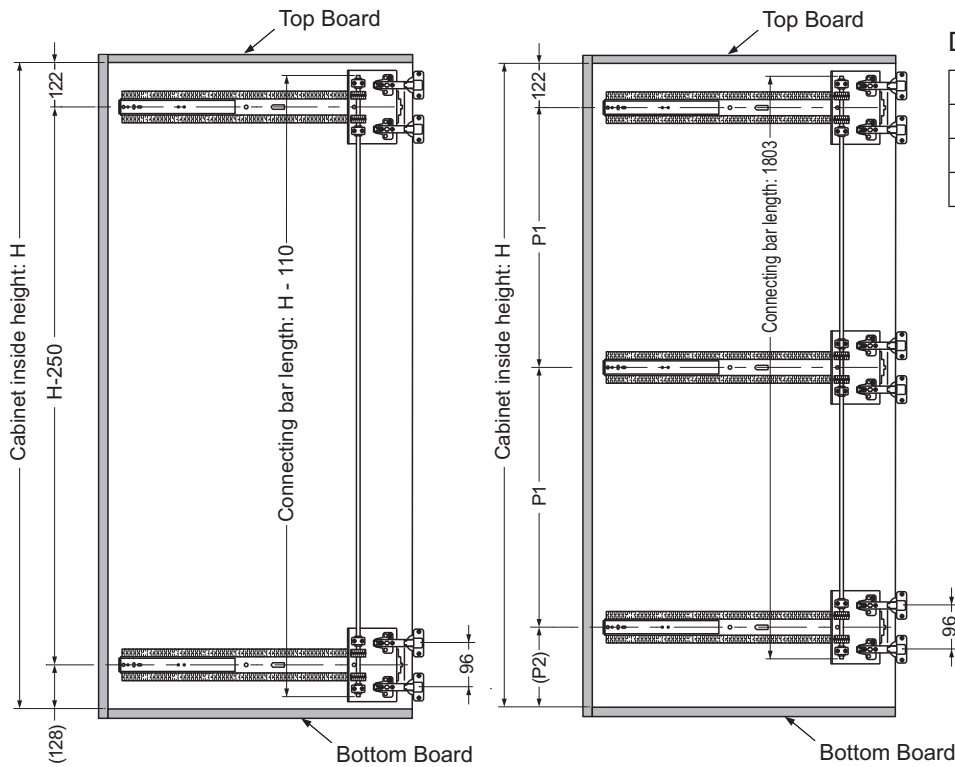

Dimensions for 3 rails model

Door height	1831 - 1903	1904 - 2400
Cabinet inside height: H	1841 - 1913	1914 - 2410
P1	$(H-250)/2$	831
(P2)	128	H-1784

#### 2 Fit rail to the rack.

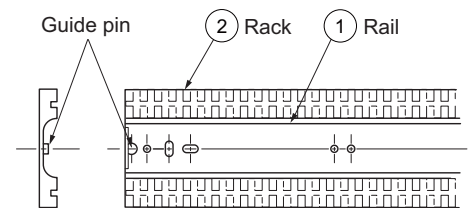

#### 3 Fixing Rails

Fix rails in order to be parallel each other.

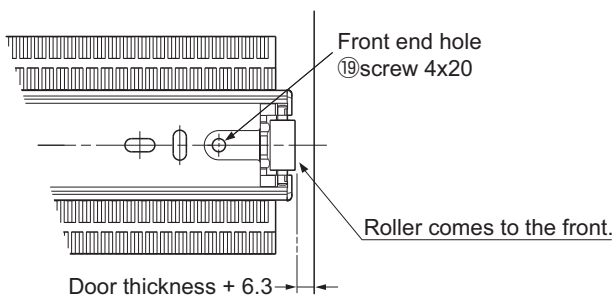

#### 4 Cutting of connecting bar

Cut connecting bar (17) as in above drawings.

**CAUTION**  
Deburr the cut surfaces of the shaft completely.

(17) Connecting bar

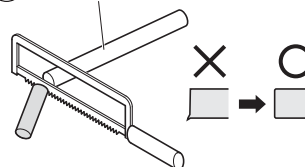



## 5 Assembling Connecting Bar and Gear

Assemble gear, connecting bar, bush, and cap as shown in the drawing.

### ⚠ CAUTION

Make sure to check the direction of gear.  
Be sure to push the cap into pinion shaft strongly.

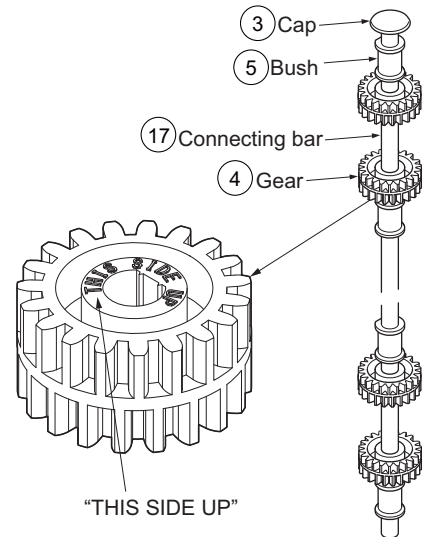

## 6 Assembling Gear into Rail

- (1) Pull the rail bracket until the end of the rail.
- (2) Engage the rack and gear of connecting shaft. Fix the stationary block as in below drawing.

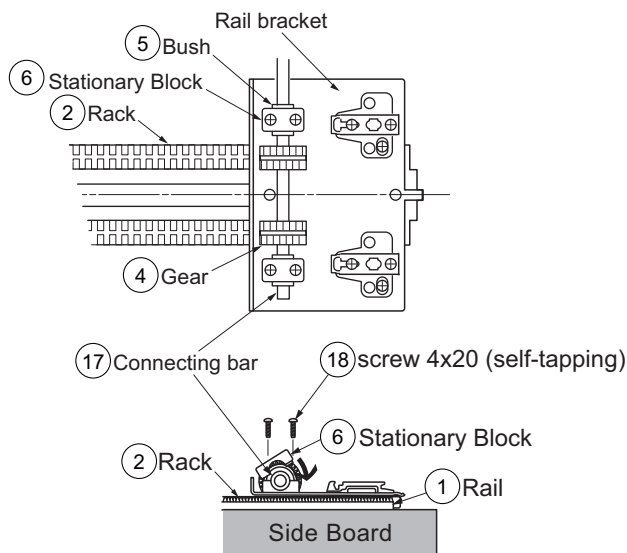

<Shaft mounted on the rail>

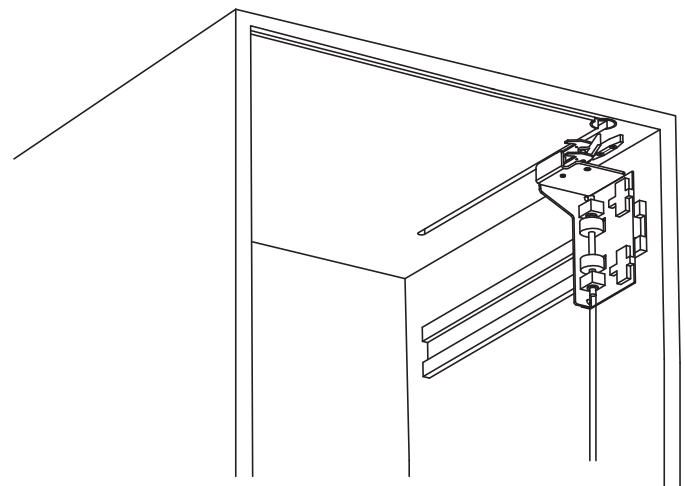

## 7 Hanging Doors

⚠ The work of hanging the doors must always be carried out by a team of two workers.

Install the door to mount the hinge set onto mounting plates.

See 9 for door adjustment instructions.

### ⚠ CAUTION

Make sure to tighten adjustment screws firmly to fix.

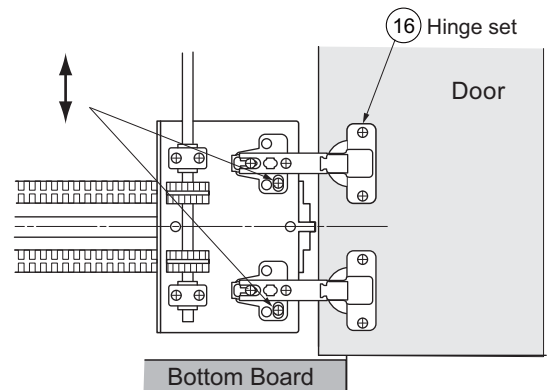

Height adjustment

## 8 Installing End Guide

Insert the end guide (8) into upper rail (13) and fix with (23) and (24) after height adjustment.

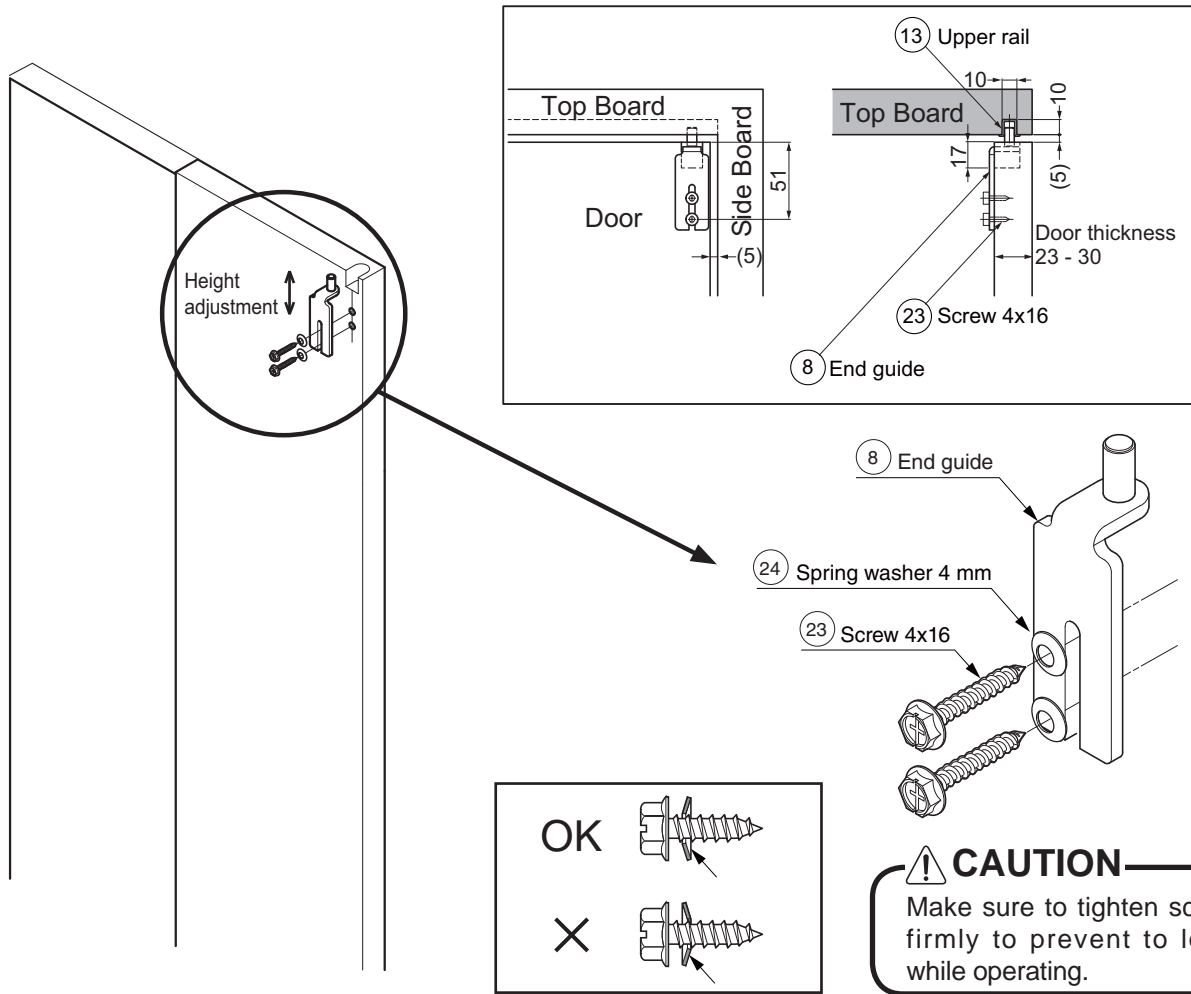

## 9 Adjusting Doors

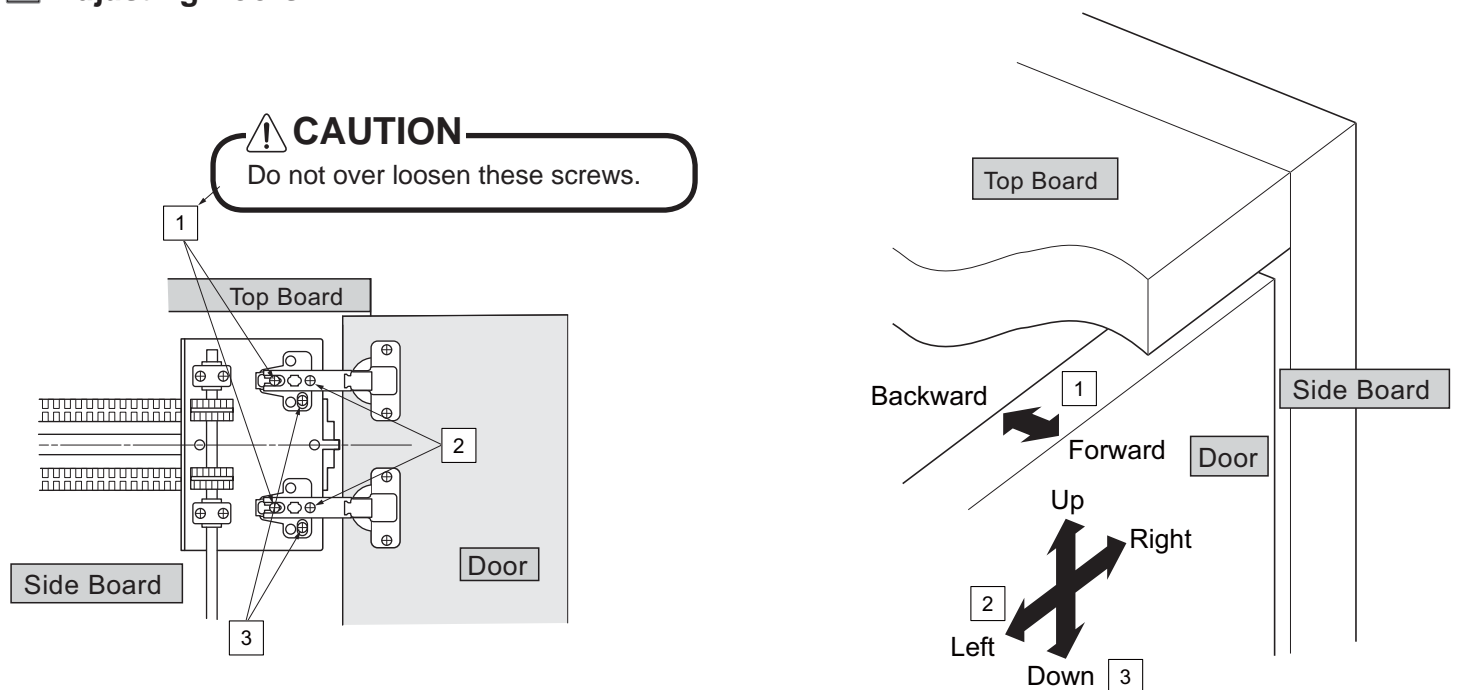

## 10 Assembling Hinge Cover Bracket

Assemble hinge cover bracket ⑫ to rail ①.  
(As for 3 slides model, assemble it to middle rail, too.)

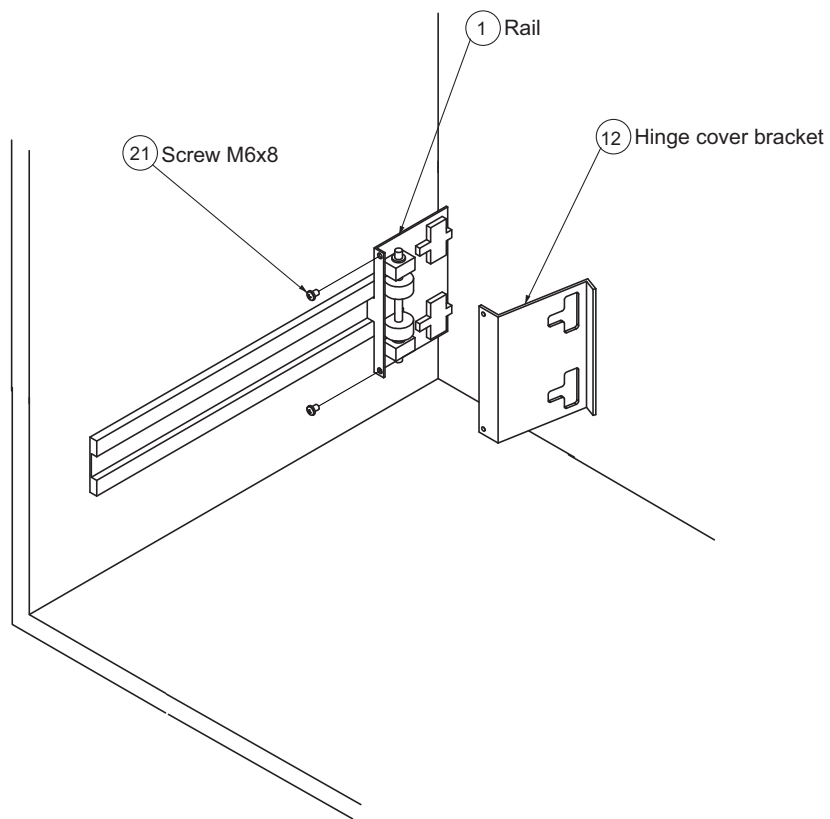

<Hinge cover bracket as assembled>

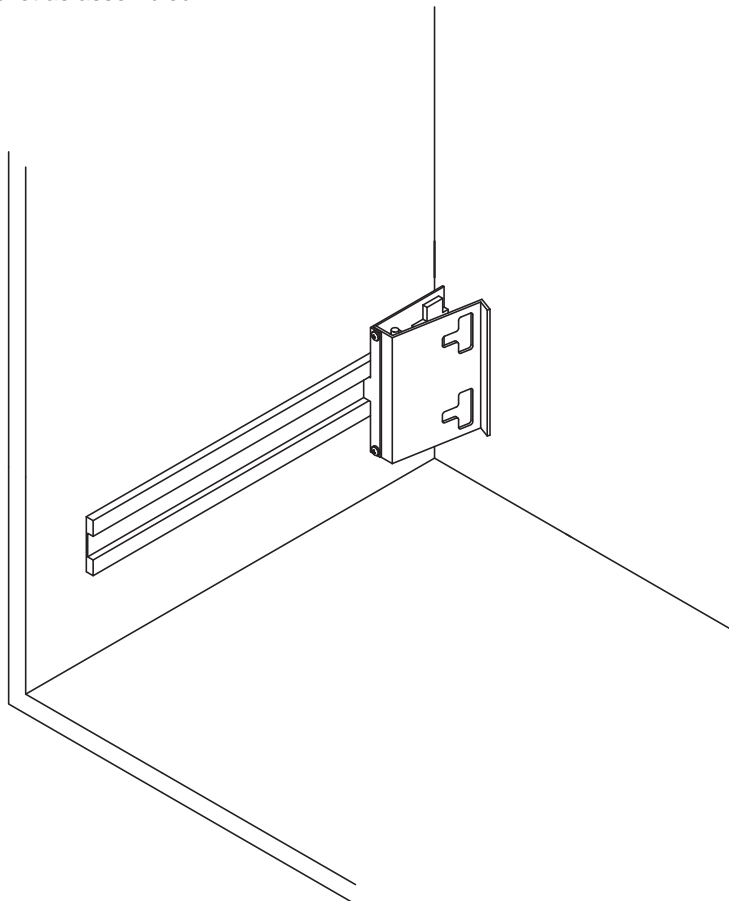

---

**SUGATSUNE KOGYO CO.,LTD**  
**Tokyo, JAPAN**

Phone: +81 (0)3 3866 2260 E-mail:export@sugatsune.co.jp

**SUGATSUNE KOGYO (UK) LTD**  
**Reading, UK**

Phone: +44 118 9272 955 E-mail:sales@sugatsune.co.uk

**SUGATSUNE EUROPE GmbH**  
**Düsseldorf, GERMANY**

Phone: +49 211 53812900 E-mail:sales@sugatsune.eu

**SUGATSUNE SHANGHAI Co., LTD**  
**Shanghai, CHINA**

Phone: +86 21 3632 1858 E-mail:lamp@sugatsune.com.cn

**Guangzhou, CHINA**

Phone: +86 20 6639 3552 E-mail:lamp@sugatsune.com.cn

**SUGATSUNE KOGYO INDIA PRIVATE LIMITED**  
**Mumbai, INDIA**

Phone: +91 22 28314490/91 E-mail:sales@sugatsune.in

**SUGATSUNE AMERICA, INC**  
**California, USA**

Phone: +1 310 329 6373 E-mail:sales@sugatsune.com

**Chicago, USA**

Phone: +1 312 461 1081 E-mail:chicagoshowroom@sugatsune.com.

**SUGATSUNE CANADA, INC.**

Phone: +1 514 312 5267 E-mail:support@sugatsune.ca

ISO9001(Japan Offices and Sugatsune America) and ISO14001(Chiba Production division and Logistics center), certified.

2018.06 0754-9