

## Photoelectric Sensor Overview

Sensors are differentiated depending on applied media. Light, one of the media, is also utilized for a sensor which is called a photoelectric sensor. It is a non-contact type which is applicable to sensing presence, passing, size, color and brightness of the target object.

## Classification by Sensing Method

Photoelectric sensors can be classified into three categories depending on sensing type.

### Through-beam photoelectric sensor

Through-beam beam type is to detect a target by using the difference of light intensity depending on presence of target with placing an emitter and a receiver face to face. Long sensing distance is available and it is not affected by background.

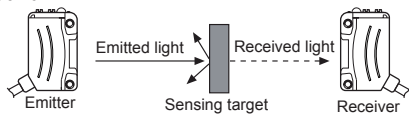

### Retroreflective photoelectric sensor

#### Retroreflective type(standard type)

Retroreflective type uses a photoelectric sensor which is integrated with emitter and receiver, and a reflector with high light radiant in order to detect a target by comparing difference of light amount determined by the presence of target between the sensor and reflector.

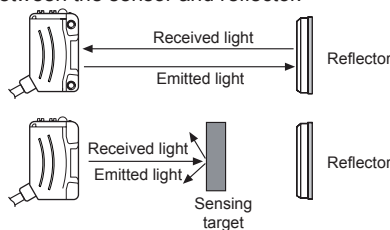

Using highly reflective objects is limited but it depends on install method, it could be available to use.

#### Retroreflective type(built-in polarized filter)

Like the standard type of retroreflective photoelectric sensor, polarized filter type uses a photoelectric sensor which is integrated with emitter and receiver and reflector. The emitter part and receiver part in the sensor have each polarized filter for receiving reflected light from the reflector which make the light polarized at 90°.

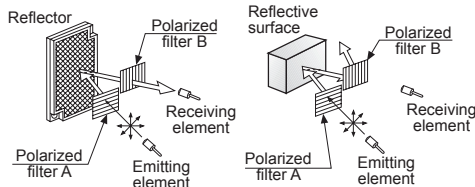
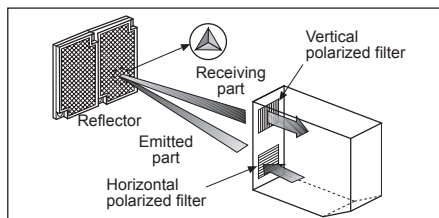

### Diffuse reflective photoelectric sensor

Diffuse reflective is to detect a target by direct reflection off the target object. (emitter / receiver in one body)

#### Standard diffuse reflective type

Light source is diffused after passing the lens, detects a target by comparing difference of light amount which depends on size, color and brightness of the target object.

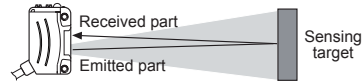

#### Narrow beam type

Narrowed beam spot size after passing the lens has little effect on background. It is suitable for sensing in narrow space or sensing small size of the target object.

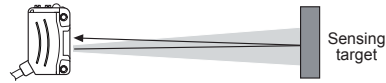

#### Convergent reflective type

Convergent reflective type sensed the limited area (checked part) where optical source is crossed.

In the figure below, the sensing target at (A) can be detected while the target at (B) cannot. Due to detecting the limited area by optical source, there is little effect by background but it is not simple to modify sensing distance and sensing target in a specific area (within 50mm).

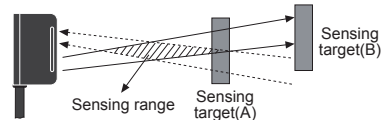

#### BGS(background suppression) type

It detects range of set distance which is applied the algorithm of triangulation principle which is for measuring the place where the reflected light forms an image on the receiving element or the optical system. Also it has little effect by size, color and surface condition of the sensing target and no effect on the background. Strong at temperature, power and voltage changes and available detect to sensing distance over 100mm.

※Triangulation : Emitting light forms an image on the receiving light element after it is reflected on the sensing target. In case sensing target is located at (B), the same amount of reflected light will be received on both N and F part of receiving element. In case sensing target is located closer (A), larger amount of reflected light will be received on N part and less amount of light on F part. In case sensing target is located further (C), both N and F part will receive the reflected light vice versa. Therefore, sensing distance can be determined with calculating the amount of reflected light on both parts of receiving element (two-segment photodiode).

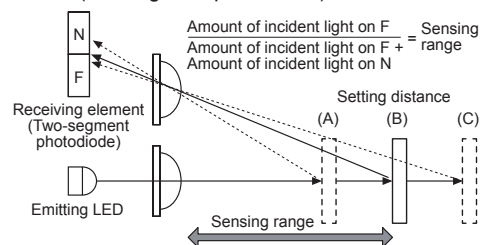

(A)	Photoelectric Sensors
(B)	Fiber Optic Sensors
(C)	Door/Area Sensors
(D)	Proximity Sensors
(E)	Pressure Sensors
(F)	Rotary Encoders
(G)	Connectors/ Connector Cables/ Sensor Distribution Boxes/ Sockets
(H)	Temperature Controllers
(I)	SSRs / Power Controllers
(J)	Counters
(K)	Timers
(L)	Panel Meters
(M)	Tacho / Speed / Pulse Meters
(N)	Display Units
(O)	Sensor Controllers
(P)	Switching Mode Power Supplies
(Q)	Stepper Motors & Drivers & Controllers
(R)	Graphic/ Logic Panels
(S)	Field Network Devices
(T)	Software

# Technical Description

## ■ Glossary

### ◎ LED : Light Emitting Diode

A semiconductor diode emits light when an electric current passes through it. The color and brightness of LED is determined by the component, construction ratio, impurities of PN junction for improving single crystal which is made with gallium(Ga) to mixed crystal.

- Infrared LED : Using P-N junction for GaAs
- Red LED : Adding impurities Zn, O to GaP
- Green LED : GaP/Green light emitting/ Yellowish green emitting is used due to low efficiency.
- Yellowish green LED : Adding N to GaP / Higher emitting efficiency than Green emitting.

The most common emitting element for photoelectric sensor is IRED having high emitting efficiency and large outputs. Red or green LED is also frequently used according to applications.

### ◎ Photo diode

A photo diode is a type of diode capable of converting light into either current or voltage when light reached to P layer. PN or PIN junction used. Si is generally used for semiconductor.

PIN photodiode is commonly used as receiving elements to catch optical signal with high response and frequency. Applicable to photoelectric sensor's receiving elements, PCM transmission for optical communication, and TV/ VTR remote controller's receiving parts.

### ◎ Photo transistor

Compared to photo diodes, photo transistor has amplifying action by transistor. Control easily due to high receiving sensitivity for Base current. Thus it is available in a wide range of photoelectric sensors.

### ◎ Sensing target

The sensing target serves as a reference for measuring basic performance.

### ◎ Beam angle

Angle range for normal sensing by the sensors.

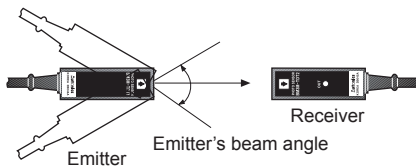

### ◎ Blind zone

The blind zone is generated near the emitter and receiver on the surface in retroreflective type, diffuse reflective type, narrow beam reflective type, convergent reflective type, and BGS reflective type photoelectric sensor or color mark sensor. Since none of object can be sensed in the blind zone, please make sure of the blind zone when installing the product.

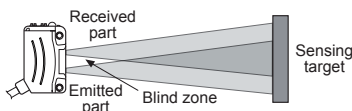

## ◎ Operation mode

### ● Light ON

Output switching elements (transistor or Relay) become ON when the receiver receives emitting light from the emitters.

### ● Dark ON

Output switching elements (transistor or Relay) become ON when the receiver does not receive emitting light from the emitters.

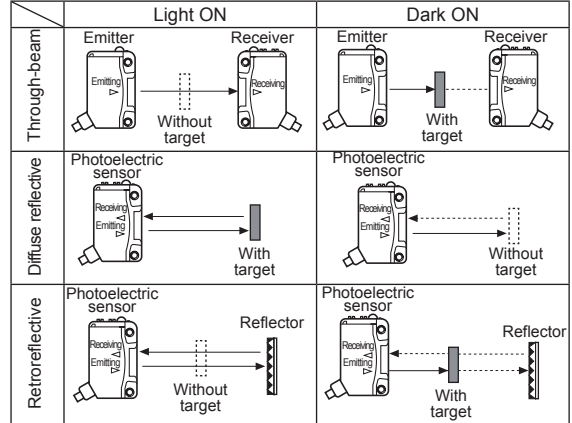

### ◎ Hysteresis (reflective type)

Distance difference between operating distance and returning distance.

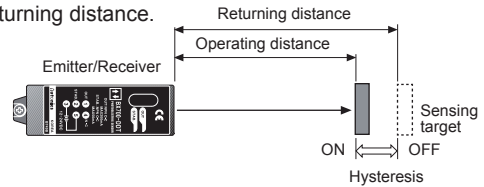

### ◎ Response time

The time lag between light received point and the point on which output operation becomes ON. (Light ON)

Generally, response time is represented as operation time (Ton). [Operating time (Ton) = Returning time (Toff)]

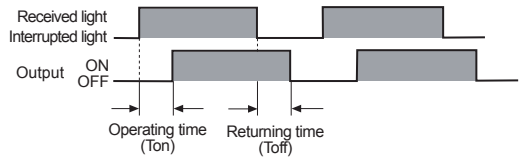

## ■ Major Features

### ● Non-contact detection

Photoelectric sensor is a non-contact type which does not have any impact on the sensing target.

### ● Wide range of sensing target

Applicable to a wide range of materials including transparent glass, metal, plastic, wood and liquid.

### ● High speed response time

Use light as the medium, it is able to detect the moving object with high speed.

### ● Superior distinction performance

Use several characteristics of light, various kinds of sensors are developed. They are able to detect presence, passing, size, color, and brightness of the sensing target.

## ● Easy to control application environment

Easy to control sensing range and environment of photoelectric sensor by using lens such as half mirror, shield boards, slit.

## ● Low influence from magnetic field and vibration

Use light when photoelectric sensor detect the sensing target, it is less affected by magnetic and vibration.

## ● Color identification

The rate at which an object reflects or absorbs light depends on both the wavelength of the emitted light and the color of the object. This property can be used to detect colors.

## ■ Sensing Objects of Diffuse Reflective Type Sensors

### ◎ Sensing distance according to color

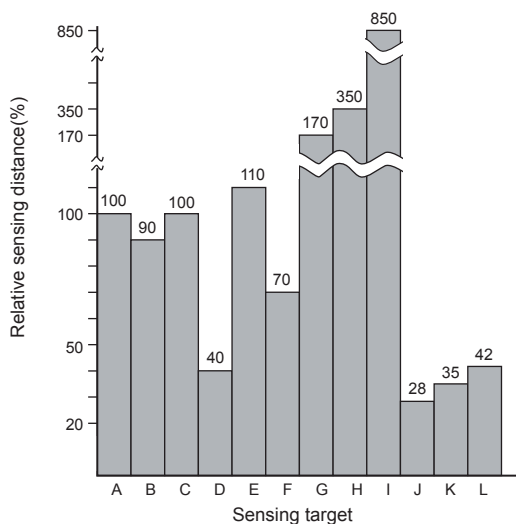

- |  |                                     |
|--|-------------------------------------|
| A: Non-glossy white paper(standard)        | F: Vinyl resin (orange)             |
| B: Corrugated card board with yellow color | G: Rubber board                     |
| C: Veneer board                            | H: Aluminum board                   |
| D: Non-glossy black paper(Brightness 3)    | I: Reflective bar                   |
| E: Bakelite board with yellow color        | J: Rusty steel bar $\varnothing$ 10 |
| Acrylic board (black)                      | K: Black cloth (towel)              |
| Vinyl resin (red)                          | L: Dark Blue cloth(towel)           |

※ It shows ratio of sensing object each detection distance based on non-glossy white paper is 100%. Relative sensing distance depends on the model and sensing object size.

※ Convergent reflective type is not affected by color or material within range of sensing distance as specified in chart.

### ◎ Sensing distance and range against the sensing target condition

- The reflectivity of the sensing target surface is higher, the sensing distance is longer.
- The size of the sensing target is bigger, the sensing distance is longer.
- The rate of reflection of the sensing target is lower, the sensing area is more narrow. However in the case of white non-glossy paper, it has lower reflectivity than glossy SUS or aluminum, but the property of sensing area is better by diffused reflection of the surface of the white paper.

## ■ Feature Data

The following describes about the feature data.

### ◎ Example of parallel shifting characteristic (Through-beam type)

This characteristic for through-beam type, indicates about width of light for the emitter.

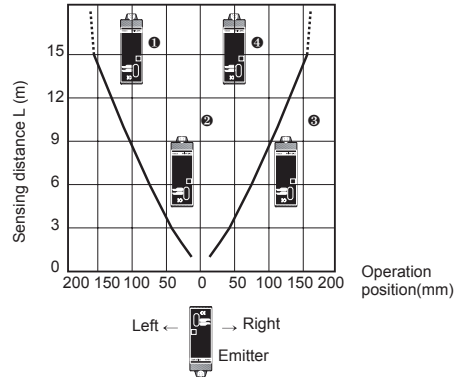

As shown in the figure, the receiver 1, 2, 4 operate normally but the receiver No. 3 does not operate normally because it is out of the width of light. Refer to this data when placing several sensors in parallel, it is able to prevent mutual inference. In case installing the receiver at 9m point (as ② in the figure), there must be 110mm interval between each unit in order to prevent mutual interference.

### ◎ Sensing distance characteristic (Diffuse reflective type)

This is featured as data of diffuse reflective type sensors same as the parallel shifting characteristic.

### ◎ Angle sensor characteristic (Through-beam type, Retroreflective type)

After fixing the emitter(or reflector), and the receiver(sensor) moves towards the center axis from right or left, up or down until operation becomes OFF.

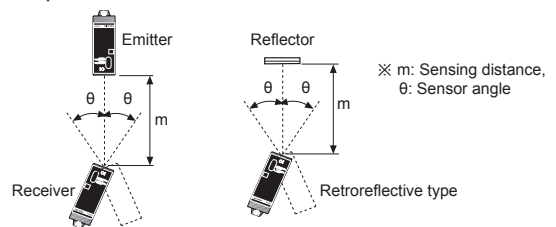

### ◎ Reflector angle characteristic (Retroreflective type)

Move a reflector towards center axis from right or left, up or down with fixing the receiver until operation becomes OFF.

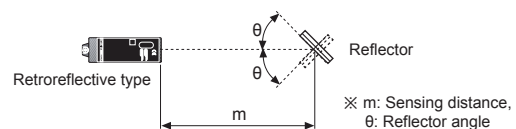

(A)	Photoelectric Sensors
(B)	Fiber Optic Sensors
(C)	Door/Area Sensors
(D)	Proximity Sensors
(E)	Pressure Sensors
(F)	Rotary Encoders
(G)	Connectors/ Connector Cables/ Sensor Distribution Boxes/ Sockets
(H)	Temperature Controllers
(I)	SSRs / Power Controllers
(J)	Counters
(K)	Timers
(L)	Panel Meters
(M)	Tacho / Speed / Pulse Meters
(N)	Display Units
(O)	Sensor Controllers
(P)	Switching Mode Power Supplies
(Q)	Stepper Motors & Drivers & Controllers
(R)	Graphic/ Logic Panels
(S)	Field Network Devices
(T)	Software

# Technical Description

## ■ Proper Usage

### Ⓞ Precaution for proper installation

- Make sure to secure sensing space(sensing stability) when selecting and installing the sensor.
- Make sure that diameter of sensor lens ( $\varnothing$ ) is smaller than sensing target when selecting the sensor.
- If there are any possibilities to be damaged by sensing targets, use protection covers for protecting photoelectric sensors.
- In case the sensor is applied to high frequency machines, such as ultrasonic welding machine, etc, insulate the sensor and high frequency machines using insulating boards to prevent malfunction from induced current.
- Keep the cable as short as possible. In case of cable extension, make sure that thickness of the cable shall be over  $0.3\text{mm}^2$ . Be careful of voltage drop.
- Photoelectric sensor is generally applied for machine, or equipment. It is easy to have the effect of vibration or shock. In order to prevent this effect, please following countermeasures before using.
  - ① Do not make sensor's main body touch the sensing target directly.
  - ② Use sturdy material supports in order not to be affected by vibration or shock.
  - ③ Tighten fixed bracket's bolts and nuts.
- If photoelectric lens are dirty by dust, clean with a dried towel softly. Do not use organic solvent, such as thinners, etc.
- Avoid dust or any corrosion causing environments.

### Ⓞ Countermeasures for mutual interference

In the case of using the photoelectric sensors closely, you should make countermeasures because of interference which affects to other's operation.

#### ● Through-beam type

- ① Increase the separation distance with referring to parallel shifting feature data.

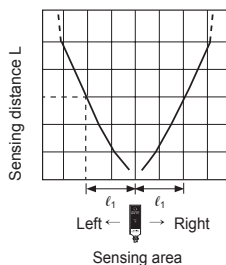
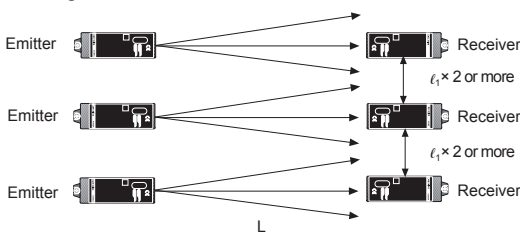

[Parallel shifting characteristic feature data]

- ② Place the emitter and the receiver alternately.

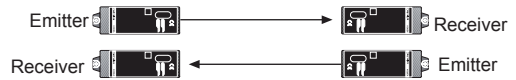

In this case, if the photo sensor is installed closely like [Figure 1], it can cause malfunction. User needs to install a shield like [Figure 2].

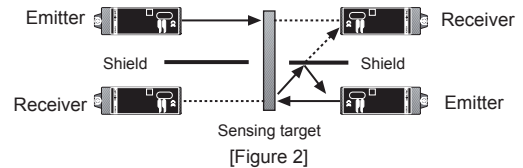
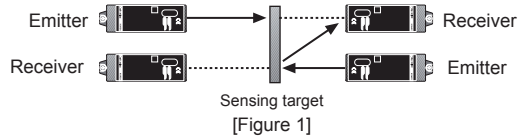

- ③ Narrow the light by using slits on the receiver.

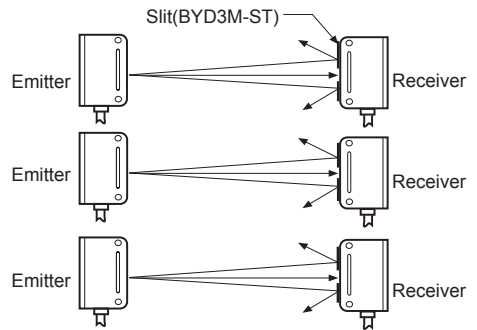

#### ● Diffuse reflective type, convergent reflective type

- ① Check the install distance which has no interference at the sensing area characteristics of the sensor. Install the sensor with the 2 times longer operating position( $\ell_1$ ) than sensing distance(L).
- ② Install shield between sensors.

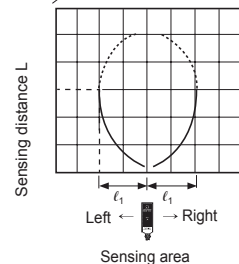
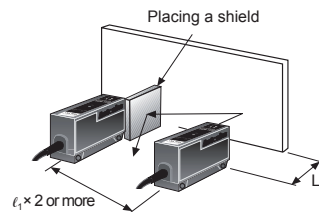

[Sensing area feature data]

## ◎ Influence of surroundings

### ●Through-beam type

Emitted light is not completely interrupted by a sensing target because some amount of emitted light gets reflected light from the mounting board and enters into the receiver.

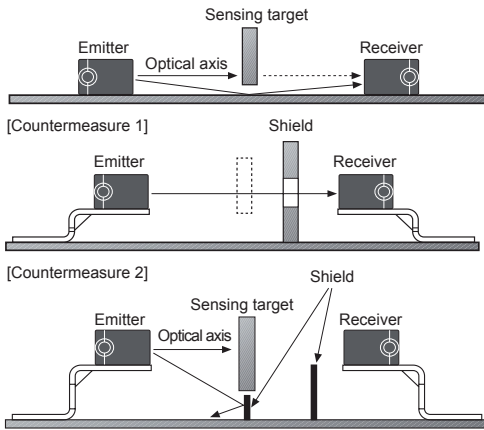

### ●Diffuse reflective type

#### 1. Effect of install surface

In case a diffuse reflective sensor is mounted on a rough mounting plate, the reflected light causes photoelectric sensor's malfunction. For preventing this, please mount the sensor with bracket.

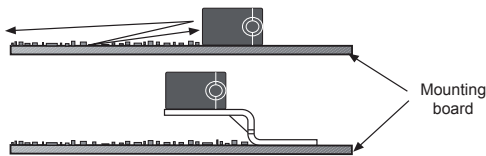

#### 2. Effect of the surrounding object

Even though the surrounding object such as wall is far apart from the sensing target, the object is able to affect the detection.

Countermeasure:

- ① Paint the background in black color to reduce reflected light.
- ② Increase the distance from the background.
- ③ Select convergent reflective type sensor.

## ◎ Influence of disturbing light

There are two types of photoelectric sensors which are modulated type and non-modulated type.

Modulated type is not affected by normal disturbing light. But it can be affected by strong disturbing light or modulated disturbing light.

- Strong disturbing light : Direct rays of sunlight
- Modulated disturbing light : Arc welding spark, Inverter fluorescent.

1. Set the optical axis of the receiver more than 30° difference with the entering light direction of disturbing light. (Set exceed the range of light width)

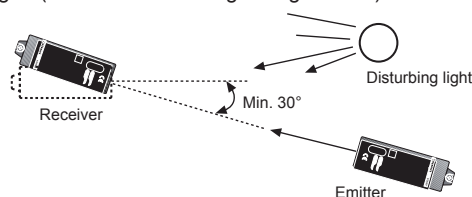

2. Attach slits or protection cover on the receiver.

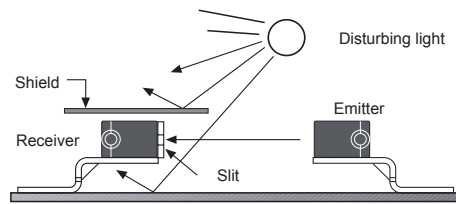

## ◎ Operation power and grounding

- In case of commercial power, use power supply with low noise/voltage variations. Avoid using the unit around the power generators or high voltage lines.
- Do not connect high voltage power source line and sensor's cable power line together. It may cause product damage or malfunction. Please wire lines separately.

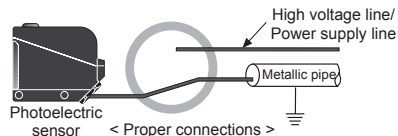
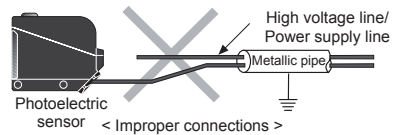

- In case of DC power photoelectric sensors, use insulation transformer for rectified power supply with  $\pm 10\%$  ripple.

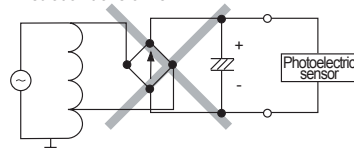
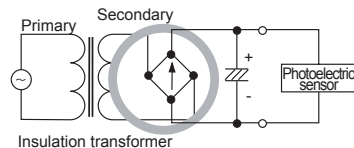

- In case power is supplied from switching mode power supply, ensure that the frame ground (F.G.) terminal of the power supply is connected to an ground and connect a condenser for noise removal between 0V and F.G. terminal. (Usually the condenser is equipped in switching mode power supply units)

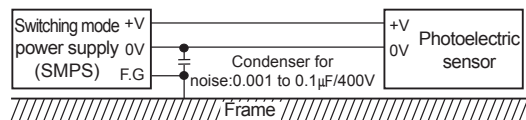

In case of sensor's material is metal, ground the metal case to prevent electrostatic or product malfunction due to noise.

## ◎ Precaution for power supply

- Please do not operate the sensors ON/OFF by power.
- It is required at least 500ms for stable sensor operations after power supply is ON.

(A)	Photoelectric Sensors
(B)	Fiber Optic Sensors
(C)	Door/Area Sensors
(D)	Proximity Sensors
(E)	Pressure Sensors
(F)	Rotary Encoders
(G)	Connectors/ Connector Cables/ Sensor Distribution Boxes/ Sockets
(H)	Temperature Controllers
(I)	SSRs / Power Controllers
(J)	Counters
(K)	Timers
(L)	Panel Meters
(M)	Tacho / Speed / Pulse Meters
(N)	Display Units
(O)	Sensor Controllers
(P)	Switching Mode Power Supplies
(Q)	Stepper Motors & Drivers & Controllers
(R)	Graphic/ Logic Panels
(S)	Field Network Devices
(T)	Software