

Autonics

Ultra-thin Photoelectric Sensor BTF SERIES

INSTRUCTION MANUAL

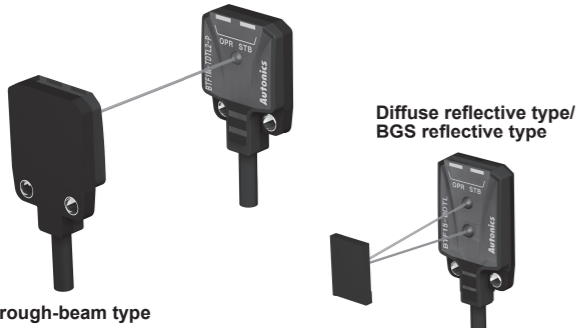

Through-beam type

Diffuse reflective type/
BGS reflective type

Thank you for choosing our Autonics product.
Please read the following safety considerations before use.

■ Safety Considerations

- ※ Please observe all safety considerations for safe and proper product operation to avoid hazards.
- ※ ⚠ symbol represents caution due to special circumstances in which hazards may occur.
- Warning** Failure to follow these instructions may result in serious injury or death.
- Caution** Failure to follow these instructions may result in personal injury or product damage.
- Warning**

 - Fail-safe device must be installed when using the unit with machinery that may cause serious injury or substantial economic loss.** (e.g. nuclear power control, medical equipment, ships, vehicles, railways, aircraft, combustion apparatus, safety equipment, crime/disaster prevention devices, etc.)
Failure to follow this instruction may result in fire, personal injury, or economic loss.
 - Do not disassemble or modify the unit.**
Failure to follow this instruction may result in fire.
 - Do not connect, repair, or inspect the unit while connected to a power source.**
Failure to follow this instruction may result in fire.
 - Check 'Connections' before wiring.**
Failure to follow this instruction may result in fire.

⚠ Caution

- Use the unit within the rated specifications.**
Failure to follow this instruction may result in fire or product damage.
- Use dry cloth to clean the unit, and do not use water or organic solvent.**
Failure to follow this instruction may result in fire.
- Do not use the unit in the place where flammable/explosive/corrosive gas, humidity, direct sunlight, radiant heat, vibration, impact, or salinity may be present.**
Failure to follow this instruction may result in fire or explosion.

■ Ordering Information

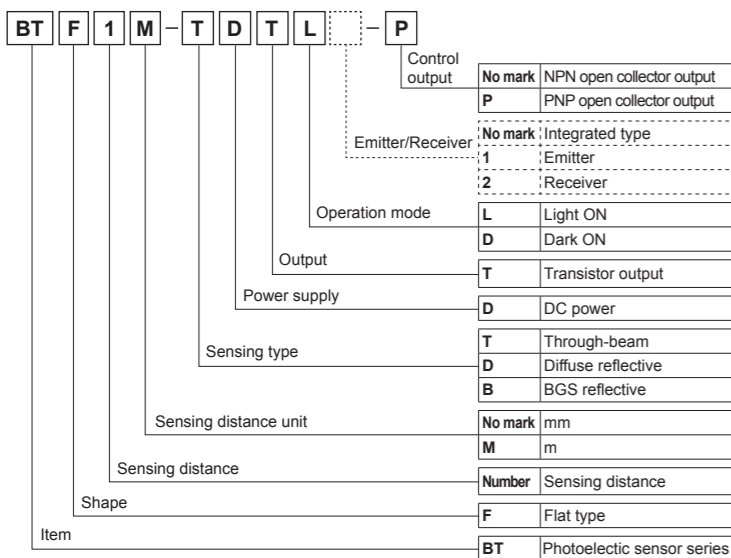

※: This information is intended for product management of through-beam type.
(No need to refer when selecting model)

※ The above specifications are subject to change and some models may be discontinued without notice.
※ Be sure to follow cautions written in the instruction manual and the technical descriptions (catalog, homepage).

■ Specifications

| Model | NPN open collector output | BTF1M-TD TL | BTF1M-TD TD | BTF30-DD TL | BTF30-DD TD | BTF15-BD TL | BTF15-BD TD |
|--|--|---------------------------|--------------------------------|---------------------------|--|---------------------------|---------------------------|
| | PNP open collector output | BTF1M-TD TL-P | BTF1M-TD TD-P | BTF30-DD TL-P | BTF30-DD TD-P | BTF15-BD TL-P | BTF15-BD TD-P |
| Type | Through-beam | | Diffuse reflective | | BGS reflective | | |
| Sensing distance | 1m | | 5 to 30mm ^{※1} | | 1 to 15mm ^{※1} | | |
| Sensing target | Opaque material over Ø2mm | | Translucent, opaque materials | | | | |
| Min. sensing target | Opaque material of Ø2mm | | Ø0.2mm (sensing distance 10mm) | | Ø0.2mm non-illuminated objects (sensing distance 10mm) | | |
| Hysteresis | - | | Max. 20% at sensing distance | | Max. 5% at sensing distance | | |
| Reflectivity characteristics (black/white error) | - | | - | | Max. 15% of maximum sensing distance | | |
| Response time | Max. 1ms | | | | | | |
| Power supply | 12-24VDC \pm 10% (ripple P-P: max. 10%) | | | | | | |
| Current consumption | Max. 20mA (this is for each emitter and receiver of through-beam type.) | | | | | | |
| Light source | Red LED (650nm) | | | | | | |
| Operation mode | Light ON | Dark ON | Light ON | Dark ON | Light ON | Dark ON | |
| Control output | NPN or PNP open collector output • Load voltage: max. 26.4VDC \pm • Load current: max. 50mA • Residual voltage - NPN: max. 1VDC \pm , PNP: max. 2VDC | | | | | | |
| Protection circuit | Power reverse polarity protection circuit, output short over current protection circuit | | | | | | |
| Indicator | Operation indicator: red LED, stability indicator: green LED | | | | | | |
| Connection | Cable type | | | | | | |
| Insulation resistance | Over 20MΩ (at 500VDC megger) | | | | | | |
| Noise immunity | \pm 240V the square wave noise (pulse width: 1μs) by the noise simulator | | | | | | |
| Dielectric strength | 1,000VAC 50/60Hz for 1 minute | | | | | | |
| Vibration | 1.5mm amplitude at frequency of 10 to 55Hz in each X, Y, Z direction for 2 hours | | | | | | |
| Shock | 500m/s ² (approx. 50G) in each X, Y, Z direction for 3 times | | | | | | |
| Environment | Ambient illu. Sunlight: max. 10,000lx, incandescent lamp: max. 3,000lx (receiver illumination) Ambient temp. -25 to 55°C, storage: -40 to 70°C Ambient humi. 35 to 85%RH, storage: 35 to 85%RH | | | | | | |
| Protection | IP67 (IEC standards) | | | | | | |
| Material | Case: polybutylene terephthalate, sensing part: polymethyl methacrylate, bracket: SUS304 (steel use stainless 304), bolt: carbon steel, sleeve: SUS304 (steel use stainless 304) | | | | | | |
| Cable | Ø2.5mm, 3P, 2m (emitter of through-beam type: Ø2.5mm, 2P, 2m) (AWG 28, core diameter: 0.08mm, number of core: 19, insulator out diameter: Ø0.9mm) | | | | | | |
| Accessory | Fixing bracket, M2 bolt: 4 | | Fixing bracket, M2 bolt: 2 | | | | |
| Approval | | | | | | | |
| Weight ^{※2} | Approx. 70g (approx. 40g) | Approx. 40g (approx. 25g) | Approx. 40g (approx. 25g) | Approx. 40g (approx. 25g) | Approx. 40g (approx. 25g) | Approx. 40g (approx. 25g) | Approx. 40g (approx. 25g) |

■ Dimensions

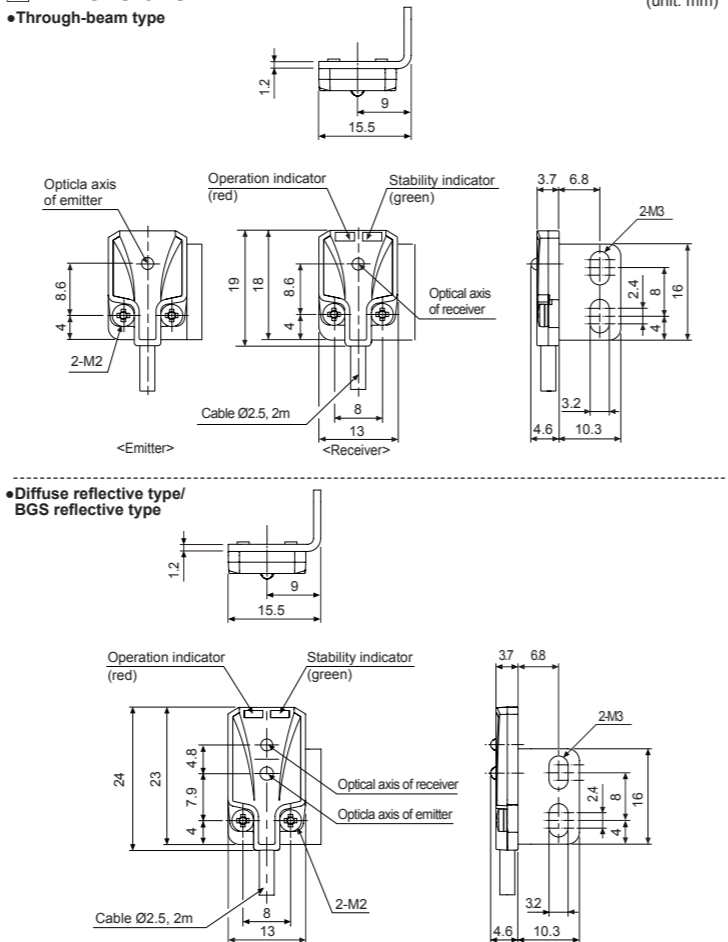

■ Operation Mode

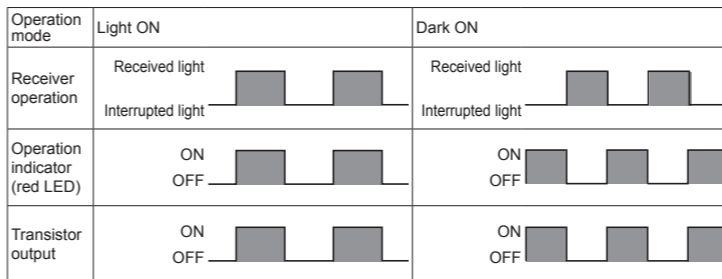

■ Operating Timing Diagram

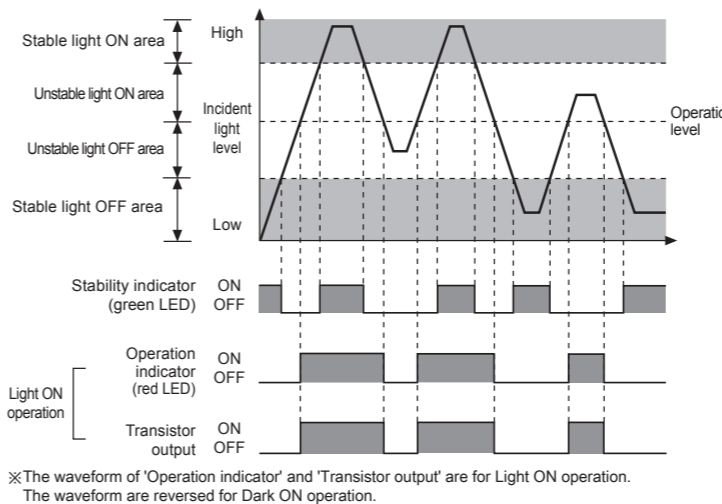

■ Installation and Adjustment

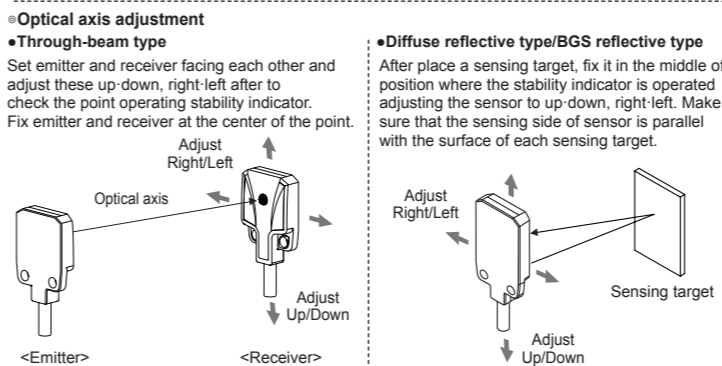
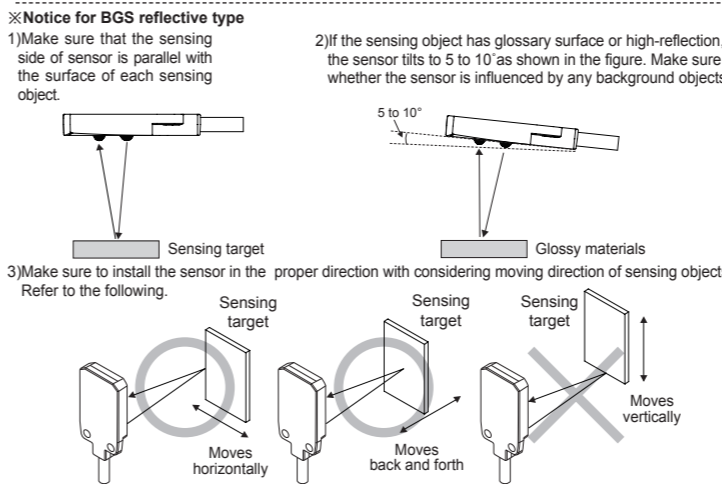
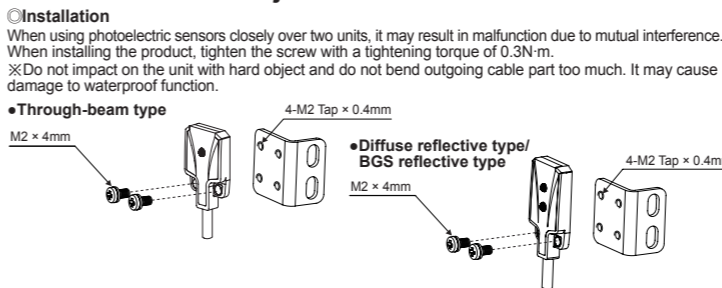

■ Connections

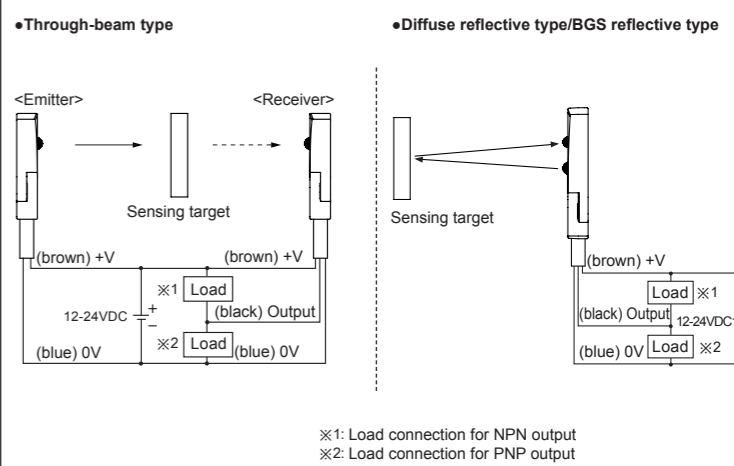

■ Control Output Circuit Diagram

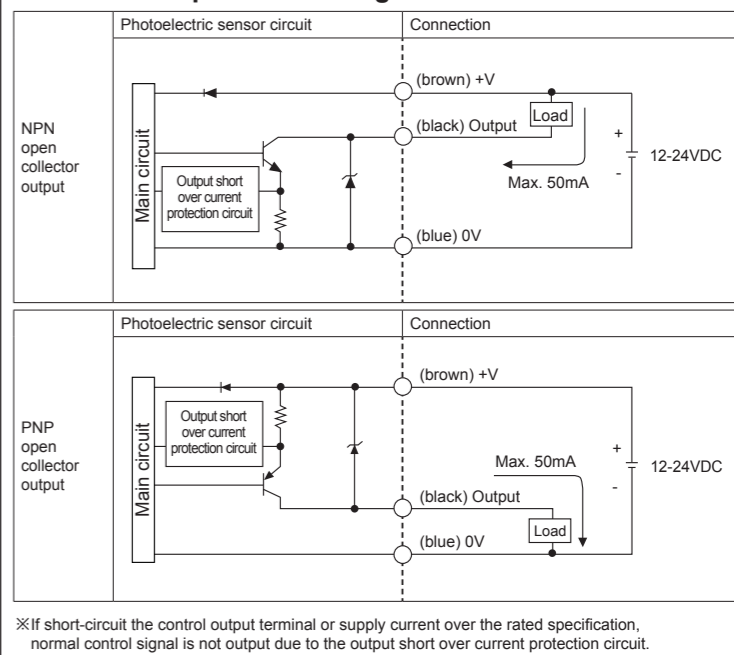

■ Cautions during Use

- Follow instructions in 'Cautions during Use'. Otherwise, it may cause unexpected accidents.
- When connecting a DC relay or other inductive load to the output, remove surge by using diodes or varistors.
- Use the product, 0.1 sec after supplying power.
- When using separate power supply for the sensor and load, supply power to sensor first.
- 12-24VDC power supply should be insulated and limited voltage/current or Class 2, SELV power supply device.
- Wire as short as possible and keep away from high voltage lines or power lines, to prevent inductive noise.
- When using switching mode power supply to supply the power, ground F.G. terminal and connect a condenser between 0V and F.G. terminal to remove noise.
- When using sensor with the equipment which generates noise (switching regulator, inverter, servo motor, etc.), ground F.G. terminal of the equipment.
- This unit may be used in the following environments.
 - ① Indoors (in the environment condition rated in 'Specifications')
 - ② Altitude max. 2,000m
 - ③ Pollution degree 3
 - ④ Installation category II

■ Major Products

- Photoelectric Sensors
- Fiber Optic Sensors
- Door Sensors
- Door Side Sensors
- Area Sensors
- Proximity Sensors
- Pressure Sensors
- Rotary Encoders
- Connectors/Sockets
- Switching Mode Power Supplies
- Control Switches/Lamps/Buzzers
- I/O Terminal Blocks & Cables
- Stepper Motors/Drivers/Motion Controllers
- Graphic/Logic Panels
- Field Network Devices
- Laser Marking System (Fiber, CO₂, Nd: YAG)
- Laser Welding/Cutting System
- Temperature Controllers
- Temperature/Humidity Transducers
- SSRs/Power Controllers
- Counters
- Timers
- Panel Meters
- Tachometer/Pulse (Rate) Meters
- Display Units
- Sensor Controllers

Autonics Corporation
http://www.autonics.com

HEADQUARTERS:
18, Bansong-ro 513 beon-gil, Haeundae-gu, Busan, South Korea, 48002
TEL: 82-51-519-3232
E-mail: sales@autonics.com