

Climate
Control

IMI TA

TA-Smart



Smart valves

2-way control valve with uniquely shaped EQM characteristics with flow, temperature and power measurement capabilities

TA-Smart

The ultrasonic flow measurement technology combined with unique actuation algorithms capabilities provide best-in-class control performances. The TA-Smart controls can be set to flow or power, giving high on-site flexibility and providing highly effective comfort in heating and cooling applications. Its compact arrangement and simple set-up reduces installation and commissioning time.



Key features

Best-in-class control

Accurate and fast control response even at very low flows in common part load conditions. Ensures full modulating control for the complete operating stroke leading to world class control and efficiencies.

Optional cloud connection

Easy remote access to data and configuration parameters allows to verify and adjust system performance.

Optional ΔT and temperature return limitation

Optimize the efficiency of your production units by ensuring optimal temperature regimes.

Change-over functionality

Possibility to switch between two operating conditions to manage seasonality or heating and cooling with the same valve in change-over applications.

High measurement accuracy

High flow and temperature measurement accuracies in all configurations (medium type, and temperature) for all flow regimes.

Compactness and limited number of components

Reduces installation time and space requirements facilitating retrofit installation.

Convenient, reliable setup

Fully customizable and commissionable using Bluetooth enabled smart device reducing commissioning and diagnostic time.

Easy diagnostics

Continuous measurement (flow, temperature, power...) enables accurate error identification in system hydraulics. Measured values covering up to 13 months and up to 4096 errors/warnings/events are stored in TA-Smart's internal memory and can be easily downloaded and exported via the HyTune app when connected to the device.

Versatility in communication

Digital (key Bus protocols and MQTT) and Analog (0(2)-10 VDC or 0(4)-20 mA).

Technical description

Application:

Heating and cooling systems.

Functions:

Control (flow, power, position)
 Pre-setting (max./min. flow, max. power, max./min. position)
 ΔT and temperature return limitation
 Reading (flow, power, energy, supply/return temperature, ΔT , position)
 Change-over function
 Manual override (via HyTune app)
 Mode, status and position indication
 Valve blockage protection
 Valve clogging detection
 Error safe position
 Diagnostic
 Logging
 Delayed start-up

Dimensions:

DN 15-150

Pressure class:

DN 15-50: PN 25
 DN 65-150: PN 16, PN 25

Differential pressure (Δp_V):

Max. differential pressure ($\Delta p_{V_{max}}$):
 400 kPa = 4 bar

Closing pressure: 600 kPa = 6 bar

$\Delta p_{V_{max}}$ = The maximum allowed pressure drop over the valve to fulfill all stated performances.

Flow range:

The flow ranges ($q_{setmin} - q_{nom}$) for different dimensions:

DN 15: 160 - 1260 l/h
 DN 20: 380 - 2000 l/h
 DN 25: 540 - 2900 l/h
 DN 32: 920 - 4900 l/h
 DN 40: 1560 - 8300 l/h
 DN 50: 2680 - 15000 l/h
 DN 65: 5800 - 29000 l/h
 DN 80: 8640 - 43200 l/h
 DN 100: 14200 - 71000 l/h
 DN 125: 22400 - 112000 l/h
 DN 150: 33000 - 165000 l/h

DN 15-50: Increased flow values valid from Firmware 12.x.

Minimum controllable flows ($q_{contr.min}$)

DN 15: 0.33% of q_{nom}
 DN 20-150: 0.5% of q_{nom}

q_{setmin} = Minimum settable flow.

q_{nom} = Maximum settable flow.

Measurement accuracy:

Flow:

Water: From 2% accuracy at 100% of q_{nom} to 2.4% accuracy at 5% of q_{nom} (according MID-Class 2 EN1434).

Water+glycol: From 3% accuracy at 100% of q_{nom} to 4% accuracy at 5% of q_{nom} (according to MID-Class 3 EN1434). (see "Flow accuracy")

Temperature difference:

± 0.1 K @ $\Delta T = 6$ K (for cooling)

± 0.15 K @ $\Delta T = 10$ K (for heating)

± 0.2 K @ $\Delta T = 20$ K (for heating)

Flow control accuracy:

$\pm 5\%$ from 4% to 100% of q_{nom}
 $\pm 10\%$ from 0.5% to 4% of q_{nom}

Temperature:

Max. working temperature: 110°C
 Min. working temperature: -10°C
 Operating environment: 0°C – +50°C
 (5-95%RH, non-condensing)
 Storage environment: -20°C – +70°C
 (5-95%RH, non-condensing)

Note: If the medium temperature is below 2 °C, then ice forming on the spindle must be prevented. Therefore valves should be insulated with vapor tight insulation (stem extension can be used).

For valves from DN 65, stem heater can be used. See "Accessories"

Media:

IMI valves were tested for performance and durability with the five following fluids:

- Water
- Water-Ethylene glycol mixtures up to 56%
- Water-Propylene glycol mixtures up to 57%
- Water-Kilfrosts GEO mixtures up to 50°C for concentration up to 40% and up to 20°C for concentration up to 50%
- Glysofor E

Note: Kilfrosts GEO and Glysofor E require TA-Smart firmware version 11.x.x or later.

Leakage rate:

DN 15-50: Leakage rate <0.01% of q_{nom} with correct flow direction (Class IV according to EN 60534-4)
 DN 65-150: Tight sealing with correct flow direction (Class V according to EN 60534-4)

Characteristics:

Settable: Stepless between EQM 0.25 and inverted EQM 0.25.

Supply voltage:

24 VAC/VDC ±15%.
 Frequency 50/60 Hz ±3 Hz.

NOTE: 24 VAC/VDC power supply must be provided only with safety isolating transformer according to EN 61558-2-6.

Power consumption:

DN 15-50:
 Operation: < 4.0 W (24 VDC);
 < 5.6 VA (24 VAC)
 Standby: < 1.9 W (24 VDC);
 < 3.3 VA (24 VAC)
 DN 65-80:
 Operation: < 5.8 W (24 VDC);
 < 10 VA (24 VAC)
 Standby: < 1.9 W (24 VDC);
 < 3.3 VA (24 VAC)

DN 100-150:
 Operation: < 7.7 W (24 VDC);
 < 10.8 VA (24 VAC)
 Standby: < 1.9 W (24 VDC);
 < 3.3 VA (24 VAC)

Input signal:

By BACnet/Modbus or Analog signal.
 Analog in VDC or mA, selectable by jumper in the SmartBox;
 0(2)-10 VDC, R_i 47 k Ω .

Adjustable sensitivity 0.1-0.5 VDC.

0.33 Hz low pass filter.

0(4)-20 mA R_i 500 Ω .

Proportional:

0-10, 10-0, 2-10 or 10-2 VDC.

0-20, 20-0, 4-20 or 20-4 mA.

Proportional split-range:

0-5, 5-0, 5-10 or 10-5 VDC.

0-4.5, 4.5-0, 5.5-10 or 10-5.5 VDC.

2-6, 6-2, 6-10 or 10-6 VDC.

0-10, 10-0, 10-20 or 20-10 mA.

4-12, 12-4, 12-20 or 20-12 mA.

Proportional dual-range (for change-over):

0-4.5 / 5.5-10 VDC.

2-5.5 / 6.5-10 VDC.

0-3.3 / 6.7-10 VDC.

2-4.7 / 7.3-10 VDC.

0-9 / 11-20 mA.

4-11 / 13-20 mA.

Default setting: Proportional 0-10 VDC.

Output signal:

BACnet/Modbus
 0(2)-10 VDC, max. 8 mA, min. 1.25 k Ω .

Wireless:

Bluetooth Low Energy (BLE)
 Thread

Temperature sensor cable:

DN 15-50: 3 m halogen free
 DN 65-150: 5 m halogen free
 10 m halogen free cable on request.

Ingress protection:

IP54 (according to EN 60529)

Protection class:

(according to EN 61140)
 III (SELV)

Material:

DN 15-50:
 Valve body: AMETAL®
 Valve insert: AMETAL®
 Valve plug: AMETAL® and PTFE
 Spindle: Stainless steel
 Spindle seal: EPDM O-ring
 Internal plastic parts: PPS
 Springs: Stainless steel
 O-rings: EPDM

Temperature housing: AMETAL®.

DN 65-150:

Valve body: Ductile iron EN-GJS-400-15
 Valve insert: Ductile iron EN-GJS-400-15
 and brass

Valve plug: Stainless steel and EPDM
 O-ring

Valve seat: Stainless steel

Spindle: Stainless steel

Spindle seal: EPDM

Springs: Stainless steel

O-rings: EPDM

SmartBox (DN 15-150):

Cover: PC/ABS, red.

Housing: PC/ABS, TPE.

Actuators:

DN 15-50:

Cover: PC/ABS GF8, white RAL 9016,
 grey RAL 7047.

Housing: PA GF40.

Swivelling nut: Nickel-plated brass.

DN 65-150:

Cover: PBT, orange RAL 2011, grey
 RAL 7043.

Bracket: Alu EN44200

Cables: Halogen free

AMETAL® is the dezincification resistant alloy of IMI.

Surface treatment:

DN 15-50: Non treated

DN 65-150: Electrophoretic painting

Pipe connection:

DN 15-50: External thread according to ISO 228.

DN 65-150: Flanges according to EN-1092-2, type 21. Face to face length according to EN 558, series 1.

Certifications and directives:

EMC-D. 2014/30/EU: EN 60730-1, -2-14.

Product standards EN 60730-x.

PED: 2014/68/EU

Cybersecurity shared responsibility:

IMI has tested the TA-Smart for cybersecurity in accordance with EN 18031. However, it is the property owner's responsibility to ensure that physical access to the device and the building management system (BMS) is restricted to authorized personnel only in order to prevent tampering. Communication cables (Modbus, BACnet, TCP/IP,..) shall not be easily accessible to unauthorised personnel. When TCP/IP is used, network needs to follow security rules forbidding unexpected and unauthorised traffic.

Flow accuracy

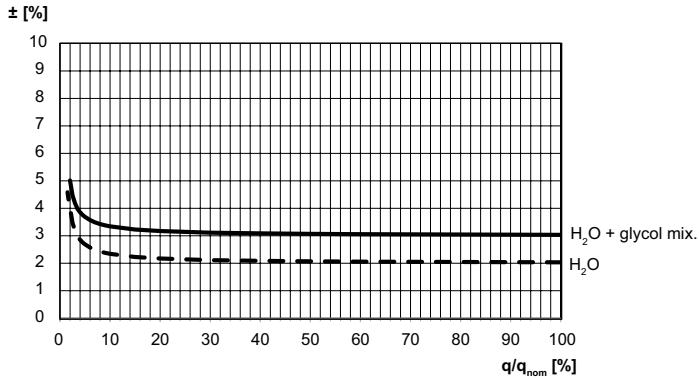

Installation

DN 15-50

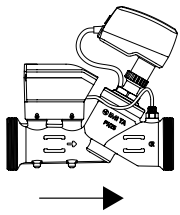

DN 65-150

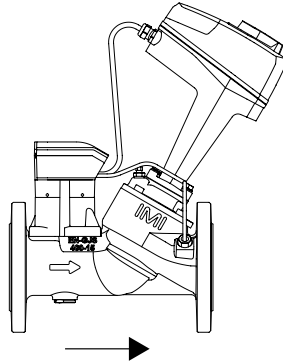

DN 15-50

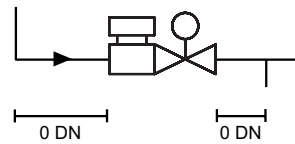

DN 65-150

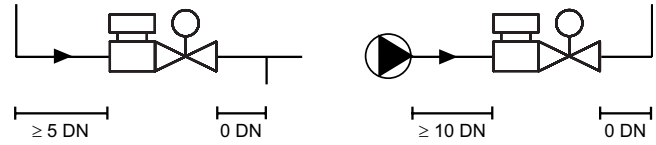

Note: Free space is required above the actuator/temperature sensor pocket for easy mounting/dismounting.

DN 15-50

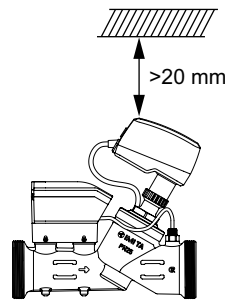

DN 65-150

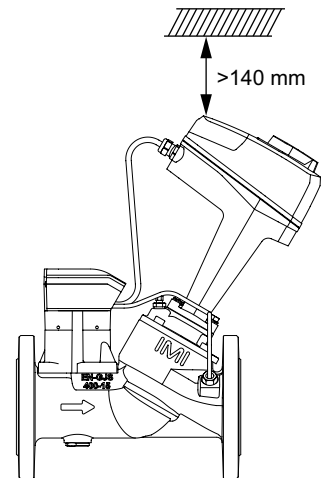

DN 15-50

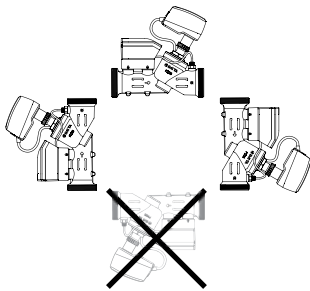

DN 65-150

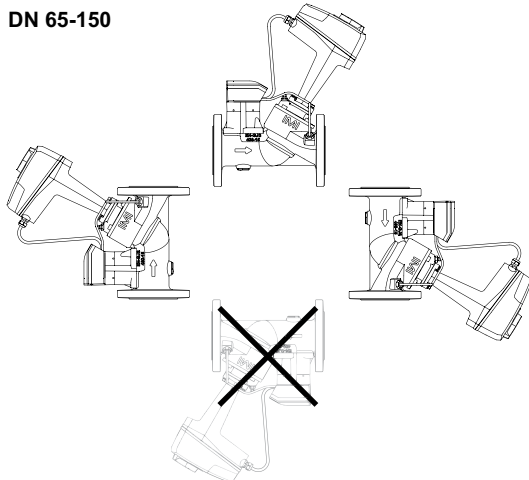

Articles

TA-Smart DN 15-50

Including temperature housing and 3 m temperature sensor cable.

(10 m cable on request, please contact IMI)

External threads according to ISO 228.

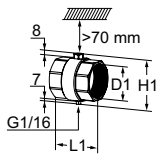
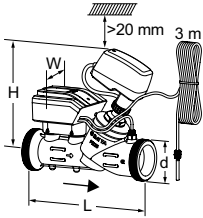

DN	d	L	H	W	Kvs	Kg	EAN	Article No
15	G3/4	167	165	97	1,90	1,4	7318794178243	322231-00015
20	G1	180	166	97	3,15	1,6	7318794174207	322231-00020
25	G1 1/4	187	166	97	4,35	1,8	7318794174306	322231-00025
32	G1 1/2	200	191	97	7,28	2,1	7318794164307	322231-00032
40	G2	218	190	97	12,3	3,0	7318794164406	322231-00040
50	G2 1/2	239	190	97	21,2	3,9	7318794164505	322231-00050

Temperature housing incl. temperature sensor pocket

Included in TA-Smart DN 15-50.

Internal threads according to ISO 228.

DN	D1	L1	H1
15*	G1/2	48	55
20*	G3/4	60	56
25	G1	62	61
32	G1 1/4	70	71
40	G1 1/2	70	77
50	G2	78	89

*) Can be connected to smooth pipes by KOMBI compression coupling.

TA-Smart DN 65-150

Including temperature sensor pocket and 5 m temperature sensor cable.

(10 m cable on request, please contact IMI)

Free space >70 mm is required above the temperature pocket.

Flanges according to EN 1092-2, type 21.

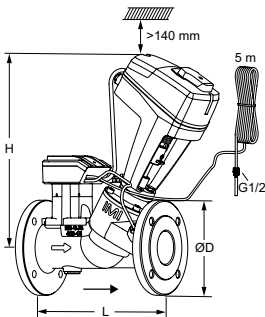

DN	Number of bolt holes	ØD	L	H	Kvs	Kg	EAN	Article No
PN 16								
65	4	185	290	377	49	16,5	7318794171206	322231-01265
80	8	200	310	380	73	18,6	7318794171305	322231-01280
100	8	220	350	438	120	29	7318794176904	322231-01290
125	8	250	400	444	190	35	7318794177000	322231-01291
150	8	285	480	462	265	52	7318794179066	322231-01292
PN 25								
65	8	185	290	377	49	16,5	7318794170803	322231-01365
80	8	200	310	380	73	18,6	7318794170902	322231-01380
100	8	235	350	438	120	29	7318794177307	322231-01390
125	8	270	400	444	190	35	7318794177406	322231-01391
150	8	300	480	462	265	52	7318794179110	322231-01392

→ = Flow direction

Kvs = m³/h at a pressure drop of 1 bar and fully open valve.

Accessories

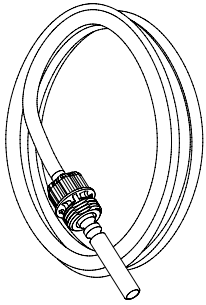

Temperature sensor

Included in TA-Smart/Fail-safe/-Dp.
 (10 m cable on request, please contact IMI)
 Tool for exchanging temperature sensor is included.

For DN	Length [m]	EAN	Article No
15-25	3	7318794178229	322230-01106
32-50	3	7318794173705	322230-01100
65-150	5	7318794173804	322230-01101

Temperature sensor pocket

Included in TA-Smart/Fail-safe/-Dp DN 65-150.
 For mounting directly on pipe. Free space >70 mm is required above the temperature sensor pocket.

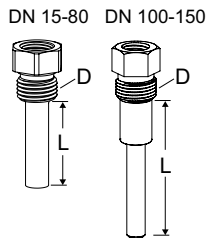

For DN	D	L	EAN	Article No
15-25	G1/4	14	7318794174603	322230-00401
15-25	G1/2	14	7318794178199	322230-00403
32-50	G1/4	30	7318794174009	322230-00400
32-50	G1/2	30	7318794178205	322230-00404
65-80	G1/2	54	7318794179233	322033-01000
100-150	G1/2	84	7318794179240	322033-01200

Temperature housing incl. temperature sensor pocket

Included in TA-Smart/Fail-safe/-Dp DN 15-50.
 To be ordered separately if the pipe size does not match the valve size.
 Internal threads according to ISO 228.

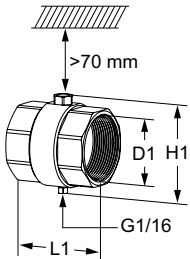

DN	D1	L1	H1	EAN	Article No
15*	G1/2	48	55	7318794178298	322230-00015
20*	G3/4	60	56	7318794174900	322230-00020
25	G1	62	61	7318794175006	322230-00025
32	G1 1/4	70	71	7318794171404	322230-00032
40	G1 1/2	70	77	7318794171503	322230-00040
50	G2	78	89	7318794171602	322230-00050

*) Can be connected to smooth pipes by KOMBI compression coupling.

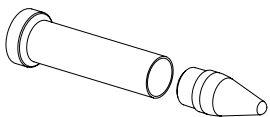

Service tool

	EAN	Article No
For exchange of temperature sensor	7318794178144	322033-00000
For exchange of TA-Slider cable	7318794178151	322033-00001

Insulation

For heating and non-condensing cooling applications.

Material: EPP.

Fire class: E (EN 13501-1), B2 (DIN 4102).

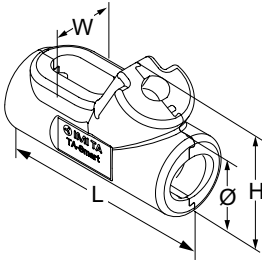

For DN	L	H	W	Ø	EAN	Article No
15	-	-	-	-	-	-
20	215	112	76	69	5902276819681	322230-00620
25	225	119	86	82	5902276819698	322230-00625
32	238	153	92	96	5902276819438	322230-00632
40	256	168	110	114	5902276819360	322230-00640
50	284	183	134	143	5902276819377	322230-00650

Stem heater

Including spindle top (extension) and extended screws.

Temperature range till -10 °C.

Voltage 24 VAC ±10% 50/60 Hz ±5%.

Power P_N approx. 30 W.

Current 1,4 A.

Surface temperature max. 50 °C.

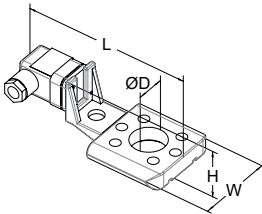

For DN	L	H	W	ØD	EAN	Article No
65 -150	146	49	70	30		110700-04031

Connections

With internal thread

Threads according to ISO 228. Thread length according to ISO 7-1.

Swivelling nut.

Brass/AMETAL®.

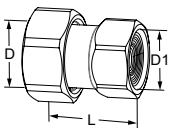

For DN	D	D1	L*	EAN	Article No
15	G3/4	G1/2	31,5	5902276820038	52 009-815
15	G3/4	G3/4	36,5	5902276820045	52 009-915
20	G1	G3/4	33,5	5902276820052	52 009-820
20	G1	G1	39,5	5902276820069	52 009-920
25	G1 1/4	G1	39	5902276820076	52 009-825
25	G1 1/4	G1 1/4	43	5902276820083	52 009-925
32	G1 1/2	G1 1/4	42	5902276820090	52 009-832
32	G1 1/2	G1 1/2	46	5902276820106	52 009-932
40	G2	G1 1/2	50	5902276820113	52 009-840
40	G2	G2	53	5902276820120	52 009-940
50	G2 1/2	G2	50	5902276820137	52 009-850
50	G2 1/2	G2 1/2	58	5902276820144	52 009-950

*) Fitting length (from the gasket surface to the end of the connection).

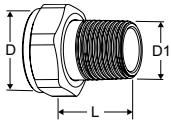
**With external thread**

Threads according to ISO 7-1.

Swivelling nut.

Brass.

For DN	D	D1	L*	EAN	Article No
15	G3/4	R1/2	29	4024052516612	0601-02.350
20	G1	R3/4	32,5	4024052516810	0601-03.350
25	G1 1/4	R1	35	4024052517015	0601-04.350
32	G1 1/2	R1 1/4	38,5	4024052517213	0601-05.350

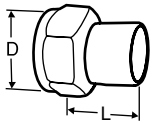
**Welding connection**

Swivelling nut.

Brass/Steel 1.0045 (EN 10025-2)

For DN	D	Pipe DN	L*	EAN	Article No
15	G3/4	15	36	7318792748509	52 009-015
20	G1	20	40	7318792748608	52 009-020
25	G1 1/4	25	40	7318792748707	52 009-025
32	G1 1/2	32	40	7318792748806	52 009-032
40	G2	40	45	7318792748905	52 009-040
50	G2 1/2	50	50	7318792749001	52 009-050

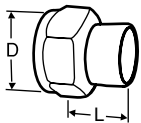
**Soldering connection**

Swivelling nut.

Brass/gunmetal CC491K (EN 1982).

For DN	D	Pipe Ø	L*	EAN	Article No
15	G3/4	15	13	7318792749308	52 009-515
15	G3/4	16	13	7318792749407	52 009-516
20	G1	18	15	7318792749506	52 009-518
20	G1	22	18	7318792749605	52 009-522
25	G1 1/4	28	21	7318792749704	52 009-528
32	G1 1/2	35	26	7318792749803	52 009-535
40	G2	42	30	7318792749902	52 009-542
50	G2 1/2	54	35	7318792750007	52 009-554

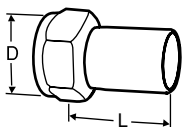
**Connection with smooth end**

For connection with press coupling.

Swivelling nut.

Brass/AMETAL®.

For DN	D	Pipe Ø	L*	EAN	Article No
15	G3/4	15	39	7318793810601	52 009-315
20	G1	18	44	7318793810700	52 009-318
20	G1	22	48	7318793810809	52 009-322
25	G1 1/4	28	53	7318793810908	52 009-328
32	G1 1/2	35	59	7318793811004	52 009-335
40	G2	42	70	7318793811103	52 009-342
50	G2 1/2	54	80	7318793811202	52 009-354

*) Fitting length (from the gasket surface to the end of the connection).